

HOW TO CHOOSE AUDIO EQUIPMENT

# Popular Electronics®

APRIL 1992

## Small Wonders

Consumer gear that's small in size but big in performance. Gizmo gives you the lowdown on Panasonic's PT-10L LCD video projector, Canon's UCS1 high band 8mm camcorder, and more.



## An Enlarging Light-Meter for your Darkroom

Get perfect photographic prints every time you use this easy-to-build darkroom accessory

A  
**GERNSBACK**  
PUBLICATION

## Bass and Treble Controls for Low-Cost Amplifiers

Add full tonal control to even the most basic designs with these simple circuits

## Build a PC-Board Agitator

Etch PC-boards in just a fraction of the usual time with this versatile, home-made agitator



\$3.50 U.S.  
\$3.95 CANADA

3 NEW  
FactCards  
IN THIS ISSUE

#BXBDCCX CAR-RT SORT xx CR24  
#60506DHM997GAD06# FEB93 61  
ROBERT DAHM RESP  
297 GRAND AVE 077 x  
AURORA, IL 60506

# We Only Skimped On The Price.

Introducing The Fluke Series 10—From \$69.<sup>95</sup>

**Fluke quality:** Made in the USA by Fluke, with the same rugged reliability that's made us the world leader in digital multimeters. Count on hard-working high performance—and a two-year warranty to back it up.

**Large, easy-to-read display:** 4000 count digital readout.

**Actual size:** Easy to carry, easy to use.

**New! Min/Max record with relative time stamp and Continuity Capture™:** Makes intermittent problems easier to find. Records highs and lows—and "time stamps" when they occurred. In continuity mode, opens or shorts as brief as 250 μs are captured and displayed.

**New! V Chek™:** For fast accurate checks on power sources and supplies, set your meter on V Chek—and let it do the rest. V Chek will determine continuity/ohms; if voltage is present, it will *automatically* change modes to measure AC or DC volts, whichever is detected. For most initial troubleshooting checks, here's the only setting you need to make.

**Capacitance:** Autoranging from .001 μF to 9999 μF. No need to carry a dedicated capacitance meter.

**Autoranging with manual option:** Your choice, depending on your situation.

**For high performance at Fluke's lowest price, get your hands on the new Series 10.** Stop by your local Fluke distributor and feel what a powerful difference the right multimeter makes—at the right price. For a free product brochure or the name of your nearest distributor, call 1-800-87-FLUKE.

**Sleep Mode:** Shuts itself off if you forget, extending long battery life even further.

**New! Slide switch and a few pushbuttons control all functions:** Designed for true one-hand operation.

**Fast, accurate tests and measurements:** AC and DC voltage measurements to 600 volts, ohms to 40 MΩ; audible continuity test; and diode test.

**Safety—a Fluke standard:** Designed to meet UL 1244, IEC 1010, CSA and VDE safety requirements; extensive overload protection built in.

**Audible Continuity:** To perform fast continuity checks, just listen for the beep; no need to watch the display.

**New! TL75 Hard Point™ Test Leads:** Comfort grip with extra strong tips for extended service life.

Fluke 10	Fluke 11	Fluke 12
\$69.95*	\$79.95*	\$89.95*
4000 count digital display	V Chek™	V Chek™
1.5% basic dc volts accuracy	Capacitance, .001 to 9999 μF	Min/Max recording with relative time stamp
2.9% basic ac volts accuracy	4000 count digital display	Continuity Capture™
1.5% basic ohms accuracy	0.9% basic dc volts accuracy	Capacitance, .001 to 9999 μF
Fast continuity beeper	1.9% basic ac volts accuracy	4000 count digital display
Diode Test	0.9% basic ohms accuracy	0.9% basic dc volts accuracy
Sleep Mode	Fast continuity beeper	1.9% basic ac volts accuracy
Two-year warranty	Diode Test	0.9% basic ohms accuracy
	Sleep Mode	Fast continuity beeper
	Two-year warranty	Diode Test
		Sleep Mode
		Two-year warranty

\*Suggested U.S. list price

Optional holster with tilt-stand available.



The New Series 10.  
A Small Price For A Fluke.

FLUKE AND PHILIPS  
THE T & M ALLIANCE

©1991 John Fluke Mfg. Co., Inc. Prices and specifications subject to change. Ad no. 00130.

**FLUKE**®

CIRCLE 8 ON FREE INFORMATION CARD



# Popular Electronics®

THE MAGAZINE FOR THE ELECTRONICS ACTIVIST!

## CONSTRUCTION ARTICLES

<b>AN ENLARGING LIGHT-METER</b> .....	<i>Rudolf F. Graff and William Sheets</i>	<b>31</b>
<i>Get perfect photographic prints everytime with this easy-to-build project</i>		
<b>THE TELEPHONE RING CONVERTER</b> .....	<i>Dean F. Poeth</i>	<b>38</b>
<i>This one-evening project alters the ring sound of your telephone, allowing you to distinguish it from other phones in the room</i>		
<b>BUILD A CABLE TESTER</b> .....	<i>D. F. Reckles</i>	<b>53</b>
<i>Take the drudgery out of testing multi-conductor cable assemblies</i>		
<b>THE "GOOD VIBRATIONS" PC-BOARD WORKSTATION</b> .....	<i>John Yacono</i>	<b>62</b>
<i>Etching printed-circuit boards can be made faster and easier with an inexpensive home-brew agitator and a heat lamp</i>		

## FEATURE ARTICLES

<b>BASS AND TREBLE BOOSTER CONTROLS</b> .....	<i>A. Singmin</i>	<b>34</b>
<i>Add some pizzazz to your low-budget audio projects</i>		
<b>HOW TO CHOOSE AUDIO EQUIPMENT</b> .....	<i>Mark Spiwak</i>	<b>35</b>
<i>Explore the down-to-earth criteria for selecting audio equipment that suits your taste and your wallet</i>		
<b>ELECTRONICS TECHNICIANS DAY</b> .....	<i>Larry Steckler, EHF/CET</i>	<b>40</b>
<i>CET's are the real pro's when it comes to electronics servicing. Here's how you can join their ranks</i>		
<b>GUGLIELMO MARCONI</b> .....	<i>James P. Rybak</i>	<b>43</b>
<i>Marconi's wireless transmitter not only spanned the seas, but helped to save lives as well</i>		
<b>MAGNETIC LIGHT</b> .....	<i>Stanley A. Czarnik</i>	<b>57</b>
<i>See how the ancestor of the CRT led to the discovery of the electron and the nature of electricity</i>		

## PRODUCT REVIEWS

<b>GIZMO</b> .....		<b>5</b>
<i>Including: Panasonic Video Projector, Cannon Camcorder, NEC Notebook Computer, and much more!</i>		
<b>PRODUCT TEST REPORT</b> .....	<i>Len Feldman</i>	<b>26</b>
<i>Memorex Model 87 Video Cassette Recorder</i>		
<b>HANDS-ON REPORT</b> .....		<b>28</b>
<i>Fluke Series-10 Digital Multimeters</i>		

## COLUMNS

<b>ANTIQUÉ RADIO</b> .....	<i>Marc Ellis</i>	<b>65</b>
<i>Coming: A new restoration project</i>		
<b>CIRCUIT CIRCUS</b> .....	<i>Charles D. Rakes</i>	<b>67</b>
<i>Op-amp based circuits</i>		
<b>THINK TANK</b> .....	<i>John Yacono</i>	<b>70</b>
<i>More automotive circuits</i>		
<b>COMPUTER BITS</b> .....	<i>Jeff Holtzman</i>	<b>72</b>
<i>Word Wizardry</i>		
<b>DX LISTENING</b> .....	<i>Don Jensen</i>	<b>74</b>
<i>A bit of Mediterranean DX</i>		
<b>HAM RADIO</b> .....	<i>Joseph J. Carr</i>	<b>76</b>
<i>Some thoughts on radio propagation</i>		
<b>SCANNER SCENE</b> .....	<i>Marc Saxon</i>	<b>78</b>
<i>Scanning a Russian space station</i>		

## DEPARTMENTS

<b>EDITORIAL</b> .....	<i>Carl Laron</i>	<b>2</b>
<b>LETTERS</b> .....		<b>3</b>
<b>FACTCARDS</b> .....		<b>49</b>
<b>POPULAR ELECTRONICS MARKET CENTER</b> .....		<b>50A</b>
<b>FREE INFORMATION CARD</b> .....		<b>51</b>
<b>ELECTRONICS LIBRARY</b> .....		<b>80</b>
<b>NEW PRODUCTS</b> .....		<b>84</b>
<b>ELECTRONICS MARKET PLACE</b> .....		<b>94</b>
<b>ADVERTISER'S INDEX</b> .....		<b>98</b>

Popular Electronics (ISSN 1042-170X) Published monthly by Gernsback Publications, Inc., 500-B Bi-County Boulevard, Farmingdale, NY 11735. Second-Class postage paid at Farmingdale, NY and at additional mailing offices. One-year, twelve issues, subscription rate U.S. and possessions \$21.95, Canada \$26.84 (includes G.S.T. Canadian Goods and Services Tax Registration No. R125166280), all other countries \$29.45. Subscription orders payable in U.S. funds only. International Postal Money Order, or check drawn on a U.S. bank. U.S. single copy price \$2.95. © 1992 by Gernsback Publications, Inc. All rights reserved. **Hands-on Electronics** and **Gizmo** trademarks are registered in U.S. and Canada by Gernsback Publications, Inc. **Popular Electronics** trademark is registered in U.S. and Canada by Electronics Technology Today, Inc. and is licensed to Gernsback Publications, Inc. Printed in U.S.A.

Postmaster: Please send address changes to **Popular Electronics**, Subscription Dept., P.O. Box 338, Mount Morris, IL 61054-9932.

A stamped self-addressed envelope must accompany all submitted manuscripts and/or artwork or photographs if their return is desired should they be rejected. We disclaim any responsibility for the loss or damage of manuscripts and/or artwork or photographs while in our possession or otherwise.

As a service to readers, **Popular Electronics** publishes available plans or information relating to newsworthy products, techniques, and scientific and technological developments. Because of possible variances in the quality and condition of materials and workmanship used by readers, **Popular Electronics** disclaims any responsibility for the safe and proper functioning of reader-built projects based upon or from plans or information published in this magazine.

**Larry Steckler**

*EHF, CET*

*Editor-In-Chief and Publisher*

## EDITORIAL DEPARTMENT

**Carl Laron**

*Editor*

**Robert A. Young**

*Associate Editor*

**John J. Yacono**

*Associate Editor*

**Byron G. Wels, K2AVB**

*Associate Editor*

**Teri Scaduto**

*Assistant Editor*

**Kathy Terenzi**

*Editorial Assistant*

**Marc Splwak**

*Editorial Associate*

**Joseph J. Carr, K4IPV**

**Marc Ellis**

**Len Feldman**

**Jeffrey K. Holtzman**

**Don Jensen**

**Charles D. Rakes**

**Marc Saxon**

*Contributing Editors*

## PRODUCTION DEPARTMENT

**Ruby M. Yee**

*Production Director*

**Karen S. Brown**

*Production Manager*

**Marcella Amoroso**

*Production Assistant*

**Janice Box**

*Editorial Production*

## ART DEPARTMENT

**Andre Duzant**

*Art Director*

**Injae Lee**

*Illustrator*

**Russell C. Truelson**

*Illustrator*

**Jacqueline P. Cheeseboro**

*Circulation Director*

**Michele Torrillo**

*P-E Bookstore*

## BUSINESS AND EDITORIAL OFFICES

Gernsback Publications, Inc.

500-B Bi-County Blvd.

Farmingdale, NY 11735

1-516-293-3000

Fax: 1-516-293-3115

President: **Larry Steckler**

**Customer Service/Order Entry**

1-800-435-0715

7:30 AM - 8:30 PM EST

**Advertising Sales offices listed on page 98**

Cover photography by Diversified Photo Services

Composition by  
Mates Graphics

 The  
Audit  
Bureau  
of Circulation



The publisher has no knowledge of any proprietary rights which will be violated by the making or using of any items disclosed in this issue.

## GET UP, GET ACTIVE!

We at **Popular Electronics** like to call ourselves the "Magazine for the Electronics *Activist*." That's because we strive to include in each issue not just things to read, but also lots of things to do.

Unfortunately, when it comes to hobby electronics, we "do'ers" are having a harder time of things as each year goes by. Parts hunting, in particular, is getting tougher all the time as many once reliable suppliers are either closing their doors or redirecting their activities toward more profitable products or markets. After running into enough dead ends in their hunt for parts, even the most dedicated hobbyists can get discouraged. As a result, there are an awful lot of soldering irons gathering rust out there.

We decided we had better act before the electronics hobbyist (and the magazine he reads!) becomes an extinct species. Last August we introduced **Popular Electronics Market Center**, a bi-monthly advertising supplement that caters specially to mail-order companies that want to do business with hobbyists.

To say the least, the response has been fantastic! Both advertisers and their customers seem to be well served. Small companies have a new and effective way to reach more potential buyers, and our readers have a new one-stop marketplace for electronics products, parts, and services.

**Popular Electronics Market Center** was started as an experiment. That experiment has succeeded and I am happy to announce that beginning with this issue, **Popular Electronics Market Center** will appear each and every month.

We are doing our part to promote electronics activism. We bring you the projects and circuits, and now we've shown you where you can get the parts. The rest is up to you. Why not scrape the rust off your soldering iron and build something? And why not do it tonight?



Carl Laron  
Editor

# LETTERS

## MANUAL SOURCE UPDATE

A well-meaning reader recently suggested *Hi-Manuals* (Popular Electronics, December 1991) as a source for electronics manuals. Unfortunately, he included both incorrect and insufficient information. First, *Hi-Manuals* (P.O. Box P-802, Council Bluffs, IA 51502) has manuals pertaining only to ham and SWL radios and accessories that were popular between 1935 and 1980. They do not give quotes for specific manuals, etc., but their current catalog, which costs \$2, has all the information needed.—Editor

## SUBWOOFER SUGGESTIONS

Thanks to everyone at Popular Electronics for the great job you did with my article "Build a Subwoofer," in the January 1992 issue. However, there are a couple of things that should be corrected or added: In the discussion of the vibration (page 31) it should be noted that my stereo system was not on at the time. An error crept into the Parts List and the schematic for the power supply (Fig. 12). In both places, T1 should be a 48-volt, 3-amp center-tapped transformer. Finally, Burr-Brown (P.O. Box 11400, Tucson, AZ 85734; 800-548-6132) has recently announced the availability of a plastic version of the OPA 541, suffixed by -AP, that costs \$17.20 in quantities of one to four. If that version is used, the power supply would have to be modified (by means of the transformer, T1) because the rating of the plastic is  $\pm 30$  volts instead of  $\pm 35$  volts for the TO-3 case; a 40-volt, center-tapped unit would suffice). The power supply shown in the article is pretty much "overkill" for most home systems anyway, and it could be scaled down by using smaller capacitors, transformer rating, etc.  
Bill Whitehead

## A THUMP ON THE HEAD

In the article "The Incredible Hot Canaries" (Popular Electronics, January 1992), when I

built the circuit as shown I noted some thumps and clicks in the output. I found that modifying the circuit by lifting R1 or R2 from the base of Q1 and feeding a second output transistor, speaker, and 33-ohm resistor, results in a more realistic and pleasant sound.  
W.B.P., WA6OCJ  
Fort Myers Beach, FL

## OH, THOSE ZERO'S!

In the "Wish List" section of *Gizmo* (Popular Electronics, January 1992), an important zero was omitted: The DM2160 Info to Go personal organizer from Royal Consumer Business Products has 160K of memory—not 16K, as was written—making it the most powerful personal organizer on the market. Sorry for the slip-up and any inconvenience it may have caused.  
Teri Scaduto and Chris O'Brian  
Gizmo Editors

## PRAISE FOR POPULAR ELECTRONICS

I'm writing to compliment you on such a fine magazine. I am an electronics instructor at Rhinelander High School, and Popular Electronics is a fantastic resource for all sorts of technical and construction information. I really like the new "Market Center" section. What a great idea! All your contributing editors do a fine job, but two of them are really great. I always read Mr. Saxon and Mr. Carr first. Nice material, gentlemen—keep up the good work. Thanks again to all of you.  
J.H.  
Rhinelander, WI

## HAVES & NEEDS

I've been a subscriber to Popular Electronics for several years now, and have written to the Letters column in the past. Once I needed schematics for an old power supply, and re-

ceived them from some very kind people. Thanks to them, that old supply is a live and useful instrument on my work bench. My letters to Popular Electronics have even led to correspondence from people who sought my help. I've heard from electronics enthusiasts living in Puerto Rico, South America, and even Flanders (Belgium).

I'm writing this time to see if I can learn what happened to the publishers of those excellent *Transistor D.A.T.A. Books*; they used to be in Orange, NJ. I still run into old dinosaurs out in the primordial electronic swamps with ancient transistors that I have trouble cross-referencing. It would be a great help to locate a *D.A.T.A. Book of Discontinued Transistors*. Libraries I've tried have never heard of them.

Also, if anyone out there has service information for a Dynaco SCA-50 stereo amplifier or FM-5 tuner, I'd much appreciate hearing from them.  
Bill Graham  
1537 Tamarind Ave.  
Fontana, CA 92336

*I don't know if the book you are seeking is still in print, but D.A.T.A. cross references are currently published by D.A.T.A. Business Publishing, 15 Inverness Way East, Englewood, CO 80155-6510. Contact them directly for more information.—Editor*

As a reader of both the old and the new Popular Electronics for more than 20 years (since I was 12 years old), I'd like to see you carry on with your present format. It has the right mix of big and small projects—all of which are useful.

Could any of your readers help me find a service manual or schematic for a Radio Shack telephone? Unfortunately, the phone doesn't appear to have a model number on it, but the PC board is marked "Tandy (c) 1979 1700105C." I hope that's

enough information for your readers to go on!  
Stephen Shaw  
P.O. Box 1404  
Randfontein, 1760  
South Africa

I have an old 1967 3M Wollensak 5280 7-inch reel-to-reel tape recorder. I need the schematics and motor schematic, or a rebuilt motor, to get my machine back in top running order. I realize that this is outdated technology and that reel-to-reel tape machines are probably not manufactured for home use anymore. Still, I've had many years of fun and enjoyment with this machine, and I'm just not ready to retire it to a landfill just yet. I'll be happy to reimburse for photocopying and postage.

Steve Harris  
2166 South Shore Road  
Erie, PA 16505

I am in need of a source for replacement transistors Q306 and Q406 for a Sylvania AM/FM stereo receiver/amplifier chassis R15-1, circa 1972. These items are listed as Sylvania part numbers 13-28471-1. I was told by Philips, successor to Sylvania, that they are no longer available. Any assistance that can be given in locating a suitable replacement would be appreciated.

I've enjoyed Popular Electronics for many years. Many thanks for the varied articles and range of subjects that are covered.

William T. Hayes  
1620 Smokey Hollow Court  
Snellville, GA 30278

I am trying to find an operator's manual and schematic for an Eico model 495 voltage calibrator (oscilloscope stabilizer), serial number 1926. I'd appreciate hearing from anyone who could help.

Larry Ray Cook  
362 East South Street  
Richland Center, WI 53581



# Countersurveillance Techniques

**Never before has so much professional information on the art of detecting and eliminating electronic snooping devices—and how to defend against experienced information thieves—been placed in one VHS video. If you are a Fortune 500 CEO, an executive in any hi-tech industry, or a novice seeking entry into an honorable, rewarding field of work in countersurveillance, you must view this video presentation again and again.**



*Wake up!* You may be the victim of stolen words—precious ideas that would have made you very wealthy! Yes, professionals, even rank amateurs, may be listening to your most private conversations.

*Wake up!* If you are not the victim, then you are surrounded by countless victims who need your help if you know how to discover telephone taps, locate bugs, or “sweep” a room clean.

There is a thriving professional service steeped in high-tech techniques that you can become a part of! But first, you must know and understand Countersurveillance Technology. Your very first insight into this highly rewarding field is made possible by a video VHS presentation that you cannot view on broadcast television, satellite, or cable. It presents an informative program prepared by professionals in the field who know their industry, its techniques, kinks and loopholes. Men who can tell you more in 45 minutes in a straightforward, exclusive talk than was ever attempted before.

### Foiling Information Thieves

Discover the targets professional snoopers seek out! The prey are stock brokers, arbitrage firms, manufacturers, high-tech companies, any competitive industry, or even small businesses in the same community. The valuable information they fish may be marketing strategies, customer lists, product formulas, manufacturing techniques, even advertising plans. Information thieves eavesdrop on court decisions, bidding information, financial data. The list is unlimited in the mind of man—especially if he is a thief!

You know that the Russians secretly installed countless microphones in the concrete work of the American Embassy building in Moscow. They converted

1-800-333-6333

**HAVE YOUR  
VISA or MC CARD  
AVAILABLE**

what was to be an embassy and private residence into the most sophisticated recording studio the world had ever known. The building had to be torn down in order to remove all the bugs.

### Stolen Information

The open taps from where the information pours out may be from FAX's, computer communications, telephone calls, and everyday business meetings and lunchtime encounters. Businessmen need counselling on how to eliminate this information drain. Basic telephone use coupled with the user's understanding that someone may be listening or recording vital data and information greatly reduces the opportunity for others to purloin meaningful information.

The professional discussions seen on the TV screen in your home reveals how to detect and disable wiretaps, midget radio-frequency transmitters, and other bugs, plus when to use disinformation to confuse the unwanted listener, and the technique of voice scrambling telephone communications. In fact, do you know how to look for a bug, where to look for a bug, and what to do when you find it?

Bugs of a very small size are easy to build and they can be placed quickly in a matter of seconds, in any object or room. Today you may have used a telephone handset that was bugged. It probably contained three bugs. One was a phony bug to fool you into believing you found a bug and secured the telephone. The second bug placates the investigator when he finds the real thing! And the third bug is found only by the professional, who continued to search just in case there were more bugs.

The professional is not without his tools. Special equipment has been designed so that the professional can sweep a room so that he can detect voice-activated (VOX) and remote-activated bugs. Some of this equipment can be operated by novices, others require a trained countersurveillance professional.

The professionals viewed on your television screen reveal information on the latest technological advances like laser-beam snoopers that are installed hundreds of feet away from the room they snoop on. The professionals disclose that computers yield information too easily.

This advertisement was not written by a countersurveillance professional, but by a beginner whose only experience came from viewing the video tape in the privacy of his home. After you review the video carefully and understand its contents, you have taken the first important step in either acquiring professional help with your surveillance problems, or you may very well consider a career as a countersurveillance professional.

### The Dollars You Save

To obtain the information contained in the video VHS cassette, you would attend a professional seminar costing \$350-750 and possibly pay hundreds of dollars more if you had to travel to a distant city to attend. Now, for only \$49.95 (plus \$4.00 P&H) you can view *Countersurveillance Techniques* at home and take refresher views often. To obtain your copy, complete the coupon below or call toll free.

**RADIO-ELECTRONICS VIDEO OFFER** **PE**

500-B Bi-County Blvd.  
Farmingdale, NY 11735

Please rush my copy of the Countersurveillance Techniques Video VHS Cassette for \$49.95 plus \$4.00 for postage and handling.

No. of Cassettes ordered \_\_\_\_\_  
Amount of payment \$\_\_\_\_\_

Bill my  VISA  MasterCard  
Card No. \_\_\_\_\_  
Expire Date \_\_\_\_ / \_\_\_\_

Signature \_\_\_\_\_  
Name \_\_\_\_\_  
Address \_\_\_\_\_  
City \_\_\_\_\_ State \_\_\_\_\_ ZIP \_\_\_\_\_

All payments in U.S.A. funds. Canadians add \$4.00 per VHS cassette. No foreign orders. New York State residents add applicable sales tax.



# GIZMO

A CHRONICLE OF CONSUMER ELECTRONICS

APRIL 1992

VOLUME 5,  
NUMBER 4

## Future Projections

**PANASONIC PT-10L COMPACT VIDEO PROJECTOR.** From: Panasonic Communications & Systems Company, 50 Meadowland Parkway, Secaucus, NJ 07094. Price: \$1400.

If there's one item that best fits the "small wonders" theme of this month's GIZMO, it's Panasonic's PT-10L LCD Video Projector. Until we actually got the projector in our hands—and it's not stretching it too far to call it palm-sized—we found it hard to believe that a unit so small and light could produce a TV picture 70 inches (diagonal measure). We're certain that we have seen the future of large-screen television.

Before we get too carried away with our excitement, we should say that 3-beam projection TV's and the more expensive LCD projectors are in no immediate danger. The PT-10L does have some real problems with picture brightness and resolution. But we'll get to that soon enough.

Just how small is the PT-10L? With a weight of six pounds and a size of less than  $8 \times 8 \times 4\frac{1}{2}$  inches, it's smaller than a 5-inch black-and-white TV with AM/FM radio that we picked up for the nightstand a number of years back. It's smaller than a typical full-sized VHS camcorder, and lighter than most. When packed in its carrying case, it's a breeze to carry around your shoulder.

And we imagine that with its extreme portability, the carrying case will get a lot of use. What better way to keep the kids occupied on a rained-out vacation day, or to watch the exciting videotape shot on the previous (sunny) day of the trip?

Using the projector on a portable basis isn't at all far-fetched. Not only is it small and light, it's also incredibly easy to set up. One RCA phono connector is provided for video input, and a second for audio input. A tiny 2-inch speaker and an audio amplifier with an output power of less than 1 watt won't provide anything remotely com-



CIRCLE 50 ON FREE INFORMATION CARD

parable to a home-theater experience. But it doesn't pretend to, either. We think that having the built-in audio amplifier is important because the PT-10L's strongest selling point is its portability. Having to carry a separate audio amplifier just to be able to use it would defeat its purpose.

The one thing you'll definitely need to use the PT-10L is a dark room. The projector's brightness, which is rated at 11.5 lux (with a picture size of 50 inches on a reflective screen), is equivalent to that of a dim slide projector. Just as you wouldn't think of watching slides without dimming the lights and closing the drapes, you won't be satisfied with the PT-10L's picture without a darkened room. We tried, for example, using the projector to watch a football game on a sunny Sunday afternoon. Without black-out shades, we found ourselves turning to the direct-view 26-inch TV to catch the fine points of play. The next evening, watching Monday Night Football, we preferred the dramatically larger picture of the PT-10L. Although a

dark room brings out the projector's best, even that best won't satisfy everyone. But the projector's performance is a direct result of the way that Panasonic was able to make the projector so incredibly small.

All LCD projectors work by shining bright light through liquid-crystal displays, which act as shutters. Other projectors we have seen (Such as the Sharp XV-100, GIZMO, May 1991) use three separate 3-inch LCD panels—one for each of the three colors, red, green, and blue, that make up a TV picture. In such projectors, the light from the lamp first passes through dichroic mirrors, which reflect only one color while allowing other colors to pass through. That separates the light from the projector bulb into red, green, and blue components. Each of the resulting three reflections are then passed through a separate LCD panel. Another set of dichroic mirrors are then used to recombine the colors.

The PT-10L, however, works quite differently. (Continued on page 18)

TURN PAGE FOR CONTENTS



# This month in GIZMO

Panasonic PT-10L Compact Video Projector ..... pg. 5

Canon UCS1 Ultra-Compact Hi-8 Camcorder ..... pg. 6

Radio Shack's Memorex PocketVision-26 Handheld Color LCD TV ..... pg. 8

Whistler Interstate Tripmate Highway Travel Planner ..... pg. 10

NEC UltraLite III Notebook Computer ..... pg. 12

Sharp CD-C900 Bookshelf Stereo System with CD Changer ..... pg. 16

Bookshelf Speakers ..... pg. 20

Compact Disc Player ..... pg. 20

UX Turbo Cassette Tape ..... pg. 20

Video Smartlites ..... pg. 20

Personal Stereo/Pedometer ..... pg. 21

Personal Organizer ..... pg. 22

"Picture Frame" Antenna ..... pg. 22

Portable Stereo ..... pg. 22

Sonny TrackMan ..... pg. 22

Gizmo is published by Gernsback Publications, Inc., 500-B Bi-County Blvd., Farmingdale, NY 11735. Senior Writers: Chris F. O'Brian and Teri Scaduto. Contributor to this issue: John Julian Jacangelo. ©Copyright 1992 by Gernsback Publications, Inc. Gizmo is a registered trademark. All rights reserved.

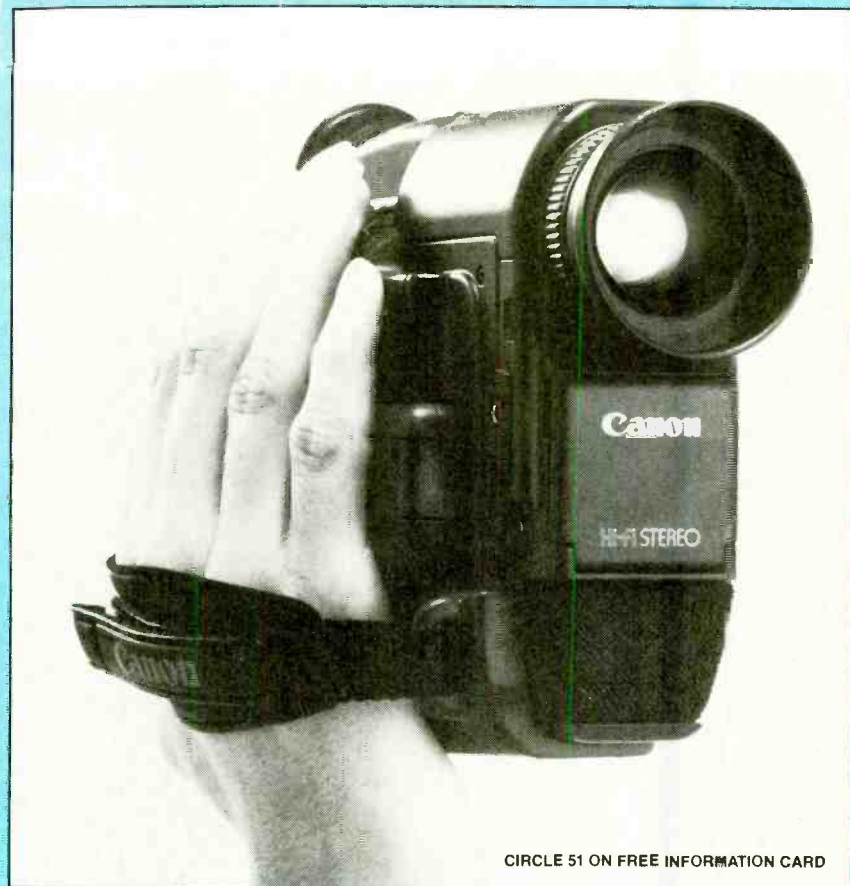

CIRCLE 51 ON FREE INFORMATION CARD

## Ultra Compact Super One

**CANOVISION 8 UCS1 HIGH-BAND 8mm CAMCORDER. Manufactured by: Canon U.S.A. Inc., One Canon Plaza, Lake Success, NY 11042. Price: \$2099.**

We missed shooting some great footage during our last trip to the West coast. After packing our bags with enough to get us through several days of business and several more of pleasure, we had to make some tough decisions about what to leave behind. Our personal stereo made the final cut—those long flights are made bearable only with some of our favorite music. Our compact 35-mm still camera did also. Our camcorder, however, didn't make the trip. It was just a little too bulky, and a little too heavy.

We might not have missed shooting some great scenes if we had had *Canon's UCS1 Hi8 camcorder*—the world's smallest, lightest, and thinnest high-band model. The UCS1 is, indeed, remarkable, weighing only 1.57 pounds without a tape, battery or remote control. (The battery pack and remote add 6.7 ounces.) It measures a diminutive  $3\frac{1}{8} \times 6\frac{1}{16} \times 5\frac{1}{16}$

inches at its widest points, but seemed smaller to us.

The shape of the UCS1 is different from most other camcorders because it's thin and almost rectangular. (It initially struck us as looking like a horizontal camcorder turned on its side.) Yet it's very comfortable to hold and use—except for people with very small hands, who will have trouble reaching the zoom and record/pause controls comfortably. Fortunately, a second record/pause button, located under the viewfinder, will allow two-handed operation.

Despite the small size of the UCS1, it is not short on features or performance. It offers a 10× zoom capability, five programmed auto-exposure modes (plus full auto and full manual), shutter speeds as fast as  $\frac{1}{10,000}$  second, several title modes, and a host of convenience features. If there's any area where the performance of the UCS1 comes up a little short when compared with its full-sized brothers, it's its low-light performance, which is rated at 5 lux in the camcorder's gain-up mode.

Canon had to come up with several design enhancements to get the size of the camcorder down. The lens, an internal-focus 6–60 mm, f/1.8 (wide angle) uses one aspherical element and a 1.3-inch CCD (or charge-coupled device, the camera's sol-



id-state pickup device). The result is that the lens is about 75% the size of other 10 × lens systems, which commonly use a ½-inch CCD. Despite the smaller size of the CCD, it provides 410,000 pixels or picture elements, which is the equivalent of ½-inch camcorder pickups.

The mechanical chassis of the UCS1 is also newly developed. The video-head drum was made smaller in diameter, which helps to give the chassis a total weight of just 5.8 ounces. Canon also reduced the size of the circuit boards by integrating components, using 6-layer boards, and by stacking components on top of one another.

Because the UCS1 is so box-like, the main control panel is flat and open, leaving plenty of room for the controls. The left side (from the shooter's perspective) features some 17 controls. The largest of them (and the only one that isn't a push-button) is the Program AE (auto-exposure) control, a 7-position rotary selector. Besides full-manual and full-auto, there are five special-situation exposure modes. In the Sports mode, the settings of the iris shutter speed, and gain are set to give the highest possible shutter speed. In Portrait mode, the iris is opened so that the depth of field is kept to a minimum and the background is out-of-focus and, therefore, not distracting to the subject. The Spotlight mode is used in situations where a brightly lit subject is surrounded by darkness—such as an actor in a spotlight on a stage. The Landscape mode automatically exposes for the land, not for the sky, so you don't end up with dark, landscapes with bright skies. The Sand & Snow mode compensates for glaringly bright backgrounds. A video of, for example, skiers or beachgoers (who would normally end up as dark shadows against a bright background) would be properly exposed.

For many people, that Program AE selector could be the only control other than the zoom and pause/record buttons that are used for good all-around videos. After we spent a little time getting accustomed to the UCS1, we couldn't wait to try out its added features—and there are plenty of them.

One feature that is very popular—but one that we almost never use—is a titler function, which lets you add handwritten titles and illustrations to your scenes. To use it, you first have to write or draw your titles on white cardboard, and then store them in memory so that you can call them up and superimpose them on top of your scenes. The UCS1 can do the standard tricks, storing two titles and displaying them in different colors, and in reverse. You can also display both titles at the same time—in different colors, if you wish. An "animation" mode is one we haven't seen before—it automatically alternates be-

tween the first and second title. If you're good, you can make it look like animation. (We weren't very good.) We did like, however, another feature of the titler: the ability to add drop-shadows to the titles to give them a little added contrast. You can also scroll and wipe one or both titles.

We did like the UCS1's ability to add character titles to recordings. Two lines, each made up of 16 letters, numbers, and punctuation marks of your choice can be stored in the camcorder's memory. Those two lines, coupled with the current date and time, which can also be displayed, cover most of our titling needs.

Of course, sometimes even the best planned scenes don't always go smoothly. Just as you start filming your dramatic view of the Statue of Liberty, the ferry captain comes on over the loudspeaker to say something about life jackets, ruining the mood you were trying to set. With the UCS1's Edit-Erase feature, you can immediately restart the scene with a minimum of fumbling. As long as the scene you were recording was less than a minute before the interruption, you can pause the recording, hit the Edit-Erase button, and the tape will be rewound at high speed back to the beginning of the scene.

In the playback mode, the same button becomes a blank-tape search key. Just pop in a tape, hit the Blank Tape Search button, and the UCS1 starts a high-speed search to find the end of a recorded section—the tape must be blank for at least one full minute, so short breaks between recorded sections won't be misinterpreted. We found it most useful when starting off on the second day of a weekend jaunt. We had watched some of the first day's video back at the hotel room, but hadn't advanced the tape to the end of the recorded section. The next day, pressing just one button let us get started.

Playing tapes on the UCS1 is a pleasure. Unlike most other camcorders, the playback controls are easy to find, and easy to use. One option is to lay the camcorder on its side, and flip up the removable remote control, but without removing it—the receiving sensor will see its signals. That gives you a clear, well-laid-out control panel for playback. (You can also, of course, remove the controller, and operate the camcorder from across the room.) Buttons on the other side of the UCS1 take on playback roles when the camcorder is in the playback mode, meaning that you can still operate the playback functions if the remote is on the other side of the room or if you chose to leave it behind to save weight.

We'd hate to leave the remote behind, though, because it also works in the record mode to control the start/stop and zoom functions. But even if you leave it back in the hotel room, you can still get yourself in

(Continued on page 19)

## SPECIAL FROM ETT

TTL1 —  
TTL POCKET GUIDE,  
Volume 1,  
7400 — 74200  
..... \$18.95.



TTL2 —  
TTL POCKET GUIDE,  
Volume 2,  
74201 — 74640  
..... \$18.95.



TTL3 —  
TTL POCKET GUIDE,  
Volume 3,  
74641 — 7430640  
..... \$18.95.

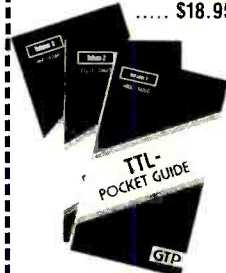

TTLX —  
ALL THREE GUIDES,  
Vols 1, 2, & 3  
(save \$6.00)  
..... \$50.85.

Each volume provides a comprehensive listing of all commonly used TTL integrated circuits within the range of types noted. The combination of three volumes covers 7400 through 7430640 TTL products from all major manufacturers. All current families are covered: standard, low power, Schottky, low power Schottky, advanced Schottky, advanced low powered Schottky, high speed and fast Schottky. There are eight sections to the book. Section 1 illustrates the device schematic using a clear and simple logic diagram. Next a brief description of the components, providing quick reference to the internal structure. The next section details input signals or levels at individual pins. The fourth section lists major applications and is followed by a summary of essential data. Below this, a table indicates the TTL families in which the device is available, and finally, device description and type number are highlighted for easy reference. A manufacturer's index at the back of the book shows in tabular form which companies manufacture each package.

MAIL TO: **Electronic Technology Today, Inc.**  
P.O. Box 240  
Massapequa Park, NY 11762-0240

### SHIPPING CHARGES IN USA AND CANADA

\$0.01 to \$5.00	\$1.50	\$30.01 to \$40.00	\$5.50
\$5.01 to \$10.00	\$2.50	\$40.01 to \$50.00	\$6.50
\$10.01 to \$20.00	\$3.50	\$50.01 and above	\$8.00
\$20.01 to \$30.00	\$4.50		

**SORRY. No orders accepted outside of USA and Canada**

Total price of merchandise	..... \$	_____
Shipping (see chart)	..... \$	_____
<b>Subtotal</b>	..... \$	_____
Sales Tax (NYS only)	..... \$	_____
<b>Total Enclosed</b>	..... \$	_____

Name \_\_\_\_\_  
Address \_\_\_\_\_  
City \_\_\_\_\_ State \_\_\_\_\_ Zip \_\_\_\_\_



## Video to Go

**POCKETVISION-26 LCD COLOR TV** (CAT. NO. 16-163); from Radio Shack, 700 One Tandy Center, Fort Worth, TX 76102. Price: \$199.00.

If you firmly believe—as many people do—that television is causing the decline of American civilization by pandering to the “least common denominators” of taste and intelligence, contributing to illiteracy, and turning the American people into mindless, unquestioning, unhealthy couch potatoes, then don’t read this; skip to the next item. If, on the other hand, you rarely leave your living room during football, baseball, hockey, and basketball seasons; become distraught at the thought of missing even one episode of *L.A. Law*; or don’t make any social plans without first consulting next week’s programming in *TV Guide*, this one’s for you.

These days, television addicts don’t have to stay at home to get their video fixes or even set the VCR to record yet another show you hope to get the time to watch. Instead, they can pick up a portable TV, and take it with them wherever they go. Today’s portable TV’s offer both better picture quality and lower prices than those of the recent past. While cathode-ray tubes have been getting bigger and bigger, LCD’s have been getting smaller and, more important, clearer. In manufacturing, more is less: The greater the quantity of an item, the lower its production cost. The proliferation of small computers and hand-held personal organizers have resulted in increased demand for tiny LCD screens; as a result, companies have invested more time and money in improving LCD’s, and with full-scale production has come lower prices.

A pocket-sized color television from *Radio Shack* is a good example of modern liquid-crystal technology. The *Memorex PocketVision-26* has a 2.7-inch, high-resolution, twisted nematic type, flat LCD with a fluorescent backlight that illuminates the screen for viewing in dark or low-light conditions. The  $5\frac{1}{2} \times 3\frac{3}{4} \times 1\frac{1}{2}$ -inch set delivers a picture that is crisp and clear—as long as you’re positioned directly in front of it. Of course, that’s not much of a problem—after all, this isn’t the sort of television you’d use for watching the Super Bowl with a bunch of friends.

The handheld TV’s front panel is uncrowded. The LCD screen is on top, two up and down tuning keys are in the center, and a speaker is on the bottom. The PocketVision-26 covers VHF channels 2 through 13 and UHF channels 14 through 69. Its electronic tuning system automatically scans either up or down the band you’ve selected, locking in on active chan-

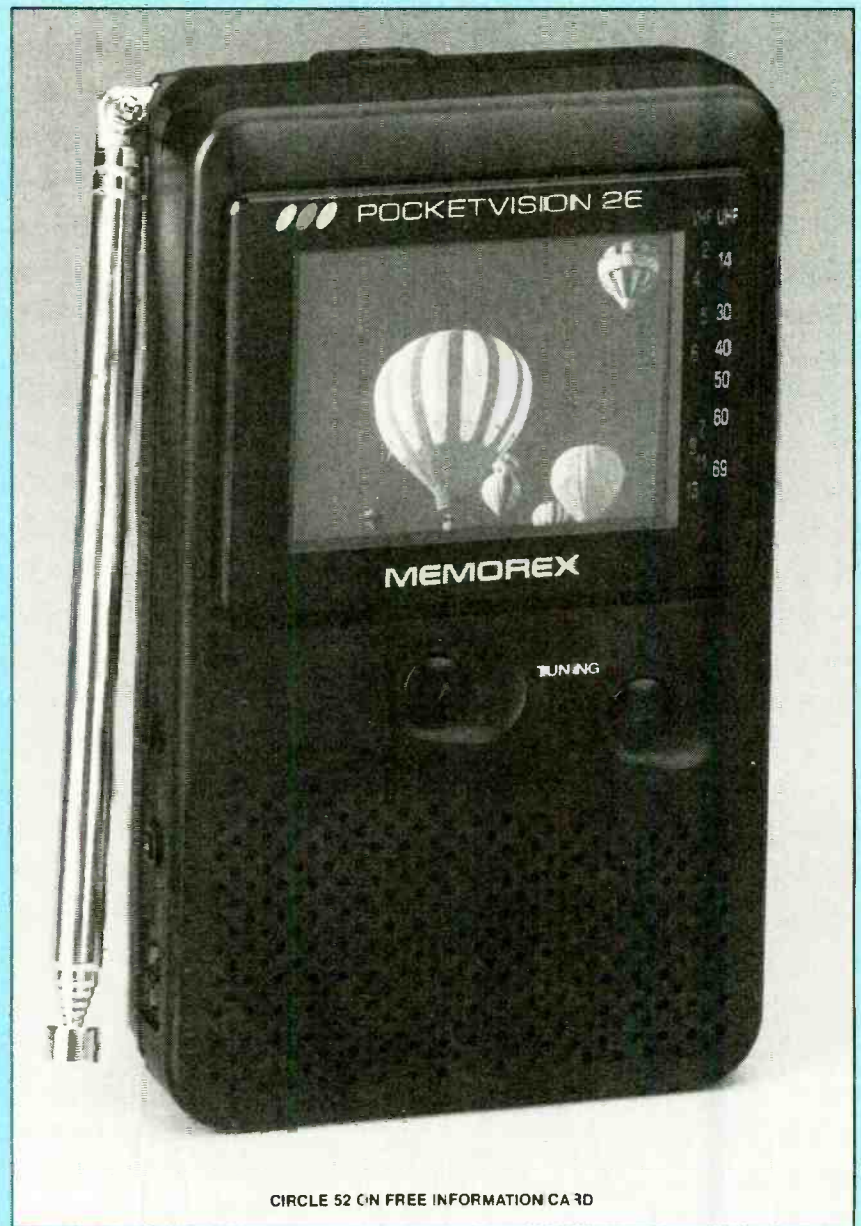

CIRCLE 52 ON FREE INFORMATION CARD

nels. A touch of the up or down tuning key starts it scanning again. Two rows of numbers representing the UHF and VHF bands run vertically along the right side of the screen, and an indicator bar points to the channel being tuned in. The  $1\frac{1}{16}$ -inch speaker provides sound that is adequate for small-scale TV viewing.

The left-side panel has a mini headphone jack, an audio/video input, and a tint control. Unfortunately, the earphone jack does not support stereo headphones—you’ll hear sound in only one ear. The A/V input allows you to connect a camcorder, VCR, or laserdisc player. According to the manual, such connection requires a special cable that your local Radio Shack store can order for you, and using standard audio patch cords will result in distorted audio and video signals. That’s what we used to connect the Canon UCS1 camcorder to the PocketVision-26, however,

and we could discern few ill effects. The TV comes in handy as a camcorder monitor, allowing you to show your tapes in places where you wouldn’t ordinarily have access to a TV.

The right-side panel contains a three-position slide switch that controls power and selects the band, a brightness control, and a DC power jack. Powered by four AA batteries, the PocketVision-26 provides a little more than two hours of continuous play, not a long time, even as portable TV’s go. Surprisingly, an AC adaptor is not included; that’s a serious oversight in our opinion. Instead, Radio Shack sells an AC adaptor to power the TV from a standard wall outlet and a DC adaptor for use in a car. We would highly recommend one or both if a good percentage of your watching will be done around the house, in the yard, or in the car or boat.

(Continued on page 18)



# SELECT 5 BOOKS for only \$4.95

(values to \$143.75)



1367P \$24.95

Your most complete source for electronics books for over 25 years.

**Membership Benefits • Big Savings.** In addition to this introductory offer, you keep saving substantially with members' prices of up to 50% off the publishers' prices. • **Bonus Books.** Starting immediately, you will be eligible for our Bonus Book Plan, with savings of up to 80% off publishers' prices. • **Club News Bulletins.** 15 times per year you will receive the Book Club News, describing all the current selections—mains, alternates, extras—plus bonus offers and special sales, with scores of titles to choose from. • **Automatic Order.** If you want the Main Selection, do nothing and it will be sent to you automatically. If you prefer another selection, or no book at all, simply indicate your choice on the reply form provided. You will have at least 10 days to decide. As a member, you agree to purchase at least 3 books within the next 12 months and may resign at any time thereafter. • **Ironclad No-Risk Guarantee.** If not satisfied with your books, return them within 10 days without obligation! • **Exceptional Quality.** All books are quality publishers' editions especially selected by our Editorial Board.

(Publishers' Prices Shown)

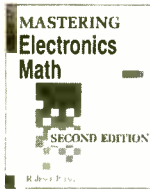

3589 \$27.95  
Counts as 2



3044P \$12.95

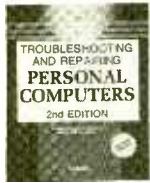

3677 \$34.95  
Counts as 2



3258 \$28.95  
Counts as 2



3671 \$29.95  
Counts as 2



585120-2 \$12.95

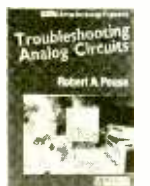

9410 \$32.95  
Counts as 2



3710 \$32.95  
Counts as 2

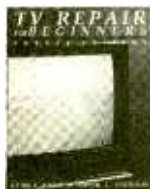

3627 \$29.95  
Counts as 2



3374P \$16.95



2947P \$13.95



3738 \$26.95



3659 \$21.95



3778 \$26.95



2790P \$14.95



2613P \$17.95

All books are hardcover unless number is followed by a "P" for paperback.



2833P \$18.95



2867P \$18.95

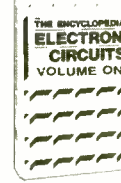

1938 \$60.00  
Counts as 3



2925P \$10.95

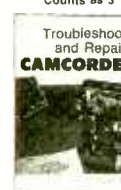

3337 \$35.95  
Counts as 2



3804P \$19.95

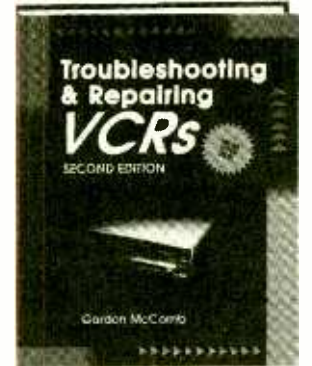

3777 \$32.95  
Counts as 2



585928-9 \$24.95



3550 \$34.95  
Counts as 2

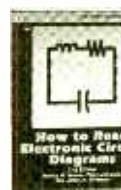

2880P \$14.95



3345 \$39.95

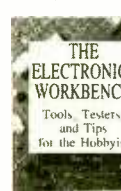

3672 \$28.95  
Counts as 2



3475 \$27.95  
Counts as 2

© 1992 ELECTRONICS BOOK CLUB  
Blue Ridge Summit, PA 17294-0810



**ELECTRONICS BOOK CLUB**<sup>SM</sup>  
Blue Ridge Summit, PA 17294-0810

Please accept my membership in the Electronics Book Club and send the 5 volumes listed below, billing me \$4.95. If not satisfied, I may return the books within ten days without obligation and have my membership cancelled. I agree to purchase at least 3 books at regular Club prices during the next 12 months and may resign anytime thereafter. A shipping/handling charge and sales tax will be added to all orders.

--	--	--	--

Name \_\_\_\_\_

Address \_\_\_\_\_

City \_\_\_\_\_

State \_\_\_\_\_ Zip \_\_\_\_\_ Phone \_\_\_\_\_

Valid for new members only. Foreign applicants will receive special ordering instructions. Canada must remit in U.S. currency. This order subject to acceptance by the Electronics Book Club. PE492

April 1992, Popular Electronics



# The Route of it All

**INTERSTATE TRIPMATE HIGHWAY TRAVEL PLANNER.** Manufactured by Whistler, Five Liberty Way, Westford, MA 01886. Price: \$99.95.

We belong to a segment of the population that might euphemistically be called "directionally impaired." Over the years, we've learned through experience that if we're told a road trip will take four hours, to allow six hours for the total trip—four hours driving, and two for finding our way out of wrong turns, short cuts, and scenic detours. You probably know someone with the same problem (although few people like to admit it), who finds reading a road map even more difficult and frustrating than trying to fold it back up again correctly. To put it bluntly, we couldn't find our way out of a paper bag.

Joining the Automobile Association of America (AAA) was a big help to us. Members can request free "Triptiks." Each Triptik is a little booklet that contains a series of maps detailing each stage of the trip, with the route you are to follow clearly highlighted, and little arrows pointing out the direction of travel. Detailed maps of cities and towns that you pass en route are also included, along with sightseeing tips, mileage for each segment of travel, the approximate time it should take you to drive, information about each town along the way, the location and cost of tolls, and AAA's emergency road service number for the area. The first time we used a Triptik, we made it from New York to Washington, D.C. to the Maryland coast, and back home without mishap—quite an accomplishment for us.

Missing from those Triptiks, however, is information about lodging and dining, for which you can request TourBooks that describe AAA-approved motels, hotels, and restaurants. If, for instance, you were planning a round-trip cross-country trek, you would require two or three TripTiks and maybe a dozen books—quite a hefty package. And you still wouldn't have some other information important on long car rides, such as the locations of gas stations, fast-food joints, tourist information centers, campgrounds, budget motels—and, perhaps most important, how far it is to the next rest room.

Now we can get all of that information in a package about the size of a TV remote control, in Whistler's *Interstate Tripmate* electronic travel planner. The handheld device lists more than 35,000 highway services along every interstate highway in the continental United States. It even "plans" trips between major cities (more than 100



CIRCLE 53 ON FREE INFORMATION CARD

of them)—provided you travel only on the interstates, of course. And it won't become outdated like maps do; a plug-in memory module allows the user to update the data without sending the unit back to the manufacturer. (According to the Whistler, updates will be made when the company decides they are appropriate, and the modules will cost \$29.95 plus shipping.)

Actually, the Tripmate more closely resembles a communicator on the old *Star Trek* TV show than a remote control, since the top half of the unit "flips" open. When open, an eight-character LCD readout is revealed on the underside of the lid. The main body of the Tripmate is completely covered with keys. At the top are round keys numbered 1 through 0 (or 0 through 9 if you prefer), which are also used for the letters "A" through "J." The rectangular "K" through "Z" keys also serve as function keys, and each is labeled with the appropriate function. Across the bottom are keys labeled SELECT/ENTER, MILE/EXIT and NEXT. The ON/STATE key is located at the upper right corner. The pocket- (or

glove-box-) sized instruction manual clearly explains each of the functions, and how to use the Tripmate to plan a trip and locate road services.

Suppose, for instance, that you and your family were traveling from Pittsburgh to New York City. Pressing the CITY key calls up FRM CITY on the LCD, prompting you to type "Pittsburgh." (Actually, all you need is the first two letters for the Tripmate to recognize and acknowledge PITTSBUR PENNSYLV on the 8-character display.) After verifying your point of departure, the screen will display TO CITY, and you would type in NEWY. After a couple of seconds, 428 MI, I-76 E, and I-95 N would begin scrolling in quick succession across the screen. A check of our handy road atlas (when you're directionally impaired, you keep a lot of maps and atlases on hand) showed that that looked like the best possible route.

So, you hit the road, bright and early. Unfortunately, as soon as you get on Interstate 76, your grumbling stomach and whining children make you realize that



skipping breakfast might not have been a good idea. This is when the Tripmate really comes in handy. You (actually, whoever is in the passenger seat—we wouldn't recommend using the device while driving!) let the Tripmate know that you're in Pennsylvania, driving east on I76, and you just passed Exit 6. The screen asks you to type in a category, and you press FOOD TYPE to look for a specific type of meal or cuisine. LOC FOOD (local) appears on the screen. You could simply keep pressing the next key to see every type of food available, or you can type in your preference (Italian, pizza, Mexican, Oriental, etc.). At 7:00 AM, "breakfast" would seem to be a good choice. Unfortunately, the first place specializing in breakfast is in Philadelphia, 275 miles down the road.

Luckily, there's also the FOOD key, which provides information on restaurant chains. The kids love breakfast at Denny's, so you press FOOD and then key in "Denny's." The Tripmate's screen shows PA 11MI, letting you know that there's one in 11 miles and that that is still in Pennsylvania. By pressing the SELECT/ENTER key, you learn that the nearest Denny's is at Exit 7, in 11 miles, and that at exit 7 you must go so 0MI, which means that the restaurant is right at the Exit 7 South ramp. You'd like to get a few more miles under your belt before stopping, but according to the Tripmate, the next Denny's is in 89 miles, so Exit 7 it is.

With everybody full on pancakes and eggs, you set out once again. But you've just passed Exit 8 when somebody needs to use the bathroom. According to the Tripmate, the next restrooms are in 37 miles, and the ones after that are 72 miles away.

Should the kids begin to get restless, you could find out if there were any interesting sights to see along the way by pressing SITES. In fact, there's an historic fort (H-FORT), something having to do with military (?) history (M-HISTORY), and a ski area coming up soon, and down the road you could find such attractions as S-WLDFLIF, M-TRAIN, and a state park.

If you were to continue at the same snail's pace, stopping every few exits, you might be tempted to call it quits before nightfall and use the Tripmate to find a motel or hotel in which to spend the night. Once again, you can type in the name of the lodging chain of your preference (Marriott, Howard Johnson's, Super 8, Motel 6, etc.), or just scroll through all of the available motels on the interstate.

In the same manner, you can obtain convenient 800 numbers for motels and auto clubs; locations of gas stations, including those that sell diesel fuel; locations of camp grounds; how far it is to the next state border and the next interstate; how to find

emergency services; where there are restaurants and gas stations that are open 24 hours a day; and phone numbers for travel assistance, road conditions, and weather reports. There's also a key to press to see all services available on a road.

In most states, the maximum distances between services listed is 20 to 30 miles, although in some less populous states, services are sometimes scarcer (up to 50 miles apart). And in Texas and Arizona, the distances are occasionally even longer than that.

To locate nearby services, you must tell the Tripmate your location, using the interstate you're on, the direction you're traveling, and the nearest mile marker number or exit number. California, however, uses neither mile markers nor numbered exits. Whistler provides a separate booklet that provides mile numbers that the Tripmate can recognize for hundreds of places in California. Perhaps, since Californians own and drive such a large percentage of all automobiles registered in the United States, a more convenient solution could have been included. But in our travels in California, we were able to use the Tripmate accurately, if not quite conveniently.

Of course, there's only so much information in the handheld device. You might find out that there's an Italian restaurant in 27 miles, but you won't know if it's a casual, inexpensive place or a gourmet restaurant, with jackets and ties required. You might learn that at the next exit there's a Howard Johnson's, a Motel 6, a Days Inn, and a Ramada Inn at the next exit, but you won't be able to compare room prices.

Still, the idea behind the Tripmate is to let you know where you can find a meal and a room, not to give you comparisons or make quality judgments. However, if you find that the price of the Ramada is higher than you wanted to pay, at least you know that three miles further down the road there's another hotel that just might have better prices. That removes that awful "If we don't stop now, who knows where the next place will be!" feeling of desperation.

Now, suppose that you didn't learn your lesson on that 428-mile trek to New York with the kids, and you decide to spend your summer vacation renting a Winnebago and traveling 3137 miles from Seattle, Washington to Orlando, Florida. A couple of drawbacks become apparent when planning such a long vacation trip. First, the Tripmate can only provide up to three interstates for each trip. On that Seattle-Orlando jaunt, it said to take 90 East to 29 South to 70 East. That would leave you stranded someplace on I70, which eventually ends up near Philadelphia—1191 miles from your destination.

Of course, you could plan the trip in  
(Continued on page 19)

## Earn Your B.S. Degree in ELECTRONICS or COMPUTERS



### By Studying at Home

Grantham College of Engineering, now in our 42nd year, is highly experienced in "distance education"—teaching by correspondence—through printed materials, computer materials, fax, and phone.

No commuting to class. Study at your own pace, while continuing on your present job. Learn from easy-to-understand but complete and thorough lesson materials, with additional help from our instructors.

Our Computer B.S. Degree Program includes courses in BASIC, PASCAL and C languages — as well as Assembly Language, MS DOS, CADD, Robotics, and much more.

Our Electronics B.S. Degree Program includes courses in Solid-State Circuit Analysis and Design, Control Systems, Analog/Digital Communications, Microwave Engr, and much more.

An important part of being prepared to *move up* is holding the right college degree, and the absolutely necessary part is knowing your field. Grantham can help you both ways—to learn more and to earn your degree in the process.

Write or phone for our free catalog. Toll free, 1-800-955-2527, or see mailing address below.

Accredited by  
the Accrediting Commission of the  
National Home Study Council

**GRANTHAM**  
**College of Engineering**  
Grantham College Road  
Slidell, LA 70460



# A Heavyweight Liteweight

NEC ULTRALITE III NOTEBOOK COMPUTER. From: NEC Technologies, Inc., 1414 Massachusetts Ave., Boxborough, MA 01719. Price: \$3699.

Since we were concentrating this month on "small wonders," we had to take a look at the one item that has undergone the most dramatic change in size in the last decade: the personal computer. To get an idea of the state-of-the-art of portables, we went to NEC, which has been a leading player in the notebook computer market since 1988, when they introduced their first UltraLite computer.

We can remember the days when portable computers were much like the portable TV's of a couple of decades ago. Yes, you could move them. But then again, you can move a house, if you really want to. Although the manufacturers called them "portables," we in the press added a little

heft and weight to the machines by using the terms "luggable" or "transportable." These days, "portable" is a bit too heavy for the manufacturers, and even "laptop" is a little too big. The term that's currently favored is "notebook."

NEC's UltraLite III is a good example of why the term "notebook" came about. With dimensions of 9 x 11½ x 1½ inches, the UltraLite III is just a tad larger than a typical notebook. Although at almost five pounds, it is quite a bit heavier. Just how much stuff was NEC able to stuff in a 5-pound package?

The UltraLite III is based on the 80386SX microprocessor, which fits in with the mainstream of desktop PC's. A 60-megabyte hard-disk drive provides a sensible amount of mass storage. Two megabytes of built-in RAM can be expanded to as much as ten megabytes—again, something that you might expect to see on a desktop.

The display is a far cry from the portables of even just a few years ago. The backlit LCD screen delivers a resolution of 640 x 480 pixels (which is standard VGA)

with 32 shades of gray. The computer comes up with black text on a white background, but with the press of a pair of keys, that can be changed to white characters on a black background.

Strangely enough, the UltraLite III doesn't include a built-in floppy-disk drive. Instead, an external plug-in drive is bundled with it. We understand the reasoning: It helps keep the weight down. You can always plug the floppy drive in and transfer the data you'll need to the hard disk before you take the laptop on the road, and then travel without being weighed down by the drive. But we don't think the theory is a very good one.

First, a portable computer should be as rugged as possible. The added floppy drive makes the UltraLite anything but rugged. You can't carry the computer with the diskette drive attached, at least if you follow the warning label on the drive. (The weight of the drive would put too much torque on the single connector.) The drive also increases the width of the computer by more than 50 percent, precluding its use in small areas such as on an airline snack tray, where portable computers are inclined to get used quite often. And even if you don't think you'll have to import data to your hard drive while you're on the road, how can you back up your data without a floppy? To be fair, we shouldn't single out NEC for this; many notebook computers have the same failing. But that doesn't mean we have to like it.

The UltraLite travels reasonably well. It fits easily inside a briefcase, although a custom carrying case is available as an option. The compressed keyboard is fairly comfortable to use. Like many other laptops, some of the keys are somewhat "squished" to save on space. For example, the function keys across the top row are about half the height of standard keys (although they are the same width.) Unfortunately, the often-used ESCAPE key is also located on the half-sized top row. At the bottom, the cursor keys are also half the standard height, and we were constantly hitting the wrong keys. Although there is no separate numeric keypad, one can be created out of the alpha keys by putting the keyboard in its NUM LOCK mode. An add-on numeric pad is available as an option.

The LCD screen, which can be tilted vertically at any angle, has a small range of angles where it can be viewed, but from head-on, it's pretty good—you don't necessarily want the guy next to you on the airplane to be able to read what's on your screen anyway. The ability to reverse the screen with a combination of keys is a big help.

Our first impression was that the black-and-white VGA screen was sometimes difficult to use. For example, in the game

(Continued on page 18)

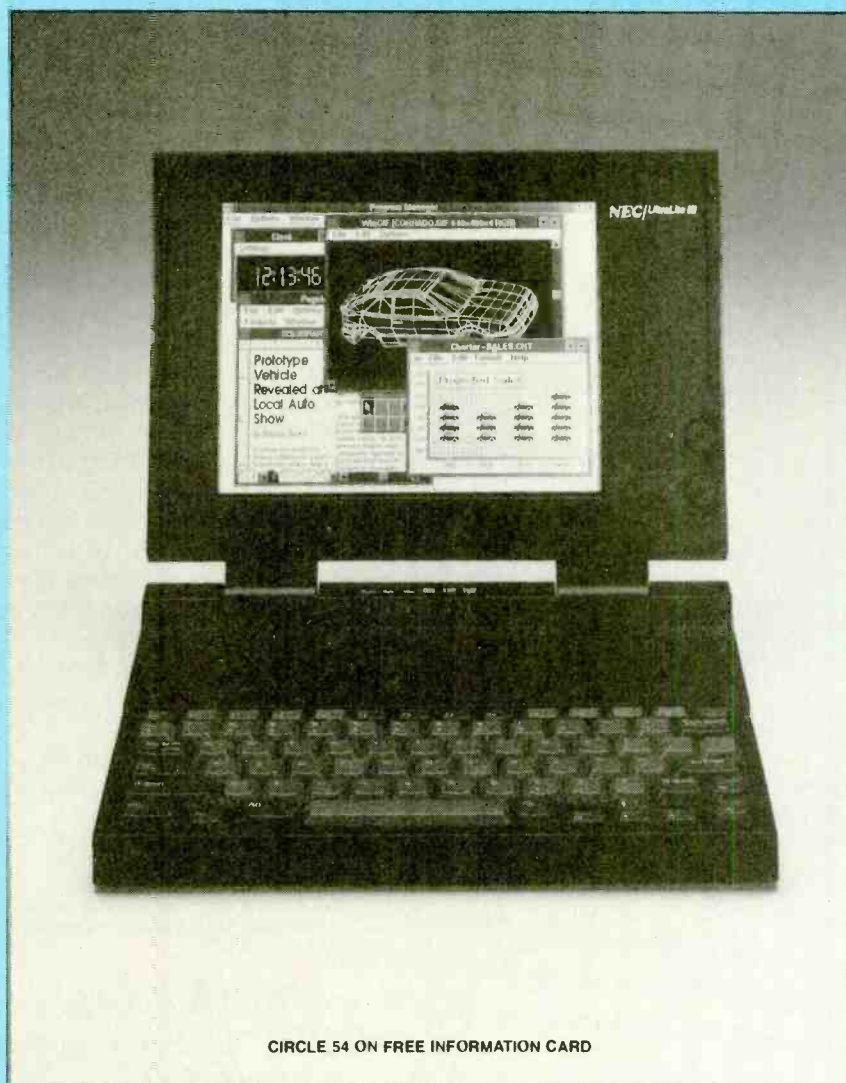

CIRCLE 54 ON FREE INFORMATION CARD



# With NRI hands-on training, you can experience the rewards of a career in computer programming

Now you can get the practical training and experience you need to succeed in computer programming, today's top-growth computer career field.

NRI at-home training gives you real-world programming skills in four of today's hottest computer languages: BASIC, Pascal, C, and COBOL. You get hands-on training that now includes a powerful 386sx/20 MHz mini-tower computer, modem, and programming software ... all yours to train with and keep! Best of all, NRI gives you the programming know-how you need to succeed on the job, in a new career, or in a business of your own.

Job opportunities for the skilled computer programmer will increase by 71.7 percent over the next 10 years according to Bureau of Labor Statistics forecasts. And now, with NRI training, you can be one of the increasing number of computer programmers using their skills to build a top-paying career — even a business of their own — in this professionally and financially rewarding high-tech field.

## ▼ The only programming course that includes a powerful 386sx-based computer system and programming software you keep

Right from the start, NRI training gets you actively involved in the challenge of real-world programming. You learn how to create the kinds of full-featured, powerful programs today's employers and clients demand.

And, unlike any other school, NRI lets you experience first-hand the power of an IBM PC/AT-compatible, 386sx-based computer system, complete with modem, a full megabyte of RAM, disk drive, and monitor — all yours to train with and keep!



Plus you explore the extraordinary capabilities of not one or two but four in-demand computer languages. You learn to design, code, run, debug, and document programs in

BASIC, Pascal, C, and COBOL. In the process you become uniquely prepared for the wide variety of programming opportunities available today.

## ▼ No previous experience necessary

Immediately, you start getting the money-making job skills you need to secure a future in computer programming — no matter what your background. NRI's unique Discovery Learning Method guides you swiftly from computer novice to computer professional with step-by-step lessons covering program design techniques used every day by successful PC programmers.

You'll find no heavy textbooks to plow through. No night classes to attend. Instead, NRI's at-home, step-by-step training covers all the bases, guiding you

from the important fundamentals to real-world methods and techniques. Backed up throughout your course by your experienced NRI instructor, you quickly gain the skills you need to handle a wide variety of programming tasks with confidence. You even use your modem to "talk" to your instructor, meet other NRI students, and download programs through NRI's exclusive programmers network, PRONET.

## ▼ Send today for your FREE catalog

Now you can experience the professional and financial rewards of a career in computer programming. See how NRI at-home training gives you the know-how, the computer, and the software you need to get started in this top-paying field. Send today for your FREE catalog!

If the coupon is missing, write to us as the NRI School of Computer Programming, McGraw-Hill Continuing Education Center, 4401 Connecticut Avenue, NW, Washington, DC 20008.

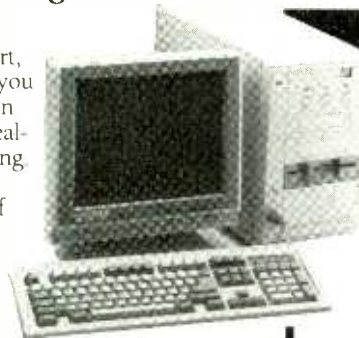
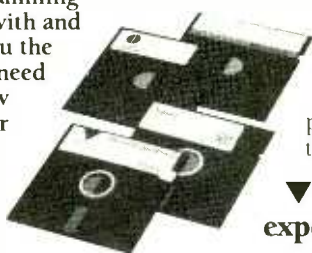

**SEND FOR YOUR FREE NRI CATALOG TODAY!**

## **NRI** Schools

McGraw-Hill Continuing Education Center  
4401 Connecticut Avenue, NW, Washington, DC 20008



### Check one free catalog only

- |   |  |
|---|--|
| <input type="checkbox"/> Computer Programming       | <input type="checkbox"/> Programming in C++ with Windows |
| <input type="checkbox"/> Microcomputer Servicing    | <input type="checkbox"/> Desktop Publishing & Design     |
| <input type="checkbox"/> PC Applications Specialist | <input type="checkbox"/> Bookkeeping and Accounting      |

Name \_\_\_\_\_ Age \_\_\_\_\_  
(please print)

Address \_\_\_\_\_

City \_\_\_\_\_ State \_\_\_\_\_ Zip \_\_\_\_\_

Accredited Member, National Home Study Council

5413-042



## Small Change(r)

CD-C900 CD Changer Bookshelf Stereo System. Manufactured by: Sharp Electronics Corporation, Sharp Plaza, Mahwah, NJ 07430-2135. Price: \$1249.95.

A few years back, we ran across an interesting service being offered in a local record store—personalized audio cassette tapes. No, they didn't come with your name imprinted on them. The store had a system that consisted of dubbing equipment and a catalog of hundreds of songs in various categories (rock, pop, jazz), and you could select the songs that you wanted to have recorded on your personalized cassette. There was a per-song fee that, if we remember correctly, brought the price up to about half again as much as a standard pre-recorded tape.

At first it seemed like a lot to pay for a tape of your favorite songs when you could do the same thing at home. Then we began to consider the hassle entailed in recording tapes from old LP's. First, of course, your component stereo system would have to be configured so that you could record off your turntable to your cassette deck (which always confused the "technically challenged" in our household). Then you'd have to do the math to determine how many songs would fit on a side. Then you'd begin cuing up album after album to obtain a mix of different artists, hoping that none of the LP's were showing the signs of age and abuse—scratches and warping. Finally, there were the problems of leaving a consistent amount of time between selections, and fading in and out those tunes that didn't start or end cleanly.

Those "custom" tapes began to seem more practical. We didn't purchase one (after all, we are avowed do-it-yourselfers, and certainly aren't "technically challenged"), but we could definitely see the appeal they would hold for less-handy music-lovers who weren't willing to spend three hours preparing a C-90 tape.

In the last few years it's become a lot easier to make your own tapes—if you've accumulated a good selection of CD's and a stereo system that includes a CD changer, that is. CD players, including changers, have come down drastically in price, putting them within reach of most consumers. And they needn't be yet another part of a bulky, space-consuming, difficult to set up, component system. CD players and changers are now being incorporated into the popular bookshelf-sized systems that offer all sorts of features intended to simplify CD-to-tape recording.

Well, somehow we've managed to amass an impressive collection of discs in a relatively short time (compared to how long it took us, in our impoverished teens



and twenties, to buy the same number of albums), and we recently got to play and record some of them on the Sharp CD-C900 compact stereo system with CD changer and subwoofer. It was a delight to simply hit the REC/PAUSE button, stick six discs in its magazine, program our selected tracks in the order of our preference, and hit play, to come up with a customized tape. If we'd wanted to simply dub an entire disc to tape, we would only have had to use the system's CD Synchro-dubbing function. But that would have been too easy.

The CD-C900, Sharp's top-of-the-line mini system with CD changer, has much more going for it than easy recording and small size. With its 40-watt-per-channel amplifier—and separate 70-watt powered subwoofer—it's powerful enough to serve as your main audio system, instead of being relegated to the bedroom or den. A full complement of audio and video input and output jacks on the back panel allows the system to be integrated into a total home-entertainment system, and its 63-key remote control can be used to operate the basic functions of a TV and a VCR as well as the tuner, cassette deck, and CD player. A pre-programmed graphic equalizer allows you to quickly adjust specific frequency bands up or down according to the type of music being played, and a 4-mode Sound Expander lets you select acoustics ranging from spacious to narrow.

The compact system consists of five pieces—the subwoofer, a pair of speakers, the CD changer/preamp, and the amplifier/tuner/cassette deck—along with the remote control. The changer and cassette deck are designed to be stacked vertically (with the changer on top), with the subwoofer standing next to them. However, each of the five pieces have the same basic height and width: the components are 6½-inches tall and 11¼-inches wide while the speakers and subwoofer are 11¼-inches

tall and 6½-inches wide. That gives you a lot of arrangement options. For instance, on a long shelf with little headroom, you could place the changer and cassette deck side by side, with the speakers and subwoofer arranged on their sides next to them. Or, to take up the least amount of counter space, you could stack the cassette deck and changer and position the speakers vertically (or even wall-mount the two main speakers). The subwoofer (which Sharp calls a "Super Woofer") features two 4¼-inch drivers in a bass-reflex enclosure. The "main" speakers feature a 4¼-inch woofer, and a 2-inch tweeter.

The top section of the CD preamp unit features a volume control that is similar to a VCR's jog/shuttle control, a large LCD readout, and a set of sound-field/graphic-equalizer controls. The LCD readout keeps you continually informed about all of the system's operations, displaying disc and track numbers, radio station, time and timer functions, sound-field setting, and a "spectrum analyzer."

Five preprogrammed graphic equalizer settings (arbitrarily named classical, jazz, rock, pop, and one simply called flat) and four "sound expander" signal-processing modes (spacious, wide, narrow, and off) are stored in the system's memory. (When the sound expander is set to "off," normal stereo sound is heard.) A four-button cursor pad is used to control the graphic equalizer and sound-field settings. In addition, three buttons are provided for making manual equalizer adjustments, and storing up to four equalizer settings of your own in memory.

We found the sound expander to be most useful depending on the type of listening we were going to do. If we planned to sit at the proper location to listen to music, we preferred to keep the expander off, and hear straight stereo sound. But if we were not able to sit in the preferred location, or if we were going to be moving around, the



expander let us enjoy stereo sound that we otherwise wouldn't have been able to.

The middle section of the top unit contains the CD controls and the magazine slot. The CD magazine holds up to six discs, which, for some reason, must be loaded label-side down, making it a bit awkward to see which disc is in each tray of the magazine. On the plus side, it's compatible with Pioneer changers, and extra magazines are available from many audio dealers. CD functions include Auto Program Search System (APSS), which automatically finds the beginning of each track, and a cue-and-review function, which provides audible fast forward and fast reverse. Other functions include true random play, which plays random songs from all six discs; direct selection of disc and track; and Automatic Programmable Music Selector (APMS), which allows you to select up to 32 specific tracks on one to six discs. (We used APMS when recording from CD's to tapes, with wonderful results.) Once those tracks are programmed, you can play them in order or randomly, or even store them in the system's reserve memory. Up to ten magazines can be stored. When you insert the magazine again, it will be automatically recognized, and only the pre-programmed songs will be played. It's also possible to bypass the programmed tracks and hear all of the songs in their normal order without erasing the tracks from memory.

The random-play function had us a bit perplexed. With different tastes in music, we figured we could avoid arguments by selecting three discs each and setting the system to random play. The first time we tried that, however, the first 12 songs played were from one person's three discs, and after that those three discs still seemed to be "favored" by the system. Subsequent uses of random play found some songs played several times (one even played twice in a row) and others virtually ignored. Despite that, we enjoyed being able to listen to a musical variety for several hours, without interrupting our work, chores, or relaxation to change discs. And we could use the APSS function to find the next random track.

The bottom section of the CD/preamp component contains the main system controls—power switch, function selector buttons, subwoofer control, balance controls, and subwoofer control. Tuner controls are on the top section of the amplifier/cassette unit, and include controls for setting the clock and timer. It's possible to have the radio, tape deck, or CD player come on at a specified time: the volume increases gradually to avoid audio shocks. Up to 30 radio stations can be stored either automatically or manually and recalled along with their modes (stereo or mono). "Auto scan memory" automatically stores

up to 20 FM stations or 10 AM stations at the press of a button; the first 20 (or 10) stations whose signals are strong enough to be clearly detected are placed in memory. More selective listeners can manually store only their favorite stations. Unfortunately, to recall stations, it isn't possible to simply press a numbered key. Instead, you must use the preset up- and down-arrow keys (on the remote or the front panel) to scroll through the programmed stations until you hit the desired one.

The dual-cassette tape deck has the features you'd expect to see on a top-of-the-line unit, including "Auto Program Search System" (APSS), which fast-forwards or fast reverses to the next song on any tape that has a pause of a few seconds between selections; various options for continuous playback between the two decks; and Dolby B noise reduction. As we mentioned earlier, the deck is quite easy to use for recording from CD's; recording from the radio or other tapes is no more difficult. A tape can be dubbed from deck 1 (playback only) to deck 2 (playback or recording) at standard or high speed at the press of a button. The timer control can be used for recording radio programs when you are not at home. (We think that all systems should have that capability—after all, VCR's do!) With the CD-C900's various audio and video inputs, it's also possible to record video soundtracks from a TV or VCR, or songs from albums. Our main complaint about recording is that there is no way to adjust the recording volume, and you can't fade in or out as we like to do at the end of tape.

After a few weeks of listening, a few other complaints about the CD-C900 have cropped up. Most concern the unit's controls: both the front panel and the remote. We found the front-panel buttons to be difficult to see, particularly in low-light situations. Using the remote control was a continual challenge, due to poorly arranged and marked buttons and a fairly narrow (30°) range of operation. The most often used buttons—POWER, MUTE, and VOLUME—are the same size and color as most of the other 60 buttons, and POWER and MUTE are positioned in the upper-left corner, which requires two-handed operation. We would have liked some visual feedback (such as seeing a motorized front-panel volume knob turn) when controlling the volume remotely. The LCD panel, while fine up close, is difficult to read at any distance beyond arm's length.

Despite those control problems, we enjoyed using the CD-C900. It's sound is impressive for a bookshelf system—in fact, it could easily compete with that of many full-size systems. With its audio/video inputs, it could serve even quite nicely as the heart of an apartment dweller's home-entertainment system. ■

## DIGITAL VIDEO STABILIZER ELIMINATES ALL VIDEO COPYGUARDS



While watching rental movies, you will notice annoying periodic color darkening, color shift, unwanted lines, flashing or jagged edges. This is caused by the copy protection jamming signals embedded in the video tape, such as Macrovision copy protection. THE DIGITAL VIDEO STABILIZER: RXII COMPLETELY ELIMINATES ALL COPY PROTECTIONS AND JAMMING SIGNALS AND BRINGS YOU CRYSTAL CLEAR PICTURES.

### WARNING

THE DIGITAL VIDEO STABILIZER IS INTENDED FOR PRIVATE HOME USE ONLY. IT IS NOT INTENDED TO COPY RENTAL MOVIES OR COPYRIGHTED VIDEO TAPES THAT MAY CONSTITUTE COPYRIGHT INFRINGEMENT.

### FEATURES

- Easy to use and a snap to install
- State-of-the-art Microchip technology
- 100% automatic
- Compatible to all types of VCRs and TVs
- The best and most exciting Video Stabilizer in the market
- Light weight (8 ounces) and compact (1x3.5x5")
- Uses a standard 9 Volt battery (last 1-2 years)
- Fast UPS delivery
- Air shipping available
- UNCONDITIONAL 30 day money back guarantee
- 1 year warranty

(Dealers Welcome)

To Order: \$59.95 ea +\$4 for p & h  
Visa, M/C, COD Mon-Fri: 9-6 EST  
**1-800-445-9285** ext. 6314  
FREE 20 Page Catalog  
SCO Electronics Inc. Dept. 6314  
581 W. MERRICK RD. VALLEY STREAM, NY 11580

CIRCLE 11 ON FREE INFORMATION CARD

## CABLE TV DESCRAMBLERS How You Can Save Money on Cable Rental Fees Bullet Proof

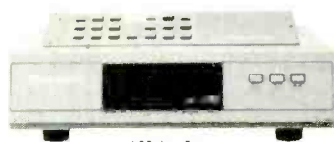

1 Unit 5+

BEST Super Tri-Bi Auto/  
Var. Gain Adjustment \$119.95 \$85  
Jerrold Super Tri-Bi ... \$109.95 \$79  
Scientific Atlanta ..... \$109.....\$79  
Pioneer ..... \$109.....\$79  
Panasonic TZPC145..... \$99.95.....\$79  
Stargate Converter..... \$95.....\$69  
Digital Video Stabilizer. \$59.95.....\$29  
Wireless Video Sender..\$59.95.....\$49.95

US Cable II Beat  
Anyone's Price  
Advertised in  
this Magazine!

**30 Day Money Back Guarantee**  
FREE 20 page Catalog

Visa, M/C, COD or send money order to:  
**U.S. Cable TV Inc.** Dept. 5314  
4100 N. Powerline Rd., Bldg. F-4  
Pompano Beach, FL 33073

**1-800-772-6244** ext. 5314

### For Our Record

I, the undersigned, do hereby declare under penalty of perjury that all products purchased, now and in the future, will only be used on Cable TV systems with proper authorization from local officials or cable company officials in accordance with all applicable federal and state laws. FEDERAL AND VARIOUS STATE LAWS PROVIDE FOR SUBSTANTIAL CRIMINAL AND CIVIL PENALTIES FOR UNAUTHORIZED USE.

Date: \_\_\_\_\_

Signed: \_\_\_\_\_

No Florida Sales!

CIRCLE 12 ON FREE INFORMATION CARD



## PROJECTION TV

(Continued from page 5)

ferently. The light from the lamp passes through a lens to a single, 1-inch LCD panel. Each pixel (or picture element) of the panel comprises three sub-pixels, one red, one green, one blue. Each sub-pixel is either clear or opaque (just like the segments on an LCD watch, only considerably smaller!). What gives it its color is a tiny color filter on each sub pixel!

Although that single-panel technology does keep the size of the projector down, it also reduces the picture resolution when compared with the three-panel system. That's because, with the current manufacturing technology, an LCD can contain only so many pixels. Each of Panasonic's 1-inch panel contains 88,908 pixels for each color (239 pixels vertically, and 372 pixels horizontally), which doesn't measure up to what's possible with 3-inch LCD's. The resulting horizontal resolution of the projector is about 200 lines. That's noticeably worse than what you're probably used to with a good broadcast signal (which can deliver resolutions as high as 330 lines), or the signal from a videodisc player (which can deliver a resolution of about 425 lines—but only on a monitor that has an equal or higher specification). It's only slightly worse, however, than a VHS cassette that was taped in the 6-hour EP mode (which typically provides a resolution of about 220 lines.)

One other problem with the PT-10L when compared to its bigger competitors is that it does not offer any zoom capability. The picture size is determined only by the distance the projector is placed from the screen (or blank wall.) (But unlike any similar projector on the market, the PT-10L can be comfortably mounted on a sturdy camera tripod.)

The picture quality and brightness of the PT-10L doesn't come close to that of today's projection TV's. But Panasonic isn't too worried about that—they're aiming the projector primarily at businessmen who need a toteable large-screen monitor. But we're convinced that LCD technology will play an important role in the future of home TV. LCD manufacturing technology is getting better all the time and—although we don't want to trivialize the problems that still exist—there's no question that LCD's will continue to get better ... and cheaper. Even though we wouldn't choose the PT-10L for our media room, we know many people who would be happy to get a 70-inch TV for a fraction of the cost of anything else available. We also know, however, that the next generation of small LCD video projectors will offer a marked improvement in performance. ■

## VIDEO TO GO

(Continued from page 8)

The unit's telescoping rod antenna measures close to 22 inches when fully extended. If that isn't adequate for good reception in your viewing area, an external antenna jack is provided so that you can add one of the many varieties of antennas sold at—you guessed it—your local Radio Shack store. However, you'll need special miniplug adaptors (not supplied) to connect 75-ohm coax-cable or 300-ohm twin-lead transmission lines to the set. The external antenna jack can also be used to connect the PocketVision-26 to any audio/video component with an RF output, including a cable box, VCR, etc.

Our viewing area, about 30 miles due east of Manhattan, has reasonably poor reception. We had best results on the UHF band, where the PocketVision-26 outperformed several other receivers that were using a "bow-tie" antenna. We were even able to pick up a Manhattan-based community-access channel that we previously didn't even know existed.

Signals that are too weak to be of use are simply passed over by the automatic electronic tuning system. For us, that meant that VHF stations 2 through 6 were bypassed completely when using just the built-in whip antenna. Those stations that did come in, however, came in strong and clear, after just a bit of fiddling with the antenna and the brightness and tint controls. Our computers played havoc with reception, as is to be expected. And moving the small set closer to a window usually resulted in a clearer picture. By adjusting the set's viewing angle and brightness, we were able to get a sharply defined, easy-to-see picture under a variety of lighting conditions—outdoors in daylight, in a darkened room, under fluorescent lights, in a normally lit living room, in a car, and on a train.

But that clear picture can be watched by only one person. You certainly won't be tempted to invite friends over to watch a big game on the PocketVision-26, or to use it for a business presentation. You might, however, want to bring it along to a game, so that you could catch all the play-by-play commentary and instant replays. It's also the sort of set you'd bring to the beach, so as not to miss a baseball game, or into the laundry room, where you could prop it up on its built-in tilt stand to watch Oprah while doing the folding or ironing. And if you like to watch David Letterman before going to sleep, but your spouse wants the lights and TV off by 11:00, the PocketVision-26 and an ear phone could go a long way toward reducing marital tension. ■

## A HEAVYWEIGHT

(Continued from page 12)

Reversi that comes with Windows 3.0, it was very difficult to tell which pieces were blue and which were red. They both appeared in similar shades of gray. Then we realized that Windows—which comes already installed on the hard disk—was set up for a color instead of a monochrome VGA monitor. Using Window's SETUP program, we then set it to its monochrome VGA mode. (We ended up setting it back—most things looked better in the color mode, and we don't make a habit of playing Reversi, anyway.)

Other software that automatically recognizes an installed video adapter would also install itself for a color monitor. That's because the video adapter is, indeed, a color adapter. The UltraLite can support a color VGA monitor as well as the LCD.

The battery that is supplied with the UltraLite III can power the computer for about two hours if you use its power-management features. Of course, disk-intensive programs will discharge power faster. Battery-management features include the ability to set the hard disk to shut down after a period of inaction. You can also reduce the speed of the processor from 20 to 8 MHz. The LCD backlight automatically shuts down after a short period with no keystrokes. If two hours of operation is not enough, an optional battery "slice" will provide 5 hours of operation. For longer trips, though, you'll have to carry the external power supply.

We would expect that many people would opt to buy the optional docking station, which not only provides a power supply, but two half-size (or one full-size) AT-type (ISA) slots, an internal half-height drive bay, and an external drive port, and an external keyboard port. Unfortunately, that combination of options adds at least 10 pounds of weight, and about \$1000 to the cost.

The UltraLite III comes bundled with a healthy assortment of software—all of it already installed on the disk. Of course there's Microsoft DOS 5.0 and Windows 3.0. There's also its own setup program, which allows you to set the power-management, ports, screen modes, etc.

Our version also came equipped with PFS:WindowWorks, which is a spreadsheet, database, chart editor, communications program, label maker, address book, and word processor. But that special offer is scheduled to run out on March 31, soon after this report is published.

If you register the computer by that same date, you'll also receive a free copy of Magic Cursor, a Windows application that lets you change the size and shape of



the Windows cursor. If you've ever used a mouse on an LCD screen—and had trouble finding the cursor—you know that it's not a frivolous program.

Like every other laptop we've ever seen, the UltraLite III makes some compromises. The lack of an internal diskette drive is just one. The tiny front-panel mouse connector that requires a special adapter so that you can plug in a standard (PS/2-type) mouse connector is another. (It doesn't strike us as being too rugged either.) Other external connectors have their own problems. The power connector is supposed to be kept covered when it's not in use. But we'd be surprised if the small plastic cover didn't get lost within the first month. The same goes for the cover for the diskette drive connector.

But when we consider how far desktop computers have come in recent years, we think that it's remarkable that laptops have kept up. Since our work doesn't demand that we own a notebook computer, we'll pass on the UltraLite III. It has to make too many compromises to be so transportable. Nevertheless, it is a remarkable piece of engineering. ■

## TRAVEL PLANNER

*(Continued from page 11)*

stages, making stops in various cities to visit friends and relatives along the way. That's when the second problem with using the Tripmate to plan pleasure trips becomes apparent: Many of the places at which you might want to stop aren't near any major cities. That includes the small town where your college roommate now lives, as well as national parks and monuments. In fact, quite a few places of interest are not even anywhere near any interstates (including Long Island, NY, where we live—an island that measures roughly 100 by 13 miles and is home to several million people).

Despite those problems, we like the idea of keeping a Tripmate in the glove compartment. We frequently take weekend driving trips, and it's good to know where we can fill up the tank and get a bite to eat when we're traveling, and to have emergency phone numbers on hand. And on long trips—especially if there are kids in the car—the Tripmate could prove to be a fun, interesting, and educational distraction, even if you do end up stopping more often than you'd intended. But even if you have a good sense of direction, the Tripmate isn't a sufficient trip planner on its own. Don't throw away those AAA maps, TourBooks, and TripTiks—between those and the Tripmate, even people who get lost going to the supermarket could become successful navigators. ■

NO COMPLICATED ELECTRONICS, NO EXPENSIVE INSTRUMENTS:

## Home study course shows you how to make good money in VCR repair.

An amazing fact: you can do more than four out of five VCR repairs with ordinary tools and basic fix-it procedures. Our home study program shows you how.

Learn all of the systems, mechanisms, and parts of almost all brands of VCRs. With *no* expensive instruments. *No* complicated electronics. *No* fancy workshop. The step-by-step texts and close personal attention from your instructor make learning easy.



Texts, course materials, and tool kit are sent to your home. Graduate ready to make up to \$50.00 or more per hour in your own spare-time or full-time business.

**Send today for your free career booklet. Or call 800-223-4542**

Name \_\_\_\_\_  
Address \_\_\_\_\_  
City \_\_\_\_\_ State \_\_\_\_\_ Zip \_\_\_\_\_

## The School of VCR Repair

2245 Perimeter Park, Dept. VE341, Atlanta, Georgia 30341

## CAMCORDER

*(Continued from page 7)*

the videos you shoot. A Self-Timer recording mode lets you put the UCS1 in a stand-by recording mode. After 10 seconds, it begins recording and continues. A second self-timer mode remains in standby for 10 seconds, records for 30 seconds, and then pauses. Of course, to use a self-timer mode, you have to have a way to hold the camcorder steady. The UCS1 does accept a standard tripod fitting, but in most cases, you won't even need it. It stands rock steady on its flat base. And it's so well balanced that as long as you have a flat surface about 2 inches square, you can reliably rest the camcorder on it except in very windy conditions.

The UCS1 uses fuzzy logic for its auto-focus adjustments. In theory, it's great. The camera makes large adjustments quickly, and then fine tunes as the optimum focus is approached. The focus motor operates at 127 different speeds so that its motion is extremely smooth. But we didn't think it was as fast as we'd like. Any focusing system we've ever seen can be fooled into focusing on the wrong

thing. That's why camcorders allow you to turn the auto focus off. The UCS1 does also, but it does something else that we like even better. If you want to shoot something in the foreground that occupies only a small portion of the frame, the camcorder will tend to focus on the background. In such situations, we normally turn off auto focus and handle it manually. With the UCS1, we can leave the auto-focus on, but turn the manual focus ring to momentarily take manual control. If we then focus on the foreground subject that we want, the camera will again take over the auto-focus chores, but maintain proper focus on the foreground!

We still haven't mentioned all of the features that Canon managed to squeeze into their 2-pound UCS1 package. Things like its AFM hi-fi stereo audio recording, its ability to fade scenes in and out, its microphone's "zooming" capability, and its LANC connector that makes it compatible with a good deal of editing equipment. We also haven't pointed out all of its weak points, such as the inability to dub audio on the digital PCM audio track, and the lack of a manual zoom ring. But the UCS1 has so much going for it that it's difficult to focus on any negatives. It's one super, super-small camcorder. ■



# ELECTRONICS WISH LIST

For more information on any product in this section, circle the appropriate number on the Free Information Card.



**B.I.C. Bookshelf Speakers**

## **Bookshelf Speakers**

*B.I.C. America (895 East Hampshire Road, Stow, OH 44224)* promises big-speaker performance from its small-package V62A bookshelf loudspeaker. The V62A is a two-way system with a high-performance 6-inch woofer and ¾-inch ferro-fluid cooled soft-dome tweeter. It features the Venturi venting system, a newly designed woofer that is said to produce deeper performance in the extreme low-frequency range, and an improved crossover network that is said to provide a more natural midrange response and extended high-frequency response. The V62A measures 14 × 8¾ × 9¾ inches. Price: \$219/pair.

**CIRCLE 56 ON FREE INFORMATION CARD**



**Sony UX Turbo Cassette Tape**

## **One for the Road**

One of the reasons that audio cassettes remain America's most popular listening medium is that so many car audio systems contain tape decks. *Sony Corporation of America (Sony Drive, Park Ridge, NJ 07656)* has introduced a cassette designed specifically for automotive use. The *UX Turbo* features UX-S Type II high-bias tape housed in a heat-resistant shell that resists warping—which can cause problems during loading or ejecting—even under extremely high temperatures. In addition to the shell, the protective cassette case, the cassette window, and the hubs are capable of withstanding temperature extremes. The highly rigid cassette shell effectively reduces vibrations that can cause modulation noise. A raised identification mark makes it possible to distinguish sides A and B by touch alone so you can keep your eyes on the road while you fumble with your music. Price: \$2.99, \$3.99, and \$4.99 for 60-, 90-, and 100-minute lengths, respectively.

**CIRCLE 57 ON FREE INFORMATION CARD**



**Velbon Video Lights**

## **"Smart" Video Lights**

*Smartlites from Velbon International (2433 Moreton Street, Torrance, CA 90505)* are so named because they automatically turn on when the camcorder begins taping and shut off when taping ends. Such efficiency can eliminate the need for separate batteries and battery packs. The lights, which come in three styles, each weigh just 4.2 ounces. They are made with various plate designs to fit specific cameras of 11 different manufacturers, including 8mm and VHS-C units made by Sony, Fuji, Ricoh, Kyocera, Sanyo, Olympus, and Pentax. The lights can bend at a 90-degree angle to accommodate certain horizontally designed cameras. Price: \$59.95.

**CIRCLE 58 ON FREE INFORMATION CARD**



**NAD CD Player**

## **Compact-Disc Player**

Offering several features unexpected in a low-priced CD player, the *NAD 5425* from *NAD (division of Lenbrook Industries Ltd., 633 Granite Court, Pickering, Ontario, L1W 3K1, Canada)* also features such basic conveniences as 16-track random-access programming, bi-directional track skip, audible fast-search, 3-inch CD-single compatibility, and a wireless remote control. It also has a low-inertia three-beam laser pickup/disc drive that is said to substantially upgrade track-access and -search speeds while ensuring stable playback with minimal jitter. In addition, extra attention has been paid to other critical elements of the CD player, including power supplies, circuit layouts, analog-section topology, and component choices. Price: \$299.

**CIRCLE 59 ON FREE INFORMATION CARD**



For more information on any product in this section, circle the appropriate number on the Free Information Card.

# ELECTRONICS WISH LIST

## Personal Stereo/Pedometer

Do you listen to music as you jog or walk? *Sanyo* 21350 Lassen Street, Chatsworth, CA 91311-2329) has come up with a way for you to keep track of how far you've traveled—and enjoy listening to the radio or cassette tapes at the same time. The *SPT1000 Sportable* is a portable AM/FM cassette player with a built-in pedometer. The pedometer offers separate exercise settings in the walking, speed walking, and jogging modes. Once you input your measured stride, targeted distance, and average pace, the unit will begin to calculate the steps taken, pace, and distance covered. When you push the start/stop button, the Sportable is ready to record each impact of your feet to make its calculations. An LCD readout displays all exercise functions, as well as the set time. To help you keep up with the set pace, pushing the pace button sends an audible intermittent tone to the headphones for 15 seconds. To keep you informed of how far you've gone, the Sportable gives a short beep at the 1 mile (or 1 kilometer) point, two beeps at 5 miles (or 5 kilometers), and another beep when you reach your target goal. You can use the clock/stopwatch function to temporarily freeze the readout for the lap time, or stop the clock at the finish line for the total elapsed time. The AM/FM cassette receiver offers a "BASSXpander" enhanced sound system and headphones for improved bass frequency response, and an extended AM band accesses the newly approved frequencies between 1600 and 1710 kHz. Price: \$54.99.

CIRCLE 60 ON FREE INFORMATION CARD



Sharp Personal Stereo/Pedometer



**H**old a piece of tape up to your eyes, dim the lights and try to fill out your taxes.

Now you're seeing things from her point of view.

Almost everybody has to file taxes, but not everyone can do it on their own. Volunteer and help make someone's taxes less taxing. Call 1 800 424-1040.



## LEARN to CLEAN/MAINTAIN/REPAIR CAMCORDERS



### HUGE EXPANDING MARKET!

Work from your home—part-time or full-time! No prior experience needed—Average mechanical ability only requirement for your success! Over 15 million camcorders in use—Over 5 million expected to be sold in 1991 alone!

It is a fact that the vast majority of camcorder malfunctions (just like VCRs!) are due to simple mechanical failure... We can show you how to easily fix those breakdowns and earn an average of \$85.00/Hr. while working at home!

**Get In Now**—Soon camcorders will be like VCRs, i.e., one in almost every home.

For a camcorder cleaning job you can earn \$65.00 or less than 30 minutes work.

For a camcorder repair job you can earn over \$100.00.

**FREE INFORMATION PACKAGE call or write:**  
Toll-Free 1-800-537-0589  
Viejo Publications, Inc.  
4470-107 Sunset Blvd. #600  
Los Angeles, CA 90027, Dept. PEC

CIRCLE 10 ON FREE INFORMATION CARD

## SUPER LONG PLAY TAPE RECORDERS

12 Hour Model — USES 120 TAPE \$119.00\*

Modified Panasonic Slimline, high quality AC-DC provide 6 continuous hours of quality recording & playback on each side of cassette for 12 hours total. Includes • Voice level control • Digital counter, etc. TDK — 120 Cassette Furnished.



### PHONE RECORDING ADAPTER

Records calls automatically. All Solid state connects to your telephone jack and tape recorder. Starts recording when phone is lifted. Stops when you hang up. \$28.50\*



### VOX VOICE ACTIVATED CONTROL SWITCH

Solid state. Self contained. Adjustable sensitivity. Voices or other sounds automatically activate and control recorder. Uses either recorder or remote mike. \$28.50\*



\* Add for ship. & handling Phone Adapter & Vox \$2.00 each. Recorders \$5.00 each. Calif. Res. add tax. Mail order. VISA available. Dealer Inquiries invited. Free data.  
**AMC SALES INC.** Dept. B 9335 Lubec Street  
Box 928 Downey, CA 90241  
1-800-926-2488  
Phones (310) 869-8519 1-800-926-2488  
FAX (310) 923-1478  
Mon-Fri 8-5 P.M. TIME

CIRCLE 7 ON FREE INFORMATION CARD



# ELECTRONICS WISH LIST

For more information on any product in this section, circle the appropriate number on the Free Information Card.



Royal Personal Organizer

## Getting Organized

You can get your act together without breaking the bank with the entry-level *DM100* personal organizer from *Royal Consumer Business Products* (Division of Olivetti Office USA, 765 Highway 202, P.O. Box 6945, Bridgewater, NJ 08807-0945). The easy-to-use organizer guides you through the use of icons that indicate various functions such as telephone, memo, calendar, schedule, conversions, and home. It has 16K of memory, which allows it to store more than 1200 entry lines. Other features include a 3-line-by-12-character display, a positive-touch keyboard with audible tone, a clock that keeps both local and world time for 23 cities, a 10-digit calculator, and a memory-check to display available memory. Price: \$69.95.

CIRCLE 61 ON FREE INFORMATION CARD

## The Sonny TrackMan

There must be plenty of folks who still have eight-track tapes taking up space in the back of their closets. Well, dig them out and dust them off: *Sonny Corporation* (One Sonny Plaza, Sonnyvale, PA 15111) has introduced the *Trackman SC-77* portable eight-track player. Now you can take those memorable sounds of the 70's anywhere you want to go, from the office to the discotheque. Weighing in at only twelve ounces, the *TrackMan* is just as light and portable as most personal cassette players. Its frequency response is also up to modern standards, although that might be difficult to prove unless you can find an eight-track tape that was recorded within the last ten years. Sonny obviously intends to capture the sorely neglected "outdated-technology pack-rat" market. To that end, the company plans to sell a Beta version of the increasingly popular personal TV/VCR devices in the near future. Price: \$64.95.

CIRCLE 4/1 ON FREE INFORMATION CARD

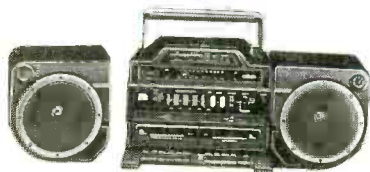

Sanyo Portable Stereo

## Boom Box for the '90's

With sleek styling, a four-band graphic equalizer, and a CD player along with its double cassette deck and AM/FM radio, the *MCD-S800* portable stereo from *Sanyo* (21350 Lassen Street, Chatsworth, CA 91311-2329) is a modern version of the boom box. The CD player offers 16-selection programming, and the cassette deck offers high-speed tape-to-tape synchronous dubbing, and continuous play from deck A to deck B. For improved stereo sound separation, the unit offers a 2-way, four speaker system with bass reflex ports; Sanyo's "BASSXpander" technology adds intensity to bass response by enhancing the frequencies at the lower end of the audio spectrum. Price: \$199.

CIRCLE 63 ON FREE INFORMATION CARD

## "Picture-Frame" Antenna

Most of us would prefer to look at a photograph of family members or a fondly remembered vacation scene than at an unsightly indoor TV antenna. Now we can have our photo and our reception too, with *Recoton's* (46-43 Crane Street, Long Island City, New York 11101) *TV 700 Picture-Frame Antenna*, which combines a VHF/UHF and FM antenna with a space to hold a picture of your choice. It features twin, four-section telescoping dipole rods that are fully adjustable. A slide tuning bar provides fine-tuning control. The UHF loop wraps around the picture frame inconspicuously, and the 6x6-inch picture area is protected by clear plexiglass. Price: \$39.95.

CIRCLE 64 ON FREE INFORMATION CARD



Recoton Picture-Frame Antenna



# Why take chances in today's job market?

## Graduate as a fully trained electronics professional.

To get ahead and stay ahead in today's economy, you need the electronics training CIE has been providing its 150,000-plus successful graduates with for nearly 60 years.

### Meet the Electronics Specialists.

When you pick an electronics school, you're getting ready to invest time and money. And your whole future depends on the education you receive in return. That's why it makes so much sense to go with number one... with the specialists... with CIE!

### There's no such thing as a bargain education.

If you talk to some of our graduates, and we recommend you do, chances are you'd find a lot of them shopped around for their training. Not for the lowest priced, but for the best training available. They pretty much knew what was available when they picked CIE as number one.

### Because we're specialists we have to stay ahead.

At CIE we have a position of leadership to maintain. Here are just a few of the ways we hang onto it...

### Programmed Learning.

That's exactly what happens with CIE's Auto-Programmed Lessons\*. Each lesson uses famous "programmed learning" methods to teach you important electronics principles. You explore them, master them completely, before you start to apply them. You thoroughly understand each step before you go on to the next. You learn at your own pace.

And, beyond theory, some courses come fully equipped with electronics equipment to actually let you perform hundreds of hands-on experiments.

### Experienced specialists work closely with you.

Even though you study at home, CIE's faculty and staff stand ready to assist via CIE's toll free number. And, each time you return a completed exam you can

be sure it will be reviewed, graded and returned with the appropriate instructional help, you get it fast and in writing from the faculty technical specialist best qualified to answer your question in terms you can understand.

### Pick the pace that's right for you.

CIE understands people need to learn at their own pace. There's no pressure to keep up...no slow learners hold you back. If you're a beginner, you start with the basics. If you already know some electronics, you move ahead to your own level.

### "Same Day" grading cycle.

When we receive your lesson, we grade it and mail it back the same day. You find out quickly how well you're doing!

### State-of-the-art laboratory equipment.

Some courses feature the CIE Microprocessor

Training Laboratory. An integral part of computers, microprocessor technology is used in many phases of business, including service and manufacturing industries. The MTL gives you the opportunity to program it and interface it with LED displays, memory devices and switches. You'll gain all the experience

needed to work with state-of-the-art equipment of today and tomorrow.

### New Courses!

CIE now offers two new career courses: Automotive Electronics and Computer Operation and Programming.

### CIE offers you an Associate Degree.

One of the best credentials you can have in electronics — or any other career field — is a college degree. That's why CIE offers an Associate in Applied Science in Electronics Engineering Technology. And all CIE career courses earn credit toward your degrees.

### Which CIE training fits you?

Beginner? Intermediate? Advanced? CIE home study courses are designed for ambitious people at all entry levels. People who have: No previous electronics knowledge, but do have an interest in it; Some basic knowledge or experience in electronics; In-depth working experience or prior training in electronics.

At CIE you start where you fit and feel comfortable where you start, then go on from there to your Diploma, Associate Degree and career!

### Today is the day. Send now.

Fill in and return the postage-paid card attached. If some ambitious person has already removed it, cut out and mail the coupon below. You'll get a FREE CIE school catalog, plus complete information on independent home study. Mail in the coupon below or, if you prefer, call toll-free 1-800-321-2155 (in Ohio, 1-800-523-9109).



**YES!** I want to get started. Send me my CIE school catalog including details about the Associate Degree program. (For your convenience, CIE will have a representative contact you — there is no obligation.) **AH27**

Print Name \_\_\_\_\_

Address \_\_\_\_\_ Apt. \_\_\_\_\_

City \_\_\_\_\_ State \_\_\_\_\_ Zip \_\_\_\_\_

Age \_\_\_\_\_ Area Code/Phone No. (\_\_\_\_\_) \_\_\_\_\_

Check box for G.I. Bulletin on Educational Benefits  Veteran  Active Duty

**CIE** CLEVELAND INSTITUTE OF ELECTRONICS, INC.  
1776 East 17th Street • Cleveland, Ohio 44114 • (216) 781-9400



A school of thousands.  
A class of one.  
Since 1934.



# PRODUCT TEST REPORTS

By Len Feldman

## Memorex Model 87 Video Cassette Recorder



*The Memorex Model 87 VHS VCR is a feature-packed, low-cost unit. It is sold exclusively at Radio Shack stores.*

Comedians take pleasure in noting that 80% of American VCR owners have never programmed their video recorders to record a TV show at some future time. That's true because although many recent-model VCR's feature simple, on-screen programming, most basic units as well as nearly all older models require the user to follow an often complex

procedure using barely visible buttons on the front panel of the VCR to use its timer functions. But Memorex is doing its part to correct that situation with a new, relatively low-cost VCR that offers on-screen programming as well as many other desirable features.

The Memorex Model 87, which is available exclusively at Radio Shack stores nationwide, features four, double-azimuth video

heads for more stable special effects (freeze-frame, slow-motion, and high-speed viewing). The built-in tuner covers a total of 179 VHF, UHF, and cable-channel frequencies. A tuner "memory-programming" feature automatically stores all the active channels in your area into memory.

If you insert a video tape whose erase-protection tab has been removed, playback starts immediately and, at the end of the tape, the cassette is rewound and ejected automatically. A real-time counter displays the actual time a tape plays and records and a "blank search" system lets you quickly locate the end of a previous recording on a tape that hasn't been fully recorded.

Special effects capabilities include visual search during fast forward and fast rewind, variable-speed slow motion and freeze-frame viewing. Unlike many late-model VCR's that can only record at two speeds, the Model 87 records and plays at three speeds (SP, LP, and EP, for a maximum of 8 hours of recording on a T-160 tape or 6 hours when using a T-120 tape).

A full-function remote control is supplied with the unit. The remote provides access to all tape-motion functions, as well as to most other control functions.

And let's not forget those on-screen programming functions: On-screen programming lets you easily program up to six events

within a one-year period. Daily and weekly recordings can also be programmed. A "quick timer" recording feature lets you start a recording immediately or within the next 24 hours and stops the recording function after the time you specify.

Speaking of features, we should point out that there is an error in the description of the Model 87 in Radio Shack's 1992 catalog. The catalog states that the unit offers automatic head cleaning and auto tracking. While the recorder is loaded with features, those two are *not* among them. Radio Shack discovered the error after the catalogs were distributed.

### CONTROLS

The front panel of the Model 87 is equipped with a power on/off switch; a cassette-eject button; a TV/CATV selector; channel-up and channel-down buttons; and record, play, stop, fast-forward, and rewind buttons. All those functions can also be controlled from the supplied remote control, as can many additional ones including tape-speed selection, timer programming, clock setting, direct tuning (accessing the TV channels by number), programming the tuner memory, tape-blank search, slow-motion viewing, and counter-memory setting.

The rear panel of the Model 87 is equipped with audio and video input and output jacks, RF (antenna) input and output coaxial



connectors, and the usual Channel 3/4 selector. The well written 41-page owner's manual clearly describes the various ways you can connect the VCR to your TV set and other optional equipment such as a video or color processor. Connection schemes for cable-TV subscribers are also clearly described and well illustrated. In fact, the entire owner's manual could serve as a good example to other manufacturers as to how such manuals should be written.

## TEST RESULTS

Advanced Product Evaluation Labs (APEL) supplied all the test data for this report. They found that the record/playback response of this VCR, using the fastest tape speed (SP), was about average for a conventional VHS unit. At 2.0 MHz, attenuation of video response was  $-2.10$  dB, while at 3.0 MHz, the attenuation was already  $-15.0$  dB. In terms of picture resolution and detail, that means that video programs recorded at this speed will fall short of having the detail available from broadcast TV. Note that this is not unusual performance for a standard VHS recorder.

The chroma video signal-to-noise ratio is measured by APEL in two ways: in terms of AM modulation and in terms of phase modulation of the color signal. For this sample, the AM chroma signal-to-noise ratio measured a high 45.5 dB, while the phase-modulation signal-to-noise ratio measured an average 39.4 dB. The luminance signal-to-noise ratio, which determines the level of the more obvious type of noise (normally described as "snow") in the picture, measured between 43.4 and 43.5 dB, depending upon the lumi-

## TEST RESULTS—MEMOREX MODEL 87 VIDEO CASSETTE RECORDER

Specification	Manufacturer's Claim PE Measured	
Video frequency response	N/A	$-2.1$ dB @ 2.0 MHz
(at 3.0 MHz)	N/A	$-15.0$ dB
Video S/N ratio (weighted)	55 dB	43.5 dB*
Red chroma S/N (AM/PM)	N/A	45.5/39.4 dB
Audio output	$-10$ dBv (0.3V)	0.48 volts
Audio THD @ 0 dB	N/A	2.15%
Peak wow-and-flutter	N/A	0.25%
Average wow-and-flutter	N/A	0.23%
Audio signal-to-noise ratio	N/A	50.8 dB
Audio frequency response (SP)	60 Hz to 11 kHz	110 Hz to 13 kHz
Audio THD @ $-10$ dB	N/A	0.43%
Power consumption	25 watts	22.5 watts
Weight	11.6 lbs	Confirmed
Dimensions (H x W x D, inches)	$3\frac{3}{8} \times 14\frac{1}{8} \times 13\frac{1}{8}$	Confirmed
List price:	\$319.95	

\*APEL's method of measurement differs from that of Memorex.

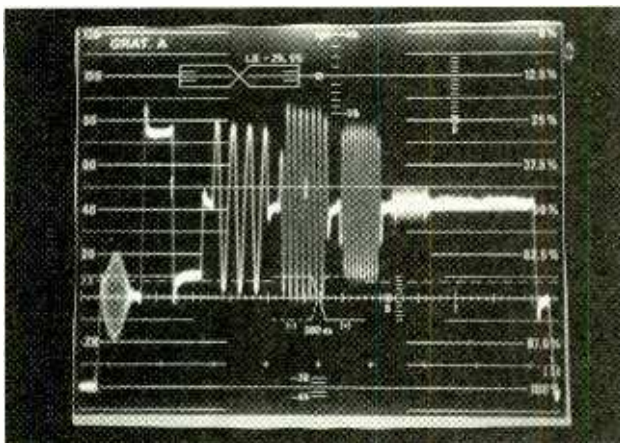

At SP speed, video response was down  $-2.1$  dB at 2 MHz, and at 3 MHz, video response was attenuated  $-15$  dB. This performance is typical of standard VHS VCR's.

nance (brightness) level used as a reference for the measurement. This is better than the average usually obtained from standard VHS models.

Turning to the audio record/play performance of this mono, non-hi-fi unit, APEL found that audio output level at 1 kHz measured 0.48 volts at a total harmonic distortion level of 2.15%. Wow-and-flutter was rather high, measuring 0.23% average and 0.25% peak. By way of comparison, a

top quality audio-cassette recorder will typically have wow-and-flutter levels of 0.1% or lower.

Considering the fact that this VCR is not equipped with any form of audio-noise reduction system, the audio signal-to-noise ratio was quite good, measuring 50.8 dB. The audio frequency response, for the  $-3$ -dB roll-off points, extended from 110 Hz to 13.0 kHz. The treble response was far better than what we have come to expect from the

linear audio-recording system used on VHS machines such as this. The total harmonic distortion measured for a 1-kHz signal at  $-10$ -dB recording levels was also quite acceptable, measuring 0.43%. We should note that all of APEL's measurements were made at the preferred SP tape speed. As with any VCR, both the audio and video performance levels would be poorer at the slower LP or EP tape speeds.

## HANDS-ON TESTS

In using the Memorex Model 87 VCR, we were particularly impressed with the fast response of the tape-loading system. Not only does the tape begin to play back in far less time than you would typically expect from a VHS-format VCR, but the tape transport itself was extremely quiet.

The menu system displayed on the connected TV-set's screen was easy to follow, both for clock setting and for timer programming. We liked the feature that enabled not only immediate recording, in 30-minute increments, but the ability to do "quick-timer" recording over the next 24 hours without having to go through all the steps involved in long-term future programming for unattended recording. We doubt whether anyone would actually program a VCR a full year in advance, but of course there's no harm (and probably no extra cost) in providing such long-term programming.

The Memorex 87 VHS VCR (Radio Shack catalog no. 16-525) retails for \$319.95. For more information on the unit visit your local Radio Shack store, contact Radio Shack (1700 One Tandy Center, Ft. Worth, TX 76102) directly, or circle 120 on the Free Information Card. ■





# FLUKE SERIES-10 DIGITAL MULTIMETERS



CIRCLE 119 ON FREE INFORMATION CARD

*With their low-cost Series-10 multimeters, everyone can now afford Fluke's legendary quality.*

The common multimeter has become the number-one tool for electronic troubleshooting. Sometimes special equipment is needed for a particular job, but you'll always need a multimeter as well. Perhaps that's why a multimeter is usually the first piece of test equipment that an electronics buff will purchase. The price of a multimeter is usually low enough to justify its purchase, even if it might be used only once in a while.

You'll find many multimeters on the market for less than \$100, many of them jam-packed with features. However, when reconciling a low price with abundant features, quite often the quality of the meter has to suffer. Multimeters are like anything else—the more whistles and bells you throw into one, without increasing its list price, the lower the quality.

Also consider that the whistles-and-bells features may rarely (if ever) be used. That's because you're more likely to use a test instrument of greater accuracy and range for test procedures requiring specialized measurements. For example, some multimeters are able to measure frequen-

cy, but most applications require the greater accuracy and range afforded by a true frequency counter anyway. So the money spent on that particular feature of the multimeter may have gone to waste.

While all-capable multimeters of poor quality might be okay in places where their use is intensive and they are frequently replaced (like a factory), they are definitely not a good choice for a first-time buyer, or a person who does limited testing in a harsh environment. Such consumers should look for a quality unit that will provide years of service and be resistant to damage, the elements, and so on. The problem has long been that quality instruments have a high price tag. Take Fluke for example. People know that any meter they make is a good, high quality instrument. They also know that they'll have to pay a bit more for one—until now . . .

Introducing the Series-10 digital multimeters from Fluke. There are three different models in the Series-10 lineup: Models 10, 11, and 12, ranging in price from \$69.95 to \$89.95. The three meters are designed without

seldom-used features, but they completely live up to the Fluke reputation for quality and safety.

All the meters in the series have short-circuit and over-voltage protection—for the user and the meter itself—which makes them ideal for a first-time buyer. The meters are also good for the infrequent user, since they are sure to work even after months of collecting dust in a closet. Field technicians will appreciate the Series-10 meters because they have an uncluttered front panel with true one-handed operation, they are very compact and take up little space in the tool box, and they're rugged enough to make it back from the field time and time again.

**Features.** The Fluke model 10, and all Series-10 models can measure up to 600 volts (AC or DC) and resistance up to 40 megohms in either autoranging or manual ranging modes. They can also perform diode and audible continuity tests. However, none of the units measure current.

The Model 11 includes all of the features we mentioned along with ca-



capacitance-measuring capability up to 9999  $\mu\text{F}$ . Another feature found in the Model 11 is Fluke's exclusive "V-Chek" function; while the meter is in the ohms/continuity mode, the V-Chek feature automatically lets the user know if a voltage is present between the probes. It also tells the user if the circuit is open, continuous, or if more than 4.5 volts is present. If such a voltage is detected, the meter displays either AC or DC volts, whichever is greater. The V-Chek function has a low input impedance of 2k. That eliminates false readings by draining any "phantom voltage" from a nearby circuit, giving a true picture of the voltage present. By the way, the V-Chek function is disabled when the meter is in its manual-range mode.

The Model 12 contains all of the features we've mentioned so far and adds a "Min/Max" recording mode with a relative time clock. In that mode, the meter records the highest and lowest voltage occurring over time, and an internal clock records the time when those points occurred during a 100-hour period. Also, when the Model 12 is in the continuity mode, the recording feature will capture and display opens or shorts that occur for as little as 250  $\mu\text{s}$ ; that feature is useful when hunting for intermittent glitches.

**Use.** We had a Fluke-12 meter on hand so that all of the features found in the entire Series-10 lineup could be tested. The meter came with a 9-volt battery installed, a pair of rugged test leads, and an easy-to-understand users manual. As soon as you pick up the meter you can tell that a lot of thought went into the design. It comfortably fits in the palm of either hand and all controls can be operated with your thumb—truly one-handed operation. The test leads plug into the bottom of the unit, and since there's no provision for measuring current, you'll never have to move the leads.

The Fluke 12's LCD readout not only tells you what quantity you're measuring, but it also provides a quick visual indication of other functions as well—if the meter is in manual or autorange mode, if V-Chek is enabled or disabled, if the Min/Max mode is on or not, and if the battery needs to be replaced.

One click to the right on a slide

switch and the meter is turned on in the voltage mode, two clicks places the meter in continuity/ohms mode. If the meter is left on but inactive for more than 45 minutes it enters "standby mode" in which the display will blank in order to conserve battery power. That's good for those of us who forget to shut off our meter rendering it useless the next time it's needed! Naturally the standby mode does not work when the meter is in the Min/Max mode.

When you turn on the meter, it automatically goes into the autorange mode. You can manually select a range by pressing the range-control button. The first time you press it locks the meter in the range that it's already in. Pressing the range button successive times steps you through the ranges, and holding the range button down for more than two seconds will return the meter to the autorange mode.

When measuring voltage, a toggling "select" pushbutton switches the meter between AC and DC mode. Also, while measuring voltage in manual mode, you can easily switch from high input impedance (5 megohms for AC and 10 megohms for DC) to low input impedance (2k) by moving the slide switch to the continuity/ohms position. During low impedance operation "LoZ" is displayed on the readout as a reminder.

To test for continuity and resistance, you simply put the slide switch in the ohms/continuity position, and toggle through the continuity/diode and ohms functions using the select button. If less than 25 ohms is measured, the continuity beeper will sound. When checking diodes, a forward drop of about 0.6 volts, which is typical for a silicon diode, will cause the meter to beep once. When you reverse the probes, a good diode will give an "OL" reading.

The V-Chek function on the model 11 and model 12 is always enabled when the meter is in the ohms/continuity mode, except if you are in a manual range or if the Min/Max or capacitance indicator is displayed. Whenever resistance is being measured, and the meter detects more than 4.5 volts, the display will indicate "AC" or "DC" and "LoZ," and sound the V-Chek beeper. The V-Chek function can also be disabled if you find the

beeping sound it generates to be distracting to you.

Capacitance is easily checked by putting the slide switch in the capacitance position and pressing the capacitance button until " $\mu\text{F}$ " is displayed. If the capacitor must first be discharged before an accurate measurement can be taken, the meter will display "dISC" while doing so.

The Min/Max function (without time recording) is easy to use, you just have to press the Min/Max button. When in that mode, if the reading changes by more than 50 digits, the meter will let out a short beep. When a new minimum or maximum reading is detected, a longer beep is heard. You can then cycle through the maximum, minimum, and present readings by successive presses of the Min/Max button. When you exit the Min/Max mode by depressing the Min/Max button for more than 2 seconds, the stored readings are erased.

The Min/Max mode with time recording is entered by holding down the Min/Max button while moving the slide switch from off to the volts or continuity/ohms position. After connecting the leads to the test circuit, pressing the Min/Max button will set the time to 00:00. After letting the meter run for the desired amount of time (up to 99 hours), you can toggle through the minimum and maximum readings, and the meter will display the time that elapsed between starting the test and the occurrence of each voltage.

To test for intermittent continuity, the Fluke 12 can capture open-to-short and short-to-open transitions as brief as 250  $\mu\text{s}$ , by entering the Min/Max mode while the slide switch is in the continuity/ohms position. If the meter detects such a transition, a graphical representation of a rising or falling waveform edge is displayed. Transitions after that only cause the meter to beep.

The Fluke 12 certainly has a lot of features for a meter costing only \$89.95. However, no matter what model you choose in the Series-10 lineup, you are sure to receive years of trouble-free service from it. For more information on the Series-10 multimeters, contact John Fluke Mfg. Co., Inc., PO Box 9090, Everett, WA 98206; Tel. 206-347-6100, or circle 119 on the Free Information Card. ■



# Electronics Paperback Books

GREAT PAPERBACKS AT SPECIAL PRICES

**BP248—TEST EQUIPMENT CONSTRUCTION** ..... \$5.95. Details construction of simple, inexpensive, but extremely useful test equipment. AF Gen, Test Bench Ampl, Audio Millivoltmeter, Transistor Tester and six more.



How to Use Oscilloscopes and Other Test Equipment



**BP267—HOW TO USE OSCILLOSCOPES AND OTHER TEST EQUIPMENT** ..... \$6.95. Mastering the oscilloscope is not really too difficult. This book explains all the standard controls and functions. Other equipment is also described.

**BP265—MORE ADVANCED USES OF THE MULTIMETER** ..... \$5.95. Use these techniques to test and analyze the performance of a variety of components. Also see how to build add-ons to extend multimeter capabilities.



**BP256—INTRO TO LOUDSPEAKERS AND ENCLOSURE DESIGN** ..... \$5.95. We explore the variety of enclosure and speaker designs in use today, so the reader can understand the principles involved.

**CMOS—CMOS POCKET GUIDE 1** ..... \$18.95. Works like the TTL Guides but covers all commonly used CMOS standard devices. Six major sections. The first shows the device schematic. Next is a brief description of the component and is followed by full operating details. The fourth section lists major applications, while the 5th and 6th sections present essential data for that device and a list of the relevant manufacturers. The final two sections are a valuable cross-reference.



**BP299—PRACTICAL ELECTRONIC FILTERS** ..... \$6.95. Presents a dozen filter-based practical projects with applications in and around the home or in the constructor's workshop. Complete construction details are included.



**BP249—MORE ADVANCED TEST EQUIPMENT CONSTRUCTION** ..... \$6.95. Eleven more test equipment construction projects. They include a digital voltmeter, capacitance meter, current tracer and more.



Digital Audio Projects

**BP245—DIGITAL AUDIO PROJECTS** ..... \$5.95. Practical circuits to build and experiment with. Includes A/D converter, input amplifier, digital delay line, compander, echo effect and more.



**BP247—MORE ADVANCED MIDI PROJECTS** ..... \$5.95. Circuits included are a MIDI indicator, THRU box, merge unit, code generator, pedal, programmer, channelizer, and analyzer.



**BP257—INTRO TO AMATEUR RADIO** ..... \$6.95. Amateur is a unique and fascinating hobby. This book gives the newcomer a comprehensive and easy to understand guide to the subject.

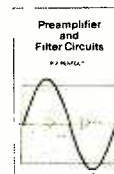

**BP309—PREAMPLIFIER AND FILTER CIRCUITS** ..... \$6.95. Provides circuits and background info for a range of pre-amplifiers, plus tone controls, filters, mixers and more. All are high-performance circuits that can be built at a reasonable cost.

**BP303—UNDERSTANDING PC SOFTWARE** ..... \$6.95. This book will help you understand the basics of various types of business software in common use. Types of software covered include word processors, spelling checkers, graphics programs, desktop publishing, databases, spreadsheets and utilities.



**BP251—COMPUTER HOBBYISTS HANDBOOK** ..... \$8.95. A wrapup of everything the computer hobbyist needs to know in one easy to use volume. Provides a range of useful reference material in a single source.



**PCP115—ELECTRONIC PROJECTS FOR HOME SECURITY** ..... \$10.00. 25 projects ranging from a single-door protection circuit that can be completed in an hour or two, to a sophisticated multi-channel security system. Each project is described in detail with circuit diagrams, explanations of how it works, instructions for building and testing, and how to adapt circuits to meet special requirements.



**BP195—INTRODUCTION TO SATELLITE TV** ..... \$9.95. A definitive introduction to the subject written for the professional engineer, electronics enthusiast, or others who want to know more before they buy. 8 x 10 in.

**BP190—ADVANCED ELECTRONIC SECURITY PROJECTS** ..... \$5.95. Includes a passive infra-red detector, a fiber-optic loop alarm, computer-based alarms and an unusual form of ultrasonic intruder detector.

**BP235—POWER SELECTOR GUIDE** ..... \$10.00. Complete guide to semiconductor power devices. More than 1000 power handling devices are included. They are tabulated in alpha-numeric sequence, by technical specs. Includes power diodes, Thyristors, Triacs, Power Transistors and FETs.

**BP234—TRANSISTOR SELECTOR GUIDE** ..... \$10.00. Companion volume to BP235. Book covers more than 1400 JEDEC, JIS, and brand-specific devices. Also contains listing by case type, and electronic parameters. Includes Darlingtons transistors, high-voltage devices, high-current devices, high power devices.

**BP99—MINI-MATRIX BOARD PROJECTS** ..... \$5.50. Here are 20 useful circuits that can be built on a mini-matrix board that is just 24 holes by ten copper-foil strips.

**BP117—PRACTICAL ELECTRONIC BUILDING BLOCKS—Book 1** ..... \$5.75. Oscillators, Timers, Noise Generators, Rectifiers, Comparators, Triggers and more.

**BP184—INTRO TO 68000 ASSEMBLY LANGUAGE** ..... \$6.95. The 68000 is a great new breed of microprocessor. Programming in assembly language increases the running speed of your programs. Here's what you need to know.

**BP179—ELECTRONIC CIRCUITS FOR THE COMPUTER CONTROL OF ROBOTS** ..... \$7.50. Data and circuits for interfacing the computer to the robot's motors and sensors.

**BP239—GETTING THE MOST FROM YOUR MULTIMETER** ..... \$5.95. Covers basics of analog and digital meters. Methods of component testing includes transistors, thyristors, resistors, capacitors and other active and passive devices.

**BP97—IC PROJECTS FOR BEGINNERS** ..... \$5.50. Power supplies, radio and audio circuits, oscillators, timers, switches, and more. If you can use a soldering iron you can build these devices.

**BP37—50 PROJECTS USING RELAYS, SCR'S & TRIACS** ..... \$5.50. Build priority indicators, light modulators, warning devices, light dimmers and more.

**RADIO—100 RADIO HOOKUPS** ..... \$3.00. Reprint of 1924 booklet presents radio circuits of the era including regenerative, neutrodyne, reflex & more.

**BP42—SIMPLE LED CIRCUITS** ..... \$5.50. A large selection of simple applications for this simple electronic component.

**BP127—HOW TO DESIGN ELECTRONIC PROJECTS** ..... \$5.75. Helps the reader to put projects together from standard circuit blocks with a minimum of trial and error.

**BP122—AUDIO AMPLIFIER CONSTRUCTION** ..... \$5.75. Construction details for preamps and power amplifiers up through a 100-watt DC-coupled FED amplifier.

**BP92—CRYSTAL SET CONSTRUCTION** ..... \$5.50. Everything you need to know about building crystal radio receivers.

**BP45—PROJECTS IN OPTOELECTRONICS** ..... \$5.50. Includes infra-red detectors, transmitters, modulated light transmission and photographic applications.

**BP255—INTERNATIONAL RADIO STATIONS GUIDE** ..... \$7.95. Provides the casual listener, amateur radio DXer and the professional radio monitor with an essential reference work designed to guide him or her around than ever more complex radio bands

CHECK OFF  
THE BOOKS YOU WANT

**ELECTRONIC TECHNOLOGY TODAY INC.**  
P.O. Box 240, Massapequa Park, NY 11762-0240

Name \_\_\_\_\_  
Address \_\_\_\_\_  
City \_\_\_\_\_ State \_\_\_\_\_ Zip \_\_\_\_\_

SHIPPING CHARGES IN  
USA AND CANADA

\$0.01 to \$5.00 ..... \$1.50  
\$5.01 to \$10.00 ..... \$2.50  
\$10.01 to 20.00 ..... \$3.50  
\$20.01 to 30.00 ..... \$4.50  
\$30.01 to 40.00 ..... \$5.50  
\$40.01 to 50.00 ..... \$6.50  
\$50.01 and above ..... \$8.00

**SORRY No orders accepted  
outside of USA & Canada**

Total price of merchandise ..... \$ \_\_\_\_\_  
Shipping (see chart) ..... \$ \_\_\_\_\_  
Subtotal ..... \$ \_\_\_\_\_  
Sales Tax (NYS only) ..... \$ \_\_\_\_\_  
Total Enclosed ... \$ \_\_\_\_\_

Number of books ordered

All payments must be in U.S. funds

P492



# An Enlarging Light-Meter for Photographic Printing

BY RUDOLF F. GRAF AND  
WILLIAM SHEETS

*Get perfect photographic prints  
every time with this easy-to-assemble darkroom accessory.*

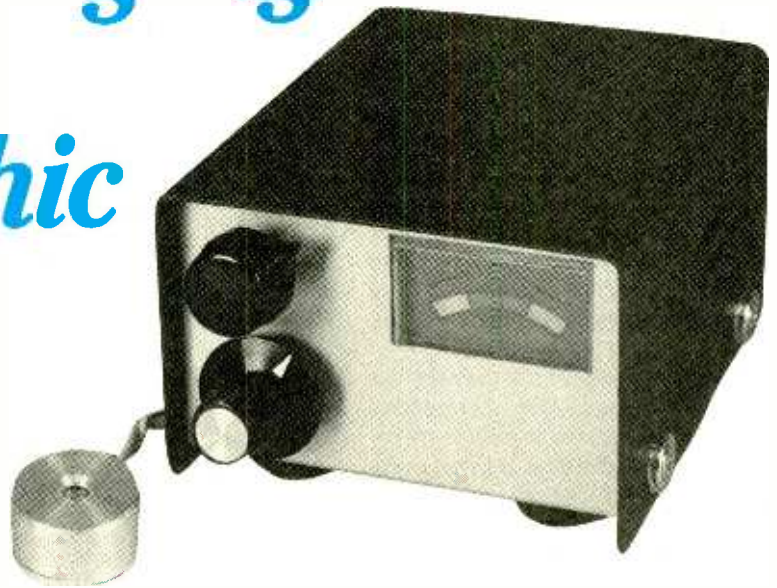

Using an enlarging light meter in the darkroom makes producing prints (both monochrome and color) easier. It also saves time, trouble, and money in otherwise wasted materials. While there are a number of such meters on the market, electronics enthusiasts who also dabble in photography can build a simple meter to do the job at very little cost. In this article we'll describe how you can build the *Enlarging Light Meter*, at a cost of \$25 or less depending on how well stocked your spare-parts bin is.

The light meter (which is essentially a comparator circuit designed specifically for photographic work) is not calibrated against any special standard. That makes it easy to build, set up, and use. All it does is compare the incident light striking a light-dependent resistor (LDR) with a level that has formerly been established—via a potentiometer and a rotary switch—as correct based on previous experience.

**Circuit Description.** A schematic diagram for the Enlarging Light Meter is shown in Fig. 1. Meter M1, a  $\pm 50\mu\text{A}$  zero center D'Arsonval meter movement is driven by U1, a TL081 FET op-amp, through R3. The gain of U1 is set at 11 by R1 and R2, while capacitor C1

is used to restrict the bandwidth of U1 to 1.6 Hz. Power for the circuit is derived from a simple dual-polarity 12-volt power supply (consisting of T1, D3, D4, C2, and C3).

A light-dependent resistor (LDR), R16 (which is a semiconductor element whose resistance decreases as it is exposed to increasing illumination), is used as a light-sensing device. One end of R16 is connected to the negative supply rail through R12, while the other end is connected to pin 3 of U1, applying a negative current to U1. A variable (over a 4:1 range) positive current determined by the settings of R14 and S1 (and derived from the positive supply rail) is also fed to pin 3 of U1.

When the two currents (of opposite polarities) are equal, they cancel each other out, so effectively no current is applied to pin 3 of U1. With no current applied to pin 3, the output of U1 is zero, and meter M1 registers accordingly, indicating a null. However, when light striking R16 causes its resistance to decrease, the current through the device increases, making the negative current greater than the positive current. Under that condition, the negative current causes the output of U1 to swing negative, causing the meter's pointer to swing in the negative direction.

That indicates that the light intensity must be reduced by using a smaller lens opening on the enlarger (smaller  $f/\text{stop}$ ). The opposite occurs if the light is too dim. Lamp L1, a 12-volt 60-mA "grain of wheat" unit, is used to illuminate the meter scale, while R15 is used to limit L1's illumination to a faint glow that is just bright enough so that the face of M1 can be plainly seen in a photo darkroom.

Resistors R3 and R4 should be selected for the meter used. With a dual supply of  $\pm 12$  volts, U1 produces an output voltage of 10 volts peak-to-peak. The resistance of R3 can be found by dividing the peak voltage (i.e., 10/2) by the full-scale meter current (in amps); i.e.,  $R3 = (10/2)/0.00005 = 100,000$  ohms. Resistor R4, the shunt resistor, should be selected to have a value equal to the meter's internal resistance—in our case, 220 ohms.

**Building the Circuit.** There is nothing critical about the construction of the Enlarging Light Meter. Most of the circuit was assembled on a couple of terminal strips, using point-to-point wiring techniques. Wire the circuit together using Fig. 1 as a guide. Note that R16 (the LDR), S1, R14, and M1 are not mounted with the other circuit elements. The LDR (which we'll get to a bit later) will be mounted



in its own enclosure and connected to the other circuit components through a length of twisted-pair wire. Meter M1, switch S1, and resistor R14 are all mounted at some convenient point on the circuit's enclosure. Note that the schematic diagram shows S1 as a seven-position switch; if a seven-position unit can not be located, a 12-position unit (with five positions left blank) will work just as well. Resistors R5 through R11 can be connected directly to S1's terminals and their free ends tied together, and then brought out to the appropriate point in the circuit.

Be careful when connecting the polarized components. Connecting them backwards could render the circuit inoperative at best, or in the worst-case scenario, destroy one or two components. Lamp I1 should be positioned somewhere behind the meter scale, and if possible, painted orange or red to reduce blue-light components emitted by the device; photo paper is sensitive to those light wavelengths. Transformer T1 is not critical; the only requirement is that the transformer be a 12-volt unit that is able to supply sufficient current to operate the circuit. The enclosure used to house this part of the circuit can be of any type that you choose.

As for the light-dependent resistor, R16, it should be mounted in separate housing; a plastic bottle cap with a hole drilled in its center is suitable. See Fig. 2. Begin by drilling a hole in the center of the bottle cap (or similar housing). Mount the LDR so that its lens is centered over the opening. Epoxy the LDR in place, clip off the excess leads so that they do not extend beyond the enclosure, and connect a two-foot length of twisted-pair wire to the LDR's leads. Attach a cover to the rear of the sensor enclosure and complete the project by connecting the twisted-pair wires from the sensor to the appropriate points in the circuit as shown in the schematic.

**Checkout.** Once the circuit is fully assembled, check for the usual construction errors; shorts, cold-solder joints, wiring mistakes, etc. If all looks okay, apply power to the circuit. Then check for +12 volts at the junction of C2 and D3 (a voltage between +10–+15 volts is okay) and for –12 volts (–10 to –15 volts) at the junction

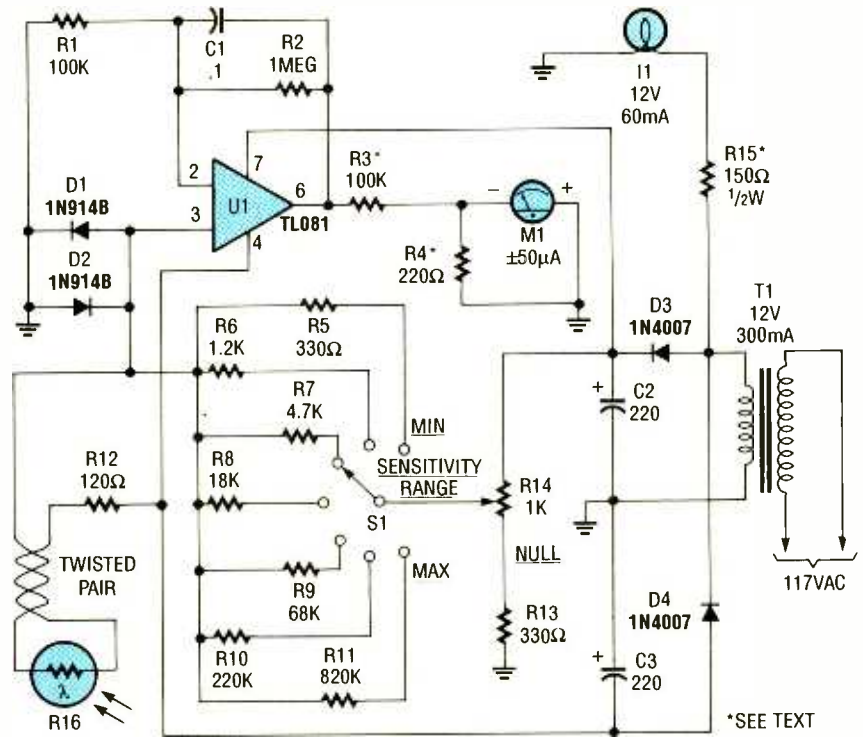

Fig. 1. As revealed by this schematic diagram, the Enlarging Light Meter is nothing more than a comparator, built around a TL081 op-amp.

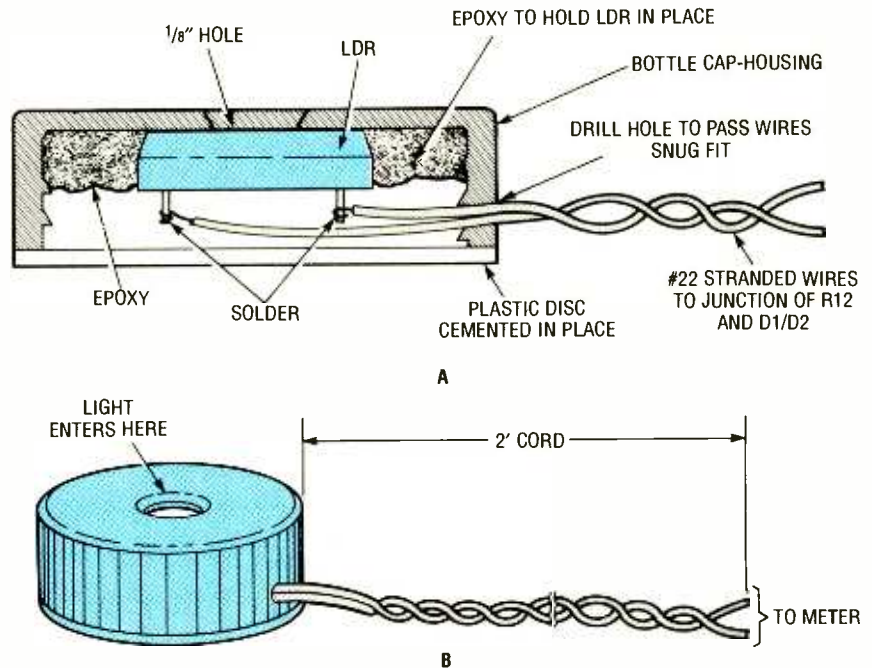

Fig. 2. The sensor (light-dependent resistor or LDR), R16, is housed in its own enclosure, and connected to the rest of the circuit via a two-foot length of twisted-pair wire. Shown here are the details for that assembly's preparation.

of C3 and D4. Next, with R16 shielded from light, set S1 to its maximum-sensitivity position. It should be possible to null, or a least move, the pointer of M1 by varying R14. Next, expose R16 to a dim light (a 7-watt night light about 3-feet away). Adjust S1 and vary R14. You

should find a setting of S1 and R14 where the meter nulls. If not, check your wiring.

Grounding pin 3 of U1 should null M1. That verifies that U1, the power supply, and M1 are operating properly. If that test works, but you cannot



## PARTS LIST FOR THE ENLARGING LIGHT METER

### SEMICONDUCTORS

- U1—TL081, NTE857M (or equivalent) JFET-input op-amp, integrated circuit  
 D1, D2—1N914B or equivalent, general-purpose silicon diode  
 D3, D4—1N4007, or equivalent 1-amp, 1000-PIV general-purpose silicon rectifier diode

### RESISTORS

(All fixed resistors are 1/4-watt, 5% units.)

- R1, R3—100,000-ohm  
 R2—1-megohm  
 R4—220-ohm  
 R5, R13—330-ohm  
 R6—1200-ohm  
 R7—4700-ohm  
 R8—18,000-ohm  
 R9—68,000-ohm  
 R10—220,000-ohm  
 R11—820,000-ohm  
 R12—120-ohm

- R14—1000-ohm panel-mounted linear-taper potentiometer  
 R15—150-ohm, 1/2-watt  
 R16—Light-dependent resistor (see text)

### CAPACITORS

- C1—0.1- $\mu$ F, Mylar or ceramic-disc  
 C2, C3—220- $\mu$ F, 16-WVDC, electrolytic

### ADDITIONAL PARTS AND MATERIALS

- T1—12-volt 300-mA or more, power transformer  
 M1—+/-50- $\mu$ A zero center D'Arsonval meter  
 S1—SP7T rotary switch (see text)  
 I1—12-volt 60-mA "grain of wheat" lamp  
 Terminal strip (see text), enclosure, AC molded power plug with line cord, bottle cap, wire, solder, hardware, etc.

the enlarger settings (distance between lens and paper, *f*/stop, and exposure time). Next, place the negative used for the print in the enlarger, and duplicate the recorded settings. Place R16 on a part of the image that corresponds to a medium gray tone.

Use meter-range switch S1 to coarse null the meter (pointer at zero center). Then, use R14 to exactly null the meter. Note the meter settings and leave it that way. That calibrates the meter for your paper and print developing technique.

When you to make another print, simply insert the negative in the enlarger. Compose and sharply focus the picture, using the enlarger lens at maximum aperture, usually *f*/3.5 or larger. Place the light sensor in a part of the image that is to be a medium gray in the final print, preferably an area somewhere in the central portion of the picture. Try to avoid the corners or extreme edges if you can.

Now, without adjusting the light meter settings from those obtained from the first negative, adjust the enlarger lens aperture for a null on the meter. That will be the correct exposure setting. Use the same exposure time and developing method as you used for the first negative. Insert a sheet of photographic paper into the enlarger easel, and make the exposure. Develop the print. It should be correctly exposed.

You may also use a lighter gray tone or even total black as a reference point. The trick is to be consistent. A medium gray reference point was suggested because it seems to be the easiest to judge. Others prefer the darkest area (lightest gray or white on final print), which works equally well. It is simply a matter of preference.

While the meter is primarily intended for BW printing, it may be also used for color, although it will give only the correct exposure; color balance is not measured. However, if you have predetermined the filter pack, the meter will work well for color. Use an area of the negative that is neutral or near neutral in color. In our experience, flesh tones work well. For landscapes, you can get good results if you use the sky areas as a reference.

That's all there is to it. Once this project is complete and operating, you should be able to obtain near perfect prints every time. ■



All of the electronics for the Enlarging Light Meter, except for the LDR, were housed in a small enclosure on whose front panel switch S1, potentiometer R14, and meter M1 are mounted. The LDR was housed in a separate enclosure about the size of a bottle cap, and connected to the circuit by wire leads.

get the meter to null, check R16, its wiring, and the wiring of R14, R13, S1, and R5 through R12.

**Use.** Do not expose R16 to very bright light before attempting to use the light meter. Bright light reduces the re-

sistance of R16, and it will take several minutes for it to recover, thereby throwing off your readings for the first few minutes.

Begin by first making a good print (monochrome or color) using your conventional technique, and record

# BASS AND TREBLE

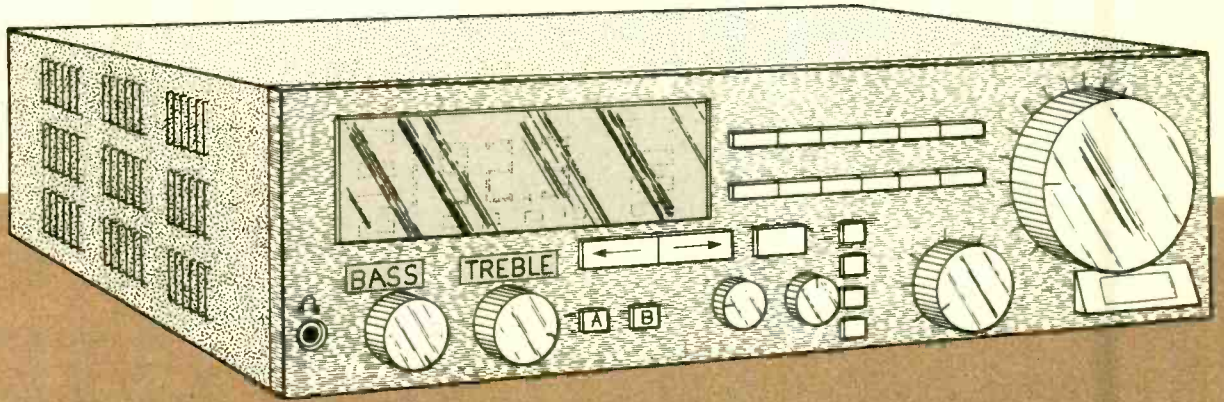

## BOOSTER CONTROLS

BY A. SINGMIN

*Add some pizzazz to your low budget audio projects with a true tone control that'll make them sound better.*

**P**ick up any electronics magazine and before long you're sure to come across an easy to build, low parts-count audio amplifier, suitable for use with your turntable, tape deck, or whatever. Typically, once you've connected the project to the often suggested junk-box speaker and managed to generate some sound out of it, you hear some dismally disappointing tinny audio—nothing at all like the bone-shaking bass and glass-breaking treble from your high cost hi-fi system in the living room. The simple circuits often published rarely have more than a volume control. When they do have a tone control, it is usually no more than a treble-cut control that merely converts the original tinny audio into an equally disgusting muddy sound.

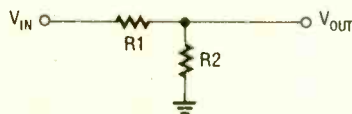

Fig. 1. This basic voltage divider forms the foundation of the bass- and treble-boost circuits. It simply lacks frequency selectivity.

Of course, using a decent speaker would improve the sound quality, but what you also need is a circuit that provides individual bass boost and treble boost just as you would find on a hi-fi set. The original Baxandall type of bass/treble control and its derivatives are found everywhere. They generally take the form of a 4-terminal network (*i.e.*, there's a terminal for the input, one for the output, one for a common ground, and a terminal for the feedback loop). For the more basic enthusiast, a simpler, easy-to-use circuit that has only three terminals (*i.e.*, an input, output, and ground) will be described.

**The Bass Section.** The best way to describe how the three-terminal circuit works is to split it into its bass- and

treble-boosting portions and handle them separately.

To help illustrate the bass-section's operation, take a look at the basic DC voltage divider in Fig. 1. You can imagine that R1 and R2 are discrete resistors, or consider them as two halves of a volume-control potentiometer with the wiper positioned between them. As shown, the input voltage ( $V_{in}$ ) is applied across R1 and R2. Let's say that  $V_{in}$  is derived from some piece of audio gear. The divided output signal is derived from the junction of R1 and R2 (or the potentiometer wiper) and is proportional to the ratio of  $R2/(R1 + R2)$ . Thus, as the value of R2 is increased (which is accompanied by a decrease in R1 for the case of a potentiometer), the output-signal voltage and volume rises.

Taking things a step further, consider the simple capacitor. Unlike the resistor, its reactance (or "AC resistance") is a function of the frequency and is found from:

$$X_C = 1/(2\pi fC)$$

where:  $X_C$  is the capacitive reactance in ohms,  $f$  is the frequency of the applied signal in hertz, and  $C$  is the value of the capacitor in farads. So we can

*(Continued on page 97)*

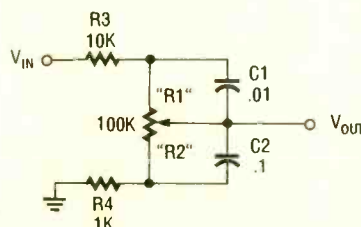
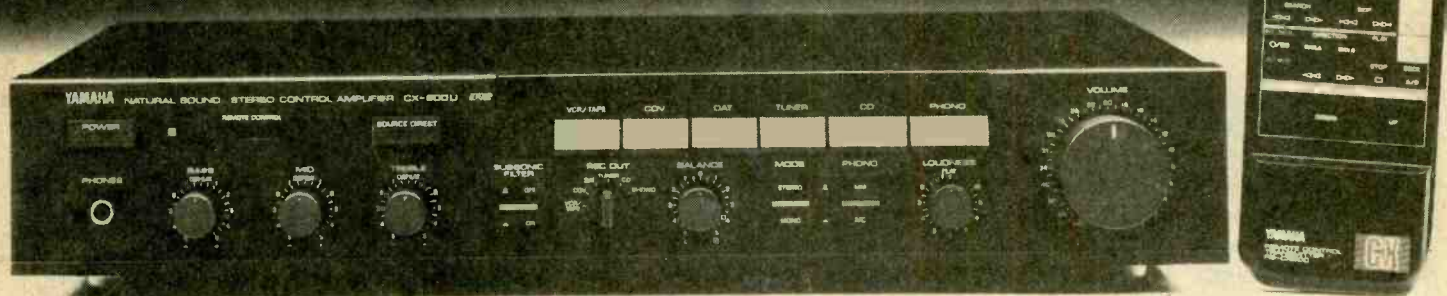

Fig. 2. The frequency dependence of the capacitor's impedance permits this circuit to boost the bass if desired.



# How to Choose



## Audio Equipment

*We explore some down-to-earth criteria for selecting audio equipment that suits your taste and your wallet.*

BY MARC SPIWAK

Choosing a piece of audio equipment that best suits your needs can be difficult. After all, there are hundreds of different models, with an extensive range of features and prices. Why, nowadays there are even quartz heaters that come with an infrared remote control! So, if you can buy a heater with a remote control, then you can imagine what features might be available on modern audio/video equipment.

The amazing thing about the features that modern technology has provided is that they come fairly cheaply. We now get more electronic-entertainment value per dollar than ever before. However, don't expect quality to go hand in hand with an extensive list of features. As a matter of fact, it's just the opposite; if a manufacturer is packing features into a unit that sells for about the same price as one with fewer features, then they have to be saving that money somewhere. And when it comes to home-entertainment equipment, those savings are usually at the expense of performance and therefore enjoyment.

The purpose of this article is to equip a non-audiophile with the knowledge he or she needs before walking into a local electronics dealer and making a selection. We will concentrate on the features that are important to look for in a high-performance stereo system, but we will also cover some that are more of a convenience.

**Amplifiers.** An amplifier is at the heart of every home-entertainment system, although a "true" amplifier contains just that and nothing else. Such amplifiers only appeal to people who want a system made of completely separate components—a separate amp, preamp, tuner, etc. Because such a person is willing to spend more, you won't find too many "cheap amplifiers." And when it comes to audio equipment, the really expensive stuff actually has fewer convenience features than you would expect. That's because audio purists want true performance, not gimmicks or convenience.

The first thing everybody asks when it comes to an amplifier is "how many

watts is it?" That's a good question, but it shouldn't be the first one because a poor amplifier can produce plenty of "dirty" watts. An amplifier spec sheet that boasts high wattage may not mention the high distortion, as well. So the first question should be "what is an amplifier's total harmonic distortion, or THD?" If an amplifier's THD is not less than 1%, it's not worth mentioning at all, and many THD ratings are less than 0.1 percent. The lower the better!

When you do get around to asking about the amplifier's power, be on the alert if it is rated in peak output power. That's because continuous output power is far more important. After all, an amplifier putting out 50 watts continuous power is actually capable of putting out a lot more in the loud portions of the music (*i.e.*, during peaks). So you should look for an amplifier that has a low THD rating at a continuous output-power level.

When deciding how many watts you need, keep in mind that, in order to double the apparent loudness, you need ten times the power. Think about it: 3 watts can produce loud music, 30 watts can produce very loud music,



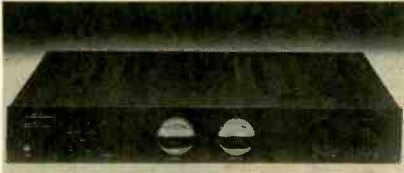

*A good amplifier should be at the heart of every stereo system. Look for one with low distortion figures at high output levels.*

but it takes 300 watts to produce excruciatingly loud music. However, for casual or mostly background music listening, a 35-watt amplifier will suffice. For more intense use, anything over 50 watts will be adequate for most listeners.

Talking about the frequency response of an amplifier is somewhat pointless nowadays. The human ear can hear between approximately 20 Hz to 20 kHz, and any modern amplifier that can't deliver that full power bandwidth doesn't have the right to be called an audio amplifier.

A preamp is needed when using a separate power amplifier. A preamp contains the controls missing from a power amplifier, like volume, bass, treble, etc. Look for low distortion figures, good versatility, and good quality in general when choosing a preamp.

**Tuners.** A tuner generally receives AM and FM-stereo broadcasts—AM stereo doesn't seem to have gone anywhere, so don't even bother looking for it. Some high end tuners don't even receive AM, but it's silly to purposely look for tuners that lack AM reception under the assumption that they must be high end units.

Most tuners are digitally synthesized these days (you tune into an exact frequency on a digital readout as opposed to positioning a pointer on a row of numbers). Digital tuning is not a necessity, although it is drift-free and much more convenient than tuning a dial. A digitally synthesized tuner will (or should) have a number of presets—buttons that can hold radio-station frequencies and other information in memory. While they are just a convenience feature, they are a great convenience to have.

There are two important things to look for in a tuner: sensitivity and selectivity. Sensitivity has to do with the tuner's ability to pick up faint and distant signals. It's usually rated for a mono signal (because stereo signals

are harder to receive clearly) in decibel femtowatts (dBf). The smaller the number, the more sensitive the receiver. This is a particularly important specification for people in rural areas.

Selectivity has to do with the tuner's ability to reject interference from adjacent channels. Selectivity is measured in dB, and the higher the number, the better the tuner is at ignoring adjacent-frequency interference. People in crowded urban areas should make it a point to look for highly selective tuners.

**Receivers.** A receiver basically contains an amplifier, a preamp, and a tuner, all in one package. Look for the features we've mentioned concerning all three units. A visually appealing receiver is somewhat important as it will be the center of your home-entertainment system.

Many modern receivers include audio inputs for video equipment as well as surround-sound processors to put you in the middle of a movie's

action. We'll discuss surround sound in just a moment, but keep in mind that you do need hi-fi video gear to reap the benefits of surround sound.

### **Equalizers/Sound Processors.**

Aside from surround sound, there are other devices intended to enhance the sound of your system. Equalizers, for example, are kind of like expanded bass and treble controls. They allow you to vary the level of individual portions of the audio bandwidth. Generally, the more bands an equalizer has, the better. However, you should know that audio purists don't usually use equalizers; their equipment has *perfect* sound without one—meaning that it reproduces exactly what the artist originally performed (and you wouldn't be able to adjust the bass at a concert, would you?). That's why many high-end manufacturers don't make equalizers.

Sound processors are a relatively modern piece of equipment. They allow you to tailor audio reproduction to



*A tuner receives AM and/or FM stereo broadcasts. Digital circuitry provides easy drift-free tuning on today's models.*



*A receiver houses an amplifier, a preamp, and a tuner, all in one. Many modern receivers like this one, commonly called an A/V receiver, include surround-sound processors for video equipment.*





*When selecting a pair of speakers, all you have to do is select the ones that sound best to you and suit your wallet.*



*A turntable is still a good thing to have in any stereo system. Look for one that resists skipping.*



*The most important thing to look for in any cassette deck is a frequency response as close to 20 Hz–20 kHz as possible.*

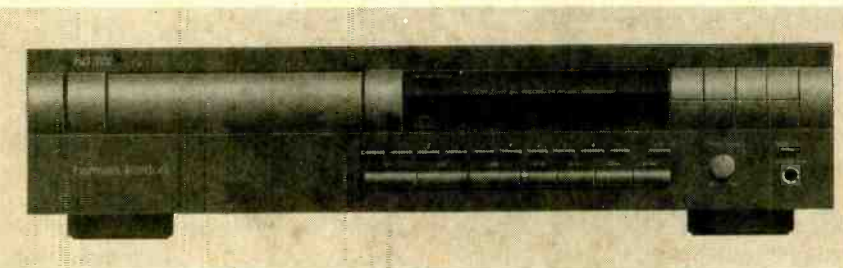

*CD players all have good audio specs so if you like a particular CD player, buy it.*

imitate different surroundings, such as concert halls or outdoors, to add ambience to music.

Surround-sound decoders, when used in conjunction with hi-fi video gear, greatly add to the excitement of any surround-sound encoded program material by putting you right in the middle of the action. In addition to the left and right audio outputs provided by a piece of hi-fi video gear, a basic surround sound processor adds left- and right-rear outputs (basically the same channel), to open up the sound stage. In addition, a Dolby Pro-Logic surround-sound processor adds a center-channel output (to keep voices "on-screen").

If you're interested in surround sound, then make sure you're getting a true Dolby Surround unit or, better still, Dolby Pro-Logic Surround. That way, you know you'll be hearing exactly what you're supposed to. Also, it's best to look for a surround decoder with built-in amplifiers for the added channels.

**Speakers.** When selecting speakers, the best advice anyone can give you is to *listen* to them, and pick the ones that sound the best to you. Make sure they're capable of handling the maximum output power of your amplifier, and that your amplifier can easily supply the minimum recommended power for the speakers. Also, most speakers are rated at either 4 or 8 ohms nominally, and most amplifiers will recommend either one—some amplifiers have switchable outputs for either load. Of course keep in mind the constraints of your wallet and available room space when picking out a pair of speakers.

**Turntables.** Although vinyl is definitely on its way out, a turntable is still an important piece of equipment for many people, and some good music is still available on vinyl at cheap

prices. A real turntable, something not intended for a child, can be purchased for as little as sixty dollars or so. However, as with anything, you get what you pay for, and a cheap turntable will skip at the slightest vibration and easily pick up outside noise. A good turntable will have a "floating" platter that resists skipping.

Turntables are available in either belt- or direct-drive configurations. Belt-drive turntables are often better at isolating both outside noise and noise from the turntable's own motor, known as rumble. That is especially true in the lower-priced models. Rumble is rated in -dB, and the higher the number, the better.

Most turntables will play 33 $\frac{1}{3}$  and 45-RPM records (it will be difficult to find a 78-RPM turntable), and have a pitch adjustment to precisely set the rotational speed. Wow and flutter have to do with variations in the playing speed of a turntable. Speed variations of only one or two per second are referred to as wow, while faster variations are referred to as flutter. Wow and flutter are rated as a percentage, and the lower the better.

An automatic turntable will start and stop a record automatically. A semi-automatic turntable must be started manually, but will shut off automatically. A completely manual turntable must be started and stopped by hand or, at most, they will merely lift the needle at the end of the record (the tonearm will not return to the outside position by itself). It's very hard to find multi-record players (changers) anymore. Actually, due to the popularity of CD's, fewer turntables are available nowadays than ever before, and most of the component turntables still around are of top quality, and carry a price to match.

The tonearm on a good turntable will have many adjustments, ranging from the tracking force (the weight of the tonearm pressing down on the record), tracking angle, anti skate, etc. High-end turntables often do not come with a tonearm. It's up to you to choose a separate one.

All tonearms require a cartridge. Most inexpensive magnetic cartridges are adequate for most average tonearms, as long as the two are mechanically compatible (the cartridge must have the proper mount-

*(Continued on page 92)*



# The Telephone Ring Converter

BY DEAN F. POETH, II K8TM

*This one-evening project alters the ringing sound of your phone so you can distinguish it from any other phone in the room.*

**M**ost companies use the same type of telephone for all of their employees, all of which sound the same when they ring. The result? Every time a phone rings, two or three people can be seen running back to their office to see if it is theirs. You only have three rings to get the call, or it switches to the department secretary. If it wasn't so darn frustrating, it would be comical.

You can put a stop to all that undignified exercise by building the Telephone Ring Converter. It is a simple one-evening project that will change the ring of your telephone to an electronic warble (usually found on expensive multi-line telephones). The pitch of the warble signal is adjustable, so you can change the note of your telephone to make it sound distinct from your neighbor's. The project can also be used to indicate that there is an incoming call in places where you don't have a phone (such as a workshop).

**How it Works.** The schematic diagram for the ring converter is shown in Fig. 1. The circuit is based on the TCM1506 ring detector/driver integrated circuit. It is a monolithic IC specifically designed to replace the telephone's mechanical bell. The chip is powered and activated by the telephone-line ring voltage, which may vary from 40–150 volts rms at a frequency of from 15 to 68 Hz. No other source of power is required.

Again referring to Fig. 1, C1–C5 are placed in parallel to form a 0.5- $\mu$ F capacitor that conducts the AC ring voltage to pin 1 of the TCM1506, but blocks any DC component. Of course, those capacitors can be replaced by a single 0.47–0.5- $\mu$ F capacitor provided it has at least a 400-WVDC rating. Resistor R1 is in series with the capacitor network and is used to dissipate power from any high-voltage transient that might appear across the line. The diluted AC voltage that reaches pin 1 on U1 powers the chip.

Capacitor C6 is used to prevent "bell tapping." That is an annoying ringing of the bell that occurs when a phone on the same line is used to dial an outgoing call. The capacitor prevents the short dial pulses from triggering the ring detector, but still allows the much longer ring signal to activate it.

Potentiometer R2 is used to vary the tone of the ring signal from below 100 Hz to over 15 kHz. Potentiometer R4 is the volume control; adjusting that potentiometer to its lowest resistance will mute the piezo element (BZ1).

When a ring signal is present on the phone-line, it powers U1. The IC then generates a tone (with a frequency determined by R2 and an amplitude set by R4) that is reproduced by BZ1.

**Construction.** Construction is straightforward and the parts layout is not critical. Any point-to-point wiring

technique will do. However, a printed-circuit board was used in the prototype to speed-up construction and to prevent wiring errors. If you wish to make a printed-circuit board, use the foil pattern shown in Fig. 2.

If you plan to use the foil pattern, take a look at the parts-placement diagram shown in Fig. 3. As you can see, to obtain the 0.5- $\mu$ F capacitance five 0.1- $\mu$ F capacitors are wired in parallel; however, note that capacitors C2 and C4 are mounted on the foil side of the board to save space.

Regardless of the wiring technique you use, a socket is recommended for the IC to prevent heat and static damage while soldering. It's also a good idea to leave the integrated circuit in its conductive packing until you are ready to install it.

Once you've mounted all the on-board components, attach leads to the off-board components as needed and solder the leads to the appropriate points on the board. Those points are shown in Fig. 3.

You will now have to attach a modular extension cord to the circuit board. The one you use will depend on whether you wish to use the project to change the pitch of a phone or just to act as an annunciator where there is no phone.

To use the project along with a phone, you will need a telephone extension cord with a dual-female end. That will permit you to connect it to the



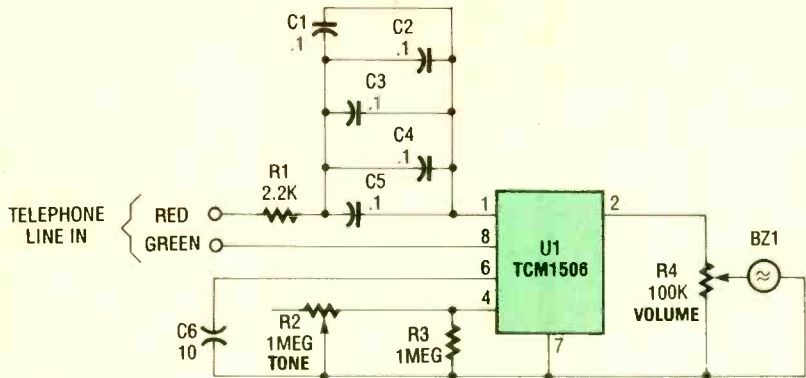
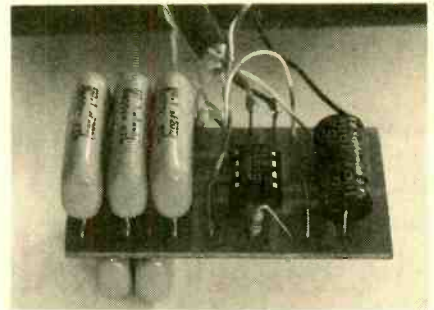

Fig. 1. The Ring Converter circuit is incredibly simple thanks to the ring detector/driver IC, which does all the work. It even runs off the ring signal making a separate power supply unnecessary.



To minimize the surface area of the PC board, capacitors C2 and C4 have been placed on the foil side of the board. Soldering them in is a little tricky, but it saves a lot of space.

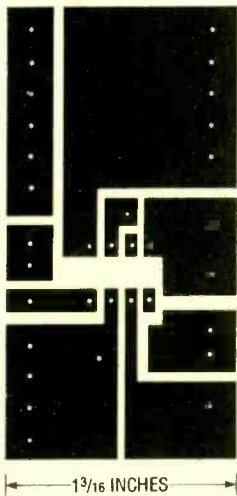

Fig. 2. If you wish to build a Ring Converter on a piece of printed-circuit board, use this pattern to etch the foil.

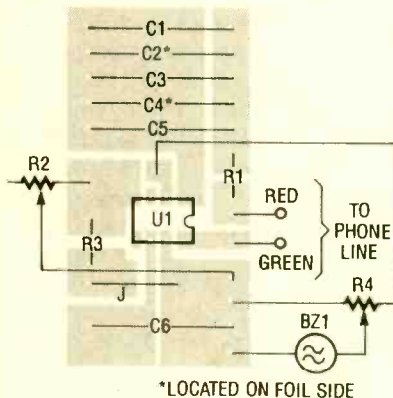

Fig. 3. Use this parts-placement diagram as a guide when mounting components on the circuit board. Note that you will need to attach leads to the two potentiometers (R2 and R4) to connect them to the board.

phone line and telephone as shown in Fig. 4A. Note that the set-up also requires a modular extension with a male connector on each end. Pro-

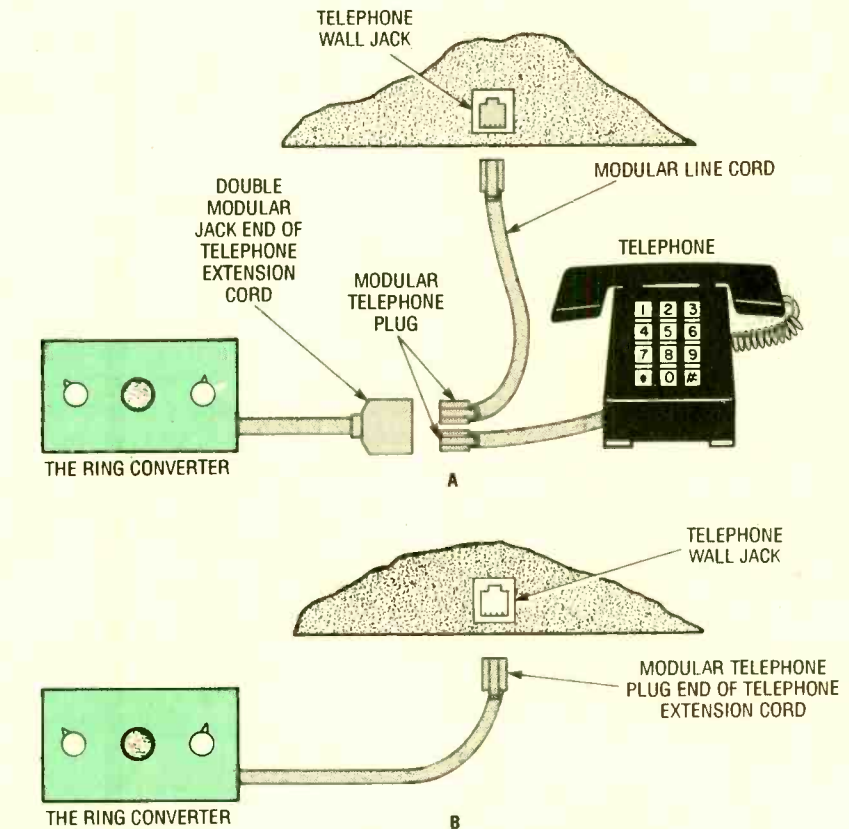

Fig. 4. You will have to wire an appropriate cable to the Ring Converter depending on whether you will use it with a nearby phone (A), or in a remote location as an annunciator (B).

vided you have a modular crimping tool, you can kill two birds with one stone: Just buy a modular extension cord that has a dual-female connector at one end and a male connector at the other. Cut the extension in half, strip the cut end of the half sporting the dual connector, and attach the green and red leads to the circuit board. Take the half with the male connector and add another male connector to the cut end. Once you've tested the unit (more on that

shortly) you can connect the project following Fig. 4A.

To use the project as a simple annunciator in a location without a phone, you just need a male plug on one end of a length of telephone wire. If you wish, you can use a telephone extension cord with one end snipped off. Connect the leads at the free end to the circuit, and once you've tested the unit, plug it into a wall jack as shown in Fig. 4B.

(Continued on page 93)

# ELECTRONICS TECHNICIANS DAY

*CET's are the real pros  
when it comes to electronics  
servicing. Here's how you  
can join their ranks.*

**LARRY STECKLER, EHF/CET**  
EDITOR-IN-CHIEF

If you maintain, repair, or upgrade electronic equipment you should become a Certified Electronics Technician (CET). More than 32,000 of your colleagues already have earned the recognition that being a CET brings, and in their honor Ernie Curtis, CET, Chairman of the International Society of Certified Electronics Technicians, has declared Tuesday, March 10, 1992, "Electronics Technicians Day."

"The electronics technician," stated Curtis, "is responsible for keeping today's electronics-dependent society operating. Without this highly-skilled and specially-trained corps of electronics technicians, breakdowns in modern complex electronics would quickly bring our world to a sparking halt. Our intention," Curtis continues, "is to focus international recognition on the high standards of performance and excellence maintained by professional electronics technicians."

More than 100 ISCET Certification Test Administrators have volunteered to give tests during the week of March 8 through 14, 1992 to honor Electronics Technicians Day. The complete list of all of these volunteer examiners and the test sites can be found elsewhere in this article.

**What is ISCET?** Iscet is the electronics-technicians division of the Na-

tional Electronic Sales & Service Dealers Association (NESDA). ISCET was founded in 1970 by a committee of Certified Electronics Technicians whose main purpose was to foster respect and admiration for their profession. By maintaining rigorous standards in its certification program, ISCET is able to separate the highly skilled technicians from those with less experience. ISCET's main functions include direction and administration of the CET program, the national apprentice and training program, the technical information training and upgrading programs, and the serviceability programs.

The CET program was designed to measure the degree of theoretical knowledge and technical proficiency of practicing technicians. A technician with a CET certificate is thought of in the industry as one who possesses the training and expertise necessary to perform his job with professional competence. Since its inception, the CET program has continued to gain acceptance by technicians, manufacturers, and consumers. Many organizations encourage, and often require, their technical employees to be certified by ISCET.

**Technician Skills.** Just keeping up with the changes that seem to occur

daily in new equipment is a full-time task. To be able to service the latest electronics equipment with its new circuitry, new components, and new principles is a difficult challenge. Today's electronics technicians must constantly learn, constantly acquire new theoretical and practical skills, and constantly develop new techniques. They must become familiar with new kinds of test equipment and new servicing techniques to repair the latest electronics products.

Perhaps this was best summed up by Leonard Bowdre, CET, ISCET's Immediate Past Chairman, when he said, "I marvel at the exponential changes in electronics since my introduction to it in 1946. The new techniques, devices, and technology that have appeared in the last two years alone are mind-boggling. With what today's technicians must know, I think they must be the most qualified, most underpaid, and the least recognized in the world's work force."

**The CET Exam.** To become certified by ISCET, the electronics technician must pass both a 75-question Associate-level CET test, and a 75-question Journeyman-level test. To pass, the candidate must score a grade of 75% or better. An electronics technician or student with less than four years of experience may apply for the Associ-

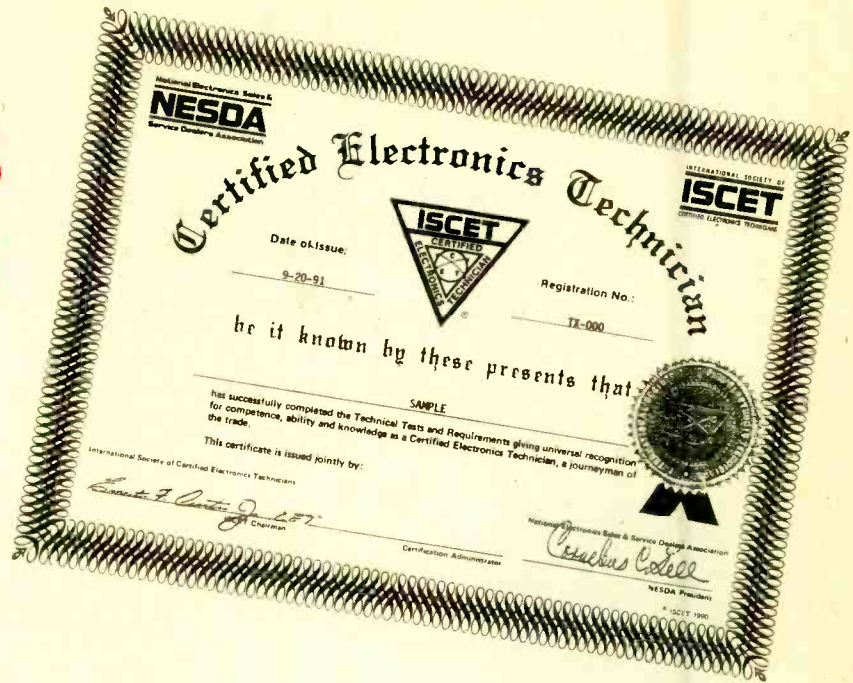



## ISCET CERTIFIED ADMINISTRATORS FOR CET EXAM

- David L. Bryan, CET  
Alabama Aviat. & Tech. Coll.  
PO Box 1209  
Ozark, AL 36360  
(205) 774-5113
- David L. McCann, CET  
64 Steele Lane  
Loxley, AL 36551  
(205) 343-8200
- Delores Rasberry  
Herzing Institute  
1218 South 20th St.  
Birmingham, AL 35205  
(205) 933-8536
- Ricky G. Reaves, CET  
Shoals Coll.  
PO Box 2545  
Muscle Shoals, AL 35662  
(205) 381-2813
- R. T. Van Iderstine, CET  
Southwest State Tech. College  
925 Dauphin Island Pkwy.  
Mobile, AL 36605  
(205) 947-4441
- Alison J. Fletcher, CET  
Southern Tech. College  
7601 Scott Hamilton  
Little Rock, AR 72209  
(501) 565-7000
- Dennis P. Blum, CET  
Phoenix Inst. of Tech.  
2555 E. University Dr.  
Phoenix, AZ 85034  
(602) 244-8111
- Frank Grabiec, CET  
Dyna-tronics  
1704 E. Claremont  
Phoenix, AZ 85016  
(602) 279-3791
- H.J. Paine, CET  
4631 E. 8th St.  
Tucson, AZ 85711  
(602) 881-6784
- Russell Scarpelli, CET  
10529 W. Dessert Forst. Crle.  
Sun City, AZ 85351  
(602) 972-3854
- Silvino Alonso  
Calif. Business Inst.  
3550 Johnson Ave.  
El Monte, CA 91731  
(818) 444-7779
- Howard Bardach, CET  
The Audio Specialist  
4381 Tujunga Ave.  
Studio City, CA 91604  
(818) 763-3009
- John V. Craig, CET  
531 W. Hueneme Rd.  
Oxnard, CA 93033  
(805) 982-5228
- Billy J. Edmonds, CET  
1311-16th St.  
Baywood, CA 93402  
(805) 543-2700 Ext 7772
- Max B. Free  
California Med. Facility  
2100 Peabody Rd.  
Vacaville, CA 95696-4000  
(707) 448-6841 Ext 3355
- Robert A. Johnson, CET  
Ameritech Colleges  
4600 Ashe Rd., #313  
Bakersfield, CA 93313  
(805) 835-9225
- Romualdo Malarayap, CET  
ITT Technical Institute  
1530 W. Cameron Ave.  
W. Covina, CA 91706  
(818) 960-8681
- David Marson, CET  
California Youth Authority  
PO Box 1245
- Paso de Robles, CA 93447-1245  
(805) 238-4040 Ext 428
- Michael R. Miller, CET  
California Mens Colicny-West  
PO Box 8103-Education Dept.  
Sio, CA 93403-0006  
(805) 543-2700 Ext 7143
- Peter J. Moreno, CET  
ITT Technical Institute  
630 E. Brier Dr., #150  
San Bernardino, CA 92408  
(714) 889-3800
- Kevin J. Price, CET  
NEC  
825 E. Hospitality Ln.  
San Bernardino, CA 92408  
(714) 885-3896
- Parviz Shams  
Southern Calif. Inst. of Tech.  
10600 Katella Ave.  
Anaheim, CA 92804  
(714) 520-5552
- Fredrick J. Smith, CET  
Ed. Dept. Calif. Mens Clin.  
PO Box 8101  
San Luis Obispo, CA 93409-0003  
(805) 772-2009
- Phillip G. Stephens  
Matsushita Reg. Tech. Center  
6550 Katella Ave.  
Cypress, CA 90630  
(714) 895-7435
- Dr. Kenneth L. Wilson, CET  
San Diego City College  
1313-12th Ave.  
San Diego, CA 92101  
(619) 230-2601
- Don Winchel, CET  
M & D Electronics  
PO Box 123  
Smartville, CA 95977  
(916) 639-2477
- John F. McMullen, CET  
Denver Inst. of Tech. Inc.  
7350 N. Broadway  
Denver, CO 80221  
(303) 426-1808
- George W. Shaifer, CET  
38 N. Dartmouth  
Widfield, CO 80911  
(719) 392-1000
- John F. Stackhouse, CET  
ITT  
2121 South Blackhawk  
Aurora, CO 80014  
(303) 695-1913
- Anthony R. Valdez, CET  
1919 Rolling Hills Rd.  
Cortez, CO 81321  
(303) 565-8457
- John E. DePalma, CET  
Conn. School of Electronics  
586 Ella Grasso Blvd.  
New Haven, CT 06519  
(203) 624-2121
- Daniel J. Shea, CET  
Conn. School of Electronics  
586 Ella Grasso Blvd  
New Haven, CT 06519  
(203) 624-2121
- Albert Moses, CET  
PO Box 188  
Cheswold, DE 19936  
(302) 571-5402
- William S. Brooks, CET  
7112 N. Habana Ave.  
Tampa, FL 33614-4365  
(813) 933-1793
- Edward Guary, CET  
Eddy's Radio & TV Service  
1110 NE 4th Ave.  
Fl. Lauderdale, FL 33304  
(305) 763-2964
- Ronald A. Handlon, CET  
Nec. Bauder College  
7955 NW 12 St.  
Miami, FL 33126  
(305) 477-0251
- Karl A. Hunter, CET  
13850 Ketch Cove Dr.  
Jacksonville, FL 32224-1143  
(904) 633-8143
- John Steven Richards, CET  
ITT Technical Institute  
2600 Lake Lucien Dr., #140  
Maitland, FL 32751  
(407) 660-2900
- J.J. Villademoros, CET  
ITT Technical Institute  
5225 Memorial Highway  
Tampa, FL 33634-7350  
(813) 885-2244
- Roy Chastlain, CET  
N.G.T.I.  
197 N. Box 65  
Clarksville, GA 30523-0065  
(404) 754-7751 Ext. 334
- Daniel B. Mundy, CET  
Normans Electronics  
3653 Clairmont Rd. NE  
Atlanta, GA 30341  
(404) 451-5057
- James Peek, CET  
Panasonic  
4245 E International Blvd.  
Norcross, GA 30093  
(404) 717-6858
- W.R. Rooks, CET  
Shiloh Rd. Rt.6  
Box 181  
Americus, GA 31709  
(912) 928-0283 Ext 26
- Ebin Shepard, CET  
Bloomfield TV Svs. Inc.  
2481 Rocky Creek Rd.  
Macon, GA 31206  
(912) 788-5281
- James P. Van Sant, CET  
Pickens Tech.  
240 Burnt Mountain Rd.  
Jasper, GA 30143  
(404) 692-3411
- Mel Streeter  
Lewis Clark St. college  
8th Ave. at 6th St.  
Lewiston, ID 83501  
(208) 799-2225
- Douglas E. Minter, CET  
American College of Tech.  
1300 W. Washington  
Bloomington, IL 61701  
(309) 828-5151
- F.A. Schwarzkopf, CET  
Triton College, Rm.T-201  
2000 Fifth Ave.  
River Grove, IL 60171  
(312) 767-4126
- George Sopocko, CET  
The Radio TV Lab  
5631 W Irving Park Rd.  
Chicago, IL 60634  
(312) 545-3622
- Paul K. Tan, CET  
915 Augusta St.  
Oak Park, IL 60302-1678  
(312) 848-6327
- Frank Teskey, CET  
F.J. Teskey Enterprises  
3094 Lafayette Rd.  
Indianapolis, IN 46222  
(317) 926-2639
- Leonard E. Bowdre, CET  
125 SE Thornton Ave.  
Des Moines, IA 50315  
(515) 964-6484
- James E. Boyer, CET
- Western Ia. Tech. Comm. Coll.  
4647 Stone Ave.  
Sioux City, IA 51102  
(712) 274-6279
- Donnin G. Custer, CET  
West Ia. Tech. Comm. College  
PO Box 265-4647 Stone Ave.  
Sioux City, IA 51102-0265  
(712) 274-6279
- Michael L. Baughman, CET  
KS City Area Vo. Tech.  
2220 N 59th St.  
Kansas City, KS 66104  
(913) 334-1000 Ext 48
- Stanley Creitz, CET  
NCK Area Vocat. Tech.  
PO Box 507, West Campus Dr.  
Beloit, KS 67420  
(913) 738-2279
- Dr. G.W. Ko, CET  
550 N. Fountain  
Wichita, KS 67208  
(316) 686-4864
- John E. Krier, CET  
1606 Timothy  
Wichita, KS 67212-3812  
(316) 722-4041
- Michael Dixon, CET  
Somerset Vo. Tech. School  
714 Airport Rd.  
Somerset, KY 42501  
(606) 679-4303
- Sanford N. Dotson, CET  
Lexington Elect. Tech.  
3340 Holwyn Rd.  
Lexington, KY 40503  
(606) 223-9608
- Edward J. Kimmel, CET  
Kimmel Electronics  
2061 Eastern Parkway  
Louisville, KY 40204  
(502) 451-3457
- Jerry D. Middleton, CET  
2906 New Haven Ct.  
Flatwoods, KY 41139  
(606) 836-4736
- Edward M. Ondo, CET  
Cumberland Vally Health Cntr.  
PO Box 187  
Pineville, KY 40977  
(606) 337-3094
- Lamarr W. Ritchie, CET  
Hazard State Vo-Tech. School  
101 Vo-Tech  
Hazard, KY 41701  
(606) 436-3101
- Jack B. Sellards, CET  
Jack's TV & Appliances  
509 Knox St.  
Barbourville, KY 40906  
(606) 546-5224
- Dr. I.F. Creel, CET  
Sullivan Tech. Inst.  
1710 Sullivan Dr.  
Bogalusa, LA 70427  
(504) 732-6640
- W.H. Hartzfeldt, CET  
Delta-Quachita Vo. Tech.  
609 Vocational Pkwy.  
W. Monroe, LA 71291  
(318) 396-7431
- M.G. McCann Jr., CET  
McCann Electronics  
100 Division St.  
Metairie, LA 70001  
(504) 837-7272
- James R. Sorrels, CET/CSM  
110 Oakridge Dr.  
Shreveport, LA 71106-7113  
(318) 686-4637
- Gordon L. Burgess, CET  
Great Northern Paper Div.  
Main St.
- E. Millinocket, ME 04430  
(207) 746-9912 Ext. 1300
- Carl F. Miller, CET  
5114 Baltimore Ave.  
Hyattsville, MD 20781  
(301) 864-5750
- Earl Tickler, CET  
Rets. Tech. Trng. Center  
1520 S. Caton Ave.  
Baltimore, MD 21227  
(301) 644-6400
- Robert A. Ciuffetti, CET  
444 Fairmont St.  
Fitchburg, MA 01420  
(508) 834-2052
- Frank Serra, CET  
Serra's TV Video  
1686 Massachusetts Ave.  
Cambridge, MA 02138  
(617) 492-2667
- Bob Bellers, CET  
Washtenaw Comm. College  
4800 E Huron River Dr.  
Ann Arbor, MI 48106  
(313) 973-3316
- John P. Boris, CET  
St. Clair Cnty Comm. College  
323 Erie St.  
Port Huron, MI 48060  
(313) 984-3881 Ext 305
- Dr. Joel Goldberg, CET  
Macomb Community College  
14500 12 Mile Rd.  
Warren, MI 48093  
(313) 445-7373
- Gerald H. Heyn, CET  
55 E. Jackpine St. Lot 113  
Gwinn, MI 49841  
(906) 346-6396
- E. Eugene Ranta, CET  
Macomb Comm. College  
14500 Twelve Mile Rd.  
Warren, MI 48093  
(313) 445-7343
- Willard Rush, CET  
Oakland College  
3361 Aspen-6304  
Orion, MI 48359  
(313) 333-2531
- John Baldwin, CET  
Farbault Campus  
1225 SW 3rd St.  
Farbault, MN 55021  
(504) 334-3965 Ext 129
- Larry Geissler, CET  
3706 Chambersburg  
Duluth MN 55811  
(218) 722-9356
- Steven M. Brumfield, CET  
Southern Technical College  
2305 Lakeland Dr.  
Jackson, MS 39208  
(601) 932-7809
- Marion B. Denny Jr., CET  
Audio-Video Service  
1405 Corinne St.  
Hattiesburg, MS 39401  
(601) 545-7606
- James D. Everett, CET  
Platte County Avt. School  
PO Box 1700  
Platte City, MO 64079  
(816) 329-4646
- Annabel L. Gooch  
Davis Hart Mavts.  
905 N. Wade St.  
Mexico, MO 65265  
(314) 581-5634
- Gregory J. Nesbo, CET  
440 1st Ave.  
Havre, MT 59501  
(406) 265-8459
- Jack Hopson, CET  
First Television Service  
5214 Center  
Omaha, NE 68106  
(402) 551-4868
- James Belanger, CET  
Belltronics Inc.  
19 Proctor Hill Rd., Box 330  
Hollis, NH 03049  
(603) 465-2422
- Joseph T. Szumowski, CET  
JTS Electronics  
412 Pomona Rd.  
Cinnaminson, NJ 08077  
(609) 829-9669
- Dr. Ronald P. Hartman  
Tech. Training Institute  
1320 S. Solano  
Las Cruces, NM 88001  
(505) 522-6533
- Anthony Abram, CET  
Bryan Stratton elect. tech.  
1028 Main St.  
Buffalo, NY 14202  
(716) 884-9120
- Joseph A. Passaretti, CET  
Pyramid Electronics Ltd.  
353 E 76th St.  
New York, NY 10021  
(212) 628-6500
- Larry Steckler, EHF CET  
Radio Electronics Magazine  
500 B Bi-county Blvd.  
Farmingdale, NY 11735  
(516) 293-3000
- Fred H. Freeman Jr.  
Reynolds Elect. & Engrn. Co.  
PO Box 98521  
Las Vegas, NV 89193-8521  
(702) 295-1915
- Linda Dickinson  
Craven Community College  
PO Box 952  
Havelock, NC 28532  
(919) 447-1141
- William H. Mast, CET  
Appalachian State Univ.  
Dept. of Ind. Ed. & Tech.  
Boone, NC 28607  
(704) 262-6352
- Melvin E. Talbert, CET  
Heilig Meyer Service Co.  
PO Box 64189-2858, Owen Dr.  
Fayetteville, NC 28306-0189  
(919) 483-0801
- Lloyd G. Chale, CET  
301-3rd St. East  
Fargo, ND 58078  
(701) 282-0430 Ext 220
- Lawrence M. Delonais, CET  
National Education Center  
1660 Martin Rd.  
Mogadore, OH 44260  
(216) 628-3115 Ext. 19
- A.C. Falcione, CET  
Falcon Electronics, Inc.  
3266 Kent Rd.  
Stow, OH 44224  
(216) 688-2451
- Andrew M. Flock, CET  
Hickok Tech. Institute  
5100 Pearl Rd.  
Cleveland, OH 44129-1240  
(216) 351-4600
- David J. Garwacki, CET  
Sales & Service  
4846 Oak Glen Dr.  
Toledo, OH 43613-3048  
(419) 475-9221
- J.R. Manchester, CET  
University of Akron  
PO Box 61, Buckingham Center  
Akron, OH 44309  
(216) 972-7575



Bary G. Rathbun, CET ETI Technical College 4300 Euclid Ave. Cleveland, OH 44103 (216) 431-4300	John F. Grzesiak, CET 27 Lighthouse St. Erie, PA 16507-1937 (814) 459-2519	Knoxville, TN 37919 (615) 546-1121	3201 Premier, #100 Irving, TX 75063 (214) 550-5266	Ralph E. Oscarson, CET ITT Technical Institute N. 1050 Argonne Rd. Spokane, WA 99212 (509) 926-2900
Rod Schlingerman, CET PVS Electronics Inc. 3949 Cleveland Ave., Box 24400 Columbus, OH 43224 (614) 471-9010	Gene Hedgepeth, CET Technicon Service Labs. RD 4-639 E. Aberdeen Rd. Mountaintop, PA 18707 (717) 868-6566	Earl W. Hines, CET Star Rt. 1 Box 1-A 1710 Lamar Sweetwater, TX 79556 (915) 235-1849	Leonard M. Cowherd, CET Piedmont Tech. Ed. Center PO Box 999 Culpeper, VA 22701 (703) 825-0476	Cecil C. Poe, CET 1012 McClain Dr. Sunnyside, WA 98944-1270 (509) 839-3995
Donald Sisk, CET 1650 Cobble Gate Ln. Reynoldsburg, OH 43068 (614) 866-5667	L.A. Leibensperger, CET Lincoln Tech. Institute 5151 Tilghman St. Allentown, PA 18104 (215) 398-5300	Loren R. Hodge 3614-28th St. Lubbock, TX 79410 (806) 795-8617	Russell R. Offhaus, CET PO Box 1116 Chincoteague, VA 23336 (804) 336-5980	Ted Rodriguez, CET Skagit Valley College 2405 College Way Mt. Vernon, WA 98273 (206) 428-1248
John E. Valerio, CET Sencore 612 Lovers Lane Steubenville, OH 43952 (614) 264-3001	Thomas Plant, CET ETG of Rhode Island 29 Dean St. Pawtucket, RI 02861 (401) 723-3500 Ext. 333	Joseph H. Hudson Jr., CET 1500 Yarborough Dr. Sherman, TX 75090-5545 (214) 892-9356	Jame Richerson, CET Blue Ridge Comm. College Box 80 Weyers Cave, VA 24486 (703) 885-5960 Ext 276	James C. Shambow, CET ITT Technical Institute 12720 Gateway Dr., Suite 100 Seattle, WA 98168-3333 (206) 244-3300
J.S. Glosemeyer, CET East Okla. County Vo. Tech. 4601 N. Choctaw Rd. Choctaw, OK 73020 (405) 390-9591	Stanley A. Saller, CET 826 Bat Blossom Sumter, SC 29150 (803) 469-3022	ISCET 2708 West Berry St. Fort Worth, TX 76109 (817) 921-9101	Jim Teeters, CET 2937 E. Malden Ave. Norfolk, VA 23518 (804) 428-5772	Duane Busby, CET Motoria Computer Systems 2027 Sherman Ave. Madison, WI 53704 (608) 244-0339
Dr. Bess Jenkins Redlands Comm. College Box 370-1300 Country Club Rd. El Reno, OK 73036 (405) 262-2552	Donald Haag, CET RR 3, Box 92 Watertown, SD 57201 (605) 886-8932	Charles W. Kelley, CET 7805 Estates Way Rowlett, TX 75088 (214) 475-4406	Cary D. Thomas Jr., CET 2209 Eastover Dr. S Boston, VA 24592 (804) 572-6474	Larry Geissler, CET Indian head Tech. College 600 N. 21st St. Superior, WI 54880 (715) 394-6677 Ext. 275
Hubert L. Wood College of Americas of Tulsa 2514 East 71st St. Tulsa, OK 74136 (918) 496-8324	Charles Daugherty, CET Electronic Service Center 166 First St. NE Cleveland, TN 37311 (615) 472-0359	Gerald Martin, CET 3347 Falcon Grove San Antonio, TX 78247 (512) 496-1134	W. Clem Small RT 1, Box 64-1 Weybridge, VT 05753 (802) 545-2141	Jacob Klein, CET Northcentral Tech. College 1000 Campus Ave. Wausau, WI 54401 (715) 675-3331 Ext. 263
Roy W. Yonce Tec-Ed Corporation PO Box 470992 Tulsa, OK 74147 (918) 663-9500	Ross Hutcherson, CET 781 Iron Workers Rd. Clarksville, TN 37043-7911 (615) 362-9440	J.W. (Dub) Newson, CET Advanced Electronics, Inc. 1310 19th St. Lubbock, TX 79401 (806) 763-8246	M.B. Hixenbaugh, CET B N H Service 3635 S. Lawrence Tacoma, WA 98409 (206) 475-8861	David E. Nida National Education Center 5514 Big Tylor Rd. Cross Lanes, WV 25313 (304) 776-6290 Ext. 24
George W. Day, CET Douglas Education Svc. Dept. 1871 NE Stephens St. Roseburg, OR 97470 (503) 440-4774	Herman Patrick 3715 Lamar Ave. Memphis, TN 38118 (901) 362-8368	Arthur J. Ruppert, CET 30217 St. Andrews Georgetown, TX 78628 (512) 495-1679	Leonard Laabs, CET Walla Walla College 204 S. College Ave. College Place, WA 99324 (509) 527-2712	Robert Ing, CET Atropos Telecom PO Box 378 Postal Station O Toronto, Ontario, Canada M4A-2N9 (416) 580-7508
William H. Manny, CET Round-Up Electronics Inc. 2927 Riverside Pendleton, OR 97801 (503) 276-3152	Ronald R. Rackley, CET Tenn Inst. of Electronics 3203 Tazewell Pike Knoxville, TN 37918-2530 (615) 688-9422	Elizabeth Sheets American Commercial College 2007 34th St. Lubbock, TX 79411 (806) 747-4339	Carl E. McDonald, CET Sun Tech 417 S 6th Sunnyside, WA 98944 (509) 837-8800	Antonio M. Avellanosa MPITTI YMCA Building Baguio City, Philippines Phone# 442-6532
	William S. Warren, CET/CSM Warren's Audio-Video Service 2540 Sutherland Ave.	Frank Sosolik Jr., CET T.S.T.I. Servicing Dept. Box 154454 Waco, TX 76715 (817) 867-4883	Arthur B. Mitchell, CET 922 N. 97th St. Seattle, WA 98103-3210 (206) 525-8331	
		Thomas C. Underwood, CET Sony Service Company		

ate-level exam only, which covers basic mathematics, DC circuits, AC circuits, transistors and semiconductors, electronic components, instruments, tests and measurements, and troubleshooting and network analysis.

A fully certified technician must have four or more years of education or experience in electronics and must pass, in addition to the Associate-level test, one or more of the Journeyman options available in specialized fields of electronics. The Journeyman options that are available are:

- **Consumer**—Subjects covered include antennas and transmission lines, digital and linear circuits in consumer products, TV and VCR servicing problems, and the use of test equipment.

- **Industrial**—Subjects include transducers, switches, power factor, differential amplifiers, closed-loop feedback, basic logic circuits and functions, elements of numeric control, thyatrons, and SCR controls.

- **Communications**—This test covers two-way radio transceiver theory and servicing, receivers, transmitters, basic communications theory, deviation sensitivity, quieting, and troubleshooting.

- **FCC Legal**—This is a 25-question optional exam covering FCC regulations. Applicants who take the associate exam, the Communication option, and the FCC Legal exams will receive a general radio-telephone license.

- **Computer**—This test covers operation of computer systems with basic emphasis on hardware. Subjects covered include basic arithmetic and logic operations, computer organization, input and output equipment, and memory and storage. Some knowledge of software and programming is required, and the ability to explain troubleshooting procedure is also required.

- **Audio**—Products covered in this option include turntables, tape decks,

compact discs, and radios. The exam consists of both digital and analog sections, amplifiers and sound quality, system set-up, speaker installation, and troubleshooting audio systems.

- **Medical**—The priorities of this option are electrical safety and accuracy of calibration for electromedical instruments. The technician must be familiar with the basic vocabulary of medical instrumentation, telemetry, measurements, and differential- and operational-amplifier applications.

- **Radar**—A general knowledge of both pulsed and continuous-wave radar is necessary to take this Journeyman option. The test covers transmitters and receivers; CRT display systems and their power supplies; and antennas, transmission lines, and their characteristics.

- **Video**—The rapidly growing field of video is covered by this exam. The technician needs to know NTSC stan-

(Continued on page 93)



# GUGLIELMO MARCONI

A large, somber crowd was at Pier 54 in New York that dreary evening of April 18, 1912. Although hesitant at first, Guglielmo Marconi allowed police to clear a path through the crowd so he could see the 712 dazed and injured survivors of the S.S. Titanic tragedy as they came off the S.S. Carpathia, which had rescued them from the icy sea.

Marconi wireless equipment and operators on board the supposedly "unsinkable" Titanic had transmitted a shocking distress message in the early morning hours of April 13. The Titanic had struck an iceberg on its maiden voyage and was sinking rapidly. Less than three hours after the collision, the luxury ship, which "even God himself could not sink", was on the bottom of the North Atlantic. Of the 2229 passengers and crew members, 1517 perished.

Marconi was, at the same time, both distressed by the enormity of the tragedy and proud that his equipment and his operators had made possible the rescue of so many. He also undoubtedly remembered that he, too, had been scheduled to be a passenger on that fateful Titanic voyage to New York but had been forced to change his plans. The world now would hail Marconi as a hero for having made possible the rescue of the Titanic's 712 survivors.

This public attention provided Marconi with a certain amount of optimism. For many years, he had tried to stress the value of wireless in providing safety for ships on the high seas. Now, perhaps, his message would be more widely appreciated. Let's follow the long road he traveled to get his message across.

**A Native of Italy.** Guglielmo Marconi was born on April 25, 1874 in Bologna, Italy, to a family which enjoyed more than moderate wealth and local public recognition. His fa-



BY JAMES P. RYBAK

*Marconi's wireless  
telegraph signals  
not only spanned  
the seas, they helped  
save lives as well.*

ther, Giuseppe, managed a very successful family estate. Guglielmo's mother, Annie, was Scotch-Irish and had influential relatives in England. She and her English kin later would provide valuable help to Guglielmo in launching his career.

As a young boy, Marconi was not very interested in school work but did like to invent or make things. He would entertain himself by taking things apart to see what made them work. Guglielmo also enjoyed building replicas of mechanical devices or scientific experiments he had seen or

about which he had read. These activities were encouraged by his mother, but discouraged by his father who considered them to be a waste of time and money.

In 1887, when Guglielmo was thirteen, he entered the Leghorn Technical Institute where he very quickly became interested in the study of science, especially electricity. That same year, coincidentally, Heinrich Hertz experimentally demonstrated the existence of the electromagnetic waves predicted in 1864 by James Clerk Maxwell.

Marconi did very well in his science studies. He persuaded his mother to hire a Professor Rosa to tutor him on electricity at home. However, science was Marconi's only interest, so he was not able to pass the entrance examinations to the University of Bologna.

Annie Marconi used her influence and persuasive personality on Professor Augusto Righi at the University of Bologna to get permission for Guglielmo to use the science laboratory over which Righi had control. Righi was a highly respected expert on the topic of electromagnetic waves, but apparently did not tutor Guglielmo directly or work with him on experiments. Marconi eagerly read books from the University library on electricity and telegraph systems.

**Inspiration Comes.** Marconi was on a holiday in 1894 when he read of the electromagnetic wave experiments of Hertz in an article written by Righi as a eulogy to Hertz. This article established the thought in Guglielmo's mind that possibly electromagnetic waves could free telegraphy from the wires and submarine cables, which at that time constrained its use.

Finding out if electromagnetic waves could be used to communicate at a distance became an obsession for Marconi. His mother allowed him to use two large rooms on the top



floor of their house as a laboratory. She also helped persuade Guglielmo's father to provide (albeit grudgingly) the money necessary for the batteries, wire, and other equipment Guglielmo needed.

Mr. Marconi remained reluctant to spend money to promote his son's "foolish activities." After all, hadn't Professor Righi questioned Guglielmo's ability to accomplish anything significant in a field of science in which the boy had so little real knowledge?

Marconi started by repeating Hertz's experiments. His oscillator was an induction coil equipped with four spheres for the spark discharge, similar to that he had seen in Righi's laboratory. The frequency of the oscillations was in what we, today, would call the VHF range.

The detector he used with his receiving coil was a Branly coherer, similar to that used by Oliver Lodge. The coherer provided much greater sensitivity than the spark-gap equipped loop of wire Hertz had used. Marconi placed a curved metal detector behind his oscillator to direct the waves toward the detecting circuit.

Before long, Marconi was able to cause a bell, located thirty feet away, to ring when the oscillator was keyed. Through trial-and-error experimentation, he was able to increase the sensitivity of the coherer significantly over what others had achieved.

**Distances Increase.** The following spring, Marconi took his experiments outdoors. Connecting metal plates to the oscillator's spark gap lowered the frequency and strengthened the intensity of the oscillations produced. Similar plates were connected to each side of the coherer.

By chance, Marconi found that if one of the metal plates was elevated high in the air and the other was laid on the ground, the range at which oscillations could be detected increased to over one-half mile. Marconi's older brother and one of his father's employees became his assistants in these long range experiments.

Soon, the elevated plates at the oscillator and detector were replaced by long vertical wires. The plates which had lain on top of the ground now were buried. This arrangement increased the distance at which sig-

nals could be received to one and one-quarter miles. An intervening hill was found to be no barrier to the reception of the signals.

The combination of using lower-frequency oscillations and using the Earth as an element in his antenna system were crucially important achievements. Guglielmo Marconi had accomplished much by the fall of 1895.

Giuseppe Marconi was becoming impressed with the results he saw and changed his attitude toward his son's activities from opposition to support. He must have thought the boy might just be on to something.

Guglielmo realized that he needed to patent his wireless telegraph system. He was convinced that others, more knowledgeable concerning electromagnetic waves than he, undoubtedly also saw how these waves could be used in a telegraphy system. His father knew people who could help obtain an Italian patent and his mother's relatives had contacts in British scientific and governmental circles to help him there.

Marconi had wanted the Italian government to have the first opportunity to benefit from his work, but his offers were declined by the Ministry of Posts and Telegraphs. It is very likely the Italian Navy would have been interested in wireless telegraphy, but Marconi never approached them with the idea.

**Off to England.** Guglielmo was twenty-one when he and his mother went to England in February of 1896. Their arrival started out badly with customs officials carelessly damaging some of Marconi's wireless equipment. Perhaps this damage was deliberate because the customs inspectors suspected Guglielmo was some kind of spy or saboteur. Marconi's unwillingness to explain the purpose of his equipment to the officials undoubtedly increased their suspicions.

The first tasks Marconi undertook were the repair of his equipment and the filing for a British patent on his wireless system. Next, a letter of introduction to William Preece, Chief Engineer for the British Post Office was obtained through the help of a relative. The Post Office was the official provider of telegraph service in England and Preece, himself, had been experimenting with



*Fig. 1. The Branly coherer consisted of loosely packed coarse metal filings between two metal plugs in a non-conducting tube.*

an inductive system of wireless telegraphy for some time.

After meeting with Preece, Marconi was invited to give a demonstration of his wireless system to Post Office officials in July. Marconi set up his equipment on two roof tops located only a few hundred yards apart, but with tall buildings blocking direct view. The successful transmission of signals impressed the Post Office officials. They then requested additional demonstrations over longer distances.

The next formal demonstration by Marconi occurred in September of 1896 with officials of the War Office and the Admiralty joining the Post Office observers. Captain (later Sir Henry) Jackson was one of the persons in attendance. He had been conducting wireless tests since 1895 and in August had succeeded in sending signals between two ships located several miles apart.

The chief purpose of the September experiments was to demonstrate the feasibility of directional control of wireless signals. Marconi placed parabolic reflectors behind both his transmitting and receiving antennas. He successfully transmitted his short wavelength signals over a distance of one and three-quarters miles.

**A Public Demonstration.** The press and public were invited to a lecture on wireless by Preece and a demonstration of Marconi's equipment in December of 1896. A black box contain-

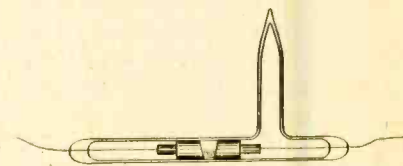

*Fig. 2. Marconi improved the coherer by using a mixture of very fine nickel and silver particles between two tapered silver plugs in an evacuated glass tube.*



ing an oscillator activated by a telegraph key was held by Preece as Marconi walked around the auditorium carrying another black box containing a receiver connected to a bell. To the amazement of the audience, whenever Preece closed the telegraph key, the bell in Marconi's box rang clearly for all to hear.

Now Marconi became a public celebrity. The press proclaimed Marconi the "inventor of wireless." This regard for Marconi's accomplishments was not shared by all, however.

Those familiar with recent scientific achievements knew that Hertz had shown how to generate the electromagnetic waves in 1887 and that Branly had observed "coherer action" in 1890. A number of people knew of Captain Jackson's work as well.

In addition, many scientists knew that Oliver Lodge had used similar equipment to send signals a distance of sixty yards before Marconi had even begun his own experiments. Lodge did not have the foresight to see the importance wireless might have for long distance communications and had not pursued his work toward that goal. Lodge did, however, obtain patents that would result in problems for Marconi many years later.

Another demonstration was held in March of 1897. This time longer wavelengths were used in conjunction with wire antennas raised some 120 feet above the ground by means of kites and balloons. This arrangement resulted in signals being received over a distance of four and one-half miles.

In May of 1887, Marconi demonstrated that wireless signals could span significant lengths across water by sending signals between the shore and an island in the Bristol Channel, a distance of 8.7 miles. This was a crucial test because the submarine cable that normally provided communications to the island had failed several times in recent months. Repairing the cable was costly both in time and in money so Marconi's system must have appeared as an excellent alternative.

**Marconi Goes Commercial.** The Wireless Telegraph and Signal Co. Ltd. was established in July of 1897. It was the first of numerous commercial enterprises Marconi would form over the years for the development and sale of

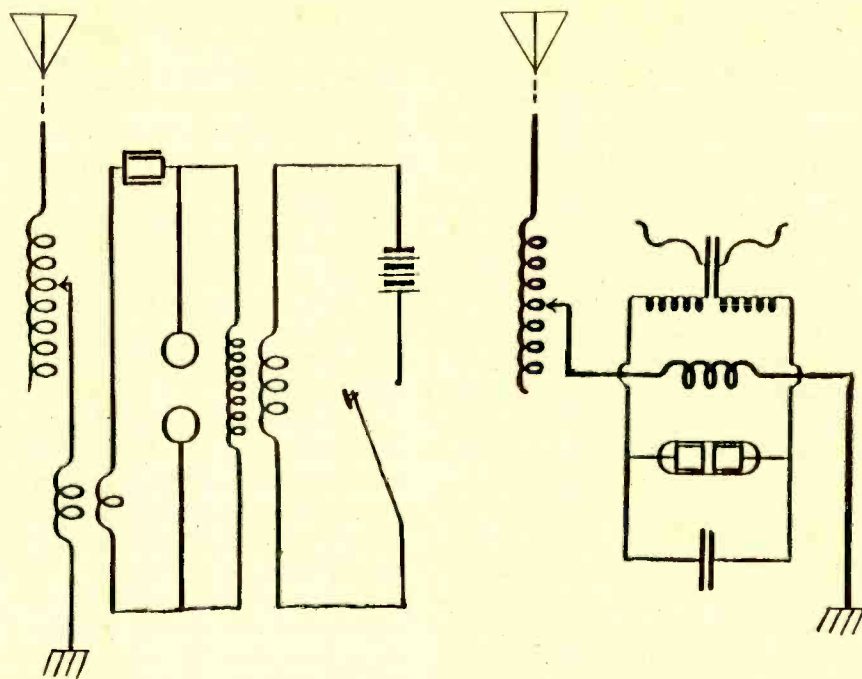

Fig. 3. Adding a "jigger" transformer in both the receiver and transmitter antenna circuits was one of Marconi's early attempts at tuning.

his wireless technology. In 1899, he changed the name of his company to The Marconi Wireless Telegraph Co. Ltd.

A major goal Marconi had in mind was to show the value of wireless for communicating with ships. In 1897, he returned home to Italy to convincingly demonstrate that wireless could communicate between naval warships. The Italian Navy soon adopted the Marconi wireless system. By the end of 1897, Marconi also had demonstrated that a wireless station he had established on the Isle of Wight in the English Channel could maintain communications with nearby ships.

Much favorable publicity came to Marconi when he operated a wireless transmitter from a boat to provide coverage of the 1898 Kingstown Regatta for a Dublin newspaper. Some seven-hundred messages sent over distances ranging from ten to twenty-five miles enabled the newspaper to out-do its competition in reporting the results of this very popular summer event. The manner in which the race was reported made as much news as the regatta itself.

Marconi was even more in the public limelight in the summer of 1898 when his wireless equipment enabled Queen Victoria to communicate regularly with her son (who one day

would become King Edward VII) while he was on a yacht recuperating from an injury. The yacht was located only two miles away, but out of sight, from the residence on the Isle of Wight where the Queen was staying. Wireless provided the only rapid means of communication. For sixteen days, the press marvelled at the accomplishments of Marconi's equipment as 150 messages passed between the Queen and her son.

While Marconi's demonstrations were highly successful and public acclaim was widespread, customers for his equipment were few. It was clear that even more convincing demonstrations of the capabilities of wireless were needed.

The next goal in Marconi's plan was to show that wireless could form a communications bond between England and the Continent. On March 27, 1899, Marconi sent the first message from his newly erected station at Wimereux, near Boulogne, in France to his English station at South Foreland, a distance of thirty-two miles. A number of French officials in attendance sent messages of greetings to their counterparts in England. This event generated for Marconi much additional publicity and good will, but, unfortunately, little that he could take to the bank.

**A Need for Tuning.** Marconi had shown that wireless could span distances that made it useful for commercial purposes. One major problem persisted, however. The untuned spark-gap transmitters generated extremely broad-band signals.

Two stations could communicate with each other without trouble. However, when a third station transmitted simultaneously, havoc ensued with each station effectively "jamming" the others so that messages were indecipherable. What was needed was some way for enabling transmitters to generate only one frequency and for ensuring that the receiving stations respond to only the signals desired.

Marconi had been aware of the need to provide such tuning for some time. His first efforts in 1897 involved coupling the receiving antenna to the coherer by means of a high-frequency transformer, or "jigger" as he called it, instead of the direct coupling previously used. The initial results were disappointing.

Continued experimentation resulted in the use of a split secondary transformer winding and the addition of a capacitor. Limited receiver tuning now was achieved, provided an antenna of the proper length was used. A small amount of transmitter tuning also was achieved when a jigger was used to couple the transmitter to its antenna. This tuning arrangement was patented by Marconi in 1898.

Still, the degree of transmitter and receiver tuning provided was not enough. Marconi's work continued. He was aware of and refined some of the tuning or "syntony" principles Oliver Lodge had demonstrated as early as 1889. Lodge had continued his own efforts and had obtained a patent in 1897 on a tuned antenna system for wireless telegraphy. Lodge's tuning system, like Marconi's, did not provide all the frequency selectivity needed.

Marconi's work ultimately resulted in the use of an effective antenna coupling circuit, which employed a tapped inductance together with a variable capacitor. That allowed both the transmitting and receiving antennas to be tuned to the precise frequency desired. In addition, and equally importantly, Marconi's system also provided tuning for both the oscillator circuit in the transmitter and

the coherer circuit in the receiver. The ability to confine the transmitted power to a narrower bandwidth not only allowed multiple stations to transmit simultaneously, but it also increased the distance over which the signal could be received.

Marconi applied for a patent on his tuning technique to establish and protect his commercial rights to its use. He was awarded British patent number 7777 (commonly referred to later as the "Four Sevens" patent) on April 26, 1900.

Eleven years later, Marconi would find that his legal position was not as solid as he had hoped. The principal features of Oliver Lodge's 1897 patent (albeit, with many improvements) clearly were incorporated in Marconi's tuning system. Lodge was prepared to defend his legal priority in court. To avoid lengthy and expensive legal proceedings that would probably be decided in Lodge's favor, the Marconi Company in 1911 purchased the rights to the 1897 patent from Lodge.

Marconi still believed that the first significant commercial market for wireless telegraphy would be the shipping industry. But to interest ship owners, it would have to be shown that truly long-distance wireless communication was possible and reliable.

**A Bold Plan.** In 1900, the Marconi International Marine Communication Company was established to develop a commercial maritime-communication network. Despite the fact that the Company's finances were

being stretched to the limit by the cost of worldwide marketing activities, which were producing distressingly few orders, Marconi proposed the grandest demonstration of all. He told the Company's directors that he wanted to build two high power stations with the goal of having signals span the Atlantic Ocean!

Marconi's goal seemed far too extreme. Due to the curvature of the Earth, the two stations were separated by the waters of the Atlantic, which effectively formed an obstacle, approximately two hundred miles high and incredibly thick. That meant he'd have to aim his signals tangential to the Earth's surface and hope for the best. At the time, the mathematical theory developed concerning the propagation of electromagnetic waves indicated that propagation slightly beyond the horizon was possible due to refraction. However, beyond a certain point the waves would travel away from the Earth's surface toward outer space, never to return.

Marconi already had achieved significant over-the-horizon propagation of signals, however. He was convinced that trans-Atlantic signaling would be possible if sufficient transmitter power were used.

The two sites initially chosen by Marconi for his stations were Poldhu, on the southwest tip of England, and Cape Cod, Massachusetts. John Ambrose Fleming (who later would develop the diode detector "valve" or "tube") was given the job of designing the necessary high power transmitters. His design utilized cascaded spark-gap resonant circuits driven by a 25-kilowatt alternator. Such transmitter power had never before been achieved.

The receiver's detector consisted of a glass tube with mercury placed between the ends of two conducting rods. At the time, this detector was called a "self-restoring coherer." However, the oxide film on the mercury actually produced a form of rectifier, rather than coherer, action. A telephone earpiece was connected to convert the hoped-for detected signals into audible sound.

The antenna selected consisted of an inverted wire cone 200 feet high supported by 20 wooden poles arranged in a circle. The design was

### Books of Interest

*Syntony and Spark—The Origins of Radio*, by Hugh G.J. Aitken, Princeton University Press, 1985.

*A History of the Marconi Company*, W.J. Baker, St. Martin's Press, 1971.

*Marconi—The Man and His Wireless*, Orrin E. Dunlap, The Macmillan Company, 1937.

*Wireless Telegraphy*, Sir Eric Eastwood, John Wiley and Sons, 1974.

*Guglielmo Marconi: 1874–1937*, Keith Geddes, Her Majesty's Stationery Office, London, 1974.

*Marconi*, W.P. Jolly, Stein, and Day, 1972.

*My Father Marconi*, Degna Marconi, Frederick Muller Ltd., London, 1962.



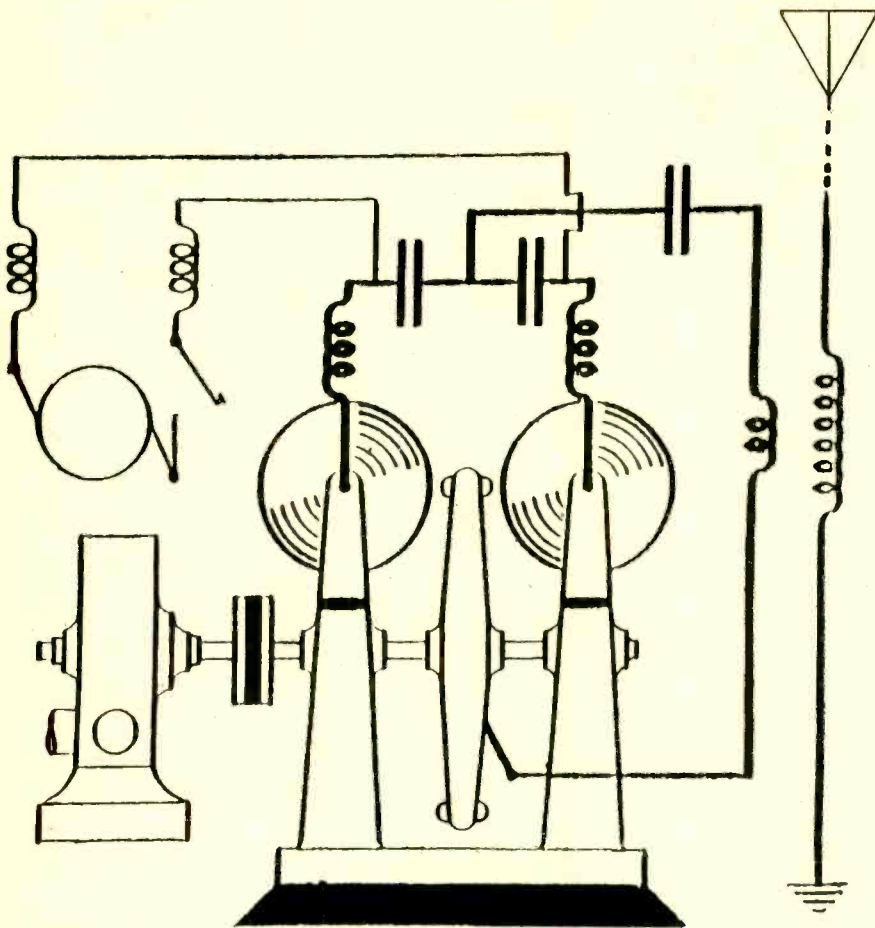

Fig. 4. After Marconi developed the "rotating-disc discharger," dependable trans-Atlantic signaling became a reality.

mechanically unstable and a storm destroyed the Poldhu antenna before tests could be begun.

Marconi then changed his plans, settling on one-way transmissions from Poldhu. The new antenna at Poldhu was simpler and sturdier, but less efficient. It consisted of a fan-shaped array of 50 wires supported by a horizontal wire stretched between two poles. The array was nearly 160 feet high and 200 feet in width. Newfoundland, the closest North American land mass, now was selected as the reception site.

Marconi and two assistants sailed for Newfoundland in late November of 1901. Bad winter weather and little available time would not allow a sophisticated receiving antenna to be built. The simple vertical wire antenna they planned to use would be supported by the kites and balloons they brought with them. The winter season provided better propagation conditions for wireless signals, but the frequent storms would make raising and

maintaining their wire antenna a difficult proposition.

Upon arriving in Newfoundland, Marconi paid a visit to the Governor and the Premier who immediately offered him their full cooperation. Marconi chose a hill overlooking the city of St. John's as the site for his experiments.

The Poldhu station was instructed by a cable message to send the letter "S" in Morse Code continuously for several hours each day beginning on December 11. The weather that first day was bad, however. The hydrogen-filled balloon used to lift the antenna rose and plunged violently before finally breaking loose and being lost. No signals were copied.

The storm continued throughout the following day. A kite used to raise the antenna soon was torn away due to the violent winds. A second kite then was employed to raise the 500-foot long antenna wire and it, too, seemed likely to be lost at any moment.

**Success!** Marconi listened intently for the signals from Poldhu. For what seemed to him like an eternity, nothing was heard. Then suddenly, at 12:30 p.m., Marconi handed the telephone earpiece to his assistant. Both men could hear the faint but unmistakable repetitive pattern of three clicks followed by a pause. Before long, the signals were lost in static.

Signals from Poldhu also were received at 1:10 and 2:20 p.m. on that historic afternoon of December 12, 1901. The twenty-seven year old Marconi now knew that his goal of a worldwide wireless-communication network was attainable.

Equipment for accurately measuring the wavelength of the transmitted signals was not available. Marconi estimated the wavelength to be approximately 366 meters while some of his engineers thought the wavelength could have been as long as 3000 meters. These wavelengths correspond to frequencies of 820 kHz and 100 kHz, respectively.

A press release describing Marconi's accomplishment was issued on December 14. While the news was believed and applauded by many members of both the general public and the scientific community, others were skeptical. Marconi's personal integrity was not questioned. Rather, some thought that the ears of Marconi and his assistant had been deceived by their enthusiasm. Unquestionable proof of the signal reception was what the skeptics demanded.

The news also caused some unexpected negative reaction. The Anglo-American Telegraph Company, owner of a cable and wire telegraphy system, had been granted a legal monopoly over all telegraph communications in Newfoundland. The Marconi Company was threatened with legal action if it did not cease its Newfoundland activities immediately. Marconi quickly accepted an invitation by the Province of Nova Scotia to move his facilities to Glace Bay on Cape Breton Island.

**Positive Proof Provided.** In January of 1902, Marconi arrived in England to plan his next experiments. He erected an antenna and set up wireless receiving equipment on the steamship Philadelphia in preparation for its February voyage to the United States.

Marconi's plan was to receive signals from Poldhu as the ship steamed westward with reliable witnesses on hand. The signals would be recorded on a Morse inker tape and verified by the ship's captain.

During the daylight hours of the ship's voyage, signals were received to a distance of 700 miles west of Poldhu. After dark, however, complete messages were received to a distance of 1550 miles and the "S" signals were copied to a distance of 2100 miles. Now Marconi had the undeniable verification of his experiments the skeptics demanded.

It must not be assumed that these successful experiments led immediately to a reliable trans-Atlantic wireless service. Propagation conditions were unpredictable and constantly changing. When signals did span the distance, messages usually had to be repeated numerous times before being received in their entirety. Wireless still could not compete successfully with cable telegraphy. More development was necessary.

**A Global Network.** The Marconi Company also began to see its goal of a worldwide communication system for ships attain reality in 1902. By the end of that year, seventy ships had been outfitted with Marconi equipment. The Company established twenty-five land-based stations around the world, including several along the Atlantic coast of North America, to communicate with ships carrying its wireless equipment.

One legal problem had to be overcome, however, before significant revenues could be generated. The British Post Office held a government-established monopoly on the handling of telegraph messages of any kind in the British Isles. It was illegal for any other organization or person to send telegraph messages for a fee.

To circumvent that monopoly, the Marconi Company rented, rather than sold, its equipment to ship owners. The rental fee included the services of a trained operator and the right to communicate with the Marconi shore stations. Since the Marconi Company did not charge for individual messages, it did not violate the law.

This rental arrangement also enabled the Company to increase its business by prohibiting ships not car-

rying Marconi equipment from communicating with its strategically located land-based stations or with Marconi equipped ships. Only in the case of distress calls would a Marconi station communicate with a non-Marconi equipped ship.

**Bigger and Better Antennas.** To allow construction of a larger antenna, Marconi moved his Nova Scotia station to a new plot of land less than two miles from Glace Bay in 1905. The maximum daytime range of the signals now increased to 1800 miles, but this still was insufficient to provide dependable trans-Atlantic communications with Britain.

Purely by accident, Marconi noticed in 1905 that a long antenna wire lying on the ground at Poldhu provided better reception when its free end pointed away from the Nova Scotia station. This fortunate observation led to the development of the "bent aerial" array of long wires. Not only was this new antenna design directional, it also was a more efficient antenna for transmitting and receiving long wavelengths. Marconi had the Nova Scotia antenna modified to this new design and achieved very good results.

The site at Poldhu was not large enough for construction of this new directional antenna. Marconi, therefore, chose a new site at Clifden in western Ireland. In addition to the directional antenna, the Clifden site was outfitted with a 300-kilowatt transmitter.

Marconi then worked to improve the last weak element in his system: the transmitter spark. The pulses of damped oscillations produced by the existing transmitter designs were coupled back and forth several times between the spark and the antenna. This caused considerable electromagnetic energy to be dissipated in the spark, producing erosion of the spark gap contacts and reducing the useful radiation.

The problem was overcome when Marconi developed the "rotating-disc discharger." This design was very efficient and could be used to produce virtually undamped oscillations, either in a continuous train or in pulses. The inherently narrower bandwidth of these nearly undamped oscillations increased the effectiveness

of the transmitter and receiver tuning and reduced interference between stations.

**A Reliable System Achieved.** The combination of the improved disc discharger mechanism together with the directional antenna resulted in a system which enabled (reasonably) dependable two-way communication between Glace Bay and Clifden, both day and night. Marconi now began his first commercial wireless telegraphy system between the two continents in October of 1907.

Over 10,000 words were sent the first day, alone. Marconi charged five cents per word for press-service usage and ten cents per word for other users. The cable telegraphy companies had been charging twenty-five cents per word. While the Company claimed a sending rate of twenty words per minute, poor conditions often necessitated numerous repetitions of the messages, resulting in a much lower effective rate of transmission.

**Safety for Ships.** While the establishment of commercial trans-Atlantic wireless telegraphy provided the Company with badly needed revenue, Marconi's greatest personal satisfaction undoubtedly came from the increased safety his wireless equipment provided ships. Marconi was an avid sailor and clearly understood the need for wireless at sea.

No longer were people on the high seas without a means of obtaining help when disasters struck due to storms, fires, icebergs, running aground, or mechanical failures. In the few short years since its inception, wireless telegraphy already had come to the rescue of imperiled passengers and crews on numerous occasions.

The first use of wireless to effect a maritime rescue occurred on March 3, 1899 when the steamship R.F. Matthews ran into the East Goodwin lightship in the English Channel during a heavy fog. Marconi equipment enabled a message to be sent to the nearby South Foreland lighthouse, bringing lifeboats to the rescue. While this was a relatively small event, it was indicative of the role wireless would play in the future.

*(Continued on page 98)*



# Build a Cable Tester

*Take the drudgery out of testing multi-conductor cable assemblies with this easy-to-build circuit*

BY D.F. RECKLIES

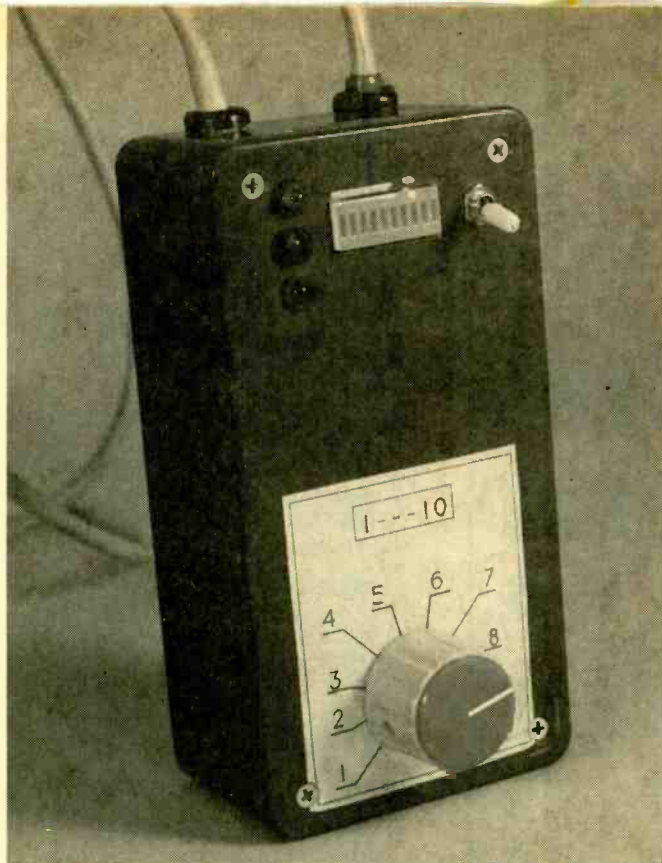

If you occasionally have a lot of cables to test, or just don't like probing around in tiny connector holes with a VOM or continuity tester, the simple *Cable Tester* described in this article may be just what you need. The Cable Tester, which can be used to test almost any cable of reasonable length and wire size for continuity, will indicate opens, shorts, or miswiring of the connectors.

At the heart of the Cable Tester are two op-amps, which are used as a window comparator to indicate a short- or open-circuit condition. A third op-amp comparator is used to indicate a good circuit (*i.e.*, neither open nor shorted). Colored LEDs are used to show the condition of individual conductors within the cable under test; a red one to indicate a short between conductors, a yellow one to identify an open conductor, and a green one to signify that the conductor is okay. Individual LEDs of a bargraph display are used to show which conductor in the cable is being tested.

**A Look at the Circuit.** Refer to Fig. 1. At the heart of the circuit are two dual op-amps, U1 and U2 (only half of U2 is used in the circuit). One op-amp, U1, is used to form a window comparator. The window comparator is used to

compare two reference voltages to a signal voltage. The reference voltages are derived from a voltage divider, consisting of R1, R2, and R3, while the signal voltage is produced by another voltage divider that's comprised of R4, one of ten 240-ohm resistors (R8–R17), and the resistance of the cable conductor (and associated cable connector) being tested. Since the conductor and connector resistances are usually minuscule when compared to the other resistances involved, they can be ignored.

Note that both dividers have LED's inserted between the top of the resistance ladder and the positive supply source—LED's 1–10 in the signal voltage divider (the one consisting of the conductor under test, and its associated LED and series-connected resistor) and LED14 in the reference voltage divider. LED14's primary function in the circuit is to provide a voltage drop in the reference voltage divider similar to that caused by LED1–LED10 in the signal voltage divider, thereby ensuring that approximately equal voltages will be present at the top of each voltage divider, even when the battery ages and the source voltage changes.

The reference voltage from point C is applied to U1-a's non-inverting input at pin 3, and the signal voltage at

point A is applied to its inverting input at pin 2. The output of U1-a will be low unless the voltage at point A falls below the reference voltage at point C—a condition which will not be met unless the conductor-under-test is open. If the conductor opens, the output of the op-amp goes high, lighting LED13.

The second half of the op-amp, U1-b, is used to compare the point-A voltage with the reference voltage at point B. The point B reference voltage is applied to the inverting input of U1-b at pin 6, and the signal voltage is applied to its non-inverting input at pin 5. The output of U1-b will be low unless the voltage at point A exceeds the voltage at point B. That condition will not be met unless two or more conductors are shorted. If a short exists, the output of the op-amp goes high, lighting LED12.

The values of R1–R3 have been chosen to provide reference voltages of about 4.2 and 2.6 volts at points B and C, respectively, when a 9-volt battery is used to power the circuit, as shown in Fig. 2A. The voltage at point A of the cable voltage divider depends on the condition of the conductor to be tested as indicated in Fig. 2B–2D. As shown in Fig. 2B, a good (neither open nor shorted) conductor would produce approximately 3.7 volts at

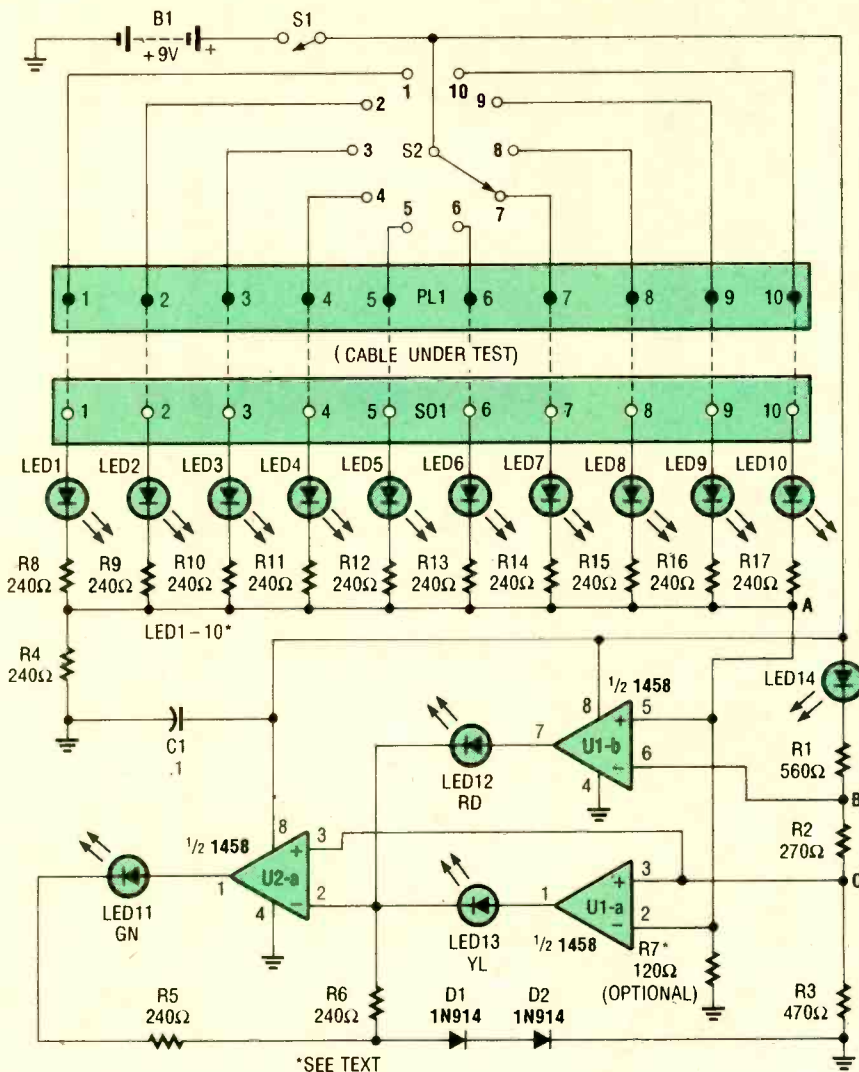

Fig. 1. At the heart of the Cable Tester, are two dual op-amps, configured as comparators.

point A. If, however, the conductor is open, the voltage at point A would be zero, as shown in Fig. 2C. But if two or more conductors are shorted, as indicated in Fig. 2D, the voltage at point A would increase beyond that of the normal (neither open nor shorted) voltage. If more than two conductors are shorted, the voltage at point A will be even higher than that indicated in Fig. 2D.

Op-amp U2-a is set up to compare the sum of U1-a's and U1-b's outputs to the voltage at point C of the reference divider. The reference voltage is applied to U2-a's non-inverting input at pin 3, while the sum of U1-a's and U1-b's outputs is applied to U2-a's inverting input at pin 2. If the outputs of U1-a and U2-b are low (i.e., the test conductor is neither open nor shorted), U2-a lights LED11. If a fault is present, a high output from either U1-a or

U1-b causes the output of U2-a to be low, so LED11 does not light.

Note that LED12 and LED13, while both serving as fault indicators, also isolate the outputs of U1-a and U1-b, so that they do not short circuit each other. When a single-ended power supply is used (as is the case in our circuit), the op-amp outputs cannot go all the way to ground; even when the outputs are low, enough voltage is usually present to dimly light the LED's that are supposed to be off. That's where D1 and D2 come in. Diodes D1 and D2 are included in the circuit so that the voltage drop across LED11-LED13 will be insufficient to cause them to light when their respective op-amp driver outputs are low. Resistor R6 serves as a current limiter for LED12 and LED13, while R5 performs the same function for LED11.

Switch S1 is used as the circuit's

### PARTS LIST FOR THE CABLE TESTER

**SEMICONDUCTORS**  
 U1, U2—1458 dual op-amp, integrated circuit  
 D1, D2—1N914 or 1N4148 general-purpose small signal silicon diode  
 LED1-LED10—10-digit LED bargraph display  
 LED11—T1-3/4 light-emitting diode (green)  
 LED12, LED14—T1-3/4 light-emitting diode (red)  
 LED13—T1-3/4 light-emitting diode (yellow)

**RESISTORS**  
 (All resistors are 1/4-watt, 5% units.)  
 R1—560-ohm  
 R2—270-ohm  
 R3—470-ohm  
 R4-R6, R8-R17—240-ohm  
 R7—120-ohm

**ADDITIONAL PARTS AND MATERIALS**  
 C1—0.1-μF, mylar capacitor  
 B1—9-volt alkaline transistor-radio battery  
 S1—Miniature SPST toggle switch  
 S2—SP12T rotary switch  
 PL1—10-pin Cinch Jones plug  
 SO1—10-pin Cinch Jones socket  
 Printed-circuit board materials, enclosure, LED holders, 9-volt transistor-radio-battery holder, 8-pin IC sockets (2), 20-pin wire-wrap IC socket, strain reliefs (2), 10-conductor cable, wire, solder, hardware, etc.

power switch, while S2 is used to select the individual conductor (within a given cable) to be tested. Note that the circuit described herein is configured to test 10-conductor cables; a 12-position switch was used for S2 simply because such switches are easier to find.

Two lengths of 10-conductor cable terminated in 10-pin "Cinch Jones" connectors (PL1 and SO1) were used for quick connection to two adapter assemblies. Each adapter cable was terminated in mating Cinch Jones connectors at one end, with the other ends terminated in various multi-pin connectors; for instance, 3-, 4-, and 5-pin XLR microphone connectors (one set male and the other female). That, coupled with various adapter sets, allows for the greatest flexibility.

On the other hand, you might choose to simply terminate the 10-



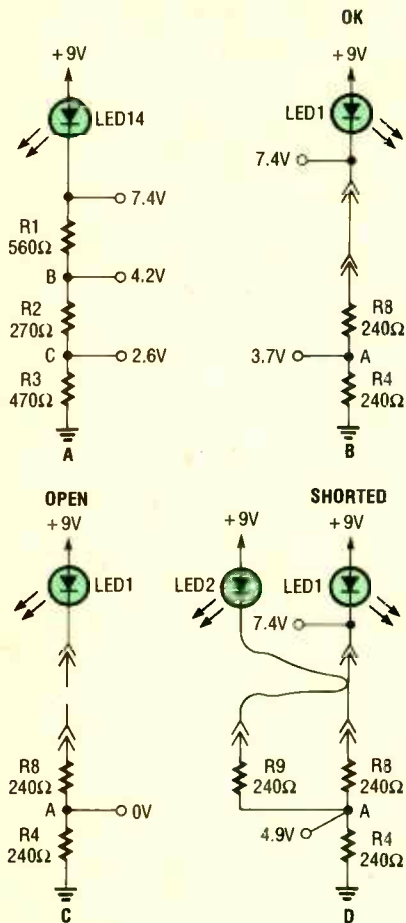
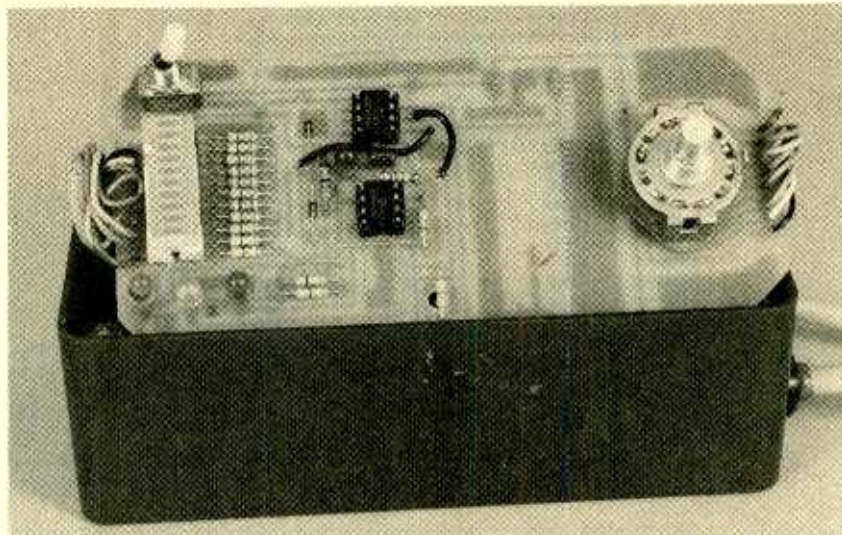

Fig. 2. The voltage divider in A provides the reference voltages that are used to determine the condition of the conductors in the cable under test. If the selected conductor is okay, the voltage at point A (in Fig. 1) will be as shown in B; if it is open, the point A voltage will be zero, as indicated in C; and if two conductors are shorted, point A will have a much larger voltage than if the cable is okay, as shown in D.

conductor cables connected to the board in a connector assortment that fits your needs, and forget about adapters. Still another course that you might take is to mount the circuit in a chassis with various chassis-mounted connectors for the various cable types that you are likely to encounter. If that chassis just happens to be a metal type, R7 (the optional resistor) should be included in the circuit. That resistor is connected between point A and chassis ground so that LED13 will light if any of the test cable conductors are shorted to the connector shell. If you have no need to test 10-conductor cables, you might want to use a different switch, such as a four- or six- position unit as appropriate.



In the author's prototype of the Cable Tester, all of the components, except the Cinch Jones connectors, were mounted directly to the board.

Although any 9-volt power source might have been used to operate the circuit, a 9-volt alkaline battery was chosen to make the circuit portable.

**Construction.** The circuit's construction is straightforward, and most of the parts are readily available from local or mail-order electronics distributors. The Cable Tester was assembled on a printed-circuit board. A template for the circuit board is shown in Fig. 3.

Note: Before gathering the parts needed for the project, you must decide whether you want to mount everything except the connectors on the board, or if you want to mount the battery, S1, S2, the LED's (including the bargraph display), and the connectors off board. How you arrange those parts will determine the size of the enclosure that you'll need. In the prototype, everything except the connectors were mounted to the board. Mounting everything on board produces a very neat layout.

The following instructions assume that you'll be mounting everything except PL1 and SO1 on the board. Once you've obtained the parts that are listed in the Parts List and etched a printed-circuit board, begin assembling the board, using Fig. 4—the parts-placement diagram—as a guide. Mount and solder the smaller parts, with the exception of the LED's, wire-wrap IC sockets, and battery-holder. When inserting parts, be especially careful of diode polarity; it's a lot easier to mount them correctly

now than it will be to troubleshoot a problem later.

When all small parts, except the LED's, wire-wrap IC sockets, and battery-holder have been soldered, insert U1 and U2 in their sockets, being careful to observe the proper orientation. Follow the IC's with the switches.

At this point, you must stop and prepare the chassis cover. Mark and drill the cover for S2 (the 12-position switch), S1 (the on/off switch), and the LED's. Then cut the rectangular hole for the bargraph display. Snap plastic LED bezels into the LED mounting holes. The 12 position switch will determine the mounting level of the PC-board inside the chassis. Insert the bargraph display into the wire-wrap socket, and then mount the PC-board to the chassis cover using the mounting hardware that comes with the switches.

Once the switches are secure, push the LED's into the mounting bezels and lift the wire-wrap socket to an appropriate height so that the bargraph display fits into the cut-out. When everything is at the correct level, solder the parts in place. Put several layers of tape on the side of the bat-

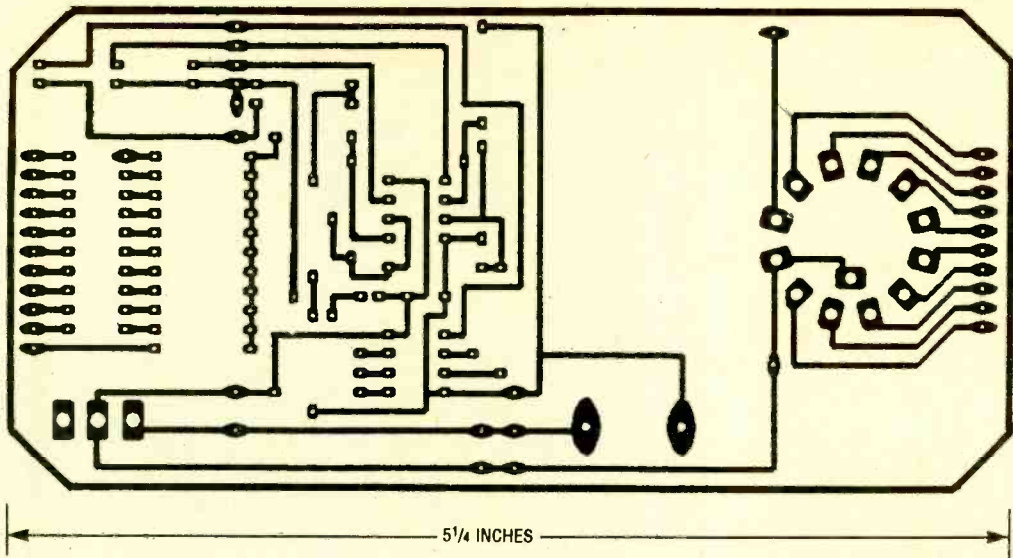

Fig. 3. The Cable Tester was assembled on a printed-circuit board. Here is a full-size template for that board.

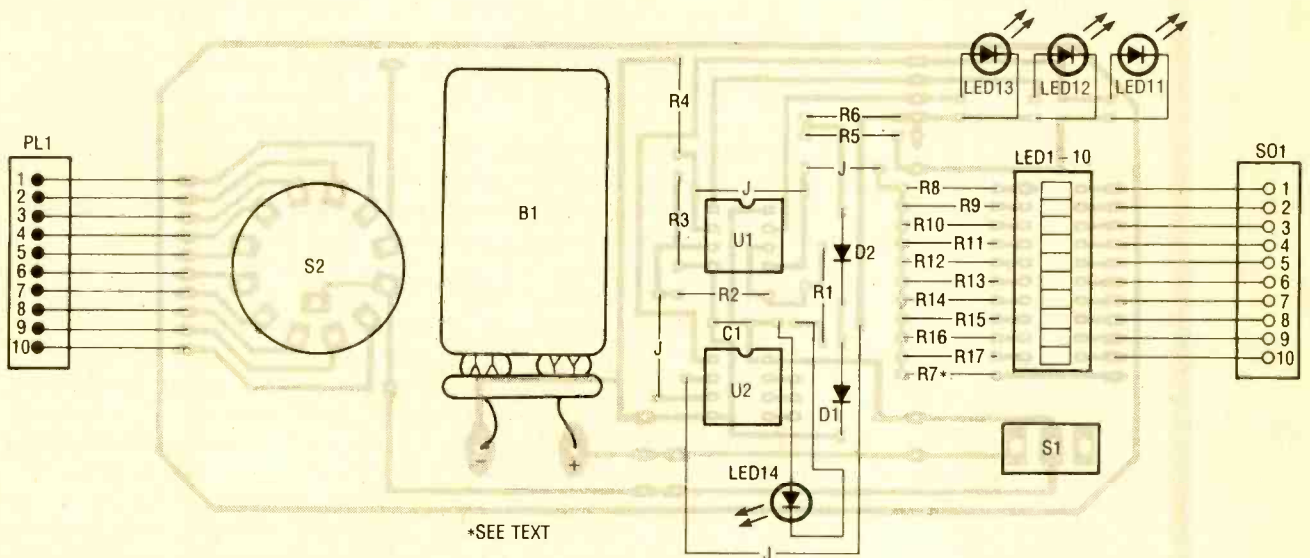

Fig. 4. Once you've obtained the parts listed in the Parts List and etched a printed circuit board, begin assembling the board, using this parts-placement diagram as a guide.

tery-holder that will lie against the printed-circuit board, then solder the battery-holder terminals to the printed-circuit board with the battery-holder on the foil side. (Note: If you can't find an appropriate battery-holder, you could use a pig-tail battery clip.) At this point, you may want to cut off the shaft excess of S2 and outfit it with a knob. Construction has now progressed to the point where we can test the circuit.

**Testing and Using the Circuit.** First, carefully examine the board for bad solder joints and solder bridges between traces. Follow the traces to find

and fix any opens where the etching may have been too vigorous. Once you are sure that all is okay, insert a battery and turn on the power to the circuit. LED14 should light, and since there is no cable plugged into the tester, LED13, which indicates an open-conductor condition, should be on.

If those LED's are not on, you've got a problem! Check the parts orientation, and voltages at the points indicated in Fig. 2. While differing battery voltages and parts tolerances may cause discrepancies between your readings and the values given in Fig. 2, be on the lookout for any voltage

readings that are widely off. If LED13 doesn't light, suspect that you have installed that unit in reverse. If the voltages differ greatly from those that are given in Fig. 2, suspect a wrong value resistor or an open or shorted trace on the printed-circuit board. If the voltages match, but the indicator LED's don't light, suspect U1 or U2 may be misoriented or that the LED's were installed in reverse.

Once you have solved any problems that have been encountered and have the yellow LED lit, use an alligator clip to jumper between pins 1 on the input and output connector,

(Continued on page 89)



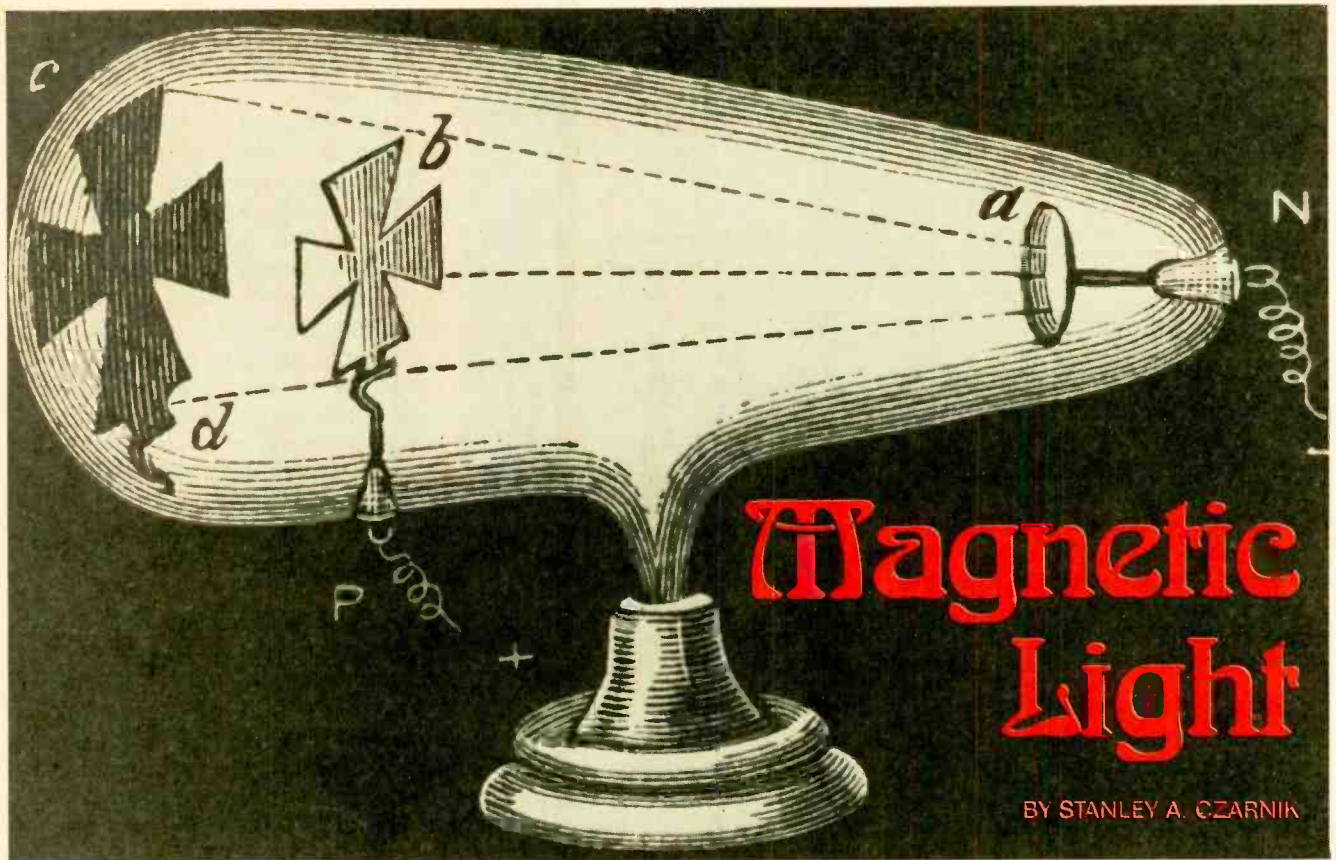

*Follow the trail illuminated by the glow of “magnetic light” tubes, and see how that ancestor of the CRT led to the discovery of the electron and the nature of electricity.*

In 1838, the great English experimenter Michael Faraday sent a current from an electrostatic generator through a sealed glass cylinder containing air at low pressure. The interior of the tube became luminous. Faraday’s comment was that “the rarefaction of the air wonderfully favors the glow phenomena.” In other words, the rarefied air, when subjected to the influence of a high-voltage impulse, lit up, and did so quite easily. Air at normal atmospheric pressure was much harder to illuminate.

Faraday noticed that the purple glow was discontinuous. The shaft of light extended from the positive end of the tube to a point not too far away from the negative end. The extreme negative end of the container was also covered with light, but a dark space appeared between the cathode glow and the purple column. That patch of black became known as the Faraday Dark Space.

Michael Faraday attached little philosophical importance to the gaseous-discharge phenomena at the

time, and his attitude could not have been much different. The technology necessary to make an extended study of gaseous conductors simply did not exist in the very early Victorian era. But the situation was destined to change, and that’s the story that follows.

### **The Artisan From Ingelschieb.**

Johann Heinrich Wilhelm Geissler was born in Ingelschieb, Thuringia, Germany on May 26, 1815. His father was a maker of glass beads, his mother was the daughter of a glassmaker, and his genealogy includes other craftsmen active in the Bohmen and Thuringian Forest. Geissler learned glassblowing at an early age and went on to work at several universities, including Munich. Beyond that, very little is known of his personal life.

In 1852, or earlier, Geissler settled at the University of Bonn and set up a workshop for the construction of laboratory apparatus. His early creations include a standard thermometer and a device for measuring the alcoholic strength of wine. Geissler was a superi-

or technician and his handcrafted instruments soon became central to many of the University’s experimental activities.

**Geissler’s Tubes.** In 1853, Geissler formed an association with a professor of physics and mathematics by the name of Julius Plucker, a man known for his correspondence with Faraday. Plucker came to rely on Geissler for the manufacture of what he liked to call “Geissler’s tubes.”

The skilled glassblower was able to make rather small glass tubes with wire electrodes fused into the glass. The tubes could then be softened and bent or blown into a wide variety of shapes. Finally, using a mercury-piston air pump that he built in 1855, Geissler was able to fill the tubes with various rarefied gases.

When a high-voltage current was sent through the gas by way of the metal electrodes, the whole tube would fill with a wonderful colored light. Geissler’s unique designs must have made that a very impressive



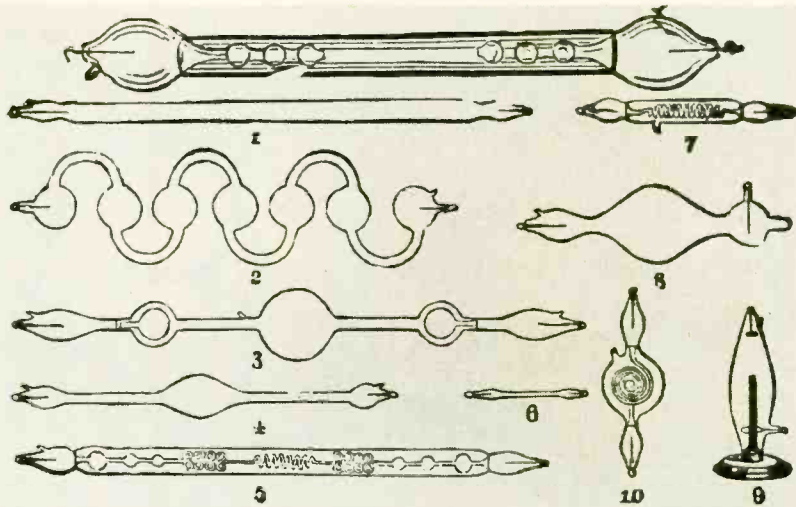

In the 1850's, a skilled German glassblower by the name of Johann Geissler was relied upon to make small glass tubes with wire electrodes fused into the glass. The cylinders were filled with various rarefied gases and illuminated with a high-voltage induction coil for experimental purposes. These early ancestors of our modern neon signs became known as "Geissler's tubes." This drawing appeared originally in *Experimental Science* (1906) and appears here courtesy of Lindsay Publications.

demonstration. By the late 1850's, the high-energy currents necessary to illuminate such tubes were usually supplied by yet another marvelous new technology: the high-voltage induction coil.

Geissler's tubes were much better than the so-called "electric eggs" made famous by Daniel Rumkorff and Jean Quet. For one thing, the eggs had to be connected to a pump by means of a stopcock; the glassblower's invention did not. Geissler's gaseous discharge tubes are nothing less than early ancestors of our modern neon signs.

In 1864, Geissler demonstrated his new mercury pump at the 39th meeting of the *Deutsche Naturforscher und Arzte*. At the same assembly, J.C. Poggendorff used Geissler's tubes to show the effects of electromagnetic induction. Finally, in 1873, at the world exhibition held that year in Vienna, Johann Geissler was awarded the Golden Cross of Merit in Art and Science. He died in Bonn on January 24, 1879.

**Magnetic Deflection.** Geissler's discharge tubes made it possible to study the beautiful glow of an electrified gas to an extent never before possible. The first person to pursue such studies was Geissler's collaborator, Julius Plucker.

Plucker noticed that Faraday's dark space became larger as the air pressure within the cylinder was reduced.

At the same time, the luminous area around the negative electrode became a bit larger. But that wasn't all. He also found that the negative glow would respond to a magnetic field. According to Plucker, it was as if the

light were made of "flexible chains of iron filings attached at one end to the cathode."

Iron filings, of all things! Plucker's effort to understand what he was looking at took him to the closest material analogy he could think of—a series of tiny iron fragments in the neighborhood of a magnet. Of course, we can say now that Plucker's parallel was not at all accurate: electrons are charged particles; bits of iron are not. But, he was on the right track. He did know that the shaft of light within the tube, whatever it was, could be forced to move by the application of a magnetic field; and that, as we'll see, turned out to be an extremely important observation.

**Letters to Faraday.** Plucker described his glow-tube experiments in a number of enthusiastic letters to Faraday, most of which were written between 1857 and 1859. Faraday's return correspondence reveals a lively interest in the work of his friend. In the summer of 1857, he even suggested a new way of connecting a discharge

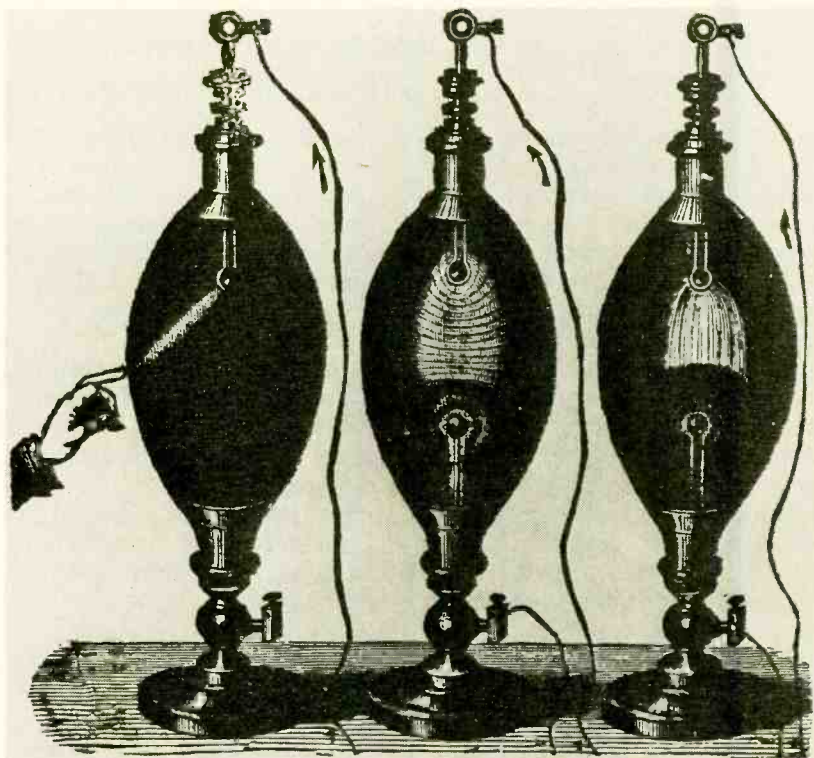

Geissler's tubes were much better than the so-called "electric eggs" made famous by Daniel Rumkorff and Jean Quet. For one thing, the eggs had to be connected to a vacuum pump by means of a stopcock; Geissler's invention did not. Note the example of the far left in which the spark is being drawn to a human hand. This drawing appeared originally in *Experimental Science* (1906) and appears here courtesy of Lindsay Publications.



cylinder to an induction coil.

But Faraday's health and memory were deteriorating, and by 1860 he could offer little more than encouragement and the hope that Plucker would continue his studies of luminous phenomena. In one of his last letters to Plucker, dated March 29, 1860, Faraday writes, with much sadness: "I have no science to send you." He died in 1867.

**The Secret.** Following the technical innovations of Geissler and the early studies of Plucker, scientists all over Europe obtained their own apparatus and began to investigate the strange new "magnetic light" for themselves.

The sudden popularity was not hard to understand. One certain attraction, as British physicist Joseph John Thomson pointed out in 1893, was the indisputable "beauty of the experiments." The other attraction was of a more philosophical nature. "No other branch of physics," he said, has ever offered so promising a way of penetrating "the secret of electricity." Gaseous-discharge equipment made it possible to actually see and examine the behavior of a current as it passed through a conductor.

**Further Experimentation.** Plucker's work was continued and extended by his pupil, Johann Wilhelm Hittorf, who was born and educated in Bonn, where his father was a merchant. Hittorf checked the effect of a magnetic field on the cathode glow, as well as on the fluorescence of the glass container, and proceeded to make an important discovery. He found that any solid object placed in front of the negative electrode cut off the energy and created a shadow image of itself at the opposite end of the cylinder. Hittorf concluded that the cathode radiance must travel in a straight line.

That property of *rectilinear motion* was verified with an L-shaped tube. When the tube was activated, the negative light was confined to the negative segment. Hittorf also came up with a very pretty name for the luminous streams; he called them *Glimmerstrahlen* (glow rays).

Additional investigations were carried out by Eugen Goldstein, a very skillful experimentalist whose lifelong interest was electrical discharge in gas at low pressure. He spent most of

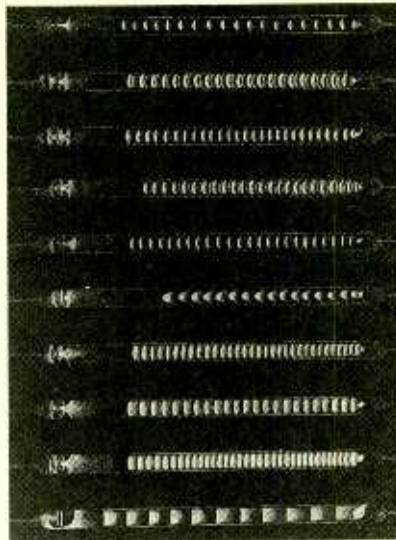

*Eugen Goldstein, another experimenter known for his early work with gaseous conductors, devoted much time to the study of anode illumination. He was especially interested in the stripes or striations (Schichtungen) that appeared in the positive column under certain conditions of gas, current, and pressure. In this illustration, the positive column is on the right; the cathode is on the left.*

his lengthy professional career at the Potsdam observatory, near Berlin. Among other things, Goldstein showed how the cathode light could make certain chemical salts change color and was able to produce some evidence for the electrostatic diversion of parallel beams. He also worked with a wide variety of electrode systems and found that it was possible to create a more concentrated light with a concave cathode.

Today, Goldstein remains known for his discovery in 1886 of what he called *Kanalstrahlen*, canal rays, or, as they were later renamed, positive rays. Goldstein was also the first to actually call the negative beams "cathode rays" (*Kathodestrahlen*); the expression was introduced in 1876.

Towards the end of his life, Goldstein devoted much time to the study of anode illumination. He was especially interested in the stripes or striations (*Schichtungen*) that appeared in the positive column under certain conditions of gas, current, and pressure. The alternating light and dark stripes in the discharge light were first noticed by Julius Plucker.

**Waves Or Particles?** The work of Goldstein, along with that of Plucker and Hittorf, shows that German ex-

perimenters had a good practical knowledge of cathode-ray tube phenomena well before the end of the 19th century. At about the same time, a great deal of contention appeared over the ultimate physical nature of the cathode beams. What were they? There were two possibilities, each of which had fit fairly well with the observable facts:

- They might be waves, an "aether disturbance," since, like ultraviolet light, they caused glass to fluoresce.
- They might be particles, since, like Plucker's imaginary iron filings, they could be forced to move by the application of a magnetic field.

Opinions on the matter tended to distribute themselves along national lines. German scientists, including Goldstein and Heinrich Hertz, claimed the cathode rays had to be wave-like. Plucker, who may have felt differently, died in 1868. British scientists, on the other hand, believed the rays had to be particle-like.

The question was settled, and settled for good, by J.J. Thomson in 1897. But before Thomson, it was William Crookes, that brilliant Victorian experimenter, who made the cathode-ray tube famous.

**William Crookes.** William Crookes was born in London, England, on June 17, 1832. His father, Joseph Crookes, was a prosperous tailor. William was the oldest boy in the family and had fifteen brothers and sisters. In 1848, he became a student at Hofmann's Royal College of Chemistry in London where he learned the rudiments of science. Between 1850 and 1854, he served as Hoffman's personal assistant and came to the attention of Michael Faraday, who in turn introduced him to Charles Wheatstone and George Stokes. Together, the three men persuaded Crookes to move away from traditional chemistry and pursue the newer problems of chemical physics, like spectroscopic analysis and photography.

Crookes is often compared to Faraday. Indeed, there are many indications that the young Crookes modeled himself after the illustrious English scientist. Like Faraday, Crookes was a superior manipulator of laboratory equipment, an excellent lecturer, and a mathematical novice. All of his work reveals an uncanny way of applying

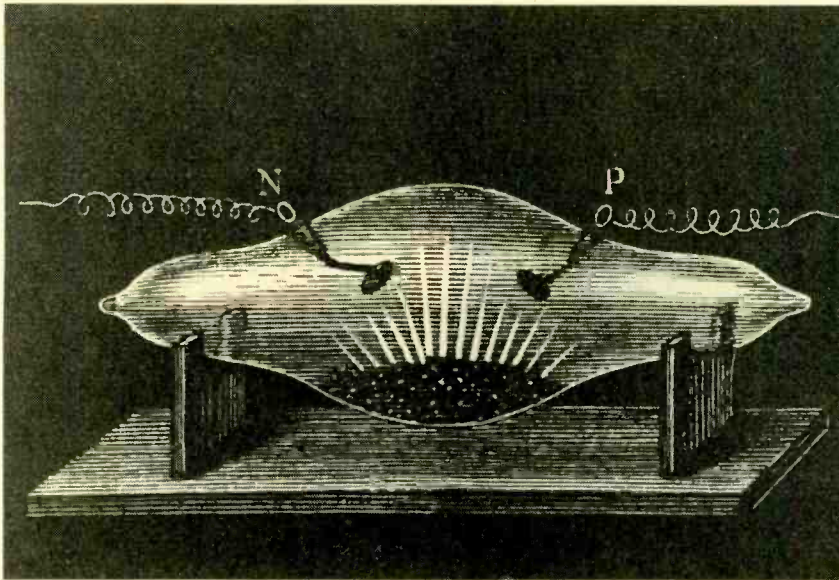

*William Crookes designed a variety of cathode-ray tubes for a variety of experimental intentions. The purpose of this high-vacuum tube was spectroscopic analysis. The substance under study, a rare earth material, for example, was placed in a depression at the center of the cylinder near the electrodes. When the tube was activated, the fluorescent light given off by the sample could be examined.*

ideas and abstractions to actual experimental sequences. The science of William Crookes had its own special beauty.

**The 4th State of Matter.** Following work involving the atomic weight of thallium and the invention of the radiometer, Crookes turned to the subject of glow discharge. His new studies were underway by the mid 1870's, and from the very beginning he was interested in understanding what really happened when electricity was passed through a gaseous conductor.

Crookes knew that, even with the best high-vacuum pump system, there always remained vast numbers of residual gas molecules in the discharge tube. A perfect vacuum, in other words, was just not possible. Crookes also believed that something very special was going on at or near the surface of the cathode and that it must have something to do with the residual molecules.

But what, exactly, was happening? Crookes' conception of relevant activity is as follows: Under normal conditions, the residual molecules of gas inside the tube move about in a random fashion. But, if a strong spark from what he called "a good induction coil" is passed through the cylinder, the situation changes. When the residual gas molecules come into contact with the negative electrode, they

acquire a negative charge. Since like charges repel, the negatively charged molecules are forced off the cathode in a direction perpendicular to its surface. The electrified cathode continues to act on the molecules, and the result is acceleration, or "a torrent of molecules."

But there's something else. More than a molecular surge, Crookes believed that the cathode ray was actually matter in a new form beyond solids, beyond liquids, and beyond gases; in other words, a 4th state of matter.

**The Shadow Tube.** In the late 1870's and early 1880's, much of Crookes' laboratory work became harnessed to an effort to verify the existence of the "ultra-gaseous" 4th state of matter. Today, some historians like to think of his original cathode-ray tube experiments as an early phase in the development of modern atomic theory. But Crookes, at least at first, had a very different reason for pursuing the research.

An example here will illustrate the point: Crookes knew that at very high exhaustions, the glass walls of the discharge apparatus itself would become luminous. With a tube made of German glass, the glow was green. With a tube made of lead glass, the glow was blue. But what created the light? Crookes believed that, given a

good vacuum, the mean free path of the residual gas molecules extended all the way across the tube. In that case, the stream of molecules driven by the cathode hit the interior wall of the tube with enough force to cause it to "vibrate and become temporarily luminous."

To lend support to his interpretation, the scientist designed a special-purpose cathode-ray tube. It became known as "Crookes' Shadow Cross High Vacuum Tube," or, for short, the shadow tube.

The shadow tube was a small glass cylinder with a circular cathode at the narrow end and a roundish blank surface at the larger end. Between them, Crookes placed the anode, which took the form of a solid Maltese cross. The cross was mounted on a hinge so that it could be taken down by tapping the tube.

When the tube was activated, a beautiful black shadow of the cross would appear on the blank glass wall. Now if, after a period of operation, the cross was taken down, the shadowed area would become very bright relative to the rest of the surface. The difference indicated the deadening effect of the cathode beam on the glass. Finally, if the power was switched off for a while and the glass allowed to "rest," the area would recover some, but not all, of its phosphorescent capability.

Crookes claimed that all of this was due to the action of the 4th state of matter. Not only did the molecular stream produce the colored light (as explained above), "but the molecules hammer away with sufficient energy to produce a permanent impression upon the glass." Compared to ordinary gas molecules, "the molecules which produce the green phosphorescence" must be "in a different state."

**The Reaction.** Crookes' theory of a 4th state of matter was never very popular, especially in Germany. Closer to home, the Scottish physicist James Clerk Maxwell was also critical and felt uncomfortable with the notion of a molecular stream carrying a negative charge.

J.J. Thomson found it possible to be a bit more sympathetic. Writing in 1893, he said that while Crookes' conception "is not free from difficulties," it



still seems "to cover the facts better than any other theory hitherto advanced." Thomson did not agree with the ethereal wave theories put forward by the German experimenters; and some particle-based theory, however imperfect, was far better than none at all.

**Interlude.** Thomson's interest in gaseous conductors remained strong, even after William Crookes' idea of a 4th state of matter was reckoned a failure. However, in the early 1890's, his attention shifted to the positive column. The positive column is the luminous area in which the alternating light and dark stripes appear. For a period of time, Thomson believed that the stratified glow was where one might find the key to the nature of gaseous-tube illumination. "The positive column," he suggested, "bears a very much more important relation to the discharge than either the negative dark space or the negative glow."

But that opinion was soon to change. For one thing, the wave-particle controversy kept cathode-ray behavior alive and within everyone's philosophical consciousness. Arthur Schuster, Philipp Lenard, as well as Hertz and Goldstein, all continued to investigate. And then, in 1895, there was the famous experiment of the French physicist Jean Baptiste Perrin.

Perrin's demonstration was a model of elegant simplicity. He connected an electrometer to a charge collector placed inside a cathode-ray tube. The charge collector was located in an electrically neutral area within the anode. When the tube was activated, the cathode rays entered the charge collector and the electrometer responded. When Perrin deflected the beam with a magnet, the charge collector returned to its original state. The experiment furnished unequivocal proof that something coming from the negative electrode carried a negative charge of electricity. For his work with cathode rays, Jean Perrin was awarded the Joule Prize of the Royal Society in 1896.

**Thomson's Project.** In many ways, Perrin's simple demonstration was a genuine breakthrough. Only a few years earlier, in 1893, Heinrich Hertz argued that "these cathode rays are

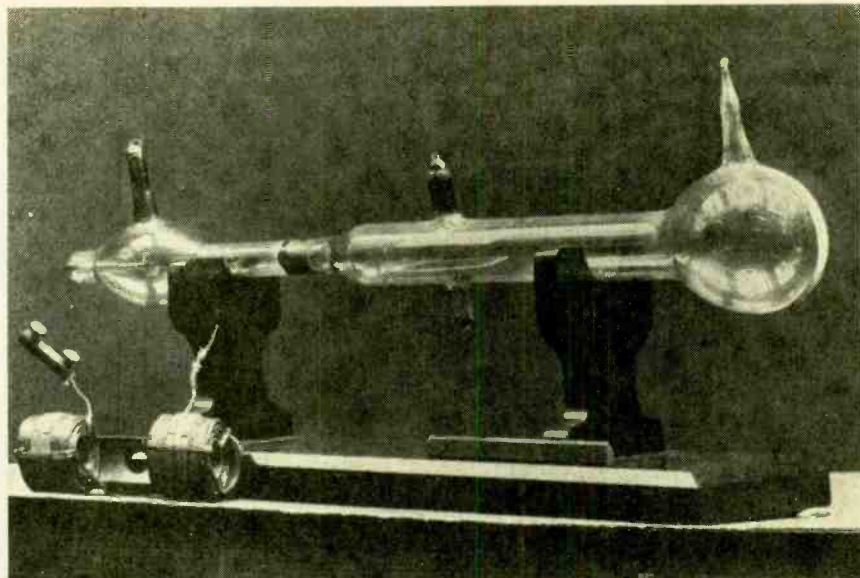

This is a photograph of the actual apparatus used by J.J. Thomson to determine the mass-to-charge ratio of the first known sub-atomic particle: the electron. The cathode, anode, and ground connections are at the left. The fluorescent indicator screen is on the right. The two electrostatic deflection plates are inside the tube near the center. The electromagnetic coils are at the left on the table. See the text for details.

### Further Reading

*Recent Researches in Electricity and Magnetism*, J.J. Thomson. Clarendon Press, 1893

*A History of the Theories of Aether and Electricity*, Edmund Whittaker. Philosophical Library, 1951

*Gaseous Conductors*, James D. Cobine. Dover, 1958

"The Experimental Researches of Sir William Crookes," Frank Greenaway, *Proceedings of the Royal Institution of Great Britain*, Volume 39 (1962): pages 172-198.

*The Discovery of the Electron*, David L. Anderson. D. Van Nostrand, 1964.

"The Induction Coil," George Shiers, *Scientific American*, Volume 224 (May 1971): pages 80-87

"William Crookes and the Fourth State of Matter," Robert K. Dekosky, *Isis*, Volume 67 (March 1976): pages 36-60.

electrically indifferent," i.e., without charge. Perrin's results contradicted the Hertzian position and opened the way for J.J. Thomson's discovery of the first sub-atomic particle.

Like William Crookes, Thomson believed that the cathode rays were particulate in nature. Perrin's work allowed him to add that the particles were electrified. But, just what sort of electrified particles were they? In

1894, Philipp Lenard showed that the cathode radiation could penetrate about ½ inch of air at standard temperature and pressure. Lenard's illustration was of special interest to Thomson. The reason is obvious: If, in fact, the cathode rays were composed of particles, then the relevant physical units must be much smaller than molecules of air.

Now Thomson had a better idea of what he was looking for and how he might be able to find it. What he had to do was measure the ratio of the mass of the particles to their electric charge ( $m/e$ ). The best way to do that was as follows: 1) deflect the cathode rays with a magnetic field, then 2) deflect the rays with an electric field, and then 3) compare the two measurements.

**Thomson's Tube.** Thomson's classic experiment involved yet another special-purpose cathode-ray tube. At one end of the cylinder, Thomson placed the cathode, anode, and ground connections. At the opposite spherical end, he had a fluorescent indicator screen.

The special function of the apparatus was made possible by a very clever arrangement near the middle of the tube. At that point, inside the cylinder, Thomson put a pair of electrostatic deflection plates. Also at that

(Continued on page 92)



# The "Good Vibrations" Printed-Circuit Board



## Workstation

BY JOHN YACONO

*Etching printed-circuit boards can be made faster and easier with a little help from an inexpensive home-brew agitator and a heat lamp.*

**F**or me, etching a PC board is one of the most nerve-wracking tasks. Just before "plunking" a slug into the etchant, I sometimes get a flashback of all the time and loving care I've taken to reach that point: figuring out the layout, cleaning the slug, laying down the pattern (pad-by-pad, line-by-line) without touching the board, inspecting the foil pattern, etc. And then, the wait begins . . .

In the past, as a slug would attempt to bathe quietly, I would become like

an annoying kid peeking at a cake in the oven; constantly disturbing the peaceful slug to see if it's done yet. For boards where there was a lot of copper to remove, the constant checking only slowed down an already prolonged and tedious process, fraying my nerves further.

Unfortunately, constantly monitoring the first-run of a board is the only way to be sure that it's not in the solution too long. It's the only form of insurance against ruining all the work you've put in. You could use less

etchant so the board is closer to the surface and more visible, helping you avoid fishing for the board and removing it (yeech, what a mess). However, boards etch faster in greater volumes of etchant. You could use an over-sized etching tank and create a shallow pool of etchant with high volume, but, without agitation, the wait will still be pretty long and the results may not be satisfactory for large boards. Further still, this is an impractical method if your work space is limited.



My solution to those dilemma's was to build the *Good Vibrations PCB Station*. It both agitates and warms the etchant, and enhances the visibility of a slug in a few different ways.

**The Station's Features.** One of the station's key components is a powerful, adjustable agitator that can be easily attached to any one of an assortment of tanks. That allows you to select a tank to suit the size of any board that you work on. Furthermore, once a tank is soiled it can be detached from the agitator for safe, easy cleaning.

The tank used for the prototype has been fitted with tiny rubber feet on the *inside* of the tank. They raise circuit boards closer to the surface of the etchant and keep them from the sides of the tank. That allows you to see the board even if you use a good volume of etchant. You won't have to play "Go Fish!" and increase the etching time. The feet also prevent the capillary effect from holding the slug in one place. So, as the tank vibrates, the board gently migrates around the tank. The combination of solution agitation and board motion etches the board faster, and the feet allow you to monitor the process more easily.

The last constituent of the station is a simple clamp-on lamp and reflector outfitted with an infrared bulb. Aiming the heat lamp at the surface of the solution speeds-up etching time by raising the etchant's temperature. It also makes boards easier to see.

The entire system can be built from readily available components in less than one evening. If you use the parts suggested in this article, the finished project won't look too bad either. It will also cost you much, much less than manufactured agitators. If you wish, the agitator can be scaled-down and built of even less expensive components (I'll point those out as I proceed) if your needs are modest.

**Agitator Construction.** The agitator circuit is childishly simple (see Fig. 1). It consists of a motor in series with a variable resistor, which is used to adjust the motor's speed. The circuit derives power from a wall-mounted DC adapter. The assembly generates vibration because the motor is mechanically imbalanced by some hardware, which I'll discuss shortly.

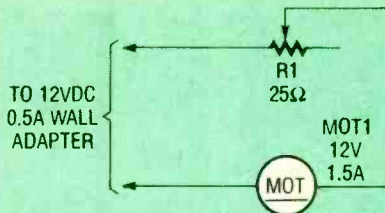

*Fig. 1. The agitator is very simple to wire together. The secret to the agitator's operation is the imbalanced motor.*

In the prototype, the motor used is a 12-volt DC, 1.5-amp unit, which is powerful enough to really shake the daylight's out of most tanks (even at just a ½-amp) if left to its own devices. However, I feel the choice was a wise one as it permits me the option of working with very large tanks if need be. Further, it can easily be tamed for use on small tanks by adjusting R1. You can use a less powerful, and less expensive motor if your needs are light. Of course, you should select a wall transformer to match the motor's requirements.

The wattage rating of potentiometer R1 (see the Parts List) is definitely over-kill, but low-wattage 25-ohm potentiometers are hard to come by in my area. You can use a low-wattage unit with higher resistance, but the useful adjustment range will be accordingly smaller.

Once you've selected all the electronic components, you can wire them together. Be sure the lead between the potentiometer and the motor is long enough to allow you to position the potentiometer wherever you wish. Solder all connections well.

Imbalancing the motor can be ac-

complished by crimping a large electrical lug onto the motor's shaft and bending it 90°. I used a circular lug so I could always securely attach additional weight to it with a nut and bolt to produce additional vibration. If you use a smaller motor and/or much larger tank than that recommended, you might need to add weight to the lug. Mount whatever hardware you will use on the motor shaft at this time and crimp into place. Make adjustments as necessary to ensure that the shaft/lug assembly rotates as a single unit without banging against the motor's body.

Now on to the agitator's case. The case does double duty: it couples vibration to the etching tank and it also acts as a stand for the tank. The tank attaches to the case via industrial-strength hook-and-loop fasteners on its underside. The heavy-duty fasteners help couple the vibrations from the agitator into the tank better than light-duty fasteners, particularly if the tank that you will be using is large. If you will be using a small etching tank, plain hook-and-loop fasteners will do and they will be less trouble to disengage.

Just about any small project box with minimum dimensions of 2¼ × 1½ × 1½ inches will make a suitable case. I chose to use the power-supply project case sold by Radio Shack (see the Parts List). It is long enough to accommodate long hook-and-loop fastener strips, it looks good, and ridges inside the case are perfectly spaced to support the motor used in the prototype. If you use this case as well, attach two lengths of hook-and-loop fasteners on the outer surface of the case section that has the ridges.

If you use another project case, you must decide which surface of the box will face the tank before attaching the fasteners. Choose a side that will permit the motor to be mounted perpendicular to it (*i.e.*, the motor shaft must point away from that side and into the case). When you've determined which side is suitable, attach lengths of hook-and-loop fasteners to its outer surface (leave gaps in the surface for any mounting hardware that you may need, as the motor must be mounted to this side).

Now you can position a hole for the potentiometer. For that you should chose a side that will not be facing the

### PARTS AND MATERIALS LIST FOR THE GOOD VIBRATIONS PCB STATION

- R1—25-ohm, 2-watt potentiometer (Radio Shack No. 271-265 or similar)
- MOT1—12-volts DC, 1-amp hobby motor (Radio Shack No. 273-255 or similar)
- 12-volt, ½-amp wall adapter; power-supply project case (Radio Shack No. 270-287 or similar); etching tank (see text); small grommets; rubber faucet washers, or O-rings; protective rubber feet; epoxy; nail polish; solder; wire; control knob; etc.



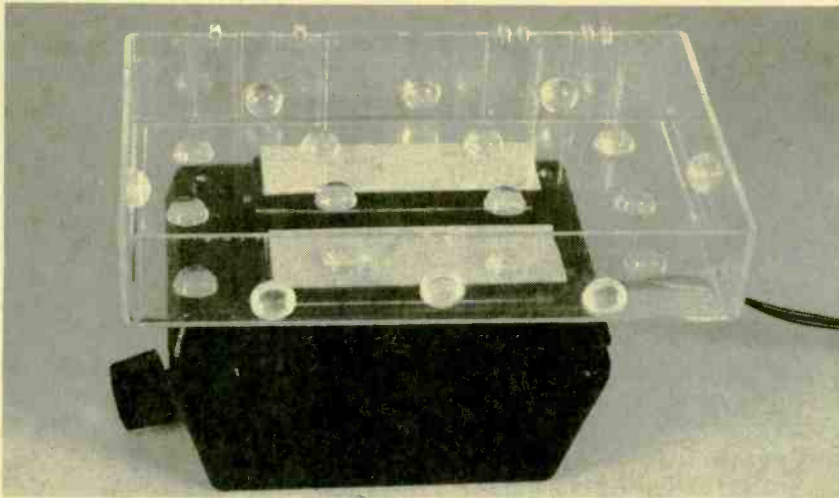

*Rubber feet in the tank spoil capillary action, allowing the board to move freely as it vibrates. The fasteners on the bottom are also visible from this vantage point.*

table top or the tank when the unit is in use. You must also make sure that the potentiometer body will not interfere with the motor when the motor is mounted. If you use the recommended case, the motor will be placed between the ridges in the middle and perpendicular to the tank when it's in place. If you also use the recommended motor, you can test-fit it snugly in place to help you decide where you wish to put R1. If you use a different case and/or motor, you will have to install your mounting hardware to test fit the motor and potentiometer. Once a good position is

found, remove the components, drill the hole for R1, and secure that potentiometer in place. This is a good time to form a strain relief where the wire to the transformer exits the case using wire ties or a knot.

If you use the recommended case, seal the grill slots between the motor-mount ridges with tape (any kind will do). Now create a ring of epoxy between the ridges so that you can pot the motor in it. A word of caution: don't use hot-melt glue (the vibrations would quickly destroy the bond), use a real 2-part epoxy. The ring should be thin enough so that the epoxy will not

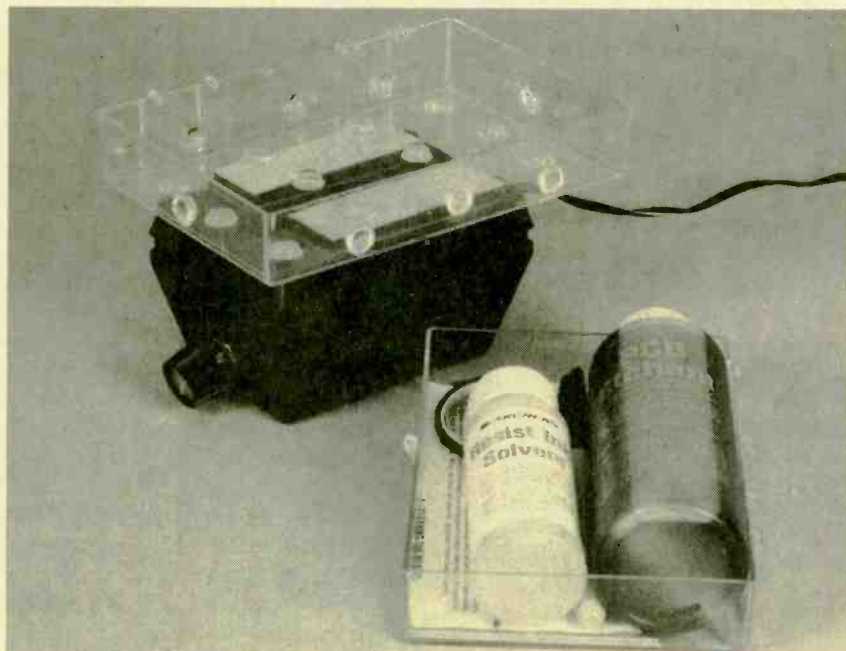

*The etching tank and agitator can be separated for safe and thorough cleaning or compact storage. However, when connected together, the hook-and-loop fasteners lock them so tight that it's incredible.*

flow up into the motor vents or cement the back end of the motor shaft. If you use another case, you'll have to create a similar ring of your own design. Place the back end of the motor (the end without the shaft and lug) in the epoxy and adjust it that so the shaft is perpendicular to, and pointing away from the surface that will support the tank. Apply generous amounts of epoxy where the motor meets the mounts (the ridges for the recommended case and motor design) and set the assembly aside to dry.

This is the perfect time to prepare the lamp and tank for the system.

**Final Assembly.** Preparing the lamp is, of course very easy. Be sure to get a clamping base with a reflector suitable for a large 250-watt infrared lamp (available from most large hardware stores), as some assemblies have reflectors shaped for use with regular light bulbs only. If the reflector is not already attached to the clamp and socket, screw it into place. Now take the bulb and screw it into the socket and the heat lamp is done.

Preparing an etching tank is almost as easy. I used the plastic case that came with the Archer PC Board kit because I needed the other materials that came in the kit as well. Like everything else in the system, you can substitute any suitable replacement. You can even make a collection of different size tanks to accommodate boards of various sizes. Note, however, that whatever you use as an etching tank can not be made of metal. (The chemical etchant used for PC-board preparation will dissolve the metal. Use a plastic or glass container for the etching tank.)

First take some protective rubber feet (preferably the rounded kind; those will permit boards to slide around easier) and attach them to the inside bottom of a tank. Try to form a pattern with them in such a way that even the smallest PC board that you expect to work on won't tip over and touch the bottom of the tank.

After that, turn the tank up-side down and make sure that the bottom is nice and clean; clean it if necessary. Assuming the epoxy on the agitator is dry, mate the hook-and-loop fasteners (with the paper backing still

*(Continued on page 91)*



# ANTIQUE RADIO

By Marc Ellis

## Coming: A New Restoration Project

Last month, we emptied out the long neglected mailbag and covered most of the letters—with the exception of a group relating to the just completed theremin project. So let's get them acknowledged before we move on to new business!

### WANTED: A MODERN THEREMIN

A number of readers, among them Ivan Shewchuk (Winnipeg, Manitoba, Canada), Alan A. David (Holiday, FL), Robert

Jeffrey (Alhambra, CA), Bernette Kerchner (Lenhartsville, PA), Gary Isod (Reading, PA), and Tom Simpson (Jamul, CA) expressed interest in plans for building a modern solid-state theremin. In fact, I recently received a second letter from Tom requesting that I be sure to print such plans before putting the theremin topic to bed for good.

To these readers, I have to reply with regrets that designing a contemporary version of Leon Theremin's invention is a bit out of my area of expertise. If anyone should accomplish this, I invite him or her to contact me; I'll be glad to publish details in the column. The September, 1987 issue of **Hands-On Electronics**, our predecessor magazine, does carry a construction article on a "digital theremin." Making use of a couple of integrated circuits, the unit requires a minimum of parts. One drawback: Although the unit has a pitch antenna, volume must be controlled via a potentiometer or foot pedal.

### OLDER THEREMIN PROJECTS

For those who don't mind going back a few years, the Louis Garner construction article from the old *Popular Electronics* for November, 1967 has both pitch and volume antennas. It makes use of bipolar transistors and FET's that are still listed in transistor-substitution guides. Reader Bob Moore (Renton, WA) passes along some corrections to the Garner article that ap-

peared in a later issue of *Popular Electronics*. Capacitors C2 and C7 should be 0.01  $\mu\text{F}$  rather than 0.001  $\mu\text{F}$  as specified; transistors Q6 and Q7 are TIS-58 rather than TIS-59.

A couple of readers sent along copies of theremin construction articles that did not appear in our original bibliography in the April, 1991 issue. Thanks to reader Bernette Kerchner for *Theremin Electronic Music Maker* by John Potter Shields (May, 1964 *Popular Mechanics*) and to reader Al Kocurek (Chino Valley, AZ) for *How to Build a Theremin* by Charles L. Hansen (November, 1953 *Radio Electronics*).

Derek Verner (291 Marbledale Rd., Tuckahoe, NY 10707) needs to locate a mid-1950's construction article (not from *Popular Electronics*) detailing a theremin using three 6B6 tubes and a 6F6, VR150, 5V4, and 6B8. Daniel J. Horowitz (Alexandria, VA), author of the January, 1961 *Electronics Illustrated* theremin construction article, was pleased to be included in the April, 1991 bibliography. And Kenneth Lundgren (Bloomington, IL) recalls his experiences building a couple of the theremins listed in the bibliography.

Thanks to reader Bob Kjallin (Portland, OR) for calling attention to the use of a theremin in the Beach Boys track "Good Vibrations," re-released on a Capitol CD. Eric Muller (6342 N. Francisco, Chicago, IL 60659) plays a mean theremin judging from a tape he sent of his "Maya Marimba Band." Eric

## WESTINGHOUSE Radio Receiving Equipment

Type RA Short-Wave Tuner  
Style 307189—180-700 Meters
Type DA Detector Amplifier  
Style 307190—2-stage, 3 tubes  
Audio Frequency

**T**HIS high-grade Westinghouse regenerative Tuner, and tube detector amplifier embody the latest ideas of two noted radio engineers, Edwin H. Armstrong and Frank Conrad.

This apparatus provides a most efficient set for telegraph and telephone reception over the amateur and normal ship wave length ranges.

**Simple in Design—Easy to Operate—Single-tuning Circuit  
Highly Efficient**

Interior View of Type RA Short-Wave Tuner
Interior View of DA Detector Amplifier

**Our Radio Folder No. 4446 will interest you.—Ask your dealer for a copy  
WESTINGHOUSE ELECTRIC & MANUFACTURING COMPANY  
EAST PITTSBURGH, PA.**

# Westinghouse

As this 1921 advertisement from the Alan Douglas book suggests, radio communications in the early '20's was carried on mostly by commercial and amateur operators.

needs some technical information on his 1960's- or 1970's-vintage *Maestro* instrument. Write him if you can help.

## BOOKSHELF DEPARTMENT

I've recently had the opportunity to review a couple of books of more than passing interest to the serious collector. The first of these is the long-awaited *Radio Manufacturers of the 1920's Volume 3* by Alan Douglas (Vestal Press, 1991). Covering manufacturers from RCA to Zenith (alphabetically), Volume 3 completes the saga begun in Volume 1 (A-C Dayton to J.B. Ferguson, Inc., 1988) and continued in Volume 2 (Freed-Eisemann to Preiss, 1989).

At the beginning of the turbulent decade covered by this three-volume series, radio was used largely for commercial point-to-point communications. By the end, radio broadcasting had become an established industry and, as pointed out in the Preface to Volume 1, three-and-a-half-billion dollars' worth of radios, parts, and accessories had been sold. The economic depression brought about by the stock market crash of 1929 changed the industry forever, flattening sales curves and throwing many radio manufacturers into receivership.

Douglas' three-volume series covers the manufacturers (about 70 in all) that were most prominent during this era of explosive boom and sudden bust. The histories of those manufacturers have been reconstructed, as completely as possible, from contemporary sources such as trade and technical publications. In addition, the author has attempted

to discuss every radio model advertised and sold by each manufacturer.

Like its two predecessors, the 285-page Volume 3 is lavishly illustrated with period advertising and handsomely printed on glossy paper. All volumes are available from Antique Radio Supply (6221 S. Maple Ave., Tempe Arizona 85283), Antique Radio Classified (P.O. Box 2, Carlisle, MA 01741), and other dealers. Volumes 2 and 3 are each priced at \$29.95 in soft cover and \$39.95 in hard cover. Volume 1 prices are \$24.95 and \$34.95. Shipping is extra.

*Just a few years into the decade covered by Radio Manufacturers of the 1920's, as evidenced by this 1924 ad reproduced in Volume 3, the broadcast industry was established and radios had become consumer items.*

While *Radio Manufacturers of the 1920's* chronicles the history and production of several firms during a momentous decade in radio, *The Hallicrafters Story* by Max De Henseler (Antique Radio Club of America, 1991) covers the four-decade history and production of a single influential manufacturer.

The five chapters of De Henseler's book interweave

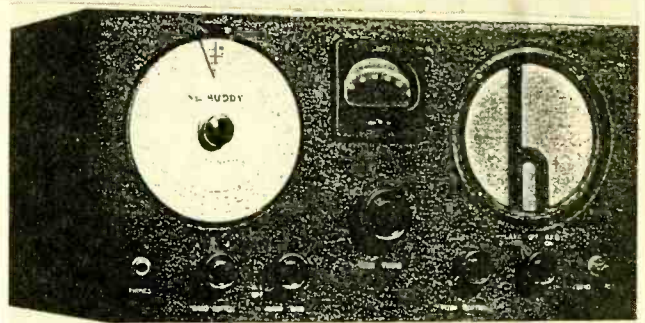

*The Sky Buddy (S-19) receiver of 1938, from a QST advertisement reproduced in The Hallicrafters Story.*

Hallicrafters' business history with Hallicrafters' model releases, beginning with the company's inception in 1933 and continuing through its closing in 1975. Though Hallicrafters' World War II military production is represented, as are its pioneering postwar TV sets, the book concentrates on products made for use by hams and shortwave listeners. Within that area of concentration, however, the book is quite definitive.

Models are illustrated with pictures taken from Hallicrafters advertisements in amateur-radio publications (especially *QST*), and, in many cases, schematic diagrams are included as well. The schematics are a little too small to be easily readable with the naked eye (especially a middle-aged eye like mine) but they are sharp enough that a magnifying glass will reveal the necessary details. The text includes detailed technical and physical descriptions of each set, as well as the release date and original selling price.

*The Hallicrafters Story* is not an elegantly produced book. The type is typewriter style (though the right-hand margin is justified, as with typeset copy) and the layout is plain. But the paper is of good quality, the illustrations are profuse and clear, and the binding is sturdy. An epilogue and four

appendices provide some interesting and valuable supplementary material, including a geological-style chart showing the evolution of various receiver models; selected bibliography; references to coverage in *Riders*, *Supreme*, and *Sams*; and a chart showing advertising activity by model and year.

*This Echophone EC-1 advertisement from Max De Henseler's book evokes the wartime atmosphere in which this set was sold.*

The 278-page book is a "must have" for anyone who needs a reference to the incredibly diverse array of models produced by Hallicrafters over its four-decade lifespan. It's available directly from the publisher, Antique Radio Club of America, Inc., 312 S. 10th St., Akron, PA 17501. Price is \$16.95 postpaid.

*(Continued on page 79)*



# CIRCUIT CIRCUS

By Charles D. Rakes

## Op-amp Based Circuits

Our first circuit came about after a delivery person dropped a valuable package while trying to ring the shop's doorbell. Fortunately, no damage occurred, but the incident gave birth to the idea of a voice-activated one-way intercom that would allow anyone to get our attention by simply speaking rather than reaching to ring a doorbell.

of U1 (an LM741 op-amp). The output of the amplifier is fed to a voltage-doubler circuit, made up of D1, D2, C2, and C6. The doubler's positive DC output is used to drive Q1, whose output (taken at its collector) is used to drive Q2. When Q2 turns on, operating power is applied to U2 (an LM386 low-voltage audio power

tentiometer R9. Potentiometer R10 can be used to adjust the output-volume level of the circuit as desired. The circuit can be powered from just about any well-filtered, 12-volt DC power source, as long as it has a 100-mA (or more) current capacity.

All of the components, except for the microphone

### PARTS LIST FOR THE ONE-WAY VOICE-ACTIVATED INTERCOM

#### SEMICONDUCTORS

U1—LM741 op-amp, integrated circuit  
 U2—LM386 low-voltage, audio-power amplifier, integrated circuit  
 Q1—2N3904 general-purpose NPN silicon transistor  
 Q2—2N3906 general-purpose PNP silicon transistor  
 D1, D2—1N914 general-purpose silicon diode

#### RESISTORS

(All fixed resistors are 1/4-watt, 5% units.)  
 R1, R7—2200-ohm  
 R2—1000-ohm  
 R3—R6—10,000-ohm  
 R8—10-ohm  
 R9—250,000-ohm potentiometer  
 R10—5000-ohm potentiometer

#### CAPACITORS

C1—C4—0.1- $\mu$ F, ceramic-disc  
 C5—0.22- $\mu$ F, ceramic-disc  
 C6—4.7- $\mu$ F, 16-WVDC, electrolytic  
 C7, C8—470- $\mu$ F, 16-WVDC, electrolytic  
 C9—100- $\mu$ F, 16-WVDC, electrolytic  
 C10—10- $\mu$ F, 16-WVDC, electrolytic

#### ADDITIONAL PARTS AND MATERIALS

MIC1—electret microphone element  
 SPKR1—8-ohm 1/4-watt speaker  
 Perforboard materials, enclosure, IC sockets, knobs, 12-volt power source, wire, solder, hardware, etc.

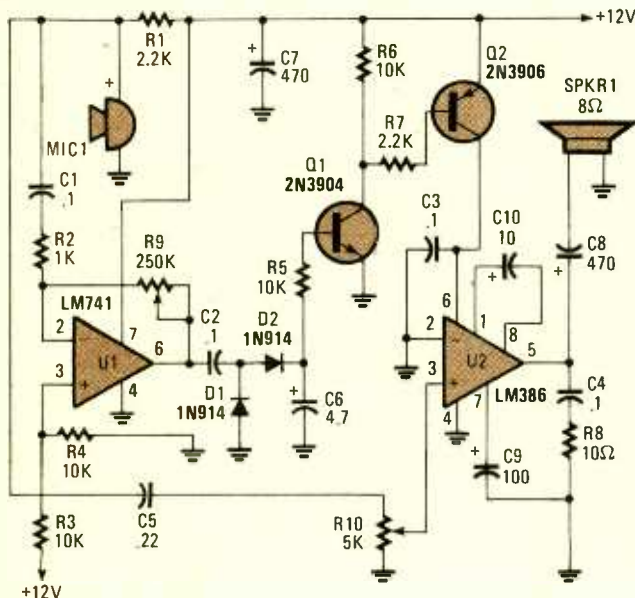

Fig. 1. The one-way intercom uses an omnidirectional electret microphone to pick up sound and convert it to an electrical signal. The resulting signal is used to activate the audio amplifier (U2) that drives the speaker (SPKR1), and is also the audio signal that is output by the speaker.

### ONE-WAY VOICE-ACTIVATED INTERCOM

A schematic diagram for the one-way intercom circuit is shown in Fig. 1. An omnidirectional electret microphone is used to pick up the sound and convert it into an electrical signal. The output of the microphone is fed along two paths.

In the first path, the signal is sent to the inverting input

of U1 (an LM741 op-amp). The output of the amplifier is fed to a voltage-doubler circuit, made up of D1, D2, C2, and C6. The doubler's positive DC output is used to drive Q1, whose output (taken at its collector) is used to drive Q2. When Q2 turns on, operating power is applied to U2 (an LM386 low-voltage audio power

amplifier) at pin 6. In the second path, the microphone signal is fed to the non-inverting input of U2, where it is amplified and output to the speaker, SPKR1.

The gain of U1, and therefore the sensitivity of the circuit, is adjustable via potentiometer R9. Potentiometer R10 can be used to adjust the output-volume level of the circuit as desired. The circuit can be powered from just about any well-filtered, 12-volt DC power source, as long as it has a 100-mA (or more) current capacity.

All of the components, except for the microphone

mounted in any convenient location and connected to the rest of the circuit via speaker wire.

## AUDIO-FREQUENCY METER

Next up in our parade of circuits is an analog audio-frequency meter. This meter differs from the norm in that it does not use a D'Arsonval movement or digital display to give a reading of the input frequency. Instead, the measured frequency is read from a hand-calibrated dial.

is variable via R13. The third and final sub-circuit is built around two transistors, Q1 and Q2 (a pair of 2N3904 general-purpose NPN silicon transistors), which, together with their support components, form a mixer/LED driver.

Any audio signal applied to the circuit is amplified by U1, and the resulting output is divided along two paths. In one path, the output signal is applied to the mixer; in the other path, the signal is applied to the input of U2 through S1 (a normally

LED3 light. That means that the circuit must be fine tuned. That's done by releasing S1 and fine tuning R13 until LED2 and LED3 go out. The dial setting at that point gives the frequency of the input signal to within 1 Hz (or as close as the calibrated dial will allow).

An accurate audio-frequency generator and frequency counter should be used to calibrate the meter, but a generator alone can be used. To calibrate the circuit using both a frequency generator and

each dial division, or setting, in the same manner that the upper and lower frequency limits were set.

To calibrate the meter with an audio generator only, connect the generator to the circuit's input and set its output level to 1 volt. With S1 closed, adjust R13 to its maximum resistance and adjust the generator's frequency to light LED1. That corresponds to the low-frequency setting of the meter. Release S1 and slowly vary the generator's frequency until both LED2

## PARTS LIST FOR THE AUDIO-FREQUENCY METER

### SEMICONDUCTORS

U1—741 op-amp, integrated circuit

U2—LM567 tone-decoder, integrated circuit

Q1, Q2—2N3904 general-purpose NPN silicon transistor

D1, D2—1N914 general-purpose silicon diode

LED1-LED3—Light-emitting diode (any color or size)

### RESISTORS

(All fixed resistors are 1/4-watt, 5% units.)

R1-R6—10,000-ohm

R7-R10—1000-ohm

R11—47,000-ohm

R12—470-ohm

R13—20,000-ohm linear-taper potentiometer

### CAPACITORS

C1-C7—0.1- $\mu$ F, ceramic-disc

C8, C9—4.7- $\mu$ F, 16-WVDC, electrolytic

### ADDITIONAL PARTS AND MATERIALS

S1—Normally open pushbutton switch

Perfboard materials, enclosure, regulated 9-volt power source, IC sockets, wire, solder, hardware, etc.

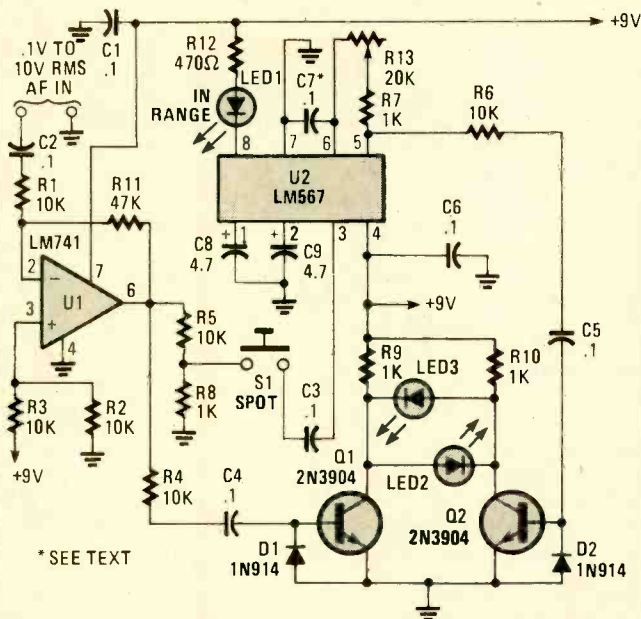

Fig. 2. The analog audio-frequency meter is actually made up of three simple sub-circuits; a conventional inverting amplifier, a phase-locked loop, and a mixer/LED driver.

A schematic diagram for the meter circuit is shown in Fig. 2. The circuit is actually made up of three simple sub-circuits. The first of those sub-circuits is centered around U1, an LM741 op-amp that's configured as a conventional inverting amplifier. With the values of R11 and R1 shown, the op-amp provides a gain of about 5.

The second of the sub-circuits is centered around U2, an LM567 tone decoder, which is operated as a phase-locked loop and whose oscillator frequency

open pushbutton switch).

The portion of the amplifier signal that is fed to the mixer is applied to the base of Q1, causing it to toggle on and off at the signal frequency. In the other path, when S1 is pressed, a portion of the op-amp's output is applied to U2. If the signal is within the range of U2's internal oscillator's operating frequency, LED1 lights, and a signal is fed to the base of Q2. If the two signals arriving at the mixer do not match exactly, LED2 and

a counter, connect the counter to the junction of R6 and C5 and the generator to the input of the circuit. Adjust R13 to its minimum and maximum positions and note the frequency at each extreme on the dial. Those two extremes represent the minimum and maximum frequencies that the circuit can read. After establishing the upper and lower extremes, mark off the area between into as many divisions as practical. Determine the frequency at

and LED3 go dark. Mark the dial to match the generator's frequency. Continue throughout the frequency range as you go.

To use the meter, close switch S1 and rotate R13 until LED1 lights; then release S1 and fine tune R13 until both LED2 and LED3 go dark. Read the frequency off the calibrated dial.

The range of the circuit can be expanded by replacing C7 with a switchable bank of capacitors; using that scheme, the



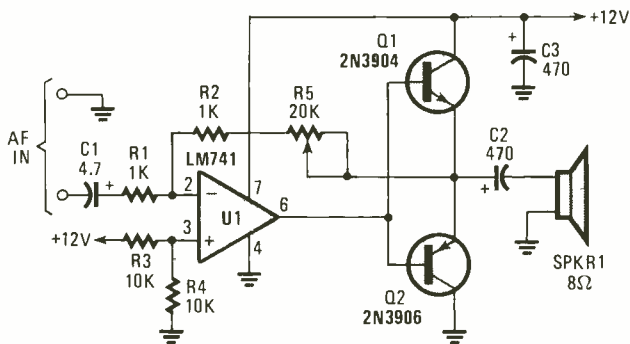

Fig. 3. This simple audio-power amplifier can be added to an existing project or incorporated in a future one.

### PARTS LIST FOR THE AUDIO POWER AMPLIFIER

#### SEMICONDUCTORS

- U1—741 op-amp, integrated circuit
- Q1—2N3904 (or similar) general-purpose NPN silicon transistor
- Q2—2N3906 (or similar) general-purpose PNP silicon transistor

#### RESISTORS

- (All fixed resistors are 1/4-watt, 5% units.)
- R1, R2—1000-ohm
  - R3, R4—10,000-ohm
  - R5—20,000-ohm potentiometer

#### CAPACITORS

- C1—4.7- $\mu$ F, 16-WVDC, electrolytic
- C2, C3—470- $\mu$ F, 25-WVDC, electrolytic

#### ADDITIONAL PARTS AND MATERIALS

- SPKR1—8-ohm 1/4-watt speaker
- Perfboard materials, enclosure, IC socket, heat sink, 12-volt power source, wire, solder, hardware, etc.

circuit can be made to indicate frequencies between 10 Hz and 20 kHz. Of course, it will be necessary to provide a calibrated dial for each value of capacitor used in the switchable capacitor bank.

### AUDIO POWER AMPLIFIER

Our last entry is a simple audio-power amplifier that can be added to an existing project or incorporated in a future one to increase the circuit's output power to more than a quarter watt. A schematic diagram of the audio-power amplifier is shown in Fig. 3.

The circuit, built around an LM741 op-amp that's configured as an inverting

amplifier, is used to drive complementary transistors (Q1 and Q2). The op-amp's feedback loop includes the base-emitter junctions of both transistors—an arrangement that helps reduce crossover distortion that would normally occur due to the emitter-to-base junction voltage drop of about 0.6 volts. Potentiometer R5 varies the amplifier's voltage gain from 1 to about 20. As much as 0.5 watt can be obtained from the circuit if a heat sink is added to the transistors. Also, if your application requires, a beefier pair of complementary transistors may be used to obtain several watts of output power from this circuit. ■

## LEARN VCR CLEANING/MAINTENANCE/REPAIR

EARN UP TO \$1000 A WEEK, WORKING PART TIME FROM YOUR OWN HOME!



Secrets Revealed!

NO Special Tools or Equipment Needed.

EARN UP TO \$80 AN HOUR AND MORE!

### THE MONEY MAKING OPPORTUNITY OF THE 1990'S

IF you are able to work with common small hand tools, and are familiar with basic electronics (i.e. able to use a voltmeter, understand DC electronics)

IF you possess average mechanical ability, and have a VCR on which to practice and learn...then we can teach YOU VCR maintenance and repair.

**FACT:** up to 90% of All VCR malfunctions are due to simple MECHANICAL or ELECTRO-MECHANICAL breakdowns!

**FACT:** over 77 million VCRs in use today nationwide! Average VCR needs service or repair every 12 to 18 months!

Viejo's 400 PAGE TRAINING MANUAL (over 500 photos and illustrations) and AWARD-WINNING VIDEO TRAINING TAPE reveal the SECRETS of VCR maintenance and repair - "real world" information that is NOT available elsewhere!

Also includes all the info you'll need regarding the BUSINESS-SIDE of running a successful service operation!

FREE INFORMATION  
CALL TOLL-FREE 1-800-537-0589

Or write to: Viejo Publications Inc.  
4470-107 Sunset Blvd., Suite 600, Dept. PE  
Los Angeles, CA 90027

CIRCLE 9 ON FREE INFORMATION CARD

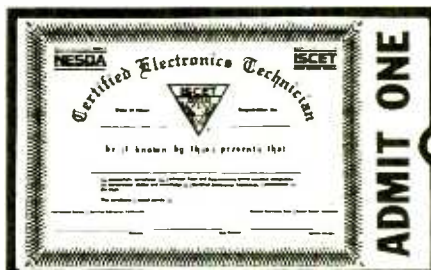

## Your Ticket To SUCCESS

Over 28,000 technicians have gained admittance worldwide as certified professionals. Let your ticket start opening doors for you.

ISCET offers Journeyman certification in Consumer Electronics, Industrial, Medical, Communications, Radar, Computer and Video. For more information, contact the International Society of Certified Electronics Technicians, 2708 West Berry Street, Fort Worth, TX 76109; (817) 921-9101.

Name \_\_\_\_\_  
Address \_\_\_\_\_  
City \_\_\_\_\_  
State \_\_\_\_\_ Zip \_\_\_\_\_

Send material about ISCET and becoming certified.

Send one "Study Guide for the Associate Level CET Test." Enclosed is \$10 (inc. postage).

# THINK TANK

By John J. Yacono

## More Automotive Circuits

**A**s promised, this month's column will be devoted to circuits that improve the friendliness of your car. However, before we get to those circuits, I would like to address your attention to a letter that distresses me.

### SECONDARY CONCERNS

I am writing in regard to the isolation-transformer circuit in the *Think Tank* column of the November 1991 issue (see Fig. 1 for the circuit). The idea of taking two identical power transformers and hooking them up plug-to-primary, secondary-to-secondary, primary-to-socket will not work.

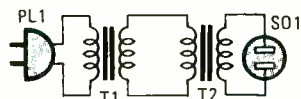

Fig. 1. This isolation-transformer circuit appeared in the November 1991 edition of *Think Tank*. Note that the transformers are both "tapless."

Here's why: The impedance of the second transformer will shove half of the current back to the first transformer and fry it. The turns of wire in the second transformer will throw the AC 180° out of phase and cause this impedance.

You see I built what you suggested. I happened to have two identical 1950's Sears hi-fi power transformers that were in good condition, but that I was going to junk. I hooked all the secondaries together. An ammeter was placed on the line side of the circuit, as well as a 2-amp

fuse. I put a voltmeter across the socket.

I blew the fuse, which I then replaced with a 10-amp unit. With the new fuse the input transformer heated up and the socket only received 65 volts.

I knew you would be interested in these results. Please correct me if I am wrong in any of my conclusions.

—Stephen M. Mauck,  
Lyons, KS

*Your conclusions are sort-of correct, but your set-up was wrong. You connected all the secondaries of the two transformers together instead of just the main ones, which can cause two problems: first, it is very likely that two or more secondary windings were connected with the wrong polarity. Current flowing through windings of different polarity in the same transformer heat up as the stronger current tries to reverse the flow of the lesser current.*

*The second problem is one of practicality: The corresponding secondaries of both transformers will not have precisely the same inductance. Therefore, even if they are connected with the right polarity, they will be slightly out of phase. That will cause potential differences between windings, strange current loops, and heating.*

*The solution to those problems is simple: wire only the main secondary windings of the transformers—do not use any of the taps (as shown in Fig. 1). I hope that this clarifies the matter, now let's get to the automotive stuff you readers have sent in.*

### TRI-COLOR INDICATOR

While working on an automotive project, I discovered that adding one more LED indicator would destroy the symmetry of the display. So, I had to find some way of making one LED already in the circuit do double duty by indicating two conditions.

I chose to use the circuit's power-on LED for that. The LED was replaced with a tri-color unit and driven by the circuit shown in Fig. 2. With

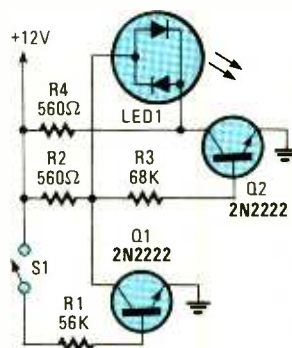

Fig. 2. In this circuit, a tri-color LED is used to indicate when a circuit is under power and the status of S1. In that way, the LED does the job of two indicators.

S1 open, base bias is supplied to Q2 through a voltage divider (formed by R2 and R3), thus turning on the green element in the LED. That indicates that power is being supplied to the project. If you close S1, current through R1 biases Q1 on, thereby grounding the voltage divider and turning off Q2. That reverses the flow of current through the LED, which causes its red element to light. That indicates that the circuit is under power and S1 (really a DPDT switch, whose remaining section controls



another circuit) is active. It's a nice touch to any front panel.

—Chad Pryson, Knoxville, TN

As you readers probably know, I like tri-color LED circuits. This is an excellent example of how they can simplify the appearance of a front panel, while indicating more information. (By the way, I recently saw an indicator operate just like yours on a famous-brand copier machine.)

### LIGHTS-ON REMINDER

After leaving my lights on three times in a row, I decided that it was time to build a headlights-on reminder alarm (see Fig. 3). A relay and two diodes are all that are needed—the relay performs the job of a buzzer so no annunciator is required. When the lights are left on, but the ignition is off, the normally-closed relay contacts are in series with the relay coil. That means the relay interrupts its own power each time it becomes active so it chatters and acts like a buzzer.

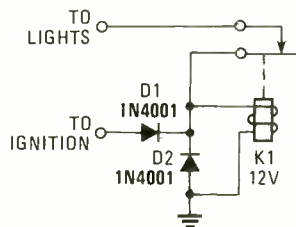

Fig. 3. Here is a real minimalist headlight reminder. It doesn't even require an annunciator because the relay acts as buzzer.

The diodes prevent any damage to the car's ignition system. Just connect the circuit to the car's fuse panel with some crimp-on connectors and you've got a handy headlight reminder.

—S. Saunders, Oshawa, Ontario, Canada

Although I've seen a lot of lights-on reminder circuits, yours is definitely one of the simplest. It should be mentioned that the relay should be placed as close to the top of the dashboard as possible. Otherwise, it might be hard to hear, particularly in noisy areas.

### BATTERY CHARGER

Greetings from the north country. I really enjoy your magazine. I've read it since almost the first issue, therefore I thought it was time to try for one of your books.

Up here where I live, it can get fairly cold in the winter. I have seen the temperature drop to  $-54^{\circ}\text{F}$ . At that temperature, you almost need a chisel to get motor oil out of a can. To start a car in such weather, we use electric block heaters, which run off household power, to keep the engine oil warm.

This weather is also hard on batteries, especially if they are low on charge. That's why I permanently installed this battery charger (see Fig. 4) in my truck, which I plug in every night along with the block heaters. The circuit is capable of supplying either a trickle (50 mA) or high current (1-amp) charge. You can select either charging method or an automatic mode that will first trickle-charge a battery if it is particularly low before switching to high-current charging.

To help explain how the automatic mode works, turn your attention to the schematic in Fig. 4. If the battery's voltage is low, Zener-diode D5 will not conduct sufficient current to produce a voltage drop across R6 to turn Q2 on. With Q2 off, R4 pulls the base of Q1 high, turning it on. That activates K1. With

(Continued on page 88)

# Be an FCC LICENSED ELECTRONIC TECHNICIAN!

Earn up to \$30 an hour and more!

Learn at home in spare time. No previous experience needed!

No costly school. No commuting to class. The Original Home-Study course prepares you for the "FCC Commercial Radiotelephone License." This valuable license is your professional "ticket" to thousands of exciting jobs in Communications, Radio-TV, Microwave, Maritime, Radar, Avionics and more...even start your own business! You don't need a college degree to qualify, but you do need an FCC License.

**No Need to Quit Your Job or Go To School** This proven course is easy, fast and low cost! **GUARANTEED PASS**—You get your FCC License or money refunded. **Send for FREE facts now. MAIL COUPON TODAY!**

**COMMAND PRODUCTIONS**  
 FCC LICENSE TRAINING, Dept. 100  
 P.O. Box 2824, San Francisco, CA 94126  
 Please rush FREE details immediately!

NAME \_\_\_\_\_  
 ADDRESS \_\_\_\_\_  
 CITY \_\_\_\_\_ STATE \_\_\_\_\_ ZIP \_\_\_\_\_

# RADON. THE HEALTH HAZARD IN YOUR HOME THAT HAS A SIMPLE SOLUTION.

Call  
1-800-SOS-RADON  
to get your Radon  
test information.



# COMPUTER BITS

By Jeff Holtzman

## Word Wizardry

Like most people, I spend the majority of my working time inside a word processor, producing everything from short memos to business letters to research papers to magazine articles to formal proposals to complex inter-linked engineering documents spanning hundreds of pages. Over the years, I have used all major PC-based word processors and numerous minor ones. However, I keep coming back to Microsoft Word.

Recently the company introduced version 2.0 of the Windows version of Word, and it is one huge program, considering both the features included and disk

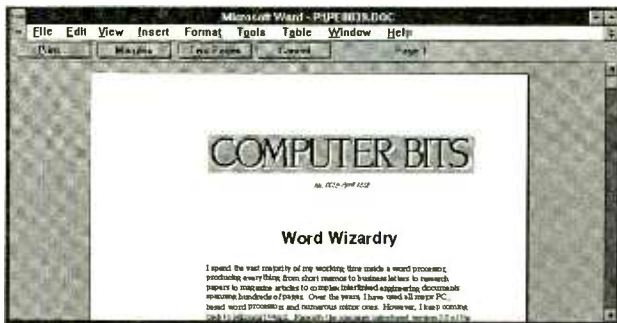

Variable zooming, drag-and-drop operation, and a wealth of new features make Word for Windows the new standard in PC-based word processing.

space required, which can vary from five to fifteen megabytes, depending on which features you install. If you want or need word-processing power, and have the CPU horsepower to run Windows 3.0 comfortably, your only choice is WinWord 2.0 (WW2). There are three categories of new features: Object Linking and Embedding (OLE), desktop publishing, and ease of use.

### OLE, SENOR!

WW2 includes a new set of tools, one each for drawing, charting, editing equations, and creating special text effects. These tools embody Microsoft's concept of Object Linking and Embedding (OLE). In its present incarnation, the Embedding part of OLE is a mixed blessing. The nice part about an embedded object is that you just double-click it to edit it. A separate window opens up, with a new set of menus and editing tools, depending on the type of object. When the object appears as you want it, just close the window, and your changes will be reflected in the main document. That process makes it easy to integrate text and graphics into a document.

The drawing and charting tools are no competition for sluggers like Designer and Excel, but they're probably sufficient for many users. The equation editor is quite powerful and much easier to use than the old method (split a window, show codes in one pane and results in the other).

The text effects editor is fun; it gives you an easy way to add headlines and various special effects to your documents. You can also embed objects from other applications. Presently, only spreadsheets and charts from Excel are supported, and getting embedded Excel objects formatted correctly is difficult and buggy.

If you need more powerful features provided by external tools, or if you're

working in a networked environment where different people prepare drawings, spreadsheets, and text, embedding won't work; in that case, you link elements of a compound document. You can't edit a linked element simply by double-clicking it. Rather, you have to bring up the application that created the object and work there.

### DESKTOP PUBLISHING

The second category is desktop publishing (DTP). In case you haven't noticed, high-end word processors and DTP programs (e.g., PageMaker and Ventura Publisher) have begun to overlap more and more in recent years. WW2 certainly continues that trend.

The biggest change is the addition of frames. Before, positioning objects on the page was a hit-or-miss proposition. Now you just draw a frame, select it, and paste or enter the text or graphics that you want into it. You can then place the frame wherever you want it. Just watch out when you try to place several frames on a page; they tend to move around at random.

Word has always been famous for its use of style sheets. A style sheet allows you to define standard formats for different paragraphs, e.g., normal text and different outline levels. By changing a particular style, all text formatted with that style changes correspondingly. Style sheets now allow you to associate a frame with a particular style. So, for example, you can put headings in the margins.



That type of thing was impossible to accomplish in an automated manner in WW1.

### EASE OF USE

The other broad category of improvements to WW2 is in ease of use, and here Microsoft has really gone the extra mile. There are so many improvements that I can only scratch the surface here; I will, however, highlight the important changes. One of the nicest features is the ability to move text simply by selecting it, dragging it to a new location, and dropping it there. It's the kind of thing that, as soon as you get used to it, you wonder how you got along without it before.

Other highly visible changes involve the ribbon (which helps formatting) and a new addition, the tool bar, both of which appear at the top of the screen. The ribbon is more efficiently organized now, with all the major formatting options shown. The tool bar presents a customizable row of buttons that you can press to initiate various commands. The default buttons include many common operations (starting a new blank file, saving a file to disk, printing the current file) and uncommon ones as well (print an envelope, insert a table, change the number of columns). If you don't like the defaults, it's easy to change them or add your own. Indeed, you can change the whole look and feel of the program by editing the menu and hot-key assignments.

Some neat new convenience features include an intelligent "bullet" command button, which inserts a user-defined character in front of one or more paragraphs. A related feature on the Insert menu allows

you to insert any character from any font installed on your system. I used to use a custom macro to do something like that; this method is much easier to use.

In fact, actions accomplished by several macros that I wrote or obtained are now built-in features of the program. Examples: the symbol character inserter, the envelope printer, the bullet inserter, a "watermark" function that allows you to print a word or phrase diagonally across every page (e.g., DRAFT or CONFIDENTIAL), and more. In addition to the spelling checker and thesaurus, WW2 now includes a grammar checker, which you can customize if you feel that it's too picky in some areas, not picky enough in others, etc.

One weakness with the previous version was that it

presented a limited number of views of your document. WW2 keeps the views provided by the old version, but adds a means so that you can zoom to any desired level, 20–200%. You can also quickly zoom to show the entire page, or zoom so that the entire space between margins occupies the width of your screen.

Microsoft is aware that Word Perfect owns the lion's share of the word-processing market; WW2 consequently includes several features that aid WP users in

converting, including the WW2's ability to respond to WP keystrokes, a special help topic, and more accurate file transfer to and from WP format.

One facet of WW2 (and most word processors) that many users find confusing is creating "personalized" form letters. WW2 includes a step-by-step walk-through of the entire process.

### WHAT'S MISSING?

With all of those powerful new features, WW2 is still missing some things. For example, editing and managing macros and glossary items is still awkward. It would be nice to see a clean way of cutting and pasting those types of objects among various documents and templates. Also, the DTP features are still slow and buggy com-

*(Continued on page 90)*

## Need Information about Businesses? Call the Business **INFOLINE!**

There are over 9 million businesses in the U.S. — and finding information about them can be virtually impossible, especially when you need it *fast*. But now there's a way...a revolutionary new service called **Business INFOLINE!** Need to know the address and phone number for "XYZ Company" somewhere in Florida, or the name and phone number of a "Cadillac Dealer" in Palm Beach? Even telephone company directory assistance can't help you in these situations...but we can!

### For example...

*"Your BMW breaks down on the interstate, and you need to know if there's a dealer in the next town."*

*"An out-of-town company is trying to sell you vinyl siding for your house, and you need more information about them — how long the company has been in business, and how many employees they have."*

*"You're planning a vacation in the Pacific Northwest, and you want to line up things for the kids to do. So you need to find the amusement parks and zoos in Oregon and Washington."*

*"A friend gave you a tip that "Apex Industries" would be a good stock investment, but you want to know more. What do they do? What are their approximate annual sales?"*

The Business INFOLINE is indispensable for home or office! And the cost is *only* \$3.00 for the first minute and \$1.50 for each additional minute, conveniently billed to your phone number. The service is available Monday through Friday, 7:00 a.m. to 6:00 p.m., Central Time.

## Dial 1-900-896-0000

Ask for Ext. # 258

*Money-back Guarantee if not satisfied.*

A Service of American Business Information • 5711 So. 86th Circle • Omaha, NE 68127

### VENDOR

**Microsoft Word for Windows, 2.0**  
(\$495)  
Microsoft Corporation  
One Microsoft Way, Redmond,  
WA 98052  
800-426-9400  
206-882-8080

# DX LISTENING

By Don Jensen

## A Bit of Mediterranean DX

Neither Europe nor Africa, the island republic of Malta is a bit of each. That tiny, independent island state lies in the middle of the Mediterranean, between Italy and Libya. Malta may not be well known today, but this island nation has a history that dates back to ancient times when sea-going Phoenicians reached its shores and proclaimed it a colony. The Carthaginians, the Saracens, Napoleon's troops and, finally, the British all had their turns at ruling this mid-ocean crossroads.



Lisa and Richard McVicar are Canadians serving on the staff of HCJB, *The Voice of the Andes* in Quito, Ecuador. SWL's will know Rich best as host of the popular DX Party Line program.

Although Malta gained its independence in 1964, it didn't really find a place on the shortwave map until several years ago when the *Voice of the Mediterranean* went on the air. It is today a

somewhat off-beat, but not too difficult listening target for SWL's.

The Voice of the Mediterranean is a curious joint broadcasting venture of the governments of Malta and Libya. It is a strange arrangement involving the Socialist, pan-Arab, and strictly Islamic regime of Libyan strongman, Muammar Quaddafi, and the democratic government of a nation that is officially Roman Catholic and recognizes England's Queen Elizabeth as its nominal monarch.

But it seems to work. The Voice of the Mediterranean is administered by a council made up of two high-level representatives from each country with a managing director named by Malta, and a deputy managing director selected by Libya. The broadcasting staff, the station says, is made up of both Maltese and Libyan personnel, "selected on the basis of their professional competence."

A joint broadcasting station—Libya also has its own foreign shortwave service, *Radio Jamahirya*—was first proposed in 1984, but it wasn't until 1987 that an agreement was finally worked out. The voice of the Mediterranean made its first SW broadcast on Sept. 1, 1988. It broadcasts daily in English and Arabic. While French has also been designated as one of the station's official languages, it has yet to transmit any programs in that language.

The Voice of the Mediterranean's role, the two countries say, is to serve as a bridge between Europe

and North Africa, broadcasting news, cultural, literary, and entertainment programming, aimed at strengthening relations between the Maltese and Libyan people and with the other countries of the Mediterranean region.

The Voice of the Mediterranean reaches out with a powerful medium-wave station and a 250-kilowatt shortwave transmitter, using the facilities of the German-owned "Cyclops" broadcasting site at Xrobil-Ghagin on the southern part of the 95-square-mile island. This is the same transmitter and omni-directional antenna complex used to relay Germany's *Deutsche Welle* shortwave signals from Malta.

Look for English programs from the Voice of the Mediterranean on 9,765 kHz from 0600 to 0700 UTC, or on 11,925 kHz between 1400 and 1500 UTC. Your reception reports may be sent to the Voice of the Mediterranean, P.O. Box 143, Valletta, Malta.

### USED RECEIVERS

Not long ago (at an estate sale in my hometown), I spotted an old friend—no, not an old school buddy or a childhood pal, but a FROG-SEVEN! Some of you "old timers" may recall that FROG-SEVEN was the affectionate nickname for the Yaesu FRG-7 shortwave receiver, one of the best of the early generation of "modern" solid-state shortwave sets that came out of Japan back in the late 1970's.

I used an FRG-7 back then and heard an awful



lot of good DX on it some 15 years ago or so. Although I went on to other and more modern receivers, I've always had a soft spot in my heart for the FROG-SEVEN, which still holds up quite well in comparison with today's mid-priced SW sets. When I spotted the dusty shortwave radio under a table, unclaimed, during the final hours of the "clean-out-the-house" sale, my eyes lit up. The price—only \$35—made it a must buy! It wasn't until a few days ago that I realized how good a buy it really was.

I later discovered, while reading Fred Osterman's new book, *Buying A Used Shortwave Receiver*, that the 1977 FRG-7 typically sells on the used-receiver market for between \$150 and \$179. As Fred notes, buying a used receiver can save you money, but obtaining technical and price data on non-current models isn't easy for the average SWL. So he has collected receiver data and recent prices at hamfests and radio stores, and in private sales. He outlines the advantages and disadvantages of buying a used shortwave set, and offers a six-point check list for quickly and accurately evaluating a second-hand receiver. But best of all is his buyer's list covering the top 50 communications radios and the top 20 digital portables of the past 25 years or so.

About my FRG-7, he notes that today it typically sells for less than half of its original price tag of \$370, making it a first rate buy. On the other hand, the long out-of-production DX-150, which Radio Shack sold back in the late 1960's, is called a poor value, even though you probably can buy a used one for as little

as \$35.

A good deal is the once-top-of-the-line Collins 51S-1 receiver, which sold for an awesome \$2,567 back in 1963. At an amateur-radio flea market today, you should be able to pick up one for about \$750, Fred notes. The popular and highly rated Kenwood R-1000, which sold new for \$399 in 1979, has held its price remarkably well. The author says that you can now expect to pay \$300 to \$339 for a used model.

Among the portables, a good buy would seem to be Panasonic's RF-2200, which was highly rated when it sold, circa 1975, for \$179. Now it can turn up on the used market for as little as \$55.

I found this slim (20 pages) book both useful and fascinating reading. It was just published by Universal Radio (1280 Aida Drive, Reynoldsburg, OH 43068; \$3.95 + \$1 S&H).

### FEEDBACK

This is the corner of the column where I take a look at your letters. If you have a question or comment about SWL'ing, or would like to pass along information on what you've been hearing on SW, write to *DX Listening*, Popular Electronics, 500-B Bi-County Blvd., Farmingdale, NY 11735.

Wittamon Lertcharoenamnuay writes from Vandalia, OH; "I'm a foreign student from Thailand studying at Ohio State. I'm very interested in shortwave radio because I would like to hear the news from my country yesterday and so I thought that it might have some information about SW radio and it has.

"I have questions. Is it possible to hear the news from Thailand over here?"

Can you give me information about time and frequency of Thailand? I look forward to hear from you. "P.S. My English needs more practice..."

Believe me, Wittamon, your English is about 1000 percent better than my Thai! Yes, you can hear *Radio Thailand* on shortwave, although it isn't as easy as some of the other major Asian broadcasters, such as *Radio Beijing* or *Radio Japan*. But not long ago, I noted a report in a radio club bulletin from another Ohio SWL who logged Radio Thailand on a modest receiver, using a wire antenna in his attic. He heard the station, signing on in English at 1130 UTC, with the Thai national anthem, followed by a newscast. The frequency is 9,655 kHz.

During the height of the civil struggle in Yugoslavia

between Croatia, which declared its independence, and the Serbian-controlled Yugoslav military forces, I received an unsigned letter mailed in Canada. The letter, clearly from a fervent Croatian supporter, noted that "Croatia started SW broadcasting. It is on the air one hour each day, 15 minutes of which is in English."

The writer listed the broadcasting schedule: Monday through Saturday at 0000 UTC and on Sunday, 0100 UTC, on 7,315 kHz. On the weekend, 9,495 kHz also is used. Although the letter writer did not say it, this programming, easily heard throughout North America, actually is relayed by the transmitters of WHRI, *World Harvest Radio*, in Indiana.

At the same time, though, I was able to log direct broadcasts from *Croatian* (Continued on page 90)

## Shortwave Listening Guidebook

by Harry Helms

The world is talking on shortwave radio, and here's the book that tells you how to listen in! In direct, nontechnical language, Harry explains how to get the most from your shortwave radio. Its 320 heavily illustrated pages are filled with practical advice on:

- antennas
- when and where to tune
- selecting the right radio for you
- accessories
- reception techniques



Learn how to hear the BBC, Radio Moscow, ham radio operators, ships at sea, even Air Force One! Includes hundreds of frequencies for stations around the world and the times you can hear them.

Only \$16.95 plus \$3.00 shipping (CA residents please include sales tax).

**HighText**  
Publications, Inc.  
7128 Miramar Road  
Suite 15L, San Diego, CA 92121

# HAM RADIO

By Joseph J. Carr, K4IPV

## Some Thoughts on Radio Propagation

Several years ago, we covered radio propagation in general, so we won't repeat that material (however, if you want a more extensive description of basic propagation, refer to my book, *Practical Antenna Handbook*, TAB Books, Cat. No. 3270, \$21.95, Blue Ridge Summit, PA 17294-0850; 1-800-233-1128). Instead, this month we are going to take a look at several different aspects of propagation: great circle paths, gray line, and the various scatter modes of propagation.

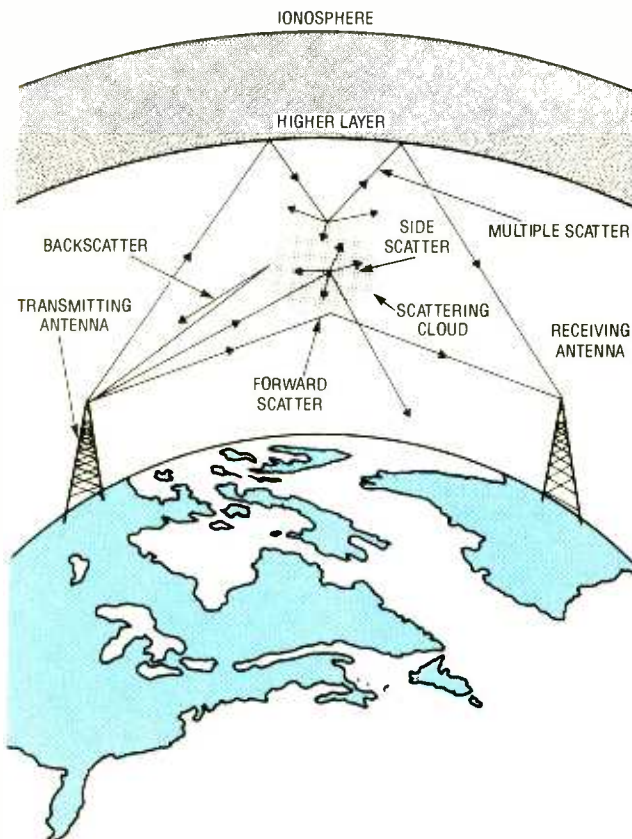

Fig. 1. Scatter-mode propagation effects. Scatter propagation (backscatter, side scatter, and forward scatter) occurs when radio signals are reflected off ionized clouds (either in the ionosphere and troposphere) to a receiver location that might otherwise not receive it.

### WHAT'S A GREAT CIRCLE PATH?

A great circle is an arc between two points on the surface of a sphere that is situated such that it lays on a plane through the Earth's center and includes the two points. When translated to "radiospeak," a great circle is the shortest path on the surface of the Earth between two points. Navigators and radio operators use the great circle for similar, but different reasons. A navigator uses the great circle in order to get from here to there; but the radio operator uses it to get an ionospheric "skip" transmission path from here to there.

The heading of a directional antenna is normally aimed at the receiving station along its great-circle path. Unfortunately, many people do not understand the concept well enough, for they typically aim the antenna in the wrong direction. For example, I live on the east coast, on approximately the same latitude as Lisbon, Portugal. If I catch a lift on Superman's back, and he flies due East, we'll have dinner in Lisbon, right? Wrong! If you head due East from my QTH, across the Atlantic Ocean, the first landfall would be West Africa, somewhere near Zaire or Angola.

Why? Because the great circle bearing 90 degrees takes us far south. Remember the Earth is nearly spherical, not a flat plane (Columbus' antagonists notwithstanding).

Great circle maps, or computer tabulations of the

same data, can often be purchased for your location by supplying your latitude and longitude to the service company that does the job. They sometimes advertise in ham-radio magazines, and sometimes appear at hamfests. Since I've never used one, I hesitate to recommend any particular company.

By drawing a line from your location at the center of the great circle chart, to the area you want to hear, and then extending it to the degree calibrations on the edge of the chart, you will obtain the beam heading required.

### LONG PATH VS. SHORT PATH

The Earth is a sphere (or more precisely, an "oblique spheroid"), so from any given point to any other point there are two great circle paths: a long path (or major arc) and a short path (minor arc). In general, the best reception occurs along the short path. In addition, short-path propagation is more nearly "textbook" compared to long-path reception. However, there are times when long path is better, or is the only path that will deliver a signal to a specific location from the geographic location in question.

A BASIC program is provided elsewhere in this article for those of you who want to calculate short-path, great-circle bearings from your own QTH. It runs on MS-DOS BASICA and GWBASIC, but should also work on others if the syntax is not terribly different. (Care was taken to use as univer-



## LISTING 1

BASIC Program For Calculating Antenna Bearings

```

100 ' The name of this program is BEARINGS
110 ' This program computes the Great Circle bearing and distance
120 ' between any two points on Earth. It is used mainly for
130 ' positioning radio antennae.
140
150 ' SET CONSTANTS
160 PI = 3.1415926#
170 R = 57.295779#
180 Q = 25
190 DIM BS(30)
200
210 ' SUBROUTINE FOR OPENING DISPLAY
220 CLS: KEY OFF
230 LOCATE 10,20:PRINT TAB(Q);"* * * * * "
240 LOCATE 11,20:PRINT TAB(Q);"* * * * * "
250 LOCATE 12,20:PRINT TAB(Q);"* ANTENNA BEARINGS CALCULATION *"
260 LOCATE 13,20:PRINT TAB(Q);"* Copyright 1991 by *"
270 LOCATE 14,20:PRINT TAB(Q);"* JJ Carr *"
280 LOCATE 15,20:PRINT TAB(Q);"* * * * * "
290 LOCATE 16,20:PRINT TAB(Q);"* * * * * "
300 LOCATE 18,25:GOSUB 1220
310 CLS
320 ' GET INFORMATION FOR CALCULATIONS
330 INPUT "YOUR latitude in DECIMAL degrees:";A
340 GOSUB 1170
350 INPUT "YOUR longitude in DECIMAL degrees:";L1
360 GOSUB 1170
370 PRINT "Now enter the Latitude and longitude"
380 PRINT "of the other city or country."
390 PRINT "If you do not know the LAT/LONG, then"
400 PRINT "consult an atlas"
410 PRINT
420 GOSUB 1170
430 PRINT "ENTER the name of Country or City:";
440 INPUT BS
450 GOSUB 1170
460 PRINT "ENTER latitude of ";BS;
470 INPUT B
480 GOSUB 1170
490 PRINT "ENTER longitude of ";BS;
500 INPUT L2
510 ' CALCULATE DIFFERENCE OF LONGITUDE
520 L3 = L1 - L2
530 IF ABS(L3) = 180, THEN GOTO 580
540 IF ABS(L3) < 180, THEN GOTO 580
550 IF L3 > 180 THEN L3 = L3 - 360
560 IF L3 < -180, THEN L3 = L3 + 360
570 ' CONVERT FROM DEGREES TO RADIANS
580 L = L3/R
590 A = A/R
600 B = B/R
610 ' CALCULATE ANGULAR DISTANCE
620 D1 = SIN(A)*SIN(B)
630 D2 = COS(A)*COS(B)*COS(L)
640 ' D3 IS COSINE D
650 D3 = D1 + D2
660 D = -ATN(D3/SQR(-D3*D3+1))+1.5708
670 ' CALCULATE BEARING
680 C1 = SIN(B)
690 C2 = SIN(A)*D3
700 C3 = COS(A)*SIN(D)
710 C4 = ((C1-C2)/C3)
720 C = -ATN(C4/SQR(-C4*C4+1))+1.5708
730 I = L3
740 IF I > 0, THEN C = C
750 IF I < 0, THEN C = (2*PI)-C
760 ' RECONVERT ANGLES FROM RADIANS TO DEGREES
770 C = C*R
780 A = A*R
790 B = B*R
800 D = D*R
810 ' ROUND-OFF BEARINGS
820 M = C - INT(C)
830 IF M > .5, THEN C = INT(C)+1
840 IF M = 0, THEN C = C
850 IF M < .5, THEN C = INT(C)
860 ' CALCULATE LINEAR DISTANCE
870 S1 IS MILES, S2 IS KILOMETERS
880 S1 = D*60*1.15078
890 S2 = D*60*1.852
900 ' ROUND-OFF ALL DISTANCES
910 G = S1 - INT(S1)
920 IF G = 0, THEN S1 = S1
930 IF G > .5, THEN S1 = INT(S1) + 1
940 IF G < .5, THEN S1 = INT(S1)
950 H = S2 - INT(S2)
960 IF H = 0, THEN S2 = S2
970 IF H > .5, THEN S2 = INT(S2) + 1
980 IF H < .5, THEN S2 = INT(S2)
990 ' OUTPUT DATA
1000 GOSUB 1170
1010 PRINT BS
1020 PRINT "LAT. ";B; " "; "LONG. ";L2
1030 PRINT S1; " Miles";S2; " Kilometers"
1040 PRINT
1050 PRINT "BEARING: ";C; " DEGREES"
1060 GOSUB 1170
1070 GOSUB 1220
1080 ' ENDING SUBROUTINE
1090 CLS:LOCATE 12,30:PRINT "1. FINISHED?"
1100 LOCATE 13,30:PRINT "2. DO ANOTHER?"
1110 LOCATE 15,30:PRINT "SELECTION?";J6=INPUT$(1)
1120 J=VAL(J6)
1130 IF J>2, THEN GOTO 1090
1140 IF J=1 GOTO 1250
1150 IF J=2 GOTO 310
1160 ' SUBROUTINE TO SKIP FIVE LINES
1170 FOR I = 1 TO 5
1180 PRINT
1190 NEXT I
1200 RETURN
1210 ' PRESS ANY KEY SUBROUTINE
1220 PRINT "Press ANY key to continue"
1230 AS=INKEY$: IF AS="" THEN 1230
1240 RETURN
1250 ' ENDING SUBROUTINE
1260 CLS:LOCATE 12,30:PRINT "PROGRAM ENDED"
1270 TIMELOOP=TIMER:WHILE TIMER<TIMELOOP+3:WEND
1280 CLS:END

```

sal a BASIC notation as I know.)

## GRAY LINE PROPAGATION

The gray line is the twilight zone (also called the planetary terminator) that lies between the night and daytime halves of the Earth. It varies up to +/-23 degrees either side of the north-south longitudinal lines depending on the season of the year and runs directly north-south only at the vernal and autumnal equinoxes. The D-layer of the ionosphere absorbs signals in the HF region. That layer disappears almost completely at night, but builds up during the day. Along the gray line, the D-layer is rapidly decaying west of the line, and has not quite built up east of the line.

Brief periods of abnormal propagation occur along the gray line. Stations on either side of the line can be heard from regions, and at distances, that would otherwise be impossible on any given frequency. For that reason, most shortwave listeners often prefer to do their listening primarily at dawn and dusk.

MFJ Enterprises, Inc. (PO. Box 494, Mississippi State, MS 39762; 1-800-647-1800) makes an MS-DOS (i.e., IBM-PC, XT or AT compatibles) program—called *Terminator*—for finding the terminator at your location. It sells for \$29.95, and runs on any MS-DOS machine with at least a Hercules graphics card (although CGA or higher graphics is recommended). The program can give you a rough idea of the latitudes and longitudes of most areas of the world, and that data can be used in the BASIC program for great circle bearings (in Listing 1) as well.

## SCATTER PROPAGATION

Ionospheric scatter propagation occurs when clouds of ions exist in the atmosphere. The clouds can exist in both the ionosphere and the troposphere, although the tropospheric mode is more reliable for communication.

Figure 1 shows the mechanism for scatter propagation. Radio signals output from the transmitter are reflected from the ion cloud to a receiver location that might otherwise not receive it. Scatter propagation occurs mostly in the VHF region, and allows communications over extended paths that are not normally available.

There are at least three different modes of scatter from ionized clouds: backscatter, side scatter, and forward scatter. The backscatter mode is a bit like radar, in that the signal is reflected back to the transmitter site or regions close to the transmitter.

Forward scatter occurs when the reflected signal continues in the same azimuthal direction (with respect to the transmitter), but is redirected towards the Earth's surface. Side scatter is similar to forward scatter, but the azimuthal direction may change.

Unfortunately, there are often multiple reflections (shown as "multiple scatter" in Fig. 1) from the ionized clouds. When those reflections are able to reach the receiving site, the result is a rapid fluttery fading that can be quite profound.

## AURORAL PROPAGATION

The auroral effect produces a luminescence in the upper atmosphere; That's caused by bursts of  
(Continued on page 90)

# SCANNER SCENE

By Marc Saxon

## Scanning a Soviet Space Station

Spring is in the air—and you may want to spring into the air when you see the new *Radio Shack Realistic PRO-37* handheld scanner. This is their top-of-the-line job, offering 200 channels and a lot of features. The frequency ranges covered are 30 to 504 MHz, 108 to 174 MHz, 380 to 512 MHz, and 806 to 960 MHz (minus the two cellular bands, which are blocked). The 200 channels are arranged in ten banks of 20 channels each, with scanning at 8 and 25 channels per second. It performs

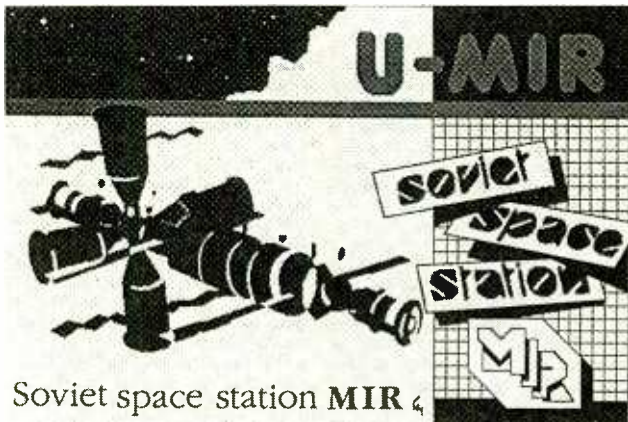

Soviet space station **MIR**

If you monitor the *Mir* spaceship, this QSL card could eventually grace your wall.

search/scan at 8 and 50 channels per second.

Selectivity is  $\pm 10$  kHz at  $-6$  dB,  $\pm 20$  kHz at  $-50$  dB. The IF frequencies are 455 kHz and 10.7 MHz, and the IF rejection is 50 dB at 154 MHz. Spurious rejection is 50 dB on frequencies between 30 and 174 MHz. Sensitivity is  $1.0 \mu\text{V}$ , except in the 108–137-MHz band and above 800 MHz, where it is

rated at  $2.0 \mu\text{V}$ .

The PRO-37 has a priority channel, a switchable backlight for night use, individual lockouts, two-second scan delay, crystal and ceramic IF filters, and a nice, large LCD readout. The six "AA" batteries are rechargeable. It carries a price tag of \$299.95, and may be seen at any Radio Shack store. We had the chance to use one, and found it to be well designed and built. It's a really fine handheld.

### LOOK, UP IN THE SKY!

If you want a good challenge, try to monitor *Mir*, the manned Soviet space station. *Mir* has been noted communicating with ham operators on 145.55 MHz, FM, and packet radio. Packet is data, and won't mean much to you unless you have the necessary terminal unit to make the signals legible to your computer. But the FM signals are basic scanner fare, and many scanner owners have picked up *Mir*.

*Mir* has also been reported on military frequencies with voice transmissions, so you might also want to punch up 121.75, 142.4175, and 143.625 MHz in the wide FM (WFM) mode to see what they might offer. Also try 166.00 MHz for data transmissions. The 143-MHz channel has proven to be especially easy to hear—although if you can't understand Russian, you won't know what they're saying.

One of the best things about *Mir* is that it has a QSL card, at least for its 145-MHz ham transmissions. The ham operator that I picked up on *Mir* was Musa, UV3AM, and the QSL address that worked for me was in care of ham UW3AX, P.O. Box 707207, Moscow, USSR. You might try it too.

Other Soviet (non-voice) satellite transmissions from navigational systems and marker beacons are often reported between 149.90 and 149.975 MHz, and also 153.40 to 153.80 MHz. Note that there are American navigational signals on 150.00 MHz.

Although most American scientific satellites now use frequencies above the range of most scanners, there are still a few birds sending out signals in the old 136–138-MHz satellite band. Just to see what might come through, search for data transmissions between 136.10 and 137.63 MHz.

The ATS satellites are still on 136.37 and 137.35 MHz, with the GEOS satellites heard on 136.38 MHz. METEOSAT has been noted on 137.075 and 137.08 MHz, while the NOAA-9 weather satellite (in a polar orbit) uses 137.62 MHz. MARCES uses 137.17 MHz, KIKU is on 136.11 MHz, and IUE operates on 136.86 MHz. Those are the American satellites being reported in this band.

### BAND AIDS

The FCC seems poised to add some new frequency



space for low-power use in the Manufacturer's Radio Service. For many years, there have been two "guard bands" protecting the 75.00-MHz aeronautical marker-band frequency. These guard bands, where no stations may be licensed, are 74.60 to 74.80 MHz, and 75.20 to 75.40 MHz. They were set aside to protect older aeronautical marker-beacon receivers from interference.

Modern aeronautical equipment no longer requires that such guard bands continue to exist, so the FCC will probably soon convert those frequencies into 20 low-power communications frequencies. They will join other similarly used frequencies in the 72.00–76.00-MHz band.

Many scanners can't receive the 72.00–76.00-MHz band, but if yours does then you ought to search through those frequencies to see if they turn up anything new. Besides low-power transceivers, that band is also used for repeaters, links, and relay stations, and all manner of control transmissions. It will open up your ears to several new stations in your local area that you never even guessed existed!

## DO-IT-YOURSELF POLICE RADIO

In Detroit, the police channels were recently lived up with transmissions from a mobile unit requesting that backup units be sent to help in the arrest of a prostitute. But when the mobile unit gave the dispatcher its identification numbers, one of the sergeants who was monitoring the channel recognized it as his own numbers. He phoned the dispatcher to say that it wasn't him on the radio.

When the dispatcher re-

quested that the mobile unit identify itself again, the station changed its number, giving another sergeant's number. At that point, the requested backup cars arrived on the scene to find a vehicle that resembled an unmarked Detroit police car. It contained a siren, a flashing red light, a police walkie talkie, a scanner—and two self-made police officers, one aged 25, the other aged 27.

At first, the younger man said he was a deputy sheriff from a nearby county. Then both men said that they were basically members of a CB club patrol group that was affiliated with the sheriff's department of a nearby county. They announced that they were on "prostitute surveillance."

The sheriff, when questioned, said that one of the men had once been a member of his neighborhood crime-watch volunteer patrol, but had been suspended months earlier. The other man had applied, but not been accepted, for membership. Neither man had been asked to go on any surveillance mission on behalf of the sheriff. Neither had any authority to operate a radio in the Detroit Police Department's radio system.

According to the story that appeared in the local news media, the two were to be charged, at the very least, with having a scanner installed in a vehicle, which police said was a misdemeanor. Other charges seemed likely for the two would-be crime fighters.

The story did not paint a very good picture of scanner owners. We like to occasionally remind readers that some people find it very easy to get carried away with the excitement of listening to a scanner. Don't be one of them. ■

## ANTIQUÉ RADIO

*(Continued from page 66)*

### THE ROMANCE OF HALLICRAFTERS

Now that our theremin is in good working order, it's time to begin a new restoration project for the column. I'd been considering several alternatives, but my recent reading of Max De Henseler's book has inspired me to choose one involving a Hallicrafters set.

Before the Japanese became dominant suppliers of equipment for the radio amateur and shortwave listener, the U.S. market was served by several prominent American companies. Besides Hallicrafters, those included such illustrious names as National, Hammarlund, RME, and Millen.

Although not everybody bought Hallicrafters, I doubt that there was a ham or SWL that didn't have a soft spot for the products of this fine old company. That's because Hallicrafters didn't just make good radios, it made *exciting* radios; sets whose appearance reflected the mystery and thrill of long-distance communications; sets with names like *Skyrider*, *Sky Chief*, and *Super Defiant*.

And of all the models produced by Hallicrafters during its long history, it was usually the "low-end" sets that had the greatest romantic aura. Those were the radios that impressionable young teens and pre-teens could reasonably imagine owning. Dreaming over the advertising illustrations in ham and shortwave magazines, the young would-be owners would invest the sets with almost mystic powers.

Even after such a young dreamer had matured and become knowledgeable enough to realize that the

object of his former desire was nothing but an inexpensive broadcast radio fitted up with some short-wave coils, a fancy front panel, and a few extra controls, the romance lingered still. And, indeed, I believe that those sets *do* deliver the excitement that their illustrations promised, even to a modern, sophisticated adult.

### RESTORING A CLASSIC HALLICRAFTERS LOW- ENDER

Without a doubt, the three best-known and best-loved of the Hallicrafters low-end models are the S-38, which was manufactured from post-World War II on into the late 1950's; the Echophone EC-1 Commercial, which the company built and sold during World War II when Hallicrafters-branded equipment was produced almost exclusively for military purposes; and, finally, the Sky Buddy series, introduced in 1936 and reaching full popularity with the improved model (S-19-R) of 1939.

An Echophone EC-1 was restored on these pages a few years ago (see *Ellis on Antique Radio* in the July, September, October, and November, 1987 issues of **Hands-On Electronics**). Also in my collection, waiting to be discussed in the column, are examples of both the S-19-R Sky Buddy and the S-38. I've wanted to dig into the Sky Buddy for quite a while, and this looks like as good an excuse as any! So watch *Antique Radio* for more on this pre-war Hallicrafters charmer.

In the meantime, if you have some Sky Buddy lore you'd like to share, write me c/o *Antique Radio*, **Popular Electronics**, 500-B Bi-County Blvd., Farmingdale, NY 11735. ■

# ELECTRONICS LIBRARY

## MASTERING IC ELECTRONICS: Through Projects & Experiments

by Joseph J. Carr

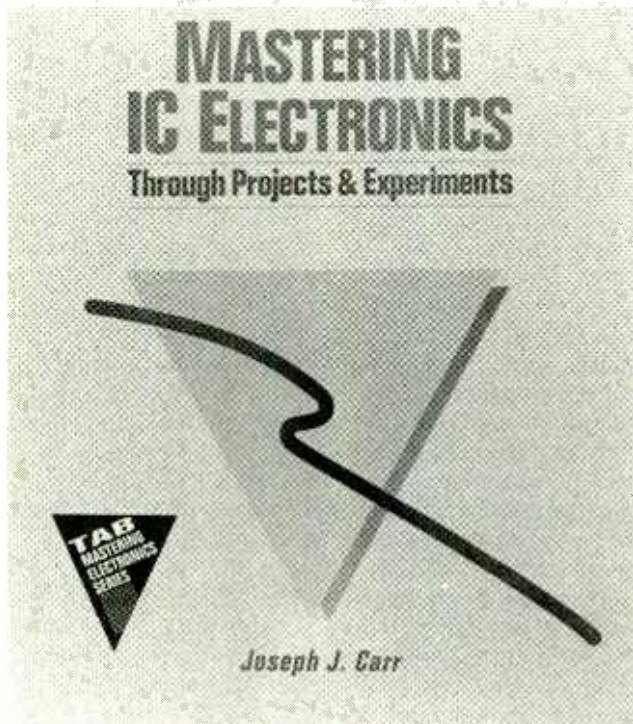

Joe Carr is well known among electronics enthusiasts for his practical instruction guides on such topics as circuit design, radio communications, and digital electronics—and his *Popular Electronics Ham Radio* column. In this book, he tackles the complexities of IC electronics, providing readers with all the data needed to become proficient in the theory and operation of integrated circuitry. Geared toward home experimenters and technical-school students, the book uses a unique blend of theoretical principles and practical experi-

ments to provide readers with a full working knowledge of component specifications, design standards, and applications for all kinds of modern IC's. The book covers IC timers, os-

illators, and all types of waveform generators. Hundreds of schematics, illustrations, and equations accompany the text. Experiments are intended to illustrate the principles presented in writing. The construction projects—including DC power supplies, op-amp circuits, DC differential amplifiers, oscillator and multivibrator circuits, and waveform generators—further illustrate the principles and also provide a working experience in practical electronics as well as useful devices.

*Mastering IC Electronics Through Projects & Experiments* costs \$19.95 and is published by TAB Books, Division of McGraw-Hill Inc., Blue Ridge Summit, PA 17294-0850; Tel. 1-800-822-8138.

**CIRCLE 98 ON FREE INFORMATION CARD**

### W1FB's QRP NOTEBOOK Second Edition

by Doug DeMaw, W1FB

Because QRP, or low-power, amateur-radio equipment is relatively uncomplicated and fairly easy and inexpensive to construct, QRP operation and electronics experimentation often go hand-in-hand. This book of construction projects is written for all QRP'ers who are also tinkerers, whether they are inexperienced newcomers to electronics or professionals. In an easy-going style, and using non-technical language, the book provides a thorough introduction to the hobby of QRP, including descriptions of organizations, books, magazines, and vendors for QRP'ers. It goes on to explain construction methods, including the terminology used in the projects. Those projects include QRP receivers, transmitters, and accessories. Some can be assembled in an evening or weekend for very



little money, and some of the simple circuits can later be put to use in some of the more complex designs. Complicated test equipment and expensive tools are not required for construction of most of the projects—a VOM, some common tools, and a soldering iron are enough to start building these QRP projects.

*W1FB's QRP Notebook, Second Edition* costs \$10 and is published by the American Radio Relay League, 225 Main Street, Newington, CT 06111.

**CIRCLE 90 ON FREE INFORMATION CARD**

### NATIONAL PARTS DIVISION CATALOG

from Tandy Electronics

Tandy's National Parts Division's products inventory has been broadened with the addition of parts from major outside manufacturers, making the division a full-line, national electronics distributor. This 232-page catalog provides users with a comprehensive listing of that inventory, which includes merchandise from 29 major producers of electronic and electromechanical parts. Designed for ease of use, product information is displayed in a format that allows the customer to find particular parts quickly. Thousands of products are rep-



# Take Any **3** PROFESSIONAL BOOKS for only \$9<sup>95</sup>

when you join the **ELECTRONICS ENGINEERS' BOOK CLUB**

values to \$121.40



9255 \$97.50  
Counts as 3

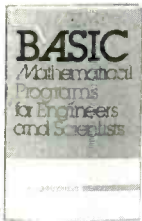

8225P \$19.95

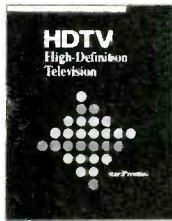

3272 \$24.95



9832 \$36.95



003957-7 \$49.95  
Counts as 2



3557 \$29.95

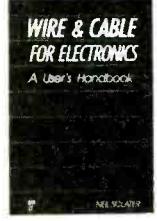

3787 \$29.95



3279 \$36.95  
Counts as 2



3205 \$24.95



9540 \$44.95  
Counts as 2



3212 \$34.95



9401P \$19.95

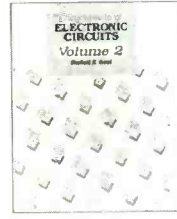

3138 \$60.00  
Counts as 2



2672 \$49.50



033559-1 \$29.95



3102 \$49.95  
Counts as 2



9244P \$19.95



3365 \$34.95

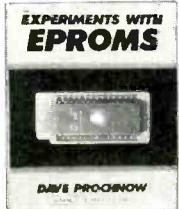

2962P \$17.95



021975-8 \$99.50  
Counts as 3



3199 \$52.00  
Counts as 2

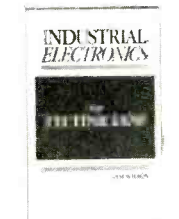

3321P \$16.95



9354 \$39.95  
Counts as 2

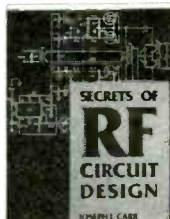

3710 \$32.95

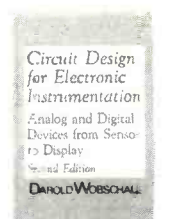

071231-X \$54.95  
Counts as 2

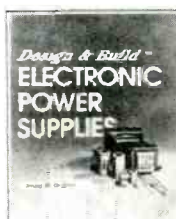

3540 \$26.95

## How the Club Works

**YOUR BENEFITS:** You get 3 books for \$9.95 plus shipping and handling when you join. You keep on saving with discounts of up to 50% off as a member.

**YOUR PROFESSIONAL BOOKSTORE BY MAIL:** Every 3-4 weeks, you will receive the Electronics Engineers' Book Club News describing the Main Selection and Alternates, as well as bonus offers and special sales, with scores of titles to choose from.

**AUTOMATIC ORDER:** If you want the Main Selection, do nothing and it will be sent to you automatically. If you prefer another selection, or no selection at all, simply indicate your choice on the reply form provided. You will have at least 10 days to decide. As a member, you agree to purchase at least 3 books within the next 2 years and may resign at any time thereafter.

**BONUS BOOKS:** Starting immediately, you will be eligible for our *Bonus Book Plan*, with savings of up to 80% off publishers' prices.

**IRONCLAD NO-RISK GUARANTEE:** If not satisfied with your books, return them within 10 days without obligation!

**EXCEPTIONAL QUALITY:** All books are quality publishers' editions especially selected by our Editorial Board. (Publishers' Prices Shown)

The Electronics Engineers and Designers Book Club and the Electronics and Control Engineers' Book Club have joined forces to bring you *all the best titles* from the most prominent electronics publishers.

## ELECTRONICS ENGINEERS' BOOK CLUB

Blue Ridge Summit, PA 17294-0860

**YES!** Please accept my membership in the ELECTRONICS ENGINEER'S BOOK CLUB and send the 3 volumes listed below, billing me \$9.95. If not satisfied, I may return the books within ten days without obligation and have my membership cancelled. I agree to purchase at least 3 books at regular Club Prices during the next 2 years, and may resign any time thereafter. A shipping/handling charge and sales tax will be added to all orders.

--	--	--

Name \_\_\_\_\_

Address \_\_\_\_\_

City \_\_\_\_\_

State \_\_\_\_\_ Zip \_\_\_\_\_ Phone \_\_\_\_\_

Valid for new members only. Foreign applicants will receive special ordering instructions. Canada must remit in U.S. currency. This order subject to acceptance by the Electronics Engineers' Book Club. **PP1F492**

resented alphabetically by product. In addition, a product index and a manufacturer index are included for easy parts cross-referencing. Photographs and specification drawings are provided in every possible instance so that the customer can make visual comparisons. Complete pricing information is printed on the same page as the part listing. The catalog also describes the Division's sales and service policies—including a minimum order requirement of only \$5.00.

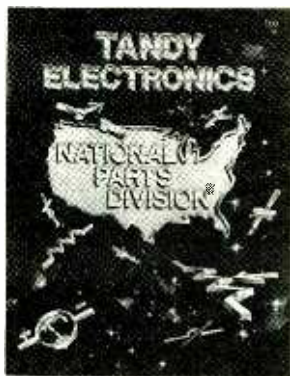

The Tandy National Parts Division catalog costs \$7 and is available from Tandy Electronics, National Parts Division, 900 East Northside Drive, Fort Worth, TX 76102; Tel: 800-322-3690.

**CIRCLE 91 ON FREE INFORMATION CARD**

## CD-ROM CATALOG

from Quanta Press

The wide selection of CD-ROM discs described in this brochure has something for everyone. Titles range from Roger Ebert's *Home Movie Companion*, a compendium of movie and video reviews, to *The North American Facsimile Book*, which provides more than 150,000 fax numbers and addresses for companies in the US, Canada, and Mexico; from *About Cows*, which needs no explanation, to *U.S. Civics*, a course in U.S. history from the 1700's to the present. A total of 27 MS-DOS- and/or Mac-compatible CD-ROM discs, priced from \$29.95 to \$495, are described.

The CD-ROM catalog is available from Quanta Press, Inc., 1313 Fifth Street SE, Suite

208C, Minneapolis, MN 55414; Tel: 614-379-3956; Fax: 612-623-4570.

**CIRCLE 92 ON FREE INFORMATION CARD**

## THE PORTABLE RADIO IN AMERICAN LIFE

by Michael Brian Schiffer

In this age of the Walkman, it's difficult to visualize life without portable radios—but we don't often think of the close-to-a-century of technology that preceded it. This book—which is the first volume in the "Technology and Culture" series from the University of Arizona Press and was written by a professor of anthropology at the University—delves into the technical and sociological history of the portable radio.

Throughout the book, parallels are drawn between the evolution of the portable radio and concurrent changes in American society and culture. In a blend of scientific thought and breezy style, the author discusses how technology is affected by consumer preference and how a vision of the technologically possible—as expressed, for instance, in science fiction—can become translated into a need (or "cultural imperative") and then into reality. More than 400 photographs of historic radios accompany the text; those photos are sure to appeal to antique-radio buffs, among others.

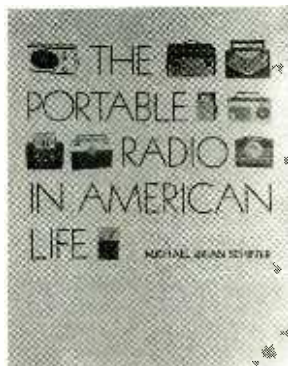

The *Portable Radio In American Life* costs \$45.00 and is published by The University of Arizona Press, 1230 North Park Avenue, Suite 102, Tucson, AZ 85719-4140; Tel: 602-621-1441.

**CIRCLE 93 ON FREE INFORMATION CARD**

## 1992 CATALOG

from Extech Instruments

This catalog contains detailed specifications and descriptions of portable and benchtop instru-

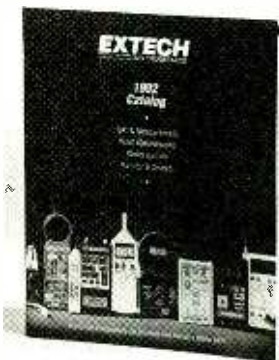

ments in the test and measurement, plant maintenance, water quality, and engineering fields, including full lines of multifunction multimeters, sound and light meters, time controllers, temperature and humidity meters, pH and conductivity meters, and instruments for controlling and monitoring. Several new products are featured in the catalog, such as a vane thermo-anemometer with remote vane wheel, an RH/temperature meter that measures humidity and temperature using a remote probe; and an LCR meter in a safety-yellow, drop-proof case. Also highlighted in the new catalog are the popular Organizer computer and peripherals and a new handheld personal computer.

The 1992 Catalog is free upon request from Extech Instruments Corporation, 335 Bear Hill Road, Waltham, MA 02154; Tel: 617-890-7440; Fax: 617-890-7864.

**CIRCLE 101 ON FREE INFORMATION CARD**

## ELECTRONIC COMPONENTS: A Complete Reference for Project Builders

by Delton T. Horn

Intended as a single-source handbook for electronics hobbyists and technicians, and containing information about a wide variety of common electronic components, this book can be used as an introductory

or refresher text, or to quickly locate relevant information about specific components. It covers the functions of basic electronic components, including discussions of the differences between the various subtypes of each major class of component and of the important factors that must be considered when making parts substitutions in circuits.

The book is divided into three sections. The first, devoted to passive, non-amplifying components, begins with simple wire and solder and continues with in-depth looks at the three major types of passive components: resistors, capacitors, and inductors. Part 2 deals with active devices, which are

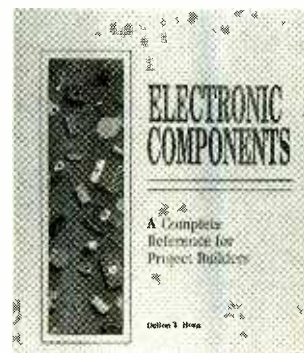

capable of amplification, and concentrates on semiconductor components—diodes and transistors—and includes a look at integrated circuits, including linear and digital IC's. Some miscellaneous devices that wouldn't fit into the other two categories are covered in the book's third section. Those include transducers and switches. Throughout the book, helpful insights are provided into the theory and operation of components in typical circuit designs, and topics like the pros and cons of using devices in various situations, where and how to find parts, and criteria for making substitutions in circuits are discussed.

*Electronic Components: A Complete Reference for Project Builders* costs \$18.95 and is published by TAB Books, Division of McGraw-Hill Inc., Blue Ridge Summit, PA 17294-0850; Tel: 1-800-822-8138.

**CIRCLE 98 ON FREE INFORMATION CARD**



# NEW PRODUCTS

## Multimedia PC

The Multimedia PC Marketing Council Inc. has set an industry standard for incorporating sound, graphics, animation, and data to the PC, opening the door for the first generation of multimedia computers and software. Bearing the MPC logo, Philips Consumer Electronics Company's 386SX-20 MPC multimedia PC system is compatible with any industry-standard multimedia software. The system's configuration meets—and in some cases exceeds—the minimum MPC standards. The system features an 80386SX CPU that runs at 20 MHz with 4MB of RAM standard (upgradable to 8MB); an 80MB hard drive; Super VGA; a



680MB CD-ROM drive; a 3.5-inch, 1.44MB high-density, external disk drive; and three 16-bit expansion slots. The 386SX-20 MPC comes with MS-DOS 5.0, Q-BASIC, Windows 3.0 (with Multimedia Extensions), Microsoft Works, Microsoft Multimedia Bookshelf, and other multimedia applications pre-loaded on the hard drive.

The 386SX-20 MPC system has a suggested list price of \$2499. For additional information, contact Philips Consumer Electronics Company, One Phi-

lips Drive, P.O. Box 14810, Knoxville, TN 37914-1810; Tel: 1-800-722-6224 or 615-475-8869.

**CIRCLE 103 ON FREE INFORMATION CARD**

## IN-LINE PRINTER BUFFER

If you frequently produce data-intensive output that exceeds the built-in capacity of your printer—such as large spreadsheets, bit-mapped graphics, or



CAD applications—an in-line printer buffer could solve the problem. The versatile *Microbuffer Universal 16* from *Practical Peripherals* supports any printer/computer combination—parallel to parallel, parallel to serial, serial to serial, and serial to parallel—and can be configured to provide up to 16MB of memory using any combination of 256K, 1 Meg, or 4 Meg SIMMS. Its touch-sensitive front-panel controls allow you to clear buffer memory, interrupt operation, make up to 255 copies, and manage other operations. The Microbuffer Universal 16 has three handshake modes. Different input/output baud rates (from 300 to 38,400) and handshake protocols are supported. It is shipped with 32K of memory installed, a power adapter, a user's manual, and an IBM-compatible buffer-configuration/utility disk.

The Microbuffer Universal 16 has a suggested retail price of \$259. For further information, contact Practical Peripherals, 31245 La Baya Drive, Westlake Village, CA 91362; Tel: 818-706-0333.

**CIRCLE 104 ON FREE INFORMATION CARD**

## MULTI-REMOTE LIGHT CONTROL

You can control a lamp from any location using any infrared TV or VCR remote control, an ordinary wall switch, an ordinary

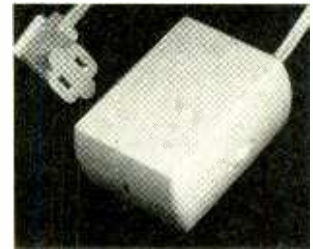

lamp switch, and the *IRUS* multi-remote light control from *Hometek*. It not only lets you turn lights on and off, but also adds dimming capability from the wall switch, lamp switch, or remote. No rewiring or electronic modifications are required. The IRUS simply plugs into a wall outlet. It allows you to turn a light on from one location and turn it off or dim it from another location.

The IRUS remote light control has a suggested retail price of \$34.95. For further information, contact Hometek, 12450-2 Ralston Ave., Sylmar, CA 91342; Tel: 818-362-5036; Fax: 818-362-6537.

**CIRCLE 105 ON FREE INFORMATION CARD**

## CONSOLE-STYLE SURGE PROTECTOR

Serving as a power-control center as well as a surge protector,



*Belkin Components' Powermaster* is designed to sit under the computer monitor. Its five

power outlets provide surge and noise protection for the PC and its peripherals, guarding against data loss and damage caused by voltage spikes and EMI/RFI. The front panel features a master power switch and individual on/off toggle switches for each system component. The UL-rated surge protector includes a 15-amp resettable circuit breaker and a 6-foot power cord.

The Powermaster surge protector has a suggested retail price of \$59. For additional information, contact Belkin Components, 1303 Walnut Park Way, Compton, CA 90220; Tel: 310-898-1100; Fax: 310-898-1111.

**CIRCLE 106 ON FREE INFORMATION CARD**

## WIRELESS VIDEO MICROPHONE

Aimed at professional videographers as well as serious amateurs, Azden's WHX-PRO handheld VHF microphone is completely self-contained, with



both the transmitter and the antenna built into the microphone. The powerful miniature receiver is only 3-inches long and 2½-inches wide, and the telescoping antenna is short enough to allow the user to place it in a shirt pocket. The receiver comes with both a shoe mount and Velcro, for attachment to a video camera.

The WHX-PRO has two switchable frequencies (169.445 and 170.245 MHz) and a range of more than 250 feet. A three-position (on/off/standby) switch makes it easy to pass the microphone around without picking up unwanted noises. The ring surrounding the WHX-PRO's windscreens is octagonal, so that when the microphone is set down it won't roll.

The WHX-PRO wireless vid-

eo microphone has a suggested retail price of \$275. For additional information, contact Azden Corporation, 147 New Hyde Park Road, Franklin Square, NY 11010; Tel: 516-328-7500; Fax: 516-328-7506.

**CIRCLE 107 ON FREE INFORMATION CARD**

## POCKET-SIZED DMM

About the size of a slim pocket calculator, Bel Merit's Model DM80 digital multimeter offers easy, one-hand operation. The compact unit features a 32-segment bargraph, a high-speed sampling rate, manual and autoranging, data hold, a continuity beeper, auto polarity,



low-battery mark, and over-range indicator. Its functions include diode test, DC voltage from 300 mV to 450 V, AC voltage from 3 V to 450 V, and resistance from 300 ohms to 30 megohms. The 2 x 4 x ¾-inch digital multimeter comes in a burgundy leather protective case.

The Model DM80 DMM costs \$49.95. For further information, contact Bel Merit Corporation, 17 Hammond, Suite 403, Irvine, CA 92718-1635; Tel: 714-586-3700; Fax: 714-586-3366.

**CIRCLE 108 ON FREE INFORMATION CARD**

## BACKPACK TOOL ORGANIZER

Allowing an engineer or technician to carry more than 100 tools, charts, and meters while keeping both hands free for more important things—like holding onto handrails or carry-

ing other supplies without sacrificing safety—the Toolpak from Paktek Inc. is carried on one's back. The Toolpak is made of durable abrasion- and puncture-resistant nylon. It has three zippered compartments that each open out into two panels for easy access to tools. Those six panels contain a total of more than 100 pockets to hold tools securely in place. In addition, the pack has a large pocket intended to hold oversized diagrams or maps and two outer pockets for quick access to frequently used items.



The heavily-padded, reinforced, back-pack style straps are adjustable, and attache-type handles can be used to carry the pack by hand or to hang up the unzipped pack.

The Toolpak backpack tool organizer costs \$99.97 (plus \$4 shipping). For additional information, contact Paktek Inc., 7307 82nd Street CT SW, Tacoma, WA 98498; Tel: 800-258-8458; Fax: 206-851-2365.

**CIRCLE 109 ON FREE INFORMATION CARD**

## MODULAR BNC TEST-LEAD KIT

Allowing the technical user to select several accessories and snap them together for use in accessing hard-to-reach, high-density circuitry—such as IC's, wire-wrap pins, terminals, and other miniature components—



Probe Master, Inc.'s Modular BNC Test Lead Kit contains a

unique universal test lead and nine plug-in accessories. The kit is available with the user's choice of several lengths of RG58C/U or RG174/U shielded cable, ranging from 24 to 72 inches. The plug-in accessory leads are 6-inches long with gold-plated male pins.

The Modular BNC Test Lead Kit costs \$34. For further information, contact Probe Master, Inc., 4898 Ronson Court, San Diego, CA 92111-1807; Tel: 800-772-1519.

**CIRCLE 110 ON FREE INFORMATION CARD**

## CD LENS CLEANER

CD-player lenses tend to accumulate dust, dirt, smoke, and other airborne contaminants, which can cause mistracking and distortion. Bib America's C-639-A automatic compact-disc laser lens cleaner—the first that can be used in multi-player



cartridge systems and changers—uses a patented process to remove such contaminants. When the specially encoded disc with six optical-grade cleaning brushes is inserted into the player, it plays music like a regular CD as it cleans. The brushes remove unwanted foreign matter by means of a wave action generated by the rotating disc. According to Bib, the disc is entirely safe, and is effective for ensuring continued optimum CD-player performance.

The C-639-A CD-lens cleaner has a suggested retail price of \$34.95. For more information, contact Bib America, 10497 Centennial Road, Littleton, CO 80127; Tel: 303-972-0410.

**CIRCLE 112 ON FREE INFORMATION CARD**



# No other training shows you how to troubleshoot and service computers like NRI!

## NEW! 386sx/20 MHz MINI TOWER COMPUTER!

Features 32-bit 80386sx CPU, 1 meg RAM, 64K ROM, 1.2 meg high-density floppy disk drive

## MONITOR

High-resolution, nonglare, 12" TTL monochrome monitor with tilt and swivel base

## NEW! 40 MEG HARD DISK DRIVE!

You install this 40 meg IDE hard disk drive internally, for greater data storage capacity

## DIAGNOSTIC HARDWARE AND SOFTWARE

R.A.C.E.R. plug-in diagnostic card and QuickTech menu-driven software, both from Ultra-X, give you hands-on experience with today's professional

## SOFTWARE

Train with MS-DOS, GW-BASIC, and popular Microsoft Works applications software

## DISCOVERY LAB

Complete breadboarding system lets you design and modify circuits, diagnose and repair faults

## DIGITAL MULTIMETER

Professional test instrument for quick and easy measurements

## DIGITAL LOGIC PROBE

Simplifies analyzing digital circuit operation

## LESSONS

Clear, illustrated texts build your understanding of computers step by step

**Only NRI walks you through the step-by-step assembly of a powerful 386sx computer system you train with and keep — giving you the hands-on experience you need to work with, troubleshoot, and service today's most widely used computer systems. Only NRI gives you everything you need to start a money-making career, even a business of your own, in computer service.**

No doubt about it: The best way to learn to service computers is to actually build a state-of-the-art computer from the keyboard on up. Only NRI, the leader in career-building at-home electronics training for more than 75 years, gives you that kind of practical, real-world computer servicing experience.

Indeed, no other training — in school, on the job, *anywhere* — shows you how to troubleshoot and service computers like NRI.

## Get inside the West Coast 386sx computer system ... and experience all the power and speed of today's computer technology!

With NRI's exclusive hands-on training, you actually build and keep the powerful new West Coast 386sx/20 MHz mini tower computer system.

You start by assembling and testing your computer's 101-key "intelligent" keyboard, move on to test the circuitry of the main logic board, install the power supply and 1.2 meg high-density floppy disk drive, then interface your high-resolution monitor.

What's more, you now go on to install and test a powerful 40 meg IDE hard disk drive — today's most-wanted computer peripheral — included in your course to dramatically increase your computer's data storage capacity while giving you lightning-quick data access. But that's not all!

## Professional diagnostic hardware and software makes troubleshooting fast and accurate

Your NRI training now includes a remarkable diagnostic package that allows you to quickly locate and correct defects in IBM XT, AT 80286/80386, and compatible computers.

You'll use your Ultra-X QuickTech diagnostic software to test the system RAM and such peripheral adapters as parallel printer ports, video adapters, and floppy and hard disk drives. You'll go on to use your R.A.C.E.R. diagnostic card, also from Ultra-X, to identify individual defective RAM chips, locate interfacing problems, and pinpoint defective support chips.

This ingenious diagnostic package is just one more way NRI gives you the confidence and the know-how for advancement, a new career, or a money-making business of your own.



## No experience necessary ... NRI builds it in

With NRI, you learn at your own pace in your own home. No classroom pressures, no night school, no need to quit your present job until you're ready to make your move. And all throughout your training, you have the full support of your personal NRI instructor and the NRI technical staff, always ready to answer your questions and give you help whenever you need it.

## FREE catalog tells more. Send today!

Send today for NRI's big, free catalog that describes every aspect of NRI's innovative computer training, as well as hands-on training in TV/video/audio servicing, telecommunications, industrial electronics, and other high-growth, high-tech career fields.

If the coupon is missing, write to NRI School of Electronics, McGraw-Hill Continuing Education Center, 4401 Connecticut Avenue, NW, Washington, DC 20008.

IBM is a registered trademark of International Business Machines Corp. QuickTech and R.A.C.E.R. are registered trademarks of Ultra-X, Inc.

## SEND TODAY FOR FREE CATALOG

### NRI Schools

McGraw-Hill Continuing Education Center  
4401 Connecticut Avenue, NW, Washington, DC 20008



For career courses approved under GI Bill  
 check for details.

### Check one FREE catalog only

- |  |  |
|--|--|
| <input type="checkbox"/> MICROCOMPUTER SERVICING           | <input type="checkbox"/> Computer Programming            |
| <input type="checkbox"/> TV/Video/Audio Servicing          | <input type="checkbox"/> Security Electronics            |
| <input type="checkbox"/> Industrial Electronics & Robotics | <input type="checkbox"/> Electronic Music Technology     |
| <input type="checkbox"/> Telecommunications                | <input type="checkbox"/> Desktop Publishing              |
| <input type="checkbox"/> Basic Electronics                 | <input type="checkbox"/> PC Software Engineering Using C |

Name \_\_\_\_\_ (please print) \_\_\_\_\_ Age \_\_\_\_\_

Address \_\_\_\_\_

City/State/Zip \_\_\_\_\_

Accredited Member, National Home Study Council

18-042

## THINK TANK

(Continued from page 71)

K1 active, the only thing between the battery and the power supply is R2 and D4 (which prevents current from flowing in the circuit from the battery).

Once the battery charges a bit, the current through D5 increases, causing a voltage drop across R6 that is of sufficient magnitude to turn on Q2. Transistor Q2, in turn, grounds the base of Q1, keeping it off. With Q1 off, K1 remains in its normally closed state. That places R1 in series with the battery, thereby reducing the current to a trickle.

The circuit can be easily modified. For example, adding diodes in series with D6 can increase the voltage at which the circuit switches to trickle charge. You could even use a string of diodes and replace S1 with a multiposition switch so that you could select one of several switch-over voltages.

For me, the total cost of

this project turned out to be zero since I was able to scrounge up the parts. If you are not so lucky, the circuit should still be inexpensive, and at least cost much less than a tow job and a battery.

—Barry Nordin, Kinistino, Saskatchewan, Canada

*Absolute minimalists may wish to use a SPDT relay and eliminate the mode indicators LED1, LED2, and their shared resistor, R3. I suspect that Q1, Q2, and R4 could've been replaced with a PNP transistor. Does anyone have any ideas on that?*

## THE SIMPLEST REMINDER

I thought some of your readers might be interested in an inexpensive and simple automobile headlight reminder (see Fig. 5). The whole circuit costs less than \$4.00 and the parts are readily available.

If the lights are on and the ignition is also on then both sides of buzzer (BZ1) are at 12 volts so the buzzer doesn't sound. If the ignition is off with the lights on,

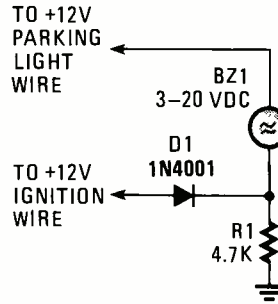

Fig. 5. This headlights-on alarm is the ultimate in simplicity.

current from the lights flows through the buzzer (which is grounded by R1), causing it to sound.

—Craig Merz, Oldwick, NJ

*People might wish to add a switch to deactivate the buzzer. That way you could leave the lights on without the engine running in the event that you must change a tire.*

## POLARITY INDICATOR

By following some simple steps, and with the help of a little circuit, you can safely connect jumper cables without sparks.

The circuit (see Fig. 6) consists of a tri-color LED, a resistor, wire and a coin-size test plate. You will have to build two such circuits—one for each black clamp on a set of jumper cables. The author installed the circuits inside the black clamps themselves using lengths of wire to make the connections to the red clamps.

To help explain the circuit's operation, let's discuss its use. The first step is to connect one red clamp to what you believe is the positive post on the okay battery. Then touch the test plate at that end of the cable to the negative terminal on the good battery. The LED will light red if the red clamp is on the wrong terminal. If so move the clamp to the other post and check again. If all is well, the LED

will light green. Pick up the other black clamp and connect it to the remaining post on the good battery.

Now let's deal with the connections at the dead-battery end. Connect the remaining red clamp to what you assume to be the positive terminal on the bad battery. Now touch the test plate on the remaining clamp to the engine block or a bare area on the dead car's frame. If the LED appears red or doesn't glow, switch the red clamp to the other terminal and test again. When the LED glows green attach the black clamp to the car's frame

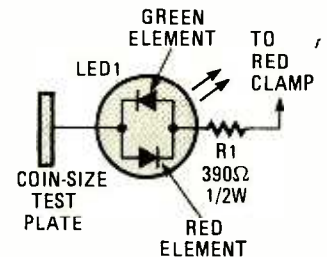

Fig. 6. A simple jumper-cable polarity checker like this one can save you from injury (or worse).

(which will prevent any sparks from occurring near the battery).

Jump start the car as you normally would. When you remove the clamps, take the clamps off in reverse order to avoid sparks.

—Mike Giamportone, Yale, MI

*Very nice. I always connect the dead battery first, that way the jumper cables are not too lively most of the time.*

Well, that's a wrap for automotive projects. If you have a simple electronic device, send the plans to **Think Tank, Popular Electronics**, 500-B Bi-County Blvd., Farmingdale, NY 11735. If your circuit makes these pages, you will be rewarded with a book from our selection.

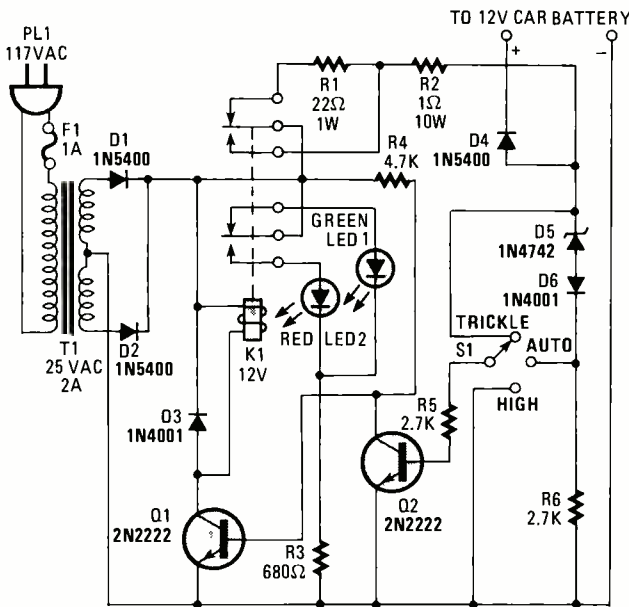

NOTE: ALL RESISTORS ARE 1/2 WATT EXCEPT WHERE INDICATED

Fig. 4. This car-battery charger has built-in smarts that allow it to automatically switch from high to trickle charge.



## CABLE TESTER

(Continued from page 56)

with S2 set to position 1. The green LED should come on indicating a complete circuit, and the other indicators should go out. Use another alligator clip to simulate shorted conductors by jumpering two of the input resistors (say, R17 and R16). The red LED should come on indicating a shorted-conductor condition, and the green LED should go out. Upon switching to position three, which is still an open circuit, the yellow indicator should come on, and the others should all go out.

When all has been checked out, put the board aside and prepare the cable/connector assemblies. Drill holes in the end of the project's enclosure to accommodate the cable/connector assemblies. Make the holes of suitable size to accommodate cable strain-reliefs. Be careful; with a plastic chassis it's easy to make the holes too large. If you should accidentally over-enlarge the holes, the strain reliefs will be able to rotate and put too much strain on the board connections.

Make sure that you have allowed enough wire inside the chassis to easily reach the solder pads, then snap the strain reliefs in place. If you've decided to use a metal chassis with chassis mount connectors instead of the 10 pin connectors, connect a jumper from the pad at resistor R7 to the chassis. That will cause LED12 to light if any of the cable conductors are shorted to the connector shell.)

Finally, secure a piece of foam inside the chassis to prevent the battery-holder from shifting, then button the tester up. Plug the male into the female connector, turn the circuit on, and switch S2 through its 12 positions while monitoring the bargraph display to make sure that the conductors have been wired consecutively. Once that is done, it is a good idea to label the switch positions.

To use the project plug in your cable via the Cinch-Jones connectors, turn on the tester, and switch through the conductor positions while monitoring the LED's. If the cable is faulty, a fault LED will come on, while the bargraph display indicates which conductor is bad. You are now ready to go out and test just about any suspected bad cable with relative ease. ■

# GET THE LATEST ADVANCES IN ELECTRONICS WITH A SUBSCRIPTION TO

# Radio Electronics®



Radio-Electronics gives you exciting articles like:

- DSP in Consumer Electronics
- Build a Tesla Coil
- Analog-to-Digital Conversion
- Build a Spectrum Analyzer
- All About Fuel Cells
- Build an EKG
- Voltage Doublers
- PC-Based Test Equipment
- VGA-to-NTSC Converter

ENJOY THE WORLD OF ELECTRONICS EACH MONTH! Now you can subscribe to the best electronics magazine. The only one that brings you articles on—electronics projects, technology, circuit design, communications, new products and much more.

Radio-Electronics looks to the future and shows you what new video, audio and computer products are on the horizon. What's more you'll find helpful, monthly departments such as Video News, Equipment Reports, Hardware Hacker, Audio Update, Drawing Board, Computer Connections. All designed to give you instruction, tips, and fun.



FOR  
FASTER SERVICE  
CALL TODAY  
1-800-999-7139

# SUBSCRIBE TODAY

Just fill out the order card in this magazine and mail it in today.

5PD22

## DX LISTENING

(Continued from page 75)

Radio, Zagreb, on 9,830 kHz. The broadcasts consisted of non-stop light music, with short news items on the hour and half hour between about 0100 and 0300 UTC. No English programming was heard, however.

## DOWN THE DIAL

Here is some interesting SW listening that you can try:

**ARGENTINA**—15,345 kHz. *Radio Nacional* in Buenos Aires has been reported on this frequency from about 2330 to signoff at 0000 UTC in Spanish, relaying that country's medium-wave home service.

**EGYPT**—9,900 kHz. *Radio Cairo* can be heard with English programming at 2200 UTC. A talk on Egyptian agriculture was noted by one listener.

**LEBANON**—11,530 kHz. *King of Hope*, an American-owned religious broadcaster located in southern Lebanon, has been noted on this frequency, and on a parallel frequency of 6,280 kHz, where the signal was weaker, from 2130 until 2200 UTC signoff.

**MONGOLIA**—13,782 kHz. *Radio Ulan Bator*, from the Mongolian capital, broadcasts in English on this frequency at around 1445 UTC.

**MYANMAR**—5,990 kHz. This is the country formerly known as Burma and its *Voice of Myanmar* is on the air in English at 1430 UTC, with news at 1445 UTC. ■

\*Credits: Scott Newman, IN; Mark Spat, NH; Jerry Berg, MA; Brian Boulden, CA; William Flynn, OR; North American SW Association, 45 Wildflower Road, Levittown, PA 19057

## HAM RADIO

(Continued from page 77)

particles being released from the Sun 18 to 48 hours earlier. The light emitted is called the northern lights and the southern lights. The ionized regions of the atmosphere that create the lights acts as a radio reflection shield, especially at VHF and above, although 15 to 20 MHz effects are known. Auroral-propagation effects are normally seen in the higher latitudes, although listeners in the southern tier of states in the USA are often treated to reception of signals from the north reflected from auroral clouds.

## METEOR SCATTER PROPAGATION

When meteors enter the Earth's atmosphere, they do more than simply heat up to the point of burning. The burning meteor leaves a wide, but very short duration transient cloud of ionized particles in its path. Those ions act as a radio mirror that permits short bursts of reception between sites correctly situated.

Meteor scatter reception is not terribly reliable, although at least two companies offer meteor scatter communications services for users in the higher latitudes. ■



"Hold on, Ed—I think I see what's been happening to my signal."

## COMPUTER BITS

(Continued from page 73)

pared to PageMaker and the like.

## CONCLUSIONS

For most projects, I used to use three separate products: an outliner for early information gathering and organizing, a word processor for detailed writing, and a desktop publisher for final polishing. The original version of Word for Windows allowed me to eliminate the outliner altogether, and the desktop publisher in many cases. WW2 doesn't obliterate the need for the DTP package, but the wealth of new features makes the program much easier to use—and a lot more fun, too. All in all, Microsoft has set a new standard for PC-based word processing. ■

THIS SPACE CONTRIBUTED AS A PUBLIC SERVICE

## A defense against cancer can be cooked up in your kitchen.

There is evidence that diet and cancer are related. Follow these modifications in your daily diet to reduce chances of getting cancer:

1. Eat more high-fiber foods such as fruits and vegetables and whole-grain cereals.
2. Include dark green and deep yellow fruits and vegetables rich in vitamins A and C.
3. Include cabbage, broccoli, brussels sprouts, kohlrabi and cauliflower.
4. Be moderate in consumption of salt-cured, smoked, and nitrite-cured foods.
5. Cut down on total fat intake from animal sources and fats and oils.
6. Avoid obesity.
7. Be moderate in consumption of alcoholic beverages.

No one faces cancer alone.

AMERICAN CANCER SOCIETY

Make the most of your general coverage transceiver with *Monitoring Times!*

Every month *Monitoring Times* brings everything you need to make the most of your general coverage transceiver: the latest information on international broadcasting schedules, frequency listings, international DX reports, propagation charts, and tips on how to hear the rare stations. *Monitoring Times* also keeps you up to date on government, military, police and fire networks, as well as tips on monitoring everything from air-to-ground and ship-to-shore signals to radioteletype, facsimile and space communications.

**ORDER YOUR SUBSCRIPTION TODAY** before another issue goes by. In the U.S., 1 year, \$19.50; foreign and Canada, 1 year, \$26. For a sample issue, send \$2 (foreign, send 5 IRCs). For MC/VISA orders (\$15 minimum), call 1-704-837-9200.

## MONITORING TIMES

Your authoritative source, every month.

P.O. Box 98  
Brasstown, N.C. 28902



## PC BOARD

(Continued from page 64)

covering the adhesive) with those already on the agitator's case. Make sure that they are properly aligned for maximum coupling. If not, disengage them and try again. Once positioned properly, remove the paper backing, position the agitator (adhesive-side down) right over the center of the tank and press firmly into place for 30 seconds. Disengage the hook-and-loop fasteners, using a firm rocking motion and set the tank aside. You can use this procedure to prepare as many tanks as you wish.

If the agitator case that you use has posts for the screws to mate in (like the specified case) place a tiny grommet, rubber faucet washer, or O-ring on the circular surface of each post. They help dampen vibration that would be transmitted to the base while allowing the tank more freedom of movement. If you use a faucet washer and the recommended case, you might have to trim a little piece off two of the washers so they will not be displaced by the ridge in the case. If the washers are cone shaped, the narrow portion of the cone should face the section of your case that the motor is mounted to.

Now mate the other half of the case with the section that has the posts being careful not to knock the rubber hardware out of position. Attach the two case halves with screws, but don't tighten them so firmly that the case compresses the grommets or O-rings. Plug the transformer in for a second to test the circuit and, if all is well, apply some clear nail polish to the heads of the screws to prevent them from backing out. Your unit is now ready for use.

**Set-Up and Use.** To prepare your system, start by making sure the tank you wish to use is nice and clean on the inside. Clean it if necessary, and attach it to the agitator using the fasteners. Now find a spot on your workbench that has either a vertical or horizontal edge (such as a shelf or shelf riser) above it. Place a folded fluffy terry-cloth towel there and place the tank/agitator assembly on top of it. The towel will absorb vibrations from the agitator and prevent it

from roaming around. Now fill the tank with etchant. Clamp the lamp to whatever edge juts out above the workbench and plug it in, but leave it turned off. Aim the bulb and reflector downward right into the middle of the solution, repositioning the tank/agitator assembly if necessary; be very careful not to spill any etchant.

Turn the lamp on, wait 5 minutes, and feel the sides of the tank; they should be warm to the touch. If the warmth seems insignificant, move the lamp closer by adjusting its ball-joint and clamp position as necessary. Be careful not to harm the tank with too much heat.

Any amount of heat introduced to the solution will help etch boards faster, but a temperature between 90–120°F would be ideal. If you want to be particularly accurate about the solution temperature, you can place a small thermometer in the solution and mark the optimum positions for the tank/agitator assembly and heat lamp.

With that minor calibration aside, you can now use the station to etch a PC board. Turn R1 to the position of minimum motion (maximum resistance) and plug in the wall transformer. There should be a little vibration of the tank. Slowly increase the current to the motor until you see vibration patterns form in the solution. If any of the patterns develops a noticeable peak, back the control down until it disappears. Such peaks could grow and eventually sputter etchant if not reduced in size. Monitor the solution a few more seconds (as it takes time for peaks to form) and adjust the control as necessary. Always take the time to adjust R1 properly as differences in board size and household current can cause the agitator to make a mess.

Now you can gently "plunk" a prepared slug into the soup. Monitor it for a few seconds just in case the board geometry causes peaks to form—adjust as necessary. As the board swims around the bottom, try to gauge how visible it is. If it is hard to see, make a mental note to add less etchant or use a wider, more shallow tank the next time. When your board is done, remove it from the tank and pour the etchant back into its container. Detach the tank from the agitator and wash it out as you normally would. ■

## SPECIAL FROM ETT

□ **PCP101—PRACTICAL DIGITAL ELECTRONICS HANDBOOK ... \$9.95.** Introduces digital circuits, logic gates, bistables and timers, as well as microprocessors, memory and input/output devices. Special section on digital test gear projects



□ **PCP102—INTRODUCING DIGITAL AUDIO ... \$9.95** Shows what is involved in the digital part of audio signals, particularly in the newest devices such as CD, DAT and sampling. Bridges the gap of understanding for the technician and enthusiast.

□ **PCP103—PRACTICAL MIDI HANDBOOK ... \$9.95.** Covers all MIDI based equipment you can use—keyboards, drum machines, sequencers, effects units, mixers, drum pads and guitars. Also a section on computer music that covers software and more.



□ **PCP104—ELECTRONICS BUILD & LEARN, Second Edition ... \$9.95.** You start by assembling a circuit demonstrator that is then used to build and investigate a variety of useful circuits including oscillators, multi-vibrators, bistables and logic circuits.

□ **PCP105—MAKE MONEY FROM HOME RECORDING ... \$10.00.** Now that you've spent all that money on all that recording gear, wouldn't it be nice to get some of it back? Well here's the book that can show you how.



□ **PCP106—SYNTHESIZERS FOR MUSICIANS ... \$10.00.** All current popular forms of synthesis explained; LA, additive, phase distortion, FM and sampling. Get the sounds you want from your synth. Written especially for musicians.

□ **PCP107—SYNTHESIZERS FOR MUSICIANS ... \$10.00.** All current popular forms of synthesis explained; LA, additive, phase distortion, FM and sampling. Get the sounds you want from your synth. Written especially for musicians.

MAIL TO: Electronic Technology Today, Inc.  
P.O. Box 240  
Massapequa Park, NY 11762-0240

### SHIPPING CHARGES IN USA AND CANADA

\$0.01 to \$5.00	.. \$1.50	\$30.01 to \$40.00	\$5.50
\$5.01 to \$10.00	.. \$2.50	\$40.01 to \$50.00	\$6.50
\$10.01 to \$20.00	.. \$3.50	\$50.01 and above	\$8.00
\$20.01 to \$30.00	.. \$4.50		

**SORRY, No orders accepted outside of USA and Canada**

Total price of merchandise	..... \$	_____
Shipping (see chart)	..... \$	_____
<b>Subtotal</b>	..... \$	_____
Sales Tax (NYS only)	..... \$	_____
<b>Total Enclosed</b>	..... \$	_____

Name \_\_\_\_\_  
Address \_\_\_\_\_  
City \_\_\_\_\_ State \_\_\_\_\_ Zip \_\_\_\_\_

## CHOOSING AUDIO EQUIPMENT

(Continued from page 37)

ing mechanism to mate with the tonearm). However, look for a cartridge with a high frequency response (at least 20 Hz to 20 kHz), and good channel separation rated in dB (the higher the better).

**Tape decks.** Cassette-tape decks are available with an unlimited number of convenience features ranging from auto reverse to dubbing capability, and it's up to you to pick the ones that are important to you. But as far as sound quality goes, the frequency response, signal-to-noise ratio, and wow and flutter are the important specifications to look at.

A good tape deck will have a frequency response from 20 Hz to 20 kHz. However, most tape decks don't go much over 15 kHz, so if it's sound quality you're looking for, insist on full-range response. Most tape decks bury the important specifications in a plethora of convenience features, so you'll have to do some hunting. By the way, decks with metal-tape capability will usually exhibit a better frequency response when metal tape is used.

A cassette deck's signal-to-noise (S/N) ratio is also important. That's the ability of the deck to subdue tape hiss, and it's measured in -dB—the higher the number, the better. Various noise-reduction schemes are used to increase a deck's S/N (signal-to-noise) ratio. Most decks today include Dolby-B and/or -C circuitry to drastically reduce tape hiss on appropriately processed tapes. Higher-end decks may also include HX Pro and dBx noise-reduction schemes to further reduce tape noise. Just look for the best signal-to-noise figures you can afford when buying a tape deck.

Wow and flutter specifications are also a concern for tape decks, and they refer to speed variations in the same way as they did for turntables. Follow the same guidelines for tape decks as you would a turntable.

**CD Players.** Virtually all CD players have a frequency response from 20 Hz to 20 kHz, high S/N ratio, and low distortion, and that's why they all sound so good. So those specifications are not critical here, although you can look for the better numbers if

you like. In general, a higher priced unit will be of higher quality (that translates into a longer life) and will offer more convenience features than less expensive models.

Basically if you like a particular CD player and its price, buy it. You don't have to be confused with things like the oversampling rate and digital filtering but, for your information, here's what those frequently used terms mean: An analog signal is continuous, but digital processing chops that signal into many individual *samples*. On a Compact Disc, each second of audio has been broken up into 44,100 individual digital "words." Half of those words are for the left channel and half are for the right. A CD player must read back all 44,100 words every second. (That gives a frequency response of 20 kHz with a margin of safety.) Oversampling involves re-reading the words 2, 4, 8, or more times and averaging the results. While that technique increases accuracy and lessens the number of errors, at higher oversampling rates, the law of diminishing returns comes into play.

Digital-to-analog (D/A) converters are then used to convert the digital words read from a CD back into an analog audio signal. Older CD players used to use a filter to chop off anything above 20 kHz (considered noise) after the D/A converter, but that often added harshness to the music in the process. Most modern CD players have some kind of digital-filter scheme that removes the noise in digital form before the D/A converter.

High-end CD-player features may include a separate D/A unit, optical coupling, direct digital outputs (for use with a DAT player), and so on.

**DAT.** There's a relatively new audio component that's finally on the market here in the U.S., and that's DAT, or digital audio tape. It's a medium that lets you record music with sound quality that compares with that of CD's. However, they're still limited to the high-end of the market, so they're all very expensive and of good quality.

Two lower priced recordable digital formats—DCC and Mini Disc—have also been recently introduced. Both of those formats promise performance and convenience features approaching that of DAT, and should be on the market soon. ■

## MAGNETIC LIGHT

(Continued from page 61)

point, but this time outside the tube, he placed two electromagnetic coils. The diameter of the coils was equal to the length of the plates (about 2 inches). The system allowed the scientist to adjust the currents producing the electric and magnetic fields so that the two canceled out. Then, one effect could be switched off leaving the other in operation.

**Primordial Substance X.** Thomson found that the ratio of mass to charge was very small; the value he obtained was  $10^{-4}$ , the smallest value for the  $m/e$  ratio known at the time. In other words, the cathode ray projectiles were 1000 times smaller than hydrogen ions. Thomson repeated the experiment with various gases, like hydrogen, carbonic acid, methyl iodide, and air. The results were always the same. But why? Thomson was forced to suggest to a disbelieving world the existence of sub-atomic units common to all matter. At first, he called the material "unknown primordial substance X." That became "primordial atoms" and finally "corpuscles." Today, using a term first introduced by George Johnstone Stoney in 1891, we call them electrons.

J.J. Thomson's electron hypothesis is considered one of the great theoretical contributions to modern physics. Indeed, it is possible to argue that contemporary physical theory originated with the discovery of the first sub-atomic particle, and for his work with cathode rays Thomson won the Nobel Prize in 1906.

On the other hand, no theoretical structure, however revolutionary, comes from nowhere. Thomson's notion of primordial corpuscles would have been impossible to explore without the fairly sophisticated cathode-ray tube machinery he had at his disposal. But Thomson's tube was not an entirely novel creation. As we've seen, many of the operational aspects were anticipated, in a piecemeal fashion of course, by the German investigators, made famous by Crookes, and influenced still further by Lenard and Perrin. And let us not forget the mechanical skill and manual dexterity of Johann Geissler, the artisan from Ingelsheib. ■



## TELEPHONE RING CONVERTER

(Continued from page 39)

**Testing and Operation.** Start by re-checking your wiring to make sure you haven't made any errors. When you are confident that everything is okay, you can check out the ring converter by using the 60-Hz signal present on your home's powerlines. To do that you will have to take a line cord and add a fuse to it to form a test jig as shown in Fig. 5. **Be sure to use a ¼-amp fast-acting fuse as shown, and insulate all connections to prevent a shock hazard. Be cautious when working with house current—remember: safety first!** Once you've modified the line cord, attach it securely to the appropriate points on the circuit board.

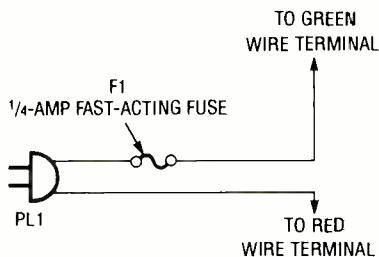

Fig. 5. A quick test jig can be made from a linecord and a fast-acting fuse, as shown here. Be very careful to insulate all the connections of this assembly.

Turn both the volume and tone controls to mid-position, and plug the assembly into a wall outlet. Adjust the volume and tone controls through their ranges; you should hear the warble of the ring converter. If nothing is heard, unplug the assembly and check to make sure the fuse hasn't blown. If it has, check for a wiring error before replacing the fuse.

Make sure the ring converter passes this test before connecting it to the phone line. When you are satisfied with its performance, disconnect the line-cord/ fuse assembly. Finish the project by using decals or a label maker to provide legends for the controls, and fit the circuit into an appropriate case.

Disable the bell in the telephone by switching the bell off (look for a slide switch on the side of the telephone near the bottom), or move the bell loudness lever to low. Another way to

## PARTS LIST FOR THE TELEPHONE RING CONVERTER

### RESISTORS

(All fixed resistors are ¼-watt, 5% units.)

- R1—2200-ohm
- R2—1-megohm, linear-taper potentiometer
- R3—1-megohm
- R4—100,000-ohm, linear-taper potentiometer

### CAPACITORS

- C1—C5—0.1 $\mu$ F, 400-WVDC, Mylar
- C6—10- $\mu$ F 100-WVDC non-polarized electrolytic

### ADDITIONAL PARTS AND MATERIALS

- U1—TCM1506 Texas Instruments ring-detector/driver, integrated circuit
- BZ1—25,000-pF piezo transducer element
- Modular telephone extension cord (see text for type), project box, potentiometer knobs, circuit-board materials, wire, solder, etc.

mute a mechanical bell is by wrapping the bell rim(s) with electrical tape. The tape will dampen the bell ring to a whisper.

To use the Ring Converter simply plug the jack into a modular wall socket as shown in either Fig 4A or Fig. 4B. Call up a friend and ask them to call you back and let the phone ring. Adjust the tone and volume to a pleasant level and you are done. You will find the Ring Converter indispensable if you work in an office area full of ringing telephones. ■

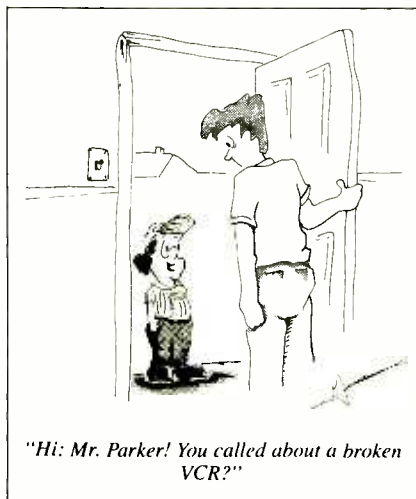

## ELECTRONICS TECHNICIANS DAY

(Continued from page 42)



Here's Ernie Curtis, CET and chairman of ISCET at his workbench troubleshooting a balky video camera.

dards, video basics, test signals, and the operation of both the electronic and mechanical systems in VCR's. Also covered are 8mm video, camcorders, cameras, monitors, and the microprocessors used in video products.

**Paying and Passing.** The fee for the CET exam is \$25.00, which includes both the Associate exam and any one Journeyman option, if taken in one sitting. If the Journeyman option is taken separately from the Associate exam, each test is \$25.00. Each additional Journeyman option is \$25.00. If you fail any portion, the first retake is free, after a 60-day waiting period. The fee for any additional retake is \$12.50. If you choose to take the FCC Legal exam after you have successfully completed the Communications option, there is an additional fee of \$10.00.

Don't underestimate the difficulty of the CET exam—only 30% of those who take a CET test pass! The best way to prepare for this exam is to study diligently. Tab Books publishes *The CET Study Guide* by Sam Wilson, which will help you prepare for both tests. ISCET also has additional study guides available for a nominal fee.

If after reading this article you're interested in taking the CET exam and joining the growing ranks of Certified Electronics Technicians, contact any of the ISCET's volunteer test administrators for details. The exams are scheduled to be given during the week of March 8 through 14, 1992. If you've missed the tests, or need more information, contact ISCET at 2708 West Berry St., Fort Worth, TX 76109; phone 1-817-921-9101. ■

# ELECTRONICS MARKET PLACE

## FOR SALE

**CABLE descrambler liquidation.** Major makes and models available. Industry pricing! (Example: Hamlin Combo's, \$44 each... Minimum 10 orders). Call **WEST COAST ELECTRONICS**, 1 (800) 628-9656.

**CABLE TV descramblers, converters, lowest prices guaranteed, best quality, free catalog, CNC CONCEPTS INC.,** Box 34503, Minneapolis, MN 55434. 1 (800) 535-1843.

**HUGE 92 page communications catalog** of short-wave, amateur and scanner equipment. Antennas, books and accessories too. Send \$1.00 to: **UNIVERSAL RADIO**, 1280 Aida Dr., Dept. PE, Reynoldsburg, OH 43068.

## CB RADIO OWNERS!

We specialize in a wide variety of technical information, parts and services for CB radios, 10-Meter and FM conversion kits, repair books, plans, high-performance accessories. Thousands of satisfied customers since 1976! Catalog \$2.

### CBC INTERNATIONAL

P.O. BOX 31500PE, PHOENIX, AZ 85046

**JERROLD, Tocom and Zenith "test" chips.** Fully activates unit. \$50.00. Cable descramblers from \$40.00. Orders 1 (800) 452-7090. Information (310) 867-0081.

**OUR** monthly picture flyer lists quality surplus parts at low prices. Send today for yours. **STARTRONICS**, Box 683, McMinnville, OR 97128.

**SPEAKER** repair. All makes — models. Stereo & professional kits available. Refoaming \$18.00. **ATLANTA AUDIO LABS**, 1 (800) 568-6971.

## CABLE TV DESCRAMBLERS ★ CONVERTERS ★ and ACCESSORIES.

**SAVE MONEY.  
DON'T RENT!**

PANASONIC,  
PIONEER, JERROLD, OAK,  
SCIENTIFIC ATLANTA  
AND MORE. LOWEST PRICES.  
FREE CATALOG.

**(800) 234-1006**  
**CABLE READY COMPANY**

**ENGINEERING** — shareware programs. IBM 5 1/4" format. Request list. Helpful engineering pack disk \$1.50 no s&h. **AGBSOFT**, Rm 2708, 1350 Sixth Ave., New York, NY 10019.

**NEON** in thirty days. Course with free video. Details free. **NEOXA**, Box 4410, Arlington, VA 22204.

**KENWOOD & ICOM** service bulletins. 175+ pages covering all models. \$33.95 catalog — \$3.00. CODs (602) 782-2316 / Fax (602) 343-2141. **TELECODE**, Box 6426-RE, Yuma, AZ 85366-6426.

## FREE CATALOG

**FAMOUS "FIRESTIK" BRAND CB ANTENNAS AND ACCESSORIES. QUALITY PRODUCTS FOR THE SERIOUS CB'er. SINCE 1962**

**FIRESTIK ANTENNA COMPANY**  
2614 EAST ADAMS  
PHOENIX, ARIZONA 85034

**PERMANENT** match, lights 15,000 times, to get yours send \$2.00. **OS**, 226 Franklin St., Marietta, OH 45750.

**HIGH** efficiency concentrator solar cells. 70 sun, 125 sun both 2.2 watts per cell. 1x sun 40MA 555MV and 1x sun 20MA \$8.00, \$4.00. **JAMES CARTER**, PO Box 21532, San Jose, CA 95151. (408) 729-4881.

## CLASSIFIED AD ORDER FORM

To run your own classified ad, put one word on each of the lines below and send this form along with your check to:

**Popular Electronics Classified Ads**, 500-B Bi-County Boulevard, Farmingdale, N.Y. 11735

**PLEASE INDICATE** in which category of classified advertising you wish your ad to appear. For special headings, there is a surcharge of \$11.00.

( ) Plans/Kits ( ) Business Opportunities ( ) For Sale  
( ) Education/Instruction ( ) Wanted ( ) Satellite Television  
( )

Special Category: \$11.00

### PLEASE PRINT EACH WORD SEPARATELY, IN BLOCK LETTERS.

(No refunds or credits for typesetting errors can be made unless you clearly print or type your copy.) Rates indicated are for standard style classified ads only. See below for additional charges for special ads. **Minimum: 15 words.**

1	2	3	4	5
6	7	8	9	10
11	12	13	14	15 (\$23.25)
16 (\$24.80)	17 (\$26.35)	18 (\$27.90)	19 (\$29.45)	20 (\$31.00)
21 (\$32.55)	22 (\$34.10)	23 (\$35.65)	24 (\$37.20)	25 (\$38.75)
26 (\$40.30)	27 (\$41.85)	28 (\$43.40)	29 (\$44.95)	30 (\$46.50)
31 (\$48.05)	32 (\$49.60)	33 (\$51.15)	34 (\$52.70)	35 (\$54.25)

We accept MasterCard and Visa for payment of orders. If you wish to use your credit card to pay for your ad fill in the following additional information (Sorry, no telephone orders can be accepted.):

Card Number \_\_\_\_\_ Expiration Date \_\_\_\_\_

PRINT NAME \_\_\_\_\_ SIGNATURE \_\_\_\_\_

**IF YOU USE A BOX NUMBER YOU MUST INCLUDE YOUR PERMANENT ADDRESS AND PHONE NUMBER FOR OUR FILES. ADS SUBMITTED WITHOUT THIS INFORMATION WILL NOT BE ACCEPTED.**

**CLASSIFIED COMMERCIAL RATE:** (for firms or individuals offering commercial products or services) \$1.55 per word prepaid (no charge for ZIP code)... **MINIMUM 15 WORDS.** 5% discount for same ad in 6 issues within one year; 10% discount for 12 issues within one year if prepaid. **NON-COMMERCIAL RATE:** (for individuals who want to buy or sell a personal item) \$1.25 per word, prepaid... no minimum. **ONLY FIRST WORD AND NAME** set in bold caps at no extra charge. Additional bold face (not available as all caps) 30¢ per word additional. Entire ad in boldface, \$1.85 per word. **TINT SCREEN BEHIND ENTIRE AD:** \$1.90 per word. **TINT SCREEN BEHIND ENTIRE AD PLUS ALL BOLD FACE AD:** \$2.25 per word. **EXPANDED TYPE AD:** \$2.05 per word prepaid. Entire ad in boldface, \$2.45 per word. **TINT SCREEN BEHIND ENTIRE EXPANDED TYPE AD:** \$2.55 per word. **TINT SCREEN BEHIND ENTIRE EXPANDED TYPE AD PLUS ALL BOLD FACE AD:** \$2.95 per word. **DISPLAY ADS:** 1" x 2 1/4"—\$205.00; 2" x 2 1/4"—\$410.00; 3" x 2 1/4"—\$615.00. General information: Frequency rates and prepayment discounts are available. **ALL COPY SUBJECT TO PUBLISHERS APPROVAL. ADVERTISEMENTS USING P.O. BOX ADDRESS WILL NOT BE ACCEPTED UNTIL ADVERTISER SUPPLIES PUBLISHER WITH PERMANENT ADDRESS AND PHONE NUMBER.** Copy to be in our hands on the 18th of the fourth month preceding the date of issue (i.e.; Sept. issue copy must be received by May 18th). When normal closing date falls on Saturday, Sunday or Holiday, issue closes on preceding work day. Send for the classified brochure. Circle Number 49 on the Free Information Card.



**Quality Microwave TV Antennas**

WIRELESS CABLE - IFTS - MMDs - Amateur TV  
Ultra High Gain 50db(+/-) • Tunable 1.9 to 2.7 GHz.

- 36-Channel System Complete \$149.95
- 12-Channel System Complete \$114.95
- Call or write (SASE) for "FREE" Catalog

**PHILLIPS-TECH ELECTRONICS**  
P.O. Box 8533 • Scottsdale, AZ 85252  
(602) 947-7700 (\$3.00 Credit all phone orders)  
MasterCard • Visa • COD's • Quantity Pricing

LIFETIME WARRANTY

**LONG play cassette recorder** — Records 12 hours on a single standard cassette. Voice-activated. Also miniature long play recorders, mini microphones, telephone record controllers, stun guns, surveillance/countermeasures devices. Catalog \$2.00 **PRODUCTIVE ELECTRONICS**, Box 930024-E, Norcross, GA 30093.

**OSCILLOSCOPE** 50MHz, dual channel, solid state calibrated, manual \$250.00 1 (800) 835-8335.

**PRINTED** circuit boards — etched, drilled, tin plated. Single sided \$1.25/sq. inch. Free shipping. **CHELCO ELECTRONICS**, 61 Water Street, Mayville, NY 14757. (716) 753-3200.

**IMPOSSIBLE** cable systems. New user programmable units authorize any or all features of Pioneer or Jerrold descramblers. Take control 1 (800) 968-4041.

**ANTIQUE RADIO CLASSIFIED**  
Free Sample!  
Antique Radio's  
Largest Circulation Monthly.  
Articles, Ads & Classifieds.

6-Month Trial: \$15. 1-Yr: \$27(\$40-1st Class).  
A.R.C., P.O. Box 802-L8, Carlisle, MA 01741



20,000+ IBM-PC public domain and shareware programs. 1.2Mb diskette. Catalog — \$3.00. 400+ page catalog — \$17.95 (refundable). Individual programs/bulk. **TELECODE**, PO Box 6426-PE, Yuma, AZ 85366-6426.

**CABLE TEST CHIPS** S-A 8550, S-A 8500 — 310, 311, 320, 321 (specify) — \$33.95. S-A 8580/338 — \$69.95. Tocom 5503/07 VIP — \$33.95. **TELECODE**, PO Box 6426-CC, Yuma, AZ 85366-6426.

**THE** most advanced hi-tech security, surveillance, and counter-surveillance equipment available anywhere. All affordable. Send \$10.00 for complete catalog. (refund on first purchase over \$100.00) to: **COMCON SYSTEMS**, 501 Boston Post Rd., Dept. 153, Orange, CT 06477.

## PLANS & KITS

**HOBBY/broadcasting/ham/CB/surveillance** transmitters, amplifiers, cable TV, science, bugs, other great projects! Catalog \$1.00 **PANAXIS**, Box 130-H4, Paradise, CA 95967.

**BUILD** — five-digit, ohms, capacitance, frequency, pulse, multimeter. Board, and instructions \$9.95. **BAGNALL ELECTRONICS**, 179 May, Fairfield, CT 06430.

**FASCINATING** Electronic Devices! Dazers! Lasers! FM/AM/phone transmitters! Detectors! Kits/assembled! Catalog \$2.00. **QUANTUM RESEARCH**, 16645-113 Avenue, Edmonton, Alberta T5M 2X2.

**DESCRAMBLER** kits. Complete cable kit \$44.95. Complete satellite kit \$49.95. Add \$5.00 shipping. Free brochure. No New York sales. **SUMMIT PE**, Box 489, Bronx, NY 10465.

**VHF** amplifier plans. 75-110 MHz, 15-25 watts. Complete schematics, instructions, antenna designs. \$8.95: **PROGRESSIVE CONCEPTS**, 1313 North Grand Ave., Suite 291, Walnut, CA 91789.

**BUILD** your own digital sampling drum! It's easy! For complete instructions, schematics, and parts list; send check or money order for \$10.95 payable to: **MERSCHAT ENTERPRISES**, Box 1044, Easthampton, MA 01027.

**FREE CATALOG!**  
**1-800-648-7938**  
**JERROLD HAMLIN OAK ETC**  
**CABLE TV**  
**DESCRAMBLERS**

- Special Dealer Prices!
- Compare our Low Retail Prices!
- Guaranteed Prices & Warranties!
- Orders Shipped Immediately!

**REPUBLIC CABLE PRODUCTS, INC.**  
4080 Paradise Rd. #15, Dept. PE 4/82  
Las Vegas, NV 89109  
For all other information (702) 362-9026

**SATELLITE TV** descrambler. Build your own. Easy to follow instructions, parts list, circuit board and wiring diagram. Send: \$9.95. **ABG ENTERPRISES**, 27081C, Halifax, NS, Canada, B3H-4M8.

**KITS**, sound, light and high tech. Send for free catalog. **JM ELECTRONICS**, Box 150454, Altamonte Springs, FL 32715-0454.

**SURVEILLANCE — countermeasures!** Guaranteed lowest prices! Huge catalog \$5.00 (refundable). **PROTECTOR**, PO Box, 520294-E, Salt Lake City, Utah, 84152.

**CIRCUIT** boards etched and drilled for as low as .70 cents per square inch. **JM ELECTRONICS**, Box 150454, Altamonte Springs, FL 32715-0454 or (407) 767-8196.

**BUILD** — 0 to 15 volts programmable power supply. Includes schematics and instructions. Easy to build. \$2.00 — **JAS**, PO Box 8274, West Chester, OH 45069.

**RECEIVING TUBES**  
OVER 3000 TYPES IN STOCK!  
Also hard-to-find transformers, capacitors and parts for tube equipment.  
Send \$2.00 for our 32 page catalog.

**ANTIQUE ELECTRONIC SUPPLY**  
6221 S. Maple Ave. • Tempe, AZ 85283 • 602-820-5411



**SURVEILLANCE transmitter kits** tune from 65 to 305 MHz. Mains powered duplex, telephone, room, combination telephone/room. Catalog with **Popular Communications**, **Popular Electronics** and **Radio-Electronics** book reviews of "Electronic Eavesdropping Equipment Design." \$2.00. **SHEFFIELD ELECTRONICS**, 7223A Stony Island Ave., Chicago, IL 60649-2806.

**VIDEOCIPHER II/scanner/cable/satellite** modifications books. Catalog — \$3.00. **TELECODE**, PO Box 6426-PE, Yuma, AZ 85366-6426.

**FM STEREO TRANSMITTER** kit. Broadcast any audio signal, CD player, VCR to FM stereo radios throughout home/yard. PC board and components: \$22.00. **TENTRONIX**, Dept. PC492, 3605 Broken Arrow, Coeur d'Alene, ID 83814.

**IR REMOTE INTERFACE** for your IBM or compatible PC. Control TV, VCR, CD etc. Simple construction, all parts available locally. Uses printer parallel port. Specify 3 1/2" or 5 1/4". Complete plans, software \$15.00. **LABSoft**, 36274 Bordman Rd., Memphis, MI 48041. (313) 392-3228.

**ANTIQUE** radio schematics 1926 — 1942 \$2.00 for list \$5.00 per schematic. **SASE**, 505 Sunnyside Place, Edmond, OK 73034.

## REPAIR SERVICE

**20 YEARS EXPERIENCE** Repair modern, older and antique cameras, lenses, meters, projectors, scopes, binoculars, clocks. **VINTAGE CAMERA AND CLOCK REPAIR**, (303) 484-2564.

## BUSINESS OPPORTUNITIES

**YOUR own radio station!** Licensed/unlicensed. AM, FM, TV, cable. Information \$1.00 **BROADCASTING**, Box 130-H4, Paradise, CA 95967.

**EASY work!** Excellent pay! Assemble products at home. Call toll free 1 (800) 467-5566 Ext. 5730.

**MAKE \$75,000.00 to \$250,000.00 yearly** or more fixing IBM color monitors. No investment, start doing it from your home (a telephone required). Information, USA, Canada \$2.00 cash for brochure, other countries \$10.00 US funds. **RANDALL DISPLAY**, Box 2168-H, Van Nuys, CA 91404, USA. Fax (818) 990-7803.

**HOME** assembly work available! Guaranteed easy money! Free details! **HOMEWORK-P**, Box 520, Danville, NH 03819.

**MAKE \$\$\$!** Become an American electronics dealer! Profit opportunities since 1965. Call Wayne Marks, 1 (800) 872-1373.

**EARN** money repairing microcomputers. Booklet lists suppliers of Apple, Compaq, IBM, and other parts and supplies. Send \$6.00 to **LGI COMPUTER SERVICES**, PO Box 711225, Houston, TX 77271. Texas residents add 6.25% tax.

**EARN** extra money working from home. Assemble products, mail brochures. Information: **LEE**, Box 2048, Winnetka, CA 91306-2048.

**WANTED**  
SN76477 OR SN76488

**SOUND CHIPS ANY QUANTITY;**  
**BIOFEEDTRAC INC.**  
ASK FOR ARIEL  
(718) 852-7856

★★★★ PRESENTING ★★★★★  
**CABLE TV**  
**DESCRAMBLERS**  
★★★★ STARRING ★★★★★  
**JERROLD, HAMLIN, OAK**  
AND OTHER FAMOUS MANUFACTURERS

- FINEST WARRANTY PROGRAM AVAILABLE
- LOWEST RETAIL / WHOLESALE PRICES IN U.S.
- ORDERS SHIPPED FROM STOCK WITHIN 24 HRS
- ALL MAJOR CREDIT CARDS ACCEPTED

FOR FREE CATALOG ONLY **1-800-345-8927**  
FOR ALL INFORMATION **1-818-709-9937**

**PACIFIC CABLE CO., INC.**  
7325 1/2 Reseda Blvd., Dept. 2013  
Reseda, CA 91335

## T.V. FILTERS

T.V. notch filters, phone recording equipment, brochure \$1.00. **MICRO Thinc.**, Box 63/6025, Margate, FL 33063. (305) 752-9202.

## SATELLITE TV

**FREE** — Catalog — Lowest prices worldwide. **SKYVISION**, 1048 Frontier, Fergus Falls, MN 56537. 1 (800) 334-6455. (See full page ad The Market Center).

## GRAVITY

**DOES** anti-gravity interest you? If it does, let's correspond, maybe we can exchange some ideas. Write to: **JAMES LONGRICH**, 524 East Erie Ave., Lorain, OH 44052.

# FUN WITH ELECTRONICS



◀ **160—COIL DESIGN & CONSTRUCTION MANUAL** .... \$5.95. How to make RF, IF, audio and power coils; chokes and transformers. Practically every possible type is discussed.

◀ **PCP113—THE PC MUSIC HANDBOOK** .... \$13.95. Learn the basics of computer music systems. For the professional musician, gifted amateur or just plain curious.



◀ **BP297—LOUDSPEAKERS FOR MUSICIANS** .... \$6.25. Loudspeaker design from the musician's point of view! All you need to know, and you should be able to design your own after reading this.



◀ **BP277—HIGH POWER AUDIO AMPLIFIER CONSTRUCTION** .... \$6.25. Here's background and practical design information on high power audio amplifiers capable of 300 ± 400 watts r.m.s. You'll find MOSFET and bipolar output transistors in inverting and non-inverting circuits.

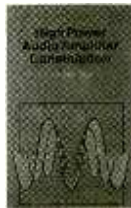

◀ **BP302—A CONCISE USER'S GUIDE TO LOTUS 1-2-3 RELEASE 3.1** .... \$6.25. If you are a PC user and want to upgrade to Lotus 1-2-3 release 3.1, this book can teach you how to do that in the shortest and most effective way.



◀ **BP298—A CONCISE INTRODUCTION TO THE MACINTOSH SYSTEM AND FINDER** .... \$6.25. This introduction for those new to the Mac, this book also serves as a quick refresher for experienced owners that have not used the machine in some time.



MAIL TO: **Electronic Technology Today, Inc.**  
P.O. Box 240  
Massapequa Park, NY 11762-0240

### SHIPPING CHARGES IN USA AND CANADA

\$0.01 to \$5.00	.. \$1.50	\$30.01 to \$40.00	.. \$5.50
\$5.01 to \$10.00	.. \$2.50	\$40.01 to \$50.00	.. \$6.50
\$10.01 to \$20.00	.. \$3.50	\$50.01 and above	.. \$8.00
\$20.01 to \$30.00	.. \$4.50		

**SORRY, No orders accepted outside of USA and Canada**

Total price of merchandise	..... \$	_____
Shipping (see chart)	..... \$	_____
<b>Subtotal</b>	..... \$	_____
Sales Tax (NYS only)	..... \$	_____
<b>Total Enclosed</b>	..... \$	_____

Name \_\_\_\_\_  
Address \_\_\_\_\_  
City \_\_\_\_\_ State \_\_\_\_\_ Zip \_\_\_\_\_

## WANTED

**INVENTORS!** Confused? Need help? Call **IMPAC** for free information package. USA/Canada: 1 (800) 225-5800. (24 hours!).

## HOME EXTERMINATION

**New book: "Become Roach-Free"** Exterminator explains: in detail. \$20.00 EPE, POB 74C, Calhoun, LA 71225-0074.

## EDUCATION/INSTRUCTION

**LEARN IBM PC assembly language.** Book \$18.00. Disk \$5.00. **ZIPFAST**, Box 12238, Lexington, KY 40581-2238.

**VCR repair.** Save money — make big profits! Learn how from *How to Keep Your VCR Alive*. "This detailed, step-by-step manual enables anyone with no previous knowledge or experience to fix most VCR problems easily, quickly, and inexpensively with a few simple tools." — *Small Press Review*. Highly recommended by *Popular Electronics*, *Modern Electronics*, *Popular Communications*, *Electronic Servicing*, *Videomaker*, *Library Journal*, and many other electronics and video magazines "Far better than *Viejo* at 1/7 the cost." 403 page book, with 704 illustrations, plus professional head-cleaning tool. Obtain from B. Daltons, or send \$24.95 to **WORTHINGTON PUBLISHING**, 6907-202H Halifax River Drive, Tampa, FL 33617. Publisher pays S&H. Money-back satisfaction guarantee!

**LEARN computer software at home.** Catalog \$1.00 refundable. **SOFT-TECH**, 1516 Osprey, Suite 207, Desoto, TX 75115.

**MAKE a thing... Make a living... Study Industrial Design Technology** and bring your ideas to life. Learn to problem-solve, sketch, render and design. Develop models, create prosthetic appliances. Build your future in movie and theater special effects, toy and product, exhibit, transportation, furniture/fixture, architectural and amusement environmental design at **The Art Institutes Of Pittsburgh, Fort Lauderdale, Seattle or The Colorado Institute Of Art**. For information write 526 Penn Avenue, Dept. 34, Pittsburgh, PA 15222 or call 1 (800) 525-1000.

**FCC general radiotelephone.** Operator license study material. Theorays, formulas, and rules. Send \$27.00, check or M.O. to: **BUSSER DEBARR PRODUCTION AND DESIGN**, PO Box 902, Webster Station, Alameda, CA 94501-8902.

## BEST BY MAIL

Rates: Write National, Box 5, Sarasota, FL 34230  
OF INTEREST TO ALL

**VCR REPAIR - TECHNICIANS' SECRETS REVEALED** Do it yourself, literally save hundreds. Start your own community business! Complete easy to follow **MANUAL** with Schematics/Diagrams. Includes 800 numbers of all major manufacturers for ordering parts direct. More. \$14.95 to: **ACME VCR REPAIR**, 2104 Renwick Lane, Antioch, CA 94509.

**RETIRE EARLY 1-900-776-3348 CODE AB 5180** Mention Code (\$6.95).

**WE CAN FIND ANY Record Ever Made!** Send Request! Box 6184(PE), San Rafael, CA 94903.

### BOOKS - CATALOGS - MAGAZINES

**ELECTRONIC ENGINEERING.** 8 volumes complete. \$109.95. No prior knowledge required. Free brochure. **BANNER TECHNICAL BOOKS**, 1203 Grant Ave., Rockford, IL 61103.

### TOOLS

**CORDLESS SOLDERING IRON.** Increases mobility, improves accuracy! Rechargeable. \$14.95. Free information. **McGregor Imports**, PO 428135-S, Chicago, IL 60642.

### MONEYMAKING OPPORTUNITIES

**GET PAID FOR stuffing envelopes!** Free details. Write: **Stuff-It**, Box 276(PE), Graham, TX 76450.

### HEALTH

**HAIR LOSS? INFORMATION** about new treatments. Peter Proctor, MD 1-800-926-1752.

## SPEECH SYNTHESIS

**SPEECH synthesizer**, the most advanced speech synthesizer available with unlimited vocabulary, but flexible enough to control speech rate, articulation, inflection, and more. At a low cost and remarkably easy to use. (kit or assembled) For data sheet, user's guide and catalog send \$5.00 to: **MARZAK CORP.**, 66 Bryden Lane, Pittston, PA 18640.

**MASTERCARD AND VISA** are now accepted for payment of your advertising. Simply complete the Classified Ad order form and we will bill you.

**THIS IS A BOLDFACE EXPANDED AD.** If you like this format, request it. Your cost is \$2.20 per word.

# BUY BONDS



**OPEN DOOR Student Exchange** has been providing intercultural learning opportunities for high school students and families since 1964. Much of our success in bringing visiting foreign students and host families together is the result of our extensive network of local Area Representatives and State Coordinators. Their efforts in promoting student participation, recruiting host families and counseling visiting students, their host families and schools are a vital part of our program.

If you're interested in international education, have the communication and interpersonal skills needed to effectively recruit, promote and counsel, we would like to tell you more about our organization, assignments available in your area, and our expense/compensation packages.

Just call: 1-800-366-OPEN (6736).



250 Fulton Street  
P.O. Box 71  
Hempstead,  
NY 11551

**OPEN DOOR STUDENT EXCHANGE**





## BASS AND TREBLE

(Continued from page 34)

see that as the frequency increases, the reactance drops. We can take advantage of that to make a frequency-dependent voltage divider that we can use as a tone control.

Let's now look at a bass-boost circuit (see Fig. 2). Consider an AC signal fed to resistor R3 and ground, with the output taken across the potentiometer wiper tap. For clarity, the 100k potentiometer can be considered to be a series combination of 2 resistors (R1 and R2), as shown. Capacitors C1 and C2 shunt R1 and R2 respectively.

Note the differing values for R3 and R4, and C1 and C2 (we will explain the difference shortly). The output signal magnitude is given by:

$$V_{out} = V_{in} \div (1 + ((R1/X_{C1}) + R3)/((R2/X_{C2}) + R4))$$

This seemingly cumbersome statement is no more than the basic voltage-divider equation reworked to include the capacitors.

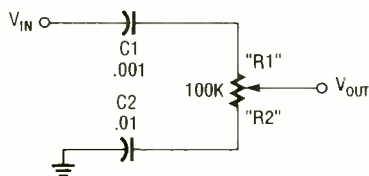

Fig. 3. The treble control is similar in principle to the bass control, but the capacitors are placed in series with the potentiometer.

Fortunately, you won't have to use this formula to determine the output as a function of frequency and various ratios of R1 and R2 as that information is already summarized in Table 1. For example; with R1 = 0 and R2 = 100k (representing the potentiometer fully advanced to one end), the output voltage is a maximum (86% of the input) at the low frequency end (10Hz) and drops to only 9% at the high frequency end (100kHz). What that means is that the bass frequencies are enhanced with the potentiometer in this position. As the potentiometer is rotated so R1 starts to get larger and R2 starts to decrease, the amount of bass is reduced. Finally at the other end of the scale, with R1 = 90k and R2 = 10k, the output is essentially flat with respect to frequency.

**The Treble Control.** The treble control (shown in Fig. 3) works in a similar way. The input is applied to C1 and the output is taken from a potentiometer wiper. Resistors R1 and R2 make up the two halves of the potentiometer.

The output signal is given by:

$$V_{out} = V_{in} \times (R2 + X_{C2}) / (R2 + X_{C2} + R1 + X_{C1})$$

The response of the circuit as a function of frequency is summarized in Table 2. With R1 = 0 and R2 = 100k, the high frequency signals are now enhanced, while the low frequencies remain nearly the same.

With a few additional components, the two circuits (bass and treble) can be combined as shown in Fig. 4. It is

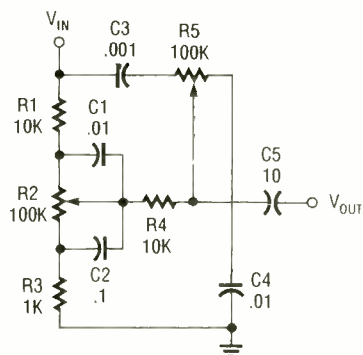

Fig. 4. The bass and treble circuits can be combined to form a two-control tone-adjust circuit, as shown here. Note the additional AC-coupling capacitor.

assumed that the signal sent into the network has been AC coupled and contains no DC component.

If your application requires, you can use just the treble portion (shown with the capacitors in series with the potentiometer) by itself. However, if you want to use just the bass-boost circuit (on the left side of the circuit), be sure to AC-couple both the input and output terminals. ■

TABLE 1—BASS BOOST

R1	R2	Percentage Output Across R2				
		10Hz	100Hz	1kHz	10kHz	100kHz
0	100K	86%	60%	20%	10%	9%
10K	90K	75%	43%	14%	9%	9%
30K	70K	56%	28%	11%	9%	9%
50K	50K	40%	21%	10%	9%	9%
70K	30K	25%	16%	10%	9%	9%
90K	10K	10%	10%	10%	9%	9%

TABLE 2—TREBLE BOOST

R1	R2	Percentage Output Across R2				
		10Hz	100Hz	1kHz	10kHz	100kHz
0	100K	9%	14%	42%	86%	98%
10K	90K	9%	14%	39%	78%	89%
30K	70K	9%	12%	31%	61%	68%
50K	50K	9%	11%	24%	44%	49%
70K	30K	9%	10%	17%	27%	30%
90K	10K	9%	9%	9%	10%	10%

**THE UNCENSORED  
CONTENT OF  
THIS MAGAZINE IS  
MADE POSSIBLE BY  
THE CONSTITUTION  
AND  
THE BILL OF RIGHTS  
OF THE  
UNITED STATES.**

THE CONSTITUTION. THE WORDS WE LIVE BY.

To learn more about the Constitution write: Constitution, Washington, D.C. 20006. The Commission on the Bicentennial of The U.S. Constitution.



## ADVERTISING INDEX

POPULAR ELECTRONICS magazine does not assume any responsibility for errors that may appear in the index below.

Free Information No.	Page	6	Heathkit	7	
7	AMC Sales	21	—	HighText Publications, Inc.	75
—	Antique Electronic Supply	95	—	ISCET	69
—	Antique Radio Classified	95	—	Monitoring Times	90
—	Biofeedtrac Inc.	95	—	NRI Schools	15, 87
—	Business INFOLINE	73	—	Pacific Cable	95
—	CBC International	94	—	Phillips Tech	95
—	CIE	25	5	Radio Shack	CV4
—	Cable Ready Company	94	—	R.E. Video Offer	4
—	Command Productions	71	—	Republic Cable	95
—	Electronic Tech. Today	30, 91	—	Tab Books	81
—	Electronic Tech. Today	96	11	SCO Electronics	17
—	Electronics Book Club	9	—	Science Probe	CV3
—	Firestik II	94	—	The School of VCR Repair	19
8	Fluke Manufacturing	CV2	12	U.S. Cable	17
—	Grantham College	11	9,10	Viejo Publications	21, 69

### GUGLIELMO MARCONI

*(Continued from page 48)*

**Many Lives Saved.** During the next ten years, wireless provided assistance to the victims of at least ten major maritime disasters. While hundreds of lives were saved, the value of wireless at sea had not received a high level of public recognition. This would change, however, following the collision of the White Star Line's S.S. Republic with the Italian steamship Florida on January 23, 1909.

The Florida rammed the Republic in a dense fog 26 miles southwest of Nantucket. The Republic's wireless room and dynamo were badly damaged, but the wireless equipment was unharmed. The Marconi operator used emergency batteries to send out the distress call. A nearby land station picked up the call for help and alerted ships in the area.

The Republic's sister ship, the S.S. Baltic, was 200 miles away and responded at top speed, reaching the collision site within twelve hours. The

Republic's wireless had to guide the Baltic through the still-thick fog. The Baltic safely took on all 1690 passengers from the two wrecked ships. The severely damaged Florida struggled to New York under escort, but the Republic sank near Martha's Vineyard.

Fortunately, the loss of life due to the collision was limited to six. Marconi and his wireless operators were heroes in the public mind. However, more disasters would have to occur before all ships would be required to carry wireless equipment.

**The Titanic Tragedy.** As mentioned earlier, the disaster that earned Marconi and his wireless the greatest acclaim was the sinking of the S.S. Titanic. Partly because it was the largest and grandest ship ever launched and partly because the passengers included celebrities and socialites of great renown. It's no wonder that the world's focus was on the Titanic as it began its maiden voyage from Southampton to New York on April 10, 1912.

Wireless enabled the Titanic to re-

### ADVERTISING SALES OFFICE

**Gernsback Publications, Inc.**  
500-B Bi-County Blvd.  
Farmingdale, NY 11735  
1-(516) 293-3000

President: **Larry Steckler**  
Vice President: **Cathy Steckler**  
Vice President: **Cathy Steckler**

**For Advertising ONLY**  
516-293-3000  
Fax 1-516-293-3115  
**Larry Steckler**

publisher  
**Arline Fishman**  
advertising director  
**Denise Haven**  
advertising assistant  
**Kelly McQuade**  
credit manager

**Subscriber Customer Service**  
1-800-435-0715  
1-800-892-0753  
7:30 AM - 8:30 PM EST

#### SALES OFFICES

##### EAST/SOUTHEAST

**Stanley Levitan**, Eastern Sales Manager  
1 Overlook Ave.  
Great Neck, NY 11021  
1-516-487-9357, 1-516-293-3000  
Fax 1-516-487-8402

##### MIDWEST/Texas/Arkansas/Okla.

**Ralph Bergen**, Midwest Sales Manager  
One Northfield Plaza, Suite 300  
Northfield, IL 60093-1214  
1-708-446-1444  
Fax 1-708-559-0562

##### PACIFIC COAST/Mountain States

**Marvin Green**, Pacific Sales Manager  
5430 Van Nuys Blvd. Suite 316  
Sherman Oaks, CA 91401  
1-818-986-2001  
Fax 1-818-986-2009

ceive warnings concerning the ice field that laid ahead on April 12, although the warnings apparently were not taken seriously. After its collision with an iceberg, the Titanic sent out a wireless distress call which summoned help from the S.S. Carpathia. The Carpathia's sole wireless operator, though officially off-duty, fortunately had returned to his wireless equipment before going to bed and heard the Titanic's signals from 58 miles away.

Regrettably, the help came too late for the over 1500 who perished. How many hundreds more could have been saved if the wireless operator of the S.S. Californian, which lay stopped in the water only ten miles from the Titanic because of the ice, had not gone to bed leaving his ship deaf to the stricken vessel's calls for help?

International laws would soon be established requiring all major vessels to carry wireless equipment and maintain continuous monitoring of the airwaves for distress signals. Marconi and all the world could only wish that the value of wireless equipment at sea had been realized sooner. ■



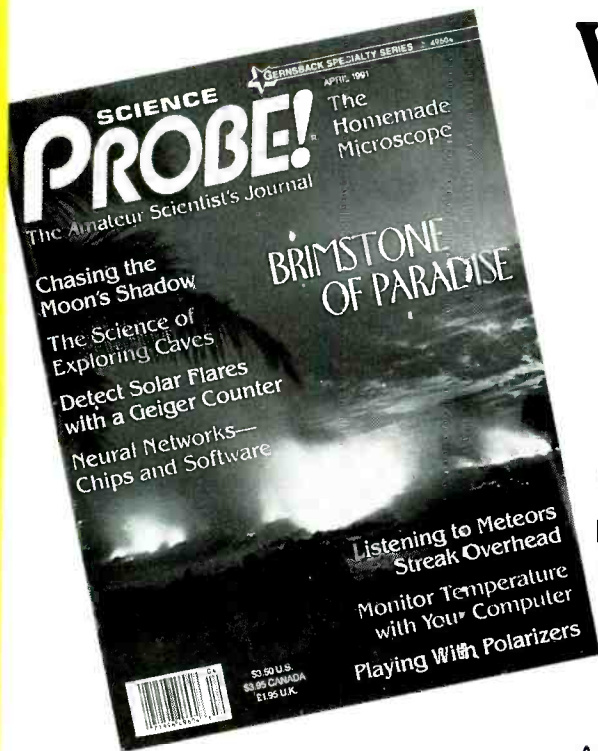

Welcome to...

# SCIENCE PROBE!

The Amateur Scientist's Journal

Embark on an irresistible new journey into the realm of mystery, challenge, and exploration! The perfect magazine for the budding scientist, the serious amateur, the professional who would like to relax, and those who simply want to gaze at the stars.

**Science PROBE!** — the *only* magazine devoted entirely to Amateur Scientists! If you are fascinated by science in all its many forms... if you can't stay away from a microscope, telescope, calipers, or test tube — we invite you to share the wonders in every issue of **Science PROBE!** You will join a community of Amateur and Student Scientists who enthusiastically seek scientific knowledge or follow scientific pursuits for their own sakes and not merely as a profession.

Obtain your next issue of **Science PROBE!** by visiting a quality Newsstand, Convenience Store, or Supermarket or by reserving your personal copy through the mail by completing the coupon below.

From your very first issue of **Science PROBE!** you will be involved in a world of scientific facts, experiments, and studies pursued by amateur scientists who are university students, investors, academicians, engineers, or office workers, salesmen, farmers—whose *quest* is to probe into the mysteries of science and reveal them to all.

Plan to become a **Science PROBE!** reader!

Articles to appear in upcoming issues of **Science PROBE!** are:

**How an Amateur Mapped the Milky Way**  
**Make your own Seismometer**  
**Operate a Solar-powered Weather Station**  
**Grow Crystals Automatically**  
**Experiment with a Saltwater Aquarium**  
**How to Keep a Science Notebook**

If you're fascinated by science in all its many forms, if you are compelled to experiment and explore, then **Science PROBE!** is your kind of magazine!

**Science PROBE!**

500-B Bi-County Boulevard  
 Farmingdale, NY 11735

Please forward my copy of **Science PROBE!** as soon as it comes off the press. I am enclosing \$3.50-U.S.A. (\$4.23-Canada-includes G.S.T.) plus \$1.00 for shipping and handling. Better still, please enroll me as a subscriber and send the next four (4) quarterly issues of **Science Probe**. I am enclosing \$9.95-U.S.A. (Canada: \$16.00—includes G.S.T.)

Next Issue Only       Next Four Issues (1 Year)

Offers valid in the U.S.A. and Canada only. No foreign orders.

Name \_\_\_\_\_

Address \_\_\_\_\_

City \_\_\_\_\_ State \_\_\_\_\_ ZIP \_\_\_\_\_

All Orders payable in U.S.A. Funds only.

7PD20

**ON SALE AT QUALITY NEWSSTANDS, CONVENIENCE STORES AND SUPERMARKETS**  
**GET YOUR COPY TODAY—\$3.50-U.S.A.—\$3.95-Canada**

## THE PARTS PLACE<sup>SM</sup>



### Super Selection! Try Our Special-Order Hotline

Your local Radio Shack stocks over 1000 popular electronic components. Plus, we can special-order over 10,000 items from our main warehouse—ICs, semiconductors, tubes, crystals, photo cartridges and still, popular modules, even SAMS<sup>®</sup> manuals. There are no postage charges or minimum requirements for this service. Come in today for details!

### NEW! Micronta<sup>®</sup> LCD Digital Multimeter

With big display and protective rubber holster. Autoranging with manual override, high-speed sampling. Has data hold, 33-dot analog bargraph, 200  $\mu$ A low-current range and continuously sounding. Fold-out stand/hanger. Measures to 1000 VDC, 700 VAC, 10A AC/DC, 30 megohms resistance. Batteries extra. #22-167 . . . 69.95



**Infrared Detector Module.** A ready-to-use IR receiver for remote-control projects. Combines detector, limiter and demodulator in a compact 3-lead package. 5VDC. With data. #276-137 . . . . . 3.49

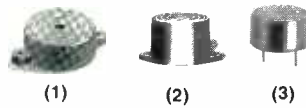

(1) Pulsing Buzzer. Extra-loud! 3 to 28 VDC. #273-066 . . . . . 4.29  
 (2) "Ding-Dong" Chime. For doorbell, entry alert. Requires 6 to 18 VDC. #273-071 . . . . . 8.99  
 (3) Mini Buzzer. Efficient! Draws 7 mA at 12VDC. #273-074 . . . 2.99



(1) High-Speed 12VDC Motor. Up to 15,200 RPM with no load. About 2" long (including shaft). #273-255 . . . . . 2.99  
 (2) Low-Voltage Motor. For projects and solar power demos. 1 1/2 to 3VDC. #273-223 . . . . . 99¢



**Mini Audio Amplifier.** With built-in speaker. Use to boost computer audio, signal tracing and more. Has a high-gain IC circuit, 1/8" headphone jack, 1/8" input jack and volume control. Battery extra. #277-1008 . . . . . 11.95

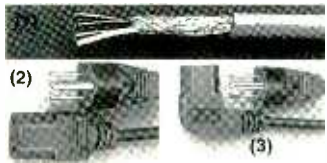

(1) 4-Conductor Double Shielded Cable. 30 feet. For audio or data hookups. #278-777 . . . . . 7.95  
 (2) 12-Foot "Business Machine" Power Cord. #278-1261 . . . 5.99  
 (3) 6-Ft. Version of Fig. 2. 90° connector. #278-1260 . . . . . 5.99



(1) Binding Posts/BNC Adapter. For dependable test instrument hookups. #274-715 . . . . . 8.95  
 (2) Binding Post to Banana Plugs. Stackable. Includes one red and one black. #274-716 . . . . . Set 4.95



(1) Power Supply Project Case. Vented 2 1/2 x 4 5/8 x 3 1/4" molded box. #270-287 . . . . . 3.99  
 (2) Deluxe Project Box. 3 1/16 x 8 1/4 x 6 1/8". All metal. With protective rubber feet. #270-274. 10.79  
**20 different enclosures in stock!**



**Infrared Detector Card.** Detects normally invisible IR light. Fast way to confirm output from remote controls, infrared LEDs or laser in CD and video players. Great for science projects, too! #276-099 . . . . . 5.95



**Portable Shortwave Antenna.** Boosts reception on worldband portables! Clips to rod antenna. Wire extends up to 23 feet. Winds up on pocket-size reel for storage and travel. #278-1374 . . . . . 8.95

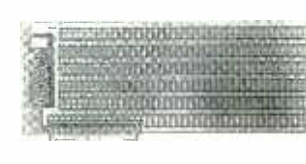

**PC/XT Experimenter's Circuit Card.** Premium epoxy prototyping board fits computer's XT bus connector. Plated-through holes. 3 7/8 x 10 1/16 x 1/16". Accepts D-sub at right. #276-1598 . . . . . 29.95



**Right-Angle D-Sub 25 Female Connector.** Ideal for use with card at left. Radio Shack has solder-type and IDC solderless connectors for computer and printer hookups. #276-1504 . . . . . 2.49

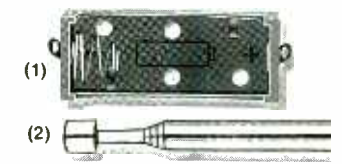

(1) Holder for Type "N" Battery. #270-405 . . . . . 59¢  
**16 different holders in stock!**  
 (2) Telescoping Antenna. 17 3/4". Six sections. #270-1409 . . . . 2.59  
**16 different antennas in stock!**

Since 1921 Radio Shack has been the place to obtain up-to-date electronic parts as well as quality tools, test equipment and accessories at low prices. Our nearly 7000 locations are ready to serve you—NOBODY COMPARES

Prices apply at participating Radio Shack stores and dealers. Radio Shack is a division of Tandy Corporation

**Radio Shack** SINCE 1921  
**AMERICA'S TECHNOLOGY STORE**

CIRCLE 5 ON FREE INFORMATION CARD