

Popular Electronics

SEPTEMBER 1991

Make a Mac

Get a better, more expandable machine, and save some cash in the bargain, when you build your own Macintosh computer



The Electronic Dragonfly

Turn pieces of piezo-electric film into a fun-to-build, fun-to-use conversation piece

All About Receiver Sensitivity

Find out what those receiver-sensitivity specs really mean

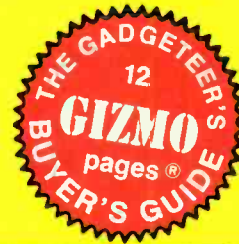

Build the Socket Sentinel

A surge-protected, "smart" power strip that let's you use one device to control up to three others

What Do Electrical Engineers Do?

Is a career as an electrical engineer right for you? After you read this article, you may be better able to answer that question

Product Reviews

Sony portable SW receiving system, Pulsar 72-inch projection TV, and much more

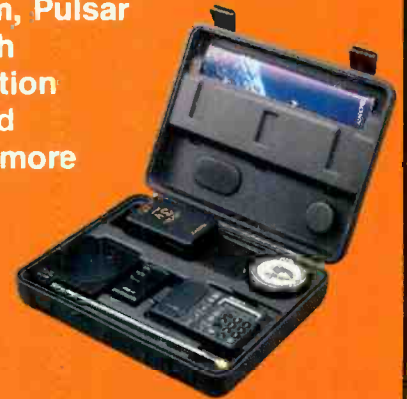

\$2.95 U.S.
\$3.75 CANADA

3 NEW
FactCards
IN THIS ISSUE

#BXBD0CH***** 5-DIGIT 60506
#60506DHM997GADD6# FEB92 61
ROBERT DAHM RESP
997 GRAND AVE 070
AURORA, IL 60506

Electronics Paperback Books

GREAT PAPERBACKS AT SPECIAL PRICES

BP248—TEST EQUIPMENT CONSTRUCTION \$5.95. Details construction of simple, inexpensive, but extremely useful test equipment. AF Gen, Test Bench Ampl, Audio Millivoltmeter, Transistor Tester and six more.

Test Equipment Construction



BP267—HOW TO USE OSCILLOSCOPES AND OTHER TEST EQUIPMENT \$6.95. Mastering the oscilloscope is not really too difficult. This book explains all the standard controls and functions. Other equipment is also described.

How to Use Oscilloscopes and Other Test Equipment

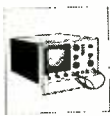

BP265—MORE ADVANCED USES OF THE MULTIMETER \$5.95. Use these techniques to test and analyze the performance of a variety of components. Also see how to build ad-ons to extend multimeter capabilities.

More Advanced Uses of the Multimeter



An Introduction to Loudspeakers and Enclosure Design

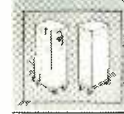

BP256—INTRO TO LOUDSPEAKERS AND ENCLOSURE DESIGN \$5.95. We explore the variety of enclosure and speaker designs in use today so the reader can understand the principles involved.

BP263—A CONCISE INTRO TO dBASE \$6.95. The dBASE series of programs are probably the best known database programs for microcomputers. This book is designed to help you get started working with them.



BP260—CONCISE INTRO TO OS/2 \$5.95. If you are a multitasking PC user and want to get the most out of your computer, then you must learn its OS/2 operating system. This book shows you just how to do that, quickly and easily.



BP249—MORE ADVANCED TEST EQUIPMENT CONSTRUCTION \$6.95. Eleven more test equipment construction projects. They include a digital voltmeter, capacitance meter, current tracer and more.



Digital Audio Projects



BP245—DIGITAL AUDIO PROJECTS \$5.95. Practical circuits to build and experiment with. Includes A/D converter, input amplifier, digital delay line, compander, echo effect and more.

BP247—MORE ADVANCED MIDI PROJECTS \$5.95. Circuits included are a MIDI indicator, THRU box, merge unit, code generator, pedal, programmer, channelizer, and analyzer.



BP257—INTRO TO AMATEUR RADIO \$6.95. Amateur is a unique and fascinating hobby. This book gives the newcomer a comprehensive and easy to understand guide to the subject.



PCP102—INTRODUCING DIGITAL AUDIO \$9.95. Covers all kinds of digital recording methods—CD, DAT and Sampling. Bridges the gap between the technician and the enthusiast. Principles and methods are explained.

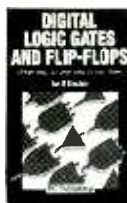

PCP107—DIGITAL LOGIC GATES AND FLIP-FLOPS \$10.00. Thorough treatment of gates and flip-flops for enthusiasts, student and technicians. Only a basic knowledge of electronics is needed.

BP251—COMPUTER HOBBYISTS HANDBOOK \$8.95. A wrapup of everything the computer hobbyist needs to know in one easy to use volume. Provides a range of useful reference material in a single source.



PCP108—COMPUTERS AND MUSIC \$9.95. Explains the basics of computers and music with no previous knowledge of computers needed. Covers types of music software and explains how to set up your own computer music studio.

BP195—INTRODUCTION TO SATELLITE TV \$9.95. A definitive introduction to the subject written for the professional engineer, electronics enthusiast, or others who want to know more before they buy. 8 x 10 in.

BP190—ADVANCED ELECTRONIC SECURITY PROJECTS \$5.95. Includes a passive infra-red detector, a fiber-optic loop alarm, computer-based alarms and an unusual form of ultrasonic intruder detector.

BP235—POWER SELECTOR GUIDE \$10.00. Complete guide to semiconductor power devices. More than 1000 power handling devices are included. They are tabulated in alpha-numeric sequence, by technical specs. Includes power diodes, Thyristors, Triacs, Power Transistors and FET's.

BP234—TRANSISTOR SELECTOR GUIDE \$10.00. Companion volume to BP235. Book covers more than 1400 JEDEC, JIS, and brand-specific devices. Also contains listing by case type, and electronic parameters. Includes Darlingtons, high-voltage devices, high-current devices, high power devices.

BP99—MINI-MATRIX BOARD PROJECTS \$5.50. Here are 20 useful circuits that can be built on a mini-matrix board that is just 24 holes by ten copper-foil strips.

BP117—PRACTICAL ELECTRONIC BUILDING BLOCKS—Book 1 \$5.75. Oscillators, Timers, Noise Generators, Rectifiers, Comparators, Triggers and more.

BP184—INTRO TO 68000 ASSEMBLY LANGUAGE \$6.95. The 68000 is a great new breed of microprocessor. Programming in assembly language increases the running speed of your programs. Here's what you need to know.

BP179—ELECTRONIC CIRCUITS FOR THE COMPUTER CONTROL OF ROBOTS \$7.50. Data and circuits for interfacing the computer to the robot's motors and sensors.

BP239—GETTING THE MOST FROM YOUR MULTIMETER \$5.95. Covers basics of analog and digital meters. Methods of component testing includes transistors, thyristors, resistors, capacitors and other active and passive devices.

BP97—IC PROJECTS FOR BEGINNERS \$5.50. Power supplies, radio and audio circuits, oscillators, timers, switches, and more. If you can use a soldering iron you can build these devices.

BP37—50 PROJECTS USING RELAYS, SCR'S & TRIACS \$5.50. Build priority indicators, light modulators, warning devices, light dimmers and more.

RADIO—100 RADIO HOOKUPS \$3.00. Reprint of 1924 booklet presents radio circuits of the era including regenerative, neutrodyne, reflex & more.

BP42—SIMPLE LED CIRCUITS \$5.50. A large selection of simple applications for this simple electronic component.

BP127—HOW TO DESIGN ELECTRONIC PROJECTS \$5.75. Helps the reader to put projects together from standard circuit blocks with a minimum of trial and error.

BP122—AUDIO AMPLIFIER CONSTRUCTION \$5.75. Construction details for preamps and power amplifiers up through a 100-watt DC-coupled FED amplifier.

BP92—CRYSTAL SET CONSTRUCTION \$5.50. Everything you need to know about building crystal radio receivers.

BP45—PROJECTS IN OPTOELECTRONICS \$5.50. Includes infra-red detectors, transmitters, modulated light transmission and photographic applications.

BP185—ELECTRONIC SYNTHESIZER CONSTRUCTION \$5.95. Use this book to learn how to build a reasonably low cost, yet worthwhile monophonic synthesizer and learn a lot about electronic music synthesis in the process.

CHECK OFF THE BOOKS YOU WANT

ELECTRONIC TECHNOLOGY TODAY INC.
P.O. Box 240, Massapequa Park, NY 11762-0240

SHIPPING CHARGES IN USA AND CANADA

\$0.01 to \$5.00	\$1.50
\$5.01 to \$10.00	\$2.50
\$10.01 to 20.00	\$3.50
\$20.01 to 30.00	\$4.50
\$30.01 to 40.00	\$5.50
\$40.01 to 50.00	\$6.50
\$50.01 and above	\$8.00

SORRY No orders accepted outside of USA & Canada Number of books ordered

Total price of merchandise \$ _____
Sales Tax (New York State Residents only) \$ _____
Shipping (see chart) \$ _____

All payments must be in U.S. funds Total Enclosed . . . \$ _____

Name _____
Address _____
City _____ State _____ Zip _____

P-991

Popular Electronics®

THE MAGAZINE FOR THE ELECTRONICS ACTIVIST!

CONSTRUCTION ARTICLES

BUILD A SIMPLE LASER POWER SUPPLY	Gregory Gray	32
<i>Learn about laser operation with this easy-to-build, low power, laser-tube power-supply circuit</i>		
THE ELECTRONIC DRAGONFLY	Marc Spiwak	55
<i>Make your next project a most unusual one</i>		
BUILD THE SOCKET SENTINEL	Marc Spiwak and John Yacono	63
<i>Control the power to all the components in your A/V or other system using one component's own on/off switch!</i>		

FEATURE ARTICLES

MAKE YOUR OWN MAC	Elliot Kantor	26
<i>You can build an easily expandable Macintosh with some built-in frills for less than what a new no-frills unit would cost</i>		
WHAT DO ELECTRICAL ENGINEERS DO?	Harry L. Trietley	35
<i>Read this article and find out; maybe you'll also learn if an engineering career is for you</i>		
INSIDE THE SONY MINI DISC	Brian C. Fenton	39
<i>Will Sony's new Mini Disc revolutionize the portable audio industry, or will it simply muddy the waters for years to come?</i>		
ALL ABOUT RECEIVER SENSITIVITY	Joseph J. Carr	61
<i>Learn about the different ways that receiver sensitivity is measured and specified, and what each rating really means</i>		

PRODUCT REVIEWS

GIZMO		43
<i>Including: Sony Portable Shortwave Receiving System, Design Acoustics Video Speakers, and much more</i>		
HANDS-ON REPORT		66
<i>OWI WAO II Mobile Robot Kit</i>		
PRODUCT TEST REPORT	Len Feldman	68
<i>Pulsar TVP 2000 "Prodigy" Projection TV Receiver</i>		

COLUMNS

THINK TANK	John Yacono	18
<i>Controlling power</i>		
COMPUTER BITS	Jeff Holtzman	70
<i>The 386 revolution continues</i>		
ANTIQUE RADIO	Marc Ellis	72
<i>The theremin: A first look inside</i>		
CIRCUIT CIRCUS	Charles D. Rakes	74
<i>Detector circuits, and more</i>		
FUN SOFTWARE	Fred Blechman	80
<i>Flying with the best</i>		
SCANNER SCENE	Marc Saxon	82
<i>Preparing for stormy weather</i>		
DX LISTENING	Don Jensen	84
<i>Shortwave radio: It's no laughing matter</i>		
HAM RADIO	Joseph J. Carr	86
<i>A random walk through the technical mailbag</i>		

DEPARTMENTS

EDITORIAL	Carl Laron	2
LETTERS		4
ELECTRONICS LIBRARY		6
NEW PRODUCTS		14
FACTCARDS		41
FREE INFORMATION CARD		60
ADVERTISER'S INDEX		98

Popular Electronics (ISSN 1042-170X) Published monthly by Gernsback Publications, Inc., 500-B Bi-County Boulevard, Farmingdale, NY 11735. Second-Class postage paid at Farmingdale, NY and at additional mailing offices. One-year, twelve issues, subscription rate U.S. and possessions \$21.95, Canada \$28.84 (includes G.S.T. Canadian Goods and Services Tax Registration No. R125166280), all other countries \$29.45. Subscription orders payable in U.S. funds only, International Postal Money Order, or check drawn on a U.S. bank. U.S. single copy price \$2.95. © 1991 by Gernsback Publications, Inc. All rights reserved. Hands-on Electronics and Gizmo trademarks are registered in U.S. and Canada by Gernsback Publications, Inc. Popular Electronics trademark is registered in U.S. and Canada by Electronics Technology Today, Inc. and is licensed to Gernsback Publications, Inc. Printed in U.S.A.

Postmaster: Please send address changes to Popular Electronics, Subscription Dept., P.O. Box 338, Mount Morris, IL 61054-9932.

A stamped self-addressed envelope must accompany all submitted manuscripts and/or artwork or photographs if their return is desired should they be rejected. We disclaim any responsibility for the loss or damage of manuscripts and/or artwork or photographs while in our possession or otherwise.

As a service to readers, Popular Electronics publishes available plans or information relating to newsworthy products, techniques, and scientific and technological developments. Because of possible variances in the quality and condition of materials and workmanship used by readers, Popular Electronics disclaims any responsibility for the safe and proper functioning of reader-built projects based upon or from plans or information published in this magazine.

Larry Steckler

EHF, CET

Editor-in-Chief and Publisher

EDITORIAL DEPARTMENT

Carl Laron

Editor

Robert A. Young

Associate Editor

John J. Yacono

Associate Editor

Byron G. Wels, K2AVB

Associate Editor

Teri Scaduto

Assistant Editor

Kathy Terenzi

Editorial Assistant

Marc Spiwak

Editorial Associate

Fred Blechman

Joseph J. Carr, K4IPV

Marc Ellis

Len Feldman

Jeffrey K. Holtzman

Don Jensen

Charles D. Rakes

Marc Saxon

Contributing Editors

PRODUCTION DEPARTMENT

Ruby M. Yee

Production Director

Karen S. Brown

Production Manager

Marcella Amoroso

Production Assistant

Janice Box

Editorial Production

ART DEPARTMENT

Andre Duzant

Art Director

Injae Lee

Illustrator

Russell C. Truelson

Illustrator

Jacqueline P. Cheeseboro

Circulation Director

Michele Torrillo

P-E Bookstore

BUSINESS AND EDITORIAL OFFICES

Gernsback Publications, Inc.

500-B Bi-County Blvd.

Farmingdale, NY 11735

1-516-293-3000

Fax: 1-516-293-3115

President: **Larry Steckler**

Customer Service/Order Entry

1-800-435-0715

In IL 1-800-892-0753

7:30 AM - 8:30 PM EST

Advertising Sales offices listed on page 98

Cover photography by Elliot Kanter

Composition by

Mates Graphics



The
Audit
Bureau
of Circulation



The publisher has no knowledge of any proprietary rights which will be violated by the making or using of any items disclosed in this issue.

THE DIGITAL GUESSING GAME

The lines are being drawn for a battle that seems sure to reshape the home-recording marketplace. We don't know who will win, but it's a good bet that at least some consumers will be among the losers.

To bring you up to date: For years, the Philips-developed compact cassette has been the dominant medium for home recording and for portable audio. While that medium is not without significant flaws (a high noise level, for one), its convenience has made it an overwhelming success, at least among non-audiophiles.

Its success was so complete that compact cassettes even withstood the introduction of the CD. Using digital techniques, that non-recordable medium offered audio quality that could not be matched by tape or vinyl. CD's soon replaced records on the shelves of most stores, but they did not replace compact cassettes. For many consumers, the compact cassette's convenience, especially for portable use, was more important than the CD's superior sound quality.

Perceiving a need that may or may not exist, the electronics industry began to look for a new product—one that would combine CD-like sound with compact-cassette-like convenience and recordability. The first entry was digital audio tape (DAT), an audiophile-quality product with a price tag to match. Then, this past winter, Philips introduced the more modestly priced digital compact cassette (DCC). Now, Sony has announced a third recordable digital medium, the Mini Disc (MD). For a full report on the MD, turn to page 39.

The stage is now set for a three-sided format war beginning sometime next year when DCC and MD hardware arrives on stores' shelves. All three formats have their advantages, and drawbacks, so only time will tell which will survive; although if consumer confusion (not to mention the fear of getting stuck with obsolete and non-supported hardware) is high enough, it's possible that ultimately none may make it.

The consumer-electronics graveyard is filled with products that though highly touted at first, failed due to consumer apathy, consumer confusion, inadequate marketing, or just poor performance. Whether DAT, DCC, and/or MD will join the quadriphonic amplifier, the 8-track tape deck, the CED/VHD videodisc player, and the Beta VCR in the backs of unlucky consumer's closets is still anyone's guess.

Carl Laron

Editor

We Have **QUALITY PARTS** • We Have **DISCOUNT PRICES** • We **SHIP FAST**

ALL ELECTRONICS CORP.

Highest Quality Metal C-60 Cassettes (Erased)

Premium quality metal tape in C-60 cassettes (30 min. per side). One of the finest "brand-name" tapes on the market, in durable, clear plastic transport mechanisms. Recorded and bulk erased, the record-protect tabs have been removed and therefore, need to be taped over to re-record. Audiophiles will appreciate the wide dynamic range of this tape. If your cassette deck has a "metal" setting you will hear the difference. A real bargain!

CAT# C-60M \$1.25 each • 10 for \$10.00

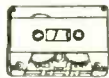

TOUCH DIMMER

The "brain" part of the "LITE TOUCH" touch dimmer, when connected to any lamp, will turn it on and off and change the brightness level when any metal part is touched. We don't have the wiring harness that originally connected this to the lamp, but we can provide a simple hook-up diagram and instruction sheet. The solid-state circuitry is contained in a thermoplastic box 1.91" X 3.11" X 0.835".

CAT# DMR-1 \$3.50 each



INFRARED SECURITY LIGHT (AS-IS)

Elektriko # SIL-101 - Experiment with infrared sensors with these outdoor security lights. Contain lots of interesting components, and IR detector, photoresistor, relay, transformer, IC's, voltage regulator, capacitors, trim pots and other goodies. Returned to the distributor for variety of reasons, we've found that most of them work to some extent. We don't want to test them and would prefer to sell them "as-is" at a greatly reduced price. Mounts to any standard electrical junction box. Infrared sensor detects movement up to 65 feet and turns on lights. Sensor can be adjusted for sensitivity and duration of lighting. The position of the sockets and the infrared sensor can be easily adjusted. Will handle two 150 watt PAR 38 lamps. Suitable for wet locations. Bubs not included. **CAT# IL-101 \$7.50 each**

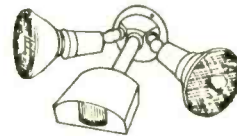

SWITCHES

Dip P.C. Pushbutton

ITT Schadow Digistat Series SE S.P.D.T. momentary pushbutton. Mounts in 14 pin DIP configuration. Designed for low current switching applications. Grey keycap is 0.68" X 0.67".

CAT# PB-28 \$1.00 each
10 for \$9.50 • 100 for \$85.00



Pushbutton Switch
SMK Manufacturing 0.47" square black pushbutton. SPST normally open. 4 p.c. pins for mounting. Ideal for low current switching applications. **CAT# PB-29**
5 for \$1.00 • 100 for \$15.00



Rotary BCD Switch

EECO # 2310-02G BCD 10 position rotary switch. DIP configuration fits in standard 8 pin I.C. socket. Right angle style. Screwdriver actuation. 0.42" cube.

CAT# RDIP-2 \$1.75 each
10 for \$16.00 • 100 for \$145.00



Miniature Toggles

Rated: 3 amps @ 120 Vac

S.P.D.T. (ON-ON) P.C. mount **CAT# MTS-4PC \$1.00 each**
10 for \$9.00 • 100 for \$80.00

S.P.D.T. (ON-ON) solder lugs **CAT# MTS-4 \$1.35 each**
10 for \$12.50 • 100 for \$110.00

D.P.D.T. (ON-ON) solder lugs **CAT# MTS-8 \$1.75 ea.** 10 for \$15.00

D.P.D.T. (ON-ON) P.C. mount **CAT# MTS-8PC \$2.00 ea.** 10 for \$17.50



TELEPHONE KEYPAD

12 button telephone keypad. Ivory finish. 2.83" x 2.2" x 0.58" thick. Matrix encoded. Ideal for telephone or security keypad.

CAT# KPT-1 \$1.00 each • 10 for \$9.00



OPTO-SENSOR

TRW/Optron # OPB5447-2 IR emitter/sensor pair in Rectangular package with 28" color coded leads.

CAT# OSR-4 2 for \$1.00



PHOTOFLASH CAPACITOR

Rubicon CE 210 Mfd 330 Volt photoflash capacitor. 0.79" dia. X 1.1" high. These are new capacitors that have been prepped with 1.4" black and red wire leads soldered to the terminals. **CAT# PPC-210**
\$1.25 each • 10 for \$11.00
100 for \$100.00

Large quantities available. Call for pricing.



RECHARGEABLE BATTERIES

6 Volt 1 Amp/Hour

Japan Storage Battery Co. Portalac # PEGV1 6 Volt 1 Ah rechargeable sealed lead-acid (gell cell). 2" X 1.635" X 2" ht. Batteries are prepped with 5" black and red leads terminated with 2 pin connector.

CAT# GC-61 \$4.75 each
10 for \$42.50



Nickel-Cad

AAA SIZE \$1.50 each
1.2 volts 180 mAh
CAT# NCB-AAA

AA SIZE \$2.00 each
1.25 volts 500 mAh
CAT# NCB-AA

AA SIZE \$2.20 each
WITH SOLDER TABS
CAT# NCB-SAA

C SIZE \$4.25 each
1.2 volts 1200 mAh
CAT# NCB-C

D SIZE \$4.50 each
1.2 volts 1200 mAh
CAT# NCB-D



HALL EFFECT SENSOR

Microswitch #SS41 Tiny, solid state switch reacts instantly to proximity of magnetic field. Operates at extremely high speeds, up to 100 khz. Case size: 0.12" X 0.17" X 0.06" thick. 4.5 Vdc to 24 Vdc supply voltage. 10 ma. sink type digital output. Operating gauss - 15 to 40. P.C. leads.

CAT# HESW-2 75¢ each • 10 for \$6.50
100 for \$60.00 • 1000 for \$500.00



3 1/2" DISKETTES

Quality, double-sided 3 1/2" diskettes. These diskettes were recorded, but never used. Flip the write-protect tab to off position and use for your own data storage at a fraction of the cost of new diskettes.

CAT# DTS-1 \$1.00 each • 10 for \$9.00

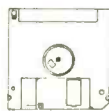

AUDIO SLIDE POT

Dual 1K audio. 3 1/2" long, 2 1/2" slide

CAT# ASP-1KD
Reduced to 50¢ each
100 for \$40.00

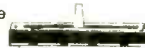

I.E.C. POWER CORD

6 foot BLACK, SPH-386 jack to 3 prong molded A.C. plug. Fits most computers, computer terminals and test equipment.

CAT# LCAC-C6 \$3.00 each



FLASH ASSEMBLY

New compact flash assembly from a U.S. manufacturer of cameras. Operates on 3 Vdc and measures 2 1/2" x 1 1/4". Ideal for use as a strobe, warning light or attention getter. Includes hook-up diagram. **CAT# FSH-1 \$3.75 each**
10 for \$35.00 • 100 for \$325.00



P.C. RELAYS

The following relays all have p.c. pins for both input and output as well as quick-connect terminals on the output. 1.5" X 1.05" X 1.08". UL & CSA listed.



12 Vdc, SPDT
Potter & Brumfield # T91R5D22-12-02
12 Vdc, 155 ohm coil, Normally open contacts rated 20 amps. Normally closed contacts rated 10 amps.
CAT# RLY-31 \$2.50 each
10 for \$22.50

12 Vdc, SPST N. O.
Potter & Brumfield # T91R5D22-12-01
12 Vdc, 155 ohm coil, S.P.S.T. normally open contacts rated 30 amps.
CAT# RLY-32 \$2.00 each
10 for \$18.00

L.E.D.'s

Standard JUMBO
Diffused T 1-3/4 size (5 mm)

RED **CAT# LED-1**
10 for \$1.50 • 100 for \$13.00

GREEN **CAT# LED-2**
10 for \$2.00 • 100 for \$17.00

YELLOW **CAT# LED-3**
10 for \$2.00 • 100 for \$17.00

FLASHING LED
W/ built in flashing circuit
5 volt operation. T 1-3/4 (5mm)

RED \$1.00 each
CAT# LED-4 10 for \$9.50

GREEN \$1.00 each
CAT# LED-4G 10 for \$9.50

YELLOW \$1.00 each
CAT# LED-4Y 10 for \$9.50

LED HOLDER
Two piece holder.
CAT# HLED 10 for 65¢

KITS

L.E.D. FLASHER KIT

Two L.E.D.'s flash in unison when a 9 volt battery is attached. This kit includes a p.c. board, all the parts and instructions to make a simple flasher circuit. A quick and easy project for anyone with basic soldering skills.

CAT# LEDKIT \$1.75 per kit



L.E.D. CHASER KIT

Build this variable speed led chaser. 10 leds flash sequentially at whatever speed you set them for. Easy to build kit includes pc board, parts and instructions. Ideal for special lighting effects, costumes, etc. Operates on 3 to 9 volts. PC board is 5" X 2.25". A great one hour project.

CAT# AEC \$6.50 each



STEPPING MOTOR CONTROLLER KIT

Learn about stepping motors while building this simple circuit. Includes circuit board, stepping motor and all parts except 12 Vdc power supply. **CAT# SMKIT \$18.00 each**



METRONOME KIT

This simple device can be set to click from 20 to 1,000 beats per minute. Easy to build, includes circuit board, all components and instructions. Operates on a 9 volt battery (not included).

CAT# METRO \$3.75 each



PHOTO RESISTOR

1,000 ohms bright light.
16K ohms dark.
0.182" dia. X .08" high. 0.18" long leads.
CAT# PRE-7 2 for \$1.00
100 for \$45.00 • 1000 for \$400.00

ORDER TOLL FREE 1-800-826-5432

FAX (818) 781-2653 • INFORMATION (818) 904-0524

Call Or Write For Our Free 64 Page Catalog

Outside the U.S.A. send \$2.00 postage for a catalog.

Minimum Order \$10.00 • All Orders Can Be Charged To Visa, Mastercard Or Discovercard • Checks and Money Orders Accepted By Mail • California, Add Sales Tax • Shipping And Handling \$3.50 for the 48 Continental United States - All Others Including Alaska, Hawaii, P.R. And Canada Must Pay Full Shipping • Quantities Limited • No C.O.D. • Prices Subject to change without notice.

DISCOVER

VISA



SEPTEMBER 1991

MAIL ORDERS TO: ALL ELECTRONICS CORP • P.O. BOX 567 • VAN NUYS, CA 91408

CIRCLE 10 ON FREE INFORMATION CARD

www.americanradiohistory.com

LETTERS

JUMPING SHIP?

Since 1966, except for a brief period several years ago when you tried to emulate a computer magazine, I have been a faithful subscriber to **Popular Electronics** because I enjoyed the electronic articles and projects, and columns such as *Think Tank*, *Circuit Circus*, etc.

However, I have a bone to pick with you. If I want to read about computer language and game software, such as featured in your *Computer Bits and Fun Software* columns, I will buy and read computer magazines! I do *not* want to read computer articles in my electronics magazines, unless they are electronic projects such as "A Telephone-Operated Switch for your Computer."

Have you opened the door to become just another computer magazine, as you did a few years ago? Is your memory so short that you do not realize that a second transition to a computer magazine will end as it did with your first transition, when most of your subscribers deserted you?

If you insist on being computer-oriented, I will join the throng that will say "Aloha Oe" to **Popular Electronics** for the second, and probably final, time.

A.L.M.
Honolulu, HI

Have no fear, the transition you speak about was done under a previous ownership, and is a move that we have no plans of duplicating. We will continue to cover computer software as it is a topic that many electronics hobbyists find interesting, but we don't anticipate expanding that coverage beyond what you currently see.—Editor

PARTS AVAILABILITY?

I've been reading **Popular Electronics** for a few years now, and I really like the projects that appear in its pages. But I wonder about the longevity of availability of parts and circuit boards for those projects. Sometimes I look back at projects in older issues thinking that, if I could still get the parts and boards, I would like to build them.

R.W.B.
Richmond, CA

That depends on the project. We have no control over parts suppliers. Sometimes parts and boards are available for years; other times, just a few months. Your best bet is to do your research before you buy anything, starting with the supplier of the board and any specialized parts.—Editor

A HANDY PROJECT

Each month, **Popular Electronics** comes up with several interesting projects, including those in *Think Tank* and *Circuit Circus*. About the best and handiest project I have seen in a long time was Charles Rakes' "Sure-Luck Ohms" in the April 1991 issue. It's a great workbench addition. I was going to hard-wire the project, but I was glad that I sent for the PC board (quite a few wires). I've worn out two or three Radio Shack resistor color code decoders. (Even with the decoder, it sometimes requires a calculator.) With the Sure-Luck Ohms Box you just twist three knobs to match the colors on the resistor, press a button, and, presto, you have the value of the resistor shown in lights. If you know the value you want, but don't know the colors, just turn the knobs until the correct value lights up, and you automatically have the colors required.

The box is sitting by my DMM, and I know I will get much use from it.

B.M.
Gold Bar, WA

ELECTRO GUARD INSTALLATION

Thank you for a fine magazine, in general. However, I must point out an error in the May 1991 *Gizmo* section that I feel should never have been made by someone qualified to write in **Popular Electronics**.

A product called Electro Guard was reviewed, and an alleged error in their installation procedure was pointed out. I have not seen their manual, but

the wording of the problem leads me to believe that whoever wrote the article doesn't understand how to wire a service entrance box.

The author stated, "A figure illustrating how the hookup is done shows the hot wires connected to breakers that are on top of one another—that is, on the same side of the incoming line—rather than across from one another." With rare exception, all modern main panels are set up with a staggered main bus, which mechanically puts two full-size adjacent breakers on opposite sides of the line. The exception that should be pointed out is the possibility of someone mistaking a Piggyback breaker, or two slim breakers found in some G.E. and similar boxes, as "adjacent breakers." While they are certainly beside each other, they are on the same side of the line. I can only hope that the Electro Guard manual is correct in its pictorial diagram, because that is what most people will tend to use.

Personally, if I were to use such a device, I would use the red/black indicated wires on a 240-volt breaker so that when the device trips or is turned off, both sides of the Electro Guard would be disconnected. The possibility to back-feed one 120-volt circuit with the other side of the line under some conditions could exist internally in the device.

Finally, I would like to point out what I consider a major philosophical question regarding electronics hobbyists repairing or working on their own home wiring. As the old saying goes, "A little knowledge is a dangerous thing." I am not calling your readers dumb. I am sure many of them could whip my socks off in the knowledge department. However, it is very hard even for most people in my business (professional electricians) to keep up with this equipment and how it should be connected. Just learning the N.E.C. requirements and local

rules is a staggering task. There are even legal and insurance implications: A fire or electrocution after performing your own home wiring could result in a shift of liability from the homeowner's insurance carrier to the homeowner. Is the risk worth it?

Hire a professional electrician to evaluate and install equipment like this. The service entrance is no hobbyist or weekend-mechanic proving ground. It is hazardous to your health.

L.E.Y.
Cincinnati, OH

You're right. The installation instructions were, indeed, correct. We couldn't see the internal structure of our service panel, and made incorrect assumptions based on what we could see. We still installed the Electro Guard correctly, however, because we measured for 240 volts between two convenient breakers on opposite sides of the box before we proceeded with the installation. You are also correct in saying that a professional electrician wouldn't make our mistake, and we like your suggestion about installing the Electro Guard across a 240-volt breaker. However, the Electro Guard is sold as a consumer-installable device (albeit with suggestions that a professional may be needed). A hobbyist who is knowledgeable about safety precautions, and is careful to follow them, should be able to install the Electro Guard without any problems.—Chris F. O'Brian

MORE ON SIGNALS FROM SPACE

The hope of finding exceptions to known physical laws springs eternal. Remember the efforts to read paranormal implications into Kirlian photographs? Now, the talk of signals from space through a previously unknown medium seems to fall into the same category.

The author of the April article, "Are We Receiving Biological

Signals from Outer Space?," suffers from no doubts. He claims outright that experiments have "... confirmed the existence of biological signals as a new, non-electromagnetic reality."

Here, the term "biological signals" is used in a sense quite different from its usual use in existent extensive literature, wherein it has nothing at all to do with signals from space. But that is a minor point. The real question is does the author present enough proof to confirm what it is that he means to say.

Unfortunately, his exposition is rather muddy. How do the experimenters know that the sensors are not responding to electrical or micro-climatic influences? And what in the world is meant by "pictures" expanding as they travel through space? Does that mean that only a small detail of the whole picture can be decoded because of the small area of the detectors used? Furthermore, if the signal is distinguished only by "discrete intensity modulations," then the carrier, which continues between periods of

modulation, can only be characterized as noise, inasmuch as it is irregular but conveys no information. Would highly intelligent beings use noise as a carrier? Above all, regardless of the scanning method used, how is a picture derived without benefit of separately distinguishable timing or clock signals? That violates information theory; you can't get more out of a signal than you put in.

Finally, the fact that image enhancement brings out images is scarcely convincing. There are patterns in any kind of disorder. Think of the "man in the moon" the "great stone face," the canals on Mars, etc. (Statisticians brand any purportedly random series of numbers as actually non-random if runs do not occur.)

It takes a true believer to conclude, in the face of all this, that a vague likeness of an arm in an image suggests that the human form is the standard of the universe.

Or is the whole article an April Fool's put-on?
W.C.

Beverly Hills, CA

HAVES AND NEEDS

I have an Eico model 322 signal generator, serial number 10448, that was used only a few times. I'm looking for a service manual for the instrument, and would appreciate any help in finding one. Thank you.

Darrell Crimmins
6025 NW Westside Road
McMinnville, OR 97128

I have a visually impaired friend who is looking for instructions on how to invert the video on a black-and-white video camera. The solution would need to be a switch, so that he could go between normal and inverted and get the most readable image. White type on a black background is easier to see. The switch would be handy when the type is already reversed to white on black.

Mark McMahan
P.O. Box 1163
Jamestown, NC 27282-1163

I am a partially disabled veteran and I'm trying to set up my own test bench. If any of my fellow readers in the San Francisco

Bay area can help me find old but working test gear it would be most appreciated.

Edward J. Matthews
402 Broadway #42
San Francisco, CA 94133

I am trying to locate a Reticon analog delay chip—either SAD-512 or SAD-1024—neither of which is still in production.

The SAD-1024 was sold at one time by Radio Shack as part #276-1761. If anyone knows where I can purchase either or both of these devices, please contact me. Thank you.

Richard Marshall
P.O. Box 3256
Easton, PA 18043

Do you have a question, comment, complaint, or compliment about something you've read in **Popular Electronics**? Then why not write to:

Letters
Popular Electronics Magazine
500-B Bi-County Blvd.
Farmingdale, NY 11735

We're waiting to hear from you!

12" Subwoofer Box



The perfect high volume cabinet for dual voice coil subwoofers. Box comes with pre-cut woofer and port holes. Cabinet volume: 2 cu. ft. with dual ports. Charcoal carpet. Dimensions: 13" (H) x 13" (D) x 30" (W). Net weight: 29 lbs.

#PK-260-495 \$59⁹⁰ Each

12" Pioneer Subwoofer



PIONEER
12" super duty, dual voice coil subwoofer. 30 oz. magnet, 2" voice coil. 100 watts RMS, 145 watts max power handling capability. 6 ohm impedance (4 and 8 ohm compatible). Sensitivity: 89 dB 1W/1M. Response: 25-700 Hz. QTS=.31, VAS= 10.3 cu ft. Net weight: 6 lbs. Pioneer #A30GU30-55D.

#PK-290-145 \$39⁸⁰ \$36⁸⁰
(1-3) (4-up)

800 Hz Horn



Piezo midrange/tweeter driver unit. Response: 800-20 KHz. Power handling capability: 20-30 volts (approximately 50 watts RMS). Sensitivity: 93 dB, 2.83V/1M. 4" round. Motorola #KSN1086.

#PK-270-085 \$25³⁰ \$23⁹⁵
(1-3) (4-up)

18" Eminence Woofer



Professional driver for use in auditorium and studio sound systems. Giant 100 oz. magnet. 250 watts RMS, 350 watts max power handling capability. fs= 30 Hz, QMS= 3.17, QES= .373, QTS=.33. VAS= 10.5 cu ft. SPL= 95 dB 1W/1M. Net weight: 29 lbs.

#PK-290-200 \$99⁸⁰ \$93⁴⁰
(1-3) (4-up)

12" Pyle Woofer



PYLE
12", 70 oz. magnet woofer. 2-1/2" voice coil. 105 watts RMS, 155 watts max power handling capability.

#PK-292-050 \$62⁹⁰ \$59⁸⁰
(1-5) (6-up)

5-1/2" Cone Midrange

Original Sanyo high end system midrange. Large 5" paper cone with gold look dust cap. Heavy 12 oz. magnet. 1" ferro fluid cooled voice coil. 50 watts RMS, 75 watts max. Sanyo part #S12H10. Net weight: 1-1/2 lbs.



SANYO
#PK-281-100 \$5⁹⁵ \$3⁹⁵
(1-9) (10-up)

Subwoofer Crossover Network

Super duty, 200 watt RMS power handling capability. Designed specially for dual voice coil subwoofer systems. 12 dB per octave roll-off at 150 Hz into 8 ohms. Crossover also features a set of outputs for use with your existing speaker system. Network is totally passive, requiring no power source of its own.



#PK-260-220 \$28⁸⁰ \$24⁹⁵
(1-5) (6-up)



340 E. First St., Dayton, Ohio 45402
Local: 1-513-222-0173
FAX: 513-222-4644

• 15 day money back guarantee • \$15.00 minimum order •
We accept Mastercard, Visa, Discover, and C.O.D. orders. •
24 hour shipping • Shipping charge = UPS chart rate + \$1.00
(\$3.00 minimum charge) • Hours 8:30 am - 7:00 pm EST,
Monday - Friday • 9:00 am - 2:00 pm Saturday. Mail order
customers, please call for shipping estimate on orders exceeding 5 lbs.
Foreign customers please send \$5.00 U.S. funds for catalog postage.

CALL TOLL FREE

1-800-338-0531

NEW REVISED CATALOG

Parts Express
FREE CATALOG

ELECTRONICS LIBRARY

Secrets Of RF Circuit Design

by Joseph J. Carr

Maybe we're not keeping him busy enough with his *Ham Radio* column and all the feature articles he writes for **Popular Electronics**. Joe Carr somehow manages to find the time to write books that are as practical and clear as his magazine pieces. In this book, he presents experiments and real-life applications that make radio-frequency circuit theory crystal-clear.

Many electronics enthusiasts consider that part of the electromagnetic spectrum known as

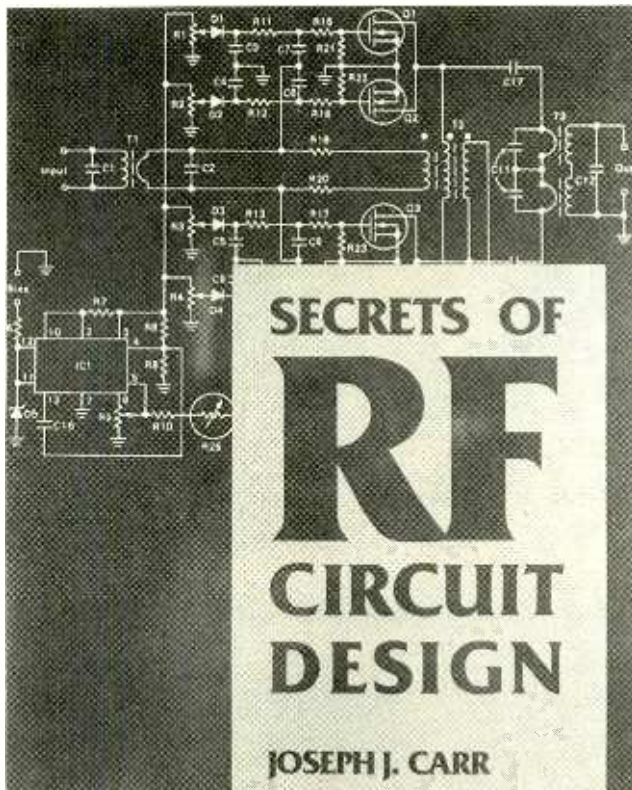

the radio-frequency band to be somewhat mysterious, for a number of reasons. First, RF formulas and circuits don't seem to work the same on paper as they do on the bench because at such high frequencies stray capacitances and

inductances affect the circuits. In addition, resistance isn't the same in RF circuits as in DC and low-frequency AC circuits. Finally, RF-measuring instruments are both more expensive and more complex.

Carr uses non-technical language to explain what RF is, how it works, how it differs from other electromagnetic frequencies, how to build some of your own instruments. His book covers everything from antennas to transistors, including how to repair variable capacitors, cope with electromagnetic interference, and align RF circuits. It also explains how to build a digital frequency-counter module, design and wind inductor coils, and design and build RF-amplifier and preselector circuits and simple wire antennas. In addition, the book teaches the basics of receiver operation, the proper use and repair of components in RF circuits, and the principles of radio-signal propagation from low frequencies to microwaves.

Secrets of RF Circuit Design costs \$19.95 and is published by TAB Books Inc., Blue Ridge Summit, PA 17294-0850; Tel. 1-800-233-1128.

CIRCLE 98 ON FREE INFORMATION CARD

WINDOWS 3 QUICKSTART: The Step-by-Step Approach

by Ron Person and Karen Rose

Surveys and controlled studies have shown that Windows programs make personal computers more accessible to users of all levels of experience, and this book aims to make Windows 3 more accessible to the same audience. The step-by-step instructions include only the most important issues, so that readers don't get side-

tracked. Numbered steps and concise explanations make it easy to work through the book without much page-turning, re-reading, and flipping through indexes.

In each chapter, new commands and procedures are described briefly, and then numbered steps guide readers through the required keystrokes or mouse actions. Illustrations



show how the screen should appear, and some procedures are followed by tips or cautions about using that feature of the program. The book begins with an overview of Windows and directions on how to use Windows menus and dialog boxes, and then explains how other Windows programs—including Windows Write and Windows Paintbrush—work. It explains how to use the Program Manager to keep related programs and documents together so they can be easily located; how to use the File manager to copy and erase files, create directories, and format diskettes; and how to use the Clipboard to copy and paste work. The book describes how to control the printer, use the personal-productivity programs that come free with Windows, and how to create macros to automate procedures. It also shows how to run multiple non-Windows programs, and how to copy and

Why take chances in today's job market?

Graduate as a fully trained electronics professional.

To get ahead and stay ahead in today's economy, you need the electronics training CIE has been providing its 150,000-plus successful graduates with for nearly 60 years.

Meet the Electronics Specialists.

When you pick an electronics school, you're getting ready to invest time and money. And your whole future depends on the education you receive in return. That's why it makes so much sense to go with number one... with the specialists... with CIE!

There's no such thing as a bargain education.

If you talk to some of our graduates, and we recommend you do, chances are you'd find a lot of them shopped around for their training. Not for the lowest priced, but for the best training available. They pretty much knew what was available when they picked CIE as number one.

Because we're specialists we have to stay ahead.

At CIE we have a position of leadership to maintain. Here are just a few of the ways we hang onto it...

Programmed Learning.

That's exactly what happens with CIE's Auto-Programmed Lessons®. Each lesson uses famous "programmed learning" methods to teach you important electronics principles. You explore them, master them completely, before you start to apply them. You thoroughly understand each step before you go on to the next. You learn at your own pace.

And, beyond theory, some courses come fully equipped with electronics equipment to actually let you perform hundreds of hands-on experiments.

Experienced specialists work closely with you.

Even though you study at home, CIE's faculty and staff stand ready to assist via CIE's toll free number. And, each time you return a completed exam you can

be sure it will be reviewed, graded and returned with the appropriate instructional help, you get it fast and in writing from the faculty technical specialist best qualified to answer your question in terms you can understand.

Pick the pace that's right for you.

CIE understands people need to learn at their own pace. There's no pressure to keep up...no slow learners hold you back. If you're a beginner, you start with the basics. If you already know some electronics, you move ahead to your own level.

"Same Day" grading cycle.

When we receive your lesson, we grade it and mail it back the same day. You find out quickly how well you're doing!

State-of-the-art laboratory equipment.

Some courses feature the CIE Microprocessor

Training Laboratory. An integral part of computers, microprocessor technology is used in many phases of business, including service and manufacturing industries. The MTL gives you the opportunity to program it and interface it with LED displays, memory devices and switches. You'll gain all the experience

needed to work with state-of-the-art equipment of today and tomorrow.

New Courses!

CIE now offers two new career courses: Automotive Electronics and Computer Operation and Programming.

CIE offers you an Associate Degree.

One of the best credentials you can have in electronics — or any other career field — is a college degree. That's why CIE offers an Associate in Applied Science in Electronics Engineering Technology. And all CIE career courses earn credit toward your degrees.

Which CIE training fits you?

Beginner? Intermediate? Advanced? CIE home study courses are designed for ambitious people at all entry levels. People who have: No previous electronics knowledge, but do have an interest in it; Some basic knowledge or experience in electronics; In-depth working experience or prior training in electronics.

At CIE you start where you fit and feel comfortable where you start, then go on from there to your Diploma, Associate Degree and career!

Today is the day. Send now.

Fill in and return the postage-paid card attached. If some ambitious person has already removed it, cut out and mail the coupon below. You'll get a FREE CIE school catalog, plus complete information on independent home study. Mail in the coupon below or, if you prefer, call toll-free 1-800-321-2155 (in Ohio, 1-800-523-9109).



AH16

YES! I want to get started. Send me my CIE school catalog including details about the Associate Degree program. (For your convenience, CIE will have a representative contact you — there is no obligation.)

Print Name _____

Address _____ Apt. _____

City _____ State _____ Zip _____

Age _____ Area Code/Phone No. (_____) _____

Check box for G.I. Bulletin on Educational Benefits Veteran Active Duty

CIE CLEVELAND INSTITUTE OF ELECTRONICS, INC.
1776 East 17th Street • Cleveland, Ohio 44114 • (216) 781-9400



A school of thousands.
A class of one.
Since 1934.

paste data and graphics from one program to another.

Windows 3 QuickStart: The Step-by-Step Approach costs \$19.95 and is published by Que Corporation, 11711 North College Avenue, Suite 140, Carmel, IN 46032; Tel: 1-317-573-2500.

CIRCLE 89 ON FREE INFORMATION CARD

65 WAYS TO SAVE TIME AND MONEY DESIGNING AND TESTING TODAY'S ELECTRONICS

from *Global Specialties*

Ten new products are featured in this 36-page catalog of electronic testing and prototyping equipment. Those include a ten-instrument-in-one handheld multimeter, three logic-analyzer test kits, and a digitally synthesized function generator. The catalog also contains complete



descriptions and specifications for complete lines of breadboards and prototyping cards, meters, frequency counters, function generators, power supplies, oscilloscopes, logic test instruments, and enclosures.

65 Ways to Save Time and Money Designing and Testing Today's Electronics is free upon request from Global Specialties, 70 Fulton Terrace, New Haven, CT 06512; Tel: 800-572-1028.

CIRCLE 88 ON FREE INFORMATION CARD

ELECTRONIC SIGNALS AND SYSTEMS

by Stan Prentiss

A true understanding of electronic signals requires more than simply illustrating waveforms from selective sources and describing them. This book

provides technicians and hobbyists with a working knowledge of the equipment that produces the signals, so that they will be able to fully define signal characteristics. It presents a detailed study of signal analysis as it applies to the operation and signal-generating capacities of today's advanced electronic devices. The test-equipment section describes spectrum analyzers, digital-storage oscilloscopes, logic analyzers, high-end multimeters, and frequency counters. Various transmission media are explored, including fiber-optics analysis, AM- and FM-stereo modulation and demodulation, vectors, and a broad spectrum study of television antennas. The book takes a detailed look at satellite earth terminals, including the latest developments in C and Ku bands; low-noise block-down converters; and a 1.2-meter reflector for use with Ku-band video, voice, and data traffic. The book covers monophonic and stereophonic audio—C-QUAM AM-stereo transmission and reception, Bessel functions and tables, harmonic distortion, and stereo separation—all illustrated with spectrum-analyzed waveforms. Also covered are multiple and satellite-master antenna systems, and the latest developments in analog color-television systems. It examines today's automotive electronics, including conventional distributors, fuel injections, turbos, and superchargers.

Electronic Signals and Systems: Television, Stereo, Satellite TV, and Automotive costs \$19.95 and is published by TAB Books Inc., Blue Ridge Summit, PA 17294-0850; Tel: 1-800-233-1128.

CIRCLE 98 ON FREE INFORMATION CARD

TEST INSTRUMENTS BK-91

from B&K-Precision

Instruments for such applications as engineering, maintenance and repair, field service, education, production line testing, research and development, and quality-control programs are featured in this 68-page catalog. It includes B&K's full line of electronic test instruments—oscilloscopes, IC



comparators, digital multimeters, power supplies, video test instruments, signal and function generators, component testers, probes, and accessories. The catalog provides complete specifications in convenient comparison charts and in detailed listings. Key features are summarized, along with selected product specifications. For each major product category, the catalog provides a glossary of terms. A full line of accessories is also described.

Test Instruments BK-91 is free upon request from B&K-Precision, Maxtec International Corp., 6470 West Cortland Street, Chicago, IL 60635; Tel: 312-889-1448.

CIRCLE 87 ON FREE INFORMATION CARD

THE MECHANICS OF SOUND RECORDING

by Tony Zaza

Devoted to the creative use of the sound track for narrative purposes, this book covers the entire technical process of film and video location and studio work. It aims to prepare readers to solve recording problems by applying the proper use of the basic recorder and the intelligent placement of professional microphones. The book illustrates how sound is linked to the process and storytelling functions of a production. State-of-the-art equipment and facilities for sound generation and manipulation are described, along with the complexities of audio post-production with an emphasis on the mix. The book is organized in a series of chapters that stand alone as "modular units." Each chapter provides full details of the technique, technology, and limitations of its subject matter.

A practical appendix includes exercises, operation manuals, sources of information, a complete glossary, operation guidelines for recording with Nagra, and an historical perspective on sound technology.

The Mechanics of Sound Recording costs \$40.00 and is published by Prentice Hall, Englewood Cliffs, NJ 07632; Tel: 201-767-5937.

CIRCLE 99 ON FREE INFORMATION CARD

THE MIDI MANUAL

by David Miles Huber

The musical instrument digital interface—MIDI—has had quite an impact on electronic musical instruments, as is evident in the techniques and production styles of modern music, live stage production, video, and film. Thanks to MIDI, computers are now musical tools. As the MIDI 1.0 specification enters its second decade, this book introduces readers to the latest industry and advances, and thoroughly covers the basics of MIDI technology. Written as an all-around guide to this popular technical-art form, the book gives a close-up look at the industry's top products. Illustrations and step-by-step lessons show readers how to set up an efficient MIDI system. The book explains MIDI components, functions, and fundamentals; explores MIDI's full range of production techniques; looks at the science of synchronization and the art of sequencing; and describes how to combine MIDI and sync-pulse timing.

The MIDI manual costs \$24.95 and is published by Sams, 11711 North College Avenue, Suite 140, Carmel, IN 46032; Tel: 800-628-7360.

CIRCLE 86 ON FREE INFORMATION CARD

SATELLITE TV AND SMATV: Books, Videos & Software

from Baylin Publications

This catalog offers an assortment of books dealing with satellite television and satellite master-antenna TV (SMATV), including two new titles: *World Satellite TV and Scrambling Methods*, *The Technician's*

Handbook and *The 1991 World Satellite Annual*. Other featured titles include the newly revised third editions of *Home Satellite TV—Installation & Troubleshooting* and *The Hidden Signals on Satellite TV*. A variety of tools for installing, aiming, and repairing satellite-TV systems is featured, and includes compasses, inclinometers, tuning meters, filters, cable strippers, TVRO software, and a "how-to" video tape.

Satellite TV and SMATV: Books, Videos & Software is free upon request from Baylin Publications, 1905 Mariposa, Boulder, CO 80302; Tel: 303-449-4551; Fax: 303-939-8720.

CIRCLE 85 ON FREE INFORMATION CARD

HOME AUTOMATION BY HEATH

from Heath Company

The premier issue of *Home Automation*, a catalog of innovative home-electronic products, encompasses a broad scope of consumer items designed for safety, security, convenience, entertainment, and energy management. The products are designed to create a safe, easy, and energy-efficient home environment. The 36-page, full-color catalog is aimed at the do-it-yourself home enthusiast and the electronics innovator. It fea-

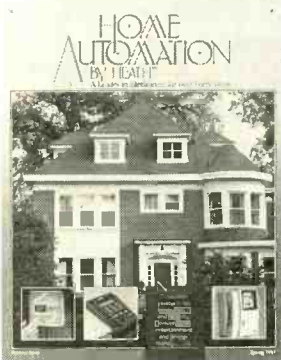

tures whole-house automation and security systems, motion-sensing indoor and outdoor lighting controls, wall switches, security cameras, portable security alarms, wireless video broadcasters, wireless phone extensions, flood-sensor alarms, energy-saving thermostats, and automatic lawn-sprinkling systems.

Designed to inform and educate the consumer, the catalog features product shots and practical in-use photos along with detailed descriptions to provide a thorough understanding of each product. It explains the various types of technology used in the products and how these technologies enable the products to work. Installation steps are also included, so that the consumer knows in advance what the hookup entails.

Home Automation by Heath is free upon request from Heath Company, Department 350-056, Benton Harbor, MI 49022; Tel: 1-800-44-HEATH. CIRCLE 84 ON FREE INFORMATION CARD

MASTERING TURBO DEBUGGER

by Tom Swan

Based on two fundamental ideas—that bugs are an unfor-

tunate, unavoidable part of every programmer's life and that by mastering certain skills, every programmer can successfully debug programs—this book explains how to use Borland's Turbo Debugger for MS-DOS programs written in C, C++, Pascal, or assembly language. It then explains how to combine that practical knowledge with the elements of a good debugging style, to improve programs and write error-

ELenco & HITACHI PRODUCTS AT DISCOUNT PRICES

48 HOUR SHIPPING

48 HOUR SHIPPING

<p>Hitachi RSO Series (Portable Real-time Digital Storage Oscilloscopes)</p> <table border="0"> <tr><td>VC-6023 - 20MHz, 20MS/s</td><td>\$99/mo*</td></tr> <tr><td>VC-6024 - 50MHz, 20MS/s</td><td>\$120/mo*</td></tr> <tr><td>VC-6025 - 50MHz, 20MS/s</td><td>\$135/mo*</td></tr> <tr><td>VC-6045 - 100MHz, 40MS/s</td><td>\$125/mo*</td></tr> <tr><td>VC-6145 - 100MHz, 100MS/s</td><td>\$200/mo*</td></tr> </table> <p><small>RSO's from Hitachi feature roll mode, averaging, save memory, smoothing, interpolation, triggering, cursor measurements. These scopes enable more accurate, simpler observation of complex waveforms. In addition to such functions as hardcopy via a plotter interface and waveform transfer via the RS-232C interface. Enjoy the comfort of analog and the power to digital.</small></p>	VC-6023 - 20MHz, 20MS/s	\$99/mo*	VC-6024 - 50MHz, 20MS/s	\$120/mo*	VC-6025 - 50MHz, 20MS/s	\$135/mo*	VC-6045 - 100MHz, 40MS/s	\$125/mo*	VC-6145 - 100MHz, 100MS/s	\$200/mo*	<p>LEASING AVAILABLE For all Hitachi Scopes - Call for details <small>* Based on 24 months except V-1150, VC-6045, VC-6145 (36 months)</small></p> <p>Hitachi Portable Scopes</p> <table border="0"> <tr><td>DC to 50MHz, 2-Channel, DC offset function, Alternate magnifier function</td><td></td></tr> <tr><td>V-525 - CRT Readout, Cursor Meas.</td><td>\$1,025</td></tr> <tr><td>V-523 - Delayed Sweep</td><td>\$995</td></tr> <tr><td>V-522 - Basic Model</td><td>\$995</td></tr> <tr><td>V-422 - 40MHz</td><td>\$795</td></tr> <tr><td>V-223 - 20MHz delayed sweep</td><td>\$695</td></tr> <tr><td>V-212 - 20MHz</td><td>\$425</td></tr> </table>	DC to 50MHz, 2-Channel, DC offset function, Alternate magnifier function		V-525 - CRT Readout, Cursor Meas.	\$1,025	V-523 - Delayed Sweep	\$995	V-522 - Basic Model	\$995	V-422 - 40MHz	\$795	V-223 - 20MHz delayed sweep	\$695	V-212 - 20MHz	\$425	<p>HITACHI COMPACT SERIES SCOPES This series provides many new functions such as CRT Readout, Cursor measurements (V-1085/1065/665), Frequency Ctr (V-1085), Sweeptime Autoringing, Delayed Sweep and Trigger Lock using a 6-inch CRT. You don't feel the compactness in terms of performance and operation.</p> <table border="0"> <tr><td>V-660 - 60MHz, Dual Trace</td><td>\$1,195</td></tr> <tr><td>V-665 - 60MHz, DT, w/cursor</td><td>\$1,345</td></tr> <tr><td>V-1080 - 100MHz, Dual Trace</td><td>\$1,425</td></tr> <tr><td>V-1085 - 100MHz, DT, w/cursor</td><td>\$1,605/mo*</td></tr> <tr><td>V-1085 - 100MHz, QT, w/cursor</td><td>\$1,255/mo*</td></tr> <tr><td>V-1100A - 100MHz, Quad Trace</td><td>\$1,255/mo*</td></tr> <tr><td>V-1150 - 150MHz, Quad Trace</td><td>\$1,115/mo*</td></tr> </table>	V-660 - 60MHz, Dual Trace	\$1,195	V-665 - 60MHz, DT, w/cursor	\$1,345	V-1080 - 100MHz, Dual Trace	\$1,425	V-1085 - 100MHz, DT, w/cursor	\$1,605/mo*	V-1085 - 100MHz, QT, w/cursor	\$1,255/mo*	V-1100A - 100MHz, Quad Trace	\$1,255/mo*	V-1150 - 150MHz, Quad Trace	\$1,115/mo*
VC-6023 - 20MHz, 20MS/s	\$99/mo*																																							
VC-6024 - 50MHz, 20MS/s	\$120/mo*																																							
VC-6025 - 50MHz, 20MS/s	\$135/mo*																																							
VC-6045 - 100MHz, 40MS/s	\$125/mo*																																							
VC-6145 - 100MHz, 100MS/s	\$200/mo*																																							
DC to 50MHz, 2-Channel, DC offset function, Alternate magnifier function																																								
V-525 - CRT Readout, Cursor Meas.	\$1,025																																							
V-523 - Delayed Sweep	\$995																																							
V-522 - Basic Model	\$995																																							
V-422 - 40MHz	\$795																																							
V-223 - 20MHz delayed sweep	\$695																																							
V-212 - 20MHz	\$425																																							
V-660 - 60MHz, Dual Trace	\$1,195																																							
V-665 - 60MHz, DT, w/cursor	\$1,345																																							
V-1080 - 100MHz, Dual Trace	\$1,425																																							
V-1085 - 100MHz, DT, w/cursor	\$1,605/mo*																																							
V-1085 - 100MHz, QT, w/cursor	\$1,255/mo*																																							
V-1100A - 100MHz, Quad Trace	\$1,255/mo*																																							
V-1150 - 150MHz, Quad Trace	\$1,115/mo*																																							
<p>20MHz Elenco Oscilloscope</p> <p>MO-1251 \$375</p> <ul style="list-style-type: none"> • Dual Trace Component Tester • 6" CRT • X-Y Operation • TV Sync • 2 P-1 Probes 	<p>FREE DMM with purchase of ANY SCOPE</p> <p>SCOPE PROBES P-1 65MHz, 1x, 10x \$19.95 P-2 100MHz, 1x, 10x \$26.95</p>	<p>Elenco 35MHz Dual Trace</p> <p>MO-1252 \$495</p> <ul style="list-style-type: none"> • High luminance 6" CRT • 1mV Sensitivity • 6KV Acceleration Voltage • 10ns Rise Time • X-Y Operation + Z Axis • Delayed Triggering Sweep • Includes 2 P-1 Probes 																																						
<p>All scopes include probes, schematics, operators manual and 3 year (2 yrs for Elenco scopes) world wide warranty on parts & labor. Many accessories available for all Hitachi scopes. Call or write for complete specifications on these and many other fine oscilloscopes.</p>																																								
<p>Beckman TEST EQUIPMENT All Models Available</p> <p>Call for special price</p>	<p>Digital Capacitance Meter CM-1550B</p> <p>\$59.95</p> <p>9 Ranges 1pF-20,000uF .5% basic acy. Zero control w/ Case Big 1" Display</p>	<p>Digital LCR Meter LC-1801</p> <p>\$125</p> <p>Measures: Coils 1uH-200H Caps 1pF-200uF Res .01-20M</p>	<p>Multimeter with Capacitance & Transistor Tester</p> <p>\$55 CM-1500B</p> <p>Reads Volts, Ohms Current, Capacitors, Transistors and Diodes / with case</p> <p>Big 1" Display</p>	<p>FLUKE MULTIMETERS All Models Available</p> <p>Call for special price</p>																																				
<p>Quad Power Supply XP-580</p> <p>\$59.95</p> <p>2-20V @ 2A 12V @ 1A 5V @ 3A -5V @ .5A</p> <p>Fully regulated and short circuit protected</p>	<p>Triple Power Supply XP-620</p> <p>Assembled \$69</p> <p>KR \$45</p> <p>2 to 15V @ 1A, 2 to 15V @ 1A (or 4 to 30V @ 1A) and 5V @ 3A</p> <p>All the desired features for doing experiments. Features short circuit protection, all supplies</p>	<p>AM/FM Transistor Radio Kit with Training Course</p> <p>Model AM/FM 108</p> <p>\$26.95</p> <p>14 Transistors • 5 Diodes Makes a great school project</p>	<p>True RMS 4 1/2 Digit Multimeter M-7000</p> <p>\$135</p> <p>05% DC Accuracy .1% Resistance with Freq Counter and Deluxe Case</p>																																					
<p>Soldering Station Temperature Controlled</p> <p>SL-30 \$99</p> <p>Digital Display Temp Range: 300F-300F Grounded Tip Overheat Protect</p>	<p>Color Convergence Generator SG-200</p> <p>\$69.95</p> <p>Finest in the industry 10 rock steady patterns</p>	<p>Four-Function Frequency Counters</p> <p>F-100 120MHz \$179 F-1000 1.2GHz \$259</p> <p>Frequency, Period, Totalize, Self Check with High Stabilized Crystal Oven Oscillator, 8 digit LED display</p>	<p>Digital Triple Power Supply XP-765</p> <p>\$269</p> <p>0-20V at 1A 0-20V at 1A 5V at 5A</p> <p>Fully regulated. Short circuit protected with 2 limit control. 3 separate supplies. XP-660 with Analog Meters \$195</p>																																					
<p>GF-8016 Function Generator with Freq. Counter</p> <p>\$249</p> <p>Sine, Square, Triangle Pulse, Ramp, 2 to 2MHz Freq Counter, .1 - 10MHz</p> <p>GF-8015 without Freq. Meter \$179</p>	<p>Function Generator Box</p> <p>#9600 \$28.95</p> <p>Provides sine, triangle, square wave from 1Hz to 1MHz AM or FM capability</p>	<p>MOVIT EDUCATIONAL ELECTRONIC ROBOT KITS</p> <p>The MOVIT line is a series of computerized (and logic controlled) battery robot kits that can teach the basic principles of robotic sensing and locomotion. Each of the kits features pre-assembled PC boards, hardware and mechanical-drive systems that can be handled by almost anyone from ages 10 and up. Only basic hand tools are required for assembly. These fascinating robots allow you to experience and learn any one of the following features: sound sensor, remote control, infra-red sensor, wired control and / or programmable memory. The MOVIT line has provided the future with an innovative electronic educational kit. They are affordable robots that can entertain as well as educate. Now meet the family!</p> <table border="0"> <tr><td>MV-912 Avoder Infra-red</td><td>\$45.95</td><td>MV-939 Medusa Sound Sensor</td><td>\$29.95</td></tr> <tr><td>MV-915 Piper mouse Sound Sensor</td><td>\$45.95</td><td>MV-963 Line Tracker Infra-red</td><td>\$45.95</td></tr> <tr><td>MV-916 Peppy Sound Touch</td><td>\$25.95</td><td>MV-966 Mania Sound/Touch</td><td>\$29.95</td></tr> <tr><td>MV-931 Mr. Bootsman Wire Control</td><td>\$35.95</td><td>Y-01 Robotic Arm/Robotic Control</td><td>\$45.95</td></tr> <tr><td>MV-932 Catrat Remote Control</td><td>\$45.95</td><td>BT-802 Grand Piano Electronic Piano</td><td>\$29.95</td></tr> <tr><td>MV-936 S-Cargo Sound Sensor</td><td>\$45.95</td><td>BT-805 Roulette Digital Wheel</td><td>\$35.95</td></tr> </table>		MV-912 Avoder Infra-red	\$45.95	MV-939 Medusa Sound Sensor	\$29.95	MV-915 Piper mouse Sound Sensor	\$45.95	MV-963 Line Tracker Infra-red	\$45.95	MV-916 Peppy Sound Touch	\$25.95	MV-966 Mania Sound/Touch	\$29.95	MV-931 Mr. Bootsman Wire Control	\$35.95	Y-01 Robotic Arm/Robotic Control	\$45.95	MV-932 Catrat Remote Control	\$45.95	BT-802 Grand Piano Electronic Piano	\$29.95	MV-936 S-Cargo Sound Sensor	\$45.95	BT-805 Roulette Digital Wheel	\$35.95													
MV-912 Avoder Infra-red	\$45.95	MV-939 Medusa Sound Sensor	\$29.95																																					
MV-915 Piper mouse Sound Sensor	\$45.95	MV-963 Line Tracker Infra-red	\$45.95																																					
MV-916 Peppy Sound Touch	\$25.95	MV-966 Mania Sound/Touch	\$29.95																																					
MV-931 Mr. Bootsman Wire Control	\$35.95	Y-01 Robotic Arm/Robotic Control	\$45.95																																					
MV-932 Catrat Remote Control	\$45.95	BT-802 Grand Piano Electronic Piano	\$29.95																																					
MV-936 S-Cargo Sound Sensor	\$45.95	BT-805 Roulette Digital Wheel	\$35.95																																					
<p>Learn to Build and Program Computers with this Kit</p> <p>Model MM-8000</p> <p>\$129.00</p> <p>Starting from scratch you build a complete system. Our Micro-Master trainer teaches you to write into RAMs, ROMs and run a 8085 microprocessor, which uses assembly machine language as IBM PC. Robotics Kit for above (MM8010) 71.95</p>	<p>Wide Band Signal Generators</p> <p>SG-9000 \$129</p> <p>RF Freq 100K-450MHz AM Modulator 10KHz Variable RF output SG-9500 w/ Digital Display & 150MHz built-in Counter \$249</p>	<p>WE WILL NOT BE UNDERSOLD! UPS Shipping: 48 States 5% (\$3 Min \$10 Max) Shipping IL Res., 7% Tax. FAX: 708-520-0085</p>																																						
<p>C & S SALES INC. 1245 Rosewood, Deerfield, IL 60015 (800) 292-7111 (708) 471-0710</p>		<p>15 Day Money Back Guarantee 2 Year Warranty WRITE FOR FREE CATALOG</p>																																						

CIRCLE 12 ON FREE INFORMATION CARD

LEARN VCR

CLEANING/MAINTENANCE/REPAIR

EARN UP TO \$1000 A WEEK, WORKING PART TIME FROM YOUR OWN HOME!



Secrets Revealed!

NO Special Tools or Equipment Needed.

EARN UP TO \$60 AN HOUR AND MORE!

THE MONEY MAKING OPPORTUNITY OF THE 1990'S

IF you are able to work with common small hand tools, and are familiar with basic electronics (i.e. able to use voltmeter, understand DC electronics) . . .

IF you possess average mechanical ability, and have a VCR on which to practice and learn. . . then we can teach YOU VCR maintenance and repair!

FACT: up to 90% of ALL VCR malfunctions are due to simple MECHANICAL or ELECTRO-MECHANICAL breakdowns!

FACT: over 77 million VCRs in use today nationwide! Average VCR needs service or repair every 12 to 18 months!

Viejo's 400 PAGE TRAINING MANUAL (over 500 photos and illustrations) and AWARD-WINNING VIDEO TRAINING TAPE reveals the SECRETS of VCR maintenance and repair—"real world" information that is NOT available elsewhere!

Also includes all the info you'll need regarding the BUSINESS-SIDE of running a successful service operation!

FREE INFORMATION
CALL TOLL-FREE 1-800-537-0589
Or write to: Viejo Publications Inc.
5329 Fountain Ave.
Los Angeles, CA 90029 Dept. PE

CIRCLE 15 ON FREE INFORMATION CARD

SUPER LONG PLAY TAPE RECORDERS

12 Hour Model — USES 120 TAPE

\$119.00*

Modified Panasonic Slimline, high quality AC-DC provide 6 continuous hours of quality recording & playback on each side of cassette for 12 hours total. Includes • Voice level control • Digital counter, etc. TDK — 120 Cassette Furnished.



PHONE RECORDING ADAPTER

Records calls automatically. All Solid state connects to your telephone jack and tape recorder. Starts recording when phone is lifted. Stops when you hang up.

\$28.50*

FCC APPROVED

VOX VOICE ACTIVATED CONTROL SWITCH

Solid state Self contained Adjustable sensitivity. Voices or other sounds automatically activate and control recorder. Uses either recorder or remote mike.

\$28.50*

* Add for ship & handling. Phone Adapter & Vox \$2.00 each. Recorders \$5.00 each. Calif. Res. 80¢ tax. Mail order VISA/MC. COD's OK. Money Back Guarantee. Free data available. Dealer Inquiries invited.

AMC SALES INC. Dept. B 9335 Lubec Street
Box 928 Downey CA 90201
Phones (213) 869 8519 1-800-826-2488
FAX (213) 823-1478
Mon-Fri 9-5 PAC TIME

CIRCLE 9 ON FREE INFORMATION CARD

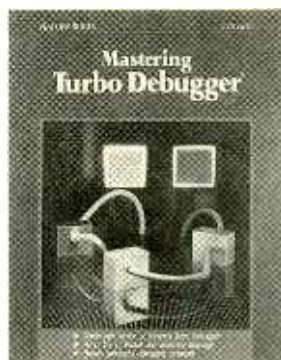

free code. After a thorough overview, the book introduces and explains every Turbo Debugger command and feature. It shows how to identify and get rid of common bugs that plague programs. The book also explores advanced debugging topics such as keystroke recording, remote and dual-monitor debugging, TSR's (terminate-and-stay-resident) and device drivers, and object-oriented problem solving. Step-by-step instructions detail how to examine simple and complex data structures for investigating variables in the code. Three convenient templates serve as handy references to Turbo Debugger's function keys. The book helps programmers to reduce their design-compile-debug cycle time; master the programs windows, commands, and "hot keys"; automate debugging procedures using macros and keystroke recording; and more.

Mastering Turbo Debugger costs \$29.95 and is published by Hayden Books, Division of SAMS, 11711 North College Avenue, Suite 140, Carmel, IN 46032.

CIRCLE 95 ON FREE INFORMATION CARD

TEST INSTRUMENTS CATALOG

from Optoelectronics Inc.

Targeted at two-way radio users, monitoring hobbyists, cellular-phone technicians, law-enforcement and security personnel, TV- and radio-station engineers, and others involved in radio broadcasting and reception from sub-audio to 3-GHz, this 16-page brochure describes Optoelectronics' newest handheld and bench-top instruments. It includes descriptions, technical data, and useful tips

on how to use frequency-finding handi-counters, universal counter/timers for lab and field, PC-based counters with Windows 3.0 for control and display, active preselector bandpass filters, antennas, and accessories.

The Test Instruments Catalog is free upon request from Optoelectronics Inc., 5821 NE 14th Avenue, Fort Lauderdale, FL 33334; Tel: 800-327-5912 or 305-771-2050.

CIRCLE 83 ON FREE INFORMATION CARD

TROUBLESHOOTING AND REPAIRING VCR's: 2nd Edition

by Gordon McComb

With this book in hand, it's not necessary to be an electronics expert to keep your VCR up and running. That's because many of the problems that afflict VCR's are caused by things that are not difficult for most people to fix—dirty video heads, old and worn rubber belts and rollers, broken wires, and damaged videotapes.

This book provides simple and straightforward instructions on how to care for and repair all types of VCR's, including more than 100 different brands of VHS, 8mm, and even Beta units, as well as popular camcorders. The book describes the tools and supplies required for VCR maintenance, outlines preventative-maintenance schedules, provides comprehensive flowcharts for a variety of common malfunctions, and explains how to troubleshoot and repair problems caused by outside influences such as Macrovision anticopying signals. Even if you'd rather not tackle some of those repairs on your own, this book will help you explain your VCR's problems when you take it into the repair shop. The book's several appendices include a VCR reference guide, a maintenance log, and a specifications chart of more than 300 VCR's and camcorders.

Troubleshooting and Repairing VCR's, Second Edition costs \$19.95 and is published by TAB Books Inc., Blue Ridge Summit, PA 17294-0850; Tel. 1-800-233-1128.

CIRCLE 98 ON FREE INFORMATION CARD

Take Any 3 PROFESSIONAL BOOKS for \$9.95

when you join the **ELECTRONICS ENGINEERS' BOOK CLUB**

values to \$116.40

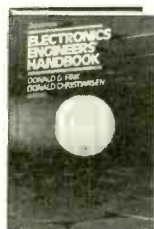

9255 \$97.50
Counts as 3

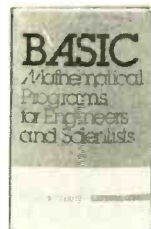

8225P \$19.95

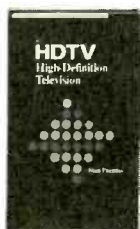

3272 \$24.95



9832 \$36.95



10012 \$59.50
Counts as 2

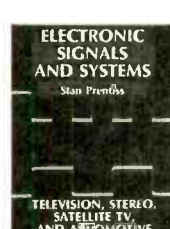

3557 \$29.95

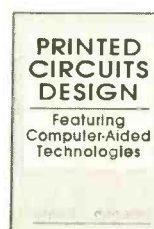

10016 \$39.95
Counts as 2

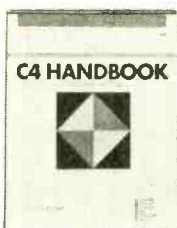

3098 \$44.50
Counts as 2



3205 \$24.95



9340 \$44.95
Counts as 2



3201 \$89.50
Counts as 3



3147 \$38.95

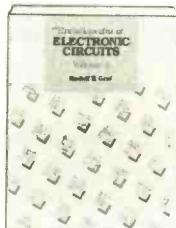

3138 \$60.00
Counts as 2

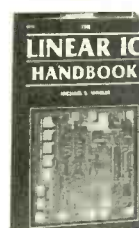

2672 \$49.50



033559-1 \$27.95

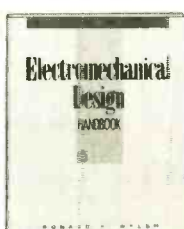

3102 \$49.95
Counts as 2

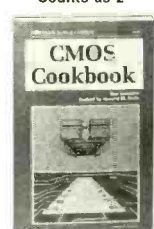

9244P \$18.95



3365 \$34.95

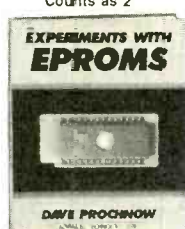

2962P \$17.95

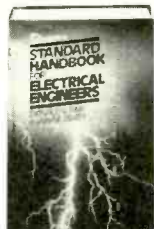

020975-8 \$99.50
Counts as 3



9245 \$46.95
Counts as 2



042330-X \$56.95
Counts as 2



3151 \$42.95



3100 \$75.00
Counts as 3

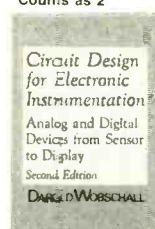

071231-X \$54.95
Counts as 2



10037 \$44.95
Counts as 2

How the Club Works

YOUR BENEFITS: You get 3 books for \$9.95 plus shipping and handling when you join. You keep on saving with discounts of up to 50% off as a member.

YOUR PROFESSIONAL BOOKSTORE BY MAIL: Every 3-4 weeks, you will receive the Electronics Engineers' Book Club News describing the Main Selection and Alternates, as well as bonus offers and special sales, with scores of titles to choose from.

AUTOMATIC ORDER: If you want the Main Selection, do nothing and it will be sent to you automatically. If you prefer another selection, or no selection at all, simply indicate your choice on the reply form provided. You will have at least 10 days to decide. As a member, you agree to purchase at least 3 books within the next 2 years and may resign at any time thereafter.

BONUS BOOKS: Starting immediately, you will be eligible for our *Bonus Book Plan*, with savings of up to 80% off publishers' prices.

IRONCLAD NO-RISK GUARANTEE: If not satisfied with your books, return them within 10 days without obligation!

EXCEPTIONAL QUALITY: All books are quality publishers' editions especially selected by our Editorial Board. (Publishers' Prices Shown)

The Electronics Engineers and Designers Book Club and the Electronics and Control Engineers' Book Club have joined forces to bring you *all* the best titles from the most prominent electronics publishers.

ELECTRONICS ENGINEERS' BOOK CLUB

Blue Ridge Summit, PA 17294-0860

YES! Please accept my membership in the ELECTRONICS ENGINEERS' BOOK CLUB and send the 3 volumes listed below, billing me \$9.95. If not satisfied, I may return the books within ten days without obligation and have my membership cancelled. I agree to purchase at least 3 books at regular Club prices during the next 2 years and may resign any time thereafter. A shipping/handling charge and sales tax will be added to all orders.

--	--	--

Name _____

Address _____

City _____

State _____ Zip _____ Phone _____

Valid for new members only. Foreign applicants will receive special ordering instructions. Canada must remit in U.S. currency. This order subject to acceptance by the Electronics Engineers' Book Club. PPIF991

All books are hardcover unless number is followed by a "P" for paperback.
© 1991 EEBC, Blue Ridge Summit, PA 17294-0860

NEW PRODUCTS

Ni-Cd Charger Conditioner

Because battery performance directly affects the performance of a wide range of portable electronic gear—including laptops, camcorders, and cellular phones—it is important for consumers to keep their rechargeable batteries in top condition. The *Surecharge Power System's* patented circuitry ensures that Ni-Cd batteries deliver 100% of their rated energy every time they are used. It also corrects and eliminates battery capacity

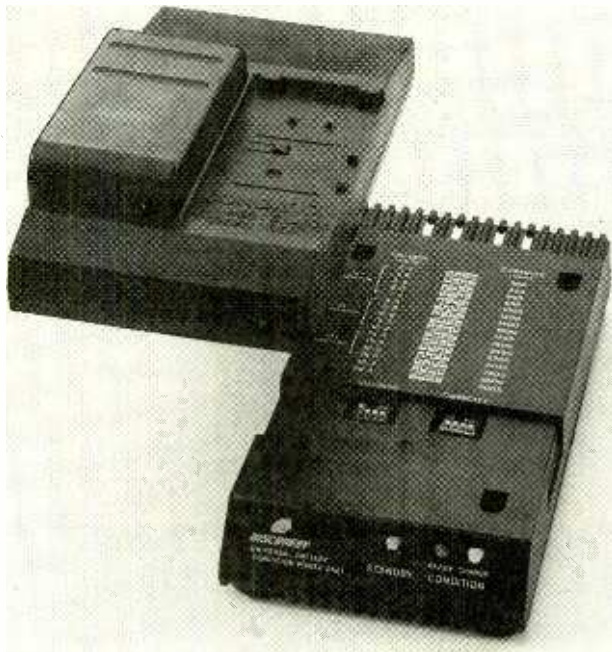

problems. According to Surecharge, battery life will be extended to 2000 cycles, the equivalent of more than five years of daily use.

The Power System consists of a "universal" base and interchangeable tops. The base houses the Discovery Battery-Conditioning System technology, which can be set to accommodate a range of Ni-Cd battery voltages and capacities. By switching tops, one base can condition and rapid-charge the batteries used in a variety of portable electronic equipment. You simply adjust the switch

settings on the Power Base, clip on the Power Top, and drop in a battery. A green light indicates that battery is ready—up to five times faster than conventional trickle chargers. Power Tops are currently available for the Sony Handycam camcorder and several popular cellular phones (the Motorola PT-500 and 8000 Series, the Mitsubishi 3000/DiamondTel 99X, the OKI 700/750, and the NEC P300). More tops will be available by the end of the year, including one for the Toshiba line of laptop computers.

The Power System, which includes the universal base and one interchangeable top, has a suggested retail price of less than \$150. Additional tops will retail for under \$40. For further information, contact Surecharge Industries Inc., 278 East 1st Avenue, Vancouver, BC, Canada V5T 1A6; Tel: 609-876-6710 or 800-661-4405.

CIRCLE 101 ON FREE INFORMATION CARD

HOME COMPUTER

The second generation of Tandy's popular home computer is represented by the *1000 RLX*, which combines the home-management tools of the original 1000 RL plus the power of an office PC. The 1000 RLX offers the extra power of a 10-MHz 80286 processor and a 3.5-inch 1.44MB floppy-disk drive, and a second 3.5-inch drive bay will accept either a floppy-disk drive or a 20MB or 40MB hard-drive option. The system also has one PC-compatible expansion slot. The system still comes with Tandy's DeskMate and DeskMate Home Organizer's 24 easy-to-use home management applications, but also handles the bigger jobs normally left in the office. Built-in tutorials, pull-down menus, and pop-up dialog boxes, along with the point-and-click convenience of a mouse, make it quick and easy to perform tasks.

The 1000 RLX comes in flop-

py-disk and hard-drive configurations. Both include high-resolution VGA graphics, a voice-message option, a two-button mouse, two joystick connectors, microphone and stereo-headphone jacks, and a real-time clock with battery backup. Because all internal components are designed to



function without the need for a fan, the system runs cooler and quieter than most other computers. The hard-drive version comes with 1MB RAM and a 40MB hard drive. It is factory loaded with the DeskMate and DeskMate Home Organizer software, MS-DOS operating system, and a comprehensive demo program with voice, music, and photographs.

The floppy-disk and hard-drive versions of the 1000 RLX home computer cost \$799.95 and \$1199.95, respectively. Monochrome and color monitors are additional. The system is available at participating Radio Shack Computer Centers and Stores nationwide. For more information, contact Tandy Corporation, 700 One Tandy Center, Fort Worth, TX 76102.

CIRCLE 102 ON FREE INFORMATION CARD

DUAL-DRIVER POWERED SUBWOOFER

The key to M&K's *MX-70* compact subwoofer's high performance is its push-pull dual-driver configuration, which virtually eliminates even-order harmonic distortion through a novel cancellation technique. Although it measures only 18 x 10 1/8 x 13 1/4 inches, the sub-

woofer contains two high-performance subwoofer drivers and an internal 125-watt rms power amplifier. One driver is mounted conventionally on the cabinet's front baffle. The second driver, however, is located inverted on the cabinet's bottom. The front of its cone faces the inside of the cabinet, with the back side of the cone, magnet, and frame exposed. Each cone is always in the exact opposite position in its travel relative to the other. The push-pull technique increases the



subwoofer's efficiency in comparison to a single 8-inch-driver subwoofer, equivalent to doubling the amplifier's power. Those features, combined with the MX-70's large magnet and voice coil, make the subwoofer capable of low distortion and dynamic, detailed musical output even at very high output levels at low frequencies. Designed for either horizontal or vertical installation, the MS-70 cabinet features rounded side edges and a separate grille for each speaker.

The MX-70 powered subwoofer has a suggested retail price of \$795. For more information, contact Miller & Kreisel (M&K) Sound Corporation, 10391 Jefferson Blvd., Culver City, CA 90232; Tel: 213-204-2854; Fax: 213-202-8782.

CIRCLE 103 ON FREE INFORMATION CARD

TRIPLE-OUTPUT TRACKING DC POWER SUPPLY

Designed to power a mix of analog and digital circuitry, B&K-Precision's model 1651 is essentially three power supplies in one—two variable 24-volt, 0.5-A supplies, plus a fixed 5-volt, 4-amp supply. To supply greater voltage or current needs, the 24-volt supplies are switch-selectable for series, parallel, or independent opera-

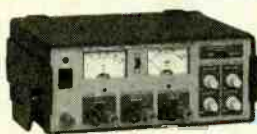

tion. Series operation doubles output to a maximum of 48 volts, while parallel delivers up to 1-amp output. In either configuration, autotracking provides voltage control of both supplies

with a single adjustment. Conservatively rated, the 1651 will deliver maximum power output in continuous operation without overheating. Four methods of protection—reverse polarity, overload, short-circuit, and current-limiting protection—guard the power supply from damage by accidental abuse. Current limiting is infinitely variable from 0 to 500 mA with automatic recovery. For convenience, the 1651 has separate volt and amp

meters, each accurate to within 2.5%. The compact instrument weighs 10½ pounds.

The Model 1651 triple-output DC power supply has a suggested price of \$395. For further information, contact B&K-Precision, Maxtec International Corp., 6470 West Cortland Street, Chicago, IL 60635; Tel: 312-889-1448; Fax: 312-794-9740.

CIRCLE 104 ON FREE INFORMATION CARD

Major Manufacturer Service and Repair Documentation

SAMS, the leading source for service and repair documentation and manufacturers' schematics, offers you comprehensive coverage of a wide range of products.

- TVs (PHOTOFACT®)
- VCRs
- Computers
- Citizen Band Radios
- Scanners
- Automobile Radios
- Tape Recorders
- Transistor Radios
- Modular Hi-Fi
- Videodisc Players
- Disc Drives
- Monitors

Overnight Delivery Available

See your local Electronics Distributor or call SAMS at 1-800-428-7267 and ask for Operator RE-1.



HOWARD W. SAMS & COMPANY
2647 Waterfront Parkway East Drive, Suite 300
Indianapolis, Indiana 46214-2012

CIRCLE 5 ON FREE INFORMATION CARD

Protel Easytrax 2™

Outstanding value in Printed Circuit Board/CAD for your Macintosh and PC

Protel Easytrax 2 is a new, low-cost design package for PC and Macintosh users that includes everything required to produce professional quality Printed Circuit Board artwork.

Our easy-to-learn menu-driven design system breaks the 'expert barrier'—you'll be designing in minutes, not hours. Our comprehensive tutorials guide you through the program's extensive features that take the tedium out of board layout.

- Comprehensive library of Through-hole devices
- Gerber photoplotting and N/C drill tapes
- On-the-fly library components creation
- Intelligent Pad to Pad autorouting
- Switchable Metric/Imperial grid
- Auto-panning
- PostScript™ printing
- Powerful user-definable Macros
- Independent print/plot program
- Multi-layer boards of up to 32 X 32 inches.

At Protel, we offer free technical support, 24-hour BBS, and 30-day money back guarantee. Prices start at

\$450

Free Evaluation Package
Toll Free: 800-544-4186

Protel Technology, Inc.
50 Airport Parkway, San Jose, CA 95110
Tel: 408-437-7771 Fax: 408-437-4913



CIRCLE 11 ON FREE INFORMATION CARD

LAPTOP PHONE LINK

Now any telephone, including those connected to a PBX or digital system, can be used for communication through a modem or fax. *Solectek's Laptop Phone Link* connects any fax or modem-equipped desktop, laptop, or notebook computer directly to any office or hotel phone system without requiring a dedicated telephone line. It attaches to the standard RJ11 connector on the phone handset, and works on both analog and digital phone sys-



tems. The compact (2½ ounce, 3¼ × 1⅜ × 1⅞-inch) stand-alone unit requires no software or external power, making it especially convenient for business travel.

The Laptop Phone Link has a suggested retail price of \$119.95. A second model, designed for use with modems or faxes that require line voltage, comes with an AC adapter and features automatic voice/data switching; it has a suggested retail price of \$149.95. For more information, contact Solectek Corporation, 6370 Nancy Ridge Drive, Suite 109, San Diego, CA 92121; Tel: 800-437-1518 or 619-450-1220.

CIRCLE 105 ON FREE INFORMATION CARD

SWEEP FUNCTION GENERATOR

Incorporating features generally found in more expensive equipment, *Protel's Model B-810* sweep function generator offers a frequency scan of 0.1 Hz to 10 MHz in nine ranges. It can

generate gate and trigger functions, has an overall frequency-counter range of 0.1 Hz to 10 MHz, and includes a built-in oscilloscope that can produce burst waves from 1 ms to 10 s. It also features a built-in linear/logarithmic sweep function, a built-in amplitude-modulation circuit with suppressed-carrier

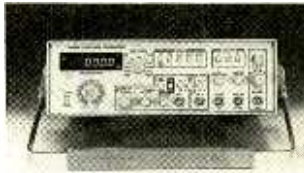

mode, a VCG function for external control of output frequency, and a GCV function that will generate voltage in proportion to frequency. Variable waveform symmetries can also be generated. The sweep function generator measures 10⅝ × 3¾ × 11¼ inches and weighs nine pounds.

The Model B-810 sweep function generator costs \$895. For further information, contact Protel, P.O. Box 59, Norwood, NJ 07648; Tel: 201-767-7242; Fax: 201-767-7343.

CIRCLE 106 ON FREE INFORMATION CARD

COMPACT SPEAKER SYSTEM

Designed for either free-standing use or to be augmented by a subwoofer, *PSB Speakers' Stratus Mini* is a compact, high-performance two-way system. Its ¾-inch aluminum dome tweeter and long-throw 6½-inch mid/bass driver are arranged in an unusual "woofer-over" array (the tweeter is placed below the mid/bass unit to ensure that response remains unchanged

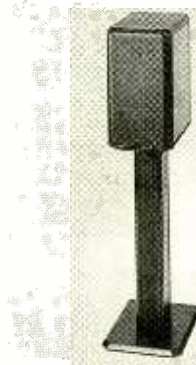

whether the listener is sitting or standing) and are integrated by a 24-dB/octave crossover network. Performance parameters include a frequency response of 55 Hz–20 kHz (–3 dB and –10 dB at 45 and 34 Hz, respectively), and typical listening-room sensitivity of 86 dB at one meter with 2.83-volt input.

To encourage bi-wiring, the loudspeaker includes dual "five-way," gold-plated binding post sets. The Stratus Mini's tongue-and-groove cabinet features sides, front, and back that are joined by heavy-gauge aluminum extrusions to enhance rigidity. The optional matching stands place the speakers at optimal listening height.

The Stratus Mini speaker system has a suggested retail price of \$800/pair; the PSB Mini Stands cost approximately \$200/pair. For additional information, contact PSB International Inc., 633 Granite Court, Pickering, Ontario, Canada L1W 3K1.

CIRCLE 107 ON FREE INFORMATION CARD

TELEPHONE FILTERS

Designed to meet FCC and European requirements, *Coilcraft's EMI Filters* quickly and easily eliminate electromagnetic interference (EMI) from telephone lines. The in-line filter modules provide better than 30-dB attenuation of EMI over the 5-kHz to 10-MHz range (20-dB attenuation from 100 kHz to 110 MHz). Isolation is

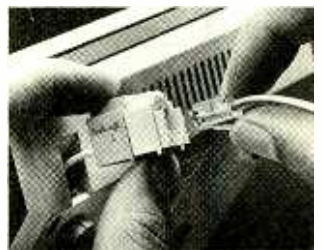

1000 volts between windings, and DC resistance per winding is 65 megohms. The EMI filters are available in 2- or 4-line versions for RJ-11, RJ-14, and RJ-45 cables. One end plugs into the line or handset, while a jack at the other end receives the cable.

The four-line RJ-14 filters cost less than \$12 each in 500 quantities. For further information,

contact Coilcraft, 1102 Silver Lake Road, Cary, IL 60013; Tel: 708-639-6400.

CIRCLE 109 ON FREE INFORMATION CARD

WIDE-BAND ANTENNA

Designed to improve the performance of many types of VHF/UHF communications equipment, *ACE Communications' DA-301* wide-band transmit and receive antenna covers the frequency range of 100 kHz to 1.3 GHz. The compact unit is 51 inches tall and is of the "Discone" type, featuring eight horizontal radials, eight diagonal radials, and a single

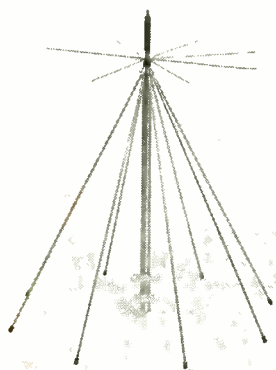

vertical-top whip element. Transmit and receive characteristics are flat within 2 dB over the entire range of 25-1300 MHz. The input-power rating is 200 watts and the impedance is 50 ohms. Supplied with the antenna are N-type and BNC connectors plus 50 feet of coaxial cable.

The DA-301 wide-band transmit and receive antenna has a suggested retail price of \$99.50. For additional information, con-



"There's nothing wrong with your receiver, but you'll need a better antenna to work that distance."

tact ACE Communications, Monitor Division, 10707 East 106th Street, Indianapolis, IN 46256; Tel: 317-842-7115; Fax: 317-849-8794.

CIRCLE 110 ON FREE INFORMATION CARD

SURGE PROTECTOR

With a response time of less than one nanosecond, *Intermatic's Electra Guard EG12* six-outlet strip protector eliminates potential damage from power surges by responding to them quickly and effectively. It is designed for use with personal computers, printers, electronic typewriters, and a wide variety of other sensitive electronic gear. The strip protector continuously monitors the incoming power line, operating only when a surge or other disruption occurs. Then, the unit absorbs the overload while allowing normal voltage to pass through. The EG12 also automatically resets to its monitoring mode after the disruption occurs. The strip features a lighted master on/off

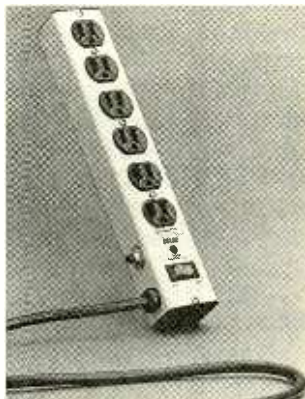

switch, six-foot power cord, an internal safety fuse, a resettable circuit breaker, and an indicator that shows the protection circuits are working. Rated for use at 120 VAC and 15 amps, the EG12 offers protection against surges on all three lines—hot, neutral, and ground—while offering protection against EMI/RFI with across-the-line filtering.

The Electra Guard EG12 six-outlet strip protector has a suggested retail price of \$44.95. For further information, contact Intermatic, Inc., Intermatic Plaza, Spring Grove, IL 60081-9698.

CIRCLE 112 ON FREE INFORMATION CARD

Earn Your B.S. Degree in ELECTRONICS or COMPUTERS



By Studying at Home

Grantham College of Engineering, now in our 41st year, is highly experienced in "distance education"—teaching by correspondence—through printed materials, computer materials, fax, and phone.

No commuting to class. Study at your own pace, while continuing on your present job. Learn from easy-to-understand but complete and thorough lesson materials, with additional help from our instructors.

Our Computer B.S. Degree Program includes courses in BASIC, PASCAL and C languages — as well as Assembly Language, MS DOS, CADD, Robotics, and much more.

Our Electronics B.S. Degree Program includes courses in Solid-State Circuit Analysis and Design, Control Systems, Analog/Digital Communications, Microwave Engr, and much more.

An important part of being prepared to *move up* is holding the right college degree, and the absolutely necessary part is knowing your field. Grantham can help you both ways—to learn more and to earn your degree in the process.

Write or phone for our free catalog. Toll free, 1-800-955-2527, or see mailing address below.

Accredited by
the Accrediting Commission of the
National Home Study Council

GRANTHAM
College of Engineering
Grantham College Road
Slidell, LA 70460

THINK TANK

By John J. Yacono

Controlling Power

Well, another month is upon us and with it a batch of new circuits. As always, all the circuit creators whose work appears in this month's column will receive a *Think Tank II* book. Send your submissions to *Think Tank*, Popular Electronics, 500-B Bi-County Blvd., Farmingdale, NY 11735.

My topic for this month, optoisolators, was prompted by a comment made by John Caywood (*Think Tank*, August 1991) who expressed an interest in power-control devices, and by a request made in our first letter for this month. After we deal with optoisolators, I'll answer a couple of other letters.

A CHRISTMAS DISPLAY

Every year, I set up a large animated Christmas-light display in my front yard. How big? Well one of the displays is shaped like a 6 by 7-foot present com-

boy riding a rocking horse and next to that, there's a wagon and a tricycle.

After 3 years, the cars keep coming from all over and line up outside to watch and film the display. It does get somewhat embarrassing, what with all the traffic and jokes about the drain on the electricity, but kids of all ages like what they see.

Up to now I have been using 555 timers with relays and Triacs to sequentially supply power to the lights. The circuit is so large that it takes up two circuit boards that contain a total of eleven 555's with their support components, relays, etc. I've wanted to replace the relays with solid-state components and reduce the overall number of components. Well, your "Multiplexing with Counters" circuits (*Think Tank*, May 1991) are just what I need, I think. My question is what would be the best way to control AC with the 4017 counters?

—Bill J. Stern, Sistersville, WV

It's really pretty simple to control the lights in your display. What you need to do is connect an optoisolator at each output of each 4017. Then connect the optoisolator to a Triac that will actually control each light circuit.

To see exactly how that should be done, take a look at Fig. 1. Since the 4017 is a CMOS chip, any one of its outputs can supply enough current to light an LED in an optoisolator. The optoisolator contains a light-activated Triac driver, so when the LED turns on, the Triac driver conducts a little current. That current

flows through the gate of the Triac, turning it on. The Triac then allows current to pass from the AC source to your light display.

A couple of technical tips are in order at this point. First, be sure that you power the 4017's from a 10-volt source to ensure that the optoisolators will activate good and hard. Second, be sure not to confuse the two main terminals on the Triac (the terminals that go to the AC source and the lamps) with one another: The main terminal drawn near the gate should always go to the power source, the other terminal should go to the load. Third, select Triacs that can handle the current required for your displays (use heat sinks if necessary). Last, whenever working with AC-power circuits observe extreme (make that obsessive) caution. Never work on such circuits while they are under power and use heavy-gauge Romex wire for all power connections. Use wire nuts wherever possible in the AC circuit; solder melts when passing high current.

The optoisolator circuit presented in Fig. 1 will not work well with highly inductive loads. That's because an inductive load will not permit the current and voltage flowing through the Triac to fall to zero at the same time. That prevents the Triac from turning off once the LED turns off. For those of you that would like to use such optoisolators to power inductive loads, try the circuit in Fig. 2. The extra capacitor and resistor help to overcome the effects of the inductive load, allowing the Triac to turn off.

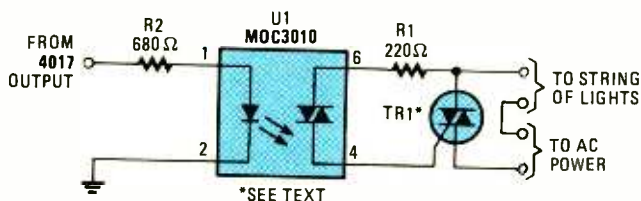

Fig. 1. A Triac-output optoisolator used with a Triac will allow a 4017 decade divider to control an AC load, such as a string of lights.

plete with a large bow on top. The lights are sequenced so that the bow goes out and the next set of lights, shaped like an open lid, comes on. When the lid turns on, a 4-foot rabbit complete with a drum and trumpet appears. As the rabbit waves and beats the drum, musical notes appear around the instruments. There is also a

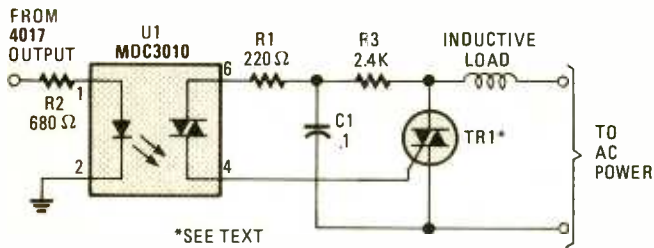

Fig. 2. For controlling an inductive load, the basic circuit in Fig. 1 needs to be augmented with an additional resistor and capacitor. Without the extra components, the Triac may not turn off.

There are many other types of optoisolators (in fact, too numerous to cover all of them here); each with its own special properties and uses. For example, some optoisolators are equipped with transistor outputs (or drivers), as shown in Fig. 3. They are useful when you want one DC circuit to control another. You may be wondering why one wouldn't just use a transistor. Well, there are times when the control circuit must have separate voltage-supply and ground lines from the circuit that it's controlling. A transistor-driver optoisolator allows the LED and the transistor drive to reside in completely separate circuits.

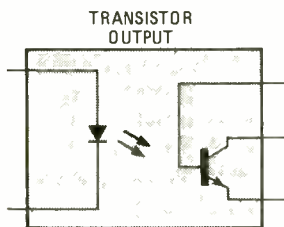

Fig. 3. Transistor-output optoisolators are useful to allow one DC circuit to control another. That allows you to separate the grounds of the two circuits.

Closely akin to the transistor-output optoisolator is the Darlington-output optoisolator (see Fig. 4). They are also useful when you want to isolate one DC circuit from another, but they provide "snappier" action. To put that another way, the output will snap on and

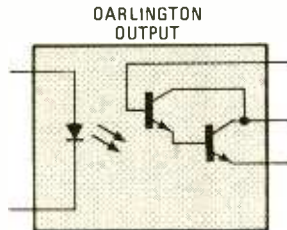

Fig. 4. A Darlington-output optoisolator has a harder action. It runs fully on even if the LED only glows dimly.

conduct at its maximum capability even if the LED only glows dimly. That's useful for applications that require high sensitivity and/or fast action.

Another common optoisolator sports an SCR output (See Fig. 5). That SCR acts like any other SCR, but it's a light-activated SCR (or LASCR). It turns on when the LED packaged with it glows. As you probably know, SCR's act like diodes that can be turned on. When turned on, they allow current to flow in only one direction. Once turned on, they latch—they will continue to allow current to flow until the current drops to a low value. That makes these optoisolators

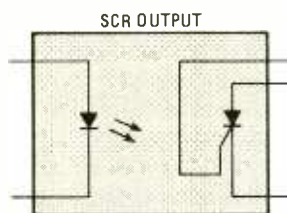

Fig. 5. Optoisolators with SCR outputs latch on. Once activated, the only way to turn them off is to prevent current from flowing through the SCR.

Safety, Security, Convenience, Entertainment and Energy Management

Home Automation from Heath, the catalog that has it all...

Enter the world of Home Automation. Remote lighting and appliance controls. Security alarms and lighting. Automated thermostats. Video monitoring systems. Whole-house security systems. They're all yours in the Heath Home Automation Catalog. To receive your FREE copy, call today toll-free.

1-800-44-HEATH
(1-800-444-3284)

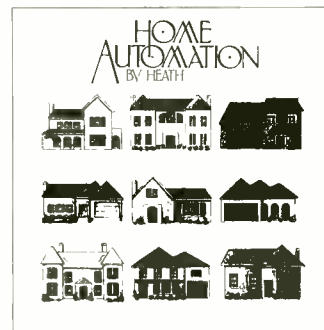

Heath Company

Marketing Dept. 107-090
Benton Harbor, MI 49022

CL-907R1

CIRCLE 17 ON FREE INFORMATION CARD

contact east
PRODUCTS TO SERVICE ELECTRONIC EQUIPMENT
Same Day Shipment
 To Order, Call (508) 682-2000

FREE CATALOG TEST INSTRUMENTS & HARD-TO-FIND TOOLS

Packed with over 10,000 quality products for testing, repairing, and assembling electronic equipment. A full selection of test instruments, power protection equipment, precision hand tools, tool kits, soldering supplies, and much more. Products are shown in full color with detailed descriptions and pricing. All products come with a 100% satisfaction guarantee. SAME-DAY shipment program.

In a hurry to receive your catalog?

Call (800) 225-5370

In Massachusetts call (508) 682-2000

Contact East, Inc., Dept. R470
 335 Willow St., No. Andover, MA 01845

CIRCLE 7 ON FREE INFORMATION CARD

Be an FCC LICENSED ELECTRONIC TECHNICIAN!

Learn at home in spare time.
 No previous experience needed!

No costly school. No commuting to class. The Original Home-Study course prepares you for the "FCC Commercial Radio-telephone License." This valuable license is your professional "ticket" to thousands of exciting jobs in Communications, Radio-TV, Microwave, Maritime, Radar, Avionics and more...even start your own business! You don't need a college degree to qualify, but you do need an FCC License.

No Need to Quit Your Job or Go To School
 This proven course is easy, fast and low cost! **GUARANTEED PASS**—You get your FCC License or money refunded. **Send for FREE facts now. MAIL COUPON TODAY!**

COMMAND PRODUCTIONS
 FCC LICENSE TRAINING, Dept. 100
 P.O. Box 2824, San Francisco, CA 94126
 Please rush **FREE** details immediately!

NAME _____
 ADDRESS _____
 CITY _____ STATE _____ ZIP _____

very nice for alarm circuits. Once triggered they latch on to sound an alarm, and they isolate any sensitive detection circuits from the electrically noisy annunciator.

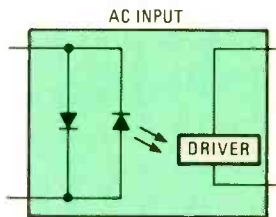

Fig. 6. AC-input optoisolator devices contain two oppositely oriented LED's. One of the LED's will light no matter which direction the current flows.

Some optoisolators have the ability to accept an AC control signal. Take a look at Fig. 6 to see how that is done. There are two LED's placed back-to-back at the input. One LED will be forward biased and glow when current flows in one direction, and the other LED will glow when the current reverses. This variety of optoisolator is useful when you don't know the polarity of the control signal, or when you want an AC signal (such as audio-controlled current) to activate a device.

A "BALANCED" PRESENTATION.

This is in regard to Mr. Grabosky's contribution (*Think Tank*, June 1991) and your reply thereto. Mr. Grabosky's use of a 500-ohm resistor in each line feeding power to his telephone (see Fig. 7) is correct. Telephone companies go to great expense to keep the tip and ring leads of the talking paths balanced through all of their equipment, including the cables leading up to the customers' premises. That is done to prevent crosstalk and noise from degrading the entire network. In that context, it behooves all experimenters

and hobbyists to try to emulate their example. In that respect, that means that if you introduce an impedance in one side of the line, a corresponding impedance should be added to the other side. Along similar lines, the tip and ring lines should be opened by contacts in both lines simultaneously except at the terminal equipment.

Since the FCC has permitted private individuals to connect all sorts of equipment to telephone lines, there has been a gradual degradation of the total network by poorly designed equipment. A good example is to listen to the transmission of some portable telephones. The crosstalk and noise introduced by them affects all of the users of the network.

Both the 500-ohm resistors in each leg of Mr. Grabosky's circuit can be replaced by a small inductor, about 500-mH, in series with a 100-ohm resistor. That should improve the sound quality of the circuit.

—Ted LeBaron, Ft. Myers, FL

I applaud your defense of the telephone company standards. I agree that any device connected to the phone line should obey every FCC and telephone-company rule, and anyone connecting devices to the telephone lines should make every effort to study and adhere to the standards. However, Mr. Grabosky's circuit didn't connect to the phone line, and cannot be prone to crosstalk (it contained only one voice channel). Be that as it may, thank you for pointing out a very important issue. I hope everyone appreciates your point.

CLEARING UP SOME NOISE.

The April 1991 *Think Tank* featured a white-noise generator circuit from Bob

McVay. While I am sure that it is a perfectly fine circuit, I would like to address your comments concerning the use of the device for audio equalization. White noise—which contains equal energy per hertz—is not used to equalize audio. What is needed is pink noise, which contains equal energy per octave. White noise can be converted to pink noise by passing it through a pinking filter, which attenuates the white noise by 3 dB per octave to achieve the desired equal energy per octave.

An easy method for setting an equalizer with a pink-noise generator involves using a hand-held sound-level meter (such as the one from Radio Shack). You start by lowering all the equalizer's faders all the way down. Feed the pink noise through the audio system to the speakers and raise the middle fader to its middle (zero) position. Adjust the volume of the audio system so that the sound meter reads 0 dB. That sets a reference point to measure the other octaves against, so don't alter the volume level for the rest of the procedure. Lower the center fader back down.

Now take the lowest fader and raise it up until the sound meter reads 0 dB. Write down its position on a piece of paper and lower the fader back down. Perform this procedure with all the remaining faders, writing down the position of each that produced a reading of 0 dB. When finished, set each fader to the position you recorded and you're done.

However, Mr. McVay's circuit can be used to set an equalizer without a pinking

filter. First send the white-noise generator's output into one channel of a graphic equalizer. Then set the lowest fader to its maximum-output position. Now adjust all successive faders so that each one is 3 dB lower than the one preceding it. Do the same with the other channel and you're done.

—Steven Weiss, *Sunrise FL*
You got me! It is obvious that I got my noises con-

fused, so you're quite right. (I guess I was the only one making noise that month!) Thanks for the tips for using both white and pink noise.

NOTHING BOX

I built this circuit (see Fig. 8) so that I could watch my music as well as hear it. It's nothing more than a toy and has no practical value that I can find. It uses very ordinary parts, and for a power supply I used a

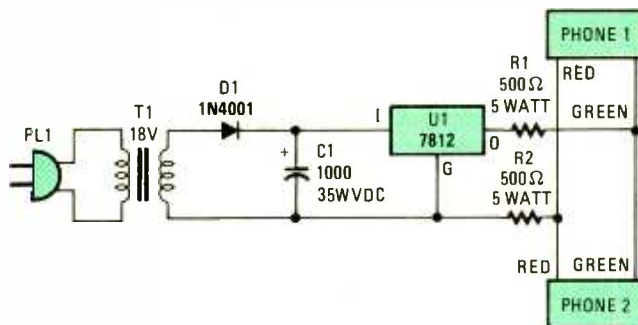

Fig. 7. The telephone intercom has two resistors in it to balance the circuit. This seems unnecessary, but it is a technique used by phone companies to reduce cross-talk.

The World's Most Popular Probe



Model SP100
 100 MHz Switchable 1x-10x ... **\$45**



Free probe guide shows economical replacements for Tektronix, H-P, Philips and all others

More SP100 Probes Have Been Sold Worldwide Than Any Other Probe Ever Made

- **Universal**
 For Tektronix, Hewlett Packard, Philips, Leader, B&K, Kikusui, Hitachi, Beckman and other oscilloscopes
- **Economical**
 Substantial savings compared to OEM probes
- **10 day return policy**
 Guaranteed performance and quality

TEST PROBES, INC.

TPI

9178 Brown Deer Road, San Diego, CA 92121
 Toll Free 1-800-368-5719

CIRCLE 18 ON FREE INFORMATION CARD

three-volt battery pack, which is more practical than using household electricity.

Transistors Q1 and Q2 are configured (as a Darlington) to amplify the signal coming in from the speaker terminals. The signal from the Darlington amplifier is fed through resistor ladder, with the resistor junctions feeding the base terminals of ten NPN transistors. Once turned on, the transistors will light the LED's. As the signal from the speaker increases, the LED's light in sequence. I used a bargraph unit for the LED's. At very loud musical passages, all the circuit's LED's light up.

As I said, there isn't a practical value for this unit, but the aesthetics more than make up for it.

—David Litke, St. Catharines, Ontario, Canada

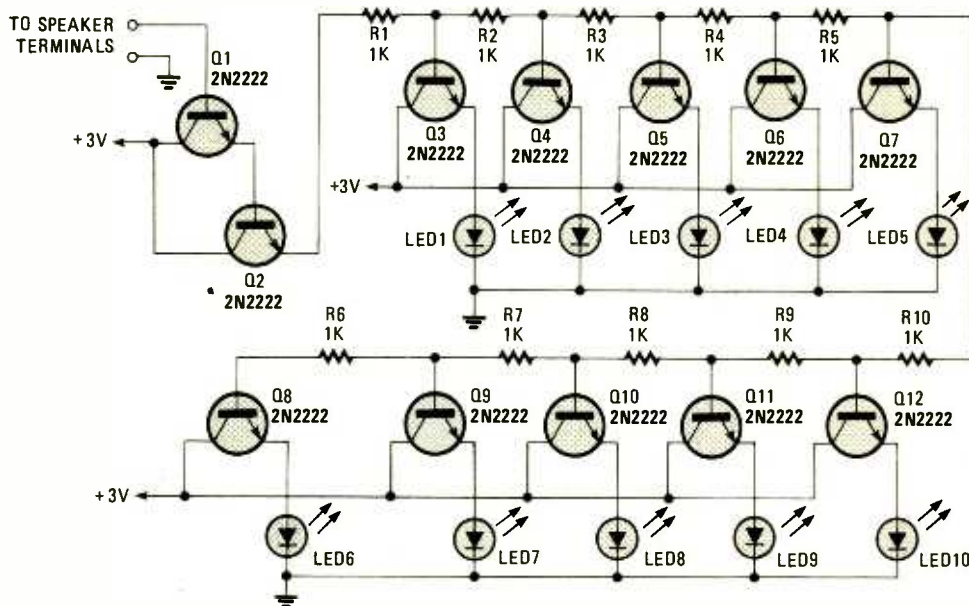

Fig. 8. This circuit is typical of what can be accomplished using a resistor network and several transistors. The circuit is essentially a transistor-based light organ.

Dave, I'm certain that people visiting you are impressed by what you've done, so, you see, there is a practical use for your circuit after all.

RINGER APPLICATION

The ringer on my phone was so low that I could hardly hear it. I checked with GTE and learned that the maximum "Ringer Equivalency Number" (REN) was five. I added the REN's of all my phones and found that was the seat of my problem.

I could have replaced all the ringer bells with electronic ringers to solve the problem, or I could have used a single bell in a central area where it could be heard. The best place was the hallway where the front and back door chimes were located.

I adapted a circuit (see Fig. 9) from a Motorola book, using one of three available IC's, each requiring a different capacitor for the level of tone required. The MC34017-1 provides a 1.0 kHz tone when C1 is 1000 pF. The MC34017-2 provides 2.0 kHz with a C1 value of 500 pF. The

MC34017-3 offers a 500 Hz tone with a C1 value of 2000 pF.

The important features are that you can completely replace the telephone bell circuit using a minimum number of components. Each IC version offers on-chip diode

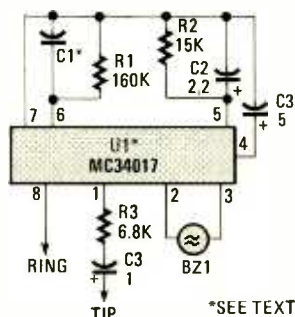

Fig. 9. The remote ringer is built around a single integrated circuit, the MC34017, which comes in three flavors with differing tone-frequency outputs.

bridge and transient protection, direct drive for the piezoelectric transducers, and base frequency options; the input impedance signature meets Bell and EIA requirements, and it rejects rotary-dial transients. That solved my problem and I hope that it will solve similar

problems for some other readers.

—Lloyd F. Thomas, Oxnard, CA

You know, Lloyd, a lot of our readers have had to put up with that sort of thing, and now, thanks to your contribution they won't have to anymore! Good going.

WATER DETECTOR

They say that necessity is the mother of invention. This circuit was designed to monitor our basement for floods. Occasionally our washing machine or sink would overflow and if ev-

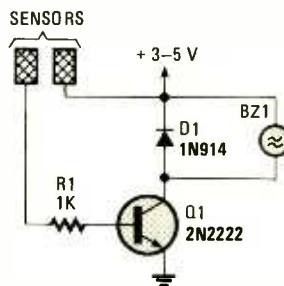

Fig. 10. The Water Detector is an extremely simple circuit that is triggered by bridging the gap between its sensor plates.

erybody was upstairs, the water could damage many of our valuable possessions.

This circuit (which is shown in Fig. 10) is really quite simple and it is also easy to assemble.

You won't have to etch PC boards, or even use perfboard. Simple, point-to-point wiring is sufficient. I soldered my wiring directly to the transistor leads. Here's how the water detector works: When the sensors are dry, transistor Q1 does not receive power, and so the buzzer (BZ1) is not activated.

When water bridges the sensors, power is applied to the base of transistor Q1 allowing current to flow to BZ1, turning it on. The sensors are nothing more than pieces of foil tape with wires soldered to them. You could even use nails or just plain wire. For best results, I found that the sensors should be placed about 1/8-inch apart.

Incidentally, this is my first effort at circuit design! I learned electronics by watching electronic shows and reading magazines. I enjoy the hobby and hope to be able to major in electronics when I get to college.

—Tony Rossi, Lititz, PA

Readers, Tony is 15 years old, and I think you'll agree that his first effort is worthy of encouragement. Hope you enjoy your Think Tank book, Tony!

Well that wraps up things for another month. Don't forget, your contributions are an important part of this column, so keep those circuits and comments coming!



No other training—in school, on the job, anywhere—shows you how to troubleshoot and service computers like NRI

DIGITAL MULTIMETER

Professional test instrument for quick and easy measurements.

LESSONS

Clearcut, illustrated texts build your understanding of computers step by step.

HARD DISK

20 megabyte hard disk drive you install internally for greater data storage capacity and data access speed.

NEW! AT-COMPATIBLE COMPUTER

High-speed 80286 CPU (12 MHz clock, 0 wait states), 1 meg RAM, 1.2 meg, 5¼" high-density floppy disk drive.

MONITOR

High-resolution, non-glare, 12" TTL monochrome monitor with tilt and swivel base.

TECHNICAL MANUALS

With professional programs and complete specs on your computer.

DIGITAL LOGIC PROBE

Simplifies analyzing digital circuit operation.

DISCOVERY LAB

Complete breadboarding system to let you design and modify circuits, diagnose and repair faults.

SOFTWARE

Including MS-DOS, GW BASIC, word processing, database and spreadsheet programs.

Only NRI walks you through the step-by-step assembly of a powerful AT-compatible computer system you keep—giving you the hands-on experience you need to work with, troubleshoot, and service all of today's most widely used computer systems. You get all it takes to start a money-making career, even a business of your own in computer service.

No doubt about it: The best way to learn to service computers is to actually build a state-of-the-art computer from the keyboard on up. As you put the machine together, performing key tests and demonstrations at each stage of assembly, you see for yourself how each part of it works, what can go wrong, and how you can fix it.

Only NRI—the leader in career-building, at-home electronics training for more than 75 years—gives you such practical, real-world computer servicing experience. Indeed, no other training—in school, on the job, *anywhere*—shows you how to troubleshoot and service computers like NRI.

You get in-demand computer servicing skills as you train with your own AT-compatible system—now with 20 meg hard drive

With NRI's exclusive hands-on training, you actually build and keep the powerful new AT-compatible West Coast 1010 ES computer, complete with 1 meg RAM and 20 meg hard disk drive.

You start by assembling and testing the 101-key "intelligent" keyboard, move on to test the circuitry on the main logic board, install the power supply and 1.2 meg 5¼" floppy disk drive, then interface your high-resolution monitor. But that's not all.

Only NRI gives you a top-rated micro with complete training built into the assembly process

Your NRI hands-on training continues as you install the powerful 20 megabyte hard disk drive—today's most wanted computer peripheral—included in your course to dramatically increase your computer's storage capacity while giving you lightning-quick data access.

Having fully assembled your West Coast 1010 ES, you take it through a complete series of diagnostic tests, mastering professional computer servicing techniques as you take command of the full power of your computer's high-speed 80286 microprocessor.

In no time at all, you have the confidence and the know-how to work with, troubleshoot, and service every computer on the market today. Indeed you have what it takes to step into a full-time, money-making career as an industry technician, even start a computer service business of your own.

No experience needed, NRI builds it in

You need no previous experience in computers or electronics to succeed with NRI. You start with the basics, following easy-to-read instructions and diagrams, quickly

moving from the fundamentals to sophisticated computer servicing techniques. Step by easy step, you get the kind of practical hands-on experience that makes you uniquely prepared to take advantage of every opportunity in today's top-growth field of computer service.

What's more—you learn at your own pace in your own home. No classroom pressures, no night school, no need to quit your present

job until you're ready to make your move. And all throughout your training, you have the full support of your personal NRI instructor and the NRI technical staff always ready to answer your questions and give you help whenever you need it.

Your FREE NRI catalog tells more

Send today for your free full-color catalog describing every aspect of NRI's innovative computer training, as well as hands-on training in robotics, video/audio servicing, electronic music technology, security electronics, telecommunications, and other growing high-tech career fields.

If the coupon is missing, write to NRI School of Electronics, McGraw-Hill Continuing Education Center, 4401 Connecticut Avenue, Washington, DC 20008.

AT is a registered trademark of International Business Machines Corporation

NRI School of Electronics

McGraw-Hill Continuing Education Center
4401 Connecticut Avenue, Washington, DC 20008



For career courses approved under GI bill
 check for details

Check one FREE catalog only

- Computers and Microprocessors
- Robotics
- TV/Video/Audio Servicing
- Computer Programming

- Security Electronics
- Electronic Music Technology
- Basic Electronics
- Telecommunications

Name _____ (please print) Age _____

Address _____

City/State/Zip _____

Accredited Member, National Home Study Council

18-091



Make Your Own MAC

BY
ELLIOT KANTER

There's nothing really magical about assembling your own IBM PC compatible computer, in fact, nearly everyone has or will be doing it. Some experts feel that most electronics companies are now actively and aggressively producing IBM clones—even the off-shore companies that used to make CB radios. But that's something you probably already know. Besides, the topic of this article is how to build your own Macintosh®, so perhaps we should ponder the question: "Why aren't there any Macintosh clones as well?"

The answer to that question is one of legality, rather than technology. Apple Computers in their infinite wisdom designed and patented a rather unique product line—the Apple Computer, and more recently the Macintosh. While there have been several companies who have tried to "clone" or dupli-

*Macintosh is a registered trademark of Apple Corporation.

You can build an easily expandable Macintosh with some built-in frills for less than what a new no-frills unit would cost.

cate the Apple computer system, they have found themselves facing perhaps the industry's most aggressive and successful legal department. If you've followed the newspapers over the years, the marketplace is littered with the "bones" of firms who tried to duplicate or replicate Apple products but got legally burned.

You might now wonder, how then can a magazine as reputable as **Popular Electronics** even consider running an article on building your own Macintosh. The answer is quite simple: No step or procedure contained in this article will violate any of Apple Computer's legal

rights—you will be using original Apple parts, not illegal duplicates.

That may sound expensive, but it's really not because good used Macintosh motherboards can be purchased very cheaply. Unlike IBM clones, Macintosh computers don't have a bunch of expansion slots. So when a user wants to upgrade a Macintosh, say by adding a hard disk, the motherboard must be replaced. The old motherboards are usually consigned to the local landfill, or retained by a dealer as a source of spare parts. (If you are concerned about the environment, and want to save some landfill space, building your

own Macintosh is the way to go.) So distributors for used motherboards have sprung up, and you could buy your own legal Apple Macintosh motherboard at low cost. For example, we bought ours for \$45 from one of the sources we mention elsewhere in this article.

However, a motherboard does not a Macintosh make. Sure you could go out and buy the original Macintosh case, power supply, CRT, etc., but what you'd have would be a somewhat crippled computer limited by whatever the motherboard's original configuration might have been. If it was an early model, you'd have about 128K RAM and be forced into using a low capacity space-eating 5.25-inch floppy drive—hardly a state-of-the-art system. But what if we told you that you could assemble a high performance, "infinitely" expandable Macintosh with only a few simple hand tools and at a price less than the original cost of an unadorned Macintosh? What if you could do it in less than two hours and in most cases without the need for a soldering iron? Would you be interested? If your answer is "yes," read on.

Enter the Convertible Kit. The idea of building a home-made Macintosh is an old one. However, up to now building a Macintosh was a project only for the full-blown hacker. You'd have to assemble components, solder and cut foil traces, and really get into the circuitry. Hopefully, the end result was a usable Macintosh. Frankly you had to be a real glutton for punishment to shop, modify, solder, shop some more, and then still not really have what you wanted.

What the less daring of us needed was a "Volkswagen" approach to building your own Macintosh. Something along the lines of an IBM clone, so anyone with a few screwdrivers and a moderate amount of skill could build one, and do so at a cost-effective price.

With the easy and legal availability of certain key components—namely the motherboards and BIOS ROM chips—for a reasonable cost, all we needed was for someone to figure out how to produce a kit platform that would allow the integration of these components with a decent-sized power supply, and to figure out how we could use a regular PC-compatible monitor to further limit the expense.

Well, there's a little company called ATS, Inc. (Atlanta Technical Services Inc.)

TABLE 1—ITEMIZED COST

Item	Approximate Cost
Motherboard 128K	\$ 45.00
128K ROM set	\$120.00
Memory Upgrade/SCSI Adapter	\$249.00
Mouse	\$ 69.00
256K Memory Modules (minimum of 4 needed)	\$ 25.00/ea
Monitor	\$149.00
SCSI 40MB Hard Drive	\$400.00
ATS Convertible Kit	\$375.00
Keyboard (Basic Mac)	\$ 99.00
Total:	\$1606.00
Note 1: Available from ATS (see box entitled "Accessory Sources" elsewhere in this article).	
Note: You'll also need a copy of the Macintosh Operating System from your local Apple dealer.	

that has produced a kit with almost all the features we'd hoped for. The ATS Convertible Kit, as the package is called, sells for less than \$400 and includes a small-footprint PC-like case, power supply, cables, video/power adapter, 800K 3.5-inch floppy drive, and a well written instruction manual. What remains is for you to do a bit of shopping on your own and acquire the "guts," namely a Macintosh motherboard and ROM. You'll also need a memory/SCSI adapter board (which ATS can also supply), a few hand tools, and a bit of time.

Shop 'Till You Drop. We've already identified some of the key components of our Macintosh system, and Table 1 gives you a run-down of what you need to acquire, and the actual costs we encountered while ordering the supplies. You might stop and wonder about the cost, considering there have been advertisements for Macintosh Plus computers for less than \$1000 in the media. However, the Macintosh advertised does not come with a hard drive, nor is it what I tend to refer to as a "platform," which can be expanded at will and in an almost infinite manner. Likewise, you will be getting a system with a full-sized power supply and a conventional PC monitor—a far cry and improvement over the minimal display which comes standard on the Macintosh Plus.

However, for the accountants or bean-counters in our readership, the total price shown is still less than the original Apple Macintosh computer pricing, and still represents a cost-effective savings over the actual or true cost (apples to apples minus the display) of a similarly configured Macintosh Plus with a 40-MB hard drive. If you are in the mood to be frugal, and don't

see a hard drive in your immediate future, you could instead add a second floppy drive to the system and reduce the cost by some \$200. Likewise, if you have a monitor that can easily be converted to reproduce the Apple/Macintosh/ATS video output, you can save another \$149—that is providing you can safely make the modifications (that topic will not be covered in this article.)

Ordering Information. Now that you've got an idea of what it will cost, you need to know where to buy your supplies, and how to get in touch with the sources. The boxed text entitled "Accessory Sources" lists sources as well as addresses and, in most cases, toll-free telephone numbers.

Before you order your motherboard or Convertible Kit, there's something you should know: For some unknown reason, Apple elected to use two different package styles for their CPU IC's. One type of chip, easily identified by its black-plastic body requires a connector called a "Killy clip" in order to install the memory/SCSI adapter board. The Killy clip can be installed in a few moments with the use of just a screwdriver.

The other chip has a gray ceramic case and will require the use of a different connector called a "pin header." Installing the pin header requires the use of a small tip, low wattage soldering iron to make 64 connections. So, if at all possible (especially if you doubt your soldering skills) request a motherboard with a black-plastic 68000 CPU chip. You will also need to let the people at ATS know which type of CPU you have before ordering a Convertible Kit so they can ship you a kit with the proper connector.

On a different note, you might be

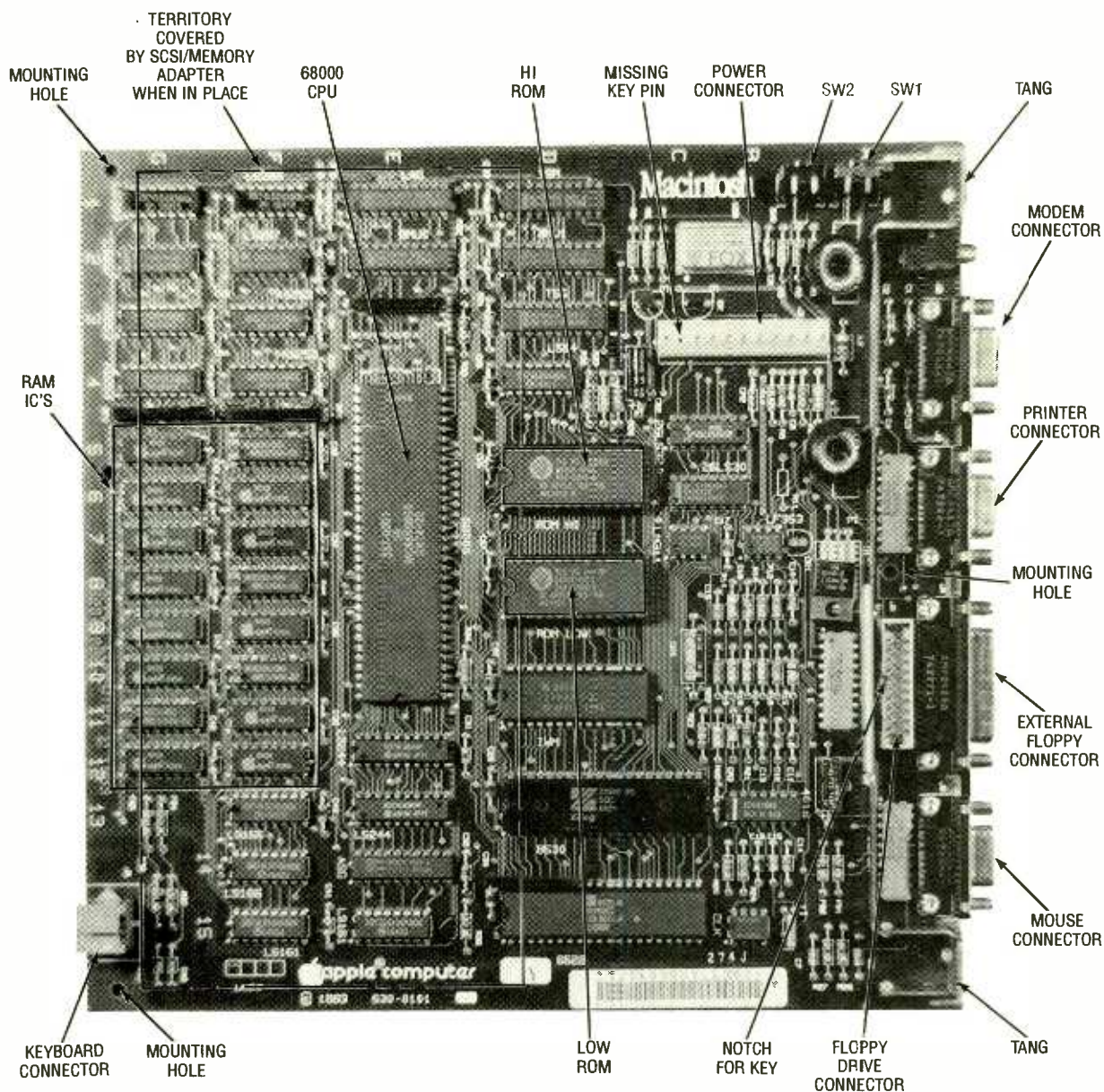

Fig. 1. This is a basic Macintosh motherboard. The most useful features shown here are the locations of the ROM chips and the area that will be covered up by the SCSI/memory adapter.

able to save some money if you know someone who has just added an additional 800K drive to their system, and won't be using their (supplied) BIOS ROM chips. **Under no circumstances should you attempt to copy or knowingly purchase copied/counterfeit Apple Macintosh BIOS ROM chips.** The author, **Popular Electronics**, Gernsback Publications, as well as the people at ATS Inc., caution you against potential violations of Apple's copyrights. Regardless of how much you might think you'll save, the potential legal hassles you could run into can be more costly. In short, don't do it!

Likewise, you could possibly acquire an as-is motherboard at a flea-market or swap meet. If you find one out of

commission, keep in mind that the under-rated power supply and CRT in the early Macintosh systems were more prone to failure than the motherboards, which is really what you'd be interested in anyway.

Assuming you've placed all your orders, you will still need a few common hand tools such as a Phillips-head screwdriver, a small flat-blade screwdriver, a 3/16-inch nut driver, a 7/32-inch nut driver, gas-joint pliers (common household pliers), long-nose pliers, and an anti-static grounding wrist strap. If you couldn't find a plastic-CPU motherboard, you'll also need a 15-25-watt soldering iron with a small tip, a supply of rosin-core solder, and some liquid flux.

Replacing the ROM Chips. Now that we have all of our components together, let's get underway. Our first step will be to replace the motherboard's 64K ROM chips with 128K units. There are two socketed chips (see Fig.1), clearly identified on the silk screening as "HI" and "LOW" ROM. They should bear the part numbers 342-0220 and 341-0221, respectively.

Wearing your anti-static wrist strap, remove each of the IC's by sliding a flat-blade screwdriver between the ROM and its socket. Rotate the screwdriver and gently pry the ROM free. Repeat this process for the remaining ROM chip. You can discard the two old chips as you won't be using them in your "new" Macintosh.

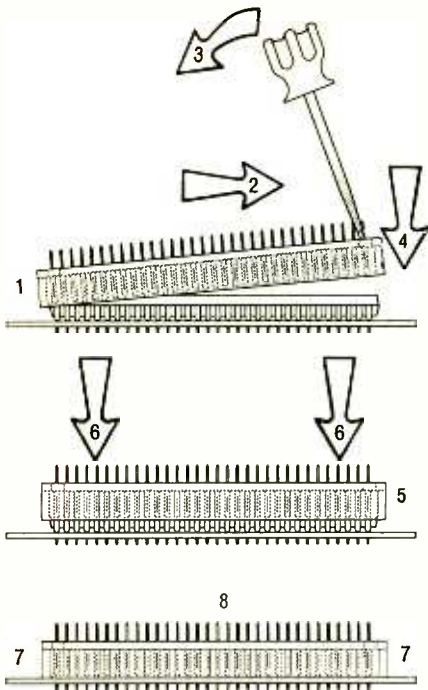

Fig. 2. This drawing shows the step-by-step installation for the Killy clip. You'll need to follow these steps if your motherboard has a plastic CPU.

Locate the new HI ROM chip (part number 342-0341) and examine it to be sure that the pins are all straight and extend the IC at right angles. If any pin (or leg) is bent, carefully straighten it using your long-nose pliers. One end of the ROM has a notch. Insert the ROM in the HI ROM socket, with the notched end pointing towards the CPU chip as shown in Fig. 1. In a similar manner, locate the new LO ROM chip (part number 342-0342) and carefully insert it into the LO ROM socket. The notch on the LO ROM should also point towards the CPU. Make sure that both ROM chips are firmly seated in their sockets.

Installing the Connectors. Now you can unpack your Convertible Kit (if you haven't already). You will find a low-profile case and an instruction manual. Use your Phillips screwdriver or a 7/32-inch nut driver to remove the four cover screws on the sides of the case, and carefully pry the cover up and towards you. Inside the case you will find the cables, hardware and battery pack as well as a package of four AA alkaline batteries. Remove the components and set them aside. At the same time, take out the 800K floppy drive by removing the four screws that secure the floppy drive plate and lifting the assembly, placing it aside; we will be reinstalling the floppy drive later in our procedure.

Because we have no way of knowing which of the two CPU's (black plastic or gray ceramic) your motherboard has, we will describe both the Killy clip and pin-header installation procedures. Throughout our discussion we will use numbers in the parenthesis to refer to special points in the figures. For either procedure be sure to wear your anti-static wrist strap and read the instructions at least once before beginning.

Let's start with the procedure for the black-plastic CPU using the Killy clip (illustrated in Fig 2), which should be somewhere among the hardware. Place the clip over the CPU chip with the flange on one end of the clip centered on the body of the CPU chip (1). **Do not** hook the flange under the CPU chip at this point. Holding the Killy clip firmly, push the clip towards the other end of the CPU (2). The end of the clip resting on the CPU will bend slightly outward. While maintaining pressure on the clip, insert the flat-blade screw-

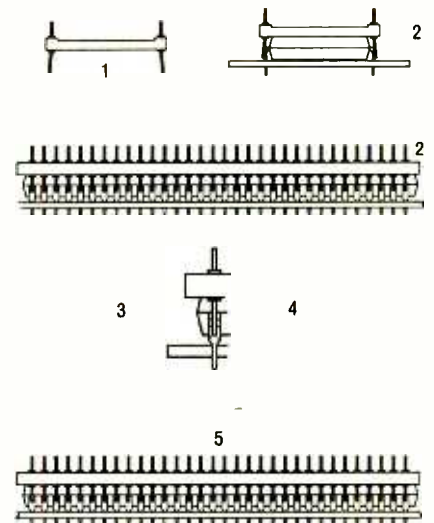

Fig. 3. Follow this guide to install the pin header on a ceramic CPU. Be sure to remove the spacers first.

driver into the slot on the free end of the clip. Use the screwdriver as a lever to gently bend the end wall of the clip away from the chip (3) while sliding the clip down over the CPU (4). Remove the screwdriver once the flange is resting on the body of the CPU chip (5). Now apply downward pressure to the Killy clip (6). The clip will first snap into position on one side of the CPU chip so it rests on the circuit board. Push down on the side that has not fallen into position. It may take considerable force to seat the clip, which will be indicated by an audible snap as the flanges fit under the CPU chip. When the clip has been installed properly, both sides of the Killy clip should touch the circuit board (7). Examine the clip, the pins should extend vertically from the top of the clip, if necessary, straighten any bent pins (8).

To install the pin header (see Fig. 3) instead, start by removing the U-shaped plastic spacers on the CPU if any are present on the motherboard. You should be able to push them off with your fingers or a small screwdriver.

Examine the pins of the CPU for corrosion. Clean the pin surfaces by rubbing them with a pencil eraser and remove any residue with a cloth dipped in common rubbing alcohol. You may wish to apply a light coating of liquid flux to the pins before beginning to solder. Bend the pins outward on one side of the pin header by approximately 10 degrees (1). That is necessary to fit the header over the pins of the CPU. Place the pin header over the CPU (2). Make sure that the pins of the header are aligned with the pins extending from the CPU chip. Push the header down as far as it will

ACCESSORY SOURCES

CONVERTIBLE KIT AND MONITOR:

ATS (Atlanta Technical Specialists), Inc.
3550 Clarkston Ind. Blvd.
Suite F
Clarkston, GA 30021
1-404-292-6655

USED MOTHERBOARDS:

Pre-Owned Electronics
30 Clematis Ave.
Waltham, MA 02154
1-800-274-5343

Shreve Systems
2421 Malcom St.
Shreveport, LA 71108
1-800-227-3971

128K ROM/UPGRADES:

Pre-Owned Electronics
30 Clematis Ave.
Waltham, MA 02154
1-800-274-5343

Peripheral Outlet
314 S. Broadway
Ada, OK 74820
1-800-332-6581

MacProducts USA
8303 Mopac Expressway Suite 218
Austin, TX 78759
1-800-622-3475

CMO
101 Reighard Ave.
Williamsport, PA 17701
1-800-233-8950

Shreve Systems
(See address under "Used Motherboards").

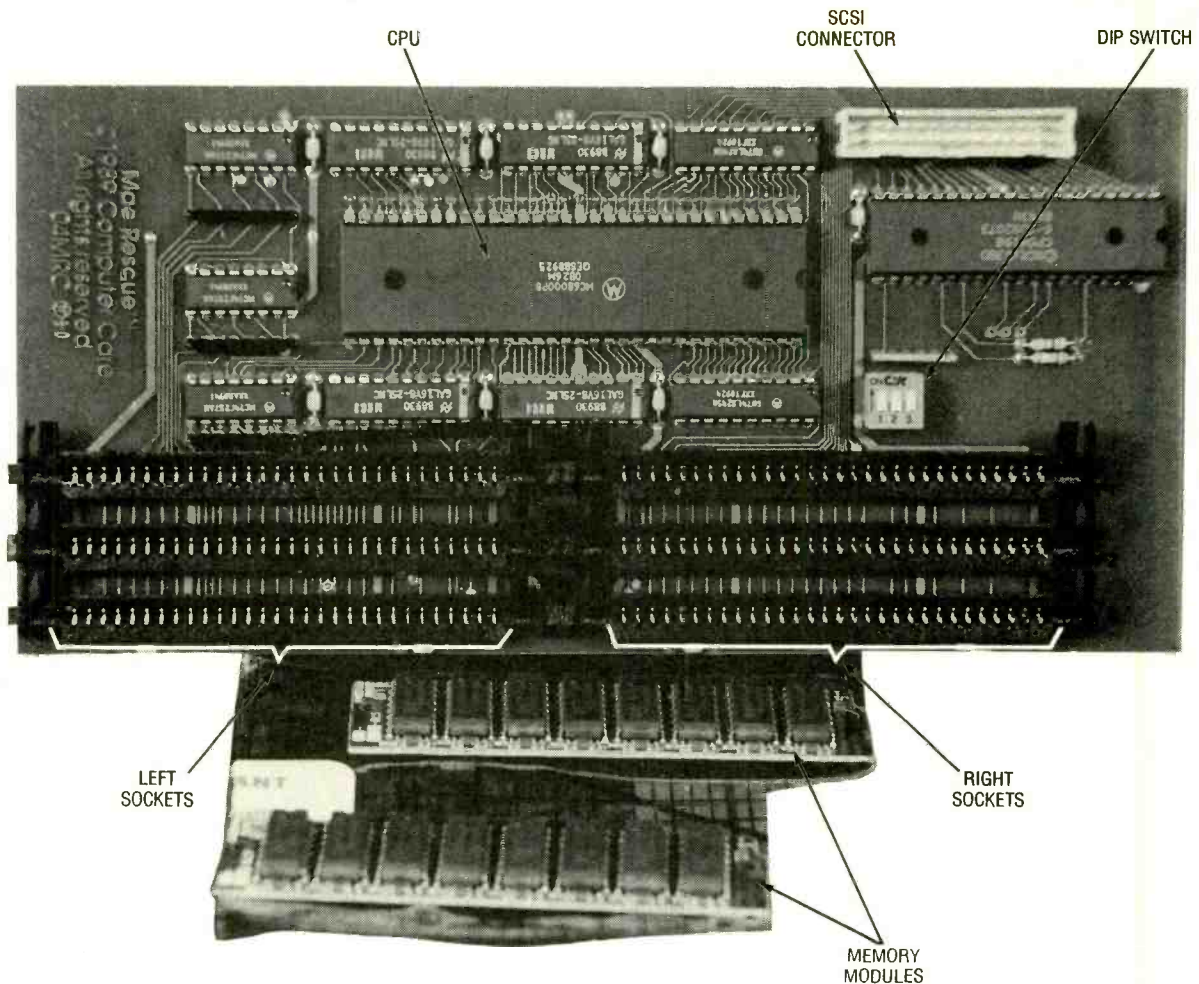

Fig. 4. This is the memory/SCSI adapter board with two SIMM's at the bottom. Note that each row of SIMM sockets requires two SIMM's.

go. There will be a slight gap between the body of the pin header and the body of the CPU.

You can now begin carefully soldering the pin header in place (3). Note that the ceramic chip can act as a very efficient heat sink, so you may need to use a higher temperature setting (if you have one) on your soldering iron in order to make good connections. First solder the four corner pins to hold the header stationary. Before soldering the remaining pins, make certain that the header is parallel to the motherboard.

Once you've soldered the header in place, it is impossible to reposition it.

Inspect your work. A good solder joint will be shiny (not grainy) in texture, and will have a filet of solder between the contacts (4). Examine the pins on the pin header. They should extend vertically from the top of the header. If necessary, straighten any bent pins (5).

Memory Installation. We've now completed perhaps the most difficult part of our Macintosh assembly, and are ready to configure our memory/

SCSI adapter board (see Fig. 4). Table 2 shows how to configure the DIP switch located on the adapter board to suit the memory and motherboard's "base

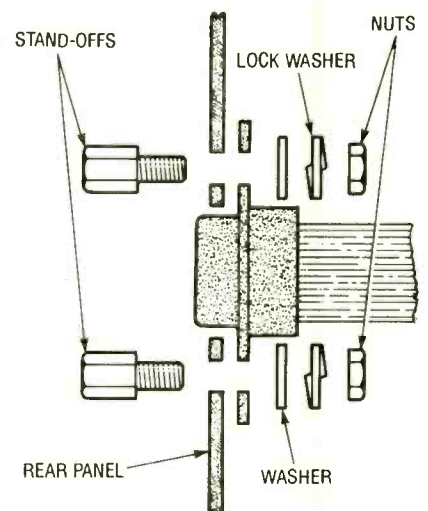

Fig. 5. Use these mounting details for the Video and SCSI connectors. It's a good idea to mount them onto the back panel before installing the motherboard.

TABLE 2—DIP-SWITCH CONFIGURATION

Motherboard Type	Total Memory	S1	S2	S3
128K	1MB	OFF	OFF	OFF
128K	2MB	OFF	OFF	ON
128K	4MB	OFF	ON	ON
512K	1MB	ON	OFF	OFF
512K	2MB	ON	OFF	ON
512K	2.5MB	ON	ON	OFF
512K	4MB	ON	ON	ON

memory size."

The information in Table 3 should allow you to properly arrange the memory modules (called SIMM's) in the slots on the adapter board to suit the motherboard and the amount of memory you desire. Note that each row on the adapter board has two sockets, a left one and a right one. Both must be filled with the specified SIMM to complete a row.

The SIMM's should be installed by inserting them at a 75° angle, then rotating them downward until they snap into place, causing both plastic locating tabs to engage. Once the memory is installed, and the DIP switches are configured, you are ready to connect the adapter board to the motherboard, either via the Killy clip or the pin header. If you are curious, look back at Fig. 1 to see the area that will be covered up by the adapter's circuit board.

Start by setting the motherboard on a flat surface and then orient the adapter board so that its six SIMM sockets are positioned over the RAM chips on the motherboard. Sight between the motherboard and the adapter board to ensure that all of the pins are aligned. Apply downward pressure to the CPU chip on the adapter board. Once installed, the pins of the Killy clip or pin header should be fully inserted into the socket on the underside of the SCSI/memory-adapter board. Now carefully set the motherboard/adapter board aside so you can proceed with

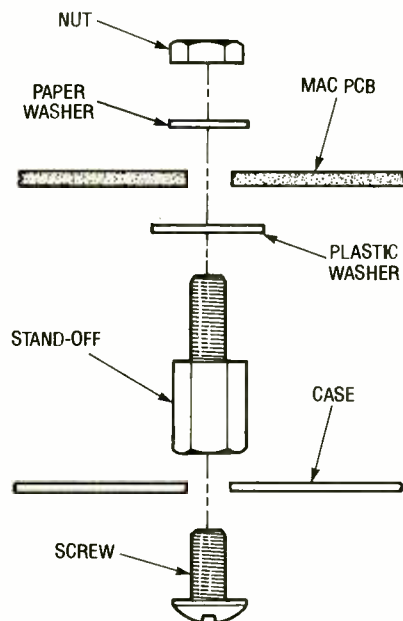

Fig. 6. Mount the circuit board standoffs using this figure as a guide. You should place the plastic washers between the PC board and the body of the standoffs.

TABLE 3—SIMM CONFIGURATION

Motherboard	Memory	SIMM's For Row 1	SIMM's For Row 2	SIMM's For Row 3
128K	1MB	256K	256K	Empty
128K	2MB	1MB	Empty	Empty
128K	4MB	1MB	1MB	Empty
512K	1MB	256K	Empty	Empty
512K	2MB	256K	256K	256K
512K	2.5MB	1MB	Empty	Empty
512K	4MB	1MB	1MB	Empty

Note: Each row has a left and a right socket and both sockets must be filled with the designated SIMM.

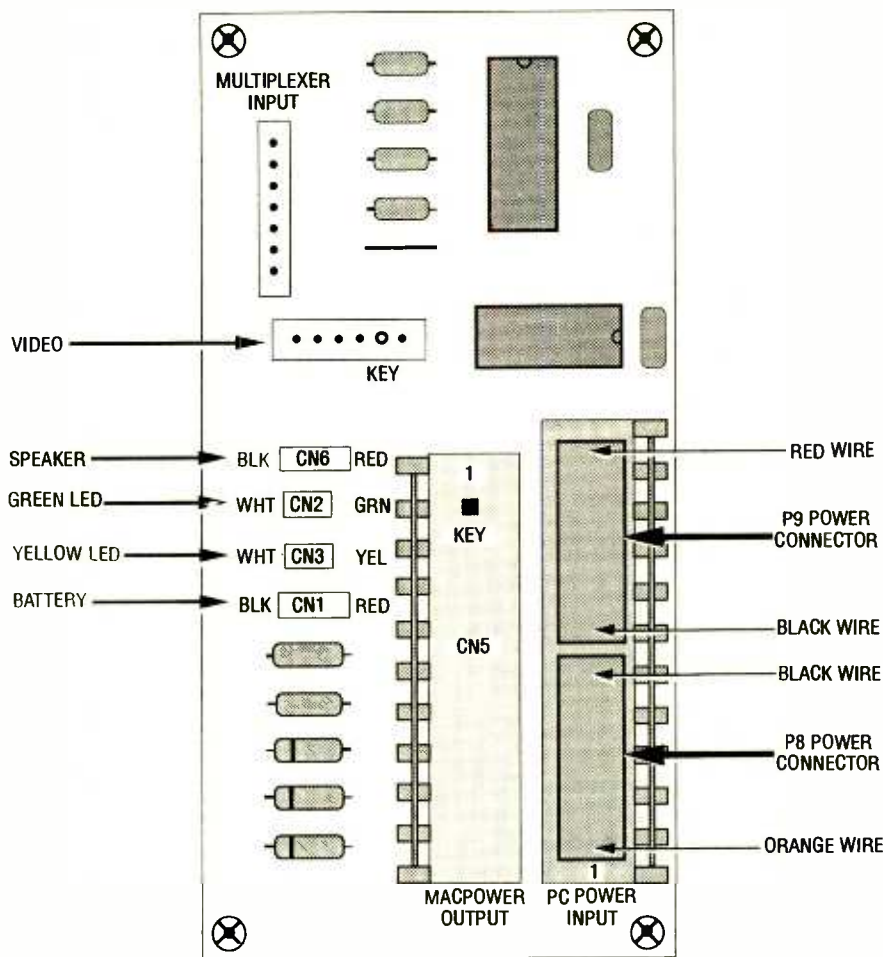

Fig. 7. This is a top view, of the power/video-adapter board. It's mainly responsible for performing the Converter Kits magic.

the assembly of the "home" for your Macintosh.

Final Assembly. The manual which comes with each ATS Convertible Kit is well illustrated and very detailed. For that reason, we will merely summarize the remaining assembly steps, adding illustrations, photographs, and some suggested changes in assembly order that we found to be of benefit.

Although the manual suggests mounting the SCSI and video connectors to the rear panel after installing the motherboard, that's not a good

idea. We found that the motherboard left little room for maneuvering the connectors into place, so you should install the connectors first.

In that vein, open the parts packages and select the SCSI and video-cable assemblies. Using your 3/16-inch nutdriver and long-nose pliers, mount the two connectors to the two vertical slots on the rear panel. The hardware assembly for this step is shown in Fig. 5. Flop the cables attached to the connectors over the rear of the case to move them out of the way for the next steps.

(Continued from page 90)

BUILD A SIMPLE LASER POWER SUPPLY

BY GREGORY GRAY

Here's a simple, inexpensive, and easy-to-build power-supply circuit for your low-power laser tube.

I had always been fascinated with lasers, but until recently, the cost of laser tubes always seemed to be just beyond my modest budget. That's no longer the case; today hobbyists can buy small helium-neon (He-Ne) gas laser tubes for \$35.00. A similar tube would have cost hundreds of dollars just five years ago.

Isn't progress wonderful? But as luck would have it, just as soon as you clear one hurdle, another crops up to take its place. Now the problem no longer lies in getting the laser tube; instead the problem is getting a power supply that's capable of driving the tube. Although there are commercial units available, locating an inexpensive laser power supply can be a big problem—much bigger than I had expected.

Of course, there have been many magazine articles dealing with the subject, but most required special parts and special high-voltage transformers, which were only available from the

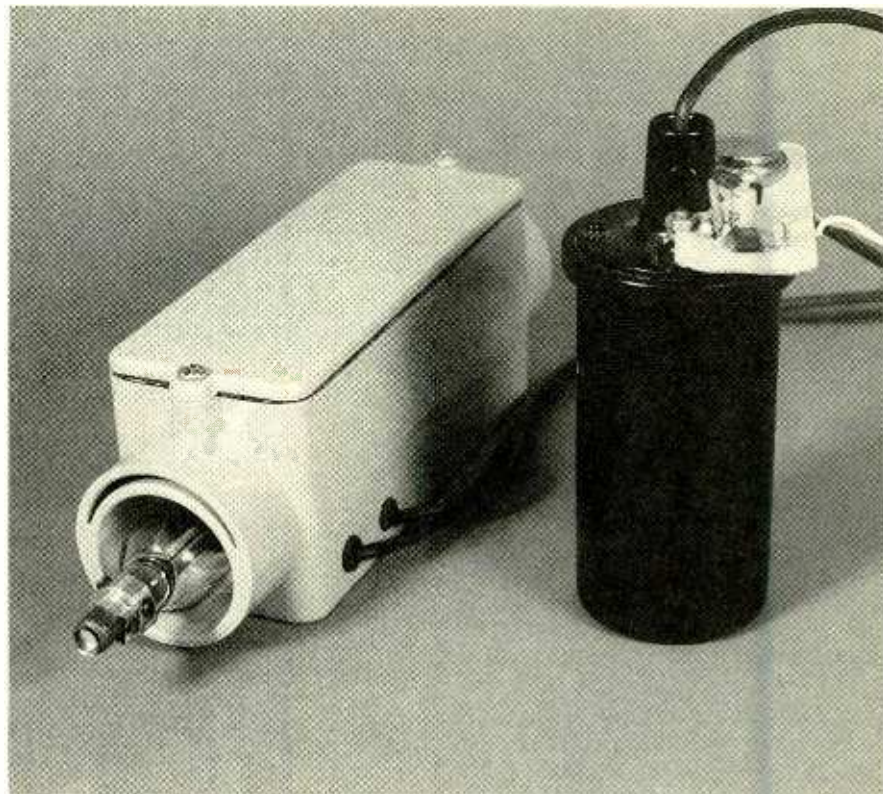

manufacturer at somewhat higher prices than I wanted to pay. Being a graduate of the "Burned Silicon" technical institute, I decided to design my own.

The *Laser Power Supply* presented in this article is the way I got around the power-supply dilemma. While it is not what you'd call "high tech," it does serve its purpose quite well. The circuit is capable of driving most tubes with 0.5 mW to 7 mW ratings. But before we get to the project, a few cautionary words are in order.

The power supply uses an automobile ignition coil to generate a high voltage, which is required to operate the laser tube. If you've ever been zapped by a car's live spark plug wire, you know it's not a pleasant feeling. Also, the beam of light produced by a laser is very intense, and can cause damage to the eye if viewed directly. Doctors use lasers to weld severed blood vessels in patients whose retinas (back part of your eye) have detached; therefore, **never look directly into any laser beam.** Viewing a laser head on is akin to looking at the sun through a telescope, which can damage the eye depending on the level and duration of exposure. So resist the urge to view the beam directly, or reflected off any mirrored surface.

How It Works. Figure 1 shows the

schematic diagram of the Laser Power Supply. The circuit consists of a 555 oscillator/timer (U1), two transistors—a 2N2222 general-purpose unit and a 2N3055 power transistor, Q1 and Q2, respectively—an ignition coil (L1), and a few support components, which are required for U1.

Configured as an astable multivibrator, the 555 oscillates at approximately 500 Hz. The output of U1 at pin 3 is fed to the base of Q1, causing it to alternate off and on in time with U1's output. The collector of Q1 is connected to the base of Q2. As Q2 turns on and off, a rising and collapsing magnetic field is created in the primary winding of L1 (the auto ignition coil). The rapid switching of Q2 induces a sufficiently high voltage in the secondary of L1 to drive the laser tube. Note that a pulsating DC voltage is delivered to the laser, which will cause problems if you try to send data over the beam. So this project is not suitable for voice- or data-transmission applications.

A 6-volt ignition coil was used to keep the operating voltage as low as possible. The circuit was designed to be powered from a 6-volt source. **Warning:** The source voltage to the Laser Power Supply should never be allowed to exceed 7 volts; any higher voltage could damage the laser tube. The Laser Power Supply can also be used to operate up to a 2-mW laser tube from a

source of as little as 5 volts as long as the power supply is capable of delivering at least 500 mA. A 6-volt lantern battery can also be used to provide power to the circuit. But, the battery must be fresh and it will not last very long in actual operation.

Construction. In developing the Laser Power Supply, the main criteria was that it contain no special parts. So all of the parts used in the circuit, with the exception of the laser tube, are locally available; the ignition coil from auto-parts distributors, and the electronics components from Radio Shack and other electronics suppliers.

Although the circuit board for the prototype was hand-drawn directly on a copper-clad slug (unetched circuit-board material), a refined full-size template of the original printed-circuit pattern is shown in Fig. 2. A parts-placement diagram corresponding to that printed-circuit template is shown in Fig. 3.

Begin construction by first installing a socket for U1 where called for in the parts-placement diagram, but *do not* insert the IC yet; that's the last thing to be installed. Following that, install the resistors and capacitors. Note that two resistors R1 and R2, are vertically mounted to the board. When installing C2 (the electrolytic unit) be sure that it is properly oriented, as shown.

After installing the passive components, install the transistors. When installing Q1 and Q2, be sure to observe the proper orientation of those components. The emitter and collector terminals of Q2 are clearly marked on the bottom of the package, and the unit will comfortably fit the layout in only one way, because the base and emit-

ter terminals of the unit are slightly off center.

Once you've assembled the printed-circuit board, check your work for construction errors: misoriented compo-

nents, solder bridges, etc. Note that Fig. 3 shows the printed-circuit board mounted to the ignition coil. The coil must be modified before being connected to the board. The modification to the ignition coil is a modest one. Simply remove the screw inside the tower; that's the screw terminal inside the

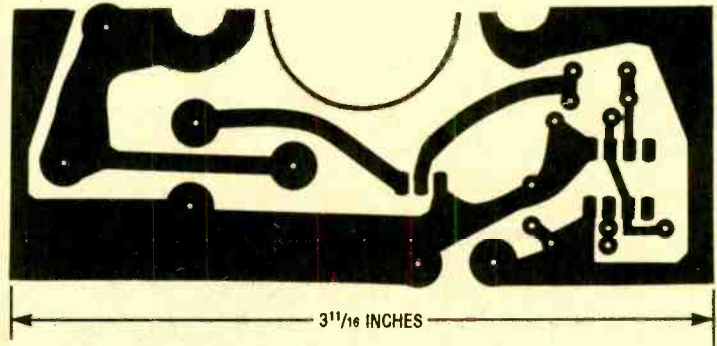

Fig. 2. Here is a refined full-size template of the original printed-circuit pattern that was used to produce the authors prototype.

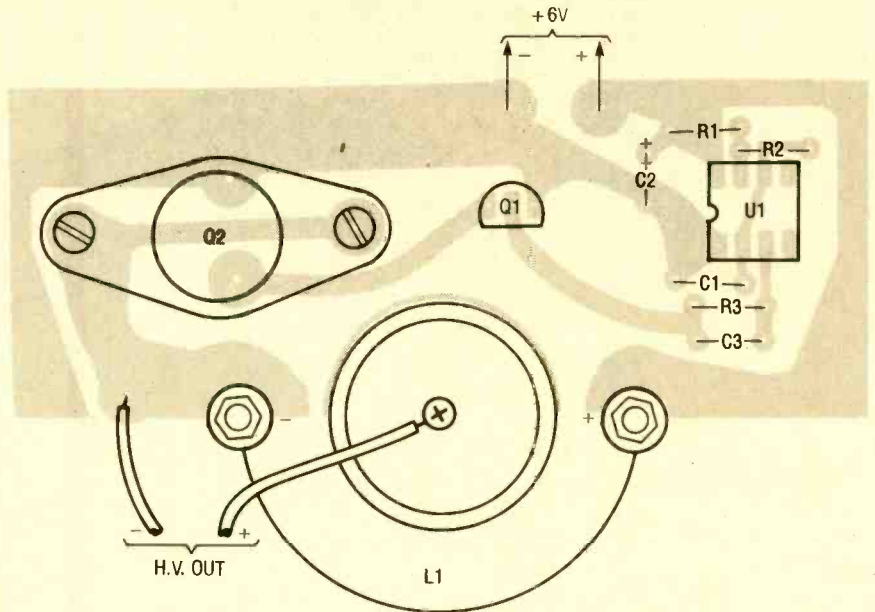

Fig. 3. This parts-placement diagram corresponds to the printed-circuit foil pattern shown in Fig. 2. Begin construction by first installing a socket for U1, but do not insert the IC yet; that's the last thing to be installed.

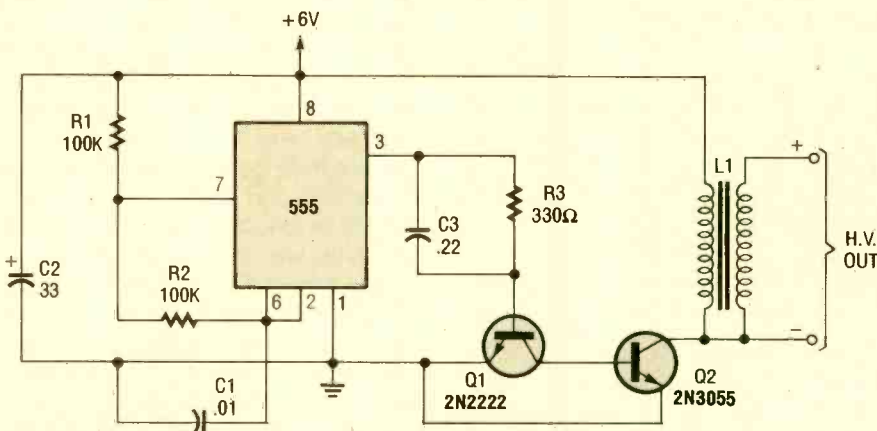

Fig. 1. The Laser Power Supply consists of a 555 oscillator/timer (U1), two transistors—a 2N2222 general-purpose unit and a 2N3055 power transistor, Q1 and Q2, respectively—an ignition coil L1, and a few support components, which are required for U1.

WARNING!! This article deals with and involves subject matter and the use of materials and substances that may be hazardous to health and life. Do not attempt to implement or use the information contained herein unless you are experienced and skilled with respect to such subject matter, materials and substances. Neither the publisher nor the author make any representations as for the completeness or the accuracy of the information contained herein and disclaim any liability for damages or injuries, whether caused by or arising from the lack of completeness, inaccuracies of the information, misinterpretations of the directions, misapplication of the information or otherwise.

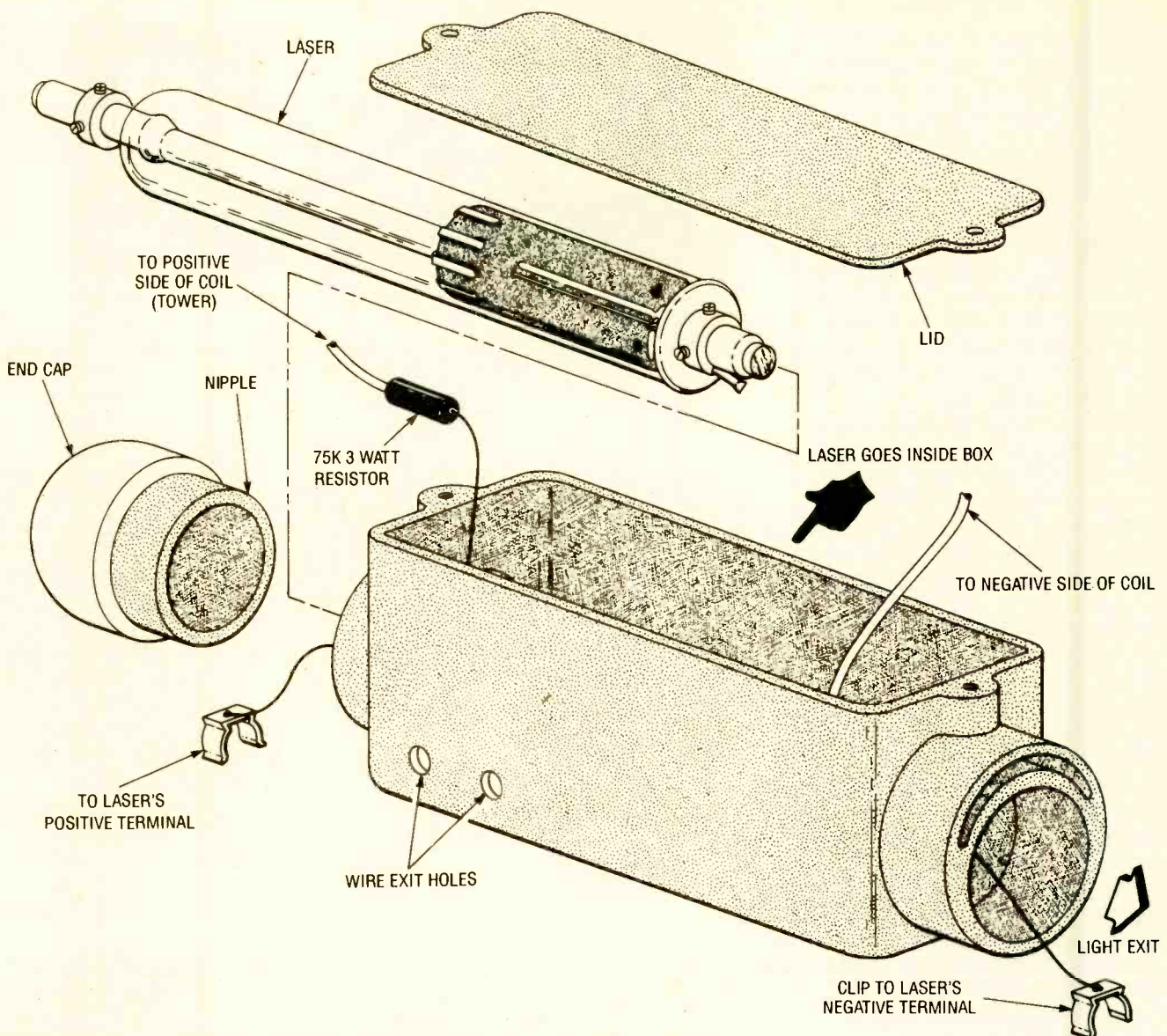

Fig. 4. Prepare the laser tube for connection to the Laser Power Supply by removing the clips from the ends of the tube, and connecting a 75k, 3-watt resistor to the clip that goes to the glass end, and the high-voltage wire from the coil's center terminal to the other end of the resistor. The wire from the negative output terminal of the Laser Power Supply connects to the other clip.

PARTS LIST FOR THE LASER POWER SUPPLY

SEMICONDUCTORS

- U1—555 oscillator/timer, integrated circuit
- Q1—2N2222 general-purpose NPN silicon transistor
- Q2—2N3055 NPN silicon power transistor

CAPACITORS

- C1—.01- μ F, ceramic-disc
- C2—33- μ F, 25-WVDC, miniature electrolytic
- C3—0.22- μ F, polyester

ADDITIONAL PARTS AND MATERIALS

- R1, R2—100,000-ohm, 1/4-watt, 5% resistor
- R3—330-ohm 1/4-watt, 5% resistor

- L1—6-volt auto-ignition coil
- Printed-circuit materials, 1/2-mW standard size He-Ne laser tube, 75,000-ohm 3-watt ballast resistor, Carlon electrical feed-through box, 5-foot rubber heater cord, wire, solder, hardware, etc.

Note: The following items are available from Meredith Instruments, 6403 N. 59th Ave., Glendale, AZ 85301; Tel. 602-934-9387: Model #09 1/2-mW standard size He-Ne laser tube, \$35.00; 75,000-ohm, 3-watt ballast resistor, \$1.50. Add \$5.00 shipping and handling. Arizona residents please add appropriate sales tax.

tube-like structure at the center of the coil. Remove and discard the spark-plug wire holder. Then take a length of rubber insulated heater-supply cord, and separate the two leads. Heater cord was used to ensure adequate insulation from the high voltage that it will carry. Strip one end of one lead and wrap it around the screw. Then reinstall the screw with the wire attached.

Now install U1 in its socket and apply 5 volts DC to the circuit's supply terminals. The circuit should emit a high-pitch whine due to the rapid switching of the power transistor. Move the high-voltage wire (the one coming from the coil center) close to the negative side of the coil. You should get a spark of
(Continued on page 90)

What Do Electrical Engineers Do?

Allow me to introduce myself. I am an electrical engineer—have been for twenty five years. I've worked in research, new product design, engineering-support services, and various levels of management. I've also done some writing, teaching, and speaking on the side. Today I'm working as the engineering vice-president for a young and growing instrumentation company.

Why am I writing this article? Because, probably like you, I became "hooked" on electronics as a youngster. I got my engineering degree because I knew I wanted to work in electronics, but I knew nothing about what an engineer actually did. Twenty five years later, I think I've found out! I've enjoyed it, and hope this article will help you figure out if you would, too.

Engineers, Technicians, and Hobbyists.

There is no single answer to the question, "What do electrical engineers do?" We can, however, contrast an engineer's work to that of a technician or, for that matter, a hobbyist. Where a hobbyist might be happy to create a single circuit or device that works well on the bench, an engineer must produce designs that can be repeatedly reproduced. Component values generally cannot be "tweaked" but, instead, must be carefully calculated to work despite component tolerances, temperature extremes, line-voltage changes, and the like. The calculations and designs must be verified by multiple tests of both prototypes and production units.

Engineers generally do the bulk of the theoretical-design work and are held ultimately responsible for their designs. Technicians, on the other hand, often translate paper designs into reality through breadboarding, model building, programming, testing, trou-

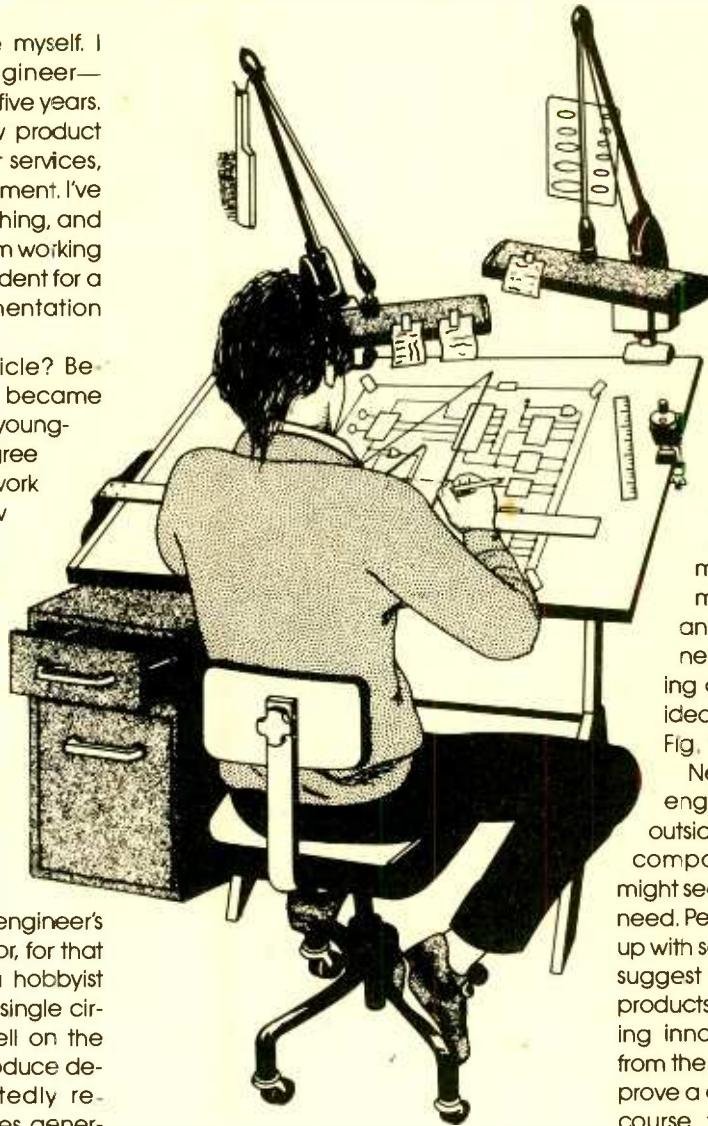

BY HARRY L. TRIETLEY

What does an electrical engineer do? Read this article to find out, and maybe learn if a career as an engineer is right for you.

blesshooting, PC-board layouts, etc. The relationship between an engineer and his or her technician is much like that of a doctor and nurse, or architect and carpenter. The nurse or carpenter might perform much of the hands-on work, but the doctor or architect is responsible for the outcome.

Engineers in Industry.

Just as a doctor might be a surgeon, a psychiatrist, a researcher, a teacher, or a general practitioner, an engineer might choose from among many specialties. You can get an idea of the variety of engineering jobs in industry by following a new product from the "raw-idea" stage to full production (see Fig. 1).

New product ideas, which spur engineering activity, often begin outside engineering. For example, a company's marketing department might see a competitive opportunity or need. Perhaps a salesman might come up with some ideas, or customers might suggest or request new or modified products from him or her. Manufacturing innovations might be requested from the production department to improve a design and/or reduce costs. Of course, the engineering department might also come up with a hot idea or see a way to redesign products using new technology. No matter where a new idea starts, though, it usually winds up in an engineer's hands for initial evaluation. Defense or other contracts require highly technical proposals before a project is even begun.

Proposals involving new technology (or at least "new" to the company), or requiring fundamental technical investigation, might move first to a research department. Engineers and technicians involved in research seldom produce final designs. Their task is to

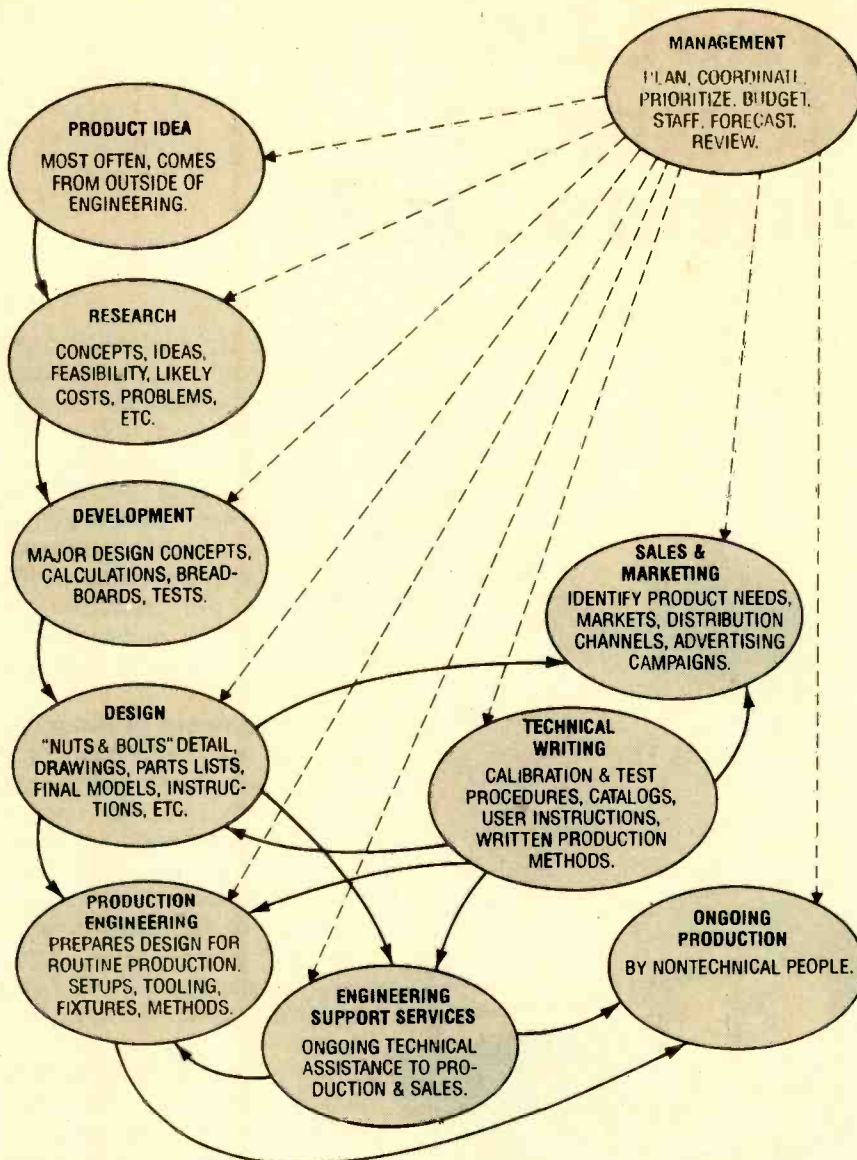

Fig. 1. A product flows through many departments on its way from concept to manufacture and sale. All of these departments might require engineers and technical people.

investigate concepts, feasibilities, costs, likely problems, etc. and to come up with further proposals and recommendations. Their work may include literature searches, laboratory investigations, breadboarding and testing, but their final "product" is usually a report.

For some, this is the "fun" part of engineering since it involves less of the nitty-gritty details. Others find it frustrating, because their ideas are turned over to other engineers who, of course, "improve" them! (Ever hear of the "not-invented-here" syndrome?) Incidentally, proving an idea to be unworkable is a perfectly successful outcome, and might save the company from wasting considerable time and money on unworkable, unprofitable, or otherwise unsalable designs.

If further development is recom-

mended or if the idea does not need basic research, the project moves to development and then to design. The development group creates the major design concepts, details, and design calculations, and builds and tests prototypes. The design department creates the final "nuts-and-bolts" design down to the last electrical, mechanical, and housing detail. The end result is a fully tested and documented design, including all necessary board layouts, mechanical designs, parts and assembly drawings, models, tests, reports, and calibration procedures. The lines between development and design departments are blurred and, in some organizations, do not really exist.

You might think this would be the end of the project, but it's not. The design generally advances on two parallel

paths into marketing and manufacturing. In manufacturing it goes to a department with a name like "production engineering," "manufacturing engineering," or "methods engineering." The engineers in this group are less apt to be circuit-design experts, but instead concentrate on production tools and methods.

Production engineers are in tune with the latest in assembly techniques (electrical and mechanical) and create tooling, fixtures, test equipment, etc., that fit the company's equipment and expertise. They also produce step-by-step procedures, diagrams, etc., that make it possible for nontechnical production workers to produce the product. They might also be involved with automation, robots, and the like. When they are finished, production is ready to build the product.

Sales, marketing, and technical-writing departments all require engineers if the product is technical in nature. Engineers are also needed for applications assistance, technical marketing campaigns, instruction manuals, and advertising.

Most companies have one or more engineering support services groups. Those departments assist production with technical problems and revise, upgrade, or redesign products. They might be involved in submittals to Underwriters Laboratories and other approval agencies, and with customer problems. The people who do best in these departments tend to be people-oriented, outgoing types who can juggle many balls at once.

Finally, of course, engineers can be found in management positions throughout most technological companies, from project leaders and supervisors, to top management.

Technical Specialization. By reading **Popular Electronics** you know that there are many technical specialties in electronics. No one can be expert in all of them. My own career has specialized in measurement instruments and control systems. You might be more interested in communications, while someone else might live and breathe computers. Audio, power generation, microwaves, satellites, and defense electronics are other possibilities. Figure 2 illustrates how complex systems can require engineering expertise running from computers and satellites to controls and power distribution. Even within these areas there are specialties.

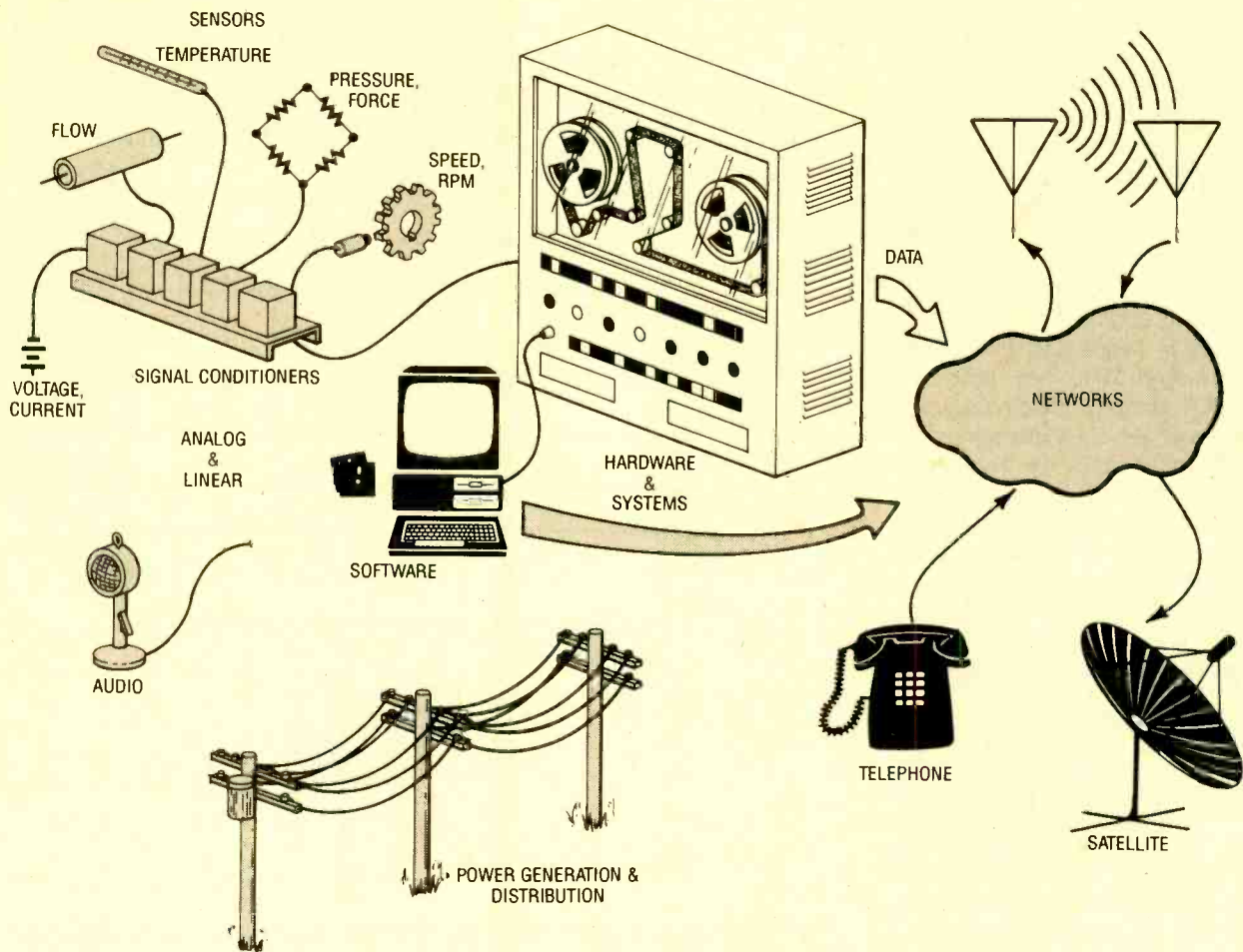

Fig. 2. Electrical engineering runs the gamut from "glamour" areas such as computers and satellites to "bedrock" areas such as power and controls.

Consider, for instance, computerized banking or airline-reservation systems. Integrated-circuit engineers design the necessary computer chips (some of which might be custom) that hardware engineers use to design circuitry. Systems engineers design, coordinate, and install the networks and computers that operate and communicate using programs designed by software engineers. All these people are "computer" engineers, but not one of them is an expert in all areas of computing. The project might be planned and managed under the direction of a generalist, someone whose knowledge is broad enough to understand what all the experts are doing but not deep enough to be able to specialize in any one area.

Other fields have sub-specialties as well. "Linear" designs run from measurement and controls to audio, RF, and microwaves, while "communications" includes circuitry, microwave and satellite antennas, networks, systems, and complex communications theory.

Job Opportunities. You might think of the opportunities in engineering as a large 3-D matrix (Fig. 3). Along the vertical axis are the technical specialties—power, analog, audio, computers, satellites, etc. Across the bottom we see areas of employment, from research and design to production engineering and the support areas. There are even related fields such as law and biomedical research (more on that in a minute).

Add to all of this a third dimension: specialist or generalist. As mentioned before, a true specialist is an expert in his or her area of technical concentration and is highly skilled in one or more related fields. Using the medical analogy again, a surgeon might specialize in heart, brain, or other surgery. Engineering specialists are most apt to be found in research and development.

As you'll recall, a generalist has broader knowledge, quite often including mechanical, chemical, or manufacturing engineering as well as

electronics, but with less depth. A generalist is often a competent designer, but probably needs help for in-depth, complex state-of-the-art designs. Smaller companies generally cannot afford to hire a number of specialists and so hire mainly generalists, perhaps turning to outside consultants when specialized expertise is needed. In larger organizations, a generalist might direct, coordinate, or manage several specialists on large, complex projects.

So far we have looked at industry, but engineers serve in other areas as well. Many government positions are available, ranging from the military and NASA, to state and local positions. (State and local governments, however, are more apt to hire civil or environmental engineers than electrical.)

Furthermore, other areas include education, patent and technical law, research, and consultation. Although you generally need a Ph.D. (a doctorate) degree to become a full college professor, technical and trade schools offer other positions in education as well. (It

should be noted that education generally pays engineers less than industry.) Lawyers with engineering backgrounds are needed in patent law, technical litigation (lawsuits involving technical claims), and other areas. Engineers with medical training are valuable in certain areas of medical research (artificial limbs, nerve stimulation, brain studies, sports medicine, etc.) and in medical-product development.

Consulting engineers might be self-employed or might work for contract and consulting firms. They most often work with industrial or governmental clients, but also serve as researchers, expert witnesses, and the like. A self-employed or senior consulting engineer should have a professional engineer's license, which requires several years experience in addition to passing state licensing exams.

Becoming an Electrical Engineer.

First and most obvious, it takes a B.S. (Bachelor of Science) or B.E. (Bachelor of Engineering) degree in electrical engineering to become an electrical engineer. Four years of full-time university study is typically required, sometimes longer if the student is lacking pre-admission requirements or wishes to take specialized courses. Part-time takes much longer, but many companies offer tuition reimbursement plans to their employees and recognize scholastic progress at review time.

Most companies are firm in their requirements—you cannot be an engineer without a degree. Some will promote their best senior technicians to quasi-engineering positions with titles like "Designer" or "Engineering Associate." Smaller and less formal companies can be more flexible in their promotion policies.

I want to stress, from experience, that the degree might give you the title, but it alone does not make you an engineer. (You can't become a surgeon, or even learn to drive a car, without hands-on experience!) What the degree mostly does is give you the basics (lots of theory, math, and the like) and teaches you to think analytically. Speaking personally, I was not a competent engineer when I started my first job even though I had been a hobbyist since junior high school. I became an engineer by working side-by-side with a first-rate senior engineer and by association with other engineers and technical people in the company.

I also want to stress, because it was

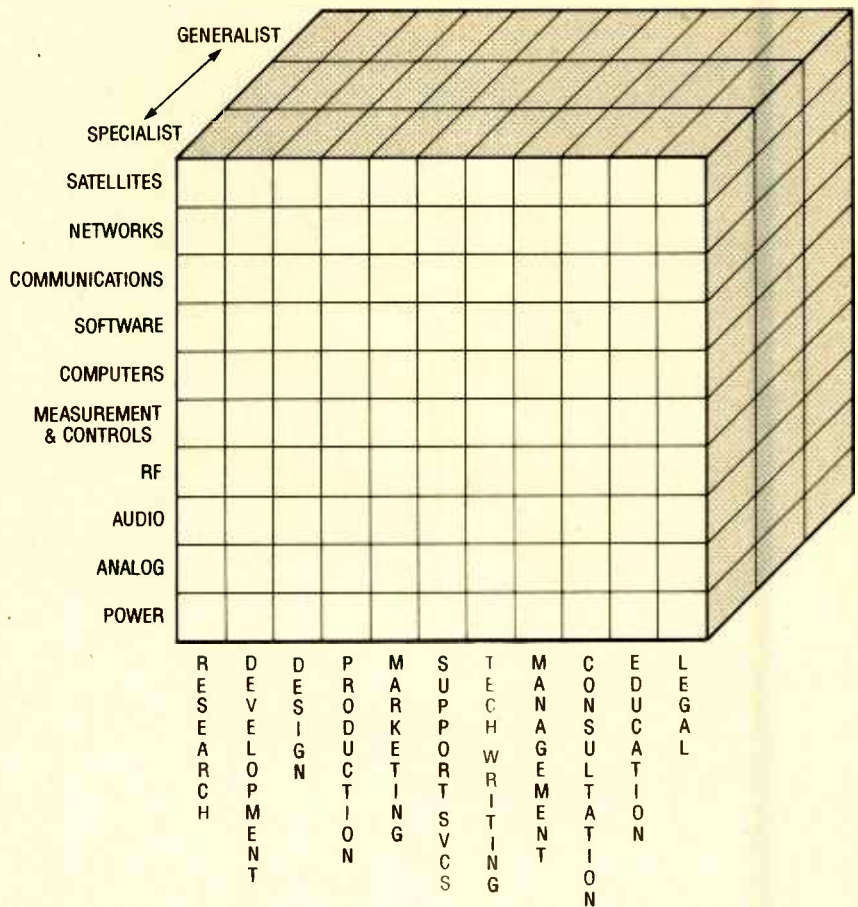

Fig. 3. The field of electrical engineering might be visualized as a 3-dimensional grid. The generalist has knowledge of a broad portion of the grid, while the specialist has in-depth knowledge of a few areas.

never taught to me during my education, that an engineer needs much more than a technical education. First and foremost, you need writing skills. Engineers are famous (or maybe infamous) for their lack of writing ability, sometimes lacking even basic grammar and spelling. You don't need to be an Art Buchwald or an Agatha Christie, but you do have to write proposals, reports, user instructions, and applications literature. You must be able to explain what you are doing (and why your employer should fund you) in non-technical terms. A person who can't spell or use proper grammar has a hard time being accepted as a professional.

No matter where you end up on the grid back in Fig. 3, you will need to do more than just design and build circuits. Projects need goals. An employer will not hire you to "do your own thing." He or she will need to know what you are doing and if it is worth his while to pay you to do it. You wouldn't hire an architect who couldn't tell you what he or she planned to build, how long it would take, or what the cost would be!

To progress very far you will need "people" skills. Whether you ever go into management or not, you almost certainly will end up supervising support people such as technicians and drafters. Most projects are team efforts, not one-man shows. Engineers must work cooperatively with production, marketing, and finance departments. Marketing needs to know what the end result of a project will be. The production department needs to know they will be able to build it at a competitive cost, and the finance group needs to know the end result will be profitable. The best designs in the world are no good if they cannot be produced and sold at a profit.

What are the Rewards? First, of course, income. Engineering is probably the best-paying profession available to a four-year college graduate. Starting salaries in industry generally parallel what a highly-experienced senior technician earns and rise 50% or more over the first several years.

(Continued on page 93)

Inside

SONY'S NEW MINI DISC



Will Sony's new Mini Disc revolutionize the portable audio industry, or will it simply muddy the waters for years to come?

BY BRIAN C. FENTON

Just when you thought it was safe to decide on your next audio recorder, the waters look dangerous again, thanks to Sony's announcement of their new recordable audio format, the Mini Disc (MD). What does it mean for you, your current audio gear, and your future purchase plans? According to the president of Sony Corporation of America, "We are replacing nothing." But let's see where the Mini Disc fits in.

Today, consumers are spending their music dollars on pre-recorded compact cassettes and CD's. Sales of digital audio tape (DAT) recorders are moving slowly because of their expense, the non-availability of software, and the general uneasiness and consumer confusion caused by the recording industry's attack on the hardware.

What's more, in January of this year, yet another new format was announced. That format, called Digital Compact Cassette (DCC), combines the familiarity and recordability of today's popular audio cassette with the sound quality of a compact disc. We thought that DCC had a fairly strong shot at success, since it was backed by Philips, Tandy, and a number of record companies. More important, perhaps, was that DCC recording decks would be capable of playing back all of your existing cassettes. We had envisioned DCC co-existing with DAT; DAT would be aimed at the serious audiophiles, DCC sold to everyone else, and the venerable compact cassette would be relegated to answering-machine duty. Now, however, all bets are off.

What is the Mini Disc? Sony's Mini Disc is a brand new audio format that is specifically designed for portable applications—personal stereos, boom boxes, and, perhaps, even car audio. The disc, about 2½ inches in diameter, looks—and acts—like a cross between a compact disc and a micro floppy computer disk. Like a compact disc, the Mini Disc is an optical medium—it is read by a laser and can store up to 74 minutes of digital audio. Like a floppy disk, the Mini Disc can be recorded on again and again. The Mini Disc differs from standard computer disks in that it uses magneto-optical technology for recording.

One of the main benefits touted by Sony is "shock-proof" memory. In other words, unlike portable CD players now

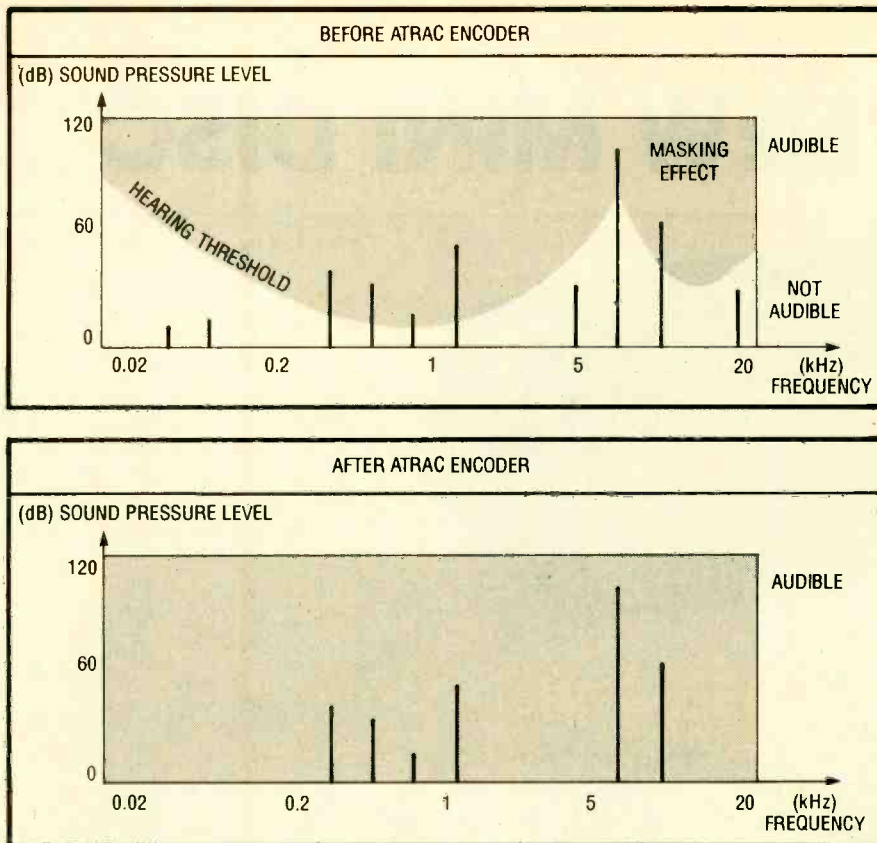

Fig. 1. ATRAC digital audio compression uses the psychoacoustic principles of the masking effect and the threshold of hearing to gain an almost 5-to-1 advantage in storage when compared to a CD.

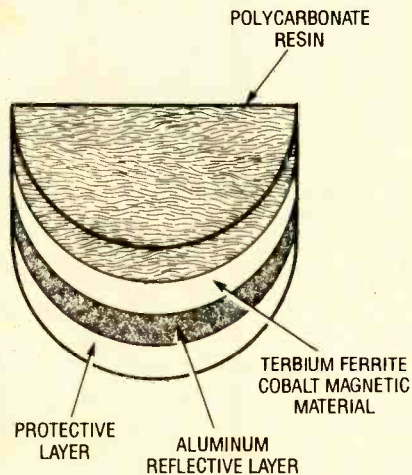

Fig. 2. Cross section of the MD magneto-optical disc. The terbium-ferrite-cobalt magnetic layer allows the MD to use less intense magnetic fields than other magneto-optical discs.

on the market, the Mini Disc player won't mistrack even while undergoing shock and vibration. Actually, the laser pickup will mistrack, but the results of that mistracking will not be audible.

Shock-proof memory works because data is read off the disc faster than it is required by the decoder. Thus, a buffer

of data that may be as long as three seconds, is created. If the laser mistracks, it simply stops filling the buffer while it finds its way back to the proper location. The listener, unaware of the tracking troubles, is treated to flawless sound.

In order to get 74 minutes of audio (the same capacity as a CD) onto a disc that is only 2½ inches in diameter (¼ the area of a CD) something, obviously, had to be left out. That something is digital data. Normally, a reduction in the amount of data on the disc could be expected to reduce the audio quality. However, because of a data-compression scheme called ATRAC (Adaptive Transform Acoustic Coding), Sony claims to be able to achieve CD-audio quality—or quality that is so close to a CD that only 2% of the population will be able to tell the difference. See Fig. 1.

ATRAC is nearly five times more efficient in encoding data than the conventional non-compressed 16-bit linear encoding used on CDs. The main savings comes from ignoring the sounds that won't be heard anyway because they're below the threshold of hearing or because they'll be masked by other sounds.

Since the threshold of hearing varies with frequency, the components of the sound are analyzed by the ATRAC encoder and are eliminated depending on their frequency and level. A similar analysis determines whether they will be masked by other sounds, and thus can be eliminated from the recording. Masking is a psychoacoustic effect that we've all experienced. If a loud sound and a soft sound of similar frequencies are produced, you won't hear the softer sound. Theoretically, if the soft sound is removed, you won't notice the difference. As the level of the recorded material becomes louder, more components can be removed without audible effect.

Read/Write Magneto-Optical Disc.

Although the Mini Disc is like a CD in that it is read by a laser, writing to (or recording on) the disc requires both a laser and a magnetic head. The laser heats the disc's magnetic layer to a temperature of around 400°F. At that temperature, the magnetic layer loses its coercive force—in other words, it becomes very easy to magnetize. Before the disc cools, the signal on the magnetic head polarizes the magnetic layer. The polarization of the magnetic layer affects the polarization of the laser light reflected from the surface.

Unlike other read/write optical-disc technologies, the Mini Disc overwrite method is a single-step process that requires a single laser. To reduce the power consumption to levels that are compatible with portability, Sony developed a terbium-ferrite-cobalt magnetic layer (see Fig. 2) that allows the Mini Disc to use less intense magnetic fields than other magneto-optical discs.

What's in the Future? Predicting the future of consumer electronics is, indeed, a difficult task. Even Sony has an uneven track record. Their Beta VCR format, for example, lost out to the better-marketed VHS. The Sony-backed Elcaset tape-cartridge format was not exactly a smashing success. Their 8mm camcorder format is making gains continuously, although it was greeted with skepticism when it was first introduced in the U.S.

Sony, of course, also co-developed (with Philips) compact-disc digital audio. The strides that the CD has made in the less than 10 years since its introduction have been nothing short of re-

(Continued on page 98)

GIZMO®

VOLUME 4,
NUMBER 9

A CHRONICLE OF CONSUMER ELECTRONICS

A SW(el)L Receiver

SONY ICF-SW1S PORTABLE SHORT-WAVE RECEIVING SYSTEM. Manufactured by: Sony Corporation of America, Sony Drive, Park Ridge, NJ 07656. Price: \$349.95

For the makers of world-band radio receivers, the past year has brought a mix of good news and bad news. The good news is that interest in shortwave radio surged dramatically. The bad news is that it took a major conflict, namely the Persian Gulf war, to get people to rediscover the medium. It's still unclear how many people will continue to tune in now that the war is over—even network TV news lost almost ten million viewers following the end of the war.

Those people who had ignored shortwave radio for the last 20 years or so were probably astounded by the sophisticated receivers of today. Instead of hunting around on the old, notoriously inaccurate tuning dials for stations of interest, phase-locked-loop circuitry permits instant, precise tuning and digital frequency readout. And today, a high-quality receiver needn't fill up the better part of a small desk. In fact, the Sony ICF-SW1 doesn't even fill up a shirt pocket.

The ICF-SW1 receiver is the heart of the ICF-SW1S shortwave receiver system, which is specifically designed for portable operation. (The SW1S is available only as a complete system in the U.S., although in some other countries, the receiver is available separately.) The complete system consists of a receiver, an AC-power adapter, stereo earphones, an active antenna, and an antenna controller, a rugged carrying case, and a couple of other handy accessories.

The receiver itself is the smallest world-band receiver we've ever seen, measuring about $4\frac{3}{4} \times 2\frac{1}{8}$ inches, and is less than an inch thick. Being smaller than most personal-portables, it easily fits in a shirt pocket. Its tuning range, however, is what



CIRCLE 50 ON FREE INFORMATION CARD

you'd expect from a desktop general-coverage receiver. It begins at 150 kHz, which is below the standard AM-broadcast band (and which is usually called longwave), and extends up to about 30 MHz, the top end of most general-coverage receivers. Also included is an FM band ranging from 76 to 108 MHz. (While the FM band in the U.S. begins at 88 MHz, in some other parts of the world, notably Japan, it begins lower.)

A small front-panel speaker provides adequate audio for those who aren't too fussy, but the supplied earphones are a

better bet (and permit FM-stereo listening as well). The rest of the front panel is taken up by twenty pushbuttons and a tuning display. Although the buttons are necessarily small, they're not difficult to operate. Ten numeric buttons let you enter frequencies directly, or call up one of the ten station memories. AM and FM keys let you select the mode of operation or serve as "execute" buttons when a frequency is entered. Manual up/down tuning buttons are included—they also work in conjunction with the band/alarm set and time set

(Continued on page 7)

TURN PAGE FOR CONTENTS

This Month In GIZMO®

Sony ICF-SW1S Portable
Shortwave Receiving System . pg. 1

Design Acoustics PS-55C
Point Source Video Speakers pg. 2

Konami LaserScope Voice-Command
Optical-Targeting Headset pg. 3

Franklin Electronic Publisher's
The Holy Bible: King James
Version KJ-21 pg. 4

Saitek 861 Electronic Championship
Backgammon pg. 5

Nady Systems WH-90 Wireless
Stereo Headphones pg. 6

Diskette File pg. 9

High-Quality Cassette Tape pg. 9

Extended-Memory Remote pg. 10

Personal Computers pg. 10

Repeat Learning System pg. 10

Ear Lenses pg. 11

Subwoofer System pg. 11

Wall-Mount LCD Monitors pg. 11

Wrestling Video Game pg. 11

Automotive Subwoofers pg. 12

Metal Detector pg. 12

Multi-Room Controller pg. 12

Projection TV pg. 12

Gizmo is published by Gernsback Publications, Inc., 500-B Bi-County Blvd., Farmingdale, NY 11735. Senior Writers: Chris F. O'Brian, Teri Scaduto. Contributors to this issue: Michael Scaduto, Injae Lee. © Copyright 1991 by Gernsback Publications Inc. Gizmo is a registered trademark. All rights reserved.

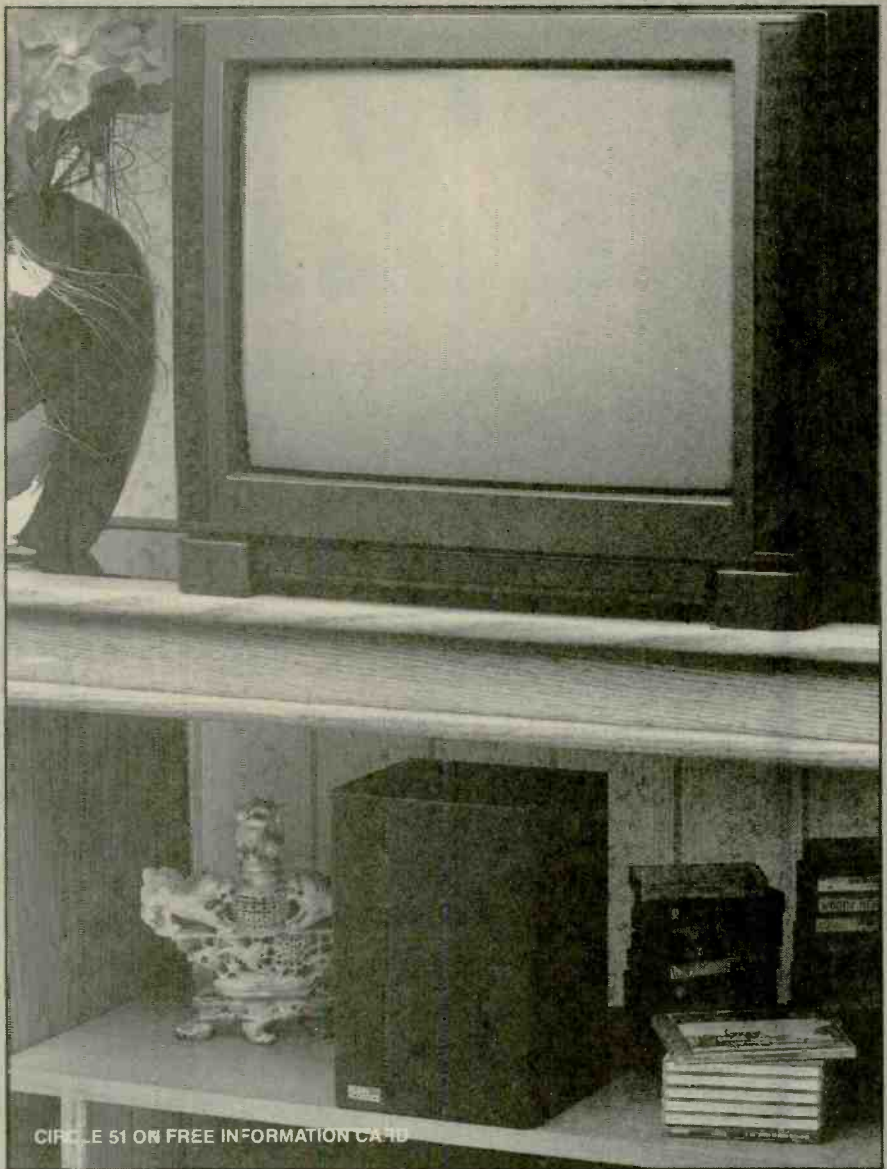

CIRCLE 51 ON FREE INFORMATION CARD

Did You Hear What Was On TV?

DESIGN ACOUSTICS PS-55C POINT SOURCE VIDEO SPEAKERS. Manufactured by: Audio-Technica U.S., Inc., 1221 Commerce Drive, Stow, OH 44224. Price per speaker: \$119.95.

We sometimes joke that if it weren't for our surround-sound audio system, we'd never watch network TV. Actually, it's not that much of a joke—good audio is an essential accompaniment to video.

Today's video-equipment sales suggest that we're not alone in our views; stereo TV's and Hi-Fi VCR's are making continuous gains. It's a far cry from the earlier days of TV, when a set's audio section was an afterthought, if it was given any thought at all.

Of course, it's not network TV that has fueled the desire for better audio. Nor can it be the cable-TV movie channels, considering the poor quality signals delivered by most cable systems. Rather, it's the hi-fi VCR and laserdisc players, coupled with consumers' ever-increasing expectations, that has made TV-set manufacturers pay close attention to the amplifiers and speakers that they install in their new sets.

If you're like most people, you bought your current TV before audio was considered as important as it is today—or you couldn't afford the top-of-the-line set that *did* offer good audio. If you're unwilling to plunk down the big bucks required to get one of the latest sets with hi-fi audio built in, don't despair. You *can* improve the quality of your current setup. If your TV offers external-speaker outputs, improving your audio might be as simple as adding a new pair of speakers, like the *Design Acoustics PS-55CV*. The speakers have a frequency response of 65–20,000

(Continued on page 7)

Shooting Off at the Mouth

LASERSCOPE VOICE COMMAND OPTICAL TARGETING HEADEST. Manufactured by: Konami Inc., 900 Deerfield Parkway, Buffalo Grove, IL 60089. Price: \$39.95.

Somehow, despite our love of gizmos, we managed to pass through the Nintendo Era unscathed. We don't own any video games, and our playing has been limited to Penn Station arcade games as we waited for delayed Long Island Railroad trains, and the hands-on exhibits at trade shows like CES. There is a very practical reason behind our reluctance to get involved with videogames. We know all too well just how addictive such games can be. We did own an Atari 2600, back in the pre-Nintendo days, on which we played "Pac Man" and "Joust" until our fingers were blistered from the joystick and our eyes were blurred from exhaustion. "Grown-up life"—busy work schedules, lawns to mow, family obligations, and the like—doesn't permit such indulgences.

Accordingly, we had mixed feelings when we received a *Konami LaserScope* voice-command optical-targeting headset for review. The LaserScope consists of a pair of stereo headphones that features an "eyescope" which lets you line up targets simply by looking at them through the cross-hairs. The eyescope sticks out from the front of the headset and hangs down in front of your right eye. Jutting out from just below the left ear piece is a wrap-around microphone that rotates up and down and swivels in and out so that you can position it right in front of your mouth. You simply aim through the cross-hairs at a target, and trigger shots by saying "Fire!" or "Shoot!" into the microphone. The result is the same as if you had pulled the trigger on the Nintendo Zapper gun. The targets on the screen flash, and if you've aimed directly at the target, an optical sensor in the eyescope detects that flashing, and the game registers a hit.

Needless to say, our misgivings about having a Nintendo in our offices were overshadowed by our curiosity. So we trekked off to our local video store, rented a Nintendo set and a bunch of games, hooked it all up with the LaserScope, and proceeded to neglect home, family, and deadlines for a week.

The LaserScope is easy to hook up; you simply plug the standard game controller into the Nintendo's A port and plug the LaserScope into the B port, just as you would connect a Zapper gun. (That arrangement means that for multi-player games, you must pass the headset around between turns.) The controller is used for everything other than shooting. The only



CIRCLE 52 ON FREE INFORMATION CARD

other adjustments are optional ones—you can turn off the television's sound so that no one else in the room is subjected to video-game generated music and sound effects, and you can switch the headset to "turbo fire" to rapid fire five shots with each vocal command.

We thought it a bit strange that Konami could boast, "Parents will love it because game play noise is eliminated"—as though repeated shouts of "Fire!" or "Shoot!" couldn't be considered "game play noise." But a bit of experimentation (a necessity due to the threats of co-workers in the office) showed that the LaserScope responds to quieter cues. In fact, even a quick "puff" of air triggers the shooting—without triggering the tempers of anyone else in the room. And, for those who are really into playing video games, the LaserScope can be used, minus the eyepiece, with any Nintendo game, to surround the player with (and protect bystanders from) the sound effects, and to block out ambient sounds. (Having observed several video-game addicts who are oblivious to everything but the game action even without headsets, we're not sure that's a plus.)

It takes only a couple of minutes to get used to the shooting style. Once you've

become accustomed to the optical-targeting action, the sight-speak-and-shoot action is quite accurate. Using the LaserScope for shooting frees both hands for using the control pad (although we really didn't find that necessary). The controller is still used to move back and forth or up and down the screen, and we quickly found ourselves effortlessly coordinating our hands, eyes, and voice. We would have preferred, however, an eyepiece that could be used over either eye. If your left eye is your dominant eye, you'll find the LaserScope takes a while to get used to.

All NES games designed for use with the Zapper gun are compatible with the LaserScope. More than a dozen Zapper games are available, only a few were in stock at our local video-rental shop. We tried it out with "Shooting Gallery" and "To The Earth." In addition, Konami loaned us their new "Lone Ranger" game, one of the games that the company has developed specifically for use with the LaserScope.

The LaserScope brings a whole new dimension to video-game playing. The foam-padded headset is reasonably heavy and, particularly when worn by adults, pretty funny looking. Even so, it's not

(Continued on page 8)

Search, and Ye Shall Find

THE HOLY BIBLE: KING JAMES VERSION (MODEL KJ-21). Manufactured by Franklin Electronic Publishers, Inc., 122 Burrs Road, Mt. Holly, NJ 08060. Price: \$299.95

There was a time in our country's not-too-distant past when it wasn't uncommon for a household to possess only a handful of books, or even just one. One volume could invariably be found in those tiny libraries: The Holy Bible. In poor rural households or frontier homesteads, children were often taught to read and write using the Bible as a primer, and moral and religious lessons, of course, were based on the same source. Family histories—births, deaths, weddings, baptisms—were recorded in the family Bible, and important documents could be found carefully tucked into its pages.

While it hasn't lost its spiritual place, in this day of inexpensive paperback books, daily newspapers, books-by-mail clubs, and a plethora of magazines, the Bible is no longer one of just a few literary works on most bookshelves. And the Bible certainly isn't the only literary work that's been displaced in many homes by electronic media, from television and radios to personal computers. As a society, we've become accustomed to switching on electronic equipment when we want informa-

tion, entertainment, and even spiritual salvation. It was simply a matter of time before someone would try to transfer the age-old wisdom of the Bible into a modern format.

The time is now, and the someone who took on that formidable task is *Franklin Electronic Publishers*, a company well known for its electronic reference materials. And putting both the Old and New Testaments in a handheld device that measures only about $5\frac{1}{2} \times 5\frac{1}{2} \times \frac{3}{4}$ inches and weighs just 13 ounces it is an impressive achievement. An even more impressive feat, however, is to make easily accessible—even for people who are unfamiliar with the Bible—all of the writings contained in all 66 books of the King James Version.

The highlight of the KJ-21 is its comprehensive search capabilities. Looking up words and phrases, and even performing advanced search functions, is incredibly simple. A thesaurus and a phonetic spelling corrector provide help with unfamiliar words. Franklin has provided yet another tool—one that is all-too-often lacking in electronic gear—a clear, concise, legible, and helpful instruction manual.

The KJ-21's front panel contains an LCD readout that measures approximately 4×2 inches. The display contains four lines for text, a list of abbreviations for each book in the Old and New Testaments, and an illustration of an open book. Below the LCD is a QWERTY-style keypad and assorted function and arrow keys. As on most hand-held gear, the keys are too

small and closely spaced for regular typing. The LCD, unfortunately, was very difficult to read. Although the contrast is easy to adjust (using the up- and down-arrow keys to make it darker and lighter), we had a hard time finding a setting that was clearly legible in the ambient light of our offices. The 5×7 -dot-matrix display just doesn't cut it anymore.

That is, however, the only technical drawback we found. The program is designed for simplicity, and the design works as intended. To use the KJ-21, you must make one of two types of requests by typing in information. To begin reading ("open" the book) from a specific place in the Bible, you can type in a book, chapter, and verse (for instance, JOHN 3 16). To "search" for matches for a phrase or word, you simply type in the words. For instance, when you key MEEK INHERIT EARTH, and hit enter, the words "PSLM" and "MATT" appear highlighted on the display, indicating that those words appear in that order and close to each other in the Book of Psalms and the Book of Matthew. Hitting the enter key again will take you to the first instance of their occurrence (Psalms 37:11—"But the meek shall inherit the Earth;"). To continue reading from that point in the text, you simply use the down arrow for page down. To find the next instance where those words appear, the N (for next) key is used. The pages on the picture of the book flip as the KJ-21 searches, and in about one second the next instance appears on the screen (Matthew 5:5—"Blessed are the meek; for they shall inherit the Earth.") If you'd rather return to Psalms, a touch of the P key brings you back to the previous example. (The pages on the little book flip backwards; backward searches take slightly longer.)

That's all you need to know for basic operation of the KJ-21. And, even at that simple level, you have quite a bit of leeway. Unlike most computers, which require that you type in requests in very specific fashions, the KJ-21 is not at all picky. For example, if you want to read from First Corinthians, you have the options of typing your request as 1 COR, COR 1, ICOR, FIRST COR, COR FIRST, FIRST COR, COR-FIRST, 1 COR. COR 1, ICOR, COR1, 1ST COR, COR 1ST, 1STCOR, or COR1ST. If you wanted to read from the second chapter, third verse of that book, you could type in FIRST CORINTHIANS CHAPTER 2 VERSE 3 or simply ICO2 3. Similarly, if you were to type in MEAK INHIRIT ERTH, the LCD would display "Trying to correct, please wait" and then would bring up four options preceded by flashing numbers:

1. TO USE "MEAT" 2. TO USE "MEEK" 3. TO USE "MAKE" 4. TO DELETE, THEN RETYPE.

In the same manner, options are provided for "inhibit" and "erth." In the unlikely event that you were confused by those on-screen instructions, a press of the help key

(Continued on page 8)



CIRCLE 33 ON FREE INFORMATION CARD

A Game for All Times

ELECTRONIC CHAMPIONSHIP BACKGAMMON MODEL 681. Manufactured by Saitek Industries Ltd., 2291 West 205th Street, Suite 101, Torrance, CA 90501; Price: \$164.95.

Backgammon certainly has staying power. Its combination of strategy, skill, luck, and gambling has appealed to people around the world for several centuries. Although its exact origins are unknown, its likely ancestors date back some 5,000 years to ancient Mesopotamia, as evidenced by similar games unearthed there by archaeologists. It seems that the Egyptians were enjoying a version of the game a few thousand years later, since similar boards dating from 1500 B.C. were found in the tomb of King Tut. A thousand years after that, a backgammon-like game was alive and well in Greek civilization: Plato mentions the popularity of the game, and Homer wrote about it in the *Odyssey*.

The Romans weren't a culture to miss out on a good thing. Called *tabulae*, or tables, their version of backgammon was so popular among the upper classes that it was called the sport of emperors. And it is said that Marc Antony and Cleopatra played the game, Caligula cheated at it, Nero played for stakes as high as (the equivalent of) \$15,000 a point, and that—true to the excesses of the Roman Empire—some Romans played a sort of “strip backgammon.”

While it's likely that the Roman legions brought *tabulae* with them as they conquered most of Europe and Britain—in fact, the English version was called “tables”—it was the return of the Crusaders in the twelfth century that most effectively spread the game to medieval Europe. References to “tables” appear in works by Shakespeare and Chaucer, and James the First of Scotland is said to have played it the night before he was murdered. In France, where it was called “tric-trac” (for the sound the tiles made against the wooden playing board), specially designed, ornate game tables were popular among the aristocrats in the court of Louis XVI and Marie Antoinette. When the Spaniards, who called the game *laquet*, invaded Mexico in the sixteenth century, they found that the Aztecs played a game so similar that anthropologists cite the fact as evidence that the native tribes of the Western hemisphere had migrated there from Asia. The earliest recorded use of the name “backgammon” was in 1645, and that was the name used in the next century by Thomas Jefferson when he recorded his losses at the game in his expense log.

The game—as we know it and in various versions that have evolved through histo-

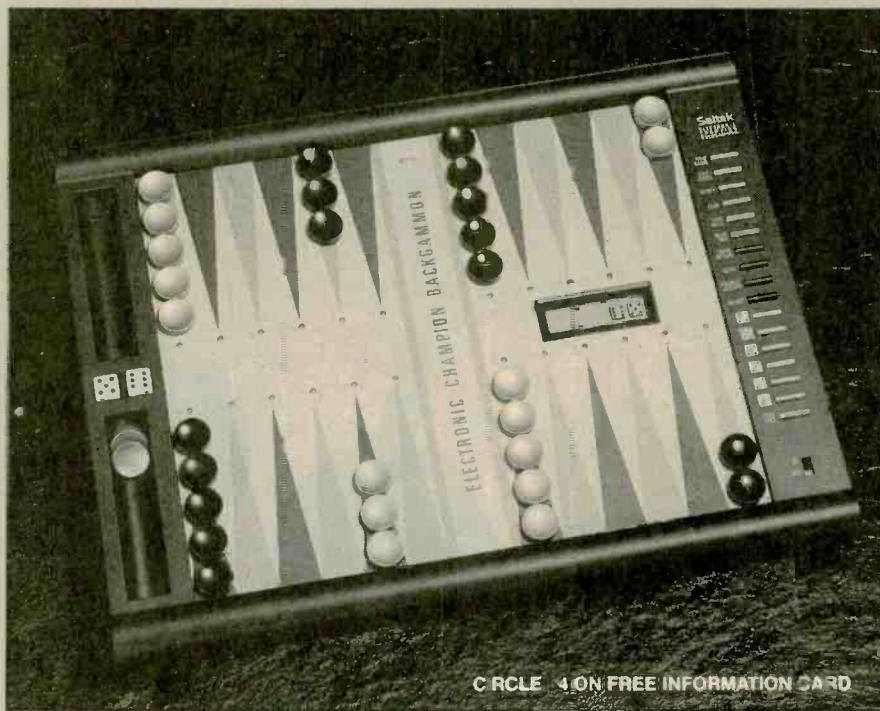

CIRCLE 4 ON FREE INFORMATION CARD

ry—has remained popular in the Middle East for thousands of years, and had its ups and downs elsewhere. In the U.S., a burst of renewed interest in backgammon began with the invention in the 1920's of “doubling,” a twist in which the player whose turn it is can insist on doubling the stakes. His opponent has the option of agreeing to the increased stakes, or surrendering the game at the original stakes. Doubling both added to the excitement (with the higher risk) and gave players a quick “out” when a game whose outcome was decided early on was dragging on.

Backgammon remains popular today, although it doesn't get the attention of Nintendo-style electronic entertainment. That's not to say that backgammon and electronics are incompatible: Saitek's *Electronic Champion Backgammon* is a fine example of their merger. Incorporating what Saitek calls “the world's strongest dedicated backgammon computer” (a 16K program), the game is quite versatile. It offers 10 levels of play, from novice to tournament, and three types of strategy (standard, conservative, and aggressive). In addition, you can choose between standard backgammon, and four “common” variations: Jacquet, Trictrac, Moultezim, and Plakato. (We had never played—or heard of—those variations, but we understand they are quite popular in other countries.) You can play against the computer or against another person, and can opt to use either electronic or regular dice.

The black-and-silvery-taupe board is pressure-sensitive, and automatically registers each move. To move, you simply press down on the bar from which you want to move, and then press down on the bar to which you want to move. Each time you press on a bar, a red LED at its tip

lights up. When it's the computer's turn to move (you must press the “Roll Dice” button for it), it indicates its move by lighting up LED's in the same manner (you must also move its pieces). Unfortunately, the LED's protrude above the board. We would have preferred to have the LED's recessed, since they make it difficult to slide the playing pieces across the board.

Other than that, the checker-like pieces are easy to grasp and pick up, and, since they are backed by magnets, they hold their places even when the board is turned upside down. (Sudden movements, however, can dislodge them.) At 14 × 10½ × 1 inches, *Electronic Champion Backgammon* fits inside a briefcase, and weighing just under two pounds (batteries not included—and they're *not*), it is portable enough to carry on board a plane to help alleviate boredom on a long trip. Should you hear the “Please return your seatbacks to an upright position and stow your tray table as the flight attendants prepare for landing” announcement in the middle of a good game, there's no need to despair. If you turn the unit off, *Electronic Champion Backgammon* will pick up the game exactly where you left off when you turn it back on again. (A truly portable version, model 682, has all the same play options and skill levels, but trades off the individual playing pieces and comfortable feel for reduced size and weight. We prefer to have the ability to move our own pieces.)

A row of 17 buttons running down the right-hand side of the board are used to start each new game, roll the electronic dice, select game levels and options, and activate some special features that we'll explain later. As you push the buttons, an LCD readout recessed into the board indi-

(Continued on page 8)



CIRCLE 55 ON FREE INFORMATION CARD

Private Broadcasts

WH-90 WIRELESS STEREO HEADPHONES. Manufactured by: Nady Systems, Inc., 6701 Bay Street, Emeryville, CA 94608. Price: \$124.95

We've all become addicted to portable audio, and we've become so accustomed to the idea of having news and music wherever we are that we're often disappointed when portable equipment doesn't live up to our expectations.

Personal portable stereo receivers are an essential piece of equipment, and we never leave home without one. Unfortunately, while they all work great in the city, out in the wilds of suburbia where we are, we've yet to find one that works as well as we want it to. We wouldn't really have any problem if we listened to the powerhouse pop music stations. But we're fans of National Public Radio, obscure college stations, and other underpowered non-commercial outlets. While we're outside taking care of our lawn and garden chores, we have a hard time listening to the radio—every time we hear something interesting, we have to stop cutting, or whatever else we're doing, so that our reception stays clear. Of course, we don't

get very much work done that way, so we usually end up popping in a cassette, instead of listening to something new.

Well, if there's something that we can complain about, you can be sure that someone will come up with something to shut us up. And that's just what Nady Systems, Inc. has done with their *WH-90 Wireless Stereo Headphones*. Even if you've never heard of Nady Systems, you've probably already heard some of their products in action. Their wireless audio-transmission equipment for microphones and electric guitars are used by such artists as Tina Turner and the Rolling Stones.

The WH-90 consists, naturally enough, of two main devices: a stereo transmitter that attaches to your home-stereo system (or TV, or anything else with line-level audio outputs) and a stereo headphone receiver. The transmitter is a circle with a diameter of about 4 $\frac{3}{8}$ inches, although it has a flat side that protrudes a bit from the circle. That flat side holds the rear panel, which contains left- and right-channel inputs; the 15-inch telescopic antenna; and an input for an optional (\$9.95) AC adapter. A gold-colored half sphere protrudes from the top face of the transmitter to give it a bit of a high-tech look. An LED in the center of the sphere serves as a power-on indicator.

A standard phono-to-phono cable is

supplied with the set. A second cable, with a miniature phone plug on one end and phono plugs on the other, is provided so that you can hook the transmitter up to your portable stereo. While it may seem silly to use wireless headphones with a personal portable stereo, it really isn't. The FM receivers always work better when they're stationary, and portable CD players are notoriously poor performers when they're on the move. The WH-90 transmitter can be powered by a 9-volt battery for use in portable applications.

The headphones are reasonably large, around-the-ear types that mimic the shape of the transmitter—right down to the gold spheres protruding from the side. Unfortunately, instead of lending a high-tech look, they tend to make the wearer look a little silly. On the right side, it seems that Nady's original intention was to use the protruding sphere as a channel-selection knob. (Our headphones were still silkscreened with three channel positions, although we assume that later models will not be.)

The headphones are powered by two "AAA" batteries that mount in one earpiece. The other earpiece contains the electronics, including the power switch, stereo/mono selector, two reception-indicating LED's (both are on if you're listening in stereo), and a volume control. The receiving antenna, a thin, 2-foot wire, hangs down from that earpiece. The headphones are well balanced, and the cushioning makes them quite comfortable, but they're a little heavy for our tastes, and can get fatiguing after about an hour. And since most of the weight is concentrated over, and slightly away from, the ears, the headphones can pick up a healthy amount of angular momentum if you turn your head quickly—enough that they'll require some re-adjustment every once in a while.

The transmitter works on the 49-MHz band with an output power of about 30 milliwatts. Although that's anything but high power, it does provide a healthy range, which we measured to be about 100 feet for un-interrupted reception.

Interestingly, Nady doesn't make any claims for the range of the headset. Our favorite application—using the WH-90 to bring our home audio system outdoors—is not what Nady suggests at all. The company recommends the headphones mainly for around-the-house use. Private listening to your TV or stereo so as not to disturb others is the main purpose, and the WH-90 is being marketed against other home wireless headphones that use infrared light to transmit the audio (and are thus limited to line-of-sight use, usually in the same room). For less private listening, you may want to invest another \$69.95 for a second set of headphone receivers so that someone else can listen along with you.

If you're looking for high-fidelity repro-

duction, you may be disappointed by the WH-90 wireless headphones. They are subject to interference from a number of devices, (including the computer on which this is being written). We also had to experiment with proper placement of the transmitter before we obtained reasonably quiet results because even your audio sources can be interference sources as well. For example, when the transmitter was placed too near the power transformer of our stereo amplifier, we heard, as you might expect, a good amount of hum. If you use the headphones for private TV listening, you might get some interference from the TV itself. (You might be better off, as Nady suggests, using your VCR as the audio source—an especially good suggestion if your TV doesn't offer an audio output.) CD players, notorious producers of "hash," can be a problem depending on the transmitter's placement. And even the transmitter's power adapter can contribute a small amount of hum depending on the placement of the power cord.

The WH-90 does, however, provide a convenient way to enjoy some of your stationary audio sources while you move around. If you're willing to put up with less-than-audiophile-quality sound for the sake of convenience, then add Nady's WH-90 to your must-have list. ■

DID YOU HEAR WHAT WAS ON TV

(Continued from page 2)

Hz, and a power-handling capability of 70 watts. The cabinet, finished in black-ash vinyl, measures a compact $7 \times 10\frac{1}{4} \times 6$ inches, and houses a $5\frac{1}{4}$ -inch woofer and $\frac{3}{4}$ -inch ferrofluid-cooled dome tweeter.

The most common way to upgrade a video system's audio is by integrating an existing stereo audio system into the video setup, and using the stereo system's amplifier and speakers. Although that's a good first step, it doesn't work as well as you might expect. The biggest problem is that—unless you have a huge projection screen—your stereo system's speakers are probably in the wrong place! The proper speaker location for music listening is not the same as for video entertainment, where you don't want the same wide soundstage. Video speakers should be installed relatively close to the sides of your screen, so that on-screen sounds don't sound as if they're coming from the other side of the room.

Unfortunately, you can't install ordinary speakers too close to your video screen because of the permanent magnets in the speakers. If the magnetic field is strong enough, it can distort the picture or the color of your TV screen. Like other speakers meant expressly for video applications, the PS-55CV are magnetically "shielded" (actually, "compensated" is the better word).

We're not going to suggest that you buy

a second set of speakers to use solely for video, especially if you're happy with the performance of your current speakers. If you have a Dolby surround decoder with a center-channel output, a single speaker mounted in the center of the soundstage might do the trick. Using the center channel, which on most soundtracks contains primarily dialogue, makes it easier to hear what is being said more clearly during loud passages. More important, it can eliminate the "hole in the middle" of widely spaced speakers and create a more realistic soundfield for on-screen voices and action. The PS-55CV is a perfect speaker for that application.

If you haven't integrated your audio and video systems, you may be putting up with the typically poor stereo speakers that come with most low- and mid-level (and even some high-end) TV's. Adding a "real" pair of speakers like the PS-55 will help you realize that you really did make the right decision when you shelled out the extra money for MTS capability. Of course, the PS-55CV make pretty good surround-channel speakers, too.

It's been ten years since Dolby Laboratories developed the Dolby Surround home surround-sound system, one of the driving forces behind consumers' interest in better video sound. It's been about seven years since the FCC authorized stereo-television transmission. If you have yet to upgrade the sound of your video system, we can't think of any reasons for you to wait any longer. And the PS-55CV video speakers are a good way to start. ■

A SW(EL) RECEIVER

(Continued from page 1)

buttons. A scan start/stop button allows you to search for new stations (tuning stops automatically when a strong-enough signal is found), and a key-protect button, once hit, locks out any accidental key presses. Of course there's an on/off switch, but there's also a sleep switch to automatically shut down the receiver after an hour.

The receiver is powered by either two "AA" batteries or the AC-power adapter. There are two power switches on the unit. One is a slide switch on top of the receiver. Sliding it to on puts the receiver in its standby mode; it's not really on until you touch the front panel on/off key. While that may sound like an annoyance, it's actually a most welcome feature, especially for travelers. You don't have to worry about the receiver being turned on by another object pressing a button while it's packed away in your luggage, and ending up at your destination with dead batteries.

When used by itself, the ICF-SW1 is a competent receiver. On the shortwave bands, it has no trouble picking up such well-known powerhouses as the BBC, Voice of America, Radio Moscow, Radio

Korea, Spanish National Radio, and the like. Many are audible even with the receiver in its low-sensitivity local mode.

When we tried to tune in some of the harder-to-get stations, the receiver presented a couple of its few shortcomings. First is its relatively coarse tuning increment of 5 kHz on the shortwave bands. Off-channel stations (of which there are relatively few) cannot be tuned in exactly, even with direct frequency entry. (On the AM broadcast band, the tuning increment is 10 kHz, but can be changed to 9 kHz—the channel spacing that most of the rest of the world uses for AM broadcasts.) The receiver also suffers from poor image rejection: we encountered several spurious "images" of stations, especially strong local ones.

As any shortwave enthusiast knows, even the best receiver can only be as good as its antenna permits. Unfortunately, by their very nature, portable receivers usually are equipped with antennas that are marginal, at best. The SWIS, however, includes a good compromise—a portable active antenna.

The active antenna is a 45-1/2-inch telescoping element on a $3-1/4 \times 3-3/4 \times 1-1/4$ -inch base (which holds the 4 "AA" batteries that power the antenna). Thanks to a 12-foot connecting cord (which is stored in the base on a very convenient, self-contained take-up spool), you can mount the antenna near your hotel window while you sit in the comfort of your listening position. A small, rubber suction cup supplied with the system can hold the antenna in any desired position.

The antenna connects to the receiver through the antenna controller. The controller plugs into the receiver via the receiver's tape-record jack, which is normally used for direct output to a tape recorder. (The controller brings the record output straight through to a jack on the opposite side.) The record jack is used only as a kind of friction-fit device as far as the antenna is concerned. The actual antenna connection is via a small pin that makes contact with the tip of the telescopic antenna. A small switch on the face of the controller turns the power on and off. Unfortunately, the receiver's on/off switch has no effect on the antenna controller—nor, of course, does the sleep function. Also, unfortunately, the power for the active antenna must be supplied by its batteries; we would have preferred if the AC adapter could also be used for that.

If you've never given shortwave listening a chance, you really should. But the SWIS should not be your first receiver—there are better and less expensive (although much larger) models on the market that the SWIS is not meant to replace. We, of course, have long been fans of world-band radio, and we'll continue to listen both in times of peace and of war. The only difference is that now, we can also listen when we travel. ■

SHOOTING OFF AT THE MOUTH

(Continued from page 3)

difficult to forget that you're wearing them as you get caught up in the game action. Once we discovered that soft sounds worked as well as shouted commands, we could play for hours on end without voice fatigue. Our ears did take a beating—the headset definitely is meant to fit smaller heads—and an hour or so of continuous play resulted in stiff necks. While we never got to the point where we mistook our sofa for the cockpit of an army helicopter, we did enjoy the relative ease and accuracy with which the LaserScope works.

As a bonus, the headset can also function as spare headphones for your personal stereo, radio, or Game Boy (although you wouldn't catch us wearing it in public). A slide switch on the side of the headset is used to change between NES and stereo modes, the mouthpiece swivels out of the way, and the eyepiece snaps off when it isn't needed. The LaserScope wouldn't be our first choice for music listening. The audio quality is certainly adequate for listening to Nintendo sound tracks, and the kids probably won't have any complaints listening to their rock and roll. But these are not headphones for serious listening.

Our only other complaint (and bear in mind that this is coming from non-parents) stems from the fact that for best results we tended to keep the microphone practically touching our mouths as we played. When a multi-player game is in progress, the controls are passed from player to player in turn—not what we'd consider to be a very hygienic arrangement. (Although kids do tend to share their sodas, food, etc., anyway.)

That's a small price to pay, in any case, for a device that offers a lot of fun and a quiet game room—for a small price. At less than \$40, the LaserScope will be a welcome addition to many Nintendo systems. We have to run now—we have only a few hours before the rental is up on our Nintendo, and we're dying to get in a few more games! ■

SEARCH AND YE SHALL FIND

(Continued from page 4)

calls up further instructions: "Press one of the blinking numbers to make your selection, or press EXIT to return to the Request Line." Another press of the help button lets you know that you are looking at a help screen and to use the exit key to return to the main screen.

The manual explains—for those who are totally unfamiliar with electronic reference sources—the basic functions of the KJ-21 as can be accessed using the enter and exit keys, which "zoom in" to call up more detailed information and "zoom

out" again to return to more general screens, respectively. Those two keys are used for several operations. One is exiting the help function, as described above. Another is to use the pronunciation function. When unfamiliar words (most frequently, proper names) appear in the text, they are often followed by a superscript P. That indicates that pronunciation help is available: by pressing the enter key you will see both the phonetic (using accepted dictionary symbols) and the "newspaper-style" (to help you "sound out" a word) pronunciations of that word. (For instance, the newspaper-style pronunciation of "Judaea" is "joo-DEE-uh." A list of phonetic symbols is provided in the manual.) A superscript "N" following a word indicates that the word's archaic meaning differs from the modern one; pressing enter in that case will call up a definition of the word as it appears in context.

The advanced operations, for the most part, center around the KJ-21's ability to recognize words and concepts that correspond to each other in some way. For instance, when the word "water" is typed followed by a single question mark, the word's entire "family" is brought into the search. That includes singular and plural forms of the noun "water," all tenses of the verb "to water," some synonyms ("sea"), and even compound words like "water-pot." You can type a question mark after one, several, or all of the words in a search, or you can go to the menu and select the "?" option. Either method will cause a list of related words to scroll by and then the number of family members is displayed. Using another menu option, "Approval," allows you to select which of those related words you want to include in the search, and even to view related phrases from the Thesaurus.

The "word family" recognition ability, made possible by Franklin's algorithms, is what makes the KJ-21 something more than a book. It offers an array of new possibilities by instantly answering questions that couldn't easily be satisfied before. The search functions display centuries old words in such a way that interrelationships and structures can clearly be seen.

We here at Gizmo don't have the extensive background required to understand or evaluate the literary structure or the interrelationships between Books of the Bible. As writers, however, we found the KJ-21 to be a handy tool for finding quotable phrases on a variety of subjects. Our unfamiliarity with the Bible, however, led to a few instances where we got "lost." For instance, we wanted to read the Sermon on the Mount, but didn't know what book it was in. "Sermon on the Mount" is not recognizable, and neither is "Beatitudes." Luckily, we knew that part of the Beatitudes is "Blessed are the poor," and were able to search for that phrase.

We loaned the KJ-21 to a friend who is

heavily involved in Bible study and who teaches a Bible class to 8-year-olds. Her reaction to the electronic Bible was that the search capabilities were impressive—but for general study and casual reading, she prefers the Bible in book form. Her students, on the other hand, thought the KJ-21 was "really cool" and a terrific way to study the Bible. We'd expect it to find easier acceptance among kids, who are already so accustomed to using all sorts of electronic equipment and are eager to use new forms of communication.

We hate to sound like the older generation, but we, too, like the feel of a hefty tome, enjoy flipping pages, jotting notes in the margins, and reading the printed word. Those simple pleasures can't be replicated in a handheld device with an LCD readout. And, of course, we'd have a hard time trying to store our family's birth certificates or marriage licenses between the electronic "pages" of the KJ-21. While the KJ-21 makes an excellent reference tool, we can't imagine it replacing the written Word—although the kids might disagree. ■

A GAME FOR ALL TIMES

(Continued from page 5)

icates the corresponding data. For instance, when you press the roll-dice key, the display will show your roll in the form of two dice; as you make each move, the corresponding die is removed from the display. The LCD also indicates whose turn it is by displaying a small black or white playing piece, and what the stakes are by displaying a tiny number in the upper-left corner.

When selecting game level and options, repeatedly pressing the reject button causes the unit to scroll through each option, and the LCD indicates each option in turn (G0 for normal backgammon, G1-G4 for the variations, H0 for standard play, H1 for conservative, H2 for aggressive, and L0-L9 for beginner to expert playing levels). When your choice appears on the display, you lock it in by pressing the double/accept button (which is also used when you want to double the stakes). While that sounds easy enough, it's not intuitive, and the instructions in the manual are anything but helpful.

The special features—in particular, the statistics function—are educational tools. When you press the statistics button once, the display shows which player is ahead, and the pipcount by which he, she, or it is winning. The pipcount refers to the total number of points that a player must move his men before they are all off the board. When in the statistics mode, repeatedly pressing the verify key will first show the score of the game, and then will cause the computer to scan the board and show the chances of each single game piece ("blot") being hit ("pinned"). If you then

push the roll-dice button, the LCD will indicate precisely which dice rolls will pin that blot; if you keep pressing verify, every possible roll will be shown. Using the statistics key teaches you about how the odds can work for or against you, and can help you find a move that gives the computer the least opportunity to pin one of your men.

Similarly, if you've rolled the dice but you're not sure what move to make, hitting the play button causes the computer to switch sides and play that move for you. That way, you can learn what the recommended move is for a certain situation. If you'd rather not take the computer's advice, you can press play a second time, and the move is displayed by the LED's, but is not executed.

The verify key, which is used to make sure that all the playing pieces are physically located in the positions that the computer thinks they should be, comes in handy when you return to an interrupted game (particularly if the board was put in its case and carried around before resuming play). At each press of the verify button, the LED at the end of an occupied bar lights, and a number on the LCD readout lets you know how many men should be on that bar. As you continue to press verify, the computer works its way around the board, stopping at each bar that has (or should have) playing pieces on it. It takes

less than a minute to verify the whole board.

Other than the LED's that stick out of the board, our only complaint about the design of the board is that you must lock closely to find the bear off key—which must be used on almost every move at the end of each game—among all the other buttons. We'd prefer to see it set either slightly apart from the other keys or at the top of the column of keys, or made larger or in a different color, so that it could be distinguished at a glance.

In one of those unfortunate ironies to which we should be accustomed by now, the ease, convenience, and good design of Electronic Champion Backgammon is inversely proportional to the quality of its user's manual. For example, we found that trying to select the various game options according to the manual's instructions is particularly tricky, and, further, the directions for using the statistics function erroneously says to use the accept key to access detailed statistics.

Once we managed to figure it all out on our own, however, the game went smoothly, and we had a great time with it. The differences between the "aggression" modes are subtle, but they do change the feel of the game enough to make it seem as though you're playing against different opponents.

The computer tended to win more often

than we did, but we won enough games so that we felt fairly evenly matched. When, in the midst of an extended losing streak, we began to wonder if the computer was "cheating" by giving itself all the lucky rolls, we were able to use the manual dice option (rolling the included set of dice and then inputting the roll using the six dice keys on the side of the board) to keep the game honest (and to let us cheat if we wanted!).

Saitek is not the first to use feats of engineering to enhance the game of backgammon. The ancient Egyptians, to guard against cheaters, invented a mechanical dice box that shook and rolled out the dice. Nor is Saitek the first to come up with an easily transportable game board. The Roman emperor Claudius had a *tabulae* table mounted on his chariot so that he could play while on the road (although it's highly unlikely that he had magnetic game pieces!), and, 150 years ago, riverboat gamblers on the Mississippi used a portable backgammon set.

And that brings us to the one important thing that is missing from Electronic Champion Backgammon: The pay-off. When you're playing against a computer, you're not going to win or lose any real money, and that takes some of the edge off the game. Oh well, at least we'll be more experienced players the next time we do play for money. ■

For more information on any product in this section, circle the appropriate number on the Free Information Card.

ELECTRONICS WISH LIST

Top-of-the-Line Tape

Back in 1968, TDK Electronics Corporation (12 Harbor Park Drive, Port Washington, NY 11050) introduced the "SD," a high-fidelity cassette that cost about three times more than any other tape on the market. While it never became a mass-market hit, it found a niche with deep-pocketed audiophiles. TDK is out to recapture that same market with its MA-XG audio cassette. Claimed to be both "the first metal tape to achieve the seemingly contradictory goals of low bias noise and high output" and "the world's first dual-layer (Type IV) audio cassette," the MA-XG combines two separately tuned layers of ultrafine Finavinx magnetic particles to create an audio cassette with -59-dB bias noise and +75 dB at 315 Hz output. The tape is housed in the "Reference Standard III (RS-III)" mechanism, which uses a five-piece design with dual-layer face plates made of non-rigid plastic (for resonance reduction) and fiberglass-reinforced plastic (for strength). The housing is also designed to ensure maximum vibration attenuation and the highest degree of azimuth accuracy. Price: 60-minute: \$15; 90-minute: \$18.

CIRCLE 56 ON FREE INFORMATION CARD

Roll-top Disk File

We're always on the lookout for places to store all the little gizmos that go along with the high-tech life. Rolykit, Inc. (303 E. Wacker Drive, Suite 412, Chicago, IL 60610) offers an attractive way to store as many as 80 3½-inch diskettes. Their Rolydata disk file has a sleek, roll-top design with anti-skid feet and a built-in carry handle. It comes with eight section dividers and divider labels to help organize the disks. Rolydata features a patented, dust-proof roll-top enclosure to protect the disks, and comes with a metal key-lock. Pretty soon we'll need a larger office in which to store all our storage gizmos. Price: \$29.95.

CIRCLE 57 ON FREE INFORMATION CARD



TDK High-Quality Cassette Tape

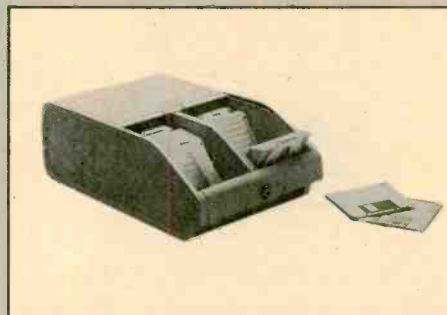

Roll-Top Disk File

ELECTRONICS WISH LIST

For more information on any product in this section, circle the appropriate number on the Free Information Card.



Sony Repeat Learning System



Jasco Extended-Memory Remote

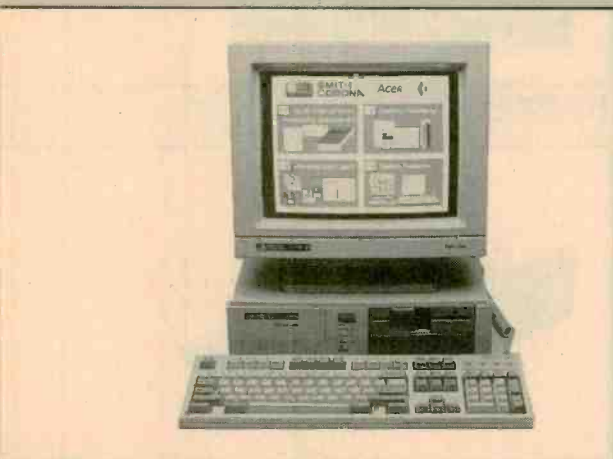

Smith Corona Personal Computers

Language Course, Language Course

Traditionalists in the field of education have long favored teaching by rote. Even those of us who were taught the "new math" can remember learning the "times tables" through endless repetitions of "Three times one is three, three times two is six, three times three is nine, ..." *Sony Corporation of America* (Sony Drive, Park Ridge, NJ 07656) is applying the same basic concept to teach foreign languages. Consisting of a course work package and a portable audio-playback unit that can be used for self-paced study or to reinforce classroom instruction, the *Repeat Learning System* is a new method of language learning that emphasizes memorization of short, conversational sentences through repeated listening. What sets Sony's system apart from cassette-based systems, is that the spoken dialog is recorded on cards with a thin magnetic strip similar to the one found on credit cards. When the cards are run through the Repeater, it will automatically replay the phrase up to 100 times, with no tiresome rewinding between repetitions. Set on manual mode, it replays once at the touch of a button. The first program developed for the system, "Natural Japanese," is offered in two levels. The basic course covers greetings, requests, and phrases used in shopping and banking; the intermediate course builds on those basic skills to teach conversation appropriate in different business situations. Each level consists of 150 Repeatcards; a textbook that provides grammatical explanation, usage guidelines, Japanese characters, and information on Japanese culture and social interaction; and an audio cassette tape of a series of extended practice dialogues. Other programs include four levels of American English and a Chinese course for Japanese-speaking people, as well as French, Spanish, German, and Italian for English-speaking people. Price: \$179.95-\$219.95 for the Repeater Playback Unit and \$149.95-\$189.95 for each language course.

CIRCLE 58 ON FREE INFORMATION CARD

Extended-Memory Universal Remote

If Mother Goose's tales were to be updated for the nineties, we might hear something along the lines of "There was a young yuppie who lived in a condo. He had so many remote controls he didn't know what to do." (Okay, so we're not poets!) *Jasco Products Company* offers a happy ending, of sorts, in the form of their *Model HE 8257* extended-memory remote control. It is preprogrammed to work with up to eight electronic devices; the old remotes are not necessary since it uses preset codes. The device is designed to fit comfortably in either the right or the left hand, and promises to take only seconds to set up. Price: \$89.95.

CIRCLE 59 ON FREE INFORMATION CARD

Into the Computer Age

Smith Corona (65 Locust Avenue, New Canaan, CT 06840), long a leader in the electronic typewriter and word-processor field, has introduced "the logical progression," a line of seven personal computers developed jointly with The Acer Group. The "plug-in-and-go" systems, designed to be easy to use and expandable, are aimed at first-time users in home, school, small-business, and home-office environments. The IBM-PC compatibles contain built-in application software and an opening menu that guides users through the computer's functions. Other convenience features include a spell checker, thesaurus, personal dictionary, and address merge. The PC's are equipped with "the latest version of MS-DOS," and include a DOS shell that has been enhanced to provide users with quick access to frequently used DOS commands, as well as GW-BASIC, Self-Diagnostics, and QuickLearn tutorials. The Smith Corona Acer line includes six 80286-based systems, including three ROM cartridge models and three hard-disk drive models, and one 80386 model with hard drive. Each is available with either a VGA monochrome or VGA color 14-inch monitor, along with two serial ports, one parallel port, a 101-key keyboard, 3½ and/or 5¼-inch floppy drives, and two expansion slots. Shown here is the lowest-priced model, *PC 100*. Price: \$999.99.

CIRCLE 60 ON FREE INFORMATION CARD

For more information on any product in this section, circle the appropriate number on the Free Information Card.

ELECTRONICS WISH LIST

Infinitesimal Micro

No, we're not talking about this season's skirt lengths. *Infinity Systems, Inc.* (9409 Owensmouth Avenue, Chatsworth, CA 91311) is resurrecting the name of their respected Infinitesimal series from a decade ago and has given their passive three-way subwoofer satellite system the name *Infinitesimal Micro*. The compact set is designed to "physically hide yet sonically shine." The 4.8 × 4.8 × 7.6-inch Micro satellite has a frequency response of 150 Hz to 20 kHz at ± 3 dB. When used with the 20 × 7.25 × 11.38-inch subwoofer, bass response extends down to 50 Hz. The subwoofer features an 8-inch dual voice-coil woofer that radiates into a vented enclosure, a format that requires less cone motion to reproduce low frequencies for reduced distortion, and improved sound efficiency. Price: \$519.95 (sold separately: satellite speakers, \$295.95/pair; subwoofer \$269.95).

CIRCLE 61 ON FREE INFORMATION CARD

Picture Perfect

For the past few decades, we've been hearing the wall-mounted TV monitors "will be reality in ten more years." It took quite a bit longer, but *Sharp Corporation* (22-22, Nagaike-cho, Abeno-ku, Osaka 545, Japan; Sharp Electronics Corporation, Sharp Plaza, Mahwah, NJ 07430-2135) has just introduced a line of eight wall-mount color TV monitors—in Japan. The *9E-H Series*, which each feature an 8.6-inch, high-contrast, full-color LCD panel, are being marketed as the "Liquid Crystal Museum." Developed to create an impression of "equipment as art," they are intended to enhance a room in the same way as pieces of art. Each model incorporates the same LCD, but different styles of "frames" complement various interior design styles. A compact tuner can be integrated into the "Crystal" and "Art" models, allowing the entire system to be wall-mounted. The LCD monitors deliver a contrast ratio of more than 60:1 and high image resolution is achieved by a 456 × 960-pixel image and a double-speed scanning system. Perhaps it will become reality here in the states in "a few more years." Price: Not available.

CIRCLE 62 ON FREE INFORMATION CARD

Headset Amplifiers

Taking the "natural" approach to sound amplification, *National Market Makers, Inc.* (P.O. Box 2188, Venice, CA 90294) came up with *Ear Lenses*, a sound-detail amplifying headset that requires no electricity. Resembling headphones, but with black-plastic half-shells that fit behind the wearer's ears instead of speakers placed over the ears, *Ear Lenses* "can make everything from home-stereo systems and TV sets to live music performances sound better to the wearer," according to the inventor. The open-fronted shells reflect, focus, and amplify sound details from any source of sound in front of the wearer. In tests performed by National Market Makers (using a dummy head with microphones in place of ears), they delivered up to eight decibels more sound details to the wearer's ears, and block 55% of the sounds from the user's sides and rear. The company compares the product's aural benefits to the effect that binoculars have on sight, and states that while a similar effect can be achieved "simply by cupping one's hands behind one's ears... with the *Ear Lenses* headset, your arms won't get tired." (We tried them, and were overwhelmed by how loud the laughter sounded from anyone who saw us wearing them.) Price: \$12.95 (plus \$2.00 postage).

CIRCLE 63 ON FREE INFORMATION CARD

Game Boy Wrestling

Fans of big-time wrestling can safely experience thrills, spills, pins, and holds with *Hal America's* (7873 S.W. Cirrus Drive, #25-F, Beaverton, OR 97005) *Hal Wrestling* video game for the handheld Game Boy. Players can program the game for one-on-one or four-man team wrestling. Players can pit themselves against the computer or against another player via a video link, or select a four-man team and pit the group against a computer-selected four-man squad. The field of "athletes" includes wrestlers like King Sampson, The Big Crusher, and The Death Monster. Price: \$28.95.

CIRCLE 64 ON FREE INFORMATION CARD

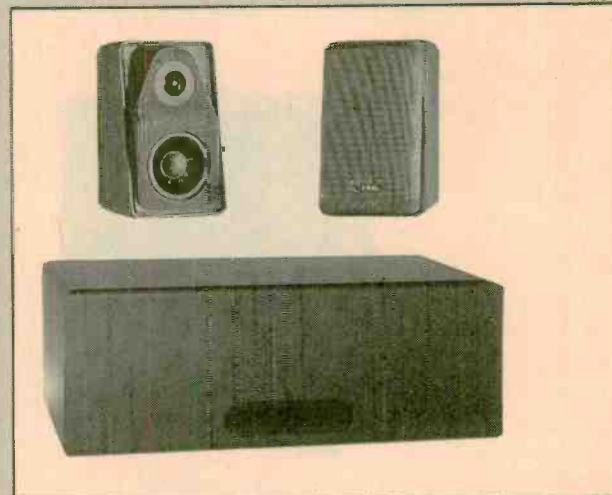

Infinity Subwoofer System



Sharp Wall-Mount LCD Monitors

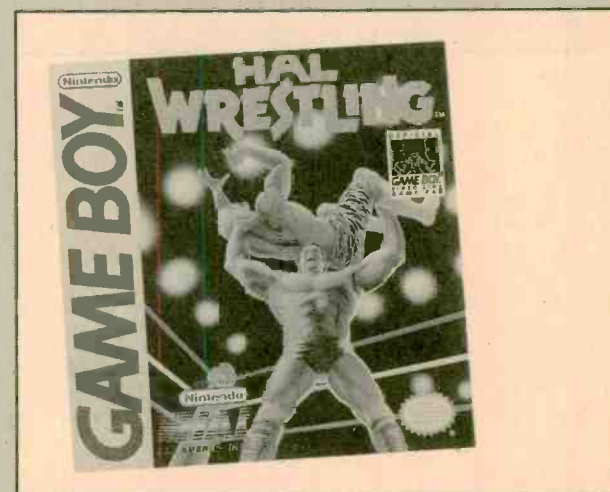

Hal Wrestling Video Game

ELECTRONICS WISH LIST

For more information on any product in this section, circle the appropriate number on the Free Information Card.



Philips Projection TV

61-Inch Projection TV

If you've been putting off buying a home-theater system because it will take up too much floor space, you might want to look into *Philips Consumer Electronics Company's* (One Philips Drive, P.O. Box 14810, Knoxville, TN 37914-1810) *61MP60 WallVision* projection television system that can operate as a stand-alone set or can be installed directly in the wall as part of an integrated entertainment system. The system features only one accessory kit, which includes a color-enhancement filter, side speaker grilles that fit over the wall-speaker cabinets, a decorative speaker grille for the speaker located below the screen, and an air dam that controls the internal air flow through the system. The 61MP60 has center-screen output jack panels, LCD learn remote control, color picture-in-picture, 50-watt Dolby Pro-Logic Surround Sound system, parental control, and channel guide. Also included is a comprehensive installation guide and a 15-minute videotape that explains wall construction, audio- and video-component hookups, wiring during installation, proper ventilation, and installation of the door on the optional cabinet. Price: \$3,799. (The accessory kit and in-wall cabinet are sold separately.)

CIRCLE 65 ON FREE INFORMATION CARD

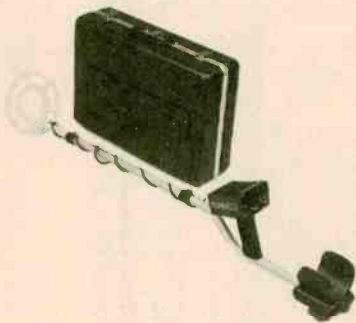

Fisher Metal Detector

Compact Metal Detector

Traveling treasure hunters will appreciate *Fisher Research Laboratory's* (Dept. P-E, 200 West Willmott Road, Los Banos, CA 93635) *1266-XB* metal detector, which disassembles to fit into a small carrying case. Virtually identical to the popular model *1266-X*, the *1266-XB* differs in that it has a three-piece break-down handle and comes with a hard carrying case. The 15 x 21 x 6-inch case is small enough to act as carry-on luggage on most airlines. Features include twin VLF-slow-motion trash-reject modes; silent, no threshold operation; patented double-derivative, quartz-crystal locked electronics; near perfect balance; cushioned arm rest and grip; and an 8-inch, open-center, lightweight "Spider" coil. Price: \$650.

CIRCLE 66 ON FREE INFORMATION CARD

Car Subwoofers

For those who want their car-stereo components to look and sound good—and still have enough money left to fill the tank—*International Jensen Inc.* (25 International Tri-State International Office Center, Suite 400, Lincolnshire, IL 60069) offers the *JW1500* 15-inch subwoofer. It features a frequency response of 20 Hz to 2.1 kHz, with sensitivity of 94 dB. It has a continuous power-handling capability of 150 watts rms. Updated cosmetics include wet-look cones and dust caps featuring the company's logo with red, white, and blue accents. Price: \$99.95.

CIRCLE 67 ON FREE INFORMATION CARD



Bang & Olufsen Multi-Room Controller

"Chameleon" Multi-Room Controller

The chameleon-like *Beolink 7000* infrared system controller from *Bang & Olufsen of America, Inc.'s* (1150 Feehanville Drive, Mt. Prospect, IL 60056) automatically configures its controls and displays to match the audio or video source being used at the moment. Using touch panels instead of buttons, the device commands virtually all functions of Bang & Olufsen audio/video systems. Its motorized operating panel automatically tilts up for easier access, and only those controls that are needed appear on the panel. The *Beolink 7000* never presents extraneous controls that might cause confusion, which makes it easy for a consumer to operate even the most sophisticated whole-house audio/video systems. A built-in microcontroller memorizes the unique configuration of the owner's components and systems throughout the house. Then, it presents only the sources and control options possible with that particular system. Special command sequences can be programmed, and special functions are available (timer programming is possible even in components that don't integrate that feature). The *Beolink 7000* provides full two-way interactive operation with the *Beosystem 2500* music system, *Beosystems 4500* and *6500*, the *Beocenter 9500* music system, and the *Video System 5500*; can control room lighting with optional accessory units; and will be able to control future Bang & Olufsen products yet to be designed. Price: \$1000.

CIRCLE 68 ON FREE INFORMATION CARD

The Electronic Dragonfly



BY MARC SPIWAK

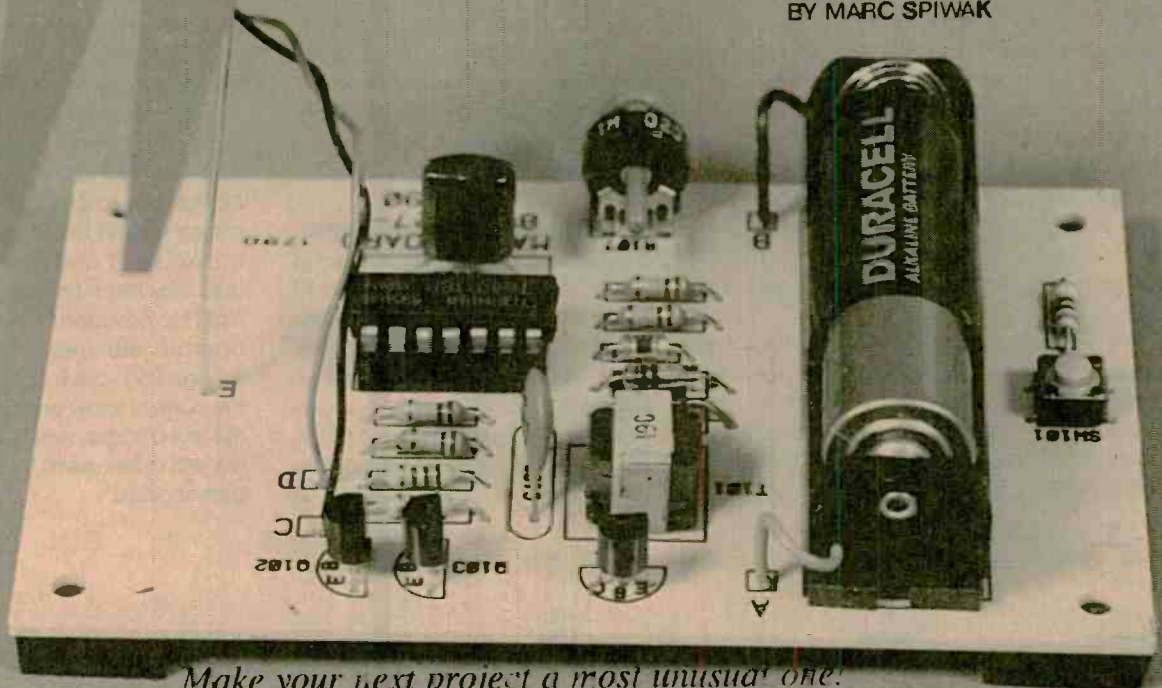

Make your next project a most unusual one!

Here's a riddle for you: What makes an excellent inexpensive gift for any electronics hobbyist, the perfect starter kit for the electronics beginner, a good way for anyone to brush up on their soldering skills, a clever demonstration piece for piezoelectric film, and an unusual conversation piece for the desk of an electronics buff? The answer is the *Electronic Dragonfly*.

The Electronic Dragonfly—designed by Heathkit and sold as kit SK-113 (see the ordering information in the Parts List)—is quite simple. Its body is a cardboard cutout with silver cellophane-like

"wings" attached. The wings are made of a material called piezoelectric film—but we'll talk more about the film later. The wings of the Electronic Dragonfly are connected to a printed-circuit board that causes the wings to "flap" up and down when a button is pressed.

The circuit is powered from a single "AA" cell, and has a flap rate that is variable from full up-and-down motion to just a slight vibration. The circuit is certainly a critical component in the system, for without it, the wings would only flap in the breeze. However, this project would be impossible without the use of piezoelectric film. So, before

we can begin to discuss how the circuit works, some familiarity with piezoelectric film is in order.

Piezoelectric Film. A piezoelectric material is one that can turn mechanical force into electrical energy and vice-versa—in other words, such materials also produce a mechanical force when subjected to electrical energy. The material can be a rigid ceramic or a flexible plastic, which is the case with our piezoelectric film. Keep in mind that the higher the mechanical force, the higher the generated voltage, and vice-versa.

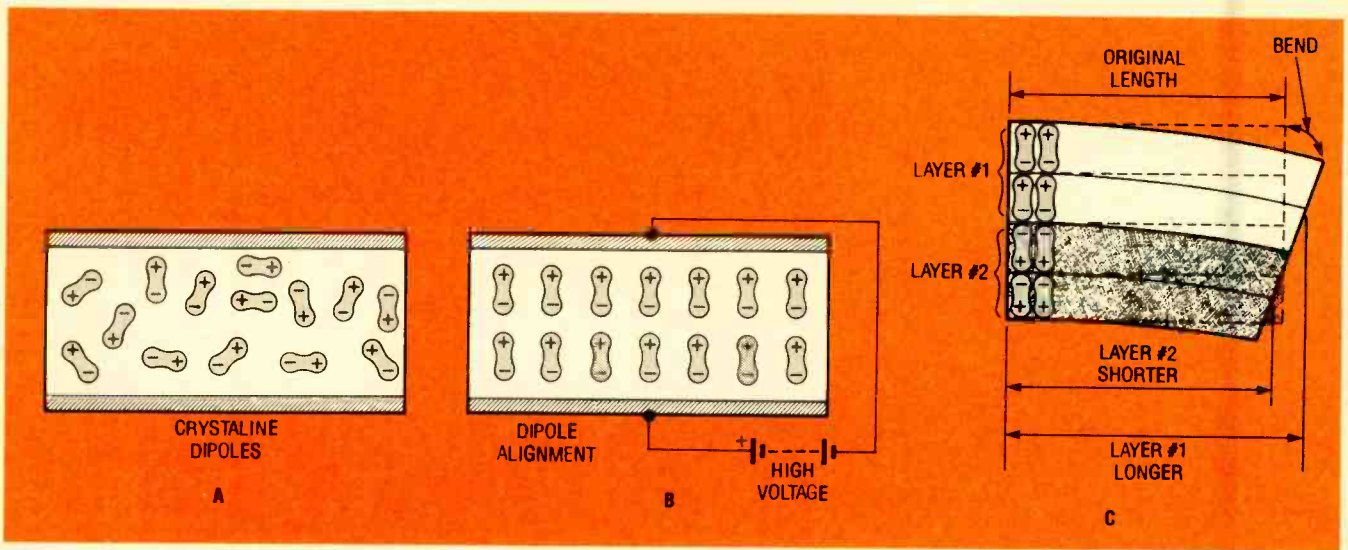

Fig. 1. A dipole has a natural opposite polarity on either end (A). A voltage potential causes the dipoles to align, and the material to change in shape (B). When a potential is placed across two layers of piezoelectric film, the film will bend (C).

The manufacturing procedure of piezoelectric film is such that dipoles are produced in the material's crystalline structure. A dipole is a molecule that has a natural opposite polarity on either end (see Fig. 1A). The film is then metallized on either side so that a voltage potential can be placed across the film. As shown in Fig. 1B, the application of a voltage causes the dipoles to align, and the material to change in shape (as it gets thinner, it gets longer and wider).

The dragonfly wings are made of two layers of the piezoelectric film with opposite dipole orientations (see Fig. 1C). Because the poles of the outer metallized surfaces are now the same, a voltage placed across the surfaces causes

one layer to expand while the other contracts. That, in turn, causes the film to bend. When the voltage polarity reverses, the film bends in the opposite direction. Now that we know how the wings are made to flap, let's see how the circuit creates an AC signal that causes them to do so.

A Look At The Circuit. The schematic for the Electronic Dragonfly is shown in Fig. 2. An AC signal of approximately 10 kHz is created by battery B1, transistor Q1, transformer T1, resistor R1, and push-button S1 in the following manner. When S1 is pressed, Q1 turns on, drawing current from the primary side of T1. A rising pulse from pin 4 of T1's secondary (which is of higher voltage than that at

T1's primary) is applied back to the base of Q1 via R1 and S1, turning it off. That stops the current in both the primary and secondary, allowing the base of Q1 to go low again. As long as S1 remains closed, the cycle will repeat itself.

Diode D2 and capacitor C1 rectify and filter the low-voltage AC from T1's center tap to provide +5 volts DC to power a 4011 quad 2-input NAND gate, U1. Diode D1 and capacitor C2 rectify and filter the high-voltage AC from pin 3 of T1 to produce about 260-volts DC to operate the piezoelectric wings. Although 260 volts is nothing to snicker at, the current is low enough so that there's no real danger; resistors R3 and R4 limit current in the event that T1 accidentally gets shorted.

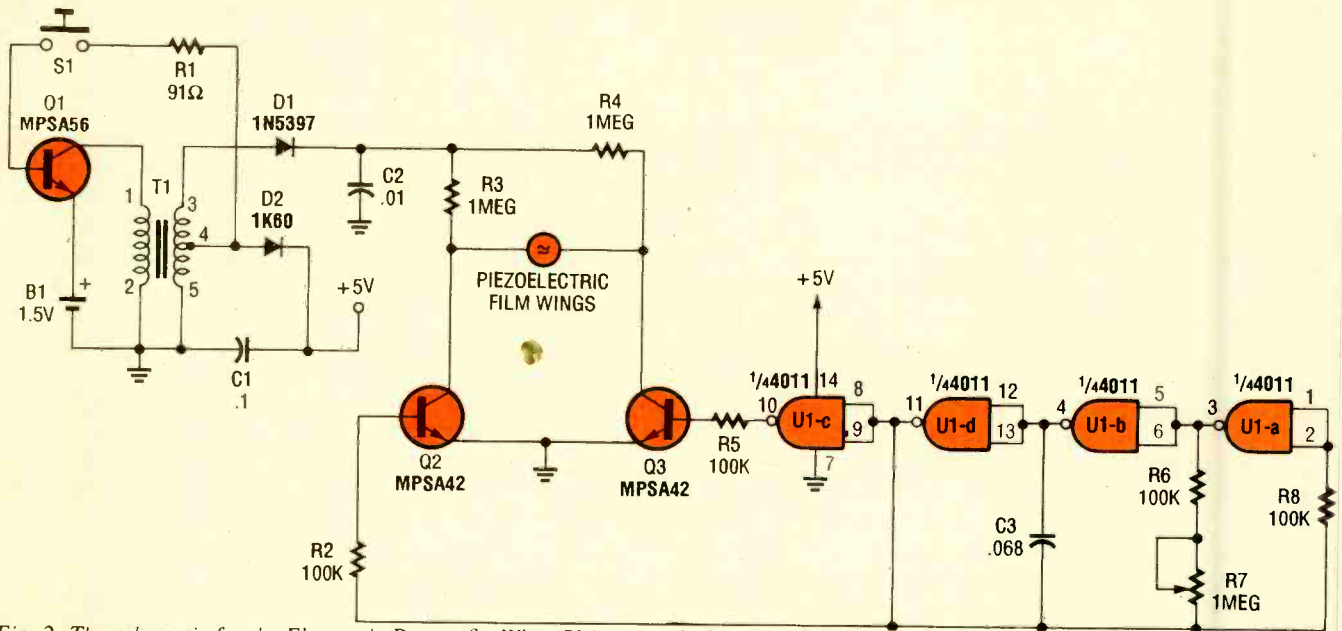

Fig. 2. The schematic for the Electronic Dragonfly. When S1 is pressed, the wings flap up and down.

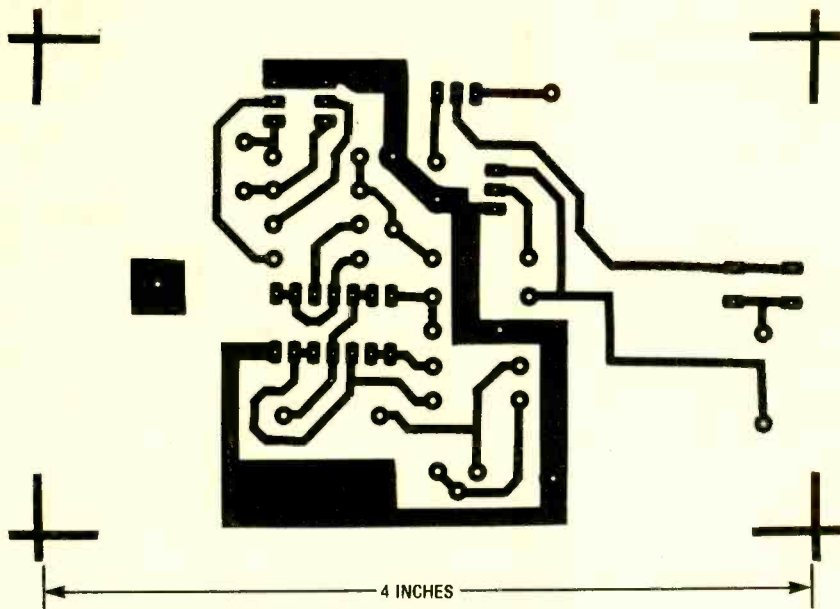

Fig. 3. You can make your own printed-circuit board from this foil pattern.

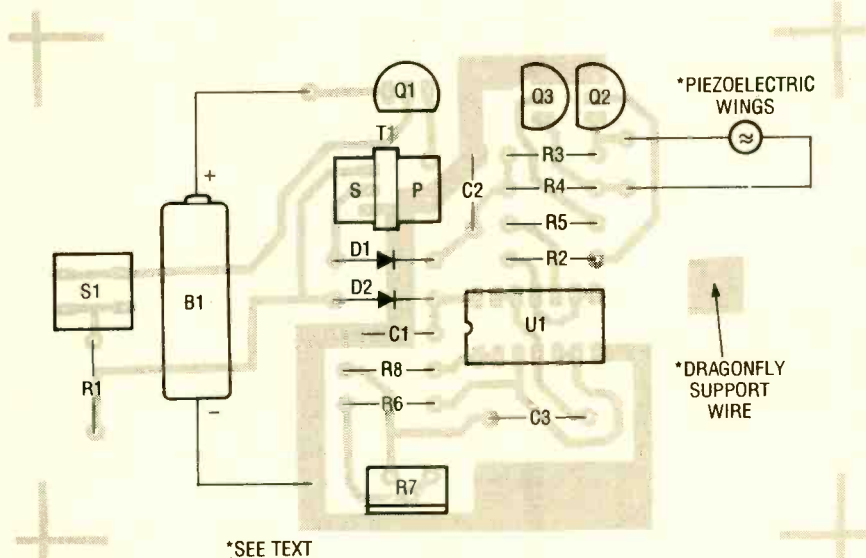

Fig. 4. Solder the parts to the printed-circuit board as shown here. Note where the support wire solders to the board.

quirements, the only alternative to using the transformer that comes with the kit (unless you can find one that provides the same outputs), is to wind one yourself, and that's going to be very difficult; plus, the wire will be expensive and hard to find. Two other advantages to purchasing the kit are that you'll get a pre-etched and drilled printed-circuit board and a colorfully laminated dragonfly body, as well as the piezoelectric-film wings.

For you die-hard do-it-yourselfers (who simply must "roll their own"), the transformer must be wound on a silicon-steel core; the windings are as follows:

- From pin 1 to pin 2, wind 6 turns of 24-gauge enameled wire.
- From pin 3 to pin 5, wind 12 turns of 33-gauge enameled wire.
- From pin 3 to pin 4, wind 1300 turns of 44-gauge enameled wire.

No, 1300 turns is not a misprint, and for those of you brave enough to take on the task of winding the transformer, good luck!

Whichever way you decide to go, it is recommended that the circuit be assembled on a printed-circuit board; printed-circuit construction makes assembling the project a lot easier and makes for a much neater finished appearance. For those of you who want to do everything from scratch, a full-size template for the printed-circuit pattern is shown in Fig. 3. Solder the parts to the printed-circuit board as shown in the parts-placement diagram in Fig. 4. Install them in the order that they're shown in the Parts List so that you can check off each part as it's installed.

Be sure to observe the proper polarity of all the transistors and U1. Because U1 is a CMOS device, we recommend that a socket (which is included in the kit) be provided for that component. If you are not assembling the project from a kit and can't locate the transistors and diodes shown in the schematic diagram, alternative units are listed in the Parts List. Proper soldering, as always, is a must. After the board is finished, carefully inspect it for any solder shorts, opens, cold-soldered leads, and heavy-flux buildups.

The battery holder is mounted to the board using some double-sided tape. Observing the proper polarity, the leads from the battery holder are soldered to the plus and minus pads (points A and B in the kit) on the printed-circuit board. The dragonfly body that comes with the kit is a colorfully lami-

A low-frequency oscillator circuit of about 10 Hz is formed from U1-a, U1-b, C3, and R6-R8. The frequency of the oscillator—which is the rate at which the wings will flap—is adjustable via potentiometer R7. The output of the oscillator is fed to the input of U1-d, which is configured as an inverting buffer. The output of U1-d is used to drive both the base of Q2 via R2 and the input to U1-c, which, like U1-d, is set up as an inverting buffer. The inverted output of U1-c is used to drive the base of Q3, causing its drive signal to be 180 degrees out of phase with that applied to Q2. Because the base inputs of transistors Q2 and Q3 are 180 degrees out of phase, they alternately pull opposite sides of the

piezoelectric film wings low, which causes the dragonfly wings to flap up and down.

Construction. For mainly two reasons, it's best if you purchase the kit for the dragonfly. For one, the piezoelectric film will be pretty expensive in the quantities that are available. And two, the transformer used in the circuit is a very specific part. It must take the 1.5-volt input applied to its primary (at pins 1 and 2) and generate about 5 volts at pin 4, and about 260 volts at pin 3 (after being filtered and rectified, of course). Also, pin 4 supplies the feedback pulse that shuts off the transformer, thus causing the oscillation. Because of those re-

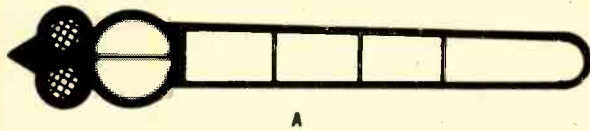

A

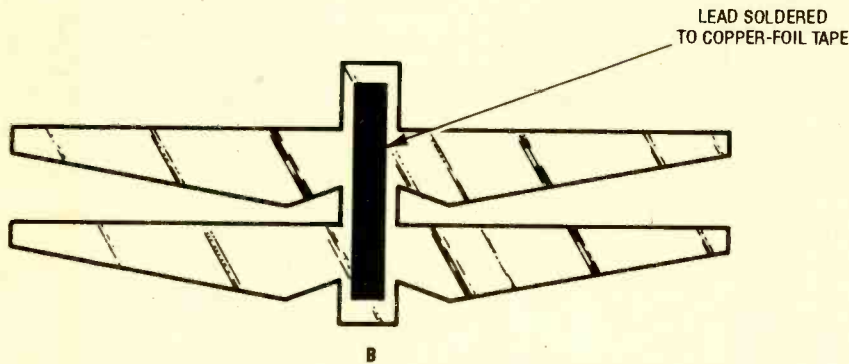

B

Fig. 5. If you're not building the project from a kit, an actual-size template for the dragonfly body is shown in A. Shown in B is an actual-size template for the wings. Remember to use double-layer piezoelectric film.

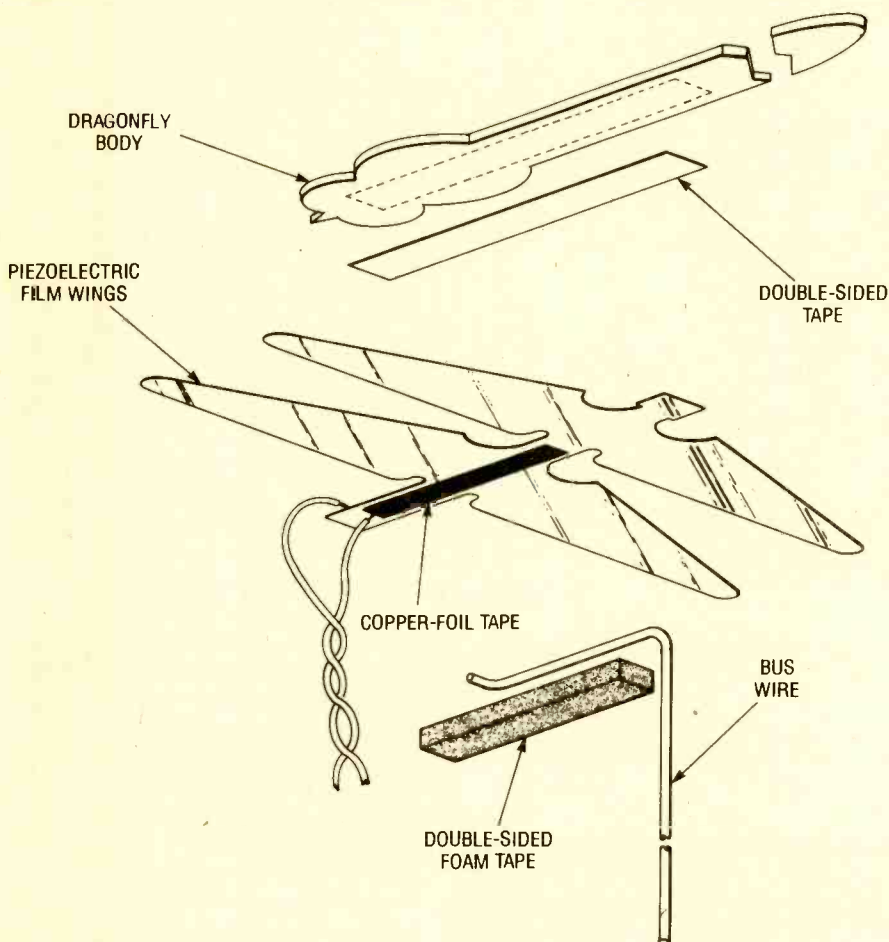

Fig. 6. The wings are held onto the body (as shown here) with double-sided tape, and the dragonfly is held onto the support wire with a piece of double-sided adhesive-backed foam rubber.

nated piece of cardboard. It really spruces up the appearance of the finished project. If you're not building the project from a kit, you're going to have to improvise where the body is concerned—an actual-size template for the body is shown in Fig. 5A.

Also if you're not building the project from a kit, you're going to have to fashion the wings yourself. You'll need some double-layer piezoelectric film cut into the shape of dragonfly wings. We've provided a source for the film in the Parts List, and an actual-size template

PARTS LIST FOR THE ELECTRONIC DRAGONFLY

SEMICONDUCTORS

U1—CD4011 quad 2-input NAND gate, integrated circuit
 Q1—MPSA56, 2N5401, SK3466/159, TCG/NTE159, ECG159, or equivalent PNP silicon transistor
 Q2, Q3—MPSA42, ECG287, SK3433/287, TCG/NTE287, or equivalent NPN silicon transistor
 D1—1N5397 (or similar) 3-amp, 600-PIV silicon rectifier diode
 D2—1K60, SK3090, 1N34A, 1N60, or similar germanium diode

RESISTORS

(All fixed resistors are 1/4-watt, 5% units.)

R1—91-ohm
 R2, R5, R6, R8—100,000-ohm
 R3, R4—1-megohm
 R7—1-megohm, PC-mounted miniature potentiometer

CAPACITORS

C1—0.1- μ F, ceramic-disc
 C2—.01- μ F, ceramic-disc
 C3—.068- μ F, Mylar

ADDITIONAL PARTS AND MATERIALS

T1—printed-circuit-mount step-up transformer with center tap (see text)
 S1—printed-circuit-mount pushbutton switch
 B1—1.5-volt AA battery
 Printed-circuit materials, double-sided piezoelectric film, 14-pin IC socket, bus wire, hook-up wire, battery holder, double-sided tape, rubber feet, solder, hardware, etc.

Note: The Heathkit Dragonfly (kit SK-118) is available for \$21.95 from Heathkit, Heath Company, Benton Harbor, MI 49022 (800) 253-0570. The kit includes everything in the Parts List except the AA battery. Piezoelectric film is available from Atochem North America, 3 Parkway, Philadelphia, PA 19102. Contact them directly for pricing and other information.

for the wings is shown in Fig. 5B. If you can't find double-layer film, try folding over a single-layer piece holding the two sides together with some adhesive. Then cut out the wings from that.

Making electrical contact to the film is a bit tricky. If you are making the wings yourself, you obviously can't solder a lead to the film—the solder will melt right through the film. To make electrical contact, you'll have to use some copper-foil tape. The tape, which is used to repair PC-board traces, has a

(Continued on page 93)

All about Receiver

Sensitivity



Learn about the different ways receiver sensitivity is measured and specified, and what each specification really means.

BY JOSEPH J. CARR

George was both a professional communications technician and a ham-radio/shortwave enthusiast. He had a brand new general-coverage shortwave receiver that was top-of-the-line for the day (I won't say what model—it'd date me!). George claimed that it was the "...most sensitive radio made..." and that it would "...pick up a breath of hot air..." way down in the mud.

While such enthusiastic endorsements are somewhat useful (especially when made by an experienced person), they also evade the question of just what "sensitive" means. In this article we'll provide a useful answer to that elusive question. First, though, let's look at the chief factor that limits receiver sensitivity.

Noise. A radio receiver is a device that must examine the radio portion of the electromagnetic spectrum to find and detect the desired signal. It must also reject undesired signals, man-made noise, and natural noise.

The bottom-line limit to signal detectability is noise, which consists of randomly occurring signals of varying power (or voltage) levels. For that reason noise is handled statistically in radio math. It is necessary to talk about noise in a root-mean-squared (rms) manner because of its randomness. To the listener, noise sounds like a "hissing" tone. A good example of noise can be heard by tuning any receiver (TV, FM, AM, VHF, etc.) to a frequency that is between

active stations (with the mute function off, if one is present).

Noise can come from several different sources. There is incoming noise that is picked up by the receiver antenna (for example, noise generated by galactic and solar activity), and noise contributed by the fact that the amplifiers and other active devices in the receiver are not perfect (these are specified by the noise figure of the receiver).

There is also a certain elementary or basic noise contribution that will be present no matter what other noise is present. If the antenna input is terminated in a resistance that is equal to the input impedance so that no external noise enters the system, and the "ideal" internal circuits are so perfect that they contribute no additional noise signals, there will still be a level of noise present in the output. Why? Because of thermal agitation of electrons in the resistance of the input circuitry. In most cases, the input impedance of a receiver is either 50, 75, or 300 ohms, and R would have a value equal to one of these values (as appropriate). The elementary noise is:

$$P_n = 4KTBR$$

Where P_n is the noise power (in watts) at the receiver input, K is Boltzmann's constant (1.38×10^{-23} Joules/°K), T is the temperature in degrees Kelvin, B is the bandwidth in hertz (Hz), and R is the resistance in ohms. To find the noise voltage, take the square root of that equation. For a 1-MHz bandwidth, 50-

ohm resistance system, P_n is on the order of 10^{-13} watts, so the noise from this source is not a large number. However, it also cannot be overcome no matter how "ideal" the receiver is.

Figure 1 shows the detection problem graphically. Given a noise signal with an average amplitude N , there are three conditions for signal detection shown. First, the signal at A is undetectable because it is below the noise floor (i.e., it is buried in the noise). Second, signal B is barely detectable because it is at the threshold of noise (i.e., it has an amplitude that is at or near the average noise amplitude). Finally, we have a signal at C that is easily detectable. Its amplitude is clearly above the noise threshold, so the radio receiver will have no trouble detecting the signal and producing a useable output.

What's Sensitivity? A radio receiver's sensitivity is a measure of its ability to pick up extremely small signals. More specifically, the sensitivity is defined as the amount of signal required to achieve a certain condition at the output. So, can we define acceptable sensitivity as the ability to pick up and output very weak signals? No, not quite. First we need to know *how weak* is very weak, and how clean the output should be. Both are highly dependent on the nature of the input signal (AM, FM, SSB, etc.) and the type of output desired (voice, Hi-Fi music, dots and dashes, etc.).

Put another way, a sensitivity specifi-

cation is based on an operational definition, rather than fundamental physical principles. So sensitivity measurements are highly contextual. They depend on the the type of modulation and the desired output quality.

The nature of the signal (or type of modulation) will help determine the theoretical limits of a receiver's sensitivity (or "how high is up"). The desired output will determine what is acceptable sensitivity. For a television receiver, minimal sensitivity should produce a snow-free picture. For an AM or FM broadcast receiver, good sensitivity should produce a clear version of the voice or music signal that modulated the transmitter. For a radiotelephone-communications receiver, the tonal quality or fidelity is less important than it is for a broadcast receiver because only a minimally acceptable clarity of communications is required.

Since the definition of what is "sensitive" depends on the type of receiver in question, how sensitivity is measured depends on the receiver in question. There are many different methods used to measure sensitivity, each suitable for a different form of communication. If the wrong method is used for a certain receiver, it can produce misleading results.

Sensitivity in Context. The sensitivity should be measured with respect to other important parameters such as bandwidth or input impedance to have any relevant meaning. As you might have guessed, which parameters are important and their actual values depends on the context: once again, the signal type and the desired output.

Let's take an example to show the importance of different parameters when measuring the sensitivity of a communications receiver. It might have the sensitivity specified for a given signal-to-noise ratio (or SNR). The SNR can be computed by actually dividing the power of an output signal by the power of the noise present in it, or, more commonly, by computing it in decibels (dB) like this:

$$SNR = 10 \log((S + N)/N)$$

or, expressed in voltage units:

$$SNR = 20 \log((S + N)/N)$$

Typical receiver sensitivity specifications call for various levels of SNR (6 dB, 10 dB, 12 dB, or even 20 dB).

Simple measures of sensitivity are ac-

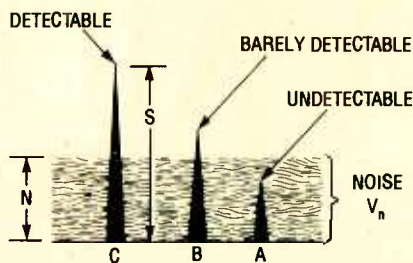

Fig. 1. Here are three signals with some noise. Signal A is undetectable, signal B is marginally detectable, and signal C is easily detectable.

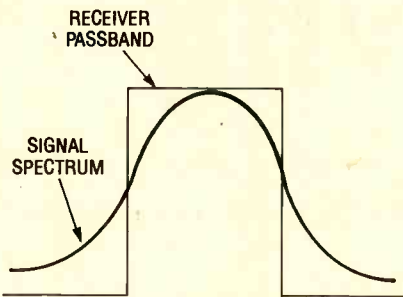

Fig. 2. An ideal match between signal bandwidth and receiver bandwidth results in maximum sensitivity with little or no distortion.

tually not straight SNR, but rather are signal-plus-noise to noise measurements. A more mathematical representation would be:

$$(S + N)/N$$

but that ratio should be converted to decibels. A more sophisticated method used, especially in FM receivers, overcomes some of the limitations of that measurement. These measurements are called SINAD measurements, which stands for "signal plus noise and distortion" and are the principal means for specifying some receiver sensitivities. SINAD—or $(S + N + D)/(N + D)$ converted to decibels—measurements are generally more meaningful than simple signal-plus-noise to noise measurements.

Ways of Specifying Sensitivity.

Obviously, noise is clearly a factor in the sensitivity specification of a receiver when measured in this fashion. However, the amount of noise present at the input is directly proportional to the bandwidth of the selective filter of the receiver. Therefore, the bandwidth of the receiver must also be considered. Ideally, the receiver-selectivity controls, which usually adjust the IF amplifier filter, are set to the instantaneous bandwidth required to correctly receive and demodulate the desired input signal; no more, no less (see Fig. 2). If the band-

width is too high for the received signal, then the noise present goes up, and sensitivity (in terms of SNR) goes down.

Figures 3A and 3B show two different scenarios in which two receivers have the same bandwidth, but vastly different sensitivities. Keep in mind that the noise term is proportional to the area under the passband curve. Figure 3A has a relatively decent shaped passband characteristic, with bandwidth BW. But, because the receiver with the bandwidth curve shown in Fig. 3B has a very poor filter that causes peaks in the passband, (definitely not desirable), it can actually produce a lower noise figure. Here, we have "apparent sensitivity" at a cost of significant distortion of the spectrum of the received signal; not good!

To prevent any "creative" specification writing that might result from taking advantage of such situations, several different ways of determining sensitivity have become standards (or near standards). Each "standard" depends on the signal type, the desired signal quality, and usually takes into account any additional important specifications (like bandwidth and input impedance).

For example, in performing a SINAD sensitivity test, one must take into account the signal level, noise level, and the output distortion. Figure 4 shows a typical test set-up. The FM signal generator must be modulated by a 1000-Hz tone to a level of 60% of the peak deviation acceptable to the receiver (peak deviation is typically 5 kHz on communications receivers and 75 kHz on broadcast receivers). The audio signal source must have a very low inherent total harmonic distortion (THD) level. The audio output of the receiver is set to 50% of its rated maximum power level.

The output voltage level is measured under two conditions in the SINAD test. First, the level is measured with switch S1 in the A position. This signal represents the signal, noise, and distortion components. Next, the switch is set to B, so that a 1000 Hz notch filter is in the signal path. This filter takes out the modulation signal (S), leaving only the harmonic distortion and noise components. The SINAD sensitivity is the number of microvolts that will yield an $S + N + D/N + D$ figure of 12 dB. Typical values for 12 dB SINAD sensitivity are stated as 0.1 μ V to 0.2 μ V.

Another way of specifying sensitivity is the "dBm method." It indicates the input power required to achieve the desired

(Continued on page 92)

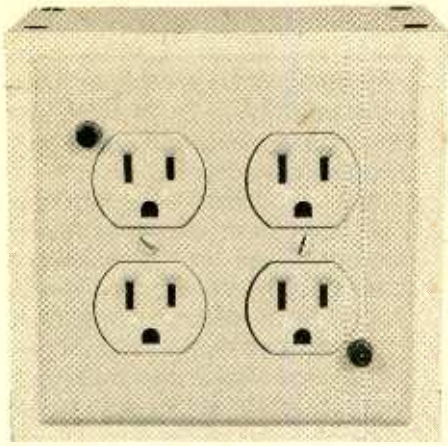

BUILD THE SOCKET SENTINEL

BY JOHN YACONO AND MARC SPIWAK

Most people would agree that it's a good idea to have some kind of protection on any AC outlet used to power a computer. That kind of thinking probably came about not just because computers are more sensitive to line fluctuations than most appliances, but because they were more expensive in the past as well. And while many computers are still quite expensive, it's very likely that most computer owners have a video system that's worth a lot more than their computer. Also, the damage done to a TV or VCR by a line surge will probably be much more costly than to a PC—after all, a PC's power supply can be replaced for under \$100. So, it stands to reason that just about any expensive electrical appliance should be protected from line surges.

As you're probably aware, you can buy surge-protected outlet strips for a reasonable price these days. They'll not only provide the protection you need, but they'll also give you the convenience of being able to turn on many different things from one switch. However, the major problem with them is that the master switch must be accessible in order to turn everything on. And, with several things plugged into it, it can be an unsightly rat's nest of line cords.

But imagine plugging a number of items into a surge-protected outlet box that could be hidden from view, and being able to turn on all of them by merely turning one item on using its own on/off switch. That's what the *Socket Sentinel* described in this article is designed to do.

The unit has one "master" outlet and three "slave" outlets. When the Sentinel

You don't have to put up with unsightly powerstrips to control multiple devices with one switch. Our device senses current flowing into one device and automatically turns on up to three others!

is plugged in, the master outlet is always hot and ready to go. An AC-powered device plugged into the master outlet will function normally. A neon indicator next to that socket is always on to both identify the master outlet, and to tell you that the surge protectors are in good condition. If the device connected to the master outlet is off (*i.e.* draws no current), the three slave outlets remain unpowered. It's only when the master device is turned on that the three slave outlets become hot, and a second neon indicator (at the opposite corner of the Sentinel) turns on. That's to let you know that the slave outlets are alive, and anything plugged into them will receive power.

The prototype unit has been designed to withstand only moderate current levels. Our unit has been built to provide the master outlet with up to 1 amp of current, and can provide the slave outlets with a combined output of 6 amps. However, those limits are not written in stone; later we'll describe ways to increase the unit's current capacity. Furthermore, you can add more slave and master sockets, if you wish, as long as you don't violate the current ratings of the components that you use in your unit.

There are many possible uses for the unit. One obvious use is to have your entire computer turn on when you turn on your monitor. Or your stereo or video system can be turned on in a similar manner. It would also be neat to have some of your test equipment turn on when you turn on a shop lamp.

Triacs. The Sentinel uses a Triac to switch power on and off, so a few words about Triac operation are in order. (If you are already familiar with quadrant-I and -III firing of Triacs, you might want to skip down to the next section.)

Triacs are multi-layered three-terminal semiconductor devices. Their three terminals are commonly denoted G, MT1, and MT2 (which stand for gate, main-terminal 1, and main-terminal 2, respectively), as shown in Fig. 1. Each terminal has a different function.

To help you understand how they operate, take a look at Fig. 2, which is a "characteristic curve" of a Triac. Let's consider quadrant I—the upper right—of the graph first. That's where the current and voltage are both positive. The voltage (V) is applied between the two main terminals, and the current (I) is the current that flows between those terminals.

As you can see, if you apply voltage across the main terminals, they will not conduct significant amounts of current until the voltage reaches a certain value called the *breakdown voltage*. At that point the Triac's resistance suddenly drops, allowing current to flow freely. After breakdown, the voltage across the main terminals can drop to a low value without the Triac turning off. As you can see, that behavior forms a "knee-bend" in the characteristic curve.

If a voltage is applied between the gate and main-terminal 1, current flows through the gate. The flow of gate current causes a decrease in the value of



Fig. 1. Triacs are multi-layered three-terminal semiconductor devices. Each terminal has a different function.

breakdown voltage needed to turn on the Triac. In other words, the knee-bend becomes less sharp. You can increase the gate current to the point where the knee-bend is hardly noticeable. At that point, it only takes a small voltage across the main terminals to turn the Triac on and the Triac can be considered similar to a low-value resistor. That is called "quadrant-I operation."

The same knee-bend behavior can be seen when the polarity of the voltage across the Triac is reversed. In that situation, applying voltage to the gate still reduces the breakdown voltage, but the gate voltage must be more *negative* than main-terminal 1. As you may have guessed, this is called quadrant III operation.

To handle alternating current, the gate voltage must be positive with respect to MT1 when MT2 is more positive than MT1, and negative with respect to MT1 when MT2 is more negative than MT1. That is almost always accomplished by connecting some electrical component between MT2 and the gate. That has the effect of pulling the gate voltage toward MT2, and thus away from MT1, thereby providing the necessary potential between the gate and MT1.

As you'll see, our unit does just the opposite. A potential of the right voltage and polarity is applied between MT1 and the gate without the assistance of MT2. That is accomplished through an unusual diode network.

The Circuit. To do its job, the Sentinel uses some basic components in an unusual fashion (see Fig. 3). The unit is protected from surges by the two metal-oxide varistors or MOV's (MOV1 and MOV2). An MOV is basically a component that appears as an open circuit until the voltage across it exceeds a certain value. If then appears as a short circuit so that any voltage spikes large enough to cause it to short can be harmlessly shunted to ground.

Neon indicator NE1 is used to show that the MOV's are okay, as you'll see in a moment. If the MOV's ever have to divert a surge with a current of more than seven amps, fuse F1 will blow. That

PARTS LIST FOR THE SOCKET SENTINEL

SEMICONDUCTORS

- TR1—6-amp, 400-PIV Triac (ECG5616 or equivalent; see text)
- D1-D6—1N4004 1-amp, 400-PIV, silicon rectifier diode (see text)
- MOV1, MOV2—V130LA120A high-power, metal-oxide varistor

ADDITIONAL PARTS AND MATERIALS

- R1—10,000-ohm, ¼-watt, 5% resistor
- F1—7-amp fast-acting Pico II fuse
- NE1, NE2—Neon power indicators with built-in resistors (Radio Shack 272-712 or equivalent)
- PL1—Three-conductor AC-line cord with plug
- SO1, SO2—Dual-outlet wall socket
- Heavy gauge wire, heat sink, heat-sink grease, perfboard, junction box, wood, screws, solder, etc.

opens the circuit to NE1, which then goes out to let you know that the MOV's may be "unhealthy." As long as NE1 is on, the MOV's should be okay, and the devices plugged into the Sentinel are protected.

The protection circuit is designed that way because the only way to tell if an MOV is good is to expose it to high voltage and measure its impedance. But it's a good bet that a surge of over seven amps will damage one.

The rest of the circuit is responsible for monitoring current through socket SO1-a (the master socket), and turning on sockets SO1-b, SO2-a, and SO2-b (the slave sockets). The sockets are labeled SO1 and SO2, -a and -b, because they are common two-outlet type wall sockets.

Ignoring R1 for the moment, if a device plugged into SO1-a starts to draw

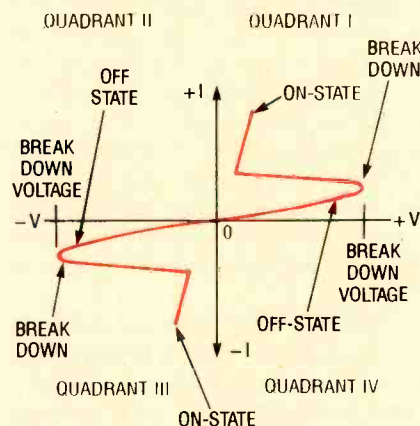

Fig. 2. This is the characteristic curve of a Triac without gate current. It is a plot of the voltage across the main terminals versus the current through them.

current, the current will flow through the diode network. Current will flow through one string of three diodes during positive alterations of the AC line, and through the other set of three during negative alternations.

As you probably know, there is a voltage drop across any diode when it's forward biased. For the rectifying diodes specified, that drop is around 0.8 volt. So when the three diodes on the left are forward biased, each drops 0.8 volt, giving a total of 2.4 volts across the entire string of three (3×0.8). When the string of diodes on the right is forward biased, it also drops a total of 2.4 volts, but with the opposite polarity.

That voltage looks very much like an AC squarewave if viewed on an oscilloscope. That squarewave is sent to the gate of the Triac (TR1) and used as a trigger signal. To summarize, if current flows to the master socket, the diode network supplies TR1 with a voltage-limited gate signal of the proper polarity. The Triac then turns on and supplies power to the slave sockets. Indicator NE2 then comes on to indicate that power is available at the slave sockets.

There are brief intervals when the voltage across the diodes is above -2.4 volts, but below $+2.4$ volts. During those times, both sets of diodes don't conduct. That would cause the Triac to shut off briefly because there would be no gate current. Resistor R1 allows some current to flow during those intervals so that TR1 can deliver uninterrupted power.

By the way, it is the Triac itself that limits the combined output current of the slave outlets to 6 amps, because that's the rating of the unit used in the prototype. Of course, if you use a beefier Triac, your slaves will be that much more powerful. Triacs of 10, 15, 25, and 40 amps are available as common replacement parts.

To increase the current-handling capacity of the master socket or to add more master sockets, use hardier diodes. The current rating of the diodes should be at least equal to the maximum current required by the master socket (or the total of all the sockets in a unit with multiple master sockets). Note that you don't have to replace R1 with a higher-wattage resistor because it will never see more than ± 2.4 volts.

You may be wondering why we didn't just use a resistor in place of the diodes. Well, the voltage drop across a resistor would vary with the current to SO1-a. Since too much gate voltage would

blow the Triac, you would have to adjust the value of the resistor to suit the device plugged into SO1-a, which would be quite cumbersome. Also, if the device draws different amounts of current at different times, adjustment of the unit would become impractical.

Construction. There's not much to say concerning the construction of the circuit itself. Basically all of the parts, with the exception of the neon lamps, are mounted on a piece of perfboard with the low-power interconnections made with bits of bus wire. That's with the exception of certain component leads that were simply twisted together and soldered—the string of diodes, for example. The connections to and from the board, as well as any other connections that carry heavy current loads were made with 12-gauge stranded wire. The connections to the Triac leads were first wrapped tightly around the leads and then soldered. We also provided the Triac with a heat sink, as it is common practice with such devices.

The unit described here doesn't handle extreme current loads, so soldering is adequate. But keep in mind that solder will melt at relatively low temperatures, so the mechanical connections between leads must be strong to begin with. If you wish to power larger devices from the slave outlets, you must not only use a larger Triac, but the wiring should also be beefed up accordingly. As a matter of fact, the connections to the leads of a larger Triac might have to be twisted and secured with a wire nut. Whatever you do though, be extremely careful to avoid shorts and potential future shorts by keeping live connections well spaced.

Keep in mind that you can build your own Socket Sentinel with as many slave outlets as you like, as long as the parts you use can handle the total load. Do make sure that the line cord, as well as the outlet that you plug the entire unit into, can handle the total current.

You don't have to go crazy with the wiring for the surge-protection circuitry. It will never have to handle continuous high-current loads, and a surge of seven amps will blow the fuse anyway. The same goes for the neon lamps, as they do not draw much current.

As mentioned before, the sockets are of the duplex (double-outlet) type. So, in order to have the master *and* one of the slaves on the same assembly, the tab that connects the two socket's hot terminals together must be broken off

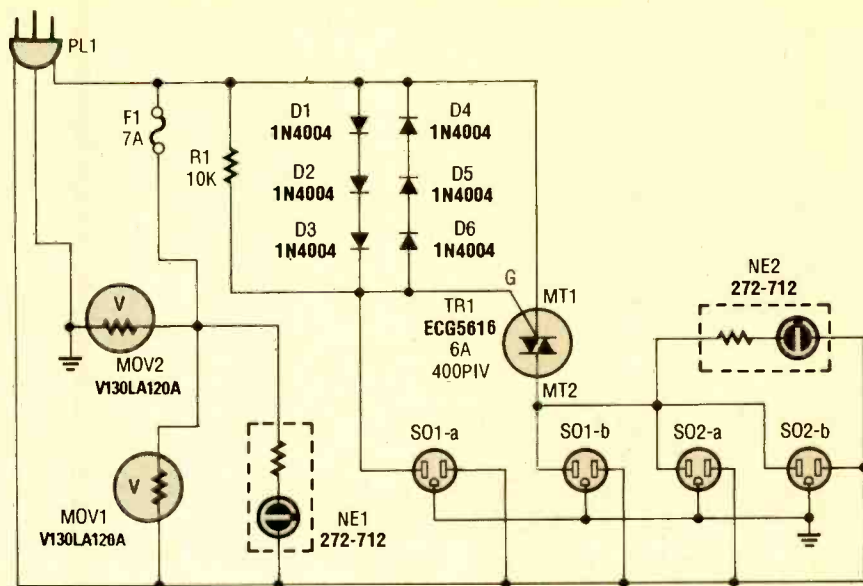
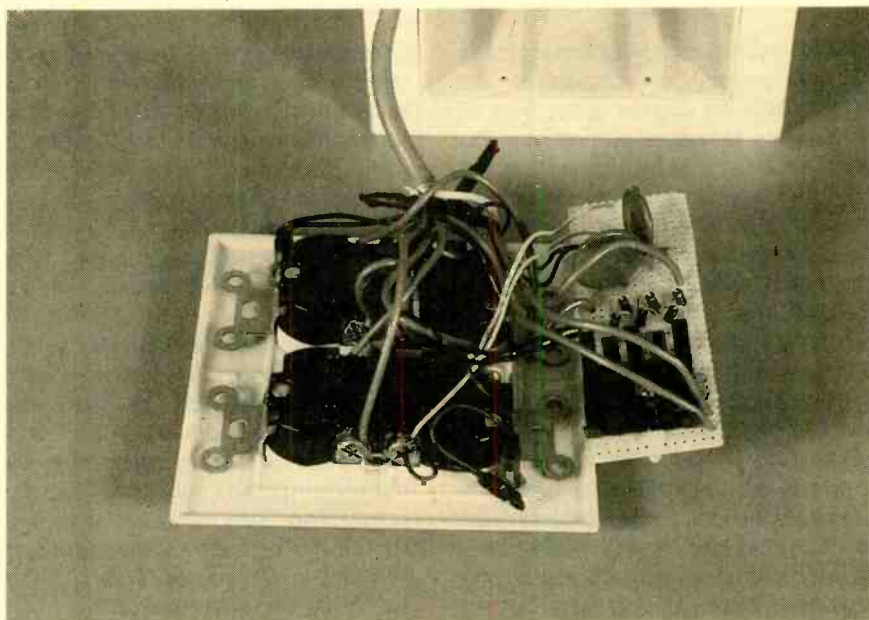

Fig. 3. This circuit for the Socket Sentinel looks odd, but it works very well. The diodes provide the Triac gate with a voltage-limited gate signal.



This internal view of the Sentinel should give you some idea of what gauge wire goes where. Be sure to give the components plenty of room to prevent shorts.

with a pair of pliers (modern duplex sockets have tabs that are designed to be broken).

The neon lamps, which were purchased from Radio Shack (see Parts List), come complete with internal current-limiting resistors, panel-mounting red lenses, and pre-wired leads. Appropriately sized holes were drilled in the plastic outlet plate that covers the top of the unit to accommodate the lamps. Remember to mount the neon bulbs before making the electrical connections to the rest of the circuit as the leads must go through the mounting holes.

A plastic outlet box, designed to be

nailed directly to a wood beam, greatly simplified the assembly of the cabinet. The tabs for the nails were cut off, and two holes were drilled in the bottom to secure the circuit board with two nylon screws. If you use metal screws, beware of potential shorts. The socket assemblies are simply mounted directly in the preformed holes in the plastic box, and the outlet panel is attached by screws to the sockets—just as it is in your wall.

As a nice finishing touch, a box was made from white particle board to enclose the plastic box. That step is unnecessary, as you can simply paint the box or leave it unfinished—it can, after all, be hidden from view.

A Hands-on Electronics REPORT

OWI, INC. WAO II MOBILE-ROBOT KIT



CIRCLE 119 ON FREE INFORMATION CARD

Build the WAO II programmable robot for hours of mechanized fun.

Designing a project from scratch is certainly one of the best ways to educate yourself in the field of electronics. However, sometimes you might feel like building something just for the fun of it or to keep yourself busy—and that's where kits come in. A good kit comes with everything you'll need to build a project from beginning to end, without having to run to the electronics store every ten minutes to pick up that one "last" part.

The problem with many kits is that the finished product often has a very unfinished look about it. You usually have to spend extra money for things not included in the kit such as a project case to house the unit in. And, quite often, there's more work involved in preparing the case than in building the project in the first place. On top of that, the appearance of the finished case often leaves much to be desired despite all of your hard work.

That's where the beauty of the MOVIT robots from OWI kits really shines through. When finished, they actually look good enough to be used as a prop in a science-fiction movie (keep that in mind if you enjoy making amateur sci-fi videos). The kits are available in different configurations, complexities, and price ranges.

All of the robots come with assembled and tested PC boards, which is good if you would rather start out with a known-good circuit, and bad if soldering is something you really enjoy doing. However, because all of the kits are recommended for ages 10 and up,

it's probably best that the soldering has already been done. The kits will make excellent gifts for children, although some of them may be too complex for some 10-year-olds—you have to use your judgment as to whether the child you have in mind will be able to assemble the kit. A schematic diagram of the circuit is included with the kit.

WAO II's Main Features. In this hands-on report, we will review one of the most complex kits, the WAO II Intelligent Robot (model MV-961) with an MN1551KHA 4-bit microcomputer. The microcomputer's fundamental programming (including some built-in demonstration routines) is permanently installed in an on-board 1K × 8 ROM. The WAO II can be further programmed to move as you like, and respond to inputs from two obstruction sensors. The programming steps you add are stored in an on-board 96 × 4 bit RAM.

Also, the WAO II can even be used as a timer; you set it for a number of minutes between 1 and 9, and it will remain at rest until the time is up, at which time it will start to rotate.

A pen attachment allows the unit to draw as it moves, as well as write a random number from 1 to 6 in its "dice" mode. You can program the robot through a keypad on the back of the robot or by using an optional interface card for an Apple computer (more on programming later).

The robot is powered from three "AA" batteries and one 9-volt battery. The three "AA" cells power the drive motors,

and must supply a maximum current of 600 mA, for about 20 minutes of continuous use. The 9-volt battery powers the microcomputer circuitry, which requires a maximum of 5 mA, yielding up to two weeks of continuous use; when the microcomputer is in the "sleep" mode (more on that later), it consumes only a low 3 μ A.

The Robot Assembly. With the exception of the batteries, a ballpoint-pen refill, and the tools you'll need, the kit comes with everything; even a little tube of grease for the gears. For assembly you'll need long-nosed pliers, a small hammer, and a small Phillips-head screwdriver. The front page of the assembly manual includes descriptions and diagrams of all parts included in the kit. The parts are neatly packaged in numbered bags. That's very helpful because when an instruction calls for a particular part, it states which bag the part should be in.

The kit can be built in a few leisurely hours, quicker if you're in a hurry, and slower if you're not. Building the kit is much like building a radio-controlled car, although on a much smaller scale. All of the parts are of high quality, and they all line up perfectly.

The first (and fifth) assembly step involves pressing or lightly tapping some plastic gears onto metal shafts. Although an adult shouldn't have any trouble doing this, it may be difficult for children, at least without an adult's supervision.

The unit has two drive motors, and

therefore two simple gearboxes that must be assembled but, by carefully following the assembly diagrams, you shouldn't have any trouble with that. After assembling the gearboxes and checking them for smooth operation, the gears should be lubricated with the included grease. The two completed transmissions attach to the robot frame using small Phillips-head screws, as do all mechanical connections—there is no glue involved in the assembly of the WAO II.

Because the unit is able to draw and write numbers, you must supply a ball-point-pen refill. Before installation, it must be cut down to about two inches. That can be messy, especially if it's a full refill. The cut-down refill fits inside an included penholder that mounts on the underside of the robot.

The next step is to mount the PC board and control panel to the robot chassis, and complete all of the wiring. Wiring is made easier with the prepared leads that come with the kit and some very unique binding posts that are already soldered to the board. The binding posts stand vertically on the board with a plastic body around them and a hole down the center. To use them, all you have to do is pull the plastic body straight up, about 1/8-inch, insert the tinned wire ends, and push the plastic body back down. The posts make for a quick, easy, and reliable connection that is easy to undo should you make a mistake.

You may be confused by the fact that the kit includes two 9-volt battery clips. It's nothing to worry about, one of them attaches to the 9-volt battery, and the other clips onto the 4.5-volt battery pack (a holder for three AA cells). Space is provided to house the batteries on the underside of the chassis.

Once the wiring is complete, all that's left to do is install the body shell and clear-plastic dome that covers the circuit board, and attach the feeler sensors to the left and right sensor switches. At this point, the robot is complete and ready to run (provided that you put the batteries in).

Testing and Use. The first thing you'll want to do is to make sure that the motors will at least turn on, so the easiest thing to do is to run the "roulette" or "dice" demonstrations. First try the roulette; press reset, then run/sleep, and then roulette. The robot should rotate a random number of times and stop—but who knows where?

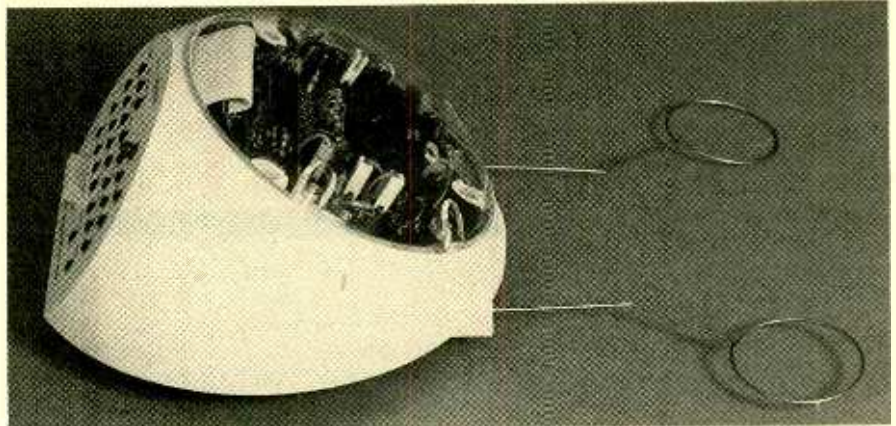

The WAO II can be programmed to check the condition of the left and/or right sensors (with feelers shown here on the right), to determine if (and where) an object is in its path. On the back of the unit (on the left here) is the control panel.

The first time you try the dice demo, do it without a pen attached, just to see the robot go through its paces. If you want to see the robot write a number, then you'll have to attach the pen and place the robot on a large sheet of paper or some other flat surface that you don't mind it writing on.

At this time, it's best if you carefully read the instructions on programming the robot. Before trying to enter your own programs, try loading and running some of the included demonstration programs to get a feel for the keypad and the robot's behavior. Programming is done through the keypad on the back of the robot or using an optional interface card for Apple computers. (The optional interface, designed for use with Apple II, IIe, and II Plus computers, allows you to enter commands to the WAO II from the computer, edit programs, store programs, and download programs to the robot.)

The microcomputer is activated when you press the reset button; that clears the RAM and readies the microcomputer to accept input from the keypad. Programming involves pressing a

command button (forward, stop, turn right, turn left, rotate right, etc.), and entering a duration number from 1 to 9. (The robot moves forward or backward when both motors are running in the same direction, and rotates when they run in opposite directions.) A complete series of motions and durations constitute a program.

For/next loops can also be included, as can instructions to beep, light the LED, and check the condition of the left and/or right sensors. A run/sleep button serves two functions: it will cause the robot to execute any program that has been entered, or put the robot in the "sleep" mode if no program is installed at the time. The sleep mode is basically the "off" mode, as the circuit draws only 3 μ A when sleeping.

The WAO II is not only fun to put together and play with, but it's also an excellent way for beginners to learn how programming works. But don't be scared by the word "programming," as it is very easy to pick up after only a short time of use. Before long, you'll be programming the robot to run through obstacle courses, avoid obstacles when encountered, and whatever else you can think of. Even people who understand the programming right away will still find the WAO II very entertaining. And the WAO II is not only an excellent step into the world of computers, but it will also help exercise anyone's mechanical skills.

The WAO II is available from OWI Incorporated, 1160 Mahalo Place, Compton, CA 90220 for \$109.95. The Apple-interface card is \$54.95. You can call OWI at 1-213-638-4732, or fax them at 1-213-638-8347. For more information on the WAO II robot, contact OWI directly, or circle 119 on the Free Information Card. ■

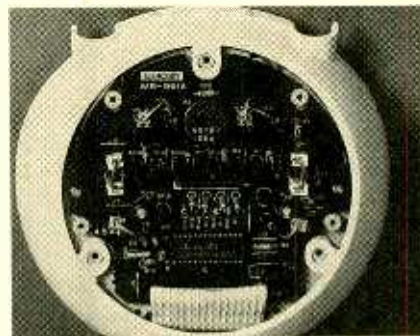

These are the brains of the WAO II intelligent robot. It contains an MN1551KHA 4-bit microcomputer, with on-board 1K \times 8-bit ROM and 96 \times 4-bit RAM.

PRODUCT TEST REPORTS

By Len Feldman

Pulsar TVP 2000 "Prodigy" Projection TV Receiver

A front-projection set, the "Prodigy" TVP 2000 from Pulsar Video Systems (7676 Clairmont Mesa Blvd., San Diego, CA 92111) provides a level of performance sure to please even the most demanding home-theater enthusiast. To the point, the large 72-inch (diagonally measured), bright picture produced by this superb do-it-all TV monitor/receiver can involve viewers in program fare in a way that just can't be done even with 40- or 50-inch rear-projection sets. Furthermore, the unit takes up surprisingly little floor space when used with a properly mounted, separate screen with high gain,

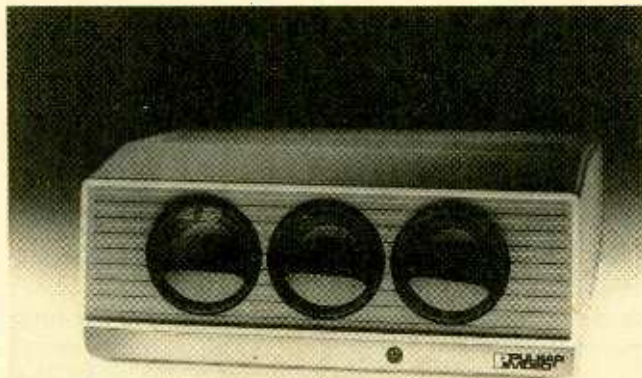

CIRCLE 120 ON FREE INFORMATION CARD

The Pulsar TVP 2000 "Prodigy" projection TV monitor/receiver.

such as the 6-foot diagonally measured curved screen provided by Pulsar for our tests. That's especially true when the receiver itself is combined with an optional floor stand that can double as a coffee table; the receiver can also be ceiling mounted.

While most front-projection systems we've seen

require a separate TV tuner or other video input as a program source, the Pulsar TVP 2000 not only contains a TV tuner capable of receiving broadcast as well as cable channels, but it incorporates an MTS (stereo/SAP) decoder as well. The audio outputs on the rear of the Pulsar TVP 2000 cannot be controlled by the volume control, which only affects the unit's internal speakers. However, since those speakers are mounted on the bottom of the cabinet, for better stereo effect an external stereo amplifier and speakers should be used.

Auxiliary components that supply baseband audio and video can be connected directly to the Pulsar TVP 2000. A digital comb filter is incorporated so that truer color pictures and better resolution can be obtained even from broadcast or cable TV sources. Operation of the set is greatly simplified by on-screen display of main and sub menus. Digital freeze frame of pictures is possible, as is picture-in-picture when more than one program source is available.

A channel and time display comes on screen when the set is turned on or when a channel is changed. Using the menu button on the remote control, it is even possible to activate a full demonstration of all the on-screen menus and what they do. The main menu is made up of 4 menu pages: the setup page, features page, audio

page, and video page. Most menu pages can be enlarged on-screen by pressing a text-size button on the remote control. Pressing that button a second time brings the menu back to its normal size. The owner's manual describes in detail what can be done from each menu page. Within the features-menu page, for example, you can set a sleep timer. That page also allows you to place a label (such as the network name or cable channel name) along with the channel number that appears in the channel/time display. Custom labels can be given to four channels, but there is also a long list of available labels that have been preset by Pulsar. "Parental control" or lockout of specific channels can be done using the remote control while accessing the features-menu page. You can store your favorite TV or CATV channels so that when you scan channels later, only those channels you've stored will be scanned.

The audio-menu page allows adjustment of such audio-related operating parameters as bass, treble, and balance controls, and selection of stereo mode. There's even an audio-only setting that allows you to play an auxiliary audio component such as a stereo receiver, CD player, etc. without having the TV picture on the screen. All major adjustments can be made from the remote control with on-screen displays and bar charts showing you the

TEST RESULTS—PULSAR TVP 2000 PROJECTION MONITOR/RECEIVER

SPECIFICATION

PE MEASURED

Video Section

Maximum usable luminance	140 Foot-Lamberts
Resolution, horizontal	600 lines
Convergence (center/corners)	Good/good
Video frequency response	7.5 MHz
Interlace	50/50
Transient response	Very good
Black-level retention	100%
Color quality	Very good
Overscan	Excellent

Audio Section

Audio output, 0 = dB reference level	0.28 V, 0.15% THD.
Total harmonic distortion, 1 kHz @ -10 dB	0.09%
Signal-to-noise ratio, A-weighted	66.1 dB
Frequency response	20 Hz to 16 kHz

TV Stereo Section

Signal-to-noise ratio	
Stereo (L/R)	58.6/58.5 dB
SAP	65.5 dB
Mono	58.1 dB
Harmonic distortion @ 1 kHz, -20 dB (L/R)	0.24/0.26%
Frequency response (at -20-dB modulation level)	
Stereo (left)	41 Hz to 12.3 kHz
Stereo (right)	41 Hz to 12.8 kHz
SAP	250 Hz to 4 kHz
Mono	38 Hz to 3.5 kHz
Stereo separation (100%/-20-dB re 100%)	
Left	19.5/18.4 dB
Right	18.8/19.2 dB

Additional Data

Picture size	72 inches (diag.)
Power requirements	185 watts
Dimensions (H x W x D, inches)	9¾ x 25½ x 24½
Weight	55 lbs.
Suggested retail price:	\$4295.00

range of the adjustments as you go.

CONTROLS

The front jack panel on the Pulsar TVP 2000 lets you connect a variety of audio/video components to the set. Typical components that can be used include VCR's, camcorders, home videogames, videodisc players, stereo receivers, external speakers, etc. Necessary input jacks for any of these devices (including an S-video input) are all available on the front jack-panel. Also found here is a toggle switch that's used for switching between internal speakers and external audio or speakers.

Back-panel controls include a video selector (S-video or regular video in-

put), adjust buttons for selecting the menu displays, a menu button for displaying the menu or for initiating the automatic demonstration of all the menu features, volume up and down buttons, channel up and down buttons, and an on/off switch. All of those controls are also found on the supplied remote control, as are number buttons for direct channel access, various buttons associated with the picture-in-picture and flashback features, and a mute control.

TEST RESULTS

APEL tested this projection TV set using a separate screen supplied by Pulsar. The 6-foot screen, mounted at a slight downward angle, was positioned approxi-

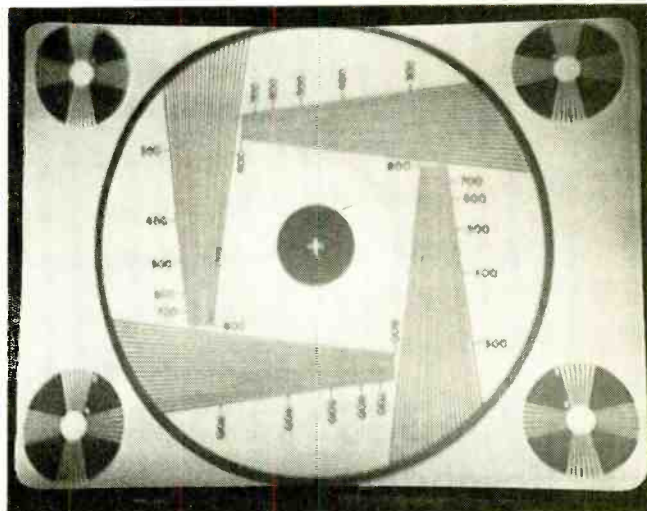

Horizontal resolution for the TVP 2000 tested out at a superb 600 lines.

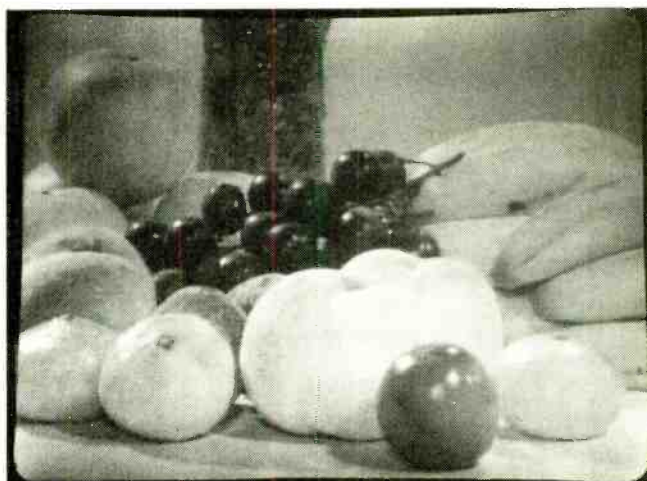

When the equivalent of a fringe-area signal was input to the set's antenna terminals, the resulting picture retained accurate color reproduction and showed hardly any snow or noise.

mately 7 feet from the set and viewing distance was set at approximately 12 feet from the screen. As is true of any projection TV set, it was first necessary to adjust the convergence of the three picture tubes. In this case, red and blue tubes are adjusted to register properly along with the fixed green projection tube. This task was easily accomplished in a matter of just a few seconds.

APEL reported a maximum usable luminance of 140 foot-lamberts for this projection TV set. That's more than enough to afford comfortable viewing in a normally illuminated room.

Horizontal resolution was

a superb 600 lines, while video frequency-response extended to 7.5 MHz. Interlace was a perfect 50/50, so that even at the minimum recommended viewing distance we were not troubled or distracted by scan lines being obvious in the image that was displayed.

Transient response was very good too, with no bothersome white-line borders or overshoot showing up at transition points between major dark and light borders of a scene. Another thing that was particularly noteworthy was the perfect 100% black-level retention of the set. With such an expanded picture size and

(Continued on page 94)

COMPUTER BITS

By Jeff Holtzman

The 386 Revolution Continues

Last time I talked about how the old distinctions between PC, XT, and AT have now given way to distinctions among 386-class machines. What used to be the PC category is now determined by 386 (and 386SX) systems running at 16 or 20 MHz, the XT by 25-MHz 386 systems, and the AT by 33-MHz 386 systems. Due to Intel's lost monopoly on the 386, gradations of the 486 will quickly start overtaking the

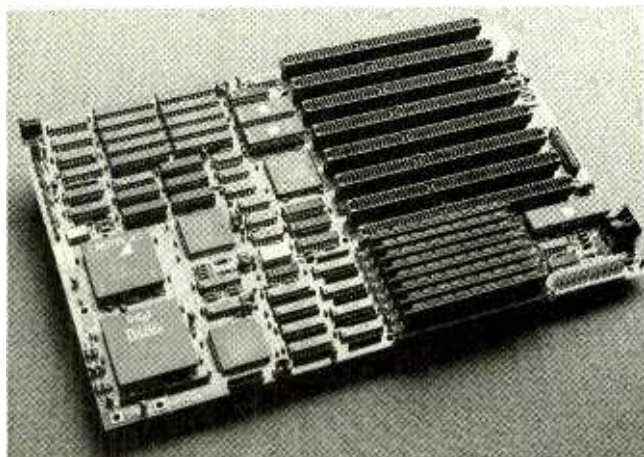

This 25-MHz 486 motherboard from Pioneer Computing can accommodate up to 32MB of SIMM memory in various combinations (256K, 1MB, and 4MB) without using a slot.

386. Already, you can buy basic 486 systems for about \$2000.

This new world of PC power enjoys greater compatibility across the range of performance than did the old PC/XT/AT division. All systems based on the 386SX, 386DX, and 486 offer identical memory and task management abilities. For example, Windows will run in 386 enhanced mode identically on a 16-MHz 386SX laptop and on a 33-MHz 486 monster. Of course the 486 will run somewhat faster.

I had been running a first-

generation 16-MHz 386, and have worked on 386SX-based laptops. Now I wanted to get a feel for higher performance levels. So I tested 25-MHz 386 boards from Hauppauge Computer Works, JDR Microdevices, and Mylex Corporation; a 33-MHz 386 board from Jameco Electronics; and a 25-MHz 486 board from Pioneer Computing. All five are built well and speedy.

Upgrading my old 16-MHz board to the first board (the 25-MHz Hauppauge) was in some ways the best experience, not only for the speed increase, but also because I had been experiencing random system crashes under Windows. Even with identical peripherals installed, none of the motherboards I tested exhibited any of those problems. Overall, I found running Windows with the Pioneer board and eight megabytes of RAM most enjoyable.

The test hardware included several types of video adapters, SCSI hard-disk interface, LANtastic network-interface card, and miscellaneous I/O cards (serial, parallel, modem). My primary working environment was Windows 3.0 running Word for Windows 1.1, MS Project 1.0, Excel 3.0, Corel Draw 1.21B, CrossTalk for Windows 1.1, and numerous small utilities. I experienced no hardware or software anomalies or incompatibilities.

Now for a quick run-down on each board, in alphabetical order by manufacturer. Each board's features are summarized in Table 1.

HAUPPAUGE

Of the group, this 25-MHz 386 motherboard is the only board that accepts DIP IC's on the motherboard, a maximum of 4MB. (Some of the others accept SIMM's on the motherboard.) You can also add another 4MB via a special memory card. Without the memory card, you gain an additional 8-bit slot. This was the only uncached board I tested, consequently it was slightly slower than the others. Nonetheless, I was impressed with its overall quality and with Hauppauge's step-by-step installation.

JAMECO

At 33 MHz, this 386 was the second fastest board that I tested. The board itself accepts no memory; all memory is mounted on a separate expansion card that reduces the total number of slots to seven. Depending on whether you use 256K or 1MB SIMM's, the board will run with 1, 2, 4, 8, or 16MB. Interleaving functions only at 2, 8, or 16MB. I found 8MB quite comfortable for running multiple applications simultaneously under Windows. The price of the board includes the required memory card. Other than speed, this board is virtually identical to the JDR board. In addition to "generic" documentation, the board came with a specially written installation guide. A 25-MHz version is also available.

JDR

See my comments on the Jameco board. Faster overall than the Hauppauge, but slower than the Mylex

TABLE 1—FEATURE SUMMARY

Feature	Hauppauge	Jameco	JDR	Mylex	Pioneer
Model No.	ATCL25-04	JE3533	MCT-C386-25	MWS386-25	Vantage 486/25
CPU Type	386	386	386	386	486
BIOS	Award	AMI	AMI	Phoenix	AMI
BIOS shadow	Yes	Yes	Yes	No	Yes
Speed	25 MHZ	33 MHZ	25 MHZ	25 MHZ	25 MHZ
Max. on-board RAM	4 MB	16 MB***	16 MB*	8 MB**	32 MB
Type of RAM	DIP	SIMM	DIP or SIMM	SIM	SIMM
Wait States		0/1	0/1		0-3
Memory Speed	70 ns	60 or 70 ns	80 ns	80 ns	80 ns
Memory Architecture	Interleave	Interleave	Interleave	Interleave	Interleave
Size	Mini-AT	Mini-AT	Mini-AT	AT	Mini-AT
Math Coprocessor	387	387 or Weitek 3167	387 or Weitek 3167	387 or Weitek 3167	Built in 486, Weitek 4167
Cache	0K	32K	32K	64K	0-256K
System Logic	C & T	C & T	C & T	C & T	Opti
Expansion Slots	6 16-bit, 1 8-bit, 1 memory	4 16-bit, 3 8-bit, 1 memory	4 16-bit, 3 8-bit, 1 memory	6 16-bit, 1 8-bit, 1 memory	8 16-bit
Warranty	1 year	1 year	1 year	1 year	2 years

* On expansion board (not included)
 ** Optional Expansion board allows additional 8 MB
 *** On expansion board (included)

you can fill memory to 1, 2, 4, 5, 8, 16, or 32 megabytes. Physically, the SIMM socket latches are flimsy and prone to break. The 486 CPU contains its own built-in 8K cache; you can supplement that with 0, 128K, or 256K of external cache RAM. The AMI BIOS is more versatile than some, allowing you to shadow the main or video BIOS, or both, or neither. Its documentation is excellent. A 33-MHz version is also available.

CONCLUSION

My favorite board is the Pioneer. Its overall speed was simply outrageous, and its versatile memory-expansion scheme helps ensure that it will grow with you. The Jameco and JDR boards are off-shore clones, and in several months of testing performed flawlessly. They are easy to get hold
(Continued on page 88)

that we'll review next. The memory card is an extra-cost option. The board included only the "generic" documentation. A 33-MHz version is available.

MYLEX

This board contains a 64K cache, twice as much as the JDR board, hence it was slightly faster. It holds 1, 2, 4, or 8MB right on the motherboard, and has provision for a separate card to expand all the way to 16MB. Documentation is skimpy, but overall quality is excellent.

PIONEER

This 25 MHz 486 speed demon is roughly twice as fast as the 33-MHz Jameco, and it has lots of other nice features. First, you can mount as much as 32MB of SIMM memory directly on the board without using a slot. In addition, the SIMM's are located behind the keyboard connector, well

out of harm's way. (Some boards have SIMM sockets opposite the expansion connectors and can interfere with expansion boards.) In various combinations of 256K, 1MB, and 4MB SIMM's,

VENDORS

Jameco Electronics
 1355 Shoreway Road
 Belmont, CA 94002
 415-592-8097

JDR Microdevices
 2233 Branham Lane
 San Jose, CA 95124
 800-538-5000
 408-559-1200

Hauppauge Computer Works, Inc.
 91 Cabot Court
 Hauppauge, NY 11788-3706
 516-434-1600

Mylex Corporation
 47650 Westinghouse Drive
 Fremont, CA 94539
 800-446-9539
 415-683-4600

Pioneer Computer Inc.
 49066 Milmont Drive
 Fremont, CA 94538
 415-623-0808



Now, in a **complete** multimedia package consisting of a 200-page training manual and a 1-hour 22-minute video training tape, you can learn **secrets** of Advanced VCR Repair. (Also includes Color Bar Test Tape.)

Includes many examples of VCR make/model specific troubleshooting tips... Learn how to quickly isolate most "tough" VCR malfunctions, whether electrical or mechanical.

Complete coverage of Theory of Operation — Read manual, view 1-hour 22-minute video!

FREE INFORMATION PACKAGE!

Call **1/800-537-0589**
 Viejo Publications, Inc.
 5329 Fountain Ave., Dept. PE A
 Los Angeles, CA 90029

CIRCLE 16 ON FREE INFORMATION CARD

ANTIQUUE RADIO

By Marc Ellis

The Theremin: A First Look Inside

The May, June, and July issues of this column featured a bibliography of theremin articles, a history of the theremin in this country and a discussion of the instrument's operating theory. Last month, we temporarily interrupted our theremin story for a long-overdue look into the mailbag. But now we're back to our exploration of that fascinating granddaddy of all electronic musical instruments.

In this issue, we're going to begin work on an actual theremin—the one, in fact, that was responsible for all

COSMETIC INSPECTION

Tony's theremin and its accompanying speaker have been reposing in my basement since I acquired them over a year ago. Since I wanted to take some "before" pictures before dismantling the units for inspection, my first official act was to dust off both pieces and bring them upstairs where I would have room to do the photography.

I don't usually invade the upstairs with my projects, so I prudently accomplished that task while my wife was on an errand. She was a pretty good sport when she came home to find the furniture shoved aside to make room for an odd-looking pair of artifacts. She even agreed to pose with the instruments to give the picture a little scale. Needless to say, though, the normal furniture arrangement was restored very quickly after completion of the photography!

Considering that the theremin had been used during the last several years of its active life at a high school, and obviously hadn't exactly been treated with tender loving care by the student stagehands who moved it around, the cabinet is in surprisingly good shape. Although there are a couple of nasty-looking gouges and some loosened leg joints, it's basically quite sound and should be fairly easy to restore to decent appearance.

The speaker system that came with the theremin is an RCA Model 106, which is the type recommended by RCA for best results with the

instrument. The Model 106 consists of a hefty dynamic speaker housed in a decorative floor cabinet that has elaborate turned legs and tapestry grille cloths. The 106 speaker isn't as rare a piece as the theremin, since it was widely sold as an optional accessory for RCA 1929-era radios such as the Model 60.

In good condition, the 106 is quite a handsome unit. But the one that came with the theremin has definitely seen better days. The finish is badly scuffed and scratched, the power and audio cords are frayed and patched, the grille cloth for the rear panel (luckily, not tapestry) is hanging in shreds, and the bottom of one leg is missing—probably knocked off in a fall. Fortunately, the tapestry front and side pieces are reasonably intact, if a little faded.

Though a bit more of a restoration challenge than the theremin cabinet, I have no doubt that the Model 106 could be made quite presentable. A good dry cleaning might work wonders with the tapestry pieces, and a clever woodworker might be able to turn a replacement for the missing leg on a small lathe. The rest is simple wood refinishing.

INSIDE THE CABINETS

Removing the speaker cabinet's back panel, I was pleasantly surprised by what I saw. The speaker itself looked quite good and, as I later confirmed by removing the speaker from the enclosure, the cone seemed to be in perfect shape.

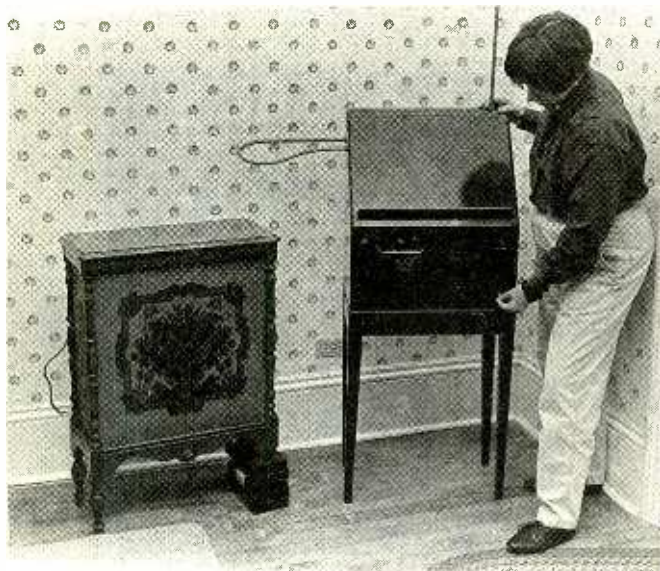

The theremin and its model 106 speaker pose for a "before" picture in our living room.

of the earlier articles on that fascinating device. The instrument came into my possession courtesy of reader Tony du Bourg of Summit, NJ. Tony wanted to encourage the development of a series of *Antique Radio* columns devoted to the theremin, and that is exactly what he has accomplished!

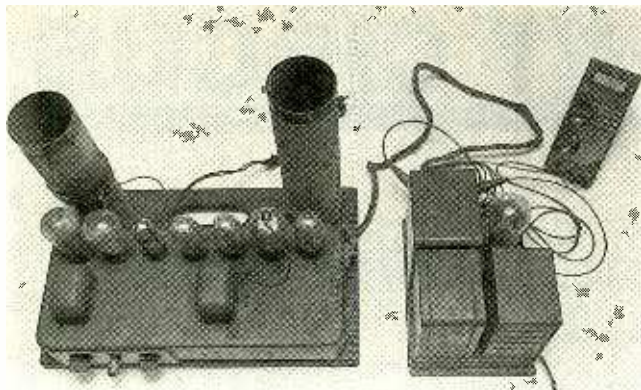

The theremin chassis (left) and its power supply as removed from the cabinet for testing.

Access to the theremin cabinet is gained by swinging open a pair of doors at the back. The space inside is divided by a slide-out wooden shelf holding the theremin chassis and coils. The heavy power supply, which is the same basic model used in RCA AC-operated broadcast receivers of the period, is mounted under the shelf on the cabinet floor.

Physically, all of the theremin and power-supply components appeared to be intact and in good condition—except for one trouble spot. A small coil wound over the bottom of one of the two large resonance coils mounted at the back of the theremin shelf was in disarray. Its turns were loose and jumbled—and closer inspection revealed that they had been wound over several layers of what looked like modern electrical tape.

Consultation of RCA's service notes for the theremin revealed that this coil is the pickup loop for the filament supply of the type-20 volume-control tube. (For more information on the volume-control circuit, please refer to the July, 1991 issue, which discusses the operating principles of the theremin in some detail.) Apparently the coil had become loose at some time in the past, which made it the subject of that not-too-convincing fix.

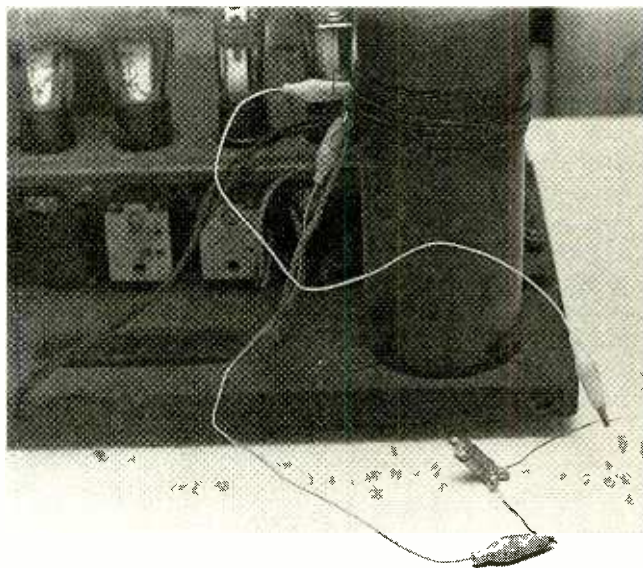

The test lamp, in holder, is clipped to the terminals of the pickup loop for volume-control tube filament voltage.

POWERING UP THE SPEAKER

Up to this point, I hadn't applied power to any of the theremin components. Powering up long-disused electronic equipment is a chancy business and, according to Tony, this theremin hadn't been used since the 1950's. But I'd taken the visual inspection as far as I could, and it was "smoke test" time. I decided to begin with the loud-speaker.

Like all dynamic speakers, the model 106 requires a source of DC voltage to energize its field magnet. Most dynamic speakers that we come across are built into specific radios and receive their field voltage from that radio's power sup-

ply. The model 106, however, is a free-standing speaker designed to be a radio accessory. So the 106 has its own built-in field supply.

The field supply circuit is made up of two copper-oxide rectifier elements, each the equivalent of two diode rectifiers, mounted on opposite sides of the speaker frame. The four rectifiers are wired in a bridge circuit that converts

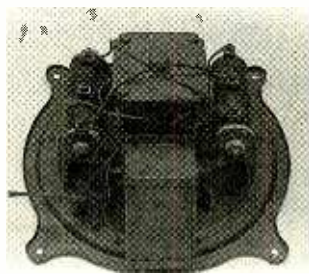

The model 106 speaker was removed from its cabinet to check its cone. Note the two cylindrical copper-oxide rectifier stacks.

the 117-volt AC line voltage into the 80 volts of direct current needed to power the field. (The copper oxide rectifier is a primitive semiconductor power rectifier that is functionally equivalent to the selenium

rectifiers of later years and the silicon rectifiers that are in use today.)

Placing a DC voltmeter across the field coil to monitor the performance of the rectifier, I plugged in the Model 106's AC power cord and gingerly flipped on the power switch. I was ready to cut the power at the slightest sign of smoke or abnormally low field voltage. However, the meter immediately registered 69 volts DC, and there was no smoke or burning smell that I could detect.

Though the reading was well over 10% lower than the 80 volts called for in the RCA specifications, the speaker wasn't humming too badly and it looked like the rectifier wasn't going to fail. I decided to leave the power on for a while to see if things would improve. My patience was rewarded—just before I shut the speaker off about an hour later, the voltage had risen to 79 and the hum had dropped to a very low level.

It'll be interesting to see how the rectifiers perform the next time I turn on the speaker, but indications are that the unit is still going to be capable of making it on the old copper-oxide stacks. If not, of course, I'll always have the option of switching to modern semiconductor rectifiers.

By the way, if you have an RCA 106 (or similar) speaker whose rectifier stacks do need replacing, I'd recommend the short article *Hum in Your Radiola 41 or Similar RCA?* in the February, 1991 *Old Timer's Bulletin* (the official journal of the Antique Wireless Association). In a few well-chosen paragraphs, author Bob Haworth explains how to change over to modern rectifiers while maintaining the original appearance of the speaker as closely as possible.

(Continued on page 94)

CIRCUIT CIRCUS

By Charles D. Rakes

Detector Circuits, And More

This time around, we'd like to share with you a number of unrelated circuits that can be fun to build and may prove useful in some upcoming project. In any case, drag out the junkbox, heat up the iron, and get ready for some circuit fun.

PRESSURE DETECTOR

Our first entry, see Fig. 1, uses a piezo transducer as a sensor in a circuit that responds to changes in air pressure. A piezo transducer is mounted in one end of a plastic tube facing out toward the open end. By blowing into the tube opening, the pressure increases, causing the piezo

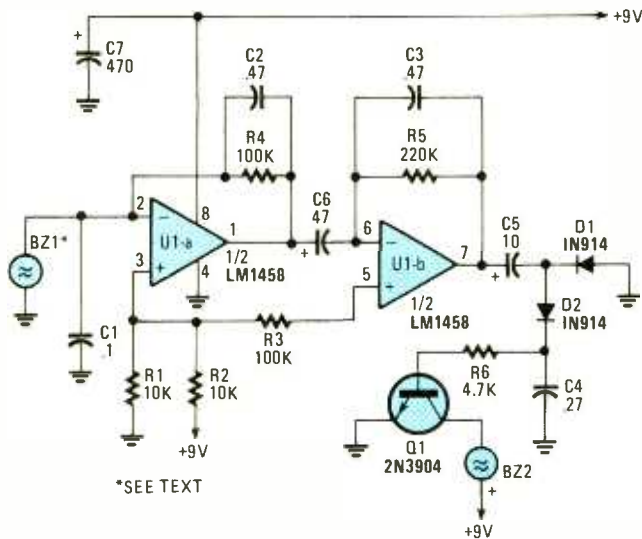

Fig. 1. In this circuit, a piezo transducer (BZ1) is used as an air-pressure sensor. The circuit responds to changes in air pressure by sounding a buzzer (BZ2).

element to bend slightly, producing a small output signal.

A 0.1- μ F capacitor, C1, is connected across the piezo element to help filter out high-frequency sounds and allows only very low frequency, air-pressure signals to pass. Half an LM1458

PARTS LIST FOR THE PRESSURE DETECTOR

SEMICONDUCTORS

U1—LM1458 dual op-amp, integrated circuit
Q1—2N3904 general-purpose NPN silicon transistor
D1, D2—1N914 general-purpose small-signal silicon diode

RESISTORS

(All resistors are 1/4-watt, 5% units.)
R1, R2—10,000-ohm
R3, R4—100,000-ohm
R5—220,000-ohm
R6—4700-ohm

CAPACITORS

C1—0.1- μ F, ceramic-disc
C2, C3—0.47- μ F, ceramic-disc
C4—0.27- μ F, ceramic-disc
C5—10- μ F, 16-WVDC, electrolytic
C6—47- μ F, 16-WVDC, electrolytic
C7—470- μ F, 16-WVDC, electrolytic

ADDITIONAL PARTS AND MATERIALS

BZ1—Piezoelectric buzzer (without internal oscillator)
BZ2—Piezoelectric buzzer (with internal oscillator)
Perfboard materials, enclosure, plastic tube, IC socket, 9-volt power source, wire, solder, hardware, etc.

dual op-amp, U1-a, is configured as a low-frequency, high-gain amplifier, which is used to boost the transducer's output.

A second high-gain, low-frequency amplifier, formed around U1-b, increases the output of U1-a to several volts, with the exact output depending on the air-pressure variations at the transducer. Diodes D1 and D2, and capacitors C4 and C5, convert the amplifier's output to a DC pulse that's used to turn Q1 on, thereby causing piezo buzzer BZ2 to sound for each change in air pressure.

The pulsed DC output, at the cathode of D2, can also be used to drive a voltage-controlled oscillator. Such a circuit could be made into an electronic whistle to produce a varying output tone in relation to the air pressure applied to the transducer.

VCO

The circuit in Fig. 2 is a simple, voltage-controlled oscillator that can be connected to the output of the circuit in Fig. 1. A single 4093BE quad 2-input NAND Schmitt trigger is connected in a simple RC audio-oscillator circuit. An MPF102 FET operates like a voltage-variable resistor, shifting the oscillator's frequency as its gate voltage is varied. Without a DC input, the oscillator's feedback path is open, due to the near-infinite resistance between the FET's drain and source, so no output tone is produced.

As the FET's gate voltage rises, the drain-to-source resistance decreases sufficiently to start the oscillator. The oscillator starts out with a very low frequency tone that increases in pitch as the input voltage rises. The third gate drives a

piezo buzzer, which produces a low-level tone output.

The oscillator's frequency range can be changed by increasing the value of C1 for a lower-frequency range or by decreasing the value for a higher-frequency range. To connect the pressure-sensor circuit to the VCO, just remove Q1, R6, and BZ2 from the circuit in Fig. 1, and connect a wire from the junction of D2 and C4 to R3 in Fig. 2. Also connect the two ground circuits together.

RF DETECTOR

Our next circuit, see Fig. 3, uses half of an LM1458 dual op-amp in a sensitive, wide frequency range, RF-detector circuit. The circuit can detect milliwatt levels of RF energy from below the standard broadcast band to frequencies beyond the FM broadcast band.

A small pull-up antenna (ANT1) collects the RF signal and sends it to a broad-band RF detector made up

of L1 and D1, a germanium diode. The diode converts the sampled RF to a DC signal that's fed to the negative input of U1-a. A 50- μ A meter is used to indicate the approximate strength of the RF signal. The circuit is powered from a standard 9-volt transistor battery.

CURRENT SENSOR

The circuit in Fig. 4, built around a single 2N3904 general-purpose silicon transistor configured as an RF oscillator, can be used as a DC current sensor. Inductor L1—which is connected in the oscillator's tank circuit—is a hand-wound coil consisting of 36 turns of #26 enamel-covered copper wire wound evenly spaced on a donut-shaped Amidon (Amidon Associates, Inc., PO Box 965, Torrance, CA 90508; Tel. 818-760-4429) FT50-43 ferrite core. The sense wire (designated L2) is simply a length of number 16 insulated copper wire looped

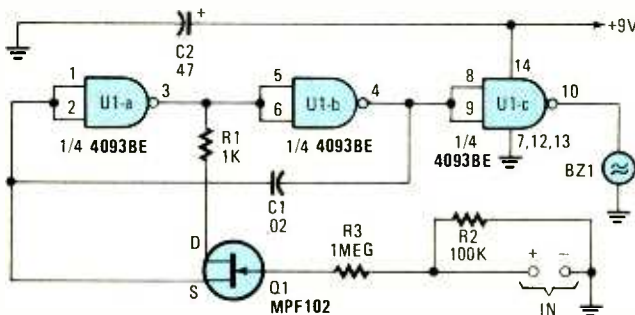

Fig. 2. Here a 4093BE quad 2-input NAND Schmitt trigger is configured as a simple voltage-controlled audio oscillator. The MPF102 FET (Q1) operates like a voltage-variable resistor, shifting the oscillator's frequency as its gate voltage is varied.

PARTS LIST FOR THE VCO

- U1—4093BE quad 2-input NAND Schmitt trigger, integrated circuit
 - Q1—MPF102 N-channel FET
 - R1, R2—100K $\frac{1}{4}$ -watt, 5% resistor
 - R3—1-megohm, $\frac{1}{4}$ -watt, 5% resistor
 - C1—.02- μ F, ceramic-disc capacitor
 - C2—47- μ F, 16-WVDC, electrolytic capacitor
 - BZ1—Piezoelectric buzzer (without internal oscillator)
- Perfboard materials, enclosure, IC socket, 9-volt power source, wire, solder, hardware, etc.

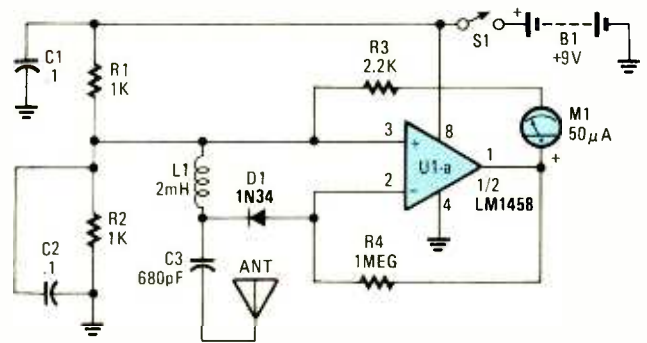

Fig. 3. This circuit uses half of an LM1458 dual op-amp to form a sensitive wide-range RF detector that's capable uncovering RF signals in the milliwatt region.

PARTS LIST FOR THE RF DETECTOR

RESISTORS

(All fixed resistors are $\frac{1}{4}$ -watt, 5% units.)

- R1, R2—1000-ohm
- R3—2200-ohm
- R4—1-megohm

ADDITIONAL PARTS AND MATERIALS

- U1—LM1458 dual op-amp, integrated circuit
 - D1—1N34 germanium diode
 - C1, C2—.01- μ F, ceramic-disc capacitor
 - C3—680-pF ceramic-disc capacitor
 - L1—2-mH choke
 - S1—SPST switch
 - B1—9-volt transistor-radio battery
 - M1—50-mA meter
 - ANT1—Small telescoping antenna
- Perfboard materials, enclosure, IC socket, wire, solder, hardware, etc.

through the center of L1's core. When power is applied to the circuit, it begins to oscillate at a fixed frequency of about 180 kHz.

The application of DC power causes current to flow through L2, changing the core's permeability, which, in turn, causes the oscillator's frequency to shift. Resistor R3, a 20-ohm, 25-watt unit, limits current in the sensing circuit, thereby protecting the power supply and keeping L2 from acting like a shorted turn in the oscillator's tank circuit. A frequency counter can be connected as shown to monitor the oscillator's frequency shift.

The circuit will respond to currents from as low as a few milliamps to over 1 amp. With a current flow of 50 mA, the frequency will

increase by about 1 kHz; and when the current is increased to 100 mA, the frequency will increase by about 2.5 kHz. With 1 amp of current, the frequency will increase to about 238 kHz. A potentiometer can be substituted for R3, allowing the current through the sense loop to be varied, and by extension, the operating frequency of the oscillator.

CURRENT SENSOR MODIFICATION

By using the coil/potentiometer combination shown in Fig. 5, the current sensing circuit can be made to respond linearly to relatively low levels of current, ranging from 1 to 50 mA, at a rate of about 100-Hz-per-milliamp. The 33-mH choke (L3) completely removes

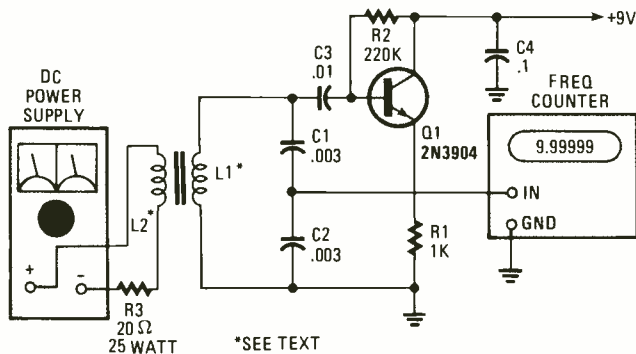

Fig. 4. Here a single transistor, configured as an RF oscillator, is used to detect changes in current flow.

PARTS LIST FOR THE CURRENT SENSOR

RESISTORS

(All resistors are 1/4-watt, 5% units, unless otherwise noted.)

R1—1000-ohm

R2—220,000-ohm

R3—20-ohm, 25-watt, see text

CAPACITORS

C1, C2—.003- μ F, ceramic-disc

C3—.01- μ F, ceramic-disc

C4—0.1- μ F, ceramic-disc

ADDITIONAL PARTS AND MATERIALS

Q1—2N3904 general-purpose NPN silicon transistor

L1—See text

L2—See text

Perfboard materials, enclosure, DC supply, frequency counter, Amidon FT50-43 ferrite toroidal core (see text), wire, solder, hardware, etc.

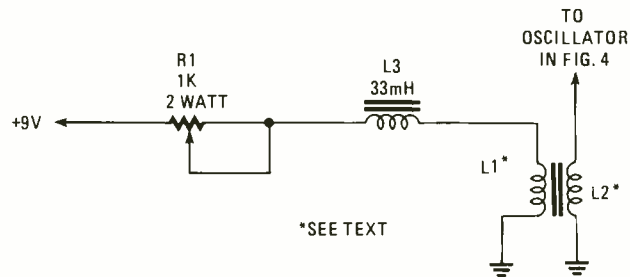

Fig. 5. The current sensing circuit in Fig. 4 can be modified (through the coil/potentiometer combination shown here) to respond linearly to relatively small current changes: the frequency of oscillation will shift at a rate of about 100 Hz per milliamp.

PARTS LIST FOR THE CURRENT-SENSOR MODIFICATIONS

R1—1000-ohm, 2-watt potentiometer

L1—5-turns #26 copper wire, see text

L2—36-turns #26 copper wire, see text

L3—33-mH choke (Mouser, part 43LH333)

Perfboard materials, enclosure, 9-volt power source, wire, solder, hardware, etc.

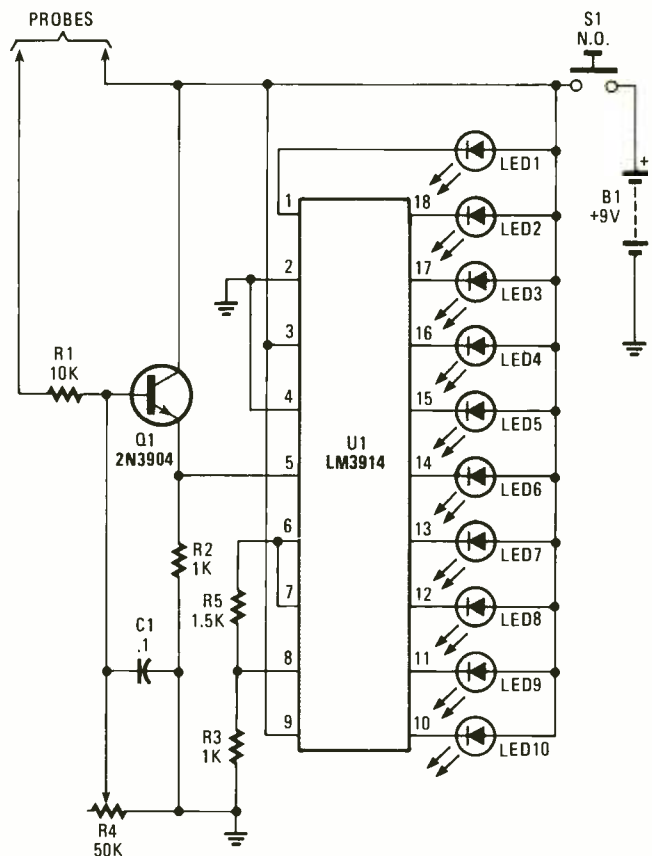

Fig. 6. The moisture detector is built around a 2N3904 general-purpose NPN transistor (configured as an emitter follower), an LM3914 dot/bar display driver, and a few support components.

PARTS LIST FOR THE MOISTURE MONITOR

SEMICONDUCTORS

U1—LM3914 dot-bar-display driver, integrated circuit

Q1—2N3904 general-purpose NPN silicon transistor

LED1—LED10—Jumbo light-emitting diode (any color)

RESISTORS

(All fixed resistors are 1/4-watt, 5% units.)

R1—10,000-ohm

R2, R3—1000-ohm

R4—50,000-ohm, potentiometer

R5—1500-ohm

ADDITIONAL PARTS AND MATERIALS

C1—0.1- μ F, ceramic-disc capacitor

B1—9-volt transistor-radio battery

S1—Normally-open pushbutton switch

Perfboard materials, enclosure, 18-pin IC socket, probe material (see text), 9-volt battery connector, wire, solder, hardware, etc.

the shorted turn effect of the current sensor. The five turns used in Fig. 5 for L2 increases the circuit's sensitivity. The number of turns on L2 may be varied to increase or decrease the circuit's sensitivity to current

changes. Adding turns to L2 will increase sensitivity and reducing the number of turns will reduce the sensitivity.

The oscillator's frequency range may also be

(Continued on page 88)

SELECT 5 BOOKS for only \$4⁹⁵ (values to \$120.75)

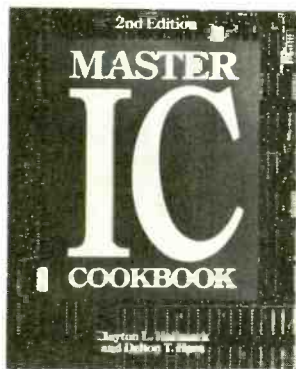
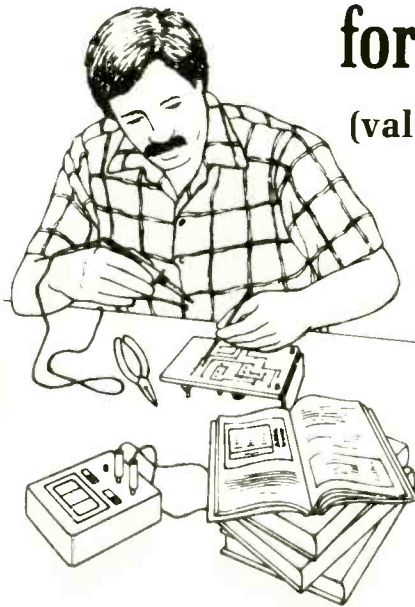

3550 \$34.95
Counts as 2



2980P \$19.95



2800P \$16.95



3260P \$14.95



2950P \$13.95



3414 \$39.95
Counts as 2



3540 \$26.95
Counts as 2



3226 \$22.95

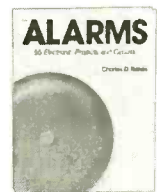

2996P \$14.95



3265 \$22.95

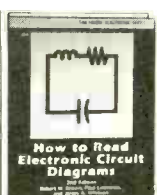

2880P \$14.95



3632 \$18.95



3267P \$16.95

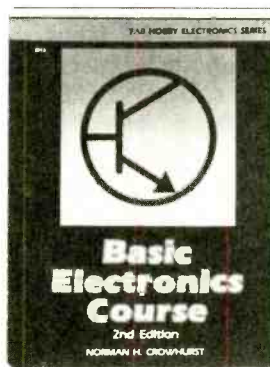

2613P \$17.95



2883P \$18.95



2867P \$18.95



3475 \$27.95
Counts as 2



1938 \$60.00
Counts as 3



2707P \$17.95



3329 \$29.95
Counts as 2

Your most complete source for electronics books for over 25 years.



3343 \$29.95
Counts as 2



2865P \$14.95



1367P \$24.95



3445 \$21.95

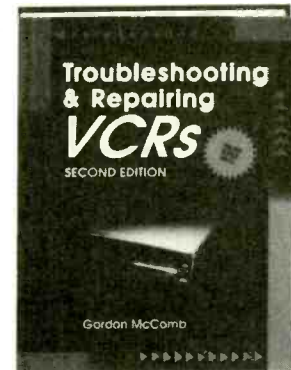

3777 \$32.95
Counts as 2

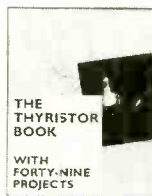

3307 \$26.95
Counts as 2



2995 \$25.95



3454 \$23.95



3457 \$29.95
Counts as 2

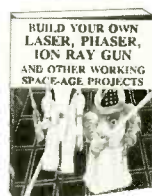

1604P \$17.95



3274 \$25.95
Counts as 2



3345 \$39.95
Counts as 2



3358 \$28.95
Counts as 2



2790P \$14.95



3258P \$18.95

Membership Benefits • Big Savings. In addition to this introductory offer, you keep saving substantially with members' prices of up to 50% off the publishers' prices. • **Bonus Books.** Starting immediately, you will be eligible for our Bonus Book Plan, with savings of up to 80% off publishers' prices. • **Club News Bulletins.** 15 times per year you will receive the Book Club News, describing all the current selections—mains, alternates, extras—plus bonus offers and special sales, with scores of titles to choose from. • **Automatic Order.** If you want the Main Selection, do nothing and it will be sent to you automatically. If you prefer another selection, or no book at all, simply indicate your choice on the reply form provided. You will have at least 10 days to decide. As a member, you agree to purchase at least 3 books within the next 12 months and may resign at any time thereafter. • **Ironclad No-Risk Guarantee.** If not satisfied with your books, return them within 10 days without obligation! • **Exceptional Quality.** All books are quality publishers' editions especially selected by our Editorial Board. PE991



2831P \$16.95

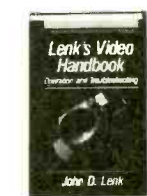

10018 \$39.95
Counts as 2



2925P \$9.95



3072P \$16.95

©1991 ELECTRONICS BOOK CLUBS™
A shipping/handling charge and sales tax will be added to all orders.

If card is missing, use this address to join:
ELECTRONICS BOOK CLUB, Blue Ridge Summit, PA 17294-0810

All books are hardcover unless number is followed by a "P" for paperback. (Publishers' Prices Shown)

FUN SOFTWARE

By Fred Blechman

Flying With The Best

Life is full of coincidences, but some are really weird. Although it was published six years ago, I only started reading General Chuck Yeager's book *Yeager* a few days ago. My wife spotted the paperback version at a used book store and got it for me because of my revival of interest in flying in the last few years. The coincidence is that just yesterday I received an advanced review copy of Chuck Yeager's *Air Combat* from Electronic Arts. I dropped other assignments to get this to you right away.

Among the most popular games for decades (centuries?) are Checkers, Backgammon, Gin Rummy, and Cribbage. What better

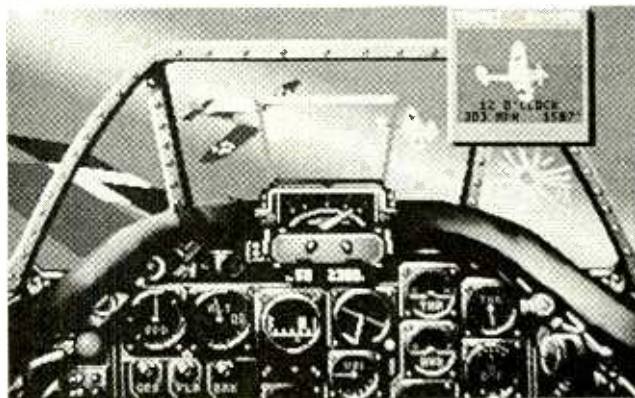

Take flight with Chuck Yeager's *Air Combat*, a flight-simulator/air-combat game that offers unsurpassed realism.

name for a package with computerized versions of those games than *The Games People Play*? Featuring high-resolution graphics and lots of options, we'll take a look at this group of programs a little later on.

CHUCK YEAGER'S AIR COMBAT

This is the third Chuck Yeager's flight simulator

from Electronic Arts. I liked the original version, the *Advanced Flight Trainer*, but it was produced several years ago and would not be up to today's standards of high-resolution graphics, smoothly animated screens, and VGA color. That was followed a couple of years ago with the *Advanced Flight Trainer 2.0*. Although this was an improvement over the original in some respects, overall I liked the original version better.

Now along comes Chuck Yeager's *Air Combat*, and this is a real winner! Although the version I received was pre-publication, and in place of the manual I only received a few typed sheets, I fell in love with this program. I'm now at the end on my third day of "flying" and I keep discovering new missions and new effects.

I suppose what makes this one of the very best flight simulators I've tested is the realism. The flight-control response, the smooth animation, and the many options are all right up there with the best. In fact, you can even "blackout" in high-G maneuvers (the screen goes gray or black, depending on the number of G's and how long they are sustained), a neat effect I haven't seen before.

Although it may seem like a small thing, the delineation between the green ground and the light blue sky is particularly effective. Instead of just changing from one color to the other, the actual horizon is white (like clouds in the distance) fading to cyan and then light blue. This makes the horizon unmistakable. Incidentally, when those clouds

are nearby you can fly right through them.

When you destroy a plane, bit-mapped graphic explosions are very realistic. I even saw the pilot bail out of a plane I hit just before it exploded. And you can bail-out, too. When you do, you watch the ground come up as you descend. A bail-out at 20,000 feet can bring you down through some clouds.

Seventeen types of planes and fifty pre-defined missions reflect the fact that this program covers three wars—World War II, Korea, and Vietnam. Not only that, you can create your own missions, flying any of 6 aircraft against up to 15 "enemies" in 17 different types of planes, and the enemies can be amateur, mediocre, good, or excellent pilots! Is that enough choices for you?

The flight control is so good that this is the first simulator I've found where I could actually fly formation on nearby planes. I got a real kick out of flying around and among formations of bombers in my own created scenarios. Matching speed, heading, and altitude is a real challenge. One of the many outside-the-cockpit views allows you to fly behind your own aircraft, matching each maneuver as the real horizon responds just as it does in actual flight.

I flew Chuck Yeager's *Air Combat* with a 12-MHz 80286 machine using a hard drive, VGA graphics, and an AdLib sound board. The screen updates are so rapid that the action appears almost movie-like. Although the graphics are

not the highest resolution I've seen (probably to provide fast action), they are colorful and detailed. B-17's, B-29's, and B-52's look like they should when you get close enough, as do all the other aircraft.

This is strictly an air-combat simulator. While there are many buildings, roads, rivers, and bridges in the scenery, your missions involve air combat. You can, however, practice takeoffs and landings with six different planes: North American P-51D Mustang or F-86E Sabre, Focke-Wulf FW-190A-8, Mikoyan-Gurevich MiG-15 or MiG-21MF, and the McDonnell Douglas F4-E Phantom II. Quite an assortment!

A pull-down menu system uses 6 headings with a total of 49 choices, giving you an idea of the flexibility of Air Combat. A VCR mode lets you record and play back missions for further study. Various sounds (engine, background, stalls, etc.) can be enabled or disabled. The sound with my AdLib board was great. You can use a joystick, mouse, or keyboard for flight control. I much preferred a joystick, and found CH Product's FlightStick the most natural of the three joysticks I tried.

All kinds of views, with zoom, are offered, and you can test planes by starting on the runway, on final landing approach, at 10,000 feet, or at 40,000 feet. The best option I found was "Invincible;" until then I was getting shot down in a matter of minutes every time!

Although the pre-release version I tested didn't have all the final features (such as a digitized version of Yeager's voice instead of screen messages), I was mighty impressed with the program as it is. Now all I have to do is try to keep away from it so I can get some other work done.

(Electronic Arts, 1820 Gateway Drive, San Mateo, CA 94404, Tel. 800-245-4525. Requires IBM PC or compatible, 640K RAM, DOS 2.1 or higher, hard drive or high-density floppy drive, EGA or VGA graphics. AdLib and Sound Blaster sound boards supported. PC/AT or above recommended. Suggested retail price is \$59.95.)

CIRCLE 130 ON FREE INFORMATION CARD

THE GAMES PEOPLE PLAY

The Software Toolworks, publishers of the award-winning Chessmaster 2000/2100 and Mavis Bacon Teaches Typing, have put four popular games—Gin Rummy, Cribbage, Checkers, and Backgammon—into a single package that costs what you might expect to pay for only one.

Installation allows you to put each game onto one or more floppy disks (a total of five 360K diskettes for all programs, taking a half-hour or more.) Or, you can put them all on a hard drive in less than ten minutes if you have about 1.4MB of free space.

I ran all these games on a 12-MHz AT with a hard drive, color VGA, and a mouse, and had no installation or operational problems. I also tried Checkers and Backgammon on a 4.7-MHz XT with CGA and no mouse. The color was sad compared to VGA, the keyboard use was clumsy at best, and it took Backgammon forever to load. My suggestion is that you use The Games People Play on a machine with EGA or VGA, a hard drive, and a mouse. Non-intrusive sound is used in all the games, and can be turned off. The regular speaker is used, and special sound boards are not supported or needed.

Backgammon and Checkers use a pull-down menu interface with dialogue boxes, similar to a Windows approach. They offer context sensitive help, easily moved pieces, and multiple levels of play. Gin King and Cribbage King use the F1 key to pop-up a Main Menu, with some choices leading to sub-menus. I preferred the pull-down menus and dialogue boxes.

I played Backgammon first, since I used to love playing a variant of that game, called Acey Deucey. This and two other variants of the traditional Backgammon (Dutch and Plakoto) can be played.

Also, in addition to the traditional board design, four other "far out" board designs are available. Many other features are included, like hints, switching sides with the computer, taking back a move, and more.

Each of the game pieces has a 3-dimensional appearance, and is "dragged" quickly and easily with a mouse. Using any printer, you can print out the board and piece locations anytime.

I played Checkers next—and lost every time! You can have the computer as an opponent, or two humans can play, or you can have the computer play against itself in a kind of demo mode. Two- or three-dimensional graphics are available, and a printout of piece locations on the board is available anytime.

Gin King lets you play Standard Gin or Oklahoma Gin against any of seven computer "people," each with his or her own unique playing style. Also, any of the computer people can be your personal tutor. Play is very fast, the cards look very real, and there is even a demo mode.

As for Cribbage King, I just

put it in its demo mode and watched. I've never played Cribbage and didn't want to take the time to learn. You can play Two-Handed, Four-Handed, or Five-Card Cribbage with seven unique computer opponents. It sure looked (and sounded) good as cards were dealt and pegs moved along the board. I'm sure the 82-page Cribbage King Users Manual would answer any questions I'd have.

Perhaps most significant is that, although an excellent manual is provided for each game, I successfully played all but Cribbage without even looking at the manuals! I have to say I was very impressed with all these games. They looked great and they played great. I could easily spend many hours investigating the variations of each.

(The Software Toolworks, 60 Leveroni Court, Novato, CA 94949, Tel. 800-231-3088. Requires IBM PC, XT, AT, PS/2 or Tandy PC compatibles, except Tandy 2000; DOS 2.0 or later; 512K RAM; CGA, EGA, or VGA color graphics. Mouse optional. Suggested retail price is \$39.95.)

CIRCLE 131 ON FREE INFORMATION CARD

NEW FUN SOFTWARE

Here are some recently announced programs you can order from your regular software supplier. Versions and suggested retail prices, where announced, are shown in parentheses.

Electronic Arts Affiliates: Strategic Simulations has released the IBM version of Death Knights of Krynn, the sequel to the popular Advanced Dungeons and Dragons (IBM, Amiga: \$49.95; C64/128: \$39.95) and Eye of the Beholder, the first in The Legend Series of Advanced Dungeons and Dragons fantasy role-

(Continued on page 94)

SCANNER SCENE

By Marc Saxon

Preparing for Stormy Weather

We are fast approaching that time of year when we have come to expect the unwanted—violent hurricanes, for instance. And don't forget that the 1989 earthquake in the San Francisco Bay area turned up in early October. Those events should remind you that a VHF radio is a handy thing to have for your family's safety.

NOAA (National Oceanic and Atmospheric Administration) VHF broadcasts can be heard in virtually all populated areas of the



Midland's WeatherMax 74-104 VHF weather monitor offers a couple of bonuses: AM/FM reception and a siren to signal any severe-weather alerts.

United States. Depending upon the area in which you live, your local broadcast might be on 162.40, 162.475, or 162.55 MHz. During times of approaching severe weather (thunder storms, hurricanes, tornadoes, etc.), or at other times when there is a danger to the general public, you're likely to hear about it first via NOAA VHF radio.

Some CB transceivers have a switch that will allow

them to receive the NOAA frequencies. Oddly, although the frequencies can be picked up on all VHF scanners, none seem to be made with a switch that enables the operator to jump right to the local channel. The best way of establishing that capability is to program your local NOAA channel into memory Channel 1 on your scanner (which is most likely to be where the Priority feature functions). Then, lock out Channel 1 so that your scanner won't hang up there during its regular scanning process. When you want to hear the NOAA transmission, simply touch the Priority button on the scanner, and the NOAA broadcast will immediately kick into action on your set. When you want to resume normal scanning, touch the Priority button again to turn off that function.

Or, you might consider getting a special VHF receiver intended for picking up only NOAA transmissions. Radio Shack has six different models for desktop and handheld use. The prices range down to as little as \$17.95. The deluxe (\$39.95) unit will respond to a special coded signal sent out by an NOAA station, sounding a siren-type alarm in the receiver (even if the set is turned off) to alert you to impending danger. All of these sets operate from, or have backup, flashlight batteries so they'll continue to operate during power blackouts in order to continue to bring you updated bulletins.

Another good entry is the *Weather Max*, which combines the 162-MHz NOAA receiving capability with a tunable FM-broadcast receiver. This set also has the built-in NOAA alerting alarm. *Weather Max* operates from house current, from a vehicle's cigarette lighter, or from internal batteries. The telescoping antenna offers a 50-mile receiving range, and there's a jack for connecting an external antenna for extended base range, or a mobile antenna.

More information on *Weather Max* (Model 74-105) is available from *Midland International Corp.*, Consumer Communications Division, 1690 N. Topping, Kansas City, MO 64120. The Radio Shack units are all on display at the chain's 7,000 retail outlets, or may be ordered by mail through their catalog.

And, for those who are curious, Canadian weather broadcasts take place on 161.65 and 161.775 MHz.

ANYBODY KNOW THIS SET?

We received a letter and photo from Jack DeAlmeida, 18017 Horst Ave., Artesia, CA 90701. Jack reports that he has an "old" scanner that serves him well, but is capable of receiving only the 148–174-MHz and 450–470-MHz bands. The set wasn't designed for receiving the UHF-T band (470–512 MHz), and he would like to modify or adjust the set to function in that band in addition to its existing capabilities. The

photo Jack sent shows the set with its two banks of plug-in crystals exposed. He tells us the set is a MacDonald Instruments Model CE-100.

We have never heard of this set, but would guess that it's from about 1970. If any reader can help Jack, please contact him directly at the above address.

REFERENCES

A while back, Uniden issued a two-book (East/West) series of *Betty Bearcat* police/fire frequency directories. They were nothing much. Meanwhile, letters we received here also indicated disappointment with the *Police Call* series. Then, in 1989, Uniden began issuing a different series of *Betty Bearcat* public-safety directories, dividing the U.S. into seven regions represented in different books. That series now includes even a Canadian directory, plus a 651-page *National Police Frequency Directory*.

It appears to us that Uniden's series quickly became very popular within the hobby. We notice that many local Radio Shack stores no longer have *Police Call* in stock, and the Radio Shack catalog simply notes that they are "Available on special order."

It looks as though the Uniden books have eclipsed everything else in the area of general police/fire scanner data. You might want to check out the Uniden series. They are sold by many leading dealers. Their list price is \$14.95 each.

LOCKED OUT!

"Why did the factory lock out some 800-MHz frequencies in my Realistic PRO-2006? I thought that receivers could cover all frequencies." That not-uncommon question arrived in a letter from Clint Yates of Pine Bluff, AR.



Do you know any modifications for this old MacDonald Instrument's scanner?

Legally, morally, and ethically, a receiver can cover any and all frequencies. There is no law against importing, selling, or owning such a receiver. Indeed, some scanners are sold without any gaps in their 800-MHz frequency coverage. However, there is also nothing to stop a scanner owner from restoring any blocked out frequencies, a relatively simple task that can be performed by the average hobbyist. Or, a converter can be obtained to provide 800-MHz coverage.

The frequencies that are blocked out are those allocated for cellular-phone use. Manufacturers who sell scanners with blocked-out bands do so as a matter of their own choice. The best guess we can take to explain this is that they also sell cellular phones and perhaps fear complaints from those customers about providing equipment that can so easily be used to (illegally) eavesdrop on cellular calls.

MARSHAL PLAN

The U.S. Marshal transports federal prisoners, protects federal witnesses, captures federal fugitives, and provides a myriad of other fascinating services. Some of the agency's better nationwide frequencies include: 162.7125, 162.7875, 163.20, 163.8125, 164.60, 165.0625, and 165.7125 MHz.

ATTENTION! ELECTRONICS TECHNICIANS

EARN YOUR
**B.S.E.E.
DEGREE**



THROUGH HOME STUDY

Our New and Highly Effective Advanced-Placement Program for experienced Electronic Technicians grants credit for previous Schooling and Professional Experience, and can greatly reduce the time required to complete Program and reach graduation. No residence schooling required for qualified Electronic Technicians. Through this Special Program you can pull all of the loose ends of your electronics background together and earn your B.S.E.E. Degree. Upgrade your status and pay to the Engineering Level. Advance Rapidly! Many finish in 12 months or less. Students and graduates in all 50 States and throughout the World. Established Over 40 Years! Write for free Descriptive Literature

COOK'S INSTITUTE
OF ELECTRONICS ENGINEERING

CI 4251 CYPRESS DRIVE
JACKSON, MISSISSIPPI 39212

CIRCLE 8 ON FREE INFORMATION CARD

AMAZING SCIENTIFIC & ELECTRONIC PRODUCTS

LASERS AND SCIENTIFIC DEVICES

VRL2K	3mw Vis Red Laser Diode System Kit	\$159.50
LLI51K	Laser Beam "Bounce" Listener Kit	\$199.50
LHC2K	Visible Simulated 3 Color Laser Kit	\$44.50
LC7	40 Watt Burning Cutting Laser Plans	\$20.00
RUB4	Hi Powered Pulsed Drilling Laser Plans	\$20.00
LGU40	1 to 2mw HeNe Vis Red Laser Gun Assembled	\$199.00
LLS1	Laser Lite Show - 3 Methods Plans	\$20.00
SD5K	See in the Dark Kit	\$299.50
EML1K	Electromagnetic Coil Gun Kit	\$69.50
MCP1	Hi Velocity Coil Gun Plans	\$15.00
LEV1	Levitating Device Plans	\$10.00
EH1	Electronic Hypnotism Techniques Plans	\$10.00

HIGH VOLTAGE AND PLASMA DISPLAY DEVICES

HVM7K	75,000 Volt DC Variable Output Lab Source Kit	\$149.50
IDG3K	Ion Ray Gun Kit, project energy without wires	\$69.50
NIG9K	12V/115 VAC Hi Out Nag Ion Generator Kit	\$34.50
EMA1K	Telekinetic Enhancer/Electric Man Assembled	\$99.50
LG5K	Lightning Display Globe Kit	\$54.50
BTC1K	Worlds Smallest Tesla Coil Kit	\$49.50
BTC3K	250KV Table Top Tesla Coil Kit	\$249.50
BTC5	1.5 Million Volts Tesla Coil Plans	\$20.00
JL3	Jacobs Ladder - 3 Models Plans	\$15.00
GRA1	Anti Gravity Generator Plans	\$10.00
PFS20	Plasma Fire Saber Assembled	\$69.50
DPL20	Dancing Plasma to Music and Sounds Assembled	\$79.50

SECURITY AND PROTECTION DEVICES

ITM10	100,000 Volt Intimidator up to 20' Assembled	\$129.50
IPG70	Invisible Pain Field Blast Wave Gun Assembled	\$74.50
PSP4K	Phasor Sonic Blast Wave Pistol Kit	\$59.50
LIST10	Infinity Xmtr, Listen in Via Phone Assembled	\$199.50
TAT30	Automatic Tel Recording Device Assembled	\$24.50
VWPM7K	3 Mi. FM Auto Tel Transmitter Kit	\$49.50
FMV1K	3 Mi. FM Voice Transmitter Kit	\$39.50
HDD1K	Homing/Tracking Beeper Transmitter Kit	\$49.50

EASY ORDERING PROCEDURE TOLL FREE 1-800-221-1705
or 24 HRS DN 1-603-673-4730 or FAX IT TO 1-603-672-5406
VISA, MC, CHECK, MO IN US FUNDS. INCLUDE 10% SHIPPING. ORDERS
\$100.00 & UP ONLY ADD \$10.00. CATALOG \$1.00 DR FREE WITH ORDER.

INFORMATION UNLIMITED
P.O. BOX 716, DEPT. PE, AMHERST, NH 03031

DX LISTENING

By Don Jensen

Shortwave Radio: It's No Laughing Matter!

"There is a lot of news and music on SW, and that's fine, but what about comedy? Though I tune around to different stations, I haven't found much comedy. Any thoughts?"

That's the complaint from one of our readers, Sam Terry of Port Angeles, WA.

That's all too true, Sam; there isn't very much to laugh at on shortwave. And, historically, there have only been a couple of successful comedy programs on shortwave over the

has some thoughts on the reasons: "Since much humor is topical in nature, and uses domestic politics and politicians for fodder, humor doesn't often travel well via shortwave."

An exception, Richard suggests, is the CBC's satirical show, "Double Exposure." "While that program is intended primarily for a Canadian audience," he says, "it is often a treat for U.S. SWLs, as well, with some understanding of Canadian politics. Double Exposure," he writes, "is relayed on shortwave by CBC's Northern Quebec Service at 1637 to 1700 UTC, Saturdays, on 9,625 kHz."

At this writing, a fiscal crisis has left uncertain the broadcasting future of the CBC's *Radio Canada International*. While I cannot believe that Canada will totally abandon its international shortwave voice, I don't know if this favorite station of many SWLs will continue with its present level of programming. If, however, only limited schedule changes result, you may still find Double Exposure aired internationally on RCI, Mondays at 0037 UTC on 5,960 and 9,755 kHz.

Although the subject is controversial, I should also note that the spate of unlicensed "pirate" stations is probably the major source of humor programs on shortwave today. Because these stations are unauthorized, unregulated, and in violation of the law, they operate only periodically and irregularly, mostly in the 7,355–7,550 kHz range, to avoid being tracked down by the broadcasting authorities.

While a number are taken off the air, usually with the imposition of substantial fines and confiscation of transmitting equipment, others have continued for years.

They are, indeed, illegal and I do not endorse their activities. But, ignoring the presence of these scores of sporadic voices is akin to sticking your head in the shortwave "sand." They are there, at least once in a while, and, along with pop music, humor is a staple fare. Some of the pirate comedy is crude, sophomoric, and genuinely awful stuff. But, much of it is fresh and clever parody. This is the sort of programming that I'd like to "see" more of on shortwave radio!

Some listeners hate the idea of pirate broadcasters. Others love them, despite or perhaps because of their quirky nature. If you fall in the latter category, one of the best guides to the pirate-radio netherworld is the 1991 edition of George Zeller's *The Pirate Radio Directory* (Tiare Publications, PO Box 493, Lake Geneva, WI 53147; \$8.95 plus \$2 shipping and handling).

MORE LETTERS

I am delighted to report that the volume of mail from you readers grows each month. This is, after all, your column and the shortwave-radio subjects

*Credits: W. Karcheski, MA; Rufus Jordan, PA; Bob Zilmer, NM; Sheryl Paszkiewicz; Ed Cichorek, NJ; Brian Alexandr, PA; Harold Frodge, MI; David Copp, IL; John Carson, OK; North American SW Association, 45 Wildflower Road, Levittown, PA 19057.

RADIO KOREA



Korean cultural tradition is reflected in this ancient bronze, illustrating one of the program schedules sent to SW listeners by Radio Korea in Seoul.

years. One of my favorites was the now departed and much lamented "Royal Canadian Air Force," a domestic *Canadian Broadcasting Corp.* show that was rebroadcasted on SW in years past.

Richard Cuff, whose excellent "Easy Listening" column appears monthly in *The Journal of the North American SW Association*,

covered in *DX Listening* will reflect your interests when you write in. What questions do you have about SWL'ing? Your comments on the international-broadcasting scene today? What are you hearing on short-wave? You can reach me by addressing your letters to *DX Listening*, **Popular Electronics**, 500-B Bi-County Blvd., Farmingdale, NY 11735. Oh, and by the way, photos of you and your listening setup are also more than welcome!

The Gulf War earlier this year focused a surprising amount of attention on shortwave. Newspapers from the New York Times to hometown weeklies featured stories of shortwave listening and listeners. Sales of SW receivers boomed, with many radio dealers sold out, at least temporarily. And, indeed, there was much fascinating listening for SWLs who tuned in on breaking news from the Mideast.

One of our readers, J. Keith Dunbar of Jamestown, KY, passes along some of his experiences: "At 0125 UTC on Jan. 18, I received a broadcast from *KOL Israel* on 7,465 kHz. The normal foreign service broadcast was discontinued for 35 minutes, after it was announced that an Iraqi SCUD missile had hit Tel Aviv. Instead, there was an announcement that Israeli citizens could remove their gas masks, but should stay in their sealed rooms.

"At 0200 UTC the broadcast continued with a telephone number for Civil Defense departments in Israel, and a warning to keep gas masks ready and to stay tuned for further updates and warnings. *KOL Israel* reported that another SCUD missile was knocked down over Dhahran, Saudi Arabia, near a U.S. military base. Later it was announced that the Tel Aviv

raid caused only seven slight injuries."

Another bit of information on wartime monitoring of shortwave comes from Jerry Bartok, Chapel Hill, NC. He notes that he tried to follow Iraq's *Radio Baghdad*, but found them in English only on a few occasions after the air war started in mid-January. "It was possible, however, to hear a number of different Arabic-language Iraqi transmissions," Jerry says, "including the General Service, the *Voice of the Masses* and the so-called *Mother of Battles Radio*, on frequencies ranging from 3,980 and 8,350 kHz to 15,600 and 17,940 kHz."

Although the bombing reportedly knocked out Baghdad's international broadcasting facilities, the Iraqis remained on the air, seemingly using Kuwaiti transmitters. Jerry says he heard Baghdad's interview of captured US airmen—"a real scoop"—on 11,990 kHz before it was broadcast on CNN or the television networks.

Thanks, Keith and Jerry, for passing along those reports; they're good examples of what short-wave can deliver in times of important world events! My own vivid memories of tuning in the Gulf War include a pair of listening vignettes, both from Israel's radio: the eerie wailing of the air-raid sirens signaling a missile attack, early in the hostilities, and the *KOL Israel*'s hourly playing and replaying of Kate Smith's "God Bless America" when the ceasefire was announced.

Next a letter from Dr. Sebastian J. Kenight, Rochester, MI, who refers to the station chart that came with the shortwave-radio kit he bought and built. "I have not been able to listen to the USS Hope hospital ship or the World Health Organization
(Continued on page 89)

DIGITAL VIDEO STABILIZER ELIMINATES ALL VIDEO COPY PROTECTIONS



While watching rental movies, you will notice annoying periodic color darkening, color shift, unwanted lines, flashing or jagged edges. This is caused by the copy protection jamming signals embedded in the video tape, such as Macrovision copy protection. Digital Video Stabilizer: RXII completely eliminates all copy protections and jamming signals and brings you crystal clear pictures.

WARNING :
SCO Electronics and RXII dealers do not encourage people to use the Digital Video Stabilizer to duplicate rental movies or copyrighted video tapes. RXII is intended to stabilize and restore crystal clear picture quality for private home use only.

(Dealers Welcome)

- FEATURES:**
- Easy to use and a snap to install
 - State-of-the-art integrated circuit technology
 - 100% automatic - no need for any troublesome adjustments
 - Compatible to all types of VCRs and TVs
 - The best and most exciting Video Stabilizer in the market
 - Light weight (8 ounces) and Compact (1x3.5x5")
 - Beautiful deluxe gift box
 - Uses a standard 9 Volt battery which will last 1-2 years.

To Order: \$59.95 ea + \$4 for FAST UPS SHIPPING
1-800-445-9285 or **516-568-9850**
Visa, M/C, COD M-F: 9-6 (battery not included)
SCO ELECTRONICS INC.
Dept. CPE9 581 W. Merrick Rd. Valley Stream NY 11580
Unconditional 30 days Money Back Guarantee

CIRCLE 13 ON FREE INFORMATION CARD

CABLE TV DESCRAMBLER

How You Can Save Money
on Cable Rental Fees

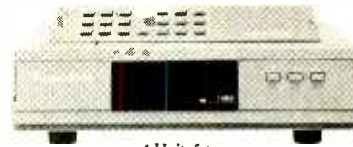

1 Unit 5+
Jerrold SB w/Tri-Bi.....\$99....\$70
SuperTri-Bi (TBM).....\$109....\$75
Jerrold 450 combo.....\$189....\$139
Scientific Atlanta.....\$109....\$75
SA 8536.....\$250....\$195
Pioneer.....\$109....\$79
Oak KN12 (w/VS).....\$109....\$65
Hamlin MLD 1200.....\$89....\$59
Tocom.....\$169....\$129
Stargate converter.....\$89....\$69
Panasonic TZPC145.....\$99....\$79

US Cable will Beat Anyone's Price. Advertised in this Magazine!

30 Days Money Back Guarantee
Free 16 page Catalog
Visa, M/C, COD or send money order to:
US Cable TV Inc. Dept. KPE9
4100 N. Powerline Rd., Bldg F-4
Pompano Beach, FL 33073

1-800-772-6244

For Our Record

I, the undersigned, do hereby declare under penalty of perjury that all products purchased, now and in the future, will only be used on Cable TV systems with proper authorization from local officials or cable company officials in accordance with all applicable federal and state laws. FEDERAL AND VARIOUS STATE LAWS PROVIDE FOR SUBSTANTIAL CRIMINAL AND CIVIL PENALTIES FOR UNAUTHORIZED USE.

Date: _____

Signed: _____

No Florida Sales!

CIRCLE 14 ON FREE INFORMATION CARD

HAM RADIO

By Joseph J. Carr, K4IPV

A Random Walk Through The Technical Mailbag

At least once a year, I like to cover some technical questions from personal contacts and the mail bag, so this month's column will be a "potpourri of ham-radio exotica and miscellanea" (or some such). Although a lot of readers ask questions related to the ham-radio hobby, many of those queries are not general enough to be discussed in this column. However, the ones that are selected are intended to reflect a cross section of the more popular questions asked of me.

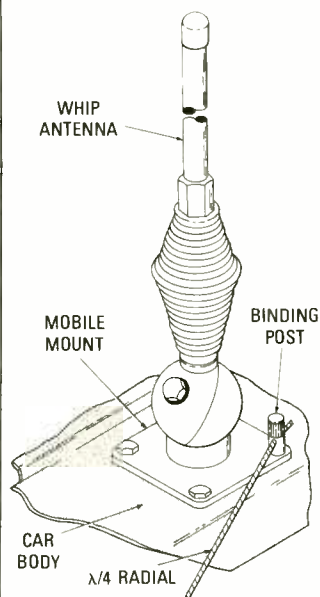

Fig. 1. Adding quarter-wavelength radials extend mobile-antenna range and efficiency.

EXTENDING MOBILE/PORTABLE OPERATION

At a hamfest last summer (1990), a reader recognized my callsign, and asked me about a little problem that he was trying to solve. Interestingly enough, the solution was right in front of him (as you'll see in a moment). He owned a small

weekend cabin in the mountains of western Virginia, on the west slope of the Shenandoah Valley.

The ham routinely used the Icom HF mobile transceiver from his vehicle indoors on these little weekends. The Kawasaki light-plant generator he uses has a 12-volt DC output sufficient to power the rig, even while supplying 115-volt, 60-Hz AC for the lights in the cabin. He didn't want to leave an antenna erected at the site—it would get stolen as did some light appliances and a generator—and he didn't want to waste time each weekend erecting a temporary antenna. His solution was to use the mobile antenna on the car with a long piece of 52-ohm coax "extension cord" from indoors to a double female "barrel" connector under the dash. The problem is simple: HF mobile antennas are terribly inefficient compared to dipoles and full-size verticals. What could he do to improve the situation?

As it happens, we were standing next to the display of an antenna dealer (the only products on display) who stocked a "quarter-wavelength radial kit" for vertical antennas. It contained a set of pre-cut wires, several ceramic end insulators, and about 50-feet of nylon rope. I picked up the kit, and told him use this.

Refer to Fig. 1. The quarter-wavelength radial is made from #14 or #12 wire, the length of which is given by:

$$L = 492/f$$

where L is the length of the radials in feet and f is the

operating frequency at center band in megahertz. The radial can be connected to one of the grounded mounting bolts with an alligator clip, but that's not really such a good practice. Alligator clips do not make good RF connections. A better solution is to mount a grounding type five-way binding post to the mobile antenna mount through a new hole drilled for that purpose. Underneath the car's body panel, make sure that the paint and undercoating are well cleaned, and the metal is bright. Run a short, heavy piece of braid from a piece of coax to the coax transmission-line shield, and its own grounding point.

To operate, take the radial out of the trunk, straighten it out, and connect it to the binding post. Run the radial either a short distance above the ground, or laying on the ground, and secure its far end to a convenient tree or fence post. The best operation occurs when two to six such radials (running from the same binding post) are used, but substantial improvement may be had with only one. I used that method when I lived in rented property, and could not erect a permanent antenna at the house.

One note, however: Be absolutely sure that no visitors, small children, or yourself can accidentally trip on the wire. Also keep in mind that the end of the radial wire is a voltage node, and can cause a nasty shock and RF burn. If you are using high power (or even sometimes 100

watts), an arc can cause a fire. So be very careful with the installation of the temporary radial.

This question seems to come up periodically. That's one of the reasons why I wrote about this solution in my book *Practical Antenna Handbook* (TAB Books, Inc., Blue Ridge Summit, PA, 17294-0850; to order, call 800-233-1128) Cat. No. 3270, \$21.95.

THE "OTHER" COAXIAL CONNECTOR

A reader sent me a color snapshot of an "odd-ball" coaxial connector that he found on a piece of antenna test equipment that he recently bought. He asked that I identify it. Simple: It's a BNC connector. It's used on a wide variety of instruments, and has all but replaced the PL-259/SO-239 combination "UHF" connectors used on most receivers and transmitters. One advantage of the BNC connector is that it exhibits a constant (or nearly so) impedance, despite the fact that it represents a discontinuity in the transmission line.

The BNC connector is "bayonet" style, rather than screw threaded. In other words, to attach a BNC connector, it is pressed onto its mate, and then given a half-turn in the clockwise direction. Removal requires exactly the opposite rotation. That form of adapter can be used to troubleshoot circuits with a signal from a BNC-equipped instrument. Get used to BNC's, they have almost totally replaced the UHF connector, except on the backs of transmitters. Even some receivers use them for the coaxial antenna connection.

MEASURING FM-RIG DEVIATION

Another reader wanted to know how come his local

repeater could tell when he was overmodulating his 2-meter FM rig. An unmodulated FM transmitter outputs only one frequency, the carrier (f_c). When it is modulated, the carrier frequency swings above (positive deviation) and below (negative deviation) the carrier frequency. The distance from the carrier to the maximum and minimum frequencies is a function of the audio-signal amplitude, while the number of times per second it swings back and forth is a function of the audio-modulating frequencies.

Most ham systems are optimized around a narrow-band FM standard, ± 6 kHz deviation, for example. In other words, a maximum signal will cause the carrier frequency to deviate $f_c + 6$ kHz, and $f_c - 6$ kHz. The repeater would produce a 1000-Hz beep when the deviation exceeds $+ 6$ kHz, or a 400-Hz beep if it exceeds $- 6$ kHz. Some repeaters also tell you when your carrier frequency is above or below the set "netted" value.

How, you ask? The means for producing that information is essentially the same for each case. Both systems measure the output voltage from the FM demodulator (discriminator) in the FM receiver. Figure 2 shows the characteristic curve for an FM discriminator. Suppose f_u and f_l are the upper and lower deviation limits for the system. Those limits produce output voltages of V_1 and V_2 , respectively. A voltage comparator, or similar circuit issues a digital output bit every time one of the pre-set limits is exceeded.

Of course, if you want to measure the deviation yourself, and don't want to butcher a good VHF FM, ham-band receiver to tap the discriminator voltage (or find that the FM-demod-

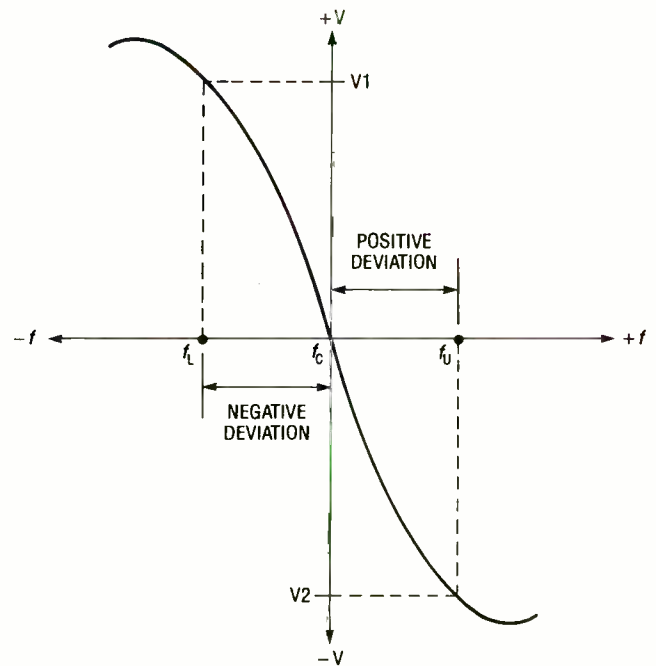

Fig. 2. FM discriminator characteristic curve.

ulator IC isn't so accommodating), then you might want to try another approach. Heath sells a battery-operated, FM deviation meter in kit form (Model IM-4180) that will do the job nicely. It is basically a metered, tunable receiver operating in the VHF/UHF bands. Press the TUNE button, and then peak the meter with the tuning knob, while transmitting on the rig under test. Press one of the deviation-range buttons (2-, 7.5-, 20-, and 75-kHz full-scale are the selections; the latter being for FM-broadcast transmitters), while still transmitting, and the deviation will show on the meter. The IM-4180 can be used as a receiver (a speaker output jack is provided), and it can also be monitored on an oscilloscope for a more dynamic look at the rig's performance.

NOTE TO A READER

One reader wrote to ask an operating question, but failed to provide a return address. His or her question was so important, however, that it merits a mention. The reader asked "Why is it illegal to talk about religion,

and social issues on ham radio?"

First, it's not illegal to discuss those topics. The Communications Act of 1934, under which hams operate, did not repeal the First Amendment of the U.S. Constitution. As far as I know, only obscenity (which is different from profanity, if the crowd sometimes heard on 75- and 20-meters SSB is any measure) is illegal.

However, hams have traditionally refrained voluntarily from discussing those potentially explosive issues in recognition that we are a widely varied plurality on the ham bands. All religions, all political persuasions, all races, all nationalities and ethnic groups, and all manner of social opinions are found on our frequencies. For the sake of order, common decency, and good manners, we don't discuss issues that are so vitally contentious. You can start such a conversation, if you really want to, but expect to receive disapproval from other hams who are exercising their own First Amendment rights. ■

SPECIAL FROM ETT

□ **PCP101—PRACTICAL DIGITAL ELECTRONICS HANDBOOK ... \$9.95.** Introduces digital circuits, logic gates, bistables and timers, as well as micro-processors, memory and input/output devices. Special section on digital test gear projects.



□ **PCP102—INTRODUCING DIGITAL AUDIO ... \$9.95** Shows what is involved in the digital part of audio signals, particularly in the newest devices such as CD, DAT and sampling. Bridges the gap of understanding for the technician and enthusiast.

□ **PCP103—PRACTICAL MIDI HANDBOOK ... \$9.95.** Covers all MIDI based equipment you can use—keyboards, drum machines, sequencers, effects units, mixers, drum pads and guitars. Also a section on computer music that covers software and more.



□ **PCP104—ELECTRONICS BUILD & LEARN, Second Edition ... \$9.95.** You start by assembling a circuit demonstrator that is then used to build and investigate a variety of useful circuits including oscillators, multi-vibrators, bistables and logic circuits.

□ **PCP105—MAKE MONEY FROM HOME RECORDING ... \$10.00.** Now that you've spent all that money on all that recording gear, wouldn't it be nice to get some of it back? Well here's the book that can show you how.



□ **PCP106—SYNTHESIZERS FOR MUSICIANS ... \$10.00.** All current popular forms of synthesis explained; LA, additive, phase distortion, FM and sampling. Get the sounds you want from your synth. Written especially for musicians.

MAIL TO: **Electronic Technology Today, Inc.**
P.O. Box 240
Massapequa Park, NY 11762-0240

SHIPPING CHARGES IN USA AND CANADA

\$0.01 to \$5.00 ... \$1.50	\$30.01 to 40.00 .. \$5.50
\$5.01 to \$10.00 .. \$2.50	\$40.01 to 50.00 .. \$6.50
\$10.01 to 20.00 .. \$3.50	\$50.01 and above .. \$8.00
\$20.01 to 30.00 .. \$4.50	

SORRY, No orders accepted outside of USA and Canada

Total price of merchandise	\$ _____
Shipping (see chart)	\$ _____
Subtotal	\$ _____
Sales Tax (NYS only)	\$ _____
Total Enclosed	\$ _____

Name _____
Address _____
City _____ State _____ Zip _____

CIRCUIT CIRCUS

(Continued from page 76)

changed by decreasing or increasing the number of turns in L1. For higher frequency operation, reduce the number of turns. For lower frequency operation, increase the number of turns.

The values of C1 and C2, in Fig. 4, also may be varied to shift the oscillator's frequency. To lower the oscillator's frequency, increase the value of C1 and C2, and for a higher frequency operation decrease their values.

A carbon microphone can be used in place of R1 in Fig. 5, turning the oscillator into a low-power FM transmitter. The carbon microphone's internal resistance varies in step with the audio, causing the current flow through L1 to vary in a like manner. The varying current through L1 frequency modulates the oscillator.

MOISTURE MONITOR

Our last entry for this month is ideally suited to the horticulturist in your family. If the majority of the plants that you have end up like specimens from the petrified forest, or like drowning rats in a flash flood, it's probably due to improper watering. Too much or too little moisture can end the life of even the most hardy plant.

The moisture monitor shown in Fig. 6 will help keep the plant life around you green and healthy. The circuit is built around a 2N3904 general-purpose NPN transistor (configured as an emitter follower), an LM3914 dot/bar display driver, and a few support components. The probes and the emitter follower (Q1) sample the current flow through the soil. Current flow through the soil

causes Q1 to turn on—the degree to which Q1 turns on is determined by the amount of moisture detected in the soil. That causes a voltage to be developed at the emitter of Q1. That voltage is fed to the input of U1 (the bar/dot display driver). The ten LED's, connected in the bar configuration, light up to indicate the soil's approximate moisture content.

The best material for the probes is stainless steel, but almost any metal will do as long as it is kept clean. A simple way to calibrate the circuit is to short the probes together and adjust R4 until all of the LED's light. That, of course, indicates too much moisture. Now take your moisture meter to an expert gardener and check out a number of plants to get an idea how many LED's should light when the soil has the proper moisture content. ■

COMPUTER BITS

(Continued from page 71)

of, and are supported directly by the respective companies.

The Mylex and Hauppauge boards are produced domestically and are of the highest quality. They are normally sold through dealers, although Hauppauge indicated a willingness to sell directly to end users. Pioneer sells only through dealers.

In general, since I began the process of evaluating these boards, prices of boards at all performance levels have nosedived, and the trend will continue. It seems that no matter when you buy, you can make a better deal six months later. However, that's the nature of this business. Spend a little bit more now and your investment will last a little bit longer. ■

DX LISTENING

(Continued from page 85)

zation, or the medical network from Europe or scientific transmissions. The chart says they should be around 10–20 meters. Also, what happened to the Philippines and Scotland?"

Sadly, doctor, such charts are virtually worthless! At best, they are outdated. At worst, they are just plain wrong! And when they are right, they often leave out essential information about the nature and mode of transmission, leaving the incorrect impression that limited or occasional amateur or utility-type communications are regularly heard voice broadcasts.

Additionally, vague frequency references (such as 10 to 20 meters) are of no real help, since they span a huge range of frequencies, nearly 15,000 kHz! That's about as helpful as directing a motorist running out of gas by "pinpointing" the location of a service station as "somewhere in the state of Montana!"

Next month, I will suggest some more up-to-date and accurate sources for station frequency and schedule information.

DOWN THE DIAL

Your listening reports are wanted. Why not pass along your SW tips, what you are hearing and when, to help fellow DX'ing enthusiasts to tuning these stations. Remember that Coordinated Universal Time (UTC) is equivalent to EST + 5 hours, CST + 6 hours, MST + 7 hours or PST + 8 hours.

AUSTRALIA—4,920 kHz. *VLM4* in Brisbane is one of the Australian Broadcasting Commission's home service shortwave, directed to Australians living in the rural "outback." Still it often puts a decent signal into North

America at around 1200 UTC.

DOMINICAN REPUBLIC—4,930 kHz. *Radio Barahona* is an old station that returned to shortwave after a long, long, absence. It has been heard with all-Spanish programming during the 0030–0100 UTC time slot.

JORDAN—9,560 kHz. *Radio Jordan*, with English news and musical requests, is heard with good signals during the 1500 to 1600 UTC hour.

LEBANON—6,279 kHz. *King of Hope* is an American-owned and operated religious broadcaster operating from southern-Lebanon, near the Israeli border. The station has been noted with English-language religious programming and identifications at around 2130 to 2200 UTC sign off.

MONGOLIA—12,015 kHz. *Radio Ulan Bator* operates on this frequency in English during the early morning hours, until 0940 UTC, when the station's programming language changes to Chinese.

NORTHERN MARIANAS—15,405 kHz. *KHBI* is a Pacific-area shortwave voice, operated by the Christian Science Monitor, broadcasting from Saipan. The station's English programming can be heard at around 2200 UTC, with some interference from the *Voice of America* and Germany's *Deutsche Welle*.

SOUTH KOREA—5,975 kHz. *Radio Korea* is noted on this frequency, and also broadcasting in parallel on 9,870 kHz, in English at 1600 UTC.

U.S.A.—7,416 kHz. *Action Radio* is the identifier used by one of the many unlicensed U.S. "pirate" stations sometimes found on frequencies in this 41-meter band. It has been reported at about 2230 UTC with popular music and comedy. ■

Enter A World Of Excitement with a Subscription to

Popular Electronics

Get the latest electronic technology and information monthly!

Now you can subscribe to the magazine that plugs you into the exciting world of electronics. With every issue of *Popular Electronics* you'll find a wide variety of electronics projects you can build and enjoy.

Popular Electronics brings you informative new product and literature listings, feature articles on test equipment and tools—all designed to keep you tuned in to the latest developments in electronics. So if you love to build fascinating electronics, just fill out the subscription form below to subscribe to *Popular Electronics*. It's a power-house of fun for the electronics enthusiast.

EXCITING MONTHLY FEATURES LIKE:

- ▶ **CONSTRUCTION**—Building projects from crystal sets to clocks, from radio to...
- ▶ **FEATURES**—Educational training on digital electronics, Ohm's Law, Antennas, Communications, Antique Radio, simplified theory.
- ▶ **HANDS-ON-REPORTS**—User test comments on new and unusual consumer products.
- ▶ **SPECIAL COLUMNS**—Think Tank, Circuit Circus, Computer Hits, TV Listening, Antique Radio, Amateur Scanner, Six in...

PLUS: ALL OUR GREAT DEPARTMENTS!

You'll get 12 exciting and informative issues of *Popular Electronics* for only \$18.95. That's a savings of \$16.45 off the regular single copy price. Subscribe to *Popular Electronics* today! Just fill out the subscription order form below.



FOR FASTER SERVICE CALL TODAY
1-800-435-0715
 (7:30AM - 6:30PM)
 EASTERN STANDARD TIME

Popular Electronics SUBSCRIPTION ORDER FORM

P.O. Box 318 Mt. Morris IL 61054 APEJ1

YES! I want to subscribe to *Popular Electronics* for 1 Full year (12 Issues) for only \$18.95. That's a savings of \$16.45 off the newsstand price.

Payment Enclosed Bill me later
 Please charge my: Visa Mastercard

Acct. # _____ Exp. Date _____
 Signature _____ Address (Please check for accuracy of Postman, U.S. Postmark)

PLEASE PRINT BELOW:

NAME _____
 ADDRESS _____
 CITY _____ STATE _____ ZIP _____

Make the most of your general coverage transceiver with *Monitoring Times!*

Every month *Monitoring Times* brings everything you need to make the most of your general coverage transceiver: the latest information on international broadcasting schedules, frequency listings, international DX reports, propagation charts, and tips on how to hear the rare stations. *Monitoring Times* also keeps you up to date on government, military, police and fire networks, as well as tips on monitoring everything from air-to-ground and ship-to-shore signals to radioteletype, facsimile and space communications.

ORDER YOUR SUBSCRIPTION TODAY before another issue goes by. In the U.S., 1 year, \$19.50; foreign and Canada, 1 year, \$26. For a sample issue, send \$2 (foreign, send 5 IRCs). For MC/VISA orders (\$15 minimum), call 1-704-837-9200.

MONITORING TIMES

Your authoritative source, every month.

P.O. Box 98
 Brasstown, N.C. 28902

SEPTEMBER 1991

MAKE A MAC

(Continued from page 31)

When installing the motherboard, we found that the "tang" (identified back in Fig. 1) could get in the way. You might consider using your gas-joint pliers to bend the two tangs slightly to eliminate that problem.

The instruction manual tells you to mount three standoffs to the motherboard. A word of caution, while it might seem more logical to mount the standoffs first to the case, and then mount the motherboard on them, you are advised not to try it. Stick to the instructions in this respect.

The instructions call for "two paper washers" to mount each standoff to the motherboard. This was not exactly accurate. First, there are only three such washers supplied (you would need a total of six) and they are really made of fiber. However, there are three other washers supplied. They are black in color and seem like plastic. Figure 6 shows the assembly for mounting the standoff hardware. We placed the plastic-type washers on the foil or bottom side of the circuit board, and used the paper washers on the top or component side of the motherboard. All other steps and procedures remained the same.

The next phase of the installation concerns the on-board SCSI 3.5-inch disk drive. In our system, we decided to make use of an external drive, and were able to skip these steps. However, the instructions are clear, and accommodate virtually any Macintosh-compatible 3.5-inch SCSI drive.

The balance of the assembly process is purely mechanical with the manual clearly directing you to install and position the cables, etc. The key to a successful Macintosh clone lies with the connections of the various (clearly identified) cables to the ATS power supply and video adapter.

The single-board video adapter is the "magic" we alluded to earlier in this article. Customer engineered and built by ATS, this single board (see Fig. 7) is the difference between a project that "anyone" with a few common hand tools can complete and a project which should be attempted by only the most experienced and prolific "hacker." The instructions that are included with the kit clearly describe how to connect the remaining cables between this board, the power supply, the floppy drive, the SCSI and video con-

nectors, and the backup batteries to complete the job.

Start Your Engines. Assuming you've had no problem getting any parts and have followed the excellent manual to complete all the steps, it's time for the initial powerup. The manual assumes you will be using the ATS monitor and gives you a few simple steps for adjusting the image (horizontal and vertical). These steps call for the use of an insulated screwdriver, but our experience has indicated that the same small flat-blade screwdriver we used earlier can easily accomplish the task. If you have another monitor, naturally the set-up will be different. However, we strongly recommend that you acquire the ATS monitor or an exact equivalent.

All of the necessary instructions to configure and set-up your Macintosh clone are augmented with some additional information that might be of use should you have problems with your fixed- or hard-disk drive format, or in case of other problems.

We promised to show you how to build your own Macintosh, and have succeeded not only in demonstrating how to build a "street-legal" Mac, but one that even Apple hasn't considered. What we mean is an expandable Macintosh platform, with power for all of the possible accessories and adapters presently or soon to be available for the Macintosh computer family.

As we were going to press, we learned of yet another ATS Convertible Kit, this one based on the now-available Mac SE motherboard that will enable you to have more performance, more features, and at a lower cost, despite the increased cost of acquiring a Mac SE motherboard. You may want to look into one for yourself.

We'd like to acknowledge the assistance of ATS's president John Yaeger for his help and permission to reproduce line art from the Convertible's Manual. ■

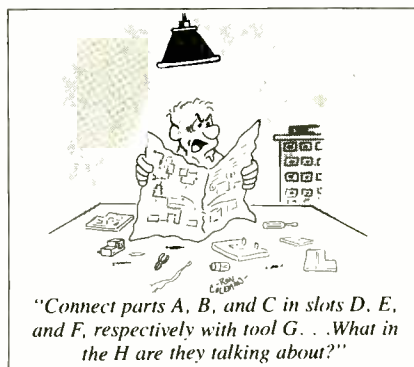

LASER POWER SUPPLY

(Continued from page 34)

about 1/8 inch. If you do not get a spark, check pin 3 of U1 for the presence of a 500-Hz signal with an approximate 50% duty cycle. If that checks out, check the two transistors for proper orientation and output.

If you get the proper response, remove power from the circuit and disconnect the lead from the center terminal of the coil.

Preparing the Laser Tube. Most laser tubes come with clips attached to the ends (see Fig. 4). Remove the clips, but do not discard them; they will be used to deliver power from the Laser Power Supply to the laser tube. If your tube doesn't have clips, do not attempt to solder wires to the tube ends. The ends contain mirrors that allow the tube to lase. Their alignment will be distorted if heat is applied directly or too close to them. If the tube doesn't have clips, the high-voltage wires will have to be wrapped around the ends. Also, laser tubes might have adjustment screws at their ends that are used to align the mirrors, which are factory set by the tube's manufacturer. Do not attempt to re-align the mirrors.

Now is the time to consider the enclosure. The author's unit was enclosed in a Carlon electrical feed-through box, see Fig. 4, which is normally used for plastic conduit. It was necessary to fashion collars to secure the tube in position. For that task, the author used two pieces of plastic conduit tubing, which were cut to about 1 inch. The 1-inch

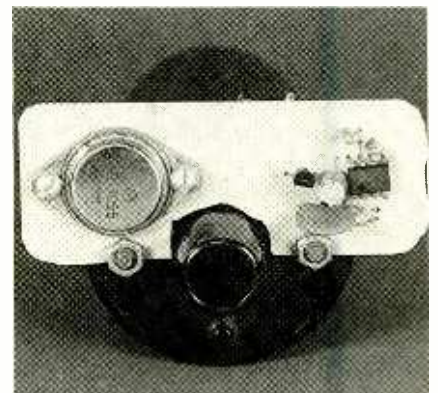

Here is the Laser Power Supply board mounted to the auto ignition coil. Note that the board is held in place by screws on the coil's positive and negative power-input terminals. Those screws also make electrical connection from the board to the coil.

lengths of tubing were cemented inside the lead-in holes in the feed-through box. Tiny holes, just large enough for pieces of heavy-gauge bus wire to pass through, were drilled at the conduit/feed-through box joint at both ends of the enclosure. A pair of small holes were also drilled in one wall of the enclosure for the leads that connect the tube to the power supply.

Once the holes have been drilled, insert the laser tube (with clips removed) into the enclosure. Solder short lengths (about 2 to 3 inches long) of bus wire to the clips. Then insert the free ends of the wires through the holes at the conduit/feed-through box joints. Solder one lead of a 75k, 3-watt ballast resistor to the wire that's connected to the clip that goes to the glass end of the tube, and connect one of the heater-cord leads to the other end of the resistor. That lead goes to the hot side of the coil. Solder the other heater-cord lead to the other bus wire. That lead will serve as the ground wire.

Connect the heater-cord leads to the Laser Power Supply, with the lead connected to the 75k resistor going to the coil's center output terminal (refer to Fig. 3). Solder the other heater-cord lead to the appropriate point on the printed-circuit board. Now reattach the clips to their respective laser-tube ends. Once done, again check your work. If all checks out, you are now ready for the "smoke test." But first make sure that the laser is pointing away from you and/or any reflective surface.

To be on the safe side, apply only 5 volts to the circuit. If all has gone well, you should see a tiny red dot on the wall. If not, check the oscillator circuit; it is the only part of the circuit that is critical. If an oscilloscope is available, check for the presence of 500-Hz, 50% duty-cycle (or thereabouts) signal. If that checks out, determine whether the transistors are switching.

High voltage, but not much current, is required to operate a laser. To test for the presence of a high-voltage output from the ignition coil, hold a neon lamp near (or connect one end to) the center terminal of the coil. The lamp will glow in the presence of the fields generated by the coil. Also check the current drawn by connecting an ammeter between the 75k ballast resistor and the laser tube. If no current is being drawn, back track until you find the point where the signal is lost. If current is detected, make sure it's within your tube's parameters. ■

Popular Electronics

REPRINT BOOKSTORE

- 221** Popular Electronics (1991 back issues) **\$4.00**
Write in issues desired _____
- 220** Popular Electronics (1990 back issues) **\$4.50**
Write in issues desired _____
- 119** Popular Electronics (1989 back issues) **\$4.75**
Write in issues desired _____
- 118** Hands-On Electronics (1988 back issues) **\$5.00**
Write in issues desired _____
- 117** Hands-On Electronics (1987 back issues) **\$5.25**
Write in issues desired _____
- 116** Hands-On Electronics (1986 back issues) **\$5.50**
Write in issues desired _____
- EH91** Experimenters Handbook (1991) **\$4.50**
- EH90** Experimenters Handbook (1990) **\$5.00**
- EH88** Experimenters Handbook (1988-89) **\$5.50**
- EH87** Experimenters Handbook (1987) **\$6.00**
- HH91** Popular Electronics Hobbyist Handbook (1991) **\$5.00**
- HH90** Popular Electronics Hobbyist Handbook (1990) **\$5.50**
- HH89** Popular Electronics Hobbyist Handbook (1989) **\$6.00**
- 126** Radio-Electronics Annual 1986 **\$6.00**
- 211** Radio-Electronics (1991 back issues) **\$4.00**
Write in issues desired _____
- 210** Radio-Electronics (1990 back issues) **\$4.50**
Write in issues desired _____
- 109** Radio-Electronics (1989 back issues) **\$4.75**
Write in issues desired _____
- 108** Radio-Electronics (1988 back issues) **\$5.00**
Write in issues desired _____

- 107** Radio-Electronics (1987 back issues) **\$5.25**
Write in issues desired _____
- 106** Radio-Electronics (1986 back issues) **\$5.50**
Write in issues desired _____

REPRINTS

REPRINTS

- 169** Think Tank (133 Circuits) **\$3.50**
- 169A** Think Tank Vol. 2 **\$3.00**
- 168** Fact Cards (#34-66) **\$4.00**
- 168C** Fact Cards (#67-99) **\$3.50**
- 168D** Fact Cards (#100-132) **\$3.50**
- 167** Designing With IC's **\$4.00**
- 166** Collected Works of Mohammed Ulysses Fips (62 pages, April Fools Collection) **\$5.00**
- 165** How to Repair CD Disc Players **\$5.00**
- 164** Modern Electrics (April 1908) **\$3.00**
- 163** Receiving Satellite TV **\$5.00**
- 162** Build Your Own Satellite TV Receiver **\$5.00**
- 161** Descrambling (Feb. 1984) **\$4.00**
- 160** New Ideas - 42 Circuits **\$3.50**
- 159** Low Frequency Receiving Techniques Building and using VLF Antennas. **\$5.00**
- 158** Electro Importing Co. Catalog (Circa 1918) **\$5.95**
- 157** All About Kits **\$2.00**
- 156** How To Make PC Boards **\$2.00**
- 155** IBM Typewriter To Computer **\$2.00**
- 154** How To Repair VCR's **\$3.50**
- 150** Pay TV Decoder (1981) **\$3.00**

To order any of the items indicated above, check off the ones you want. Complete the order form below, **include your payment**, check or money order (DO NOT SEND CASH), and mail to **Popular Electronics**, Reprint Department, P.O. Box 4079, Farmingdale, NY 11735. Please allow 4-6 weeks for delivery.

If you need a copy of an article that is in an issue we indicate is unavailable you can order it directly from us. We charge 50¢ per page. Indicate the issue (month & year), pages and article desired. Include payment in full, plus shipping and handling charge. Make checks payable to Gernsback Publications, Inc.

ARTICLE _____

PAGES _____

MONTH _____

YEAR _____

TOTAL PAGES _____

@50¢ each

TOTAL PRICE _____

MAIL TO: **Popular Electronics**

Reprint Bookstore, P.O. Box 4079, Farmingdale NY 11735

All payments must be in U.S. funds

SHIPPING CHARGES IN USA & CANADA

\$0.01 to \$5.00	\$1.50	\$30.01 to 40.00	\$5.50
\$5.01 to \$10.00	\$2.50	\$40.01 to 50.00	\$6.50
\$10.01 to 20.00	\$3.50	\$50.01 and above	\$8.00
\$20.01 to 30.00	\$4.50		

SORRY — We only ship to USA & Canada

Total price of merchandise _____ \$ _____
 Sales Tax (New York State Residents only) _____ \$ _____
 Shipping Charge (see chart) _____ \$ _____

Name _____

Total Enclosed _____ \$ _____

Address _____

City _____ State _____ Zip _____

PE991

RECEIVER SENSITIVITY

(Continued from page 62)

SNR in decibels relative to 1-mW dissipated in a 50-ohm resistive load. In other words, 1 mW dissipated in a 50-ohm load represents a signal level of 0 dBm. Typical sensitivities specified in dBm range from -60 dBm to -120 dBm or so. The dBm level of any given signal with power P_{sig} is found from:

$$\text{dBm} = 10\text{LOG}(P_{sig}/.001)$$

If you want to know the amount of power that a given dBm level represents:

$$P_{sig} = .001 \times 10^{\text{dBm}/10}$$

If you need to know how much signal voltage is represented by a specified dBm level, then use:

$$V_{sig} = 7.07\sqrt{P_{sig}}$$

Another unit, the dBmv, is used in some TV-antenna and cable-TV systems, and refers to a measurement in which all signals are relative to a reference level of 1 mV across a 75-ohm

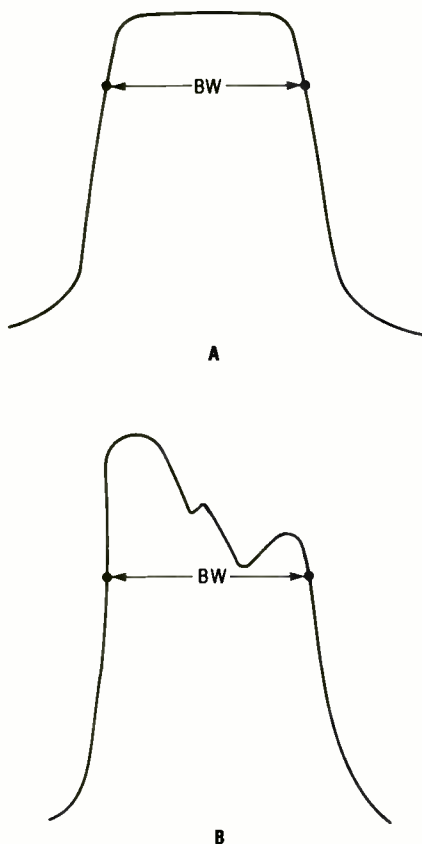

Fig. 3. The pass-band of a good receiver has flat response across the tuned bandwidth (A). The pass-band of a "dog" receiver (B) might yield a better signal-to-noise ratio.

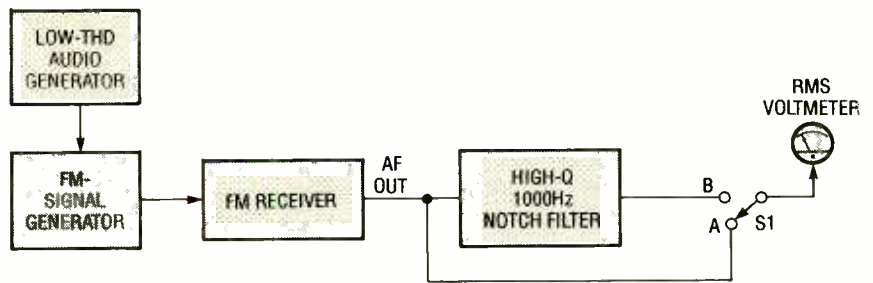

Fig. 4. This is a block diagram of a SINAD sensitivity test set-up. The test is performed in two parts: first with a filter in the signal path and then without a filter.

load (0 dBmv). The 1-mV level is considered to be the point at which the picture is snow-free.

Sometimes sensitivity is specified in microvolts (μV). This method simply states the number of microvolts, impressed across the input impedance of the receiver (usually 50 ohms), required to achieve the required signal-to-noise ratio.

AM sensitivity is usually specified to achieve a standardized SNR (10 dB is common) using a given percentage of sinusoidal amplitude modulation (30% is typical), of a given audio frequency (400 and 1,000 Hz are common), with the receiver bandwidth set (if it is adjustable) to a certain point. For plain AM receivers, the bandwidth can be just enough to pass the highest significant AM sidebands. However, for broadcast and communications receivers a bandwidth of 6 kHz is common and 8 or 10 kHz for broadcast models. Sensitivities of $1 \mu\text{V}$ are common on AM receivers.

The sensitivity of a receiver set for SSB or CW operation is generally considerably higher than the same receiver set to the AM mode of operation. One reason for that is that a SSB/CW signal is directly converted to audio and does not pass through an envelope detector as does an AM signal. Second, the bandwidth of the signal is considerably less. The latter factor means that the receiver bandwidth is less, so the noise term (which is a function of bandwidth, among other things) in SNR is also less. Typical values for a 10 dB SNR are 0.02 to $0.1 \mu\text{V}$.

An FM receiver must be tested with an FM-signal generator set to some value of frequency deviation that approximates the bandwidth of the typical signals received. For example, a scanner or other FM or PM communications receiver may require a signal that deviates on the order of 2.1-kHz rms, or 3-kHz peak, at an audio rate of 1000 Hz.

FM-receiver sensitivity is also some-

times specified for the signal level required to cause 20 dB of output-level "quieting." This method is preferred by some technicians who lack an FM-signal generator because it can be performed with just a CW-signal (i.e., unmodulated) generator. The "quieting" occurs when an unmodulated signal is applied to the input of an FM receiver. Tune the receiver off-channel, and measure the rms value of the output noise ("hiss") voltage. Next, tune a signal generator to the same frequency, and increase the output level until the noise output voltage drops 20 dB. The input signal level that produces this result is called the "20-dB quieting sensitivity," and values on the order of 0.15 μV to 0.25 μV are typical.

A pulse receiver, such as used in radar and certain other applications, may be specified for a certain "tangential" sensitivity level. This sensitivity is the pulse amplitude that exactly doubles the noise-signal amplitude. Thus, the pulse level is equal to the rms level of the noise in the system.

Conclusion. Receiver sensitivity varies from one model to another, even when the two receivers are nearly the same, for several reasons. One reason is that modulation and bandwidth make a difference. Hence the difference between AM sensitivity, SSB sensitivity, CW sensitivity, and FM sensitivity on exactly the same receiver. Once you appreciate the differences, receiver specification sheets will not be a mystery. Also, you will be able to spot creative "spec" writing on the part of some manufacturers.

For example, a receiver that is used mostly for AM-shortwave listening might be promoted using its CW sensitivity. Why? The narrower CW bandwidth makes the receiver look better. If you are aware of such things you'll know how to avoid comparing apples with oranges when considering the merits of a receiver. ■

ELECTRONIC DRAGONFLY

(Continued from page 58)

conductive adhesive backing. First solder a thin-gauge lead to a piece of copper-foil tape, let it cool, and then stick it to the piezoelectric-film wings. Do the same on the opposite side of the wings in the same position.

As shown in Fig. 6, the wings are held to the body of the dragonfly with double-sided (cellophane) tape, and the leads to the wings are soldered to the appropriate pads (points C and D in the kit) on the printed-circuit board (in the kit, the red wing-lead goes to point D—for you do-it-yourselfers, that's the lower pad). The dragonfly is supported over the board by a stiff piece of bus wire, which is soldered to the pad that's indicated in Fig. 4. Be sure to bend about 1/4 inch of the lower end of the wire at a 90-degree angle before soldering in place to increase the strength of the joint. About 3/4 inch of the upper end of the wire is also bent at a 90-degree angle, as is about 1/8 inch of the very tip of the wire, to provide a resting place for the dragonfly, which is held on with double-sided adhesive-backed foam rubber (see Fig. 6). Four rubber, adhesive-backed feet are then placed in the corners on the foil side of the board, and some protective insulation is placed over the high-voltage traces to complete the project.

Now simply pop a battery into the holder, press S1, and watch the wings flap. You can adjust the rate at which the wings flap by varying R7. The dragonfly should come to life right away. If you have any problems, go back and check your work for proper parts placement, poor solder joints, etc.

Once you have the project working, the Electronic Dragonfly is ready to hover over your desk or mantle and entertain your friends. Perhaps the best thing to do is help a young hobbyist build the project, or build it yourself and give it to a youngster. ■

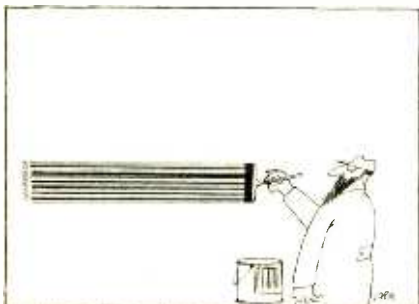

WHAT DO ELEC. ENGINEERS DO?

(Continued from page 38)

There is a flip side, though—pay scales tend to rise rapidly at first and then plateau after about ten years, unless you go into management. Also, there is the "engineering half-life." It has been said that half of what an engineer learns becomes obsolete in five years. I'm not sure I agree with the 5-year part, but it is a constant effort to keep up-to-date. As I look around the industry, I find that the majority of active design engineers are under forty. This does not mean that the rest of us have lost our jobs, but we have moved into management, sales, or other areas.

Will Rogers once said, "If you want to be successful, know what you are doing, love what you are doing, and believe in what you are doing." That is especially true in engineering. If someone you know is planning to go into engineering just for the money, tell them to forget it. They'll probably fail. The successful people I've known have been those who are in electronics because they love it. They're simply practicing their hobby! ■

**Honoring
a friend or
loved one has
never been easier.**

1-800-242-8721

The American Heart
Association Memorial Program.
An Investment in Life.

**American Heart
Association**

This space provided as a public service.

FCC LICENSE PREPARATION

General Radiotelephone
Radiotelegraph
Amateur Radio Licenses

We offer the most up-to-date study materials available. Our formats include: tests, audio programs, and video programs.

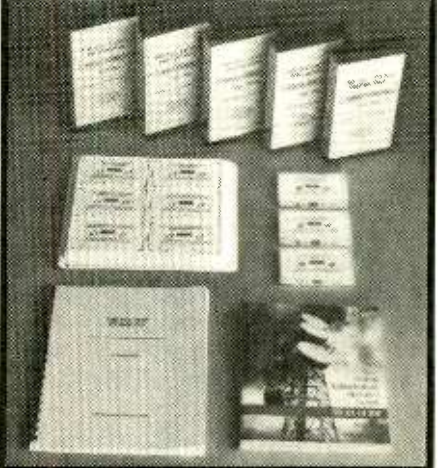

WPT PUBLICATIONS

979 Young Street, Suite E
Woodburn, OR 97071
(503) 981-5159

CIRCLE 19 ON FREE INFORMATION CARD

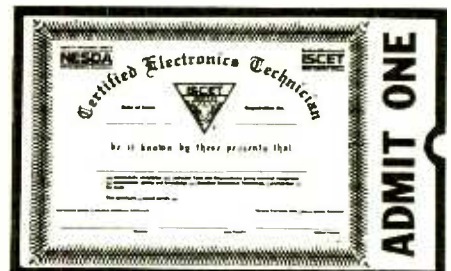

Your Ticket To SUCCESS

Over 28,000 technicians have gained admittance worldwide as certified professionals. Let your ticket start opening doors for you.

ISCET offers Journeyman certification in Consumer Electronics, Industrial, Medical, Communications, Radar, Computer and Video. For more information, contact the International Society of Certified Electronics Technicians, 2708 West Berry Street, Fort Worth, TX 76109; (817) 921-9101.

Name _____
Address _____
City _____
State _____ Zip _____

Send material about ISCET and becoming certified.

Send one "Study Guide for the Associate Level CET Test." Enclosed is \$10 (inc. postage).

PROJECTION TV

(Continued from page 71)

using such a high-gain reflective screen, pictures tend to look somewhat washed out when black level retention is less than perfect. There was no such problem with this set.

Color quality was very good and there was not the slightest amount of overscan. With this system, you will see the entire picture, right out to its extreme edges.

Pulsar didn't skimp in the design of their TV-tuner section either. There was hardly any video noise (or snow) visible, and colors remained accurate when APEL input the equivalent of a fringe area signal (of 100 micro-volt/meter intensity) to the antenna input.

The audio output jacks delivered 0.28 volts of audio with only 0.15% distortion, and distortion decreased to an insignificant .09% at lower voltage-output levels. Frequency response of the audio section was excellent, extending from 20 Hz to 16 kHz. Tone controls provided the usual range of 10 dB or so of bass and treble boost or cut at 100 Hz and 10,000 Hz, respectively. As for the MTS-decoder section, it provided adequate stereo separation of between 18.8 and 19.5 dB (depending on which channel was being measured) at maximum audio-modulation levels, and the separation remained virtually the same at lower modulation levels.

As for the SAP (secondary audio program) mode of the MTS decoder, it provided only minimal frequency response extending from about 250 Hz to 4 kHz. Monophonic frequency response from the MTS decoder circuitry extended to around 3.55 kHz, or enough for most dialogue program

material commonly listened to on broadcast TV.

Aside from the unusual mounting arrangement of the speakers referred to earlier, there is little that we could take issue with concerning the design and performance of this excellent large screen front-projection TV system. If you are about to set up a home audio/video theater, or even if you already own one and feel that you are ready for a bigger, brighter picture than you currently have, you should check out the Pulsar TVP 2000. In light of its features and performance that this set offers, we feel that even at \$4295.00, it's priced within reason, too.

For more information on the Pulsar TVP 2000 "Prodigy" projection TV monitor/receiver, contact the manufacturer directly, or circle no. 120 on the Free Information Card. ■

FUN SOFTWARE

(Continued from page 83)

playing games with 3-D graphics and enhanced sound (IBM, Amiga: \$49.95).

MicroProse packs in the action with Gunship 2000, the first multicopter simulation. Topographical 3-D graphics, seven types of helicopters and hundreds of missions in the Persian Gulf and Central Europe are featured (IBM). Another new MicroProse release is Legend Entertainment's Timequest, a time-travel action adventure spanning three thousand years, from Stonehenge to Hitler (IBM: \$59.95).

Sierra (recently merged with Borlund) has announced Space Quest IV—Roger Wilco and the Time Rippers, a topsy-turvy sequel through time and space. It comes on six high-density diskettes (IBM: \$59.95). ■

ANTIQUE RADIO

(Continued from page 73)

POWERING UP THE THEREMIN

Next, I decided to try applying power to the theremin unit, now removed from its cabinet. Since the power supply was easy to isolate from the theremin chassis, requiring only disconnection of a 9-wire power cable from its terminal strip, the first tests were conducted on the supply alone.

Had the power supply contained electrolytic filter capacitors, which can be destroyed by sudden application of power after long periods of disuse, I would have used a variable transformer to bring up the line voltage slowly. However, electrolytics weren't common in the era (late 1920's) when this unit was built—and the power supply didn't contain any.

Accordingly, I just crossed my fingers and flipped the switch—having connected a DC voltmeter so that I could monitor power-supply output. The meter almost immediately registered an appropriate value, and there was no sign or smell of smoke. Continuing to make voltage tests as outlined in the RCA service notes, I found all values within specifications for the unloaded power supply.

Now it was time for a round of voltage checks with the theremin chassis connected. In preparation for that, I hooked up the power cable to its terminal strip on the power supply and shorted out the speaker connection. The latter move applied voltage to the plate of the power-output tube under close to operating conditions, but avoided the distraction of having the speaker emitting various unearthly sounds during testing.

I also pulled the type-20 volume-control tube, since its filament power source (that jumbled-up pickup coil) was in question, replacing it with a small penlight bulb that had voltage and current ratings similar to those of the tube filament. That bulb was clipped directly across the coil's output leads and would give an indication of the presence of filament power.

The voltages at all checkpoints agreed closely with RCA's published values for a power supply under load. However, there wasn't a glimmer of light in the penlight bulb filament. I knew that the 420-kHz volume-control oscillator was operating (a necessary condition for power to be available at the pickup coil) because I could hear its second harmonic at about 840 kHz on a transistor radio.

UNTIL NEXT TIME

It's quite obvious that the coil is going to need some work before the theremin can be made to operate properly, and I hope to be able to solve that problem in time for the next column. See you then, but in the meantime don't forget about our contest! Tell us how you catalog and display your radios, how other members of your family relate to them, and what tactics (if any) were needed to gain the support of other members of your family.

Photos are welcome! All entries must be received before the Labor Day holiday, and the eight judged most interesting will receive reprint copies of *100 Radio Hookups*, the same 1924 Gernsback publication sent to the winners of our theremin contest. Write c/o *Antique Radio, Popular Electronics*, 500-B Bi-County Blvd., Farmingdale, NY 11735. ■

ELECTRONICS MARKET PLACE

FOR SALE

CABLE descramblers (Jerrold) from \$40.00. Tocom VIP test chip. Fully activates unit. \$50.00. Call (213) 867-0081.

CABLE descrambler liquidation. Major makes and models available. Industry pricing! (Example: Hamlin Combo's, \$44 each... Minimum 10 orders). Call **WEST COAST ELECTRONICS**, 1 (800) 628-9656.

PRINTED circuit boards — etched, drilled, tin plated. Single sided \$1.25/sq. inch. Free shipping. **CHELCO ELECTRONICS**, 61 Water Street, Mayville, NY 14757. (716) 753-3200.

CABLE converters all major brands info + orders 1 (800) 782-0552 **FREEWAY INC.** (s.m.p.), PO Box 5036, Burnsville, MN 55337.

DESCRAMBLERS, cable TV converters, **lowest prices**, guaranteed, best quality, special Sacramento units, **CNC CONCEPTS INC.**, Box 34503, Minneapolis, MN 55434. 1 (800) 535-1843.

CLASSIFIED AD ORDER FORM

To run your own classified ad, put one word on each of the lines below and send this form along with your check to:

Popular Electronics Classified Ads, 500-B Bi-County Boulevard, Farmingdale, N.Y. 11735

PLEASE INDICATE in which category of classified advertising you wish your ad to appear. For special headings, there is a surcharge of \$11.00.

() Plans/Kits () Business Opportunities () For Sale
() Education/Instruction () Wanted () Satellite Television
()

Special Category: \$11.00

PLEASE PRINT EACH WORD SEPARATELY, IN BLOCK LETTERS.

(No refunds or credits for typesetting errors can be made unless you clearly print or type your copy.) Rates indicated are for standard style classified ads only. See below for additional charges for special ads. **Minimum: 15 words.**

1	2	3	4	5
6	7	8	9	10
11	12	13	14	15 (\$23.25)
16 (\$24.80)	17 (\$26.35)	18 (\$27.90)	19 (\$29.45)	20 (\$31.00)
21 (\$32.55)	22 (\$34.10)	23 (\$35.65)	24 (\$37.20)	25 (\$38.75)
26 (\$40.30)	27 (\$41.85)	28 (\$43.40)	29 (\$44.95)	30 (\$46.50)
31 (\$48.05)	32 (\$49.60)	33 (\$51.15)	34 (\$52.70)	35 (\$54.25)

We accept MasterCard and Visa for payment of orders. If you wish to use your credit card to pay for your ad fill in the following additional information (Sorry, no telephone orders can be accepted.):

Card Number

Expiration Date

PRINT NAME

SIGNATURE

IF YOU USE A BOX NUMBER YOU MUST INCLUDE YOUR PERMANENT ADDRESS AND PHONE NUMBER FOR OUR FILES. ADS SUBMITTED WITHOUT THIS INFORMATION WILL NOT BE ACCEPTED.

CLASSIFIED COMMERCIAL RATE: (for firms or individuals offering commercial products or services) \$1.55 per word prepaid (no charge for ZIP code). **MINIMUM 15 WORDS.** 5% discount for same ad in 6 issues within one year; 10% discount for 12 issues within one year if prepaid. **NON-COMMERCIAL RATE:** (for individuals who want to buy or sell a personal item) \$1.25 per word, prepaid...no minimum. **ONLY FIRST WORD AND NAME** set in bold caps at no extra charge. Additional bold face (not available as all caps) **30¢ per word additional.** Entire ad in boldface, \$1.85 per word. **TINT SCREEN BEHIND ENTIRE AD:** \$1.90 per word. **TINT SCREEN BEHIND ENTIRE AD PLUS ALL BOLD FACE AD:** \$2.25 per word. **EXPANDED TYPE AD:** \$2.05 per word prepaid. Entire ad in boldface, \$2.45 per word. **TINT SCREEN BEHIND ENTIRE EXPANDED TYPE AD:** \$2.55 per word. **TINT SCREEN BEHIND ENTIRE EXPANDED TYPE AD PLUS ALL BOLD FACE AD:** \$2.95 per word. **DISPLAY ADS:** 1" x 2 1/4"—\$205.00; 2" x 2 1/4"—\$410.00; 3" x 2 1/4"—\$615.00. **General Information:** Frequency rates and prepayment discounts are available. **ALL COPY SUBJECT TO PUBLISHERS APPROVAL. ADVERTISEMENTS USING P.O. BOX ADDRESS WILL NOT BE ACCEPTED UNTIL ADVERTISER SUPPLIES PUBLISHER WITH PERMANENT ADDRESS AND PHONE NUMBER.** Copy to be in our hands on the 18th of the fourth month preceding the date of issue (i.e.; Sept. issue copy must be received by May 18th). When normal closing date falls on Saturday, Sunday or Holiday, issue closes on preceding work day. Send for the classified brochure. Circle Number 49 on the Free Information Card.

CABLE TV DESCRAMBLERS
★ **CONVERTERS** ★
and **ACCESSORIES.**

SAVE MONEY.
DON'T RENT!

PANASONIC,
PIONEER, JERROLD, OAK,
SCIENTIFIC ATLANTA
AND MORE. **LOWEST PRICES.**
FREE CATALOG.

(800) 234-1006
CABLE READY COMPANY

SUPER low prices on computers, motherboards, hard and floppy drives, and add-on cards. We have everything. Full line of test equipment at unbeatable prices. Free catalog. **APPLIED ELECTRONIC RESEARCH, INC.**, 4701 SW 45th St., Ft. Lauderdale, FL 33021. (305) 987-9785.

SAM'S photofacts. #11 thru 2520 while stock lasts. \$6.00 per set. Discounts for volume purchases. 1 (800) 274-2081 MC/Visa.

RADIO software, PC/MSDOS 5.25" 360K disk, 23 programs including subprograms. **INTERMOD—RFRANGE—SWRCALC—dBCALC—PATHLOSS—more!** Great for technicians and students. Complete package \$19.95. **SPARTAN RADIO**, PO Box 15178, Dept. PE, Spartanburg, SC 29302.

CB RADIO OWNERS!

We specialize in a wide variety of technical information, parts and services for CB radios. 10-Meter and FM conversion kits, repair books, plans, high-performance accessories. Thousands of satisfied customers since 1976! Catalog \$2.

CBC INTERNATIONAL
P.O. BOX 31500PE, PHOENIX, AZ 85046

FREE catalog — Military/government ID's certificates, prints; with official insignias. **COUCHPOTATO PUBLISHING**, 8642 Centre, Largo, FL 34647-1239 or (813) 399-2631.

DYNAMIC savings on dynamite parts! I.C.'s, capacitors, connectors, etc. For catalog: **DYNASTY ELECTRONICS**, 200 South Semoran Blvd., Orlando, FL 32807. Fax: (407) 381-0785. We buy excess inventory.

FREE CATALOG

FAMOUS "FIRESSTIK" BRAND CB ANTENNAS AND ACCESSORIES. QUALITY PRODUCTS FOR THE SERIOUS CB'er. SINCE 1962
FIRESSTIK ANTENNA COMPANY
 2614 EAST ADAMS
 PHOENIX, ARIZONA 85034

FLYERS: Regular, vintage, meter, experimental, and electronic kits. Send stamp for each wanted. B-E since 1954. **BIGELOW ELECTRONICS**, Box 125, Bluffton, OH 45817.

Quality Microwave TV Antennas

WIRELESS CABLE - IFTS - MMDS - Amateur TV
 Ultra High Gain 50db(+/-) • Tuneable 1.9 to 2.7 Ghz.

- 36-Channel System Complete \$149.95
- 12-Channel System Complete \$114.95
- Call or write (SASE) for "FREE" Catalog

PHILLIPS-TECH ELECTRONICS
 P.O. Box 8533 • Scottsdale, AZ 85252
(602) 947-7700 (\$3.00 Credit all phone orders)
 MasterCard • Visa • COD's • Quantity Pricing

LIFETIME WARRANTY

BEST BY MAIL

Rates: Write National, Box 5, Sarasota, FL 34230
 OF INTEREST TO ALL
INSTANT ETHANOL. MAKE Your Own Fuel. Send only \$10.95 to: Marflat Ltd., Box 66132, Baltimore, MD 21239.
SHOP BY MAIL Catalog \$5: Gifts N Things, Box 234, Sac, IA 50583.

FINANCIAL

GUARANTEED LOANS! PERSONAL. Business. No Credit Check! Prompt. Professional. (212)323-8006.

BUSINESS OPPORTUNITIES

\$10,000.00 MONTHLY! TAKING Photos at home. No experience. Photopro, 21839 Avalon #199-E, Carson, CA 90745. Recorded details: (213)549-0997.

PLANS & KITS

HOBBY/broadcasting/ham/CB/surveillance transmitters, amplifiers, cable TV, science, bugs, other great projects! Catalog \$1.00 **PANAXIS**, Box 130-H9, Paradise, CA 95967.

BUILD — five-digit, ohms, capacitance, frequency, pulse, multimeter, Board, and instructions \$9.95. **BAGNALL ELECTRONICS**, 179 May, Fairfield, CT 06430.

SURVEILLANCE transmitter kits tune from 65 to 307.5 MHz. Mains powered duplex, telephone, room, combination telephone/room. Catalog with **Popular Communications, Popular Electronics** and **Radio-Electronics** book reviews of "Electronic Eavesdropping Equipment Design," \$2.00. **SHEFFIELD ELECTRONICS**, 7223A Stony Island Ave., Chicago, IL 60649-2806.

Motion Control System → \$159.00



Includes Computer, Monitor, Keyboard, Power supply, 4 Motors, and Software.
 Call or Send for **Free Robotics Catalog**

Silicon Valley Surplus 4222 E. 12th St. Serving you since 1983
 415 261-4506 Oakland Ca. 94601 8 am to 4 pm PST

MINIATURE FM transmitters! Tracking transmitters! Voice disguisers! Bug detectors! Phone devices! More! Available as kits or assembled and tested! Catalog \$2.00 (refundable): **XANDI ELECTRONICS**, Box 25647, Dept. 32H, Tempe, AZ 85285-5647.

DAZER Personal protectors! Lasers! AM/FM/infrared transmitters! Detectors! More! Kits/assembled. Catalog \$2.00. **QUANTUM RESEARCH**, 16645-113 Avenue, Edmonton, Alberta T5M 2X2.

SURVEILLANCE — Audio/video/infra-red/laser. Law enforcement, industrial, private. 500 item catalog \$7.00. **SECURITY SYSTEMS**, 3017F Hudson, New Orleans, LA 70131.

REMOTE car starter plan. 30 pgs. Universal. Simple. Works! \$12.75 **SCHLITZER**, 414 Alva, Grand Prairie, TX 75051.

SURVEILLANCE — countermeasures! Guaranteed lowest prices! Huge Catalog \$5.00 (refundable). **PROTECTOR**, PO Box 520294-E, Salt Lake City, Utah 84152.

SMD How to use surface mount technology. Build ultra miniature projects! Plans included free, infra red control, and an interesting light display. Send \$15.00 to **CHARLIE'S VIDEO**, Dept SMT, PO 7782, La Sierra, CA 92503.

I'LL HAVE MINE DESCRAMBLER



If you find a better deal, We'll beat it! **JERROLD • TOCOM • HAMLIN • OAK • SCIENTIFIC ATLANTA • ZENITH** • ask about our warranty program C.O.D. Visa, M/C, AM. EX. welcome. **FREE CATALOG • FREE CALL • OPEN SATURDAYS**
1 800 562-6884
VIDEO TECH
 3702 S. Virginia St. Ste. 160-304
 Reno, NV 89502

FREE cable and satellite descrambler plans. Send self addressed stamped envelope. **MJH INDUSTRY**, Box 531, Bronx, NY 10461-0208.

VIDEODIPHER II/scanner/cable/satellite modifications books. Catalog — \$3.00. **TELECODE**, PO Box 6426-PE, Yuma, AZ 85366-6426.

SAVE your ni-cad's. Power pack charger automatically deep cycles and charges. Information \$1.00. Circuit board kit \$35.00. Complete kit \$70.00. California residents add 6%. \$5.00 shipping per order. **R. DANA NEGLEY**, 8032 Levering Way, Sacramento, CA 95823.

DESCRAMBLER kits. Complete cable kit \$44.95. Complete satellite kit \$49.95. Add \$5.00 shipping. Free brochure. **SUMMIT PE**, Box 489, Bronx, NY 10465. No NY sales.

CABLE TV "BOXES"

Converters-Descramblers
Remote Controls-Accessories

- ★ Guaranteed Best Prices ★
- ★ 1 Year Warranty - C.O.D.'s ★
- ★ Immediate Shipping ★
- ★ FREE CATALOG ★

Call or Write
NAS/TRANS-WORLD CABLE CO.
 3958 North Lake Blvd. • Suite 255
 Lake Park, Florida 33403
 1-800-442-9333
 1-800-848-3997

WIRE sorter. Save time and money when identifying multiple wire runs and bundles. Easy to follow prints and instructions. Send \$5.00 to **PATTEN ENTERPRISES**, PO Box 1666, Spring Valley, CA 91978-1666. CA residents add \$.35.

\$.50 software. Best of shareware. 25 meg for \$45.00. Add \$3.00 S/H. Send to D.T.S., Box 34879, Houston, TX 77234-4879.

BUILD a regulated battery charger for your car, boat or motorcycle. Simple construction. Four different schematics. \$3.50 **JOHNSON**, 46 Bennett, Wolf-forth, TX 79382.

TELEPHONE bug FM plans. Convert Radio Shack device easy. \$8.00 **ALLAN LABORATORIES**, PO Box 14302, Research Triangle Park, NC 27709.

ANTIQUE RADIO CLASSIFIED

Free Sample!
 Antique Radio's
 Largest Circulation Monthly.
 Articles, Ads & Classifieds.
6-Month Trial: \$15. 1-Yr: \$27(\$40-1st Class).
A.R.C., P.O. Box 802-L8, Carlisle, MA 01741

KITS, sound and light effects, games, unusual and high tech. Write for free catalog to **JM ELECTRONICS**, Box 150454, Altamonte Springs, FL 32715-0454.

BUILD 20-900 Mhz. spectrum analyzer using common TV parts. Use with any oscilloscope, simple design that works. For plans send \$10.00 cash or check made payable to **P. GAUL**, 1014 Hopper Ave., Suite 122, Santa Rosa, CA 95403.

MICROCOMPUTER, Discover the power and ease of computer control. Plans/application notes for inexpensive, compact, powerful microcomputer \$5.50. **ACS**, 6220 Shallowford. RD. #152, Chattanooga, TN 37421.

KELVIN 200

AC/DC VOLTAGE
 AC/DC CURRENT
 RESISTANCE DIODE TEST
 LOW BATTERY Warning
 ACCURACY +/- 0.5%
 CONTINUITY TEST/BUZZER
 TRANSISTOR CHECKER
 CAPACITANCE CHECKER

\$39.95

Stock No 990091

KELVIN Electronics
 7 Fairchild Ave., Plainville, NY 11803
 (516) 349-7620 1(800) 645-9212

CHRISTMAS star. Design for an 8 point sequencing star. Schematics, PCB layout and sources included. \$10.00. **CONTINUOUS CONCEPTS**, PO Box 60414, San Diego, CA 92166. CA residents add 7% tax.

WORLD'S smallest infrared motion detector piezo alarm. Complete kit \$19.50. **QUINTEL**, 6707 Hurteau, MTL, Quebec H4E 2Y7.

AMAZING electronic dice. Excellent for games, learning and lottery picks. Ideal for elderly, children, and handicapped. Professional plans with PCB layout: \$4.95. Assembled: \$19.95. **SOTA ELECTRONICS**, 230 Berkeley Drive, Neenah, WI 54956.

"VCR Commercial Zapper" Revolutionary device pauses your VCR during commercials automatically! Easy and inexpensive to build. Plans cash \$10.00, money order \$12.00. No checks. PA residents 6% tax. **ENGINEERED DESIGNS**, 46 Minden Court, Nanticoke, PA 18634.

CABLE DESCRAMBLERS
OAK M35B COMBO \$39.95

Jerrold, Zenith, Hamlin, Sci. Atlanta, Pioneer & MORE! OUR PRICES ARE BELOW WHOLESALE!

CABLE+PLUS
 14417 Chase St. #481-B Panorama City, CA 91402
 1-800-822-9955 • Other Info. 1-818-785-4500
 NO CALIF. SALES — DEALERS WANTED

PC board etched and drilled for as low as \$.70 per square inch. (407) 767-8196 or fax (407) 767-5969. Or write **JM ELECTRONICS**, Box 150454, Altamonte Springs, FL 32715-0454.

T.V. FILTERS

T.V. notch filters, phone recording equipment, brochure \$1.00. **MICRO THINC.**, Box 63/6025, Margate, FL 33063. (305) 752-9202.

CABLE EQUIPMENT

CABLE TV secrets — the outlaw publication the cable companies tried to ban. HBO, Movie Channel, Showtime, descramblers, converters, etc. Suppliers list included. \$9.95. **CABLE FACTS**, Box 711-H, Pataskala, OH 43062.

CALL DOCTOR DESCRAMBLER

...for symptoms relating to scrambled cable T.V. signals. We have JERROLD • TOCOM • ZENITH • HAMLIN OAK • SCIENTIFIC ATLANTA. Six month warranty! We ship C.O.D. Lowest retail/wholesale prices. FREE CATALOG: Global Cable Network 1032 Irving St. Ste 109 S.F., CA 94122 NO CALIFORNIA SALES!!! OPEN SATURDAYS

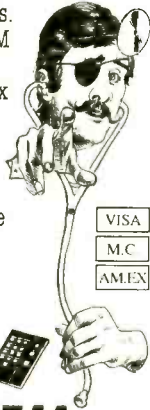

VISA
M.C.
AMEX



1-800-327-8544

EDUCATION/INSTRUCTION

REJUVENATE your tired Ni-cads. Little known process, anyone who uses Ni-cads, will need this money saving manual. Easy low tech system. \$9.95 to NI-CADS, PO Box 4091, Minneapolis, MN 55343.

WANTED

INVENTORS! Confused? Need help? Call **IMPAC** for free information package. USA/Canada: 1 (800) 225-5800. (24 hours.)

INVENTIONS/new products/ideas wanted: Call **TLCI** for free information 1 (800) 468-7200 24 hours/day — USA/Canada.

★★★★PRESENTING★★★★
**CABLE TV
DESCRAMBLERS**
★★★★ STARRING ★★★★★
JERROLD, HAMLIN, OAK
AND OTHER FAMOUS MANUFACTURERS

- FINEST WARRANTY PROGRAM AVAILABLE
- LOWEST RETAIL/WHOLESALE PRICES IN U.S.
- ORDERS SHIPPED FROM STOCK WITHIN 24 HRS.
- ALL MAJOR CREDIT CARDS ACCEPTED

FOR FREE CATALOG ONLY 1-800-345-8927
FOR ALL INFORMATION 1-818-709-9937

PACIFIC CABLE CO., INC.
7325 1/2 Reseda Blvd., Dept. 2006
Reseda, CA 91335

Now Tax Free For College



U.S. Savings Bonds

Great money in VCR repair!

Home study. Learn high-profit repairs without investing in high-tech instruments. **FREE BOOKLET: 800-223-4542.**

Name _____
Address _____
City _____ State _____ Zip _____
The School of VCR Repair, 2245 Perimeter Park, Dept. V K341 Atlanta, Georgia 30341



BUSINESS OPPORTUNITIES

YOUR own radio station! Licensed/unlicensed. AM, FM, TV, cable. Information \$1.00 **BROADCASTING**, Box 130-H9, Paradise, CA 95967.

EASY work! Excellent pay! Assemble products at home. Call for information (504) 641-8003 Ext. 5730.

MAKE \$50.00/hr working evenings or weekends in your own electronics business. Send for free facts. **MJPI INDUSTRY**, Box 531, Bronx, NY 10461.

MAKE \$75,000.00 to \$250,000.00 yearly or more fixing IBM color monitors. No investment, start doing it from your home (a telephone required). Information, USA, Canada \$2.00 cash for brochure, other countries \$10.00 US funds. **RANDALL DISPLAY**, Box 2168-H, Van Nuys, CA 91404, USA.

BIG PROFITS

ELECTRONIC ASSEMBLY BUSINESS

Start home, spare time. Investment knowledge or experience unnecessary. **BIG DEMAND** assembling electronic devices. Sales handled by professionals. Unusual business opportunity.

FREE: Complete illustrated literature
BARTA PE-00 Box 248
Walnut Creek, Calif. 94597

MAKE \$\$\$! Become an American electronics dealer! Profit opportunities since 1965. Call **WAYNE MARKS**, 1 (800) 872-1373.

HOME assembly work available! Guaranteed easy money! Free details! **HOMEWORK-P**, Box 520, Danville, NH 03819.

UNLIMITED income operating your own business. Opportunity is knocking. Free information: **JUPITER ENTERPRISES**, PO Box 541782 Dept. R, Dallas, TX 75354-1782.

\$ DISTRIBUTORS needed \$\$. New mini satellite antenna. Tremendous demand. 100% profit. No experience necessary. Serious inquiries only. 1 (800) 762-7952 Ex 774 24 hours.

CABLE T.V. CONVERTERS WHY PAY A HIGH MONTHLY FEE?

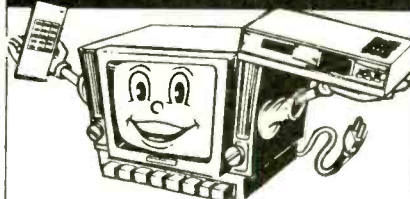

All Jerrold, Oak, Hamlin, Zenith, Scientific Atlanta, Magnavox and all specialized cable equipment available for shipment within 24 hours. For fast service MC / VISA or C.O.D. telephone orders accepted (800) 648-3030 60 Day Guarantee (Quantity Discounts) 8 A.M. to 5 P.M. C.S.T. **CLOSED WEEK-ENDS.** Send self-addressed Stamped envelope (60¢ postage) for Catalog.

**MIDWEST
ELECTRONICS INC.**

P.O. Box 5000
Suite 311 (PE)
Carpentersville, IL 60110

No Illinois Orders Accepted.

SATELLITE TV

FREE catalog — Do-it-yourself save 40—60% **Lowest prices** world wide, systems, upgrades, parts, all major brands factory fresh and warranted. **SKYVISION**, 2008 Collegeway, Fergus Falls, MN 56537. 1 (800) 334-6455.



ANNOUNCING: AN END TO HIGH MONTHLY CABLE FEES!

All Jerrold, Oak, Hamlin, Zenith, Scientific Atlanta, Magnavox and all specialized cable equipment available for shipment within 24 hours. For fast service MC/VISA or C.O.D. telephone orders accepted. 60 Day Guarantee (Quantity Discounts). Send self-addressed Stamped envelope.

1-800-232-5017



C.O.D. ORDERS
ACCEPTED



CABLE-TRONICS, INC.

1304 E. Algonquin Road Suite 501
Algonquin, Illinois 60102

WHY PAY SKY HIGH MONTHLY ★ RENTALS ★



If you find a better deal, We'll beat it! **JERROLD • TOCOM • HAMLIN • OAK • SCIENTIFIC ATLANTA • ZENITH •** ask about our warranty program C.O.D. Visa, M.C. AMEX. welcome. **FREE CATALOG • FREE CALL • OPEN SATURDAYS**

GTV 1464 Garner Station Blvd #315 Raleigh, NC 27603

1 800 328-0198

FREE CATALOG! 1-800-648-7938 JERROLD HAMLIN OAK ETC CABLE TV DESCRAMBLERS

- Special Dealer Prices!
- Compare our Low Retail Prices!
- Guaranteed Prices & Warranties!
- Orders Shipped Immediately!

REPUBLIC CABLE PRODUCTS, INC.

4080 Paradise Rd. #15, Dept. PE991
Las Vegas, NV 89109



For all other information (702) 362-9026

ADVERTISING INDEX

POPULAR ELECTRONICS magazine does not assume any responsibility for errors that may appear in the index below.

Free Information No.	Page		Page
9	AMC Sales	12	5
10	All Electronics	3	—
—	Amazing Concepts	83	—
—	Antique Radio Classified	96	—
—	Barta	97	—
12	C & S Sales	11	—
—	CBC International	95	—
—	CIE	9	—
—	Cable Plus	96	—
—	Cable Ready Company	95	6
—	Cable-Tronics	97	—
—	Command Productions	20	11
7	Contact East	20	—
8	Cook's Institute	83	—
—	Electronic Tech. Today	CV2, 88	13,14
—	Electronics Book Club	79	—
—	Electronics Engineers B.C.	13	18
—	Firestik II	96	—
—	GTV	97	—
—	Global Cable Network	97	15,16
—	Grantham College	17	19
17	Heathkit	19	—
	Howard W. Sams & Co.	15	5
	ISCET	93	—
	Kelvin	96	—
	Midwest Electronics	97	—
	Monitoring Times	89	—
	NAS/TransWorld	96	—
	NRI Schools	25	—
	P.E. Reprint Bookstore	91	—
	Pacific Cable	97	—
	Parts Express	5	6
	Phillips Tech.	96	—
	Protel Technology	16	11
	R-E Video Offer	CV3	—
	Republic Cable	97	—
	SCO Electronics	85	13,14
	Silicon Valley Surplus	96	—
	Test Probes	21	18
	School of VCR Repair	97	—
	Video Tech	96	—
	Viejo Publications	12, 71	15,16
	WPT Publications	93	19
	Windjammer	CV4	—

ADVERTISING SALES OFFICE

Gernsback Publications, Inc.
500-B Bi-County Blvd.
Farmingdale, NY 11735
1-(516) 293-3000
President: Larry Steckler
Assistant to the President: Christina Estrada

For Advertising ONLY

516-293-3000
Fax 1-516-293-3115
Larry Steckler
publisher

Arlene Fishman
advertising director

Denise Haven
advertising assistant

Kelly McQuade
credit manager

Customer Service/Order Form

1-800-435-0715
1-800-892-0753
7:30 AM - 8:30 PM EST

SALES OFFICES

EAST/SOUTHEAST

Stanley Levitan, Eastern Sales Manager
259-23 57th Avenue
Little Neck, NY 11362
1-718-428-6037, 1-516-293-3000
Fax 1-718-225-8594

MIDWEST/Texas/Arkansas/Okla.

Ralph Bergen, Midwest Sales Manager
540 Frontage Road—Suite 204
Northfield, IL 60093
1-708-446-1444
Fax 1-708-559-0562

PACIFIC COAST/Mountain States

Marvin Green, Pacific Sales Manager
5430 Van Nuys Blvd. Suite 316
Van Nuys, CA 91401
1-818-986-2001
Fax 1-818-986-2009

SONY'S MINI DISC

(Continued from page 40)

markable—especially since such a strong base of incompatible equipment stood fighting against obsolescence. Sony's Walkman, introduced in 1979, dramatically changed the way we listen to music. At the time of its introduction, however, it seemed nothing more than a neat gimmick.

Although Sony says they are not trying to replace anything with Mini Disc, there are other items with which it will have to compete for consumer dollars. There's the personal cassette stereo, of course, which should remain a viable format for some time. There's also the DCC player slated for introduction in 1992—at or before the time when the Mini Disc is due.

The portable CD player could also put up a reasonable fight. The main complaint now is that they are not shock resistant. But there's no technological reason that a data buffer couldn't give standard CD players "shock-proof" performance—although considerably more memory would be



The Mini Disc is only 2.5 inches (2.7 including the caddy). Yet it holds as much music—74 minutes—as does a standard CD.

required than in MD players.

The shock resistance, small size, and high quality that are promised by Mini Disc should also be available from DCC. Fast random access—the ability to get to any track on a disc in less than a second—won't, although DCC promises much faster (and more accurate) access than standard cassettes, and CD-like programmability.

Will record companies support Mini Disc? At least one will, since Sony owns CBS Records. We expect others to do

the same. Mini Disc will support SCMS, the Serial Copy Management System that allows copies of CD's to be made, but not copies of copies. And even more important, the same equipment that is used to manufacture CD's can also be used to make MD's. (Even though the Mini Disc is not compatible with compact discs, a Mini Disc player can read both magneto-optical discs and manufactured read-only optical discs.)

Audio quality is another important consideration, but not necessarily the most important—don't forget that the aurally inferior audio cassette far outsells the CD, mainly because of its convenience. At its announcement, Sony demonstrated a working MD prototype, but it was hard to get a feel for its performance; only a 20 second or so demonstration was given in a crowded hotel ballroom, and no A/B comparison was made with other formats.

Regardless of what we say here, however, Mini Disc seems destined to come and compete. Sony will test the waters with the Mini Disc in late 1992. However, based on what we've seen thus far, we're not ready to dive in just yet. ■

Never before has so much professional information on the art of detecting and eliminating electronic snooping devices—and how to defend against experienced information thieves—been placed in one VHS video. If you are a Fortune 500 CEO, an executive in any hi-tech industry, or a novice seeking entry into an honorable, rewarding field of work in countersurveillance, you must view this video presentation again and again.

Wake up! You may be the victim of stolen words—precious ideas that would have made you very wealthy! Yes, professionals, even rank amateurs, may be listening to your most private conversations.

Wake up! If you are not the victim, then you are surrounded by countless victims who need your help if you know how to discover telephone taps, locate bugs, or “sweep” a room clean.

There is a thriving professional service steeped in high-tech techniques that you can become a part of! But first, you must know and understand Countersurveillance Technology. Your very first insight into this highly rewarding field is made possible by a video VHS presentation that you cannot view on broadcast television, satellite, or cable. It presents an informative program prepared by professionals in the field who know their industry, its techniques, kinks and loopholes. Men who can tell you more in 45 minutes in a straightforward, exclusive talk than was ever attempted before.

Foiling Information Thieves

Discover the targets professional snoopers seek out! The prey are stock brokers, arbitrage firms, manufacturers, high-tech companies, any competitive industry, or even small businesses in the same community. The valuable information they filch may be marketing strategies, customer lists, product formulas, manufacturing techniques, even advertising plans. Information thieves eavesdrop on court decisions, bidding information, financial data. The list is unlimited in the mind of man—especially if he is a thief!

You know that the Russians secretly installed countless microphones in the concrete work of the American Embassy building in Moscow. They converted



**HAVE YOUR
VISA or MC CARD
AVAILABLE**

what was to be an embassy and private residence into the most sophisticated recording studio the world had ever known. The building had to be torn down in order to remove all the bugs.

Stolen Information

The open taps from where the information pours out may be from FAX's, computer communications, telephone calls, and everyday business meetings and lunchtime encounters. Businessmen need counselling on how to eliminate this information drain. Basic telephone use coupled with the user's understanding that someone may be listening or recording vital data and information greatly reduces the opportunity for others to purloin meaningful information.

The professional discussions seen on the TV screen in your home reveals how to detect and disable wiretaps, midget radio-frequency transmitters, and other bugs, plus when to use disinformation to confuse the unwanted listener, and the technique of voice scrambling telephone communications. In fact, do you know how to look for a bug, where to look for a bug, and what to do when you find it?

Bugs of a very small size are easy to build and they can be placed quickly in a matter of seconds, in any object or room. Today you may have used a telephone handset that was bugged. It probably contained three bugs. One was a phony bug to fool you into believing you found a bug and secured the telephone. The second bug placates the investigator when he finds the real thing! And the third bug is found only by the professional, who continued to search just in case there were more bugs.

The professional is not without his tools. Special equipment has been designed so that the professional can sweep a room so that he can detect voice-activated (VOX) and remote-activated bugs. Some of this equipment can be operated by novices, others require a trained countersurveillance professional.

The professionals viewed on your television screen reveal information on the latest technological advances like laser-beam snoopers that are installed hundreds of feet away from the room they snoop on. The professionals disclose that computers yield information too easily.

This advertisement was not written by a countersurveillance professional, but by a beginner whose only experience came from viewing the video tape in the privacy of his home. After you review the video carefully and understand its contents, you have taken the first important step in either acquiring professional help with your surveillance problems, or you may very well consider a career as a countersurveillance professional.

The Dollars You Save

To obtain the information contained in the video VHS cassette, you would attend a professional seminar costing \$350-750 and possibly pay hundreds of dollars more if you had to travel to a distant city to attend. Now, for only \$49.95 (plus \$4.00 P&H) you can view *Countersurveillance Techniques* at home and take refresher views often. To obtain your copy, complete the coupon below or call toll free.

RADIO-ELECTRONICS VIDEO OFFER **PE**

500-B Bi-County Blvd.
Farmingdale, NY 11735

Please rush my copy of the Countersurveillance Techniques Video VHS Cassette for \$49.95 plus \$4.00 for postage and handling.

No. of Cassettes ordered _____
Amount of payment \$_____

Bill my VISA MasterCard
Card No. _____
Expire Date _____ / _____

Signature _____
Name _____
Address _____
City _____ State _____ ZIP _____

All payments in U.S.A. funds. Canadians add \$4.00 per VHS cassette. No foreign orders. New York State residents add applicable sales tax.

East of the sun. West of the moon. Windjammer.



A place to live your fantasies.
A place to free your soul.

To cozy up to the Caribbean sun.
To dance among a thousand stars
to the rhythms of steel drums.
To play on sparkling white and
pink sand beaches.
To discover the underwater
paradise of the reefs.
To find a new friend and share the
intimacies of a sensuous night.

To come alive and live.
To remember for a lifetime.

6 days and 6 nights. From \$675

Reservations toll free
1-800-327-2600
In Florida 305/373-2090.

**Windjammer
Barefoot Cruises**

Post Office Box 120,
Miami Beach, Florida 33119.



Cap'n Mike rush me my free, full color 'Great Adventure' booklet and show
me the way to Paradise for 6 days and 6 nights from \$675.
Windjammer Barefoot Cruises.
P.O. Box 120, Dept. 1642 Miami Beach, Fla. 33119.

Name _____
Address _____
City _____
State, Zip _____