

Popular Electronics

JANUARY 1991

BUILD A BINARY CLOCK

It's a great conversation piece, and an attractive accessory for your home or office



ROLL YOUR OWN RADIO

Build a crystal radio from scratch, using only homemade parts

BARGAINS FOR YOUR WORKBENCH

How to set up a useful workbench on even the tightest budget

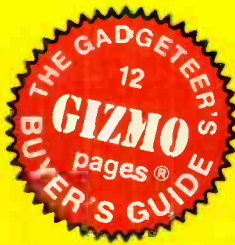

BUILD A SHORTWAVE PRESELECTOR

Improve the performance of your shortwave receiver

MODEMS AND COMMUNICATIONS

Find the answers to your computer-communications questions

LOOKING AT LIGHT SENSORS

Explore the world of electro-optical sensors, and how they are used

SUPER SIMPLE COUNTER

Build it as a stand-alone unit or as an add-on for other projects



\$2.95 U.S.
\$3.75 CANADA

3 NEW
FactCards
IN THIS ISSUE

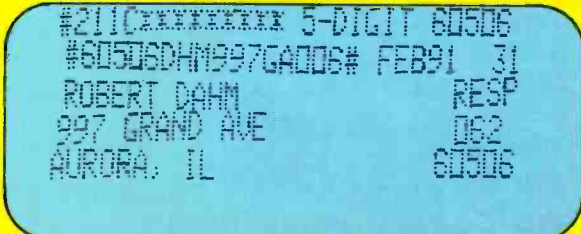

DAMARK

INTERNATIONAL, INC.

ORDER TODAY!
1-800-729-9000
 THE "GREAT DEAL" CATALOG



cordata 386SX COMPUTER with VGA MONITOR

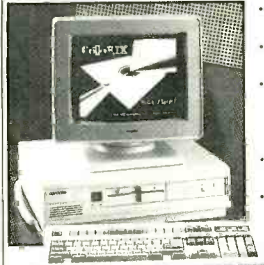

- 100% IBM compatible.
- Includes 14" VGA color monitor.
- 80386SX-16/8 MHz speed, zero wait state, upgradable to 20 MHz.
- One 3-1/2" 1.44 MB floppy disk drive.
- One 5-1/4" 1.2 MB floppy disk drive.
- 40 MB hard drive/millisecond access time.
- 1 MB RAM on motherboard, expandable to 8 MB.
- Expansion slots: four IBM AT slots.
- Built-in VGA video support. Battery backed real time clock/calendar. • Two serial ports. • One parallel port.
- 80387SX-16 math co-processor socket.
- 101 key IBM style keyboard.
- Phoenix BIOS.
- Model # CPC8248
- Includes MS-DOS 4.0. • Dim.: 16"W x 18"D x 5"H.
- **One Year Warranty through Cordata.**
- **Factory New!**
- Does not include software shown on screen.

Mfr. Sugg. Retail: **\$2,968.00**

DAMARK \$1499⁹⁹
 PRICE

Item No. B-2467-143578
 Insured Ship/Hand.: \$49.00



HALOGEN TORCHIERE FLOOR LAMP

Fill your room with light from this Halogen Torchiere Floor Lamp.

- 500 watt halogen bulb included.
- Shines light upward, yet fills entire room.
- Variable light control switch.
- Contemporary design.
- Glass insert below shade allows light to shine downward also—for a complete lighting effect.
- Color: Black, white, brass, chrome, or almond.
- U.L. listed.
- Height: Approx. 72"
- **One Year Mfr. Warranty!**
- **Factory New!**

Mfr. Sugg. Retail: **\$170.00**

DAMARK \$39⁹⁹
 PRICE

(Black) Item No. B-2467-140905
 (White) Item No. B-2467-141051
 (Brass) Item No. B-2467-141069
 (Chrome) Item No. B-2467-144923
 (Almond) Item No. B-2467-144915
 Insured Ship/Hand.: \$9.50

SHARP BACKLIT LAPTOP COMPUTER

- Fast 10 MHz clock speed.
- 8088 compatible CPU.
- Dual 3.5" 720 KB floppy disk drives.
- 100% IBM compatible.
- Supertwist display with EL backlighting.



- High res.: 640 x 400 graphics with 4 shades of gray. • Monitor compatibility: CGA, MDA & AT&T.
- 640 KB RAM expandable to 1.6 MB.
- Parallel port. • Serial port.
- Lightweight & compact.
- 10 function keys. • Built-in carrying handle.
- Includes: MS-DOS 3.3 and GW-Basic 3.22.
- 25 lines x 80 characters.
- Cursor control keys.
- Separate numeric key pad.
- Battery or AC operation.
- Low battery indicator.
- Dim.: 12.1"W x 13.7"D x 3.2"H. • Weight: 10.8 lbs.
- Model #: MZ-100.
- **1 Year Ltd. Mfr. Warranty!**
- **Factory New & Perfect!**

Mfr. Sugg.: **\$1,999.00**

DAMARK \$599⁹⁹
 PRICE

Item No. B-2467-146266
 Insured Ship/Hand.: \$19.00



Southwestern Bell Freedom Phone

CORDLESS SPEAKER PHONE FF1700

- Range approx. 1000 ft. with built-in range extending antenna.
- 46/49 MHz duplex.
- Cordless, integrated speakerphone with volume control.
- 2 separate keypads; one on handset and one in base.
- 9 number auto dialing plus auto redial.
- Built-in two-way intercom with hold.
- 10-channel selectable.
- Pulse/tone switchable. • Digital coded security.
- Status-indicator lights. • Includes 3 rechargeable nickel cadmium batteries. • Snap-out battery pack.
- Color: Almond. • Dim.: 10"D x 2-1/2"H x 6-1/2"W.
- Model #: FF-1700. • Factory serviced, but like new.
- **90 Day Manufacturer's Warranty!**



Dual keypad speakerphone!

Mfr. Sugg. Retail if new: **\$179.95**

DAMARK \$79⁹⁹
 PRICE

Item No. B-2467-150680
 Insured Ship/Hand.: \$7.00

SHARP COMPACT FAX/PHONE MACHINE

Due to Sharp's fiscal year-end closeouts, you save on this Compact Fax/Phone Machine. Its auto fax/phone switch distinguishes between fax calls and phone calls--you only need one line!

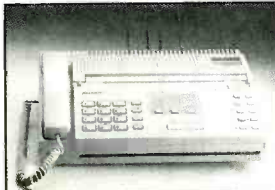

AUTO FAX PHONE SWITCH

- 9600 baud.
- 5-sheet auto document feeder.
- Auto fax/phone switching function.
- 16-level gray-scale halftone control.
- Auto dial up to 20 numbers.
- Answering machine hook-up. • Talk reservation signals receiver to pick-up phone after transmission.
- Fine Superline transmission modes. • CCITT G3 compatible. • 15-second transmission time.
- Redialing/pause. • 11" document width capability.
- Copy function. • Manual/Auto receiving selection.
- Dim.: 14.49"W x 10.16"D x 3.62"H.
- Model #: GQ-60.
- **90 Day Mfr. Warranty!**
- **Factory New!**

Mfr. Sugg. Retail: **\$1,149.00**

DAMARK \$499⁹⁹
 PRICE

Item No. B-2467-160059
 Insured Ship/Hand.: \$25.00

GoldStar VGA MONITOR WITH VGA CARD

Impress the board members with eye-catching color graphs and charts. This 14" VGA Color Monitor and VGA



Graphics Adapter Card adds high resolution and a full spectrum of COLOR to your important computer work.

- 100% IBM® PC/XT/AT, PS/2 and compatibles.
- 14" non-glare VGA monitor.
- Includes VGA graphics adapter card.
- Resolution: 640 x 480.
- 16 out of 256K colors.
- Horizontal scanning frequency: 31.5 kHz.
- Built-in tilt-swivel base.
- Dim.: 13.9" x 14.7" x 14.1".
- Weight: 28 lbs.
- Model #: GT3051.
- **1 Year Mfr. Warranty, 3 Years Picture Tube Warranty!**
- **Factory New!**

Mfr. Sugg. Retail: **\$648.00**

DAMARK \$329⁹⁹
 PRICE

Item No. B-2467-151605
 Insured Ship/Hand.: \$13.00

FOR FASTEST SERVICE CALL TOLL FREE

1-800-729-9000

CUSTOMER SERVICE: 1-612-531-0082

QTY	DESCRIPTION	ITEM #	S/H/I	PRICE

NAME _____
 ADDRESS _____
 CITY _____ ST _____ ZIP _____
 PHONE _____

DELIVERY TO 48 U.S. CONTINENTAL STATES ONLY SUB TOTAL _____
 VISA MasterCard DISCOVER in MN add 6% Sales Tax
 Total S/H/I _____
 Check/Money Order GRAND TOTAL _____

CARD NO. _____ EXP. DATE _____ SIGNATURE _____ B-2467
 Send To: DAMARK INTERNATIONAL, INC., 7101 Winnetka Ave. N., Minneapolis, MN 55428-1619
 Copyright 1990, DAMARK International, Inc. All rights reserved.

Popular Electronics®

THE MAGAZINE FOR THE ELECTRONICS ACTIVIST!

CONSTRUCTION ARTICLES

BUILD A BINARY CLOCK	Fred Blechman	31
<i>Here's an unusual timepiece that will acquaint you with the binary numbering system</i>		
ROLL YOUR OWN RADIO	Homer L. Davidson	37
<i>Build this simple radio receiver using homemade parts</i>		
SUPER-SIMPLE FREQUENCY COUNTER	Steven J. Stroncsek	41
<i>Build one for your workbench or as an add-on for other gear</i>		
BUILD A SHORTWAVE PRESELECTOR	Joseph J. Carr	57
<i>Improve the performance of your shortwave receiver with one of these easy-to-build circuits</i>		

FEATURE ARTICLES

LOOKING AT LIGHT SENSORS	Joseph J. Carr	61
<i>Learn how optoelectronic sensors work, and how you can use them in your circuits</i>		
MODEMS AND COMPUTER COMMUNICATIONS	Isaac Szlechter	64
<i>Here are some of the answers to the most commonly asked questions about modem communications</i>		
BARGAINS FOR YOUR WORKBENCH	Larry Lisle	67
<i>Used test gear may not be state-of-the-art, but it does provide an economical way to stock your workbench</i>		
BUILD AN "ANTIQU" MICROPHONE	Stanley A. Czarnik	69
<i>Learn how the earliest microphones worked, and recreate experiments that made the telephone possible</i>		
THE DIGITAL ELECTRONICS COURSE	Robert A. Young	72
<i>Explore the world of binary comparators, and learn how error and parity checking, as well as other functions are accomplished</i>		

PRODUCT REVIEWS

GIZMO		45
<i>Including: Nikon VN-960 Action-8 Camcorder, Sharp SA-R56A Audio/Video Stereo receiver, and much more</i>		
PRODUCT TEST REPORT	Len Feldman	74
<i>Casio TV-7500 Color-LCD Television Receiver</i>		
HANDS-ON REPORT		76
<i>Sams PhotoFact Series</i>		

COLUMNS

THINK TANK	Byron G. Wels	22
<i>How I spent my summer vacation</i>		
ANTIQU" RADIO	Marc Ellis	78
<i>More tube-testing power</i>		
CIRCUIT CIRCUS	Charles D. Rakes	80
<i>More circuits for your circuits library</i>		
COMPUTER BITS	Jeff Holtzman	82
<i>Why compute?</i>		
FUN SOFTWARE	Fred Blechman	84
<i>A history lesson</i>		
HAM RADIO	Joseph J. Carr	88
<i>Using an RF dip meter</i>		
DX LISTENING	Don Jensen	90
<i>Collecting stamps, business news on SW, and more</i>		
SCANNER SCENE	Marc Saxon	92
<i>An array of antennas</i>		

DEPARTMENTS

EDITORIAL	Carl Laron	2
LETTERS		4
ELECTRONICS LIBRARY		6
NEW PRODUCTS		14
ADVERTISERS INDEX		104

Popular Electronics (ISSN 1042-170X) Published monthly by Gernsback Publications, Inc., 500-B Bi-County Boulevard, Farmingdale, NY 11735. Second-Class postage paid at Farmingdale, NY and at additional mailing offices. One-year, twelve issues, subscription rate U.S. and possessions \$21.95, Canada \$26.95, all other countries \$29.45. Subscription orders payable in U.S. funds only, International Postal Money Order, or check drawn on a U.S. bank. U.S. single copy price \$2.95. © 1990 by Gernsback Publications, Inc. All rights reserved. **Hands-on Electronics** and **Gizmo** trademarks are registered in U.S. and Canada by Gernsback Publications, Inc. **Popular Electronics** trademark is registered in U.S. and Canada by Electronics Technology Today, Inc. and is licensed to Gernsback Publications. Printed in U.S.A.

Postmaster: Please send address changes to **Popular Electronics**, Subscription Dept., P.O. Box 338, Mount Morris, IL 61054-9932.

A stamped self-addressed envelope must accompany all submitted manuscripts and/or artwork or photographs if their return is desired should they be rejected. We disclaim any responsibility for the loss or damage of manuscripts and/or artwork or photographs while in our possession or otherwise.

As a service to readers, **Popular Electronics** publishes available plans or information relating to newsworthy products, techniques, and scientific and technological developments. Because of possible variances in the quality and condition of materials and workmanship used by readers, **Popular Electronics** disclaims any responsibility for the safe and proper functioning of reader-built projects based upon or from plans or information published in this magazine.

Larry Steckler

*EHF, CET
Editor-In-Chief and Publisher*

EDITORIAL DEPARTMENT

Carl Laron

Editor

Robert A. Young

Associate Editor

John J. Yacono

Associate Editor

Byron G. Wels, K2AVB

Associate Editor

Teri Scaduto

Assistant Editor

Kathy Terenzi

Editorial Assistant

Marc Spiwak

Editorial Associate

Fred Blechman

Joseph J. Carr, K4IPV

Marc Ellis

Len Feldman

Jeffrey K. Holtzman

Don Jensen

Charles D. Rakes

Marc Saxon

Contributing Editors

PRODUCTION DEPARTMENT

Ruby M. Yee

Production Director

Karen S. Tucker

Production Manager

Marcella Amoroso

Production Assistant

Janice Box

Editorial Production

ART DEPARTMENT

Andre Duzant

Art Director

Injae Lee

Illustrator

Russell C. Truelson

Illustrator

Jacqueline P. Cheeseboro

Circulation Director

Michele Torriolo

P-E Bookstore

BUSINESS AND EDITORIAL OFFICES

Gernsback Publications, Inc.
500-B Bi-County Blvd.
Farmingdale, NY 11735
1-516-293-3000

Fax: 1-516-293-3115

President: **Larry Steckler**
Vice President: **Cathy Steckler**

Customer Service/Order Entry

1-800-435-0715
In IL 1-800-892-0753
7:30 AM - 8:30 PM EST

Advertising Sales offices listed on page 103

Cover photo by Diversified Photo Services

Composition by
Mates Graphics



The
Audit
Bureau
of Circulation



The publisher has no knowledge of any proprietary rights which will be violated by the making or using of any items disclosed in this issue.

IT'S MAGIC!

By an accident of nature, we humans have five fingers on each hand. Because of that, we count using a system based on the number 10. If, instead, we only had four fingers on each hand, then we would almost certainly count in octal, a system based on the number 8.

In any event, we go through our early years learning our times table, how to do long division, etc., in our nice and orderly base-10 world, blithely assuming that there is just no other way to do things.

Oh, how wrong we were! Many of us first learned about binary, octal, hexadecimal, and other numbering systems while still in school. Others learned about them later in life, perhaps through their hobby efforts, or even in the pages of this or other electronics magazines. And these numbering systems are not just a curiosity. For instance you must be familiar with binary to understand how digital circuitry works. And much computer machine code is written in hexadecimal.

But being familiar with something, and being comfortable with it, are two entirely different things. And for some, no matter how intelligent or well educated, their mind will simply not accept the concept of different numbering systems.

Several years ago, I had the pleasure of sharing an office with an accomplished writer and editor who was many years my senior. One day, while reading some material that was being prepared for publication, he suddenly sat upright, took a deep draw on his ever-present pipe, and exclaimed: "Now I've got it! Hexadecimal is hex, which means it must work by magic!"

But whether or not you are comfortable with other numbering systems, the Binary Clock presented in this issue still makes an attractive, fun to build project. It uses a matrix of bi-colored LED's to show time in a binary format called BCD (binary-coded decimal). Give it a try, we think you'll like it—even if it takes you an extra second or two to figure out what time it is!

Carl Laron
Editor

Never before has so much professional information on the art of detecting and eliminating electronic snooping devices—and how to defend against experienced information thieves—been placed in one VHS video. If you are a Fortune 500 CEO, an executive in any hi-tech industry, or a novice seeking entry into an honorable, rewarding field of work in countersurveillance, you must view this video presentation again and again.

Wake up! You may be the victim of stolen words—precious ideas that would have made you very wealthy! Yes, professionals, even rank amateurs, may be listening to your most private conversations.

Wake up! If you are not the victim, then you are surrounded by countless victims who need your help if you know how to discover telephone taps, locate bugs, or “sweep” a room clean.

There is a thriving professional service steeped in high-tech techniques that you can become a part of! But first, you must know and understand Countersurveillance Technology. Your very first insight into this highly rewarding field is made possible by a video VHS presentation that you cannot view on broadcast television, satellite, or cable. It presents an informative program prepared by professionals in the field who know their industry, its techniques, kinks and loopholes. Men who can tell you more in 45 minutes in a straightforward, exclusive talk than was ever attempted before.

Foiling Information Thieves

Discover the targets professional snoopers seek out! The prey are stock brokers, arbitrage firms, manufacturers, high-tech companies, any competitive industry, or even small businesses in the same community. The valuable information they filch may be marketing strategies, customer lists, product formulas, manufacturing techniques, even advertising plans. Information thieves eavesdrop on court decisions, bidding information, financial data. The list is unlimited in the mind of man—especially if he is a thief!

You know that the Russians secretly installed countless microphones in the concrete work of the American Embassy building in Moscow. They converted



**HAVE YOUR
VISA or MC CARD
AVAILABLE**

what was to be an embassy and private residence into the most sophisticated recording studio the world had ever known. The building had to be torn down in order to remove all the bugs.

Stolen Information

The open taps from where the information pours out may be from FAX's, computer communications, telephone calls, and everyday business meetings and lunchtime encounters. Businessmen need counselling on how to eliminate this information drain. Basic telephone use coupled with the user's understanding that someone may be listening or recording vital data and information greatly reduces the opportunity for others to purloin meaningful information.

The professional discussions seen on the TV screen in your home reveals how to detect and disable wiretaps, midget radio-frequency transmitters, and other bugs, plus when to use disinformation to confuse the unwanted listener, and the technique of voice scrambling telephone communications. In fact, do you know how to look for a bug, where to look for a bug, and what to do when you find it?

Bugs of a very small size are easy to build and they can be placed quickly in a matter of seconds, in any object or room. Today you may have used a telephone handset that was bugged. It probably contained three bugs. One was a phony bug to fool you into believing you found a bug and secured the telephone. The second bug placates the investigator when he finds the real thing! And the third bug is found only by the professional, who continued to search just in case there were more bugs.

The professional is not without his tools. Special equipment has been designed so that the professional can sweep a room so that he can detect voice-activated (VOX) and remote-activated bugs. Some of this equipment can be operated by novices, others require a trained countersurveillance professional.

The professionals viewed on your television screen reveal information on the latest technological advances like laser-beam snoopers that are installed hundreds of feet away from the room they snoop on. The professionals disclose that computers yield information too easily.

This advertisement was not written by a countersurveillance professional, but by a beginner whose only experience came from viewing the video tape in the privacy of his home. After you review the video carefully and understand its contents, you have taken the first important step in either acquiring professional help with your surveillance problems, or you may very well consider a career as a countersurveillance professional.

The Dollars You Save

To obtain the information contained in the video VHS cassette, you would attend a professional seminar costing \$350-750 and possibly pay hundreds of dollars more if you had to travel to a distant city to attend. Now, for only \$49.95 (plus \$4.00 P&H) you can view *Countersurveillance Techniques* at home and take refresher views often. To obtain your copy, complete the coupon below or call toll free.

RADIO-ELECTRONICS VIDEO OFFER PE

500-B Bi-County Blvd.
Farmingdale, NY 11735

Please rush my copy of the Countersurveillance Techniques Video VHS Cassette for \$49.95 plus \$4.00 for postage and handling.

No. of Cassettes ordered _____
Amount of payment \$ _____

Bill my VISA MasterCard
Card No. _____
Expire Date _____ / _____

Signature _____
Name _____
Address _____
City _____ State _____ ZIP _____

All payments in U.S.A. funds. Canadians add \$4.00 per VHS cassette. No foreign orders. New York State residents add applicable sales tax.

LETTERS

SAFETY CORRECTION

There is a serious error in the article "Staying Alive" in the November 1990 issue. In the schematic of Fig. 1, the receptacle is drawn incorrectly.

Standard practice requires that the hot wire be connected to the narrow slot. That is the opposite of what is shown. I hope that nobody rewires their house receptacles in the belief that you are right and they are wrong.

D.G.
Canoga Park, CA

You, and the many other readers who wrote in about this, are obviously correct. The error is not the author's; it was made here in preparing the article for publication.—Editor

DIODE DILEMMA

I just discovered an error in my article "Digital Entry Lock" in the November, 1990 issue of **Popular Electronics**. The 1N914 diode in Fig. 6, which appeared on page 96, is inverted. It should point up, not down.

Fred Blechman

TAKING A SHORTCUT

Referring to the technical note in Joe Carr's *Ham Radio* column in the November 1990 issue of **Popular Electronics**, I'd like to contribute a shortcut method with calculations that can be easily done. Remembering only a few values—i.e., 3, 6, 10, and 20 dB—almost all other values can be found with an accuracy of about 1%.

$$3 \text{ dB} = 2 \times \text{power} = 1.414 \times \text{voltage}$$

$$6 \text{ dB} = 4 \times \text{power} = 2 \times \text{voltage}$$

$$10 \text{ dB} = 10 \times \text{power} = 3.3 \times \text{voltage}$$

$$20 \text{ dB} = 100 \times \text{power} = 10 \times \text{voltage}$$

As per the article, $0 \text{ dBm} = 1 \text{ mW}/50 \text{ ohms} = 0.2236068 \text{ volts}$. Rounding off the voltage to 223.6 mV is easier to handle. Now, the reference level of -12 dBm can easily be found by dividing it into two 6-dB levels: $-6 \text{ dB} = \frac{1}{4} \times \frac{1}{4} = \frac{1}{16}$. The ratio is $\frac{1}{16}$ of reference, or $1 \text{ mW}/16 = 0.0625 \text{ mW}$, or $62.5 \mu\text{W}$. For voltage, that is $223.5 \text{ mV}/4 = 55.9 \text{ mV}$.

+ 7 dB can be easily transformed, 6 dB being $4 \times \text{power}$,

and 1 dB being approximately $1.26 \times \text{power}$. $1.26 \times 4 + 5$, approximately; therefore, +7 dB will be approximately 5 mW. That accuracy is well within practical limits.

Measuring the levels can pose another problem. RF power meters and RF voltmeters are scarce, and not found on too many workbenches. An oscilloscope with enough bandwidth is a more common tool. In measuring with it, you have to convert the power levels to rms voltage, then to p-p voltage. The above -12 dBm would be seen on the oscilloscope as 55.9×2.828 , or 158 mV p-p.

I have been using decibels for a long time when working with CATV/MATV systems (75 ohm) and in the repair of amateur radios. The article was fun, and I'd like to see others written on the likes of what happens when you connect the oscilloscope or counter probe into the circuit.

C.M.
N. Dartmouth, MA

READER FEEDBACK

To answer your request for reader feedback in the October 1990 issue of **Popular Electronics**, let me start by saying that I love your magazine. I am only 17 years old, but have been an electronics buff for about five years. When I could finally afford to buy electronics magazines, I went to a store with a large selection and finally narrowed it down to **Popular Electronics**. It was September 1988, and it was still called **Hands-on Electronics**. I was impressed with it, and kept buying it.

For someone like me, who is just learning about electronics, the range of projects is much appreciated. I really enjoy *Think Tank*. It gives me a chance to learn about the more simple concepts in electronics, and also to build some useful and cheap circuits. *Circuit Circus* is good too, although in some issues it focuses on subjects

that don't interest me. I've even tried my hand at some of the more complex projects. Although I don't read the columns on ham radio, scanners, computers, etc., I appreciate that you present a little bit of everything for those people who do enjoy them. I prefer the construction articles, and I really appreciate the fact that the parts used in most of your projects are relatively easy to find.

I'd like to see more articles on how things work—even little things like transistors, which I haven't quite got down pat. Other articles on fundamentals would be helpful too. I'd also like to see more projects that involve turning some old appliance into something else, like turning a TV into an oscilloscope. I'm sure I'm not the only electronic pack rat who has a couple of boxes of old equipment that could be adapted in some way.

Keep up the good work!

I.S.
Victoria, BC, Canada

MORE OF THE SAME

I'm writing in response to the editorial that asked the readers what we would like to see in the magazine. The best I can say right now is ... more of the same! I have been a subscriber for a few months; before that I read a friend's copies and occasionally bought my own. I've always liked **Popular Electronics**, and I must say that the issues I've received since subscribing have been excellent. The more educated I become in science and electronics, the more I find that I appreciate the magazine.

I would like to see more articles about the pioneers in electronics, such as the ones about Oliver Lodge and Nikola Tesla, as well as more on electronics history and current technology—such as the ones about St. Elmo's fire, pacemakers, early TV, lasers, batteries, and printer technology. All of those articles were informative and a pleasure to

read. I especially like "Gizmo" and "Think Tank, to which I hope to contribute a circuit or two in the near future. I also enjoyed the construction articles on the Super-Simple Shortwave Receiver, the Tesla generators, and the Lepton Candle, as well as others.

There are a few subjects that I'd like to see addressed in **Popular Electronics**: development in photo-voltaic cells, high-power lightweight electric motors. I am very enthusiastic about the high-performance electric cars that seem to be just around the corner. I love the idea of not idling the motor at stoplights or in stop-and-go traffic; the electric motors would simply shut off when the car stopped!

I do have a trivial error to report. In the October 1990 issue, in Fig. 2 on page 36, Q1 is shown as an NPN transistor. It should be a PNP.

Once again, thanks to **Popular Electronics** and its contributors for a great electronics magazine!

J.R.
Columbus, OH

HAVES & NEEDS

I am one of those "diehards" whose pet interest is the operation of a quality four-channel audio system. Unfortunately, I didn't acquire enough CD-4 or SQ records, and those I have are worn out. I do have an 8-track, four-channel tape player and would like to expand my cassette library, even though I am fully aware of 8-track cassette limitations. I would deeply appreciate hearing from anyone who might have any quadraphonic 8-track cassettes for sale. I'm sure that there are many that are not being used, or maybe are in stores, unsold. I might also be interested in CD-4 or SQ records if they are unused.

A.C. Olbrich
P.O. Box 479
Magnolia Springs, AL 36555

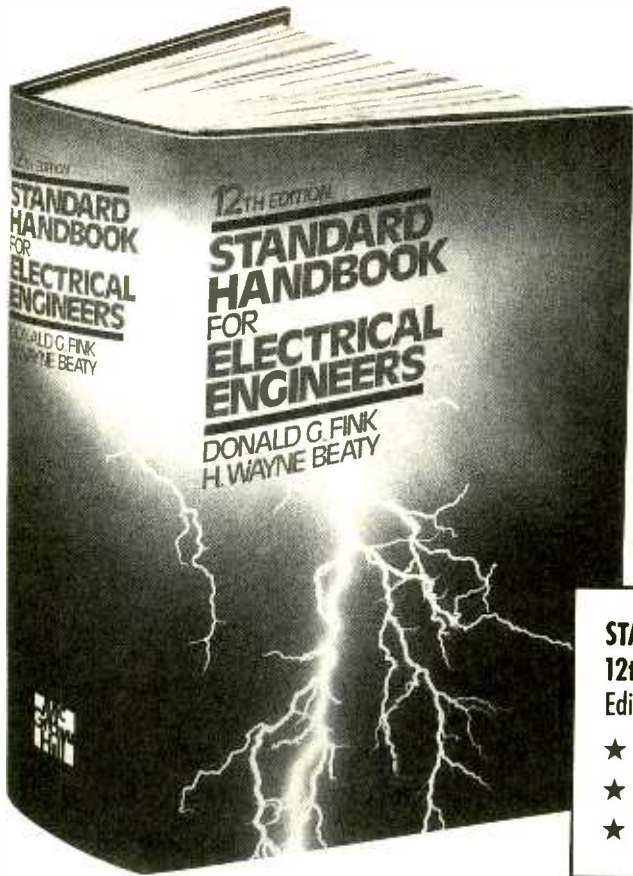

TAKE THIS GIANT \$95.00 HANDBOOK FOR ONLY \$14.95...

When you join the Electronics and Control Engineers' Book Club®

You simply agree to buy 2 more books — all at substantial discounts — within the next 12 months.

STANDARD HANDBOOK FOR ELECTRICAL ENGINEERS, 12th Edition.

Edited by Donald G. Fink and H. Wayne Beaty.

- ★ 2248 pages, 1863 illustrations and tables
- ★ Fully updated to cover all recent advances and developments
- ★ Written and compiled by 115 leading experts

The essential reference for Electrical Engineers!

Why you should join today:

THE BEST AND NEWEST BOOKS FROM ALL PUBLISHERS — Books are chosen from a wide range of publishers, by expert editors and consultants, to give you the best selection of books in your field

BIG SAVINGS — Build your professional library at savings of usually 20-30% and often as much as 40% off publishers' list prices.

BONUS BOOKS — You will immediately begin to participate in our Bonus Book Plan that allows you savings of up to 70% off publishers' prices of many professional and general interest books.

CONVENIENCE — 14-16 times a year (about once every 3-4 weeks) you will receive the Club Bulletin FREE. It fully describes the Main Selection and a variety of alternate selections. A dated Reply Card is included. If you want the Main Selection, simply do nothing — it will be shipped automatically. If you want an alternate selection or no book at all, indicate it on the Reply Card and return it by the date specified. You will have at least 10 days to decide. If because of late delivery of the Bulletin you receive a Main Selection you do not want, you may return it for credit at the Club's expense.

As a Club member you agree only to the purchase of two books, from over 300 different titles that will be offered, during the first year of membership. Membership may be cancelled by either you or the Club at any time after you have purchased the two additional books.

The Twelfth Edition of this classic handbook provides up-to-the-minute information in such rapidly changing areas as nuclear power generation, high-voltage transmission systems, and alternative energy sources. It also covers such essentials as basic circuits, magnetism, power distribution, telecommunications, industrial electronics and electrical standards. All information is geared toward the practicing engineer and organized for quick on-the-job reference.

Take advantage of this outstanding limited-time offer — join the Electronics and Control Engineers' Book Club today and get your Handbook for only \$14.95!

FILL OUT THIS COUPON AND MAIL TODAY



McGraw-Hill Book Clubs Electronics and Control Engineers' Book Club®

P.O. Box 582, Hightstown, NJ 08520-9959

Please enroll me as a member and send me the STANDARD HANDBOOK FOR ELECTRICAL ENGINEERS, 12th Edition (209/758) for just \$14.95, plus local tax, shipping and handling charges. I agree to purchase a minimum of two additional books during my first year of membership as outlined under the Club plan described in this ad. I understand that a shipping and handling charge is added to all shipments.

Signature _____

Name _____

Address/Apt. # _____

City _____

State _____ Zip _____

This order subject to acceptance by McGraw-Hill. All prices subject to change without notice. Offer good only to new members. Foreign member acceptance subject to special conditions

ECGB-039

ELECTRONICS LIBRARY

Simple Short Wave Receiver Construction

by R.A. Penfold

For those who are looking to beat the high cost of their short-wave hobby, this book presents an assortment of low-cost, do-it-yourself shortwave receivers. The sets are all easy to build; instructions, full wiring diagrams, illustrations, and parts lists are provided. The receivers require only simple antennas; no complex alignment or other difficult set-up procedures are needed. The book also includes discussions of several relevant topics, such as the broadcast and amateur bands and their

construction projects are a shortwave crystal set, simple tuned-radio-frequency (TRF) receivers, and a direct-conversion receiver.

Simple Short Wave Receiver Construction (order no. BP275) is available for \$8.95, including shipping and handling, from Electronics Technology Today Inc., P.O. Box 240, Massapequa Park, NY 11762-0240.

CIRCLE 97 ON FREE INFORMATION CARD

systems, noise, communication channels, optimal detections, signal processing, pulse modulation and transmission, and phase-shift keying. An extensively cross-referenced index makes all the material easy to find.

Communications Formulas & Algorithms For Systems Analysis & Design is available in hardcover for \$39.95 from McGraw-Hill Book Company, 11 West 19th Street, New York, NY 10011; Tel. 1-800-2-MCGRAW.

CIRCLE 96 ON FREE INFORMATION CARD

Simple Short Wave Receiver Construction

R. A. PENFOLD

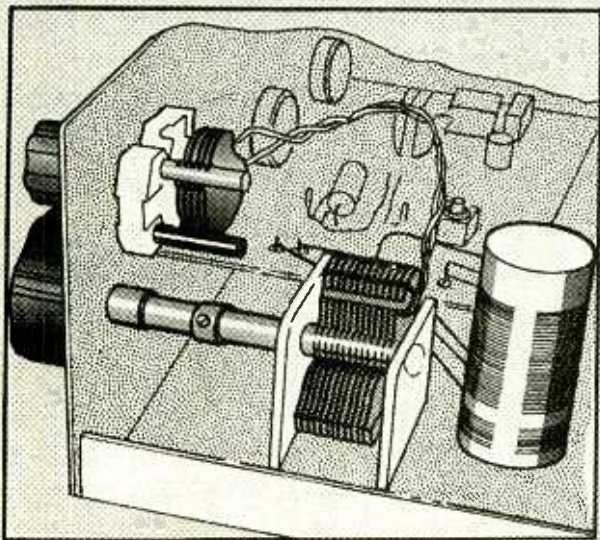

characteristics, the propagation of radio signals, simple antennas, and making an earth connection. Some of the con-

COMMUNICATIONS FORMULAS & ALGORITHMS For Systems Analysis & Design

by C. Britton Forabaugh

Organized into a convenient "cookbook" format, this book presents the essential definitions, formulas, algorithms, and design data needed by communications engineers, programmers, and technicians. The book makes it easier to quickly locate, understand, and apply the most useful techniques to analyze, simulate, design, and test communications systems, greatly speeding up the design process. Most of the mathematics presented are distillations and clarifications of material that is often difficult to find elsewhere. Where applicable, important practical material is provided for each procedure, method, and algorithm, including a clear, concise description plus the appropriate mathematical notation and pseudocode; guidelines for selection and use, function plots, graphs, and diagrams; and practical examples. With an emphasis on the key details and pertinent mathematical background needed to solve everyday problems, the book presents helpful information on probability distributions in communications, random processes, signals and spectra,

GORDON McCOMB'S GADGETEER'S GOLDMINE!

55 Space-Age Projects
by Gordon McComb

The author defines "gadgeteering" as "the art of experimenting with mechanics, electronics, chemistry, physics, and other branches of scientific inquiry to come up with new and better ways of doing things." In this book, he presents a mixture of old—Tesla coils, Van de Graaff generators—and new—laser-light displays, radiation detectors—projects, all infused with the exciting spirit of invention. The construction projects include a plasma-sphere generator, a He-Ne laser pistol, a holography darkroom, a Kirlian camera, a fiber-optic



communications link, a seismograph, audio amps, a universal receiver, a laser alarm system, and dozens of others using state-of-the-art voice-control technology, robotics, and superconductivity. The book provides tested designs, instructions (and suggested alternate approaches), safety tips, parts lists, sources, and plenty of photos and illustrations.

Gordon McComb's Gadgeteer's Goldmine! is available for \$18.95 from TAB Books Inc., Blue Ridge Summit, PA 17294-0850; Tel: 1-800-233-1128.

CIRCLE 98 ON FREE INFORMATION CARD

PRE-OWNED TEST EQUIPMENT CATALOG

from Tucker Electronics Company

This catalog offers a glimpse of Tucker's huge inventory of pre-owned, reconditioned test equipment. Included in its 30 pages are pulse generators, oscilloscopes, frequency counters,



DMM's, signal generators, X-Y recorders, AC circuit testers, digital voltmeters, portable scopes, analog and digital DC power supplies, test oscillators, spectrum analyzers, and more. Some of the manufacturers represented are Hewlett Packard, Fluke, Tektronix, and Minolta. Each reconditioned instrument is covered by a 90-day warranty.

The Pre-Owned Test Equipment Catalog is free upon request from Tucker Electronics Company, P.O. Box 551419, Dallas, TX 75355-1419; Tel: 1-800-527-4642,

1-800-749-4642 in Texas, or 214-348-8800 in Dallas; Fax: 214-348-0367.

CIRCLE 90 ON FREE INFORMATION CARD

BASIC DIGITAL ELECTRONICS: 2nd Edition

by Ray Ryan and Lisa A. Doyle

This easy-to-follow introduction to the fundamentals of modern digital electronics retains many of the features of the popular first edition, and has been expanded and updated to reflect recent developments in the field. The second edition has kept the original's thorough descriptions of digital codes, conversions, and number systems; explanations of logic gates, families, and networks; and example applications for digital circuitry in modern equipment. New material includes 9's and 10's complement; EX-OR and EX-NOR logic gates; CMOS logic family; parity generators/checkers; data-transfer concepts and hardware; com-

binational logic; and microprocessors. The book presents in-depth information on all types of digital circuits in a simplified manner that can be easily understood even by those who have no special training.

Basic Digital Electronics: 2nd Edition is available for \$16.95 from TAB Books Inc., Blue Ridge Summit, PA 17294-0850; Tel: 1-800-233-1128.

CIRCLE 98 ON FREE INFORMATION CARD

MASTERING ELECTRONICS: Third Edition

by John Watson

Thoroughly revised and updated to reflect the most recent developments and advances in the field, this third edition features clear, straightforward explanations of the basics of electronics, laying the groundwork to understanding the inner workings of more advanced electronic products. Geared for hobbyists and technical profes-



2-1/2" SANYO TWEETER

Paper cone with gold tone dust cap. 8 oz. magnet. 8 ohm. 1/2" ferro fluid voice coil. Power handling: 50W RMS, 70W max. Frequency response: 3K-20KHz.



#PB-271-020 \$195 \$175 95c
(1-9) (10-59) (60-up)

SUPER HORN TWEETER

Original piezo tweeter made by Motorola. SPL=94 dB 2.83V/1M. Response: 4KHz-27KHz. Handles approximately 50 watts.



#PB-270-010 \$530 \$450 \$395
(1-9) (10-79) (80-up)

2" DOME MIDRANGE

Textile dome midrange made by Philips. 8 ohm. SPL=90 dB 1W/1M. 30W RMS, 40W max. Response: 550-5KHz.



#PB-280-210 \$2790 \$2570
(1-3) (4-up)

15" SUBWOOFER



Dual voice coil. 40 oz. magnet. 6 ohm imp. 100W RMS, 140W max. Response: 20-1.2KHz. Resonant frequency: 21Hz. SPL=93 dB 1W/1M.

PIONEER
#PB-290-190 \$5450 \$4960
(1-3) (4-up)

SUBWOOFER XOVER



200W RMS crossover designed specifically for use with dual voice coil sub woofers. 12 dB per octave roll-off at 150Hz.

#PB-260-220 \$2880 \$2440

10" POLY WOOFER

Medium duty. 60W RMS, 80W max. 14 oz. magnet. Response: 25-2.5KHz. fs=28Hz.



#PB-290-096 \$1850 \$1690
(1-3) (4-up)

TITANIUM COMPOSITE TWEETER

The advantages of both hard and soft dome technologies. 8 ohm. Ferro fluid cooled voice coil. SPL=90 dB 1W/1M. 50W RMS, 70W max. 4" round. Polydax #DTW100T125.

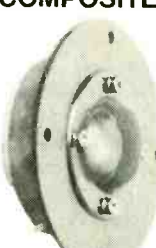

polydax
#PB-270-047 \$2750 \$2480
(1-9) (10-up)

SPEAKER BUILDING BOOK

Revised edition of David Weems' best selling book. Learn to build low cost speakers that rival the high priced models.



#PB-500-021 \$1695

12" CAST FRAME WOOFER



EMINENCE

12" woofer made in the USA by Eminence. Paper cone and dust cap with treated cloth surround. 80 oz. magnet. 2-1/2" vented voice coil. 8 ohm. 170W RMS, 235W max. 40-4.5KHz response.

#PB-290-147 \$7290 \$6950
(1-9) (4-up)



340 E. First St., Dayton, Ohio 45402
Local: 1-513-222-0173
FAX: 513-222-4644

* 15 day money back guarantee • \$15.00 minimum order • We accept Mastercard, Visa, Discover, and C.O.D. orders • 24 hour shipping • Shipping charge = UPS chart rate + \$1.00 (\$3.00 minimum charge) • Hours 8:30 am-7:00 pm EST, Monday - Friday • Mail order customers, please call for shipping estimate on orders exceeding 5 lbs. Foreign customers please send \$5.00 U.S. funds for catalog postage.

**CALL TOLL FREE
1-800-338-0531**

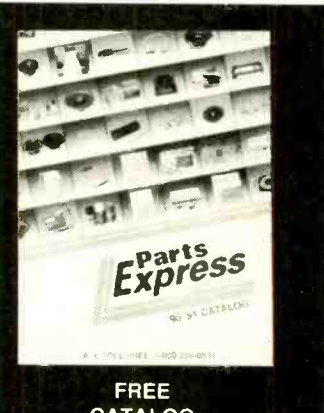

FREE CATALOG

CIRCLE 17 ON FREE INFORMATION CARD

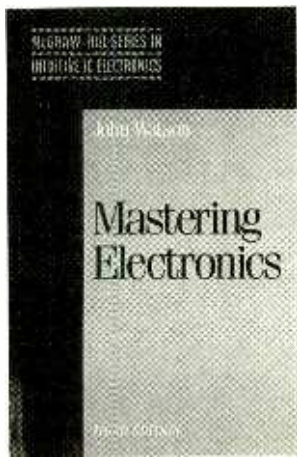

signals who work in fields other than electronics, the book is a self-study guide designed to help readers gain an intuitive understanding of electronics and computers. Its emphasis is on the systems and applications of today's technology; mathematics is kept to a minimum. The book covers both the fundamentals and the theory of electronics, as well as presenting up-to-date material on compact discs, camcorders, and satellite TV receivers. From a discussion of basic electricity as it applies to electronics to an explanation of the principles of digital electronics, the book provides coverage of many important topics, including optoelectronics, semiconductors, logic gates and logic families, tools and test equipment, and safety procedures. Scores of detailed circuit diagrams provide readers with an opportunity for hands-on experience with construction projects.

Mastering Electronics: Third Edition is available in hardcover for \$34.95 or in paperback for \$19.95 from McGraw-Hill Book Company, 11 West 19th Street, New York, NY 10011; Tel: 1-800-2-MCGRAW.

CIRCLE 96 ON FREE INFORMATION CARD

ANALOG SWITCHES: Applications and Projects

by Delton T. Horn

While mechanical switching is okay for simple, infrequent routing of signals inside an electronic circuit, an analog switch is essential for complex functions that demand speed and accuracy. This book pro-

vides a wealth of information about electronic switches, what they are, and how they work. It covers everything from a simple push-button switch to a digitally controlled four-channel stereo switch. Included are details on standard and special transistor switches; FET and SCR switches; monostable, bistable, and astable multivibrators; digitally controlled bilateral switching circuits; and "intelligent" sample and hold circuits. To help readers learn to design, build, and modify their own analog-switch circuits, the book includes 15 practice projects for readers to experiment with.

Analog Switches: Applications and Projects is available for \$12.95 from TAB Books Inc., Blue Ridge Summit, PA 17294-0850; Tel: 1-800-233-1128.

CIRCLE 98 ON FREE INFORMATION CARD

UNIVERSAL COMMUNICATIONS CATALOG

from Universal Radio

Several new equipment lines are premiering in this 92-page catalog, including A.O.R. scanners, Optoelectronics frequency counters, Philips automotive shortwave, GE super radio, D.R.S.I. packet interfaces, and Outbacker mobile antennas. The catalog covers a wide range of equipment for amateur, shortwave, and scanner enthusiasts. It features an extensive selection of antennas, headphones, books, and accessories.

The Universal Communications Catalog (#90-08) is available for \$1.00, or four IRCs, and is free with any purchase from Universal Radio, 1280 Aida Drive, Reynoldsburg, OH 43068; Tel: 800-431-3939 or 614-866-4267.

CIRCLE 89 ON FREE INFORMATION CARD

PRACTICAL GUIDE TO ELECTRONIC AMPLIFIERS

by John D. Lenk

Boasting "something for everyone," this book is full of practical information on experimenting with, troubleshooting, testing,

and designing electronic amplifiers. Enough information is provided for experimenters, students, and serious hobbyists to design and build electronic amplifiers from scratch. The book starts by defining the guidelines for selecting components on a trial-value basis and continues step-by-step from assuming a specific design goal to testing the finished circuit. A minimum amount of mathematics is used, and the design data and techniques presented can be put to use even by those with no previous design experience. For

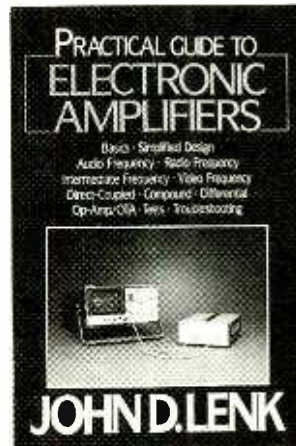

service technicians and field-service engineers, two chapters provide in-depth coverage of advanced amplifier-testing and troubleshooting procedures, along with information on the operation of the amplifier circuit. Working engineers who are responsible for the design or selection of amplifiers can use the book as a comprehensive source for solid-state/IC amplifiers. A wide variety of circuits and configurations are described, including all types of amplifiers currently in use—audio, RF, VF, IF, DC, compound, differential, and op-amps.

Practical Guide to Electronic Amplifier is available for \$39.00 from Prentice-Hall, Englewood Cliffs, NJ 07632.

CIRCLE 99 ON FREE INFORMATION CARD

INDUSTRIAL ELECTRONICS CET EXAM STUDY GUIDE

by Sam Wilson

Passing the Journeyman Certified Electronics Technician (CET) exam is an important career step, offering the pos-

sibility of more rapid advancement, increased earning potential, enhanced professional standing, and new job opportunities. For those who are planning to take the Journeyman CET test in the Industrial Electronics Option, or who are simply curious to find out what it requires, this book offers a comprehensive review of all the information needed to achieve certification.

Written as a companion to *Industrial Electronics for Technicians (Electronics Library, Popular Electronics, November 1990)*, the study guide helps reader review related subjects before taking the CET test. Practice questions help readers to pinpoint their areas of strength and weakness so they can determine which areas to concentrate on. The book helps readers become familiar with test terminology and procedures as well as the subject areas covered by the exams. In addition to the questions presented in each chapter, a complete practice exam is included.

Industrial Electronics: CET Exam Study Guide is available for \$16.95 from TAB Books Inc., Blue Ridge Summit, PA 17294-0850; Tel: 1-800-233-1128.

CIRCLE 98 ON FREE INFORMATION CARD

STAYING WITH DOS: How to Get the Most from Your Computer Without Changing Your Operating System

by Dan Gookin

If you've been noticing signs of advanced age in your "old-faithful" operating system, that doesn't necessarily mean you need to replace it with a newer model. Taking the viewpoint that most PC users don't really need the power and sophistication of Unix or OS/2, this book explains how to stay with DOS and get enough power from it. A special section provides checklists and other criteria that you can use to determine if your needs would best be met by staying with DOS as it is, modifying and/or upgrading DOS, or moving on to a new operating system. It also covers, in detail, new DOS

(Continued on page 12)

Discover Your Career Potential In The Fast Growing Field Of High-Tech Electronics!

CIE Gives You The Training You Need to *Succeed...*
At Your Own Pace...& In Your Own Home!

If you're anxious to get ahead...and build a *real* career...you owe it to yourself to find out about the Cleveland Institute of Electronics!

CIE can help you discover your career potential in the fast growing field of high-tech electronics. A career that will challenge and excite you every day...reward you with a powerful feeling of personal accomplishment...and deliver a level of financial security you may have only dreamed of before!

As the leading school in home-study electronics, CIE has helped over 150,000 students in the U.S.A. and over 70 foreign countries get started in this exciting field. To find out how CIE could be helping you...read on...then send for a CIE catalog TODAY!

A Growing Need For Trained Professionals!

The career opportunities shown here are only a few of the challenging, high-paying careers you could enjoy as an electronics technician.

You could be the "brains" behind the scenes of an exciting TV broadcast...trouble-shoot life-saving medical equipment...design exotic new aeronautics systems...CIE's job-oriented programs offer you the quickest possible path to the career of your dreams! And CIE also features military and union re-training, to build on what you already know.

Dozens Of Fascinating Careers To Choose From!

Even if you aren't sure which career is best for you, CIE can get you started with core lessons applicable to *all* areas of electronics. As you advance, CIE makes job opportunities available to you through the bimonthly school paper, *The Electron*.



Data Communications



Automotive Electronics



Avionics



Computer-Assisted Manufacturing



Consumer Electronics



Military Electronics

Personal Training From A Renowned Faculty.

Unlike the impersonal approach of large classroom study, CIE offers you one-on-one instructional help 6 days a week, toll-free. Each CIE lesson is authored by an independent specialist, backed by CIE instructors who work directly with you to answer your questions and provide technical assistance when you need it.

Practical Training... At Your Own Pace.

Through CIE, you can train for your new career while you keep your present job. Each course allows a generous completion time, and there are no limitations on how fast you can study. Should you already have some electronics experience, CIE offers several courses which start at the intermediate level.

"State-Of-The-Art" Facilities & Equipment.

In 1969, CIE pioneered the first electronics laboratory course, and in 1984, the first Microprocessor Laboratory. Today, no other home study school can match CIE's state-of-the-art equipment. And all your laboratory equipment is included in your tuition cost. There is no extra charge—it's yours to use while you study at home and on the job after you complete your course!

Earn Your Degree To Become A Professional In Electronics!

Every CIE course you take earns you credit towards the completion of your Associate in Applied Science Degree, so you can work towards your degree in stages. And CIE is the only school that awards you for fast study, which can save you thousands of dollars in obtaining the same electronics education found in four-year Bachelor's Degree programs!

Send For Your Catalog Today!



CIE World Headquarters

Cleveland Institute of Electronics, Inc.
1776 East 17th St., Cleveland, Ohio 44114

YES! Please send me your independent study catalog (For your convenience, CIE will have a representative contact you—there is no obligation.)

Print Name _____

Address _____ Apt # _____

City/State/Zip _____

Age _____ Area Code/Phone No. _____

Check box for G.I. Bill bulletin on educational benefits: Veteran Active Duty

Mail This Coupon Today! AHO-160

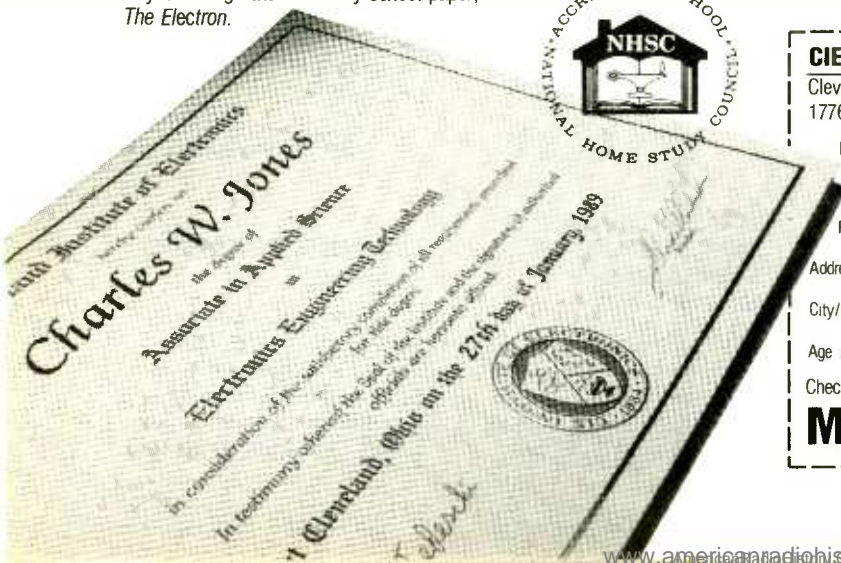

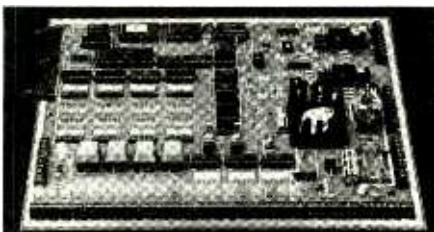

Knight Patrol™ Talking Home Alarm Kit

A high end alarm system at an affordable price!

Features include:

- ◆ State of the art PCF 8200 Speech Synthesizer
- ◆ 21 Sensor Zones, 2 Arming Circuits
- ◆ 2 Five Watt Audio Amplifiers
- ◆ Auxiliary Alarm
- ◆ Real Time 24 Hr. Clock
- ◆ A 10A & 3A Relay Circuit for Sirens, etc.
- ◆ Alert/Sleep Monitoring Modes (verbal status)
- ◆ Trigger Memory (verbal status)
- ◆ Self Diagnostics & Performance Monitoring
- ◆ Microprocessor Controlled
- ◆ Pleasant Female Voice
- ◆ Expandibility & so much MORE!

Available as a kit or pre-assembled. Send \$3 for full-line catalog. A complete line of peripherals is also available. Complete circuit board kit \$220.00 + \$10.50 S & H. (CA residents add 6.75% tax) Complete systems starting from \$440.00. Instructional video tape (VHS \$9.95 + \$2.50 S & H).

Paladin Electronics

17425 B Salsmond Court Rd
Suite 333 Derby, CT
Cheshire County, CT 06425

"We protect your castle"

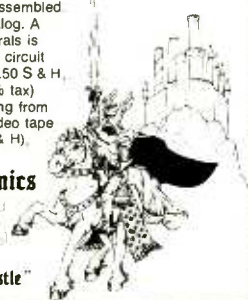

CIRCLE 7 ON FREE INFORMATION CARD

New AOR Receiver

2016 Channels.
1 MHz to 1500 MHz



AR2500

Total Price, Freight Prepaid (Express Shipping Optional)

\$499

- ◆ Continuous coverage
- ◆ AM, FM, wide band FM, & BFO for SSB, CW
- ◆ 64 Scan Banks
- ◆ 16 Search Banks
- ◆ RS232 port built in
- ◆ 25 Day Satisfaction Guarantee
- ◆ Full refund if not Satisfied
- ◆ Includes AC/DC power cord, Antenna, and Mounting Bracket
- ◆ Size: 2 1/4"H x 5 5/8"W x 6 1/2"D Wt. 11lb



COMMUNICATIONS

10707 E. 106th St. Fishers, IN 46038

Toll Free 800-445-7717



Visa and MasterCard
(COD slightly higher)



In Indiana 317-849-2570 Collect FAX (317)849-8794

CIRCLE 16 ON FREE INFORMATION CARD

ELECTRONICS LIBRARY

(Continued from page 8)

extenders, utilities, programing tools, and other products that increase DOS's power and performance.

Using clever techniques and innovative technologies, the author explains how to give DOS new dimensions at a fraction of the expense and learning time required with a new operating system. It lists a comprehensive survey of options for using memory, increasing speed without buying a new PC, improving hard-drive performance, multi-

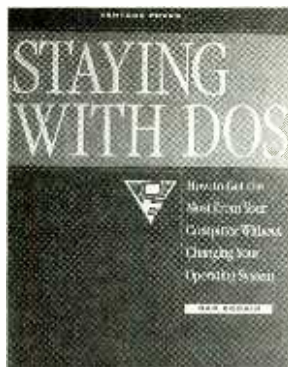

tasking, networking, and getting better graphics. It explains how to transcend DOS's 640K memory barrier, and what to do with the confusing Extended and Expanded memory. The book shows how hardware and software add-ons can be used to save time, and how to work with graphical user interfaces like Windows and GEM. A diskette that includes utilities, batch files, and other DOS enhancers is available optionally.

Staying With DOS: How to Get the Most From Your Computer Without Changing Your Operating System is available for \$22.95, and the diskette for \$39.95, from Ventana Press, P.O. Box 2468, Chapel Hill, NC 27515; Tel: 919-942-0220.

CIRCLE 88 ON FREE INFORMATION CARD

ECG REPLACEMENT SEMICONDUCTOR SUPPLEMENT

from Philips ECG

This 40-page supplement to the *ECG Semiconductor Master Replacement Guide* includes more than 150 semiconductor devices—including 76 new

ones—and cross references nearly 13,000 industry part numbers. The new device types include transistors; general-purpose and ultra-fast industrial rectifiers; optoelectronic devices; IC protectors; and linear IC's for TV, VCR, audio (CD/stereo/ auto), personal computer, and other applications. The supplement includes electrical and mechanical specifications for those new devices.

The *ECG Replacement Semiconductor Supplement* is available from Philips ECG, 1025 Westminster Drive, Williamsport, PA 17701; Tel: 800-526-9354.

CIRCLE 87 ON FREE INFORMATION CARD

SOLDER CREAMS: A COMPLETE GUIDE TO THE SELECTION AND USE OF SOLDER CREAM

from Multicore Solders

The formulation, application methods, and use of solder creams are described in detail in this comprehensive 24-page brochure. It covers the various alloys, fluxes, properties, and rheology of solder creams for surface-mount applications, as well as techniques for deposition, reflow soldering, and cleaning. A "Good Working Practices" chart is included, along with a three-page glossary of terms. Other subjects include recommended alloys and fluxes, solder creams for surface mount technology, qualification approvals, and storage.

Solder Creams: A Complete Guide to the Selection and Use of Solder Cream is available by sending a request on your company letterhead to Multicore Solders, Cantiague Rock Road, Westbury, NY 11590; Fax: 516-334-7098.

CIRCLE 85 ON FREE INFORMATION CARD

TEK DIRECT CATALOG

from Tektronix, Inc.

The latest issue of the *Tek Direct Catalog*, which allows buyers to order test and measurement equipment directly from Tektronix, includes a wide variety of handheld and low-end

portable oscilloscopes, as well as printers, accessories, software, and training aids. A wide range of prices is also represented, with products ranging from \$150.00 to \$5,000.00. The catalog features special offerings, such as discounts and free products, and some of the items are available to the public only through the catalog.

The Tek Direct Catalog is free upon request from Tektronix, Inc., P.O. Box 19638, Portland, OR 97219-9881; Tel: 1-800-426-2200.

CIRCLE 86 ON FREE INFORMATION CARD

BROADCAST SOUND TECHNOLOGY

by Michael Talbot-Smith

Written for those who are training for or working in professional sound engineering and operations, this book aims to impart a thorough understanding of modern audio technology. In one comprehensive volume, it presents material that previously could be found only by consulting three or four separate books. The main items in the broadcast chain are covered, including studio acoustics, microphones, loudspeakers, mixing consoles, recording and replay (both analog and digital), and the principles of stereo. All the information is presented in a clear, easy-to-read style.

Broadcast Sound Technology is available in hardcover for \$42.95 from Butterworths, 80 Montvale Avenue, Stoneham, MA 02180; Tel: 617-483-8464.

CIRCLE 84 ON FREE INFORMATION CARD

FOUR 1991 CATALOGS from Radio Shack

Radio Shack's lines of consumer electronics, home and business computer systems and peripherals, educational products, and software are showcased in four new catalogs. The Radio Shack Consumer Catalog features many new products, including the Realistic MD-1000 CD/Laserdisc player and the Optimum CD-36 under-dash auto CD player. The 183-page booklet also includes electronic parts, radios, scanners, audio and video equipment and ac-



cessories, antennas, camcorders, computer equipment, fax machines, radio-controlled toys, security systems, and telephone equipment. Highlighted in the Tandy Computer Catalog is the new Tandy 1000 RL easy-to-use personal computer for the family. The PC-compatible 1000 RL comes with 24 built-in programs designed to make home tasks easier. The Radio Shack Educational Products Guide features educational software solutions

for school curriculum and administrative needs as well as home-education uses. The fourth catalog is the Radio Shack Software Buyer's Guide (pictured), which offers more than 1,000 popular software titles.

The 1991 Radio Shack catalogs are available at more than 7,000 Radio Shack stores and Radio Shack Computer Centers nationwide.

CIRCLE 83 ON FREE INFORMATION CARD

ELENCO & HITACHI PRODUCTS AT DISCOUNT PRICES

NEW! RSOs (Real-Time & Storage Oscilloscopes) From HITACHI **NEW!**
View, Acquire, Test, Transfer and Document Your Waveform Data

4-Channel, 100MS/s Model Introductory Price
100MS/s (25MS/s on 4 channels simultaneously), 100MHz, 4kw x 1ch., 2kw x 2ch., 1kw x 4ch. VC-6145 \$4,195.00

Compact, Full Feature Models

40MS/s, 100MHz, 4kw x 1ch., 2kw x 2ch.	VC-6045	\$3,049.00
20MS/s, 50MHz, 2kw x 2ch.	VC-6025	\$2,295.00

Low Cost/High Value Models

20MS/s, 50MHz, 2kw x 2ch.	VC-6024	\$2,049.00
20MS/s, 20MHz, 2kw x 2ch.	VC-6023	\$1,749.00

RSOs from Hitachi feature such functions as roll mode, averaging, save memory, smoothing, interpolation, pretriggering, cursor measurements, plotter interface, and RS-232C interface. With the comfort of analog and the power of digital.

Hitachi Portable Scopes

V-212 DC to 50MHz, 2-Channel, DC offset function, Alternate magnifier function	\$435
V-523 CRT Readout, Cursor Meas.	\$1,025
V-522 Delayed Sweep	\$995
V-522 Basic Model	\$895

20MHz Elenco Oscilloscope \$375
MO-1251

- Dual Trace
- Component Tester
- 5" CRT
- X-Y Operation
- TV Sync
- 2 p-i Probes

FREE DMM with purchase of ANY SCOPE

SCOPE PROBES

P-1 65MHz, 1x, 10x	\$19.95
P-2 100MHz, 1x, 10x	\$23.95

All scopes include probes, schematics, operators manual, and 3 year (2 yrs for Elenco scopes) world wide warranty on parts & labor. Many accessories available for all Hitachi scopes. Call or write for complete specifications on these and many other fine oscilloscopes.

Compact Series Scopes

Delayed Sweep
Lightweight (13lbs)
2Mv Sens
3 Yr Warranty

Model V-1085 Shown

This series provides many new functions such as CRT Readout, Cursor measurements (V-1085-1085/665), Frequency Ctr (V-1085), SweepTime Autoranging and Trigger Lock using a 5-inch CRT. You don't feel the compactness in terms of performance and operation.

V-660 60MHz Dual Trace	\$1,195
V-665 60MHz Dual Trace w/Cursor	\$1,345
V-1060 100MHz Dual Trace	\$1,425
V-1065 100MHz Dual Trace w/Cursor	\$1,695
V-1085 100MHz Quad Trace w/Cursor	\$2,045
V-1100A 100MHz Quad Trace w/Cursor	\$2,295
V-1150 150MHz Quad Trace w/Cursor	\$2,775

Elenco 35MHz Dual Trace Good to 50MHz \$495
MO-1252

- High luminance 6" CRT
- 1mV Sensitivity
- 8KV Acceleration Voltage
- 10s Rise Time
- X-Y Operation = 2 Axis
- Delayed Triggering Sweep
- Includes 2 P-1 Probes

WE NOW CARRY COMPLETE LINE OF FLUKE MULTIMETERS Models

21F	83
23F	85
25F	87
27F	8050A
73	8060A
75	8062A
77F	+ More

CALL FOR SPECIAL PRICING

True RMS 4 1/2 Digit Multimeter M-7000 \$135

- .05% DC Accuracy
- 1% Resistance with Freq. Counter and deluxe case

10 Function Multimeter CM-365 \$65

AC + DC Voltage & Amps
Resistance to 2000MΩ
Diode, Logic, & Trans test
Capacitance to 200μF

Digital Capacitance Meter CM-1550 \$58.95

9 Ranges
.1pF-20,000μF
5% basic accy
Zero control with case

Digital LCR Meter LC-1801 \$125

Measures:
Coils 1μH-200H
Caps 1pF-200μF
Res. 01-20M

Function Generator Box \$28.95

Provides sine, triangle, square wave from 1Hz to 1MHz AM or FM capability

Triple Power Supply XP-620 Assembled \$65 Kit \$45

2 to 15V at 1A
2 to 15V at 1A (or 4 to 30V at 1A) and 5V at 3A

Contains all the desired features for doing experiments. Features short circuit protection, all supplies.

Wide Band Signal Generators SG-9000 \$129

RF Freq 100K-450MHz
AM Modulation of 1KHz
Variable RF output

SG-9500 w/ Digital Display and 150MHz built-in Counter \$249

Soldering Station Temperature Controlled

SL-30 \$99
Digital display
Temp range 300F-900F
Grounded tip
Overheat protect

Color Convergence Generator SG-200 \$69.95

Finest in the industry
10 rock steady patterns

10MHz Oscilloscope S-3000 \$275

10MHz DC or AC
Triggered Sweep
Calibrated Vert & Htz
Reacts Voice & Freq

Temperature Probe M-110CF \$29.95

Semiconductor type
Range -50F-302F
Fits most digital multimeters

Autorangeing DMM M-5000 \$45

9 Functions
Memory and Data hold
1/2 % basic acc
3 1/2 digit LCD

AC Current Meter ST-1010 \$69.95

1000 Amps
Data & Peak hold
8 Functions
Deluxe Case

Decade Box #9610 or #9620 \$18.95

#9610 Resistor Box
47 ohm to 1M & 100K pot
#9620 Capacitor Box
47pF to 10MF

Quad Power Supply XP-580 \$59.95

2-20V at 2A
12V at 1A
5V at 3A
-5V at .5A

Fully regulated and short circuit protected
XP-575 without meters \$39.95

LEARN TO BUILD AND PROGRAM COMPUTERS WITH THIS KIT!
INCLUDES: All Parts, Assembly and Lesson Manual

Model MM-8000 \$129.00

Starting from scratch you build a complete system. Our Micro Master trainer teaches you to write in BASIC, PASCAL and on a 6808 microprocessor, which uses a simpler machine language as IBM PC. You will write the initial instructions to tell the 8085 processor to get started and store those instructions in permanent memory in a 2816 EP-ROM. Teaches you all about input and output ports, computer timers. Build your own keyboard and learn how to scan keyboard and display. No previous computer knowledge required. Simple easy to understand instruction teaches you to write in machine language.

ROBOTICS KIT FOR ABOVE (MM-8010) \$71.95

Digital Triple Power Supply XP-765 \$249

0-20V at 1A
0-20V at 1A
5V at 5A

Fully regulated, Short circuit protected with 2 limit control, 3 separate supplies
XP-660 with Analog Meters \$175

GF-8016 Function Generator with Freq. Counter \$249

Sine, Square, Triangle
Pulse, Ramp, 2 to 2MHz
Freq Counter 1 - 10MHz

GF-8015 without Freq. Meter \$179

WE WILL NOT BE UNDERSOLD!
UPS Shipping: 48 States 5% (\$10 Max) IL Res., 7% Tax

C & S SALES INC.
1245 Rosewood, Deerfield, IL 60015
(800) 292-7711 (708) 541-0710

15 Day Money Back Guarantee
2 Year Warranty Prices subject to change
WRITE FOR FREE CATALOG

CIRCLE 14 ON FREE INFORMATION CARD

NEW PRODUCTS

Shallow-Water Metal Detector

A shallow-water version of Fisher Research Laboratory's 1280-X Aquanaut underwater metal detector—a favorite of divers, archaeologists, and professional treasure hunters—provides the same high performance for land and shallow water treasure hunters. The 1280-X Wader features the same easy-to-use electronics, and water-proof search coil and control housing as the Aquanaut, although the Wader's headset is not submersible and its carrying case is optional. The Wader can be used in both salt water and fresh water, and since everything but the head-



set is submersible, users can go in water up to their necks—or use the metal detector on dry land.

The Wader features audio and visual target response, and will ignore small pieces of trash. With patented quartz-crystal circuitry, it provides silent, no-threshold operation. The control box slips off the telescoping fiberglass shaft for easy belt mounting. The foam hand grip, padded stainless-steel armrest, high-impact injection-molded control housing, and the 8- or 10½-inch light-weight search coil are designed for comfort, durability, and balance.

The 1280-X Wader has a suggested list price of \$549.95 with the 8-inch search coil or \$559.95 with the larger "Spider" coil. For further information, contact Fisher Research Laboratory, Dept. PE, 200 West

Willmott Road, Los Banos, CA 93635; Tel: 209-826-3292.

CIRCLE 102 ON FREE INFORMATION CARD

PEN-STYLE DIGITAL MULTIMETER

Designed for those applications in which the technician has almost no room to maneuver, Beckman Industrial's DM73 could come in handy for troubleshooting or installing electronics on computer boards, under a dashboard, or behind an arcade game. The handheld, pen-type meter easily fits into a shirt pocket and features a 3½-digit display with 0.5% accuracy. Data Hold lets the user manually "freeze" the display and then move the meter away from the measurement point to take the reading. The DM73 has full auto-ranging capabilities on 12 measurement ranges. DC voltages up to 500 volts, AC voltages to 250 volts, and resistance up to 2 megohms are measured using an accurate dual-slope, integrating A-to-D conversion technique. Other features include an audible continuity check, a buzzer that sounds when changing func-



tions, a built-in scabbard for the ground probe, and a display of the function in use. Batteries, test leads, and a user's manual are included.

The DM73 pen-style DMM has a list price of \$69.95. For further information, contact Beckman Industrial Corporation, 3883 Ruffin Road, San Diego, CA 92123-1898; Tel: 619-495-3200.

CIRCLE 103 ON FREE INFORMATION CARD

FULL-SIZE CAMCORDER

Sylvania's top-of-the-line camcorder, the 4½-pound VHS model VLC225, features their exclusive Super Edit control. The control allows the zoom control to be used for editing functions without the need to take your eye off the action. The VLC225 also has "record edit search" function that, when activated, locates the end of the recorded portion of tape, then searches ahead for five seconds to determine if there is an



additional signal, and returns to the end of the recording if no signal is found. In addition, "synchronous editing" allows the user to edit and/or duplicate personally-made tapes from the camcorder to a VCR. Other features include 2-lux low-light sensitivity, 8:1 f/1.2 zoom with macro, flying erase head, audio/video dubbing, a switchable high-speed shutter, an integrated DC video light, and time-lapse/self-timer recording.

The VLC225 VHS camcorder has a suggested retail price of \$1,199.95. For additional information, contact Sylvania Consumer Affairs Department, One Philips Drive, P.O. Box 14810, Knoxville, TN 37914-1810; Tel: 615-475-0317.

CIRCLE 104 ON FREE INFORMATION CARD

PHONE-LINE SHARING DEVICE

To smooth the way for a telephone, fax machine, modem, and other RJ-11 devices that share one telephone line, Data Spec has introduced two modu-

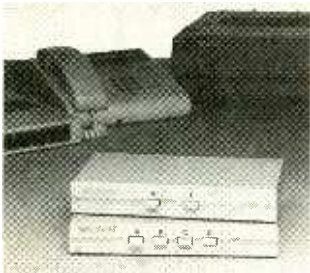

lar RJ-sharing devices. The two-way model, *DSRJ02*, allows two RJ-11 machines to share one phone line. The four-way model, *DSRJ04*, connects up to four devices to a single telephone line. The slim, compact switch boxes can be unobtrusively placed in an office or home.

The models *DSRJ02* and *DSRJ04* have suggested retail prices of \$49.95 and \$59.95, respectively. For more information, contact Data Spec, 9410 Owensmouth Avenue, Chatsworth, CA 91311; Tel: 818-772-2700.

CIRCLE 105 ON FREE INFORMATION CARD

MINIATURE SOLDERING IRON

The *Antex Model G/3U* from *M. M. Newman Corporation* is a miniature precision soldering iron that accommodates over 40 different types of slide-on tips, including needle points, chisels, spades, pyramids, cones, and a special hot knife. The iron features a heating element that is located under its tip for optimum thermal efficiency, and both the heating element and the tips are directly grounded to protect sensitive electronic components. Concentrating the heat for electronics assembly and rework, the *G/3U* heats up to 725°F in just 45 seconds and recovers instantly after soldering each



joint. The 18-watt iron is comparable in power to a conventional 30-watt iron, but is lighter and easier to handle, according to the manufacturer. It has a plastic handle that stays cool and comes with a six-foot cord and a three-prong molded plug.

The *Antex Model G/3U* miniature soldering iron with one tip has a list price of \$19.95. Replacement tips are priced from \$1.48 each. For further information, contact *M. M. Newman Corporation*, 24 Tioga Way, P.O. Box 615, Marblehead, MA 01945; Tel: 617-631-7100; Fax: 617-631-8887.

CIRCLE 106 ON FREE INFORMATION CARD

HANDHELD IMAGE SCANNER

Providing unmatched resolution, the *Marstek's Mars 800 Plus* is the first 800-dots-per-inch hand scanner with 64 levels of gray for both the PC and Macintosh. It allows users to scan postage-stamp-sized images while capturing intricate detail. Users can select from 12 different halftone patterns to produce the best output for each specific image. Special effects can be created with the *Mars 880 Plus'* inverse-image function. *ScanKit*, a powerful utility program, is bundled with the scanner and



allows the user to save images under today's most popular file formats. The PC version includes *PC Paintbrush Plus*, while the Macintosh package comes with *Digital Darkroom* along with the *Scanlink* universal SCSI interface. Both versions also include *Mars Pro-Reader OCR* (Optical Character Reader) software, an accurate and easily trainable OCR for quick document scanning. Other features include same-size printing, auto-merge, and pixel editing.

Courteous Service • Discount Prices • Fast Shipping

ALL ELECTRONICS

P.O. Box 567 • Van Nuys, CA 91408

5 Vdc 3 AMP POWER SUPPLY

ACDC Electronics# 5N3-1
New, prepped power supply with wires and connectors soldered to inputs and outputs. Open frame style. Regulated. Voltage and current adjustment trimmers. 4.94" X 4.03" X 2". UL and CSA listed. CAT# PS-53 \$10.00 each

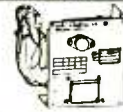

210 MFD 330 VOLT PHOTOFLASH CAPACITOR

Rubicon CE photoflash capacitor. 0.79" dia. X 1.1" high. These are new capacitors that have been prepped with 1.4" black and red wire leads soldered to the terminals. CAT# PPC-210 \$2.50 each • 10 for \$22.50 • 100 for \$200.00
Large quantities available. Call for pricing.



13 Vdc @ 1.95 AMP

Armstrad # PPC 640AC-A
Desk top power supply. Input: 120 Vac 60 hz
Output: 13 Vdc @ 1.9 Amp
6 foot cord on input.
6 foot cord on output
terminated by DC barrel plug 2.1mm id. 4.1" X 3.12" X 2.44" U.L. listed. CAT# DCTX-1319 \$7.50 each



Special - Special - Special 12 VOLT DC COOLING FAN

Rotron # NC12E3
These are the same fans we have in our catalog for \$9.00 each. We just received another load of them and want to move quantities at a special price. Rated: 12Vdc, 0.18 amp, 2.2 watts. 4.69" square plastic housing X 1.25" thick. 5 blade fan. Two 9" pigtail leads. CAT# CF-122
10 for \$65.00 • 100 for \$500.00



RG 11/U 75 OHM VIDEO CABLE

Ivory RG 11/U terminated with heavy-duty F connectors. Also includes a F-61 splicer and a 75 ohm terminator load. New cables manufactured for IBM pc networks. UL listed. Specs: 75 ohm impedance. Cable jacket O.D. 0.405". Dielectric 0.285" dia. Center conductor 0.047" diameter. IBM P/N 1501908 COM/SCOPE. CAT# RG-11-1 100 foot roll \$15.00
CAT# RG-11-2 200 foot roll \$27.50



TOLL FREE ORDER LINES 1-800-826-5432

CHARGE ORDERS to Visa, MasterCard or Discover

TERMS: Minimum order \$10.00. Shipping and handling for the 48 continental U.S.A. \$3.50 per order. All others including AK, HI, PR or Canada must pay full shipping. All orders delivered in CALIFORNIA must include state sales tax (6 1/4 %, 6 3/4 %, 7 1/4 %). Quantities Limited. NO C.O.D. Prices subject to change without notice.

Call Toll Free, or clip this coupon

FREE 60 Page Catalog
Containing over 4,000 ITEMS
ALL ELECTRONICS CORP.
P.O. Box 567 • Van Nuys, CA • 91408

Name _____

Address _____

City _____ State _____ Zip _____

PE 01/91

CIRCLE 5 ON FREE INFORMATION CARD

AMAZING SCIENTIFIC & ELECTRONIC PRODUCTS

PARTS ARE
IN STOCK
PLANS

GRA1 — ANTI GRAVITY GENERATOR	\$10.00
LC7 — 40 WATT BURNING CUTTING LASER	\$20.00
RUB4 — HI POWER PULSED ORILLING LASER	\$20.00
BTC5 — 1 MILLION VOLT TESLA COIL	\$20.00
MCP1 — HI VELOCITY COIL GUN	\$15.00
LLS1 — LASER LIGHT SHOW 3 METHODS	\$20.00
EH1 — ELECTRONIC HYPNOTISM TECHNIQUES	\$8.00
EML1 — LOWER POWERED COIL GUN LAUNCHER	\$8.00
JL3 — JACOB LADDER 3 MODELS	\$10.00
SD5 — SEE IN THE DARK	\$10.00
LEV1 — LEVITATION DEVICE	\$10.00

ASSISTANCE
KITS PROGRAM AVAILABLE

FMV1K — 3 MILE FM VOICE TRANSMITTER	\$34.50
PFS1K — HAND CONTROLLED PLASMA FIRE SABER	\$49.50
NIG7K — HI FLUX NEGATIVE IDN GENERATOR	\$34.50
PG5K — PLASMA LIGHTNING GLOBE	\$49.50
LHC2K — VISIBLE SIMULATED 3 COLOR LASER	\$44.50
HOD1K — HOMING/TRACKING BEEPER TRANSMITTER	\$44.50
LGU6K — 2.5 MW HAND-HELD VISIBLE LASER GUN	\$249.50
BTC3K — 250,000 VOLT TABLE TOP TESLA COIL	\$249.50
IOG2K — IDN RAY GUN, project energy without wires	\$129.95
TKE1K — TELEKINETIC ENHANCER/ELECTRIC MAN	\$79.50
VWPM7K — 3 MILE AUTO TELEPHDNE TRANSMITTER	\$49.50

ASSEMBLED

ASSEMBLED IN OUR LABS

LIST10 — INFINITY XMTR Listen in via phone lines	\$199.50
IPG70 — INVISIBLE PAIN FIELD BLAST WAVE GENERATOR	\$74.50
ITM10 — 100,000 VOLT INTIMIDATOR UP TO 20"	\$99.50
TAT30 — AUTOMATIC TELEPHONE RECORDING DEVICE	\$24.50
PSP40 — PHASOR SONIC BLAST WAVE PISTOL	\$89.50
DNE10 — ALL NEW 26" VIVID COLORED NEON STICK	\$74.50
LGU20 — 5 TO 1MW VISIBLE RED HeNe LASER GUN	\$199.50
BLS10 — 100.00 WATT BLASTER DEFENSE WAND	\$89.50

EASY ORDERING PROCEDURE - TOLL FREE 1-800-221-1705
or 24 HRS ON 1-603-673-4730 or FAX IT TO 1-603-672-5406
VISA, MC, CHECK, MO IN US FUNDS. INCLUDE 10% SHIPPING. ORDERS
\$100.00 & UP ONLY ADD \$10.00. CATALOG \$1.00 OR FREE WITH ORDER.

INFORMATION UNLIMITED
P.O. BOX 716, DEPT P N, AMHERST, NH 03031

SUPER LONG PLAY TAPE RECORDERS

**12 Hour Model —
USES 120 TAPE
\$119.00***

Modified Panasonic Slimline,
high quality AC-DC provide 6
continuous hours of quality
recording & playback on each
side of cassette for 12 hours
total. Includes • Voice level
control • Digital counter,
etc. TDK — 120 Cassette
Furnished.



PHONE RECORDING ADAPTER

Records calls automatically. All Solid
state connects to your telephone
jack and tape recorder. Starts
recording when phone is lifted
Stops when you hang up.



VOX VOICE ACTIVATED CONTROL SWITCH
Solid state. Self contained. Adjust-
able sensitivity. Voices or other
sounds automatically activate and
control recorder. Uses either re-
corder or remote mike **\$28.50***



*Add for ship & hdlg. Phone Adapter & Vox \$150 ea.
Recorders \$400 ea. Cal. Res. add tax. Mail order. VISA,
MIC, COD's OK. Money Back Guarantee. Qty. disc.
avail. Dealer Inquiries invited. Free data.
AMC SALES INC. Dept. B 9335 Lubec St.
Box 928. Downey, CA 90241.
Phone (213) 869-8519
FAX (213) 923-1478

CIRCLE 6 ON FREE INFORMATION CARD

The Mars 800 Plus has a suggested retail price of \$459.00 for the PC version or \$549.00 for the Macintosh version. For more information, contact Marstek, Inc., 17795-F Skypark Circle, Irvine, CA 92714; Tel: 714-833-7740.

**CIRCLE 107 ON FREE
INFORMATION CARD**

PORTABLE TRAVEL ALARM

For security-conscious travelers, *Executive Travelware* has introduced the *Portaguard*, a portable alarm system that keeps watch for hotel-room intruders and provides a warning if someone attempts to enter the room. The battery-powered device measures just 5¼ by 4¾ by 1½ inches. When placed on a dresser or nightstand, it can monitor the room's door, win-



dow, or both. Its passive infrared detector will sense an intruder and activate a loud alarm or a chime. *Portaguard* can also function as an automatic night light or as a flashlight.

The *Portaguard* travel alarm costs \$39.95; plus \$4.25 shipping. For more information, contact *Executive Travelware*, P.O. Box 49387, Chicago, IL 60659; Tel: 1-800-397-7477.

**CIRCLE 108 ON FREE
INFORMATION CARD**

REMOTE AC POWER SWITCH SYSTEM

A remote-control switch, *Midland's 72-300*, can be used to regulate the on/off functions of almost any AC-powered device. The 72-300 works via a compact transmitter and a small module that plugs into an AC outlet. Electrical items that are plugged into the module can be controlled by the transmitter from distances of up to 50 feet. The device handles up to 1000-Watt loads and controls TV's,



lamps, stereos, radios, appliances, fans, and most other electrical items. The remote-control system operates on the UHF radio band and is powered by a 9-volt battery.

The 72-300 remote AC power-switch system has a suggested retail price of \$39.95. For more information, contact *Midland International, Consumer Communications Division*, 1690 North Topping, Kansas City, MO 64120; Tel: 818-241-8500.

**CIRCLE 109 ON FREE
INFORMATION CARD**

SATELLITE RECEIVER

Featuring a computerized satellite-locator system, *R.L. Drake's ESR 1424* automatically tracks more than 25 active C- and Ku-band satellites, making installation faster, easier, and more precise. That feature is particularly appealing to installers, but consumers also benefit because the system results in fewer service calls for adjustments.

Consumers will also appreciate the *ESR 1424's* progressive features, including extended



threshold video, a full-function UHF remote control, *Vid-eoCipher II Plus*, and on-screen color menus. Extended threshold video ensures sharp, clear pictures even in weak signal conditions and virtually eliminates snow and noise. Programming is easy with the direct-channel-access remote and on-screen color graphics. Other features include parental lock-out, a built-in VCR timer; a choice of discrete, matrix, or

digital stereo sound; 100 audio and 100 video presets; and a program-name memory and display feature.

The ESR 1424 satellite receiver has a suggested retail price of \$1,689.00. For additional information, contact R. L. Drake Company, P.O. Box 112, Miamisburg, OH 45342; Tel: 513-866-2421.

CIRCLE 110 ON FREE INFORMATION CARD

CELLULAR-PHONE ACCESSORY KIT

To provide users with everything they need to get maximum performance and convenience from their Motorola 8000/9000 Series portable cellular telephones when used in their vehicles, *ORA Electronics* has introduced the *MOTKARKIT* car kit. The kit contains the performance-enhancing *CMS808 Delta* cellular antenna, which has suction cups for mounting on glass surfaces; the *CTS304* tilt/swivel-



control head-mounting kit with thumbscrew adjustments; the *MTS600* cradle; and the *MOT800* battery saver with heavy-duty fused cigarette-lighter plug.

The *MOTKARKIT* has a suggested retail price of \$99.00. For additional information, contact *ORA Electronics*, 9410 Owensmouth Avenue, Chatsworth, CA 91311; Tel: 818-772-2700.

CIRCLE 111 ON FREE INFORMATION CARD

AUDIO FILTER

Designed to eliminate annoying background noise and boost weak signals, *Electron Processing* has introduced the *Sound Purifier*. The device improves the reception of signals that are either weak or experiencing interference. A simple connection in the speaker line between the



receiver and the speaker allows the *Sound Purifier* to effectively sharpen the receiver's filters and remove extraneous "garbage" from the sound. Two multi-stage active "switched-capacitor" audio filters greatly reduce noise and interference, and a potent 5-watt audio amplifier delivers plenty of sound. The unit is housed in a compact metal cabinet with three controls—high pass, low pass, and volume—conveniently located on the front panel. It is powered by 115 VAC; for mobile use a +12V DC version is available for an additional \$4.00.

The *Sound Purifier* is available at a special introductory price of \$79.95. For further information, contact *Electron Processing, Inc.*, P.O. Box 68, Cedar, MI 49621; Tel: 616-228-7020.

CIRCLE 112 ON FREE INFORMATION CARD

ANTI-THEFT CAR STEREO

The flagship model of *Profile Consumer Electronics'* line of Detachable Function System (DFS) car stereos is the model *DN-930*. For theft deterrence, the unit's control section slips on or off its mount simply by moving a lever, rendering the unit unusable. The removable portion is only a few inches long, and weighs just ounces,

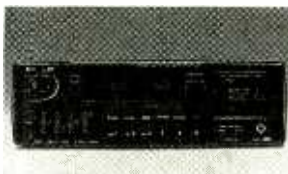

so it's easy to carry around. The *DN-930* features a DIN chassis, 25-watt receiver, an auto-reverse tape deck with Dolby noise reduction, and a 5-band equalizer. The car stereo also has electronic tuning with 30 station presets, automatic music search on the tape deck, and

Become an EKI Certified Electronics Technician



with EKI's home-study program.

FREE
FREE
FREE
FULL COLOR
CATALOG

Features:

- Low cost (only \$39 per module)
- 32 modules
- Used in schools all over the world
- Fast delivery
- No contract to sign
- Go at your own pace
- Can be completed in less than 6 months

CALL OR WRITE TODAY:



1-800-453-1708
1-714-833-8711

EKI 16631 NOYES AVE
IRVINE CA 92714

CIRCLE 12 ON FREE INFORMATION CARD

CD-input capability. The front panel offers a large three-color display with a quartz clock, along with volume, balance, and front/rear fader controls.

The DN-930 car stereo has a suggested retail price of \$274.95. For more information, contact Profile Consumer Electronics, 11155 Knott Avenue, Suite 1, Cypress, CA 90630; Tel: 714-893-5717.

CIRCLE 113 ON FREE INFORMATION CARD

ABRASIVE CORDS

Available in a variety of sizes, E.C. Mitchell Company's line of abrasive cords are used for deflashing through-holes and connectors on PC boards to ensure a good solder joint. The abrasive cords come in 17 sizes, ranging from 0.012 to 0.150 inches in diameter, and are flexible enough to reach around connectors, leads, and through-holes. Packaged on convenient 25-yard spools, the



abrasive cords fit neatly into field-service repair kits or can be stored on a benchtop.

Mitchell's Abrasive Cords are list priced from \$12.00 per spool. For more information, contact E.C. Mitchell Co., Inc., 88-90 Boston Street, P.O. Box 607, Middleton, MA 01949; Tel: 508-774-1191; Fax: 508-774-2494.

CIRCLE 114 ON FREE INFORMATION CARD

COMPUTER SECURITY SYSTEM

The protection of sensitive data stored in personal computers is a serious problem in engineering and other fields. To stop the

unauthorized accessing of confidential computer files, MIU Automation has developed the patented *INTRA-LOCK* security system. The system, which eliminates all access to the personal computer, printers, and disks by unauthorized intruders, consists of a plug-in circuit board, a key receptacle and electronic key, and a software



package. The combination of an encoded key and a special password, used with the software package, prevents all unauthorized personnel from accessing restricted data.

The *INTRA-LOCK* system costs approximately \$900.00 per installation. For further information, contact MIU Automation, Inc., 10 Allstate Highway, 10th Floor, Ontario, Canada L3R 6H3; Tel: 416-479-6722.

CIRCLE 115 ON FREE INFORMATION CARD

HANDHELD PARTS TESTER

Designed for field-service, general-industrial, or hobbyist applications, *B&K-Precision's Model 815* tests capacitance and resistance in a variety of components and tests transistors, SCR's, diodes, LED's, and batteries in 26 ranges. The handheld parts tester is built for durability—it can withstand a five-foot drop and is water- and overload-resistant. Its case will seal out rain, grease, dirt, and other adverse environmental contaminants. The *Model 815* tests capacitance from 0.1 pF to 20 mF in capacitors, cables, switches, and other components, with accuracies ranging from 0.75% to 1.5%. Resistance measurement spans from 0.1 ohm to 20 megohms. Transistors are tested by measuring gain and leakage. SCR's, diodes, and LED's are tested for forward junction voltage. Batteries are tested under load for



voltage output. The parts tester features a large 3½-digit LCD readout, a tilt stand for bench use, test leads, and component-insertion sockets.

The *Model 815* handheld parts tester has a suggested price of \$99.00. For more information, contact B&K-Precision, Division of Maxtec International Corp., 6470 West Cortland Street, Chicago, IL 60635; Tel: 312-889-9087.

CIRCLE 116 ON FREE INFORMATION CARD

SOLDER MASK REPAIR PEN

To enhance reliability and safety during the design, prototyping, and repair of printed-circuit boards and other delicate electronics, the *3300 Circuit Works Overcoat Pen* applies a durable coating that protects against moisture, abrasion, and chemicals while insulating against shorting, arcing, and static discharge. The pen-style instrument makes applying overcoat protection as easy as writing. The polymer coating is available in several colors and clear. It matches the durability



and color of solder masks for nearly invisible circuit-board repairs. The material dries in minutes at room temperature, has excellent adhesion, and is flexible when cured. The overcoating is safe for gold, silver,

copper, and solder alloys. The *Overcoat Pen* has a self-cleaning tip that opens when normal writing pressure is applied and closes when not in use. Overcoat traces as narrow as 1/16-inch are possible, and each pen contains enough material to cover approximately 60 feet of exposed traces.

The *3300 Overcoat Pen* costs \$9.95 plus shipping (\$1.00 by mail or \$2.50 for UPS) and appropriate sales tax. For more information or to place an order, contact Planned Products, 303 Potrero, Suite 53, Santa Cruz, CA 95060; Tel: 408-459-8088; Fax: 408-459-0426.

CIRCLE 117 ON FREE INFORMATION CARD

COPIER SURGE SUPPRESSOR

A 20-amp direct plug-in surge suppressor from *Tripp Lite* is designed specifically for use with large copy machines, telephone systems, and other office products that demand higher current. The *Isoblok IB2-P20* features two protected outlets that guard equipment from damaging spikes while also filtering line noise, providing effective AC protection. Direct



plug-in connection to the AC outlet is provided by a NEMA 5-20 plug. A green "protected" light goes on whenever power is present to indicate that the main spike-suppression components are functioning properly.

The *Isoblok IB2-P20* has a suggested retail price of \$69.95. For additional information, contact Tripp Lite, 500 North Orleans, Chicago, IL 60610; Tel: 312-329-1777.

CIRCLE 118 ON FREE INFORMATION CARD

5 sure steps to a fast start as a high-paid computer service technician

1. Choose training that's right for today's good jobs

Jobs for computer service technicians will almost double in the next 10 years, according to the latest Department of Labor projections. For you, that means unlimited opportunities for advancement, a new career, or even a computer service business of your own.

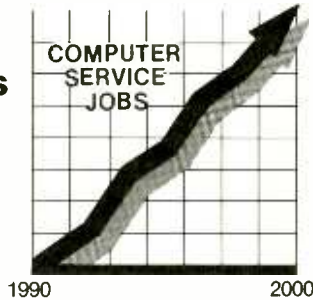

But to succeed in computer service today, you need training—complete, practical training that gives you the confidence to service any brand of computer. You need NRI training.

Only NRI—the leader in career-building, at-home electronics training for more than 75 years—gives you practical knowledge, hands-on skill, and real-world experience with a powerful AT-compatible computer you keep. Only NRI starts you with the basics, then builds your knowledge step by step until you have everything you need for a fast start as a high-paid computer service technician.



2. Go beyond "book learning" to get true hands-on experience

NRI knows you learn better by doing. So NRI training works overtime to give you that invaluable practical experience. You first read about the subject,

studying diagrams, schematics, and photos that make the subject even clearer. Then you do. You build, examine, remove, test, repair, replace. You discover for yourself the feel of the real thing, the confidence gained only with experience.

3. Get inside a powerful computer system

If you really want to get ahead in computer service, you have to get inside a state-of-the-art computer system. That's why NRI includes the powerful new West Coast 1010 ES computer as the centerpiece of your hands-on training.

As you build this fully IBM AT-compatible micro from the keyboard up, performing key tests and demonstrations at each stage of assembly, you actually see for yourself how every section of your computer works.

You assemble and test your computer's 101-key "intelligent" keyboard, install the power supply and 1.2 meg 5¼" floppy disk drive, then interface the high-resolution monitor. But that's not all.

You go on to install a powerful 20 megabyte hard disk drive—today's most-wanted computer peripheral—included in your training to dramatically increase the data storage capacity of your



computer while giving you lightning-quick data access.

By getting inside this powerful computer, you get the confidence-building, real-world experience you need to work with, troubleshoot, and service today's most widely used computer systems.



4. Make sure you've always got someone to turn to for help



Throughout your NRI training, you've got the full support of your personal NRI instructor and the entire NRI technical staff. Always ready to answer your questions and help you if you should hit a snag, your instructors will make you feel as if you're in a classroom of

one, giving you as much time and personal attention as you need.

5. Step into a bright new future in computer service—start by sending for your FREE catalog today!

Discover for yourself how easy NRI makes it to succeed in computer service. Send today for NRI's big, 100-page, full-color catalog describing every aspect of NRI's one-of-a-kind computer training, as well as training in robotics, TV/video/audio servicing, electronic music technology, security electronics, and other growing high-tech career fields.

If the coupon is missing, write to: NRI School of Electronics, McGraw-Hill Continuing Education Center, 4401 Connecticut Avenue, NW, Washington, DC 20008. AT & IBM are registered trademarks of International Business Machines Corp.



McGraw-Hill Continuing Education Center 4401 Connecticut Avenue, NW, Washington, DC 20008		For career courses approved under GI Bill <input type="checkbox"/> check for details.
<input type="checkbox"/> CHECK ONE CATALOG ONLY		
<input type="checkbox"/> Computers and Microprocessors	<input type="checkbox"/> Security Electronics	
<input type="checkbox"/> Robotics	<input type="checkbox"/> Electronic Music Technology	
<input type="checkbox"/> TV/Video/Audio Servicing	<input type="checkbox"/> Digital Electronics Servicing	
<input type="checkbox"/> Telecommunications	<input type="checkbox"/> Computer Programming	
		<input type="checkbox"/> Basic Electronics
Name _____		
Address _____		
City _____ State _____ Zip _____		
Accredited Member, National Home Study Council		
		18-011

THINK TANK

By Byron G. Wels, K2AVB

Answering The Mail

I've been chuckling to myself all month! In my last column, I mentioned the "guy who always tells me how easy my puzzles are, except when he can't solve them, and I don't hear from him at all." Boy! Are you people paranoid! I must have gotten at least 50 letters from assorted readers who knew I was talking about them! I heard from just about everybody (except the guy I was talking about).

A lot of you (bless you) have been asking in the mail about my recent cruise. I'm forced to admit

got our luggage (now I know why they call it *luggage*) and had to *lug* it all the way to the bus that took us to the dock. Now in all honesty, I can't fault the food, the service, or the entertainment, which was all top notch. But I did not like being my own porter.

Naturally, since Murray and I are both single, we were hoping to meet some female-type companions, but the women were all either newlyweds on their honeymoons, or a bit too old. I suppose, in retrospect, that I set myself up for some of the disappointment. I'd

having trouble with his left turbocharger, and we would not be able to get to St. Maartin. But he'd stop us at San Juan instead, on the way home.

Back in Miami (we arrived and debarked there at eight in the morning) we learned that our return flight would not be until eight that evening. I dare *anybody* to spend a full day at a busy airport with Murray. At each port of call, there was plenty to see and do, but the only way to get around was to walk. I let Murray do the walking while I sat under a palm tree with a cool pina.

My next vacation will be to a luxury hotel where I can pull up in front of the place, have a bellboy bring my luggage to my room and have a valet park my car. Cruising? It's not for me!

I should also inform you that back in the early forties, I was flying out of Boca Raton, Florida, on a radar mission, designed to familiarize us with airborne radar equipment. The plane was a retired Vega Ventura, and the pilot couldn't get the wheels down. He called the tower and was informed that he could take his choice. Ditch at sea, come in wheels up, or bail out.

The pilot (kindly) passed the choice to the six radar students on board. I was all for working a little longer on the wheels. It's against my religion to bail out. (I'm a devout coward!) But the other guys could only see the extra \$50 we got as "jump pay." The bomb bay doors were opened, chutes were hurriedly strapped on, and out they went. One guy dove out in pike position, another swan dived. Me?..!

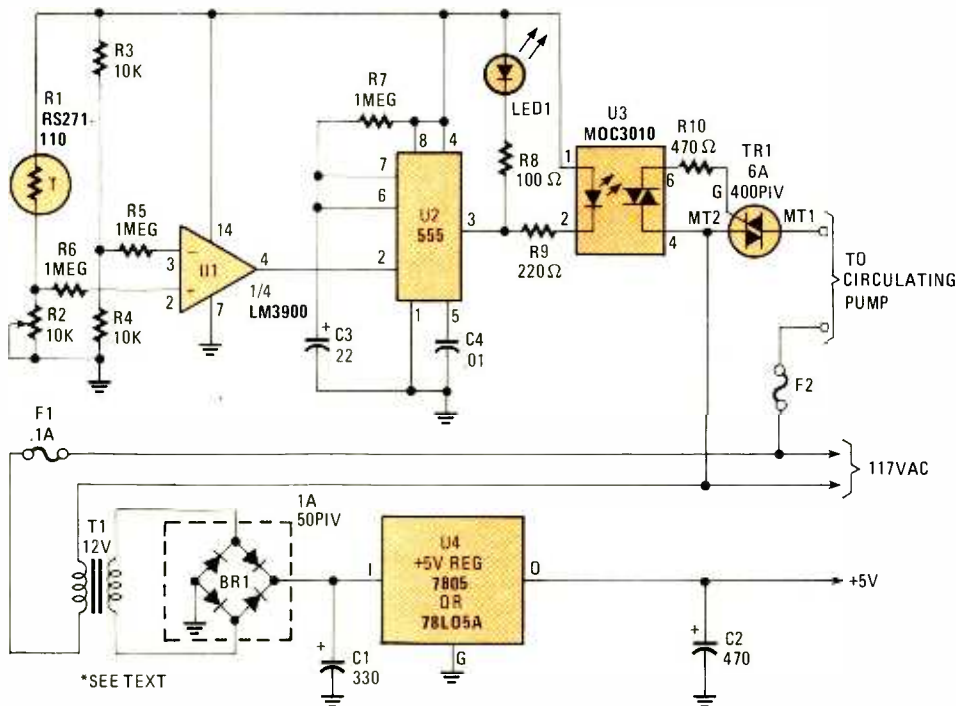

Fig. 1. This temperature control circuit is little more than a thermistor-fed comparator triggering a 555 timer. The output of the timer is used to activate an optocoupler, which, in turn, triggers a Triac.

that, in retrospect, it was a bomb. Never again.

Murray and I did alright on the way to Miami, where we were to meet the ship. But at the Miami airport, we

probably never admit it, but I was kind of hoping that I'd come back married.

When we left our first port of call, the Captain announced that he was

clung to the forward end of the bay, my body at trail. Finally, I let go and dropped. I remember saying something about "Geronimo." The chute opened and I settled, dazed, into the Atlantic, where air-sea rescue fished me out. Some swabbie put a lit cigarette into my mouth, and I've been smoking ever since.

Lately, I've been trying to quit. Went to a Chinese accupuncturist who put staples in my ear (it didn't work) and then I tried a series of filters designed to cut down on the nicotine. I'm sure I'll quit the next time I go into a hospital for a week. I just hope I get out again!

Okay, that's what I've been up to. Let's see what you've been up to.

TEMPERATURE CONTROLLER

I just completed the building of a new house that has a sauna in the basement. I get hot water for domestic use by circulating water from the electric hot-water heater through a heat exchanger that is attached to the side of my wood stove or by using electric power as a back-up source. After the plumber and electrician were done, I was left with a manually switched, $\frac{1}{20}$ HP 120-volt AC induction motor pump for circulating water between the hot water tank and the wood stove heat exchanger.

That meant that I had to fire up the stove, wait about 20 minutes for it to get hot, then switch on the pump. If I forgot to turn on the pump, the water would boil in the heat exchanger. If the pump was left on and the stove cooled down, heat would be lost to the heat exchanger. I needed an automatic controller that would sense the wood-stove temperature and

switch the circulating pump on or off.

The design I came up with uses an LM3900 quad op-amp to drive a Triac. In that circuit (see Fig. 1), $\frac{1}{4}$ of the LM3900 is set up as a voltage comparator. Resistor R2 provides the set point or temperature setting. As the thermistor gets hot, its resistance drops, raising the voltage presented to pin 2 of U1. Resistors R3 and R4 keep pin 3 at 2.5 volts.

When the set point is reached, the output of U1 at pin 4 goes high, triggering U2, causing it to start its timing cycle. Integrated circuit U2 (a 555 oscillator/timer) operates as a delay timer between U1 and the Triac. Resistor R7 and capacitor C3 offer a 25-second delay. When the input of U2 goes high, its output is already high and it will not go low until the delay has elapsed.

The entire circuit was assembled on perfboard and mounted in a small plastic box, at a cost of about \$25 ... a good deal less than some of the commercial units.

—Michael R. Martin,
Westminster, MA

Nice job Mikel! You used your head and applied a few inventive skills to solve a major problem. We're rewarding your ingenuity with a Think Tank Book.

SWITCH DEBOUNCER

If you enjoy digital electronics, chances are that another switch debouncer will come in handy. Mine is a push-on, push-off function using an SPST momentary-contact switch. (See Fig. 2.) As an added kicker, there's a 100 ms pulse available.

With switch S1 open, the clk input of U1-a is held high through resistor R1. When S1 is closed, C1 briefly brings the clock (clk) input low until charged through R1. Capacitor C1 discharges

Put Professional Knowledge and a COLLEGE DEGREE in your Technical Career through HOME STUDY

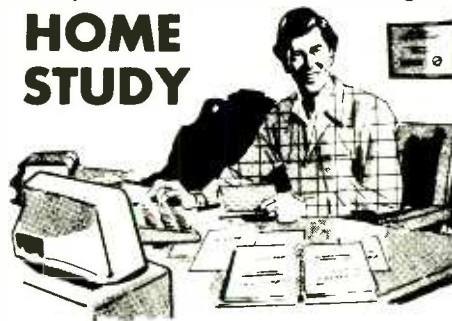

Add prestige and earning power to your technical career by earning your Associate or Bachelor degree through directed home study.

Grantham College of Engineering awards accredited degrees in **electronics and computers.**

An important part of being prepared to *move up* is holding the right college degree, and the absolutely necessary part is knowing your field. Grantham can help you both ways—to learn more and to earn your degree in the process.

Grantham offers two degree programs—one with major emphasis in **electronics**, the other with major emphasis in **computers**. Associate and bachelor degrees are awarded in each program, and both programs are available completely by correspondence.

No commuting to class. Study at your own pace, while continuing on your present job. Learn from easy-to-understand lessons, with help from your Grantham instructors when you need it.

Write for our free catalog (see address below), or phone us at toll-free 1-800-955-2527 (for catalog requests only) and ask for our "degree catalog."

Accredited by
the Accrediting Commission of the
National Home Study Council

GRANTHAM
College of Engineering
250 Frontage Road
Slidell, LA 70460

ATTENTION! ELECTRONICS TECHNICIANS

EARN YOUR
**B.S.E.E.
DEGREE**

THROUGH HOME STUDY

Our New and Highly Effective Advanced-Placement Program for experienced Electronic Technicians grants credit for previous Schooling and Professional Experience, and can greatly reduce the time required to complete Program and reach graduation. No residence schooling required for qualified Electronic Technicians. Through this Special Program you can pull all of the loose ends of your electronics background together and earn your B.S.E.E. Degree. Upgrade your status and pay to the Engineering Level. Advance Rapidly! Many finish in 12 months or less. Students and graduates in all 50 States and throughout the World. Established Over 40 Years! Write for free Descriptive Literature.

**COOK'S INSTITUTE
OF ELECTRONICS ENGINEERING**

CI 4251 CYPRESS DRIVE
JACKSON, MISSISSIPPI 39212

CIRCLE 13 ON FREE INFORMATION CARD

**LEARN VCR
CLEANING/MAINTENANCE/REPAIR**
EARN UP TO \$1000 A WEEK, WORKING
PART TIME FROM YOUR OWN HOME!



Secrets
Revealed!

NO Special
Tools or
Equipment
Needed.

EARN UP TO \$60
AN HOUR AND
MORE!

**THE MONEY MAKING OPPORTUNITY
OF THE 1990'S**

IF you are able to work with common small hand tools, and are familiar with basic electronics (i.e. able to use voltmeter, understand DC electronics).

IF you possess average mechanical ability, and have a VCR on which to practice and learn. . . then we can teach YOU VCR maintenance and repair!

FACT: up to 90% of ALL VCR malfunctions are due to simple MECHANICAL or ELECTRO-MECHANICAL breakdowns!

FACT: over 77 million VCRs in use today nationwide! Average VCR needs service or repair every 12 to 18 months!

Viejo's **400 PAGE TRAINING MANUAL** (over 500 photos and illustrations) and **AWARD-WINNING VIDEO TRAINING TAPE:** reveals the **SECRETS** of VCR maintenance and repair—"real world" information that is **NOT** available elsewhere!

Also includes all the info you'll need regarding the **BUSINESS-SIDE** of running a successful service operation!

**FREE INFORMATION
CALL TOLL-FREE 1-800-537-0589**

Or write to: Viejo Publications Inc.
5329 Fountain Ave.
Los Angeles, CA 90029 Dept. PE

CIRCLE 9 ON FREE INFORMATION CARD

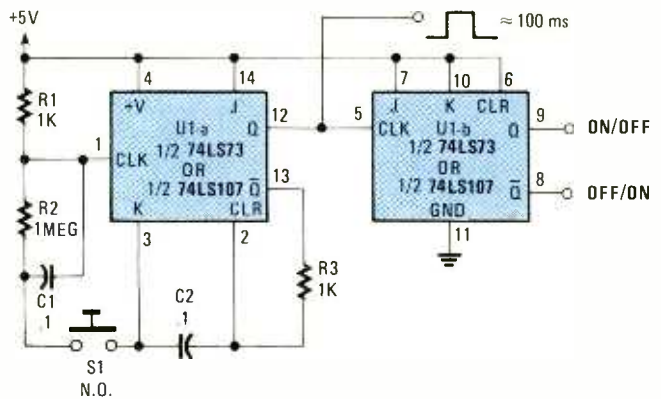

Fig. 2. This switch-debouncer circuit is built around a 74LS73 JK flip-flop, and a few support components. It also provides a 100 ms pulse.

through R2 in about 100 ms, debouncing S1. Flip-flop U1-a (which is wired as a monostable) is self clearing on power up, resulting in its Q output being brought low and its Q-bar output being brought high. If it tries to power up with Q-bar low, the CLR input would be enabled through R3 and clear U1-a.

Since U1-a's K input is grounded and its J input is at +5 volts, when U1-a's CLK input is brought low via R1, C1, and S1, the Q output goes high and the Q-bar goes low. With Q-bar now low, C2 discharges through R3. About 200 ms later, the CLR input will be low enough to clear U1-a. The Q output of U1-a goes to the CLK input of U1-b. Since U1-b is wired in the toggle mode, it will change states once on each falling edge of the Q output of U1-a, or once each time S1 is pressed.

I hope others will find this simple, inexpensive circuit useful. I've used it in many projects.

—Josh Friedman, Eugene, OR

Yup! That's another clip-n-save Josh! Your book is on the way, along with our gratitude for this excellent effort.

DIFFERENT FLASHER

Yes, it's another light flasher, but this time with an unusual twist! Of all the light chasers I've ever seen, I've

never found one that can reverse the LED direction. Enter my circuit (see Fig. 3). That unusual flasher uses a 555 oscillator/timer (U1) to clock a 74190 BCD up/down counter (U2). Its four-bit output, in turn, drives a 7442 BCD-to-decimal decoder (U4), which is used to sequentially light ten LED's.

Here comes the twist: The 7476 J-K flip-flop (U3) is the key to reversing the LED's direction. When U4's "0" output is pulsed, U3's Q output is preset to logic 1, switching the level at U2 pin 5 (the count-direction pin), thereby changing the count direction and the LED's movements. As U2 counts back and pulses U4's "0" output, U3's Q output is reset to logic 0 once again switching the level presented to pin 5 of U2, causing the counter to count up until it reverses direction once again.

For additional versatility, a 74191 binary up/down counter and a 74154 4-16 decoder/demultiplexer would allow for 16 individual outputs instead of 10.

I worked out this circuit while attending Oregon Institute of Technology in Klamath Falls, OR, where I'm an electronic engineering student. Worth a book Byron?

—Darren Snook, Pasco, WA

Okay Darren, right on all

Protel Easytrax 2™

Outstanding value in Printed Circuit Board/CAD for your Macintosh and PC

Protel Easytrax 2 is a new, low-cost design package for PC and Macintosh users that includes everything required to produce professional quality Printed Circuit Board artwork.

Our easy-to-learn menu-driven design system breaks the 'expert barrier'—you'll be designing in minutes, not hours. Our comprehensive tutorials guide you through the program's extensive features that take the tedium out of board layout.

- Comprehensive library of Through-hole devices

- Gerber photoplotting and N/C drill tapes

- On-the-fly library components creation

- Intelligent Pad to Pad autorouting

- Switchable Metric/Imperial grid

- Auto-panning

- PostScript™ printing

- Powerful user-definable Macros

- Independent print/plot program

- Multi-layer boards of up to 32 X 32 inches.

At Protel, we offer free technical support, 24-hour BBS, and 30-day money back guarantee. Prices start at

\$450

**Free Evaluation Package
Toll Free: 800-544-4186**

Protel Technology, Inc.

50 Airport Parkway, San Jose, CA 95110

Tel: 408-437-7771 Fax: 408-437-4913



CIRCLE 10 ON FREE INFORMATION CARD

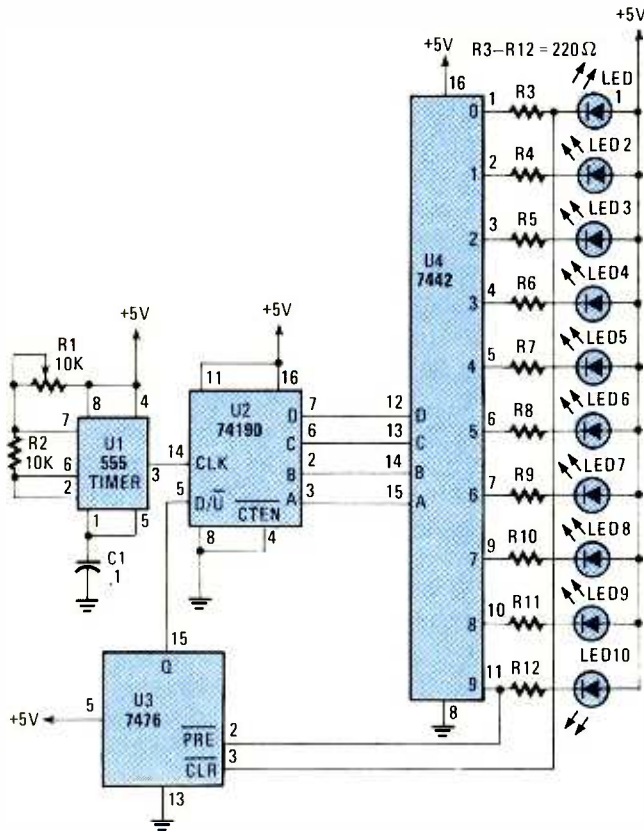

Fig. 3. This unusual flasher uses a 555 oscillator/timer (U1) to clock a 74190 BCD up/down counter (U2), which in turn, drives a 7442 BCD-to-decimal decoder (U4) that's used to sequentially light ten LED's.

counts! We've really had a belly-full of light chasers, but this was sufficiently different to warrant its inclusion. Your book is on the way to you now.

LATCHING CONTINUITY TESTER

This continuity tester will detect brief opens and shorts. It's a lot less costly

than a commercial equivalent. See Fig. 4. When S2 is in the up position, the circuit will indicate that there was or is continuity by lighting LED1. The down position indicates exactly the opposite—it will tell you if continuity was interrupted. The tester can be reset by pressing S1 momentarily; however, LED1 will not go off

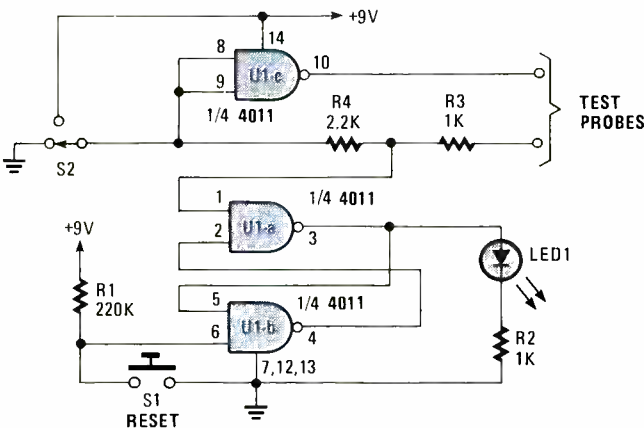

Fig. 4. This continuity tester will detect brief opens and shorts.

if there is continuity when S2 is in the up position, nor will it reset if there is no continuity when S2 is in the down position. Gate U1-d is not being used; so its inputs (pins 12 and 13, as indicated) are grounded.

The circuit, which can be powered from a 9-volt transistor-radio battery, feeds less than 3 mA through the test probes, and will make tests up to about 1000 ohms. The range of the circuit can be changed, if you like, by replacing R3 and R4. Just make sure that R4 has a higher value than R3. By subtracting the value of R3 from R4, you'll come up with the maximum operating resistance. And the larger you make R3 and R4, the less current will flow between the probes.

—Jeremy Miller, Mandan, ND

Readers, Jeremy is 13 years old! Jer, your book is on the way and I hope you'll enjoy it.

ELECTRONIC MUSIC MAKER

This is a one-evening project that can keep kids amused for hours. It also has the benefit of being inexpensive and easy to throw together.

See Fig. 5. The parts can be assembled on a piece of perfboard, and the wiring is straightforward. If you like, the circuit can be mounted in a small utility box, and the only additional thing you'll need is a bright lamp focused on PC1, which can be any photocell. You'll find that when the lamp shines on the photocell, a tone is heard in the loudspeaker. Move your hand between the photocell and the lamp, and the tone changes. Cover the photocell completely to cut the tone off. With a bit of practice, you'll find yourself playing simple tunes.

It's reminiscent of the famous Theremin, except it

“Where can I turn for help?”



There is a way to get help when you need it. The American Home Satellite Association. An organization created exclusively to protect and enhance your enjoyment of your satellite TV system.

Take our toll free “Helpline,” for example. From locating satellite signals to locating a reputable dealer, help is just a phone call away. AHSA provides educational videotapes and informative books, too. At very special member prices.

Plus, 10 times a year, AHSA’s official newsletter, *Sky Report*, will bring you the latest word on products, legislation, programming, and more. Not to mention reviews of new products and services. And that’s not all AHSA has in store for you.

Programming shouldn’t cost a fortune.

With AHSA’s group buying power, you can save on premium services, superstations and basic programming services. Enjoy savings on accessories, equipment, and programming guides, too.

You’re not alone anymore!

With your voice behind us, AHSA is promoting legislation to guarantee fair access at reasonable prices. Addressing zoning and piracy issues. Even sending expert witnesses to Congressional hearings. Join other dish owners around the nation, and become a force to be reckoned with.

Rush my free information kit.

Name _____

Address _____

City _____ State _____ Zip _____

Sign me up right away and send my complete membership kit.

Check enclosed for \$36 (made out to AHSA)

Bill my VISA MasterCard

Card # _____

Exp. Date _____

Authorized Signature _____

X _____

30-day Money Back Guarantee



**American Home
Satellite Association**

CA

Return completed coupon to:
American Home
Satellite Association, Inc.,
Suite 800, 500 108th Ave. NE,
Bellevue, WA 98004-5560
Or call Toll Free
1-800-321-AHSA (2472).

uses light instead of capacitance. I've found that using one hand to change the tone and the other to cover the photocell works best. Add a bit of pizzazz by making the hand movements graceful. Worth a book Byron?

—Marlene Miller, Tucson, AZ

Why not Marlene? It's on the way now, and I'm sure you'll like it.

and satisfaction of providing sight-impaired friends and relatives with additional freedoms.

The first circuit is a *Liquid Level Indicator*. (See Fig. 6.) The probes, which are made of copper, are placed over a cup or glass, and when the container is nearly filled, the buzzer sounds to tell the blind user.

The second item for the sight impaired is a *Light*

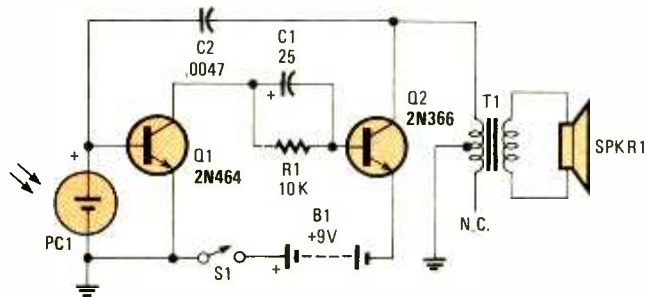

Fig. 5. The electronic music maker circuit is reminiscent of the famous Theremin, except it uses light instead of capacitance.

BLIND AIDS

Byron, I've been making and distributing these devices to blind people. They've been extremely helpful to them, and I certainly enjoy assembling them and enjoy the reward

Probe (see Fig. 7). Lots of devices use pilot lamps as indicators, and unfortunately, blind persons can't see the lights. The light probe shown here serves as a transducer, turning the light into sound.

Note that the photodiode was installed in a black opaque mini-plug housing. That was done to neatly solve the problem of shielding the photodiode from ambient light.

Byron, I hope that others will get involved in this very worthwhile project.

—Len Elder, Edmonton, Alberta, Canada

Good job, Len. If more people took an interest in the physically impaired,

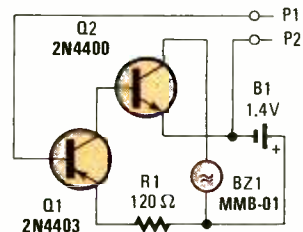

Fig. 6. The liquid-level indicator probes are placed over a cup or glass, and when the container is nearly filled, the buzzer sounds to tell the blind user.

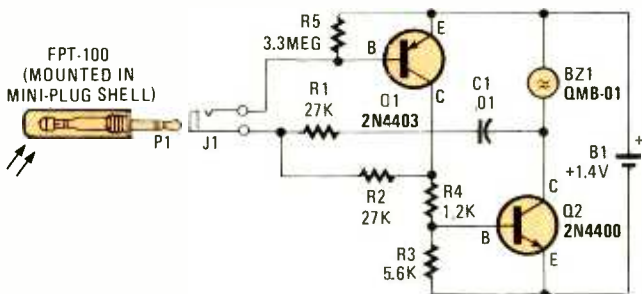

Fig. 7. The light probe turns light into sound.

DISCOVER EXPERIMENT LEARN ADVANCE ELECTRONICS LASERS CAD-CAM HOME STUDY HEATHKIT HOMEWORKS!

Now you can learn beginning to advanced electronics at home, with the same courses used today in the world's top colleges and tech schools, and pay a lot less! You'll learn just what you want, when you want, at your own pace. The complete story is in our free catalog, *Homeworks by Heathkit*. Order yours today, call toll-free:

1-800-44-HEATH
(1-800-444-3284)



YES! Please send me a FREE copy of the *HomeWorks by Heathkit* Catalog.

Send to: Heath Company, Dept. 107-014
Benton Harbor, Michigan 49022

Name _____

Address _____

City _____

State _____ Zip _____

FD-240

Bull Data Systems, Inc.

CIRCLE 18 ON FREE INFORMATION CARD

and those less fortunate than ourselves, that out-pouring would surely enrich all of our lives.

ALARM CIRCUIT

Byron, on page 42 of the Think Tank book, is a really neat circuit for a burglar alarm. Mr. Reeder, of Greensboro did a great design job on that one, but in looking it over, I saw the opportunity for a great modification! (See Fig. 8.) The original circuit leaves two unused gates, which I took advantage of, and added a counter and a few floor-sweepings.

When pin 4 of U1 goes high, it not only lets Q1 turn on and activate the relay, but D5 reverse biases and lets U1-f oscillate and clock U2 (the additional chip). Integrated circuit U2 is a 4020 14-stage ripple counter, but others are equally usable. A jumper-switch arrangement allows you to pick how much of an alarm shut-off delay you want it to have. When the selected stage goes high, U1-e changes to low, which adds a current sink to the base of Q1,

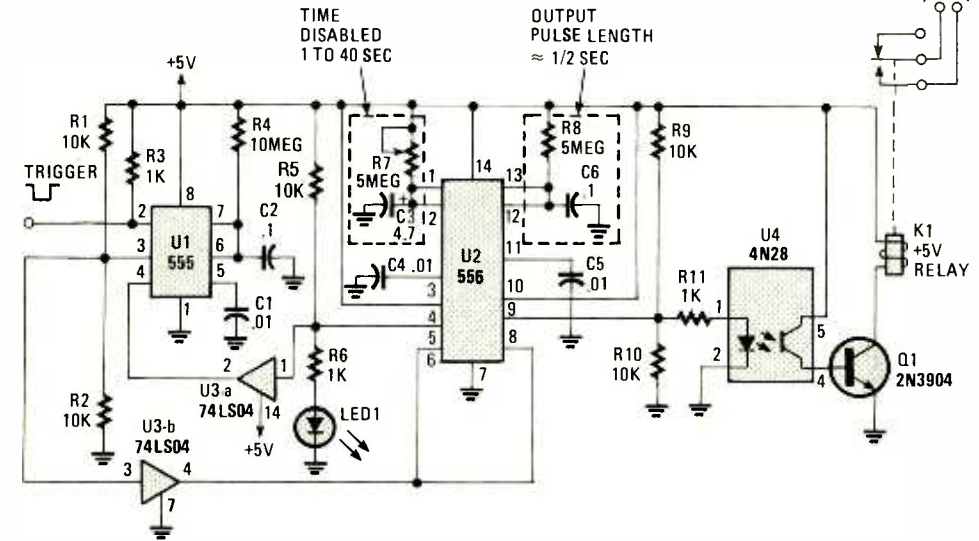

Fig. 9. Here is a circuit that will trigger your camera shutter when an animal or person steps on a switch or breaks an invisible beam.

turning off the alarm. Inverter U1-e also performs its original job of arming the circuit. LED2 flashes to let you know that the system has been activated during your absence and has auto-shutoff. You must re-establish the broken loop however, to turn off the blinking, even though re-

turning the switch to the reset position will shut off the alarm at any time. With the values given, auto shut-off will occur at between eight seconds for stage four and increasing to 33 minutes when stage nine is selected. Hope you like my little addition to Gordon's circuit!

—Sid Buck, Key Largo, FL
Now what do I do, Sid? Do I have to send another book to Gordon also? Still, this is the kind of experimenting we do. Nice improvement pal. Your book is on the way.

SMILE!

The problem? I needed a circuit that, completely unattended, would trip a camera shutter when an animal or person stepped on a switch or broke an invisible beam. The local staff of our state fish-and-game department said they could get good quality photos of animals in the wild with such a circuit. Sounds simple, right?

The camera they had would automatically advance the film. So if the animal stood on the switch or blocked the beam for any length of time, all the film in the camera would be used up in a few seconds. I could just see the animal laughing as it burned up \$5.00 worth of film. Expensive problem.

It still sounded like a fairly simple problem for an engineer. But I'm not an

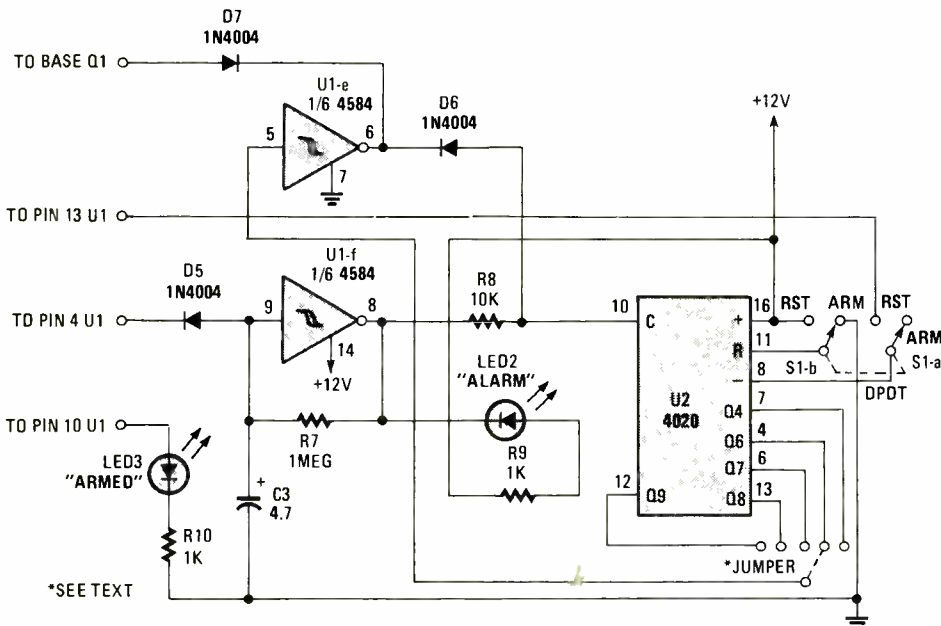

Fig. 8. You must reestablish the broken loop to turn off the blinking, even though returning the switch to the reset position will shut off the alarm at any time.

engineer, but a tech who repairs computer equipment for a local newspaper. I looked through your magazine hoping to find a circuit that I could use, but wasn't that lucky. I did remember from my electronics training that a timer could be used as a one-shot. So the circuit in Fig. 9 came about.

The operation is as follows: Temporarily grounding pin 2 of the 555 makes the output go high. Resistor R3 being used as a pull-up resistor to hold the input high, I fed the high output pulse through an inverter to trigger both inputs of the dual 556. One output (pin 5) of the 556 is used to hold the reset (pin 4) of the 555 low for a time determined by R7 and C3. That keeps the 555 from accepting another trigger.

I installed LED1 so that it would light as long as the input of the 555 was inhibited. That allows for easy adjustment of R7. The second output of the 556 at pin 9 is connected through R11 to an optocoupler and transistor, and used to fire a relay, which in turn, flashes the camera. Resistor R8 and

capacitor C6 determine the length of the output pulse to the camera; it should be just long enough to trigger only one exposure. It's a rather simple circuit, but it does work!

Making capacitor C3 4.7 μ F and potentiometer R7 5 megohms gives a delay of about 1 to 40 seconds. With the right values, the time can be adjusted to just about any length imaginable. In addition, I used a 9-volt battery and an LM7805 5-volt, 1-amp voltage regulator (not shown) to power the circuit so that it would work in the forest where it's hard to find a "current bush!" By the way, this circuit works with people too. Hunters and fishermen beware!

—Jim McIver, Lewiston, ID
Nice Jim! Your book was sent out today, so watch for it. The circuit is well thought out, and it's one with excellent application in a number of areas.

Well, that ought to do it for this month. Remember to send your offerings to *Think Tank*, **Popular Electronics**, 500-B Bi-County Blvd., Farmingdale, NY 11735.

Free Newsletter For Treasure Hunters



Los Banos, CA. What does a five pound chunk of gold have in common with a statue of a nude female, a Roman battlesite, a hoard of 10,000 coins and a murder weapon? Answer: They were all found recently with metal detectors.

To find out by who, when, where and how, check out volume 4, issue 4 of Fisher World Treasure News, a 16 page periodical published by the world's oldest metal detector company. Topics covered include "Treasure Hunters and the Law", "Metal Detectors and Archaeology" and "Underwater Treasure".

For a free copy write: Fisher Research Laboratory, Dept. PE, 200 W. Willmott Ed., Los Banos, CA 93635.

CIRCLE 11 ON FREE INFORMATION CARD

FREE

**POPULAR ELECTRONICS
 1990 EDITORIAL INDEX
 FREE COUPON**

Return this FREE coupon together with a No. 10 (business-size) envelope on which your name and address appear and to which you have affixed a 25-cent postage stamp and we will send you a copy of the POPULAR ELECTRONICS 1990 EDITORIAL INDEX. Send your request to: Popular Electronics Annual Index, 500-B Bi-County Blvd., Farmingdale, NY 11735. This is a limited offer so act today!

**THIS FREE OFFER EXPIRES APRIL 30, 1991
 AFTER APRIL 30, 1991 THERE WILL BE
 A \$1.00 CHARGE.**

FREE

Be an FCC LICENSED ELECTRONIC TECHNICIAN!

Earn up to \$30 an hour and more!

Learn at home in spare time. No previous experience needed!

No costly school. No commuting to class. The Original Home-Study course prepares you for the "FCC Commercial Radiotelephone License." This valuable license is your professional "ticket" to thousands of exciting jobs in Communications, Radio-TV, Microwave, Maritime, Radar, Avionics and more...even start your own business! You don't need a college degree to qualify, but you do need an FCC License.

No Need to Quit Your Job or Go To School
 This proven course is easy, fast and low cost! **GUARANTEED PASS**—You get your FCC License or money refunded. **Send for FREE facts now. MAIL COUPON TODAY!**

COMMAND PRODUCTIONS
 FCC LICENSE TRAINING, Dept. 100
 P.O. Box 2824, San Francisco, CA 94126
 Please rush FREE details immediately!

NAME _____
 ADDRESS _____
 CITY _____ STATE _____ ZIP _____

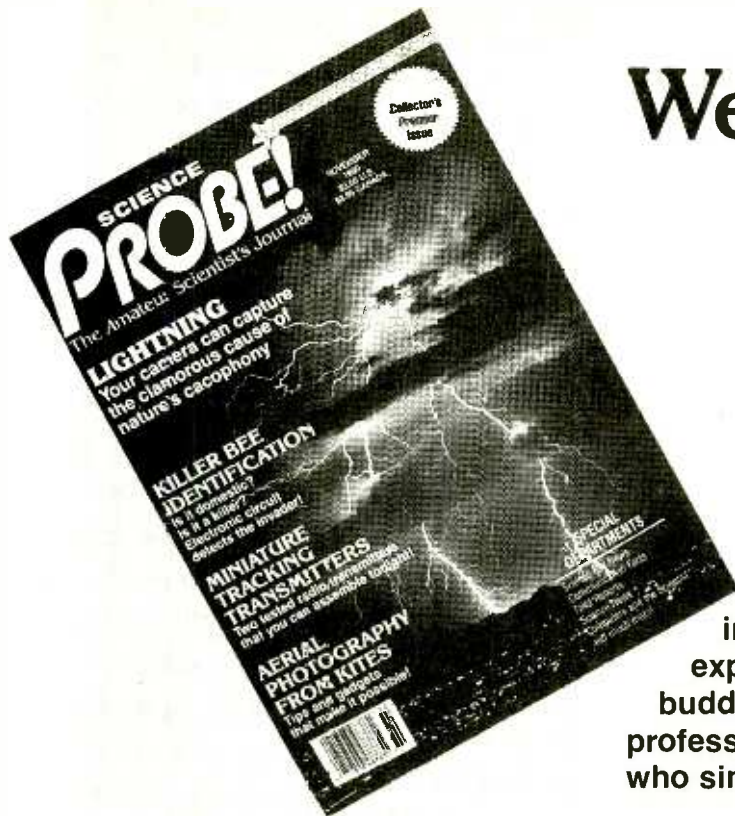

Welcome to. . .

SCIENCE PROBE!®

The Amateur Scientist's Journal

Embark on an irresistible new journey into the realm of mystery, challenge, and exploration! The perfect magazine for the budding scientist, the serious amateur, the professional who would like to relax, and those who simply want to gaze at the stars.

SCIENCE PROBE! — the *only* magazine devoted entirely to Amateur Scientists! If you are fascinated by science in all its many forms . . . if you can't stay away from a microscope, telescope, calipers, or test tube — we invite you to share the wonders in every issue of **SCIENCE PROBE!** You will join a community of Amateur and Student Scientists who enthusiastically seek scientific knowledge or follow scientific pursuits for their own sakes and not merely as a profession.

Obtain your personal *premier* edition of **SCIENCE PROBE!** by visiting a quality Newsstand, Convenience Store, or Supermarket this Fall or by reserving your personal copy through the mail by completing the coupon below.

From the very first issue of **SCIENCE PROBE!** you will be involved in a world of scientific facts, experiments, and studies pursued by amateur scientists who are university students, inventors, academicians, engineers, or office workers, salesmen, farmers—whose *quest* is to probe into the mysteries of science and reveal them to all.

Plan to become a **SCIENCE PROBE!** reader!

Articles to appear in early issues of **SCIENCE PROBE!** are:

- LIGHTNING—CAPTURE IT ON FILM**
- MONITORING ULTRAVIOLET FROM THE SUN**
- MOBILE-MOUNT EXPERIMENTAL WIND TUNNEL**
- CHECKING OUT ACID RAIN**
- AERIAL PHOTOGRAPHY FROM KITES AND BALLOONS**
- MINIATURE TRACKING TRANSMITTER**
- KILLER BEE IDENTIFICATION**
- HOW TO OBTAIN ANIMAL EYESHINE PHOTOGRAPHS**

If you're fascinated by science in all its many forms, if you are compelled to experiment and explore, then **SCIENCE PROBE!** is your kind of magazine!

SCIENCE PROBE!

500-B Bi-County Boulevard
Farmingdale, NY 11735

7PA15

Please forward my Premier Edition of **SCIENCE PROBE!** as soon as it comes off the press. I am enclosing \$3.50-U.S.A. (\$3.95-Canada) plus \$1.00 for shipping and handling. Better still, please enroll me as a charter-member subscriber and send the next four (4) quarterly issues of Science Probe. I am enclosing \$9.95-U.S.A. (Canada: \$14.95 U.S.A. Funds)

Premier Edition only First Four Issues (1 Year)

Offers valid in the U.S.A. and Canada only. No foreign orders.

Name _____

Address _____

City _____ State _____ ZIP _____

All Orders payable in U.S.A. Funds only.

**ON SALE AT QUALITY NEWSSTANDS, CONVENIENCE STORES AND SUPERMARKETS
STARTING SEPTEMBER 13, 1990 — \$3.50-U.S.A. — \$3.95-Canada**

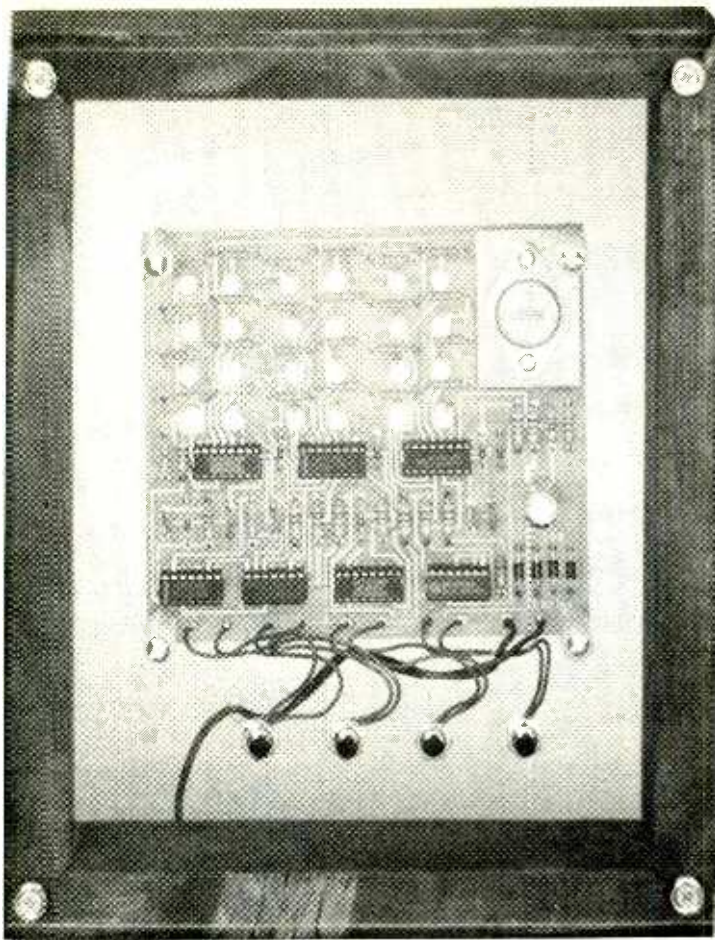

Build a BINARY CLOCK

BY FRED BLECHMAN

Here is an unusual timepiece that is sure to receive lots of attention. Aside from its conversational value, it can also acquaint you with the binary numbering system—the language of computers.

The trouble with most digital clocks is that they are a bit boring. Oh, they look all right and keep accurate time, but what the world needs is the convenience and accuracy of electronic time keeping along with a little excitement and intrigue. The *Binary Clock* presented in this article, which you can build from scratch or from a kit, is the answer. It looks great, keeps good time, but not everyone can read it; you have to know something about the binary numbering system to figure out what time it is—making it an effective conversation piece.

One or more of a field of 24 lights changes from green to red, or red to green, each second, making the display both eye-catching and mysterious. You can sit back, watch your clock, and know what time it is while everyone else is in a quandary.

A Little Background. About 15 years ago a special BCD clock chip was available, and Electronic Kits International (EKI) offered a BCD clock in kit form. Designed by David McDonald, EKI's circuit *guru*, it had only red lights, and not much circuitry. Since then, the special chip has become unavailable, so the clock has been completely re-

designed by David to use discrete integrated circuits and a special two-color display. It's much better looking than the original, easier to read, and you can learn a lot about digital counting and gates by following the "theory of operation" of David's ingenious little circuit.

Since the clock "counts" from the 60-Hz (cycles per second) AC line, the Binary Clock will remain as accurate as the atomic clock standard used by the power company, unless the power is interrupted. Also, because the Binary Clock has both RESET and HOLD (stop) buttons, it can be used as a one-second timer or stopwatch.

Description. The Binary Clock display consists of 24 bi-color light emitting diodes (LED's) in six vertical columns and four horizontal rows. The two left columns represent 1–12 hours, the two middle columns represent 0–59 minutes, and the two right columns represent 0–59 seconds. (More information on how to read the binary clock display will be given later in this article.)

Two power supply voltages are generated from an AC wall-plug transformer. An unregulated voltage (about 14-volts DC) powers seven integrated circuits—counters, AND gates, NAND

gates, and flip-flops. A voltage regulator provides 7-volts DC, and is a source or sink for the bi-polar LED's. When current flows in one direction through this special type of LED, it lights green. When the current is reversed, it lights red.

The integrated circuits count incoming pulses from the AC power line, and control LED current flow, sequentially advancing in binary-coded-decimal format to display seconds, minutes, and hours to the closest second. Four switches are used for reset, fast set, slow set, and hold.

The strong of heart can build this clock from scratch, although there is a considerable amount of circuitry involved. An available double-sided printed circuit board simplifies construction to about three hours. A complete kit, less enclosure, is also available, saving you the time and cost of finding all the parts—especially the

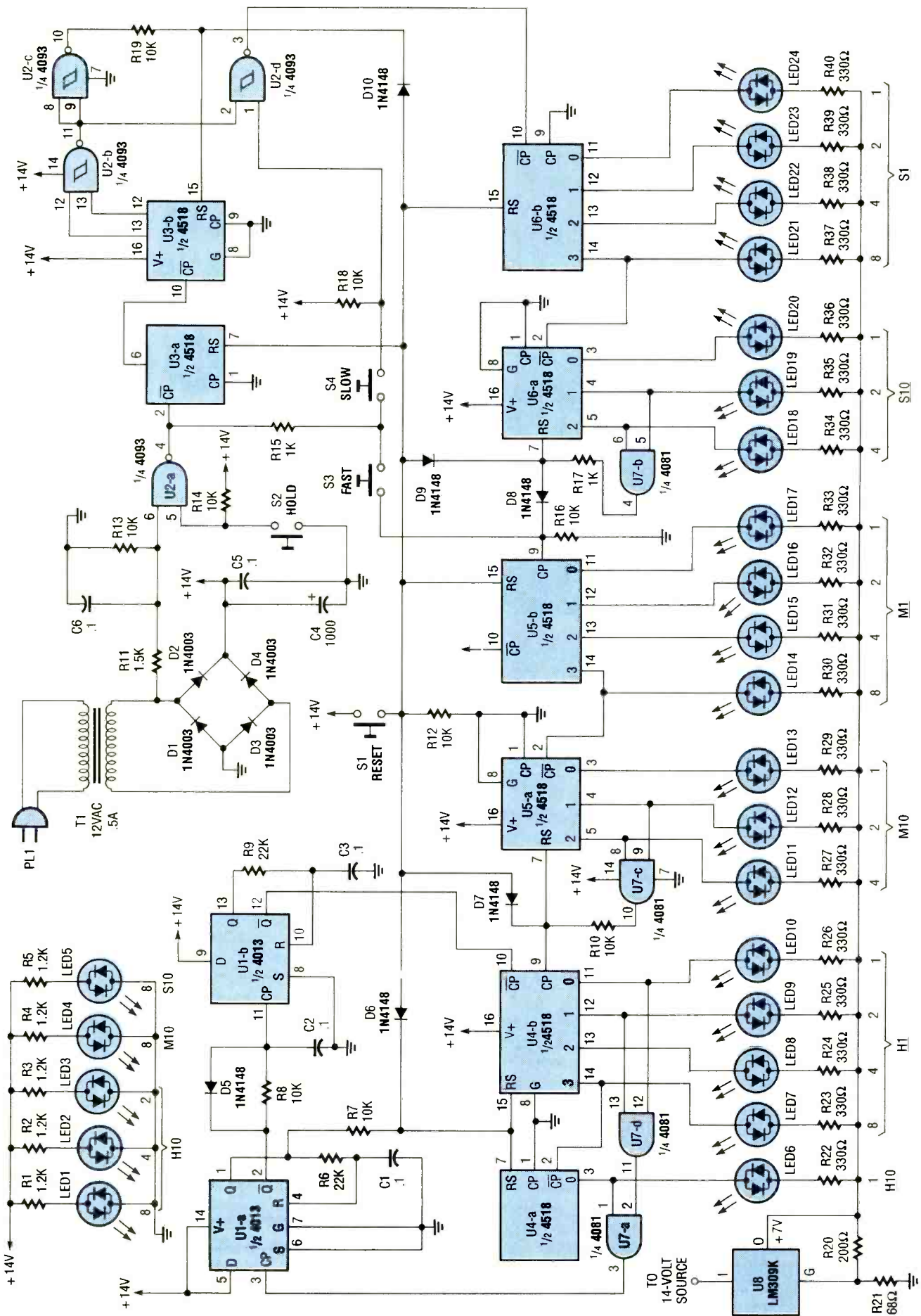

Fig. 1. The Binary Clock is an unusual timepiece. In that, in order to read the time displayed by the LEDs, you must understand the binary numbering system, which has only two digits: 1 and 0.

bi-polar LED's. A classy enclosure is also offered.

Theory of Operation. The schematic diagram of the Binary Clock is shown in Fig. 1. Power for the circuit is derived from a 117-volt, AC wall-plug transformer (T1) that provides 12 volts AC at the secondary winding. That voltage is applied to a full-wave bridge rectifier (consisting of D1–D4), and filtered by capacitors C4 and C5, to provide an unregulated 14-volt DC source. The unregulated 14-volt output of the rectifier is used to power the integrated circuits, U1–U7.

That unregulated source is also fed to the input of U8, an LM309K 5-volt, voltage regulator whose output voltage is boosted via resistors R20 and R21 to about 7 volts DC. The two voltages—14 and 7 volts—are used to control the direction of current flow through the LED's. LED6–LED24 are connected between the +7-volt output of U8 and the output pins of U4, U5, and U6. Each of those outputs is normally at or near ground potential. That produces a current flow from the +7-volt bus through the LED to ground, and the LED turns green. In this case, the +7-volt bus is the source.

However, when an integrated-circuit output pin connected to an LED is active (high), it is essentially at +14 volts, and current flows through the LED in the opposite direction, toward the lower +7-volt bus, and the LED turns red. In this case, the +7-volt bus is the sink. Simply put, when an output is low, the associated LED is green; when the output is high, the LED turns red. Incidentally, since the LED's are bi-polar, if you connect them opposite to the direction shown, they'll light in the opposite condition. Red will be the default, and green will be the active high mode. Throughout the remaining discussion, however, we will assume green is default and red is active.

The trick now is to get the IC outputs to clock in such a way that they can be used to count seconds, minutes, and hours in binary-coded decimal, changing the proper LED's from green to red (or back to green) at the proper time. That means we need one-second clock pulses. The clock pulses are derived from the intersection of D1 and D2. Sixty positive half-wave cycles are produced every second through the transformer from the 60-Hz AC power line.

Resistors R11 and R13 comprise a voltage divider to drop the voltage, which

is filtered by C6 and applied to pin 6 of a NAND Schmitt trigger, U2-a. Pin 5 is held high through R14. Whenever a positive pulse is detected at pin 6, pin 4 of U2-a goes low. That negative-going pulse is applied to pin 2 of U3-a, a divide-by-10 counter configured for negative-edge triggering.

At each incoming clock pulse on pin 2, the outputs of U3-a (pins 3, 4, 5, and 6) count upward in BCD (binary-coded decimal—1, 2, 4, 8, referred to as bits 0, 1, 2, 3 in the schematic diagram) until U3-a internally resets on the tenth count. That drops the output on pin 6 low, providing a negative-edge clock pulse to the input of U3-b, another decade counter. In other words, U3-b receives a clock pulse for every 10 power-supply pulses or every sixth of a second.

Now we need to divide by six, so that we have an output of one-pulse-per-second. That is accomplished by U2-b, another NAND Schmitt trigger, which monitors the output of U3-b at pins 12 and 13. Because those two outputs represent numerical values of 2 and 4, when both are active, the count is 6 ($2 + 4 = 6$). Since it took 10 input pulses for each count of U3-b, 6 counts of U3-b is actually 60 pulses, or one second. Putting it another way, U3-b pins 12 and 13 both become high exactly once each second, on the sixth count.

That instantly causes pin 11 of U2-b to go low, pulling pins 8 and 9 of U2-c low, which, in turn, forces pin 10 high. That places a high on reset pin 15 of U3-b, through R19, instantly causing pins 12 and 13 of U3-b to drop low. Notice that the reset pulse is isolated from the other integrated circuit reset pins by D10.

Now look back at U2-b. Since pins 12 and 13 have just been reset low, pin 11 goes high, bringing pins 8 and 9 of U2-c high. That makes pin 2 of U2-d, another NAND Schmitt trigger, high. Since the other input to U2-d at pin 1 is held high by positive voltage through R18, pin 3 of U2-d goes low. That negative edge provides a clock pulse to the seconds counter, U6-b, at pin 10. At that point, everything repeats, creating a clock pulse every second to U6-b.

Now that the clocking is established, how about the counting by the LED's? When the clock is first plugged in, all the LED's should turn on green, but random circuit power-up may cause one or more of the LED's to turn on red. Pressing switch S1 feeds a high voltage to the reset pins of U4, U5, and U6, forcing all their outputs low, causing LED6–LED24 to turn green.

PARTS LIST FOR THE BINARY CLOCK

SEMICONDUCTORS

U1—4013B, CMOS dual D flip-flop, integrated circuit
U2—4093B, CMOS quad 2-input NAND Schmitt-trigger, integrated circuit
U3, U4, U5, U6—4518B, CMOS dual synchronous divide-by-10 counter, integrated circuit
U7—4081B, CMOS quad 2-input AND gate, integrated circuit
U8—LM309K, voltage regulator, integrated circuit
D1–D4—1N4003, 1-amp, 200-PIV, general-purpose rectifier diode
D5–D10—1N4148, general-purpose small-signal diode
LED1 to LED24—bi-color light-emitting diode, red/green

RESISTORS

(All resistors are 1/4-watt, 5% units.)

R1–R5—1200-ohm
R6, R9—22,000-ohm
R7, R8, R10, R12–R14, R16, R18, R19—10,000-ohm
R11—1500-ohm
R15, R17—1000-ohm
R20—200-ohm
R21—68-ohm
R22–R40—330-ohm

ADDITIONAL PARTS AND MATERIALS

C1–C3, C5, C6—0.1- μ F, ceramic-disc capacitor
C4—1000- μ F, 16-WVDC, radial-lead, electrolytic capacitor
S1–S4—SPST normally open pushbutton switch
T1—12-volt AC, 500-mA wall-plug transformer
Printed-circuit or perfboard materials, sockets, enclosure, hook-up wire, solder, hardware, etc.

Note: The following items are available from Electronic Kits International, Inc., 16631 Noyes Avenue, Irvine, CA 92714, Tel. 800-453-1708 and 714-833-8711: A complete kit with all parts and case, \$59.90 (order B01098); all parts except case, \$47 (order B00898); etched and drilled double-sided circuit board, \$10.50 (order B00798); set of all eight integrated circuits U1–U8, \$20 (order B00098); set of 24 dual-color LED1–LED24, \$20 (order B06007); wood/Plexiglas case with hardware (see text), \$14.90 (order B24003). Add \$3.00 total per order for shipping and handling. California residents please add local sales tax.

Fed directly from the 14-volt line to ground through 1.2k resistors, LED1–LED5 are always green. They are

only put into the display for cosmetic purposes, to visually fill in the 6 × 4 display matrix, and they never change states.

When the first clock pulse enters U6-b, pin 11 goes high. Because that places that pin at a higher voltage (around 14 volts) compared to the other side of the LED, which is tied to the +7-volt bus, the current reverses and the LED turns red, indicating a count of one second. When the next one-second clock pulse enters U6-b, pin 11 goes low and pin 12 goes high. That causes LED24 to turn green, and LED23 to turn red.

Following the binary-coded decimal output of U6-b, during the third second both LED23 and LED24 will be red. In the fourth second, LED22 will be red, and LED23 and LED24 will be green, and so on.

Finally, at the tenth count, when U6-b resets internally, pin 14 drops low, providing a negative-edge clock pulse to pin 2 of U6-a. Every tenth second, another pulse causes U6-a to count upwards, indicating tens of seconds. But we know that there are only sixty seconds in a minute, so how does the clock stop counting at 60 and advance to show minutes?

Look at pins 5 and 6 of U7-b. They are monitoring the signal level on pins 4 and 5 of U6-a. At the 40th second, pin 5 goes high and stays high as the clock counts up toward 60. At the 60th count, however, pin 1 goes high for the first time together with pin 5. With both pins 4 and 5 of U6-a high, pins 5 and 6 of U7-b are now also high, making pin 4 of U7-b high. That provides a reset pulse to pin 7 of U6-a through R17, and also sends a positive-edge clock pulse through diode D8 to pin 9 of U5-b. LED17 turns red to indicate the one minute count.

The minute LED's light red in BCD sequence, until both LED14 and LED17 are red at nine minutes. At the tenth minute, U5-b internally resets, so pin 14 of U5-b drops low, clocking pin 2 of U5-a. As the tens-of-minutes are counting upward, once again the sixtieth minute count is monitored, this time by U7-c, in a similar manner to that of U7-b monitoring sixty seconds.

Hours counting is the same for the units column, since it counts from 1 to 9. However, the tens-of-hours column has to stop at 12 hours and reset not to 0, but 1! That takes some fancy electronic footwork, which is performed by U1-a, U1-b, U7-a, and U7-d.

When LED6 and LED9 are both red,

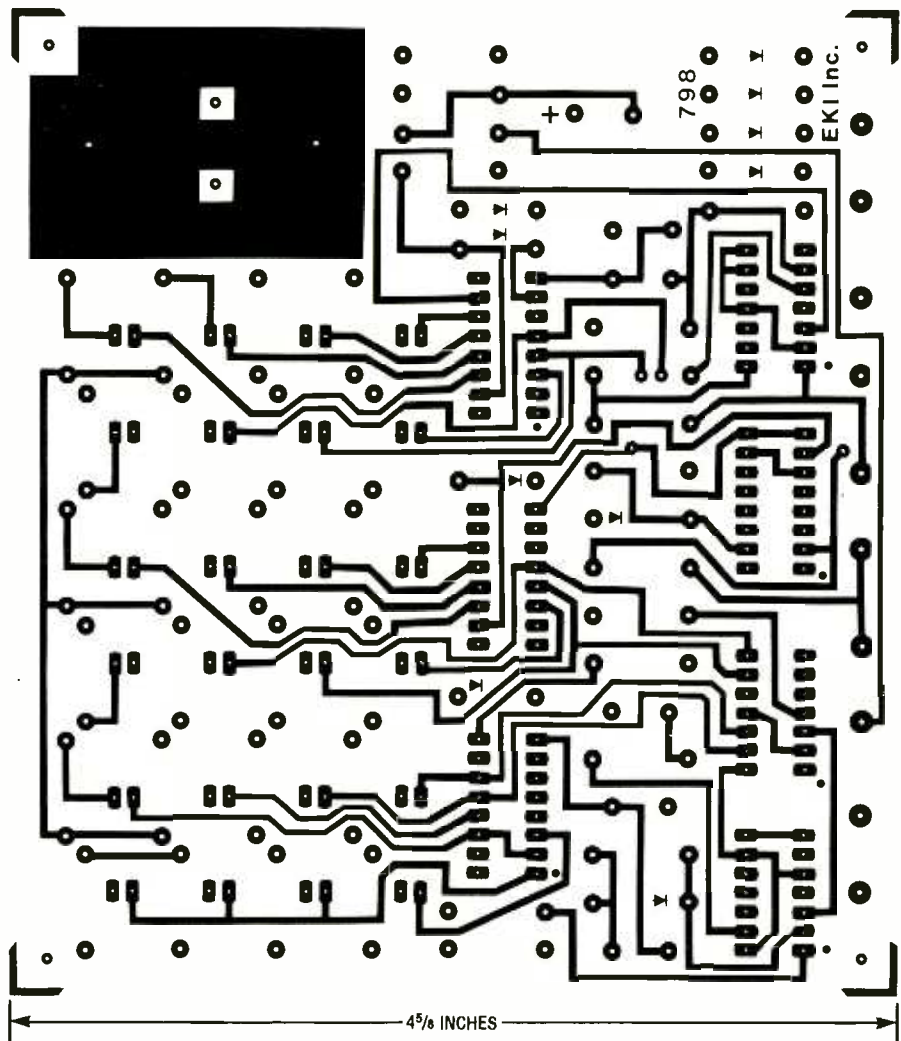

Fig. 2. The Binary Clock was built on a double-sided printed-circuit board; the component side is shown here.

signifying 12AM or 12PM, the next hour would try to count to 13. That, of course, is not allowed with a 12-hour clock. At the 13-hour count, pin 11 of U4-b goes high. Since pin 12 is already high, this means both input pins 12 and 13 of AND gate U7-d are high, making its pin-11 output high. That forces pin 2 of U7-a high. Since the other input, pin 1, is already high, the output of U7-a at pin 3 goes high.

Two things now have to happen. All the hour LED's must be reset to green (the others already are green, indicating zero seconds and minutes), and the one-hour LED, LED10, must be made red. Flip-flops U1-a and U1-b are wired so that the D pins are high. That forces their \bar{Q} outputs to reset to high, and the Q outputs low. The positive-edge pulse from the output of U7-a is applied to the clock input of U1-a at pin 3. That, in turn, causes U1-a pins 1 and 2 to change states; pin 1 goes high and pin 2 goes low. The positive pulse from pin 1 travels

through R7 to reset U4-a and U4-b, causing LED6, LED9, and LED10 turn green. That pulse also goes through a time delay created by RC circuit R6 and C1, to pin 4, which resets U1-a, causing pin 2 to go high and pin 1 to go low.

At that point, the positive-going pulse from pin 2 of U1-a goes through a short RC delay circuit, consisting of R8 and C2, to trigger the clock input (pin 11) of U1-b. That instantly makes the \bar{Q} output of U1-b at pin 12 to go low, and pin 13 go high. The output at pin 12 clocks pin 10 of U4-b, thus turning LED10 red, indicating 1 AM or 1 PM. Flip-flop U1-b is then reset when the pin 13 pulses after a short delay created by R9 and C3, which is feed to the reset input of U1-b at pin 10. Flip-flop U1 is now set for its next action 12 hours later.

Clock time setting is accomplished via switches S1-S4. The RESET switch, S1, applies a positive voltage, directly or through diodes, to reset all the LED's to green and the count to zero. The HOLD

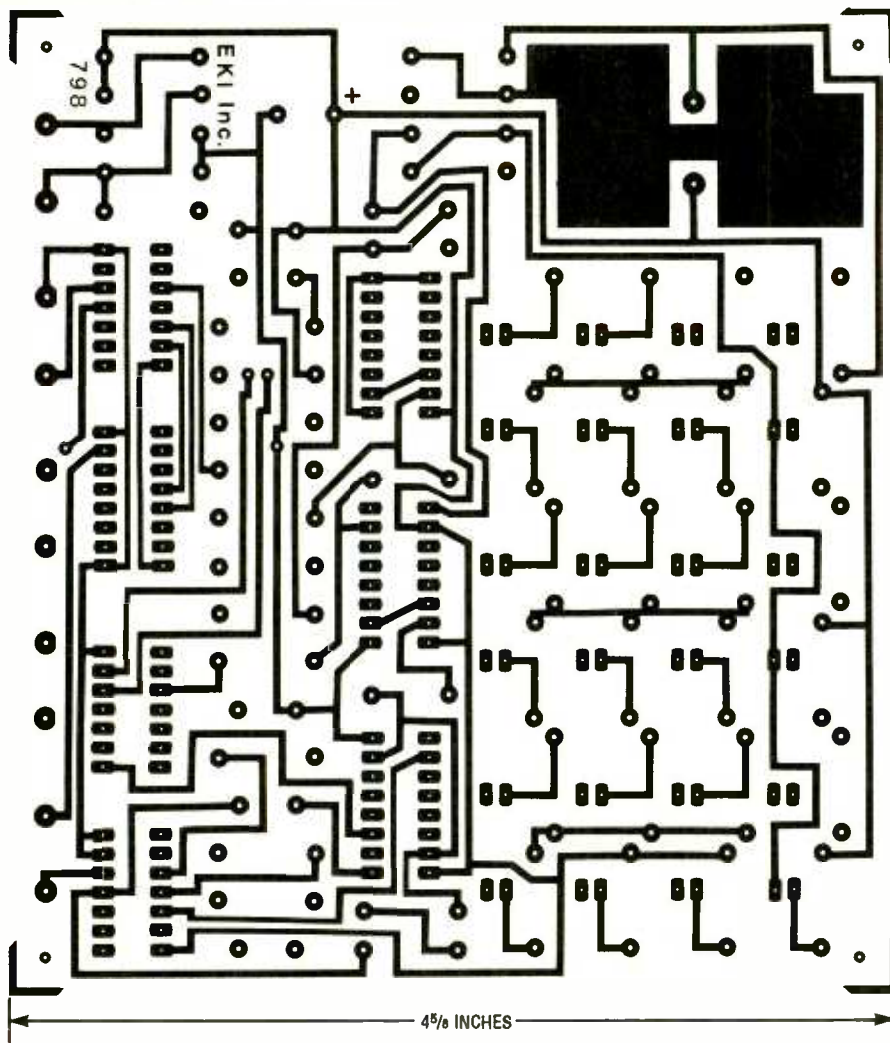

Fig. 3. Here's the foil side of the Binary Clock's double-sided printed-circuit board.

switch, S2, stops all counting by grounding one input to U2-a. The FAST switch, S3, applies positive clock pulses to U5-b sixty times per second, thus advancing the display sixty minutes—one hour—each second. Similarly, the SLOW switch, S4, causes U6-b to count at sixty times the normal speed, advancing the display one minute for each second of real time.

Construction. There is really nothing critical in the wiring of the Binary Clock. You can build it on a perfboard, using wire-wrap to complete the electrical connections, but there will be a lot of wires! Certainly, a printed-circuit board is a better approach.

However, the printed-circuit layouts shown in Figs. 2 and 3 represent a two-sided board with "plated-through" holes. If you are not equipped to produce that kind of board, I'd certainly recommend that you purchase the printed-circuit board offered in the Parts List. It is a very clean design, with

no jumpers (except the plated-thru holes.)

Figure 4 shows the parts-placement diagram for the double-sided, printed-circuit board. (Only the component-side of the board is shown in that layout.)

Most of the parts are readily available, but the bi-polar LED's are, by their nature, fairly expensive. The wall-plug transformer, T1, does not have to be a 12-volt AC unit; you can operate the Binary Clock, with less brightness, using a 9-volt AC unit—just make sure that it can supply at least 250 mA.

If you assemble the Binary Clock from the kit offered in the Parts List, it should take only about 2½ to 3 hours to complete. There are only a few precautions. Make sure all your 278 solder joints are good, with no bridges between pins on the IC sockets. Polarity is critical on the LED's, or they will light green when they should be red, and red when they should be green. The LED's (with the board oriented as shown) should be

mounted with the flat side down for a background of green, with red doing the counting.

The six small-signal diodes (D6–D10), the four power diodes (D1–D4), and the large filter capacitor (C4) all must be installed with the proper polarity as shown in the parts-placement diagram. After all the soldering is done, insert the integrated circuits so that they are all oriented in the same direction, with pin 1 on the left, as shown in the parts-placement diagram.

Integrated circuits U1–U7 are CMOS devices and as such are static sensitive. Extreme care should be exercised when removing them from their anti-static pad since only a small static discharge can permanently damage them.

Checkout. When you plug the transformer into 117-volts AC, all 24 LED's of the display should turn on green, but a few may turn on red. Press the RESET switch, S1. If all the LED's don't turn green, you have a problem. If none of the LED's light, make sure you have power. Check both the 14-volt and 7-volt buses for the proper voltages.

If individual LED's don't light, they may be defective, badly soldered, or the integrated circuit driving that unit might be defective, improperly oriented, or improperly seated in its socket. If an LED turns red on reset, it might be installed with reversed polarity. Once you have all the LED's properly lighted, check the counting sequence; if everything is working correctly, it should start with the LED in the lower right corner turning red on the first second.

The count should proceed in binary fashion up the last, rightmost, column (seconds), then to the tens of seconds column, and so forth. Press switch S2 to stop the count. Switch S2 is used to synchronize the display to real time, to the second. Press switch S4 and the two right-most columns should blink furiously as the minutes column counts once per second. Press switch S3 and the minutes column goes wild as the hours column advance once per second.

When everything is working, use S3 to set hours and minutes less than real time, S4 to advance minutes and seconds slightly ahead of real time, and then press S2 to hold count until real time catches up with clock time. If you go too far, you will need to count ahead another twelve hours, stopping just ahead of real time.

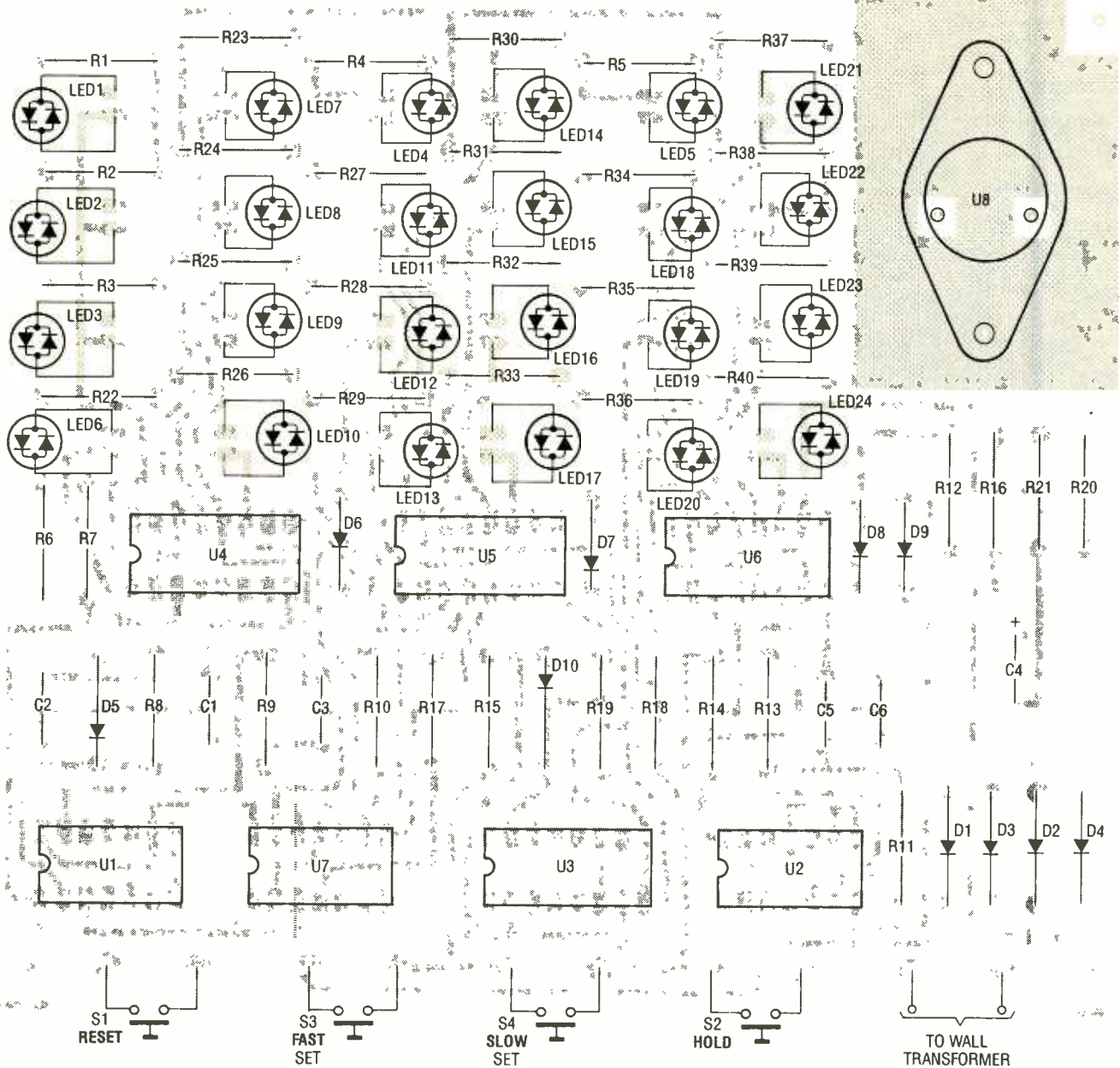

Fig. 4. Here is the parts-placement diagram for the Binary Clock's printed-circuit board. It is recommended that the all DIP IC's be socketed.

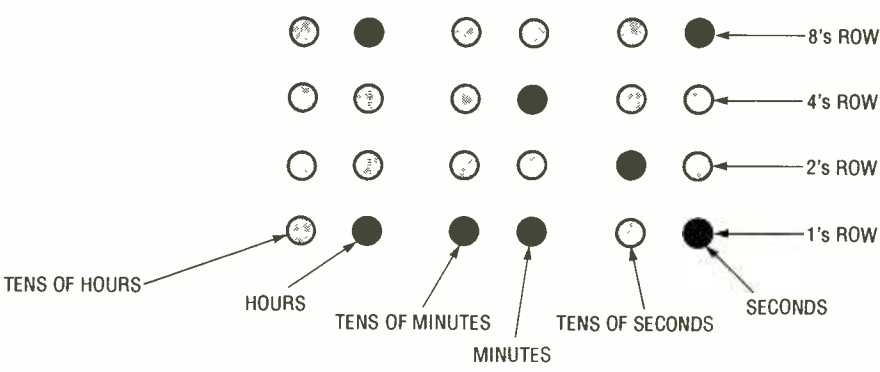

Fig. 5. The Binary Clock uses vertical columns of LED's that display the time in binary-coded decimal (BCD) form. Each LED in the columns represents a specific numerical value that are added together to determine seconds, tens of seconds, minutes, tens of minutes, hours, and tens of hours.

Preparing the Enclosure. You can "package" the Binary Clock any way you please. The photos show a wooden frame with Plexiglas plates front and back. The clock is mounted on spacers to "float" between the Plexiglas plates, making for a very striking display. The wooden frame and undrilled Plexiglas plates, with screws, nut, and spacers, are offered by the supplier in the Parts List.

The front panel is prepared for mounting by drilling four small holes for the mounting screws, four holes to mount the switches, and four holes in the corners to mount the Plexiglas to the

(Continued on page 104)

Back in the 40's Dad rolled his own cigarettes with a piece of thin paper and tobacco from a can or bag. Rolling your own radio is just as easy, with one exception: you make your own parts out of readily available material. In fact, all of the parts are homemade, including the crystal detector.

The Circuit. The basic circuit (see Fig. 1) is very simple with only five components. The broadcast signal is picked up by the antenna and applied across a

may be needed. If on the other hand, the output of the detector is to be fed to a transistor or IC amplifier output stage, that capacitor may not be necessary.

Capacitor Construction. As the title of this article implies, every necessary electrical component in the circuit is home-made. Because the construction of C1 (the variable capacitor) is the most difficult, let's start with it.

The variable capacitor was fabricated from pieces of unetched, double-sided, printed-circuit board materi-

ner stators (the pieces in Fig. 2B) will have only two assembly holes each—one in each of the lower corners.

Next drill the center (rotor shaft) hole in the end-stator plates. Mark the front of each end-stator plate with an F so they can be bolted in the same direction as drilled. Remove the copper from around the shaft holes on both sides of the two stator end-plates, so that the end-stator plates and metal rotor rod will not short to each other when the capacitor is assembled. Place adhesive-backed laminating film (or a sim-

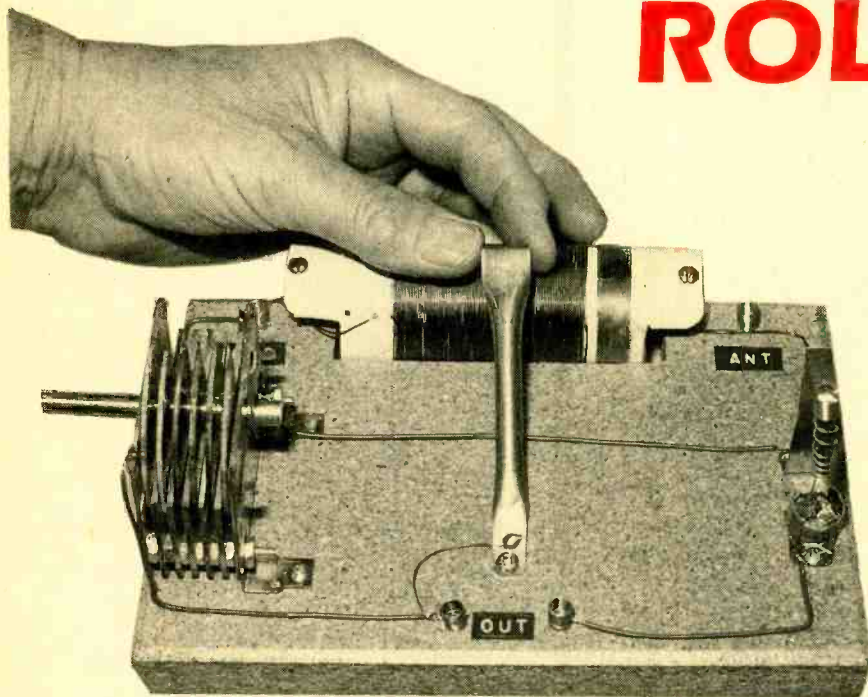

ROLL YOUR OWN RADIO

For little or nothing, you can build a simple radio receiver using materials that you have on hand. Its performance may not rival present-day receivers, but then neither does its price!

coil (L1). The signal across L1 is inductively coupled to L2. Inductor L2 and capacitor C1 are used to tune the RF signal. The RF signal is rectified by a homemade crystal detector (D1). Upon leaving the detector, the signal is fed across C2 to the output of the circuit.

As it is, the circuit provides sufficient power to drive a pair of high-impedance (2000-ohm) earphones. (Remember, this is a simple crystal detector radio with no amplification.) However, if earphone operation is not desirable, an amplifier stage (either transistor or IC type) may be connected to the output of the circuit, allowing it to drive an 8-32-ohm speaker.

Note that C2 is not homemade, but it is optional; it is used to bypass any residual RF in the detector's output signal to ground. Generally speaking, if the circuit is to feed earphones directly, C2

al. Figure 2 gives details of how the variable capacitor was made. As shown, it consists of three variously shaped pieces, each of which must be duplicated two or more times. Two end-stator plates (Fig. 2A), five inner-stator plates (Fig. 2B), and six rotor plates (Fig. 2C) are needed.

After the three types of plates have been cut, clamp all the rotor pieces together and round them off with a sander or a file. And while they are clamped together, it's a good idea to drill the rotor's shaft hole. That hole should be sized for a snug fit with 1/4-inch O.D. hollow brass rod.

Likewise, drill holes in the stator plates to the dimensions and in the positions indicated in Fig. 2. Do the end-stator and inner-stator plates separately. Note that the end-stator plates (Fig. 2A) will have four assembly holes, while the in-

ilar insulating material) over the inside surface of the two end-stator plates. The plastic prevents the rotor plates from shorting against the stator plates should any of the plates become warped.

Once that's done, assemble the variable capacitor (as shown in Fig. 2D) by inserting two 1 1/2-inch 6-32 bolts into the bottom assembly holes of one end-stator plate. Place a nut on the bolt after insertion into the end stator; the nut will serve as a spacer between the end- and inner-stator plates. Make sure all surfaces marked F are to the front as they are mounted. Tighten each nut securely.

After the last stator plate is mounted, place an L bracket on the end of the

BY HOMER L. DAVIDSON

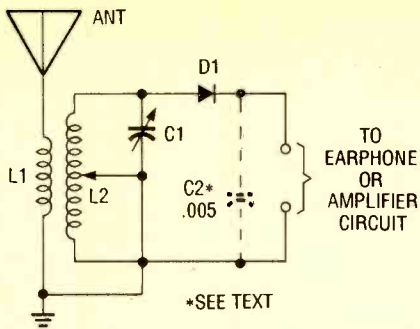
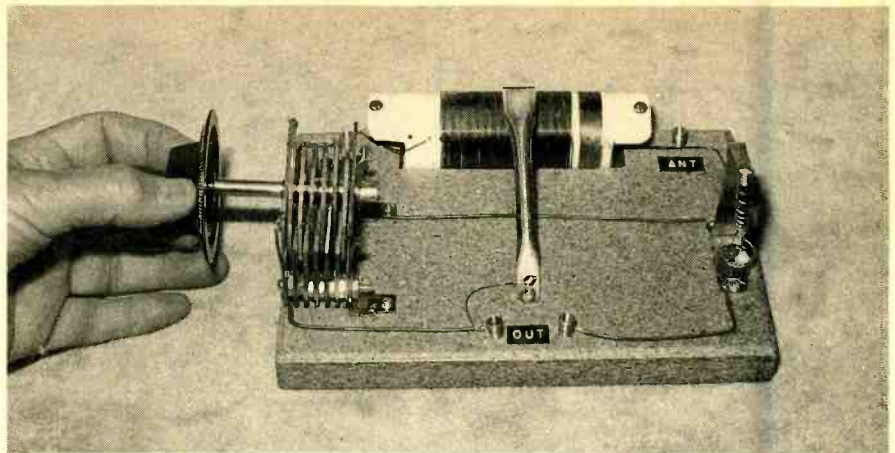

Fig. 1. Here is the schematic diagram of our home-brewed radio. All components in the circuit were fabricated from readily available parts.



Slip a large knob over the tuning shaft and adjust to the high end of the band with less of the plates meshed.

bolt. The L bracket will be used to mount the capacitor. As an extra precaution, solder a bare piece of hookup wire to both sides of each stator section. Doing so maintains a good electrical connection should a nut loosen or poor contact exist between the nut and the copper foil on the stators.

Insert the hollow brass rod through the front stator hole, place a rotor plate between the front-end stator and first inner-stator plate, and push the rod through it. Do the same for the next rotor and stator until all rotors have been installed (see Fig. 2D).

When completed, allow the brass rod to protrude about 1/2 inch at the rear. Center all rotor plates between the stator plates. Cut 1/2-inch strips of light cardboard and place one on each side of the rotor plates to hold them centered and level. Make sure the top of each rotor plate is level with the other.

Solder both sides of each rotor plate to the brass rod so that when the rotor shaft is rotated, the rotor turns along

with the rod. Wrap a piece of bare, solid number-2 hookup wire around the front end of the rod. Center the wire at each end. The wire helps to keep the rotors in place. Cut off the brass rod two inches from the front-end stator plate. The rod will turn hard and slow, but works nicely when a knob is mounted to the brass-rod shaft.

The Coil. Inductors L1 and L2 were wound on a single 4-inch length of 1/4-

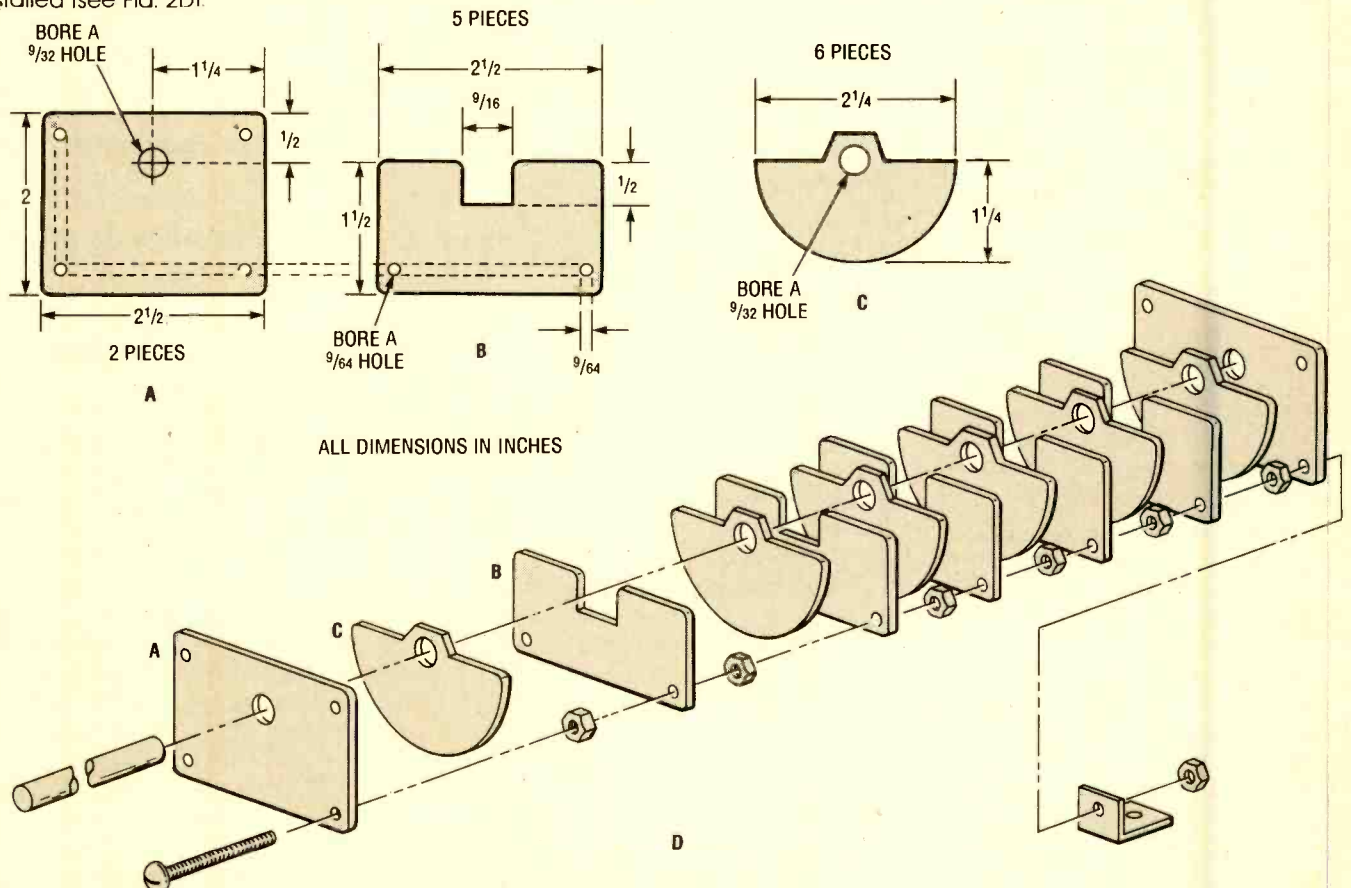

Fig. 2. The variable capacitor, C1, in the home-brewed radio was fabricated from variously shaped pieces of unetched double-sided, printed-circuit material. Fabrication details of that unit are shown here.

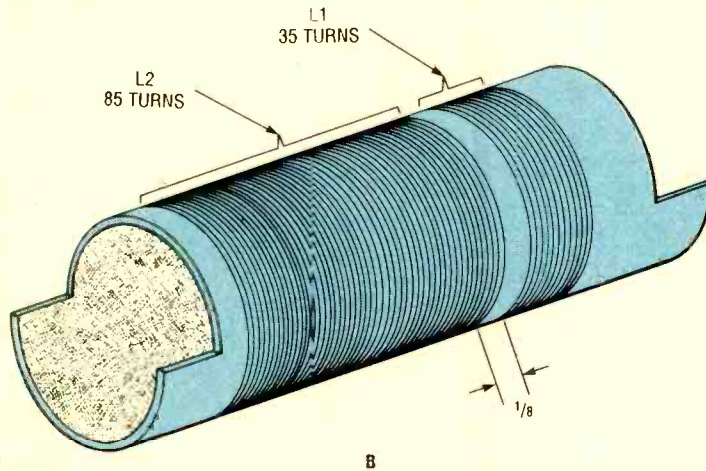
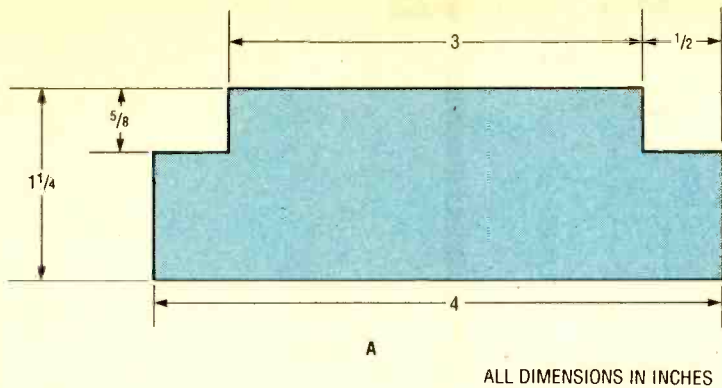

Fig. 3. The inductors for the home-brewed radio were hand-wound on a 4-inch length of 1/4-inch diameter PVC pipe. Inductor L1 consists of 35 turns of number 24 or 26 enameled wire, while L2 consists of 85 turns of the same enameled wire wound on the same pipe in the same direction.

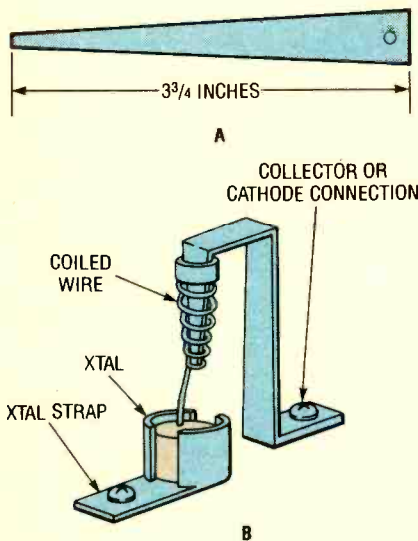

Fig. 4. The cat's whisker holder was fashioned from slit and flattened brass tubing.

inch diameter plastic PVC pipe. Make a slit about a 1/2-inch deep at the diameter of the pipe on both ends. Then cut the coil form as shown in Fig. 3A, and drill a hole in both end flaps for mounting the coil. Wind 35 turns of number-24

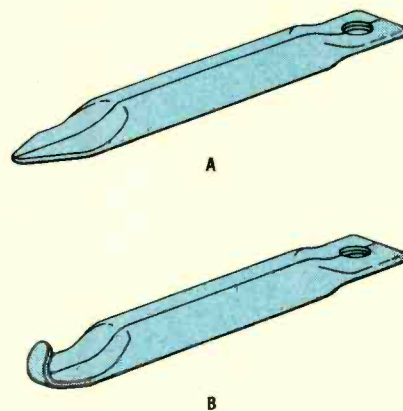

Fig. 5. The wiper for L2, like the cat's-whisker stand, was fashioned from brass tubing. However only the ends of the tubing were flattened. One end is then tapered to a semi-point and bent against the roll of the tubing.

or -22 enameled wire onto the form for L1 (see Fig. 3B).

Then, leaving a space of about 1/8-inch, wind 85 turns of the same size wire in the same direction for L2. Drill small holes through the pipe near the ends of each coil and feed the ends through

the holes to hold the windings in place. As an alternative, you can place a layer of tape on the ends of the coils so that they do not unravel.

Making the Detector. The home-brewed detector was made from a piece of galena rock crystal, which can be found at rock-collectors or western-souvenir shops. (A fifty-cent piece can make several hundred detectors.) Break off a very small chunk. Next cut 1/2 inch off the end of a dead AA battery. Thoroughly remove all the battery material from the battery casing and then wash clean.

Take a couple of lead fishing sinkers and place them in the clean battery casing and melt them down with a pocket gas or butane torch, or on a gas stove. Be careful not to melt the lead-zinc battery casing. Place the piece of galena crystal into the molten lead with tweezers, and then allow to cool. Once the lead has cooled, brush away any loose particles, and move on to the next stage of construction.

Cat's Whisker Stand. Cut a 4-inch piece from the remainder of the hollow brass rod. Slice it down the middle with the hacksaw, and flatten it out. Taper one end of the flattened rod piece to a sharp point (see Fig. 4A). File down the rough edges and bend the flattened rod, as shown in Fig. 4B, to form the cat's whisker stand with a two-inch support. Fit a small spring over the tapered end, and solder it in place on the cat's whisker stand.

Next, cut off 1- and 2-inch pieces from the remaining brass rod; they'll be used to form the crystal-detector holder. Slit and flatten the pieces as before, and wrap the larger one around the crystal detector; trim as needed. Solder the assembly to the other pieces of tubing, as shown in the photos, to create a stable holder.

Fabricate the coil wiper for L2 from the remaining rod. Again slit the rod, this time flattening only the ends of the rod, as shown in Fig. 5A. Taper one end to a semi-point. Then bend the tapered end against the roll (see Fig. 5B) of the slit rod.

Chassis Fabrication. Take an 8 x 5 1/2-inch piece of 1-inch thick white pine or pressed wood and cut a 6-by-1-inch notch along its length (see Fig. 6) to form the chassis. Temporarily mount the coil assembly in the cut-out notch and mark the positions for the mounting

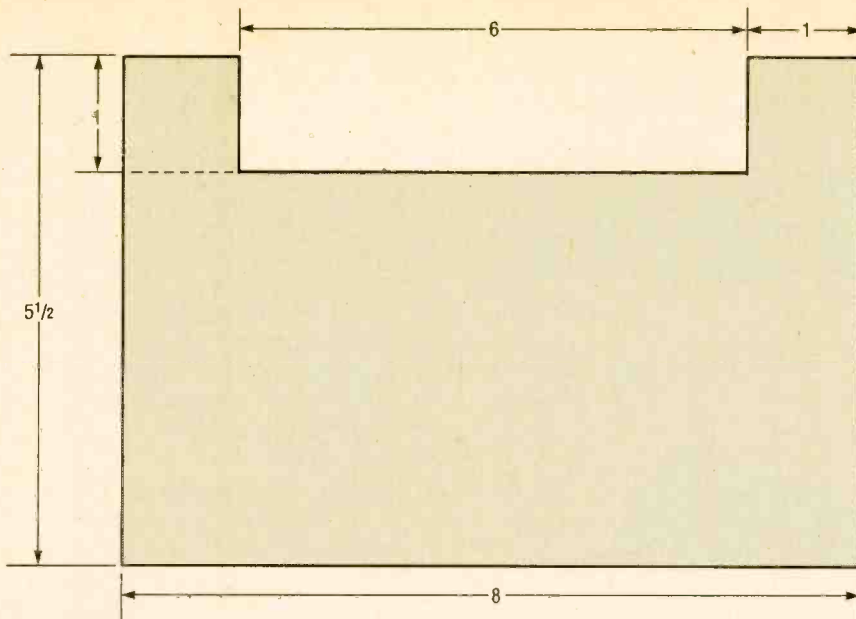

ALL DIMENSIONS IN INCHES

Fig. 6. The chassis for the home-brew radio was made from a piece of wood, cut to 8 × 5½ inches. A notch of about 6-inches long was then cut into the chassis to receive the coil assembly.

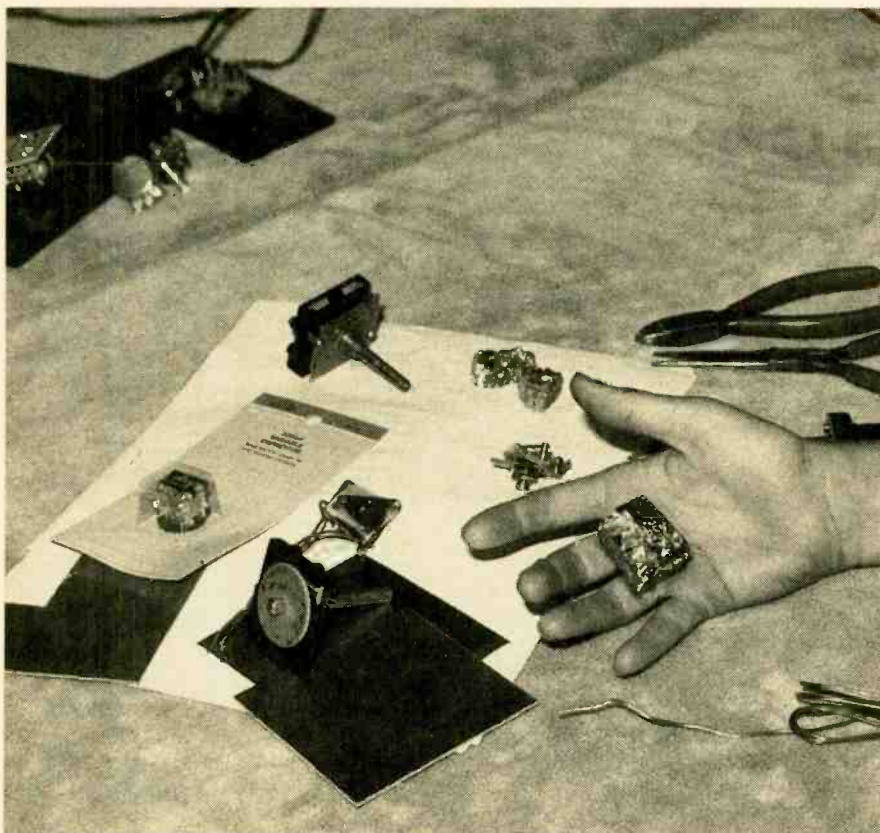

Every component, including the wooden chassis, is homemade. Here is the project's humble beginning.

screws (one is located on each side of the coil).

About half an inch from the coil-mounting holes (moving toward the left and right edges of the chassis), drill holes of sufficient size to accommo-

date lead-retention spring clips—those clips are small springs through which quick connections to the other circuit components can be made. (You need not use springs; other quick connect/disconnect schemes may be used. For

PARTS LIST FOR THE HOMEBREW RADIO

L1, L2—See text

C1—See text

C2—.005- μ F ceramic disc capacitor, optional

D1—Galena crystal, see text

Hollow brass rod (¼-inch O.D., 12- or 16-inch length), 1-inch thick 8 × 5½-inch wood chassis, spring clips (see text), hookup wire, etc.

example, screws and butterfly nuts.) Drill two more spring-clip holes directly in front of the coil position, at about the center and a ½ inch from the front edge of the wooden chassis.

Smooth all rough edges and surfaces. Afterward, spray two or three coats of lacquer, varnish, or clear plastic spray on the chassis, allowing each coat to dry before applying the next. Once the final coat has dried, drill the component mounting holes.

Assembly. Mount the coil assembly first by screwing it to the wooden chassis in the cutout notch. Mount C1 to the left of the coil assembly and center it between the front and rear edges of the chassis. Likewise, mount the crystal-detector holder and cat's whisker stand to the right side of the chassis centered between the front and rear edges. Cement each spring connection into its respective hole in the chassis. Connect all components together so that the circuit conforms to the schematic diagram shown in Fig. 1.

Slip a large tuning knob onto the shaft of the variable capacitor to make it easy to rotate. Connect a good ground and antenna to the appropriate terminals of the circuit and 2000-ohm earphones or an amplifier to the output terminals.

Operation. The circuit does not require external power, so you needn't worry about connecting a battery or other power source. Simply rotate C1's shaft towards the high end of the band. Slide the wiper of L2 to about mid position. Then lift the cat's whisker and set it down on a sensitive spot on the crystal detector for best reception. Several tries may be needed.

Readjust C1 and L2 as needed for the strongest signal. Now, try to tune in a local station at the lower end of the band by sliding L2's wiper toward its grounded end and tuning the circuit via C1. ■

Super Simple



FREQUENCY COUNTER

If you work with digital circuits, you know how aggravating it can be to check for timing signals without a frequency counter. Don't you think it's about time you added one to your test bench?

A frequency counter is a useful tool for troubleshooting, aligning, or evaluating various electronic equipment or projects. However, for the average hobbyist, the commercially available units may be priced beyond reach. But, for under \$40. (or less with studious shopping), you can build this *Super-Simple Frequency Counter* for a mere fraction of the cost of commercially available equipment.

With an upper-frequency limit of 500 kHz (shown on a 6-digit display in hertz), the Super-Simple Frequency Counter has very good accuracy. On the lower end of the scale, the counter will display as little 1 Hz with reasonable accuracy. The counter may be used as a stand-alone test instrument or incorporated into some existing or future project to provide an accurate frequency readout.

If the range of the counter in its present form is not wide enough for you, you

BY STEVEN J. STRONCZEK

can always add a prescaler (essentially a frequency divider) to its front end, thereby widening the range of frequencies that can be measured by the circuit. Prescalers are available in DIP IC form, in versions designed for frequencies that extend into the gigahertz region. Such circuits usually require some sort of pre-conditioning circuitry (often buffers and/or amplifiers).

The printed-circuit board for the counter measures a scant 2¼ by 3 inches, so it will easily fit into the enclosure of existing projects. The project can be incorporated into gear such as wide-range audio oscillators or function generators; or it may be used to set an RF signal generator to a 455 kHz IF.

The counter's input sensitivity is on the order of several hundred millivolts, but it will accept peak-to-peak voltages as

high as 20 volts. Voltages higher than that may also be measured by feeding the input signal across a resistor divider network to reduce the input signal voltage to within the operating range of the counter. Conversely, if greater input sensitivity is needed an amplifier may be added to the front-end of the counter to give a little boost to the signal.

Circuit Description. Figure 1 is a schematic diagram of the Super-Simple Frequency Counter. At the heart of the unit is MOD1, a Red Lion Sub Cub series component counter that has a built-in 6-digit LCD display and all the necessary driver circuitry to operate the display. The Sub Cub is supplied in two versions with .2- or .35-inch digits designated Sub Cub I or Sub Cub II, respectively. The counter is packaged in a clear plastic housing with elastomeric contacts for connection to the outside world. The component's housing snaps

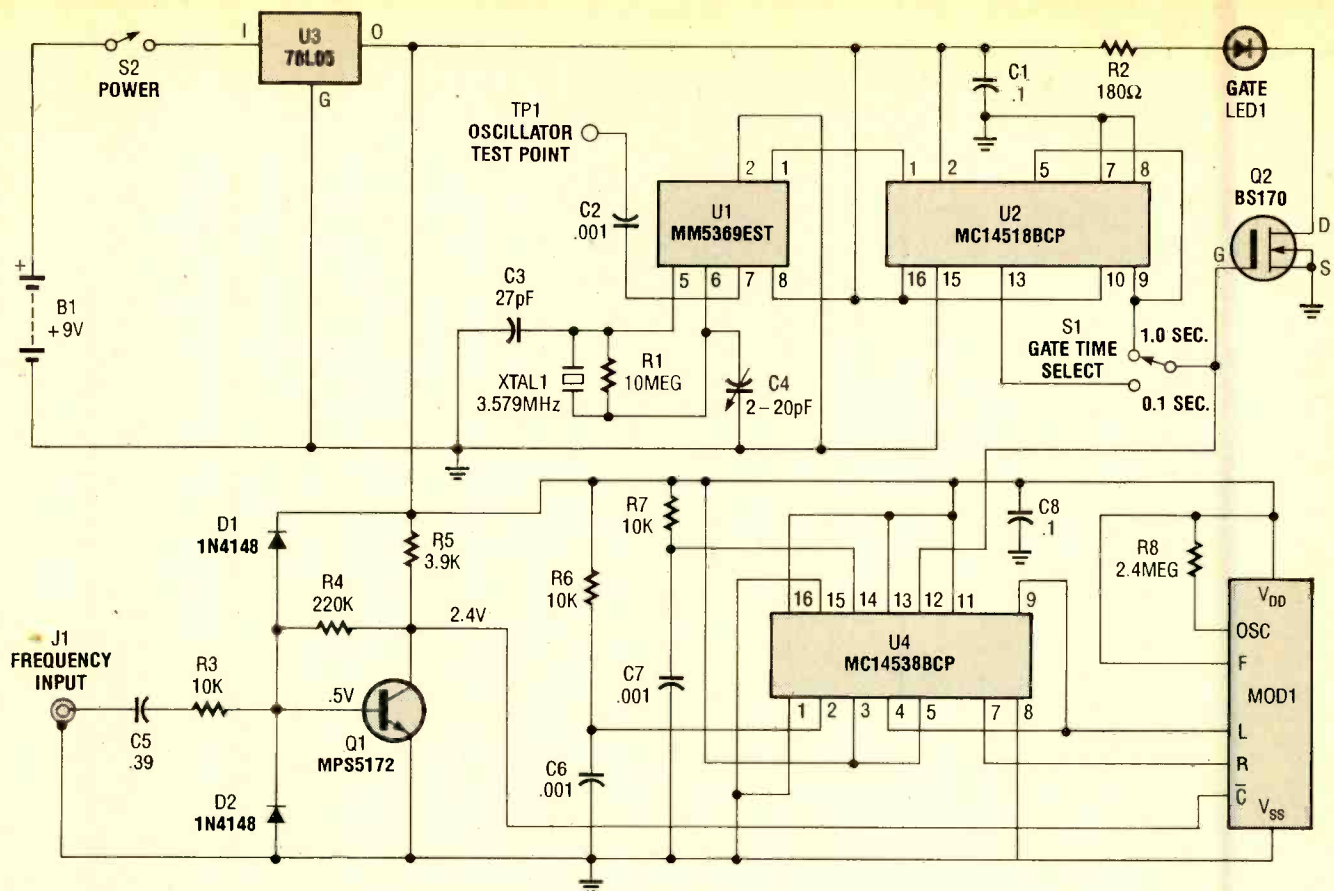

Fig. 1. The Super-Simple Frequency Counter is built around three IC's—an MM5369EST/N 17-stage oscillator/divider (U1), an MC14518B dual synchronous up-counter (U2), and an MC14538BCP dual precision monostable multivibrator (U4)—and a Red Lion Sub Cub 1, counter module (MOD1).

onto the foil side of a PC board, where the connectors contact the PC-board foil.

In any frequency-measuring application, an accurate standard or time base must be provided for a measurement comparison. The time base used in the Super-Simple Frequency Counter is provided by a quartz crystal and an MM5369EST/N 17-stage oscillator/divider. (When collecting the parts for the project be sure to specify the MM5369-EST/N version, which has a 100-Hz output. The MM5369-AA/N version has 60-Hz output and will cause an incorrect frequency display.)

The MM5369EST/N contains an oscillator and a frequency-divider chain, which divides the oscillator signal to provide a square-wave reference signal. A 3.579-MHz crystal is used to stabilize the oscillator frequency. The oscillator's output is internally divided (by almost 35,800) to obtain a 100-Hz output. It is interesting to note that any error in oscillator frequency is also divided by the same factor resulting in an accurate time-base frequency. For example, even if the oscillator was 1 kHz off frequency, the time-base output

would be off by less than .03 Hz—making it possible to obtain oscillator accuracies to within tens of hertz or closer, resulting in a very accurate time base.

The 100-Hz time-base signal is applied to the input of U2, an MC14518B dual synchronous up-counter. Each counter in that IC package is configured to divide by ten. Dividing the 100-Hz signal by 10, produces a 10-pulse-per-second time base; further division of the signal (by the second counter in U2) produces a 1-pulse-per-second time base. Those gate times are selectable via the GATE TIME switch, S1.

The selected gate time is fed to U4, an MC14538BCP dual precision monostable multivibrator, each monostable being governed by the RC networks, consisting of R6/C6 and R7/C7, connected to pins 2 and 14, respectively. The values specified for those components have been chosen to provide output pulses that are short in time with respect to the time-base pulses applied to the input of the one-shots. The outputs of U4 are applied to the L and R inputs of MOD1, as a timing gate.

The gate opens at the beginning of the time-base period, allowing MOD1

to accumulate the input pulses. At the end of the timing period, the gate closes, MOD1 then latches, resets, and displays the accumulated pulses. The counter module, MOD1, requires a backplane oscillator to function. The backplane oscillator is internal to MOD1 and requires only a single timing resistor (R8).

The signal to be read is first buffered by transistor Q1. The buffer stage is used to protect MOD1 from static charges and high-voltage input signals, and the moderate gain provided by the buffer increases input sensitivity. The buffer along with a pair of 1N4148 general-purpose diodes connected across the input are used to protect the MOS IC's from static discharge.

A visual indication of the measurement gate time is provided by LED1. When the gate LED blinks, it indicates that the frequency display has been updated. That's useful when measuring slowly changing frequencies. The GATE indicator (LED1) is driven by VMOS transistor, Q2, by connecting its gate directly to the time-base output. A VMOS transistor is a physical variation of the MOSFET die and is used due to its high

PARTS LIST FOR THE SUPER-SIMPLE FREQUENCY COUNTER

SEMICONDUCTORS

- U1—MM5369EST/N 17-stage oscillator/divider (100 Hz out)
 U2—MC14518BCP dual up-counter, integrated circuit
 U3—78L05 low-power 5-volt regulator, integrated circuit
 U4—MC14538 BCP dual precision monostable multivibrator, integrated circuit
 MOD1—Red Lion Sub Cub I, counter module
 Q1—MPS5172 NPN silicon transistor
 Q2—BS170 N-channel VMOS transistor
 D1, D2—1N4148 general-purpose, small-signal, silicon diode
 LED1—Jumbo red light-emitting diode

RESISTORS

- (All resistors are 1/4-watt, 5% units.)
 R1—10-megohm
 R2—180-ohm
 R3, R6, R7—10,000-ohm
 R4—220,000-ohm
 R5—3900-ohm
 R8—2.4-megohm

CAPACITORS

- C1, C8—0.1- μ F, ceramic-disc
 C2, C6, C7—0.001- μ F, ceramic-disc
 C3—27-pF, NPO, ceramic-disc
 C4—2–20-pF, trimmer
 C5—0.39- μ F, ceramic-disc

ADDITIONAL PARTS AND MATERIALS

- S1, S2—Single-pole, double-throw, toggle switch
 Printed-circuit materials, enclosure, phone jack and mating plug, battery(s), battery holder and connector, wire, solder, hardware, etc.

Note: The following parts for the Super-Simple Frequency Counter are available from SHF Microwave Components (7102 West 500 South, Laporte, IN 46350): etched, predrilled printed-circuit board (part FC-PCB) for \$7.50; a kit of parts, including printed-circuit board and all parts (except enclosure, battery holder, power switch, phone jack and plug) for \$43.50. All prices include shipping within the continental U.S. Indiana residents must include appropriate sales tax.

input resistance coupled with its ability to sink high output currents.

Power for the circuit is provided by feeding a 9-volt battery source through U3, an MC78L05 3-terminal 5-volt regulator, to provide a regulated +5-volt DC power source. If power consumption is a factor in your application, LED1

along with R2 and Q2, may be omitted, thereby reducing current consumption to less than 5 mA.

Assembly. The author's printed-circuit pattern for the Super-Simple Frequency Counter is shown in Fig. 2. As mentioned earlier, there are two versions of the counter module. The pattern in Fig. 2 is designed for the Sub Cub I module. For those etching their own printed-circuit boards, 1/16-inch thick printed-circuit board material recommended. If you choose not to etch your own board, one may be purchased from the supplier listed in the Parts List.

For those making their own printed-circuit board, when drilling the mounting holes for the counter module, be sure to use the correct size drill bits. The polarizing hole requires a number 42 (.093 inch) or 3/32-inch drill bit. The two mounting holes require a number 31 drill size (.120 inch). Use of a 1/8-inch (.125) drill bit may make the hole too large and the counter will not stay put after being snapped in place.

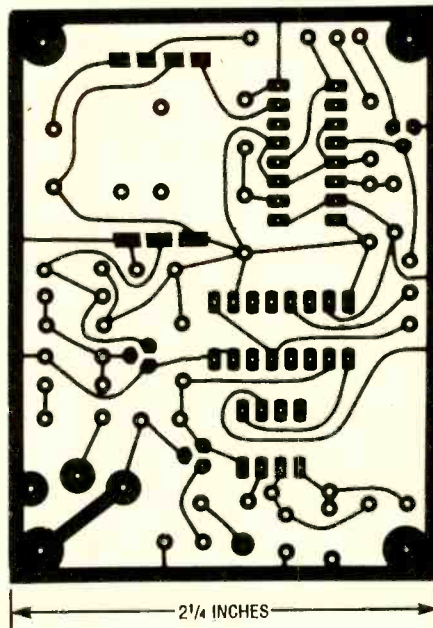

Fig. 2. The author's prototype of the counter was built on a small printed-circuit board, the template for which is shown here.

Once you've obtained the parts and the printed-circuit board, construction can begin. Start by installing the two jumper connections (as shown in Fig. 3), followed by the passive components (resistors and capacitors), followed by the semiconductors. IC sockets are recommended for all of the IC's.

Note that counter module MOD1 and LED1 (which are shown with dashed lines) are not mounted to the component side of the board. MOD1 is snapped into position, with its elastomeric connectors making electrical contact to the pads on the foil side of the board.

It is a good idea to observe the necessary precautions regarding static discharge when installing the IC's, including the counter module. The VMOS transistor, Q2, is also a static-sensitive component. Static stations with wrist straps and earth grounds are usually the exception rather than the rule in most home workshops. A method that has been successfully and effectively used is to mount static-sensitive components last with the board on a sheet of aluminum foil. Place the PC board, soldering station, tools, and the components on the foil before removing the components from their conductive foam or tube packaging.

Then while resting at least some part of your hand or arm on the foil, the components may be picked up and removed from their protective packaging and placed on the foil with their leads contacting the conductive surface. The board may then be handled and the components installed. If you have a soldering station that has a grounding point, it too may be attached to the foil with a clip lead. If you have a soldering iron in a stand, simply place it in a convenient spot on the foil before starting assembly.

The author used a miniature phone jack for J1, but any suitable jack can be used. The jack can be of the printed-circuit or panel-mounted type, depending on your application. An extra pad (marked with an asterisk) is provided for terminals of the printed-circuit type.

If the jack is to be remotely located, use a short piece of miniature coaxial cable to connect J1 to the printed-circuit board. The coaxial cable shielding is soldered to the grounded lug of the phone jack. A convenient length of similar coaxial cable is used to make the test lead, using a mating phono plug. A couple of alligator clips or miniature hook connectors can then be attached to the other end of the coaxial test lead.

The circuit can be housed in any type of enclosure of your own choosing. The author's unit was housed in a metal enclosure, measuring 3 by 5 1/8 by 5 1/4 inches. Prepare the enclosure by mak-

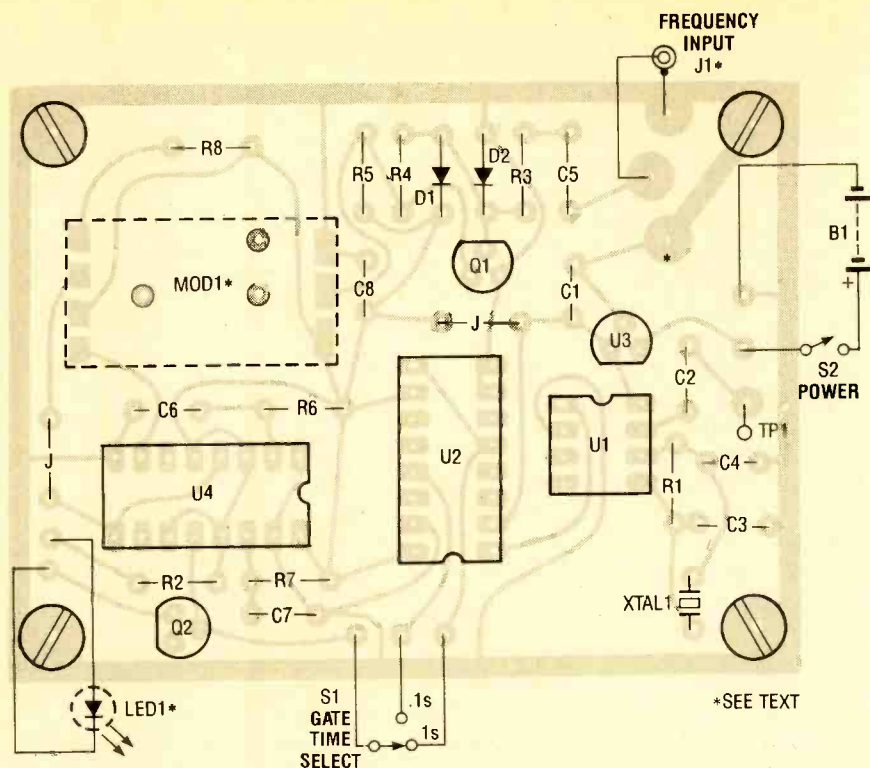
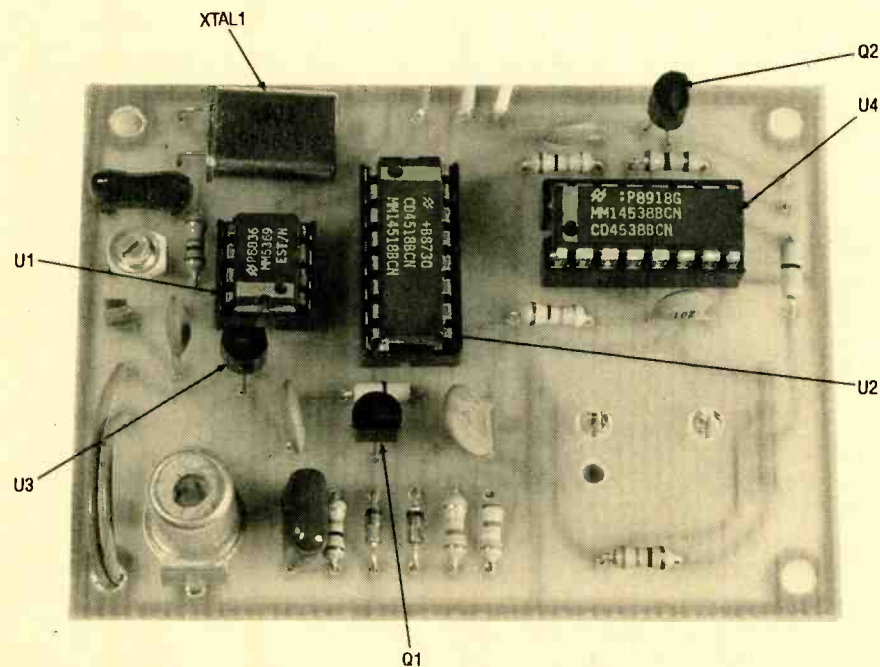

Fig. 3. Here is a parts-placement diagram corresponding to the foil pattern shown in Fig. 2. Mounting the components to the board is straightforward, but be aware that LED1 and the counter module (which are indicated by the dashed lines) are mounted on the foil side of the board.

ing a cutout in the front panel for the display, and drilling 4 holes for the input jack, the two switches, and the LED indicator. Labels can then be added to the front panel.

When the assembly is complete, apply power to the counter. The GATE indicator (LED1) should blink in step with the time base selected (rapidly for the 0.1-second time base, and more slowly



Note that the counter module (MOD1) and LED are conspicuously absent from the component side of the board; those components are mounted to the foil side. The counter module is simply snapped into position, with electrical contact being made through its elastomeric connectors. The LED, on the other hand, is simply tack-soldered to the foil side of the board.

for the 1-second time base). The counter circuit should draw no more than about 25 mA when the gate LED is illuminated (assuming that you've included it in your circuit). The gate-time switch is used to select the amount of time the counter accumulates input pulses to be counted and displayed. With the switch in the 1-second position, the counter will have the highest accuracy and display the frequency measured to the nearest cycle. With the switch in the 0.1-second position, the counter will display the frequency measured to the nearest ten cycles. The one tenth position will also provide the fastest measurement update, which is useful when measuring a rapidly changing frequency.

Calibration. There are several methods that will produce varying degrees of accuracy when calibrating the reference oscillator. The first and best method is to use a frequency counter of known accuracy. Connect the counter input to the oscillator test point (TP1). The trimmer capacitor, C4, is then adjusted for exactly 3,579,545 Hz at TP1. If a counter is not available, the 60-Hz line frequency may be used to check the counter's operation. A small power transformer with a 5- to 10-volt secondary is used to obtain the 60-Hz line frequency sample. Connect the transformer secondary to the counter input J1. Set the oscillator trimmer to the center of its range.

With a one second gate time, the counter display should indicate 60 Hz. Accurate calibration of the counter is not possible using a relatively low-frequency such as 60 Hz. It is possible to verify that the counter is operating correctly and that the displayed frequency is reasonably close. An alternate calibration method would be to use an accurate shortwave or ham receiver that tunes the 80 meter (3.5 MHz) band.

The receiver should have a digital frequency readout. Set the receiver to receive 3.5795 MHz and turn the BFO on. The frequency counter's time-base oscillator may be heard in the receiver speaker as the oscillator trimmer, C4, is adjusted through its range. Set trimmer C4 for zero beat in the receiver's speaker.

It may be necessary to use a piece of wire as an antenna for the receiver. One end of the wire should be connected to the receiver antenna terminal and the other end placed near the

(Continued on page 104)

GIZMO

JANUARY 1991

VOLUME 8,
NUMBER 1

A CHRONICLE OF CONSUMER ELECTRONICS

Hi-8 Hi-lights and (3-lux) Lowlights

NIKON VN-960 ACTION-8 CAMCORDER. Manufactured by Nikon Inc., 623 Stewart Avenue, Garden City, NY 11530. Price: \$1800.

Virtually everyone we know who owns a camcorder is a proud parent. Being childless, the camcorder craze has, to some extent, passed our personal lives by. We here at GIZMO usually find ourselves on the viewing end of our more-prolific friends' home videos of their offspring—including one enthusiastic set of first-time parents whose child's video history began *in utero*, with a sonogram! We recently found ourselves on the videomaker's end when Nikon's loan of their Action-8 VN-960, with a tempting array of professional features, coincided with a family wedding and a vacation, probably the two next-most-popular home-video subjects.

Up to now, we haven't been too keen on becoming videomakers except while on active GIZMO duty. Using a camcorder always seemed to us to be an intrusion, a hindrance to having fun at the event being recorded. Besides the need to lug around bulky equipment and accessories, we didn't want to join the ranks of amateurs producing dull, poor-quality home videos—or spend weeks honing our videotaping skills to produce more sophisticated results. We've never succumbed to the desire to "pay back" our family-oriented friends by making them watch footage of our vacations—or even to the promise of big bucks for submitting to national television videotaped evidence of our occasional feats of clumsiness.

The 8mm VN-960 provided us with some motivation for using a camcorder. With its small size and combination of professional and automatic features, it holds a lot of appeal for gadget-loving, but decidedly amateur videographers—and for experienced cameramen as well. At the top of its list of attributes is the high-



CIRCLE 66 ON FREE INFORMATION CARD

quality video provided by the camcorder's Hi-8 format, which is complemented by hi-fi stereo sound. The picture quality can be maintained in a wide variety of situations, thanks to such features as variable shutter speeds (up to one ten-thousandth of a second), an 8× power zoom lens with macro closeup, and 3-lux low-light sensitivity—all of which can be set on manual or automatic modes. Add to those an S-video output, an array of editing features, animation, and titling, and you can accommodate most filmmaking styles. Setting everything on automatic, almost no preparatory study is necessary to produce a watchable tape. Of course, the more you put into the VN-960, the more you'll get out of it. And, with a hefty 128-page user's manual, it's easy to put a lot of time and energy into it.

The feel of the camcorder is quite comfortable. Naked (without a battery or cassette), it weighs 2 pounds 10 ounces. That's light enough not to wear out your

arm, yet heavy enough to allow for jitter-free shooting and panning.

The full-automatic mode is an excellent way to get acquainted with the feel and the basic operation of the camera, and results in excellent high-resolution images as you learn the position of the dozens of controls, switches, and buttons. (We counted 48. Fortunately, some of the lesser-used controls are hidden behind doors.)

Because it performs its job so well, we're sure that many users will be content to stay in automatic mode. Of course, if we felt that way, we wouldn't be working at GIZMO. But we have to admit that it was a real challenge trying to use every feature packed into the Action-8.

To ease a user into making the most of the camera, several semi-automatic modes add shooting flexibility without adding complexity. For example, in the "Sports" mode, the shutter speed is automatically set to the fastest speed that the lighting will allow, which results in the ability to cap-

(Continued on page 6)

TURN PAGE FOR CONTENTS

This month in **GIZMO**

Nikon VN-960 Action-8 Camcorder	pg. 1
Seiko Instruments Smart Label Printer	pg. 2
Moss Music Group Ultimate Test CD	pg. 3
Sharp SA-R56A Audio/Video Stereo Receiver	pg. 4
Videonics Video Equalizer	pg. 5
AudioSource Amp One Amplifier	pg. 6
Audio Cassette Deck	pg. 8
Personal Stereo	pg. 8
Stay-Cool Toaster	pg. 8
Trapshooter Radar Detector	pg. 8
CD-Player Stand	pg. 9
Radio-Controlled-Toy Batteries	pg. 9
Smart TV	pg. 9
Video Light	pg. 9
Car Stereo with CD-Changer Control	pg. 10
Compact-Camcorder Lens Set	pg. 10
Laptop Computer	pg. 10
Video Walkman TV/VCR	pg. 10
Easy-Read Telephone	pg. 11
Laser-Video Player	pg. 11
Multi-Room-Remote A/V Receiver	pg. 11
Sing-Along Machine	pg. 11
Carousel CD Changer	pg. 12
Dual-Battery Camcorder	pg. 12
Mini-Transportable Cellular Phone	pg. 12
Ultra-Light Personal Tape Player	pg. 12

Gizmo is published by Gernsback Publications, Inc., 500-B Bi-County Blvd., Farmingdale, NY 11735. Senior Writers: Chris F. O'Brian, Teri Scaduto. Contributors to this issue: Alicia Dunn, Jim Zampino, Carolyn Kerwin. ©Copyright 1990 by Gernsback Publications. Gizmo is a registered trademark. All rights reserved.

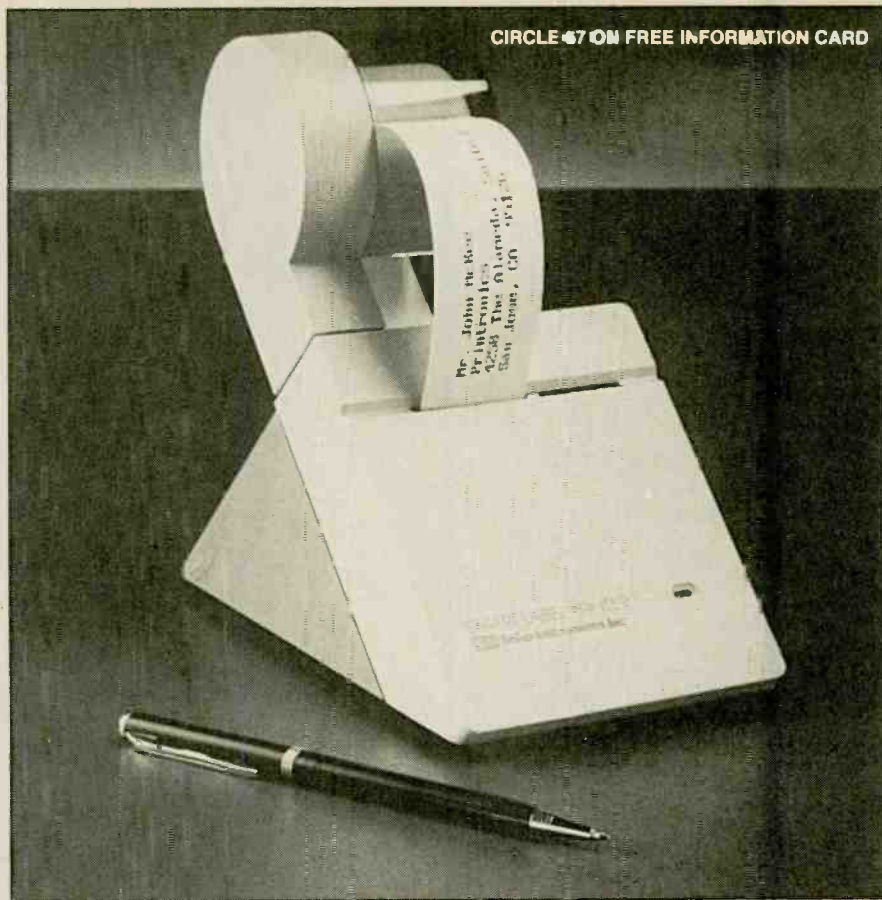

Send this Printer Back to School!

SEIKO INSTRUMENTS SMART LABEL PRINTER. Manufactured by Seiko Instruments USA, Inc., PC Products Division 1144 Ringwood Court, San Jose, CA 95131. Price: \$249.95.

Do you remember the typewriter? Before computers came along, it was the instrument of choice for preparing letters, reports, proposals, and the like. It had no provision for storing files or for moving paragraphs. It couldn't do a simple search-and-replace or any of the other functions to which we've become so accustomed since the computer came along. The problem is that we were so overwhelmed by the power that the computer gave us that we were willing to overlook some of its failings. Case in point: Computers are great at printing out letters. However, they don't do so well finishing up the job—that is, printing the envelope.

We at GIZMO usually use a dot-matrix, near-letter-quality printer for most of our work, including correspondence. We don't enjoy writing letters, however, because after printing the letter itself, we have to remove the tractor-fed paper, put

our printer in its friction-feed mode, insert an envelope and try to get it straight, and then capture our return address and inside address, change the formatting to fit our envelope, and then hope that we can get it all printed before the bottom of the envelope passes our printer's paper-out sensor.

It sounds like a lot of work, and it is. Needless to say, we usually don't get it right on the first try. We've tried pre-printing sheets of return-address labels so that all we had to worry about was the easier job of printing in the middle of the envelope. We've also tried using labels instead of printing directly on the envelope and, assuming we could line up the printhead in the right place, they worked alright. But that still involved changing the paper and taking pains to get everything lined up correctly—usually more than once. It got so bad that we even considered purchasing a typewriter!

We generally don't talk about our problems here at GIZMO unless we have a potential solution at hand. And we thought we had found one in Seiko's Smart Label Printer. As of now, we're still not sure. But we'll get to that in time.

As the name implies, the Smart Label Printer prints nothing but labels. It's a stand-alone unit available for IBM PC's, compatibles (on which we tested it), and Apple Macintosh computers. The idea is

(Continued on page 7)

Not-So-Easy Listening

MOSS MUSIC GROUP ULTIMATE TEST CD. Distributed by The Moss Music Group, 75 Essex Street, Hackensack, NJ 07601. Price: \$8.99.

How good is your CD player? How about your amplifier, speakers, and cassette deck? Do you put more faith in your ears or in the specifications printed in the owner's manuals for your audio equipment?

Here at **GIZMO**, we tend to trust our ears. Although we've been known to bring out the test equipment on occasion, we try to report only on our subjective tests. We feel that those are the only tests that really count.

Unfortunately, if you're in the market for a new receiver, speakers, or other audio equipment, you can't always rely on subjective tests. Unless the audio store in which you shop has a good listening room—and lets you use it without trying to steer you into buying equipment you don't necessarily want or can afford—you might as well just read the specification sheets and look at the price tags. Even worse, you could simply take the salesman's word on the best bargain. (In some of the less-than-reputable stores we've visited, the best bargains always seemed to match the items with the highest profit margins.)

Another problem for many audio buyers moving up to new gear is that they don't trust their own ears. After all, although some equipment has benefits that can be heard by almost anyone (take, for example, the difference between LP's and CD's) other benefits can be heard only by experienced ears. If you're not constantly exposed to new equipment, how can you train your ears to recognize real improvements?

The problem with subjective tests is that everybody hears things differently. A buyer who likes dance music might give rave reviews to an amplifier that provides a very boomy bass response. A classical-music lover might be more inclined to notice deficiencies at the high end. Neither listener, however, would necessarily be rating the amplifier on its ability to reproduce sound accurately and equally over the audio spectrum. Fortunately, there's now a way to infuse your subjective tests with a shot of objectivity.

The *Ultimate Test CD* from Moss Music Group just might be the first audio accessory that you should buy *before* you purchase an audio system. It provides tones, noise, silence, and more to allow you to judge the performance of your amplifier, speakers, cassette player, CD player, and even your ears. For example, a number of sine waves of different frequen-



cies are provided. The first track is a 1-kHz sine wave at a level of 0 dB. It's ideal for setting a tape deck's recording level. Other frequencies (at the more listenable level of -10 dB) are 20-60 Hz in 10-Hz steps, 100 Hz, 125 Hz, 250 Hz, 400 Hz, 800 Hz, 1 kHz, 1250 Hz, 2500 Hz, 3150 Hz, and 4000 to 20,000 Hz in 1-kHz steps.

So what can you do with all of those tones (besides driving audio-sensitive household members up the wall with its assortment of annoying hums, shrills, and squeals)? First, you can find out if your audio system can really produce the edges of the audio spectrum, namely 20 Hz and 20 kHz. Of course, you shouldn't do this test alone. If you can't hear either frequency, you can't be sure whether your system can't produce it or if you simply cannot hear it. Most men, for example, lose the ability to hear very high frequencies in their 20's, while women retain that ability much longer.

You can also test whether the tones you can hear can be recorded by your tape deck. The 3150-Hz track is particularly well suited to allow you to judge speed deviations in your cassette player. Since all tones are recorded at the same -10-dB level, you can test whether the response of your system is flat over the audio range.

Musicians will appreciate the 440-Hz tone—an "A" note, which comes in handy for tuning instruments.

Following the discrete tones is a sweep on each channel from 20 Hz to 20 kHz, which can give a quick check of your system's performance. A slower sweep (40 as opposed to 11 seconds) lets you find any resonances in the room as well as judging the frequency response of your system.

Two tracks of Pink noise—one with both channels in-phase and the second with the right and left channels 180° out-

of-phase—let you verify whether your speakers are properly connected. The test is repeated with in-phase and out-of-phase tones of 200 Hz.

Separate tones of 10 kHz for each channel let you judge the channel separation of your equipment. Good channel separation is essential for good stereo reproduction.

A drum solo is provided in stereo and mono modes. The mono solo is suggested to be a good way to find the right listening position. You should hear both speakers equally well from your preferred listening position, or you can find the correct position by moving until both speakers appear equally loud. We're not sure why this is supposed to be better than listening to tones or any random music. But we did enjoy listening to the solo.

Two tracks of SMPTE synchronization code for various standards are provided. SMPTE code, developed by the Society of Motion Picture and Television Engineers, is used to synchronize various equipment. Each of the two tracks provides two standards: 25 (EBU or European Broadcast Union and Australia) and 24 (International film standard), and 30 (American standard for black-and-white video) and 29 (American standard for color video) frames per second.

After listening to all of the tones, sweeps, codes, and such, you'll probably be more than ready for track number 48: one minute of silence. By comparing that track to the sound produced when your CD player is turned off, you can be sure that your CD player is not adding any noise to your audio system.

Assuming that your equipment passes all of the audio tests, you're ready to check the performance of your CD player's index and track functions. The index test deter-

(Continued on page 7)

Viva la Revolution!

SHARP SA-R56AV AUDIO/VIDEO STEREO RECEIVER. Manufactured by Sharp Electronics Corporation, Sharp Plaza, Mahwah, NJ 07430-2135. Price: \$389.95.

We in the consumer-electronics press have been writing about the audio/video revolution since about 1982. You know, how audio is becoming a more important part of the enjoyment of video. What, you mean you haven't noticed what we've been talking about all of this time?

Well, unless you're in that very small minority that runs out to buy the latest high-end equipment as soon as it's introduced, we're not surprised. Although we in the press have been calling it a "revolution," equipment manufacturers have been slow to catch on to the fact that you can't have a true revolution without involving the "common man"—that is, the middle-of-the-road audio consumer. The reason for their sluggishness is puzzling. After all, 21 percent of U.S. households have color TV's with MTS capability. That's only one percent behind the penetration of CD players, the most talked about new audio product in decades. Yet A/V receivers are relatively rare items in home-entertainment systems.

Although the *Sharp SA-R56AV* is certainly not the first mid-priced stereo receiver with special provisions for use in a combined audio/video system, it could go a long way toward furthering the "revolution."

What makes an audio/video receiver different from a standard stereo receiver? Nothing too dramatic. Basically, an A/V receiver has a couple of features that make it a little easier to integrate the receiver into your video system. For example, the SA-R56AV has audio inputs not just for a turntable, tape deck, and CD player, but also for hooking up a TV and a VCR. Video input/output terminals let you use the receiver as a video switch box.

First and foremost, of course, the SA-R56AV is an AM/FM stereo receiver. It features an output power rating of 55 watts per channel (into 8 ohms), and a frequency response from 20 Hz to 20 kHz with no more than 0.08% total harmonic distortion. A 5-band graphic equalizer lets you tailor the sound to match your listening environment.

Sharp's "Extra Bass System," or "X-BASS," boosts the bass frequencies. It does so with a touch of a button, but why that's preferable to using the graphic equalizer, we don't know—except that you can turn on X-BASS using the remote, while you can't adjust the graphic equalizer that way. We also don't understand

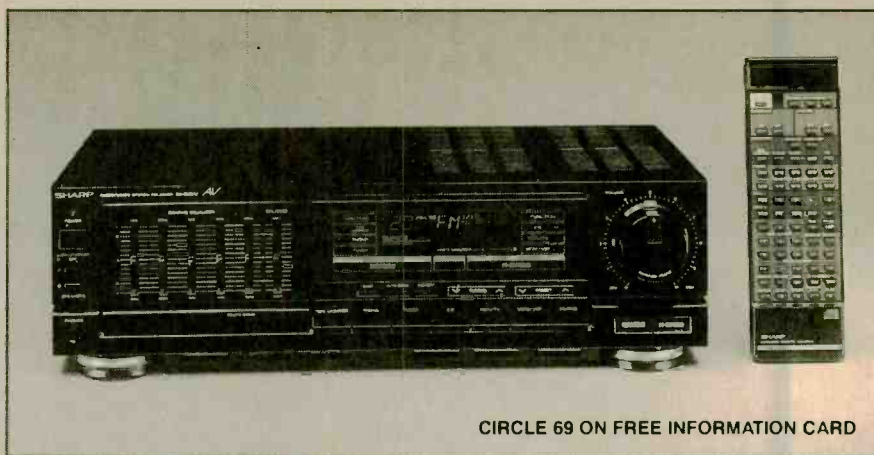

CIRCLE 69 ON FREE INFORMATION CARD

why the inclusion of X-BASS precludes a loudness switch, which would boost the treble as well as the bass so that low-volume listening sounds fuller. But then, as a car passes by three blocks away, booming out the latest top-40 hit, we realize that X-BASS must be what sells.

The tuner section of the receiver features a digital frequency synthesizer, 20 FM presets, and 10 AM presets. We assume that it's because of the large number of presets that the remote control doesn't have any channel-scanning provision for the tuner, even though the receiver itself does feature an "Auto Scan" mode that searches for the next station, passing over blank frequencies and inter-station noise.

The tuner's AM section, with a frequency range from 530 to 1720 kHz, is ready for the expansion of the AM band. Sharp seems to have paid some attention to the usually neglected AM tuner. Its sound is a pleasant surprise.

What really makes the SA-R56AV stand out from the other receivers, however, is the flexibility it offers for connection to your video system. Two video inputs and one output are provided on the rear panel for A/V hookups (a separate monitor output is also provided). One set of jacks, labeled VCR1/TV accepts video and stereo audio inputs and offers the same outputs. A second set, labeled VCR2/VDP offers video and stereo audio inputs only. The manual, as seems to be the unfortunate norm with consumer-electronics equipment, does a pretty poor job of describing the various options available and the benefits or disadvantages of each.

Through experimentation, we found that the most flexible arrangement was to hook a VCR to the VCR1/TV jacks, and use that as the tuner and audio source. The monitor is used only as a display device and is hooked to the Monitor Out jack. A second video source (camcorder, laserdisc player, etc.) can be hooked to the VCR2/VDP jacks.

The only disadvantage to that setup is that you must use your VCR's tuner instead of your TV's. However, it does let you use the audio system to enhance your

viewing experience—including the use of the receiver's "surround" mode. Notice we didn't say "Dolby Surround." The surround mode offered by Sharp is a matrix surround that doesn't take advantage of all that the Dolby system has to offer. The matrix surround feeds the difference between the left- and right-channel signals to the rear speakers, which results in a fuller sound, and an apparent increase in the ambience or spaciousness of the sound. For stereo signals, the effect is pleasing.

Dubbing between video sources becomes easy with the SA-R56AV. The VCR2 input must always be used as the source, and VCR1 is the recorder. Your video monitor can be used to view the signals being recorded.

A pair of system control jacks are provided to allow the remote control to be used with compatible Sharp equipment, and the handheld remote has provision to control a Sharp tape deck and CD player. While we like the idea of using a single remote to control an audio system, that setup does have one disadvantage, namely that if you don't have other Sharp equipment, you're stuck with a remote control with a lot of buttons that you'll never use. Out of the 65 buttons on the control, you'll use only 25 for tuner operation.

Even though we don't like the way that Sharp handled some of the user-convenience features, we are happy to see that they have given some thought to that area. For example, while we don't like the overbuttoned remote control, we do like their "Motorized Volume." On the receiver, a standard round volume control is used instead of the usual up- and down-volume buttons. And while we don't like the absence of scanning controls on the remote control, we do like the 30-channel memory, and the ability to directly access any of those channels with either one or two presses of a button. In the end, we don't think Sharp has built the perfect receiver—perhaps no one ever will. But at least Sharp is trying, and in doing so has succeeded in producing an A/V receiver that brings the audio/video revolution closer to the average consumer. ■

Move Over, Ted Turner!

VIDEONICS VIDEO EQUALIZER. Manufactured by Videonics, 1370 Dell Avenue, Campbell, CA 95008 Price: \$299.

By the time you read this, the football season will be nearing its conclusion. As we write this, however, the season is still in its early stages. Nevertheless, being very partisan N.Y. Giant fans, we've seen enough to get pretty cocky about their prospects for this season.

The only problem that the Giants seem to have this year is that, in some people's minds, they're boring. Their ball-control offense typically nets them a 40-minute time of possession per game, as they run play after play in their relentless—but slow—progression down the field.

OK, we'll admit it. It *can* be boring. That's how we came to find ourselves one Sunday wondering aloud what football would be like if they played on an orange field.

We didn't have to use our imaginations to find out. We simply hooked up the *Videonics Video Equalizer*, put its "Digital Paintbrush" into action, and adjusted its "Colorizer" controls until we had an orange field. Was the game any different? No. The Giants still won.

Your home videos, however, can be significantly improved using the Equalizer's other, more practical, features. Many home videos suffer from poor color and off-kilter white balance. Even well-edited videos must face the reality that, after repeated copying, any video tends to show the strain by developing annoying video noise.

Fortunately, the ability to change colors of some objects on the picture while leav-

ing other objects unaffected is only one of the interesting features of the Video Equalizer. (And it's probably why Videonics called it an "Equalizer." Just like its audio counterpart, it lets you change a certain band of frequencies while leaving others unaffected. But we'll get to that later.) Other noteworthy features of the equalizer include audio-mixing capabilities, video enhancement, color and tint correction, and such special effects as solarization and the ability to produce the negative of the input image.

The feature that we think would get the most use is the enhancer. "Enhancer" is actually a misnomer, because its job isn't really to make a picture look better. Instead, it keeps an image from looking worse—as it usually does after you copy it from one tape to another. If you start with a good image, the enhancer won't make it look better, because there are no problems to correct. If used improperly, however, it can make an image look worse.

The enhancer function uses two of the twelve slide controls or pots on the unit's sloped front panel. One adjusts the sharpness of the image and the other varies the effects of video noise. The sharpness control boosts the effects at the boundaries where different colors meet to sharpen the edges of objects. If you go too far, you end up with very harsh edges. If you go even further, you can end up with a white outline around everything.

The other half of the enhancer is the video-noise control, which can remove some of the snow that shows up mostly in darkly colored areas. It does so by "smoothing out" the variations in the video. As with the sharpness control, you can go too far and remove some of the detail as well. The general rule for using this (or any other) enhancer is to leave a good picture alone. Enhance an image only if it shows signs of degradation.

The equalizer's video-processor section gives you control over the contrast, brightness, and overall color and tint of the picture. It can be used, for example, to fade the picture to black for smoother scene changes when you're editing tapes. Because of the digital nature of the equalizer, fades, if done slowly, will not be smooth. Rather you'll see a stair-step effect. Fast fades hide that effect and appear to be smooth.

The color and tint controls operate just like their counterparts on TV's and monitors, but they give greater control by letting you make finer adjustments. They can boost the colors of dull videotapes, or reduce the color to eliminate blooming and to make noise less noticeable.

The Colorizer section is the one that we had a lot of fun with, and it's the one that's open to the most abuse—such as turning football fields orange. Three slide controls, for adjusting the red, green, and blue colors that make up a TV picture, work by themselves or in concert with the "Digital Paintbrush" to create some interesting effects.

With the digital paintbrush off, the colorizer controls affect the entire picture. For example, pushing the Blue control up adds blue over the entire scene.

The controls work independently of the color and tint controls of the video-processor section. For example, if the color control is reduced to the point where the picture is black and white, the colorizer controls can add overall color to the black-and-white image. For example, to get an "old time" look, you could add a little red and green for a sepia tone.

If you don't want to change the color of the entire scene, you can use the digital paintbrush to select only those colors that you do want to change. On-screen crosshairs are adjusted with horizontal and vertical position controls. When the crosshairs are on the color you want to change, you adjust the "Size" control. The crosshairs will disappear, and the color that you chose will start to flash. The Size control varies the range of colors that will be affected. For example, if you put the crosshairs over a bright red car, you could change the color of just that car with a "narrow" paintbrush. But as you turned the control clockwise, more of the scene would start to flash—perhaps even some of the pinker faces. Once you choose the range of colors to be adjusted, you can use the colorizer controls to change those colors while leaving the rest of the scene untouched. The important thing to remember is that the crosshairs let you pick colors, not objects, to be changed. For example, if the driver of the red car were wearing a red shirt, its color would be changed along with the car.

As with the other controls, it's easy to overuse the colorizer. For subtle color
(Continued on page 6)

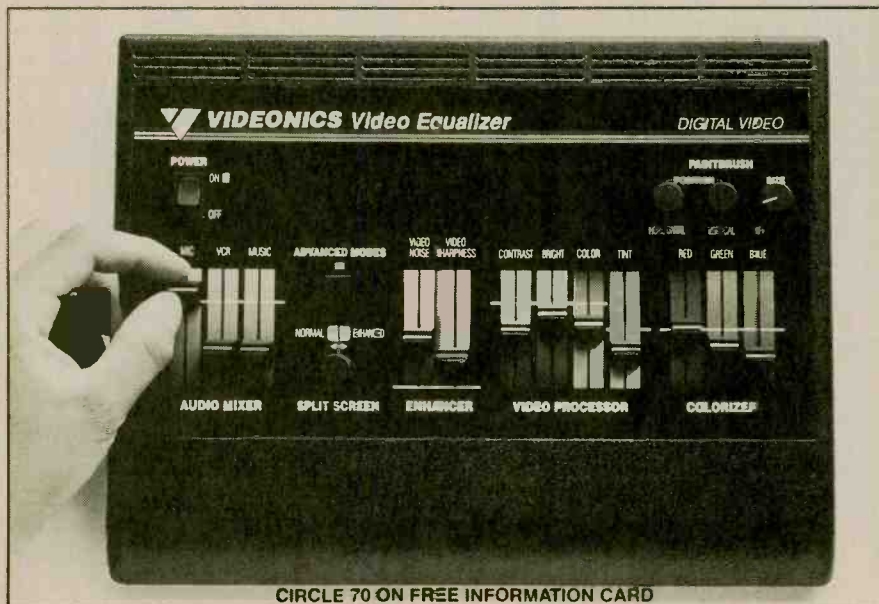

CIRCLE 71 ON FREE INFORMATION CARD

TED TURNER

(Continued from page 5)

changes and for correcting the white balance of scenes, it can do a great job. Used too heavily, it can look quite silly. Of course, if you're facing a stultifying evening of sitcom reruns, silly could be a major improvement ("All" looks much better as a negative image.)

Advanced modes include solarization, which harshens the changes of the picture's middle tones for some interesting effects; the ability to turn the picture into a color negative; and, for those of you who are offended by Ted Turner's colorization of classic black-and-white films, the ability to take all color out of the picture at the touch of a button. Audio-mixing controls let you mix audio from a microphone and a line input along with the audio from the video input.

The equalizer is compatible with all tape formats, and accepts standard and S-video. It's a good way to liven up those vacation videos and to improve the quality of tape dubs. And playing around with colors is a good way to liven up some of the otherwise dull fare on TV. ■

HI-LIGHTS/LOWLIGHT

(Continued from page 1)

ture high-speed motion without blurring. If you recorded the swing of a baseball bat in the sports mode and played it back in the slow or still frame-by-frame mode, you would see a sharp, non-blurred picture for each frame. Since we don't swing a baseball bat with such impressive speed, we needed another way to get a handle on what a shutter speed as fast as 1/10,000 second could do in practical terms. We were most impressed when we played back some scenes shot out of a car moving at about 50 MPH. We were amazed to be able to see fence pickets and even blades of grass recorded clearly and without a blur.

A Shutter-Priority mode works using the same principle as the Sports mode, but—instead of automatically selecting the fastest shutter speed that the lighting will allow—you select the particular shutter speed. The aperture or iris opening is adjusted automatically for proper exposure.

The Aperture-Priority mode, as its name implies, gives priority to the setting of the aperture, while the shutter speed is automatically adjusted to maintain proper exposure. A wide aperture gives you a shallow depth of field so that the subject is in focus, but objects in front of and behind the subject are not. A narrow aperture has the opposite effect. That is, everything is in focus regardless of its distance.

While the effect of different apertures will be second nature to anyone with pho-

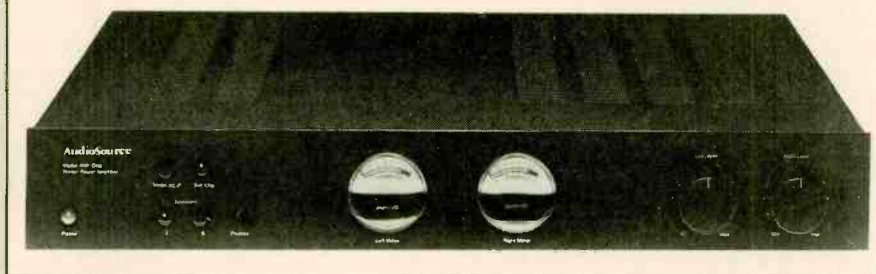

Life, Liberty, and the Pursuit of Accuracy

AUDIOSOURCE AMP ONE AUDIO POWER AMPLIFIER. Manufactured by AudioSource, 1327 North Carolan Avenue, Burlingame, CA 94010. Price: \$299.

One of the things we like best about preparing GIZMO is that we are constantly learning. Better still, we're occasionally pleasantly surprised by what we learn. Before we had the opportunity to listen to the AMP One, we were not at all familiar with AudioSource, a 15-year old manufacturer of audio equipment and accessories. Although they're a U.S.-based company—and one of the few consumer-electronics manufacturers left in this country—they do most of their manufacturing overseas in Japan and Taiwan. Oh well.

The first thing we noticed about the American-designed, Asian-built AMP One was its sleek, European-like design. The front panel, as you might expect from a power amplifier, has few controls. Yet, thanks to two large, analog, output-power meters and a separate level control for each channel, the basic-black face of the amplifier hardly looks sparse. AudioSource also manufactures a pre-amplifier and tuner whose styling and performance complement the AMP one.

What's inside the amplifier, of course, is more important than how it looks. A toroidal power transformer not only keeps the size (16½ × 2¾ × 11¾ inches) and weight (14½ pounds) of the amplifier down, but also allows for a high current transfer and inaudible hum and distortion. Perhaps, as a company brochure claims, the minimum magnetic field leakage of the transformer results in purer sound as well. Certainly, the basic specifications have something to do with it.

For those of you who are into the numbers, the AMP One has a frequency re-

sponse from 20 Hz to 20 kHz, ±0.5 dB, and a signal-to-noise ratio of 110 dB. The power output is rated at 60 watts per channel into 8 ohms. For a higher power output, the amp is bridgeable with a flick of a rear-panel switch. In the bridged mode, the AMP One becomes a monaural amplifier with an output that is rated conservatively at 170 watts.

Besides the bridging switch, the rear panel isn't too exciting. Two sets of binding posts are provided for hooking up the two pairs of speakers that the amplifier can support. The binding posts accept banana plugs, which are suggested as the connectors of choice because of their low contact resistance and their ability to handle high current. Two sets of input jacks, one for a pre-amp input and the other for direct connection of a CD player or other high-output device, are also provided. The input is not switchable.

A switch-selectable "Soft Clip" feature is designed to minimize possible distortion—or even speaker damage—that can be caused by the intense power demand when listening to high-level audio at high volume levels. Since we weren't able to get our hands on a schematic of the circuitry, we're not sure exactly how it works or whether it protects the output transistors from damage as well. In any case, since we value our ears as well as our speakers, we didn't test whether the soft-clipping circuitry performed as claimed. (After all, what if it didn't?)

Instead, we concentrated on how the AMP One sounds at normal listening levels. We firmly believe that a good amplifier should provide accurate sound reproduction, as opposed to some amplifiers that could be called "mellow" or "strident" because they colored the sound. An amplifier's job is to treat a performance of the *1812 Overture* the same way it treats a subtle violin passage, and to treat either the same way it treats rock and roll, and the AMP One did just that on a wide variety of musical test selections. Perhaps a fundamental American principle subtly affected its design, for the AMP One certainly treated all music as created equal. ■

tographic experience, it may be too much for the beginner to think about. That's probably why Nikon included a Portrait mode, which automatically sets the aperture to the widest opening that the lighting conditions will allow. That lets you, for example, remove a distracting background such as a busy street from a portrait shot.

In full manual mode, there are so many settings to worry about that, until you get the hang of things, it's easy to forget what you're trying to record as you adjust the gain, white balance, focus, shutter speed, and iris. Fortunately for those who get frustrated easily, a single switch will get you back in full automatic mode. Conversely, it's also easy to put everything or just one function back under manual control if the situation requires it.

If you're someone who likes to be both in front of and behind the video camera, you'll love the "Wireless Remote Commander" that lets you do both *at the same time!* The infrared remote control lets you start and stop recording, zoom the lens, and also control all playback functions. A wired remote control is also provided.

As anyone who's ever been forced to watch someone else's home videos can attest, shooting a video is only half the job. Even good camera work will require some editing. The Action-8 also provides special features that help during the editing process. First, the high quality of the Hi-8 recording system ensures that a second-generation dub is that much better. Second, indexing and counter-memory functions makes it easy to insert new scenes where you want them and to find specific scenes to transfer to other tapes.

A host of other features too numerous to discuss in detail include the ability to record the time and date and to remember custom configurations. An LCD on the side of the camera reports complete information on the camera's operation, and a headphone jack lets you monitor the sound during recording or playback. The camcorder also offers an electronic wind-noise filter, S-video inputs and outputs, a macro-focusing distance of less than one-half inch, and a one-button fader control that lets you fade a scene in or out for smoother scene changes. A battery charger/AC power supply is included with the camcorder, as is an RF modulator.

If we may say so ourselves, our home videos had a decidedly professional look to them. We found that the Action-8 VN-960 camcorder was not as obtrusive as we imagined it would be, nor was it as difficult to use in manual mode as we had originally feared. We enjoyed replaying vacation scenes, and various family members were impressed with the wedding footage—Grandma even cried again. While we might not make it to *America's Funniest Home Videos*, we're hoping for a new show called "America's Finest Home Videos." There, with an Action-8 in hand, perhaps we'd have a shot. ■

NOT-SO-EASY

(Continued from page 3)

mines whether your player can display and track index points from 1 to 99. The track test can be used to determine whether your CD player can read all possible tracks from a CD—up to 99.

Each of the 99 tracks on the disc is introduced with a spoken announcement, so you don't have to keep a list of the tracks handy. The booklet that comes with the disc is written with the beginner in mind, which is both good and bad. Although all audio jargon is explained, there is little thorough detail.

Although this isn't the first CD test disc we've seen, it is the first disc that is priced reasonably. With a retail price of under \$10, it's less expensive than most other CD's. And it's a small investment, especially when compared to the cost of buying the wrong speakers or component. We know that we will find it an invaluable addition to our testing gear.

Of course, even the professionals at audio magazines often come up with differing or inconclusive results using the same sort of test. But since you'll be the primary listener of the equipment under test, you're the one whose "objective opinion" counts. Happy listening! ■

SMART PRINTER

(Continued from page 2)

to make easy work out of printing mailing labels, video- and audio-cassette labels, disk labels, name tags, etc. Software that's included with the printer makes it easy to capture text from the application that you're running, edit it if you wish, and print it with the press of a key.

The Smart Label Printer doesn't look like any printer you've ever seen before. Basically, it's a wedge with a label-roll dispenser on top. Its gray-and-beige plastic matches our system perfectly. The footprint is small—roughly $3\frac{3}{4} \times 4\frac{1}{4}$ inches—so it's right at home on top of the computer itself. It's audibly unobtrusive as well; the thermal print process it uses is so quiet that you won't mind having it right in front of you.

Although there are two controls (a power switch and a form-feed button located on the rear of the printer) most user interaction is via the software that's supplied with the printer. The software is a TSR, or Terminate-and-Stay-Resident, program. That is, once run, it resides in memory, but stays in the background while you run other applications. You call it into action by pushing the user-selected "hot keys" on the keyboard. The software is well done with one exception, which we'll discuss shortly.

Solving one frustrating problem shouldn't create an even more difficult

one. For the most part, Seiko kept that philosophy in mind when designing the Smart Label Printer. The installation process could hardly be easier. We didn't even have to read the manual to hook it up—but we did anyway. We don't encourage hooking up equipment without reading the manual, especially when a company goes through the trouble that Seiko did to provide a useful, detailed manual.

The printer comes with an AC adapter, a roll of labels, and a cable to connect the printer to your serial port. On the printer side, a modular phone jack is used; the computer side has both 25-pin and 9-pin connectors to handle the two PC standard connectors used for serial ports. Hooking all those together is a rather simple procedure, and one that offers very little opportunity for error.

Loading the thermal labels into the printer is also easy. Once you feed the labels into the feed slot, the printer grabs hold and does the rest. When everything is hooked up and loaded, you're ready to install and run the software. A setup program lets you select the screen colors and the hot keys you'll use to call up the program. The printing software itself gives you a host of setup and operation options ranging from the serial port you want to use, to the number of copies you want of each label.

When you're ready to go, you simply press the hot keys and a box, called a "capture frame," pops up on the screen. If you choose, you can have the capture frame automatically pop up on the first or second address that it finds on the screen. Once it pops up, you can adjust the size of the capture box and edit its contents if you want. You can, with a couple of key presses, center the text or align it with either margin. When you're satisfied, a single key press will send the text to the printer, which will quietly and quickly spit the label out—at least that's what it's supposed to do.

Our Smart Label Printer started out smart. It printed any label we asked it to, even in bar-code form if we wanted, just like it's supposed to. We were quite impressed by its operation. Somewhere along the way, however, our printer lost its smarts. Even though we had labels installed correctly, we kept getting the message that the printer was out of labels! To make matters worse, the software wouldn't let us back out gracefully. It just kept insisting that we should do something about running out of labels. The only way out of the program was to re-boot the computer. Needless to say, the file we were working on when we called up the printer software was lost.

Because GIZMO deadlines can't wait, we can't report on what made our "smart" printer so stupid. We do hope to update this story next month. In the meantime, we're heading over to a local antique store and getting a typewriter. ■

ELECTRONICS WISH LIST

For more information on any product in this section, circle the appropriate number on the Free Information Card.



Sangean Personal Stereo



Technics Audio Cassette Deck



Cobra Trapshooter Radar Detector



Panasonic Stay-Cool Toaster

Digital Personal Stereo

Offering full-size features in a portable package, *Sangean America Inc.'s* (9060 Telstar Avenue, Suite 202, El Monte, CA 91731) *DT-200V* is dubbed a "pocket-sized digital entertainment center." The personal stereo features a digital readout, PLL-synthesized tuning, a built-in speaker, automatic and manual tuning, 19 presets, and automatic shutoff after 60 minutes. The radio receives AM and FM as well as TV audio from channels 2 through 13. It comes in a compact, rugged high-impact case with a removable belt clip, and adjustable stereo headphones are included. Price: \$79.95.

CIRCLE 72 ON FREE INFORMATION CARD

Top-of-the-Line Tape Deck

Technics (One Panasonic Way, Secaucus, NJ 07094) calls its flagship *RS-B965* "the finest cassette deck we've ever made." At its heart is a "double-motor, quartz-locked, direct-drive, closed-loop, dual-capstan transport system" that provides uniform tape speed and tension. To further protect against unwanted vibration, the *RS-B965* has a specially designed cassette stabilizer with a motorized door that locks the tape into place against six rear pads—which also reduces modulation noise and improves tape-to-head contact. The three-head system sets playback heads at a narrow gap for excellent high-frequency response, while the record head's wider gap ensures a wide dynamic range. To reduce electronic interference, the cassette deck's main circuits are isolated and shielded: a "Linear Magne-Field" circuit improves record-amplifier circuitry performance and linearity. Other sound-quality features include Dolby HX Pro, Dolby B, C, and dbx noise-reduction systems, low-distortion PXS capacitors, and a special non-resonant base with large insulating feet. Operating features include "Advanced Precise Record-Level System" that simplifies setting precise recording levels, a semi-automatic bias/record-level calibration feature, CD direct input, and a real-time electronic tape counter. Price: \$675.95.

CIRCLE 73 ON FREE INFORMATION CARD

Radar Detector

With sleek aerodynamic styling, rounded edges, and wrap-around alarm-lamp indicators, *Cobra Electronics Group's* (6500 West Cortland Street, Chicago, IL 60635) model *RD-23125* represents an update of the familiar wedge-shaped Trapshooter radar-detector design. It offers Cobra's exclusive anti-falsing circuitry as well as a five-segment signal-strength meter with amber and red LED's and a three-position dimmer switch. Other features include a test/mute switch with auto reset, and a highway/city mode selector. Price: \$159.95.

CIRCLE 74 ON FREE INFORMATION CARD

Stay-Cool Toaster

Updating an old kitchen standard, *Panasonic Company* (One Panasonic Way, Secaucus, NJ 07094) has introduced a toaster that stays cool to the touch. The heating elements in the *NT-136* are shielded with a reflective metal that keeps the heat inside. The toaster is topped by a plastic coating that doesn't get hot and it's as easy to use as it is safe. The user selects a shade of brown with the control dial, and a microchip monitors the toaster's interior temperature to produce the desired "toastedness" every time—even if the toaster starts off hot. Different thicknesses of toast can be accommodated, and a snap-out crumb tray allows easy cleaning. Just remember, though. Mom's warning not to stick anything metal in there without first unplugging it still holds! Price: \$49.95.

CIRCLE 75 ON FREE INFORMATION CARD

For more information on any product in this section, circle the appropriate number on the Free Information Card.

ELECTRONICS WISH LIST

Cordless Video Light

Cool-Lux Lighting Industries (5723 Auckland Avenue, North Hollywood, CA 91601-2207), which manufactured the video lights selected by NASA for the space shuttle (but shares none of the blame for its recent problems), has introduced the *Cordless/One-Piece Video Light*. The well-balanced, self-contained unit includes a lightweight, 6-VDC NiCd battery pack and a charger. Its 20-watt lamp produces 420-Lm at 3200 K with a running time of about 25 minutes. The video light also includes a tilt-head for bounce lighting, a heat-resistant safety-glass shield, and a hand-grip/camera-shoe mount. An AC adaptor cord is available as an option. Price: \$75.50.

CIRCLE 50 ON FREE INFORMATION CARD



Cordless Video Light

Radio-Controlled-Toy Batteries

Specialization has hit just about every aspect of modern life, and the battery industry is no exception. Gates Energy Products, Inc. (P.O. Box 23649, Gainesville, FL 32602) has introduced a battery pack that was specially developed for radio-controlled toys. According to Gates, their *Millennium Radio Controlled Vehicle Power Car Pack* boasts up to 25% longer run time for radio-controlled applications than standard battery packs. Two designs are available, to fit the two most popular RC vehicles. Each pack contains six matching CdS cells and provides 1500 mA per cell. Price: \$20-\$25.

CIRCLE 51 ON FREE INFORMATION CARD



Millennium RC-Toy Battery Pack

Smart TV

Four new color TV receivers from JVC (41 Slater Drive, Elmwood Park, NJ 07407) include features that the company refers to as "Artificial Intelligence." The first of the two special "AI" features keeps track of your favorite TV selections for you. By maintaining a record of your viewing habits, the set determines what the three most-frequently viewed (and presumably favorite) off-the-air or cable selections are in your household for both daytime (4:00 AM to 6:00 PM) and evening (6:00 PM to 4:00 AM) periods. Should you have trouble remembering your own favorites, the set will display them for you. The other "AI" feature automatically adjusts the volume of the sound to the time of day, based on data it has recorded about the way you listen to TV. When you turn the set on, it adjusts the level to that which you usually use at that time. Other features available on some "AI" models include one that allows you to store frequently viewed channel numbers according to category ("Network," "Movies," "News," etc.); when you select a category, freeze-frames from each channel in it are displayed to show you what's going on. Another interesting new function involves a "child timer," which automatically turns the set off at a specified time (unless it is overridden using a unique ID code). Price: Not yet announced.

CIRCLE 52 ON FREE INFORMATION CARD



Philips CD-Player Stand

Portable CD-Player Base

To get more use out of portable CD players, many people hook them up to their home stereo systems; some even use portables as full-time in-home components. Now those portable players can get to look as if they really do belong in the home, with the *SBC3545A01* CD player base from Philips Consumer Electronics Company (One Philips Drive, P.O. Box 14810, Knoxville, TN 37914-1810). The futuristic-looking, goose-necked unit not only provides a stylish, secure storage place for the CD player, but also offers three special connections that allow the player to be used with other audio equipment, headphones, or an AC power supply. Price: \$129.95.

CIRCLE 53 ON FREE INFORMATION CARD

ELECTRONICS WISH LIST

For more information on any product in this section, circle the appropriate number on the Free Information Card.



Arkon Tele/Wide Camcorder Lens Set

Compact Camcorder Lenses

If you have a mini-camcorder, outfitting it with large lenses can make it look and feel unbalanced. *Arkon Resources, Inc.* (11627 Clark Street, Suite 101, Arcadia, CA 91006) has addressed that problem with their *Arkon LV-002 Tele/Wide* video conversion lens set. The ultra-compact set complements the reduced size of the latest generation of mini-camcorders with 37mm mounts. The set includes a 0.5× wide-angle lens that measures only 1 × 1½ inches and weighs 3.8 ounces, and a 1.5× telephoto lens that measures 1 × 1¼ inches and weighs 3.5 ounces. No cumbersome ring adapter is required. The lenses are fully compatible with auto-focus operation, and come packaged in a protective leatherette storage case. Price: \$99.95.

CIRCLE 54 ON FREE INFORMATION CARD



Sony Video Walkman TV/VCR

Stereo Video Walkman

Video on-the-go has taken a step forward with the introduction by *Sony Corporation of America* (Sony Drive, Park Ridge, NJ 07565) of the *GV-300 Video Walkman TV/VCR*. It incorporates a multiplex tuner for stereo-broadcast reception and AFM Hi-Fi Stereo, which several major studios intend to use on their 8mm pre-recorded movies. The GV-300 provides two levels of bass response, a built-in speaker, and dual headset jacks. The Video Walkman's video performance has also been enhanced with improved LCD technology, color on-screen channel display, and station presets. A control "S" terminal has been added, allowing the GV-300 to be used with a remote editing controller as part of a home video-editing system. Audio/video input/output jacks and a camera connector are also provided. The set is only slightly larger than a paperback book, and weighs about 2½ pounds. Price: \$1,400.

CIRCLE 55 ON FREE INFORMATION CARD



Blaupunkt Car Stereo With CD-Changer Control

By the Time We Got to Woodstock

Three days of peace, love, and ... in-dash CD-changer controllers? *Blaupunkt* (2800 South 25th Avenue, Broadview, IL 60153) has dubbed an all-in-one pull-out AM/FM auto-reverse cassette-receiver, with CD-changer controller and display, the *Woodstock CM 20*. The unit eliminates the need for a separate CD-changer control panel, allowing users to easily switch up and down, from disc to disc or track to track. In addition, functions such as track and disc mix, cue, pause, play, track scan, disk scan, and cue can be activated from the front panel. The CM 20 is compatible with Blaupunkt's CDC 01 changer (\$629.95), which is meant to be mounted in the trunk. The Woodstock's cassette mechanism has Dolby B noise reduction, a patented tape guide and key-off pinch-roller release for long tape life, and cassette program search. The receiver offers 18 FM and six AM presets, plus six "TravelStore" presets. The radio monitor button lets users listen to the radio while the tape is rewinding. The built-in amplifier can drive two or four external speakers. The Woodstock can be permanently installed or, using the standard "pull-out" mounting, can be removed at will. For added anti-theft protection, a security-code system disables the radio if it is stolen; a four-digit code is required to reactivate it. Price: \$399.95.

CIRCLE 56 ON FREE INFORMATION CARD



Bondwell Laptop Computer

Powerful Laptop

Gone are the days when choosing a laptop computer meant compromising between portability, power, and price. *Bondwell Industrial Company's* (47485 Seabridge Drive, Fremont, CA 94538) *B200* packs a lot of power and performance into an affordable, ultra-slim unit. Weighing less than eight pounds, the B200 comes with 640K RAM on board, dual 3½-inch floppy-disk drives, a full-size 81-key keyboard, and a removable rechargeable NiCd battery pack. The laptop is bundled with MS-DOS 3.3 and utility programs. Options include an extra battery pack, a take-along battery charger, and a soft briefcase-style carrying case. Price: \$999.

CIRCLE 57 ON FREE INFORMATION CARD

For more information on any product in this section, circle the appropriate number on the Free Information Card.

ELECTRONICS WISH LIST

Sing-A-Long Machine

For those who dream of becoming singing sensations, *Seiko Instruments Inc.* (2990 West Lomita Boulevard, Torrance, CA 90505) has introduced *Carry-A-Tune*, "the world's first portable, professional sing-along machine." The device consists of a cassette player combined with a built-in microphone, amplifier, reverb control, multiplex balance control, and mixer. When a specially recorded sing-along cassette is inserted, users can turn the multiplex balance-control wheel to eliminate the voice track and then sing into the microphone. The unit's mixer blends the user's voice with the music; an echo can be added with the reverb unit. The end result is heard through a built-in speaker. The Carry-A-Tune can also be used as a regular cassette player, or as a megaphone or public-address system. A six-song sing-along tape—containing songs such as "White Christmas" and "New York, New York"—is included, along with four AA batteries and a catalog that lists more than 2300 additional sing-along cassettes that are available by mail. Price: \$99.00.

CIRCLE 58 ON FREE INFORMATION CARD



Seiko Sing-Along Machine

Laser Video Combination Player

Offering both high performance and versatility, the *CDV-1700* CD Video player provides 440 lines of horizontal resolution and a 48-dB video signal-to-noise ratio and will play 12- and 8-inch laser videodiscs, 5-inch CD videos, conventional audio CD's, and 3-inch CD singles. *Yamaha Electronics Corporation, USA's* (6722 Orangethorpe Avenue, Buena Park, CA 90620) combination player incorporates the company's FM time-base corrector, an 8-times oversampling digital filter, and 18-bit twin digital-to-analog converters. Its S-video output terminal makes it compatible with S-VHS television receivers and monitors. Independent power-transformer coils for audio and video reduce cross-function interference. The CDV-1700 offers quick search and quick index functions, a 38-key remote control, and 15-selection programmability. Price: \$699.

CIRCLE 59 ON FREE INFORMATION CARD



Yamaha Laser Video Player

Multiple-Room-Remote A/V Receiver

Onkyo's (200 Williams Drive, Ramsey, NJ 07446) versatile *TX-866* audio/video receiver offers a unique room-to-room remote capability that should appeal to both audiophile do-it-yourselfers and custom equipment installers. With a small remote infrared sensor, the receiver and other compatible Onkyo audio components can be operated from another room as well as from the primary listening area where the equipment is located. The other audio components receive commands via a cable link to the receiver. Video components can be controlled by an optional infrared emitter attached to the receiver, either from their own remote controls or from an optional universal remote control. The TX-866 comes with a standard Onkyo Remote-Interactive remote control. The A/V receiver's amplifier provides accurate, low-distortion sound reproduction, and its "Automatic Precision Reception" system continuously monitors the FM signal from the antenna and adjusts the tuner for optimum performance. The receiver has seven inputs, with audio/video switching and dubbing facilities. Other features include direct access tuning, forty station presets that can be stored in six classes of memory, a sleep timer, and a "Stereo Image Expander" for added spaciousness. Price: \$480.

CIRCLE 60 ON FREE INFORMATION CARD

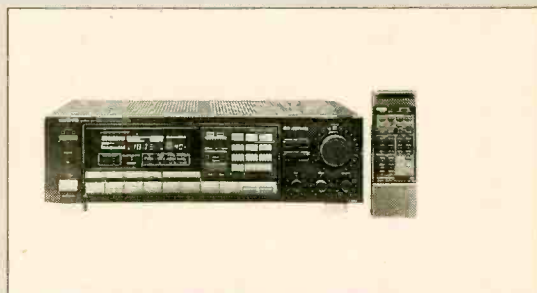

Onkyo Multi-Room-Remote A/V Receiver

Trimline Telephones

The "EasyRead" dialpad on *Code-A-Phone Corporation's* (16261 S.E. 130th, Clackamas, OR 97015) *Styline II* trimline phone offers larger buttons, bigger numbers and letters, and backlighting to make dialing easier. The phone's ten-number memory conveniently stores emergency or frequently-called numbers, and last-number redial is also provided. The phone comes in your choice of white, cream, or gray, and can be wall mounted or set on a table top. Price: \$39.95.

CIRCLE 61 ON FREE INFORMATION CARD



Code-A-Phone Easy-Read Telephone

ELECTRONICS WISH LIST

For more information on any product in this section, circle the appropriate number on the Free Information Card.



Audiovox Mini-Transportable Cellular Phone

Mini-Transportable Cellular Phone

Unlike a "bag" phone, the model *CTR-1900* from *Audiovox Corporation* (150 Marcus Blvd., Hauppauge, NY 11788) is housed in a compact hard case that includes the battery. Weighing in at less than six pounds, the mini-transportable cellular phone features full 3-watt output, 911 emergency calling in all modes, auto answer, automatic storage into a vacant memory address, and multi-city registration. Fifty numbers can be stored, and the *CRT-1900* provides one hour of talk time and eight hours in standby mode. Price: \$795.

CIRCLE 62 ON FREE INFORMATION CARD



Sharp Ultra-Light Personal Tape Player

Ultra-Light Personal Tape Player

At 3.502 ounces, the *JC-K99* is the world's lightest personal cassette stereo, according to its manufacturer, *Sharp Electronics Corporation* (Sharp Plaza, Mahwah, NJ 07430-2135). The cassette player contains circuits and mechanisms that are about half the size and weight of those in other players. The size of a cassette case, the *JC-K99* offers performance features such as auto-reverse, Dolby B noise reduction, an anti-rolling mechanism, and "X-Bass" to enhance the lower frequencies and extend frequency response. It comes with a multi-function remote for fingertip control of start, stop, volume, fast forward, rewind, and autoreverse. The cassette player runs on an AA rechargeable battery pack and comes with lightweight, twin-circuit-duct headphones. Price: \$249.95.

CIRCLE 63 ON FREE INFORMATION CARD

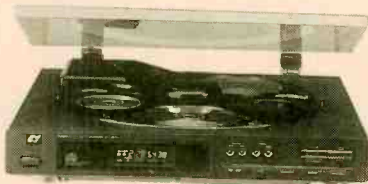

Sansui Carousel CD Changer

Carousel CD Changer

Sansui USA Inc.'s (1250 Valley Brook Avenue, Lyndhurst, NJ 07071) first entry in the carousel CD-changer market is the 5-disc *CD-3100M*. The carousel design allows discs to be changed while the unit is playing, and 3-inch discs can be intermixed without an adapter. Its 4-time oversampling digital-to-analog converters ensure accuracy for high-quality sound. Convenience features include random programming of up to 30 tracks, music scan, random play with direct access, five-way repeat play, and a full-function remote control. Price: \$349.95.

CIRCLE 64 ON FREE INFORMATION CARD



Zenith Dual-Battery Camcorder

Dual-Battery Camcorder

The dual-battery system in *Zenith Electronic Corporation's* (1000 Milwaukee Avenue, Glenview, IL 60025) *VM7170* full-size VHS camcorder allows up to three hours of uninterrupted shooting. The camcorder has a conventional hand-grip battery with the option to mount a second battery on the back of the unit. When the first battery runs low, the camera automatically switches to the second—even in mid-shoot, and without cutting power. The *VM7170* also has a built-in 10-watt light; with the light on, the dual battery provides up to 90 minutes of taping. The camcorder offers a "quick review" of the last few seconds, animation capabilities, time-lapse controls, background-music input to dub the sound track in stereo, a memory bank for title shots, two-speed 8:1 zooming, and an ultra-high-speed shutter. Price: \$1400.

CIRCLE 65 ON FREE INFORMATION CARD

Improve the performance of your shortwave receiver with any one of these simple, easy-to-build circuits

BY JOSEPH J. CARR

Build a

Shortwave

Low-priced shortwave receivers often suffer from performance problems that are a direct result of the tradeoffs that are made at the manufacturing level in order to produce low-cost units. Older receivers, as well as home-brew receiver designs, often suffer performance problems, too. Chief among those shortcomings are sensitivity, selectivity, and image response.

Poor sensitivity—a measure of the receiver's ability to pick up weak signals—is caused, in part, by low gain in the front end of the receiver; that's because the IF amplifier provides most of the receiver's gain. Selectivity (again a function of the receiver's IF circuitry) is a measure of the receiver's ability to separate two closely spaced signals, and reject unwanted signals that are not on or near the desired frequency being tuned.

Image response, which affects only superheterodyne receivers (which most are), is an inappropriate response to a signal that is at a frequency of twice the receiver IF from the frequency to which the receiver is tuned. A "superhet" unit converts the incoming radio-frequency (RF) signal into an intermediate frequency (IF) by mixing it with a local oscillator (LO) signal; the LO signal is generated within the receiver.

The IF can be either the sum or difference between the LO and RF ($LO + RF$ or $LO - RF$, respectively); in most older receivers and nearly all low-cost units, the difference ($LO - RF$) is selected. The problem is that there are always two frequencies that meet the "difference" frequency criteria: $LO - RF$ and an image frequency (f_i) that is equal to $LO + IF$. Both $f_i + LO$ and $LO - RF$ are equal to the IF frequency. If the image frequency gets through the radio's front-end tuning to the mixer, it will appear in the output as a valid signal.

A cure for all of those problems is a circuit called a *preselector*. Preselectors can be either active or passive. In either case, the preselector contains an inductor/capacitor (LC) resonant

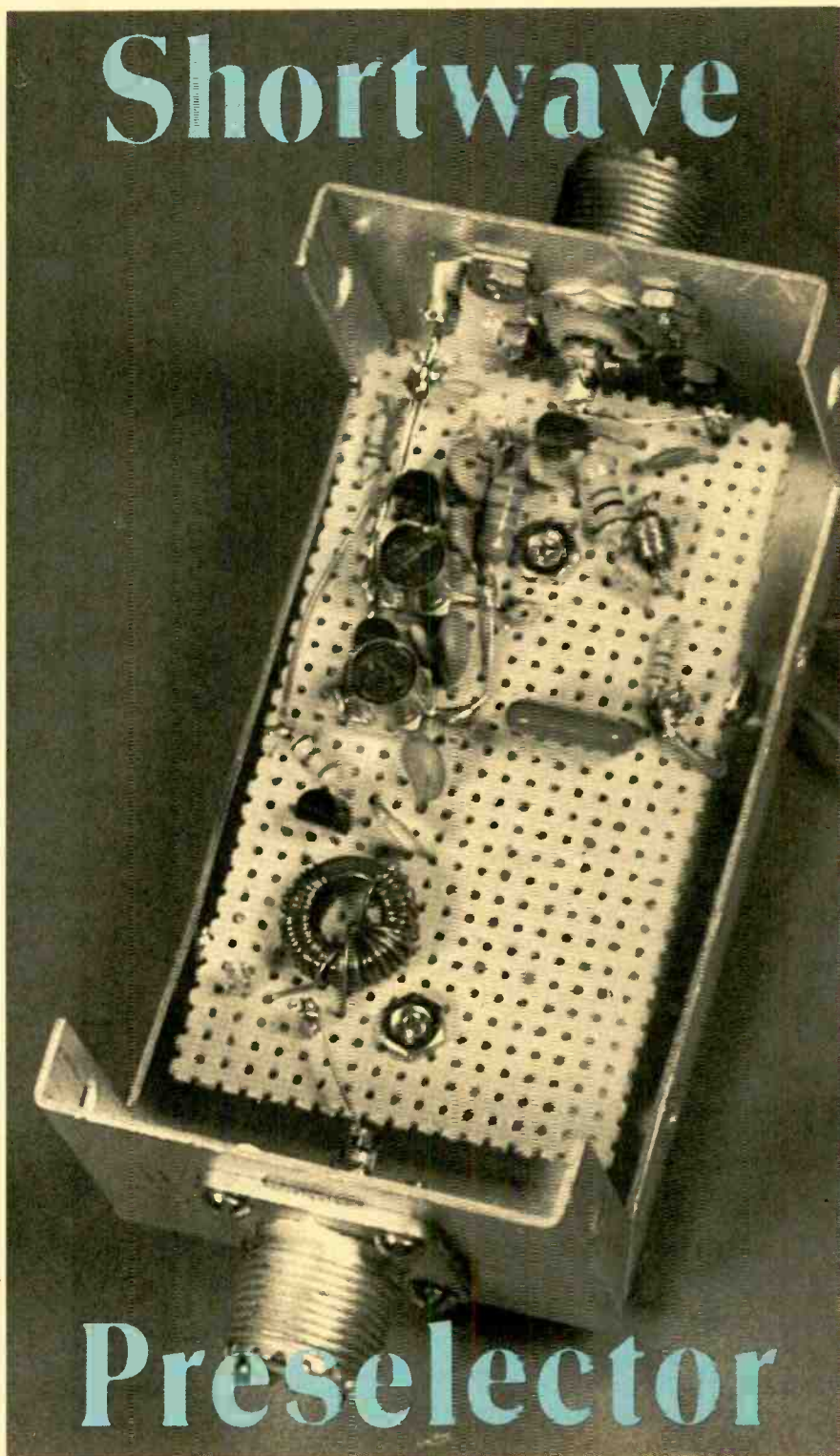

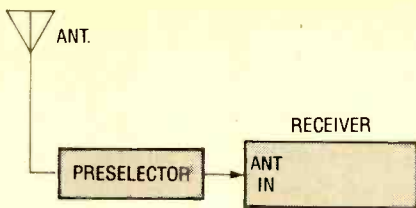

Fig. 1. A preselector (which can be either active or passive, and contains an LC resonant circuit) is connected between the antenna and the receiver's antenna input.

circuit, which is tuned to the same frequency as the receiver. The preselector is connected between the antenna and the receiver's antenna input (see Fig. 1).

In that position, it adds a little extra selectivity to the receiver's front end to help discriminate against unwanted signals. The difference between the active and passive designs is that the active design contains a stage of RF amplification, while the passive design does not. So, active preselectors also help to improve receiver sensitivity.

In this article, we will take a look at several active preselector circuits that you can build and adapt to your own needs. The preselector circuits are based on either of two devices: the MPF102 junction field-effect transistor (JFET), and the 40673 metal-oxide semiconductor field-effect transistor (MOSFET). Both devices are easily available from mail-order sources and from local replacement distributors (for example, the MPF102 is available as the NTE312 and the ECG312, and the 40673 is available as the NTE222 and ECG222). Those transistors were selected because they are well behaved at frequencies in the VHF region.

Preselectors should be housed in shielded, metal enclosures (to prevent RF leakage) that are either diecast or are made of sheet metal and have an overlapping lip. Do not use the lower cost, tab-fit sheet-metal type box.

JFET Circuits. Figure 2 shows the most basic form of JFET preselector, which can be used in the low VHF region. In Fig. 2, transistor Q1 is wired in a common-source configuration, meaning that the transistor's source terminal is tied to the common (or ground) bus, the input signal is applied to the gate, and the output signal is taken from the drain. Source bias is supplied by the voltage drop across resistor R2, with drain loading provided by a series combination of a resistor (R3) and RF choke (L3).

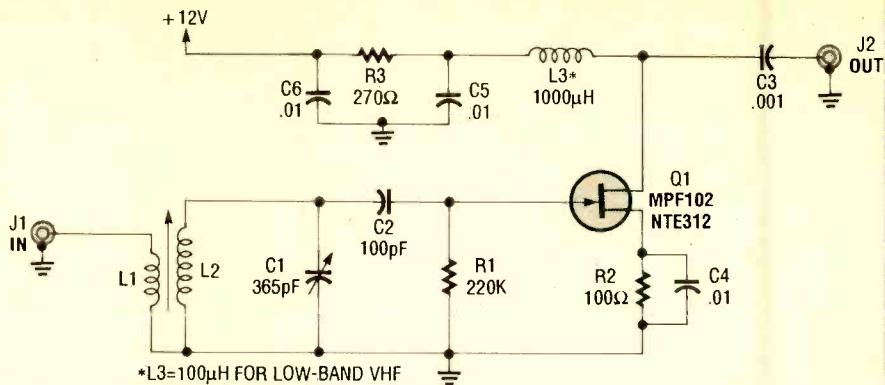

Fig. 2. In this single-tuned JFET preselector, which can be used in the low VHF region, transistor Q1 is wired in a common-source configuration.

PARTS LIST FOR FIG. 2

- Q1—MPF102 or NTE312 JFET
 - R1—220,000-ohm, 1/4-watt, 5% resistor
 - R2—100-ohm, 1/4-watt, 5% resistor
 - R3—270-ohm, 1/4-watt, 5% resistor
 - C1—365-pF variable capacitor
 - C2—100-pF, ceramic-disc capacitor
 - C3—0.001- μ F, ceramic-disc capacitor
 - C4—C6—0.01- μ F, ceramic-disc capacitor
 - L1, L2—See text
 - L3—1000- μ H RF choke
 - J1, J2—Coaxial jack
- Perfboard materials, 12-volt DC source, enclosure, connectors, etc.

The choke should be rated for 1000 μ H (1 mH) at the AM-broadcast and HF (shortwave) bands; in the low VHF region (>30 MHz), a 100- μ H choke is recommended. For VLF frequencies below the broadcast band, use a 2.5-mH choke for L3, and increase all 0.01- μ F capacitors to 0.1 μ F. All capacitors should be either ceramic-disc, or one of the newer "poly" capacitors and rated for VHF use (not all are!). The input circuit is tuned to the RF frequency, but the output circuit is untuned.

The reason for the lack of output tuning is that tuning both input and output permits the JFET to oscillate at the RF

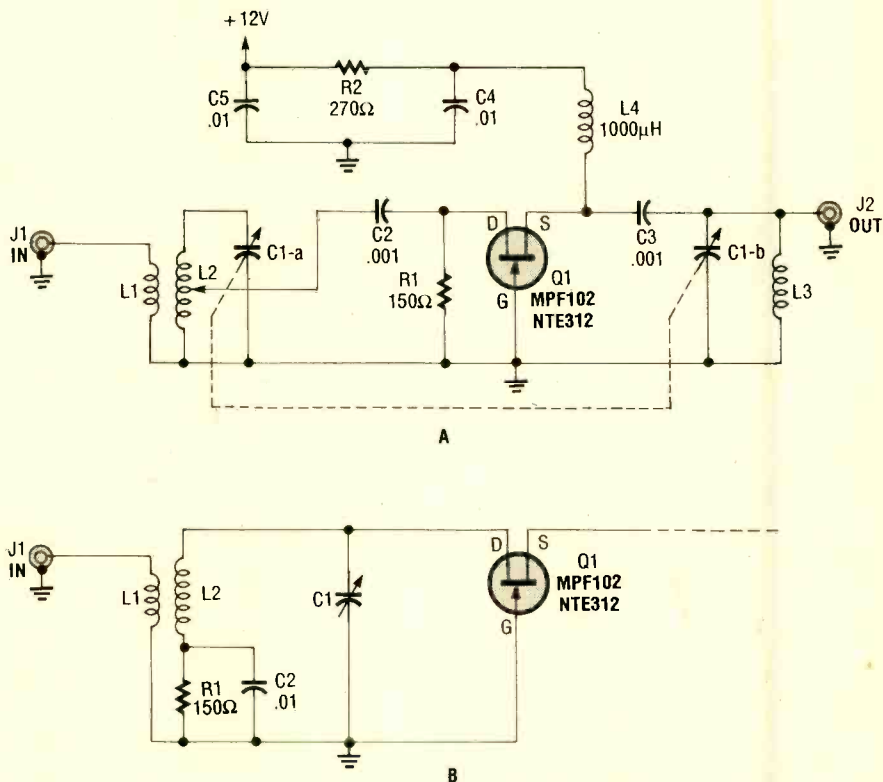

Fig. 3. Here are two methods for tuning both the input and output circuits of the JFET-based preselector. In A, a tapped inductor is used for L2; in B a slightly different configuration is used.

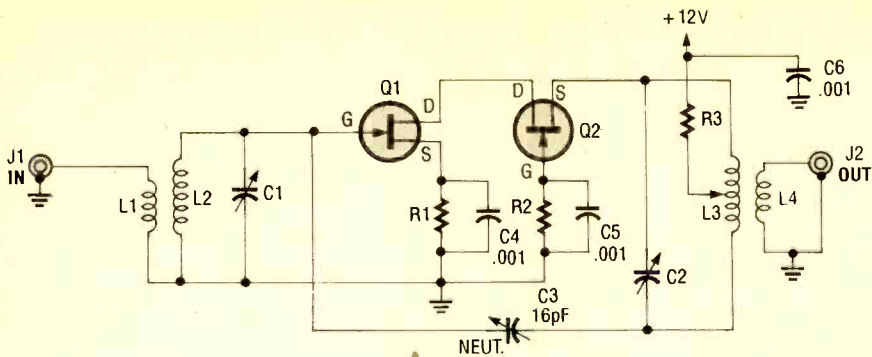

Fig. 4. Here's a VHF preselector that uses two JFET's (Q1 and Q2) connected in cascade.

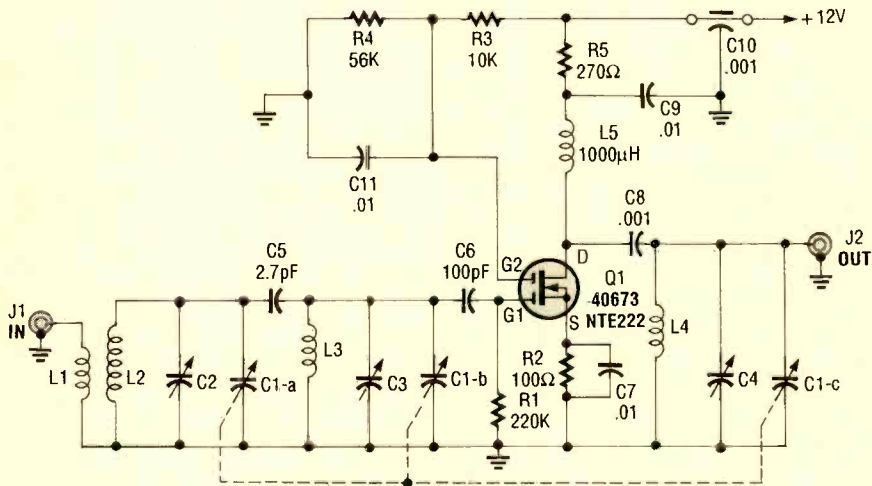

Fig. 5. Here's a preselector circuit built around a 40673 dual-gate MOSFET, wired in a common-source configuration.

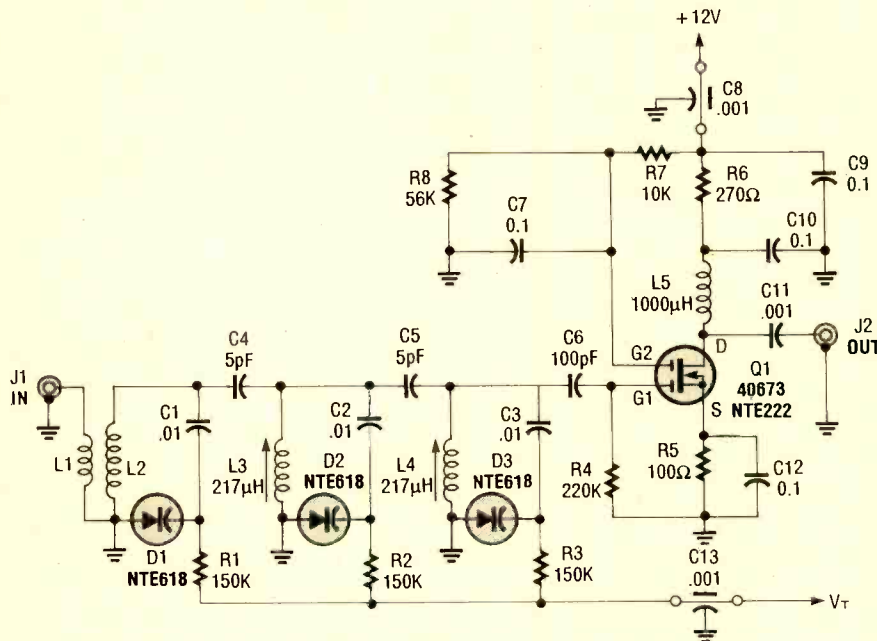

Fig. 6. This MOSFET-based preselector circuit, in addition to using only input tuning (which lessens the potential for oscillation), also uses voltage tuning.

frequency (which is something that we don't want). Other possible causes of oscillation include the layout. Self oscillation also occurs if the self-reso-

nance frequency of L3 is too near the RF frequency.

The input to the circuit consists of an RF transformer that has a tuned sec-

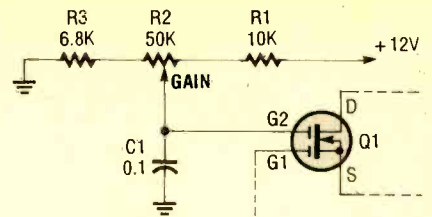

Fig. 7. The fixed-bias network used to place gate G2 at a positive DC potential in the two previous MOSFET-based preselectors can be replaced by a variable-voltage arrangement like that shown here.

PARTS LIST FOR FIG. 6

RESISTORS

(All resistors are 1/4-watt, 5% units.)

- R1-R3—150,000-ohm
- R4—220,000-ohm
- R5—100-ohm
- R6—270-ohm
- R7—10,000-ohm
- R8—56,000-ohm

CAPACITORS

- C1-C3—0.01-μF, ceramic-disc
- C4, C5—5-pF, ceramic-disc
- C6—100-pF, ceramic-disc
- C8, C13—0.001-μF, feedthrough capacitor (see text)
- C7, C9, C10, C12—0.1-μF, ceramic-disc
- C11—0.001-μF, ceramic-disc

INDUCTORS

- L1, L2—See text
- L3, L4—217-μH, variable inductor
- L5—1000-μH, RF choke

ADDITIONAL PARTS AND MATERIALS

- Q1—40673, NTE222, or ECG222 dual-gate MOSFET
- D1-D3—440-pF, varactor diode (NTE618 or equivalent)
- J1, J2—Coaxial jack
- Perfboard materials, 12-volt DC source, enclosure, connectors, wire, solder, hardware, etc.

ondary (L2) and a variable capacitor (C1), which is used as a tuning control.

Although C1 is shown as a standard 365-pF AM-broadcast variable, any form of variable capacitor can be used provided that the inductor is selected for the desired range. Components L2 and C1 are related by:

$$f = 1/6.28 \sqrt{LC}$$

where f is frequency in hertz, L is inductance in henrys, and C is the capacitance in farads. Be sure to convert inductances from microhenrys to henrys, and picofarads to farads. Add

about 10 pF to the capacitance value account for stray capacitances; keep in mind that the suggested tolerance of 10 pF for stray capacitance is an approximation and may have to be adjusted to fit the situation. (Stray capacitance, in this instance, is a function of your layout, among other things.)

You can modify the above equation to solve for either inductance (L) or capacitance (C) using:

$$L = 1/39.5 f^2 C$$

or

$$C = 1/39.5 f^2 L$$

Space does not warrant making a sample calculation, but we can report results for you to check for yourself. In a sample calculation, I wanted to know how much inductance would be required to resonate 100 pF (representing a 90-pF capacitor, plus 10-pF of stray capacitance) to 10 MHz.

The solution, when all numbers are converted to hertz and farads, results in 0.00000253H, or 2.53 μ H. Keep in mind that the calculated numbers are close, but are nonetheless approximate and that the circuit may need tweaking on the bench.

The transformer (L1/L2) can be a variable inductor, as shown (suitable units are manufactured by Toko and others, are available from distributors such as Digi-Key P.O. Box 677, Thief River Falls, MN, 56701; Tel. 1-800-344-4539). You could also use a home-brewed fixed unit, wound on a toroidal core for the frequency of interest.

If you choose to make your own inductor, use a T-50-6 (RED) or T-68-6 (RED) toroid (available from Amidon Associates, 12033 Otsego Street, North Hollywood, CA, 91607) for shortwave applications. The number of turns required for the toroid is calculated from $N = 100 \times (L_{\mu H}/A_L)^{1/2}$, where $L_{\mu H}$ is inductance in microhenrys, and A_L is 49 for T-50-6 and 57 for T-68-6. For example, a 2.53- μ H coil needed for L2 in Fig. 2 wound on a T-50-6 core requires 23 turns. Use #26 or #28 enameled wire for the winding. Make L1 about 4-7 turns over the form on which L2 is wound.

Circuit Variations. Figure 3 shows two methods for tuning both the input and output circuits of the JFET-based preselector. In both cases, Q1 is wired in a common- (or grounded-) gate configuration, so the input signal is applied to the drain and output is taken from the source. The dotted line between C1-a

and C1-b indicates that those capacitors are ganged to the same shaft. The source (or output) circuit of Q1 has a low impedance, so some means must be provided to match it to the tuned circuit. In Fig. 3A, a tapped inductor is used for L2 (tapped at 1/3 of the coil winding), and in Fig. 3B a slightly different configuration is used.

The circuit in Fig. 4 is a VHF preselector that uses two JFET's (Q1 and Q2) connected in cascode, which is defined as a high-gain, low-noise, high-input-impedance amplifier consisting of two stages; the input stage being (in this case Q1) in a common-source configuration and direct-coupled to the output stage (Q2), which is in a common-gate configuration.

In order to prevent self oscillation, a neutralization capacitor (C3) is included in the circuit. Capacitor C3 is adjusted to keep the circuit from oscillating at any frequency within the circuit's band of operation. In general, the circuit is tuned to a single channel by the action of L2/C1 and L3/C2.

MOSFET-Preselector Circuits.

Figure 5 shows a preselector built around a 40673 dual-gate MOSFET, wired in a common-source configuration. That unit was chosen because of its low cost and availability. The input signal is applied to gate 1 (G1), while gate 2 (G2) can either be biased to some fixed positive voltage (as shown) or connected to a variable DC voltage, which would serve as a gain-control signal. The DC network is similar to that of the previous (JFET) circuits, except that a resistor voltage divider (R3/R4) is needed to bias G2.

There are three tuned circuits in this preselector, so it will produce a large amount of selectivity improvement and image rejection. The gain of Q1 also provides additional sensitivity. The circuit is tuned by a 3-gang capacitor, C1, with three trimmer capacitors (C2, C3, and C4) used to adjust the tracking of the three-tuned circuits, thereby ensuring that they are all tuned to the same frequency at any given setting of C1.

The inductors are of the same sort as described previously. It is permissible to put L1/L2 and L3 in close proximity to each other, but they should be kept separate from L4 to prevent unwanted oscillation due to feedback arising from coil coupling.

The circuit in Fig. 6 is a little different. In addition to using only input tuning (which lessens the potential for oscilla-

tion), it also uses voltage tuning. Further, the hard to find variable capacitors are replaced with varactor diodes (also called voltage-variable capacitance diodes). Varactor diodes exhibit a capacitance that is a function of the applied reverse bias voltage, V^{-1} .

Although the original circuit was built and tested for the AM broadcast band (540 kHz to 1610 kHz), it can be modified to operate on any band by selecting the proper inductor values. The designated varactor (NTE618) offers a capacitance range of from 440 pF down to 15 pF over a voltage range of 0 to +18 volts DC. As before, the inductors may be either store-bought types or may be of the home-brewed variety (wound over toroidal cores).

I used a toroid for L1 and L2 and store-bought adjustable inductors for L3 and L4. While there is no reason why manufactured units could not be used for all the inductors, unfortunately not all values are available in the form that has a low-impedance primary winding to permit antenna coupling.

The circuit can be assembled on ordinary perfboard, and should be housed in a shielded enclosure (perhaps an aluminum utility box). The RF input and output connectors can be any coaxial type that match your receiver and antenna system.

Capacitor C8 and C13 in Fig. 6 are not the type of capacitors that most of us are accustomed to; they are 0.001- μ F ceramic feed-through capacitors. Such units are a little hard to find locally, but are available from Newark Electronics (stores nationwide) and other distributors.

In both of the MOSFET circuits (Fig. 5 and Fig. 6), the fixed-bias network used to place gate G2 at a positive DC potential can be replaced by a variable-voltage arrangement like that shown in Fig. 7. The advantage of that circuit is that potentiometer R2 can be used as an RF GAIN control to reduce gain on strong signals, and increase it on weak signals. That allows the active preselector to be custom set to prevent overloading due to strong incoming signals.

Conclusion. A preselector can significantly improve the performance of your receiver, regardless of whether you listen to VLF, the AM broadcast band, shortwave, or the VHF/UHF bands. The information and circuits presented in this article will allow you to design and build your own units, and to be successful at it. ■

Looking At Light Sensors

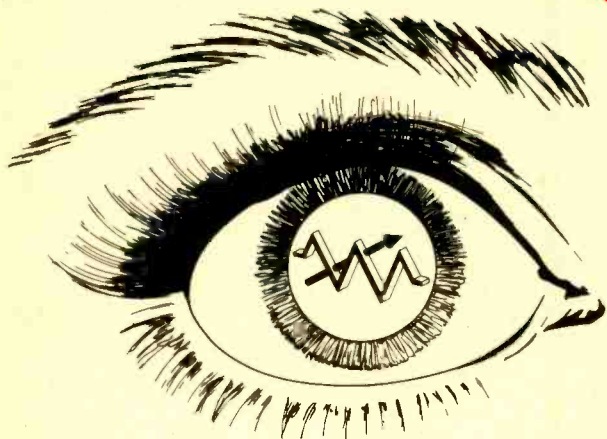

BY
JOSEPH J. CARR

Learn how optoelectronic devices and sensors work, and how you can use them in your designs and circuits.

Optoelectronic devices are electronic components that respond in some way to light. Most readers are familiar with a common form of optoelectronic emitter called the light-emitting diode (LED), but perhaps fewer are aware of the photosensors that are available. We'll take a look at each of them and some common circuits that they appear in, but first, let's take a look at light itself.

Light. Light is a form of electromagnetic radiation, and is thus essentially the same as radio waves, infrared (heat) waves, ultraviolet light, and X-rays. The only differences between the various types of electromagnetic waves is their frequency (f) and wavelength (λ).

Frequency and wavelength are related by the equation:

$$\lambda = c/f$$

where c is the velocity of light (300,000,000 meters/second), λ is the wavelength in meters, and f is the frequency in hertz.

The wavelength of visible light is 400 to 800 nanometers (1 nm = 10^{-9} meters), which corresponds to frequencies between 7.5×10^{14} and 3.75×10^{14} Hz. Infrared has wavelengths longer than 800 nm and ultraviolet has wavelengths shorter than 400 nm; X-radiation has wavelengths even shorter than ultraviolet. From the equation you can see that visible light has a frequency on the order of 10^{14} hertz.

The similarities between visible, IR, UV, and X-ray radiation allow us to use sim-

ilar optoelectronic techniques and sensors in those regions of the electromagnetic spectrum.

At this point it's a good idea to mention that the visible light portion of the electromagnetic spectrum can be further broken down into seven basic colors: red, orange, yellow, green, blue, indigo, and violet (in order of decreasing wavelength). White light contains the entire visible light spectrum from red to violet. When white light is passed through a prism, long wavelengths are refracted (or less-literally "bent") less than short wavelengths (e.g. violet). As a result, the colors are spread out and separate. The divergence allows you to see the individual colors that make up white light.

Quanta and Energy Levels. The photosensors we'll discuss depend upon "quantum effects" for their operation. Quantum mechanics, as the field is called, arose as a new idea in physics in December, 1900, the very dawn of the 20th century, with a now-famous paper by a German physicist named Max Planck. He had been working on thermodynamics problems, and found the experimental results reported in 19th-century physics laboratories could not be explained by classical Newtonian mechanics—the then-prevailing "world view" of physics. The solution to the problem turned out to be a simple, but terribly revolutionary idea: electromagnetic energy existed in discrete bundles. In other words, electromagnetic energy travels in packets having a specific value. The name eventually

given to the packets was quanta (later changed to photons as the definition of quanta broadened), thus was born quantum mechanics.

The energy contained in each photon is expressed by the equation:

$$E = ch/\lambda$$

or alternatively,

$$E = h\nu$$

where E is the energy in electron volts (eV), c is the velocity of light (in meters/sec.), λ is the wavelength (in meters), h is Planck's constant (6.62×10^{-34} Joule-sec.), and ν is the frequency of light (sec. $^{-1}$).

Emitters and Sensors. When an electron moves to a lower energy level (for whatever reason), it gives off a photon whose energy equals the energy lost by the electron. By forcing electrons to move from one specific energy level to a lower one they will give off light of more or less the same wavelength. That's exactly what happens in an LED, which gives off "monochromatic" (one-color) light. In most other light sources, electrons jump between a variety of different energy levels producing photons of various wavelengths, which results in a broad spectral output.

Figure 1 shows the spectral output of a number of different light emitters. The vertical scale is "normalized," meaning that full-scale is arbitrarily labelled 100 percent. Note the narrow frequency output of the LED's in comparison to the other light sources.

Conversely, a light sensor is con-

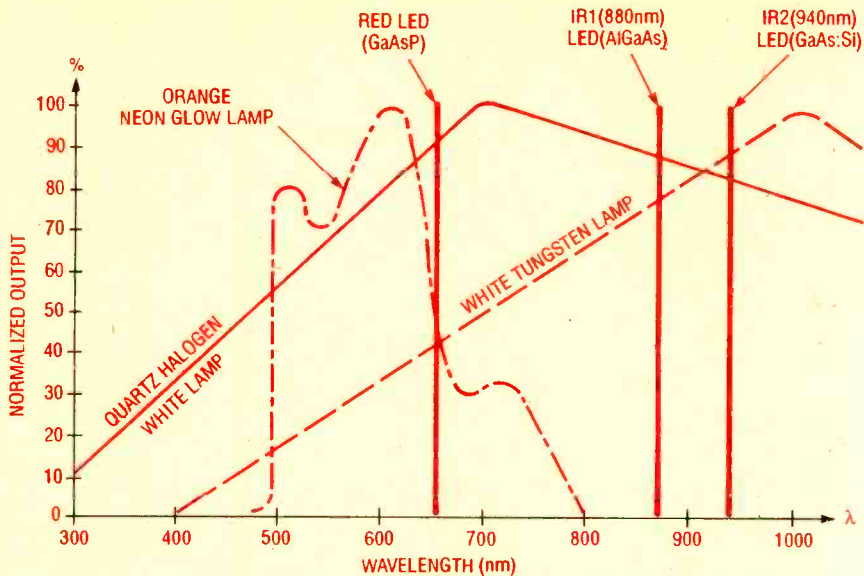

Fig. 1. This is a graph of the spectral output of commonly available light sources. The graph is normalized, meaning that the most intense frequency is arbitrarily placed at the 100% mark and the other frequencies are graphed proportional to it.

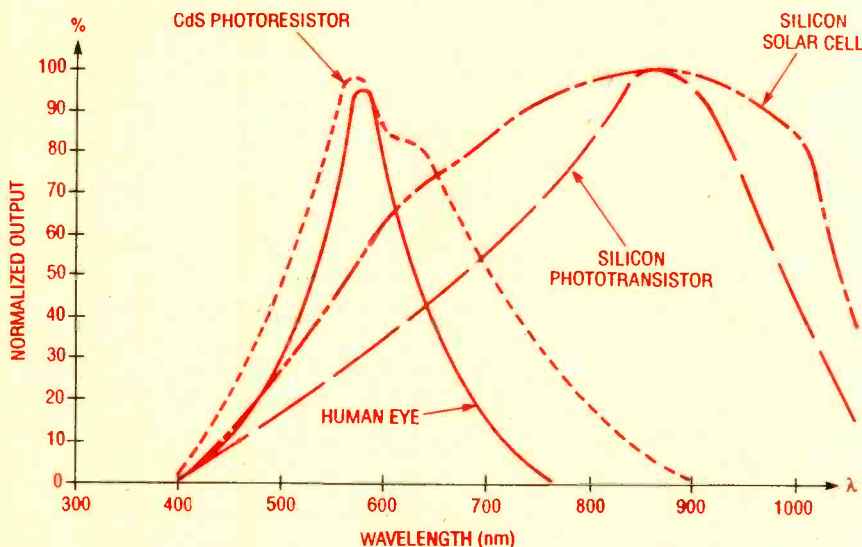

Fig. 2. This is the spectral response of the more common optoelectronic sensors. This is also a normalized graph.

constructed from material that allows at least one electron to be freed from its associated atom by one photon of light. Interestingly, it takes a certain amount of energy (i.e. a photon of a certain frequency and wavelength) to "liberate" an electron.

In this respect, sensing materials are somewhat selective about the wavelengths of light that affect them. However, most sensing materials currently manufactured are chosen to respond to a broad range of frequencies to maximize their usefulness (see Fig. 2). The mechanics of such broad-bandwidth response can get a little complex depending on the material, so let's just say that such a material has various

energy levels to accept a range of frequencies.

Another criteria for selecting a sensor material is the lowest energy needed to liberate an electron. Materials in which the electrons are too tightly bound would require photons too energetic and possibly beyond the visible spectrum. Such materials will not work well as typical light sensors.

There are a number of solid-state light sensors commonly used in electronics. They include: photoresistors, photovoltaic cells, photodiodes, and phototransistors. The type of sensor selected for any given purpose is determined in part by the spectral response required for the specific application.

For example, if you want to detect infrared radiation to measure carbon dioxide (CO₂), one would want to select a device with a strong response within the IR region (roughly > 800 nm). By looking at Fig. 2, you can clearly see that silicon solar (photovoltaic) cells and silicon phototransistors would be the choice.

Photovoltaic Cells. A photovoltaic (PV) cell is a device that generates an electric potential when light shines on its surface. The common solar cell is an example of a photovoltaic cell.

Some PV cells are meant to generate electrical power, while others are meant for instrumentation purposes. Figure 3 shows a typical circuit to interface a photovoltaic cell to instrumentation. The cell is connected across the non-inverting input of a high-impedance amplifier, such as the operational amplifier shown. The output voltage is found from:

$$V_o = V_{c1}(1 + R2/R1)$$

Photoresistors. A photoresistor is a device whose resistance changes with variations in light intensity. Photoresistors are specified by their "dark" resistance and their light/dark resistance ratio. In most common varieties, the resistance is very high when dark, and drops very low under intense light. They are often used in photographic lightmeters, densitometers, colorimeters, and so forth.

Figure 4 shows three circuits in which photoresistors can be used. The circuit shown in Fig. 4A is called a "half-bridge." In that circuit, the photoresistor is connected across the output of a voltage divider made up of R1 and R2. The output voltage is given by:

$$V_o = V \times R2 / (R1 + R2)$$

Where V_o is the output potential, V is the applied excitation potential, R1 and R2 are in ohms. A problem with the circuit is that the output potential does not drop to zero, but always has an offset value.

A second way to use the photoresistor is shown in Fig. 4B. Here the photoresistor is the feedback resistor in an inverting operational-amplifier circuit. The output voltage, V_o, is found from:

$$V_o = V_{ref} \times R2/R1$$

The circuit of Fig. 4B provides a low-impedance output, but like the other half-bridge circuit (Fig. 4A), the output voltages does not drop to zero. In addi-

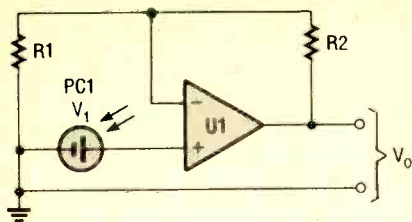

Fig. 3. This simple circuit is useful for buffering and amplifying the output of a photovoltaic cell for instrumentation.

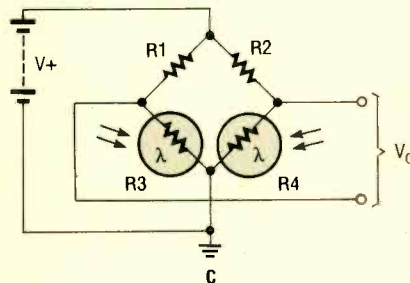
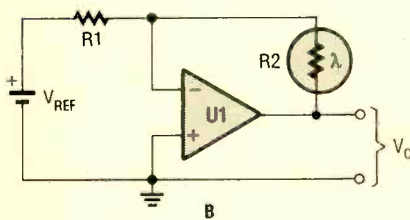
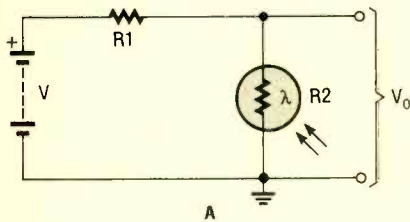

Fig. 4. These are some photoresistor circuits. In order they are: A) a half-bridge circuit; B) an inverting-amplifier circuit; and C) a Wheatstone bridge.

tion, with some photoresistors the dynamic range of the operational amplifier may not match the dark/light ratio of the photoresistor at practical values of V_{ref} .

Our last photoresistor configuration is the Wheatstone bridge shown in Fig. 4C. That circuit allows the output voltage to be zero under the right circumstances, and is the circuit favored by most designers. If a low output impedance is required, or additional amplification is needed, then a differential DC amplifier can be connected across output potential V_0 .

The Wheatstone bridge can be considered as two half-bridges in parallel. The output voltage is equal to the difference between the respective half-

bridge output voltages. The voltages at those points can be found from the same equation used for the half-bridge in Fig. 7A, so we may conclude from this information that the output voltage from the bridge is equal to:

$$V_0 = V(R3/(R1 + R3) - R4/(R2 + R4))$$

Photodiodes and Phototransistors.

Perhaps the most modern light sensor is the photodiode. The level of the reverse leakage current increases when such a diode's PN junction is illuminated. Figure 5 shows a basic circuit for for such a sensor. The diode is normally reverse biased, and in series with a current-limiting resistance. Microammeter M1 measures the reverse leakage current that crosses the PN junction during this type of operation. When light strikes the PN junction, the reading on M1 will increase.

The same principle applies to a class of NPN or PNP transistors called phototransistors. In those devices, collector-

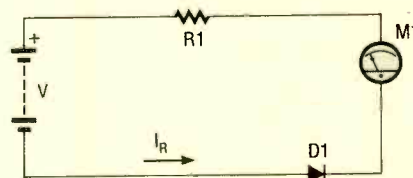

Fig. 5. This is the world's Simplest photodiode circuit. It works rather well if you select the parts properly.

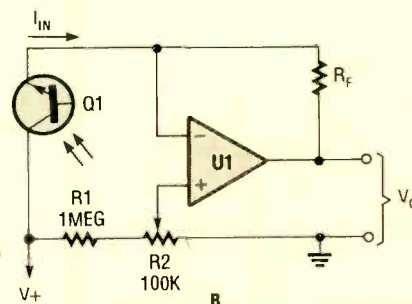
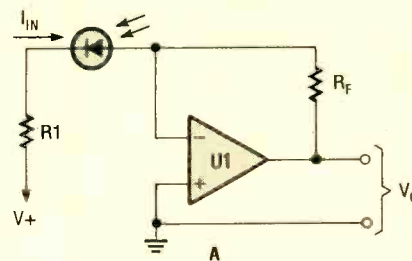

Fig. 6. The circuit in A is a photodiode buffered and amplified by an inverting amplifier. The one in B is a phototransistor in a similar circuit, but with an adjustable offset value.

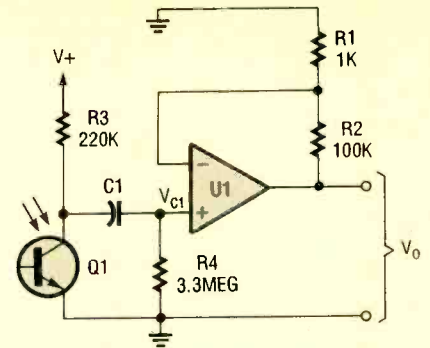

Fig. 7. This phototransistor circuit can be used to examine varying or amplitude-modulated light sources.

to-emitter current flows when the base region is illuminated. Those devices are the heart of various types of optoisolator and optocoupler integrated circuits, as well as being used in various instrumentation applications.

Figures 6A and 6B show one way in which photodiodes and phototransistors are used. Both devices control current flow according to light intensity, so we must connect them into a circuit that measures current. The inverting operational amplifier circuit will do that well. In all such cases, the output voltage, V_0 , is equal to the product of the input current and the feedback resistance ($I_{IN} \times R_F$). In the case of Fig. 6B, a zero control (which can also be used in the circuit of Fig. 6A) is added.

Figure 7 shows a circuit for use when the light signal is varying and even modulated. It consists of a phototransistor (Q1) driving an AC-coupled noninverting operational amplifier. The sensitivity of Q1 is determined in some measure by the resistor in series with the collector and the $V+$ supply (R3). A high value, 100 kilohms to 1 megohm, will increase sensitivity, while a low value, 10 kilohms to 100 kilohms, will increase operating speed.

The collector of Q1 has a large DC offset, with variation due to stimulus light levels being superimposed on the DC. The capacitor (C1) strips off the DC component, allowing only the variations to pass on to the amplifier. The low-frequency response of this circuit depends on the capacitor value and R4:

$$f = 1/(2\pi R4 \times C1)$$

Optoelectronic sensors are easily available to any electronics enthusiast, and are easy to use. There is no reason why you cannot come up with applications of your own based on the principles discussed in this article.

MODEMS AND COMPUTER COMMUNICATIONS

BY ISAAC SZLECHTER

In order to call another computer, you must have more than just a telephone line; You must also have some way of converting the computer's particular type of electrical impulses to the kind carried by telephone lines. In other words, you must have a modem.

Communication with modems is a highly-technical, fast-growing field. In any discussion of how to establish and maintain proper communications between two computers, some technical questions are almost unavoidable. Yet most users know very little about the particulars of modems and communications technology. In an attempt to fill in the gaps in most people's knowledge, we present answers to some frequently asked questions.

Terminology. Of course a brief introduction to some common modem terms are in order.

Q: *What does a modem do, anyway?*

A: A modem makes it possible for you to transmit or receive information, usually over a phone line, from one computer or peripheral to another. It *modulates* (translates) your signal to a form that can be transmitted along the wires. The modem at the other end can *Demodulate* (restore) the original signal. You can keep track of salesmen on the road, or inventory in branch stores, communicate with a colleague in another state or in another country, or contact electronic bulletin boards and data bases.

Q: *What is meant by "Hayes compatibility?"*

A: As it is generally used, the phrase "Hayes compatibility" indicates that a modem uses the command set developed by the manufacturers of Hayes



Here are the answers to some of the most common questions about modems, their attributes, computer communications, and more.

modems. Those commands all start with "AT" (for *attention*) as a prefix, followed by specific symbols for various actions. Most of the modems that are on the market today are Hayes compatible

Q: *What does full-duplex mean?*

A: Full duplex means that data can be transferred in both directions at the same time. Half duplex means the modems take turns sending data back and forth on the telephone line.

Q: *What exactly are bits and bytes?*

A: In binary notation, a bit is the smallest increment of data represented by a 0 or 1. A single bit can be thought of as a tiny switch that is either on or off.

A byte consists of 8 bits. All the information in your computer is stored, retrieved, or operated on in bytes. A single byte can be represented by a string of eight 1's and 0's. For example, 10101010.

Q: *What are synchronous and asynchronous transmissions?*

A: In asynchronous transmission, time intervals between transmitted characters may be of unequal length. Transmission is controlled by start and stop bits at the beginning and end of character. On the other hand, synchronous transmission sends data bits at a fixed rate, with the transmitter and receiver synchronized. Synchronized transmission eliminates the need for start and stop bits.

However, you don't have a choice about the transmission mode. Your operating environment determines the mode you need. Typically, IBM mainframes and minicomputers require synchronous transmission. And typically, some other mainframes and minicomputers are asynchronous. IBM PC's and compatibles are also asynchronous.

Q: What does the baud specification indicate?

A: The baud, after J. Baudot, indicates the number of discrete signal changes per second. In binary transmissions, each change represents a single bit, so in popular usage the term has become synonymous with bits-per-second. Although many transmission rates are possible, 300, 1200, 2400, and 9600 baud are those commonly encountered.

Many modems recognize the incoming rate and automatically adjust to meet it. However, a modem cannot exceed its own maximum rate, so a 300-baud modem cannot adjust to handle 1200- or 2400-baud data.

Q: What is a communications protocol?

A: Since there are many ways to transmit a series of characters across a phone line, the modems at both ends must agree on how that will be done. This is often referred to as the "communications protocol," where protocol means a mutually acceptable configuration for transmitting data.

Hardware Selection. Now that you're more familiar with the terminology of modem communications, you need an idea of the types of modems that are out there.

Q: Is an external modem better than an internal one?

A: A modem for a personal computer may be either an internal or external device. An internal modem is completely self contained and is simply inserted into a slot on the system board. An external modem is connected to the PC via cable to a "serial port." The port is called "serial" because data is transmitted serially, one bit at a time.

The two types perform identical functions, and the choice is strictly one of personal preference, with each type having the usual advantages and disadvantages of other external and internal devices.

Q: How can I connect an external modem to my PC?

A: An external modem may be connected to the PC via a cable connected to a "communications adapter." The communications adapter is a board that plugs into the main board in the computer. Among the more common adapters are asynchronous communication, binary synchronous communication, serial/parallel, and synchronous data-link control communications types.

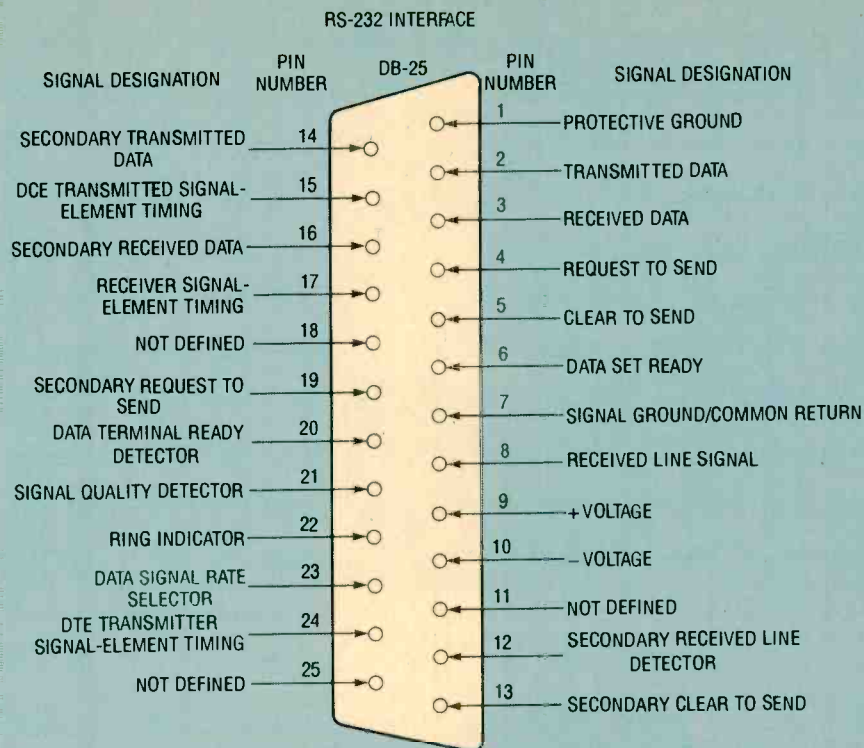

Fig. 1. The RS-232 interface standard has been widely accepted in the field of computer and data communications. We have included this diagram as a convenient pin reference.

Communication Jargon Made Easy.

Acoustic coupler—A device that converts electrical signals into audio signals. It allows data to be transmitted over the public phone by way of a conventional phone handset.

Bit—Contraction of binary digit. The smallest unit of information in a binary system, a one or zero.

Buffer—A storage device used to compensate for a difference in data rate and data flow between two mechanisms.

Byte—A group of bits used as a unit. Eight-bit bytes are most common.

Crosstalk—Interference between data channels.

Dial network—A network that can be dialed in and shared among many users.

Line driver—A signal converter that ensures reliable transmission over a distance.

Modem eliminator—It connects a local terminal and a computer port, replacing the pair of modems that ordinarily connect them.

Parallel transmission—Transmission mode that sends a number of bits at the same time over separate lines.

Parity bit—A bit that is set at 0 or 1 in a character to guarantee that the total number of 1 bits transmitted is even or odd.

Pulse dialing—Older form of phone dialing. It utilizes breaks in DC current to designate the number being dialed.

Telex—A teleprinter dial network sponsored by Western Union. It uses baudot code.

Wideband—A communication channel that has a greater bandwidth than voice-grade lines.

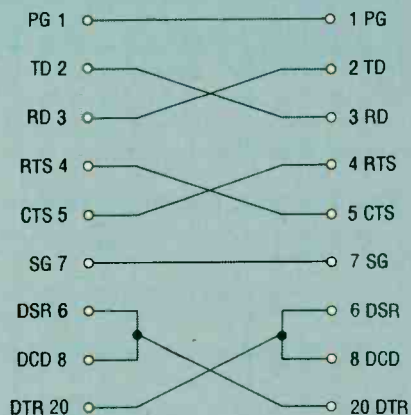
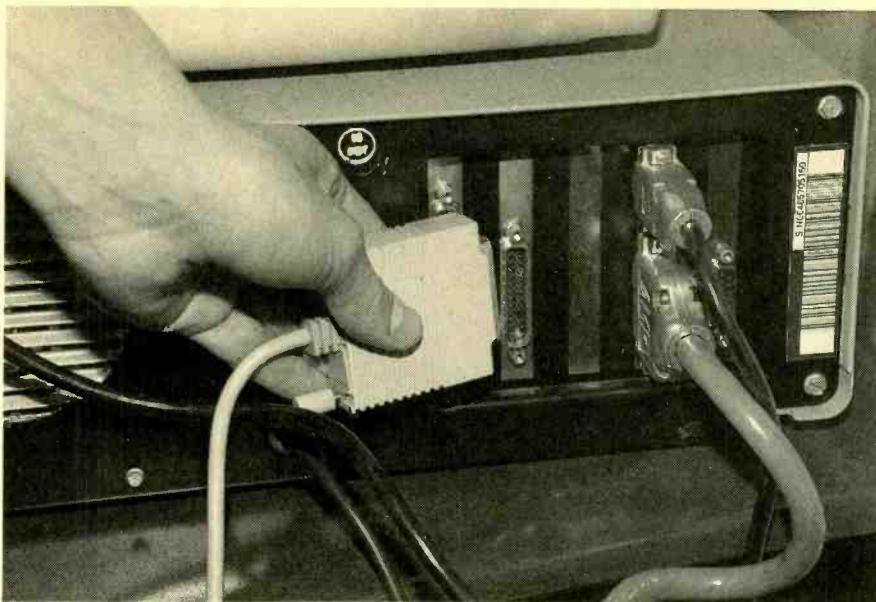

Fig. 2. You can make a null-modem cable from a standard RS-232 cable by connecting the pins on one end of the cable to the pins on the other end as shown here. Note not all 25 pins are used.

The rear-panel connector on most external modems is a 25-pin D-shell connector, so called because of its D-like shape. In popular usage, the connector is often incorrectly referred to as an RS-232 plug.

RS-232 is actually an Electronic-Industry Association (EIA) standard, applicable to the 25-pin interconnection of data-terminal equipment (DTE) and data-communication equipment (DCE) using serial-binary data communication. The standard has been widely accepted in the field of com-



An external modem can be connected to the PC with a 25-pin connector. However, the PC must contain a communications adapter to plug into.

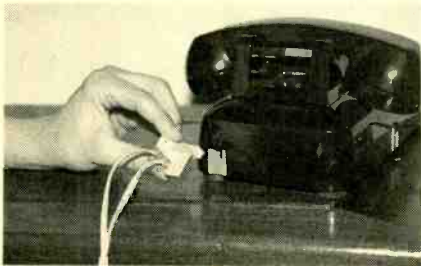

A Y-connector allows you to plug both your modem and a telephone into a single modular phone jack.

puter and data communication. For the standard functions for each pin see Fig. 1.

IBM PC's support two communications ports, identified as COM1 and COM2. Additional ports are supported by many non-IBM systems.

Q: Do I need a null, short-haul, or remote modem?

A: The answer depends on how far you want to reach. A remote or standard modem gives you the greatest distances—from about 3 miles to anywhere in the world. For medium or semi-remote distances (100 feet to about 3 miles) you'd need a short-haul modem or line driver. If you want to reach only 100 feet or so, that's local, you'd just need a null modem. A null modem is, in fact, no modem at all, but simply a cable connection between the serial ports on two nearby computers.

Q: Can I use a null modem to test serial ports?

A: For diagnostic purposes, you can use the null modem to make sure that two computers in the same area and their serial ports are functioning prop-

erly. Testing can be done without tying up a phone line. To use the null modem, make the necessary connection between the two serial-port connectors as shown in Fig. 2.

Q: What operating-speed modem should I buy?

A: The first consideration is how much data you are going to transfer. If you occasionally need to send a message or transfer a file, then a modem operating at 1200 baud full duplex is quite sufficient.

On the other hand, if you need to transmit large quantities of data, such as daily transaction records, a high-speed modem (9600 baud, 19200 baud, or higher) that can send all the data in a short amount of time is a good choice.

Q: Should I choose dial-up or leased lines?

A: If you do not plan to transfer data often, choose a dial-up line and modem. A dial-up line is any standard 2-wire telephone line that you can dial into, such as the telephone line in your home. Like any phone call, you pay only for the time you use.

If you plan to send large amounts of data every day, choose a leased line and modem. Leased lines are 4-wire telephone lines. One pair of wires sends data in one direction and the other pair sends data in the opposite direction. The phone company reserves the private lines for the leasing customer, who pays a flat monthly charge. So before deciding on a leased line or dial-up line modem, evaluate how much you'll use the modem link.

Software and Troubleshooting.

Once you have a modem, using one isn't always smooth sailing. Here are a few tips to shake out the bugs:

Q: How can I configure my communications (modem) software?

A: You must take two things into account when configuring your software: The hardware link between the computer and modem, and the communications link between the user's modem and the modem at the other end of the phone line.

You begin the process by running the communications program and selecting a configuration option. When the screen menus are displayed, you indicate any changes, and these changes are written back to the software. The next time you run the program the default settings will be those you selected during the configuration procedure.

Q: How can I view the commands I send to my modem?

A: You need to give your modem the command to turn on echoing. The Hayes command is ATE1.

Q: How can I download without getting the message "File Creation Error"?

A: Downloading is the process of sending data from a central source to remote location. If you have set up a default download directory, then make sure that the directory is valid. If you are using a PC or compatible, make sure you have FILES=20, or more, in your CONFIG.SYS file (check your DOS manual for more information). Make sure hidden or read-only files of the same name don't exist in the directory you're downloading to.

Q: How can I switch between voice and data on the same phone call?

A: If your modem is Hayes-compatible and does not have a physical switch for alternating between voice and data modes, you might still be able to do it with software commands.

For switching from data to voice, while on-line, both parties can just pick up their phones. That forces the modem to hang up and go back to its command state enabling voice communication.

For switching from voice to data, one party should issue the ATA command from the communications software and the other should execute the ATO command. Then both parties can hang up their handsets.

Q: My communications program isn't dialing my modem. What can I do?

A: You have to make sure there is a
(Continued on page 100)



Bargains for your Workbench

Used gear may not be state-of-the-art, but it gives the enterprising hobbyist an excellent way to stock a workbench without draining a bank account.

BY LARRY LISLE, K9KZT

Test equipment usually isn't a high priority item for most electronic hobbyists—until something won't work or breaks! That's because new test gear can be costly, and we'd rather put our hobby money into something that puts watts into a speaker, a signal into an antenna, or is just fun to play with.

Happily, there's a way to equip a workbench without draining your bank account: You can buy older test gear at a hamfest or electronic flea market for very low prices and wind up with a test bench that will take care of most of your hobby needs.

Now older test gear is hardly state-of-the-art, but it's better than no test equipment at all! Remember, your most important piece of testing apparatus is between your ears. With a little thought you can often come up with ways to get the answers you need, even though modern equipment might do the job more directly and quicker. You can also build accessories to extend older gear's range and usefulness. In addition, older test equipment is often more direct in its operation, which can help you get acquainted with electronic testing in general. That will help you determine what

new gear you really need—before you plunk down your hard-saved hobby money.

People sell test equipment at hamfests for a variety of reasons—repair shop owners retiring, selling the old to buy new, and so on. Whatever the reason, the prices are often rock bottom.

Of course, when buying anything used there are never any guarantees, but my experience has been very good. Even so, since it's seldom possible to see the equipment in operation it's wise to make a thorough eyeball inspection. The external appearance of the test gear, and especially the line cord, will often tell a great deal about how it's been treated. Be sure to ask if the item is working properly. By far, the great majority of people at hamfests are honest, but don't expect them to blurt out that there's something wrong with their little gem if you don't ask! And be sure you get an instruction book and any special cables or probes.

Now, let's take a look at some of the equipment you might consider.

Measuring Voltage, Current, and Resistance. There are many different

types of instruments used for measuring voltage, current, and resistance. The simplest is the conventional volt-ohm-milliammeter, or VOM. That should be the first item on your shopping list. You'll be using your VOM even after you acquire more sophisticated meters, simply because it's so handy and easy to use.

Many times, the question is only whether voltage is present or absent, or if there's continuity between point A and point B. The VOM will tell you that with a minimum of fuss. I recommend a small unit because the main advantage of the VOM is its handiness.

The VOM has a major limitation, however. It tends to "load" the circuit to which it's connected. That can give false readings in high-impedance circuits or may cause a device to stop operating.

Historically, the earliest solution to the loading problem was the vacuum-tube voltmeter, or VTVM. Today, the same objective is accomplished using FET's. Both VTVM's and FET-VM's have good and bad points. The VTVM requires a source of line current, which limits its portability, but VTVM's usually have a larger meter,

which is easier to see out of the corner of your eye while you're adjusting a control. VTVM's are also considerably cheaper at hamfests. You can often find a very good one for \$10 to \$15.

Finally we come to digital voltmeters, or DVM's. As their name implies, they use a digital display instead of a swinging meter pointer. They're especially useful for measuring very small quantities accurately, such as the voltage drop across an emitter resistor.

Their main disadvantage is in taking readings where you're trying to find a peak or null, which is often required when aligning receivers.

RF and Audio Measurements. You won't work with radio receivers very long before you'll need an RF-signal generator to provide a signal on a known frequency. RF-signal generators are indispensable for alignment and very handy for troubleshooting in-operative sets.

State-of-the-art generators are fantastic pieces of equipment with prices to match. Fortunately, used, older units will take care of many of the same duties and can be purchased usually for under \$10.

At hamfests you'll find the standard RF-signal generator and also the more elaborate sweep generator. The latter will do everything the standard generator will, but can also be made to "sweep" the output frequency rapidly back and forth across a center frequency. When used with an oscilloscope, that lets you see the actual selectivity curve of the receiver. Since there's usually little price differential between the two at hamfests, for the best value keep your eyes open for a sweep generator.

Another kind of signal generator deserves special mention. The grid-dip oscillator (or its solid-state equivalent) is very useful if you build projects with tuned circuits. As its name implies, the meter dips when the "dip-meter" (as it's sometimes called) is tuned to the resonant frequency of a coil and capacitor. It can also be used as a signal generator when high accuracy isn't needed; as a wave meter; as a heterodyne detector, to find the value of small inductors or capacitors; to adjust antennas; and for many other purposes. They usually run around \$10, and are well worth it, but be sure you get all the plug-in coils.

Audio-signal generators are also nice to have around. They'll let you

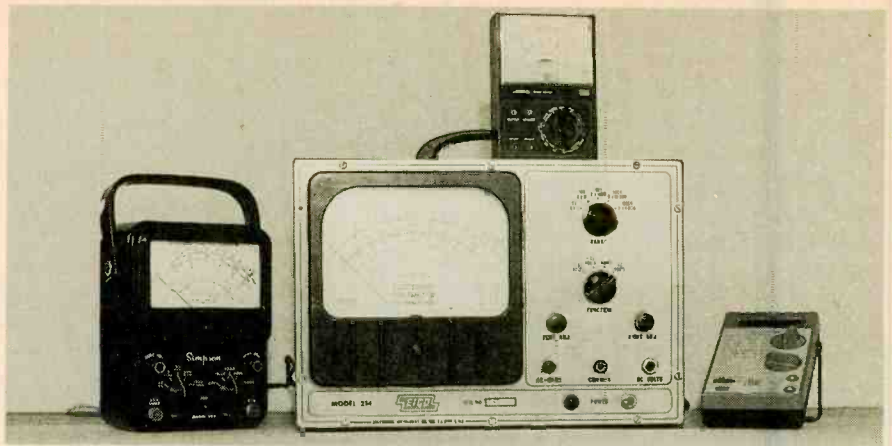

Here's a variety of instruments for measuring volts, amps, and ohms. Each has its advantages, and at hamfest prices you can afford to buy several.



A typical grid-dip oscillator, RF sweep-generator, and audio oscillator. Units like these can be found at most hamfests for around \$10.

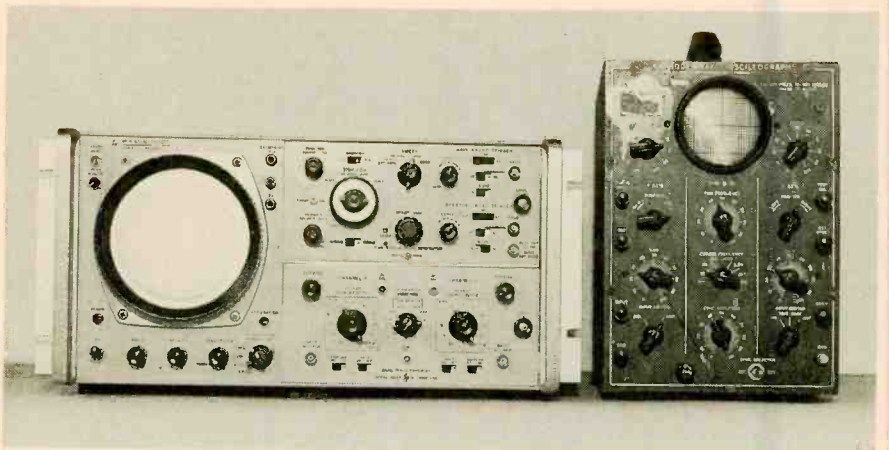

Oscilloscopes run from the sublime to the simple. On the left is a 20-MHz, dual-trace, storage scope. The one on the right is about as basic as oscilloscopes get, but might be easier for a beginner to use.

measure the gain and frequency response of amplifiers, adjust speaker systems, and so on. You'll find AF generators in the same price range as their RF cousins.

Oscilloscopes. An oscilloscope is probably the most valuable piece of gear you can have on your workbench; it can do more jobs and give more in-

formation than probably any other piece of test equipment. Because of that, oscilloscopes have become essential in many areas of electronics.

You can buy scopes with a wide variety of capabilities at hamfests for much less than their original price. As an example, I once bought a Tektronix scope, sans a plug-in module, for \$3 at

(Continued on page 98)

The modern microphone is a type of transducer built to convert sound waves or sound-creating vibrations, into electrical impulses. Currently, microphones are designed around a variety of physical principles including electromagnetism, capacitance, and piezoelectricity—the microphone has become a fairly sophisticated piece of equipment. But such was not always the case. The ancestors of the modern microphone were very primitive devices indeed.

The Otacousticon. The earliest microphone was part of an entirely acoustic communications system. It was based on the fact that a length of cord or wire stretched between two points carries sound much better than air. The principle is realized in the familiar string or "lover's telephone" made with a couple of cups or cans and a long piece of string.

When mechanical telephones of that type were first invented is not known for certain. However, Robert Hooke, an ingenious 17th century build-

er and experimenter, does make mention of the effect. Hooke says that air is only one of several materials capable of conducting sound. There are "other bodies" that function in a similar way, and some of those may be even better. With the help of a "distended wire," he tells us, sound can be communicated "to a very considerable distance in an instant."

Hooke seemed to think of it as a way of improving the performance of the human ear. Writing in 1667, he calls the instrument an otacousticon, a term already in use for at least fifty years.

An Unlikely Story. Microphone technology remained almost entirely non-electrical until the middle of the 19th century. And even then, after the great discoveries of Galvani, Volta, Oersted, and Faraday, the microphone was destined to get off to a very shaky start.

In 1854, French and English newspapers reported that the cables laid across the English Channel might be used to transmit the human voice. The method suggested is utterly unbeliev-

able. The individual wishing to make a call takes a piece of silver and a piece of zinc and puts them into his mouth. The silver goes above the tongue, the zinc goes below. Then, wires are attached to the electrodes, "and words issuing from the mouth so prepared are conveyed by the wire."

The idea seems to be a voltaic battery current made variable by building the battery inside the mouth. In such a way, linguistic and electrical variation are created simultaneously. But, just how that was supposed to work is very unclear.

A Better Idea. At about the same time a Frenchman by the name of Charles Bourseul developed a much better idea. He visualized a flexible metal plate hooked up to a battery and arranged to receive the vibrations produced by the human voice. The vibrating plate would interrupt and then re-establish its own electrical connection. He claimed that the impulses could then be converted back to sound via another vibrating plate lo-

BUILD AN "ANTIQUÉ" MICROPHONE

Learn how the earliest microphones worked and recreate a simple experiment that made the telephone possible.

BY STANLEY A. CZARNIK



cated elsewhere. Bourseul's system was very similar to one devised by an American experimenter, C.C. Page, in 1837.

The Wooden Ear. Bourseul never actually attempted to build his vibrating-plate microphone. However, his ideas did come to the attention of a German orphan boy who was very much impressed. And so begins the tale of Philip Reis, a creative man with a somewhat eccentric intelligence whose contributions to electrical technology have been almost forgotten.

As a child, Philip Reis was fascinated by physical science, and remained so for most of his adult life. He began a teaching career in 1858; and, two years later, in 1860, he constructed his first microphone.

What Philip Reis wanted to do was reproduce the human sense of hearing. But how was that to be done? Reis could think of nothing better than the construction of an artificial ear.

And that's exactly what he built. The simulacrum itself was carved from wood. He fashioned a tympanic membrane, or ear drum, out of a piece of pig's bladder. He made a malleus, or hammer bone, out of a small section of platinum wire and attached it to the membrane with some wax. The wire made loose contact with an adjustable spring. Finally, the mechanical ear was connected to a battery. When the pig's bladder vibrated in response to sound, the connection between the wire and the spring became intermittent. The result was a chain of interrupted electrical impulses which corresponded to the original acoustic input.

The wooden microphone of Phillip Reis was actually a very clever piece of apparatus and, while it didn't work too well, it did work. The problem with the system was at the other end of the line. His receiving machine consisted of a knitting needle within an electromagnetic coil placed on the top surface of a violin. Apparently, he was never able to come up with anything else.

This Little Nail. The credit for the invention of the microphone normally goes to the Anglo-American physicist David E. Hughes. Born in England in 1831, Hughes was educated in America and later became professor of music at the University of Kentucky. He announced the creation of the microphone before the Royal Society in 1878.

Hughes' first experimental device was so crude that it scarcely deserves



The earliest microphone was part of an entirely acoustic communications system. This is the familiar string telephone made with a couple of cups or cans and a long piece of string. In the 17th century, such a device was known as an otacousticon.

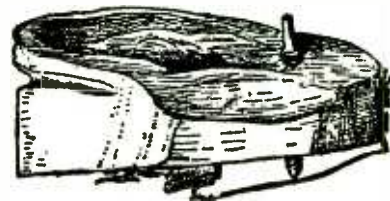
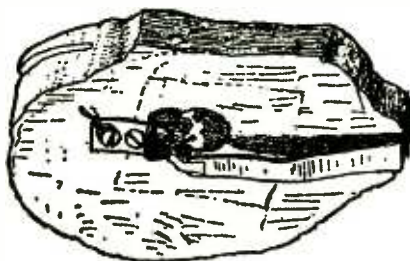
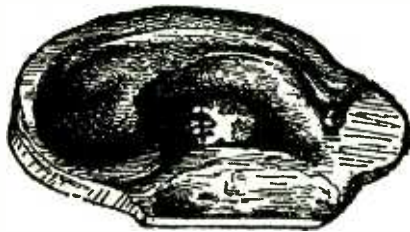

One of the first electro-mechanical microphone devices was made of wood in the form of a human ear. The apparatus was built by a German experimenter, Philip Reis, in 1860. The tympanic membrane, or ear drum, was fashioned from a piece of pig's bladder.

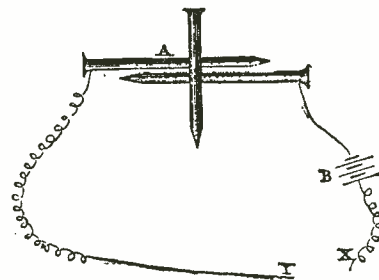

The credit for the invention of the microphone normally goes to the Anglo-American physicist David E. Hughes. His first experimental construction was very crude. It was made of nails (at A). The battery is at B and the output is at X-Y.

the name microphone. It was made of nails. Yes, that's right, nails—three of them to be exact. Two of the nails were laid down in a roughly parallel position. The third nail was laid across the first two. The parallel nails were connected to a battery and a receiver.

According to William Henry Preece, a well-known experimenter and author of several books on electricity, the nail device really worked. He tells us that words spoken and songs sung to "this little nail" were reproduced at the other end of the line with "marvelous clearness and power." William Preece appeared thoroughly enchanted with the simplicity of the apparatus, and it seems safe to say that he might have exaggerated.

It didn't take long for Hughes to make some badly needed improvements.

What he did was replace the nails with various pieces of carbon. The carbon pieces were held in position with small pieces of wood. Hughes' carbon-element microphones were quite sensitive.

In addition, Hughes' creations were, and still are, easy to reproduce. They're also lots of fun to redesign and experiment with—the variations are endless. You will be amazed at how well such extremely primitive devices hooked up to a battery and an earphone can actually change sonic vibrations to electrical impulses and then back again to sound.

Razor-Blade Microphone. One of the simplest Hughes-type microphones you can build involves the use of two razor blades and a narrow stick of carbon. The carbon sticks you'll need to perform our experiment are ordinary automatic-pencil refills. Such material is often called "black lead." But, it's not



One very simple Hughes-type microphone can be made from two razor blades and a slim stick of graphite, or, in this case, an automatic-pencil refill. The system is mounted on a couple of wood blocks. Binding posts have been added to facilitate wiring.

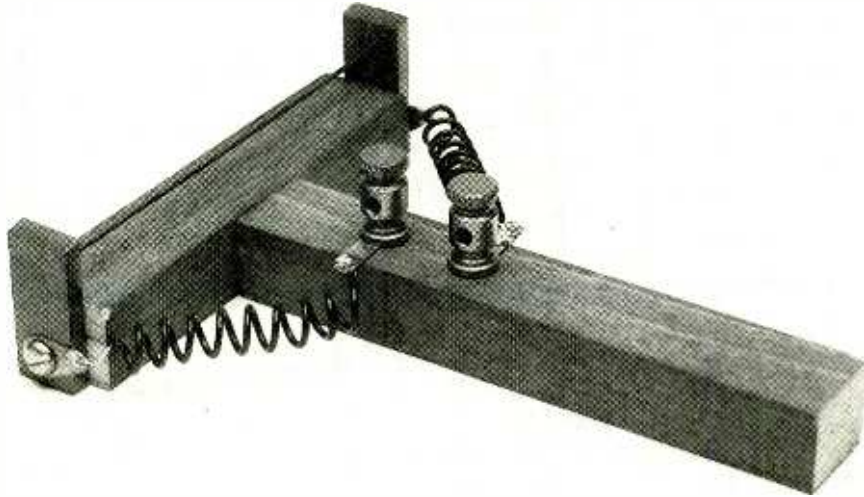

Another Hughes-type microphone can be made from a graphite stick and two properly prepared graphite blocks. When wired to a battery and an earphone this unit will respond to the tiniest mechanical disturbance.

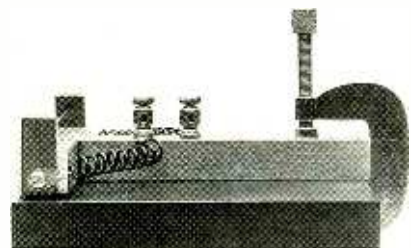

The sensitivity of the graphite microphone can be increased by clamping it to some sort of resonator, a hollow wooden box for example.

lead at all; it's graphite, an especially soft form of carbon. Automatic pencil refills are available at any large stationary store. Such refills come in a number of sizes and colors. If possible, get the longest ones; they are normally about 4 inches in length. Also, get plain black; the colored graphite does not seem to work very well.

Obtain two rectangular blocks of wood, one about 5 × 6 inches and the other about 2-3/4 × 1-5/8. The smaller piece should be no more than about 5/8

inch thick. If it's much bigger, it may begin to interfere with the movement of the graphite stick. If you wish, the appearance of the unit can be improved by darkening the wood with a good-quality stain.

Drill and countersink two holes for a couple of flathead wood screws in the smaller block. Attach the smaller block to one side of the larger block using the screws. Drill two holes near one end of the larger block and use them to mount a pair of binding posts equipped with solder lugs.

Locate two clean, unused flat razor blades. Attach one razor to each end of the smaller wooden block. Use two small screws and one small solder lug for each razor blade. Make sure the blades are perfectly horizontal. If they aren't, simply loosen the screws, move the blades into the proper position, and retighten the screws. **And please, be very careful not to cut yourself with the razor blades.**

Finally, connect the lug on each razor blade to the lug on a binding post with a piece of hook-up wire. Then place one graphite stick on top of the blades. If the graphite rolls off, readjust the blades. Now you're finished.

Operation. Now you'll need a low-voltage DC power source and a receiver. Good results can be obtained with a 6-volt lantern battery and a single 2000-ohm earphone. Do not use a crystal earpiece; it will probably not work. If you don't have an electromagnetic earphone, a small speaker may work.

Connect the battery, the earphone, and the razor-blade microphone together in series. With the earphone held up to your ear you will hear either nothing or a scratchy sound resembling static. Now, tap the base of the microphone with a pen or a nail or something similar. Then rub the base gently with your finger. The circuit will reproduce all such acoustic or mechanical activity quite well.

If you have a tuning fork, you can get the system to pick up a musical tone. Hit the fork against the side of your workbench. Then hold the bottom of the fork firmly against the microphone. The oscillations will be recreated in the earphone. It's a very pleasing effect.

What you hear in the earphone will seem to be amplified. In fact, that's one reason microphones were called microphones to begin with; William Henry Preece thought that Hughes-type devices were a bit like microscopes. What the microscope did for tiny objects, the microphone did for tiny sounds: it magnified them.

All-Graphite Microphone. There are many other ways to construct a Hughes-type microphone. Here is one of them: Essentially, what we'll do is build a different kind of frame and replace the razor blades with two small blocks of graphite. Suitable rectangular graphite blocks are available from JerryCo, a science surplus company see the Parts and Materials List for more information.

First, the graphite requires a bit of preparation. Clamp one graphite rectangle in a small vise and carefully drill a small hole near one end of it. Now drill a small depression near the other end. The depression should be no more than about 1/16-inch deep. Prepare another graphite block in exactly the same way.

Obtain two pieces wood, one about 3-1/2-inches long, one about 4-1/2-inches long, and both about 5/8- or 3/4-inch square. The exact dimensions are actually not too important, but make sure that the shorter piece is smaller than your automatic pencil refills. Attach one end of the longer section of wood to the center of the shorter section with a wood screw so the assembly resembles the letter T.

Now carefully punch or drill one small hole near the center of each end of the shorter length of wood. Then, attach the two graphite rectangles with a couple of screws. Each screw should be

(Continued on page 100)

THE DIGITAL ELECTRONICS COURSE

BINARY COMPARATORS

Ever wonder how error and parity checking are accomplished? Explore the world of binary comparators and see how those and other computer functions are implemented.

BY ROBERT A. YOUNG

In digital electronics, as in analog electronics, it is often necessary to compare two signals. In analog electronics that task is easily handled by an operational amplifier configured as a comparator. The job of a comparator is to accept two or more input voltages, determine whether one is greater or less than the other, or whether the two signals are equal, and to output a signal based on the input condition. An example of an analog comparator built around an op-amp is shown in Fig. 1.

Logic-Level Comparators. Like their analog counterparts, binary comparators are used to determine whether one signal is greater or less than another, or whether the two logic signals are equal. It then outputs a signal based on the input condition.

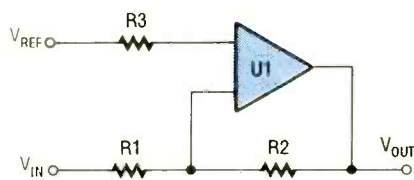

Fig. 1. In the analog world, an op-amp can be configured as a comparator.

*Our gratitude is extended to the EIA/CEG for the creation of this course, especially to the consultants who brought it to fruition: Dr. William Mast, Appalachian State University; Mr. Joseph Sloop, Surry Community College; Dr. Elmer Poe, Eastern Kentucky University.

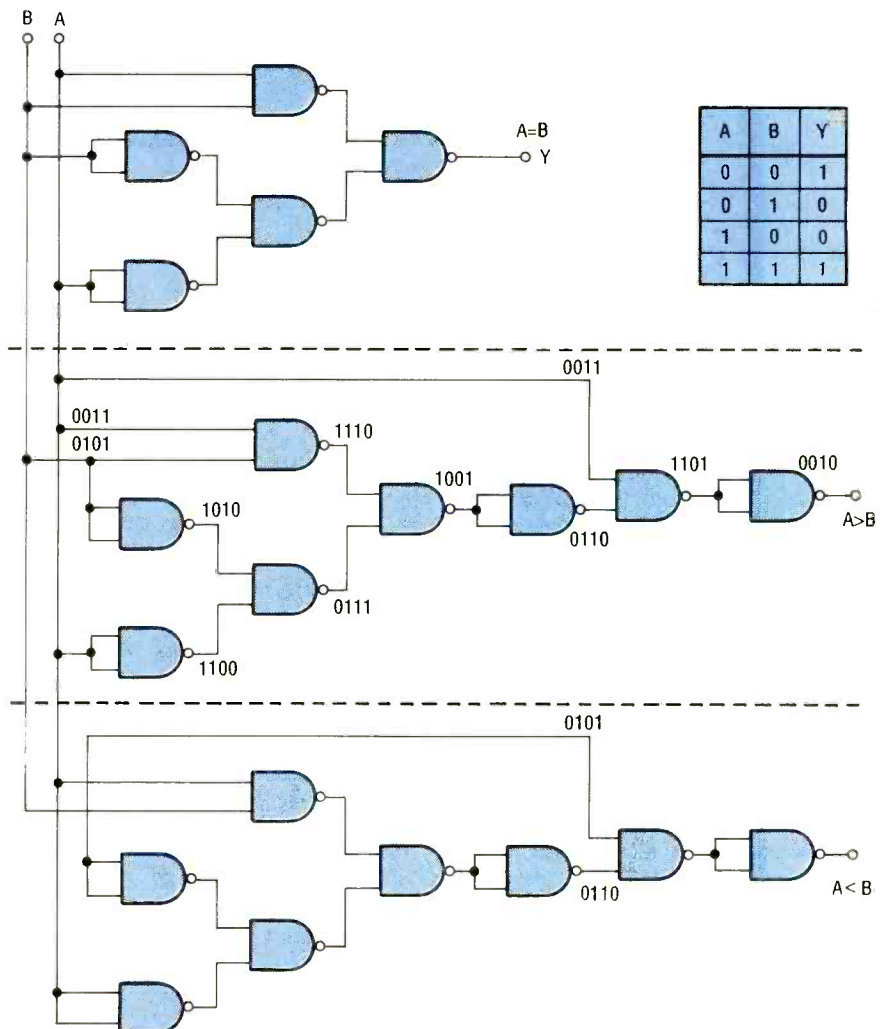

Fig. 2. This circuit, a combination of three circuits, can give a logic 1 output for the three different input conditions possible.

The upper third of Fig. 2 shows a simple circuit based on individual digital logic gates that can be used to detect when the two inputs, A and B, are equal. It outputs a logic 1 when that condition is detected. Note that it doesn't matter whether both inputs are at logic 1 or at logic 0; it only matters that they are equal.

Also shown is the truth table for that portion of the circuit. If you look closely at the truth table you may recognize that its outputs are exactly the opposite of those for a 2-input XOR gate for each input condition. That makes that

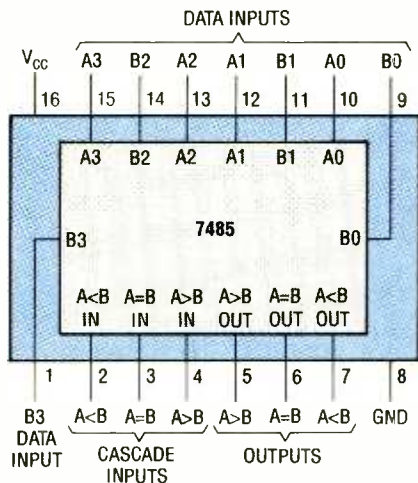

Fig. 3. This pinout diagram of the 7485 with its cascade inputs should give you a feeling of the versatility of the chip.

PARTS LIST FOR THE BINARY-COMPARATOR EXERCISE

SEMICONDUCTORS

- U1—324 quad op-amp, integrated circuit
- U2—7400 quad two-input NAND gate, integrated circuit
- U3—7490 decade counter, integrated circuit
- U4—7448 BCD to 7-segment common-cathode, decoder/driver, integrated circuit
- U5—7485 expandable four-bit magnitude comparator, integrated circuit
- DISP1—7-segment, common-cathode LED display

RESISTORS

- (All fixed resistors are 1/4-watt, 5% units.)
- R1, R2—47,000-ohm
 - R3—12,000-ohm
 - R4—Light-dependent resistor (1-megohm in dark, 100-ohms in light)
 - S1—SPDT toggle switch
 - S2—4-position DIP switch
- Breadboard materials, 5-volt power source, wire, etc.

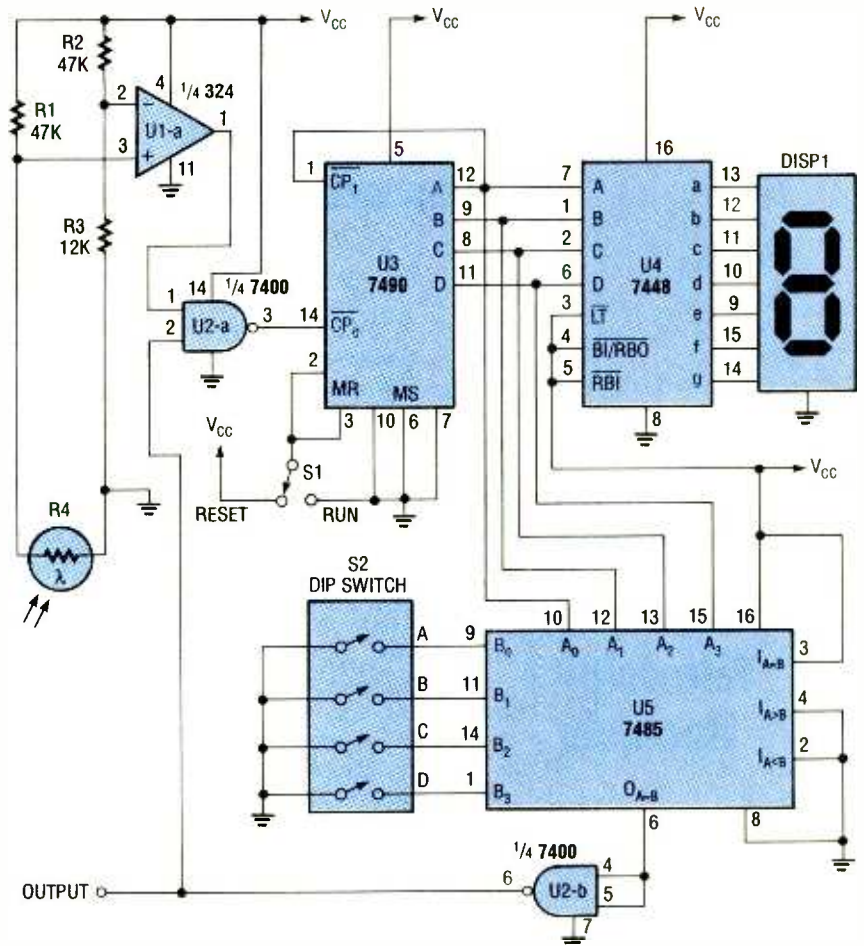

Fig. 4. This circuit digitally compares the output from a light sensor to a pre-set binary value.

portion of the circuit a NAND-implemented XNOR gate.

With the addition of another gate or two (depending on the input condition that you are trying to detect), that portion of the circuit can be made to output a 1 when input A is greater than B (A is at logic 1 and B is at logic 0) or when A is less than B (A is at logic 0 and B is at logic 1), which is what the rest of the circuit does as we'll explain.

First we need to devise a circuit that's capable of detecting and producing a logic 1 output when and only when input A is greater than input B. That function is easily handled by the middle

portion of Fig. 2. Look over the circuit and familiarize yourself with its operation. Follow each of the possible input combinations through that section of the circuit to see if it indeed outputs a logic 1 only when A is greater than B.

Next we need a circuit whose output will be at logic 1 when and only when the A input is less than the B input. By slightly rearranging the middle circuit, we get a circuit that meets that criteria, as shown at the bottom of Fig. 2.

Of course a circuit like that shown in Fig. 2 would have little practical application in digital electronics. However, it is possible to develop a circuit that will accept two multiple-bit inputs and produce an output based on the two multiple-bit inputs. One such unit is the 7485.

4-Bit Magnitude Comparator. A pinout diagram of the 7485 is shown in Fig. 3. That IC is capable of comparing two 4-bit words in any monotonic code (binary, BCD, etc.) and then generating three outputs: A is greater than B, A is less than B, and A is equal to B. Each

(Continued on page 98)

PRODUCT TEST REPORTS

Casio TV-7500 Color-LCD Television Receiver

Casio, (570 Mt. Pleasant Ave., Dover, NJ 07801) perhaps best known for their calculator and musical instrument products, was also one of the first companies to produce a small-screen color TV set using liquid-crystal display (LCD) technology. Their current entry, the Model TV-7500, not only offers a larger picture than the 2-inch (measured diagonally) screen of their older set, but its brightness is superior to that of earlier LCD TV sets made by Casio and others.

This little TV set offers a 3.3-inch screen, yet the entire set measures only 4 ×

(Model AD-K90). While batteries are supplied with the TV set, don't expect them to last as long as alkaline types, which can provide power for approximately 3 hours of viewing. Other supplied accessories include a soft carrying case and an earphone. In addition to the AC adaptor, other optional accessories include a car-battery adaptor, (CA-K900), an RF connector (CF-13), and an audio/video cable (AV-C1) for hooking the set to a VCR or a camcorder.

The TV-7500 can receive channels 2 through 69. A wire stand lifts away from

fully extended, measures 23 inches in length, but contracts to a mere 3½ inches when the set is not in use.

The major improvement in picture quality over earlier LCD sets is the use of a built-in backlight. Thanks to that, it is no longer necessary to have proper external lighting for the LCD screen to offer viewable pictures. However, that improvement comes at a cost: The rather strong backlighting made colors appear rather weak and made it impossible to see all of the shades of gray in the 10-step linearity pattern that is normally used by us during testing of any TV set.

CIRCLE 119 ON FREE INFORMATION CARD



The Casio TV-7500 color LCD TV.

3½ × 1⅞ inches and weighs slightly less than one pound. Power is supplied by six "AA" batteries, or by an optional AC adaptor

the rear of the unit so that the set can be positioned on a surface at just the right viewing angle. A monopole 11-section antenna, when

CONTROLS

In addition to the LCD screen itself, the front face of the Casio TV-7500 has a three-position switch that turns the set off or selects VHF or UHF reception. To the right of the screen are two sets of channel numbers: from 2 to 13 for the VHF channels and from 14 to 69 for UHF. Actual tuning is done by means of up and down tuning buttons located on the top surface of the set. When either of those is depressed, a small line that is displayed at the right edge of the LCD moves along much like a dial pointer so that tuning is, in effect, continuous. Each time either button is pressed, the dial pointer stops at the next received higher or lower channel. By keeping one of the buttons depressed continuously, you can scan the entire dial

without having to stop at each received signal.

The right side of the TV set is equipped with thumb-wheel brightness and volume controls, an input for the optional AC adaptor, and an external antenna jack. Access to the battery compartment is at the rear of the set. The left side panel of the TV set houses the audio/video input jack as well as an earphone jack. When the earphone is plugged in, the tiny internal loudspeaker is bypassed. A tint control is located on the underside of the TV set.

TEST RESULTS

As in our previous video-product test reports, all lab measurements were made by the Advanced Product Evaluation Laboratory (APEL). Results of their measurements, along with the actual sample tested, were then sent to my lab for further subjective testing and extended use of the product.

Maximum usable luminance was only 8.0 foot-lamberts. That was not unexpected, since LCD screens, even when supplied with proper backlighting, cannot deliver anywhere near the kind of brightness that is offered by CRT-type TV sets. Horizontal resolution was an impressively high 240 lines, or about what one can expect from a standard VHS videotape recorder or a conventional TV set that is not equipped with such enhancements as a comb filter for better resolution. Transient response, or the ability to display sudden changes from one level of brightness to another during a single horizontal sweep, was excellent. Black level was a bit poorer than we usually measure for conventional TV sets, but it was nevertheless up at 80%. As mentioned earlier, color was on the weak side.

TEST RESULTS—CASIO TV-7500 LCD COLOR TV

Specification

Maximum usable luminance
Horizontal resolution
Transient response
Color quality
Overscan
Reception at 1000 μ V
Reception at 100 μ V
Power consumption
Picture size (Diagonal)
Dimensions (H x W x D, inches)
Weight
Suggested price: \$409.95

Overscan amounted to about 2%, with the picture shifted to the left by about 8%. We have no way of knowing whether this slight picture asymmetry was caused by the need to have the simulated dial-pointer display at the right side of the screen or whether this shift was present on our sample only. In any case, the shift was not severe enough to cut off an essential portion of any scene.

Strong-signal reception, defined by APEL as signal strengths of about 1000 microvolts/meter, was good, while weak-signal reception at signal levels of about 100 μ V/m (equivalent to fringe-area reception) was

APEL Measured

8 foot-lamberts
240 lines
Excellent
Weak
2%
Good
Satisfactory
3.1 W, 0.34 A
3.3 inches
4 x 3 $\frac{3}{4}$ x 1 $\frac{1}{2}$
15 oz.

deemed satisfactory with a moderate amount of noise present on-screen. Additional measurements are summarized in the chart that appears elsewhere in this report.

HANDS-ON TESTS

Our laboratory is located some 18 miles, "as the crow flies," from transmitters of the major networks and independent TV-stations in our area. All of the signals in the VHF band were received satisfactorily using only the extendible monopole antenna supplied with the set. In addition, we had no trouble picking up some four or five UHF signals, some of which were located at distances of up to

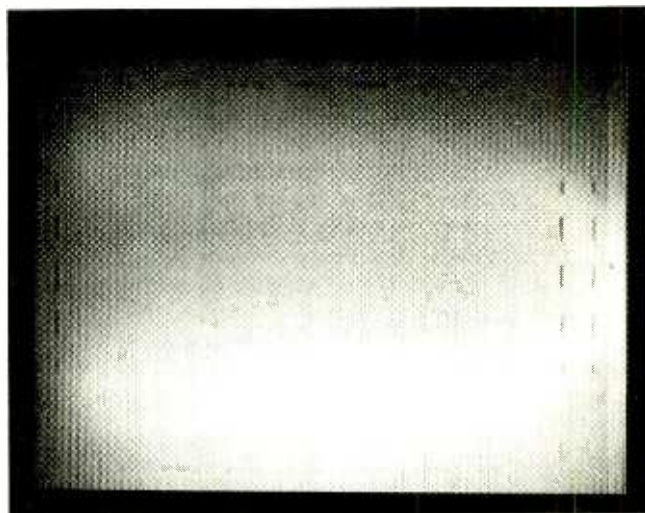

Overscan amounted to about 2%, with the picture shifted to the left by about 8%. The shift may have been intentional to accommodate the simulated dial-pointer display at the right side of the screen.

30 miles, again, using only the supplied monopole antenna.

The vertical angle at which best picture is obtained is rather limited—about $\pm 10^\circ$. If the correct viewing angle is not used, the picture either becomes too dim or too bright, but in most cases I was able to correct that effect using the brightness control.

I found the Casio TV-7500 to be particularly appropriate to use with my camcorder. Most camcorders are equipped with a tiny black-and-white viewfinder. Not only does this type of viewfinder fail to tell the camcorder user what is likely to be seen when a tape is played back in color, but it also requires that the person using the video camera have one eye "glued" to the eyepiece of the viewfinder for the entire time that a recording is being made. It seems to me one could easily fashion a little platform and attach it either to a tripod or even to the camcorder itself and have the freedom to observe a scene being recorded using both eyes.

Not everyone will want to use this small, portable color TV set for that purpose, I suspect. As a portable TV set, a unit such as the Casio TV-7500 might be thought of as the video equivalent of the ubiquitous "Walkman"-type personal audio tape player that is used by millions. The "Walkman" may, in many cases, fall short of reproducing the sound quality obtainable in your home audio system, and the TV-7500 may fall short of delivering the kind of pictures you see on your large-screen home TV set. Still, each item fills a definite need in our mobile society, and fills it well. For more information, circle no. 119 on the Free Information Card.



SAMS PHOTOFACT SERIES



CIRCLE 120 ON FREE INFORMATION CARD

If you need a schematic or other documentation on a particular electronic device, then get the facts—Sams Photofacts, that is.

Over the past few years, I've spoken to a lot of people who were in desperate need of a schematic or some other piece of technical information. It is surprising to me how few people ever consider *Sams Photofacts* as a quick, inexpensive, and reliable source for almost any kind of technical documentation.

Founded in 1946, *Howard W. Sams & Company* (P.O. Box 7092, Indianapolis, IN 46207-7092) started out providing service manuals for radio and television. Using a technique called "reverse engineering," which basically involves tearing apart a product down to its individual components to create original documentation from the ground up, they have since documented approximately 153,000 different electronic devices. Items now covered include radios, TV's, record players, car radios, CB radios, computers, printers, disk drives, VCR's, and various other products.

Similar appliances from various manufacturers are grouped together into a package of "Facts." So much for who Sams is, how they got started, and what they can provide you with. Let's take a look at exactly what's covered in some of their manuals.

Photofacts. Sams Photofact No. 2718 includes coverage on two television receivers: the Quasar model TT9808CW and the Sears model 564.40654850.

Items discussed concerning both sets are similar, so let's take a look at just the Quasar model. To begin with, alignment instructions are given, that are clearly written and logically ordered. Convergence adjustments are also provided.

Next, disassembly instructions follow. They tell you exactly which screws, connectors, clips, and latches must be removed in the proper order to open up the set without damaging anything—you know how there's always that little plastic part that snaps in two when you tug on the wrong thing. Removal of all the components of the set, including all circuit boards and the CRT, are covered.

Clear photographs of all major components and circuit boards are shown, including "gridtrace" location guides of all boards. They allow you to quickly find any component on a board. For example, C209 is in location M-7 on the main PC board, and you can clearly see it in the photo. Troubleshooting aids such as that really cut down your repair time.

Also included is a quick-check troubleshooting section that will help direct you to the source of a problem. While that by no means can substitute for first-hand TV-repair experience, it does provide you with key voltages and waveforms to check for on each board. For example, they might show you what the input waveform to a particular IC

should look like. A good input signal might tell you that the problem is due to that component or one that follows, and a bad input would indicate something before that component.

One thing that's included, that you don't see too often, is a semiconductor cross-reference guide. That allows you to substitute a part that you do have in stock, for one that you don't. It's not a necessity, but it is a nice extra. They even give you a list of the test equipment you'll need to repair each appliance.

Last, but certainly not least, easy-to-read schematics of all boards are given. They include all of the voltages and waveforms that should appear at all points in the circuit. An experienced technician should have no trouble quickly locating any kind of problem.

VCRfacts. Although *Sams' VCRfacts* are similar in content to the Photofact mentioned before, they, of course, deal with VCR's. Much of the same circuitry is found in both TV's and VCR's. That's because the two are the same with respect to the tuner circuitry. Where the two differ is that a TV contains high-voltage CRT circuitry, and a VCR has tape heads, transport mechanisms, and their associated circuits. By the way, if you feel like tinkering with either of the two, a VCR is much safer as it lacks a TV's high voltages, (although you do have to

(Continued on page 94)

Give a Friend a Year of Electronics Fun this Christmas. . .

Does fighting the crowds at Christmas short-circuit your holiday fun? Don't blow a fuse this year. . .for the friend who shares your love of project-oriented electronics — or a youngster who may need only a spark to ignite a life-long interest — give a gift subscription to Popular Electronics.

. . .Because when you give him Popular Electronics, you're giving month after month of challenging construction projects — including complete plans for testing equipment, electronic worksavers for home and car, add-ons and modifications for hi-fi, computers, radio and TV.

He'll get the how-to he needs to build exciting, useful projects like these. . .a touch light dimmer. . .a traveler's theft alarm. . .an economy NiCd battery charger. . .a voice synthesizer. . .a wave form generator. . .the ultimate burglar alarm. . .a stereo graphic equalizer. . .and many, many more!

PLUS. . .testbench tips and techniques. . .circuit design. . .electronics fundamentals. . .book reviews and new product news including our 12-page "Gizmo" section. . .regular columns on computers, scanners, dx'ing, ham and antique radio. . .the list goes on and on!

SAVE MONEY. . .A great gift to receive, Popular Electronics is also a great gift for *you* to give! The Special Holiday Rate saves you \$16.45 off the newsstand price on each gift. You can save another \$16.45 when you start or extend your own subscription at the same time. It's our "thank-you" for sharing Popular Electronics with a friend this Christmas.

Send no money, unless you prefer. We'll be glad to bill you in January, Next Year. Just take a brief moment to go over your gift list and make sure you haven't forgotten anyone who might appreciate the many benefits of Popular Electronics. Then write the names on the attached Gift Certificate and mail it back in the postage-paid reply envelope. . .we'll take it from there!

Your friends will receive a handsome gift announcement card signed with your name just before Christmas. And all through the new year they'll remember and appreciate your thoughtful gift!

So don't blow a fuse. . .take it easy and enjoy the holidays. Give Christmas gifts of Popular Electronics!



ANTIQUE RADIO

By Marc Ellis

More Tube Testing Power!

Readers who have been following the column for the last several issues know that we're currently embroiled in a long-term tube-tester design and construction project. The tester that will come out of all this work is not intended to rival the performance of a good-quality commercial unit, except in one regard: It will be equipped to handle receiving tubes from the earliest days of broadcasting, like the 99, 11, 12, and 01-A. Most good commercial testers, even earlier models, lack the test data and/or specialized sockets

The original testers used a step-down transformer to provide filament power; it was equipped either with multiple taps to supply the different voltages needed for various tubes, or with a voltmeter and heavy-duty rheostat for setting the voltage to the correct value. Plate voltage was obtained by direct connection to the AC power line—a highly dangerous procedure that makes us shudder today, but didn't seem to bother folks much about fifty years ago.

Today, tapped filament transformers for tube testers

sive variable-voltage power supply for regulating the filament voltage for the tube under test. Last month's column provides full construction details.

As also discussed last month, we'll be obtaining plate voltage from a second step-down transformer (T2 in Fig. 1) connected, secondary to secondary, with the filament power transformer (T1 in Fig. 1). The primary of this second transformer provides a safe source of 117-volts AC, completely isolated from the AC line.

PLATE VOLTAGE CONTROL

The reason we need a method for measuring and controlling plate voltage is so we can standardize that voltage to provide consistent testing conditions. Line voltages can vary in different parts of the country and at different times of day. Without being able to monitor and adjust plate voltage, we'd never be sure that the results of a tube test would be comparable with published standards.

Once again, modern semiconductor technology—this time in the form of an ordinary wall-mount lamp dimmer—provides an easy and precise method for voltage control. The dimmer is wired in series with the transformer secondary that provides plate voltage (Fig. 1) and the plate circuit of the tube under test.

Though designed for 117-volt service, the dimmer is not intended for our low-current application. Thus, it doesn't operate reliably without some added load (R5 in Fig. 1). Right now I'm

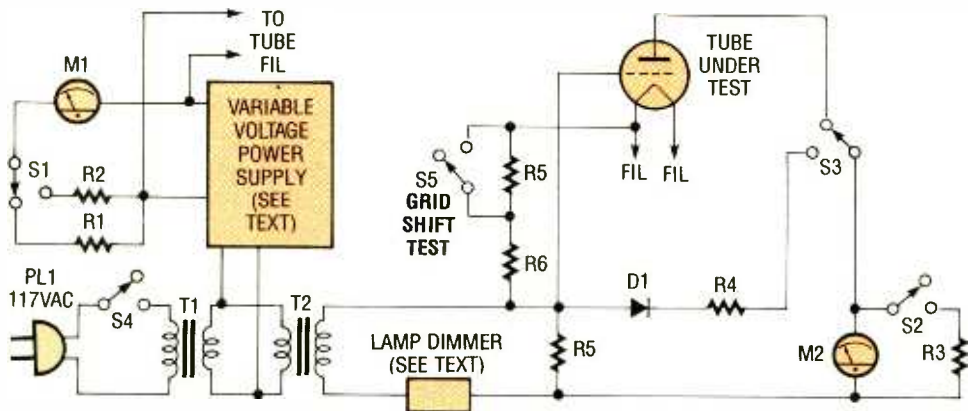

Fig. 1. Simplified schematic of tube tester illustrates how meters M1 and M2 provide all necessary metering functions (see text).

to test the full range of those early tubes.

WHERE WE'VE BEEN

So far we've covered the theoretical basis for the tube tester (based on a 1920's design) and developed the basic schematic diagram. Last month, we began practical work on the only real problem involved in creating a modern version of the tester—providing controllable voltage sources for the filament and plate circuits of the tube under test.

are all but unobtainable. Power rheostats aren't easy to get either and, in any case, are pretty crude tools for use in such an application. Finally, in these safety-conscious times, we wouldn't think of powering a unit such as a tube tester directly from the AC line.

Our present tube-tester design also uses a step-down transformer for filament power. But, thanks to modern semiconductors (notably the LM317T voltage regulator), we've been able to put together an inexpen-

using a 117-volt, 4-watt lamp at R5, but I might change to a lighter load by the time I build the prototype tube tester.

A MULTIPLE METERING

This is a meter-intensive project. For instance, the voltmeter (M1 in Fig. 1) used to measure the output of the filament-power supply should be able to read accurately in the one-volt range (the scarce and expensive type 11 and 12 tubes have 1.1-volt filaments). Yet, it needs to be able to indicate up to 16 volts if this tube tester is going to be able to serve double duty as a tube rejuvenator (see the August, 1990 issue for more information on that process). A meter that can indicate 16 volts is not going to be easy to read at 1.1 volts.

Meter M2, the plate-current indicator, also has to show a wide range of values. The plate currents involved in most amplifier-tube tests don't exceed 15 milliamperes. Yet when testing a rectifier tube, plate currents of over 100 milliamperes are not uncommon. Finally, we need a method for monitoring the plate voltage supplied by our lamp dimmer so that we can adjust it to a standard value.

Of course, you could purchase a separate meter for each of those uses. But even if you could get them at the right price, having five meters on the front panel of this simple tester would be clumsy and confusing. The answer is to get multiple usage from your meters by manipulating their ranges and providing appropriate switching circuits. That is really pretty easy, and I've always found it fun to do.

Taking a look at Fig. 1, you can see that we've managed to arrange things so that two meters, M1 and

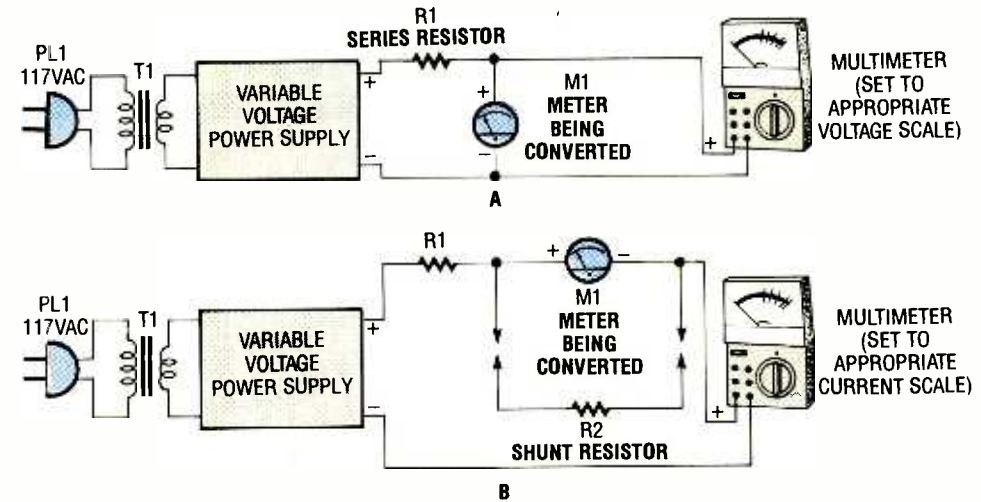

Fig. 2. A schematic diagram for the test setup for adjusting voltmeter ranges is shown in A; the test setup for adjusting milliammeter ranges is shown in B.

M2, do all of the work. Let's talk a little bit about how that was accomplished—starting with acquisition of the meters.

I've tried to make this a project that you can shop for at your local Radio Shack, and the meters are no exception. Meter #270-1754 in the Radio Shack catalogue (nominally a 0- to 15-volt DC unit) can be used at M1 and M2, and we'll talk about that a bit later. But the Radio Shack meters are modern looking, and I'd like my project to have a period feeling about it. So I decided to go flea-market shopping.

Most hamfest flea markets are loaded with old meters at dirt-cheap prices, and the one I shopped at was no exception. At one booth, I found a large box full of interesting candidates at \$1.50 each. Looking through it, I spotted several Weston 2-inch round units of similar appearance. They were all marked Model 502, but had a variety of scales and functions.

Not being too sure which of these would turn out to be most useful, and wanting to have plenty of choice in case some were defective, I picked out five

different DC current meters (one microammeter and four milliammeters).

SETTING UP THE VOLTMETER

You might be wondering why I purchased a number of ammeters for the project—but no voltmeters. That's because an ammeter can be converted to a voltmeter, but the reverse conversion is usually not possible. As you'll see later, the Radio Shack voltmeter is an exception.

Among the meters I obtained was a 0-2 DC milliammeter that looked like a good candidate for my filament voltmeter. Its scale was appropriate for conversion to a dual-range voltmeter reading either 0-2 volts (perfect for 1.1- and 1.5-volt tubes) or 0-20 volts (fine for the higher-voltage tubes and for use in tube rejuvenation).

Ammeters are converted to voltmeters by adding a series resistance (Fig. 2A). Figuring out the value of that series resistance boils down to a simple exercise in Ohm's law. In the case of the first conversion, we need to know what value of resistance in ohms (R) will cause the current (I) through the meter to have

a value of two milliamperes (0.002 amps) when the voltage (E) across the resistance and meter series combination is two volts.

Since, according to Ohm's law, $R = E \div I$, the value of the resistance is $2 \div .002$, or 1000 ohms. Using the same reasoning, the series resistance value required to convert the meter to a 0-20 voltmeter is $20 \div .002$, or 10,000 ohms. *Note:* When using Ohm's law, all quantities must be expressed in equivalent units. The practice is to express voltage in volts (not millivolts or microvolts), current in amperes (not milliamperes or microamperes) and, of course, resistance in ohms.

Choosing the correct series resistor for accurate readings is apt to be a trial-and-error process. For one thing, our equation above did not take into consideration the internal resistance of the meter (it's usually negligible, but in some cases could have a significant effect). For another, the meter (particularly if it's a flea-market version) may be inaccurate and require adjustment of the series resistance value to hit the correct reading.

(Continued on page 93)

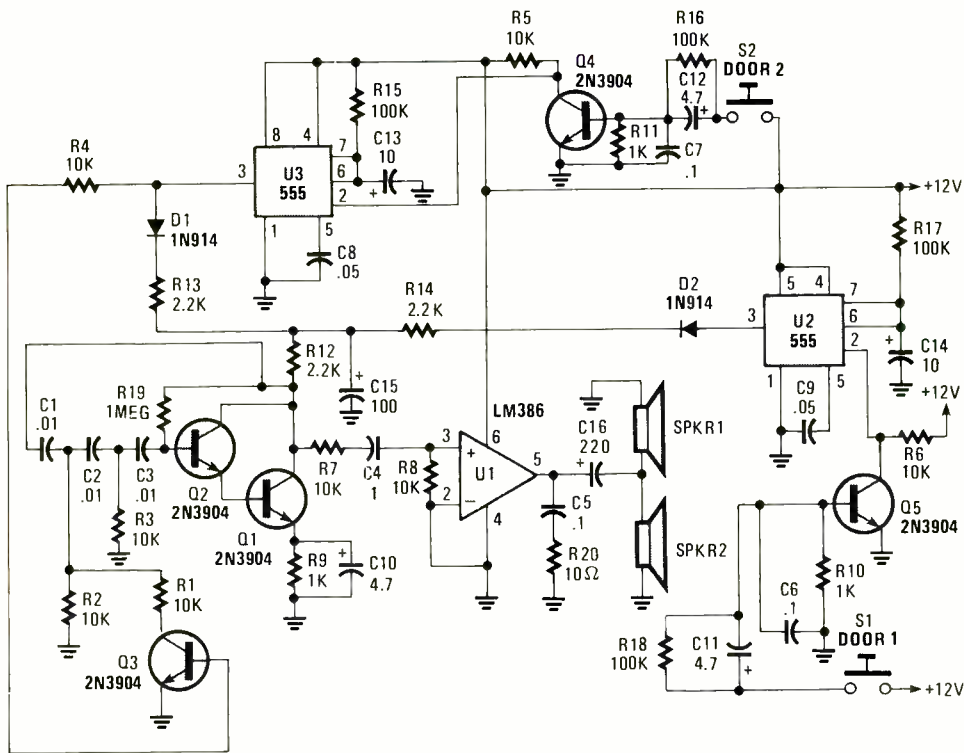

Fig. 2. This expandable two-door annunciator circuit (built around three IC's, five transistors, and a few support components) provides two distinctively different tones, so that you can tell which door to answer.

PARTS LIST FOR THE TIME-OUT CIRCUIT

SEMICONDUCTORS

- U1—555 oscillator/timer, integrated circuit
- Q1, Q2—2N3904 general-purpose NPN silicon transistor
- Q3—2N3906 general-purpose PNP silicon transistor
- D1, D2—1N914 general-purpose, small-signal silicon diode

RESISTORS

- (All resistors are 1/4-watt, 5% units, unless otherwise noted.)
- R1—2200-ohm
 - R2-R4, R7—10,000-ohm
 - R5—100,000-ohm
 - R6—10-megohm potentiometer

ADDITIONAL PARTS AND MATERIALS

- C1—0.1- μ F, ceramic-disc capacitor
 - C2, C3—47- μ F, 16-WVDC, electrolytic capacitor
 - SPKR1—Piezo speaker
 - S1—SPST toggle switch
- Perfboard materials, enclosure, 9-volt battery, battery holder and connector, wire, solder, hardware, etc.

some of you ingenious experimenters will come up with a few other creative uses for this timer circuit.

ANNUNCIATOR CIRCUIT

Our next entry turns three IC's, five transistors, and a few support components into a two entrance (expandable) door-bell (expandable) door-bell annunciator. Such a circuit might make a welcome addition to that weekend cabin, your new digs, or to replace an existing ding-dong door bell. The circuit provides each door loca-

tion with a distinct and easily identifiable bell-like tone. Additional door positions may be provided by duplicating a part of the circuit. Up to three strategically located speakers may be used to saturate the area with the announcement.

The schematic diagram for the circuit is shown in Fig. 2. The tone generator is built around two 2N3904 NPN transistors (Q1 and Q2) connected in a simple phase-shift oscillator configuration. The output of the

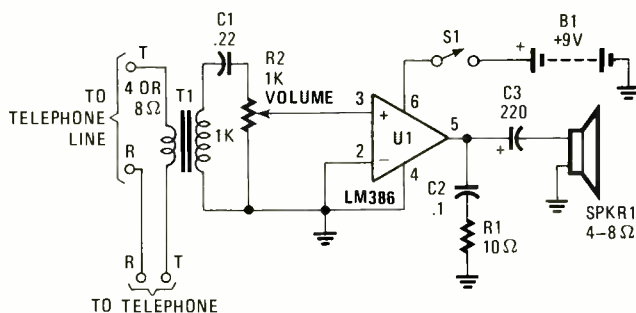

Fig. 3. This simple telephone amplifier circuit (which can be switched off for privacy) allows everyone in the room to listen in on your telephone conversations.

PARTS LIST FOR THE ANNUNCIATOR CIRCUIT

SEMICONDUCTORS

- U1—LM386 low-power audio amplifier, integrated circuit
- U2, U3—555 oscillator/timer, integrated circuit
- Q1-Q5—2N3904 general-purpose NPN silicon transistor
- D1, D2—1N914 general-purpose small-signal silicon diode

RESISTORS

- (All resistors are 1/4-watt, 5% units.)
- R1-R8—10,000-ohm
 - R9-R11—1000-ohm
 - R12-R14—2200-ohm
 - R15-R18—100,000-ohm
 - R19—1-megohm
 - R20—10-ohm

CAPACITORS

- C1-C3—0.01- μ F, 100-WVDC, Mylar
- C4-C7—0.1- μ F ceramic-disc
- C8, C9—0.05- μ F, ceramic-disc
- C10-C12—4.7- μ F, 16-WVDC, electrolytic
- C13, C14—10- μ F, 16-WVDC, electrolytic
- C15—100- μ F, 16-WVDC, electrolytic
- C16—220- μ F, 16-WVDC, electrolytic

ADDITIONAL PARTS AND MATERIALS

- S1, S2—single-pole single-throw pushbutton switch
 - SPKR1, SPKR2—8-ohm speaker
- Perfboard materials, enclosure, AC molded power plug with line cord, battery(s), battery holder and connector, wire, solder, hardware, etc.

tone generator is fed to the input of an LM386 audio power amplifier (U1), which is used to drive two speakers, SPKR1 and SPKR2.

Looking at the portion of the circuit that's tied to S1, we see a series 4.7- μ F electrolytic capacitor (C11) connected to the base of transistor Q5, the door switch (S1), and the 12-volt power source. When S1 is closed, capacitor C11

(Continued on page 99)

COMPUTER BITS

By Jeff Holtzman

Why Compute?

The other night, about 11:00 pm, inspiration struck. I had an idea for a new project, and I wanted to get it down on paper before the idea leaked out of my brain (the refresh rate of my internal "DRAM" is not what it should be). My first thought was to go down to the basement office, fire up my PC, and start typing. But I had an almost physical aversion to doing so. I wandered aimlessly about the house for awhile, eventually realizing that I didn't have



Fig. 1. Although computer technology has, over the last decade or so, done much to increase productivity, it has done precious little to aid creativity.

to use the computer, that in fact I could simply use a pencil and a pad of paper! O Revelation!

So I poured a drink, dimmed the light, sat down at the kitchen table, let my thoughts come at their leisure, and manually recorded them as they did. It may sound silly, but that was a liberating experience for one computer junkie. My revelation and the subse-

quent burst of creativity got me thinking about several issues:

1. A strong feeling that the computer interferes with the creative process.

2. A realization that most of the advances in personal computing of the past decade have really been in areas of production, not creation.

INTRUSION

By all normal standards, I have an enviable PC, including a 16-MHz Dell 80386 with 7 megabytes of RAM, a 150-megabyte Micropolis hard disk, a Video Seven VRAM Super VGA with a 19-inch NEC monitor (1024 × 768), internal Hayes modem, Microsoft mouse, Irwin tape drive, and all the latest and greatest software.

That setup is mostly used for writing, along with a fair amount of software development and desktop publishing. However, the PC has a very loud cooling fan, the entire setup is bulky, and it weighs a good deal more than 100 pounds. Not the kind of thing you would use for brainstorming at the kitchen table in dim light on a cool summer night. It's not intimate; it intrudes on that twilight area of consciousness from whence come new ideas.

Currently there is much talk in the trade press about a new class of portable computer without a keyboard that will accept stylus input via some sort of LCD panel. The primary market for that type of device seems to be hospitals (for entering medical information), and various types of sales situations. I'd like to see a device like that built

to serve creation, not just data entry.

A backlit, black-and-white, VGA-resolution screen with long battery life, and just enough smarts to get ASCII text and bit-mapped graphics files in and out would be a boon for writers, programmers, students, executives, and anyone whose job requires thought and originality, rather than slavish attention to rules of usage. And that brings us to the second topic.

WHO'S DRIVING THIS THING, ANYWAY?

The first time I saw WordStar running on an Altos CP/M machine more than ten years ago, my life changed deeply, irrevocably. I had to have it. I couldn't have expressed it at the time, but I felt that I was in the presence of something that was going to change the world. In the intervening decade, I have built up a machine with 100 times the memory, 64 times the speed, and 100 times the storage.

I no longer use WordStar, but little of the work I do calls for software that is much more powerful than WordStar 1.0. In fact, I use a \$50 text editor (Qedit) for the initial stages of most projects. Qedit is extremely fast and has a clean, simple interface based on the WordStar command structure, which I know better than the sharps and flats on my piano.

Yet I also have an HP laser printer, megabytes of soft fonts, Windows 3.0, Word, PageMaker, Corel Draw, and numerous other complex, high-powered programs. The odd thing is that I can't use that stuff

except when I put on my Production Assistant hat. All of those programs are extremely powerful and fun to use. But all of them interfere with the creative process.

They're all geared toward the final stage of document production, and can literally stifle creativity if you try to use them early on. For example, I used to work with a woman who called herself a writer; she did her "writing" in Ventura Publisher, and formatted it immediately. Her work was unplanned, unorganized, disconnected, yet it tricked casual observers because the formatting made it look finished. The poor woman had fooled herself into believing that the icing is the cake, so her true originality was lost in the process.

WordStar 1.0 was the best, most efficient typewriter I had ever seen. When MicroPro (as the company called itself until recently) released a spelling checker, the trade press and users went wild. Great feature! (Never mind the fact that early versions were extremely buggy.) I didn't care; I was always a good speller. What I wanted was a dictionary, a real dictionary with cross-references, synonyms, antonyms, etymologies.

Although a decade has passed, there is still no real dictionary available for general use. (There is a CD-ROM version of the Oxford English Dictionary, but it has several problems: The OED is not useful for everyday writing; the product costs about \$1000, not counting the cost of the CD-ROM drive; and worst of all, it has a proprietary interface that is anything but user friendly. Nor can you get it from within your own word processor.) I firmly believe that most writers would jump at the chance to put a real dictionary in their personal computers, given a product

that was cost-competitive and as easy to use as a regular collegiate desk dictionary.

The same is true of most PC tools, regardless of the type of data they work on. Take circuit design/analysis tools. They aid in getting a preconceived design into the machine, modifying it, representing it (a schematic, for instance), and generating circuit-board artwork. But do they really help the design process itself?

How about a circuit-design tool that contained its own "dictionary" of components as well as circuit examples.

For example, say you're designing an audio mixer with several bandpass filters covering different ranges of the audio spectrum. How about pressing F1 to get a display of filter circuits—lowpass, highpass, bandpass, you name it. Press a few keys to cut and paste an example into your design, specify cut-off frequencies, and the program calculates resistor, capacitor, and inductor values for you. Does all of this sound a little far-fetched to you?

When pocket calculators first came out, they had only the four most basic arithmetic functions. Those functions helped, but still left a lot of manual labor when it came to calculating logs, trig functions, etc. It seems to me that in some ways, PC software is still in the four-function stage of development. We have word processors that can produce beautiful documents, and that put an unprecedented amount of control over appearance into the hands of the writer. But to this day we have precious few tools that aid the process of creation itself.

Maybe that's all we're ever going to get out of

these machines. But I hope not. I can envision having a "dialog" with a PC-based "agent" that would act as a sounding board and research assistant, kind of like this.

"I have an idea for a new software product."

"Tell me about it."

"It would aid the process of generating ideas."

"How?"

"It would have a built-in database of terms and concepts that it would attempt to match up against the user's input."

"Sounds like simple regurgitation."

"In a way, yes. But by pointing out similarities and differences, an idea might jog the user's mind, bring out a hidden connection, a hidden assumption, and make it explicit, thereby calling it into question—in other words, it would cause the user to think, to create."

"What other functions would this system perform."

"Some sort of linguistic analysis. For example, if the user wanted to create a new type of word processor, the system might question the user about the meaning of *word*, about the meaning of *process*, about what it might mean to process words. By calling the basic terms into question, it forces the user to think about what it is he wants to do, and how that process differs from convention."

Ideally, the agent would also be able to tap into external databases and gather information about similar, possibly competing ideas.

Fanciful stuff, eh? But I bet we'll see something like it before the end of the century. If I'm right, remember that you read about it here first!

AMAZING NEW Pocket Reference

480 pages of tables, maps, formulas, and conversions and it fits in your shirt pocket (3.2" x 5.4" x 0.6")!



\$9.95*



* Plus \$2.00 shipping & handling. Colorado residents add 56¢ tax.

Small sample of contents

Air Tool CFM vs PSI	Radio Alphabet
Battery Charging	TEN Radio Codes
Tire Manufacturer Codes	Telephone Area Codes
Lumber Sizes & Grades	Lost Credit Card Phones
Concrete & Mortar	Sound Intensities
Element Tables	Wind Chill Factors
Computer ASCII Codes	Frequency Spectrum
IBM® PC Error Codes	Geology Mineral Tables
IBM® Interrupts-I/O Map	Glues and Solvents
80286 Hard Disk Types	Bolt Torque Tables
Printer Control Codes	Wood Screw/Nail Sizes
Electric Wire Size vs Load	Math Formulas & Tables
NEMA Motor Frames	Plane/Solid Geometry
Wire & Sheet Gauges	Copper/Steel/PVC Pipe
Resistor/Capacitor Colors	Rope, Cable and Chain
Pilot Lamp Specs	Tap-Die-Drill Sizes
Fuse & Battery Specs	Sand Paper & Abrasives
RF Coil Winding Data	Weld Electrode & Solder
Wire Size vs Turns/Inch	3200 Conversion Factors

Money Back Guarantee - If not completely satisfied, return book postage prepaid, in mint condition for a 100% refund!

Sequoia Publishing Inc.
Dept 916, P.O. Box 620820
Littleton, CO 80162

CIRCLE 8 ON FREE INFORMATION CARD

FUN SOFTWARE

By Fred Blechman

A HISTORY LESSON

This month you'll find yourself as an American or Japanese pilot in the thick of the furious World War II Pacific carrier battles in *Battlehawks 1942*. Then you'll try your skill at pattern recognition and manipulation with *FACES*, and finally you'll sneak a look at the *Stealth Fighter*.

BATTLEHAWKS 1942

(Lucasfilms Games, Distributed by Electronic Arts, 1820 Gateway Dr., San Mateo, CA 94404, Tel. 800-245-4525. Available for IBM PC/XT/AT/PS/2/Tandy, 384K RAM, color monitor.

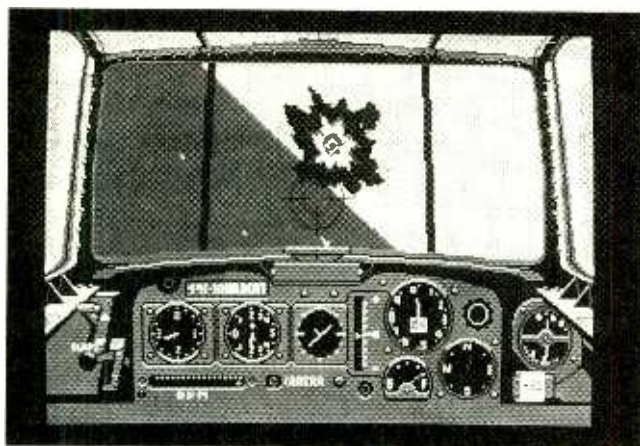

You can recreate some of World War II's most famous Pacific battles with *Battlehawks 1942*.

Joystick recommended. Reviewed on IBM XT with CGA and IBM AT with EGA.)

You won't be satisfied using this program with floppy drives, CGA, or a slow machine. You'll be unhappy with the long loading time, limited color, choppy screen updating, and poor control response. But with a 10-MHz or faster machine, a hard drive, and EGA, this program is a winner! The graphics are outstanding and the action is realistic in this simulation

of four famous carrier battles in early 1942.

The 128-page, spiral-bound, 6-by-9-inch manual is liberally-illustrated and loaded with historical facts. The battles of the Coral Sea, Midway, Eastern Solomons, and Santa Cruz Islands are covered in some detail with colored fold-out maps showing major ship movements and their related air attacks. The manual also includes flight fundamentals, aerial tactics, and tips, as well as detailed descriptions and photos of the combat aircraft and major warships used by the Japanese and Americans in 1942.

Two 5¼-inch floppy diskettes and one 3½-inch microdiskette are provided, so you can use either format. The disks are not copy protected, and the files can easily be loaded onto your hard disk. However, you'll need to answer a random airplane identification question, using the program manual, to get into the program.

Menu choices allow you to select training or active-duty combat missions. You select the battle, the country, and the aircraft. You also determine whether you want to fly fighter escort, fighter defense, dive-bombing, or torpedo-bombing missions.

Other program features allow you to get specifications and rotating views of each plane, and to preserve all action for later playback. When you're flying you can see all around and up and down, and some planes allow you to use rear gunners to protect yourself from attack.

Battlehawks 1942 combines history with arcade action. The graphics get very detailed as you close in on a ship or plane. Ammunition bursts and distinctive sounds add to the realism. A full instrument panel is provided, but landings and takeoffs are not. You choose one of seven different American or six Japanese planes to fly, with various gunnery, armor, and fuel options.

It's tough to down an enemy plane, but you can do it if you get in close, lead the target based on your deflection angle, and keep pumping cannon shells into him. First you'll see the enemy plane catch fire and then burst into a fireball and crash into the ocean. But watch your "six"—you can suffer the same fate!

CIRCLE 128 ON FREE INFORMATION CARD

FACES: TRIS III

(Spectrum Holobyte, 2061 Challenger Drive, Alameda, CA 94501, Tel.

415-522-3584. Retail Price: \$39.95. IBM PC, Tandy 1000 or compatible. Hercules, CGA, Tandy 1000 16-color, EGA, or 256-color MCGA/VGA required. 512K RAM; 640K for VGA. Joystick optional. Supports AdLib, Tandy 1000, and Sound Blaster sound. Soon to be available for the Apple Mac/MacII and Commodore Amiga.)

Soviet game designer Alexey Pajitnov, the creator of TETRIS and WELLTRIS, brings us *FACES*, his third in a series of arcade games. This time instead of falling rectangles or blocks, you are confronted with falling horizontal head parts - chins, lips, noses, eyes, and



FACES is another devilish Soviet game from the designer that brought you TETRIS.

foreheads—of 60 different faces! The object is to manipulate these falling head parts to form complete faces.

It's not as gruesome as it may sound, and can be quite challenging. The trick is to get the parts in the correct sequence as they fall from the top of the screen (two at a time.) It won't accept a nose on top of a chin; there have to be some lips in between. It doesn't matter particularly which lips—perhaps from another face—but lips they must be. Putting the right face together from its proper parts earns more points than a mixed face.

As each part falls, it is identified by number and part, such as "nose 4." You can change to some other noses (but not all) as the nose is falling, and you can shift it left or right to control, within limits, on which of five columns it falls.

FACES is not copy-protected, but you need to answer a screen question with a four-letter response found in the excellent, illustrated, 28-page staple-bound 5.5-by-8.5-inch manual. The game plays well even on a slow 4.77-MHz PC/XT with Hercules or CGA four colors, but it's better with EGA and 16 colors, and is finely detailed and even more colorful with a VGA system. A hard drive is not

required, and a joystick is supported, but seems unnatural. The cursor keys work fine.

FACES features ten levels of difficulty with a different category of faces (history, science, art, literature, music, etc.) for each level. Monsters and holiday faces are included, and you can even create new faces with any graphics program (such as Deluxe Paint III) that accepts .LBM format paint files

Head-to-head challenges allow up to ten players to compete in a tournament for preselected times. Even more amazing, two computers can be linked in a real-time contest using a null-modem cable or two modems!

With the proper sound boards, musical themes enhance every level of play. Other enhancements are background graphics, an advanced mode, and a scoring system that keeps track of the top ten high scores.

CIRCLE 129 ON FREE INFORMATION CARD

F-19 STEALTH FIGHTER

(MicroProse Simulation Software, 180 Lakefront Drive, Hunt Valley, MD 21030. Phone: 301-771-1151. Retail Price: \$69.95 for IBM PC/Tandy/100% compatibles; \$44.95 for Commodore 64/128.)

The sophisticated *F-19 Stealth Fighter* simulates the capabilities of the F-117A, the Air Force's formerly top-secret stealth fighter. Hundreds of combat scenarios are authentically represented in Libya, the Persian Gulf, the North Cape of Scandinavia, and Central Europe. The total operating area is over 250,000 square miles!

The documentation consists of an exciting, beautifully illustrated 192-page manual, a 10-page technical supplement, four detailed and colored reference maps, and three keyboard overlays (one each for PC/XT/AT, PS/2, and Tandy 1000 keyboards.)

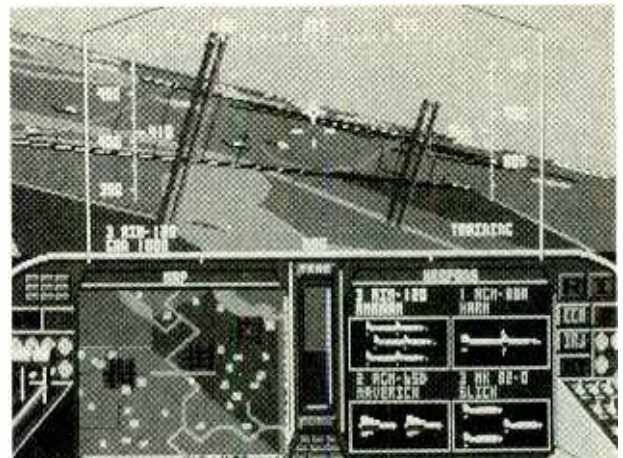

F-19 Stealth Fighter offers even the accomplished computer-pilot a tough challenge.

F-19 Stealth Fighter has an enormous number of features, and it will take you many hours to integrate them into your flight. You'll probably just take off and fly to a destination, avoiding combat, until you can handle the more sophisticated tasks of weapons selection, air-to-air combat, and strike missions. Medals and promotions from 2nd Lieutenant up to Brigadier General are based on your performance.

The colorful graphics are highly-detailed, 3-D filled images of skyscrapers, ships, bridges, aircraft, and other complex shapes. Your instrument panel includes

two multi-function CRT's. There are almost 80 keyboard controls, including a choice of 17 different types of weapons, and 5 built-in defense systems.

You are not limited to a front view from the cockpit through your heads-up display, since you can switch anytime to any of 11 different viewing perspectives (five from inside the cockpit and six more from outside the aircraft), each with zoom capability.

An original "key" disk must be used at startup, even if you're running *F-19* from a hard drive. Both 5¼ and 3½-inch diskettes are supplied. The program operates well with either

the keyboard or a joystick, and joystick calibration is provided. Use EGA if you can, since with CGA some color combinations that use numbers or text are hard to read. Also, the faster your machine's speed, the better. The *F-19* is fully aerobic with realistic stalling characteristics, but control is somewhat sluggish on a slow (4.77-MHz) PC.

Combat in the *F-19 Stealth Fighter* is difficult to master, and you may get discouraged unless you are motivated by strategy and tactics, and enjoy a tough challenge!

CIRCLE 130 ON FREE INFORMATION CARD

HAM RADIO

By Joseph J. Carr, K4IPV

Using An RF Dip Meter

Amateur radio operators work with antennas (as well as other tuned RF circuits and devices) and must be able to properly adjust them. There are a number of instruments available to aid us in that task and they run in cost and complexity from simple absorption wavemeters to "multi-kilobuck" network analyzers. But for most ham operations, the need (and available budget) suggests a simple, low-cost instrument.

DIP METERS

One of the most popular low-cost, simple instruments—one that a large number of amateur-radio

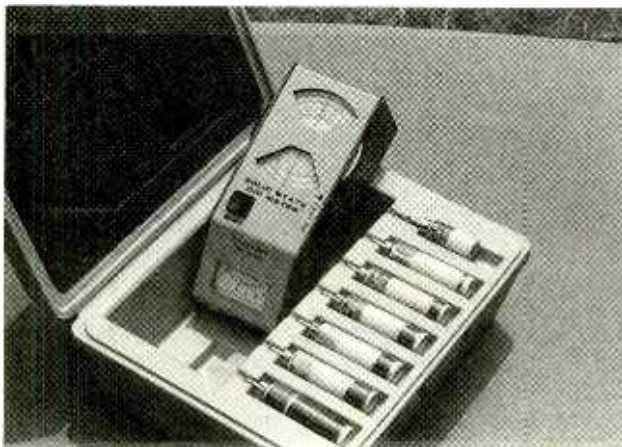

Dip meters come with an assortment of external coils that must be inserted into the meter. Here's a Heathkit dip meter with external coils in a fitted case.

operators have in their workshops—is the dip meter. A dipper, once called a grid-dip meter, is a tunable RF instrument that allows you to find the resonant frequency of antennas, tuned circuits, and other RF devices or circuits.

The dipper works because a resonant circuit will absorb RF energy at its resonant frequency, but not at

other frequencies. In other words, if you monitor the RF output of an oscillator with a meter, and couple the oscillator coil to an external tuned circuit, then a noticeable dip is seen on the meter when the RF oscillator tunes across the external circuit's resonant frequency. In older grid-dip meters, it was the vacuum-tube oscillator's grid current that showed the most noticeable dip, hence the name "grid dipper."

The Heathkit dip oscillator is a solid-state instrument that uses a field effect transistor (FET) for the oscillator. It comes with a number of external coils to allow tuning a wide range "from DC to daylight" (well, microwave to VHF). The coil for the band selected is inserted into the phono jack at one end of the dipper, and then used to close-couple to the resonant circuit or antenna under test.

At hamfests, radio clubs, and from the mail, I have heard amateurs claim, rather indignantly, that the dipper that they own is fouled up because it doesn't dip when they know that it tuned across the resonant frequency of the antenna under test. Do you want to bet that the meter isn't what's fouled up? It turns out that there are two common problems that prevent a proper dip.

FAULTY READINGS

The first reason is the fact that the antenna may *not* be actually on or near the frequency that you think it is tuned to. At the 15-meter band, for example, a very small change of antenna length results in a large change in resonant fre-

quency (on the order of 80 kHz/inch). A little "slop" in the wire or pipe length "for good measure" can drop the frequency into another band. For example, I once erected a commercial vertical antenna that resonated at 19.12 MHz because of sloppy measurement and local coupling to houses, fences, and other conductors. So don't think that the antenna is *really* resonant somewhere inside the band!

The second reason is that the operator might need adjustment. The dip on the dipper's meter is very sharp, and occurs very quickly. In addition, there is normally a small change in the output level of any oscillator as it is tuned (unless it has an automatic gain control output), and that movement is often mistaken for the dip.

What you are looking for is a very narrow, sudden dip. The only way to see that dip is to tune the dipper *very, very slowly!* If you do that, then the dip is very noticeable.

There is also the problem that lossy circuits, such as those LC circuits that contain a resistance, may be so broadly tuned that the dip is difficult to see. Figure 1 shows the method for coupling a dipper to an antenna that you can get to, such as a vertical that is ground mounted. Place the external inductor of the dipper close to the vertical radiator (usually an aluminum pipe), and then slow tune the dial from just below to just above the band in question. There will be a noticeable dip when the antenna's resonant frequency is found.

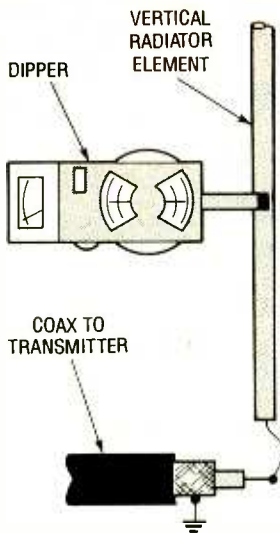

Fig. 1. A dipper is coupled to an antenna by placing its external inductor close to the vertical radiator element, and then slowly tuning the dial from just below to just above the band in question.

On antennas where the radiator element is not easily accessible, one must use a technique such as shown in Fig. 2. The "gimmick" is a 1 or 2 turn coil of wire that has a diameter just large enough to fit over the external coil of the dip meter; it is connected across the coaxial cable. Only a turn or two is allowable in order to not detune the dipper.

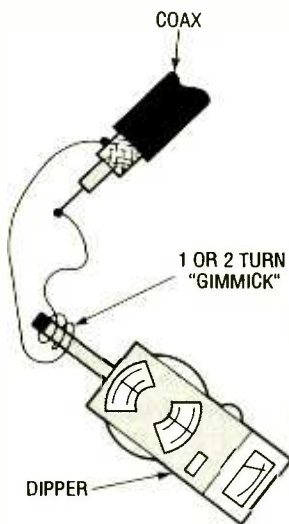

Fig. 2. On antennas where the radiator element is not easily accessible, one must use a "gimmick"—a 1 or 2 turn coil of wire that's just large enough to fit over the external coil of the dip meter; the gimmick is connected across the coaxial cable.

The dipper coil is inserted into the gimmick, and then operated in the same manner as above. You can expect the dip to be a bit broader than in the direct coupled case, and not as deep.

When testing the tuned circuits in linear amplifiers, transmitters, or antenna tuners, or when testing loaded antennas (i.e., antennas that use a series inductor to lower its resonant frequency), use the method in Fig. 3. There we see the external coil of the dipper held close to the inductor under test and then operated in the usual manner.

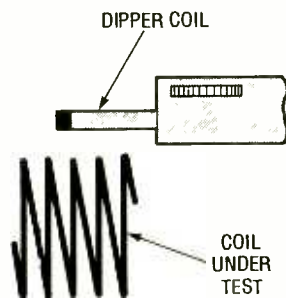
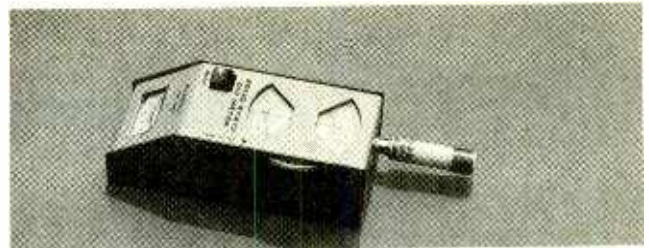

Fig. 3. When testing the tuned circuits in linear amplifiers, transmitters, antenna tuners, or loaded antennas, the external coil of the dipper is held close to the inductor under test.

We can also use the dipper to find the inductance of unknown coils. All that we need to do is connect a standard capacitor across the unknown coil, and then use the method of Fig. 3 to find the resonant frequency. For example, for larger RF coils, use a 100-pF capacitor (use a lower value for higher-frequency coils). We know that the resonant frequency of an LC resonant tank circuit is:

$$f = 1/2\pi\sqrt{LC}$$

where f is frequency in hertz, L is inductance in henrys, and C is capacitance in farads. If we know f and C , we can use a variation of that formula to find L :



The dip meter's external coil is selected according to the desired band. Here is what the meter looks like with the coil installed.

$L = 1/4\pi^2f^2C$
When using the latter equation, be sure to convert the frequency on the dipper dial from kHz or MHz to Hz, and the capacitance to farads. If the dial reads in MHz (as most do), then multiply the reading by 1,000,000. For example, if it reads 7.2 MHz, then the frequency in Hz is 7,200,000. If, on the other hand, the dial is calibrated in kHz, e.g. reads 7,200, then multiply by 1000. For the capacitance in picofarads (e.g. 100 pF), divide by 10^{12} . For example, a 100-pF capacitor is a 0.0000000001 farad capacitor (that's 1×10^{-10} for scientific-notation buffs).

Work an example to prove that you know how to make the calculation. Suppose an unknown coil in parallel with a 100-pF capacitor is measured and found to resonate at 10.16 MHz. What is the inductance? Turn the arithmetic crank and you will find the value of L is 2.456×10^{-6} H, or 2.456 μ H. Try it.

One other problem is seen on dippers. The dial calibration is (shall we be charitable?) optimistic. The true operating frequency may well be a few score kHz away from the dial indication. In order to measure the real operating frequency, couple a simple wire antenna from a short-wave receiver to the dipper (within, say, 6–8 inches of the external coil).

Set the receiver to SSB or CW to make a beatnote with unmodulated signals. With the dipper still coupled to the circuit, and tuned to

the resonant frequency, tune the receiver until the beat tone is heard. The frequency of the receiver dial will be a lot closer to the actual dipper frequency than the dipper dial indication.

A WORD OF CAUTION

A lot of older (tube type) grid-dip meters are sold for tiny amounts at hamfests and ham auctions. They are also seen in classified ads and on the used-goods shelves at ham shops. They are a good buy, but are potentially dangerous. Take a look at the AC power cord. First, is it a two-wire cord or a three-wire cord? If it is a two-wire cord, then I do not recommend using it out of doors or on a grounded floor (which includes concrete) without an isolation transformer.

Second, is the cord in good shape? Older line cords, whether made of rubber or double-cotton covered, are a hazard if not in the best of shape. If the dipper has a two-wire cord or if the three-wire cord is frayed, or appears dried out, or otherwise decrepit, then replace it with a three-wire cord. Connect the power-cord ground wire (it is usually green or green with yellow tracer) to the chassis of the dipper. Any AC-operated electronic device is dangerous when operated outdoors, but the ground wire at least gives you a chance at safety. Only an AC isolation transformer makes the AC-operated dipper really safe in my opinion. ■

DX LISTENING

By Don Jensen

Collecting Stamps, Business News on SW, And More

With little fanfare, *Adventist World Radio* (AWR) has grown to become one of the major shortwave networks in the world. This religious outreach of the Seventh Day Adventists had its start in 1930, when H.M.S. Richards began the Voice of Prophecy program on a local radio station in California.

AWR was created in 1971 as an international service, leasing air time from a major shortwave relay station, Radio Trans-Europe in Sines, Portugal. Adventist World Radio still broadcasts via that 250,000-watt station in

Portugal, seven and a half hours a week in a dozen languages.

AWR-Europe, over the years, also broadcast from leased transmitting facilities on Malta and from tiny Andorra in the mountains between Spain and France. In February 1985, AWR acquired its own modest transmitter at Forli, Italy, from which it now beams 56 hours of weekly programming in seven languages.

AWR-Asia, which formerly had its programs broadcast by the Sri Lanka Broadcast Corp., in 1987 began transmitting from its own station on the island of Guam. Two 100-kilowatt transmitters on Guam now send 224 hours of programming a week in 16 languages to listeners in Asia. Using the call letters, KSDA, AWR-Asia is the largest SW broadcast facility owned and operated by the Adventist Church.

AWR-Latin America began in 1980 from a station in Guatemala. In 1988, that station was replaced by Radio Lira in Costa Rica as the church's official station in this corner of the world. It uses a 5-kilowatt transmitter to air 114 hours of programming a week in Spanish, English, and French.

AWR-Africa uses the 250-kilowatt SW transmitter of Africa No. 1, a commercial station in Gabon. From this station, Adventist World Radio transmits seven hours of weekly programming in French and English to lis-

teners in west and central Africa.

In addition to sending QSL cards to those SWL's accurately reporting their receptions, AWR will send, on request, special verification stamps for each of its SW frequencies monitored. These collector stamps can be pasted on an attractive AWR QSL Certificate.

Here are a few AWR frequencies to try, along with the addresses to which you can send your reports of reception.

- AWR-ASIA: 11,980, 13,720 kHz; KSDA, AWR-Asia, P.O. Box 7468, Agat, Guam.
- AWR-EUROPE: 9,670 kHz, (Portugal) and 7125.7230 kHz (Italy); AWR-Europe, C.P. 383, I-47100 Forli, Italy.
- AWR-LATIN AMERICA: 9,725 kHz; Radio Lira International, AWR-LA, Apartado 1177, Alajuela, Costa Rica.

FEEDBACK

This section of DX Listening is by and for you. What do you especially like about world-band radio? Do you have any gripes or suggestions for the SW stations out there? Do you have any questions about the listening hobby? What have you been hearing lately on SW? Which are your favorite stations? Please write in and let us know!

And when you write in, how about sending along a photo of you and your SWL'ing equipment setup for the rest of us to see? Address your letters to DX Listening, **Popular Electronics**, 500-B Bi-County Blvd., Farmingdale, NY 11735.

The first letter this month is from Robert Farmer, who notes that he is an export manager for a firm in Los

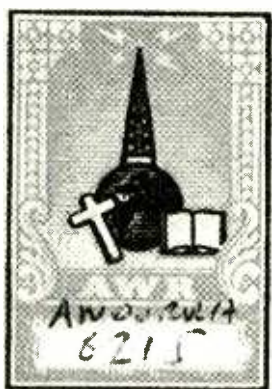
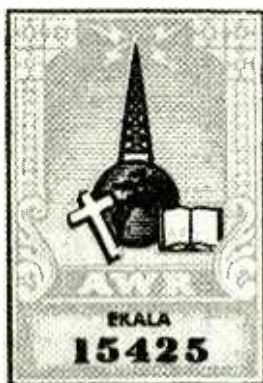
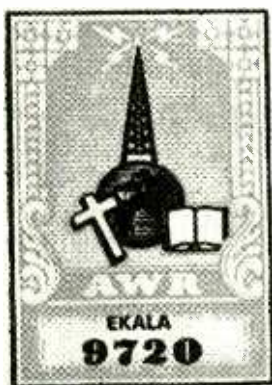

These are some of the Adventist World Radio QSL stamps collected by Ohio DX'er, Bill Matthews during the past dozen years. Each stamp represents a different AWR frequency logged by Matthews. He has filled three certificates—72 stamps—after logging various AWR shortwave frequencies and the Voice of Prophecy program on various U.S. medium-wave AM stations.

*Credits: Larry Royston, HI; Rusuf Jordan, PA; Pete Tutak, WA; Richard Wallace, NJ; Hans Johnson, MD; Brian Alexander, PA; Jerry Klinck, NY; North American SW Association, 45 Wildflower Road, Levittown, PA 19057

Angeles which does a substantial amount of business with Pacific Rim countries.

"I regularly read the business publications which cover that part of the world," Robert says, "but I like to keep up with events on even more of a 'real time' basis. Seems like shortwave radio would be the perfect medium. Any ideas on which stations?"

Robert, two international broadcasters come immediately to mind as having good coverage of business and economic matters in the Pacific region. They are *Radio Japan* and *Radio Australia*.

As this is written, for instance, *Radio Japan* has a program called "Business Today," which covers the latest trends in the Japanese economy, with a focus on industrial activity, market patterns, and technological developments. Another, "Economic Update," includes information on newly marketed products, consumer trends, and interviews with Japanese businessmen.

Radio Australia's programming includes a daily business report and regular stock-exchange reports from "Down Under" as well as features like "Business Horizons."

Specific programs, schedules, and frequencies do change, so I'd suggest, Robert, that you write the stations for up-to-the-minute program guides. The addresses are: *Radio Japan*, Overseas Service, 2-2-1 Jinnan, Shibuya-ku, Tokyo, Japan, and *Radio Australia*, P.O. Box 429G, G.P.O., Melbourne, Victoria 3001, Australia.

Next is a note from William DeTurk, Miller Place, NY: "I picked up a copy of **Popular Electronics** for the first time in many years," Bill writes. "I saw the DX Listening column. I used to be a ham-radio operator 30

years ago as a kid and I also enjoyed SWL'ing. I want to re-enter this exciting pastime but I need help."

Bill asks for specific recommendations for a shortwave receiver in the \$200 to \$300 range, and is looking for a New York City store where he can "buy equipment and talk shop."

Well, Bill, one of the hard-and-fast rules here is that I don't recommend specific receivers. It's like recommending an auto. I may like Fords while you have a soft spot in your heart for a Chevy. Your brother-in-law favors Toyota, and your old Uncle Bud wouldn't buy anything but an American-made GM product. My recommendation might be exactly the wrong receiver for you; it's a personal choice from among a number of excellent receivers. Sorry, Bill, and the rest of you who write asking which receiver I recommend.

I do agree that if the opportunity is available to you that it's a good idea to stop in at a local radio store to check out what's available—sort of "kicking the tires"—in the shortwave receiver marketplace. Compared to back when you were a ham 30 years ago, Bill, there really aren't that many local radio stores where the help knows much about shortwave. As a result, many SWL's these days have to make their selection from the mail-order catalogues of a relative handful of companies that do business on a nationwide basis, specifically catering to shortwave-listening enthusiasts. That's fine, but as Bill recognizes, it really isn't the same as having a local store where you can try out receivers and "talk shop" with somebody who knows what its all about.

I am aware of at least two such stores in the great

er New York area, although there are no-doubt others as well. They are Barry Electronics, 512 Broadway in New York City, and Gilfer Shortwave, 52 Park Avenue, Park Ridge, NJ.

DOWN THE DIAL

What's to hear on the shortwave world bands? Here are some tips from other SWL's:

Botswana—7,255 kHz. *Radio Botswana* has been noted in both English and African languages beginning at 0400 UTC with the "Breakfast Show" program.

Brazil—17,755 kHz. The program is from *Radio Surinam International*, the government broadcasting service of this small independent country on South America's northeastern "shoulder." But it is transmitted via a station in neighboring Brazil. Look for it at 1715 UTC.

Canada—11,715 kHz. Reception of English programs from South Korea improved with the start of relays of *Radio Korea* by the *Canadian Broadcasting Corp.* transmitters in New Brunswick. Look for this around 1030 UTC.

Iraq—9,515 kHz. *Radio Baghdad* is observed on this channel with English programming, news, music, and talk, around 0230 UTC.

Mongolia—12,015 kHz. *Radio Ulan Bator* is heard in the eastern part of the U.S. around 0900 UTC in English, until it shifts to Chinese at around 0940 UTC.

North Korea—9,977 kHz. *Radio Pyongyang* is heard in English around 1130 UTC with identification and talks about Korean life.

Yugoslavia—25,795 kHz. Slavic folk music can be heard from *Radio Yugoslavia* during its 1200 to 1230 UTC English transmission. ■

Make the most of your general coverage transceiver with *Monitoring Times!*

Every month *Monitoring Times* brings everything you need to make the most of your general coverage transceiver: the latest information on international broadcasting schedules, frequency listings, international DX reports, propagation charts, and tips on how to hear the rare stations. *Monitoring Times* also keeps you up to date on government, military, police and fire networks, as well as tips on monitoring everything from air-to-ground and ship-to-shore signals to radioteletype, facsimile and space communications.

ORDER YOUR SUBSCRIPTION TODAY before another issue goes by. In the U.S., 1 year, \$18; foreign and Canada, 1 year, \$26. For a sample issue, send \$2 (foreign, send 5 IRCs). For MC/VISA orders (\$15 minimum), call 1-704-837-9200.

MONITORING TIMES

Your authoritative source, every month.

P.O. Box 98
Brasstown, N.C. 28902

SCANNER SCENE

By Marc Saxon

An Array of Antennas

Let's take a look at some of the things that help improve your monitoring efforts and make scanning more effective.

For instance, we have gotten quite a number of letters from readers telling us that they can't (or simply don't wish to) put a scanner antenna on their roof. That leaves them with no choice



An unobtrusive, yet powerful, alternative to rooftop antennas, Electron Processing's Antenna Plus-3 is an internally amplified telescoping antenna system.

but to use the telescoping antenna that comes with most scanners and mounts at the rear of the set. It also leaves them with poor reception.

To the rescue comes Electron Processing, Inc. (P.O. Box 68, Cedar, MI 49621). Their *Antenna Plus-3* is an internally amplified (15- to 20-dB gain), 36-inch, telescoping antenna system intended for use with scanners. Covering the 30- to 2,000-MHz frequency range, the device is powered by 117 VAC and promises to make a big difference in reception if you're running an all-in-doors installation. A special filter eliminates any pos-

sibility of interference caused by strong out-of-band AM broadcast or shortwave signals.

The Antenna Plus-3 is easy to install with adapting cables (not supplied) for most scanners. It comes with your choice of BNC, phono, SO-239, Type N, or Type F connectors, at a manufacturer's suggested retail price of \$89.95. More information is available by writing to Electron Processing or by calling them at 616-228-7020.

The next major squawk comes from people who say that no matter how good a whip they use on their handheld scanner, they still miss a lot of good communications that can be received at their base unit. Well, the base probably uses a gain antenna mounted 20 to 50 feet above the ground. The handheld is used at ground level and isn't using a gain antenna. A reasonable solution would be to use the *Super Amplifier* made by GRE America.

The compact signal booster is designed for use with handheld scanners that have BNC-type antenna connectors. It operates from 100 to 1,000 MHz, and is powered by a 9-volt battery (not supplied). The amount of signal boosting ranges from 0 to 20 dB, and can readily be controlled by a knob on the Super Antenna.

Installation can be accomplished in seconds. All you do is remove the scanner's rubberized whip, plug the Super Amplifier into the

scanner's antenna connector, and then put the whip antenna on the amplifier's own connector. That connector is only 60mm high, 37mm wide, and 34mm deep, so it scarcely adds any bulk.

A switch (with LED) lets you turn on the Super Amplifier when needed. When it's turned off, signals bypass the device with negligible loss. But, if you're wondering where the signals are in your handheld, this little dynamo will certainly give them a big dose of needed vitamins to compensate for the inherent receiving disadvantages of handhelds when compared to base stations. While it may not make your handheld surpass or even equal a base station, it should definitely improve normal handheld operation.

The Super Amplifier has a suggested retail price of \$59.95. It's sold in communications shops and via mail order from GRE America, Inc., 425 Harbor Blvd., Belmont, CA 94002. We've had good results with our Super Amplifier.

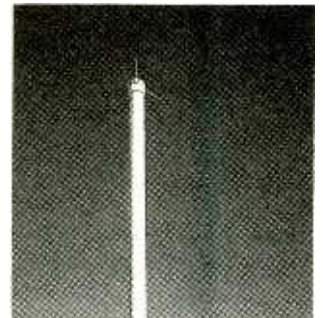

The Cellular Security Group's MAX-800 ground-plane antenna provides improved performance in the 800- to 900-MHz band.

Readers have observed that reception in the 800- to 900-MHz band often isn't up to snuff when using a regular base-station antenna. That's not too surprising, inasmuch as the majority of scanner base-station antennas are probably inefficient at those high frequencies because they were primarily intended for operation below 512 MHz.

One way to change that is simply to buy a through-glass mobile cellular-telephone antenna and mount it on a window of your home. You can also get them with magnetic or suction-cup mountings, so your mounting site options are limitless. Although the cellular bands actually lie between 824 and 896 MHz, you'll find that those antennas receive well from 800 to 900 MHz. Naturally, if you can mount it outside, and as high as possible, you'll get the best possible results.



Try using a through-glass mobile cellular phone antenna, like this suction-cup-mount one from *The Antenna Specialists Co.*, to boost reception from 800- to 900-MHz.

Most come with 12 feet of coaxial cable, so that does limit your mounting height. The antennas usually come with a TNC-type antenna connector, so you'll have to pick up an inexpensive adapter at Radio Shack to match it to the BNC or other connector on your scanner.

Many companies make the through-glass antennas, so shop around for the one best suited to your own proposed installation.

Another good approach is a high-performance 800- to 900-MHz ground-plane antenna that is intended for scanner use—the *MAX-800* from the Cellular Security Group. It can be used at a base station, or even mounted on a handheld, and offers excellent reception. The manufacturer's suggested retail price for the *MAX-800* is only \$19.95 (postpaid in the continental USA). It can be ordered from the Cellular Security Group, 4 Gerring Road, Gloucester, MA 01930. Their phone number is 508-281-8892.

STAMP OF APPROVAL

The FCC has finally given its stamp of approval on those five new 800-MHz simplex public-safety channels intended for intercommunications between various agencies. Stations licensed on any frequency in any public-safety radio service (police, fire, local government, highway maintenance, forestry conservation, and special emergency) have all been granted blanket authority to use those channels to coordinate their activities. No special license or additional authorization is required.

Monitor 866.0125 MHz (Channel 601), which is the National Public Safety Calling Channel for all of those operations. After contact is established there, stations will switch to any of four tactical channels. Those are 866.5125 (Channel 639), 867.0125 (Channel 677), 867.5125 (Channel 715), and 868.0125 MHz (Channel 753).

TALK TO US

We want your questions, opinions, frequencies, and suggestions. Send them to *Scanner Scene*, **Popular Electronics**, 500-B Bi-County Blvd., Farmingdale, NY 11735. ■

ANTIQUE RADIO

(Continued from page 79)

If you have a large collection of resistors, that should be no problem. Just mix and match, using several values in series, if necessary, until you obtain the correct reading. Otherwise, Radio Shack stocks resistors in a wide variety of values (including very low-resistance units that should be ideal for making fine adjustments). Quarter- or half-watt resistors should work just fine.

In order to carry out your adjustments, you'll need a suitable adjustable test-voltage source (I used the variable power supply constructed in the previous column). You also need a meter of known good accuracy (a multimeter is fine—see Fig. 2A) so that you can be sure of the value of the test voltage you are applying.

Start with a series resistance of about the right value, then *slowly* advance the voltage until the test meter indicates an even value somewhere in the intended range of the meter being converted. You might choose 1.5 or 2.0 volts for a 0–2 voltmeter. Go slowly because, if you happen to miscalculate the value of the series resistor, you could find yourself “pinning” the meter.

Once the meter is reading somewhere near its intended value, manipulate the value of the series resistor, as discussed, until the reading is dead on. By the way, if the meter is equipped with a mechanical zero adjustment, be sure it's set correctly before carrying out your calibration procedure.

Resistors R1 and R2 in the schematic of Fig. 1 represent the series resistors (or combinations thereof) to make my meter read 0–2

or 0–20 volts. Note that switch S1 makes it possible to place either resistor in the circuit, selecting the meter range as needed.

SETTING UP THE AMMETER

Ammeter ranges can be manipulated just as easily as voltmeter ranges. This is done by adding shunt (parallel) resistance across the meter. As it happened, one of my flea-market meters had a perfect range (0–15 mA) for use in amplifier-tube tests. I needed to add a switchable shunt so that the meter would also read 0–150 mA for rectifier-tube tests.

The test setup of Fig. 2B is used for checking ammeters, and the first thing I wanted to do was verify the accuracy of the basic meter. Series resistor R1 will not become a permanent part of the basic meter circuit, but is there only to adjust the current flow to a value falling on the scale of the meter being checked.

I put in a value of R1 near 500 ohms—calculated by Ohm's law to produce a current near 10 milliamperes with the adjustable power supply delivering 5 volts. Then, since the output of the supply is variable, I adjusted it until my test meter was reading exactly 10 mA. So did the flea-market meter, proving that its calibration was still okay.

Since I wanted to multiply the meter range by 10 (so it would read 0–150 mA), I left the power supply adjustment exactly as it was and experimented to find a shunt (parallel) resistance that would decrease the meter reading by a factor of 10. In other words, I wanted to make it read 1 mA instead of 10.

Meter shunts are easy to make and adjust because they have such low resistance (often fractions of an
(Continued on page 99)

SPECIAL FROM ETT

PCP107—DIGITAL LOGIC GATES AND FLIP-FLOPS ... \$10.00. Establishes a firm foundation for the user who wants to design and troubleshoot digital circuitry and wants to know more than a few rules of thumb. No background beyond a basic knowledge of electronics is assumed.



PCP108—COMPUTERS AND MUSIC ... \$9.95. Helps you learn the basics of computing, running applications programs, wiring a MIDI system and using the system to good effect. In fact, just about everything you need to know about hardware and programs.



PCP109—EVERYDAY ELECTRONICS DATA BOOK ... \$10.00. Presents the essential theory of electronic circuits and also deals with a wide range of practical electronic applications. Info is presented in the form of a basic electronics recipe book.



PCP110—ELECTRONIC POWER SUPPLY HANDBOOK ... \$10.00. All types of power supplies are covered, starting with cells and batteries, on to rectified supplies and linear stabilizers, to modern switch-mode systems, IC switch-mode regulators, DC-DC converters and inverters.

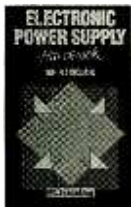

BP285—BEGINNERS GUIDE TO MODERN ELECTRONIC COMPONENTS ... \$6.50. Basic functions of resistors, capacitors, inductors, diodes (including Zeners and Varicaps), transistors, Thyristors, optoelectronic devices, op-amps, logic IC's, speakers and microphones, and meters are all described. Sort of a beginners bible of electronics.



MAIL TO: **Electronic Technology Today, Inc.**
P.O. Box 240
Massapequa Park, NY 11762-0240

SHIPPING CHARGES IN USA AND CANADA

\$0.01 to \$5.00	\$1.25	\$30.01 to \$40.00	\$5.00
\$5.01 to 10.00	\$2.00	\$40.01 to \$50.00	\$6.00
\$10.01 to \$20.00	\$3.00	\$50.01 and above	\$7.50
\$20.01 to \$30.00	\$4.00		

SORRY, No orders accepted outside of USA and Canada

Total price of merchandise	\$ _____
Shipping (see chart)	\$ _____
Subtotal	\$ _____
Sales Tax (NYS only)	\$ _____
Total Enclosed	\$ _____

Name _____
Address _____
City _____ State _____ Zip _____

PHOTOFACTS

(Continued from page 76)

be somewhat mechanically inclined to deal with the hardware.

VCRfacts No. VCR-92 covers Sanyo Models VCR3900/-II and VCR4000/-2, and Sears Model 564.53110250. All VCRfacts cover the disassembly of the entire VCR chassis, as well as troubleshooting guides to all boards. As mentioned before, gridtrace location guides, photographs, and schematics are provided. And, added to that, is complete exploded views of the mechanical assemblies. That's crucial if you're not sure how something works or how to take it apart, or if you need a part number to order a replacement.

As you may have guessed, mechan-

know concerning a computer is provided.

It pays to have information like this on hand even if you don't have any problems with your computer. For instance, it will come in very handy if you need to change a factory preset or modify your computer in any way. The information is also very interesting in that you can get a feel of how your computer actually "works."

Getting the Facts. Sams Facts cover brands from A to Z, including Admiral, Audiovox, Bendix, Capehart, Crosley, Dumont, Decca, Eico, Emerson, Fisher, GE, GM, Hallicrafters, Hitachi, Lafayette, Magnavox, Motorola, Olympic, Panasonic, Philco, RCA, Sony, Teledyne, Westinghouse, Zenith, and everything

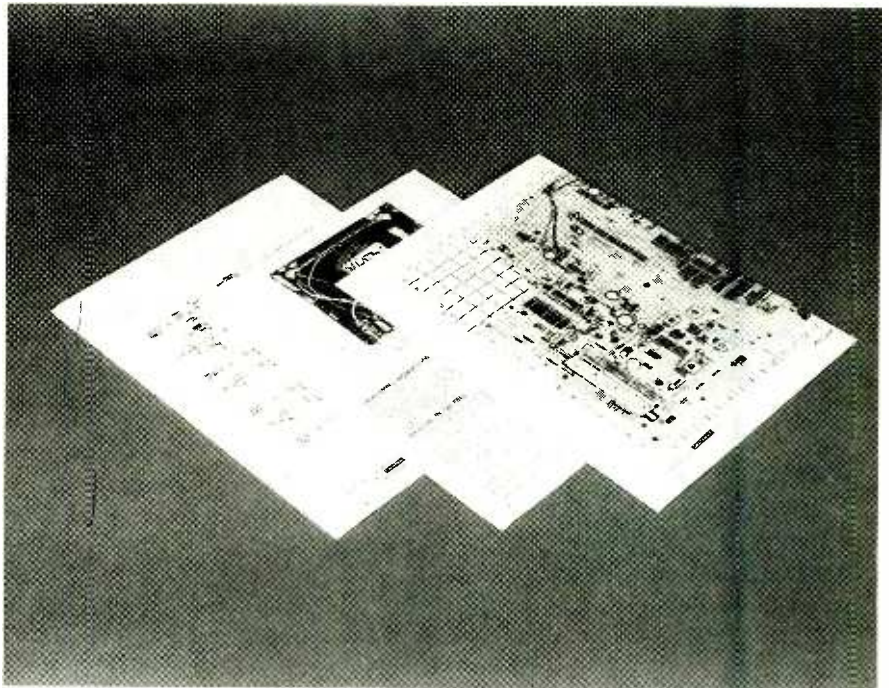

Here is a sampling of the type of material you can expect to see in a Photofact package.

ical and electrical adjustments are covered, as well as replacement-part lists and cross references. Sams' VCRfacts will help you get your VCR up and running in no time.

Computerfacts. *Computerfacts*, as you probably have already figured out, deal with computers. *Computerfacts* No. CSCS29, for example, covers the IBM Model 30 (PS/2 8530-021) computer. The disassembly of the chassis and repair of the circuit boards are covered in a similar manner as discussed before. What's different here is that information concerning keyboards, disk drives, pin designations, error codes, etc.—basically everything you would need to

in between.

Facts range in price from \$14.95 to \$39.95, with multiple-copy discounts. Most titles are still in print, but if it's not, and if it has ever been printed, Sams will make you a copy of the material at prices ranging from 1 page for \$11.95 to 60 pages for \$41.50.

Sams has an annual index available that lists all the material available. And, even if you don't see the service data you need listed in the index, or if you don't have one, you can call 800-428-SAMS and ask them if they've ever covered it. For more information contact Howard W. Sams and Company directly, or circle No. 120 on the Free Information Card.

SELECT 5 BOOKS

for only \$4⁹⁵

(values to \$126.70)
and get a **FREE Gift!**

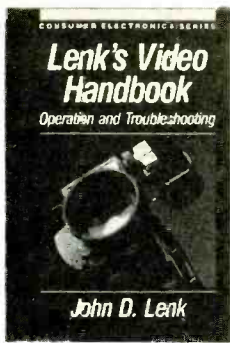
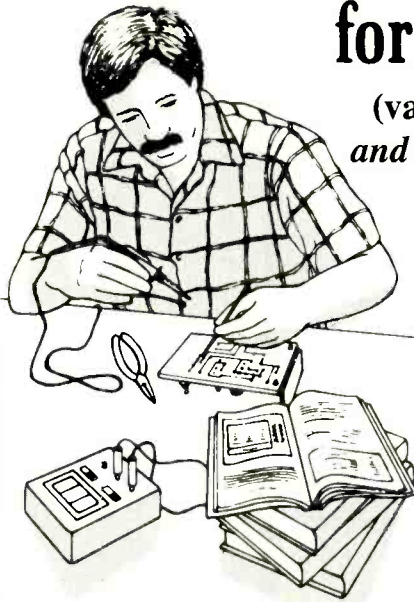

10018 \$39.95
Counts as 2

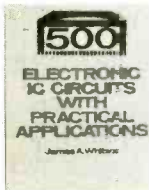

2920 \$29.95
Counts as 2



2800P \$15.95



2980P \$19.95



1604P \$7.95

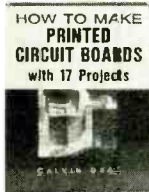

2898P \$15.95



1532P \$14.95



3260 \$22.55

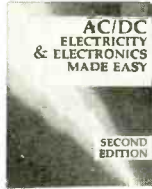

3285 \$25.95
Counts as 2



3265 \$22.45



3226 \$22.95

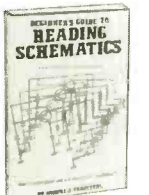

1536P \$11.95



3205 \$24.95

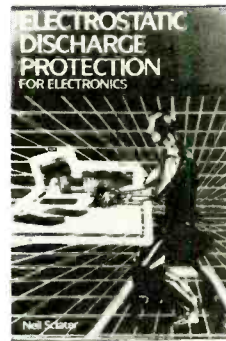

3329 \$29.95
Counts as 2



2883P \$17.95



2867P \$18.95



2826P \$16.95



2613P \$17.95



1625P \$22.95

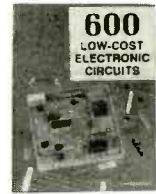

3219 \$27.95
Counts as 2

For over 25 years, your most complete source for electronics books.



3270 \$32.95
Counts as 2



3241P \$16.95



2809 \$29.95
Counts as 2



804P \$21.95
Counts as 2



3307 \$26.95
Counts as 2



3374 \$24.95



3370 \$25.95
Counts as 2



1599P \$17.95

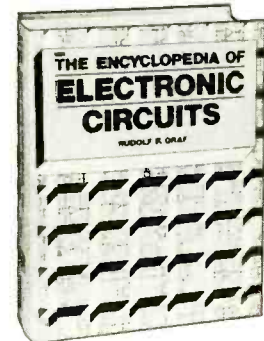

1938 \$60.00
Counts as 3

FREE when you join!

15 Easy Electronic Projects From Delton T. Horn
Projects you can build—some unique, some old favorites—from the author's vast treasury of electronics know-how.

A \$7.95 Value!



Membership Benefits • Big Savings. In addition to this introductory offer, you keep saving substantially with members' prices of up to 50% off the publishers' prices. • **Bonus Books.** Starting immediately, you will be eligible for our Bonus Book Plan, with savings of up to 80% off publishers' prices. • **Club News Bulletins.** 15 times per year you will receive the Book Club News, describing all the current selections—mains, alternates, extras—plus bonus offers and special sales, with scores of titles to choose from. • **Automatic Order.** If you want the Main Selection, do nothing and it will be sent to you automatically. If you prefer another selection, or no book at all, simply indicate your choice on the reply form provided. You will have at least 10 days to decide. As a member, you agree to purchase at least 3 books within the next 12 months and may sign at any time thereafter. • **Ironclad No-Risk Guarantee.** If not satisfied with your books, return them within 10 days without obligation! • **Exceptional Quality.** All books are quality publishers' editions especially selected by our Editorial Board. PE191



1897P \$14.95



3258 \$27.95
Counts as 2



3351 \$26.95
Counts as 2



2707 \$26.95
Counts as 2



2925P \$9.95



2931P \$16.95

A shipping/handling charge and sales tax will be added to all orders.

©1991 ELECTRONICS BOOK CLUB SM

If card is missing, use this address to join:
ELECTRONICS BOOK CLUB, Blue Ridge Summit, PA 17294-0810

All books are hardcover unless number is followed by a "P" for paperback. (Publishers' Prices Shown)

DIGITAL ELECTRONICS COURSE

(Continued from page 73)

word has four parallel inputs: A_0 – A_3 and B_0 – B_3 . Of those bits A_3 and B_3 are the most significant among their respective groupings. The three outputs are labeled $A > B$, $A < B$, and $A = B$. The 7485 also has expander inputs—labeled $I_{A > B}$, $I_{A < B}$, and $I_{A = B}$ —which allow the IC to be cascaded (chained together). For serial (ripple) expansion, the $A > B$, $A < B$, and $A = B$ outputs are connected, respectively, to the $I_{A > B}$, $I_{A < B}$, and $I_{A = B}$ inputs of the next-most significant comparator.

Figure 4 shows a circuit—consisting of a 324 quad op-amp, a 7400 quad 2-input NAND gate, a 7490 decade counter, a 7448 BCD to 7-segment common-cathode display, decoder/driver, and a 7485 expandable four-bit magnitude comparator—that can be used in simple control applications. In that circuit, the two variables to be compared are comprised of two 4-bit wide input signals, which are applied to inputs A_0 – A_3 and B_0 – B_3 of the 7485 (U5).

One 4-bit input (A_0 – A_3) to U5 is tied to the BCD output of U3 (the decade counter). The other 4-bit input of U5 (B_0 – B_3) is connected to a 4-position DIP switch that supplies the second input variable. Note that one leg of NAND gate U2-a is tied to the output of U2-b, and that U2-b is configured as an inverter and is connected to U5's $A = B$ output.

Assume that an input value of 0111 is applied to inputs B_0 – B_3 from the DIP switch. With the circuit not having been triggered, the $A = B$ output of U5 is low. That low is applied to U2-b, which inverts that signal and applies a logic high to pin 2 of U2-a. The output of U2-b acts as a sort of enable/disable for U2-a.

Binary Comparator Exercise.

Breadboard the simple controller circuit shown in Fig. 4. A jumper wire can be connected in place of S1, if you don't happen to have a single-pole single-throw or single-pole double-throw switch handy. Note that the clock input of the 7490 counter is derived from a voltage comparator, and is fed to the counter through a NAND gate.

Apply power to the circuit, and set the DIP switch (S2) for a binary 4 (0100) input. Reset the counter to binary 0 (0000), and place S1 in the run position. At this point, the 7-segment readout should display a 0 from the counter, and the 4-bit magnitude comparator's $A = B$ output should be low. ■

WORKBENCH BARGAINS

(Continued from page 68)



Tube testers are handy if you like to restore antique radios. Be sure that the one you buy will test the tubes you're likely to encounter.

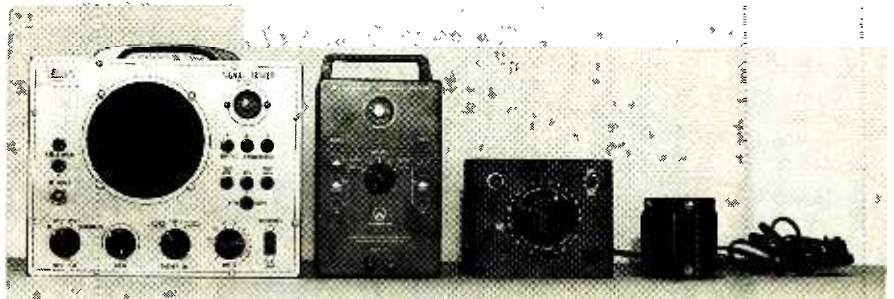

A signal tracer, capacitor tester, variable-voltage transformer, and isolation transformer are only some of the many useful pieces of gear that you're likely to find.

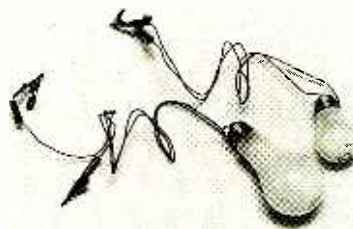

The ultimate piece of testing apparatus is between your ears. Simple things like a light-bulb "dummy" antenna can often give important clues if you think about what it tells you.

an auction; I later picked up the plug-in for \$22 at a hamfest. So, for a total of \$25, I had a very nice oscilloscope. Its only drawback was that it was the size and weight of a small doghouse. After much use, I later sold it for \$15 and bought another that took up less space on the workbench.

That's just an example of what's available. If you're new to scopes, I'd suggest you start with a simple one, and there are many to be found at almost any hamfest. After you have some idea of how they work and what you really need, you can start looking over units with more advanced features.

Other Equipment. If you're into antique radios, you're sure to want a tube tester. Make sure the one you buy can accommodate tubes of the vintage you're likely to be testing.

Other items that might be of interest include frequency counters, variable-voltage transformers or supplies, signal tracers, and so on.

With a variety of test equipment on your bench you'll be ready the next time a project just sits there when you first fire it up, or when the kitchen radio quits. You might even start looking for things to fix! ■

CIRCUIT CIRCUS

(Continued from page 81)

volts, with the charging current flowing through the base-emitter junction of Q5, turning it on and pulling its collector to ground. The negative pulse, at the collector of Q5, triggers U2 (a 555 configured for monostable operation), producing a brief positive voltage output at pin 3.

The positive output of U2 is fed through D2 and R14 to charge a 100- μ F capacitor, C15. The voltage across C15 supplies power to the tone generator (Q1/Q2), turning it on for a short period of time to announce that someone is at DOOR 1.

The on-time of the tone oscillator is controlled by the values of R17 and C14 (connected to pins 6 and 7 of U2) for DOOR 1, while R15 and C13 (connected to pins 6 and 7 of U3) does the same for DOOR 2. The operation of the second door-switch circuitry is like the first with an exception (which we'll get to in a moment). The values of those components (100k for R15 and R17, and 10 μ F for C13 and C14) set the timers' output duration to about two seconds for each closure of a door-bell switch. The length of each tone can be increased by increasing the value of either or both of its associated timing components. By the same token, decreasing either timing component will shorten the on time.

The operation of the second door switch circuit is like that of the first, except that in addition to the output of U3 being fed to the tone oscillator (Q1/Q2), it is also fed to a transistor switch (Q3) that shifts the oscillator's frequency. The positive output pulse of U3 turns Q3 on with its collector pulling R1 to ground and raising the tone's output frequency. A third door switch

may be added by duplicating the second door-switch circuit and by adjusting the value of the new frequency-shifting resistor for a tone that's different from the other two.

The output may be modified to sound more or less bell like by varying the values of R13 and R4 between 100 ohms and 4.7k. A resistor value that's too large may not allow the voltage across C15 to reach a level that reliably starts the oscillator. If that happens, reduce the resistor's value until the oscillator starts each time the door switch is activated.

Just about any well-filtered 12-volt DC power supply that can deliver a minimum of 200 milliamperes will operate the circuit. At idle, the circuit requires less than 20 mA to maintain its standby status. This circuit is a candidate for solderless breadboards, thereby allowing you to play with and fine tune the circuit. Then, if you like what you hear, you can make a printed-circuit board layout and turn it into a first-class project. But if, on the other hand, you decide to build the circuit on perfboard, use sockets for the IC's.

TELEPHONE AMPLIFIER

Our next item is a simple, but useful, telephone-accessory circuit that you can throw together in a single evening and use to enhance your very next phone conversation. How often have you had some family member, friend, or an associate near by and wanted to share a telephone conversion, but couldn't because you only had a single phone at that location? If that's the case look at the phone amplifier circuit in Fig. 3.

The phone amplifier is essentially connected in series with one side of the phone line through the low-imped-

PARTS LIST FOR THE TELEPHONE AMPLIFIER

- U1—LM386 low-power audio amplifier, integrated circuit
 - R1—10-ohm, 1/4-watt, 5% resistor
 - R2—1000-ohm potentiometer
 - C1—0.22- μ F, ceramic-disc capacitor
 - C2—0.1- μ F, ceramic-disc capacitor
 - C3—220- μ F, 16-WVDC, electrolytic capacitor
 - B1—9-volt transistor-radio battery
 - SPKR1—4 or 8-ohm speaker
 - S1—SPST toggle switch
 - T1—1000-ohm to 8-ohm, center-tapped, audio-output transformer
- Perfboard materials, enclosure, modular phone plug and jack, battery holder and connector, wire, solder, hardware, etc.

ance winding of an audio-output transformer. A power amplifier (U1) increases the phone's audio level, which is developed across the high-impedance side of T1, to drive the speaker.

Since the amplifier is only used on selected calls, a 9-volt battery will do for the power source. And if you do forget to turn the power off, the circuit will remind you the very next time you use your phone.

The telephone amplifier would be an excellent choice for that first-time, circuit-board project, and since you'll probably end up wanting more than one amplifier, that approach will make duplication of the circuit much easier. For good looks and ease of operation, the circuit may be housed in a small plastic or metal cabinet with a modular telephone plug and cord coming from one side and a receptacle (jack) on the other. That way you only need to disconnect your phone and plug it into the amplifier's receptacle and plug the amplifier's cord into the wall jack. ■

ANTIQUE RADIO

(Continued from page 93)

ohm) that they can be fashioned from lengths of wire. I used fine plastic-insulated wire from a multi-conductor telephone cable, starting with a 4-foot length.

Shorting the two ends of this wire across the meter terminals decreased the reading by about a third. Obviously, I needed less resistance, so I kept clipping off pieces of the wire and trying again. When the meter was reading just a little higher than the correct value, I changed R1 to a value that would allow about 100 mA to flow through the circuit with a supply voltage of about 5.

Finally, I adjusted the power-supply voltage control until my test meter read exactly 100 mA and continued pruning the wire until the meter being converted read 100 mA. The purpose of this increase in current was to make the final shunt adjustment at a higher meter reading that could be read more accurately.

One thing to keep in mind during testing is that the shunt resistance is so low that poor connections between the shunt and meter can really throw off the results. Make sure that both the ends of your test wire and the meter terminals are shiny-clean. After you've established the correct length for your shunt wire, wind it into a bobbin using a cardboard form. Resistor R3 in the schematic of Fig. 2 represents the shunt we've been discussing. Note how switch S2 allows it to be connected across the meter when high-current measurements are necessary.

Also note switch S3, resistor R4, and diode D1. Those make it possible for M2 to be used as a line-voltage adjust meter. More on that next month. ■

MICROPHONES

(Continued from page 71)

equipped with a solder lug to facilitate wiring. The little depressions in the graphite should face in towards the body of the wooden T. Finally, fasten a couple of binding posts plus solder lugs to the longer piece of wood and connect the posts to the lugs on the graphite pieces with some hook-up wire.

And now for the tricky part: suspending the pencil graphite between the two hollows in the graphite blocks. Start by measuring the distance between the cavities carefully with a good ruler. Then measure and cut a stick of graphite that's just slightly longer (say by about $\frac{1}{16}$ of an inch). Do not attempt to trim the graphite with your fingers, since you will almost never get the break in the right place. Using wire cutters works well.

Now, carefully loosen one of the graphite blocks and push it to one side. Then, gently place the graphite stick between the blocks and align it with the two little holes. Finally, move the block back to its original position and re-tighten the screw.

The idea is to loosely hold the stick between the blocks. In other words, the graphite stick must be free to move. Otherwise, the microphone will not

PARTS AND MATERIALS FOR THE RAZOR-BLADE AND GRAPHITE MICROPHONES

Automatic pencil refills (see text)
6-volt lantern battery (or equivalent DC power supply)
Binding posts
2000-ohm earphone (or equivalent)
Graphite blocks
Razor blades
Tuning fork
Wood blocks (see text)

ADDITIONAL PARTS AND MATERIALS

Solder lugs, solder, hardware, hook-up wire, etc.

Small graphite blocks are available from JerryCo, 601 Linden Place, Evanston, IL 60202; Tel. 1-708-475-8440. The blocks come in groups of 10 for \$1.50 and the catalog number is 4527. Their minimum order is \$12.50 and there is a flat \$4.00 fee for shipping and handling. Their catalog is 50 cents. Tuning forks are available from Analytical Scientific, Post Box 675, Helotes, TX 78123; Tel. 1-512-684-7373. The forks come in a variety of styles and frequencies. Their catalog is \$3.00.

Further Reading

Microphones, by M. Clifford, Tab Books, Blue Ridge Summit, PA 17294
Old Wires and New Waves, by A.F. Harlow, D. Appleton Century, New York
The Telephone, by W.H. Preece, D. Van Nostrand, New York

function. If the graphite stick does not move, take it out, cut a tiny bit off one end, and try again.

Operation. The microphone should then be connected in a simple series circuit with a battery and an earphone as mentioned before. Compared to the razor-blade unit, the graphite-block device has one big advantage: the graphite stick cannot fall out so you can tilt it, turn it, and move it around. Slide the microphone over the surface of your work area. You will find that the tiniest disturbance of the microphone becomes a noise in the earpiece.

You can increase the sensitivity of the unit still further by clamping it to a wooden box, a table, a bookcase, or whatever else you can think of. The vibrations picked up by the object will be transferred to the microphone.

How It Works. Hughes-type microphones operate the way they do for two major reasons: The first is the translation of mechanical or acoustic vibration into electrical interruption at the points of intermittent connection. That's how Hughes's nail microphone worked, to whatever extent the thing worked at all. William Henry Preece called it "the principle of loose contacts."

The other, and more important, reason involves a unique natural property of the element carbon. The electrical resistance of carbon decreases as pressure upon the substance increases. The operation of all modern carbon microphones is based on that elementary physical fact. ■



COMMUNICATIONS

(Continued from page 66)

"path" between your program and your modem. Verify that you have correctly specified the COM port, and that the specifications for the base address and interrupt lines are correct. Verify also that your cable and modem are functioning properly. Check that your modem is properly connected to the telephone line and that it is ready to dial. Finally, make sure you're giving a valid instruction to your modem.

Q: *Why does my modem disconnect while I'm using a database service?*

A: There are several reasons why the modem might disconnect. First, look at the "automatic hang-up" feature. If the modem or the database service detects that your computer hasn't sent or received any information for more than 30 minutes, it may automatically disconnect your telephone line. Second, a power failure or interruption on the phone lines could be the culprit because they can cause the modem to disconnect. Third, if you accidentally unplug any of the modem connections, the modem will disconnect.

The solution to those problems is to check all of the connections, and then restart the software. You may need to reinitiate the modem by unplugging it and plugging it in again.

The fourth possible cause of a disconnection is the call-waiting feature that the telephone company provides. It will disrupt communication if one of the parties has that feature and is receiving a call.

Q: *My communications software reports that the modem is unavailable. What can I do?*

A: If your communications software reports that the modem is unavailable, the problem might be that the software is configured to use the wrong port. Reconfiguring the software is then in order.

Also, if you have an internal modem, the modem may be configured to act as the wrong port. In either case reconfigure the software or hardware so they agree.

If you have an external modem, it might be connected to the wrong connector on the computer, which is an easy enough problem to fix. Another possibility is that the cable to the external modem might not be wired correctly. The solution, of course, is to reconfigure the cable. ■

ELECTRONICS MARKET PLACE

FOR SALE

DESCRAMBLERS. All brands. Special: Combo Jerrold 400 and SB3 \$165. Complete cable descrambler kit \$39.00. Complete satellite descrambler kit \$45.00. Free catalog. **MJH INDUSTRY**, Box 531, Bronx, NY 10461-0208.

CABLE descrambler liquidation. Major makes and models available. Industry pricing! (Example: Hamlin Combo's, \$44 each... Minimum 10 orders). Call **WEST COAST ELECTRONICS**, 1 (800) 628-9656.

CABLE descramblers (Jerrold) from \$40.00. Tocom VIP test chip. Fully activates unit. Also Zenith test board. Fully activates Z-Tacs. \$50.00. Call (213) 867-0081.

PRINTED circuit boards etched & drilled. Free delivery. **K & F ELECTRONICS, INC.**, 33041 Groesbeck, Fraser, MI 48026. (313) 294-8720.

CB RADIO OWNERS!

We specialize in a wide variety of technical information, parts and services for CB radios. 10-Meter and FM conversion kits, repair books, plans, high-performance accessories. Thousands of satisfied customers since 1976! Catalog \$2.

CBC INTERNATIONAL
P.O. BOX 31500PE, PHOENIX, AZ 85046

HUGE 88 page communications catalog of shortwave, amateur and scanner equipment. Antennas, books and accessories too. Send \$1.00 to: **UNIVERSAL RADIO**, 1280 Aida Drive, Dept. PE, Reynoldsburg, OH 43068.

LASERS 1mW to 2kW, world's largest selection of new & used surplus. Free catalog. **MWK INDUSTRIES**, 1269 Pomona Road, Corona, CA 91720. (714) 278-0563.

CABLE TV DESCRAMBLERS! BARGAIN HEADQUARTERS!



- JERROLD™ • TOCOM • HAMLIN
- OAK • ZENITH
- SCIENTIFIC ATLANTA

6 month warranty! We ship C.O.D.!
Lowest retail/wholesale prices!

FREE CATALOG:

Global Cable Network
1032 Irving St. Suite 109
S.F., CA 94122

NO CALIFORNIA SALES!!!

ORDER TODAY! 800-327-8544

ELECTRONIC muscle stimulator! Grow your muscles quickly and effortlessly or resale for huge profits. Complete kit — \$69.95; assembled and tested — \$98.00. **TECHNIX**, Box 55249, Bridgeport, CT 06610.

ELECTRONIC parts, kits, software. No minimum orders. Free catalog. **WELSH ELECTRONICS**, 620 Olive Lane, Ambridge, PA 15003-2458.

FREE Catalog: Save hundreds on sought after electronic, electro mechanical, and computer related hardware and components — including hard-to-find items. Call toll free: 1 (800) 776-3700. **AMERICAN DESIGN COMPONENTS/Dept.** 114-011, 815 Fairview Avenue, Fairview, NJ 07022.

***** PRESENTING *****

CABLE TV DESCRAMBLERS

***** STARRING *****

JERROLD, HAMLIN, OAK

AND OTHER FAMOUS MANUFACTURERS

- FINEST WARRANTY PROGRAM AVAILABLE
- LOWEST RETAIL/WHOLESALE PRICES IN U.S.
- ORDERS SHIPPED FROM STOCK WITHIN 24 HOURS

FOR FREE CATALOG ONLY 1-800-345-8927
FOR ALL INFORMATION 1-818-709-9937

PACIFIC CABLE CO., INC.
7325 1/2 Reseda Blvd., Dept. 1000
Reseda, CA 91335

FREE IBM shareware catalog, 1 (800) 842-6819, **OFFSHORE SOFTWARE**, 2941 Pretty Branch Drive, Mobile, AL 36618.

SECRET Scanner Frequencies: Directories list federal, police, surveillance, bugging, channels. Big free catalog. **CRB**, Box 56-PE, Commack, NY 11725.

IS it true jeeps for \$44.00 through the US gov't? Call for facts! (504) 649-5745 ext. S-730.

CLANDESTINE video-VHS video, descramble any cable TV system. Only \$29.95 cash/check/MO. **AC ENTERPRISES**, PO Box 17264, Colorado Springs, CO 80935. PH# (719) 392-4811.

CB'S, antennas, scanners, Uniden PC122 AM/SSB \$138.79. Catalog \$2.00. **STARCOMM**, PO Box 130, Cortaro, AZ 85652.

FREE CATALOG

**FAMOUS "FIRESTIK" BRAND CB ANTENNAS
AND ACCESSORIES. QUALITY PRODUCTS
FOR THE SERIOUS CB'er. SINCE 1962**

FIRESTIK ANTENNA COMPANY
2614 EAST ADAMS
PHOENIX, ARIZONA 85034

\$1.99 software for IBM Compatibles. Quality at affordable prices! Huge selection: business, games, graphics, utilities, database, spreadsheets. Free catalog. **AULT**, 1556 Halford Avenue, #242, Santa Clara, CA 95051.

EMERSON radios, CD players, TV's, VCR's, phones, microwaves, catalog \$2.00. **GLOBAL TRADES**, Box 334, Three Rivers, MI 49093.

LOTTERY numbers with a built in 100% guarantee! Hit the lottery on purpose! Catalog of 80 IBM/Comp. programs \$5.00. **SIGMA**, Box 24759, Dept. 3, Baltimore, MD 21220.

SURPLUS educational equipment shortwave receivers, adjustable 50 to 70 MGHZ, 6 meter with private line. Free info: **ELECTRO TECH SCHOOLS**, 120 N. Mechanic Avenue, Alliance, OH 44601.

TUBES. TV, radio and industrial. 10,000 stocked. Over 2,000 types available. Largest discounts. Free list. **CHUCK ADAMSON**, Box 640367, El Paso, TX 79904.

PLANS & KITS

CATALOG: hobby/broadcasting/HAM/CB: Cable TV, transmitters, amplifiers, surveillance devices, computers, more! **PANAXIS**, Box 130-H1, Paradise, CA 95967.

BUILD — five-digit, ohms, capacitance, frequency, pulse, multimeter. Board, and instructions \$9.95. **BAGNALL ELECTRONICS**, 179 May, Fairfield, CT 06430.

New Laser Diodes \$15

LASERS

Hellum-Neon Laser Tubes from \$25

New Visible Diode Modules

FREE CATALOG CALL OR WRITE TODAY! COMPLETE HELLIUM-NEON LASERS FROM \$110.00
MEREDITH INSTRUMENTS P.O. Box 1724/Glendale, AZ 85311/(602)934-9387

SURVEILLANCE transmitter kits! Four models of each; telephone, room, combination telephone/room transmitters tune from 65 to 305 MHz. Catalog with **Popular Communications** and **Popular Electronics** book reviews of "Electronic Eavesdropping Equipment Design," \$1.00. **SHEFFIELD ELECTRONICS**, 7223A Stony Island Ave., Chicago, IL 60649-2806.

VIDEOPHILIP II manuals. Volume 1 — Hardware, Volume 2 — Software — either \$34.95. Volume 3 — Projects/Software, Volume 5 — Documentation or Volume 6 — Experimentation \$44.95 each. Volume 7 — 032/Hacking \$54.95. Volume 4 — repair — \$99.95. Cable Hacker's Bible — \$34.95. Clone Hacker's Bible — \$34.95. Catalog-\$3.00. CODs: (602) 782-2316. TELECODE, PO Box 6426-PE, Yuma, AZ 85366-6426.

MINIATURE FM transmitters! Tracking transmitters! Voice disguisers! Bug detectors! Phone devices! More! Available as kits or assembled and tested! Catalog \$2.00 (refundable): **XANDI ELECTRONICS**, Box 25647, Dept. 322Z, Tempe, AZ 85285-5647.

REMOTE CONTROL KEYCHAIN

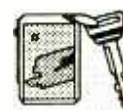

Complete w/mini-transmitter and +5 vdc RF receiver
Fully assembled including plans to build your own auto alarm
Quantity discounts available

\$24.95 Check, Visa or M/C
Add \$3 shipping

VISITECT INC./Dept. P (415) 872-0128
PO BOX 5442, SO. SAN FRAN., CA 94080

SURVEILLANCE — countermeasures! Guaranteed lowest prices! Huge catalog \$5.00 (refundable). **PROTECTOR**, PO Box 520294-E, Salt Lake City, Utah 84152.

KITS — alarms, games and test equipment. Send \$1.00 for catalog. **RAKJAB**, PO Box 1875, Apopka, FL 32704.

UNIQUE projects. Build an infrared motion detector, ultrasonic distance meter, digital rain gauge. Complete plans, PCB layout. \$4.00 each. Others available. **K. KEMP**, 13772 Goldenwest St., #549 Westminster, CA 92683.

LASER lighting entertainment systems. Create your own 3-dimensional laser light shows with these professional secrets! Detailed mechanical and electrical schematics, designs for any budget! \$20.00 **MILLENNIUM**, 229 McAfee, Thousand Oaks, CA 91360.

DAZER II Personal protection device! Plans \$8.00. Lasers! Transmitters! Detectors! More! Kits or assembled! Catalog \$2.00. **QUANTUM RESEARCH**, 16645-113 Avenue, Edmonton, Alberta T5M 2X2.

BUY BONDS

CABLE TV "BOXES"

**Converters — Descramblers
Remote Controls — Accessories**

- ★ Guaranteed Best Prices ★
- ★ 1 Year Warranty — C.O.D. ★
- ★ Immediate Shipping ★
- ★ FREE CATALOG ★

Call or Write
TRANS-WORLD CABLE CO.
12062 Southwest 117th Court, Suite 126
Miami, Florida 33186
1-800-442-9333



LIGHTING kit. The lighting controller construction project featured in the Dec. 1989 issue of "Popular Electronics" is available for immediate shipment...**just in time for a Christmas project or as the ultimate gift (built by you), for someone who loves to decorate.** Uses an MC68705P3 micro-controller to control 8, 115 vac sockets with triacs. Kit includes all parts, preprogrammed chip, quality PC board, drilled molded case, panel label, assembly instructions, theory, and spectacular decorating ideas! Speed of motion is adjustable, creating dramatic effects when set to music! Use with up to 24 sets of your midget lights on trees, wreaths, shrubs, garland, doors, windows; for home or business decorating. Great mood setter for holiday parties. Complete kit for \$75.50 USA (\$81.00 in Canada). Includes S&H. Visa, MC order today! Phone (412) 745-6760 or write to: **CANTEK METATRON CORPORATION**, 19 West Water Street, Canonsburg, PA 15317.

Motion Control System → **\$159.00**



Includes Computer, Monitor, Keyboard, Power supply, 4 Motors, and Software.

Call or Send for **Free Robotics Catalog**

Sithon Valley Surplus 415 261-4506	4222 E. 12th St. Oakland, Ca. 94601	Serving you since 1983 8 am to 4 pm PST
--	--	--

BUILD your own remote control using the same type of circuitry found in many keychain remote controls. 20 page package gives info and schematics on encoder/decoder circuitry. Part sources included. \$5.00. **CONTINUOUS CONCEPTS**, PO Box 60414, San Diego, CA 92166. CA residents add 7.25% tax.

POWERFUL single-chip FM room transmitter, size of a postage stamp, transmits to any FM radio up to one mile away. Complete kit \$19.95 postpaid. **HERTZ MICRODEVICES**, Box 41771, Los Angeles, CA 90041-41771.

REDUCE heating cost up to 60%. System developed in last oil embargo in New England. Plans \$24.95. **QUALITY ELECTRONICS**, 3128 Lake Washington Road, Suite 148, Melbourne, FL 32934.

**CABLE DESCRAMBLERS
OAK M358 COMBO \$39.95**

Jerrold, Zenith, Hamlin, Sci. Atlanta, Pioneer
& MORE! OUR PRICES ARE BELOW WHOLESALE!

CABLE+PLUS
14417 Chase St. # Panorama City, CA 91402
1-800-822-9955 • Other Info. 1-818-785-4500
NO CALIF. SALES — DEALERS WANTED

SURVEILLANCE — Audio/video/infra-red/laser equipment. Industrial or private. 500 item catalog \$7.00. **SECURITY SYSTEMS**, 3017F Hudson, New Orleans, LA 70131.

END adhesive use blues! Glue kit includes nonstick reusable mixing and work surface, stainless mixing spatula, 25 mil wide stainless micro spatula ideal for detail work, and glue tips pamphlet. Send \$10.95 each plus \$1.00 postage to: **GLUE KIT**, 125-98 Conemara, Sunnyvale, CA 94087.

PRO-2004/2005/2006 owners! Restore cellular telephone, add-on S-meter, add 6,400 channels, increase scanning speed, auto tape record, etc! Manual includes 10 modifications with detailed instructions and schematics. Only \$8.95 from the **ENGINEERING WORKSHOP**, PO Box 4176, Fullerton, CA 92634-4176.

BEST BY MAIL

Rates: Box 5, Sarasota, FL 34230

OF INTEREST TO ALL

"EASY CHESS" Computer opponent IBM-C64 compatible, FREE Learning tutorial only \$7.95! R.N.S., 23441 Golden Springs, #119, Diamond Bar, CA 91765.

CHEAT YOUR BANK outa thousands, Legally. ExBankers secret! (\$9.95): Wilson, 320 Horne, PPO San Francisco, CA 96630.

STARBURST CROSS PENDANT, 1 1/2". Gold Finished, Brilliant Silver Diamond Cut Highlights, Matching Chain, \$2.95 PPD. Morgan Co., Box 50827-(PE), Nashville, TN 37205.

JOURNALIST REVEALS SECRET to publishing books. \$20.00. Barrett, Box 11341-(PE), Clayton, MO 63105.

MONEYMAKING OPPORTUNITIES

MAKE \$100.00 DAILY selling money-making information and wholesale merchandise. Act Now! Free details. Write: Box 492-C, So. Orange, NJ 07079.

EARN UP TO \$500 on weekends. Free information. O. Bennett, 6114 LaSalle, #459, Oakland, CA 94611.

EDUCATION/INSTRUCTION/SCHOOLS

COLLEGE DEGREES BY HOME STUDY. Fully-Accredited, Bachelors, Masters, Doctorates, Complete Kit \$12.00, or write: ARTS-P, Box 291703, Ft. Lauderdale, FL 33329.

BOOKS/CATALOGS/MAGAZINES

50,000 + CATALOG LISTINGS! \$5.95: Catalogs, Box 92452GT, Atlanta, GA 30314.

EDUCATION/INSTRUCTION

MAGIC! Four illustrated lessons plus inside information shows you how. We provide almost 50 tricks including equipment for four professional effects. You get a binder to keep the materials in, and a one-year membership in the International Performing Magicians with a plastic membership card that has your name gold-embossed. You get a one-year subscription to our quarterly newsletter, "IT'S MAGIC!" Order now! \$29.95 for each course + \$3.50 postage and handling. (New York residents add applicable state and local sales tax). **The Magic Course**, 500-B BiCounty Blvd., Farmingdale, NY 11735.

LEARN IBM PC assembly language. 80 programs. Disk \$5. Book \$18. **ZIPFAST**, Box 12238, Lexington, KY 40581-2238.

AUTOMOTIVE computers. Detailed information send \$9.95 to **JMC**, 37 Tideview Drive, Dover, NH 03820.

SUPERNATURAL cloud — Earth rotation displacement nuclear warfare \$1.00. **NIEDER**, PO Box 5162, San Antonio, TX 78201.

**SURVEILLANCE
TELEPHONE**



This is a normal functioning telephone!
EXCEPT it has a secret built in monitor.
Only YOU can call and monitor ALL conversations, using a secret code, and never be detected! Range Unlimited.
\$175.00 - 6 month Warranty Catalog \$3.00
LISTEN ELECTRONICS, 603 Elgin, Muskogee, OK 74401
ALARMS 1-800-633-8277 SECURITY EQUIP

BUSINESS OPPORTUNITIES

YOUR own radio station! AM, FM, TV, cable. Licensed/unlicensed. **BROADCASTING**, Box 130-H1, Paradise, CA 95967.

MAKE \$50/hr working evenings or weekends in your own electronics business. Send for free facts. **MJPI INDUSTRY**, Box 531, Bronx, NY 10461.

MAKE \$2000.00/week — reclaiming pure gold from scrap computers. Free report! (worth \$25.00) **1 (900) 246-2323** (\$2.00 min.).

LET the government finance your small business. Grants/loans to \$500,000. Free recorded message: **(707) 448-0270. (KJ8)**

Cable TV Descramblers



If you find a better deal,
we'll better our deal.

*"Jerrold" "Tocom" "Hamlin" "Oak"
"Scientific Atlanta" "Zenith"*
Ask about our extended warranty program.

COD, Visa, M/C welcome.

Free Call — Free Catalog.

Video Tech **800-562-6884**

2702 S. Virginia St., Ste. 160-304
Reno, NV 89502.

WANTED

INVENTORS! Have an idea? Call **IMPAC** for free information package. US/Canada: 1 (800) 225-5800 (24 hours!).

HAVE a new idea? Invention? Call **THE "CONCEPT NETWORK"** for free confidential kit at 1 (800) 835-2246 ext. 197 US/Canada 24 Hrs. day.

100'S of Silicon Valley companies hiring technical professionals. For current listings send \$15.00 to **EXCEL SERVICES**, PO Box 36046, San Jose, CA 95158.

I need someone to build me a reverse TV Zapper. It must block out programs and record just commercials! **BILL**, (212) 995-1095.

ANTIQUe RADIO CLASSIFIED

Free Sample!

Antique Radio's
Largest Circulation Monthly.
Articles, Ads & Classifieds.
6-Month Trial: \$13. 1-Yr: \$24 (\$36-1st Class).
A.R.C., P.O. Box 802-L5, Carlisle, MA 01741

ZENITH DESCRAMBLERS

ZENITH ZTACS will work where others have failed, fully warranted with remote. \$175.00 call (213) 478-2506.

KELVIN 200

AC/DC VOLTAGE
AC/DC CURRENT
RESISTANCE DIODE TEST
LOW BATTERY Warning
ACCURACY +/- 0.5%
CONTINUITY TEST/BUZZER
TRANSISTOR CHECKER
CAPACITANCE CHECKER

\$39.95

Stock No
990091

KELVIN Electronics
7 Fairchild Ave. Plainville, NY 11803
(516) 349-7620 1(800) 645-9212



TEST EQUIPMENT

FACTORY direct test equipment. Function generators, frequency counters microprocessor development systems and security systems. Call for free brochure. **APPLIED ELECTRONIC RESEARCH**, Hollywood, FL, (305) 987-9785.

SATELLITE TV

FREE catalog — Do-it-yourself save 40—60% lowest prices world wide, systems, upgrades, parts, all major brands factory fresh and warranted. **SKY-VISION INC.**, 2008 Collegeway, Fergus Falls, MN 56537. 1 (800) 334-6455.

NAS CABLE BOXES FREE CATALOG 1-800-848-3997

Jerrold • Scientific Atlanta
Many Others
1 Year Warranty • COD's



T.V. FILTERS

T.V. notch filters, surveillance equipment, brochure \$1.00. **D.K. VIDEO**, Box 63/6025, Margate, FL 33063. (305) 752-9202.

CABLE EQUIPMENT

CABLE TV secrets — the outlaw publication the cable companies tried to ban. HBO, Movie Channel, Showtime, descramblers, converters, etc. Suppliers list included. \$9.95. **CABLE FACTS**, Box 711-H, Pataskala, OH 43062.

FREE CATALOG!
1-800-648-7938
For all information 1-702-362-9026
JERROLD HAMLIN OAK ETC.
**CABLE TV
DESCRAMBLERS**
• Compare our low Low Retail Prices!
• Guaranteed Prices & Warranties!
• Orders Shipped Immediately!
REPUBLIC CABLE PRODUCTS INC.
4080 Paradise Rd. #15 Dept. PE-90
Las Vegas, NV 89109

CABLE T.V. CONVERTERS
WHY PAY A HIGH MONTHLY FEE?

All Jerrold, Oak, Hamlin, Zenith, Scientific Atlanta, Magnavox and all specialized cable equipment available for shipment within 24 hours. For fast service MC / VISA or C.O.D telephone orders accepted (800) 648-3030 60 Day Guarantee (Quantity Discounts) 8 A.M. to 5 P.M. C.S.T. **CLOSED WEEK- ENDS.** Send self-addressed Stamped envelope (60¢ postage) for Catalog

MIDWEST ELECTRONICS INC.
P.O. Box 5000
Suite 311 (PE)
Carpentersville, IL 60110
No Illinois Orders Accepted

THE JOY OF PROGRAMMING!

Algorithm

THE PERSONAL PROGRAMMING NEWSLETTER

► features how-to projects for beginners and experts: fractals, moiré patterns, ecological simulations, black holes, sand-piles, wallpaper for the mind and much more!

► Write today for a free sample issue to:

Algorithm - Special Order Department
P.O. Box 29237, Westmount Postal Outlet
785 Wonderland Road South
London, Ontario, CANADA N6K 1M6

**TUBES - 2000 TYPES
DISCOUNT PRICES!**
Early, hard-to-find, and modern tubes. Also transformers, capacitors and parts for tube equipment. Send \$2.00 for 28 page wholesale catalog.

ANTIQUE ELECTRONIC SUPPLY
6221 S. Maple Ave. • Tempe, AZ 85283 • 602-820-5411

ADVERTISING SALES OFFICE

Gernsback Publications, Inc.
500-B Bi-County Blvd.
Farmingdale, NY 11735
1-(516) 293-3000

President: **Larry Steckler**

Vice President: **Cathy Steckler**

For Advertising ONLY
516-293-3000
Fax 1-516-293-3115

Larry Steckler
publisher

Arline Fishman
advertising director

Denise Haven
advertising assistant

Christina Estrada
advertising associate

Kelly McQuade
credit manager

Customer Service/Order Entry
1-800-435-0715
1-800-892-0753
7:30 AM - 8:30 PM EST

SALES OFFICES

EAST/SOUTHEAST
Stanley Levitan
259-23 57th Avenue
Little Neck, NY 11362
1-718-428-6037, 1-516-293-3000
Fax 1-718-225-8594

**MIDWEST/Texas/Arkansas/
Okla.**

Ralph Bergen
540 Frontage Road—Suite 339
Northfield, IL 60093
1-708-446-1444
Fax 1-708-446-8451

PACIFIC COAST/Mountain States

Marvin Green
5430 Van Nuys Blvd., Suite 316
Van Nuys, CA 91401
1-818-986-2001
Fax 1-818-986-2009

SPECIAL FROM ETT SAVE \$\$ TODAY

□ 2617T—BUILD A REMOTE-CONTROLLED ROBOT regular \$9.95 **SPECIAL \$8.95.** Fool-proof instructions for putting together your own full-size working robot at a fraction of the commercial cost.



□ 2645T—117 PRACTICAL IC PROJECTS YOU CAN BUILD regular \$10.95 **SPECIAL \$9.95.** Dozens of fully tested ready-to-build circuits you can put together from readily available, low-cost ICs.

□ BP53—PRACTICAL ELECTRONICS CALCULATIONS AND FORMULAE regular \$6.95 **SPECIAL \$5.95.** Six basic sections: Units and Constants, Direct Current Circuits, Passive Components, Alternating Current Circuits, Networks and Theorems, Measurements.



□ 2706T—BUILDING METAL LOCATORS regular \$9.95 **SPECIAL \$8.95.** A treasure hunter's project book. Build your own high-quality metal detector for a fraction of the factory-built cost.

□ BP234—TRANSISTOR SELECTOR GUIDE regular \$10.00 **SPECIAL \$9.00.** Offers a range of selection tables compiled so as to be of maximum use to all electronics engineers, designers and hobbyists.



□ ETTCAT—ELECTRONIC TECHNOLOGY TODAY INC. CATALOG \$2.00. 36-pages list a wide variety of electronics books. Included with catalog is a coupon good for \$3.00 off your first purchase.

MAIL TO: **Electronic Technology Today, Inc.**
P.O. Box 240
Massapequa Park, NY 11762-0240

SHIPPING CHARGES IN USA AND CANADA

\$0.01 to \$5.00	... \$1.25	\$30.01 to \$40.00	\$5.00
\$5.01 to 10.00	... \$2.00	\$40.01 to \$50.00	\$6.00
\$10.01 to \$20.00	\$3.00	\$50.01 and above	\$7.50
\$20.01 to \$30.00	\$4.00		

SORRY, No orders accepted outside of USA and Canada

Total price of merchandise \$	_____
Shipping (see chart) \$	_____
Subtotal \$	_____
Sales Tax (NYS only) \$	_____
Total Enclosed \$	_____

Name _____
Address _____
City _____ State _____ Zip _____

**NEW!!
FAX US YOUR
FREE
INFORMATION
CARDS FOR
EVEN FASTER
SERVICE!**

Now you can send your requests for Free Information by **FAX** or mail. It's simple, it's easy—just follow these three steps:

- 1** Print your name, address and Zip Code on one of the attached postage-paid cards.
- 2** Circle the number (or numbers) on the card that matches the number at the bottom of each ad or editorial item that you want information on. Advertisers' free information numbers also appear in the ad index.
- 3** **FAX** the complete card to us at **413-637-4343** or if you prefer, drop the card in the mail—it's still postage paid!

NOTE: Submit all Free Information requests by either **FAX** or mail, **NOT BOTH!** **DUPLICATE REQUESTS WILL BE DISCARDED.** Use the **FAX** telephone number and the postcard address for Free Information only. Address all editorial inquiries to Editor, Popular Electronics®, 500-B Bi-County Blvd., Farmingdale, NY 11735

POSTAGE-PAID FREE INFORMATION CARD

PE191

11	21	31	41	51	61	71	81	91	101	111	121	131	141	
12	22	32	42	52	62	72	82	92	102	112	122	132	142	
13	23	33	43	53	63	73	83	93	103	113	123	133	143	
14	24	34	44	54	64	74	84	94	104	114	124	134	144	
5	15	25	35	45	55	65	75	85	95	105	115	125	135	145
6	16	26	36	46	56	66	76	86	96	106	116	126	136	146
7	17	27	37	47	57	67	77	87	97	107	117	127	137	147
8	18	28	38	48	58	68	78	88	98	108	118	128	138	148
9	19	29	39	49	59	69	79	89	99	109	119	129	139	149
10	20	30	40	50	60	70	80	90	100	110	120	130	140	150

- 1 Please send me 12 issues of POPULAR ELECTRONICS® for \$18.95 and bill me. (Canada \$23.95 U.S. FUNDS)
- 2 Please send me 12 issues of RADIO-ELECTRONICS® for \$15.97 and bill me. (Canada \$21.97 U.S. FUNDS)

Name Please Print _____

Company Name (if applicable) _____

Address _____

City _____ State _____ Zip + 4 _____

Allow 6-8 weeks for delivery of first issue
OFFER VALID U.S. AND CANADA ONLY.

VOID after MARCH 31, 1991

POSTAGE-PAID FREE INFORMATION CARD

PE191

11	21	31	41	51	61	71	81	91	101	111	121	131	141	
12	22	32	42	52	62	72	82	92	102	112	122	132	142	
13	23	33	43	53	63	73	83	93	103	113	123	133	143	
14	24	34	44	54	64	74	84	94	104	114	124	134	144	
5	15	25	35	45	55	65	75	85	95	105	115	125	135	145
6	16	26	36	46	56	66	76	86	96	106	116	126	136	146
7	17	27	37	47	57	67	77	87	97	107	117	127	137	147
8	18	28	38	48	58	68	78	88	98	108	118	128	138	148
9	19	29	39	49	59	69	79	89	99	109	119	129	139	149
10	20	30	40	50	60	70	80	90	100	110	120	130	140	150

- 1 Please send me 12 issues of POPULAR ELECTRONICS® for \$18.95 and bill me. (Canada \$23.95 U.S. FUNDS)
- 2 Please send me 12 issues of RADIO-ELECTRONICS® for \$15.97 and bill me. (Canada \$21.97 U.S. FUNDS)

Name Please Print _____

Company Name (if applicable) _____

Address _____

City _____ State _____ Zip + 4 _____

Allow 6-8 weeks for delivery of first issue
OFFER VALID U.S. AND CANADA ONLY.

VOID after MARCH 31, 1991



BUSINESS REPLY MAIL
FIRST CLASS MAIL PERMIT NO. 71 MT. MORRIS, IL

POSTAGE WILL BE PAID BY ADDRESSEE

NO POSTAGE
NECESSARY
IF MAILED
IN THE
UNITED STATES

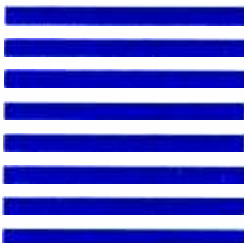

Popular Electronics®

**SUBSCRIPTION DEPT.
P.O. BOX 338
MT. MORRIS, IL 61054-9932**





BUSINESS REPLY MAIL
FIRST CLASS MAIL PERMIT NO. 132 PITTSFIELD, MA

POSTAGE WILL BE PAID BY ADDRESSEE

Popular Electronics®

READER SERVICE MANAGEMENT DEPT.
P.O. Box 5192
PITTSFIELD, MA 01203-9989



NO POSTAGE
NECESSARY
IF MAILED
IN THE
UNITED STATES

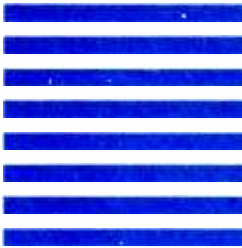

BUSINESS REPLY MAIL
FIRST CLASS MAIL PERMIT NO. 132 PITTSFIELD, MA

POSTAGE WILL BE PAID BY ADDRESSEE

Popular Electronics®

READER SERVICE MANAGEMENT DEPT.
P.O. Box 5192
PITTSFIELD, MA 01203-9989



NO POSTAGE
NECESSARY
IF MAILED
IN THE
UNITED STATES

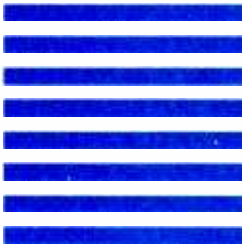

Popular Electronics®

Your best bet for projects and practical electronics!

Yes! Please enter my subscription to POPULAR ELECTRONICS® for a savings of \$16.45 per year off the single copy price!

- 1 Year (12 issues) \$18.95
(Canada \$23.95 U.S. Funds)

Please print

Name _____

Company Name (If applicable) _____

Address _____

City _____ State _____ Zip + 4 _____

Allow 6-8 weeks for delivery from publication of next issue.
Offer valid in U.S. and Canada Only.

BB191

For the best
in hobby
electronics
read
**Popular
Electronics**

Don't take a
chance on missing
even one
exciting issue.
Subscribe now
and save!



The magazine for the
electronics activist and the
consumer electronics
enthusiast!

The best in hobby electronics
appears each and every month
in Popular Electronics!

Subscribe Today!

**Radio
Electronics®**



Radio-Electronics offers a unique
combination of articles on
electronics technology, service,
audio, video, computers.
Keep up-to-date!
Subscribe Today!

Electronics Paperback Books

GREAT PAPERBACKS AT SPECIAL PRICES

BP248—TEST EQUIPMENT CONSTRUCTION \$5.95. Details construction of simple, inexpensive, but extremely useful test equipment. AF Gen Test Bench Ampl. Audio Millivoltmeter, Transistor Tester and six more

Test Equipment Construction



How to Use Oscilloscopes and Other Test Equipment



BP267—HOW TO USE OSCILLOSCOPES AND OTHER TEST EQUIPMENT \$6.95. Mastering the oscilloscope is not really too difficult. This book explains all the standard controls and functions. Other equipment is also described

BP265—MORE ADVANCED USES OF THE MULTIMETER \$5.95. Use these techniques to test and analyze the performance of a variety of components. Also see how to build ad-ons to extend multimeter capabilities.

More Advanced Uses of the Multimeter



An Introduction to Loudspeakers and Enclosure Design

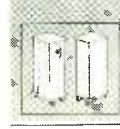

BP256—INTRO TO LOUDSPEAKERS AND ENCLOSURE DESIGN \$5.95. We explore the variety of enclosure and speaker designs in use today so the reader can understand the principles involved.

BP263—A CONCISE INTRO TO dBASE \$6.95. The dBASE series of programs are probably the best known database programs for microcomputers. This book is designed to help you get started working with them.

A Concise Introduction to dBASE

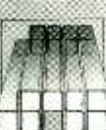

BP260—CONCISE INTRO TO OS/2 \$5.95. If you are a multitasking PC user and want to get the most out of your computer, then you must learn its OS/2 operating system. This book shows you just how to do that, quickly and easily.

A Concise Introduction to OS/2

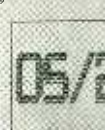

BP249—MORE ADVANCED TEST EQUIPMENT CONSTRUCTION \$6.95. Eleven more test equipment construction projects. They include a digital voltmeter, capacitance meter, current tracer and more.

More Advanced Test Equipment Construction



Digital Audio Projects



BP245—DIGITAL AUDIO PROJECTS \$5.95. Practical circuits to build and experiment with. Includes A/D converter, input amplifier, digital delay line, compander, echo effect and more.

BP247—MORE ADVANCED MIDI PROJECTS \$5.95. Circuits included are a MIDI indicator, THRU box, merge unit, code generator, pedal, programmer, channelizer, and analyzer.



BP257—INTRO TO AMATEUR RADIO \$6.95. Amateur is a unique and fascinating hobby. This book gives the newcomer a comprehensive and easy to understand guide to the subject.



PCP102—INTRODUCING DIGITAL AUDIO \$9.95. Covers all kinds of digital recording methods—CD, DAT and Sampling. Bridges the gap between the technician and the enthusiast. Principles and methods are explained.

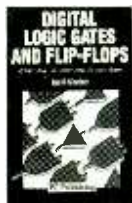

PCP107—DIGITAL LOGIC GATES AND FLIP-FLOPS \$10.00. Thorough treatment of gates and flip-flops for enthusiasts, student and technicians. Only a basic knowledge of electronics is needed.

BP251—COMPUTER HOBBYISTS HANDBOOK \$8.95. A wrapup of everything the computer hobbyist needs to know in one easy to use volume. Provides a range of useful reference material in a single source



PCP108—COMPUTERS AND MUSIC \$9.95. Explains the basics of computers and music with no previous knowledge of computers needed. Covers types of music software and explains how to set up your own computer music studio.

- BP195—INTRODUCTION TO SATELLITE TV**..... \$9.95. A definitive introduction to the subject written for the professional engineer, electronics enthusiast, or others who want to know more before they buy. 8 x 10 in.
- BP190—ADVANCED ELECTRONIC SECURITY PROJECTS**.....\$5.95. Includes a passive infra-red detector, a fiber-optic loop alarm, computer-based alarms and an unusual form of ultrasonic intruder detector.
- BP235—POWER SELECTOR GUIDE**.....\$10.00. Complete guide to semiconductor power devices. More than 1000 power handling devices are included. They are tabulated in alpha-numeric sequence, by technical specs. Includes power diodes, Thyristors, Tracs, Power Transistors and FETs.
- BP234—TRANSISTOR SELECTOR GUIDE**.....\$10.00. Companion volume to BP235. Book covers more than 1400 JEDEC, JIS, and brand-specific devices. Also contains listing by case type, and electronic parameters. Includes Darlingtons transistors, high-voltage devices, high-current devices, high power devices.
- BP99—MINI-MATRIX BOARD PROJECTS**.....\$5.50. Here are 20 useful circuits that can be built on a mini-matrix board that is just 24 holes by ten copper-foil strips.
- BP82—ELECTRONIC PROJECTS USING SOLAR CELLS**.....\$5.50. Circuits with applications around the home that are powered by the energy of the sun. Everything from radio receivers, to a bicycle speedometer, to timers, audio projects and more.
- BP117—PRACTICAL ELECTRONIC BUILDING BLOCKS—Book 1**.....\$5.75. Oscillators, Timers, Noise Generators, Rectifiers, Comparators, Triggers and more.
- BP184—INTRO TO 68000 ASSEMBLY LANGUAGE**.....\$6.95. The 68000 is a great new breed of microprocessor. Programming in assembly language increases the running speed of your programs. Here's what you need to know.
- BP179—ELECTRONIC CIRCUITS FOR THE COMPUTER CONTROL OF ROBOTS** \$7.50. Data and circuits for interfacing the computer to the robot's motors and sensors

- BP239—GETTING THE MOST FROM YOUR MULTIMETER**..... \$5.95. Covers basics of analog and digital meters. Methods of component testing includes transistors, thyristors, resistors, capacitors and other active and passive devices.
- BP97—IC PROJECTS FOR BEGINNERS**.....\$5.50. Power supplies, radio and audio circuits, oscillators, timers, switches, and more. If you can use a soldering iron you can build these devices.
- BP37—50 PROJECTS USING RELAYS, SCR'S & TRIACS**.....\$5.50. Build priority indicators, light modulators, warning devices, light dimmers and more.
- RADIO—100 RADIO HOOKUPS**.....\$3.00. Reprint of 1924 booklet presents radio circuits of the era including regenerative, neutrodyne, reflex & more.
- BP42—SIMPLE LED CIRCUITS**..... \$5.50. A large selection of simple applications for this simple electronic component.
- BP127—HOW TO DESIGN ELECTRONIC PROJECTS**.....\$5.75. Helps the reader to put projects together from standard circuit blocks with a minimum of trial and error.
- BP122—AUDIO AMPLIFIER CONSTRUCTION**.....\$5.75. Construction details for preamps and power amplifiers up through a 100-watt DC-coupled FED amplifier.
- BP92—CRYSTAL SET CONSTRUCTION**.....\$5.50. Everything you need to know about building crystal radio receivers.
- BP45—PROJECTS IN OPTOELECTRONICS**..... \$5.50. Includes infra-red detectors, transmitters, modulated light transmission and photographic applications.

BP185—ELECTRONIC SYNTHESIZER CONSTRUCTION \$5.95. Use this book to learn how to build a reasonably low cost, yet worthwhile monophonic synthesizer and learn a lot about electronic music synthesis in the process.

CHECK OFF THE BOOKS YOU WANT

ELECTRONIC TECHNOLOGY TODAY INC.
P.O. Box 240, Massapequa Park, NY 11762-0240

Name _____
Address _____
City _____ State _____ Zip _____

SHIPPING CHARGES IN USA AND CANADA

\$0.01 to \$5.00	... \$1.25
\$5.01 to 10.00	... \$2.00
\$10.01 to \$20.00	... \$3.00
\$20.01 to \$30.00	... \$4.00
\$30.01 to \$40.00	... \$5.00
\$40.01 to \$50.00	... \$6.00
\$50.01 and above	... \$7.50

SORRY No orders accepted outside of USA & Canada

Number of books ordered

Total price of merchandise \$ _____
Sales Tax (New York State Residents only) \$ _____
Shipping (see chart) \$ _____

All payments must be in U.S. funds

Total Enclosed .. \$ _____

RADIO SHACK PARTS PLACE

YOUR SOURCE FOR PROJECT AND REPAIR ESSENTIALS

SM

PARTS HOTLINE

Your nearby Radio Shack store has a huge selection of popular electronic components. Plus, we can special-order 10,000 items from our warehouse—ICs, tubes, semiconductors, phono cartridges and styli, even SAMS® manuals. Service is fast and there's no minimum order or postage charge.

BATTERY HOTLINE

In addition to our large in-store stock, Radio Shack can now supply almost any currently manufactured consumer-type battery—for cordless phones, computer memory, camcorders, transceivers, pagers and more. Service is fast. No postage or handling charges!



Studfinder. Ends guessing, easy to use! Senses changes in wall density to find wooden studs fast—also wires, conduit, pipes. Battery extra. #64-2825 **19.95**



Super Calculator! The EC-4035 makes electronics math a snap. Displays and computes with electrical units—V, A, mA, mW. 110 functions. #65-983 **39.95**



16-Piece Precision Tool Kit. Top-quality jeweler's-type philips, blade and nutdrivers plus hex keys and a torque bar. Fitted molded case. #64-1961 **10.95**



100-Watt Soldering Gun. Pull the trigger for full temperature in seconds. Built-in light. The comfort-molded handle stays cool. UL listed AC. #64-2193 **10.95**

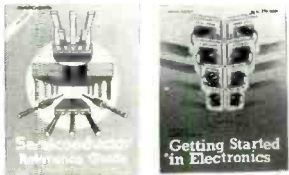

Semiconductor "Sub" Book. Our 1991 edition lists over 95,000 types and the Radio Shack replacements. #276-4014 **3.99**

Getting Started in Electronics. By Forrest Mims III. The perfect introduction to project building. 128 pages. #276-5003 **2.49**

THE PLACE TO SHOP FOR VALUE!



Engineer's Mini-Notebook Series. By Forrest Mims III. Practical project ideas and useful data in Mims' famous, friendly style—big diagrams, handlettered text. With tips and suggestions for further experiments.

- NEW! Science Projects.** #276-5018 ... **1.49**
- Timer ICs.** 555/556 ICs. #276-5010 ... **99c**
- Op Amp ICs.** #276-5011 ... **1.49**
- Optoelectronics.** #276-5012 ... **1.49**
- Basic Circuits.** #276-5013 ... **1.49**
- Digital Logic Circuits.** #276-5014 ... **1.49**
- Communications Projects.** #276-5015 ... **1.49**
- Formulas and Tables.** #276-5016 ... **1.49**
- Schematic Symbols.** #276-5017 ... **1.49**

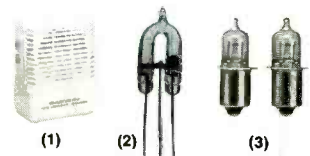

- (1) **Mini Audio Amp/Speaker.** Ideal testbench amp, also great for computer voice/music synthesis. Battery extra. #277-1008 **11.95**
- (2) **Long-Life Xenon Strobe Tube.** With data. #272-1145 **3.29**
- (3) **Halogen Flashlight and Lantern Bulbs.** HPR50, 6-volt. #272-1189, HPR52, 3V. #272-1190 .. Each **3.95**



Pocket-Size Digital Multimeter With Autoranging. Really handy for anyone working with electronics. This tester folds, with its probes, to fit a shirt pocket. Features easy-to-read LCD display, continuity sounder. Measures to 400 volts AC/DC, 2 megohms resistance. 4 1/4 x 2 1/8 x 5/16". #22-171 **39.95**

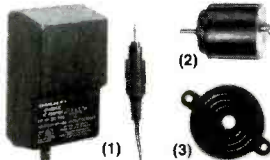

- (1) **Universal AC Adapter.** 3, 4.5, 6, 7.5 or 9VDC output. With 6-piece Adaptaplug® set. #273-1650 **12.95**
- (2) **1 1/2-3VDC Motor.** About 1 1/2" long. #273-223 **99c**
- (3) **DC Pulsing Buzzer.** Extra loud! #273-066 **4.29**

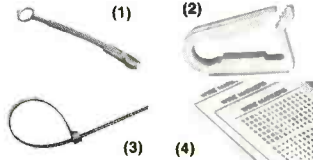

- (1) **Reusable Cable Ties.** Hang-up loop. #278-1622 . Pkg. of 10/4.99
- (2) **"Universal" Cable Clips.** #278-1647 Pkg. **10/2.79**
- (3) **Indoor/Outdoor Wire Ties.** #278-1652 Pkg. of 30/2.99
- (4) **Markers.** 630 stick-on letters. #278-1650 Set/1.79

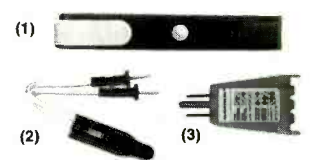

- (1) **AC Sensor.** Indicates the presence of 70 to 440VAC without direct electrical connection. Safety first! #22-103 **9.95**
- (2) **Neon Circuit Tester.** 90-300V AC/DC. #22-102 **1.99**
- (3) **AC Outlet Fault-Finder.** 3-prong for grounded outlets. #22-101 ... **5.95**

Since 1921 Radio Shack has been the place to obtain up-to-date electronic parts as well as quality tools, test equipment and accessories at low prices. Over 7000 locations to serve you—NOBODY COMPARES

Prices apply at participating Radio Shack stores and dealers. Radio Shack is a division of Tandy Corporation

Radio Shack
AMERICA'S TECHNOLOGY STORE™

CIRCLE 15 ON FREE INFORMATION CARD