

OCTOBER 1990

# Popular Electronics®

## 200,000-VOLT VAN DE GRAAFF GENERATOR

Have hours of high-voltage fun with this static-electricity generator

## LIVING WITH LIGHTNING

The truth about lightning, and the best ways to protect yourself, and your gear, from it

## BUILD AN AUTOMATIC CAR-RADIO SILENCER

Turns down the volume on command from your radar detector, cellular phone, or CB

## TUNE IN THE RADIO PIRATES

These illegal broadcasters offer a refreshing change from standard radio fare

## BUILD AN IR-CONTROLLED SOUND-EFFECTS GENERATOR

It's perfect for your Halloween haunted house, or for dozens of other applications

## THE AUTOMATED HOME

Computers and electronics team up to put man in command of his castle



A  
**GERNSBACK**  
PUBLICATION



\$2.50 U.S.  
\$2.95 CANADA

3 NEW  
FactCards  
IN THIS ISSUE

XXXXXXXXXXXX 5-DIGIT 60506  
60506DHM997GADDF FEB91 37  
ROBERT DAHM RESP  
997 GRAND AVE 059  
AURORA, IL 60506

# Electronics Paperback Books

GREAT PAPERBACKS AT SPECIAL PRICES

**BP248—TEST EQUIPMENT CONSTRUCTION** ..... \$5.95. Details construction of simple, inexpensive, but extremely useful test equipment. AF Gen, Test Bench Ampl, Audio Millivoltmeter, Transistor Tester and six more.



**BP267—HOW TO USE OSCILLOSCOPES AND OTHER TEST EQUIPMENT** ..... \$6.95. Mastering the oscilloscope is not really too difficult. This book explains all the standard controls and functions. Other equipment is also described.

**BP265—MORE ADVANCED USES OF THE MULTIMETER** ..... \$5.95. Use these techniques to test and analyze the performance of a variety of components. Also see how to build add-ons to extend multimeter capabilities.



**BP256—INTRO TO LOUDSPEAKERS AND ENCLOSURE DESIGN** ..... \$5.95. We explore the variety of enclosure and speaker designs in use today so the reader can understand the principles involved.

**BP263—A CONCISE INTRO TO dBASE** ..... \$6.95. The dBASE series of programs are probably the best known database programs for microcomputers. This book is designed to help you get started working with them.



**BP260—CONCISE INTRO TO OS/2** ..... \$5.95. If you are a multitasking PC user and want to get the most out of your computer, then you must learn its OS/2 operating system. This book shows you just how to do that, quickly and easily.



**BP249—MORE ADVANCED TEST EQUIPMENT CONSTRUCTION** ..... \$6.95. Eleven more test equipment construction projects. They include a digital voltmeter, capacitance meter, current tracer and more.



Digital Audio Projects

**BP245—DIGITAL AUDIO PROJECTS** ..... \$5.95. Practical circuits to build and experiment with. Includes A/D converter, input amplifier, digital delay line, compander, echo effect and more.



**BP247—MORE ADVANCED MIDI PROJECTS** ..... \$5.95. Circuits included are a MIDI indicator, THRU box, merge unit, code generator, pedal, programmer, channelizer, and analyzer.



**BP257—INTRO TO AMATEUR RADIO** ..... \$6.95. Amateur is a unique and fascinating hobby. This book gives the newcomer a comprehensive and easy to understand guide to the subject.



**PCP102—INTRODUCING DIGITAL AUDIO** ..... \$9.95. Covers all kinds of digital recording methods—CD, DAT and Sampling. Bridges the gap between the technician and the enthusiast. Principles and methods are explained.

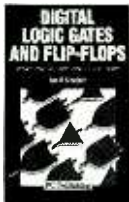

**PCP107—DIGITAL LOGIC GATES AND FLIP-FLOPS** ..... \$10.00. Thorough treatment of gates and flip-flops for enthusiasts, student and technicians. Only a basic knowledge of electronics is needed.

**BP251—COMPUTER HOBBYISTS HANDBOOK** ..... \$8.95. A wrapup of everything the computer hobbyist needs to know in one easy to use volume. Provides a range of useful reference material in a single source.

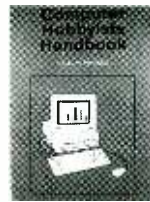

**PCP108—COMPUTERS AND MUSIC** ..... \$9.95. Explains the basics of computers and music with no previous knowledge of computers needed. Covers types of music software and explains how to set up your own computer music studio.

- BP195—INTRODUCTION TO SATELLITE TV**..... \$9.95. A definitive introduction to the subject written for the professional engineer, electronics enthusiast, or others who want to know more before they buy. 8 x 10 in.
- BP190—ADVANCED ELECTRONIC SECURITY PROJECTS**.....\$5.95. Includes a passive infra-red detector, a fiber-optic loop alarm, computer-based alarms and an unusual form of ultrasonic intruder detector.
- BP235—POWER SELECTOR GUIDE**.....\$10.00. Complete guide to semiconductor power devices. More than 1000 power handling devices are included. They are tabulated in alpha-numeric sequence, by technical specs. Includes power diodes, Thyristors, Triacs, Power Transistors and FETs.
- BP234—TRANSISTOR SELECTOR GUIDE**.....\$10.00. Companion volume to BP235. Book covers more than 1400 JEDEC, JIS, and brand-specific devices. Also contains listing by case type, and electronic parameters. Includes Darlingtons transistors, high-voltage devices, high-current devices, high power devices.
- BP99—MINI-MATRIX BOARD PROJECTS**..... \$5.50. Here are 20 useful circuits that can be built on a mini-matrix board that is just 24 holes by ten copper-foil strips.
- BP82—ELECTRONIC PROJECTS USING SOLAR CELLS**.....\$5.50. Circuits with applications around the home that are powered by the energy of the sun. Everything from radio receivers, to a bicycle speedometer, to timers, audio projects and more.
- BP117—PRACTICAL ELECTRONIC BUILDING BLOCKS—Book 1**.....\$5.75. Oscillators, Timers, Noise Generators, Rectifiers, Comparators, Triggers and more.
- BP184—INTRO TO 68000 ASSEMBLY LANGUAGE**.....\$6.95. The 68000 is a great new breed of microprocessor. Programming in assembly language increases the running speed of your programs. Here's what you need to know.

**BP179—ELECTRONIC CIRCUITS FOR THE COMPUTER CONTROL OF ROBOTS** ..... \$7.50. Data and circuits for interfacing the computer to the robot's motors and sensors

- BP239—GETTING THE MOST FROM YOUR MULTIMETER**..... \$5.95. Covers basics of analog and digital meters. Methods of component testing includes transistors, thyristors, resistors, capacitors and other active and passive devices.
- BP97—IC PROJECTS FOR BEGINNERS**.....\$5.50. Power supplies, radio and audio circuits, oscillators, timers, switches, and more. If you can use a soldering iron you can build these devices.
- BP37—50 PROJECTS USING RELAYS, SCR'S & TRIACS**.....\$5.50. Build priority indicators, light modulators, warning devices, light dimmers and more.
- RADIO—100 RADIO HOOKUPS**.....\$3.00. Reprint of 1924 booklet presents radio circuits of the era including regenerative, neutrodyne, reflex & more.
- BP42—SIMPLE LED CIRCUITS**..... \$5.50. A large selection of simple applications for this simple electronic component.
- BP127—HOW TO DESIGN ELECTRONIC PROJECTS**.....\$5.75. Helps the reader to put projects together from standard circuit blocks with a minimum of trial and error.
- BP122—AUDIO AMPLIFIER CONSTRUCTION**.....\$5.75. Construction details for preamps and power amplifiers up through a 100-watt DC-coupled FED amplifier.
- BP92—CRYSTAL SET CONSTRUCTION**..... \$5.50. Everything you need to know about building crystal radio receivers.
- BP45—PROJECTS IN OPTOELECTRONICS**..... \$5.50. Includes infra-red detectors, transmitters, modulated light transmission and photographic applications.

**BP185—ELECTRONIC SYNTHESIZER CONSTRUCTION** ..... \$5.95. Use this book to learn how to build a reasonably low cost, yet worthwhile monophonic synthesizer and learn a lot about electronic music synthesis in the process

## CHECK OFF THE BOOKS YOU WANT

**ELECTRONIC TECHNOLOGY TODAY INC.**  
P.O. Box 240, Massapequa Park, NY 11762-0240

Name \_\_\_\_\_  
Address \_\_\_\_\_  
City \_\_\_\_\_ State \_\_\_\_\_ Zip \_\_\_\_\_

P-1090

**SHIPPING CHARGES IN USA AND CANADA**

\$0.01 to \$5.00	... \$1.25
\$5.01 to 10.00	... \$2.00
\$10.01 to \$20.00	... \$3.00
\$20.01 to \$30.00	... \$4.00
\$30.01 to \$40.00	... \$5.00
\$40.01 to \$50.00	... \$6.00
\$50.01 and above	... \$7.50

**SORRY No orders accepted outside of USA & Canada**

Number of books ordered

Total price of merchandise ..... \$ \_\_\_\_\_  
Sales Tax (New York State Residents only) ..... \$ \_\_\_\_\_  
Shipping (see chart) ..... \$ \_\_\_\_\_

**All payments must be in U.S. funds**

Total Enclosed ... \$ \_\_\_\_\_

# Popular Electronics®

THE MAGAZINE FOR THE ELECTRONICS ACTIVIST!

## CONSTRUCTION ARTICLES

<b>IR-TRIGGERED SOUND-EFFECTS GENERATOR</b> .....	Jan Axelson	35
<i>This versatile circuit is perfect for Halloween trickery, or for dozens of other applications.</i>		
<b>THE LEPTON CANDLE</b> .....	Tom Fox	41
<i>An electronic candle that flickers in the wind like the real thing.</i>		
<b>THE FIRST ELECTRIC MOTOR</b> .....	Don H. Anderson	55
<i>Build a working model of Faraday's historic motor.</i>		
<b>BUILD A CAR-RADIO SILENCER</b> .....	Mike Giamportone	70
<i>It mutes the radio on command from your radar detector, CB, or cellular phone.</i>		

## FEATURE ARTICLES

<b>200,000-VOLT VAN DE GRAAFF GENERATOR</b> .....	Stanley Czarnik	29
<i>Learn how these generators work, and have a ball experimenting with a working model.</i>		
<b>LIVING WITH LIGHTNING</b> .....	E.R. Doubek	32
<i>A few good habits can protect your gear, your home, and yourself.</i>		
<b>THE AUTOMATED HOME</b> .....	Robert Angus	39
<i>Electronics and computers team up to put you in command of your castle.</i>		
<b>TUNE IN THE RADIO PIRATES</b> .....	Andrew Yoder	57
<i>Their counter-culture broadcasts are illegal, and fascinating.</i>		
<b>THE DIGITAL ELECTRONICS COURSE</b> .....	Robert A. Young	59
<i>Using flip-flops with counters.</i>		
<b>THE BEST NEW PRODUCTS OF 1990</b> .....	Josef Bernard	60
<i>The best-of-the-best from the floor of the Consumer Electronics Show.</i>		
<b>PRINTER TECHNOLOGY</b> .....	Stephen J. Bigelow	64
<i>There are many different ways to put your computer's efforts on paper.</i>		

## PRODUCT REVIEWS

<b>GIZMO</b> .....		45
<i>Including: Memorex Universal Remote Control, AKG Reference Listening System, Design Tech Stereo Silencer, and much more.</i>		
<b>PRODUCT TEST REPORT</b> .....	Len Feldman	73
<i>Sony D190K Discman CD Player.</i>		
<b>HANDS-ON REPORT</b> .....		76
<i>Heathkit Active Antenna Kit.</i>		

## COLUMNS

<b>THINK TANK</b> .....	Byron G. Wels	22
<i>Times are a changing.</i>		
<b>ANTIQUE RADIO</b> .....	Marc Ellis	78
<i>More on our tube-tester design.</i>		
<b>CIRCUIT CIRCUS</b> .....	Charles D. Rakes	80
<i>Useful amplifier circuits.</i>		
<b>COMPUTER BITS</b> .....	Jeff Holtzman	82
<i>Spring cleaning.</i>		
<b>DX LISTENING</b> .....	Don Jensen	84
<i>More than just a hobby.</i>		
<b>HAM RADIO</b> .....	Joseph J. Carr	86
<i>A digital frequency-counter module.</i>		
<b>SCANNER SCENE</b> .....	Marc Saxon	88
<i>A new name in scanners.</i>		

## DEPARTMENTS

<b>EDITORIAL</b> .....	Carl Laron	2
<b>LETTERS</b> .....		3
<b>ELECTRONICS LIBRARY</b> .....		4
<b>NEW PRODUCTS</b> .....		12
<b>ADVERTISERS INDEX</b> .....		102

**Popular Electronics** (ISSN 1042-170X) Published monthly by Gernsback Publications, Inc., 500-B Bi-County Boulevard, Farmingdale, NY 11735. Second-Class postage paid at Farmingdale, NY and at additional mailing offices. One-year, twelve issues, subscription rate: U.S. and possessions \$21.95, Canada \$26.95, all other countries \$29.45. Subscription orders payable in U.S. funds only; International Postal Money Order, or check drawn on a U.S. bank. U.S. single copy price \$2.50. © 1990 by Gernsback Publications, Inc. All rights reserved. **Hands-on Electronics** and **Gizmo** trademarks are registered in U.S. and Canada by Gernsback Publications, Inc. **Popular Electronics** trademark is registered in U.S. and Canada by Electronics Technology Today, Inc. and is licensed to Gernsback Publications. Printed in U.S.A.

Postmaster: Please send address changes to **Popular Electronics**, Subscription Dept., P.O. Box 338, Mount Morris, IL 61054-9932.

A stamped self-addressed envelope must accompany all submitted manuscripts and/or artwork or photographs if their return is desired should they be rejected. We disclaim any responsibility for the loss or damage of manuscripts and/or artwork or photographs while in our possession or otherwise.

As a service to readers, **Popular Electronics** publishes available plans or information relating to newsworthy products, techniques, and scientific and technological developments. Because of possible variances in the quality and condition of materials and workmanship used by readers, **Popular Electronics** disclaims any responsibility for the safe and proper functioning of reader-built projects based upon or from plans or information published in this magazine.

**Larry Steckler**

*EHF, CET*

*Editor-In-Chief and Publisher*

## EDITORIAL DEPARTMENT

**Carl Laron**

*Editor*

**Robert A. Young**

*Associate Editor*

**John J. Yacono**

*Associate Editor*

**Byron G. Wels, K2AVB**

*Associate Editor*

**Teri Scaduto**

*Assistant Editor*

**Kathy Terenzi**

*Editorial Assistant*

**Marc Spiwak**

*Editorial Associate*

**Josef Bernard**

**Joseph J. Carr, K4IPV**

**Marc Ellis**

**Len Feldman**

**Jeffrey K. Holtzman**

**Don Jensen**

**Charles D. Rakes**

**Marc Saxon**

*Contributing Editors*

## PRODUCTION DEPARTMENT

**Ruby M. Yee**

*Production Director*

**Karen S. Tucker**

*Production Manager*

**Marcella Amoroso**

*Production Assistant*

**Janice Box**

*Editorial Production*

## ART DEPARTMENT

**Andre Duzant**

*Art Director*

**Russell C. Truelson**

*Technical Illustrator*

**Injae Lee**

*Assistant Illustrator*

**Jacqueline P. Cheeseboro**

*Circulation Director*

**Michele Torrillo**

*P.E. Bookstore*

## BUSINESS AND EDITORIAL OFFICES

Gernsback Publications, Inc.

500-B Bi-County Blvd.

Farmingdale, NY 11735

1-516-293-3000

Fax: 1-516-293-3115

President: **Larry Steckler**

Vice President: **Cathy Steckler**

Customer Service/Order Entry

1-800-435-0715

In IL 1-800-892-0753

7:30 AM - 8:30 PM EST

Advertising Sales offices listed on page 102

Cover photography by  
Warren Faidley (Weatherstock) and Diversified  
Photo Services

Composition by  
Mates Graphics



The  
Audit  
Bureau  
of  
Circulation



The publisher has no knowledge of any proprietary rights which will be violated by the making or using of any items disclosed in this issue.



# Editorial

## KEEP US ON THE RIGHT TRACK

Lately, I've gotten the feeling that something's amiss. Don't get me wrong, things have been going rather well around here.

**Popular Electronics'** circulation is growing, and we've got all kinds of exciting articles and projects in the works, but I still felt that something was wrong.

Yesterday, I realized what it was.

When we first became **Popular Electronics**, we asked you, the readers, to keep us pointed in the right direction. We asked you what you liked, and what you didn't like. After all, it is *your* magazine, and ultimately, everyone here works for you.

And, boy, did you let us know what was on your minds! Though there were literally tons of mail, we read each and every letter, and what you told us helped us make this a better magazine.

But as I was going through some of the mail the other day, I realized that we weren't getting the same kind of feedback anymore. Sure, there were plenty of letters that said "Great Job" or something similar, and we love getting that kind of mail (who wouldn't?), but we need to get the other kind, too.

So why not drop us a line and tell us what's on your mind. What would you like to see more of in **Popular Electronics**? What would you like to see less of? What are we doing right? What are we doing wrong? What can we do to make this the perfect magazine for you?

We are waiting for your letters, and the mailman has been warned!

Carl Laron  
Editor



# Letters

## STEPPER MOTOR UPDATE

In the article "All About Stepper Motors" (*Popular Electronics*, March 1990) something was omitted that was crucial in light of the damping scheme suggested in the article. Your readers might be wondering why the circuits suggested sometimes tend to blow their switch transistors.

The two halves of a center-tapped phase winding might not be very strongly coupled. In many stepping motors, they are wound around completely separate poles and share little iron. Therefore a diode to ground from one phase terminal (say  $\phi 1$ ) is not always very effective in damping the inductive ringing at the other phase terminal (say  $\phi 3$ ). It all depends on details of the particular motor, and the damping will not be perfect even in the best case.

The damping scheme suggested throughout the article is cute, but not common. Anyone using it should at least check for voltage ringing with a fast oscilloscope and choose his transistor ratings to suit what he sees. He may find that he needs much more than the recommended value of double the voltage.

Besides the relatively slow ringback, which involves the part of the coil linked to iron, there will be a very narrow pulse due to stray inductance just when the switch turns off if the turn-off is fast. The more usual diode arrangements, reversed and connected either to +V or +2V, catch that short spike as well as the main ring-back.

The simplest circuit that both damps adequately and returns the stored coil energy to the supply is the H-bridge—but that is more complex and is probably beyond the scope of an introductory article. However, since the damping scheme that was suggested contains an obscure danger, I don't think it belongs in an introductory article either.

P.A.E.  
Shaw Island, WA

## HAVES & NEEDS

Please help! I have an old tape echo machine, a Multivox model MX-201, in pieces. I have never seen it assembled, but, even in the shape it's in, I'm impressed with what its one record and five playback heads can do for any mike or instrument! I tried writing to the address on the back cover, but it came back marked "Return to Sender." If anyone

has the manufacturer's address or information on the fate of the company, please share it. An owner's or service manual would be ideal.

By the way, there is not a better electronics magazine than *Popular Electronics* on the market.

Lawrence Nentwig  
922 Lamanda  
San Antonio, TX 78201

I need an operator's manual and schematic for a Heathkit vacuum-tube voltmeter model #V-7-A. Thank you.

Larry Cook  
362 East South Street  
Richland Center, WI 53581

I have a multimeter made in Japan from or for Kaise Electric Works, Ltd. The model number is SK-100, and it has a 100K-ohms/V sensitivity on DC and a 10K-ohms/V on AC. It needs repairs, and I am seeking an address where I can send it, in Canada, if possible. I am also looking for operating instructions and a schematic for a Triplett tube tester, model #3413-A.

L.A. Duval  
2480 Ave. de la Ronde  
Quebec, P.Q., Canada G1J 4G2

Some time ago I saw an ad for a software program called "Partlister" from Livewire Software of Pacific Palisades, CA. It looked like a good program for creating and maintaining parts lists, summary lists, and bills of materials for an electronics manufacturer. Now that I could really use such a program, Livewire Software seems to no longer exist! I would really appreciate any help I could get in tracking down the company or in obtaining a copy of that program.

Jon Sanserino  
Technical Director  
Datawave, Inc.  
16259 Stagg Street  
Van Nuys, CA 91406

## BEGINNERS' LUCK

I really appreciated the article "Build an Economy Portable Shortwave Receiver" that appeared in the August issue of *Popular Electronics*. Too often the new electronics hobbyist is overwhelmed by the complexity of a project, its cost, or the difficulty in obtaining parts. That project had none of those frustrating limitations; the instructions were easy to follow and accurate. My wife and I sat down at our kitchen table and built the radio in a few hours. We were delighted when we flipped the switch on and it worked perfectly. The first station we tuned was Radio Havana! We plan to use it camping this summer, and go DX hunting.

Our thanks to Joseph Mitsch and the *Popular Electronics* editors for a great evening's fun!

J.C.W.  
Perrysburg, OH ■

## Put Professional Knowledge and a COLLEGE DEGREE in your Technical Career through HOME STUDY

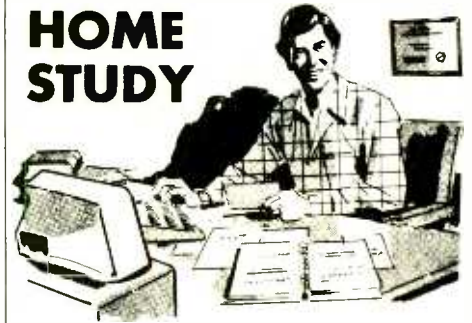

Add prestige and earning power to your technical career by earning your Associate or Bachelor degree through directed home study.

Grantham College of Engineering awards accredited degrees in **electronics and computers.**

An important part of being prepared to *move up* is holding the right college degree, and the absolutely necessary part is knowing your field. Grantham can help you both ways—to learn more and to earn your degree in the process.

Grantham offers two degree programs—one with major emphasis in **electronics**, the other with major emphasis in **computers**. Associate and bachelor degrees are awarded in each program, and both programs are available completely by correspondence.

No commuting to class. Study at your own pace, while continuing on your present job. Learn from easy-to-understand lessons, with help from your Grantham instructors when you need it.

Write for our free catalog (see address below), or phone us at toll-free 1-800-955-2527 (for catalog requests only) and ask for our "degree catalog."

Accredited by  
the Accrediting Commission of the  
National Home Study Council

**GRANTHAM**  
College of Engineering  
250 Frontage Road  
Slidell, LA 70460

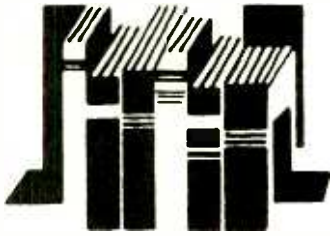

## Electronics Library

To obtain additional information on the books and publications covered in this section from the publisher, please circle the item's code number on the Free Information Card

### DON LANCASTER'S LASERWRITER SECRETS

by Don Lancaster

This collection of Don Lancaster's "Laser-Writer Corner" columns from *Computer Shopper* covers the Apple LaserWriter line of printers—including the LaserWriter, LaserWriter Plus, LaserWriter NT, and LaserWriter NTX—and much of the information also applies to almost any PostScript-speaking laser printer and to the general field of desktop publishing. Each column has been rewritten and reorganized, resulting in one comprehensive, fully-indexed sourcebook of up-to-the-minute information. The book and diskette that accompanies it are filled with tips and tricks, such as "Free Fonts," which are ways to make already existing fonts do new and unique things. Going way beyond the basics presented in any user's manual, Don Lancaster lets his readers in on inside information. He reveals secrets such as ways to drastically reduce toner costs, how to eliminate expensive AppleTalk cables, how to get decent shades of gray, working with random numbers and screens, and methods for recoating SX cartridge drums. Each page of the self-published book has Lancaster's help-line phone number in the bottom, a great source for still more help.

*Don Lancaster's LaserWriter Secrets* is available for \$29.50, including disk from Synergetics, Box 809, Thatcher, AZ 85552; Tel. 602-428-4073. Be sure to specify Apple IIe, Mac, or PC disk.

CIRCLE 81 ON FREE INFORMATION CARD

### HOW TO EXPAND, MODERNISE AND REPAIR PCs AND COMPATIBLES

by R.A. Pentfold

One of the benefits of owning a PC or compatible is that it can be upgraded and expanded. For any PC user who is ready to take advantage of that expandability—wanting to add more memory, a new disk drive, or various peripherals—this book

aims to simplify the often confusing aspects of PC upgrading and make the expansion process reasonably straightforward and painless. No advanced computing skills are required, although to get the most from the book, readers should have and be able to use a PC, PC XT, PC AT, 80386-based PC, or compatible computer.

After providing an overview of personal computers, the book covers subjects such as memory upgrades; adding a hard- or floppy-disk drive; display adapters and monitors; fitting a math coprocessor; and adding keyboards, ports, mice, and digitizers. Each subject is covered in detail, with an emphasis on practical advice rather than theory. Finally, there are two chapters covering preventative maintenance and basic repairs.

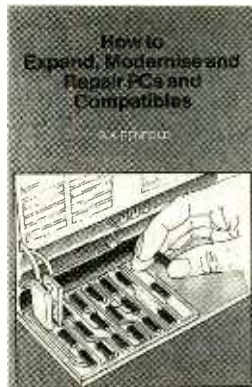

*How to Expand, Modernise and Repair PCs and Compatibles* (order no. BP271) is available for \$7.95 (including shipping and handling) from *Electronic Technology Today, Inc.*, P.O. Box 240, Massapequa Park, NY 11752-0240.

CIRCLE 97 ON FREE INFORMATION CARD

### COMPLETE GUIDE TO ELECTRONIC POWER SUPPLIES

by John D. Lenk

Experimenters, students, and serious hobbyists will appreciate this book's down-to-earth guidance on experimentation, troubleshooting, and design that they can put to use immediately—even to design and build their own power supplies from scratch. A simplified design approach, in which design problems are introduced starting with approximations or guidelines for the selection of all components on a trial-value basis, is used. Those approximate values are put to use in experimental test circuits, and then, by varying the test-component values, the desired results are produced. This hands-on approach keeps mathematical theory to a minimum, and requires no previous design experience or memorization of complex theories. Instead, readers learn as they

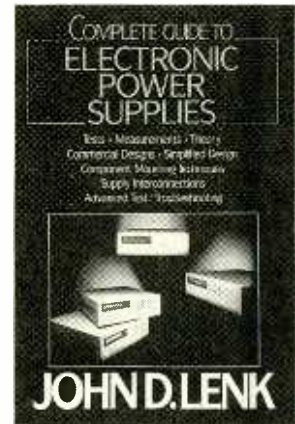

are guided step-by-step through practical experimentation.

The book also provides in-depth information on all aspects of electronic power supplies. One chapter is devoted to advanced testing and troubleshooting of power supplies for today's equipment, including digital TV's, camcorder-battery chargers, audio systems, and VCR's. The most popular forms of supply regulation—zener, feedback, op-amp, and switching—are covered. The book presents the latest information on converters and inverters, as well as practical mounting and interconnection techniques for power-supply components. More than 180 illustrations accompany the text.

*Complete Guide to Electronic Power Supplies* is available for \$39.00 from Prentice Hall, Englewood Cliffs, NJ 07632.

CIRCLE 99 ON FREE INFORMATION CARD

### UNDERSTANDING ELECTRONIC PHOTOGRAPHY: Image Processing Applications and Components

by John J. Larish

Video imaging is one of the most promising—and least understood—forms of modern communications technology. Still- and moving-video imaging; computer databanks; telephonics; and laser-disc, chip, and optical-disk data recording and storage are all interrelated technologies whose present and future possibilities are exciting and open-ended. This book takes each of those separate, but related, areas and fits them together like an "electronic jigsaw puzzle." Going beyond mere descriptions and explanations of each technological piece, the author presents a comprehensive picture of the field of electronic photography as it stands today, and predicts the exciting directions it might take in the future.

Now that still-photography equipment is finally becoming available to consumers, the book's practical advice—concerning how to choose equipment right through how to print pictures—is especially timely. In

clear, easily understood language, the author guides readers through each step needed to understand and implement the technology. The book compares the electronic-imaging products and technologies that are now available, including the latest electronic still-video cameras. It explains how to capture, process, and store electronic images, and how to use the "electronic darkroom" to manipulate those images using both analog and digital techniques to come up with creative presentations. The book demonstrates how to achieve optimum performance from optical and magnetic-storage devices, cameras, monitors, and printers. Color prints of actual still-video photographs are included.

*Electronic Photography: Image Processing Applications and Components is available for \$24.60 from TAB Professional and Reference Books, Division of TAB Books Inc., Blue Ridge Summit, PA 17294-0850; Tel. 1-800-233-1128.*

**CIRCLE 98 ON FREE INFORMATION CARD**



acquisition and conversion, analog outputs, control, and peripheral functions of plug-in data-acquisition boards. Circuit operations, formulas, diagrams, and terms are also discussed in this informative 8-page booklet.

*Tech Tip #1: Plug-in Data Acquisition Boards—Overview is free upon request from Keithley Metrabyte Corporation, 440 Myles Standish Blvd., Taunton, MA 02780; Tel. 508-880-3000.*

**CIRCLE 82 ON FREE INFORMATION CARD**

guide or a quick-reference guide, it offers information on the common uses of a DMM, including AC and DC voltage measurements and resistance, continuity, and diode checks. Multimeter safety is discussed, along with available accessories. Each section of the booklet includes illustrations and a glossary of electronic and multimeter-related terms.

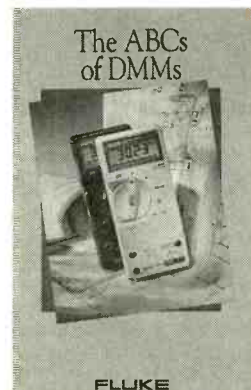

*The ABCs of DMMs is available at no charge from authorized Fluke Distributors nationwide, or from John Fluke Mfg. Co., Inc., P.O. Box 9090, Everett, WA 98206; Tel. 800-44-FLUKE.*

**CIRCLE 83 ON FREE INFORMATION CARD**

**TECH TIP #1: PLUG-IN DATA ACQUISITION BOARDS—OVERVIEW**

*from Keithley Metrabyte Corporation*

This pamphlet, the first in a series of technical tips, describes input characteristics,

**THE ABCs OF DMMs**

*from John Fluke Mfg. Co.*

A short course on the operation, capabilities, and selection of a digital multimeter is provided in this full-color, 16-page booklet. Intended as a shopper's



**2-1/2" SANYO TWEETER**

Paper cone with gold tone dust cap. 8 oz. magnet. 8 ohm. 1/2" ferro fluid voice coil. Power handling: 50W RMS, 70W max. Frequency response: 3K-20KHz.



#PM-271-020 \$1<sup>95</sup> \$1<sup>75</sup> 95c  
(1-9) (10-59) (60-up)

**SUPER HORN TWEETER**

Original piezo tweeter made by Motorola. SPL=94 dB 2.83V/1M. Response: 4KHz-27KHz. Handles approximately 50 watts.



#PM-270-010 \$5<sup>30</sup> \$4<sup>50</sup> \$3<sup>95</sup>  
(1-9) (10-79) (80-up)

**2" DOME MIDRANGE**

Textile dome midrange made by Phillips. 8 ohm. SPL=90 dB 1W/1M. 30W RMS. 40W max. Response: 550-5KHz.



#PM-280-210 \$27<sup>30</sup> \$25<sup>70</sup>  
(1-3) (4-up)

**15" SUBWOOFER**



Dual voice coil. 40 oz. magnet. 6 ohm imp. 100W RMS, 140W max. Response: 20-1.2KHz. Resonant frequency: 21Hz. SPL=93 dB 1W/1M.

**PIONEER**  
#PM-290-190 \$54<sup>50</sup> \$49<sup>90</sup>  
(1-3) (4-up)

**SUBWOOFER XOVER**

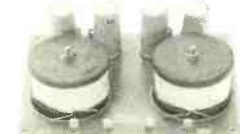

200W RMS crossover designed specifically for use with dual voice coil subwoofers. 12 dB per octave roll-off at 150Hz.

#PM-260-220 \$28<sup>80</sup> \$24<sup>40</sup>

**10" POLY WOOFER**

Medium duty. 60W RMS. 80W max. 14 oz. magnet. Response: 25-2.5KHz. fs=28Hz.



#PM-290-096 \$18<sup>50</sup> \$16<sup>90</sup>  
(1-3) (4-up)

**TITANIUM COMPOSITE TWEETER**

The advantages of both hard and soft dome technologies. 8 ohm. Ferro fluid cooled voice coil. SPL=90 dB 1W/1M. 50W RMS, 70W max. 4" round. Polydax #DTW100T125.

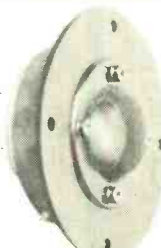

**polydax**  
#PM-270-047 \$27<sup>50</sup> \$24<sup>80</sup>  
(1-9) (10-up)

**SPEAKER BUILDING BOOK**

Revised edition of David Weems' best selling book. Learn to build low cost speakers that rival the high priced models.



#PM-500-021 \$16<sup>95</sup>

**12" CAST FRAME WOOFER**



**EMINENCE**

12" woofer made in the USA by Eminence. Paper cone and dust cap with treated cloth surround. 80 oz. magnet. 2-1/2" vented voice coil. 8 ohm. 170W RMS, 235W max. 40-4.5KHz response.

#PM-290-147 \$72<sup>90</sup> \$69<sup>50</sup>  
(1-3) (4-up)

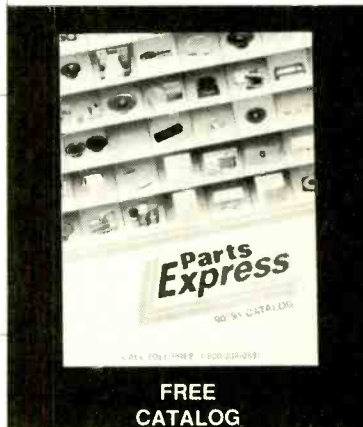

• 15 day money back guarantee • \$15.00 minimum order • We accept Mastercard, Visa, Discover, and C.O.D. orders. • 24 hour shipping • Shipping charge = UPS chart rate + \$1.00(\$3.00 minimum charge) • Hours 8:30 am-7:00 pm EST, Monday - Friday • Mail order customers, please call for shipping estimate on orders exceeding 5 lbs. Foreign customers please send \$5.00 U.S. funds for catalog postage.

**CALL TOLL FREE  
1-800-338-0531**

**CIRCLE 12 ON FREE INFORMATION CARD**



### 386SX COMPUTER WITH VGA MONITOR



- 100% IBM compatible.
- 80386SX-16/8 MHz speed, zero wait state, upgradable to 20 MHz.
- One 3-1/2" 1.44 MB floppy disk drive.
- One 5-1/4" 1.2 MB floppy disk drive.
- 40 MB hard drive/28 millisecond access time. • 1 MB RAM on motherboard, expandable to 8 MB.
- Expansion slots: four IBM AT slots.
- Two serial ports. • One parallel port.
- Built-in VGA video support.
- Battery backed real time clock/calendar.
- 80387SX-16 math co-processor socket.
- 101 key detachable IBM style keyboard.
- Phoenix BIOS.
- Included MS-DOS 4.0. Does not include software shown on screen.
- Dim.: 16"Wx18"Dx5"H. • Model # CPC8248.
- **One Year Warranty through Cordata.**
- **Factory New! Factory Perfect!**

#### VGA monitor:

- 14" non-glare color monitor.
- 100% IBM compatible.
- .42 mm dot pitch.
- 256 colors.
- Resolution: 640x480.
- Dim.: 14.72"W x 12.40"H x 15.64"D.

Mr. Sugg. Retail:

**\$2,968.00**

**DAMARK PRICE:**

**\$1499<sup>99</sup>**

Item No. B-2255-143578  
Insured Ship/Hand.: \$49.00



**FOR FASTEST SERVICE  
CALL TOLL FREE**

**1-800-729-9000**



#### DAMARK INTERNATIONAL, INC.

7101 Winnetka Ave. N., Minneapolis, MN 55428-1619  
Customer Service • 612-531-0092

Please rush me:  Cordata Computer(s)  
@ \$1499.99 each, plus \$49.00 s/h each.  
Item No. B-2255-143578 **MN res. add 6% sales tax.**

Name \_\_\_\_\_

Address \_\_\_\_\_

City, State, Zip \_\_\_\_\_

Check/MO  VISA  Master Card  Discover

Card No. \_\_\_\_\_

Exp. Date \_\_\_\_\_ Ph. # ( ) \_\_\_\_\_

Signature \_\_\_\_\_

Copyright 1990 DAMARK International, Inc. All rights reserved.

**DELIVERY TO 48 U.S. STATES ONLY**

### ENCYCLOPEDIA OF ELECTRONICS Second Edition

*edited by Stan Gibilisco  
and Neil Slater*

This single-source reference contains more than 1000 pages of information covering virtually every concept and component the student of general electronics needs to know about—and also includes concepts in physics, mathematics, computer science, and chemistry as they relate to electronics. The second edition has been extensively revised to include the most recent advances in digital electronics and computer technology. Some of the new listings include artificial intelligence, fax machines, superconductivity, laser printers, communications satellites, programmable logic devices, bar codes, computer-aided design and engineering, fiber optics, and high-definition TV.

For ease of use, the illustrated encyclopedia is arranged alphabetically, meticulously cross-referenced, and fully indexed.



The entries are written in non-technical, jargon-free terms and are supplemented with diagrams, photographs, and schematics to clarify the explanations.

*The Encyclopedia of Electronics: Second Edition is available in hardcover for \$69.50 from TAB Professional and Reference Books, Division of TAB Books Inc., Blue Ridge Summit, PA 17294-0850; Tel. 1-800-233-1128.*

**CIRCLE 98 ON FREE INFORMATION CARD**

### LISKIN'S dBASE IV PROGRAMMING BOOK

*by Miriam Liskin*

This book focuses on helping users learn to program with dBASE IV's command language, and no previous programming experience is required to benefit from its easy-to-understand guidance. Users at any level of expertise will learn to effectively use the power and sophistication of dBASE IV. The author uses plenty of examples and practical applications to demonstrate the elements of the command language. The book explains how to program using menus, pop-ups, and pick lists; access multiple files;

print reports and forms; write utility programs as well as multi-user programs for use on networks; and add password protection to programs. The step-by-step descriptions and demonstrations of application design and programming fundamentals are designed to help readers develop the skills they need to refine and optimize their own dBASE IV applications. The book is available with or without a special time-saving diskette that contains all of the example programs in the book.

*Liskin's dBASE IV Programming book is available for \$28.95 without the diskette and \$39.95 with the diskette from Osborne McGraw-Hill, 2600 Tenth Street, Berkeley, CA 94710.*

**CIRCLE 84 ON FREE INFORMATION CARD**

### MACHINE LEARNING: PRINCIPLES AND TECHNIQUES

*edited by Richard Forsyth*

Once considered strictly a post-graduate specialty, machine learning is now being taught to undergraduates as an important topic within the field of artificial intelligence (AI), and is likely to branch further out to computer science in general. While the book is intended primarily as a guide for those who are trying to develop or use a computer system that can "learn" to improve its performance, it also serves as a comprehensive survey of a dynamic research field that is beginning to result in important practical applications.

Information is presented in an easily accessible manner, in the form of a collection of articles written by some of the leading experts in the field. The authors describe some of the exciting research being done at this frontier of computer science, and also

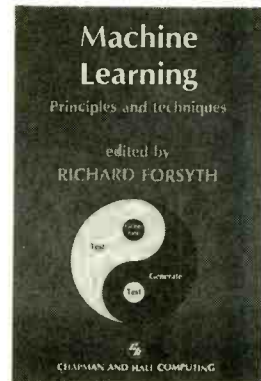

show how the techniques described can lead to impressive practical results. They offer diverse points of view, yet the overall theme of the book is one of a unified field of study.

*Machine Learning: Principles and techniques is available for \$29.95 (paperback) or \$85.00 (cloth-bound) from Routledge,*



Chapman & Hall, 29 West 35th Street, New York, NY 10001; Tel. 212-244-3336.

CIRCLE 85 ON FREE INFORMATION CARD

### TEACH YOURSELF DOS

by Herbert Schildt

To help beginners learn the basics of DOS as quickly as possible, this book is structured into fast 15-minute study sessions that each teach a specific technique. Each technique is presented using hands-on exercises and examples, with answers appearing at the back of the book. As the reader progresses through the study sessions, new skills are built on the foundation of what was learned in earlier sessions. "Skill checks" appear throughout the text, to help the reader determine if he is adequately prepared to grasp techniques presented in the following section.

The first few chapters provide the information necessary to run application programs; the complete book is designed to put the reader in command of all DOS essentials to be able to use it system as efficiently and productively as possible. All versions of MS-DOS and PC-DOS are covered in depth, and an appendix on Version 4.0 is included.

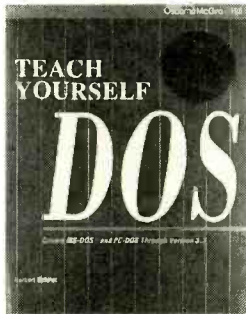

Teach Yourself DOS is available for \$19.95 from McGraw-Hill Book Company, 11 West 19th Street, New York, NY 10011; Tel. 1-800-2-MCGRAW.

CIRCLE 96 ON FREE INFORMATION CARD

### POWER ELECTRONICS HANDBOOK: Components, Circuits, and Applications

by F.F. Mazda

This book is intended to provide the electronics engineer with all the material relating to power components, circuit design, and applications needed to work effectively in the field. Its emphasis is on the design of power circuits used for various applications, the characteristics of semiconductor devices, and how they are used in power cir-

cuits. The information is presented in a practical form, with theory presented as worked-out formulas rather than showing their mathematical derivations.

The book is divided into three parts. The "Components" section covers power semiconductor devices, thermal design, components, EMC, and semiconductor protection. In the "Circuits" section, detailed information is provided on the arrangement and design of a variety of power-semiconductor circuits, including static switches, AC-line control, phase-controlled rectification and

inversion, direct AC frequency converters, forces commutation techniques, DC-to-DC converters, and DC-link frequency converters. Part three, "Applications," describes the real-world uses of power-semiconductor circuits in power supplies, electrical machine control, heating and lighting, and electromechanical applications. Ample illustrations help clarify the text, and a list of symbols, a glossary of terms, and a bibliography are provided as well.

Power Electronics Handbook: Components, Circuits and Applications is available

## ELENCO & HITACHI PRODUCTS AT DISCOUNT PRICES

**NEW!** RSOs (Real-Time & Storage Oscilloscopes) From HITACHI **NEW!**

The RSO - Its the new solution  
View, Acquire, Test, Transfer and Document Your Waveform Data

4-Channel, 100MS/s Models	Introductory Price
100MS/s (25MS/s on 4 channels simultaneously), 100MHz, 4kw x 1ch., 2kw x 2ch., 1kw x 4ch. VC-6145	\$4,695.00

**Compact, Full Feature Models**

40MS/s, 100MHz, 4kw x 1ch., 2kw x 2ch.	VC-6045 \$3,049.00
20MS/s, 50MHz, 2kw x 2ch.	VC-6025 \$2,295.00

**Low Cost/High Value Models**

20MS/s, 50MHz, 2kw x 2ch.	VC-6024 \$2,049.00
20MS/s, 20MHz, 2kw x 2ch.	VC-6023 \$1,749.00

RSOs from Hitachi feature such functions as roll mode, averaging, save memory, smoothing, interpolation, paring/gauging, cursor measurements, plotter interface, and RS-232C interface. With the comfort of analog and the power of digital.

V-212  
\$435  
DC to 20MHz  
Dual Channel

**Hitachi Portable Scopes**

V-525 CRT Readout, Cursor Meas. \$1,025  
V-523 Delayed Sweep \$995  
V-522 Basic Model \$895

V-422 40MHz Dual Trace \$795

**20MHz Elenco Oscilloscope** \$375  
MO-1251

- Dual Trace
- Component Tester
- 6" CRT
- X-Y Operation
- TV Sync
- 2 p-1 Probes

**FREE DMM** with purchase of ANY SCOPE

**SCOPE PROBES**  
P-1 65MHz. 1x, 10x \$19.95  
P-2 100MHz. 1x, 10x \$23.95

**Compact Series Scopes**

Delayed Sweep  
Light-weight (13lbs)  
2mV Sens  
3 Yr Warranty  
Model V-1065  
Shown

This series provides many new functions such as CRT Readout, Cursor measurements (V-1065/1065/665), Frequency Cir (V-1085), Sweepline Autofocusing and Trigger Lock using a 6-inch CRT. You don't feel the compactness in terms of performance and operation.

V-660 60MHz Dual Trace	\$1,195
V-665 60MHz Dual Trace w/Cursor	\$1,345
V-1060 100MHz Dual Trace	\$1,425
V-1065 100MHz Dual Trace w/Cursor	\$1,695
V-1085 100MHz Quad Trace w/Cursor	\$2,045
V-1100A 100MHz Quad Trace w/Cursor	\$2,295
V-1150 150MHz Quad Trace w/Cursor	\$2,775

**Elenco 35MHz Dual Trace** \$495  
MO-1252

- High luminance 6" CRT
- 1mV Sensitivity
- 5KV Acceleration Voltage
- 10ms Rise Time
- X-Y Operation + Z Axis
- Delayed Triggering Sweep
- Includes 2 P-1 Probes

All scopes include probes, schematics, operators manual, and 3 year (2 yrs for Elenco scopes) world wide warranty on parts & labor. Many accessories available for all Hitachi scopes. Call or write for complete specifications on these and many other fine oscilloscopes.

**WE NOW CARRY COMPLETE LINE OF FLUKE MULTIMETERS**

Models

21F	83
23F	85
25F	87
27F	8050A
73	8060A
75	8062A
77F	+ More

CALL FOR SPECIAL PRICING

**True RMS 4 1/2 Digit Multimeter M-7000**

**\$135**

.05% DC Accuracy  
.1% Resistance with Freq. Counter and deluxe case

**10 Function Multimeter CM-365**

**\$65**

AC + DC Voltage & Amps  
Resistance to 2000MΩ  
Diode, Logic, & Trans Test  
Capacitance to 200µF

**Digital Capacitance Meter CM-1550**

**\$58.95**

9 Ranges  
1pf-20,000µF  
.5% basic accy  
Zero control with case

**Digital LCR Meter LC-1801**

**\$125**

Measures:  
Coils 1µH-200H  
Caps. 1pf-200µF  
Res. 01-20M

**Function Generator Blox**

**\$28.95**

Provides sine, triangle, square wave from 1Hz to 1MHz AM or FM capability

**Triple Power Supply XP-620**

Assembled \$65  
Kit \$45

2 to 15V at 1A  
-2 to -15V at 1A  
(or 4 to 30V at 1A and 5V at 3A)

Contains all the desired features for doing experiments  
Features short circuit protection, all supplies

**Wide Band Signal Generators SG-9000**

**\$129**

RF Freq 100K-450MHz  
AM Modulation of 1KHz  
Variable RF output

SG-9500 w/ Digital Display and 150MHz built-in Counter \$249

**Soldering Station**

Temperature Controlled

SL-30 \$99

Digital display  
Temp range 300F-900F  
Grounded tip  
Overheat protected

**Color Convergence Generator SG-200**

**\$69.95**

Finest in the industry  
10 rock steady patterns

**10MHz Oscilloscope S-3000**

**\$275**

10MHz DC or AC  
Triggered Sweep  
Calibrated Volt & Hz  
Reacts Volts & Freq

**Temperature Probe M-110CF**

**\$29.95**

Semiconductor type  
Range 50F-302F  
Fits most digital multimeters

**Autorangeing DMM M-5000**

**\$45**

9 Functions  
Memory and Data hold  
1/2 % basic acc  
3 1/2 digit LCD

**AC Current Meter ST-1010**

**\$69.95**

1000 Amps  
Data & Peak hold  
8 Functions  
Deluxe Case

**Decade Box**

#9610 or #9620  
**\$18.95**

#9610 Resistor Box  
47 ohm to 1M & 100K pot  
#9620 Capacitor Box  
47pf to 10MFD

**Quad Power Supply XP-580**

**\$59.95**

2-20V at 2A  
12V at 1A  
5V at 3A  
-5V at 5A

Fully regulated and short circuit protected  
XP-575 without meters \$39.95

**LEARN TO BUILD AND PROGRAM COMPUTERS WITH THIS KIT!**

INCLUDES: All Parts, Assembly and Lesson Manual

Model MM-8000  
**\$129.00**

Starting from scratch you build a complete system. Our Micro Master trainer teaches you to write into RAM, ROM and into a 8085 microprocessor, which uses similar machine language as IBM PC. You will write the initial instructions to fill the 8085 processor to get started and store these instructions in permanent memory in a 2816 EPROM. Teaches you all about input and output ports, computer timers. Build your own keyboard and learn how to scan keyboard and display. No previous computer knowledge required. Simple easy to understand instruction teaches you to write in machine language.

ROBOTICS KIT FOR ABOVE (MM-8010) \$71.95

**Digital Triple Power Supply XP-765**

**\$249**

0-20V at 1A  
0-20V at 1A  
5V at 5A

Fully regulated. Short circuit protected with 2 limit control, 3 separate supplies  
XP-660 with Analog Meters \$175

**GF-8016 Function Generator**

with Freq. Counter  
**\$249**

Sine, Square, Triangle  
Pulse, Ramp, 2 to 2MHz  
Freq. Counter .1 - 10MHz

GF-8015 without Freq. Meter \$179

**WE WILL NOT BE UNDERSOLD!**  
UPS Shipping: 48 States 5%  
(\$10 Max) IL Res., 7% Tax

**C & S SALES INC.**  
1245 Rosewood, Deerfield, IL 60015  
(800) 292-7711 (708) 541-0710

**15 Day Money Back Guarantee**  
2 Year Warranty (Prices subject to change)  
**WRITE FOR FREE CATALOG**

CIRCLE 13 ON FREE INFORMATION CARD

## SPECIAL FROM ETT SAVE \$\$ TODAY

□ 2617T—BUILD A REMOTE-CONTROLLED ROBOT ..... regular \$9.95 ..... **SPECIAL \$8.95.** Fool-proof instructions for putting together your own full-size working robot at a fraction of the commercial cost.



□ 2645T—117 PRACTICAL IC PROJECTS YOU CAN BUILD ..... regular \$10.95 ..... **SPECIAL \$9.95.** Dozens of fully tested ready-to-build circuits you can put together from readily available, low-cost IC's.

□ BP53—PRACTICAL ELECTRONICS CALCULATIONS AND FORMULAE ..... regular \$6.95 ..... **SPECIAL \$5.95.** Six basic sections: Units and Constants, Direct Current Circuits, Passive Components, Alternating Current Circuits, Networks and Theorems, Measurements.



□ 2706T—BUILDING METAL LOCATORS ..... regular \$9.95 ..... **SPECIAL \$8.95.** A treasure hunter's project book. Build your own high-quality metal detector for a fraction of the factory-built cost.

□ BP234—TRANSISTOR SELECTION GUIDE ..... regular \$10.00 ..... **SPECIAL \$9.00.** Offers a range of selection tables compiled so as to be of maximum use to all electronics engineers, designers and hobbyists.



□ ETT CAT—ELECTRONIC TECHNOLOGY TODAY INC. CATALOG ..... \$2.00. 36-pages list a wide variety of electronics books. Included with catalog is a coupon good for \$3.00 off your first purchase.

MAIL TO: **Electronic Technology Today, Inc.**  
P.O. Box 240  
Massapequa Park, NY 11762-0240

### SHIPPING CHARGES IN USA AND CANADA

\$0.01 to \$5.00	... \$1.25	\$30.01 to \$40.00	\$5.00
\$5.01 to 10.00	... \$2.00	\$40.01 to \$50.00	\$6.00
\$10.01 to \$20.00	\$3.00	\$50.01 and above	\$7.50
\$20.01 to \$30.00	\$4.00		

**SORRY, No orders accepted outside of USA and Canada**

Total price of merchandise	..... \$	_____
Shipping (see chart)	..... \$	_____
Subtotal	..... \$	_____
Sales Tax (NYS only)	..... \$	_____
Total Enclosed	..... \$	_____

Name \_\_\_\_\_  
Address \_\_\_\_\_  
City \_\_\_\_\_ State \_\_\_\_\_ Zip \_\_\_\_\_

in hardcover for \$79.95 from Butterworths, 80 Montvale Avenue, Stoneham, MA 02180; Tel. 617-438-8464.

CIRCLE 86 ON FREE INFORMATION CARD

### COAXIAL PRODUCTS CATALOG #1990

from Pasternack Enterprises

Featured in this catalog are lines of amplifiers; breakouts; coaxial cable, switches, adapters, detectors, connectors, attenuators, and terminations; cutting and stripping tools; patch cords; push-button attenuators; waveguide adapters; coaxial cable assemblies; programmable attenuators; and twinax adapters and connectors. In addition, the catalog highlights many new adapters and connectors that use 3.5mm, 7mm, HN, SMB, SMC, SC, and SMA. Information on more than 300 new types of cable assemblies has been added to the 1990 catalog, which, in addition,



COAXIAL PRODUCTS DIVISION

tion, contains technical information as well as pricing on more than 2,200 standard catalog items.

The Coaxial Products Catalog #1990 is free upon request from Pasternack Enterprises, P.O. Box 16759, Irvine, CA 92713-6759; Tel. 714-261-1920.

CIRCLE 87 ON FREE INFORMATION CARD

### 1990 GENERAL CATALOG

from Contact East

Aimed at engineers, managers, and technicians, this 148-page catalog is a complete source book of products for testing, repairing, and assembling electronic equipment. Many new items are featured, including oscilloscopes, static-protection products, test equipment, precision hand tools, soldering supplies and stations, and tool kits. Expanded lines of voice-/data-communications products are also highlighted, including wire and cable aids, electronic adhesives, magnifiers, and inspection equipment. Specifications, full-color pho-



tographs, and prices accompany the product descriptions, and every item is guaranteed.

The 1990 General Catalog is free upon request from Contact East, 335 Willow Street South, P.O. Box 786, North Andover, MA 01845; Tel. 508-682-2000.

CIRCLE 88 ON FREE INFORMATION CARD

### TECHNICIAN'S HANDBOOK OF VCR REPAIR

by John P. Steiner

Now that VCR's have thoroughly penetrated the consumer-electronics market, the demand for qualified service is great, and new models with increasingly complex features make it hard for technicians to keep up to date.

This on-the-job answer book provides practical servicing information for the technician in one volume, making it easy to quickly find information on the adjustment and repair of major VCR models. Combining service data and guidelines from VCR and test-equipment manufacturers with no-nonsense techniques for diagnosing problems in faulty VCR units, the book aims to help technicians increase both their productivity and their incomes.

Beginning with a "refresher course" in the basic principles of video recording and VCR functions, features, and operation, the book goes on to describe industry signals and standards, and the test equipment that is required to service VCR's. Specific performance tests, to help the technician make objective evaluations, are included, along with reference guides containing many recommended mechanical-alignment and electrical adjustments. Several chapters outline factory-recommended troubleshooting techniques to help the technician pinpoint trouble spots in the VCR unit. Each system within the unit is covered, including audio, VHS recording and playback circuitry, servo systems, power-supply circuitry, microprocessor-control circuitry, and AFC and AGC circuitry.

Technician's Handbook of VCR Repair is available in hardcover for \$35.00 from Prentice Hall, Englewood Cliffs, NJ 07632. ■

CIRCLE 99 ON FREE INFORMATION CARD

**NEW**

# Only NRI gives you a 27" high-resolution stereo color TV you build to prepare you for today's video servicing careers.



## You Build a 27" Stereo TV

During the assembly process of your state-of-the-art Heath/Zenith 27" TV, you learn to identify and work with components and circuits as they actually appear in commercial circuitry. Then through tests, adjustments, and experiments you quickly master professional troubleshooting and bench techniques.



## Inside Your TV

The Heath/Zenith 27" TV has all the features that allow you to set up *today* your complete home video center of the future. Flat screen, square corners, and a black matrix to produce dark, rich colors . . . even a powerful remote control center that gives you total command of video and audio operating modes.

NRI has purposely designed your training around equipment that has the same high-tech circuitry you'll encounter in commercial equipment. That means your training is real-world training.

**Become one of America's most sought-after technicians . . . put your talents and spare time to work for you in the "explosive-growth" world of home entertainment electronics.**

Train in state-of-the-art video/audio servicing and become a fully qualified service professional the uniquely successful NRI way. It's hands-on training, at home . . . designed around the latest electronic equipment you build and keep as part of your training.

## The High-Tech Revolution in the Home Is Just Starting

Sweeping changes are taking place in our homes, changes brought about by the phenomenal growth of home entertainment electronics. Already available are high resolution TV, TVs with stereo sound, simultaneous multi-channel viewing, projection TV, Camcorders, 8 mm video cassettes, and compact disc players.

And the revolution has spread to the business sector as tens of thousands of companies are purchasing expensive high-tech video equipment used for employee training, data storage, even video conferencing.

## Join the Future or Be Left Behind

Today the consumer electronics industry represents a whopping \$26 billion opportunity for the new breed of consumer electronics technician.

Today's consumer electronics revolution is creating huge servicing and repair mar-

kets that are just starting to boom.

Here is your chance to become a fully qualified professional the way tens of thousands have trained with NRI.

## Totally Integrated Hands-On Training

Since NRI training is built around "learn by doing," right from the start you conduct important experiments and tests with your professional digital multimeter. You assemble the remarkable NRI Discovery Lab and perform a complete range of demonstrations and experiments in the process.



NRI's commitment to you goes beyond providing you with equipment appropriate to the latest technology. Best of all, we ensure that in the learning process you acquire the very skills that will make you a professional service technician on the job.

## SEND COUPON TODAY FOR FREE NRI CATALOG!

**NRI** SCHOOLS

McGraw-Hill Continuing Education Center  
4401 Connecticut Avenue, NW, Washington, DC 20008

We'll give you tomorrow.

### CHECK ONE FREE CATALOG ONLY

For Career courses approved under GI Bill  
 check for details.

- |  |   |
|--|---|
| <input type="checkbox"/> TV/Audio/Video Servicing      | <input type="checkbox"/> Small Engine Repair                        |
| <input type="checkbox"/> Computer Electronics          | <input type="checkbox"/> Air Conditioning, Heating, & Refrigeration |
| <input type="checkbox"/> Satellite Electronics         | <input type="checkbox"/> Locksmithing & Electronic Security         |
| <input type="checkbox"/> Robotics & Industrial Control | <input type="checkbox"/> Photography                                |
| <input type="checkbox"/> Industrial Electronics        | <input type="checkbox"/> Bookkeeping & Accounting                   |
| <input type="checkbox"/> Telephone Servicing           |   |
| <input type="checkbox"/> Digital Electronics Servicing |   |
| <input type="checkbox"/> Basic Electronics             |   |
| <input type="checkbox"/> Electricians                  |   |

Name (Please print) \_\_\_\_\_

Age \_\_\_\_\_

Street \_\_\_\_\_

City/State/Zip \_\_\_\_\_

18-100

Accredited Member National Home Study Council

OCTOBER 1990

11

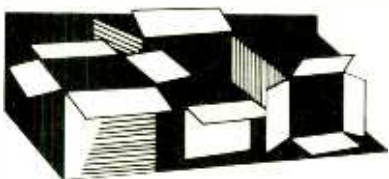

## New Products

To obtain additional information on new products covered in this section from the manufacturer, please circle the item's code number on the Free Information Card

### DETACHABLE CAR STEREO

Profile Consumer Electronics describes its DN-928 car stereo as "a breakthrough in anti-theft technology" that offers the benefits of a pull-out unit without the bulk. The car stereo has a detachable function system (DFS) that allows just its control section to be removed. The control section, which is only a few inches long and thinner than a ruler, slips on and off its mount by moving a lever. Its small size makes it easy to carry around in a pocket or purse—and the remaining parts of the stereo are unusable until the DFS is reinserted. Besides easy portability, the DN-928 offers an auto-reverse tape deck, an electronically tuned radio with 30 station presets, and 25-watts-per-channel power output.

The DN-928 detachable-function-system car stereo has a suggested retail price of \$279.00. For additional information, contact Profile Consumer Electronics, 11155 Knott Avenue, Suite I, Cypress, CA 90530; Tel. 714-893-5717.

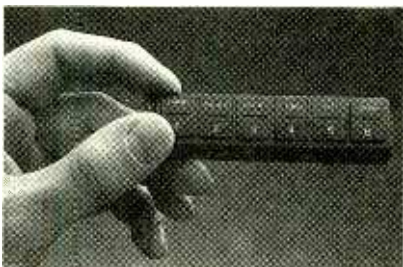

CIRCLE 101 ON FREE INFORMATION CARD

### HAND-HELD LOGIC ANALYZER

Providing a low-cost alternative to multiple logic probes, *Global Specialties' LM-8* TTL logic analyzer has trigger-word recognition that allows it to be substituted for more complex logic analyzers. The unit, designed specifically for troubleshooting 8-, 16-, and 32-bit microprocessor circuits, has eight input channels, an external-clock input, and an oscilloscope-trigger output. Captured data can be displayed on the LM-8's built-in LED's or on an oscilloscope. Up to four units

can be linked together, expanding the number of channels to 32 and allowing triggering from a 32-bit trigger word.

Each channel's trigger can be set to "0,1" or "don't care." Pulse stretching allows high-frequency or short-duration pulses to be viewed. The unit has a 25-MHz maximum clock frequency, and can capture and display pulses as narrow as 10-ns wide. The LM-8 offers two operating modes: In the "run" mode, the data is continuously updated every time the trigger word is recognized; in the "trigger" mode, the data is captured and displayed until the trigger word is recognized, at which time the analyzer is stopped and the last data is held.



The LM-8 hand-held logic analyzer, complete with grabber leads for each data channel, costs \$249.95. For further information, contact Global Specialties, 70 Fulton Terrace, New Haven, CT 06512; Tel. 800-572-1028.

CIRCLE 102 ON FREE INFORMATION CARD

### HAND-HELD RECEIVER

With continuous frequency coverage from 8-600 MHz and from 805-1300 MHz, *ACE Communications' AR-1000* 1000-channel receiver allows monitoring of civil and military aviation bands as well as all public-service bands. AM, narrow FM (NFM), FM broadcast, and TV-audio modes are selectable at any frequency. Using 26 front-panel keys, up to 1000 scan-memory channels can be programmed. Pairs of upper and lower search limits can be stored in 10 separate search-memory locations; all information is safely stored in permanent memory. Other features include selectable single-channel priority, keyboard lockout, and BNC antenna connector. The backlit LCD readout offers 21 separate prompting annunciators to help the user program and operate the unit. The compact receiver measures just 6 7/8 x 2 1/2 x 1 1/2 inches and weighs 12 ounces.

The AR-1000 hand-held receiver—including a 120-volt to 12-volt wall-plug adapter/charger, a DC cigarette-lighter plug-



charger cord, a flexible antenna, "AA"-size rechargeable batteries, and a carrying case—has a suggested retail price of \$499.00. For further information, contact ACE Communications, Monitor Division, 10707 East 106th St., Indianapolis, IN 46256; Tel. 317-842-7115; Fax 317-849-8794.

CIRCLE 103 ON FREE INFORMATION CARD

### UV EPROM ERASER

Billed by its manufacturer, *Logical Devices*, as the industry's smallest UV EPROM eraser, the *Palm-Erase* is specifically designed for field-service and engineering applications where space is at a premium. Packaged in a gray-and-white plastic enclosure, Palm-Erase measures only 4 x 2 x 2 inches. It is extremely fast, and can erase EPROM's in less than three minutes. Palm-Erase incorporates a small tray that can accommodate a single 24-, 28-, 32- or 40-pin EPROM with 600-mils pin spacing. The bulb intensity is 1.7  $\mu$ W/cm<sup>2</sup>, and average bulb life is rated at 3000 hours.



The Palm-Erase UV EPROM eraser costs \$49.95. For more information, contact Logical Devices, Inc., 1201 NW 65th Place, Fort Lauderdale, FL 33309; Tel. 800-EE1-PROM; Fax 305-974-8531.

CIRCLE 104 ON FREE INFORMATION CARD

### MICRO SPEAKERS

For those who'd rather enjoy stereo-on-the-go without wearing headphones, *Sentry* has introduced the *SEN-HO598* clip-on micro speakers. The tiny, portable speakers can be clipped to clothing, or placed on a desk or table top. For easy, compact storage, the micro speakers also can be clipped to each other. Complete with 2¼-inch dynamic speaker elements, the speakers offer 8-ohms impedance and 90-dB +3-dB sensitivity.



The *SEN-HO2598* clip-on micro speakers have a suggested retail price of \$12.95. For additional information, contact *Sentry Industries, Inc.*, 252-C Lake Avenue, Yonkers, NY 10701; Tel. 914-968-1080; Fax 914-968-5002.

**CIRCLE 105 ON FREE INFORMATION CARD**

### ANTI-STATIC TABLE MAT

To help keep work surfaces free from static electricity, the *CP606 Statfree Composite Static Dissipative Table Mat* from *Charleswater Products* features thermally bonded, multilayer construction and comes

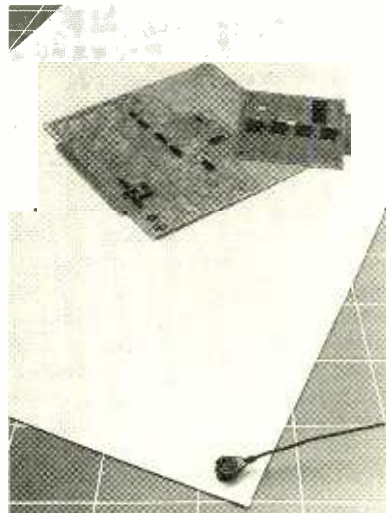

with a common-point grounding system. The mat provides <math><10^8</math>-ohms/sq. surface resistivity, <math><1108</math>-ohm/cm volume resistance, and dissipates a static charge in less than 0.1 second. The *CP606*, which meets

all appropriate DOD, MIL, and EOS/ESD requirements, is resistant to most chemicals and detergents. The scratch-resistant mat measures 24 × 48 inches and is available in blue, beige, or brown.

The *CP606 Statfree* mat is list priced from \$20.00. For more information, contact *Charleswater Products, Inc.*, 93 Border Street, West Newton, MA 02165; Tel. 617-964-8370; Fax 617-964-0172.

**CIRCLE 106 ON FREE INFORMATION CARD**

### HOME-VIDEO EDITORS/ENHANCERS

Designed specifically for "amateur videographers," *Sima's Ed/it 1* and *Ed/it 2* video editors provide professional-quality editing capabilities in easy-to-use, reasonably priced packages. The compact units are packaged in slant-faced cabinets with convenient front-panel controls. With the



# THE HOUSE SITTER THAT DOESN'T NEED A KEY

Use the keyboard to set emergency phone numbers, high and low temperatures, listen-in time and more

**ALERT/CANCEL** key cancels automatic dial-out, allows you to answer phone

**WHAT IS** key lets you listen to function settings and dial-out numbers

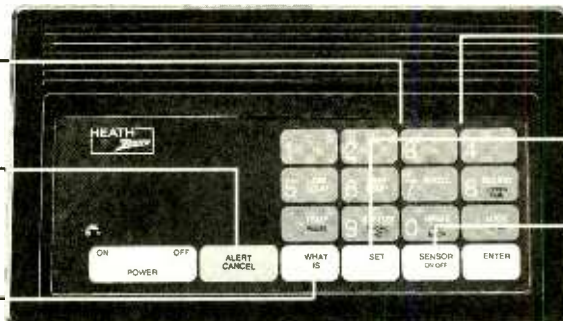

Use the keyboard to ask for information

**SET** key allows you to change previous settings

**SENSOR ON/OFF** key chooses the functions to report

**ONLY \$129.95**

"This is 555-3210. Alert condition is OK. Temperature is 65°. Electricity is on. Sound level is OK." Monitoring your home from work or a vacation spot is made easy with the *Heath/Zenith House Sitter Security Monitor/Dialer*.

### Monitors Your Home

When you call, the *House Sitter* will report on the AC electric power, the room temperature – comparing it with high and low limits you've already set, loud noises such as burglar alarms and fire alarms, the unit's own battery backup condition, and an additional alert condition. You can even listen to the sounds in the room using the built-in microphone.

©1990, Heath Company  
Subsidiary of Bull Data Systems, Inc.

### Dials Out In Alert Conditions

Set the unit to call out to your office, neighbors' and relatives' to announce any alert conditions that are outside preset limits. Up to four numbers can be programmed.

### Order Toll Free 1-800-253-0570

The *SD-6230 House Sitter* is yours for only \$129.95\*. To order, call toll-free 1-800-253-0570. VISA, MasterCard, American Express or your *Heath Revolving Charge* card accepted. Use order code 601-013.

See our full line of electronic products for your home in the *Heathkit* catalog – call 1-800-44-HEATH for your FREE copy.

**Heath**<sup>®</sup>  
Benton Harbor, MI

\*Price does not include shipping and handling, or applicable sales tax.

**CIRCLE 14 ON FREE INFORMATION CARD**

**FREE!**

## New Catalog of Hard-To-Find Precision Tools



Jensen's new catalog is jam-packed with more than 2,000 quality items. Your single source for hard-to-find precision tools used by electronic technicians, scientists, engineers, schools, instrument mechanics, laboratories and government agencies. This popular catalog also contains Jensen's world-famous line of more than 40 tool kits. Call or write for your free copy today!

**JENSEN** 7815 S. 46th Street  
**TOOLS INC.** Phoenix, AZ 85044  
(602) 968-6231

CIRCLE 11 ON FREE INFORMATION CARD

## LEARN VCR CLEANING/MAINTENANCE/REPAIR

EARN UP TO \$1000 A WEEK, WORKING  
PART TIME FROM YOUR OWN HOME!



Secrets  
Revealed!

NO Special  
Tools or  
Equipment  
Needed.

EARN UP TO \$60  
AN HOUR AND  
MORE!

### THE MONEY MAKING OPPORTUNITY OF THE 1990'S

IF you are able to work with common small hand tools, and are familiar with basic electronics (i.e. able to use voltmeter, understand DC electronics).

IF you possess average mechanical ability, and have a VCR on which to practice and learn... then we can teach YOU VCR maintenance and repair!

**FACT:** up to 90% of ALL VCR malfunctions are due to simple MECHANICAL or ELECTRO-MECHANICAL breakdowns!

**FACT:** over 77 million VCRs in use today nationwide! Average VCR needs service or repair every 12 to 18 months!

Viejo's 400 PAGE TRAINING MANUAL (over 500 photos and illustrations) and AWARD-WINNING VIDEO TRAINING TAPE: reveals the SECRETS of VCR maintenance and repair—"real world" information that is NOT available elsewhere!

Also includes all the info you'll need regarding the BUSINESS-SIDE of running a successful service operation!

**FREE INFORMATION**  
**CALL TOLL-FREE 1-800-537-0589**

Or write to: Viejo Publications Inc  
3540 Wilshire BL. STE. 310  
Los Angeles, CA 90010 Dept. PE

CIRCLE 8 ON FREE INFORMATION CARD

touch of a button, Ed/it 1 creates automatic video and audio fades at each edit point. A bypass button allows home editors to skip over poor-quality or uninteresting scenes to put together a succession of desirable scenes, and a built-in video enhancer helps achieve a more professional finished product. Ed/it 2 adds to those features an audio mixer, allowing the amateur editor to incorporate music and/or a narrative. A high-fidelity microphone is included with Ed/it 2.

Using a recording VCR in combination with a camcorder or a second playback VCR, home editors can use either Ed/it unit to select and monitor scenes from one or more videos, and transfer them to a new tape, while using a slide switch to continuously maintain picture quality. Either of two inputs can be instantly accessed by a push button. The automatic three-second fade button produces gradual, flowing changes during fade-ins and fade-outs—ensuring a practically fool-proof video-editing process and a professional-looking final product.

Ed/it 1 and Ed/it 2 have suggested retail prices of \$129.95 and \$179.95, respectively. For further information, contact Sima Products Corporation, 8707 North Skokie Blvd., Skokie, IL 60077; Tel. 708-679-7462; Fax 312-286-7227.

CIRCLE 107 ON FREE INFORMATION CARD

### DIGITAL MULTIMETERS

Two 3½-digit DMM's from B&K-Precision are designed for bench or field use and feature battery operation. The model 2704 is a 34-range, full-featured multimeter/capacitance meter with a basic DC voltage accuracy of 0.5%. Model 2703 is a 19-range multimeter with basic DC voltage accuracy of 0.8%. Each instrument measures voltage, resistance, and DC current to 10 amps. The 2704 also measures AC current, transistor gain, and capacitance to 20 µF. Each



DMM also offers a diode check and an audible-continuity checker.

Featuring high-contrast LCD readouts, tilt-out stands, and single-rotary-switch operation, each model is just 5 × 2½ × 1½

inches. The digital multimeters provide protection against accidental misuse, with high-energy fusing and overvoltage protection. They come complete with test leads, instruction manual, schematic diagram, and parts list.

The models 2704 and 2703 compact digital multimeters have suggested user prices of \$65.00 and \$44.00, respectively. For more information, contact B&K-Precision, Division of Maxtec International Corp., 6470 West Cortland Street, Chicago, IL 60635; Tel. 312-889-9087.

CIRCLE 108 ON FREE INFORMATION CARD

### COMPACT BATTERY CHARGER

Portable-audio fans and hand-held video-game enthusiasts—the most frequent users of rechargeable batteries—are sure to appreciate Panasonic's Slim Charger.



Small enough to pass for an audio cassette, it can charge either four "AA," four "AAA," or a combination of two "AA" and two "AAA" rechargeable batteries in just six hours. Its cordless design features a flip-out plug. LED's indicate charge status, and automatic shut off prevents overcharging. The Slim Charger fits easily into pockets, briefcases, or cassette cases.

The Slim Charger has a suggested retail price of \$14.95. For additional information, contact Panasonic Industrial Company, Two Panasonic Way, Secaucus, NJ 07094; Tel. 201-348-7000.

CIRCLE 109 ON FREE INFORMATION CARD

### MICROPROCESSOR-BASED DEVELOPMENT SYSTEM

Software Science's ProtoQuick Z8 microprocessor-based prototyping and application-development system comprises a 4½ × 6-inch single-board computer and prototype board based on the Zilog Z8 microprocessor chip. Along with almost 12 square inches of prototype area, ProtoQuick Z8 has EPROM, RAM, RS232C serial communications, and a decoded 8-position DIP switch. Standard 28-pin EPROM and RAM sockets support up to 32K or EPROM and 8K of RAM. The microprocessor provides six vectored interrupts; two counter/timers; and bit, nibble, and byte-wide TTL I/O. The RS232C interface operates at standard



rates up to 38,400 baud, and all of the Z8's 14 user-configured I/O lines are available at the prototype area. The ProtoQuick Z8 board requires only a single 5-volt supply.

The system can be programmed either in Z8 assembly language (using Software Systems' ASMZ8 MS-DOS-based Z8 cross assembler), or in BASIC (using Zilog's Z8671 BASIC/DEBUG BASIC-in-ROM CPU chip). For "no-programming" operation, ProtoQuick Z8 is available ready to run, with an EPROM-resident Z8 operating system, which has a serial-port command language to operate the I/O ports, control registers, and memory and which includes subroutines that can be incorporated into user applications. Complete source-code listings are included with each ProtoQuick Z8 board.

The fully assembled, ready-to-run version of ProtoQuick Z8—complete with the operating system, ASMZ8 cross-assembler, and technical manual, costs \$99.00. Without the ASMZ8 cross-assembler, it costs \$69.00. A bare ProtoQuick Z8 board (with parts list, assembly drawings, operating system, and manual) costs \$39.00. The Z8671 BASIC-in-ROM version of the Z8 chip is available separately for \$19.00. For more information, contact Software Science, 3750 Roundbottom Road, Cincinnati, OH 45244; Tel. 513-561-2060.

CIRCLE 110 ON FREE INFORMATION CARD

#### HAND-HELD ELECTRONIC ENCYCLOPEDIA

The electronic edition of *The Concise Columbia Encyclopedia*, introduced by Franklin Electronics, provides split-second access to masses of information. With advanced searching and cross-referencing capabilities, the unit provides intelligent an-



swers to inquiries made by typing in key words. Every article relating to the key word is called up, categorized by subjects such as history, politics, science, people of interest, etc. Besides having access to a wealth of information at the tap of a key, users can jump from subject to subject and quickly retrieve answers to specific questions by simply typing in the name of the subject to be researched. As a bonus, Franklin's phonetic spelling technology allows users some leeway in how they spell out their questions—a practical feature when look-

ing up unfamiliar or hard-to-spell subjects. The built-in thesaurus, enabling a sophisticated use of synonyms, helps unearth bits of knowledge that would be missed using ordinary search techniques.

The electronic version of *The Concise Columbia Encyclopedia* has a suggested retail price of \$299.00. For more information, contact Franklin Electronic Publishers, Inc., 122 Burrs Road, Mt. Holly, NJ 08060; Tel. 609-261-4800; Fax 609-261-1631.

CIRCLE 111 ON FREE INFORMATION CARD

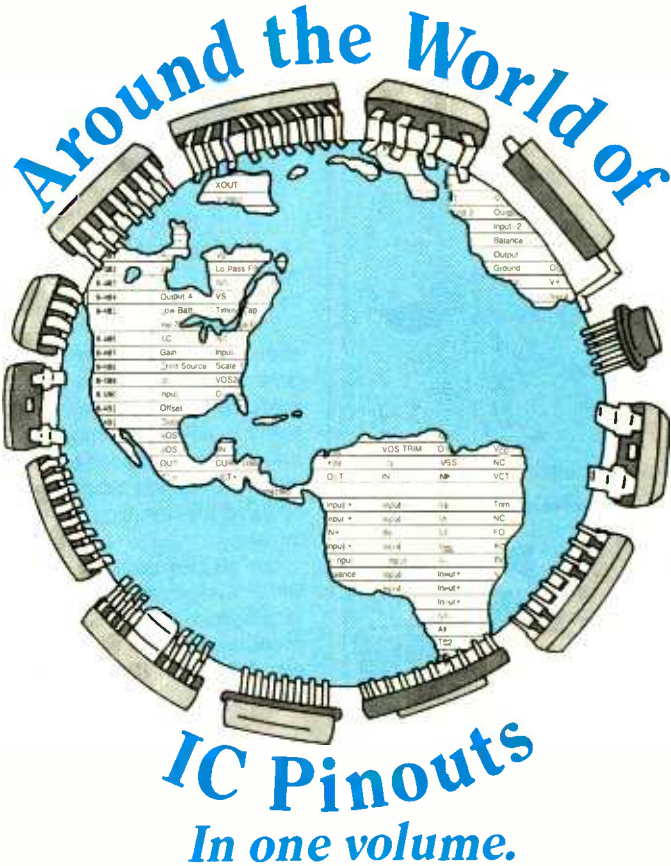

#### NEW IC Pinout Guide:

The compact, low-cost solution to your repair and maintenance headaches.

**Do you repair TVs, radios, computers... anything containing ICs?**

Now you can open one book and find all the info you need to help you do your repair jobs quickly.

- IC circuit connection data—pinouts—for over 170,000 ICs currently in use worldwide
- Package style drawings
- IC descriptions
- Manufacturer information

We guarantee the **new IC Pinout Guide** will pay for itself within two weeks.

**30-day money-back guarantee.** If you're not satisfied with the book, just contact us within 30 days. We'll refund your purchase price (less shipping and handling).

**Call today toll-free 800-854-7179 to order your copy at the introductory price of only \$99!**

You'll save \$50 off the list price.

**The NEW IC Pinout Guide: Put the world of ICs in your hands.**

**Global Engineering**

2805 McGaw Ave., Irvine, CA 92714  
Telephone: 714-261-1455 800-854-7279

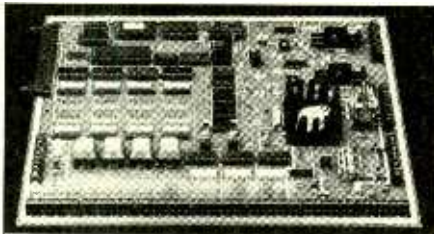

## Knight Patrol™

### Talking Home Alarm Kit

A high end alarm system at an affordable price!

Features include:

- ♦ State of the art PCF 8200 Speech Synthesizer
- ♦ 21 Sensor Zones, 2 Arming Circuits
- ♦ 2 Five Watt Audio Amplifiers
- ♦ Auxiliary Alarm
- ♦ Real Time 24 Hr. Clock
- ♦ A 10A & 3A Relay Circuit for Sirens, etc.
- ♦ Alert/Sleep Monitoring Modes (verbal status)
- ♦ Trigger Memory (verbal status)
- ♦ Self Diagnostics & Performance Monitoring
- ♦ Microprocessor Controlled
- ♦ Pleasant Female Voice
- ♦ Expandability & so much MORE!

Available as a kit or pre-assembled. Send for our FREE catalog! A complete line of peripherals is also available. Complete Circuit Board kit \$220 plus \$10.50 S&H. (Ca residents add 6.75% tax).

### Paladin Electronics

19425-B Soledad Cyn Rd  
Suite 333 Dept RES  
Cupertino, CA 91351

"We protect your castle"



CIRCLE 9 ON FREE INFORMATION CARD

## WIRE-WRAPPING TOOLS

Combining comfort and efficiency, *OK Industries'* *OK-11* and *OK-12* wire-wrapping guns both feature rugged housings, RFI noise suppression, and a light-weight nylon neck strap.

The *OK-11* Series is a heavy-duty tool designed for wire-wrapping applications ranging from R&D to production. Used with 22- to 32-AWG wire, its powerful gear-driven motor ensures performance, long-life, and low maintenance even under demanding conditions. The *BF* version of the



*OK-11*—designed for cut, strip, and wrap applications—features a back-force device designed to prevent over-wrapping.

The *OK-12* wraps 24- to 34-AWG wire, and incorporates a timing belt-drive mechanism for long life and reliability. The wire-wrapping tool also offers variable indexing ability in 45-degree increments. It is also available in a *BF* model, and the *U* version of the *OK-12* has the capacity for unwrapping by using the reversing switch mounted on the tool.

The various versions of the *OK-11* and *OK-12* wire-wrapping guns have list prices ranging from \$187.00 to \$247.00. For additional information, contact *OK Industries, Inc.*, 4 Executive Plaza, Yonkers, NY 10701; Tel. 800-523-0667.

CIRCLE 112 ON FREE INFORMATION CARD

## ANTENNA TUNER

The 300-watt *MFJ-948* antenna tuner from *MFJ Enterprises* tunes out SWR for maximum power transfer to virtually any HF antenna—including verticals, dipoles, inverted vee's, beams, quads, and mobile whips fed by coax, balanced lines, or single wire. It covers 1.8 to 30 MHz and features a lighted, peak-reading, cross-needle SWR/watt-meter with an on/off switch for the meter lamp. The large meter shows SWR, and forward and reflected power at a single

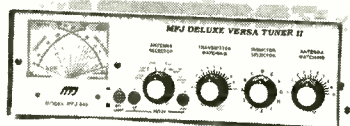

glance. It reads power on two scales—20 or 200 watts—and also reads average power. Front-panel switches let the user select peak or average power, high or low power scales, and lamp on or off. A six-position antenna switch lets the user choose two coax lines (direct or through the tuner), random wire, balanced line, or external dummy load. A 4:1 balun makes it easy to hook up balanced-line antennas.

The *MFJ-948* 300-watt antenna tuner—including a one-year, "No Matter What" guarantee—costs \$129.00. For additional information, contact *MFJ Enterprises, Inc.*, P.O. Box 494, Mississippi State, MS 39762; Tel. 601-232-5869; Fax, 601-323-6551.

CIRCLE 113 ON FREE INFORMATION CARD

## UNIVERSAL COUNTER/TIMER

Optoelectronics' hand-held, battery-powered *Handi-Counter UTC-3000* is claimed to be the smallest, lightest, and most cost-effective universal counter timer available. Operating from sub-audio to microwave, the instrument can be used as a frequency finder in laboratory benchtop service, in a wide variety of field-service applications where two-way radio communication is important, and as a tool for hobbyists.

The *UTC-3000* can be used to measure frequencies, periods, time intervals, and ratios of frequencies. It locates noise



sources and serves as a signal-strength indicator. Applications include the identification of broadcast frequencies at maximum distance from the source; and the testing and calibration of transmitter frequencies, medical equipment, oscillators, and other electronic gear.

Despite its small size and light weight, the unit offers a wide dynamic range from 10 Hz to 2400 MHz, and is useful up to 3200 MHz. Its three signal-frequency ranges include a

## SUPER LONG PLAY TAPE RECORDERS

12 Hour Model —  
USES D-120 TAPE  
\$119.00\*

Modified Panasonic Slimline, high quality AC/DC provide 6 continuous hours of quality recording & playback on each side of cassette for 12 hours total. Includes • Voice level control • Digital counter, etc. TDK D-120 Cassette Furnished.



### PHONE RECORDING ADAPTER

Records calls automatically. All Solid State connects to your telephone jack and tape recorder. Starts recording when phone is lifted. Stops when you hang up.

\$28.50\*  
FCC APPROVED

### VOX VOICE ACTIVATED CONTROL SWITCH

Solid state. Self contained Adjustable sensitivity. Voices or other sounds automatically activate and control recorder. Uses either recorder or remote mike.

\$28.50\*

\*Add for ship & hdg. Phone Adapter & Vox \$1.50 ea. Recorders \$4.00 ea. Cal. Res. add tax. Mail order, VISA, M/C, COD's OK. Money Back Guarantee. Qty disc avail. Dealer inquiries invited. Free data.

AMC SALES INC. Dept. B 9335 Lubec St.  
Box 928. Downey, CA. 90241  
Phone (213) 869-8519  
FAX (213) 923-1478

CIRCLE 6 ON FREE INFORMATION CARD



direct-counting range that goes from 10 Hz to 200 MHz, and internally-prescaled range from 600 MHz (useful to 900 MHz), and a second prescaled range specified to 2400 MHz (useful to 3200 MHz). The UTC-3000's time base is referenced to an internal 10-MHz crystal oscillator with  $\pm 1$  PPM accuracy. Its input-signal gate can be held open for 0.01, 0.1, 1.0, or 10 seconds, determining the frequency-count resolution up to 10 digits.

Other features include two BNC connectors, two independent amplifiers that present 1 Mohm and 50-ohms input impedance, a 16-segment bar graph, and easy-to-read LCD, and selectable power sources—an internal NiCad battery pack or an external 9-volt AC adaptor charger.

The Handi-Counter UTC-3000 costs \$375.00. For further information, contact Optoelectronics, Inc., 5821 NE 14th Avenue, Fort Lauderdale, FL, 33334; Tel. 800-327-5912 or 305-771-2050; Fax 305-771-2052.

**CIRCLE 114 ON FREE INFORMATION CARD**

#### MULTI-OUTLET SURGE PROTECTOR

In addition to providing protection from surges and EMI/RFI for a combination of up to five computer peripherals, *Intermatic's Electra Guard EG41* power-control center allows users the convenience of using a single switch to turn on and off their computers and peripherals. Featuring individual switching capabilities, the control center responds in less than a nanosecond to prevent dangerous voltage surges from damaging the equipment being protected. It is designed for use with IBM and Apple PC's plus a wide variety of PC compatibles and portable computers. Placed under the

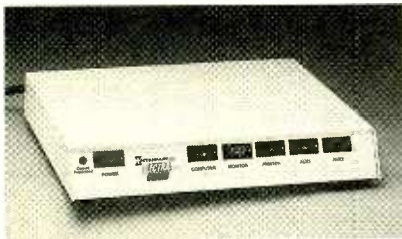

monitor, the EG41 improves the user's angle of sight and minimizes glare, without using valuable desk-top space. Five independent front-panel on/off switches can be used for various computer, monitor, and printer combinations; two auxiliary switches provide power to specific components as needed; and a master on/off switch controls the entire system. The UL-listed device provides protection against surges on all three lines—hot, neutral, and ground—and provides protection against both transverse and common-mode noise.

The Electra Guard EG41 multi-outlet power-control center, backed by a three-year limited warranty, has a suggested list price of \$89.95. For more information, contact Intermatic, Inc., Intermatic Plaza, Spring Grove, IL 60081-9698.

**CIRCLE 115 ON FREE INFORMATION CARD**

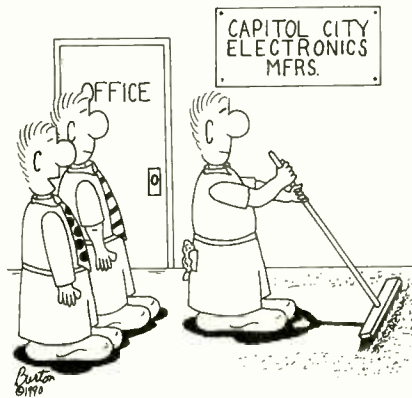

"I've got to hand it to Johnson, he's at his best when the chips are down."

THIS SPACE CONTRIBUTED AS A PUBLIC SERVICE

#### A defense against cancer can be cooked up in your kitchen.

There is evidence that diet and cancer are related. Follow these modifications in your daily diet to reduce chances of getting cancer:

1. Eat more high-fiber foods such as fruits and vegetables and whole-grain cereals.
2. Include dark green and deep yellow fruits and vegetables rich in vitamins A and C.
3. Include cabbage, broccoli, brussels sprouts, kohlrabi and cauliflower.
4. Be moderate in consumption of salt-cured, smoked, and nitrite-cured foods.
5. Cut down on total fat intake from animal sources and fats and oils.
6. Avoid obesity.
7. Be moderate in consumption of alcoholic beverages.

No one faces cancer alone.

AMERICAN CANCER SOCIETY

## BUILD YOUR OWN MICROCONTROLLER

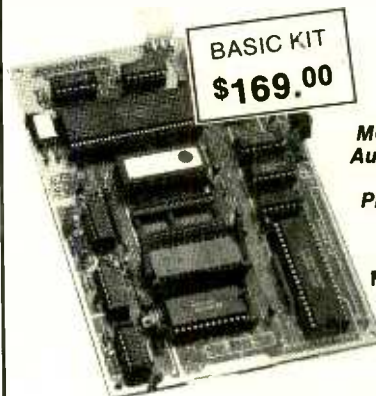

**Digital Control Single Board Microcontroller** for Computer Control, Monitoring Applications, Automated Measurement Data Acquisition, and Programs on Board with Basic Language

Sintec's Vitrax IX Microcontroller continues to lead the marketplace with its unique design, extensive capabilities and low cost. Program development available.

The Vitrax IX emphasizes real time control, equipment and sensor monitoring, automated measurement and data acquisition applications, rather than simply manipulate data and text as most microcomputers do. To handle a large scope of applications, the Vitrax IX unit contains large on-board RAM/EPROM memories, a built-in EPROM programmer and copier, two variable baud rate RS-232 interfaces, a full featured ROM based BASIC language interpreter for versatile and fast programming and 24 programmable I/O channels. (8-channel A/D converter and real-time calendar clock. Optional modules \$39.50 ea.)

**SINTEC** CO Call 1-800-526-5960  
In NJ call 201-996-4093  
P.O. Box 410 Frenchtown, NJ 08825

**CIRCLE 17 ON FREE INFORMATION CARD**

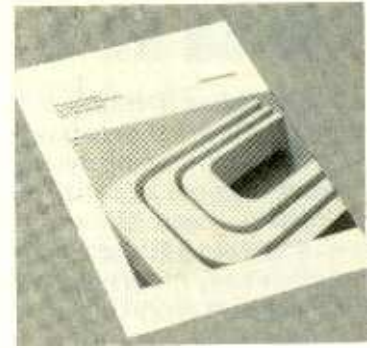

## CHEMICAL SOLUTIONS

**FREE CHEMTRONICS CATALOG!** Comprehensive new source for over 200 products used in electronic manufacturing and field service. E-Series products are CO<sub>2</sub> propelled for ozone safety. Precision cleaning agents, flux removers, bulk solvents, circuit refrigerants, precision dusters, non-residual wipers, premoistened pads/swabs, antistatic compounds, conformal coatings, lubricants, adhesives, desoldering braids and soldering products. Complete with technical specifications and application guide.

**Chemtronics Inc.**  
8125 Cobb Centre Drive  
Kennesaw, GA 30144  
1-800-645-5244  
in GA 404-424-4888

**CIRCLE 18 ON FREE INFORMATION CARD**

# Countersurveillance

*Never before has so much professional information on the art of detecting and eliminating electronic snooping devices—and how to defend against experienced information thieves—been placed in one VHS video. If you are a Fortune 500 CEO, an executive in any hi-tech industry, or a novice seeking entry into an honorable, rewarding field of work in countersurveillance, you must view this video presentation again and again.*

**ORDER LINE—1-800-522-6260**

*Wake up!* You may be the victim of stolen words—precious ideas that would have made you very wealthy! Yes, professionals, even rank amateurs, may be listening to your most private conversations.

*Wake up!* If you are not the victim, then you are surrounded by countless victims who need your help if you know how to discover telephone taps, locate bugs, or “sweep” a room clean.

There is a thriving professional service steeped in high-tech techniques that you can become a part of! But first, you must know and understand Countersurveillance Technology. Your very first insight into this highly rewarding field is made possible by a video VHS presentation that you cannot view on broadcast television, satellite, or cable. It presents an informative program prepared by professionals in the field who know their industry, its techniques, kinks and loopholes. Men who can tell you more in 45 minutes in a straightforward, exclusive talk than was ever attempted before.

## Foiling Information Thieves

Discover the targets professional snoopers seek out! The prey are stock brokers, arbitrage firms, manufacturers, high-tech companies, any competitive industry, or even small businesses in the same community. The valuable information they filch may be marketing strategies, customer lists, product formulas, manufacturing techniques, even advertising plans. Information thieves eavesdrop on court decisions, bidding information, financial data. The list is unlimited in the mind of man—especially if he is a thief!

You know that the Russians secretly installed countless microphones in the concrete work of the American Embassy building in Moscow. They converted what was to be an embassy and private residence into the most sophisticated recording studio the world had ever

known. The building had to be torn down in order to remove all the bugs.

## Stolen Information

The open taps from where the information pours out may be from FAX's, computer communications, telephone calls, and everyday business meetings and lunchtime encounters. Businessmen need counselling on how to eliminate this information drain. Basic telephone use coupled with the user's understanding that someone may be listening or recording vital data and information greatly reduces the opportunity for others to purloin meaningful information.

The professional discussions seen on the TV screen in your home reveals how to detect and disable wiretaps, midget radio-frequency transmitters, and other bugs, plus when to use disinformation to confuse the unwanted listener, and the technique of voice scrambling telephone communications. In fact, do you know how to look for a bug, where to look for a bug, and what to do when you find it?

Bugs of a very small size are easy to build and they can be placed quickly in a matter of seconds, in any object or room. Today you may have used a telephone handset that was bugged. It probably contained three bugs. One was a phony bug to fool you into believing you found a bug and secured the telephone. The second bug placates the investigator when he finds the real thing! And the third bug is found only by the professional, who continued to search just in case there were more bugs.

The professional is not without his tools. Special equipment has been designed so that the professional can sweep a room so that he can detect voice-activated (VOX) and remote-activated bugs. Some of this equipment can be operated by novices, others require a trained countersurveillance professional.

The professionals viewed on your television screen reveal information on the latest technological advances like laser-beam snoopers that are installed hundreds of feet away from the room they snoop on. The professionals disclose that computers yield information too easily.

This advertisement was not written by a countersurveillance professional, but by a beginner whose only experience came from viewing the video tape in the privacy of his home. After you review the video carefully and understand its contents, you have taken the first important step in either acquiring professional help with your surveillance problems, or you may very well consider a career as a countersurveillance professional.

## The Dollars You Save

To obtain the information contained in the video VHS cassette, you would attend a professional seminar costing \$350-750 and possibly pay hundreds of dollars more if you had to travel to a distant city to attend. Now, for only \$49.95 (plus \$4.00 P&H) you can view *Countersurveillance Techniques* at home and take refresher views often. To obtain your copy, complete the coupon below.

<b>RADIO-ELECTRONICS VIDEO OFFER</b>	<b>PE</b>
500-B Bi-County Blvd. Farmingdale, NY 11735	
Please rush my copy of the Countersurveillance Techniques Video VHS Cassette for \$49.95 plus \$4.00 for postage and handling.	
No. of Cassettes ordered _____	
Amount of payment \$ _____	
Bill my <input type="checkbox"/> VISA <input type="checkbox"/> MasterCard	
Card No. _____	
Expire Date _____ / _____	
Signature _____	
Name _____	
Address _____	
City _____ State _____ ZIP _____	
All payments in U.S.A. funds. Canadians add \$4.00 per VHS cassette. No foreign orders. New York State residents add applicable sales tax.	

**CALL TODAY TO ORDER 1-800-522-6260**

# Discover Your Career Potential In The Fast Growing Field Of High-Tech Electronics!

CIE Gives You The Training You Need to *Succeed...*  
At Your Own Pace...& In Your Own Home!

If you're anxious to get ahead...and build a *real* career...you owe it to yourself to find out about the Cleveland Institute of Electronics!

CIE can help you discover *your* career potential in the fast growing field of high-tech electronics. A career that will challenge and excite you every day...reward you with a powerful feeling of personal accomplishment...and deliver a level of financial security you may have only dreamed of before!

As the leading school in home-study electronics, CIE has helped over 150,000 students in the U.S.A. and over 70 foreign countries get started in this exciting field. To find out how CIE could be helping *you*...read on...then send for a CIE catalog TODAY!

## A Growing Need For Trained Professionals!

The career opportunities shown here are only a few of the challenging, high-paying careers you could enjoy as an electronics technician.

You could be the "brains" behind the scenes of an exciting TV broadcast...trouble-shoot life-saving medical equipment...design exotic new aeronautics systems...CIE's job-oriented programs offer you the quickest possible path to the career of your dreams! And CIE also features military and union re-training, to build on what you already know.

## Dozens Of Fascinating Careers To Choose From!

Even if you aren't sure which career is best for you, CIE can get you started with core lessons applicable to *all* areas of electronics. As you advance, CIE makes job opportunities available to you through the bimonthly school paper, *The Electron*.



Data Communications



Automotive Electronics



Avionics



Computer-Assisted Manufacturing



Consumer Electronics



Military Electronics

## Personal Training From A Renowned Faculty.

Unlike the impersonal approach of large classroom study, CIE offers you one-on-one instructional help 6 days a week, toll-free. Each CIE lesson is authored by an independent specialist, backed by CIE instructors who work directly with you to answer your questions and provide technical assistance when you need it.

## Practical Training... At Your Own Pace.

Through CIE, you can train for your new career while you keep your present job. Each course allows a generous completion time, and there are no limitations on how fast you can study. Should you already have some electronics experience, CIE offers several courses which start at the intermediate level.

## "State-Of-The-Art" Facilities & Equipment.

In 1969, CIE pioneered the first electronics laboratory course, and in 1984, the first Microprocessor Laboratory. Today, no other home study school can match CIE's state-of-the-art equipment. And all your laboratory equipment is included in your tuition cost. There is no extra charge—it's yours to use while you study at home and on the job after you complete your course!

## Earn Your Degree To Become A Professional In Electronics!

Every CIE course you take earns you credit towards the completion of your Associate in Applied Science Degree, so you can work towards your degree in stages. And CIE is the only school that awards you for fast study, which can save you thousands of dollars in obtaining the same electronics education found in four-year Bachelor's Degree programs!

## Send For Your Catalog Today!

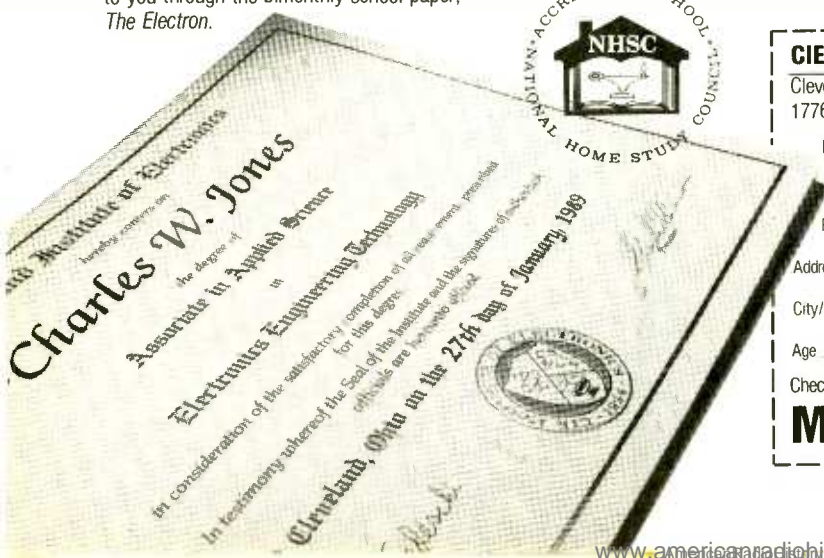
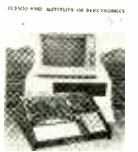

### CIE World Headquarters

Cleveland Institute of Electronics, Inc.  
1776 East 17th St., Cleveland, Ohio 44114

**YES!** Please send me your independent study catalog (For your convenience, CIE will have a representative contact you—there is no obligation.)

Print Name \_\_\_\_\_

Address \_\_\_\_\_ Apt # \_\_\_\_\_

City/State/Zip \_\_\_\_\_

Age \_\_\_\_\_ Area Code/Phone No. \_\_\_\_\_

Check box for G.I. Bill bulletin on educational benefits:  Veteran  Active Duty

## Mail This Coupon Today!

AHO-154

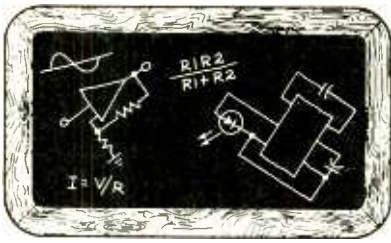

# Think Tank

## THE TIMES THEY ARE A'CHANGIN'

By Byron G. Wels, K2AVB

Things are changing rapidly and I find it harder and harder to keep abreast of them. I used to operate two-meter 'phone, and then dropped out of amateur radio for awhile. When I again found time, I dug out the old transceiver and cranked it up. All of a sudden, I heard talk about "repeaters," which I had no knowledge of, and learned that this was not the only change. Operating procedures were different, licensing had changed, the rules and regulations that I had grown up with had now gone by the boards. It was a whole new hobby. Still, it was interesting to play catch up.

Now that's not the only change. At

one point in my life, I was a pilot. Then came a relatively minor heart attack, followed by diabetes, and I couldn't get my medical renewed. I had to stop flying as pilot-in-command. Okay, I stopped flying. Recently, I fell in with a bunch of pilots who met for breakfast every Saturday and Sunday at the local diner, and we got to talking. Flying had changed. It had become more restrictive. The navigation devices, the communication equipment and procedures, all was suddenly different. It had also become almost prohibitively more expensive.

I guess that change is the name of the game. You've got to either keep up

or drop out. And I'm just not ready to go belly-up and quit. That's the advantage of magazines such as this. You read **Popular Electronics** and we'll keep you right up to the minute.

Accept the fact that change is a way of life. It isn't just flying or electronics, either. Maybe I've turned into an old fogey; but frankly, I haven't heard any good music since Glenn Miller died. (Whaddaya mean, "who's Glenn Miller?") And the new dances are impossible to keep up with. I was watching some of the shows on the ol' TV and heard names like "The Vogue," and "The Lambada." I manfully struggled to see if I could pick up the "steps." There weren't any. I couldn't see myself gyrating on a dance floor like that anyway. My gosh, the last time I danced, I dipped!

I guess that the old Latin proverb still applies: *"Tempus mutanter et nos mutamer con illis"* (Times change and we must change with them.) So okay—I'm gonna change. I've decided that I want to be 25 years old again. Put *that* in your smoke and pipe it!

Before we get to this month's circuits, I

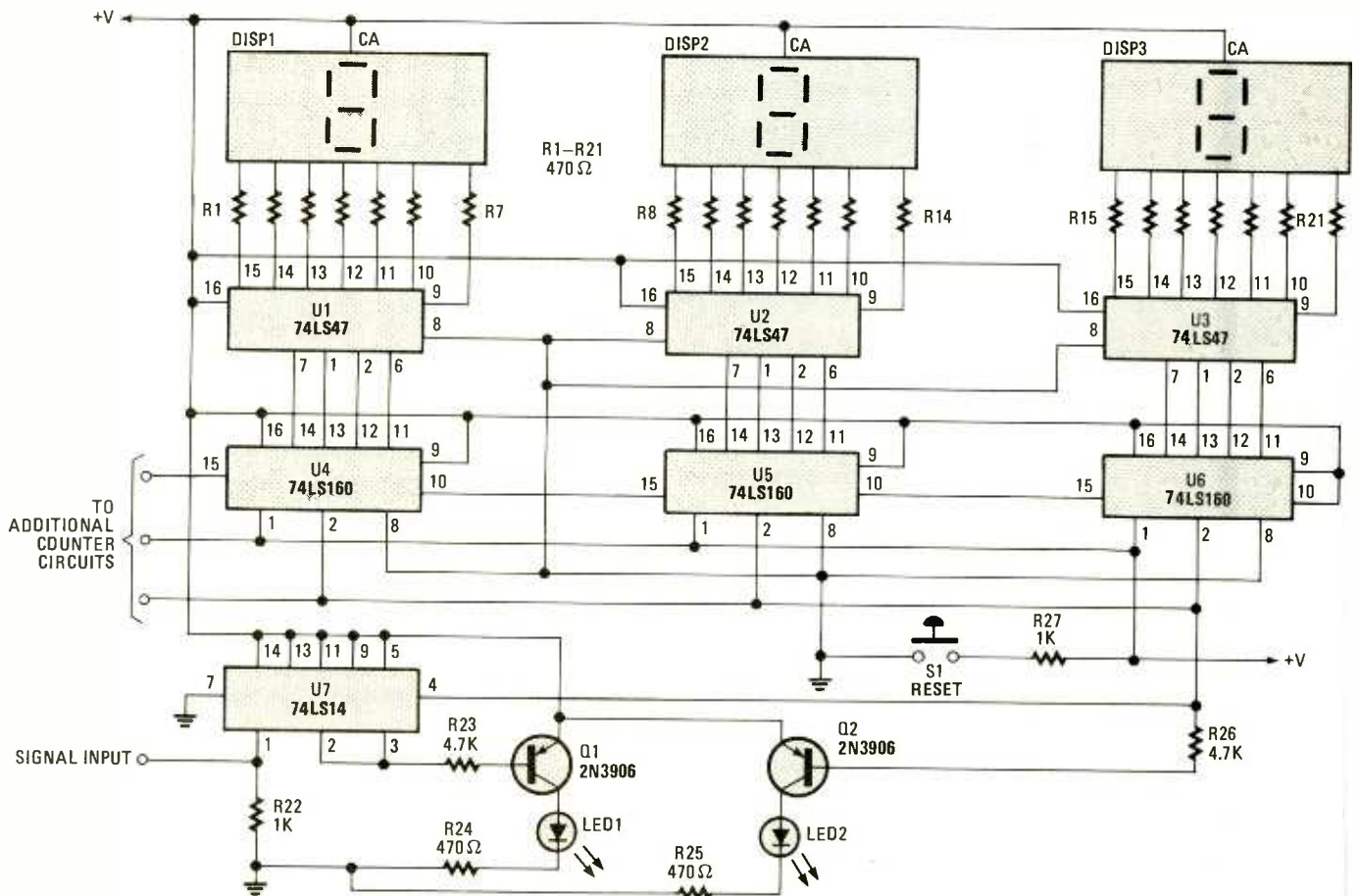

Fig. 1. The TTL Testing Tool consists of a 74LS14 hex inverting buffer (with Schmitt-trigger inputs), two LED's, three 74LS160 segment decoder/drivers, and three seven-decade counters, three 74LS47 BCD to 7-segment displays.

want to take a moment to thank all of you out there. As you must be aware, I get lots of mail (and answer all of it!) and through that mail I've learned that you are all some of the finest people I've met. Your letters are intelligent, pleasant (even from the few critics), and you all sound like the sort of folks I'd love to spend an evening or two with. Thanks again for being who and what you are. I love you all!

Now let's crack that mailbag.

**TTL Testing Tool.** This improvement to a logic probe (see Fig. 1) accepts TTL pulses and uses them to clock a three-digit, seven-segment display. By watching the display you can see when a TTL pulse flies by, like a logic probe. But it saves the pulse by incrementing the three-digit display, so you can see if one, eight, or 256 pulses have flown past. For a continuous pulse train, the frequency can be estimated by watching the counter clock from 0 up to 999, to 0 again, for frequencies well into the kilohertz range.

I've used the circuit for troubleshooting TTL counter and pulse circuits, detecting two pulses where one should have been. I've made many projects that interface to computers, such as analog-to-digital converters (ADC's), stepping-motor drivers, and so on. The circuit has also been helpful in debugging interface software.

You can "play" with it. It will show you why TTL debouncing is required. Touch a wire to its input to produce three or four hundred separate counts as the wire bounces. Put a light-sensitive diode on its input and watch the pulse train emitted by a VCR remote control.

The circuit consists of a 74LS14 hex inverting buffer (with Schmitt-trigger inputs) to clean up the incoming signal, two LED's to indicate the steady-state logic level of the input signal, three 74LS160 decade counters whose BCD output is decoded by three 74LS47 BCD to 7-segment decoder drivers, and fed to three seven-segment displays. A manual pushbutton resets the display to zero.

I found this to be the most-useful diagnostic tool for digital circuitry, as it's like an analog meter. It gives you a sense—a feel of what the TTL signals are doing.

—David Beals, Quincy, MA

Sounds like a really-useful device Dave. Our readers (as you know) are always interested in electronic test equipment, and this sure fills the bill.

**Poor Man's Frequency Counter.** The LM2917 was originally intended for low frequency-to-voltage conversion in automotive tachometer circuits. But by careful design and parts selection, I've managed to push its response well past 100 kHz.

See Fig. 2. The input signal is coupled through C1 to a voltage attenuator and is referenced to +3V above ground. That allows the input to safely range from about 300 mV to more than 30 volts peak-to-peak.

Inside U1, a Schmitt trigger drives a

"charge pump," which produces a DC output that's proportional to the input frequency. Capacitor C4 and resistor R6 control the ripple and response time of the output voltage. Switch S1 selects the desired full-scale output range in decade steps from 100 Hz to 100 kHz. The full-scale output voltage ( $V_{out}$ ) is +3.5 volts referenced to ground.

The construction of the circuit is not critical, but it is advised that you use good quality capacitors for C5 to C8, Tantalum capacitors for C3 and C4, and ceramic discs for C1 and C2. Meter

# QUALITY PARTS DISCOUNT PRICES • FAST SHIPPING

## ALL ELECTRONICS CORP.

<p><b>PIEZO BUZZER</b></p> <p>Stare HMB-06 Operates from 4-6 Vdc. TTL compatible. Draws 20 mA @ 6 Vdc. Emits high pitched signal 0.62 diameter, 0.55" high. PC pins. <b>CAT# PBZ-06 \$1.50 each</b></p>	<p><b>16 CHARACTER LCD DISPLAY</b></p> <p>Hitchel LM015 16 character dot matrix LCD display with built-in controller/driver. Interfaces with 4 or 8 bit MPU. Displays alphanumerics, kana characters and symbols. CMOS - low power dissipation. Operates on 5 Vdc. Module size: 3 1/4" X 1 1/4". Display area: 2.5" X 0.54". Character size: 0.25" high X 0.115" wide. Programming and hook-up instructions included. <b>CAT# LCD-1 \$9.50 each</b></p>	<p><b>12 VDC GEARHEAD MOTOR</b></p> <p>Sohco GBL 35-DH-21060-10Y Powerful little gearhead motor 40 RPM @ 12 Vdc 0.5 amps (no load) 32 RPM with load. Operates at lower voltages with reduced speed and torque. 6.3 pound inches torque. Shaft: 27 pound inches, 3 1/8" long X 1.375" diameter. Shaft: 0.187 dia. X 0.75" long. <b>CAT# MOTG-14 \$11.50 each</b> 10 for \$100.00</p>	<p><b>12 VDC 2.1 AMP POWER SUPPLY</b></p> <p>Laird LUS-94-12 Fully enclosed switching power supply with screw terminal connections Input: 120 Vac 60 Hz Output: 12 Vdc ± 5% @ 2.1A overvoltage and overcurrent protection. Compact ventilated case measures 5.24" X 3.81" X 1.36" overall. Includes instruction sheet. <b>CAT# PS-122 \$23.50 each</b></p>		
<p><b>PHOTO RESISTOR</b></p> <p>100 ohms light 16K ohms dark 0.182" dia. X 0.08" high. 0.18" long leads. <b>CAT# PRE-7 2 for \$1.00</b> 100 for \$45.00 - 1000 for \$400.00</p>	<p><b>SWITCHES</b></p> <p><b>ITT PUSH BUTTON</b> ITT MOP, series 3/4" X 1/2" grey rectangular key cap. S.P.S.T. N.O. Push to close. RATED 0.1 amp switching. 0.25 amp carry current. P.C. mount. <b>CAT# PB-4 \$56 each - 10 for \$6.00</b> 100 for \$350.00</p> <p><b>SPDT PUSHBUTTON</b> Marquardt 1843 Rated 8 amps @ 125-250 Vac. Black plastic pushbutton. Switch body 92" X 94" X 63". <b>CAT# PB-18 \$1.65 ea - 10 for \$15.00</b></p> <p><b>PUSHBUTTON SWITCH</b> GCTHornsted 35-400 S.P.S.T. normally open momentary pushbutton switch. Red plastic actuator 0.57" diameter. Chrome base 0.64" diameter. Threaded bushing mounts on 5/8" diameter hole. Rated 3 amp @ 250Vdc. Solder loop terminals. <b>CAT# PB-25 \$1.00 each</b></p> <p><b>THUMBWHEEL SWITCH</b> 1 pole 10 position decimal encoded switches which stick to make up desired number or digits. Terminals to 11 pc pins (1 common and 10 poles). Each section measures 31" wide X 20" high X 78" deep. End plates can be added to form a 64" high bezel. <b>CAT# SWTH-R \$1.25 each</b> 10 for \$10.00</p> <p><b>2 END PLATES - CAT# SW-SEC \$1.00/ea</b></p>	<p><b>NICKEL-CAD BATTERIES (RECHARGEABLE)</b></p> <p>AAA SIZE \$1.50 each 1.2 volts 180 mAh <b>CAT# NCB-AAA</b></p> <p>AA SIZE \$2.00 each 1.25 volts 500 mAh <b>CAT# NCB-AA</b></p> <p>AA SIZE \$2.20 each W/IT SOLDER TASS <b>CAT# NCB-SAA</b></p> <p>C SIZE \$4.25 each 1.2 volts 1200 mAh <b>CAT# NCB-C</b></p> <p>D SIZE \$6.50 each 1.2 volts 1200 mAh <b>CAT# NCB-D</b></p>	<p><b>0 - 6 HOUR AUTO SHUT-OFF TIMER</b></p> <p>M.H. Rhodes, Inc. Mark-Time 90007 Timer fits standard 3" deep wallbox. Rated 20 amps @ 125 Vac. Turn knob to desired time. Includes hardware, beige wallplate, and knob UL and CSA listed. <b>CAT# TMC-8 \$5.75 each - 10 for \$50.00</b></p> <p><b>SPECIAL PURCHASE</b> 210 MFD 330 V PHOTOFLASH CAPACITOR Rubicon CE photoflash capacitor 0.79" dia. X 1 1/8" high. These are new capacitors that have been prepped with 1 1/4" black and red wire leads soldered to the terminals. <b>CAT# PPC-210 \$2.50 each</b> 10 for \$22.50 - 100 for \$200.00 Large quantities available. Call for pricing.</p>	<p><b>LED'S</b></p> <p><b>STANDARD JUMBO DIFFUSED</b> T1-3/4 size RED <b>CAT# LED-1</b> 10 for \$1.50 - 100 for \$13.00 GREEN <b>CAT# LED-2</b> 10 for \$2.00 - 100 for \$17.00 YELLOW <b>CAT# LED-3</b> 10 for \$2.00 - 100 for \$17.00</p> <p><b>FLASHING LED</b> Built in flashing circuit. Operates on 5 volts. RED \$1.00 each GREEN \$1.00 each <b>CAT# LED-4</b> 10 for \$9.50</p> <p><b>LED HOLDER</b> Two piece holder. <b>CAT# HLED 10 for \$6.00</b></p> <p><b>RECTANGULAR L.E.D. SPECIAL</b> Red diffused rectangle 0.28" X 0 1/8" X 0.20" high. Ideal for bargraphs, chasers, etc. <b>CAT# RLED-4</b> 10 for \$1.50 - 100 for \$12.00 1000 for \$100.00</p> <p><b>LED GRAB BAG</b> 50 assorted L.E.D.'s. Many different shapes, colors, sizes. Filtered. Includes mounting hardware. <b>CAT# GRLED \$4.00 per assortment</b></p>	<p><b>L.E.D. FLASHER KIT</b></p> <p>Two L.E.D.'s flash in unison when a 9 volt battery is attached. This kit includes a p.c. board, all the parts and instructions to make a simple flasher circuit. A quick and easy project for anyone with basic soldering skills. <b>CAT# LEDKIT \$1.75 per kit</b></p> <p><b>LED CHASER KIT</b></p> <p>Build this variable speed led chaser. 10 leds flash sequentially at whatever speed you set them for. Easy to build kit includes pc board parts and instructions. Ideal for special lighting effects, costumes, etc. Operates on 3 to 9 volts. PC board is 5 1/2" X 2 1/2". A great one hour project. <b>CAT# AEC \$9.50 each</b></p> <p><b>STEPPING MOTOR CONTROLLER KIT</b></p> <p>Learn about stepping motors while building this simple circuit. Includes circuit board and all parts except 12 Vdc power supply. <b>CAT# SMCKIT \$18.00 each</b></p> <p><b>ELECTROLUMINESCENT STRIP (GLOW STRIP) AND INVERTER</b></p> <p>Used for backlighting control panels or as decorative or emergency prime lighting source. Thin, tough and flexible, they operate on low current AC voltage. The pre-wired power source is a miniature DC to AC inverter. These have a bit of an odd shape. The strips are 2 1/2" wide X 5 1/8" long and are 0.035" thick. The luminous area is 5 3/8" long X 1 1/2" wide and has one corner cut off, leaving a useful area of fairly good proportions. We are selling the strips and inverter as a package. Inverter operates on 6 Vdc. Glow strip, inverter and hook-up diagram. <b>CAT# OS-800 \$5.00 per set</b> Input: 6 Vdc. Output: 225 Vdc. <b>EXTRA INVERTERS</b> Input: 6 Vdc. Output: 225 Vdc. <b>CAT# INV-1 \$2.00 each</b></p>
<p><b>WALL TRANSFORMERS</b></p> <p>ALL PLUG DIRECTLY INTO 120 VAC OUTLET</p> <p>4 Vdc @ 600 ma <b>CAT# CTX-460 \$3.50</b> 8.3 Vdc @ 10 ma <b>CAT# DCTX-4310 \$1.50</b> 12 Vdc @ 500 ma <b>CAT# DCTX-125 \$1.50</b> 15 Vdc @ 1 amp <b>CAT# DCTX-151 \$1.50</b> 24 Vdc @ 625 ma <b>CAT# CTX-2462 \$3.00</b></p> <p><b>TELEPHONE COUPLING TRANSFORMER</b></p> <p>Multi Products International <b>A19H-10-D1</b> Primary: 600 ohm Secondary: 600/600 ohm 0.77" X 0.61" X 0.63" high 6 p.c. pins on 187 centers. Primary inductance 300 mH min. at 1kHz. 1 volt. <b>CAT# TCTX-1 \$1.25 each - 10 for \$11.00</b></p>	<p><b>RELAYS</b></p> <p>6 VOLT D.C. - S.P.D.T. Aromat RSD-6V Super small relay Rated 1 amp @ 30 Vdc. TTL drive device possible. Operates on 4.3 to 14 Vdc. Coil 220 ohms 1 1/8" X 13/32" X 7/16". <b>CAT# RSD-6V \$1.50 each - 10 for \$13.50</b></p> <p><b>12 VOLT D.C. S.P.D.T. DIP RELAY</b> Mature relay fits standard 18 pin (dip) sockets or will directly mount to p.c. boards. <b>Clared LM44D00-280</b> ohm - 30 v switching <b>CAT# CRLY-12 \$2.50 each</b></p> <p><b>24 VOLT D.C. COIL</b> KUP style 1 1/2 pin base can be socketed direct soldered or quick connect terminals can be used 1 3/8" x 1 1/2" x 2" 3 P.D.T. 5 amp contacts - 470 ohm <b>CAT# RL-3224 \$2.25 each</b></p>	<p><b>STEPPER MOTOR</b></p> <p>Airpax P/N C82711-M-1 17 Vdc dual coil permanent magnet stepper 23.25 ohm coil, 7.5 degrees per step. <b>CAT# SMT-6 \$6.00 each - 10 for \$50.00</b></p> <p><b>INSTRUMENT ENCLOSURES</b></p> <p>High quality molded ABS instrument enclosures. Integrated PC board standards and two sets of vertical mounting slots for front and rear sub panels. All enclosures are 6" wide X 6 1/4" deep. Choice of three fits. Includes non-skid rubber feet and hardware. Available in beige, ivory, black, and blue.</p> <p>Panel M: <b>CAT# P-1 \$7.50 each</b> 10 for \$67.50 2 1/2" <b>CAT# M-2 \$7.75 each</b> 10 for \$77.50 <b>CAT# M-3 \$8.00 each</b> 10 for \$80.00 Please specify color.</p> <p><b>RG-11U 75 OHM VIDEO CABLE</b></p> <p>100 ft. or 200 ft. rolls of RG 11U terminated to heavy duty F connectors. Includes 75 ohm terminators and F-41 applicator on one end. New cables manufactured for IBM PC network and registered on COMS/COPPE. <b>CAT# RG-11-1 100 ft. roll \$15.00</b> <b>CAT# RG-11-2 200 ft. roll \$27.50</b></p>	<p><b>OPTO SENSOR</b></p> <p>U shaped package with mounting ears. 1/8" opening. 3/4" mounting ears <b>CAT# OSU-1 \$0e each</b> 10 for \$4.00 - 100 for \$40.00</p> <p><b>REFLECTIVE OPTO SENSOR</b> Opteks K-8711 Wedge shaped device with IR emitter and receiver mounted the same direction. Light rays from emitter bounce off nearby object and register on receiver. Effective range approx. 6 1/2". <b>CAT# OSR-1 75e each</b></p>		

## ORDER OLLFREE 1-800-826-5432

FAX (818) 781-2653 • INFORMATIONAL (818) 904-0524

Call Or Write For Our Free 60 Page Catalog  
Outside the U.S. send \$2.00 postage for a catalog.

Minimum Order \$10.00 • All Orders Can Be Charged To Visa, Mastercard Or Discovercard • California, Add Sales Tax • Shipping And Handling \$3.50 For The 48 Continental United States • All Others Including Alaska, Hawaii, P.R. And Canada Must Pay Full Shipping • Quantities Limited • No C.O.D. • Prices Subject to change without notice

MAIL ORDERS TO: ALL ELECTRONICS CORP. • P.O. BOX 567 • VAN NUYS, CA 91403

CIRCLE 5 ON FREE INFORMATION CARD

## THINK TANK

M1 can be any (analog or digital) meter. In any event, resistors R7 and R8 should be scaled so that a 3.5 volt output produces a full-scale deflection.

A 9-volt transistor-radio battery is the recommended power source for the circuit. Other power sources can be used, but it will be necessary to adjust R5 per the spec sheet. With 7.5 volts applied to pin 9, a 9-volt battery only works down to about 8 volts before accuracy degrades. You might want to add a 1.5-volt "N" cell in series with the 9-volt battery and change R5 to 220 ohms.

The circuit is easily calibrated using a 12-volt or less AC transformer as the signal source on the 100 Hz full-scale range. Adjust R8 for a reading of 0.6 mA on M1. The linearity will be quite good from 0.1 mA to 1.4 mA. You might want to build this circuit directly into your VOM or DMM, or build it into a probe for the DMM. And by the way, the LM2917 (14 pin) is available from Digi-Key.

—Skip Campisi, So. Bound Brook, NJ

Thanks (again) Skip. As you pointed out, this is not your first submission, so to hand you an extra "thank you," wait until you see the book we sent you this time!

**Sound Switch.** Byron, I've tried to build a sound-operated switch using parts from an old LCD watch. You need the optoisolator, which is used as a trigger. I also learned that you might have to go through a dozen or so watches before you find a suitable one.

See Fig. 3. Connect a simple mike to the input and select a relay with sufficient amperage to handle your load. Now you can "clap it on" and "clap it off." I built my unit directly into the base of a lamp. Works real good, too.

—Mark Ford, Pendleton, OR

Okay Mark, but we'd advise readers to use the output relay as a "master" and put a heavier-duty relay behind it as a slave. I'm not sure just how much power that 2N2222 can handle.

**Power Supply Tester.** This simple-but-effective power supply tester (see Fig. 4) was designed to test IBM-type power supplies. As you know, IBM power supplies are switching types. To measure voltages on them, IBM supplies must be monitored under actual load conditions. Not wanting to connect my motherboard to an unknown and untested supply, I built this small tester, consisting of four resistors, two LEDs and one con-

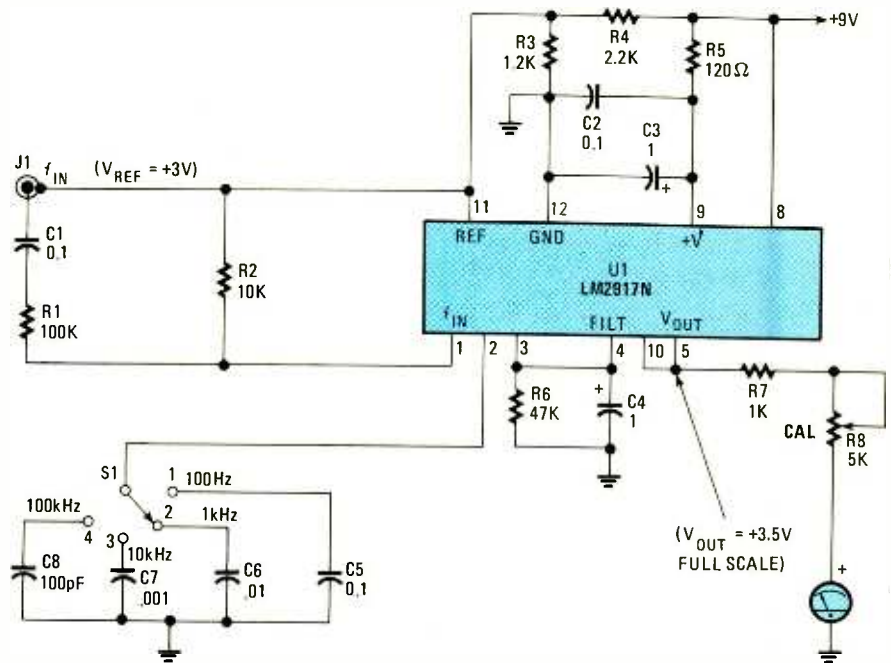

Fig. 2. This simple frequency counter is built around an LM2917, which was originally intended for low frequency-to-voltage conversion in automotive tachometer circuits. It can be used to monitor signal frequencies from 100 Hz to 100 kHz in decade steps.

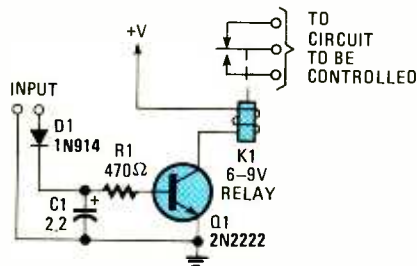

Fig. 3. All that is needed to complete the circuit is to connect a simple mike to the input and select a relay of sufficient rating to handle the anticipated load.

ductor. The tester draws about 2 amps at +5 volts and .25 amps at +12 volts. That gives the power supply a fair load so that you can measure the voltages with a voltmeter. The LED's are there just to test for the presence of voltage or a lack of it. The resistor values on my unit are slightly different, most notably the

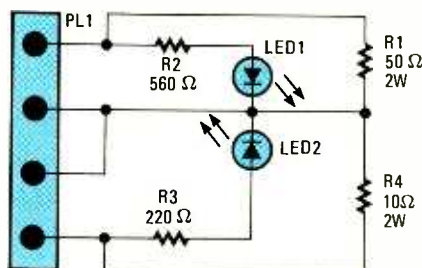

Fig. 4. Power Supply Tester was designed to test IBM-type switching power supplies, and draws about 2 amps at +5 volts and .25 amps at +12 volts.

resistors that are in series with the LEDs. I did this to keep the LED's at the same level of brightness. By the way, the resistors tend to get hot.

—Wayne R. Mullen, Hayward, CA

Good idea Wayne! I agree that it's a smart move to test a supply before connecting it to an expensive piece of equipment. Your book is on the way.

**Instruction Manual Hint.** After many years in the electronics hobby, I evolved a massive collection of instruction books, all different sizes, and types. They looked ugly in my bookcase, and I decided to do something about it. I loaded my trusty, rusty camera with 35mm black and white film, and photographed all the manuals, page for page. After processing the film, I mounted each frame in cardboard slide mounts. They store neatly, and can easily be viewed with a slide projector. When a hard copy is needed, I can simply make an enlargement. The space saving and convenience is phenomenal!

—Barry Smithers, Portland, OR

Great idea, Barry! I'm sure that a lot of our readers will be interested in doing the same thing.

**The U.L. Knot.** Here's another "Helps & Hints" for you. The U.L. knot, named for Underwriters' Laboratories, has an interesting characteristic. The harder you pull on the line cord, the tighter the knot

becomes. Therefore, it makes an excellent strain relief. See Figure 5. Separate the two wires of a zip-cord line, and form two loops, one lead going behind the line, the other in front of it. Pass the two wire ends through the loops, and pull the knot tight. Pass the line through a rubber grommet in your chassis, and then connect the wires to the circuit. Pulling on the line cord will not put any strain on the connections, and the harder the line is pulled, the tighter the knot becomes.

—Frank Samples, Bloomington, IN

Thank you Frank. The U.L. knot is an old device often used when AC was the primary source of power. We're happy to reproduce it here and help preserve some of our electronics heritage!

### Using Burned-Out Transistors.

Don't throw away those large transistors just because they've burned out! You can remove the top of the transistor case with a small, hand-held grinder using a one-inch cutoff disc. Or you can hold the transistor in your hand by applying a channel-lock pliers to the flange. You can remove the top with a metal band saw. Don't worry about it, there's a good eighth of an inch be-

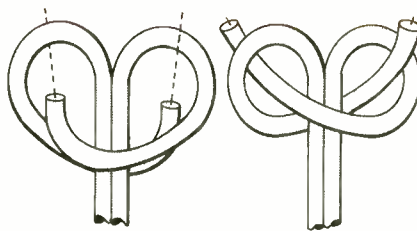

Fig. 5. The U.L. knot, named for Underwriters' Laboratories, has an interesting characteristic. The harder you pull on the line cord, the tighter the knot becomes. Therefore, it makes an excellent strain relief.

tween the top of the transistor's insides and the top of the unit. I've even cut the tops off using a large metal file.

Inside (see Fig. 6), you'll find a thin rubber gasket-like material that you can remove with a toothpick. Did you know that transistors are light sensitive? Under a bright light, the resistance of my unit between the collector and emitter was 50 ohms, and in total darkness, it went up to two megohms! With a little imagination, the transistor can now do much more than it was designed to do.

I built a touch-on, touch-off switch

using surface mount IC's inside the transistor case. When it was completed, I replaced the case top with epoxy, and used it as the touch plate. I insulated the inside with hot melt glue, and used freon to freeze the chips and quickly harden the glue. A little touch-up paint, and the transistor looked like any other.

I've been able to salvage burned out transistors by restoring the leads with a little dab of conductive epoxy. Is this worth a book Byron?

—Arville G. Drummonds, Greenville, TN

Arville is the kind of guy that if you give him a two-by-four and a penknife, he'll whittle a whole bunch of transistors for you! The book is on the way Arville.

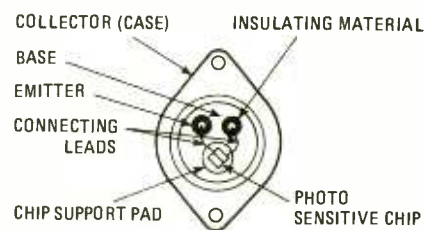

Fig. 6. All transistors are light sensitive. So by opening the casing in which they are sealed, they can be used as photo devices.

**LANDIS ELECTRONICS**

# Roman Numeral Digital Clock Kit



**\$89.95**

\*\$139.95 assembled & tested

### SPECIFICATIONS:

Display:	177 red LEDs
Logic type:	Low Power CMOS
Accuracy:	1 second per month
Power:	115VAC 60 Hz 4 watt
Dimensions:	18"L x 5"H x 3"D

## Read the time in Roman Numerals!

- Clock displays hours, minutes, and seconds in Roman Numerals.
- 177 bright red LEDs are easily readable day or night.
- Hand finished mahogany case enhances the appearance of any room.
- Kit includes all parts necessary: power supply, logic, LEDs, double-sided PCB, solid mahogany case, and complete instructions.
- Easily assembled in one or two evenings.
- Full money-back guarantee.

Send Check or money order for \$89.95 plus \$6.00 for shipping and handling to:

**LANDIS ELECTRONICS**

207 Oak Street, Norton, Massachusetts 02766

## THINK TANK

**IR Detector.** I've been seeing an increasing number of infrared detectors on the market. It made me wonder why they were so expensive, for it seemed they couldn't possibly be that complicated. Instead of opting for a commercial unit, I decided to design my own. I wanted the completed circuit to be as small as possible.

See Figure 7. This is a simple but extremely effective circuit. It consists of little more than an infrared-sensitive phototransistor (TIL99) and a 2N3904 general-purpose NPN transistor. The latter produces sufficient drive to light the LED. Infrared light striking the base of Q1 causes it to turn on, feeding a voltage to the base of Q2, which causes LED1 to light. The detector can be used to test virtually any infrared-emitting device. Just point the base of Q1 towards an infrared source from a distance of ten inches or so. When infrared light is detected, the LED will light.

To make the device easy to handle, I built the circuit on a small printed-circuit board and placed it inside the barrel of a plastic pen. I mounted the LED at one end of the pen, and Q1 at the opposite end. To power the unit, I used five 1.4-volt mercury hearing-aid cells that also fit easily into the case.

—David Strader, Danville, VA

*Good show, Dave! But readers, I'd add a miniature push-to-make switch in series with the battery. That will help preserve battery life.*

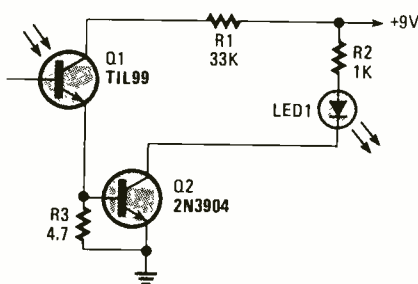

Fig. 7. This simple but extremely effective IR-detector circuit consists of little more than an infrared-sensitive phototransistor (TIL99) and a 2N3904 general-purpose NPN transistor.

**Varistor Hint.** I find places where household power goes up to 129 volts, and maintains that voltage when several motors are operating at the same time. That's great for the motors, but it's murder on light bulbs! That's especially true when there are spikes from starters and switches.

I solved the bulb burnout problem with 130-volt varistors. Bend the varistor leads so that they fit snugly into the plug-in socket on the side of an extension lamp socket. Cover any bare varistor leads with either tape or spaghetti tubing. Screw the extension into a ceiling outlet and the lamp into the extension. One varistor will protect all of the light bulbs on the same circuit.

Get written permission from both your local power company and your insurance company, and wire a varistor across the hot wires in your outlet on your breaker or fuse box.

—Jay E. Hawthorne, Claresholm, Alberta, Canada.

*Jay, that's a nifty idea that will save a lot of cost in relamping. It won't hurt as a surge protector in case of a lightning strike, either. Thanks, Jay.*

**Matching Neon Lamps.** To match the firing voltages of two or more neon lamps, connect several lamps (maybe 20 or more) in parallel and with a 100k series resistor. With a 1 megohm potentiometer (see Fig. 8) connected to the circuit, slowly increase the voltage until one lamp or more lights. If more than one lamp lights, they are matched. If only one lights, remove it from the circuit. Often, another will light. Those two are now matched. If another does not light, discard it and increase the voltage until another lights. Repeat for matched lamps.

There aren't a great many circuits that call for matched neon lamps, but when you do have a need, here's a good (and easy) way to find them!

—William E. Kenyon, Meridian, CA

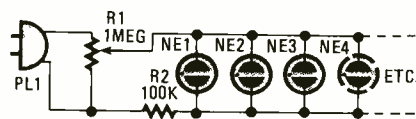

Fig. 8. This simple circuit can be used to match the firing point of several neon lamps.

*Bill also sent a second circuit in, called "Mystery Lights." When I say he sent a circuit in, I really mean it! We've been playing with this thing all day.*

**Filter Analyzer.** When this circuit is connected to a filter and an oscilloscope, the scope displays the filter's frequency response—you see the actual plotted graph of frequency vs. output amplitude—the same as those graphs normally seen only in books. It's

a real time-saver when analyzing an active filter. The circuit (see Fig. 9) is related, in a sense, to a spectrum analyzer, but with no resemblance in price.

The way it works is easy to understand: A frequency that sweeps from low to high is applied to a filter. An oscilloscope is triggered by the start of the sweep and ends its trace at the highest frequency of the sweep. The filter output goes to the vertical amplifier of the oscilloscope. Using bandpass filters as an example, as the bandpass frequency is approached, reached, and passed, the scope follows the peaking output and draws the response curve. A neat effect!

The circuit is simple. The 566 VCO (U1) produces a VLF triangle wave to frequency modulate the next stage. It also produces a square wave to externally trigger the scope. Op-amp U2 (a 741 unit) optimizes the amplitude and DC component. Another VCO (U3) produces the actual sweeping triangle wave. Its frequency is selectable via S1. Op-amp U4 (another 741 op-amp) is set up as a bandpass filter and has been included as an example filter. Finally, diode D1 chops off the bottom half of the output, leaving a nice bell curve.

To set-up and operate, power-up the circuit and scope. Set the scope's TIME/CM to 50 msec/cm. Set the VOLTS/CM control to 2 volts. Attach a probe from the circuit's trigger to the scope's external trigger input. Set the triggering mode to normal, external. Attach a probe from the vertical amplifier to TP1. You'll see a diagonal line running across the CRT. Input coupling should be set to DC. Adjust the triggering level until the diagonal runs from the upper left to lower right of the CRT to insure a displayed sweep from low to high. Now disconnect the probe from TP1 and attach to the filter output past the diode. And check that response curve!

—Nick Cinqino, Chicago, IL

*Very unusual circuit Nick. Our readers seem to like test equipment that they can build, and this one fits right into that category! Your book is on the way, and I hope you enjoy it.*

**Duty Cycle Meter.** This simple circuit (see Fig. 10) displays the duty cycle of a pulse train from 0% to 100% on a standard 100- $\mu$ A analog panel meter. It is based on old-style dwell-meter circuits, but uses a modern 3-terminal voltage regulator (LM317T) in a new role. It provides a precision clamped output volt-





# Welcome to . . .

# SCIENCE **PROBE!**®

The Amateur Scientist's Journal

Embark on an irresistible new journey into the realm of mystery, challenge, and exploration! The perfect magazine for the budding scientist, the serious amateur, the professional who would like to relax, and those who simply want to gaze at the stars.

**SCIENCE PROBE!** — the *only* magazine devoted entirely to Amateur Scientists! If you are fascinated by science in all its many forms . . . if you can't stay away from a microscope, telescope, calipers, or test tube — we invite you to share the wonders in every issue of **SCIENCE PROBE!** You will join a community of Amateur and Student Scientists who enthusiastically seek scientific knowledge or follow scientific pursuits for their own sakes and not merely as a profession.

Obtain your personal *premier* edition of **SCIENCE PROBE!** by visiting a quality Newsstand, Convenience Store, or Supermarket this Fall or by reserving your personal copy through the mail by completing the coupon below.

From the very first issue of **SCIENCE PROBE!** you will be involved in a world of scientific facts, experiments, and studies pursued by amateur scientists who are university students, inventors, academicians, engineers, or office workers, salesmen, farmers—whose *quest* is to probe into the mysteries of science and reveal them to all.

Plan to become a **SCIENCE PROBE!** reader!

Articles to appear in early issues of **SCIENCE PROBE!** are:

**LIGHTNING—CAPTURE IT ON FILM**  
**MONITORING ULTRAVIOLET FROM THE SUN**  
**MOBILE-MOUNT EXPERIMENTAL WIND TUNNEL**  
**CHECKING OUT ACID RAIN**  
**AERIAL PHOTOGRAPHY FROM KITES AND BALLOONS**  
**MINIATURE TRACKING TRANSMITTER**  
**KILLER BEE IDENTIFICATION**  
**HOW TO OBTAIN ANIMAL EYESHINE PHOTOGRAPHS**

If you're fascinated by science in all its many forms, if you are compelled to experiment and explore, then **SCIENCE PROBE!** is your kind of magazine!

**SCIENCE PROBE!**

7PEK9

500-B Bi-County Boulevard  
Farmingdale, NY 11735

Please forward my Premier Edition of **SCIENCE PROBE!** as soon as it comes off the press. I am enclosing \$3.50-U.S.A. (\$3.95-Canada) plus \$1.00 for shipping and handling. Better still, please enroll me as a charter-member subscriber and send the next four (4) quarterly issues of Science Probe. I am enclosing \$9.95-U.S.A. (Canada: \$14.95 U.S.A. Funds)

Premier Edition only     First Four Issues (1 Year)

Offers valid in the U.S.A. and Canada only. No foreign orders.

Name \_\_\_\_\_

Address \_\_\_\_\_

City \_\_\_\_\_ State \_\_\_\_\_ ZIP \_\_\_\_\_

All Orders payable in U.S.A. Funds only.

**ON SALE AT QUALITY NEWSSTANDS, CONVENIENCE STORES AND SUPERMARKETS**  
**STARTING SEPTEMBER 13, 1990 — \$3.50-U.S.A. — \$3.95-Canada**

# 200,000-Volt Van de Graaff Generator

The first known electrical generator was built in 1660 by the German experimenter, Otto von Guericke (also known to historians as the inventor of the air pump). Though Guericke's generator consisted of little more than a revolving ball of sulfur, that frictional device was capable of developing a very strong charge of static electricity.

The generator's ball was made by pouring molten sulfur into a spherical glass container "about the size of a child's head." When the sulfur cooled, the glass was broken open, and the globe removed and equipped with an iron axle. The assembly was then mounted on a wooden frame that allowed the ball to spin freely. When a dry hand was applied to the rotating sulfur sphere, the ball would become electrified, attract small objects, make a crackling sound, and glow faintly in the dark.

**Van de Graaff's Generator.** Otto von Guericke's machine quickly became obsolete, but the *triboelectric* principles that allowed that generator to operate did not. It is an elementary physical fact that extremely high voltages can be generated by the repeated contact and separation of dissimilar substances, a process that is otherwise known as friction.

In 1927, New Zealand physicist Ernest Rutherford voiced the need for "a copious supply of atoms and electrons ... transcending in energy the alpha and beta particles from radioactive substances." He was talking about an accelerator. Rutherford's wish inspired a young American scholar by the name of Robert J. Van de Graaff.

Van de Graaff knew that charged particles could be moved to high speeds by high voltages. He also knew that conventional methods of electrical transformation might not provide the necessary energy. But the electrostatic characteristics of the atomic nucleus gave him an idea. Van de

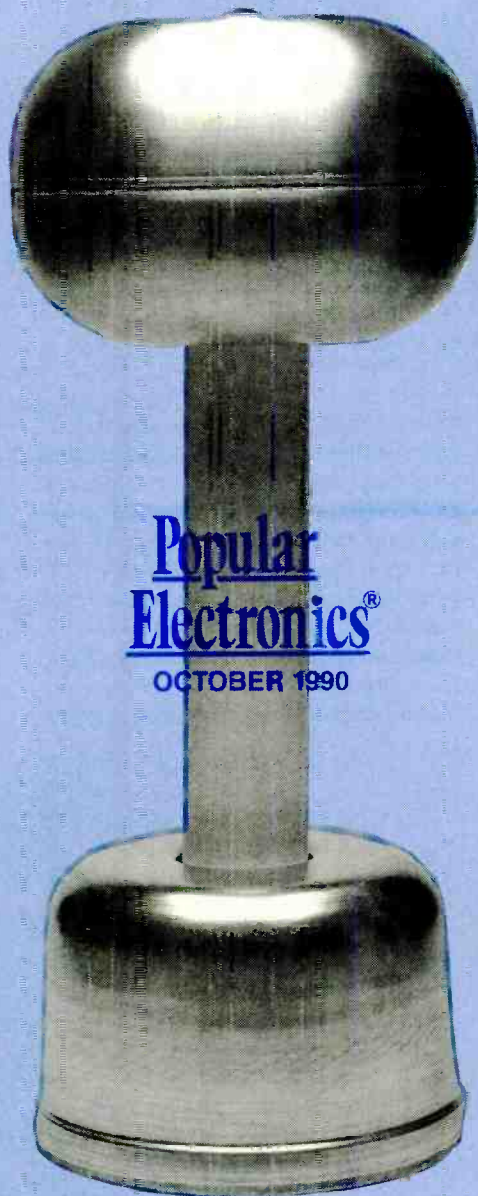

*Have hours of high-voltage fun when you experiment with this working high-voltage generator.*

BY STANLEY A. CZARNIK

Graff decided to find some way of generating high electrostatic voltages in order to, as he phrased it, "meet the atom on its own terms."

The first Van de Graaff generator was built at Princeton University in the fall of 1929. Van de Graaff built the machine from scrap: a silk ribbon, a small motor, and a tin can. The silk had to be pure; there is a story about how Van de Graaff would visit local fabric shops and set fire to silk samples to see if the cloth was tainted. Van de Graaff's primitive static device developed about 80,000 volts. The high-voltage output was restricted by corona discharge from the edges of the can.

The public became aware of Van de Graaff's new technology in 1931. That's when he demonstrated the creation of over 1,000,000 volts between the spherical terminals of two belt-driven generators. Following that, general interest in these magnificent machines grew very quickly.

**Giant Generators.** The early success of Van de Graaff's creations was encouraging. Immediately, researchers began making plans for a much, much bigger generator. The size of the machine was to be limited only by the size of the building found to keep it in. A suitable structure was located on the estate of Colonel E.H. Green at South Dartsmouth, Massachusetts. It was the biggest enclosure anyone could find. It was a hangar built originally to house a dirigible, or blimp.

Engineers built two separate machines: one for the positive charge, and one for the negative. The spherical terminals, about 15 feet in diameter, were made of welded aluminum and mounted on two large tubular insulators, each 24 feet high and 6 feet across. The generators were carried on railway track. That allowed technicians to vary the distance between the electrodes. The giant Van de Graaff system was capable of generating nearly ten-million volts.

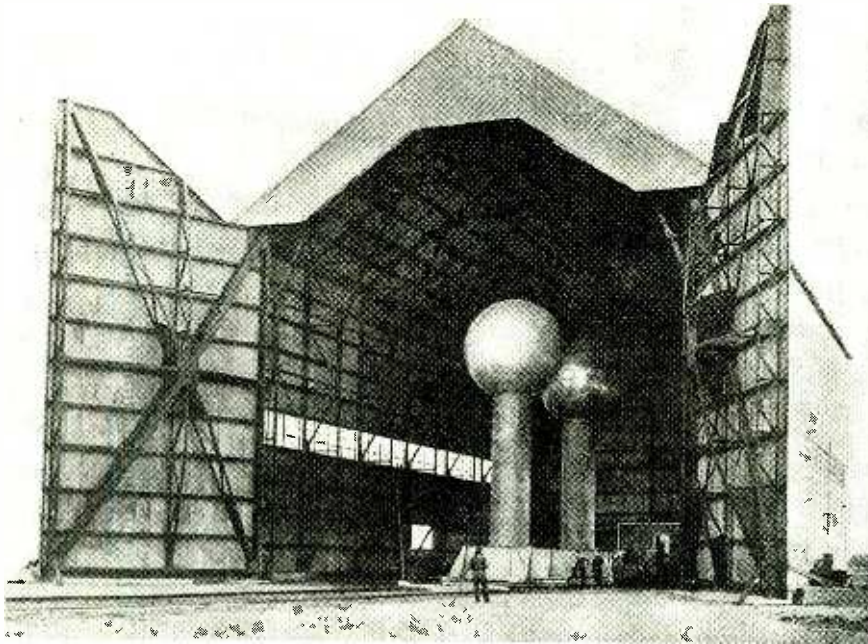

*This giant Van de Graaff generator system was built in Dartmouth, Massachusetts in the early 1930's. The machine was capable of developing nearly ten million volts. The very large structure in the background was, originally, a hangar built for a blimp.*

**A Working Model.** With a kit of parts from Analytical Scientific, a laboratory supply company in Texas, you can build your own 200,000-volt Van de Graaff static generator in about one hour. (See the Parts List for ordering information.)

The fully assembled machine is about 18 inches high. The spherical aluminum terminal, mounted on top of a heavy plastic tube (PVC pipe), is about 7 inches in diameter. The generator runs on 117 VAC and comes complete with a small electric motor and all the necessary hardware; there's even a spare rubber belt. It's a classic design and an excellent addition to any home-experimenter's workshop.

**Building your Model.** Once you've obtained the kit, begin by attaching the three rubber feet to the round metal base. Now locate the L-shaped

**WARNING!!** This article deals with and involves subject matter and the use of materials and substances that may be hazardous to health and life. Do not attempt to implement or use the information contained herein unless you are experienced and skilled with respect to such subject matter, materials, and substances. Neither the publisher nor the author make any representations as to the accuracy of the information contained herein and disclaim any liability for damages or injuries, whether caused by inaccuracies of the information, misinterpretations of the directions, misapplication of the information, or otherwise.

motor bracket and the lower brush, which is the short length of stranded wire that's connected to a soldering lug. Push three small screws (8-32 x 1/2-inch) up through the bottom of the base and the motor bracket. Place lock washers on the screws and secure the assembly with three 8-32 hex nuts. The lower brush goes on the screw furthest away from the 90-degree bend in the motor bracket. The brush should point

towards the vertical section of the bracket. Handle the brush carefully as it is delicate.

The next step is to find the electric motor and mount it by passing the two threaded studs plus the armature shaft through the three remaining holes in the motor bracket. Place lock washers on the threaded studs and secure the motor with a couple of hex nuts.

Now look for the white plastic pulley. Push the pulley over the armature shaft. If you have trouble, tap the end of the pulley very gently with a small hammer or the handle of a screwdriver. The pulley should not come into contact with the motor bracket.

The plastic pipe is held against the upper portion of the motor bracket with a large U-bolt, a metal strip, and two large hex nuts. One end of the pipe has a couple of semi-circular notches cut into it. That end of the pipe should be up; the plain end should be down. The lower end of the pipe should extend about 3/8 inch below the U-bolt. The notches on top should line up with the pulley at the bottom. To check the alignment, simply look straight down through the center of the pipe.

Next, locate the rubber belt and slip it over the metal pulley. Place the pulley into the two notches on top of the insulator and allow the belt to fall through the tube. Pull the lower end of the belt down and place it over the lower pulley. Try to avoid handling the belt too

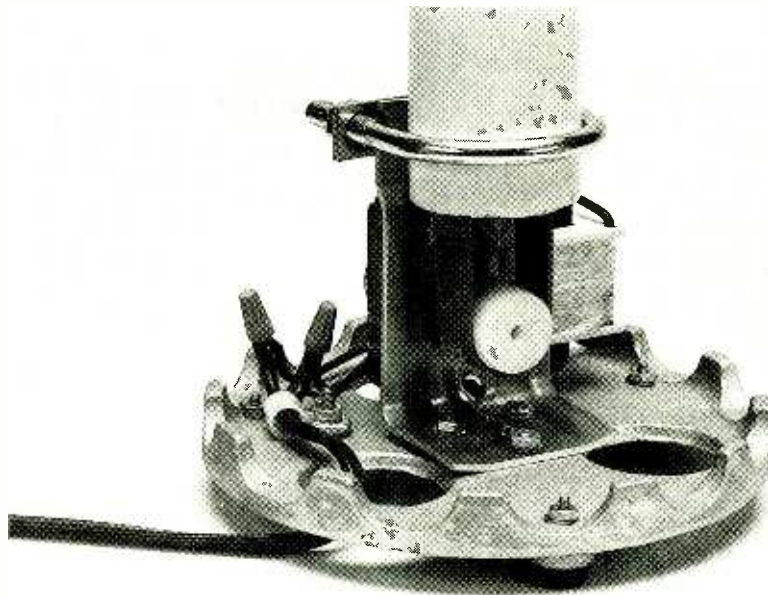

*This is how the inside of your Van de Graaff generator will look just before the lower aluminum shell is placed over the round metal base. Note the arrangement of the stranded wire brush, the rubber belt, and the pulley assembly.*

much as skin oils can reduce its effectiveness.

Now, very carefully, adjust the lower brush so that it just barely touches the rubber belt. Spread the strands of wire gently so that as many of them as possible are touching the rubber.

Find the collector support and upper-brush assembly. That's the short length of stranded wire soldered to a V-shaped piece of stiff wire. Push the V-shaped wire into the two small holes at the upper end of the insulator (PVC pipe). And here again, adjust the stranded wire brush so that it just barely touches the rubber belt.

Return to the bottom of the generator and hook up the 117-VAC line cord. Use the wire nuts provided with the kit. The line cord is held in place with a plastic strain relief. Don't forget to connect the little green ground wire. Both the strain relief and the ground wire are attached to the base of the generator with a small screw and a hex nut.

Finally, lower the cylindrical aluminum shell over the plastic tube and push it down over the base. Then place the spherical terminal over the collector support. It should balance perfectly. Now stand back and admire your new Van de Graaff generator. It's a work of electromechanical art!

**Testing.** Plug your generator in and

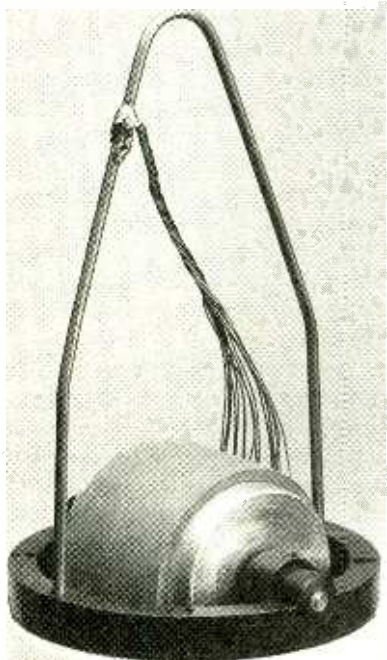

*The upper brush and upper terminal support fit into the upper end of the tubular insulator. Note how the wire brush is positioned to make contact with the rubber drive belt.*

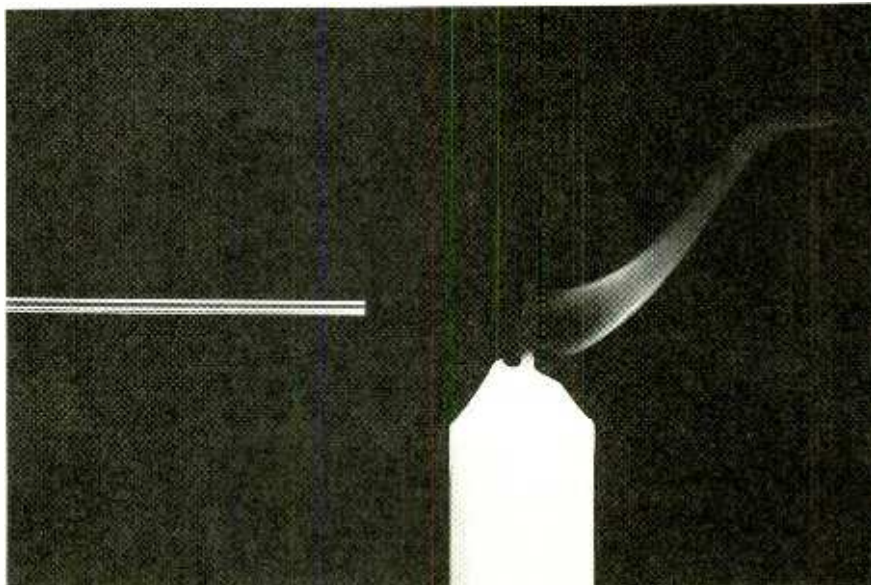

*This photograph illustrates the creation of what is sometimes called an "electric wind." Tape one end of a narrow metal rod to the top of your Van de Graaff generator. Turn on the machine and light an ordinary household candle. Now bring the candle close to the free end of the rod. As molecules of ionized air rush from the metal tip, the flame is blown to one side.*

the motor should turn. If it doesn't, remove the upper spherical terminal and give the pulley a little spin in the right direction. That should start the generator. Replace the aluminum sphere immediately.

Wait a few moments for a charge to build up on the terminal. Now approach the sphere with a large fluorescent tube. When the tube is three or four inches away from the sphere, the machine will discharge, and the tube will flash. If that doesn't happen, or if the flash isn't very bright, your generator is not working properly.

Unplug the unit and remove the upper terminal and the lower shell. (Please be careful. A small static charge may be waiting for you when you touch the aluminum sphere.) Check the belt and the pulleys for dirt and moisture. They should be clean and dry. Then check the brushes. If the wire strands are too far away from the belt, the generator will operate very poorly, or not at all.

Finally, check both the upper terminal and lower shell for dust and lint. They, too, must be very clean. I was able to improve the performance of my own Van de Graaff generator by cleaning both the shell and the terminal with a bit of good quality metal polish and a soft cloth. That seemed to make a big difference in the machine's operation. In fact, it might be a good idea to polish the aluminum sections before putting the machine together.

### **MATERIALS LIST FOR THE VAN DE GRAAFF GENERATOR EXPERIMENT**

Van de Graaff generator kit  
Aluminum-foil strips, very thin  
Candle  
Fluorescent tube  
Foam plastic packing material  
Metal polish  
Metal rod, 8 to 10 inches long  
Tape

The Van de Graaff generator kit is available from Analytical Scientific, Post Box 675, Helotes, TX 78023, Tel. 512-684-7373. The catalog number is MLE-10-065 and the price is \$137.75. Include \$4.00 for shipping and handling within the continental U.S. The Analytical catalog is \$3.00, which is refundable with first order. TX orders must include appropriate sales tax.

**Theory of Operation.** Here's how your Van de Graaff generator works: The electric charge originates with the friction of the rubber belt moving over the lower plastic pulley. The plastic pulley acquires a negative charge that appears on the outside of the belt while a positive charge appears on the inside. The negative charge is picked up by the ionized air around the lower brush. The positive charge is carried to the upper brush by the belt where it is transferred to the aluminum sphere.

*(Continued on page 98)*

# Living with Lightning



*Following a few good practices can save your gadgets, your home, and yourself from the great harm that lightning can do.*

BY E.R. DOUBEK

**L**ightning has caused much damage thru the years, but it has also done much good. The nitrogen set free by lightning strikes does much to fertilize the ground and thus help plants grow. That's very nice, but what can we do to help prevent lightning damage to the household appliances we all have at home as well as the amateur- and shortwave-radio equipment that is prevalent in many homes?

Basically, we can help lightning find a better way to dissipate itself and bypass the items we don't want damaged. But before we talk about ways of preventing lightning damage, let's set down a few facts about lightning and the characteristics of a typical lightning strike.

**The Trouble with Lightning.** Table 1 shows some electrical parameters for a typical lightning bolt (or stroke), which as you can see is very powerful. The peak current per return stroke is what makes it so difficult to protect equipment from lightning. The 20,000-amp current from a lightning bolt will cause almost all materials to be destroyed.

Table 2 shows that the rate of rise is rather fast and even a short piece of ground wire has a large enough inductance to impede current flow. That means that longer leads cause larger voltages to develop in any supposedly grounded device. The moral of the story is to go with short, straight ground leads from the devices to be protected (more about that later).

**Lightning in the Skies.** Lightning can occur from cloud to cloud, one part of a cloud to another part of the same cloud, or from a cloud to ground. The most frequently occurring form of light-

ning is from cloud to cloud; however, the most studied lightning form is from cloud to ground. That's because the cloud to ground form of lightning is responsible for most damage.

However, cloud to cloud lightning is becoming more of a problem for aircraft for two reasons: more flying is being done in bad weather, and composite materials (such as carbon filament materials) are being used more frequently in aircraft since it saves weight, and thus fuel. With conventional aircraft, the metal fuselage forms a way to conduct lightning harmlessly around the outside of the plane and only openings in the metal structure need extensive protection from lightning damage. With carbon composites, the lightning penetrates the structure.

Since lightning storms are occurring on a continuous basis around the world, the interference caused by lightning discharges is the equivalent of many high-powered transmitters. That being so, lightning strikes are responsible for generating much of the interference heard on all radio-frequency transmissions. Static propagation follows the

same rules as radio propagation. The one difference is that static is a broad-band signal that covers a large segment of the spectrum.

**Your Risk.** The boxed text entitled "Interesting Facts" lists some of the problems caused by lightning and the nature of the injuries that result from it.

When we try to determine the relative risk that lightning poses to a particular installation or facility, two factors are the most important: The first is earth resistivity, since we'll be using the ground to conduct the lightning away from the protected area. Figure 1 shows how some areas of the U.S. have a severe grounding problem. In the extreme north-east part of the country, you can see that the resistivity of the ground is very high. When the resistivity is above 100 meter-ohms, it is extremely difficult to conduct the energy away from the vicinity of the lightning strike, and consequently causes the lightning bolt to move around to find an alternate, lower-resistance path to ground. The state of Maine is an example of an area that has a very high resistivity problem.

The other factor that influences your likelihood of receiving damage is the relative risk in terms of thunderstorm days per year. Figure 2 shows that the west coast of the U.S. has the fewest thunderstorm days and the risk gradually increases as one goes to the south-east part of our country.

If you are interested in finding out your relative risk of lightning damage, simply multiply the number of thunderstorm days by the relative resistivity in your area. The product of those two numbers will provide you with a way to compare one area to another and assess the relative difficulties of protecting

**WARNING!!** This article deals with and involves subject matter and the use of materials and substances that may be hazardous to health and life. Do not attempt to implement or use the information contained herein unless you are experienced and skilled with respect to such subject matter, materials, and substances. Neither the publisher nor the author make any representations as to the accuracy of the information contained herein and disclaim any liability for damages or injuries, whether caused by inaccuracies of the information, misinterpretations of the directions, misapplication of the information, or otherwise.

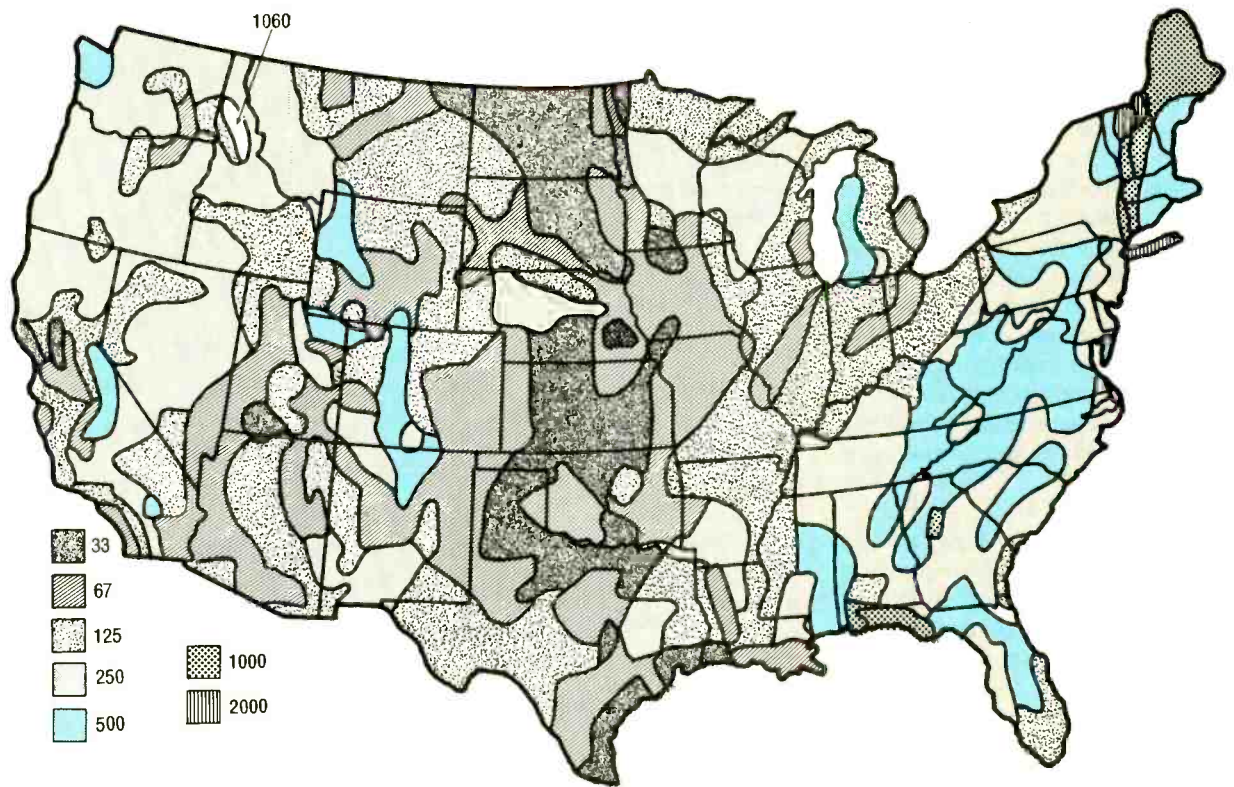

Fig. 1. This is a map of the estimated average earth resistivity in the U.S. The numbers represent resistivity in meter-ohms.

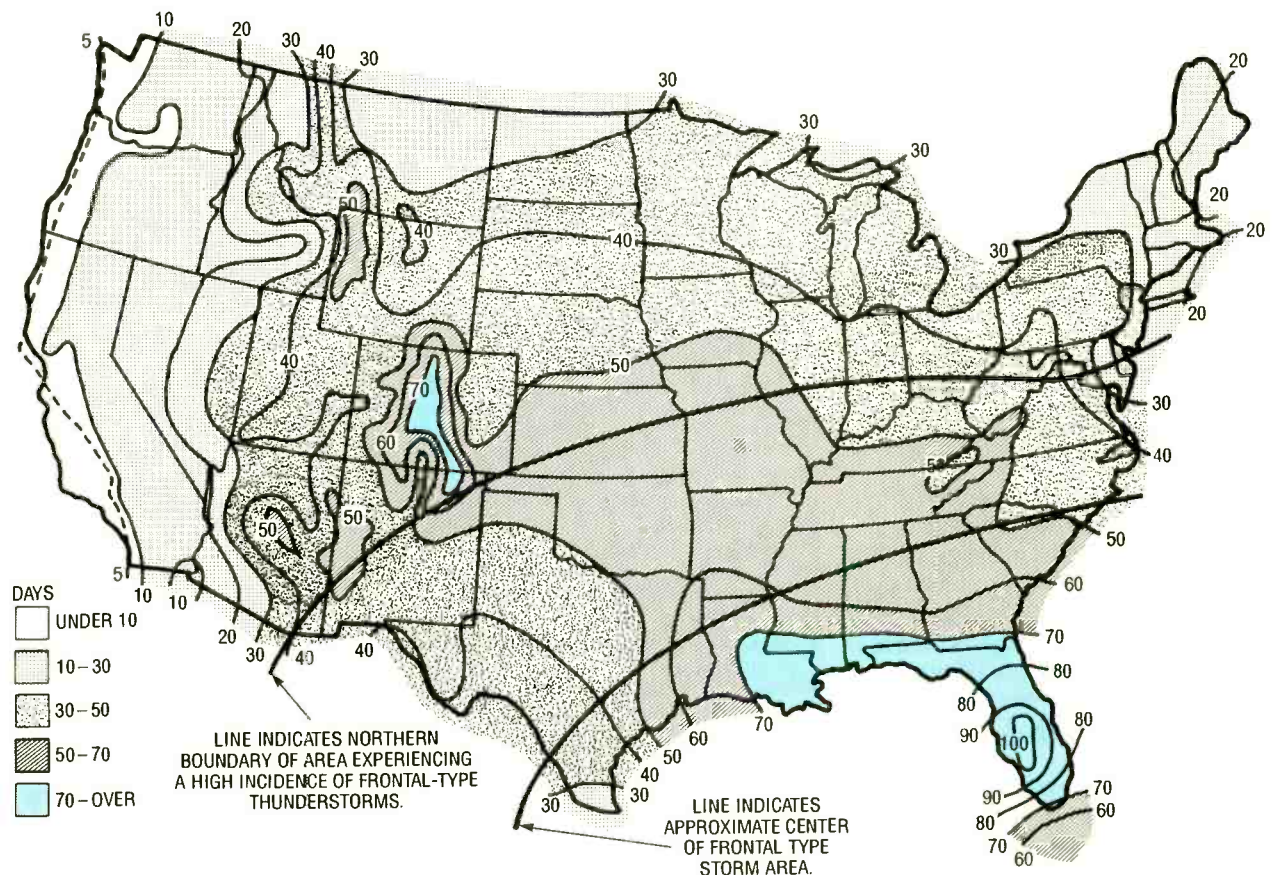

Fig. 2. This is a map indicating the average number of thunderstorm days in a year. As you can see, some areas have as many as 90 such days.

electronics gear in a specific region. The factor is frequently referred to as the "lightning-exposure factor."

If you consider an average power line, the grounds that are placed along its length can be rather ineffective in areas where the resistivity of the ground is high. As a result, it is not uncommon to have lightning travel for considerable distances directly into one's home heading for some electronic device inside. In addition, when the lightning gets into a home, arcs can occur from one system to another, such as from a power line to a water pipe. When that happens, the 4th of July comes early that year!

**Overall Protection.** But how can you prevent that type of problem? In most areas of the country the electrical codes require that the ground from the power line be connected to the water system, and tie in the telephone ground; that is about the extent of the protection scheme. That scheme works best if all services enter at the same point in the house, since then all the systems in the home have a similar voltage gradient and discharges between systems (called side discharges or side strokes) are less prone to happen.

For further protection, you can also connect TV cable systems, TVRO systems, and TV antennas to the same ground point if the electrical codes in your area permit this. If they are all brought in at the same point in the house and are grounded to the same ground rod, the danger of side strokes is greatly reduced in the structure, and the level of protection is greatly increased. Radio Shack, as well as other manufacturers, provide a simple schematic of such wiring with the instructions for some of the products they sell, including TV and radio antennas and equipment.

The possibility for a large voltage gradient exists if the services are brought in at opposite sides of the building. If that is unavoidable, connect the points outside of the structure with a buried, bare, No. 6 (at least) wire. Although not ideal, it's better than exposing the occupants and equipment within the structure to the hazards of gradients in much of the indoor wiring.

Something you should be aware of is that in the north, ground rods are not as effective in the winter because of the frozen ground. In most cases, a 6-foot long ground is the minimum that provides adequate protection.

TABLE 1—LIGHTNING-BOLT DATA

Parameter	Typical Value
Number of return strokes per flash	3
Duration of flash	0.2 sec.
Time between strokes	50 msec.
Peak current per return stroke	20 kA
Rate of rise	20 kA/ $\mu$ s
Length of stroke	3 km
Power per stroke	10,000,000 megawatts

TABLE 2—PARAMETER RANGES

Parameter	Minimum	Maximum
Peak current per return stroke	1 kA	250 kA
Rate of rise	0.5 kA/ $\mu$ s	210 kA/ $\mu$ s

TABLE 3—PROTECTION METHODS

Item to be Protected	Method of Protection
Power lines	Spike protector (MOV)
Telephone lines	Carbon block, gas tube, or solid state devices
Antennas	Coax cable with grounded shield
Computer RS232 port	Zener spike protectors

In high-resistivity parts of the country, a ground screen array in addition to the normal ground rod may be the best way to go. You may also want to salt treat the ground in the vicinity of your ground rod. That can be accomplished by perforating a plastic bucket buried in the ground with a ground rod driven thru the bottom of the bucket. If the bucket is kept filled with salt and watered at least once a week, the ground resistance will gradually be reduced and the ground rod's effectiveness will increase.

#### Interesting Facts

- There are at least 2000 thunderstorms in progress throughout the world at any time.
- About 100 lightning flashes strike the ground every second.
- Damage to buildings in the U.S. per year is 45-million dollars.
- Lightning causes 10,000 forest, grass, and brush fires per year in the U.S.
- Lightning accounts for up to 600 deaths per year in the U.S.
- About 70% of all fatal lightning accidents involve 1 person.
- Around 70% of all lightning fatalities occur in the afternoon.
- Only 30% of all lightning fatalities involve people who work outside.
- In all, 25% of all fatalities involve recreation activities.
- The afflictions most often reported as a result of lightning are as follows: heart, lung, and brain damage, amnesia, burns, and paralysis.

**Protecting Specific Devices.** Table 3 lists several devices that can protect your electronic devices with a minimum of installation trouble. Power line protection is best accomplished by putting a spike protector at several receptacles in the home, especially those used for a computer, an audio/video-entertainment center, a fish tank, any lamps with a solid-state controller, and any other valuable equipment. With each protector placed along a circuit in a home, the protection level increases more than you might think because they can share the current of a lighting bolt.

Telephones are normally protected by telephone-company supplied arresters. The level of protection can be increased by placing an additional protector (available from many sources) at the telephone that is closest to the telephone cable entrance. One of those devices is normally all that is required if the ground on the telephone-company supplied protector is properly connected to the home ground system. I do, however, recommend that a modem for your computer be disconnected when it's not in use.

The one thing that is most important when protecting a computer system is to remember that protection levels are decreased when peripherals and computers are connected to separate 117-volt receptacles. The loops that re-

(Continued on page 96)



*Just in time for Halloween, here's an infrared-triggered sound-effects generator that can give your holiday fun that perfect finishing touch.*

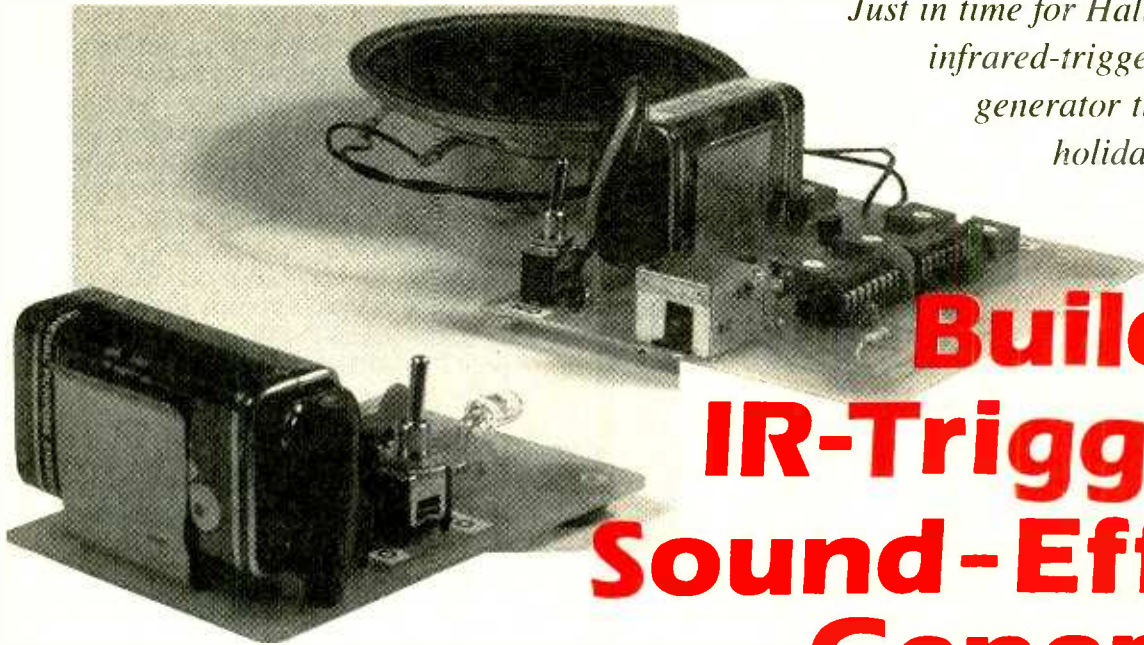

# Build An IR-Triggered Sound-Effects Generator

BY JAN AXELSON

**H**ow would you like to greet your trick-or-treaters this year with a frightening howl or scream as they approach your door on Halloween? Or how about surprising the guests in a Halloween fun house with the sound of a creaking door or sudden shriek as they pass a selected spot? This article describes a sound-effects generator that will automatically shriek, scream, howl, groan, creak, or make other sound effects when someone passes by.

The sound effects are generated by an oscillator that emits a tone that rises, then falls, in frequency. You can adjust the tone's maximum frequency, how quickly it rises and falls, and how long the tone sounds before the frequency drops off. By adjusting these characteristics, you can craft just about any sound effect you want.

The sound effect is triggered when an invisible infrared beam is blocked by an object or person passing through it. This means that you can easily set the project up so that it automatically groans, screams, or whatever as trick-or-treaters come up your walk or at a particular point in a fun house.

**Circuit Details.** The project consists of two parts: the transmitter, which emits the infrared beam, and the sound-effects generator, which monitors the infrared beam and makes a sound effect when the beam is broken.

Figure 1 shows the transmitter's circuitry. The infrared signal is controlled

by U1, a 555 timer that pulses infrared-emitting diode LED1 at 40,000 Hz. That frequency is chosen to match the response characteristics of the infrared receiver, which is discussed in greater detail below.

Timer U1 is configured as a standard astable oscillator. In each cycle, the amount of time pin 3 of U1 is high is determined by the charging of C2 through R1 and R2, and the amount of time pin 3 is low is determined by C2's discharging through R2. Potentiometer R1 is adjusted for a 25-microsecond period at pin 3.

When pin 3 is low, current through R3 turns on LED1. With the values shown, LED1 is on for about 2 microseconds of each 25-microsecond period. By turning LED1 on for just a small part of each cycle in this way, less battery power is used, yet the transmitted signal remains strong.

The transmitter is powered by 9-volt battery B1. Capacitor C1 is a decoupling capacitor for B1, and C3 provides noise immunity at pin 5.

Figure 2 shows the circuitry for the infrared receiver and sound-effects generator. The receiver, MOD1, is a GP1U52X integrated module that contains an optical filter, infrared-sensitive pin diode, amplifier, band-pass filter, and comparator all handily contained in a single package.

When MOD1 detects an infrared signal oscillating at or near 40,000 Hz, its output at pin 1 goes low. When no such signal is detected, pin 1 is high.

The module requires a 5-volt power supply, which is provided by U2, a 78L05 5-volt regulator. The output of U2 is a constant 5 volts, which powers MOD1, U3, and U4. Nine-volt battery B2 powers U2, and capacitor C4 is a decoupling capacitor for the 5-volt supply.

Pin 1 of MOD1 triggers U3-a, one half of a dual monostable multivibrator. When the infrared beam is broken, pin 4 of U3-a goes high, causing pin 6 to go high for a "timeout" period of about 5 seconds. (The length of the timeout pulse equals  $R4 \times C5$ , with the value of R4 in ohms and the value of C5 in farads.)

The timeout pulse has two functions: it triggers multivibrator U3-b, and it prevents the circuit from retriggering during the timeout period (while pin 6 of U3-a is high). The timeout makes the sound effects seem less predictable just in case someone gets curious and tries to track down what is causing them to trigger.

When pin 6 of U3-a goes high, pin 9 of U3-b emits a "low" pulse that triggers the sound effect. Pin 9's pulse length equals  $R5 \times C6$ , and may be as long as 5 seconds, depending on how R5 is adjusted.

The sound effect is generated by a voltage-controlled oscillator (VCO) contained in U4, a 4046 CMOS phase-locked loop.

The VCO's output at pin 4 of U4 is a square wave whose frequency depends on the voltage at pin 9 and on the values of R10 and C8. When pin 9 of

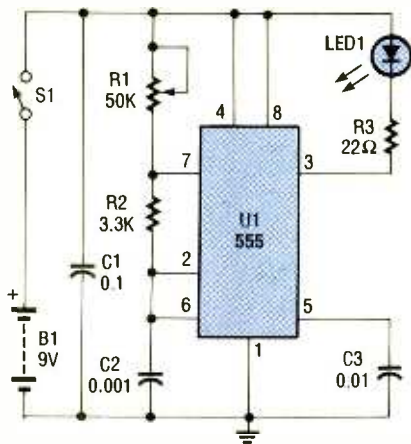

Fig. 1. In the transmitter circuit, a 555-timer IC pulses infrared-emitting diode LED1 at 40,000 Hz.

U3-b goes low, transistor Q1 switches on and allows C7 to charge through R8. That causes pin 9's voltage to rise and causes pin 4 to oscillate at a gradually increasing frequency.

If pin 9 of U4 reaches 5 volts, pin 4 will continue to oscillate at its highest frequency, until pin 9 of U3-b goes high. When that occurs, Q1 switches off and Q2 switches on, allowing C7 to discharge gradually through R9. That causes pin 9's voltage to drop and pin 4's frequency to decrease.

Resistors R6 and R7 limit the base currents through Q1 and Q2. This ensures that pin 9 of U3-b switches between +5 and 0 volts, so that Q2 is off when Q1 is on, and Q1 is off when Q2 is on.

Pin 4 of U4 drives transistor Q3, which in turn drives SPKR1. Resistor R11 limits SPKR1's volume, and R12 is the volume control.

**Building the Project.** Figures 3–6 show the PC patterns and parts placement for the project's transmitter and sound-effects boards. The project may be built entirely on the printed-circuit boards as shown, or you may build the

circuits on perforated board using point-to-point soldering or wire-wrap techniques and hardware.

Enclosures are not required, but if you decide to mount the circuit boards and SPKR1 inside project cases, you'll want to mount S1, S2, MOD1, LED1, R12, and probably R5, R8, R9, and R10 on the front panels of the enclosures for easy access. For front-panel mounting, use rotary potentiometers instead of printed-circuit-board mount types for R5, R8–R10, and R12, and use short lengths of insulated hook-up wire to connect the front-panel components to the circuit boards.

The GPIU52X infrared-receiver module is available at Radio Shack as cata-

## PARTS LIST FOR THE SOUND-EFFECTS GENERATOR

### SEMICONDUCTORS

- U1—555 timer, integrated circuit
- U2—78L05 low-power +5-volt regulator, integrated circuit
- U3—4538B CMOS dual monostable-multivibrator, integrated circuit
- U4—4046B CMOS phase-locked loop, integrated circuit
- LED1—infrared light-emitting diode
- Q1—2N2907 or similar general-purpose PNP transistor
- Q2, Q3—2N2222 or similar general-purpose NPN transistor
- MOD1—GPIU52X infrared-receiver module (Radio Shack 276-137)

### RESISTORS

- (All fixed resistors are 1/4-watt, 5% units)
- R1—50,000-ohm trimmer potentiometer
  - R2—3300-ohm
  - R3—22-ohm
  - R4—1-megohm
  - R5, R8–R10—1-megohm PC-board-mount potentiometer
  - R6, R7—10,000-ohm
  - R11—33-ohm
  - R12—1000-ohm trimmer potentiometer

### CAPACITORS

- C1—0.1- $\mu$ F, ceramic-disc
- C2—.001- $\mu$ F, polyester
- C3, C4—.01- $\mu$ F, ceramic-disc
- C5, C6—4.7- $\mu$ F, 25-WVDC, tantalum
- C7—2.2- $\mu$ F, 25-WVDC, tantalum
- C8—.047- $\mu$ F, polyester

### ADDITIONAL PARTS AND MATERIALS

- B1, B2—9-volt transistor-radio battery
- S1, S2—SPST, PC-mount toggle switch
- SPKR1—8-ohm, 0.5-watt audio speaker
- PC-board or perfboard materials, IC sockets, 9-volt battery clips, battery holders, wire, solder, hardware, etc.

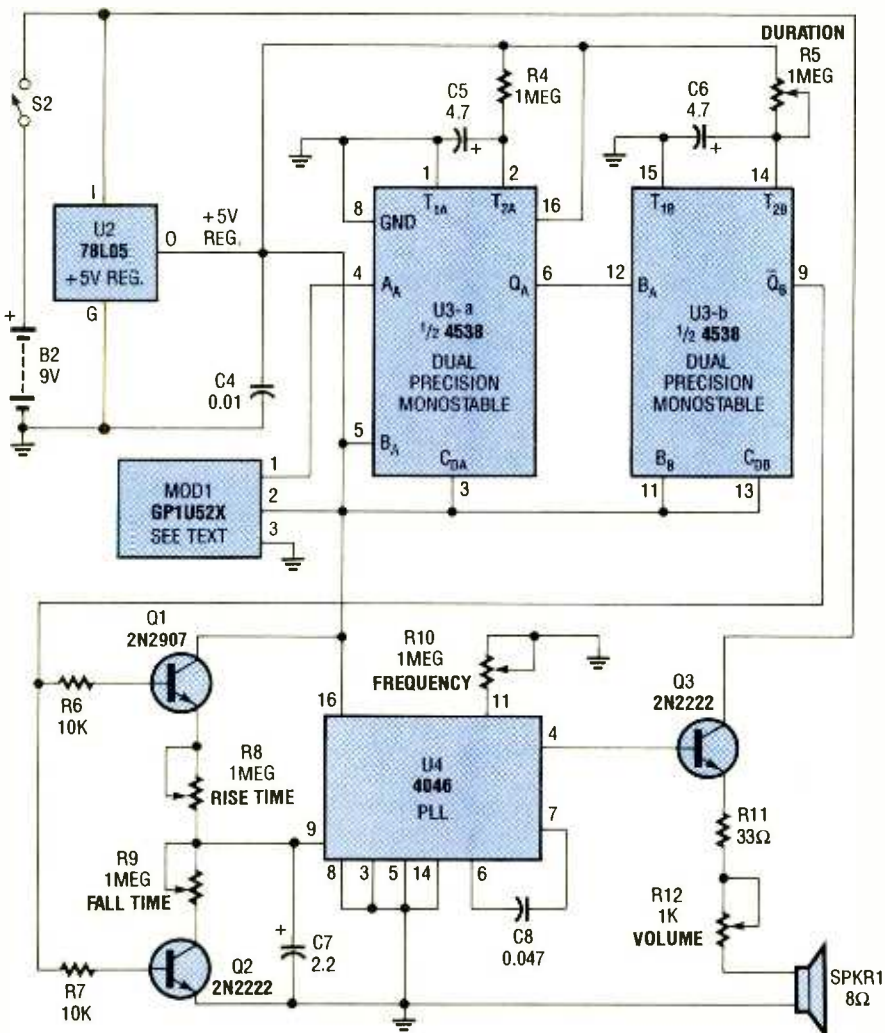

Fig. 2. An infrared beam from the transmitter circuit is aimed at receiver module MOD1. When the beam is blocked, U4's voltage-controlled oscillator generates a sound effect. The sound effect's characteristics are adjusted by potentiometers R5–R10.

log number 276-137. All other components are widely available, from a variety of sources. If you wish, you may substitute a 7805 regulator in a TO-220 case for U2.

To use the printed-circuit-board method, etch and drill the boards using the layouts shown in Figs. 3 and 5. Each board includes a hole for mounting a battery holder. Also drill holes for mounting screws or standoffs for each board (or you may instead use press-on rubber feet to elevate the boards slightly).

Install the components as follows, using the parts-placement diagrams shown in Figs. 4 and 6 as guides: Insert and solder IC sockets for U1, U3, and U4, install regulator U2, and then insert and solder R1-R12. Adjust R1 for 30,000 ohms as measured between pins 7 and 8 on U1's socket. Insert and solder C1-C8, observing proper polarity for C5-C7, then insert and solder S1 and S2.

Observing proper polarity, bend the leads of LED1 90 degrees so that the installed LED points off the circuit board as shown in the photos, and solder the leads to the board. For MOD1, cut three 1-inch lengths of hook-up wire and strip 1/4 inch of insulation from each end of the wires. Solder one end of each wire to the pins on MOD1 and insert the other ends into the appropriate holes on the circuit board. Pin 1 on MOD1 is marked by a nearby dot on the module's case.

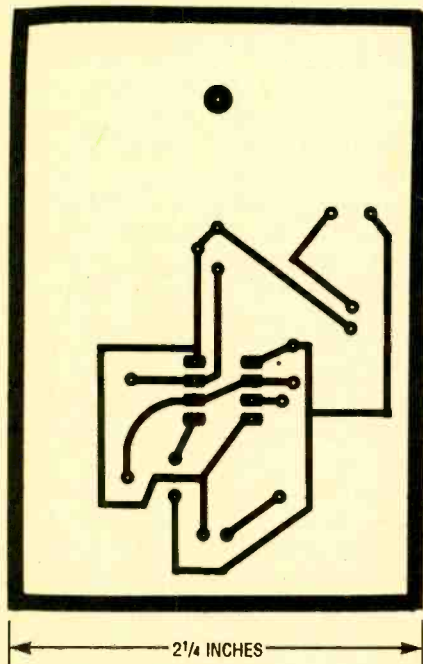

Fig. 3. If you chose to build the project on printed-circuit boards, use this pattern for the transmitter board.

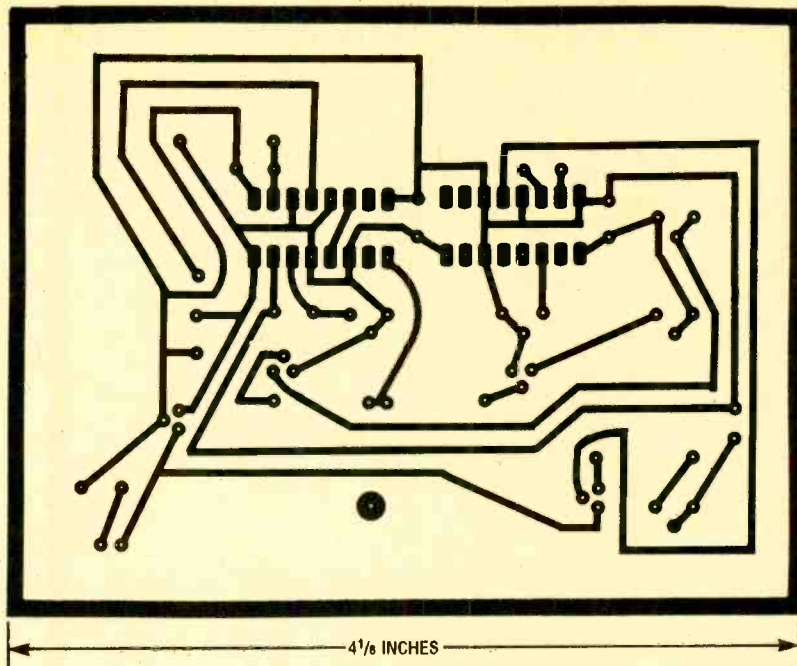

Fig. 4. Use this parts layout when installing the components on the sound-effects generator board.

To mount MOD1 on the board, mix a small amount of epoxy cement, apply the epoxy to the bottom of MOD1, and position the module on the circuit board so that its IR-sensitive diode points off the board and its case is flush with the edge of the board. Clamp MOD1 in position to dry.

On the transmitter board (Figs. 3 and 4), mount a battery holder for B1 and solder the battery-clip leads to the appropriate holes. When MOD1's epoxy has dried, do the same on the receiver/sound-effects board (Figs. 5 and 6). Solder SPKR1 to the appropriate holes in the sound-effects board using short lengths of hook-up wire with 1/4-inch of insulation stripped from each end. Use any convenient method to label S1, S2, R5, R8-R10, and R12.

**Circuit check-out.** Check over your work to be sure that all components have been installed (except U1, U3, and U4) and look for and correct any cold-solder joints or unwanted solder bridges. To check out the transmitter, open S1, plug a 9-volt battery into B1's clip, close S1, and use a voltmeter to measure the voltage between pin 8 and pin 1 on U1's socket; you should measure 9 volts there.

If you see any problems, now or anywhere in the checkout process, stop, look over your work, and find and fix the problem before proceeding to the next step.

When all looks fine, open S1 and in-

sert U1 in its socket, observing proper pin-1 orientation, and close S1. If you have an oscilloscope or frequency counter, observe the signal at pin 3 of U1 and adjust R1 so that this signal has a period of 25 microseconds. Otherwise, you can leave the frequency adjustment until you have the receiver/sound-effects board up and running.

To test the detector and sound-effects circuitry, set R5-R8 to midrange and turn R12 to its maximum resistance, then back it off about 1/10 turn. Open S2, plug a 9-volt battery into B2's clip, and then close S2.

With a voltmeter, measure the voltage between pin 16 and pin 8 on the sockets for U3 and U4, and between pins 2 and 3 on MOD1. In each case, you should measure 5 volts. If all looks fine, open S2 and install U3 and U4 in their sockets, observing proper pin-1 orientations.

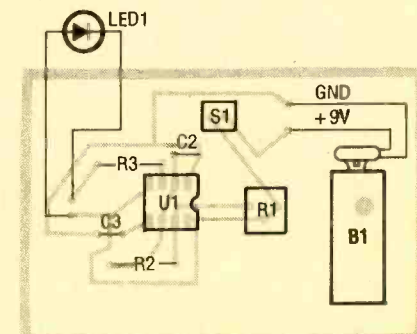

Fig. 5. Here's the placement guide for the IR-transmitter board.

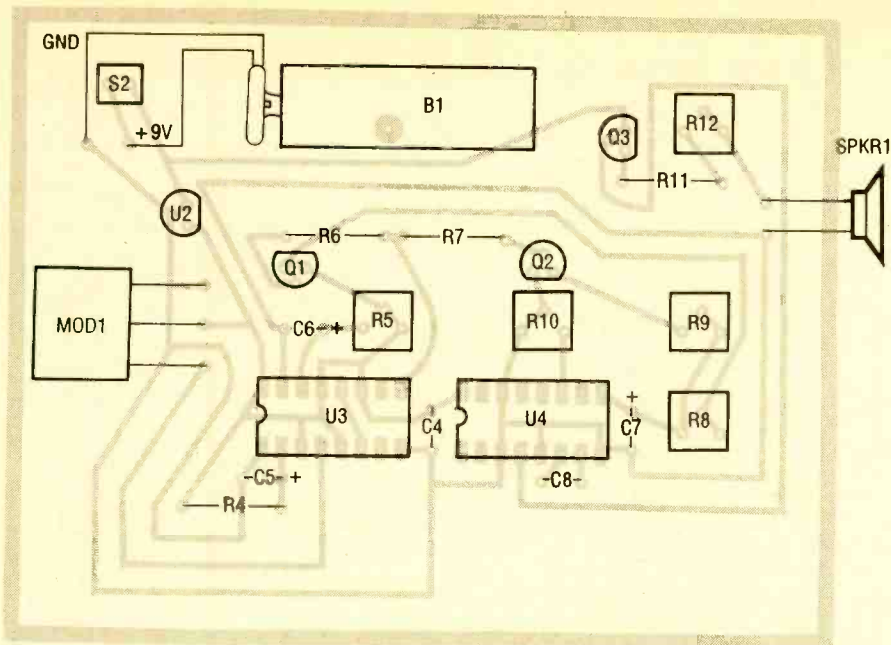

Fig. 6. Use this parts-placement diagram to build the receiver/sound-effects generator part of the project. Note that MOD1 is epoxied to the board.

Set the transmitter and sound-effects boards a couple of feet apart and aim LED1 (on the transmitter) at MOD1's diode (on the sound-effects board). Close both S1 and S2.

Pass your hand through the path between LED1 and MOD1. As your hand blocks the beam, a sound effect should trigger. Adjust the speaker's volume with R12 as needed. If nothing happens, and if you weren't previously able to

measure the transmitter's frequency, you may need to fine tune R1 for a 40,000-Hz output; use the following procedure:

Use a voltmeter or logic probe to see if pin 1 of MOD1 is low when the transmitter is pointed at it. If not, adjust R1 gradually until pin 1 goes low, indicating that the infrared beam is being detected. Now adjust R1 until pin 1 just goes high, then adjust in the opposite

direction until pin 1 goes low again. Finally, turn R1 back to about the middle of the range in which pin 1 is low, and you should be transmitting near the desired 40,000 Hz.

**Adjusting and Experimenting.** The sound-effects generator's many controls and adjustments mean that there are many possibilities to explore.

To change the maximum frequency of your sound effect, adjust R10. When you have a tone you like, fine-tune the effect with these controls: To adjust how quickly the frequency rises, adjust R8. To adjust how long the tone sounds before beginning to fall off, adjust R5. To adjust how quickly the frequency falls off, adjust R9.

Generally, lower values of R10 will give you creaking and groaning sounds, while higher values will give you howls, screams, and shrieks. Some of the controls interact, and a few settings give no audible response. To explore the possibilities and find the sound effect you want, experimenting is essential.

Test the strength of your transmitted signal by gradually moving the transmitter and receiver farther apart. You should be able to detect a blocked beam over distances of 6 to 8 feet. For transmitting over greater distances, you may use a lower-value resistor for R3, but that will drain B1 more quickly.

To use the sound effects generator, adjust the circuits for the sound effect you desire, then set the receiver and sound-effects-generator boards on opposite sides of a path you expect your "victims" to cross. Aim LED1 at MOD1's diode. Test your setup by passing between the two circuits. You should hear your sound effect trigger as the beam is blocked.

If you reblock the beam before the 5-second timeout has passed, no sound effect will trigger and another 5-second delay will begin timing. In other words, the beam must be undisturbed for 5 seconds before another sound effect will occur. If you prefer to not have this timeout period, substitute a 1000-ohm resistor for R4 and the timeout will have no effect.

While the circuit was designed specifically as a Halloween-type sound-effects generator, you're sure to find lots of interesting ways to use it. For instance, it can be used as an entry alarm. And the transmitter/receiver circuitry can be used to automatically activate other types of circuitry. The uses are only limited by your imagination.

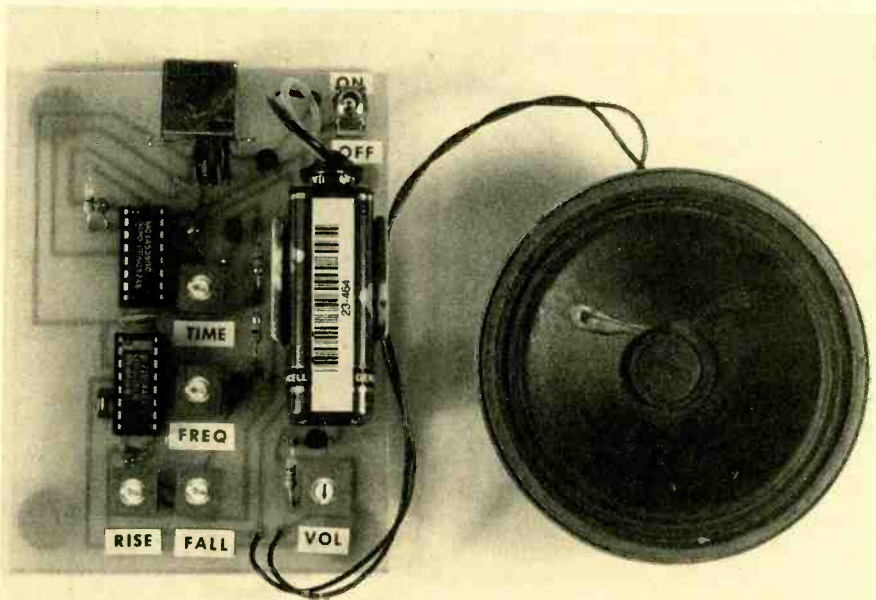

The sound-effects generator creates a selected sound effect when the infrared beam aimed at the receiver module is broken. A wide variety of sounds can be tailored by adjusting potentiometers R8-R10.

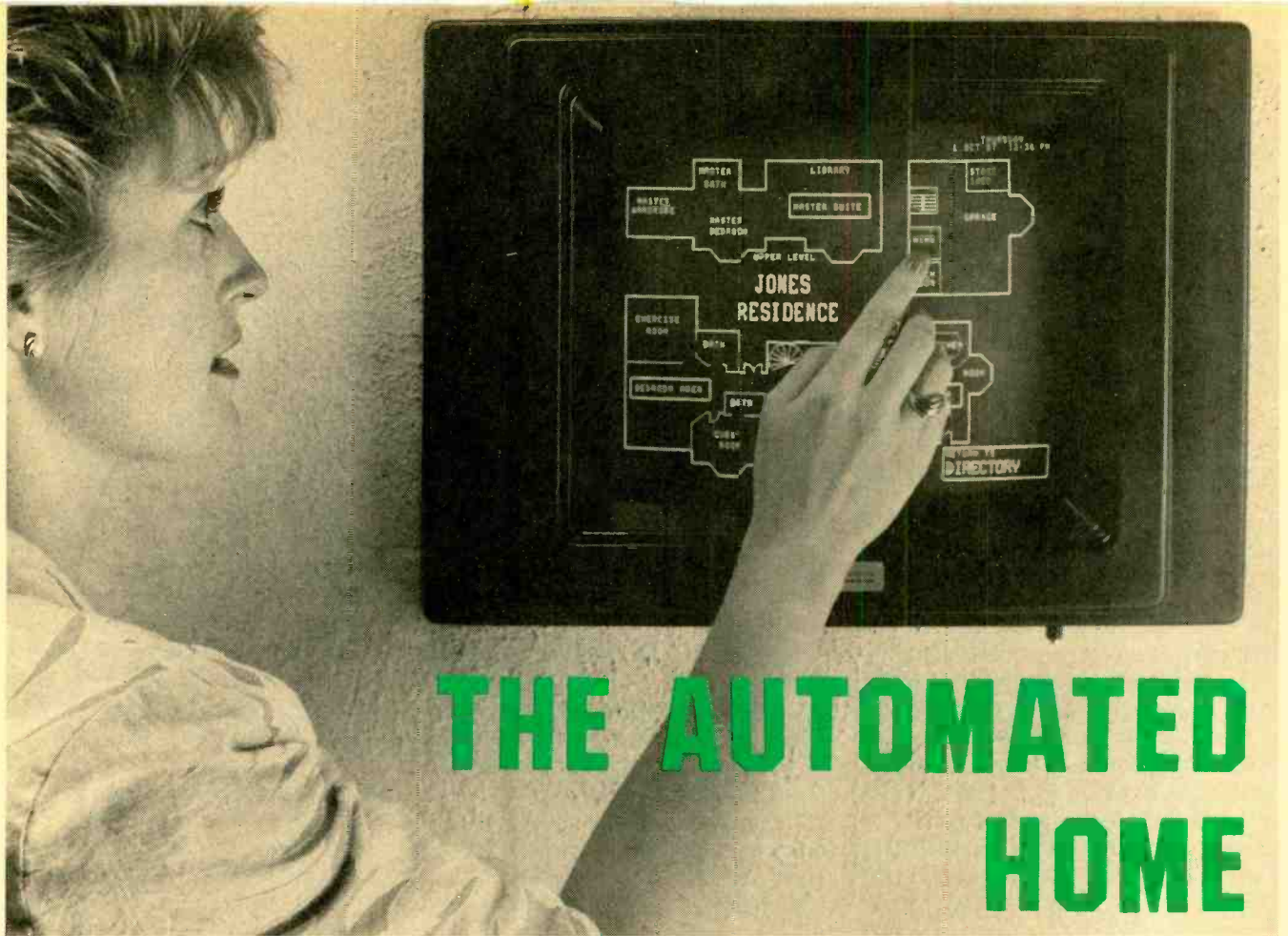

# THE AUTOMATED HOME

**P**icture it: you arrive back in town after a particularly grueling business trip. Before you leave the airport, you phone home—even though you know that your wife's out for the evening and the kids are at basketball practice. You punch a couple of keys on the phone keypad, hang up and head out of the airport parking lot.

As you drive up to the garage, lights go on automatically inside and out. You enter the house to music provided by your favorite FM station. You proceed from room to room, lights turning on to precede you and off as you leave each area. Dinner is in the microwave, and it's ready when you are. The TV set is on, tuned to your favorite channel: in fact, the home automation system that's responsible has done just about everything but lay out your slippers and fetch the evening paper.

And that's not all. Just as you've snuggled into your favorite chair, dug into dinner on the TV table, and gotten interested in what's on the screen, the doorbell rings. Is it one of the kids, who's forgotten his key, or an insurance salesman? Not to worry, you press a button on the TV's remote control, and an inset on the TV screen shows who's at the door. You can converse with the caller

through the TV set without getting up, and if it's someone you want to see, release the catch on the front door by pressing another button. If you want to see who called while you were away, you can review not only the messages on your telephone-answering machine, but also see hard-copy videotapes of everybody who rang the doorbell that day.

**Plug-in Systems.** Some or all of this is taking place now in homes stretching from Orange County, CA, to Acton, MA; from Heathrow, FL, to Bellevue, WA. Barely an idea five years ago, it was a \$350 million business last year, and if plans for Electronic Industries Association's CEBus and National Association of Home Builders' Smart House come to fruition, it'll be commonplace by the beginning of the next century. In some new homes in Greenwich, CT, Potomac, MD, and elsewhere, automated-home electronics systems worth \$100,000 and more are going in as new construction. In urban remodels, the price is more like \$10,000 including labor. But one of the beauties of home automation is that the do-it-yourselfer can do much (in some cases all) of the work himself, thereby bringing the cost down to

*Today's technology has made it possible for you to live like the Jetsons (minus the jet car, of course).*

BY ROBERT ANGUS

manageable proportions. Better yet, systems like the pioneering X-10 and CEBus are modular, which means that the system can grow and expand with your needs and finances.

X-10 is a system that uses household electric wiring to relay commands from a controller to modules plugged into regular electrical outlets. It's been on the market for ten years or more, and is the technology on which several more modern home automation systems are based. All you need to start is a small plug-in module and a couple of modules to start. You can expand the system almost infinitely by adding wall switches, wall outlets, a wireless remote controller, universal interface, and lots more.



*X-10, the first consumer infrared building-block system, now consists of a wide assortment of components. They include a timer/programmer (rear left near center), telephone interface (center), air-conditioner, and high-voltage wall modules (lower left).*

**Dedicated Systems.** CEBus and Smart House require dedicated wiring, and because the latter includes AC lines, it must be installed by a licensed electrician. The CEBus wiring protocol, however, carries nothing stronger than an audio or video signal and is ideally suited to do-it-yourself. Final details on the system won't be announced until the end of the year, and it'll probably be a year after that before the first CEBus-ready TV sets, stereo receivers, PC's, and other products appear on the market. However, if you're remodeling or building now, you might want to consider installing the CEBus wiring network: two coaxial cables (RG6 or RG59) and four twisted pairs for low-voltage wiring (like telephone or bell wire).

The system is designed to accommodate just about any type of audio or video signal that's likely to come along. In addition, it can handle home security, intercom, climate control, relay of commands from one component or control to another, telephone, home computer, and lots more. Coaxial cable costs in the range of 20 cents per foot, and four-conductor telephone cable about 15 cents per foot.

At the other end of the scale is Unity Systems' Home Manager, which costs from \$6500 to \$20,000, depending on the size of your home and how much you ask the system to do. Not only can it turn on lights and the stereo system when you come home, but it can also control temperature and humidity precisely not just in different parts of the house, but even in different parts of the same room. It tells you which windows you've left open or unlocked when you plan to go away, start dinner in response to a phone call from anywhere in the world, alert paramedics if there's

an emergency, and channel audio and video programming wherever you want it to go.

While Home Manager is most commonly found in new homes for the upwardly wealthy, the manufacturer says you can install it yourself—if you know what you're doing—or have it done by a qualified installer even in an existing home. The heart of the system is a touch-panel video screen that displays a layout of the house, your programmed schedule of commands, a menu of all the tricks it can perform and a safety alarm. Individual sensors in various parts of the house open or close shades, raise or lower heat and artificial light. According to the man-

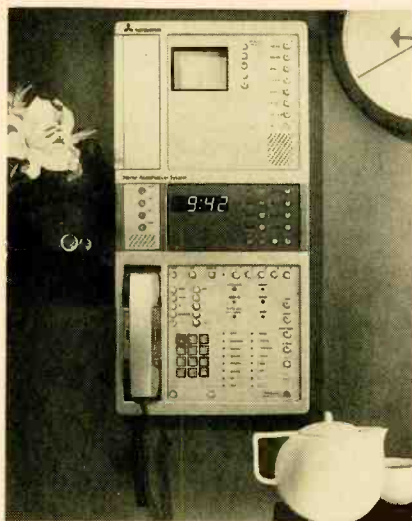

*This is the heart of the Mitsubishi home-automation system. All home lighting, electrical devices, appliances, remote-controlled A/V equipment, and home-security systems can be controlled inside or outside the home using any touch-tone remote.*

ufacturer, the system pays for itself over several years in energy savings.

Mitsubishi's home automation system consists of a single component, the Home Automation System control panel, some off-the-shelf audio and video components, and a combination of technologies, including X-10. The control panel goes for \$1400, permits the interconnection of a picture-in-picture TV receiver, electronically-controlled door and window latches, closed-circuit TV camera(s), hard-copy video printer, and infrared remote control to permit the homeowner to answer his front door without getting up from the TV. Like Home Manager, it can accept commands phoned in from outside and can be programmed to perform a wide variety of functions, including watering the lawn and cooking dinner. Mitsubishi hopes to have a complete system sometime this year.

**The Japanese Concept.** Halfway around the world, on a postage-stamp-sized lot in a Tokyo suburb, stands the Century, a house of tomorrow constructed by Misawa, Japan's largest builder of prefabricated housing. It doesn't look like \$1 million worth of house, which is what Misawa charges for a copy, but a casual view offers no indication of the unique features it includes: kitchen cabinets that rise up out of the way into the ceiling at the touch of a button (and a dining room table that sinks to the level of a coffee table when not in use), a toilet that not only provides daily health checks but reports any irregularities by phone to your doctor. The whole house stands on a turntable, so that it can rotate to provide any room with southern exposure.

On a wall just outside the living room is Misawa's equivalent of Unity's touch-screen—a floor-to-ceiling column of 3- x 4-inch panels, each featuring a symbol indicating the function it controls. A button with a stylized flame on it, when illuminated, sounds an alarm both throughout the house and at the nearest firehouse. Lights indicate the quickest path to the exits, and windows close automatically to eliminate draft. A panel bearing a musical note operates the home entertainment system. It can be programmed to provide wake-up music from the FM tuner to the kitchen and bedroom, and background music from a CD player in the front hall and living room for the tired breadwin-

*(Continued on page 90)*

BY TOM FOX

One of the fun things about a candle, to kids (or kids at heart) is the simple fact you can blow it out. Another bewitching characteristic of a common candle is that it flickers with movements of air. That 'flickering' is what makes a candle-lit Halloween Jack-O-Lantern horrendously scarier than one with a flashlight stuck in it.

Everyone knows that a flashlight bulb puts out a steady light that does not flicker. Well folks, the *Lepton Candle* (described in this article) is an electric light that flickers just like a candle and for the same reason—air currents! In fact, the Lepton Candle can even be blown out, just like the wax originals! The Lepton Candle is especially fascinating to fans of ghouls and goblins. Stick one in a scary carved-out pumpkin and the weird flickering light could even frighten a ghost (at least the short two-legged variety whose wardrobe includes several white sheets!).

By the way, a lepton is not a baby *Leprechaun*. Rather, leptons are a family of subatomic particles that include neutrinos, muons, positrons, and the electron, which just happens to be the primary lepton that powers the light. The Lepton Candle varies in brightness with changes in air currents and appears to flicker like a flame. If you blow at the Lepton Candle just right, it even goes completely out for a few seconds. In addition to being a stimulating and fun conversation piece, if a first-class job is done in its construction, the Lepton Candle can be used as the only light source at a candle-light dinner. Ghosts and goblins fans can place the light bulb inside a carved-out pumpkin for a truly creepy Halloween decoration.

**The Wind-Chill Factor.** The Lepton Candle makes use of a simple principle of physics—a heated object cools when placed in a stream of moving gas. The wind-chill factor is a name for that effect when the object is a human body and the gas is air. The energy source for the wind-chill factor is chemical—our bodies metabolic process called respiration.

In the wind chill factor, wind blows away the warmer body-heated air,



# The Lepton Candle



*Round out your Halloween decorations with this safe yet effective candle substitute.*

which lies within a fraction of a millimeter from one's skin. The removal of that intimate warm air results in a feeling of a chill if the air is cooler than our skin (about 90°F). With the Lepton Candle we consider the *flicker factor*. The source of energy for the flicker factor is leptonic—more commonly referred to as electrical. That leptonic energy warms a thermistor which is then cooled by air movement. The thermistor's change in resistance, due to moving air, is what the circuit is all about.

One thing to keep in mind here: An unheated mass, such as a rock in the shade or at night, is not cooled by wind. Of course, if the sun was shining on the rock, wind can cool it since the rock was being heated.

**About the Circuit.** Referring to the schematic diagram shown in Fig. 1, R11 (the thermistor) and R5 are connected in a voltage-divider circuit. The value of R5 is chosen so that sufficient current flows through R11 to warm it to about 40°F above the room's (calm) air temperature.

The theoretical *free-air* temperature is considerably higher than 40°F. The heat-sink effect—due to soldered

leads, paint, etc.—lowers the sustainable temperature differential.

The voltage across R11 varies directly with the air currents—the higher the gust, the higher the voltage. However, because the voltage across R11 is capacitively (AC) coupled, via C1, the circuit does not respond to constant voltage, only voltage changes. The change in the voltage is fed through C1 to the inverting input of U1 at pin 2.

The rather unique effect of the Lepton Candle is due partly to the relatively huge coupling and bypass capacitors used in the circuit. Those capacitors (C1–C3) won't let steady DC current through, but do transmit (through their dielectric) just about any change in voltage, even relatively slow ones.

The inverting-amplifier configuration (consisting of R2, R4, and U1) amplifies the input signal by a factor of  $-2000$ . (Resistors R1 and R3 are used to bias U1, since it's powered by a single supply.) The output of U1 is fed through R7 and C3 to the base of NPN power transistor Q1. The lamp, I1, is connected in series with Q1's collector and the +V source. Resistors R8, R9, and R10 form Q1's base-bias circuit. A potentiometer is used for R10 so that the average brightness level of I1 can be set to the user's preference.

OCTOBER 1990

## PARTS LIST FOR THE LEPTON CANDLE

### SEMICONDUCTORS

U1—LM324 quad low-power op-amp, integrated circuit  
 U2—LM2931Z-5.0, 5-volt, low dropout voltage regulator, integrated circuit  
 Q1—2N3055 NPN power transistor

### RESISTORS

(All resistors are 1/4-watt, 5% units, unless otherwise noted.)

R1, R2, R3—100,000-ohm  
 R4—51-ohm  
 R5—27-ohm, 1/2-watt  
 R6—6800-ohm  
 R7—1000-ohm  
 R8—3300-ohm  
 R9—680-ohm  
 R10—2500-ohm, PC-mount potentiometer  
 R11—100-ohm 25°C thermistor (Digi-Key KC001N-ND)

### CAPACITORS

C1, C2, C3—2200- $\mu$ F, 15-WVDC, electrolytic  
 C4—470- $\mu$ F, 25-WVDC, electrolytic  
 C5—0.1- $\mu$ F, ceramic-disc

### ADDITIONAL PARTS AND MATERIALS

I1—PR13 flashlight bulb  
 Printed-circuit board materials, enclosure, 1-inch diameter wood dowel, candle holder, 6-volt battery or 5- to 8-volt DC power supply, wire, solder, hardware, etc.

Integrated circuit U2 (an LM2931, 5-volt, low-dropout voltage regulator) increases the stability of the circuit. A simplified description of the circuit goes something like this: When you blow on R11, the thermistor is cooled raising its resistance. That jump in resistance causes a voltage increase across R11, which is coupled through C1 and R4 to pin 2 of U1. That causes the output of U1 to drop, which in turn, causes the positive bias at the base of Q1 to drop as well, resulting in less collector current, and so I1 becomes dimmer!

**Electronic Construction.** While the circuit is simple enough to allow the use of the less polished electrical construction techniques (perfboard or wire-wrap), a printed-circuit foil pattern is shown in Fig. 2. Once you've etched your board and obtained the parts listed in the Parts List, refer to Fig. 3 for proper placement and orientation of the components. Be sure to use a heat sink for Q1. Since less than half an amp will move through Q1 (which is rated for a maximum current of 15 amperes), a

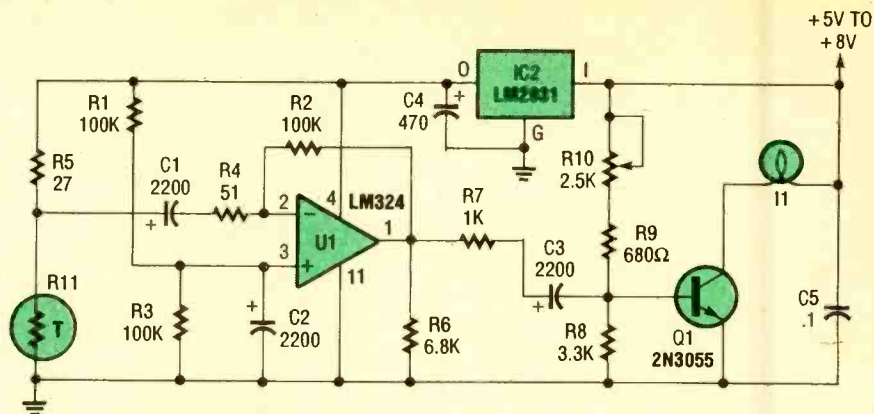

Fig. 1. The Lepton Candle is built around relatively few components; its main elements are 1/4 of a quad op-amp (U1) and a thermistor (R11). Thermistor temperature changes, producing proportional voltage changes, are presented to the op-amp and used to control lamp I1 through transistor Q1.

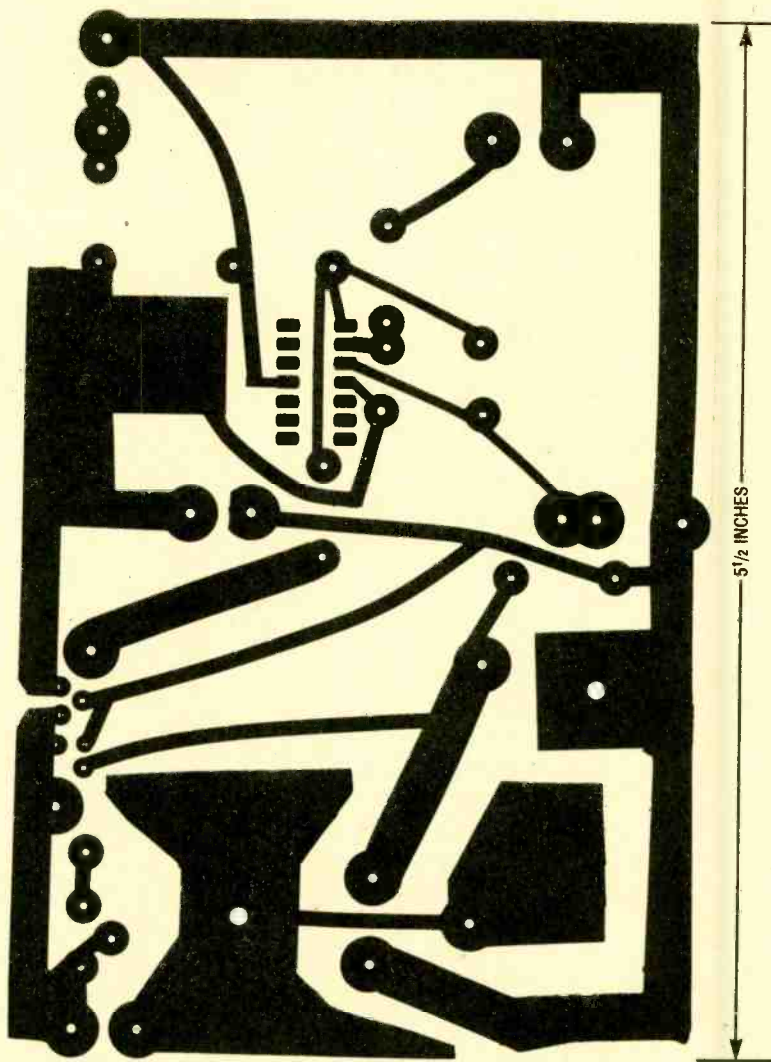

Fig. 2. Although there is nothing to prevent you from assembling the circuit on experimenter's or perfboard, printed-circuit assembly makes the job much easier and helps to reduce the common errors that find their way into hobby-electronics construction projects. Here's the foil pattern used by the author for his prototype.

relatively small heat sink will do the job. Altogether 6 wires must be connected to the circuit board. The author

used two sets of 2-conductor Mate-N-Lok connectors for R11 and I1 and two simple machine screw/nut connectors



for ground and +V. If you wish, 4-40 machine screw/nuts can be used for all connections; simply twist the end of the wire between two nuts and then tighten one nut. If desired, connect a SPST switch in series with the +V power-supply wire so that the unit can be conveniently turned on and off.

While a case isn't absolutely essential for the project's electronics section, it does make the Lepton Candle more convenient to use. The author housed the electronics in a 7½ × 4¼ × 2½-inch project box, which he covered with a homemade clear plexiglas cover, on which he painted a candle using acrylic paint. From past experience, the author found that acrylic paint adheres surprisingly well to plexiglass. Of course, said painting is only window-dressing and is optional.

Three half-inch long 6-32 screws and mating nuts were used to fasten the circuit board to the bottom of the case. A small slot was filed in one side of the case for the external cables/wires. A slot was made instead of a hole, so the circuit board could be more conveniently removed from the case.

The power supply should be able to deliver at least 1 ampere at between 5 and 8 volts. While the power supply must be DC, it need not be regulated. (Supplies of less than 5.5 volts should be regulated, however.) The two most common sources are a 5-volt regulated supply commonly used for digital equipment and a 6-volt lantern or rechargeable battery.

A 12-volt source can be used although a few components must be changed. For a 12-volt supply, R11 should be a 1k thermistor (such as Fenwall's JB31J1), R5 goes from the 27-ohm unit specified to 180 or 220 ohms, and R2 drops from its specified 100k value to 22k, 27k, or 33k. Also, the regulator, U2, should be eliminated.

By the way, the original Lepton Candle design used a 12-volt supply and was even more spectacular in its operation. The design was modified slightly because it was felt that a +5- or +6-volt supply would be more convenient for the reader. However, if a small car battery is available, one may want to build the Lepton Candle for 12-volt operation. An old near-dead car battery can sometimes be used. A battery that can't quite turn over a car engine may still be able to power the Lepton Candle for many years.

**Candle Construction.** In order to

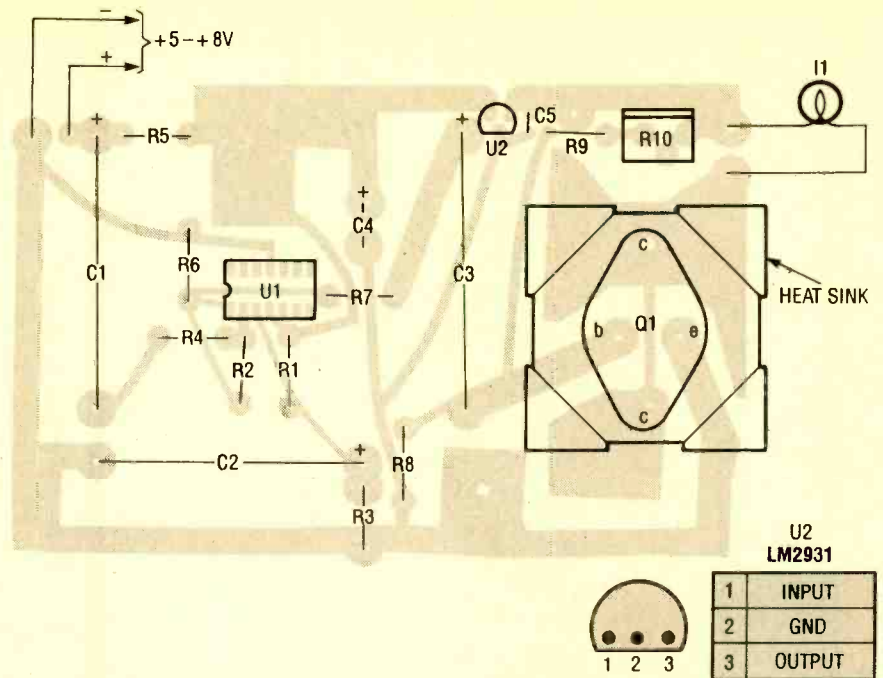
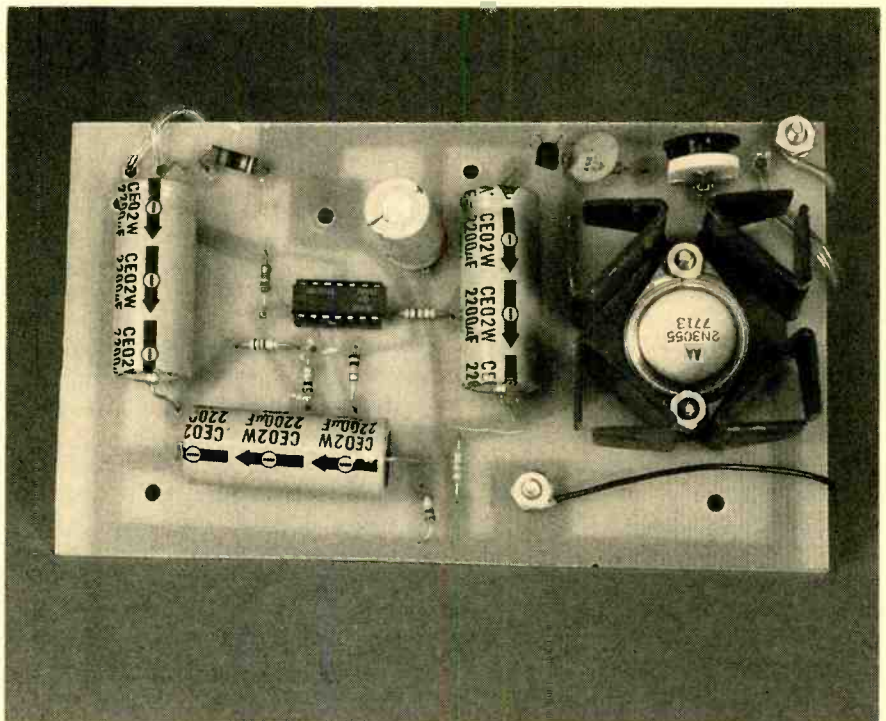

Fig. 3. Assemble the printed-circuit portion of the project guided by this parts-placement diagram. Note: C1-C3 are large, axial-lead, electrolytic capacitors, but may be replaced by radial-lead units provided that their leads are long enough to span the distance between connection points. Of course, if radial-lead capacitors are used, you'll have to consider the height of the component when selecting a housing for your project.



Most of the electronic components for the Lepton Candle were mounted on a printed-circuit board. Note that Q1 is mounted to a rather large heat sink, and that the power-supply connections to the printed circuit were made to screw/nut terminals. The screw/nut terminals make it very easy to disconnect whatever type of power supply is connected to the board so that some other type may be substituted.

make an attractive project, the construction of the candle itself requires patience, as well as a bit of skill. However, if the candle is to be used solely in

a Halloween Jack-O-Lantern, the workmanship can be a bit sloppy since the pumpkin will hide most of the sloppiness.

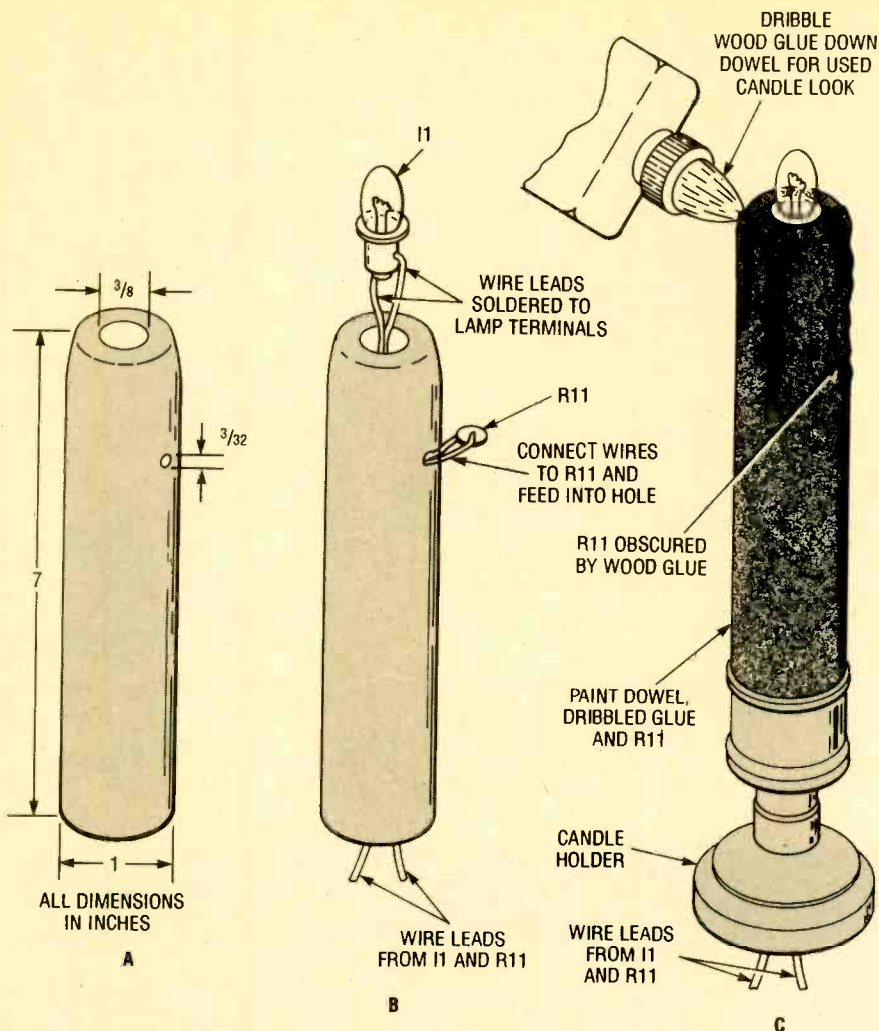

Fig. 4. The candle-stick portion of the project was fabricated from a 7-inch length of 1-inch diameter dowel. Details of its construction are shown here. To give the candle a more realistic appearance, wood glue was dribbled down the side of the dowel, giving it that runny hot-wax look.

Figure 4 gives some details on fabricating an attractive candle. The author used a 7-inch length of a 1-inch diameter wood dowel to form the candle. A  $\frac{3}{8}$ -inch hole was drilled through the center of the entire 7-inch length of the dowel. Then a Dremel motor tool was used to grind out the top of the hole so that I3, with leads soldered to its contacts, would fit snugly.

In addition, a  $\frac{3}{32}$ -hole was drilled in the side of the dowel for the thermistor (R11). Refer again to Figure 4. The wires for the thermistor were inserted in that hole and then pulled through to the bottom. The thermistor itself was then placed in the hole and covered with paint. To a casual observer, in dim light, the painted-over thermistor appears to be a glob of wax.

To give the candle a realistic appearance, the author drilled a hole through the bottom of an inexpensive candle holder and fed the light bulb

and thermistor wires through the hole. A hole was also drilled in a round wooden tray, on which the candle holder sits, for the wires.

In order to give the Lepton Candle the most realistic appearance possible, the author dribbled a bit of wood glue down the wood dowel so that it resembled hot wax running down the side of the candle. Once dried, the glue has the appearance of solidified melted candle wax. To complete the illusion the author painted the wood dowel, including dried glue and thermistor, with a reddish acrylic paint.

If the light bulb is to be placed in a carved-out pumpkin, one can use the same basic technique of candle construction. However, the dowel should be of a length so most of the light will shine out the Jack-O-Lantern's eyes. Also, place R11 in a location outside the pumpkin so it will be able to catch the slightest air movement.

**Using It.** First connect your creation to a suitable power source; be sure to observe correct polarity. A common 6-volt lantern battery is a convenient power source for intermittent and/or portable operation. A rechargeable 6-volt battery is more economical, however. For extended operation, a battery isn't practical—a suitable alternative is to use a plug-in power supply, rated for about +5 to +8 volts. A 5-volt regulated supply will work, although a slightly higher voltage increases the flicker factor.

Apply power to the circuit. Notice that when you first apply power to the project, I1 may light (depending upon the setting of R10), but the circuit will not seem to work right since there is a steady, non-candlelike glow. Blowing on the thermistor, immediately after applying power, will not change the brightness of the bulb. It appears that the Lepton Candle must 'warm up' for several minutes for the circuit to work properly. The required warm-up time is due to several factors such as the heating of the thermistor, large capacitors, and the circuit's high gain.

Potentiometer R10 is used to adjust the average brightness level of I1. Probably the optimum setting for R10 is the point where the light will just barely go out with a sudden rush of air. Keep in mind that this project only responds to changes in air movement. For instance, if the thermistor were suddenly placed in an air stream from an electric fan the light would first go out and then slowly resume its former brilliance. Turning off the fan would cause the bulb to glow extremely bright and then slowly dim to its average brilliance.

As stated earlier, the bulb of the Lepton Candle can be placed in a carved out pumpkin for an especially fascinating Halloween decoration. Since the 2N3055, with a large heat sink, can control up to 15 amps, several additional bulbs can be connected, in parallel, with the original one. If you elect to do so, it will be necessary to adjust R10 to set the average brightness of the parallel string of bulbs.

Also, with more than one bulb connected to the circuit, you may want to increase the gain of the circuit a bit by increasing the value of R2 from 100k to 150k, or even 220k. Remember, however, the higher the gain the longer the circuit requires to warm-up. Finally, use the *finger-test* to check that Q1 isn't hot to the touch even when the power is applied for an extended period of time.

# GIZMO

OCTOBER 1990

VOLUME 3,  
NUMBER 10

A CHRONICLE OF CONSUMER ELECTRONICS

## Just in the URC of Time

MEMOREX CP8 TURBO UNIVERSAL REMOTE CONTROL. Produced by: Memtech Products, P.O. Box 901021, Fort Worth, TX 76101. Price: \$119.99.

It was starting to get a little hairy around here. Too many remote controls: one for the big projection TV, another for the VCR that also served as its tuner, an additional one for the sound system, and yet another one for the laserdisc player. Oh yes, and still one more for the big stereo receiver that had come in for testing. Just too many remotes. We'd begun misplacing them, and it was getting to the point where we were losing too much time just rooting around for the proper device when we needed it. Memorex's super URC (Universal Remote Control), the Memorex CP8 Turbo, came just in time.

The CP8 Turbo is, as we shall see, a lot more than just another programmable remote control. It is a very programmable remote, and a delight to use, besides. First, though, the basics.

Although it is a "universal" remote, and can "officially" control eight different devices, the CP8 seems to be designed principally for video applications—most of the labels on its 46 keys, at least the ones not specifically related to programming the unit, are labeled for TV or VCR functions. Still, since all those keys are programmable, and since each can provide up to eight different functions—one for each different type of device (TV, VCR1, VCR2, cable, receiver, CD, tape, and auxiliary for anything not otherwise accounted for) you can use it for a lot of different things. And, by lifting off a transparent protective sheet, you can write in your own function labels in the vicinity of each of the remote's buttons. Switching from one set of commands to another is accomplished by pressing a pair of "arrow" keys labeled "SELECT"; the current mode is displayed on the remote's LCD screen, which normally shows the time and date, and also provides simple programming prompts as they are needed.



CIRCLE 50 ON FREE INFORMATION CARD

There is a pushbutton-operated backlight for the display, which might make the remote easier to use in a darkened viewing room.

Teaching the CP8 Turbo the instruction sets of other remotes is easy enough. The device can, by the way, speak four infrared-command languages—carrier, pulsed\_CW, and FSK—so it should work with just about any piece of equipment you own. It differs from most other programmable remotes in our experience in that its infrared receiver is located at its tail end, not at the head along with the IR emitters. You place the old-fashioned, about-to-be-replaced remote right behind the CP8 Turbo and align the two. That is simple—you press the learn key, which is located, along with the other programming-related keys, beneath a sliding panel toward the bottom of the unit, and then any key on the old remote. An indicator on the CP8 Turbo

lights when the two units are aligned properly. You then press the key on the CP8 to which you intend to assign a function, and then the corresponding key on the old remote. The CP8's LCD displays the word "STORED" when the command has been committed to memory, and you can proceed to program the next key.

Our programming process went very quickly, and without serious incident. We did discover, though, that the CP8 learns commands in an unusual fashion. That is, if your old remote repeats commands when you hold down one of its keys, the CP8 will memorize a bunch of them at once. There seems to be no auto-repeat function on the CP8 if you hold down a key, but you can store a bunch of repeated commands (volume up ... volume up ... volume up) in one programming swoop, and then use as many or as few of them as you need by holding the CP8 key down for the appropriate length of time. Strange, but it works once you've figured it out.

We also had a problem with the mute function of one of our devices. Since a single button on the old remote turned the muting function on and then off, we thought it was a simple toggle. It turns out that it wasn't and that alternate pressings of the mute key caused different codes to be sent. That resulted, when we programmed the CP8's mute key, in our being able to mute the sound but not to be able to turn it back up again. We solved the problem by defining a second CP8 key for the "unmute" function.

Now, most designers and manufacturers of programmable remotes stop at that point. They allow you to teach their device the language of several other devices, and to replace all of them with the one. That's nice as far as it goes, but Memtech, already having the clock, microprocessor, and memory in the CP8, made it really programmable, just like the computer it is at heart. Well, why not?

To begin with, the device can store and issue sequences of commands. For example, we defined a sequence we called "GMA" (you can give your sequences names up to five letters in length). That

(Continued on page 6)

TURN PAGE FOR CONTENTS

**This  
month  
in**

# **GIZMO**

Memorex CP8 Turbo Universal Remote Control.....	pg. 1
AKG Acoustics K 1000 Reference Listening System .....	pg. 3
Design Tech Sound Wedge Stereo Silencer .....	pg. 4
Code-A-Phone Model 2880 Dual Phone-Answering System ...	pg. 5
Alphasonik Equalizer.....	pg. 7
Fisher CD Changer .....	pg. 7
Nokia-Mobira Cellular Phone ...	pg. 7
Radio Shack Radio Silencer.....	pg. 7
ORA Cellular Antenna.....	pg. 8
Panasonic Surround System ...	pg. 8
Philips Cleanups .....	pg. 8
Ricoh Fax Adapter .....	pg. 8
Built-in Speakers .....	pg. 9
RCA TV .....	pg. 9
Soundesign Portable Stereo.....	pg. 9
Texas Instruments Calculator... ..	pg. 9
Parsec Antenna .....	pg. 10
Pioneer Cassette Changer .....	pg. 10
Technidyne Portable Stereo ...	pg. 10
Yamaha CD Player.....	pg. 10

GIZMO is published by Gernsback Publications Inc., 500-B Bi-County Blvd., Farmingdale, NY 11735. Senior Writer: Josef Bernard. Contributor to this issue: Brian Fenton. © Copyright 1990 by Gernsback Publications. GIZMO is a registered trademark. All rights reserved.

## **Farewell to a Friend**

As we were preparing to go to press with this issue, we received word that **Gizmo's** Senior Writer, Josef Bernard, had passed away suddenly at his home.

When I first joined Gernsback Publications back in 1980, I was an assistant editor who had much to learn. Fortunately, there were willing teachers and good friends here that took the time to show me the way. Among those was Joe, then the technical editor of *Radio-Electronics*, who spent countless hours showing me the fine points of presenting technical material in ways that were both informative and entertaining. His wit and wisdom helped ease a painful process, and helped me learn my lessons well.

Eventually, as these things go, Joe left Gernsback to pursue other opportunities. He ultimately relocated to the Southwest, from where he wrote numerous books and articles, including **Gizmo**.

Joe was a prolific writer who had completed several projects, including a report on the recent Consumer Electronics Show, before he died. That work will continue to appear in **Popular Electronics** over the next few months.

There are times when no matter what you say or write, the words don't really express what you feel. This is one of those times. Joe was more than a colleague; he was a good friend who's seemingly endless good cheer will truly be missed.



Carl Laron  
Editor

## There's Music in the Air

**AKG ACOUSTICS K 1000 REFERENCE LISTENING SYSTEM.** Marketed by: AKG Acoustics, Inc., 77 Selleck Street, Stamford, CT 06902. Price: \$895.

The versatile Peter Ustinov, long before he became Hercule Poirot on television, made a recording about sports-car racing in which he played all the members of several international teams ... and provided most of the sound effects, as well. We don't recall too clearly the outcome of the race, but what does stick with us is his characterization of the German team and the precision with which every part of its operation had to be carried out.

We remember, for example, that the German cars were very precisely balanced—so much so that the drivers had to sit with one leg extended in front of them and the other behind. Their coveralls had no pockets and the drivers could not carry handkerchiefs for fear of upsetting the delicate equilibrium of their racers. A member of the pit crew was delegated to help the drivers blow their noses before they were sealed into their cockpits.

The routine was probably a lot more amusing to listen to than it is to read about, but it came vividly to mind as we were reading the manual for *AKG Acoustic's* superb new *K 1000* stereo headphones—although the company is Austrian, not German. You can tell right away that this is not one of those flaky Japanese manuals—this one is full of elaborate Teutonic phraseology and detail, down to the specifications, which indicate that a serial number is supplied as a standard accessory (our phones were numbered 04323). The manual aside, the phones themselves are of a unique design. (That rigidly structured part of the world that is, nonetheless, responsible for some very unorthodox engineering.)

Headphones are generally categorized as being of the closed-ear or open-ear type. The closed-ear, or circumaural, design uses a flexible seal around the ear-piece to completely enclose the ear and "trap" bass frequencies that would otherwise escape. We find them very uncomfortable to wear and use—they also trap body heat and perspiration, and the "ear weather" gets very warm and uncomfortable in there.

Open-ear phones, the type frequently supplied with personal stereos, sit over the ear and are more-or-less acoustically transparent. They are, for most people, much more comfortable to use, but they do suffer from a lack of low-frequency response.

The engineers at AKG were dissatisfied



CIRCLE 51 ON FREE INFORMATION CARD

with the qualities of both those types of phones. The circumaural phones, they felt, were not only uncomfortable, but were also unfaithful to the material they were intended to reproduce because of resonances that occurred within the space of the ear cushions. Open-ear headphones, while they did not exhibit the standing-wave comb-filter effect to which closed-ear types were prone, were still not good enough, especially, it appears, in that in providing sound to each ear individually, they could not provide the feeling of "spaciousness" they were looking for.

Apparently, what AKG wanted was the headphone equivalent of a set of good studio-monitor speakers, where there was good imaging and a freedom from the "middle-of-the-head" effect that makes it seem as though a performance heard through headphones is taking place entirely within your skull. So, that's what they designed: The K 1000 is really a small set of speakers that is suspended away from the ear. That way, there is no sealed enclosure to promote standing waves; nor is there the ear-to-ear isolation resulting from open- or closed-ear design. Theoretically, the only sound coloration that occurs results from the ridges in the pinna (shell) of the listener's own ear—the same coloration that affects everything else he hears.

The manual—which, incidentally, is in five languages—makes a great deal of binaural hearing and binocular (or stereoscopic) vision; we suspect that the preferred word to be applied to hearing

would be "stereophonic," "binaural" these days referring to a specific stereophonic technique—but seems to make no clear point. We did learn, though, that one of the things you can do with holograms that you can't do with other forms of stereoscopic images is focus on them at different depths. What that has to do with hearing, we don't know; still we found it interesting. We think that the point of the AKG discussion is that with its off-the-ear design there is some sound leakage from one ear's transducer to the other ear, and that this provides a more natural, spacious, listening experience than would be obtained with more conventional phones. It's interesting to note that the claims for a "loudspeaker" process such as Carver's Sonic Holography say that this "cross-talk" tends to confuse the imaging information. Imaging, perhaps, is in the ear of the beholder.

AKG rates headphones—at least where it comes to "spaciousness"—in terms of AOC. Acoustic Openness Coefficient, which is the ratio of a headphone's acoustically transparent and sound-absorbing parts to its sound-reflecting parts. In its research, AKG determined that conventional headphone transducer designs have AOC's of 30% or lower, orthodynamic transducers (where the vibrating diaphragm contains current-carrying printed-circuit traces and is located between two sets of magnets) up to 55%, and electrostatic transducers no better than 45-50%.

(Continued on page 6)



CIRCLE 32 ON FREE INFORMATION CARD

## Ah, Shaddup!

**DESIGN TECH SOUND WEDGE STEREO SILENCER.** Produced by: Design Tech International, Inc., 7401 Fullerton Rd., Springfield, VA 22153. Price: \$29.95.

We like to work to the sound of good music. Not loud music, not "elevator" or "supermarket" music, but good "old-fashioned" music from the classical masters. It seems to get our creative juices flowing (you didn't think that writing GIZMO was something that just *happened*, like sunrises and sunsets, did you?) and helps get the words out of our head and onto paper. Of course, we sometimes get carried away, and when Beethoven starts going at it hot and heavy, things get kind of tumultuous around here.

Sometimes in the middle of one piece or another, the phone rings. If it's a quiet piece of music, it's not too big a problem to answer and ask the caller to hold on for a moment while we turn down the volume so we can talk. The problem becomes more acute if a call comes when we're in the last movement of Ludwig's *Ninth Symphony*, along with Fritz Reiner, the Chicago Symphony Orchestra, and the entire Chicago Symphony Chorus—all 5000 of them and the kettledrummer, or so it seems.

We have often thought about building a

little remote muting switch for our old-fashioned non-remote-controllable amp, but, as with so many other great ideas, have never gotten around to it. Fortunately, *Design Tech International* has. They have a little device called a *Sound Wedge* that goes remote-controlled muting one better. When the phone rings, it *automatically* mutes your sound system by 20 or 25 dB, and when you hang up it returns the volume to its previous level.

The little device, which is wedge-shaped and about the size of a small automobile radar detector, is simple enough to connect. You disconnect the "hot" (+) leads of your sound system's speakers from the amplifier and connect them to screw terminals on the bottom of the *Sound Wedge*. A short length of speaker cable that emerges from the body of the unit is connected to the amp's "hot" output terminals in place of the speaker wires you removed. What that does, in effect, is to route the amp's output through the *Sound Wedge*.

At the rear of the case are two modular phone jacks. Using the seven-foot cable that comes with the unit, you connect one of those jacks to any phone jack that's part of the phone circuit you will pick up on when you expect to need the muting feature. If there's already a phone using that jack, you simply unplug it from the wall and reconnect it to the second, unused jack on the *Wedge*. If there's no phone at that

jack, it makes no difference. As long as the *Sound Wedge* is plugged into a phone jack, nothing has to be plugged into it. That makes finding a place for it more convenient than it might otherwise be, since it has to be connected to both the amp and the phone line. That's about all there is to it. Power for the unit comes from a nine-volt battery, which you supply.

A switch is provided to control the way in which the *Sound Wedge* operates. In the "all" position, muting occurs when any phone on the circuit is picked up. In the "local" position, it takes place only if the phone plugged into the device's second jack is picked up; in that mode picking up another phone on the line will not affect your sound system's operation—a nice feature if you're listening to music in one room and someone in another room wants to make a call. The *Sound Wedge* works, of course, whenever the phone is off the hook, be it to answer a call or place one. Finally, the off position of the mode switch completely disables the unit.

To remind you that your sound system is muted, there's a red LED on the device that flashes when it's in operation. That, presumably, will keep you from going to sleep (or out to dinner) with the phone off the hook and the amp still on. There's also a built-in time delay of several seconds between the time you hang up and the time the sound comes back up.

We do not normally disassemble the devices we review unless it's part of the setup procedure necessary to get them working, or unless there's another good reason for it—it's too much trouble, especially the putting-them-back-together-so-they-still-work part—but since we'd had a similar idea ourselves, we thought we'd take a look inside.

The circuit, after sensing the voltage drop resulting from taking a phone off-hook, opens a relay to break the speaker line. The relay used can, it would appear from its markings, handle about 30 watts of continuous-power per channel. That is probably more than adequate for most purposes, although if you're into loud-and-heavy rock, your music may prove to be more than it can take. We would have preferred breaking the audio line earlier in the circuit where the load was lighter—say in the tape loop—but since our design is still in the paper stage and this one is real, the question is moot. We would also have felt better with a complete silencing of the amp instead of just a non-adjustable reduction in volume, but most of the time what remained going on in the background when we picked up the phone was quiet enough for us to be able to ignore it.

The *Sound Wedge* takes a little getting used to—at first, you still tend to jump up and head for the volume control when the phone rings—but it's easy to become accustomed to it. And when you do, it turns out to be a pretty clever little gadget. ■

## Two-fer TAD

**CODE-A-PHONE MODEL 2880 DUAL PHONE-ANSWERING SYSTEM.** Manufactured by: Code-A-Phone Corporation, P.O. Box 5678, Portland, OR 97228. Price: \$139.95.

On Broadway you can often pick up tickets to shows—even the “hot” ones—at the last minute at bargain prices, tickets that remained unsold or unclaimed almost up to curtain time. Those tickets are sometimes called “two-fer,” from the expression “two for the price of one.” Now Code-A-Phone has a “two-fer” telephone-answering device. Its model 2880 is actually a pair of answering machines in one package, a gimmick that could have real practical value in some situations.

Say, for example, that you use the same phone line for business and for whatever it is you do the rest of the day. You can use one side of this schizoid TAD for business messages and the other for personal ones. Or, at home, you could use one side to take messages for yourself and the other to record them for your spouse. Or one for the adults in the household and one for the kids. Maybe you don't mind mixing your personal and business affairs, or having to listen to someone else's stuff to get to your own, but keeping two lives, or sets of lives, independent can make living them a lot more convenient. Code-A-Phone refers to its system as a “message organizer” which, we guess, is as good a term as any.

The Code-A-Phone 2880 is a dual-microcassette-type device. One of the tapes holds your message or announcement for playback when the machine picks up. That same tape is also used to record one of the two sets of messages. The other cassette is used for recording the second message set and for holding the “private message” that we'll get to in a moment. We ordinarily anticipate with something less than enthusiasm using microcassette TAD's—their fidelity is usually even lower than that of the telephones they serve, and the tapes (particularly in single-cassette machines) seem to do an awful lot of time-wasting shuttling back and forth. The quality of sound from the 2880 was much better than we had expected, and although there was some tape-transport movement going on “behind the scenes” it was minimal and seemed to confine itself to taking place after we had listened to our messages, and not before. That may have been due simply to the way in which we used the machine, but it certainly helped the device to ingratiate itself to us.

The message-organizer feature is easy for a caller to get at, and you are supposed to provide the simple instructions for doing so in your announcement. For one half of the machine, all the caller has to do is wait until he hears the *beep* and then start talking. (You can set the machine to limit message length to one minute or to use “voice control” and record for as long as the caller has something to say. If he pauses for breath for more than seven seconds, however, the machine will think he's

done and disconnect.) To get to the other side of the machine, the caller must push the “0” button on his phone's keypad and *then* wait for the tone. We figured that, even in this advanced era, more businesses have *Touch Tone* phones than do homes, so the side that required the “0” took our business messages and the one that needed no response our personal ones. We had no complaints, except for one young lady who couldn't make up her mind whether her call was business or not.

The presence of messages is indicated by a flashing green light. Once that has caught your eye, you can go over to the machine and see the number of calls on each side displayed on seven-segment red LED's. For some reason, the right-hand display (the one that requires a “0”) has two digits while the other has only one. That might be because the right-hand display also tallies the total number of calls (including hangups with no message left). That seems to contradict the “calls-per-side” count, but—we just rechecked the manual—you get the total first, and the right-hand-tape count after you press stop. There will be a bit more about the manual later.

The 2880 TAD has a few other features you may find useful, in addition to those provided by its two-cassette message system. There's time-and-day stamping, for instance, that can be appended to the end of a message. A “talking clock” feature also gives the same information in the device's digitized voice at the touch of a button.

Besides having the ability to record and store a “memo” without having to use the phone, a capability found on a number of TAD's, the 2880 allows you to record a private message, accessible only by a three-digit private-message code, for playback by those who know it. How you let those people know there's a “secret” message for them without offending other callers is your problem. And, speaking of codes, a three-digit security code is required for remote access to the device. Once you're in, though, you can do just about anything remotely that you can do at the machine, except for setting the clock (you can turn time-and-day stamping on and off though). There's so much, in fact, that Code-A-Phone provides you with a little crib card to carry around with you for reference when you're away from the instruction manual.

Several of the machine's operating modes are set by slide switches on the back of the case. One allows you to choose among “Answer Only” (announcement without taking a message), or the “Voice Control” and 60-second “Message Limit” options. The second switch determines when the TAD will pick up: after one ring, after four, or in Toll Saver mode. In this last, if a call comes in and there are no messages on the tape(s) the machine will



CIRCLE 53 ON FREE INFORMATION CARD

answer after the fourth ring. If there are messages it will answer right after the first. That allows you to call in to check for messages and, if there are none, to hang up before a connection is established.

(The ring count, by the way, is approximate. Since the rings you hear as a caller are not generated at the same facility as the ring signal that sets off the machine, there may be a one-ring difference between what you hear and what actually happens. Just thought you'd like to know.)

Finally, a switch marked CPC on-off allows the TAD to respond to a phone company's Calling Party Control signal, if one is used. If there is a CPC signal, the TAD will stop recording as soon as a caller hangs up; otherwise it waits for seven seconds of silence to elapse before disconnecting and shutting down. Also, with the switch in the on position the announcement tape stops when you pick up a phone; if it's off the tape continues to play, and then the machine begins recording even if you're "live."

The instruction manual, however, needs work. All the information is there, but it is presented in such an offhand way that it is easy to miss—or misunderstand—it the first time through. For instance, the business about having a caller press "0" to access the second tape seems to be mentioned only once, in a section about what a message should sound like. Good thing we knew in advance there was supposed to be a command to do that!

Also, our usual telephone-answering machine does not have a time-and-day stamping feature. That doesn't bother us; we generally know approximately when a call came in. However, not being used to it, we forgot to enable the function on the 2880 and, indeed, forgot that the TAD could even do that trick. It wasn't until we sat down to write this that we remembered and went searching through the manual for instructions on how to turn on time-and-day stamping. We found it in a couple of paragraphs at the beginning of the "Setting the Clock" section. Why Code-A-Phone would think you would be ready to turn on the feature *before* the clock was set we don't understand, and maybe that's why we managed to overlook it until we really started digging.

Finally, the machine comes with little strips of paper on which you can write the names of the persons or businesses associated with each of the message tapes. For some reason it is supplied with the names "Kim" and "Dave" already in place. We were, therefore, confused when the manual referred to something labeled "Ann Record." Who was this Ann? One of Kim and Dave's kids? It turns out that "Ann" is short for "Announce." Oh.

The Code-A-Phone 2880 turned out to be a very useful device, and after a couple of initial misunderstandings, we got along pretty well with both of it. ■

## REMOTE CONTROL

(Continued from page 1)

sequence, called up by pressing just two keys. "seq" and "1," turned on the video projector, turned on the VCR, and then set its tuner to channel 7. A similar sequence, which we called "NEWS," got us the afternoon news on another channel. You don't know what a convenience that can be until you've had to juggle and aim two remotes at once to do the job! The only thing we had to remember was to keep the CP8 pointed at the equipment in question until the entire command sequence had been transmitted.

If your system requires a time delay between the turning on of one device and the next, provision is made for programming that into the sequence. And, should you wish to revise your programming, the CP8 has an editing feature that lets you step through a sequence and modify it.

Now, if you have the clock, and the ability to store and send sequences of commands—both which the CP8 Turbo has—you can combine the two to do even more. You can instruct the unit to send a sequence of commands at a specified time. In other words, you can have the remote operate your equipment even when you're not around. You know what a convenience that is for unattended VCR recording; now you can have it for the rest of your remote-controlled equipment, as well. For instance, you can use this scheduling capability to set up unattended audio recording sessions if your receiver and cassette deck are equipped for remote control (some decks can come on in the record mode even if they're not that sophisticated; check yours). Or, you could have the evening news come on as you walked in the door, so you could proceed directly to the cocktail hour without being troubled by such trivial matters as turning on the radio or TV. If you're going to be away for a couple of days, you can have the remote turn your gear on and off at specific times, creating a lot more believable illusion of someone's being home than simply turning a lamp on and off. Just remember to leave the remote pointed at the equipment it's to control before you go out.

And, speaking of VCR's ... as we were a paragraph or so ago ... the CP8 Turbo knows another trick. It can provide a VCR function known as "quick timer recording" (QTR), wherein you can instruct your VCR to begin recording from a certain source at a certain time with the press of a button or two. Many VCR's already include that feature, but some do not.

Applying a bit of hindsight, we're a little amazed that no one thought of using a programmable remote's programmability the way Memtech has until so late in the game. We're happy, though, that Memtech finally has (and are sure that others will now follow). ■

## HEADPHONES

(Continued from page 3)

The solution finally reached by AKG achieves an AOC of 75%, largely through the use of what it calls a "ventilated linear dynamic magnet system," which uses an array of small NdFe (neodymium-iron) magnets perpendicular to the vibrating diaphragm. The diaphragm, says AKG, is a multilayered material that contains a type of varnish used by 16th- and 17th-century violin makers; the varnish is intended to suppress "partial vibrations." Frequency response, from a graph included in the user's manual, appears to be about 40–22,000 Hz.  $\pm 3$  dB. The transducers are protected by an open grid rather like stiff metal window screening. That, we suppose, is intended to prevent high-frequency losses by absorption.

AKG obviously put a lot of engineering into these phones. A dual-suspension headband is used to support the transducers: A leather band rests on your head, and a pair of stiff orange-colored wires above it bear much of the load. Even the transducer housing was the result of much experimentation. Die-cast titanium was discarded because it proved impossible to make the walls as thin as was desired, and beryllium was deemed unsuitable because of its toxicity. The final design uses a plastic compound having a fiber content of 50%. The entire "apparatus," by the way, weighs 9½ ounces, not counting the 17 feet or so of oxygen-free wire cord. The phones do not plug into your amplifier's (you're not going to use them with a *receiver*, are you?) headphone jack—their cable has to be connected to a set of speaker terminals. AKG uses that technique because, it says, there may not be enough drive for these phones from most headphone outputs. The cable, by the way, is in two sections, joined by a studio-type XLR connector; this allows the phones to be disconnected conveniently and stored in the wooden case in which they come.

Wearing the K 1000 headset feels at first a little like having your head put into those metal clamps used during brain surgery to immobilize it while the surgeon pokes around, and you have to be leery of shaking your head too violently because of the "outrigger" design of the transducers—which, by the way, are attached by hinges so that their angle can be changed to suit your preferences—but the listening experience might very well be worth it.

The quality of the sound delivered by the K 1000 headphones is exceptionally transparent, perhaps the best we have ever heard from a set of phones. In fact, listening to the AKG K 1000 really was a lot like listening to a set of studio monitor speakers. Of course, for what these phones cost, you could *buy* a set of studio monitor speakers. But you wouldn't be able to wear them on your head. ■



For more information on any product in this section, circle the appropriate number on the Free Information Card.

# ELECTRONICS WISH LIST

## CD Changer with Turntable

Getting rid of your old sound system in favor of a new one with a CD changer? Wondering what to do with all your old black vinyl LP's and can't afford a laser turntable? Fret no more. As part of its Classic series, *Fisher* (21350 Lassen Street, Chatsworth, CA 91311-2329) is offering a CD changer with a turntable built in. The CD changer in the innovative *DAC 145* can accept five disks—3- or 5-inch types—in a carousel-style tray. The player uses an 18-bit digital filter with 8× oversampling and dual 16-bit high-speed D-to-A converters. Other features include a 32-program memory, intro scan, skip, and continuous and random play. The 12-inch turntable atop the unit incorporates a Fisher-supplied cartridge. Also included is a 30-function remote control. Price: \$349.95.

CIRCLE 54 ON FREE INFORMATION CARD

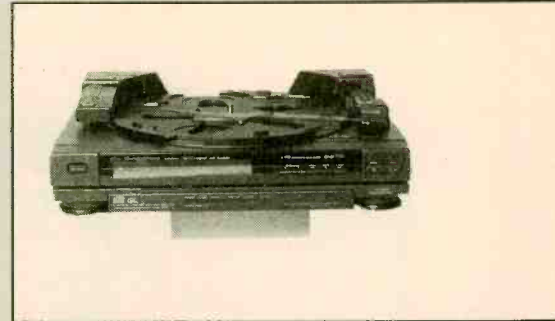

Fisher CD Changer

## Transportable Cellular Phone

The *Nokia-Mobira* (2300 Tall Pines Drive, Suite 100, Largo, FL 34641) *LX-11* cellular phone offers several possibilities for users who may not require permanent installation. Its handset, for example, can be connected directly to the transceiver, or it can be mounted directly on the dash or console of a vehicle with the transceiver safely locked away in the trunk or beneath the seat or dash. With an optional battery pack, it can be carried and used anywhere. The transceiver measures just 1.3 × 4.6 × 7.9 inches and together with the handset weighs just 2.3 pounds. The three-watt unit (switchable to 0.6-watt for transportable operation) features a dual-NAM system, which allows independent registration on two different phone systems, a 30-number memory, and separate security and lock codes. Options for the system include a hands-free noise-canceling mike system, a car-to-car carry-bag kit with antenna and cigarette-lighter-receptacle adapter, horn alert, and data interface. Price: \$620.

CIRCLE 55 ON FREE INFORMATION CARD

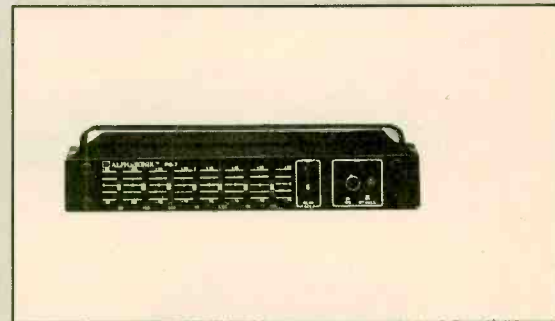

Alphasonik Equalizer

## Autosound Equalizer

The *PQ-7* equalizer from *Alphasonik* (701 Heinz Ave., Berkeley, CA 94710) is a seven-band unit for autosound applications. It can provide up to 18 dB of boost or cut in each band, and is equipped with both low-level RCA-jack inputs and balanced high-level inputs that can accept both floating- and common-ground sources. The equalizer incorporates a switching power supply that separates chassis ground from audio ground, resulting in less noise and a greater dynamic range. Frequency response is 10 Hz to 100 kHz, and the seven EQ bands are centered on frequencies of 50, 150, 350, 1000, 2500, 6000, and 16,000 Hz. A bypass switch on the front of the unit allows audio to pass through unaffected by processing. Price: \$150.

CIRCLE 56 ON FREE INFORMATION CARD



Nokia-Mobira Cellular Phone

## Silencer

What do you do if you're barreling down Route 66 with the radio blasting away ... and your cellular phone rings? With *Radio Shack's* (One Tandy Center, Fort Worth, TX 76102) *Automatic Car Radio Silencer (17-801)* you don't have to do anything; it's done for you. The device, which you connect to the vehicle's electrical system, senses the slight voltage drop that occurs when your cellular phone (or CB radio, for that matter) goes on the air—when you take the phone off the hook to answer, in other words. The car radio's power terminals are connected to the silencer during installation and, when the voltage drop is sensed, the automatic switch removes power from it, thus—of course—silencing it and permitting you to converse in peace and quiet. A sensitivity control lets you adjust the device's switching threshold. Be aware, though, that removing the power from your car radio may cause it to lose the contents of whatever memory it has. What a turnoff! Price: \$34.95.

CIRCLE 57 ON FREE INFORMATION CARD



Radio Shack Radio Silencer

# ELECTRONICS WISH LIST

For more information on any product in this section, circle the appropriate number on the Free Information Card.

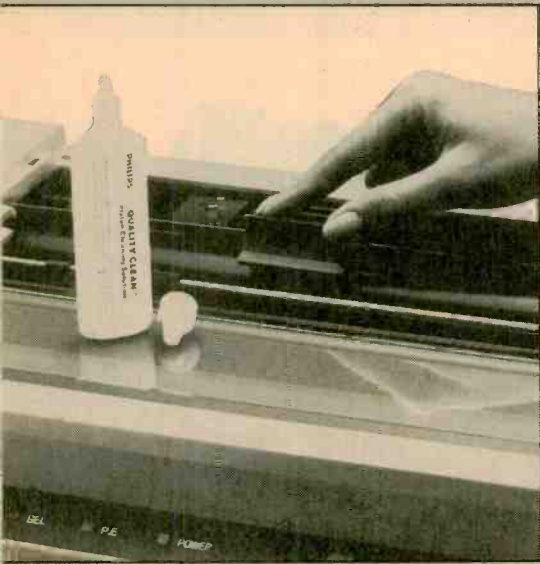

Philips Cleanups

## Computer Cleanups

The operation of the mechanical components of a computer system—printers and keyboards, for instance—can be detrimentally affected by dirt. Not only that but, in the case of printers, ink and paper dust that accumulate on printheads can be transferred to the paper passing through them and affect the appearance of the final copy. *Philips Consumer Electronics* (One Philips Drive, P.O. Box 14810, Knoxville, TN 37914-1810) has several cleaning products that can keep those problems from occurring. Its *SBM10003A01 Dot Matrix and Impact Printer Cleaning System* uses a blend of micro-encapsulated solvents and lubricants to dissolve old ink on printheads and relubricate their moving parts. Included in the kit are a one-ounce bottle of cleaning solution, two platen cleaning handles, and a sheet of printhead-cleaning materials. For keyboards, the *SBM1002A01 Keyboard and Plastic Cleaning Kit* contains a four-ounce bottle of cleaning solution that removes both organic and inorganic oils, a dozen foam-tipped swabs, and 25 fabric wipes. Price: (Either kit) \$19.95.

CIRCLE 58 ON FREE INFORMATION CARD



Ricoh Fax Adapter

## Computer Fax Adapter

If you're in the habit of leaving your computer on all day and all night, you may want to have it double as a fax system. The *DX-1* is an outboard. Group 3 (the most common kind) fax adapter from *Ricoh* (5 Dedrick Place, West Caldwell, NJ 07006) that can be used with almost any computer having an RS-232 serial port; it also permits a local fax machine to serve as a printer and scanner for that computer. The unit has the ability to convert text files directly to fax format for transmission, eliminating in many instances the need for the intermediate step of printing out hard copy. The software available for the *DX-1* (there are two packages for MS-DOS—with or without Windows—and one for the Macintosh) supports many popular graphics and desktop-publishing packages, and a file-conversion utility allows virtually any graphic produced by a personal computer to be transmitted. The device can also use the computer's memory for other fax purposes, including store-and-forward broadcasting and storage of distribution lists, and the computer can be used to control repeated and automatic polling of remote fax machines. Price: \$799 (hardware), \$275 (software).

CIRCLE 59 ON FREE INFORMATION CARD

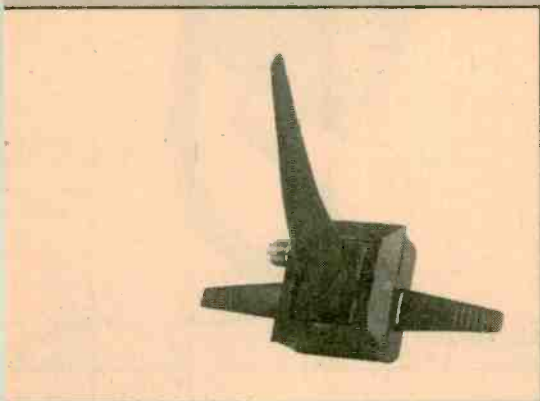

ORA Cellular Antenna

## "Shark-Fin" Antenna

The unusual "shark-fin" design of *ORA Electronics'* (9410 Owensmouth Avenue, Chatsworth, CA 91311) model *CMX893* mobile-cellular-phone antenna is said to prevent annoying wind noise and its accompanying "whistle." The antenna, intended for permanent rear-windshield mounting, is designed to withstand rough weather extremes and even automatic car washes. Other features include stabilizer-fin-like ground plane radials and a through-the-glass feed design that eliminates signal degradation caused by heater wires or other metallic windshield elements. Price: \$99.

CIRCLE 60 ON FREE INFORMATION CARD



Panasonic Surround System

## Self-Contained Surround System

Until now, says a *Panasonic* (One Panasonic Way, Secaucus, NJ 07094) spokesman, most surround-sound systems needed special decoders, extensive wiring, and at least two new additional rear speakers. *Panasonic's SY-DS1* system, though, is a completely self-contained surround system with a built-in amplifier, two speakers, and a digital sound processor. The unit can be connected to any video source that has audio-output jacks, even an audio receiver if it is part of a video system. The *SY-DS1*—which is not, it should be noted, equipped to decode Dolby Surround material—is placed on top of, or near, the television screen, in front of the viewer, yet is claimed to provide sound throughout the entire listening area. The intensity of the ambience effect can be adjusted with regard to level and the reverberation time introduced by the unit's digital circuitry. Price: \$250.

CIRCLE 61 ON FREE INFORMATION CARD

For more information on any product in this section, circle the appropriate number on the Free Information Card.

# ELECTRONICS WISH LIST

## No-Paper Printing Calculator

For people who require the "adding-machine" logic and office features of conventional desktop printer display calculators, but who don't require a printed record, *Texas Instruments'* (P.O. Box 53, Lubbock, TX 79408) *TI-5128 Paper-Free Printer* is a calculator that offers printed-output convenience without the paper. The calculator has a 4-line, 12-digit LCD display that can show decimal, comma, line item, and audit-trail symbols. The display stores 99 lines of numbers and can be scrolled forward or backward to review previous entries or calculations. Individual entries can be changed right on the display, with the result that the total is automatically recalculated, eliminating the need to re-perform an entire calculation for the sake of changing one entry. That saves time in correcting errors and is also useful in performing "what-if" comparisons. The device features a selectable decimal mode, gross-profit-margin key, and automatic constant. Power is supplied by three "AA" batteries, and an AC adapter is available separately. Price: \$95.00.

CIRCLE 62 ON FREE INFORMATION CARD

## The Walls Have Eyes

For the custom installer of audio equipment whose client doesn't want the walls festooned with remote-control infrared repeater plates, *Niles Audio* (12331 SW 130th St., Miami, FL 33186) will begin building infrared sensors into its *Blue-Print-series* in-wall speakers. In the design, a fiber-optic rod is used as a light pipe to channel the infrared signal from the front of the speaker to the back, where the sensor is located. The Niles technology is said to overcome the problems usually associated with such systems, where the speaker grille blocks or absorbs so much of the infrared signal that there is not enough left to be effective. Price: From \$320.

CIRCLE 63 ON FREE INFORMATION CARD

## Portable Stereo with Removable CD Player

In addition to an AM/FM radio, dual-tape cassette deck, and two-way speakers, *Soundesign's* (Harborside Financial Center, 400 Plaza Two, Jersey City, NJ 07311) *Model 4979* portable stereo system comes with a removable CD player. The system, which can operate from AC or battery power, measures  $22\frac{3}{8} \times 9\frac{1}{16} \times 9\frac{3}{16}$  inches and has a fold-away carrying handle for convenient transport. When personal portability is desired—on walks around campus, hiking through the mountains, or on trips to the corner store—the CD player can be removed and used all by itself through headphones. It contains its own rechargeable battery. When mounted back on the stereo system, the player can be listened to through that unit's speakers if desired, or through headphones while someone else listens to another part of the system. Price: \$299.95.

CIRCLE 64 ON FREE INFORMATION CARD

## Big Little TV Set

Campers, picnickers, and RV owners will find most of the conveniences of home in the *RCA* (600 N. Sherman Dr., Indianapolis, IN 46201-1976) nine-inch *E09435* portable TV. The AC/DC set, which comes with a DC cord that plugs into a vehicle's cigarette-lighter receptacle, has 147-channel capability and features automatic programming with a full on-screen display. Of course, there's a 24-button remote control, and a sun shield is included as well. All on-set controls, as well as the speaker and remote sensor, are placed at the front of the set to enhance built-in capability, or just make it easier to get at them if the set is placed on a crowded shelf or counter. Price: \$269.

CIRCLE 65 ON FREE INFORMATION CARD



Texas Instruments Calculator



Soundesign Portable Stereo



RCA TV

# ELECTRONICS WISH LIST

For more information on any product in this section, circle the appropriate number on the Free Information Card.



Technidyne Portable Stereo

## "Four-Wheel Drive"

What could turn out to be the world's biggest personal portable stereo system is the TD-10000 from Technidyne (1000 Stanford Ave., Los Angeles, CA 90021). The TD-10000 is a jumbo double-cassette system that includes a 10-band equalizer, sensor-driven theft alarm, and power-readout display. There's also a four-band radio, echo sing-along, and a pair of "earth-shaking" ten-inch woofers. The amplifier provides 750 watts of PMPO—a boombox term that has little relevance to the real world—output. To top—or bottom, as the case may be—things off, there are four wheels built in for extra mobility. Price: \$499.

CIRCLE 66 ON FREE INFORMATION CARD

## Energized Indoor AM/FM Antenna

"The finest energized AM/FM antenna you can own" may be the ARC (Amplified Receiving Component) indoor antenna from Parsec (400 West Ninth Street, Wilmington, DE 19801). Housed in a black 16¼ × 3¼ × 9¼-inch box, the system offers up to 43 dB of gain (depending on mode) in three different FM modes: broadband omnidirectional, tuned omnidirectional, and tuned directional, using amplifier circuitry combining both GaAsFET and JFET stages. As an AM antenna, 15 dB of gain is available from the unit's built-in loop. The FM output uses a 75-ohm "F"-type connector, and the AM output accepts 300-ohm twin-lead. Front-panel controls include a bandwidth switch, a knob for gain, and a frequency-peaking circuit. The direction of pickup of the AM loop can also be controlled by a knob on the front panel. Price: \$149.95.

CIRCLE 67 ON FREE INFORMATION CARD

## Single-Bit CD Player

Yamaha's (6722 Orangethorpe Avenue, Buena Park, CA 90620) top entry in the single-bit CD-player category is its model CDX-1030. The player uses a pulse-width-modulation scheme it calls "S-bit" with the equivalent of 768-times oversampling to achieve a high level of linearity. A MASH (that's strange shorthand for Multi-Stage Noise Shaping) digital-filter system is employed to further purify the signal by translating quantization noise products far above the audio range where they can be removed easily. The CDX-1030 uses two DAC's per channel—one 180° out of phase with the other—for common-mode rejection of external noise. The player, which can play both five- and three-inch discs, includes a "Program File" feature that can remember and save the programming instructions for any disc. At an average of ten selections per disc, information for 100 discs can be stored. Output is via conventional RCA jacks for analog audio, or through optical and coaxial connectors for digital interfaces. Price: \$699.

CIRCLE 68 ON FREE INFORMATION CARD

## Multi-Play Cassette Deck

Hot on the heels of multi-play CD players comes a multi-play cassette deck from Pioneer (2265 E. 220th St., Box 1720, Long Beach, CA 90801-1720) that can accept six C-90 cassettes for a total playing—or recording—time of nine hours. The CT-M6R, which incorporates Dolby B and C noise reduction as well as Dolby HX-Pro bias control can, when used with the appropriate Pioneer CD player, synchronize its recording with the CD-player's programming. A "relay recording" feature permits users to record a full six-cassettes'-worth of uninterrupted material with a lapse of no more than two seconds between tapes, and a random-play function can select and play tracks from across as many as six cassettes. A "six-to-six copying" feature can record six CD's to six individual cassettes, and "programmed copy" allows tracks from six discs to be dubbed onto tape in the order in which they have been programmed. The deck can also rewind all six cassettes one after the other without human intervention. Price: \$450.

CIRCLE 69 ON FREE INFORMATION CARD

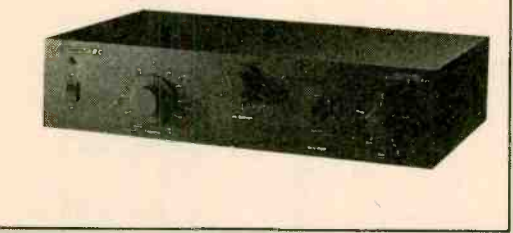

Parsec Antenna



Yamaha CD Player

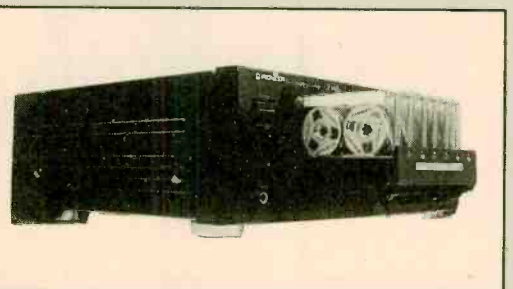

Pioneer Cassette Changer

# THE **FIRST** ELECTRIC MOTOR

*Follow Michael Faraday's  
Footsteps when you  
recreate an experiment  
that made history in  
electronics' early days.*

BY DON H. ANDERSON

**T**his experiment is based on original work by Michael Faraday described in a booklet published in England by the Royal Institution (see the boxed text). The booklet includes excerpts from his personal diaries in addition to an excellent account of his extensive scientific accomplishments.

In order to exactly duplicate his work it would require at least a cup full of mercury. We will use a substitute because of mercury's toxic qualities. Most of the early scientists used mercury freely and in large quantities for their experiments because of its good electrical conductivity in addition to its fluidity. As with many substances used by the early scientists, the extent of its toxicity was not recognized at the time. As a consequence, many experimenters with mercury, arsenic, and radium, to mention only a few, were readily exposed to such dangerous substances as they had not received proper medical scrutiny. It would be many years before studies would be made about the hazards of touching and inhaling dust and fumes produced during the handling of these and many other materials previously accepted as safe.

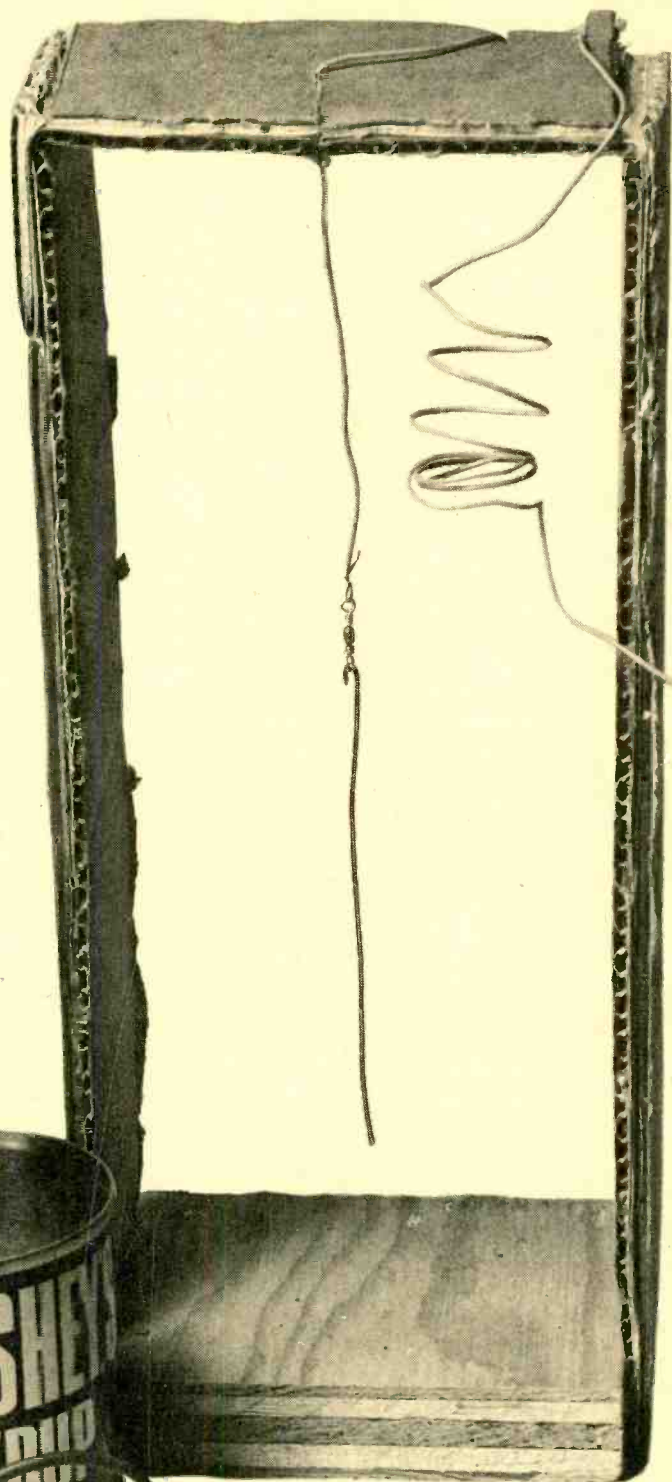

*This device is loosely modeled after the first electric motor. Its magnet (at left) is held in plaster of paris within a can, the 18-gauge copper wire "rotor" hangs from a brass swivel. The battery connects between the two free leads.*

**In His Words.** As Faraday describes his work in his journals, we can see the series of events that led him to his crucial experiments. The thoughts and experiments leading up to the first motor were reported in the Royal Institution booklet as follows:

"In 1820 the Danish scientist Oersted made his famous discovery of the link between electricity and magnetism: an electric current passed through a wire near a magnetic needle deflected the magnet. The importance of this result was immediately recognized by the scientists of the day and Oersted's experiment was rapidly followed by others, notably by Ampere and Arago in France and Davy in England. Faraday helped Davy in this work, and was moved to make a thorough study of all that was done in this field, repeating all the experiments himself and publishing a comprehensive 'Historical Sketch of Electro-Magnetism.' In September 1821 he examined carefully the action of a current in a wire on a small magnet in different positions relative to the wire and concluded that the effect was such as to urge a magnetic pole around the wire or conversely the wire around a magnet pole ... He fixed a magnet upright in a dish of mercury with one pole projecting above the surface. A wire was so set that one end, supported by a small cork, just dipped in the mercury while the other end made contact with a small metal cup vertically above the magnetic pole. A current was passed through the wire by way of the cup and the mercury, and the wire was found, as expected, to rotate around the magnet as long as the current was maintained ... In a similar arrangement the wire was fixed and the magnet was able to rotate around the wire. This was the first electric motor ... On Christmas Day of that year he succeeded in making a wire carrying a current rotate under the



*This metal can is filled with a sodium chloride solution. The can is then positioned so that the "rotor" can freely turn within it.*

influence of the earth's magnetism alone."

**The Experiment.** I tried several different magnets in efforts to duplicate his basic work. The magnet I finally selected is sometimes referred to as a "cow magnet." They are available from

#### THE MAGNET

Cow magnets, order No. H31,101, are available in sets of two from Edmund Scientific Co., 101 E. Gloucester Pike, Barrington, NJ 08007-1380, Tel. 609-573-6250. Contact them directly for pricing, shipping, or other information.

Edmund Scientific Co. (see the boxed text for more information).

The can shown in the photo is 2 inches in diameter and about 3 inches high. I used plaster of paris to hold the magnet in position. The magnet was greased before setting it in the plaster so that I did not have to leave it in the can. Use care when removing the magnet and the plaster cast can be used over and over when you want to show someone how the motor works.

The 18-gauge copper-wire rotor is suspended from a small brass swivel (from fishing tackle) so it will rotate freely. That in turn is attached to a wire lead held in a notch at the top of the mount, which is made of cardboard. A small

#### THE BOOKLET

The Booklet referred to in this article is "Michael Faraday of the Royal Institution" written by Ronald King. Information on it and other booklets available can be obtained by writing to: The Royal Institution of Great Britain, 21 Albermarle Street, London, England W1X4BS

block of wood is used for the base and it supports the upright sides, also made of corrugated cardboard. The corrugated cardboard should be doubled by gluing two layers together with their corrugations at right angles for added stiffness.

For the liquid conductor, a saturated solution of sodium chloride was tried, but it seemed to be somewhat corrosive. The solution I recommend is a saturated solution of magnesium sulfate or epsom salts. By making the copper wire negative there also seems to be less corrosion.

The voltage supplied by the battery (connected between the two free leads shown in the photo) can range from 6 to 20 volts. At 20 volts the current is about 0.1 amperes. Too low or too high a voltage causes the wire to short out on either the magnet or the tin can, respectively. Placing a strip of masking tape around the top of the magnet and around the inside of the top of the tin can eliminated the problem. ■

#### MATERIALS LIST FOR THE ELECTRIC MOTOR EXPERIMENT

- Cow magnet
- Brass swivel
- Can
- Plaster
- Cardboard
- Glue
- 18-gauge wire
- Block of wood
- Epsom salts
- Water
- Battery

# TUNE IN THE ZODIAC RADIO



Read about the  
counter-culture  
heroes of our age  
and tune-in  
to their  
clandestine  
broadcasts.

BY ANDREW YODER

## RADIO PIRATES

**T**he shortwave radio crackles, "Broadcasting from one mile north of nowhere, this is the Voice of the Voyager." The program continues; a few rock songs are interspersed with low-key banter and frequent laughter from announcers R.F. Wavelength and A.F. Gain. Attracted to the station's curious format, a listener pages through several shortwave guides in an effort to identify the station, but finds nothing. Technically, the "Voice of the Voyager" does not exist.

Many shortwave listeners first encountered pirate radio around 1978 in scenarios like this one. The Voice of the Voyager has since disappeared, but the pirate-radio scene is still growing despite many set-backs. New listeners these days are discovering underground broadcasting from the likes of RNI, Radio Clandestine, WJDI, and Hope Radio.

Stations have changed over the years, and the hobby has become more complicated, yet it's really still the

"same game." When the Voyager first took to the air on Christmas Day 1977, the station shared piracy status with only one other station—an AM pirate from New York City. Presently, at least 20 stations operate semi-regularly. Programming ranges from Neo-Nazi commentaries to discussions on building antennas. This strongly contrasted with the standard music/talk formats that dominated the scene in the 1970's.

**The Media Hype.** Pirate-radio stations attract interest because of their ingenuity, program content, and "underdog" status. Radio New York International (RNI) prospered with a combination of these elements. Approximately 20 veterans of pirate stations from the New York City area compiled their resources, bought a ship and began broadcasting from international waters off the coast of Long Island. After only a few days, the station was closed down by FCC officials. Still, RNI generated enough media attention to be named the "best station of 1987" by *Rolling Stone* magazine.

RNI's "marketable piracy" greatly influenced others in the pop-culture mass media. At least two highly-rated pop/rock legal stations from Los Angeles and Philadelphia are presently using "pirate radio" as a format. Both pretend they are actually unlicensed, alluding to offshore or mobile transmitters and throwing the "pirate radio" slogan around as though it were a license to be fashionable. The "hipper than thou" executives at MTV have even brought pirates to television—first, by featuring the RNI crew as video jockeys for an afternoon, then by creating the "Pirate Television" program. All the media attention, which seems to have spurred sudden public acceptance of airwave rule-breaking, may promote more hobby pirates in the 1990's.

**The Why's and How's.** The pleasure of operating a personal radio broadcast and receiving fan mail from across the country brings many pirates into the hobby. As the media exploits the scene, operators suddenly become heroes instead of common criminals. With such "advantages," one might wonder why everyone from "Jimmy, the kid next door" to "Bob, the corner-grocery owner" doesn't start up a free-radio station.

The truth is it's not that simple. Unlicensed radio broadcasting is illegal, and the Federal Communications Commission (FCC) enforces the rules and regulations. Under such regulations, "if convicted of operating an unlicensed radio station, the operator faces a maximum penalty of one year imprisonment, a fine of up to \$10,000 and a possible forfeiture of their radio equipment to the U.S. Government." Even though offenders have never been punished to the legal maximum (most are fined \$750 to \$2,000), many pirates take every precaution.

"I pirated because I love all aspects of radio," says the Radio Animal, former owner/operator of WKND. "WKND operated as an outlet for so-called 'underground' programs, because we believe we had a right to use the airwaves, to experiment with radio technology, and because it was great to hear from listeners."

FCC agents closed WKND (Weekend Radio) in Pittsburgh, PA in February 1990. It was the end of one of the most professional, highest-quality pirate stations. Commencing on Halloween 1988, the pirate featured a slick, but curious product with music ranging from disco and rap, to punk and heavy metal.

Technically, WKND was a brilliant example of junk-box ingenuity. The "homebrew" 1620-kHz transmitter, built from surplus and junk parts, was modified with separate equalizers for each radio-frequency range. The 6240-kHz shortwave transmitter was simply an ancient Heath CW rig that was modified for AM transmission with a variety of surplus and "cannibalized" parts. The rig was purchased for only \$10. On its first broadcast, WKND used an antenna built from 290 feet of aluminum magnet wire (from a television degaussing coil), suspended in the air by 15 helium balloons! The station was heard as far away as Wisconsin with only 25 watts on 1620 kHz. The shortwave transmitter was heard across the country. "Pirates have to be more scrappy and determined, and I suppose that's what makes free radio the special thing that it is," says Radio Animal.

When the FCC agents finally caught up with WKND, Radio Animal allowed them into the basement of his home and gave a full tour of the studio. After the tour, the three sat down and discussed the programming and history of WKND. Then Radio Animal even issued the agents station-verification (QSL) cards! Although he would have been

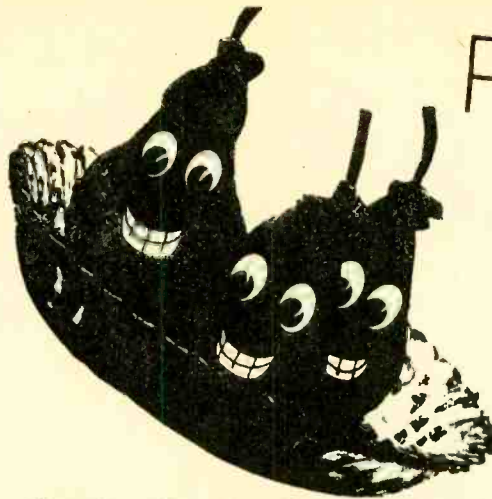

# RADIO USA



## \$\$\$\$\$\$\$\$\$\$\$\$\$\$\$\$

*Radio USA has been widely heard since 1983 with a strange assortment of punk music, skits, and commentaries.*

fined about \$1,000, he was requested to pay only \$500 due to his cooperation. The 1620- and 6240-kHz transmitters were taken by the agents to cover the other \$500.

**Tuning In.** Although unlicensed broadcasting is illegal, listening to and reporting pirates is entirely within the law. For those living in the East or Midwest, logging an occasional pirate is simple. Only a decent general-coverage shortwave receiver and some patience is required. Western listeners may have more difficulty, since Zodiac Radio is presently the only station regularly active in that region.

Wherever the location, prime broad-

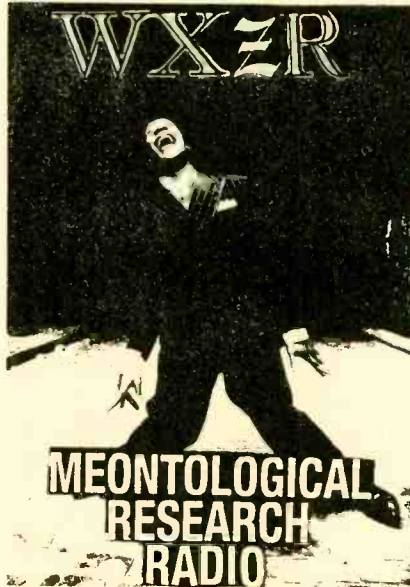

*Radio WXZR's odd mix of industrial music and skits has been heard across much of North America.*

**TABLE 1—COMMON PIRATE FREQUENCY RANGES**

1610-1630 kHz
6200-6325 kHz
6800-7000 kHz
7355-7530 kHz
15010-15100 kHz

**TABLE 2—ACTIVE STATIONS AND THEIR ADDRESSES**

Address	Station
C	East-Coast Pirate Radio
B	Hope Radio
A	KNBS
B	RFM
A	Radio Garbanzo
B	Radio Mexico
A	Radio USA
B	Samurai Radio
A	Secret Mountain Laboratory
C	Secret Society Radio
A	Voice of Laryngitis
B	Voice of Monotony
B	Voice of Stench
	WBRI
	WENJ
	WHBH
D	WJDI
A	WLAR
B	WXZR
A	Zodiac Radio

(A) P.O. Box 452, Wellsville, NY 14895  
 (B) P.O. Box 628, Slanesville, WV 25444  
 (C) P.O. Box 6527, Baltimore, MD 21219  
 (D) P.O. Box 142, Cottekill, NY 12419

casting times for pirates are weekends and holidays throughout the afternoon and evening hours. Typically, pirates operate in specific frequency bands, especially 7405–7425 kHz (see Table 1).

*(Continued on page 102)*



# THE DIGITAL ELECTRONICS COURSE

## USING FLIP-FLOPS WITH COUNTERS

Getting counters to go past nine is easy with a flip-flop.

BY ROBERT A. YOUNG

Thus far we've looked at flip-flops as one of the basic building blocks that are used to form more complex systems. The flip-flop can be incorporated into many circuit designs to perform a wide variety of functions. What we will attempt to do in this exercise is to provide you with additional experience in the use of the J-K flip-flop. You'll also be exposed to one method of obtaining a count greater than 10 using a single 7490 decade counter.

**1-1/2-Digit Counter.** The basic circuit used in this exercise is the same one used in the previous exercise, but with a few additions—half of a 7476 dual J-K flip-flop (U4), a 7490 decade counter, and an additional 7-segment display (DISP2). Figure 1 is a schematic diagram of a 1½-digit counter, which will be the center of our discussion.

The circuit gets its name from its operation. In that circuit, DISP1 is configured in the normal manner—that is, all segments of the display are connected in the circuit. The half digit refers to DISP2, which, with only the "e" and "f" terminals connected, can only display a "1." Thus it is called a "half-digit" display

\*Our gratitude is extended to the EIA/CEG for the creation of this course, especially to the consultants who brought it to fruition: Dr. William Mast, Appalachian State University; Mr. Joseph Sloop, Surry Community College; Dr. Elmer Poe, Eastern Kentucky University.

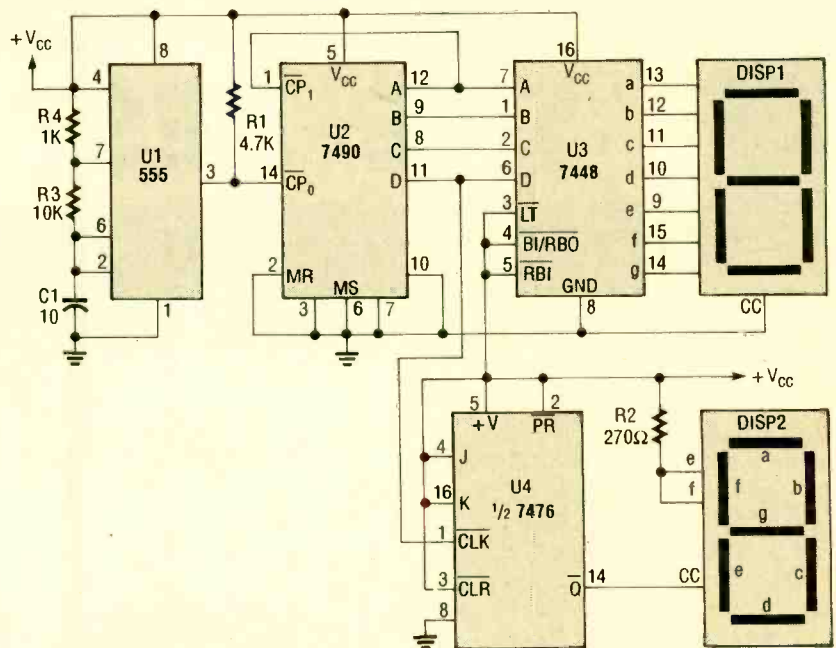

Fig. 1. This simple counter can count up to 19 in decimal with the help of the 7476 flip flop, which turns on the most-significant digit, causing the number 1 to appear in DISP2.

since not all of the available segments are utilized.

Note that the 7476 flip-flop is configured as a toggle device—that is, the  $\bar{Q}$  and  $Q$  outputs (which are always the complements of each other) will toggle or change states with each negative-going transition of the input-clock signal.

The clocking signal for the 7476 flip-

flop is derived from the MSB (most-significant bit) output of the 7490 decade counter. Whenever the output of the counter is decimal 9 (1001), the next clock pulse sets the counter output to decimal 0 (0000), at which point the MSB output of the counter changes from high to low. That transition from a high to a low logic level provides the

(Continued on page 97)

*The best efforts of the consumer-electronics industry were on display at the Summer Consumer Electronics Show; for those of you who could not make it, we present the best of the best.*

BY JOSEF BERNARD

There are two Consumer Electronics Shows held each year, one in the summer and one in the winter. The winter show takes place in Las Vegas, Nevada, and the summer show in Chicago. Since most of an editor's show time is spent indoors, perambulating up and down the aisles of huge convention centers, it's not always easy for him to tell by the weather or the landmarks in which city he happens to be at the time. Fortunately, the Chicago show has at least one feature that helps to differentiate it from the Las Vegas one—a section called "Innovations."

Innovations is a showcase of outstanding pieces of consumer electronics design and engineering whose contents are selected by a committee of ten experts in the field, including **Popular Electronics'** Len Feldman. This year there were 164 products displayed. Some of them were obviously there for esthetic reasons alone, others by virtue of their engineering. Since

most products appeared both in the Innovations exhibition and at the exhibitors' booths on the floor, we won't bother to indicate where we noted each one, unless it's to say something like, "Why *this* wasn't included in Innovations we don't know..." We can't say we saw very much that was astonishingly new and different but there were a few... well... "innovations."

Incidentally, you can also tell at which show you are by the fact that the show food is slightly more edible in Chicago, but that's another story. Well, we did it all—the main show, the press conferences, the by-invitation-only hotel suites, the turkey sandwiches—and this is what we came back with.

**Video.** Most of the CES video scene this summer centered around 8mm products. Just about everybody, including Sony, Canon, and Sanyo/Fisher, showed new 8mm camcorders. Among Sony's new entries is the CCD

## THE BEST NEW



TR4, an even-smaller version of "the world's smallest camcorder" its CCD TR5. By sacrificing a few less-frequently used features such as manual zoom, Sony came up with a unit weighing just one pound, nine ounces and able to fit comfortably in a palm or jacket pocket. Many Sony camcorders, by the way, now include a sliding door that can conceal the controls that operate their more advanced features. That keeps fumble-fingered novices—not *you*, of course!—from inadvertently pushing the wrong button, and may remove some of the confusion that can plague video amateurs.

Canon had, under glass, a prototype of a modified A1 camcorder that accepts interchangeable lenses, a boon to the serious or scientific videotaper with special needs. A standard for the new "VL" lens mount, which preserves both autofocus and autoexposure features while giving the videographer his choice of lenses, has been agreed to

by at least four major manufacturers, so the next show may bring several interchangeable-lens 8mm camcorders.

And Sanyo/Fisher introduced a thin, horizontally-held, 8mm unit that incorporates a feature called "fuzzy logic." While "fuzzy" is not a word you would normally want to associate with any kind of optical enterprise, *fuzzy logic* refers to what goes on in the camcorder's decision-making circuitry. By adding a "maybe" state of sorts to the more conventional binary "yes" and "no" ones, the Sanyo/Fisher unit is said to improve performance in several areas—focus and color rendition among them.

Both Hi-8, the 8mm equivalent of Super VHS that provides greater resolution than the original format, and standard 8mm camcorders were shown by most manufacturers. High-quality stereo capability is showing up on a number of 8mm camcorders; it looks as though the format is getting serious!

This is not to say that the compact VHS-C camp has thrown in the towel. JVC for example, the originator of the VHS-C and Super VHS-C equipment, much of it quite compact. Still, it looks as though that format, which was intended to provide compatibility with all the homebound VHS VCR's out there, has an uphill battle on its hands in the camcorder arena.

In home-video products, it looks as though the new hot item will be a new and innovative device becoming known as a "videocaster." A few years ago there was a device being sold that allowed you to transmit sound and video from your VCR over the air (and through walls) to remote TV sets in other rooms of your house. A good idea, but the FCC stepped on it claiming that the transmissions might interfere with other services using the same or nearby frequencies. Now, that guardian of the airwaves has authorized frequencies in

# PRODUCTS OF 1990



the sub-microwave 900-MHz band for this purpose, and at least four manufacturers so far have jumped on the videocasting bandwagon.

Recoton, for instance, has two such systems—one for VCR or cable video, and another for stereophonic audio. With a range of 120 feet or so, you can watch TV or listen to music from a single source anywhere in the house, or even out of doors. A videocasting system from Remex operates in the 2.1-gigahertz range and has four sets of inputs. It also retransmits commands from infrared remote controls by up-converting them to RF and then down-converting them again to infrared. It can switch from one of its inputs to another in 200 milliseconds, which makes it possible to multiplex audio, video and control signals. What that means, among other things, is that you could send your kid with his joystick and a little TV set off to a remote corner of the house, or maybe the attic, to play his Nintendo games without disturbing the rest of the family. No stereo sound yet, but there will be soon.

Go-Video, which was hindered, it says, for a long time by opposition to its product from the Japanese, has finally announced its dual-transport VHS VCR. You can record a cassette on one side of this unit while playing back another on the other side. Or, as the Japanese had feared, you can copy a tape being played on one side to a blank one on the other.

Several manufacturers, Hitachi among them, introduced VCR's with built-in head cleaners that give the head a little wipe before and after a tape is run through.

**Audio.** Probably the most excitement in the audio area was generated by Henry Kloss, whose current company is

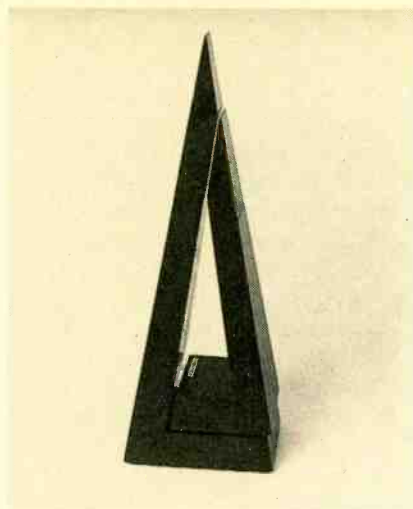

*The wireless Remex Bi-Klon "videocaster" broadcasts video and audio from a VCR or TV to a receiver in another location while also allowing full remote control. Up to four devices can be connected to one transmitter.*

Cambridge Soundworks. Henry, who is responsible for a number of speaker designs—and entire speaker companies, come to think of it—has designed several new speakers for KLH, of which he is the original "K." The speakers, known in his honor as the Founder's series, use an unusual design with a sealed woofer to produce low frequencies. What we heard at the show were only prototypes; we look forward interestedly to the final product.

Just about all the offshore manufacturers showed DAT equipment, but since no agreement on the copy-protection problem had been concluded by show time, it was there pretty much for show only. Maybe we'll be able to purchase DAT recorders and players by the time of the next CES. And one company was demonstrating its own U.S.-made PCM recording system using VCR's. Its representatives were rather vocal about the DAT issue.

Memorex showed an interesting CD repair kit. Instead of filling the scratches, which is what most such kits do, this one provides you with the wherewithal to grind and polish the surface of the disc down to a level below the bottom of the scratch; in other words, to grind it away. It seems like a lot of work, but the system is said to work and, once you've used this method you'll probably take better care of your discs so you won't have to repair them that way again.

Mini components, which tried to crash the market and failed a few years ago, seems to be attempting to make a comeback. We shall see. Finally, Aiwa

is using a version of BBE's Sonic Maximizer circuitry to improve the sound of some of its home stereo systems. It does make a difference.

**Home Theater.** Built-ins are big, and getting bigger, and media rooms seem to be becoming the upscale equivalent of the rumpus rooms of the 1950's and '60's. At the show there were lots of built-in speaker systems from companies such as Bose, a lift to move your video projector up out of the way (from Niles Audio) and, of course, yards upon square yards of large-screen video systems.

LCD projection TV's—although still not comparable in quality, in our opinion, to those using CRT technology—were more apparent. Sharp had a ceiling-mount version of its 100-inch LCD projector, and was also showing (to a select few) an LCD system with a much greater pixel density than current production units. Maybe next year ...

An interesting tuner from Audio Design Associates contains three independent AM/FM tuners, whose outputs can be routed to different rooms of a



*Go-Video's dual-well VCR-2 deck allows one-button copying of a recorded cassette in one section to a blank in the other. The two-in-one design also simplifies editing and, of course, eliminates the need for lots of connecting cables.*

house or apartment. Seen briefly—it's far from ready for marketing—was a Sharp prototype of a clear panel that upon application of a voltage, turned milky white and could be used as a projection screen. It appeared to use a form of liquid-crystal technology.

LucasFilm's THX sound system has been a theatrical attraction for several years for the quality of audio it provides. Now there's a THX home system. You can now have real movie-theater sound in your home theater, thanks to a cooperative effort of the Hollywood licensor with companies such as Snell Acoustics and Technics and, it is hoped, others to follow. The demonstration we



*Sony's—and the world's—smallest camcorder, the CCD-TR4, weighs only one pound, nine ounces and measures a mere 4 3/8 x 4 1/8 x 6 5/8 inches. Despite its small size, it has nearly all the features of its larger predecessor.*

heard was quite impressive and it *did* sound like real, really clean and powerful cinema sound.

**Design.** The term "design" can apply to visual as well as engineering qualities, and in that field we noted a few interesting items. There was, for example, an almost art deco tube-type monophonic amplifier bearing the Trillium name. It consisted of three chrome-plated cylinders atop a flat circular base, also chrome plated, with three tubes mounted atop one of the cylinders. We don't know how it sounds, but it certainly looks flashy!

We also noted two clever TV-receiver cabinet designs. One from Mitsubishi had the rear inputs and outputs on a hinged panel that could be swung up to the horizontal to permit its easily being reached from the front of the unit. A nice convenience, unless you're in the habit of running your cables so tight that their shortness would impede the panel's movement.

Toshiba had an eye-catching display on the main floor of something it called "air-spoiler design" TV sets. An attention-getting graphic represented an automobile-type air spoiler, complete with a depiction of air currents swirling turbulently around it and sure enough, all the TV sets in the area sported spoilers at the rear. While we half-seriously commented that they were there to keep the sets from flying around the living room during high winds, the purpose of the spoilers, or whatever Toshiba calls them officially, seems to be to provide a stable shelf for such items as VCR's that some of us like to perch precariously on a TV-set's narrow top. It's a pretty good idea; too bad there isn't a better name for it.

A super-premium cassette with the brand name Suono (from That's America) boasts a mean-looking black shell that was created by the same designer responsible for the looks of such cars as the Ferrari. The shell has a dome, or at least a small bulge, in the middle, which is said to have both sonic and architectural significance.

And there were lots of blank-faced black boxes containing VCR's, CD players, laserdisc players, and other horizontal pieces of consumer-electronics equipment. When you give out 164 awards, you have to give them to *something*.

**Miscellany.** Their are some products that don't fall easily into any particular

Names and Addresses	
Aiwa America, Inc. 35 Oxford Dr. Moonachie, NJ 07074	Niles Audio Corp. 12331 South-West 130 St. Miami, FL 33186
Ascom Communications, Inc. 300-1 (c) Rt. 17 Lodi, NJ 07644	Philips Consumer Electronics Co. One Philips Dr. POB 14810 Knoxville, TN 37914-1810
Audio Design Associates, Inc. 610 Mamaroneck Ave. White Plains, NY 10605	Recoton 46-23 Crane St. Long Island City, NY 11101
Bose Corporation The Mountain Framingham, MA 01701	Remex/Sicommerce 150 East 52nd St., 24th floor New York, NY 10022
Cannon USA, Inc. One Cannon Plaza Lake Success, NY 11042	Sharp Electronics Corp. Sharp Plaza Mahwah, NJ 07430-2135
Cobra/Dynascan 6500 West Cortland St. Chicago, IL 60635	Snell Acoustics, Inc. 143 Essex St. Haverhill, MA 01832
Franklin Electronic Publishers, Inc. 122 Burrs Rd. Mt. Holly, NJ 08060	Sanyo Fisher USA Corp. 21314 Lassen St. Chatsworth, CA 91311
Go-Video, Inc. 14455 North Hayden Rd., Suite 219 Scottsdale, AZ 85260	Sony Corp. of America Sony Dr. Park Ridge, NJ 07656
Hitachi Sales Corp. of America 401 West Artesia Blvd. Compton, CA 90220	Technics, Matsushita Electric Corp. of America One Panasonic Way Secaucus, NJ 07094
JVC Company of America 41 Slater Dr. Elmwood Park, NJ 07407	That's America, Inc. 1983 Marcus Ave., Suite 201 Lake Success, NY 11942
Kyocera/Yashica, Inc. 100 Randolph Rd. Somerset, NJ 08875	Toshiba America, Inc. 82 Totowa Rd. Wayne, NJ 07470
Memorex 1200 Memorex Dr., M/S 00-30 Santa Clara, CA 95050-2896	Trillium Corp. 3930 North 1st St San Jose, CA 95051
Mitsubishi Electric Sales America, Inc. 5757 Plaza Dr. POB 6007 Cypress, CA 90630-0007	

category, and aren't unusual enough to deserve a category of their own. Here are a few such products:

Cobra showed a portable-phone answering machine you can take with you when you travel. It can be AC- or battery-powered, and includes a dual-time-zone alarm clock. And a phone from Ascom Communications called the "Voice Print" can dial fifty numbers upon voice command. All you have to do is tell it the name of the party you want to call.

An ultrasonic gadget called "In-the Picture" clips to your belt and, with the rest of the system attached to your camcorder and tripod, causes the camcorder to track you as you move about. Great if you're taping a lecture

and tend to pace as you talk.

And an interesting personal-stereo earphone fits w-a-a-y deep inside the ear canal in an attempt to improve bass response.

Franklin's latest electronic word machine is the electronic edition of the *Concise Columbia Encyclopedia*. It displays the incredible contents of its memory in eight lines of about fifty characters at a time. The device also includes a built-in search thesaurus and automatic spelling correction, and permits extensive cross-referencing and topical browsing.

The ranks of still video cameras will soon have another member—Kyocera showed a mock-up of one that it ex-

(Continued on page 98)

*Printers have come a long way from their early days. Along the way, many new technologies have emerged, each with their own advantages and disadvantages.*

**B**uzz, rattle, hum . . . Buzz, rattle, hum—unmistakable sounds of a computer printer hard at work. Like the automobile, computer printers have become indispensable tools in our modern world and their diversity of shape, size, style, and speed simply staggers the imagination. Each model sports a varied range of features and options, and is compatible with many different types of host computers (if not all of them). Their relatively low cost and high reliability have made inroads for printers from the head office to the home.

Today, just about everyone with a computer owns some sort of printer, yet so few people really understand how printers work or how to care for them. This article will introduce the major families of printers, explain their advantages and disadvantages, and compare their technologies. It will also describe some important steps for routine printer maintenance that can extend their working life.

**Printer Families.** Ultimately, the purpose of any printer is to record the output of a computer. This permanent "hard copy" of the computer's information can then be stored, reviewed, or conveniently duplicated. The original printers were large, slow, incredibly complex (and expensive) electro-mechanical devices. As the demand for printers increased, manufacturers were able to develop better, simpler, more reliable technologies. Those rather diverse technologies eventually gave rise to the four popular families of printers that we see today: impact, thermal, ink



BY  
STEPHEN J. BIGELOW

# Printer

jet, and laser. Each type of printer has its own particular characteristics.

Wheel-type printers are the oldest (and probably the most straightforward) technology used to form printed characters. The technique is very much like that used in a typewriter (see Fig. 1): such a printer is equipped with one or more die sporting fully formed mirror-image characters molded on their faces. When the computer tells the printer to print a character, control circuits within the printer will order a motor to position the die so that the desired character faces the print surface. The printer's permanent ROM (for read-only memory) contains the character locations on the die. Once in position, the controlling circuitry fires a driving solenoid, often called a "hammer," that

pushes the selected die against an inked ribbon and against the paper. That makes a clean, precise impression of the character. There are currently three common types of dies: Daisy wheel, ball element, and thimble wheel.

Wheel-type printers are referred to as "letter-quality" printers. Their pre-molded character dies render a crisp, professional appearance. Their simplicity of design and operation have made wheel-printers the workhorses of business. The key limitation of wheel printers is flexibility—the printer can only generate the character set that is molded onto the particular die being used. If other characters are to be printed, the die would have to be changed. Often, the ROM is programmed to operate several different

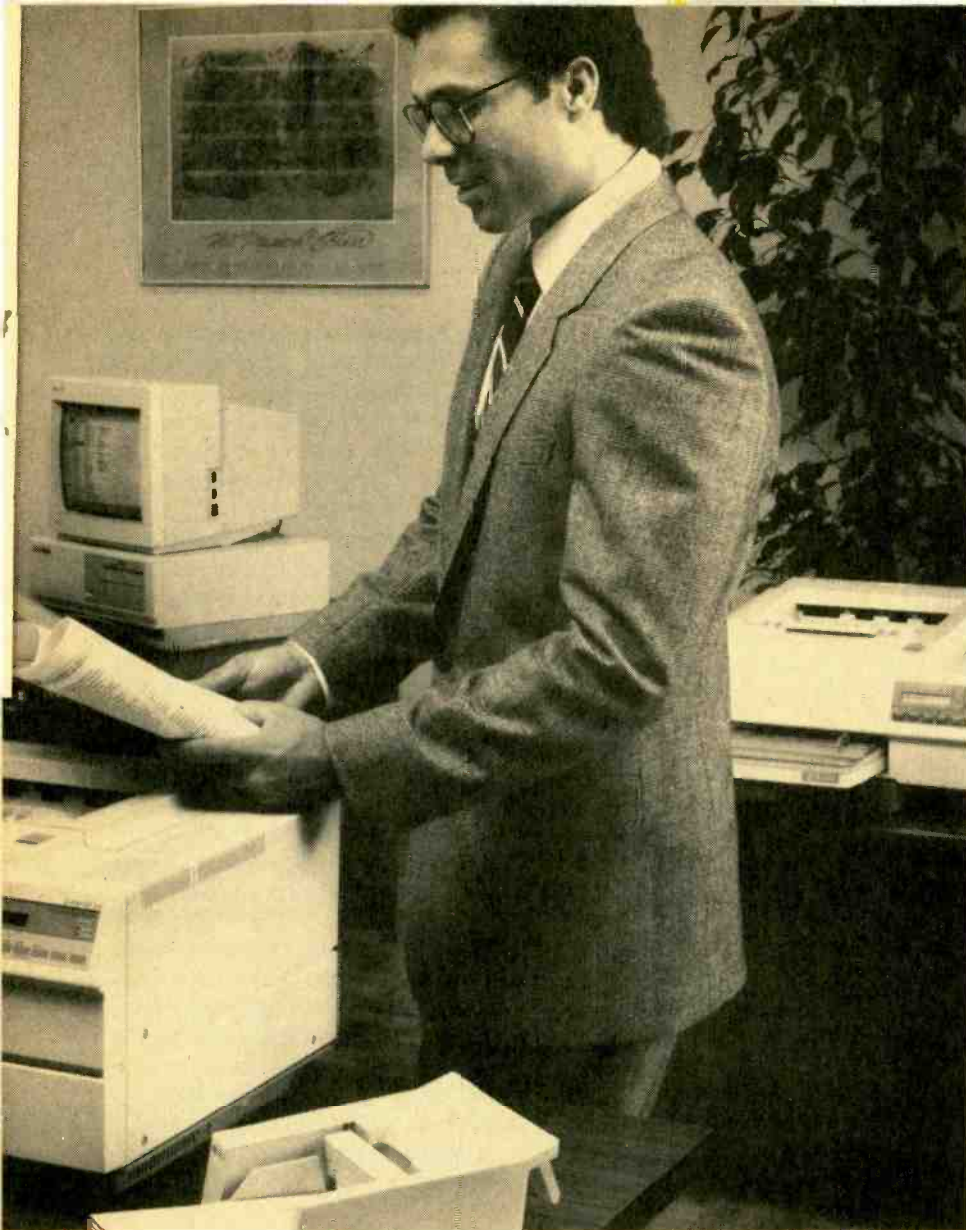

# Technology

dies, which can be selected from the printer's control panel or via control signals from the computer.

**Dot-Matrix Printers.** Dot-matrix printers also use an impact approach by striking paper through an inked ribbon to form a desired character. However, a vertical column of independently fired wires is used to impact the paper instead of pre-formed dies (see Fig. 2A). Each needed character is composed of a certain programmed set of wire movements. The various wires are fired in the appropriate sequence as the print head moves across the paper. The result is a series of dots that resembles the desired character (see Fig. 2B).

Each wire in the print head is fired

through its own solenoid under the command of the control circuits. The solenoids in the print head serve the same function as the hammer in a wheel printer. The sequence of patterns used to fire the print wires is contained in the printer's ROM. By using a ROM that is programmed with different sets of dot patterns, a printer can produce a variety of fonts (or type styles). Font selection is usually made from the printer's control panel, or through communication with the host computer.

The concentration of dots will effect the quality of the printed image. More dots will create a better quality character. For example, a fair dot-matrix printer will support about 50 DPI (dots per inch) to generate normal alphanumeric characters, while a higher

quality dot-matrix graphics printer can approach 200 DPI. To achieve such higher resolutions, additional print wires can be added to the matrix. A general-purpose dot-matrix print head uses a vertical line of 9 print wires. A dot-matrix printer used to generate graphics may use 21 print wires. As you might expect, the controlling circuitry and ROM programming for a 21-pin printer is more complex than that of a 9-pin device.

Most general-purpose dot-matrix impact printers can not produce the kind of crisp, clear impressions that are available from wheel printers. Their characters usually have a dotted appearance. The printing flexibility available from a dot-matrix printer, however, can more than make up for lower character quality. Since print wires can be fired in any sequence, it is possible to produce any type of character at any time. Many desktop publishing software packages such as Page Maker or First Publisher are designed to take advantage of that feature.

**Thermal Printers.** A long-standing complaint about impact printers concerns their noise level. The continuous clatter of metal striking paper can be quite bothersome. The printer industry responded to this by developing the thermal dot-matrix printer. Thermal printers use the same matrix technique as impact dot-matrix printers to form the desired characters. All the controlling electronics and driving circuits are essentially the same. However, instead of driving metal pins to impact the paper surface, a thermal print head uses a matrix of pin-point heaters to create the needed dots. Each heater pin is heated and cooled very quickly as the head moves across a special heat-sensitive paper. Pin heaters allow thermal heads to be small and rugged—ideal for mobile applications or use in harsh environments.

Thermal printers are quiet since no impact actually takes place. They also consume less current than impact dot-matrix printers. That has made thermal printers popular in small commercial instruments such as printing calculators. The key disadvantage to thermal printers is the need for a special heat-sensitive paper. It is generally much more expensive than conventional single-sheet or fan-fold paper. While that is not an issue in small instruments (which usually use only small rolls of

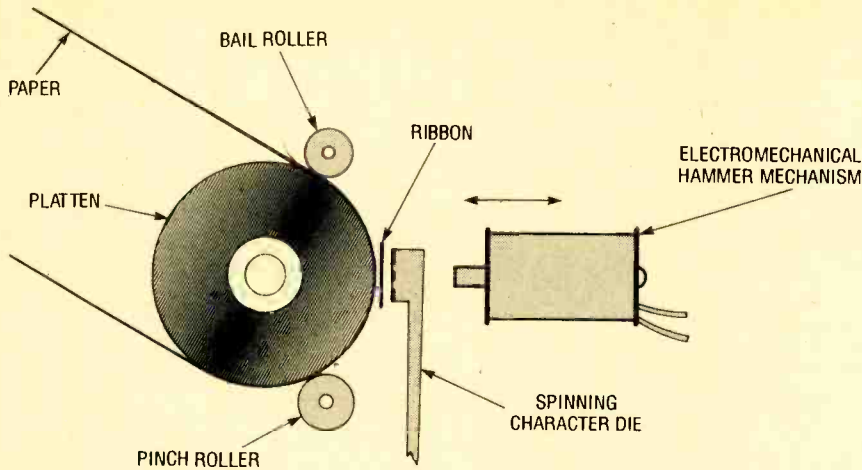

Fig. 1. Wheel-type impact printers are fairly simple devices although they can produce excellent characters. The hammer taps the back of a spinning character die that has been positioned by the control circuitry. The die then presses the ribbon against the paper to print the character.

thermal paper anyway), the significant cost difference makes thermal printers unattractive to business, or any other high-volume user.

**Ink-Jet Printers.** Ink-jet printers are a fairly new and intricate dot-matrix technology that provides a cross between the raw speed of an impact dot-matrix printer and the quality of a wheel printer. The method of printing is just as the name implies; each dot in the character is literally painted onto a surface from a reservoir of liquid ink. The intriguing aspect of ink-jet technology is that not only paper, but just about any material can be printed on at high speeds. The alphanumeric codes found on many soda bottles and product containers are almost always produced by an ink-jet printer. There are two different methods used to implement ink-jet printing.

The "drop on demand" method turns a stream of ink on and off as required to form each dot in the character. The ink jet nozzle will send out a drop of ink for each dot that is placed. Otherwise, no ink will flow out of the head.

A continuous-flow approach constantly circulates ink out of the print head. A trough is used to capture the ink that is not directed onto the print surface to form the character.

To make an ink-jet printer work (see Fig. 3), a fast-drying ink is ionized under a high voltage and made available to the nozzle of the print head. The control circuitry in the printer moves the head across the surface and translates the desired character into vertical and horizontal deflection signals. The ana-

log deflection signals drive a set of vertical and horizontal deflection plates at the ink nozzle. The electric field that is generated between the deflection plates will exert a force on the ionized ink. The force will direct the ink droplets to the desired places on the printing surface. As the X and Y deflection signals vary, the ink droplets will essentially draw the desired character.

Ink-jet printers are complex and sensitive mechanisms that require frequent attention. The ink reservoir must be kept fresh and filled with a special fast-drying, ionizing ink. That can be expensive.

Also, the print head must be cleaned carefully on a regular basis to prevent ink from clogging the nozzle. Ink-jet printers are best in heavy-duty, high-volume applications.

**Laser Printers.** Laser printers are one of the most exciting developments of the last 10 years. They combine the advantages of silent, extremely fast operation, with letter-quality characters and graphics. A typical laser printer can achieve a printing resolution of 300 DPI, yet they are reasonably reliable and need almost no routine attention.

Character information is loaded into the laser printer from the host computer in much the same way as any other dot-matrix printer. In the laser printer, however, a low-power laser beam is made to scan across the length of a photosensitive drum. The control circuits turn the beam on and off as it scans. That places rows of dots on the drum. As the drum rotates, the continuous placement of dots on each line form the page image (Fig. 4). The drum continues to rotate and picks up a fine, black powder (called "toner") in the exposed areas. When the rotating drum rolls against the feeding sheet of paper, the image (in the form of toner) is transferred to the paper. A heat lamp, or fusion lamp, melts and dries the image right into the paper to create a permanent printed page.

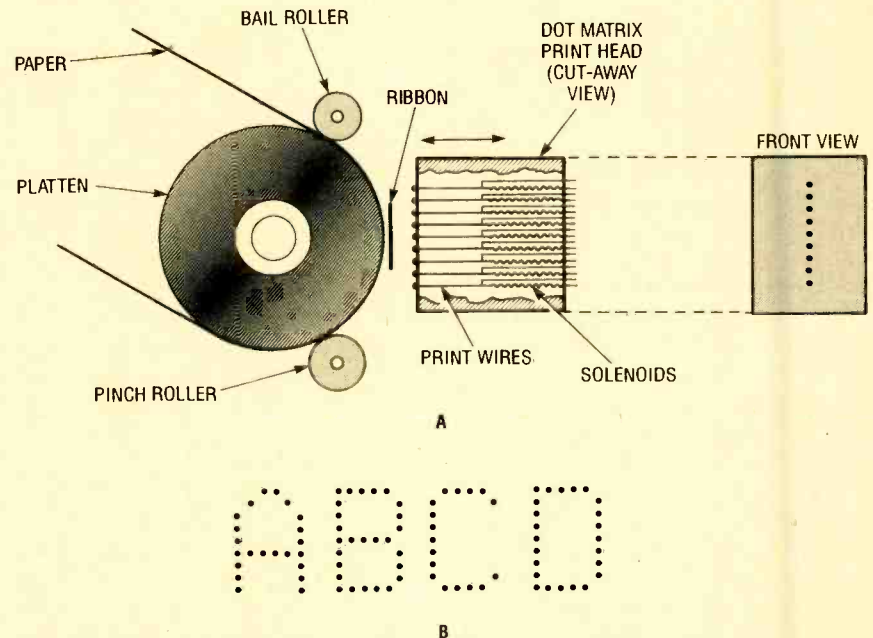

Fig. 2. A dot-matrix print head has multiple print wires (similar to the mechanical hammer of a print-wheel printer) that hit the ribbon up against the paper to form characters.



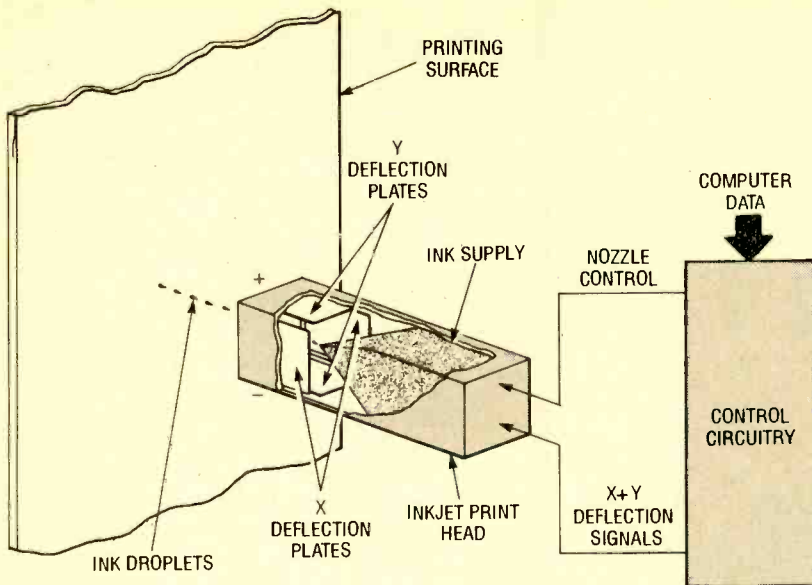
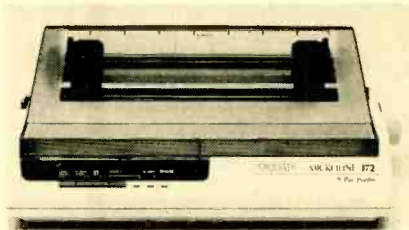

Fig. 3. An ink-jet print head "spits" special ink from a nozzle. While the ink is traveling to the paper, it is deflected by the electrical charge on two sets of plates under the guidance of the control circuitry.

Until recently, the advanced technologies and sophisticated electronics needed make a laser printer have made them incredibly expensive. That is changing, though, as constant improvements in materials, lasers, and electronics have brought many more laser printer manufacturers into the marketplace. High-volume manufacturing and sharp competition has resulted in drastic cost reductions. Costs will drop even further as laser printing technology continues to develop. Now that we have seen the major families of printers, let's take a closer look at their structure.

**Printer Components.** All printers, regardless of their design, achieve the same goal: they permanently record the information output from a host computer. To accomplish that, though, a carefully orchestrated series of events must take place (see Fig. 5). Initially, the paper and print head must be moved to some starting position. Data from the host computer is read into a temporary storage buffer. Controlling logic translates those signals into print-head data and movement commands. Those commands are executed as the printing head is moved across the page. When a line of print is completed, the paper is advanced and the head is positioned for another line. The cycle of moving and printing continues until the host computer stops sending data and the temporary buffer is empty (see the boxed text entitled "Printer Interfacing").



This typical dot-matrix impact printer was designed for home/office use, yet it can print at 180 cps thanks to modern technology.

Each of the activities can be attributed to one of the five major sections in the printer: the paper feeder, the print head, the carriage control, the interface and logic circuitry, and the power supply.

**Paper Feeder.** The paper-feeding mechanism is a combination of rollers and gears that actually hold and move the paper in the printer. The key roller in conventional printers is called the platen. It is a long, wide roller made of pliable rubber that supports the paper against the print head. A paper-bail roller rests against the top of the paper to keep it even and flat along the platen. Two common methods are used to control the travel of the paper: friction feed and tractor feed.

The friction feed method uses a hard, rubber pressure roller to pinch the paper tightly against the platen. When a "paper advance" signal is sent from the controlling circuitry, a motor in the printer will turn the platen and pressure

## Serial vs. Parallel

In order for a printer and host computer to communicate, digital information must be transferred back and forth between the devices. Two communication formats have emerged that make up the majority of printer interfaces today: serial and parallel.

Serial communication (also called RS-232) requires the least amount of wiring. A bare minimum of three wires is needed to maintain the flow of data (although most printers require more because of their handshaking protocols). In a three-wire set up, one line is used by the computer to transmit data to the printer, another is used by the printer to signal its readiness (or "busy-ness") for more data, and the last wire is the common signal ground.

Communication takes place one digital bit at a time. Each group of bits must be in a pre-defined format (i.e. the bits in each byte must perform a special job), although some are optional. Of course, the data bits—7 or 8 bits that tell the printer what character to print—are not optional. There is a start-bit, a parity (also called an "error checking") bit, and one or two stop bits, all of which are optional. The printer and computer must "know" before-hand which bits will be used (although they needn't know the number of stop bits—just whether or not they're used). The entire sequence of bits must be sent at a certain speed (called the "baud rate"), which must also be the same for both the computer and printer.

Parallel communication, on the other hand, uses many more signal wires to transfer 8 digital bits of character data one character at a time, in addition to a variety of control signals that synchronize the printer. That type of interface can be even faster than a serial interface, without the need to deal with start, stop, and parity bits.

Both methods are used extensively by many printer manufacturers and either will usually yield good performance. Newer printers make provisions for both interfaces so that the printer will work in either a serial or parallel mode. It is possible to tell the difference between basic serial and parallel printers by the data connector that is used. Serial printers normally use a general-purpose 25-pin sub-miniature "D" connector, while typical parallel printers come equipped with a 36-pin "Centronics" connector. ■

roller some set amount. That, in turn, "pushes" the paper through. Friction feeds are used mainly in single-sheet printers. The trouble with friction feed is paper skew. Any imperfections or misalignment in the rollers or paper will cause the paper to "walk" left or right across the platen.

Laser printers use a variation of friction feed to "self-feed" paper from a

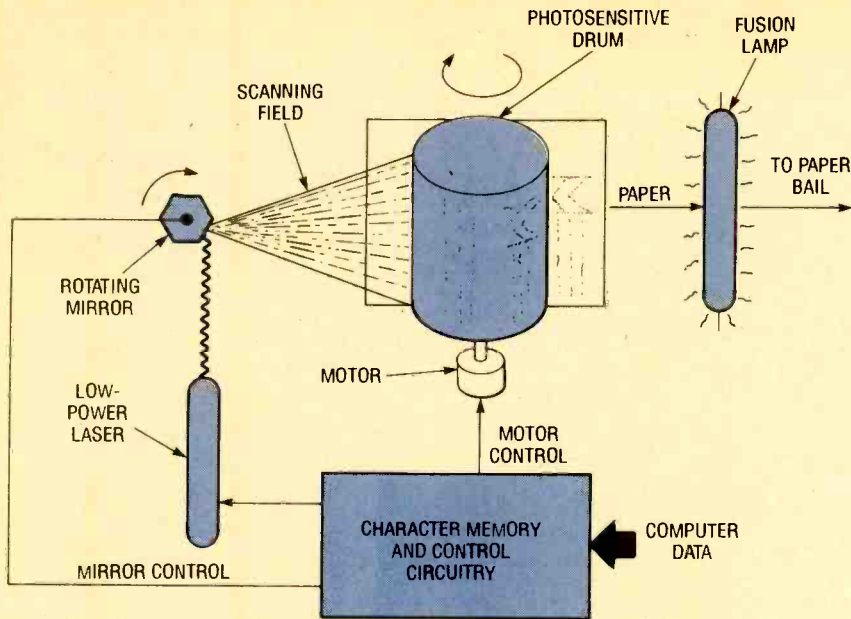

Fig. 4. In a laser printer character data is used by the control circuitry to turn a laser on and off and "paint" the laser light onto a photo sensitive drum. The drum picks up toner on its exposed areas, transfers the toner to paper, and a lamp melts it on.

single-sheet supply. The paper supply is held against a set of small grabbing rollers. When a paper feed signal is generated, the rollers literally grab the top sheet of paper and pull it into the printer. Once that sheet is on its way into the printer, the grab rollers stop until the next sheet is called for.

Tractor-feed printers use a set of special sprocket wheels that fit into the perforated holes of fan-fold computer paper. A "paper advance" signal drives a motor that turns the platen and sprocket wheels. That effectively "pulls" the paper up through the printer. Tractor feeds are very reliable and will keep paper perfectly straight over any distance. The disadvantage, though, is that tractor feed mechanisms do not work with regular single-sheet paper.

**Print Head.** As we discussed in previous sections, the printing head is a delicate, high-precision electromechanical assembly that is responsible for placing the desired characters on paper. Each different family of computer printer uses a unique type of device to perform the actual printing.

Wheel-type heads consist of pre-molded characters worked into a die. Impact dot-matrix heads use an array of hardened wires driven by electrical solenoids to place the necessary dots. Thermal dot-matrix heads operate in a similar way, but they use pin-point heating elements instead of wires to place their dots. An ink-jet head sprays the

characters onto the page. A laser print head may be considered to be the photoconductive drum that comes in contact with the paper.

**Power Supply.** The printer power supply is responsible for developing the variety of discrete DC (or low-voltage AC) voltages that the motors, solenoids, and electronics need to operate. It is a critically important section of all printers, and any trouble at all in the power supply will have drastic effects on the integrity of the printing, and can even cause damage to the printer itself.

Digital logic that is used in the interfacing and control circuits typically need +5 VDC for TTL devices, or  $\pm 12$  VDC for CMOS devices (depending on the combinations of logic components that are used in the particular printer). Electromagnets, solenoids, and motors in the paper-feed, print-head, and car-

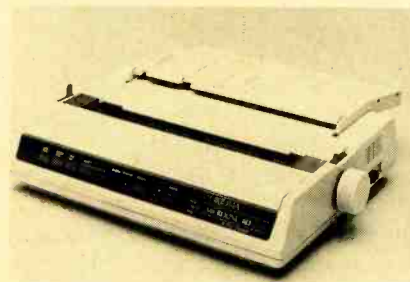

This 9-pin dot-matrix impact printer can achieve speeds of 220 cps in its super-speed draft mode. If style is more important than speed, it can print NLQ (near letter quality) at 39 cps.

riage assemblies often need a higher voltage (24 VDC or some low-voltage AC is not uncommon).

In order for the power supply to provide the proper voltage levels to the printer, the AC line voltage from the wall outlet must be within a specific operating range. A common operating range for AC line voltage is 95 to 130  $V_{rms}$ . If the AC line voltage drops below the minimum level for the particular power supply (voltage and current requirements are usually listed on a plate in the back of the printer), it may not be able to sustain the required DC levels to the rest of the printer. Under the best of circumstances, that will cause the printer to behave very erratically. Under the worst circumstances, improper voltage levels can actually damage motors, and logic chips. If, on the other hand, AC voltage rises above the maximum allowable level, the power supply can be damaged trying to limit the additional energy, and the printer will fail.

**Interface and Logic Circuitry.** The interface and logic circuits form the brain of the printer. It is this section that directs every aspect of the printer's operation.

When the printer is first turned on, the built-in microprocessor initializes using the permanent instructions stored in its ROM (read only memory). The ROM contains all of the power-up, self-test, and operating sequence instructions, as well as the character styles and formats (or font styles). The microprocessor may also refer to an electrically alterable area of ROM for default setup information programmed in by the user (if the printer has such a feature). The printer will then try to establish communication with the host computer. If the computer does not respond, the printer will simply sit idle and wait for a computer signal. When communication is established, the printer will usually display an "on-line" or "ready" indication.

During the printing process, the computer transfers data to the communications logic, which translates the information into characters that are stored in the RAM (random access memory) buffer, or commands that the microprocessor will interpret to drive the system.

Characters and commands are processed and sent along to the I/O (input/output) logic that manages the physical devices in the printer such as the print head, the carriage, and the paper

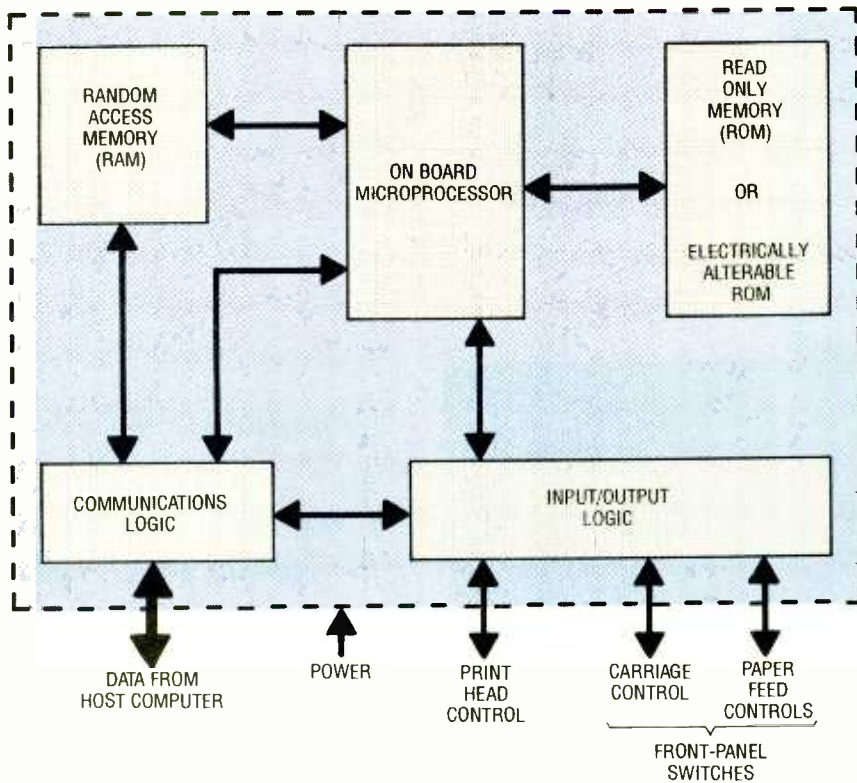
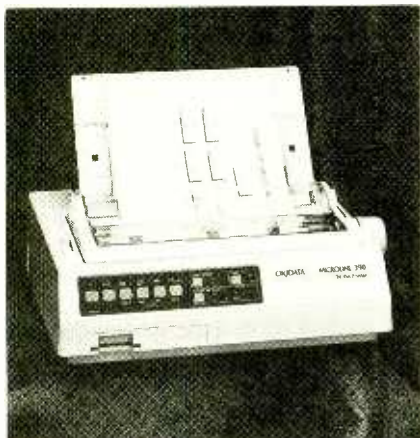

Fig. 5. This block diagram of a printer's vital parts should give you a good idea of how printers work. All printers have these subsections, only the hardware is different.



Dot-matrix impact-printers with 24-pins, like this one from Okidata, allow users to achieve letter quality with the flexibility to do graphics.

feeder. The print-head control lines carry the signals used to form the desired characters. For a wheel-type printer, it may be a position code to select a die and a trigger signal to fire the hammer. In a dot-matrix printer, the control lines will operate the print wires or pin heaters. They may also be deflection plate signals for an ink-jet printer, or on/off commands for a laser beam as it scans a moving drum. The carriage control manages the movement of the print head as it moves across the page. In a

laser printer, that signal controls the scanning of the laser beam. The paper-feed control signals are used to advance the position of the paper as needed. I/O logic will also handle any indicators and front-panel controls on the printer.

**Carriage Control.** It is the carriage control that moves the print head across the page during printing. For most printers, a stepping motor is used to transport the print head since stepping motors will move in the desired speed and direction under the control of the interface and logic circuitry. Any optoelectronic or electro-mechanical position-sensing signals are fed back to the I/O logic through selected carriage-control lines. For laser printers, the control simply regulates the rotating mirror that causes the laser beam to scan the photosensitive drum.

**Routine Maintenance.** A computer printer is a delicate and complex electromechanical device. Most will work well and provide a long and reliable service life. However, there are a large number of belts, linkages, and other working parts in printers, and each of them will wear over time. Eventually, that will cause a breakdown.

## Glossary of Printer Terms

- Bi-directional** A printer that will print left-to-right and right-to-left. They require more sophisticated control logic, but the overall printing speed will be faster.
- Buffer** An area of temporary memory in the printer where character and command data from the host computer are stored.
- Dot matrix** A method of forming printed characters by actuating a series of individual points in a desired sequence.
- DPI (dots per inch)** The resolution of a dot-matrix printer. More dots per inch indicate a better printing resolution.
- Drop on demand** A method of ink-jet printing where ink only flows out of the nozzle during the printing of a character.
- Friction feed** A method of paper feed where paper is pinched tightly between rollers, then pushed up and out of the printer.
- NLQ (near letter quality)** A dot-matrix technique of producing high-quality print by making several printing passes with the print head to overlap dots.
- Parallel** A communications format where 8 data bits are transferred simultaneously from the computer to the printer.
- RAM (random access memory)** A temporary digital-storage area found in the printer's interface and control circuitry.
- ROM (read only memory)** A permanent storage area containing operating instructions and character styles found in the printer's interface and control circuitry.
- Serial** A communications format where a pre-defined sequence of serial bits are transferred individually from the computer to the printer.
- Solenoid** An electromagnetic device used to move physical linkages and mechanisms.
- Toner** A supply of fine black powder used to impress the image from a photosensitive drum onto paper.
- Traction Feed** A method of paper feed where the perforated edges of fan-fold paper are pulled up through the printer by gear-driven sprocket wheels. ■

Electronic assemblies do not need routine maintenance. They either work or they do not. Mechanical parts, on the other hand, will wear. Luckily, there are a number of procedures that can be followed that can extend the working life of a printer. Before a program of routine maintenance can be started, it is important that the printer be set up and used in a favorable environment.

The working life of a printer can be greatly influenced by the environment that it must work in. Commercial electronic circuitry is very sensitive to temperature and humidity. Extreme heat, as well as extreme cold, can destroy integrated circuits. Humidity is almost as important. A very dry atmosphere can foster a large static charge that can

(Continued on page 96)



# Build a Car-Radio Silencer

BY  
MIKE GIAMPORTRONE



*It turns down the volume on command from your radar detector, car phone, or CB radio.*

American's have long had a love affair with their automobiles. We spend considerable amounts of time and money on them. We try getting the most for our investments by installing selected features, many after delivery, by ourselves or at specialty shops. Well, the *Automobile Radio Silencer* automatically turns the volume down on your radio whenever your car phone rings, when something interesting is picked up on your CB, or when your radar detector signals you, and resumes normal volume when the distraction is over or a radar signal is out of range. If you like, the *Automobile Radio Silencer* can even be used to automatically interrupt your cruise control for highway driving.

The *Automobile Radio Silencer* can be built easily in one evening, installed the next, and all the parts are readily available locally from Radio Shack for less than \$12, or for about half that from mail-order supply houses.

**How It Works.** A schematic diagram of the *Automobile Radio Silencer* is shown in Fig. 1. The circuit consists of an infrared (IR) phototransistor, a 555 oscillator/timer, a DPDT relay, two potentiometers, and a few support components. Let's discuss the basic circuit, which is used to reduce the volume on the car's radio whenever the auto's radar detector signals; other applications will be discussed later on in this article.

If you encounter a microwave source that alarms your radar detector, many detectors sound off, but because of

road noise, car noise, or improperly set volume controls, you may not hear, or use the audible alarm. So, I elected to use the visual light, or LED(s) to trigger the silencer. The trigger input (pin 2) of U1 is held high by R1, a PC-mount micro potentiometer, which also serves as a sensitivity adjustment.

As light from the visual alarm hits Q1 (the IR detector), the enlarged, light-sensitive base region of Q1, causes current to flow through it, pulling pin 2 of U1 low, which in turn causes U1's output at pin 3 to go high. The output of U1 is fed to the base of Q2, a 2N2222 general-purpose, silicon transistor. With a high applied to the base of Q2, current flows through it, energizing the relay's coil.

If we were to connect the speakers to the normally-closed and common contacts of each pole of the relay, energizing the relay would open the contacts, and current going to the speakers would be reduced by R4 and R5, thus reducing the volume of the radio. Integrated timer U1 is set up as a basic monostable multivibrator with C2, R2, and R3 controlling the length of the delay once the trigger is returned high.

Some radar-detector indicator lights pulse to reflect the strength of the signal. That would cause undesirable pulsing of the radio's volume. So with R2 turned fully counter clockwise, giving the circuit a maximum delay or turning down the volume for up to four seconds after the indicator light turns off. Capacitor C1 prevents false triggering. Resistors R3 and R6 prevent excessive currents from damaging any of the components.

In addition, a general-purpose diode, D1, is placed in parallel with the relay coil to pass induced reverse voltage (inductive kickback) to ground. When a coil is de-energized, the collapsing magnetic field cuts across the coil, inducing a reverse voltage that may damage any semiconductors controlling the relay.

LED1 and R5 are optional components; the LED serves the same purpose as LED indicators in radar detectors. If those components are used, the radar detector can be mounted out of sight with LED1 of the Silencer giving an indication that you are being clocked by radar. Components LED1 and R5 can be mounted in your auto's dash, or some other line-of-sight location within the vehicle. That increases safety by not blocking your view, it may prevent your radar detector from being stolen, and will likely increase the sensitivity of your unit.

**Construction.** Because the circuit is so simple, almost any construction technique can be used. However, to cut down on construction errors that could prevent the circuit from working properly at best or, at worst, destroy the semiconductors, it is recommended that the circuit be assembled on printed-circuit board. A foil pattern for the author's printed-circuit board is shown in Fig. 2.

After the board has been etched, check that all unwanted copper has been removed and that the needed copper traces are intact. Small copper bridges between traces can be severed with a straight edge or Xacto

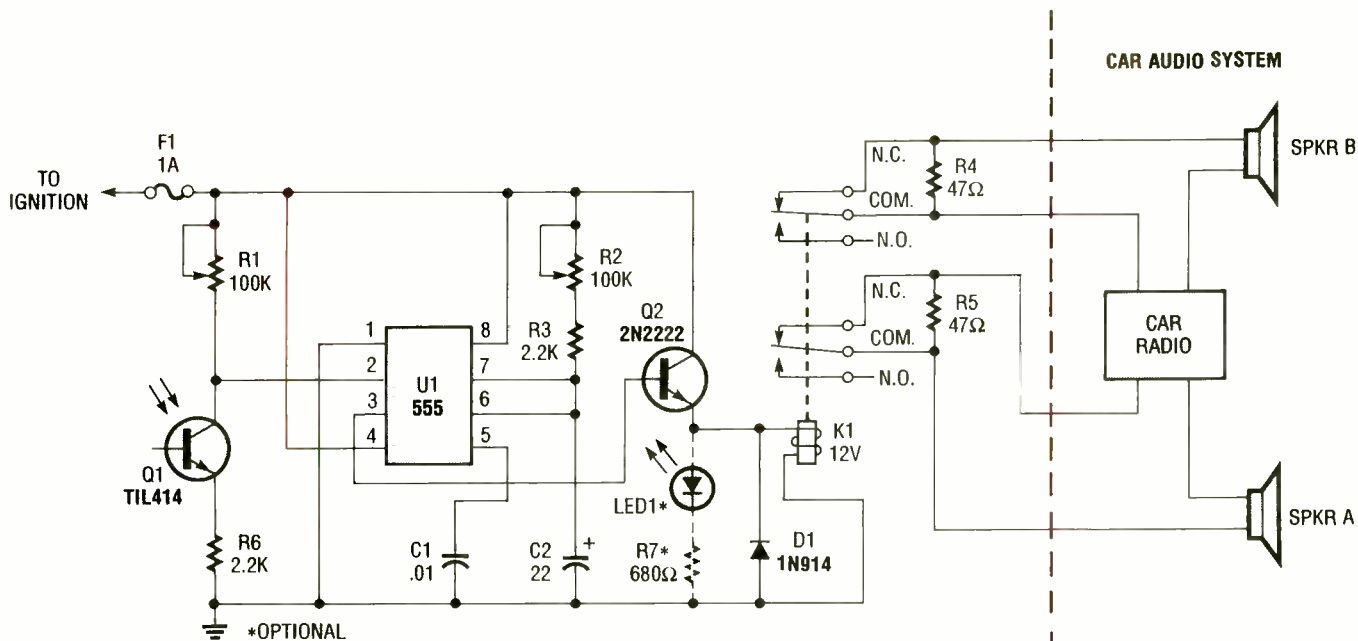

Fig. 1. The Auto Radio Silencer is little more than an IR-controlled shutdown circuit. In the Silencer circuit an IR transistor (Q1) triggers a 555 oscillator/timer (U1) that drives a general-purpose transistor (Q2), which in turn activates a relay (K1).

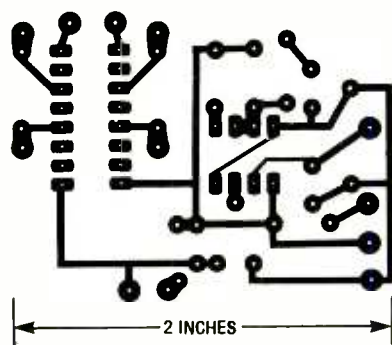

Fig. 2. The full-scale foil pattern for the Silencer's printed-circuit board is shown here. When etching the board, be sure that you do not over or under etch the board. After etching your board, check it against the pattern shown here for opens and shorts.

knife. In areas where excessive copper has been removed from the board, thin single strand wire can be used to make up for trace deficiencies.

Once you are reasonably sure that the board is okay and you've obtained the parts listed in the Parts List, construction can begin. Figure 3 gives component location and orientation for both the board-mounted and off-board components. When soldering the components in place, note polarity and pin-out of all the semiconductors, K1, and C2. Probably the easiest mistake to make on the board is to plug the relay in backwards. Don't worry, it won't hurt anything, but it won't work either.

It's a good idea to color code, or mark all wires leaving the board in such a way so as to make them easily decipherable later when the circuit is installed in your vehicle. Labels can also be used to mark the various wires. It is not necessary to use the IR transistor specified in the Parts List; just about any IR detector transistor that you may have can be used for Q1.

In any event, clip the collector lead of Q1 to about 1/4 inch and the emitter lead to about 1/2 inch. Hook-up wires will be soldered to the leads of Q1. Slide a piece of 1/8-inch diameter shrink tubing over at least one of the wires to be soldered to Q1 to prevent the leads from shorting. Solder the wires to Q1, slide the heat shrink tubing on the hook-up wire up so that it covers Q1's leads.

Next, place a 4-inch length of 1/4-inch heat-shrink tubing over the entire Q1 assembly. Position the tubing to cover the soldered connections and extend it about 1/4 inch past the lens end of Q1. That allows only selected light to hit Q1's base. That prevents ambient light from striking Q1 and affecting the unit's sensitivity. When heating the shrink tubing, don't use so much heat that the tubing completely covers the lens end. At this time, with the shrink tubing warm, it is recommended that you bend the wire to fit your radar detector; (see the installation instructions for more on that); the shrink tubing bends easier now and will hold that shape after cooling.

## PARTS LIST FOR THE AUTOMOBILE RADIO SILENCER

### SEMICONDUCTORS

- U1—NE555 oscillator/timer, integrated circuit
- Q1—TIL414 (or similar) NPN IR-detector transistor
- Q2—MPS2222A general-purpose NPN silicon transistor
- D1—1N914 general-purpose, small-signal, silicon diode
- LED1—Jumbo red light-emitting diode (optional, see text)

### RESISTORS

- (All resistors are 1/4-watt, 5% units, unless otherwise noted.)
- R1, R2—100,000-ohm, micro-miniature PC-mount potentiometer
- R3, R6—2200-ohm
- R4, R5—47-ohm, 1/2-watt
- R7—680-ohm (optional, see text)

### ADDITIONAL PARTS AND MATERIALS

- C1—0.01-μF, ceramic-disc capacitor
- C2—22-μF, 25-WVDC, radial-lead, electrolytic capacitor
- K1—12-volt, DPDT 16-pin DIP relay
- Printed-circuit materials, enclosure, IC socket, fuse, fuse holder, wire, solder, etc.

**Troubleshooting.** Whenever a problem arises, check that all parts are in the proper location with the correct orientation; also check for solder bridges, cold solder joints, and for improper wire connections. The next thing to check is the power-supply connections for re-

verse polarity. Also make sure the U1 outputs a pulse at pin 3 when a trigger is applied to pin 2. By walking through the description of circuit operation, you should be able to pinpoint any errors or defective components.

**Installation.** With the silencer in hand and the enclosure open, mount Q1 and its wire in place by sticking a piece of velcro on the wire and the matching piece on the radar detector. Detector Q1 should face the LED indicator of the radar detector. Once that's done, you can run Q1's wire along with the power cord for the radar detector, or conceal it as you wish.

Connect the Silencer's power leads to the auto's fuse box. Select an empty slot that is on only when the key is on. It's possible to use a male crimp-on spade on the end of the Silencer's fuse assembly to tap into the vehicle's fuse box. That may also work along side an existing fuse if necessary. Set the Silencer for maximum sensitivity by turning R1 completely counterclockwise. Adjust R2 to about the mid position.

Power up the Silencer and turn on the radar detector. Most radar detectors will give a brief warning to test their alarms when first powered up. That should be sufficient to test the Silencer. Slowly adjust the sensitivity and delay as needed. You should be able to listen to the relay and determine how the circuit is working.

Once working, cut one of the two wires going to each speaker, and connect the cut wires to the appropriate points on the printed-circuit board. Turn on the radio and adjust it to a comfortable volume. Turn on the radar detector to alarm it, and listen to the amount of reduction in the volume. Don't judge the amount of change until trying it out driving down the road under actual conditions. The value R4 and R5 can be increased to reduce volume even more, or decreased for less of a reduction in volume. Mount the optional LED if used, at this time.

**Alternate Applications.** If you have a 4-speaker system, you will have to use a 4PDT relay, or add another DPDT relay. The Silencer can also be made to interrupt your cruise control when your radar detector is activated; that's easily done by removing R4 and R5 from across the relay, and cutting and connecting one of the cruise-control-switch wires through K1's normally-closed and common contacts. The cruise-control switch

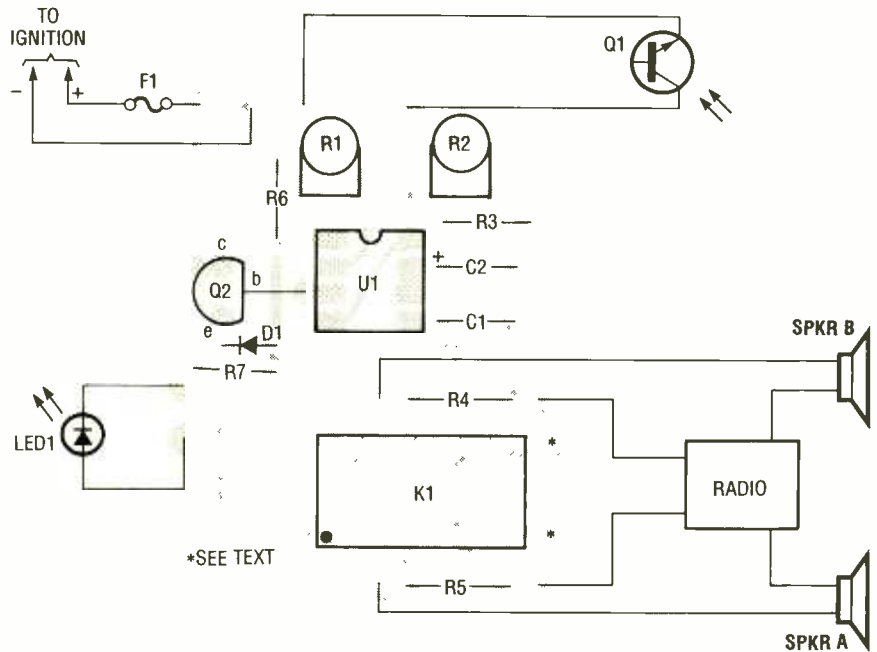
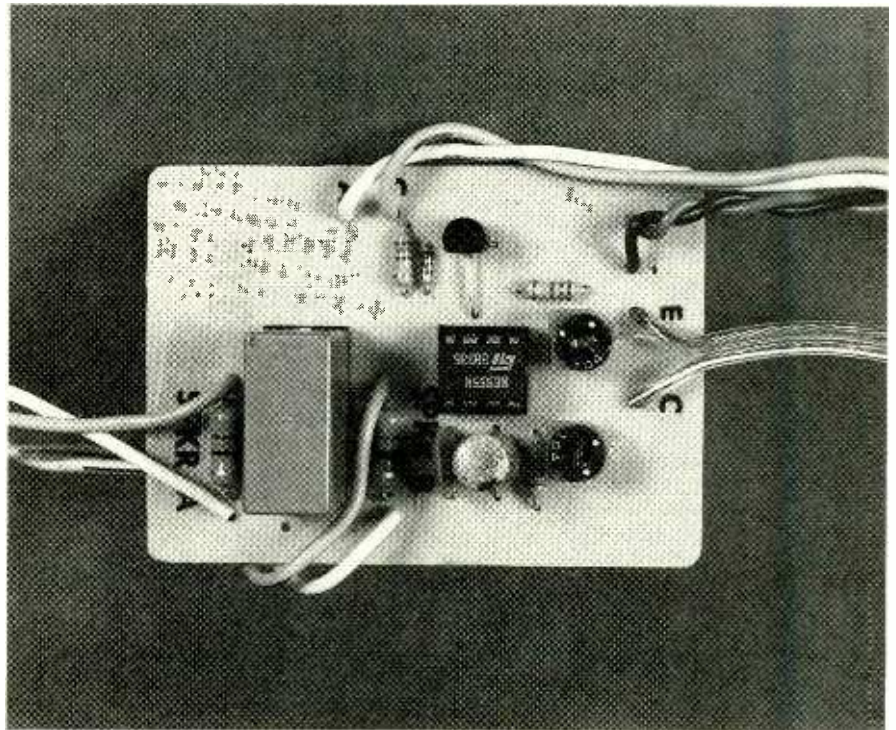

Fig. 3. There is nothing to assembling the Silencer. Simply install the board-mounted components guided by the layout diagram. Note: The two asterisks on the right side of K1 indicate pads that are connected to normally-closed contacts of the relay.



Here is the finished printed-circuit board for the Silencer. Note the absence of LED1, F1, and the IR transistor (Q1). The LED and IR transistor are connected to the circuit board through lengths of wire. The fuse is connected in series with the +V power-supply lead.

is mounted on both the brake pedal and clutch pedal where applicable. Be sure not to connect the unit to the brake light switch or starting switch on clutch pedals. Even though I've heard it suggested that the Silencer could be connected to the brake lights, don't do it; safety first must always be observed!

Hooking the Silencer to car phones

or CB's is identical to the radar-detector hookup if the equipment has an LED or lamp indicator that lights when you are transmitting, or the car-phone handset is taken off the hook.

Another way of installing the Silencer is shown in Fig. 5. In that installation, an infrared emitter and detector are  
(Continued on page 83)

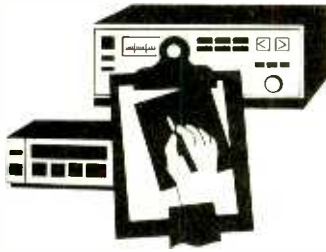

# Product Test Reports

By Len Feldman

## SONY D-180K "DISCMAN" CD PLAYER

**W**hen CD players were first introduced back in 1983, it is doubtful if anyone could have envisioned the kind of compact, portable player represented by Sony's (Sony Drive, Park Ridge, NJ 07656) D-180K. Not only have CD players for portable use been greatly miniaturized, but their resistance to mistracking caused by external jarring or vibration has also been improved. In fact, one of the uses recommended by Sony for the D-180K is as an add-on car CD player. If that conjures up visions of having to make cut-outs in the dashboard and of having to crawl around beneath or inside the vehicle, forget it. The D-180K comes with a clever accessory that looks for all the world like an ordinary tape cassette. In fact, it is really a magnetic coupling device that transmits the output signals of the CD player to the tape head in the cassette player of your existing car stereo system, thereby eliminating any need for complex installation.

Of course, the CD player can be

used in the home as well, since it comes equipped with an AC adaptor. There's even an optional, wired remote control available for the unit. Or, you can install four ordinary "AA" batteries and expect about 8 hours of play time before replacement. If you wish, you can also buy an optional car-battery cord that plugs into your vehicle's cigarette lighter to power the player.

While the D-180K does not have the random-programming capability commonly found in larger, home CD players, it does offer several repeat-play modes, as well as the ability to advance to a given track or selection, and to advance to a given point in a given selection. Repeat-play modes include repeating the current selection; repeat play of an entire disc; or "shuffle play," a format in which tracks are played in random order. Each time shuffle play is selected, the tracks are played in a different random order. Should you need to interrupt play for any reason, it is possible to resume play

from exactly the same spot on the disc.

When powered by AC or by the car-battery adaptor cord, the disc compartment is illuminated, as is the LCD readout window and even the operating pushbuttons. To extend battery life, when the unit is battery powered, that illumination is not present.

Sony seems to have thought of just about everything in designing and packaging this little CD player. They even throw in four pieces of self-adhesive Velcro tape. Two of these can be affixed to the underside of the D-180K, while the other two are stuck onto a flat surface such as the area above the dashboard, near the windshield. That lets you anchor the player firmly to a surface in the car, with no danger of its being shaken loose by bumps in the road.

**Control Layout.** A pushbutton on the top surface of the player pops the disc compartment open and also provides access to the battery compartment. Because someone might accidentally hit that button while a disc is playing (for example, while walking along and listening to the player via headphones, or when reaching for another control on the player without taking your eyes off the road while driving your car), a tiny slide switch along the side surface of the player can be set to lock the disc-compartment door if you wish. A jack for connecting the optional remote control is also found on this side surface. A miniature phone jack is found on the right-side surface of the player while the line-level output jack and an external DC-power input terminal are found on the rear surface of the unit.

All of the remaining operating controls are found on the front panel, which is nicely sloped for good visibility. The display area at the left shows either the track number being played or, if a tiny key-mode button is depressed, the time into a given track. Other indicators in the display area include total playing time (shown initially when a disc is loaded into the disc compartment), type of repeat play (if activated), and graphic indicators that tell you when the player is searching for a given track or when it is in the paused condition.

To the right of the display are a pair of search buttons (either for advancing or reversing the laser pickup to find a specified track, or for advancing to a given point within a track), the pause button, a play-mode button, the key-mode button that determines the func-



CIRCLE 119 ON FREE INFORMATION CARD

Sony's D-180K Portable CD Player

## TEST RESULTS—SONY D-180K PORTABLE CD PLAYER

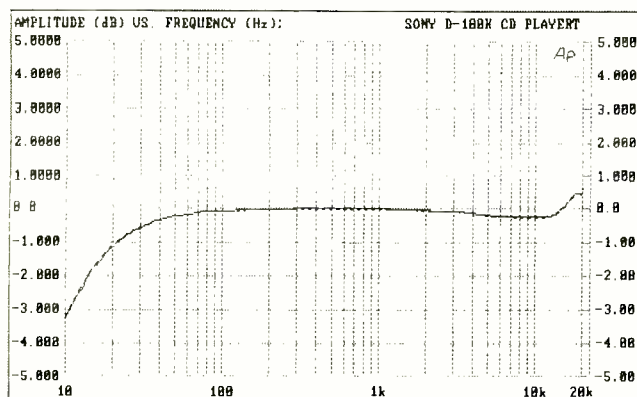

The frequency response of the D-180K was essentially flat from 20 Hz to 20 kHz, ranging from +0.4 dB to -1.1 dB over that span.

SPECIFICATION	MFR'S CLAIM	PE MEASURED
Frequency Response	20 Hz to 20 kHz, +1, -3 dB	+0.4, -1.1 dB
Signal-to-Noise	N/A	89.0/88.7 dB
Dynamic Range	N/A	105 dB (EIA)
THD + Noise (1 kHz, 0 dB)	N/A	0.033/0.04%
Separation, at 1 kHz	N/A	71 dB/65 dB
Output Level		
Line Output	1 V	Confirmed
Phone Output	9 mW/channel, 32 ohms	Confirmed
Power Consumption	1.2 W DC	Confirmed
Dimensions (W x H x D, inches)	5½ x 11¼ x 6½	
Weight	1 lb. 3 oz. including batteries	
Suggested Price:	\$270.00	

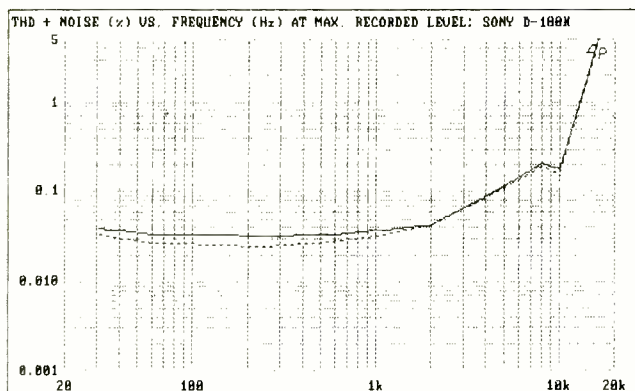

Throughout the low- and mid-frequency region, distortion plus noise was around 0.04% or less. The apparent rise in THD plus noise at higher frequencies was caused by the interaction with the 44.1-kHz sampling rate of the CD digital format.

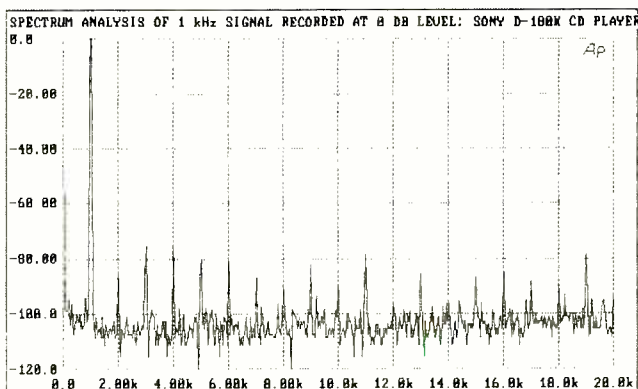

In this spectrum analysis of a 1-kHz signal, we observed a tall spike at 1 kHz, which represents the test signal, and shorter peaks at 2 kHz, 3 kHz, 4 kHz, etc., which represent the actual harmonic-distortion components.

tion of the two search buttons, and a stop button. A volume control along the lower edge of the front surface of the D-180K adjusts volume at the headphone-output jack as well as at the line-out jack. Also found here is a hold/resume switch that, when set to the hold position locks all other controls so that they cannot be accidentally activated, while setting the switch to the resume position causes play to resume from the point at which it was interrupted, as explained earlier. Should you wish to connect this player to a home audio system, Sony supplies a cable for that purpose.

**The Test Results.** Frequency response of the D-180K was essentially flat from 20 Hz to 20 kHz, ranging from +0.4 dB to -1.1 dB. We suspect that the slight roll-off beginning below 100 Hz is attributable to a low-value output-coupling capacitor. In any event, it amounts to

no more than -1.0 dB or so at 20 Hz, which is probably just as well if you are going to listen to the player through headphones—most headphones can't reproduce such low frequencies without high orders of distortion.

Throughout the low- and mid-frequency region, distortion plus noise was around 0.04% or less—an audibly insignificant level. There was an apparent rise in THD plus noise at higher frequencies, but that is not really an indication of higher levels of distortion; rather, that shows the presence of some spurious "beats" caused by the interaction of the audio high frequencies with the 44.1-kHz sampling rate of the CD digital format. It is unlikely that under actual music-listening conditions you would hear any audible artifacts despite the higher apparent readings.

Next, we played a disc with a 1-kHz test signal and examined how THD plus noise varied with changes in the re-

corded level. Over most of the range, THD plus noise was 80 dB or more below the maximum level. Quoted in percentage terms, that works out to be 0.01% or less. At the maximum recorded level, THD ranged between -67.5 and -69.5 dB, corresponding to percentages of between 0.042% and 0.033%.

In order to separate the actual distortion products from the accompanying noise, we ran a spectrum analysis of a 1 kHz signal reproduced at the maximum recorded level. We observed a tall spike at 1 kHz, which represented the desired signal, and shorter peaks at 2 kHz, 3 kHz, 4 kHz, etc., which represented the actual harmonic-distortion components. The worst of these, at 3 kHz, was still some 77 dB below the maximum recorded level, corresponding to an insignificant percentage of only 0.014%.

At a test frequency of 1 kHz, stereo separation measured about 65 dB from left-to-right and about 71 dB from right-



to-left. At 16 kHz, separation decreased to about 40 dB for the poorest of the two measurements (left-to-right). While we have measured much better separation figures for many full-sized home CD players, we must state in all fairness that higher separation figures than those measured for this unit really do not contribute significantly to the stereo illusion. After all, 30 dB of separation was considered to be more than adequate for "good stereo" in the days of LP records, and the same holds true for FM-stereo broadcasts even today.

Signal-to-noise ratio for this player measured 89 dB on the left channel and 88.7 dB for the right channel. We took a look at the distribution of residual noise as a function of frequency by playing back the "no signal" or silent track of our special test disc. Even though this test was conducted while powering the unit from the separate AC adaptor, there was no evidence of any rise in noise at the power-line frequency (60 Hz) or its harmonics; a good reason for operating such players with physically separate AC adaptors rather than with built-in AC to DC power supplies.

We examined the unit's deviation from perfect linearity at various recorded levels. We first plotted linearity errors from the maximum recorded level (0 dB) down to -90 dB, using so-called undithered signals. At that extremely low signal level, deviation from perfect linearity was actually less than 1 dB. Many expensive CD players using all sorts of sophisticated digital-to-analog conversion schemes do no better, and often do far worse.

Next, we used dithered signals (signals containing deliberate and specific amounts of noise that, believe it or not, enables digital players to extract lower-level information from a CD that would otherwise not be possible) in the range from -70 dB to -90 dB below the maximum recorded level. Again, deviation from perfect linearity was minimal even at -90 dB, never exceeding 2 dB of error.

Finally, using a special test signal consisting of a gradually fading test tone from -60 dB to -120 dB, we plotted deviation from perfect linearity as the signal fades into the noise level. Good correlation was obtained between that test and the previous one in that at -90 dB, deviation amounted to about 2 dB. That test also enables us to determine the dynamic-range capability of the system which, according to U.S. mea-

surement standards, is that point at which the residual noise overwhelms the signal by about 3 dB. In the case of the D-180K, that occurred at between 100 and 110 dB.

**Hands-On Tests.** One of the most important qualities of a portable CD player is its ability to handle external vibration and shock without mistracking. In this respect, the Sony D-180K surpassed any earlier portable CD players that we have tested; of course, most of those would mistrack even when their surfaces were lightly tapped with a finger. Not so with the D-180K. Sony seems to have gone to great lengths to isolate the delicate laser-pickup assembly from external disturbances by designing an innovative and effective suspension system for that assembly.

What's more, the D-180K was remarkably good when it came to tracking CD's that had extensive defects in them, such as long-duration dropouts. Such dropouts might normally occur if a disc's surface is scratched or dirty—an event that's much more likely when using CD's in a car or in an outdoor environment. In any case, the Sony D-180K only started to mistrack when dropout lengths exceeded 1.5 millimeters. That may not sound like a very long dropout until you learn that first generation CD players, whether for home or portable use, were seldom able to play through dropouts that were only 0.7 millimeters in length. Even today, many home players don't measure up to this relatively inexpensive portable in this regard.

The controls worked well and were easy to understand, even with just a minimal reading of the owner's manual. The sound quality was beyond reproach. The only possible additional feature we might have wanted for a CD player at this price would have been some sort of minimal random-programming capability—the ability to have the player play specific tracks out of sequence. Still, in the absence of that feature, we did find that repeated pushing of the search buttons moved the pickup to the tracks we wanted to hear in short order, and without ever making a mistake.

At its suggested price, the Sony D-180K represents good value in a portable CD player, and is likely to find its way into many a home audio system as well. For more information on the player, contact Sony directly, or circle No. 119 on the Free Information Card. ■

# AMAZING SCIENTIFIC & ELECTRONIC PRODUCTS

<b>PLANS PARTS ARE IN STOCK</b>	GRA1 — ANTI GRAVITY GENERATOR	\$10.00
	L77 — 40 WATT BURNING CUTTING LASER	\$20.00
	RUB4 — HI POWER PULSED DRILLING LASER	\$20.00
	BT5C — 1 MILLION VOLT TESLA COIL	\$20.00
	IN MCP1 — HI VELOCITY COIL GUN	\$15.00
	LLS1 — LASER LIGHT SHOW 3 METHODS	\$20.00
	EHT — ELECTRONIC HYPNOTISM TECHNIQUES	\$8.00
	EML1 — LOWER POWERED COIL GUN LAUNCHER	\$8.00
	JL3 — JACOB LADDER 3 MODELS	\$10.00
	SD5 — SEE IN THE DARK	\$10.00
	LEV1 — LEVITATION DEVICE	\$10.00

<b>KITS ASSISTANCE PROGRAM AVAILABLE</b>	FMV1K — 3 MILE FM VOICE TRANSMITTER	\$34.50
	PF51K — HAND CONTROLLED PLASMA FIRE SABER	\$49.50
	NIG7K — HI FLUX NEGATIVE ION GENERATOR	\$34.50
	PG5K — PLASMA LIGHTNING GLOBE	\$49.50
	LHC2K — VISIBLE SIMULATED 3 COLOR LASER	\$44.50
	HOD1K — HOMING/TRACKING BEEPER TRANSMITTER	\$44.50
	LGU6K — 2.5 MW HAND-HELD VISIBLE LASER GUN	\$249.50
	BT3C — 250000 VOLT TABLE TOP TESLA COIL	\$249.50
	IOG2K — ION RAY GUN, project energy without wires	\$129.95
	TKE1K — TELEKINETIC ENHANCER/ELECTRIC MAN	\$79.50
	VWPM7K — 3 MILE AUTO TELEPHONE TRANSMITTER	\$49.50

<b>ASSEMBLED</b>	<b>ASSEMBLED IN OUR LABS</b>	
	LIST10 — INFINITY XMTR Listen in via phone lines	\$199.50
	IPG70 — INVISIBLE PAIN FIELD BLAST WAVE GENERATOR	\$74.50
	ITM10 — 100000 VOLT INTIMIDATOR UP TO 20'	\$99.50
	TAT30 — AUTOMATIC TELEPHONE RECORDING DEVICE	\$24.50
	PSP40 — PHASOR SONIC BLAST WAVE PISTOL	\$89.50
	ONE10 — ALL NEW 26" VIVID COLORED NEON STICK	\$74.50
	LGU20 — .5 TO 1MW VISIBLE RED HeNe LASER GUN	\$199.50
	BLS10 — 10000 WATT BLASTER DEFENSE WAND	\$89.50

EASY ORDERING PROCEDURE - TOLL FREE 1-800-221-1705 or 24 HRS ON 1-603-673-4730 or FAX IT TO 1-603-672-5406  
VISA, M.C. CHECK, MO IN US FUNDS. INCLUDE 10% SHIPPING. ORDERS \$100.00 & UP ONLY ADD \$10.00. CATALOG \$1.00 OR FREE WITH ORDER.

**INFORMATION UNLIMITED**  
P.O. BOX 716, DEPT. PN, AMHERST, NH 03031

## AMAZING NEW Pocket Reference

480 pages of tables, maps, formulas, and conversions and it fits in your shirt pocket (3.2" x 5.4" x 0.6")!

**\$9.95\***



\* Plus \$2.00 shipping & handling. Colorado residents add 5% tax.

Small sample of contents	
Air Tool CFM vs PSI	Radio Alphabet
Battery Charging	TEN Radio Codes
Tire Manufacturer Codes	Telephone Area Codes
Lumber Sizes & Grades	Lost Credit Card Phones
Concrete & Mortar	Sound Intensities
Element Tables	Wind Chill Factors
Computer ASCII Codes	Frequency Spectrum
IBM® PC Error Codes	Geology Mineral Tables
IBM® Interrupts-IO Map	Gases and Solvents
80286 Hard Disk Types	Bolt Torque Tables
Printer Control Codes	Wood Screw/Nail Sizes
Electric Wire Size vs Load	Math Formulas & Tables
NEMA Motor Frames	Plane/Solid Geometry
Wire & Sheet Gauges	Copper/Steel/PVC Pipe
Resistor/Capacitor Colors	Rope, Cable and Chain
Pilot Lamp Specs	Tap-Die-Drill Sizes
Fuse & Battery Specs	Sand Paper & Abrasives
RF Coil Winding Data	Weld Electrode & Solder
Wire Size vs Turns/Inch	3200 Conversion Factors

**Money Back Guarantee** — If not completely satisfied, return book postage prepaid, in mint condition for a 100% refund!

**Sequoia Publishing Inc.**  
Dept 913, P.O. Box 620820  
Littleton, CO 80162



## HEATHKIT ACTIVE ANTENNA KIT



CIRCLE 120 ON FREE INFORMATION CARD

*Bring in those distant stations you've longed for and gain some knowledge in the process by building a convenient, tunable antenna for shortwave and other listening.*

**S**hortwave listening—and all radio listening, for that matter—requires an antenna with the optimum length for the frequencies you want to receive.

Recommended antennas for receiving international shortwave broadcasts are typically 20- to 60-feet long. Unfortunately, antennas of such length aren't always convenient to erect. Apartment dwellers usually have to make do with shorter, indoor antennas, and travelers require equipment that's easily and readily portable.

Also, since ideal length varies with frequency, an antenna designed to receive one band of frequencies will be less effective at lower and higher frequencies. No single antenna, as a matter of fact, can do it all.

A solution to the antenna dilemma is to use electronics to make a short antenna behave like a much longer one. In such a way you can amplify the signals picked up by an antenna and even adjust the antenna's "length" for best response to each frequency you tune. Building the Heathkit HD-1424-A Active Antenna is a moderately priced (\$59.95) way to do that.

**Antenna Details.** The active antenna includes a 25-inch telescoping whip antenna, a tunable circuit that you ad-

just for best reception at the frequency you want to hear, and a 3-transistor amplifier that boosts the level of the received signals. The amplified signal feeds to your shortwave receiver via coaxial cable. If you have an external antenna, you may also use the project as a preselector and preamplifier to improve its reception.

The antenna's tunable circuit consists of an adjustable capacitor wired in parallel with a series of inductors. A five-position switch allows you to select an inductor, a series of inductors, or no inductor at all in the tuned circuit. The tuned circuit couples directly to the project's whip antenna or an external antenna, and provides the input to the first stage of the amplifiers.

The active antenna's tunable range is from 300 kHz to 30 MHz. That includes the international shortwave bands (including tropical bands), as well as long-wave and medium-wave bands (used for navigation beacons), ham-radio bands, and the AM-broadcast bands.

The project's front panel holds a tuning knob that adjusts the tuned circuit's capacitance, a band switch that selects the inductance, a gain-control knob for the amplifiers, and a power-on switch and LED. The back panel contains the connector for the whip antenna, a jack for the optional external

power supply, and coaxial-cable connectors for your receiver and the optional 50-ohm external antenna.

The project may be powered by a 9-volt battery, or by an external DC supply of 6 to 14 volts at 45 milliamperes. You can bypass the active-antenna's circuitry by turning the project off; signals will then flow directly from the project's whip antenna to your receiver. With the antenna collapsed, the project's dimensions are about 5- x 5- x 2-inches, so it's compact and easily portable.

To use the active antenna, you set the gain knob to a low-to-midrange setting and use the band switch to select which of the five frequency bands you want to hear. For easy reference, the frequencies covered by each band are labeled on the front panel. After selecting the band, you set the tuning dial to the approximate frequency you want within the band you've selected.

You then tune your shortwave receiver for the desired frequency and fine-adjust the active antenna's tuning knob for best reception. You can tune by ear, or watch your signal-strength meter, if you have one.

With the gain knob, you can amplify weak signals or decrease strong signals that are overloading your receiver. If you're curious about what effect the active antenna's circuitry has, just turn

the project off and you'll hear what your reception is like with just the whip antenna.

How effective is the active antenna at pulling in and amplifying signals? Of course, the project's usefulness depends in part on what broadcasts you're tuning. Some transmissions come in so loud and clear that an active antenna isn't required.

But the tuned circuit and amplifiers can help to boost signals that you otherwise can't hear clearly, or at all. It also can help to get rid of irritating static and other interference on "marginal" signals. We found the active antenna useful for that one night while tuned to *Ecos del Torbes* at 4980 kilohertz in San Cristobal, Venezuela.

In general, we found the active antenna's abilities to be moderate rather than dramatic. It wasn't as effective as a 60-foot single-wire horizontal antenna strung from our receiver out the window to a shed roof. But the active antenna is a good choice where an outdoor antenna isn't feasible. And when you're

tuning fading or scratchy signals, you need all the help you can get. In such cases, the boost of the active antenna can mean the difference between making a successful station "ID" or not. Best reception was obtained when we connected our outdoor antenna to the active antenna's input and used both together.

The project's documentation warns that the antenna may pick up noise generated by fluorescent lights, computers, and other electronic devices. We experienced interference on selected bands from a computer sitting next to the antenna and light dimmers elsewhere in the house. But the interference was easily eliminated by turning the devices off.

**Project Construction.** Building the project is straightforward. Beginners as well as experts should have few problems. In addition to a soldering iron, a few hand tools are required: pliers, long-nose pliers, diagonal cutters, wire strippers, 1/8-inch blade screwdriver,



*The Heathkit HD-1424-A SWL Active Antenna kit makes an attractive and worthwhile addition to any SW-listening set up. It is shown here with Heathkit's HD-1418 Active Audio Filter.*

and #1 and #2 Phillips-head screwdrivers. We completed the project in about four hours.

Transistors, capacitors, resistors, and coils form the main components that you solder to the circuit board provided. Other tasks consist mainly of wiring and mounting the various controls and connectors to the front and back panels of the enclosure, which is conveniently machined with the required openings.

As with all Heathkits, you get lots of helpful documentation, including illustrated, step-by-step instructions for assembling, testing, installing, operating, and even troubleshooting the project. You also get tips on how to identify component values and make sound solder joints, a brief circuit description, detailed assembly drawings, and a complete schematic diagram.

If you're looking for a convenient way to boost your receiver's input, the active antenna will do the job. Experimenting with it is a practical lesson in antenna theory. And building from a kit saves you the hassles of rounding up components and drilling out the enclosure, while still giving you the satisfaction, and security that comes from knowing what's inside. For ordering information on the Active SWL Antenna (Kit HD-1424-A) contact the Heath Company, P.O. Box 8589, Benton Harbor, MI 49022-8589; Tel. 1-800-253-0570, or circle No. 120 on the Free Information Card. ■

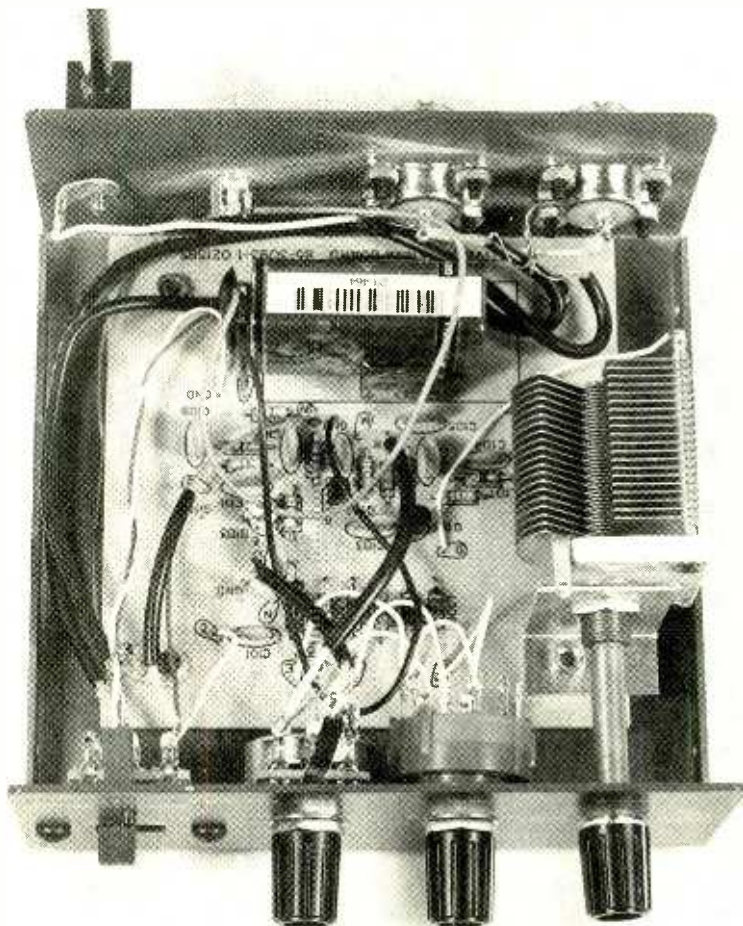

*Building the active antenna involves soldering components to the included printed-circuit board and mounting and wiring the switches, controls, jacks, and other components to the front and back panels.*



# Antique Radio

## MORE ON TUBE TESTER DESIGN

By Marc Ellis

Last month's column heralded the beginning of a brand-new project—the construction of a practical tube tester. As was discussed at some length back then, our object is not to duplicate the performance of a sophisticated commercially built tester. That would be virtually impossible for the home builder to accomplish. In any case, with the availability of good instruments on the second-hand market at very reasonable prices, it would be foolish even to try.

Yet any tester modern enough to offer the accuracy and flexibility we'd like to have probably won't be able to handle some of the older tube types. It's easy to find equipment that will check almost anything dating back to the late 1920's. But many instruments lack the data and/or the specialized sockets required to test early battery powered tubes such as the types 12, 99, or 01-A.

It would be really useful, then, to have a unit designed to test *only* those older tubes. Since such a unit would be required to handle just a few types, it would be relatively easy to design, build, and calibrate. And, with it on hand to supplement your regular tester, you'd be able to check almost any early tube that might happen to come your way.

Last month, we spent some time establishing the technical basis for the tube tester and discussing individual examples of circuitry for assessing tube quality, "gassiness", and heater-to-cathode leakage. For simplicity's sake, our example circuits were all powered by batteries.

Now I'd like to talk about a single tube-checker circuit that incorporates all of the tests previously discussed and that would be powered by the AC line. Of necessity, this month's discussion will depend heavily on last month's. So if you've just joined us, try to get yourself a copy of the September column to read for background information.

**The Basic Tester Circuit.** Our AC-powered "do-it-all" tester circuit is shown as Fig. 1. But, although that circuit is very close to the one that we're actually going to build and test, it's not quite construction-ready. It's not time, yet, to unlimber your soldering iron and start scrounging for parts!

The first thing you'll probably notice is that there are five sequentially-numbered tube sockets. Those are required to accommodate the five different categories of tubes we want the tester to be able to handle: triodes with battery-powered filaments (socket 1); triodes with AC-powered heaters (socket 2); screen-grid tubes, or *tetrodes*, with battery-powered filaments (socket 3); tetrodes with AC-powered heaters (socket 4); and rectifier tubes (socket 5).

The socket terminals are labeled according to the tube elements to which

they connect: "F" for filament or heater; "C" for cathode; "P" for plate; and "SG" for screen grid. A spring clip (labeled "CG") is included for attachment to the top-cap control-grid terminal provided on tetrode tubes.

I've shown a tube plugged into socket 2, and will discuss the operation of the tester as it applies to that tube. But, since all tube sockets are connected in parallel ("like" elements wired together), the tester would work in a similar fashion (with exceptions to be discussed) on an appropriate tube plugged into any one of the sockets.

**Powering Up The Tube.** In this version of the tester, power to light up the tube being checked comes from the low-voltage transformer, T1, which substitutes for the "A" battery used in our circuit examples last month. Rheostat R1 is used to adjust the filament voltage to the correct value, as indicated on voltmeter M1. The transformer supplies AC, rather than the DC supplied by the "A" battery. However, for testing purposes, the filament, or heater, of any tube may be operated from either an AC or DC source.

Plate and grid voltages for the tube to be checked come from the AC line, and are adjusted to a standard value (as indicated on meter M2) by rheostat R2. Though DC (as supplied by the "B" and "C" batteries used in our example

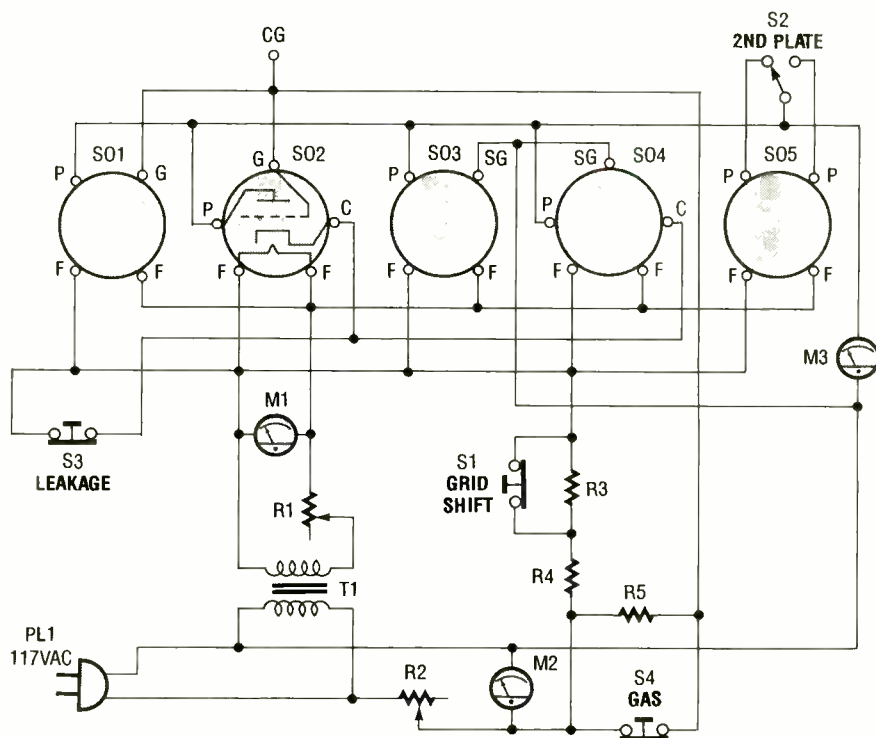

Fig. 1. Our basic late-1920's tube-tester circuit. It needs more refinements (to be added next month) before being construction-ready, so don't get out your soldering irons yet!

circuits last month), rather than AC, is required for the plate and grid circuits, that's not a problem. Because of the way it's wired in the test circuit, the tube acts as a rectifier—converting the AC from the power line into the DC needed for testing purposes.

**The Grid-Shift Test.** As we discussed last month, our basic check for tube quality—as exhibited by amplifying ability—will be the *grid-shift test*, or *mutual-conductance* test. In the test, two different voltages are placed on the control grid of the tube, and the plate current (as indicated on milliammeter M3) is measured for each one. The difference between the two plate currents is a measure of the amplifying ability of the tube (the greater the better).

The two different grid voltages are provided via the circuit formed by resistors R3 and R4, and switch S1. The tube's plate current flows through R4 as it passes from one side of the AC line, through the tube and milliammeter, and back to the other side of the line. Thanks to Ohm's law, that current causes a small voltage to be developed across R4—and the voltage also appears at the grid of the tube, which is wired to the bottom of R4 through the normally-closed gas switch S4 (which we don't need to worry about right now).

After measuring the plate current flowing in the mode just discussed, the normally-closed *grid-shift* switch S1 is pressed—opening its contact and allowing the plate current to pass through *both* R3 and R4. That changes,



*Tony du Bourg (right) and I mug for the camera just prior to loading the Theremin into my VW camper. The instrument made the trip back to Illinois strapped securely atop the VW's sink.*

by a given amount, the voltage appearing at the bottom of R4 and, therefore, at the grid of the tube. Thus, we obtain the second of the two plate-current readings we need to gauge the quality of the tube.

**Gas and Leakage Tests.** As we also discussed last month, checking for gas is a matter of determining whether current is flowing in the tube's grid circuit (in this case, the connection running from the bottom of R4 to the grid terminal). If there *is* current flow in the wire (which would be an indication of the presence of gas), it can be detected by pressing normally-closed switch S4.

Pressing the switch causes its contacts to open, allowing any current that might be flowing to pass through resistor R5. Current flow in the resistor would create a voltage drop, reducing the voltage appearing at the grid. That change in grid voltage would cause a change in the plate current observed on meter M3. If no change in plate current is observed on pressing S4, the tube can be considered to be free from gas.

If a tube has a cathode (such as the one shown under test in the diagram), we need to check for electrical leakage between the cathode and filament (which is known as a "heater" in this type of tube). The cathode and heater are in very close association. Thus, a small breakdown in the insulation between them can cause leakage currents that might interfere with the tube's operation and also make it noisy.

Testing for cathode-heater leakage is as simple as opening the external electrical connection between those two elements (which is accomplished by pressing normally-closed switch S3). When the connection is opened, the reading shown on plate-current meter M3 should drop all the way to zero. If it

doesn't, then internal leakage is present.

**Rectifier Tube Test.** Since rectifier tubes aren't equipped with grids, they obviously can't be checked by means of the "grid-shift" test. However, we can judge the condition of a rectifier by using the simpler "emission" test. The emission-test method was explained in detail in last month's column, and the basic principle is simple: Just power up the tube, apply a standard plate voltage, and observe the resulting plate-current reading. If it's up to standard, and the "gas" test is negative (gas content can give false emission readings), the tube is probably in decent shape.

Socket 5 is wired up for emission testing of rectifier tubes. And you'll notice that S2, a single-pole, double-throw switch, is associated with that socket. The switch is provided for individual testing of the two sections of full-wave rectifier tubes such as the very common

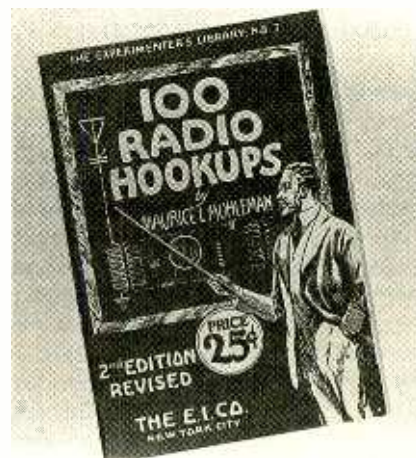

*Would you like to have a reprint copy of this most interesting 1924 Gernsback publication? If you have information about the Theremin to share, you might win one (see text).*

type 80. Just leave the switch in its normal position to test using one of the rectifier plates, then press to remove the original plate from the circuit and substitute the second one.

As described, our tube tester represents state-of-the-art circa 1929. And it should work just as well for us today. But as I've already said, don't be tempted to start building! Between now and next month, I have some refinements to add, including circuitry that will (1) allow the substitution of modern semiconductor-based controls for the clumsy  
*(Continued on page 89)*

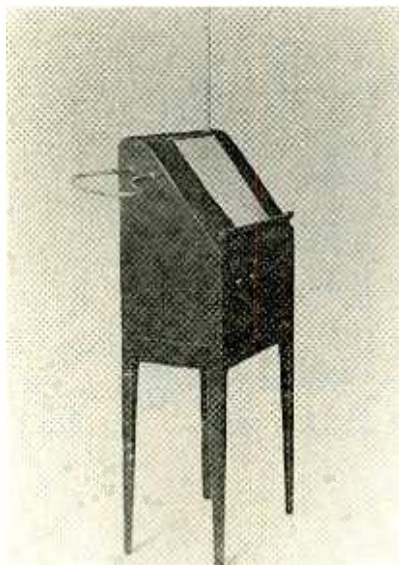

*A photo of the Theremin taken from RCA advertising literature. the straight rod controls pitch; the loop controls volume.*

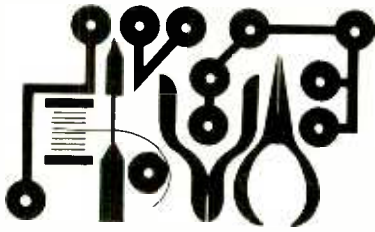

# Circuit Circus

## USEFUL AMPLIFIER CIRCUITS

By Charles D. Rakes

This month we're going to play around with a number of unrelated circuits that can stand alone or be combined with circuits of your own design to complete a new or on-going project. In any case get out your junkbox, plug in your iron, and let the Circus begin.

How many times have you needed to speak to someone in another room, but couldn't without interrupting your work and making the journey in person to deliver the message? If that scenario fits your predicament then consider building our handy-dandy little intercom circuit, and send your messages at lightning speed electronically.

**Two-Way Com-Link.** Figure 1 shows a schematic diagram of a two-station intercom system. Not only is that intercom circuit simplicity itself, but it also offers features not found in some commercial units. There's only one IC per unit and a single inexpensive spring-return toggle switch takes care of the TALK/LISTEN function. When the intercom is in the normal listening position there's no current drain from the battery, and just about any two-wire cable can be used for the transmission line between units. Also, you can connect up to four units to the same two-wire circuit.

A miniature omni-directional electret-microphone element picks up the audio, eliminating the need for a matching transformer and additional switch contacts for switching a single pickup/output device between the input and output circuitry. In a typical intercom a single speaker and matching transformer is used for both sound pickup and output duties. Our approach works just as well and is less expensive and easier to build.

The input audio passes through C1 to the volume-control potentiometer, R2, and from there is fed to the input of the IC amplifier (U1, an LM386 low-voltage audio-power amplifier), where it is amplified about 200 times. The output of U1 is coupled through C4 to one contact

of switch S1-b. From there the signal is routed to the other intercom speakers via the two-wire interconnecting cable.

Each intercom is powered by a single inexpensive 9-volt battery.

At rest, each intercom unit is in the LISTEN position with their speakers tied together through the two-wire cable. In that condition, no power is applied to either of the two stations. When any one of the intercom stations is switched to the TALK position, the battery is connected and the amplifier's output is fed to the intercom speaker at the other end of the com-link through the two wire cable.

Building the intercom is simple. Since the parts count is small and the circuit is

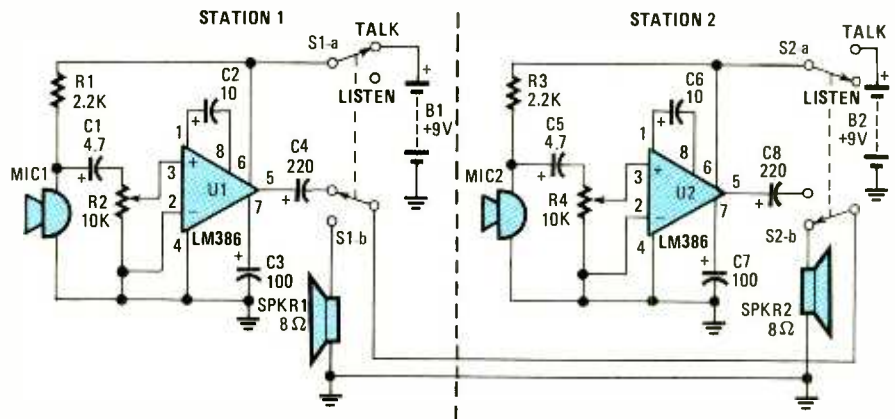

Fig. 1. The Two-Way Com-Link is a simple amplifier design, built around the LM386 low-voltage audio-power amplifier. A single-pole double-throw (SPDT) spring-return switch is used to toggle between the talk and listen modes at each station.

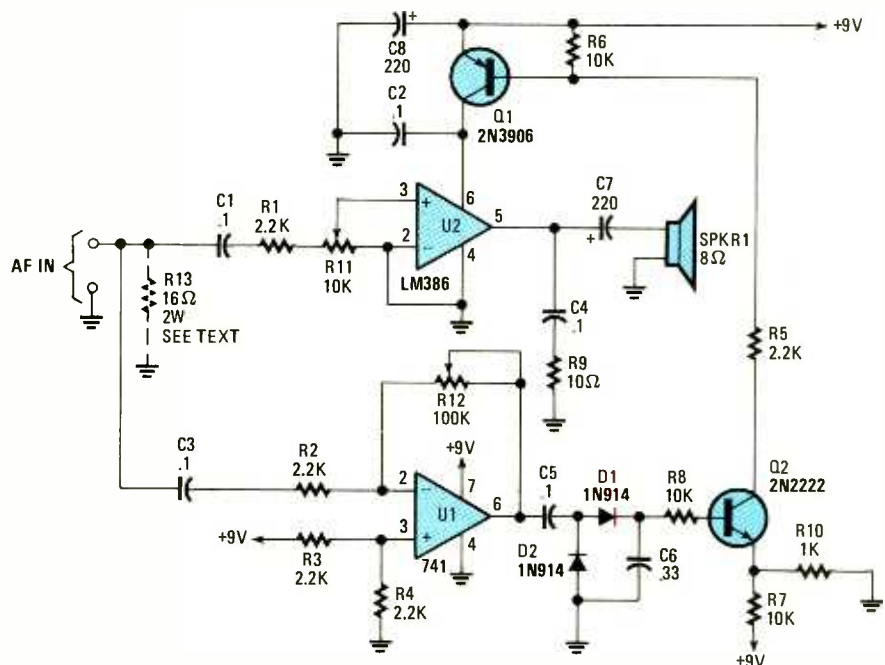

Fig. 2. The Audio-Squelch Circuit is designed to be connected between a receiver's audio output and a speaker to suppress the background noise that might be present between transmissions and during tuning. The circuit can also be used as a power amplifier (with built-in squelch) for a homebrew receiver designed for headphone use only.

## PARTS LIST FOR THE TWO-WAY COM-LINK

### CAPACITORS

C1, C5—4.7- $\mu$ F, 16-WVDC, electrolytic  
C2, C6—10- $\mu$ F, 16-WVDC, electrolytic  
C3, C7—100- $\mu$ F, 16-WVDC, electrolytic  
C4, C8—220- $\mu$ F, 16-WVDC, electrolytic

### ADDITIONAL PARTS AND MATERIALS

U1, U2—LM386 low-voltage audio-power amplifier, integrated circuit  
R1, R3—2200-ohm, 1/4-watt, 5% resistor  
R2, R4—10,000-ohm potentiometer  
B1, B2—9-volt transistor-radio battery  
M1, M2—Electret microphone element  
S1, S2—DPDT spring-return toggle switch  
SPKR1, SPKR2—3 to 4-inch 8-ohm speaker  
Printed-circuit or perfboard materials, enclosure, knob, battery snap, battery holder, wire, solder, hardware, etc.

not critical, you can follow just about any construction scheme that suits your ability. This com-link is an ideal project for printed-circuit board construction and would be a good choice for your

## PARTS LIST FOR THE AUDIO-SQUELCH CIRCUIT

### SEMICONDUCTORS

U1—741 op-amp, integrated circuit  
U2—LM386 low-voltage audio-power amplifier, integrated circuit  
Q1—2N3906 general-purpose, PNP silicon transistor  
Q2—2N2222 general-purpose, NPN silicon transistor  
D1, D2—1N914 general-purpose, silicon diode

### RESISTORS

(All resistors are 1/4-watt, 5% units, unless otherwise noted.)  
R1—R5—2200-ohm  
R6—R8—10,000-ohm  
R9—10-ohm  
R10—1000-ohm  
R11—10,000-ohm potentiometer  
R12—100,000-ohm potentiometer  
R13—16-ohm, 2-watt

### CAPACITORS

C1—C5—0.1- $\mu$ F, ceramic-disc  
C6—0.33- $\mu$ F, Mylar or similar  
C7, C8—220- $\mu$ F, 16-WVDC, electrolytic

### ADDITIONAL PARTS AND MATERIALS

SPKR1—8-ohm, 4-inch speaker  
Perfboard materials, enclosure, knobs, DC power source (see text), wire, solder, hardware, etc.

first attempt at laying out a printed-circuit board, or you can use perfboard and push-in pins. In any case it's a good idea to use IC sockets for the LM386 amplifiers.

The circuit can be housed in just about any enclosure, but plastic is usually cheaper and easier to work with. Mount the electret mike element(s), speaker(s), and switches to face the front of the cabinet. Since you'll probably only need to set the talk volume once, R2 can be located inside the project's enclosure. That will also discourage Murphy from cutting you off by turning the gain down to zero.

To test your homebrew com-link, simply connect the two stations together through a two-conductor run of wire—they should be separated by at least 10 feet to reduce acoustical feedback—and set R2 to its mid position. Place the switch of either (not both) stations in the "talk" position and speak into the mike and adjust R2 for the desired output level in the other unit's speaker. Then reverse the procedure using the other intercom.

**Audio-Squelch Circuit.** If you enjoy listening to a radio that is equipped with a squelch, then you'll love our next circuit. Figure 2 shows an audio-squelch circuit that can be connected between a receiver's audio output and a speaker to suppress the background noise that's present between transmissions and during tuning. The audio squelch can make an AM, CW, or SSB receiver sound like a squelched FM radio. The circuit can also be used as a power amplifier (with built-in squelch) for a homebrew receiver designed for headphone use only.

At the heart of the circuit are two IC's: an LM386 low-voltage audio amplifier and a 741 general-purpose op-amp. The LM386 supplies drive for the external speaker and the 741 op-amp controls the squelch's threshold level.

The receiver's audio is fed to the input of both IC amplifiers. The op-amp (U1) can amplify the audio presented to its input by up to 45 times, as determined by the setting of the threshold/gain control, R12. The output of the op-amp at pin 6 is converted to DC by D1 and D2, producing a positive DC signal. That signal is fed to the base of Q2, forward biasing it. The voltage at the junction of R7 and R10 sets the emitter of Q2 to about a 1-volt bias level. When the DC signal voltage at the base of Q2 rises above a 1.6-volt level, Q2 turns on.

Transistor Q2's collector pulls R5 to near ground potential, turning Q1 on and powering up the LM386 audio amplifier. The audio signal is amplified and fed to the speaker. As long as the average input-signal level remains fairly constant, U2 remains on, but if the audio drops sufficiently or stops altogether the procedure reverses and U2 is turned off. The values of C6 and R8 determine the time constant for the turn-off delay period.

The audio squelch circuit can be built on perfboard and mounted in a small metal or plastic enclosure, or located inside a receiver. Any 9- to 12-volt DC source that can supply up to 100 mA will power the circuit.

To use the squelch circuit, connect the squelch's audio input to the receiver's external-speaker output and add R13 (a 16-ohm, 2-watt resistor) between the positive signal input and ground, as shown in Fig. 2. That resistor (as indicated by the dashed line) is only needed when the squelch circuit is connected to an output designed to drive a speaker.

Set R12 for its maximum resistance and R11 to about mid range. With the squelch circuit disconnected, tune in a strong station and adjust the receiver's volume for a normal listening level. Reconnect the squelch circuit and readjust R11 for the desired volume. Turn R12 to its minimum resistance setting and the audio should turn off. Slowly increase R12's value until the audio returns. Now slowly tune the receiver to a new station and the audio should turn off between stations and return when the signal is strong and steady. Some experimenting with R12 will help in obtaining the desired squelch action.

To increase the time that the audio remains on between signals, increase the value of C6; to decrease the on time, decrease C6's value.

**Audio Power Amp.** Our next circuit might just turn out to be the very project you've been needing in your shack. How often have you needed a small, but powerful, portable audio amplifier that could be used to jack up an audio signal so it could be heard in a high-noise environment? Or to increase the anemic output of a mini transistor radio? Or to use as a miniature PA system in a pinch? If you've ever been in that predicament, take a look at the circuit shown in Fig. 3.

Thanks to National Semiconductor  
(Continued on page 90)



# Computer Bits

By Jeff Holtzman

## SPRING CLEANING

Spring has long since come and gone, and summer will soon be a memory, but my office is still a mess. There is computer crud covering every square inch of horizontal space. Stacks of partially-read trade journals. Stacks of new books from Microsoft, McGraw-Hill, and others. Software, hardware, dead computers, live computers, disassembled computers, a broken hard disk, extra floppy drives, a couple of mice, a couple of trackballs, a modem, soft fonts for the LaserJet II, LaserJet emulation software for the Panasonic dot-matrix, Forte's wonderful music synthesizer, Autodesk's Animator, Word-Bench from Addison-Wesley, the new version of Qedit, lists of things to do, lists of lists of things to do, old Turbo Pascal listings, old VAX Pascal listings, unfiled columns, unfiled bills, unfiled catalogs, and that's only what I can see!

It's definitely time for a little "spring" cleaning. My wife might have her father dispose of it with a front-loader. I'd better do it before they do. First thing next week, I promise I'll get started—really!

All that stuff doesn't really bother me. What does bother me is that last fall I installed a second hard disk in my workaday machine (an AST Premium/286), and I'm almost out of storage space. That's 80 megabytes of who knows what? My wife thinks the room is a disaster area; it's a good thing that she can't see what a disaster it really is!

Since my computer station is due for some house cleaning, I thought that showing you how I deal with that sort of problem might give you a few ideas for thrashing through the jungle on your own hard disk.

**What's There.** My basic setup consists of two 42-megabyte hard disks configured as shown in Table 1. But before doing any shuffling of disk information, there are some basic questions that must be answered: What's there? Are there redundancies? What do I need? What can I dispose of?

TABLE 1

Drive	Name	Size	Free
C	System	32 MB	2.3 MB
D	Text	21 MB	2.4 MB
E	Test	10 MB	0.4 MB
F	Graphics	21 MB	8.4 MB

The first thing to do is to get a road map of what's contained on each drive. For that purpose I use a little utility called *Vtree*, which was published by PC Magazine years ago. What *Vtree* does is display a graphic view of the directory structure of the specified drive. *Vtree*'s output can be redirected to a file or printer. After running *Vtree* on each drive, I quickly obtained printouts showing the contents of each.

Drive C contains DOS, peripheral device drivers (memory board, mouse, etc.), software for the Irwin 785 tape backup, and numerous utility programs—which occupy about 30 megabytes worth, altogether. Drive D contains working copies of several editors, word processors, and outliners (XyWrite, WordStar, Q&A Write, Word, GrandView, and Qedit), along with a huge directory that branches off into 16 subdirectories, most of which branch off into several more.

Drive E is not quite so complicated, but it's still almost filled. Drive F has a fair amount of space, and most of what's there no longer gets used. That drive was supposed to be for graphics (Windows, PageMaker, Designer), but most of that type of work is done on the Dell 386, so perhaps I can erase most of that stuff.

After staring at the printouts for a while, it became obvious that there were several copies of some programs, and several whose value were, at best, suspect.

**Erasing Files.** I wanted to jump in and start cutting and pruning, but decided to run a backup on the Irwin first, just in case I accidentally deleted something

valuable. During the hour or so while the backup was running, I went through the drive/directory printouts carefully, crossing off unneeded directories, drawing arrows showing how to reorganize others, placing question marks by some whose contents I was unsure of, etc.

When the tape backup was complete, I was ready to go. The first step was to run CHKDSK /F on each drive. Doing so generally places several files of the form FILE000.CHK in the root directory of the drive. It's usually safe to delete those files—but it's worth viewing them just in case. I use a shareware program called LIST.COM for most file viewing because it lets you switch between text and DEBUG (hex/ASCII) formats instantly. (I'll post copies of all the public-domain and shareware programs mentioned here on the Gernsback BBS, 516-293-2283, 300/1200, 8N1. Shareware programs are not free, so please send the registration fee to the respective author.) None of the CHK files contained anything of value, so I deleted them.

Next I went through each drive and removed each unnecessary subdirectory. For that purpose I used another public-domain program called Prune. Prune lets you remove a directory, all files in it, all subdirectories of the specified directory, all files in them, etc., to whatever level that branch happens to lead. Obviously, that's a dangerous operation, so Prune makes you verify twice that you really want to do it.

I knew that were lots of .BAK files all over those disks, and that there were lots of files beginning with JUNK (JUNK, JUNK1, JUNKME, etc.) because I often use that name for creating test files. The point is that I wanted to delete all such files. Another PC Magazine utility called Sweep came in handy there. Sweep executes a specified program in the current directory and all subdirectories of it. So by typing SWEEP DEL \*.BAK while in the root directory, Sweep will delete all BAK files from the current drive. Typing SWEEP DEL JUNK\*.\* eliminates all the junk files.

**Reorganizing.** At this point I had gotten rid of all the unnecessary stuff. But I still had to move other files and directories. In some cases, I wanted to move a single file to a different directory on the same disk. In others, I wanted to move an entire directory to a different disk. In yet others, I wanted to move a directory along with several subdirectories to an-



other spot on the same disk. In still others, I wanted to move a directory structure to another disk.

For moving single files or groups of files, I use a simple public-domain Move utility. It's not fancy, and its lack of error checking can be dangerous. However, it works fast. For moving a directory structure on the same disk, I use a commercial program, KeepTrack, which also happens to be an excellent floppy-based backup system. I used it exclusively for a long time before getting a tape drive, and still use it to perform "incremental" backups (quick backups to floppy) between backups to tape.

For moving files, directories, or directory structures from one disk to another, I use DOS's XCOPY followed by judicious pruning (using Prune, of course) of the original. If you type XCOPY C:\DIRA\\*. \* D:\DIRB\DIRC /S the program will copy all files in DIRA on C to \DIRB\DIRC on D. In addition, the /S tells XCOPY to copy all subdirectories and their contents as well. That method is slightly dangerous, because XCOPY doesn't verify that the copy worked.

However, in a non-networked environment, I've never had any trouble. But I know that some versions of XCOPY (old Zenith versions, among others) do not work right. And XCOPY usually won't work on a network. But the network itself usually provides a comparable utility. NetWare, for example, provides NCOPY.

After moving all files into the proper directories on the proper logical drives, the physical organization of the drives left something to be desired. Here

again I used several commercial utilities.

First I used the DS (directory sort) program that comes with the Norton Utilities. DS will sort a directory according to filename, extension, time/date, or size, so that when you issue a DIR command, files are listed in the appropriate order. Typing DS EN /S at the root directory of a drive sorts every directory by extension, and within common extensions, by file name. Doing so makes all COM files, all BAT files, etc., appear together.

The next step was to run VOPT on each drive. That program defragments a drive, meaning that it rearranges the disk so that all sectors associated with any given file are located one after the other. Doing so makes program and file loading much faster. You should only run this type of program on a thoroughly backed up disk, because if the program crashes in the middle, you could end up with severe problems. Norton includes a similar utility (SD, for Speed Disk), but it takes longer to run, and the result is marginally (if any) better than VOPT's.

The last step was to go through all the XCOPY'ed directories and run a basic test to make sure things worked as they should. Then I backed up the new setup (on a different tape!) to the Irwin.

With all of that out of the way, I started in on the untouched piles of stuff. My wife just wouldn't understand. But even if she couldn't see it, I knew that I had accomplished a lot that afternoon.

**Qedit Update.** I don't know how, but Sammy Mitchell has done it again: He's added features to Qedit while simultaneously making it smaller. Version 2.1 (\$55) has lots of small fixes and new features, including better macro support, a center-line command, a repeat command, top and bottom page margins (but no headers or footers), sorting, box drawing, swapping to EMS. The new version also includes an update program that will read configuration information from earlier versions and patch the new one.

In addition, SemWare has released a separate memory-resident version of the program (\$99). The latter requires only about 9K of DOS memory; it loads the remainder of itself into either expanded or extended memory, where it also stores data. An OS/2 version (\$79) is also available. Registered users of previous versions can obtain updates for roughly half the regular price. ■

## RADIO SILENCER

(Continued from page 72)

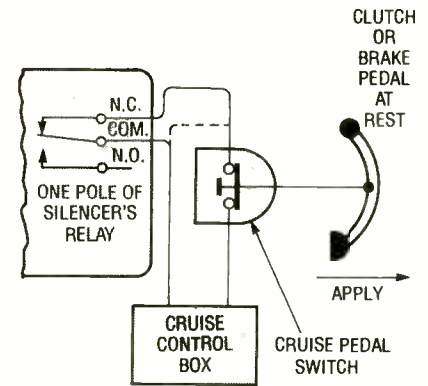

Fig. 4. The Silencer can be made to interrupt your auto's cruise control (as outlined here) whenever the radar detector alarms. You just remove R4 and R5, and cut and connect one of the cruise-control-switch wires through K1's normally-closed and common contacts.

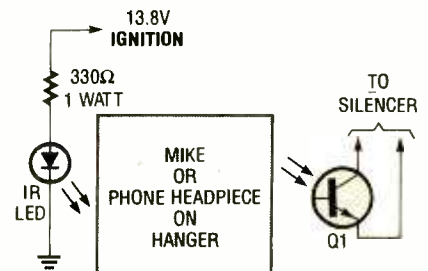

Fig. 5. Another way of installing the Silencer is to mount the infrared emitter and detector on opposite sides of the base unit, so that when the car phone or CB handset is in its cradle, it blocks IR radiation from the IR emitter from reaching the detector. Removing the handset from the rest position would then activate the circuit.

mounted on opposite sides of the base unit, so that when the car-phone handset is in its cradle or the CB mike is on its hook, it blocks IR radiation from the emitter from reaching the detector. Then when the handset or mike is removed from its rest position, the detector senses IR from the emitter and reduces radio volume. If you intend to use this installation, it is recommended that you use a matched IR pair. Matched pairs give the best sensitivity, and are usually cheaper as well.

Finally, the Silencer can also be used to quiet the TV or radio whenever an in-home phone is lifted off its hook. By installing a larger amperage relay, or using the present relay to control a larger relay, the radio's power, or any device you choose, could be shut off all together. ■

### Commercial Programs/Vendors

Norton Utilities  
Peter Norton Computing, Inc.  
100 Wilshire Blvd., 9th Floor  
Santa Monica, CA 90401  
Tel. 213-319-2000

VOPT  
Golden Bow Systems  
2870 Fifth Avenue, Suite 201  
San Diego, CA 92103  
Tel. 619-298-9349

KeepTrack Plus  
The Finot Group  
2390 El Camino Real, Suite 3  
Palo Alto, CA 94306  
Tel. 415-856-2020

Qedit  
SemWare  
4343 Shallowford Road, Suite C-3  
Marietta, GA 30062-5003  
Tel. 404-641-9002

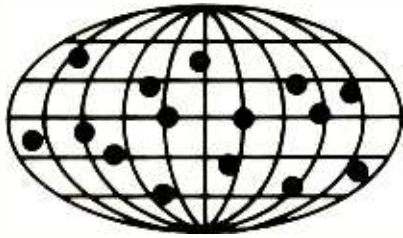

# DX Listening

## MORE THAN JUST A HOBBY

**Y**ou and I listen to shortwave for fun. But out there in the workaday world, there are shortwave monitors who get paid for listening. An ideal job, right? Well maybe. But for the professionals at the British Broadcasting Corporation Monitoring Service (BBCMS), it's hard and serious work.

The BBCMS is funded by the British Foreign Office, but bristles at any suggestion that it is some sort of cloak-and-dagger spy agency. (Its U.S. shortwave-monitoring counterpart, the Foreign Broadcast Information Service, is an arm of the CIA, however.)

The British monitoring operation is located in a former boys school at Caversham Park, some 40 miles west of London. There, some 130 radio monitors—part of a staff of 500 employees—tune in on the world, and note what those voices are saying.

The monitors—both British and foreign nationals, who collectively understand many languages—work in shifts around the clock, listening to the world's broadcasts. They transcribe the broadcasts, but their skills go far beyond linguistics. They are more than just translators; they exercise a high degree of news judgment as well. They must recognize what is newsworthy from among the millions of words that go out on the airwaves from many countries every day.

From the raw transcriptions, 40 editors summarize the monitored information into daily summaries, which are printed and dispatched to the BBCMS subscribers. The information goes into government channels, of course, but it also goes to commercial subscribers, including newspapers, magazines, commercial corporations, universities, even foreign embassies.

\*CREDITS: Steve Wallace, PA; William Taylor, PA; Jerry Klinck, NY; John Carson, OK; Richard D'Angelo, PA; John Tuchscherer, WI; Rufus Jordan, PA; Adrienne Barhydt, OR; Robert Zilmer, NM; Hans Johnson, GA; North American SW Association, 45 Wildflower Road, Levittown PA 19057

By Don Jensen

The BBCMS shares its monitoring duties with the American FBIS, with the British concentrating on broadcasts from the Soviet Union, eastern and western Europe, and the Middle East to Afghanistan. America's professional shortwave listeners cover the rest of the globe—the Far East, Asia, Africa, and Latin America.

Together the two agencies listen in to SW transmissions from 130 different countries, transcribing more than a half-million words a day. The material is boiled down to 100,000 words a day, which is published in a Summary of

World Broadcasts. Other publications include weekly reports on industrial, scientific, and agricultural developments; a 24-hour teletype news and current-affairs file; and a weekly summary on events in the world of broadcasting.

BBCMS has been the first to break many a major news story, based on its monitors' listening. In the midst of the 1962 Cuba missile crisis, before the establishment of the Kremlin/White House "Hot Line," it was the first to pick up, via Radio Moscow, Khrushchev's offer to withdraw the weapons. More recently, BBCMS broke the news of the Ayatollah Khomeini's "death sentence" on author Salman Rushdie.

The service's general manager, Barry Whitehall, says that with the increased freedom of expression within the Soviet Union and eastern Europe, there is even more work for the shortwave-monitoring facility at Caversham Park.

A nearly \$30-million modernization program is underway at BBCMS, which will not only improve the restored mansion—which got its last major overhaul



*These two views show the inner workings of the shortwave relay station operated by Deutsche Welle, the West German international broadcaster, on the Mediterranean island of Malta.*

after an 1850 fire—but will provide sophisticated new electronics gear in a computerized listening room. Still to come is a three-year project to refurbish the main building at Caversham Park to its historic prime.

The British Broadcasting Corporation's Monitoring Service, organized just before the start of World War II, marked its 50th birthday last year. It moves into the '90's with its mission basically unchanged from a half century ago: being a good listener.

**Feedback.** Your comments and questions about shortwave listening, as well as information about some of your latest and most interesting loggings, are always welcome. Send all correspondences to *DX Listening*, **Popular Electronics**, 500-B Bi-County Blvd., Farmingdale NY 11735.

Two letters on the top of the mail stack this month have given me the chance to make a point (even though it may be obvious to some) that shortwave listening is a wonderful pastime for shut-ins and others with various physical challenges. Many SWL's, despite handicaps, are enjoying the listening hobby and traveling the world by radio.

Our first letter is from **Popular Electronics** reader Lew in Fairmont, MN. He says he is "confined to a wheelchair with much time during the day with nothing to do. My hands don't always do what I want them to, but I can operate the controls of a radio."

You sure can, Lew. My father, who introduced me to shortwave radio many years ago, was similarly limited in the use of his limbs and to him, shortwave was his window to the world.

Lew continues, "I am on a fixed income, so I must wisely choose the equipment I wish to purchase. I turn to you for advice because nobody in this area is into serious SWL'ing. In researching books at the library, I find that even the experts differ as to which radios and antennas to choose. Is the buyer's guide in *Passport To World Band Radio* a reliable publication?"

"I would like to purchase a receiver that gives me the widest band coverage, and the best selectivity and sensitivity possible. I would want to pick up AM, FM, single-sideband, and CW signals. I've seen one receiver that seems to have the desired features, but it is priced at \$500, which is more than I intended to spend."

You may not realize it, Lew, but you've already taken the first steps that I rec-

ommend to new listeners seeking advice about receivers. You've thought about what you want from a receiver and how much you're prepared to spend. You've done your homework, and you've read about what's available on the market and what the experts think about the various receivers.

But remember that selecting a shortwave receiver is a bit like buying a car. Uncle Joe says a Ford is tops, your next-door neighbor swears by his Toyota, and your Yuppie brother-in-law gets glassy-eyed talking about his BMW. Listen to their opinions, but make up your own mind about what's right for you. No one else can do that!

Now, in answer to your question, I've found that receiver reviews published in the annual *Passport to World Band Radio* are thorough, careful, and unbiased. *Passport To World Band Radio*—the 1991 edition will be out shortly—covers most receivers, in all price ranges, on the market today. The information is written so even non-technical types can understand it. *Passport To World Band Radio* (Box 300, Penn's Park, PA 18943) also offers supplemental "White Papers" that individually review SW receivers for the potential buyer who wants greater technical detail.

Our next letter is from Sammy who lives in Conroe, TX. He is 41 and is getting back into the radio hobby after many years. But, Sammy says, "I have lost 40 percent of my hearing in both ears. Do you think that will be much of a problem?"

Well, Sammy, that's something only you can determine. I can say, this, however; I have known a number of listeners who have overcome serious disabilities to enjoy their listening hobby. One of the most respected experienced shortwave DX'ers in the world is Arthur Cushen of New Zealand, who is blind. I would suggest that with your hearing loss, you should try using headphones rather than just your receiver's speaker.

**Down The Dial.** Here are some of the shortwave stations others are hearing. How about you? As always, air time is given in Coordinated Universal Time (UTC); which is equal to EDT+4 hours, CDT+5, MDT+6 or PDT+7.

**Brazil**—3,285 kHz. *Radio Sentinela de Amazona* has been heard testing with bi-lingual announcements at around 0200 UTC. Amid the lively vocal selections, SWL's have heard English ID's with call letters ZYG366.

**Brazil**—11,745 kHz. *Radio Bras* is probably the easiest of the Brazilian stations for beginning SWL's to hear. Their English-language programming is aired at 0200 UTC.

**Cameroon**—4,975 kHz. *Radio Douala* is heard with West African hi-life music and French announcements at around 0600 UTC.

**Cameroon**—4,850 kHz. *Radio Yaounde* is another shortwave outlet in this West African nation. You can hear bi-lingual English and French announcements at sign off at 0000 UTC.

**Chile**—15,140 kHz. *Radio Nacional de Chile* is reported with Spanish programming, music, and talk at around 0300 UTC.

**Norway**—17,765 kHz. *Radio Norway International* broadcasts its own programs to North America in English only on Sundays. Try listening at 1600 UTC for "Norway Today."

**USSR**—21,460 kHz. *Radiostansiya Atlantika* is a Russian-language service directed to seamen and produced in studios in the northern port of Murmansk, although the signal is transmitted from stations elsewhere in the Soviet Union. Listen for this one at around 1300 UTC. ■

# ATTENTION! ELECTRONICS TECHNICIANS



## EARN YOUR B.S.E.E. DEGREE

### THROUGH HOME STUDY

Our New and Highly Effective Advanced-Placement Program for experienced Electronic Technicians grants credit for previous Schooling and Professional Experience, and can greatly reduce the time required to complete Program and reach graduation. No residence schooling required for qualified Electronic Technicians. Through this Special Program you can pull all of the loose ends of your electronics background together and earn your B.S.E.E. Degree. Upgrade your status and pay to the Engineering Level. Advance Rapidly! Many finish in 12 months or less. Students and graduates in all 50 States and throughout the World. Established Over 40 Years! Write for free Descriptive Literature.

## COOK'S INSTITUTE OF ELECTRONICS ENGINEERING

 4251 CYPRESS DRIVE  
JACKSON, MISSISSIPPI 39212

CIRCLE 16 ON FREE INFORMATION CARD



# Ham Radio

By Joseph J. Carr, K4IPV

## A DIGITAL FREQUENCY COUNTER MODULE

Every now and then along comes a product that really excites me. One such product is a digital frequency-counter module that you can use to make your own counter (good up to 2-meters) in your own configuration and in the manner that you prefer. Optoelectronics, Inc., Model UTC-150 counter-timer module is a high performance digital counter assembled in "panel-meter" format. That is, it is treated as a component that can be installed on a panel in a cabinet.

The module measures only 3.55 inches wide, 1.765 inches high, and 0.85 inches thick (0.44 inches if the connector is not included). What makes it possible to pack a lot of performance into such a small package is the special applications-specific integrated circuit (ASIC) designed by Optoelectronics for the UTC-150.

The Optoelectronics UTC-150 will perform the following functions: frequency measurement, period measurement ( $T = 1/f$ ), time interval measurement, ratio, and average. Only the most costly counters usually have all of those features. Applications for the UTC-150 include a free-standing or handheld (battery-powered) instrument, an output meter for a signal generator, an add-on frequency-measurement accessory for an oscilloscope (which must have a VERT OUT connection), an output-frequency indicator for an RF signal generator (either newly built or retrofitted into an older instrument), or a digital-frequency dial for an older ham transceiver that has an analog dial.

Homebrewers have long wanted a module like the UTC-150. Only a minimal amount of external circuitry (Fig. 1) is needed to engage all of the module's functions. While other circuits can be added to extend the usefulness of the UTC-150, it will operate as specified with the circuit shown. A +5-volt DC power supply capable of supplying at least 50 mA is needed. The unit consumes only 250 mW of power, so it can be battery powered.

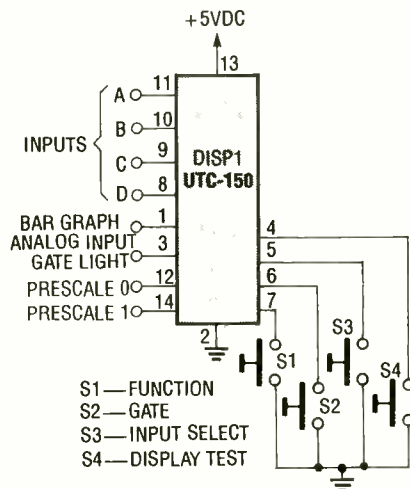
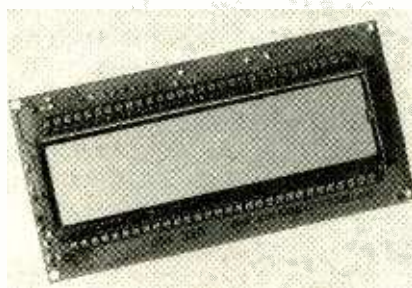

Fig. 1. The Optoelectronics, Inc., Model UTC-150 counter-timer module can perform frequency, period ( $T = 1/f$ ), and time interval measurements, as well as ratio and average measurements, with only a minimal amount of external circuitry needed to engage all of the module's functions.

The UTC-150 will cover the guaranteed frequency range of 0.1 Hz to 150 MHz. Mine clocked on the bench to greater than 210 MHz on an unmodulated signal from my elderly Measurements Model 80 signal generator, but that performance is not guaranteed by the manufacturer. You can get frequen-



Optoelectronics, Inc., Model UTC-150 counter-timer module is a high performance digital counter, measuring only 3.55 inches wide, 1.765 inches high, and 0.85 inches thick.

cy coverage to more than 1 GHz (1000 MHz) if you buy an out-board prescaler for the counter.

Prescalers are very high-speed frequency dividers. A 10:1 prescaler will down-convert a 1.3-GHz signal to 130 MHz. Alternatively, you can also homebrew a heterodyne down-converter. Various editions of the ARRL *Radio Amateur's Handbook* have circuits that will work for prescaler applications.

The display of the UTC-150 is a 10-digit, 120-segment, liquid-crystal (LCD) assembly. The large display area makes it possible to display VHF signals with as fine as 0.1-Hz resolution (10 digits displayed). It will also resolve 1 Hz at 150 MHz (9 digits) when the time-base is one second. In addition to the digits, the display has GATE, FUNCTION and INPUT annunciators. It will tell you whether the counter is measuring frequency, period, ratio, interval, or average, and will indicate the units being used to place the decimal point.

The time base of the UTC-150 is an on-board 1-PPM, 10-MHz crystal oscillator; and provides gate times of 0.01, 0.1, 1.0 and 10 seconds. In the average mode, the UTC-150 will average your selection of 1, 10, 100, or 1000 cycles. The UTC-150 display also has an analog bar graph on the lower right quadrant. That horizontal bar graph is driven by an eight-bit analog-to-digital converter (ADC), and because the bar graph input is available to the user, it can be used as a signal-level display (the bar graph is a 16-segment LCD bar, 3-dB-per-step, over a range of 0- to 2.5-volts DC).

The UTC-150 has four TTL-level inputs (labelled A, B, C, and D). An RF sensitivity of 600 mV is provided.

Optoelectronics also offers a variation on the UTC-150 theme—the UTC-150 Engineering Evaluation Kit (\$299). The kit includes a printed-circuit board and DC power supply to run the kit. Although it is intended for operation on an engineer's bench, it is also useful for some readers as a project. Note, however, that the printed-circuit board is difficult to mount in a box so that the switches are in the right spot. Some readers therefore might want to dismount the switches and install them elsewhere, retaining the power supply and input connector portions of the printed board. Otherwise, just buy the UTC-150 straight—not the evaluation kit. In the near future, I plan to design a complete project around the UTC-150. As I said above, seldom do new prod-

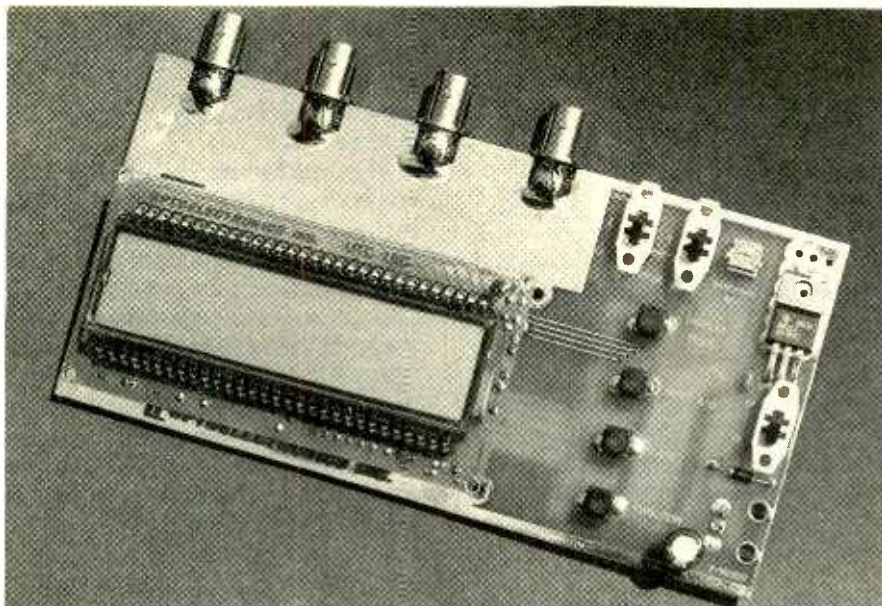

The 10 digit, 120 segment, UTC-150 liquid-crystal display (LCD) module can be powered from a +5-volt DC power source capable of supplying at least 50 mA (250 mW), making it ideally suited to battery-powered applications. The module is also available as an engineering evaluation kit.

ucts spark my imagination as much as the Model UTC-150. The list price of the UTC-150 is \$225 (lower in quantity), but Optoelectronics told me that the price may drop for amateur applications. For more information on the UTC-150, contact Optoelectronics, Inc. (5821 N.E. 14 Avenue, Fort Lauderdale, FL, 33334; Tel. 305-771-2050 or 1-800-327-5912; or FAX on 305-771-2052).

Incidentally, for those who don't want to build a counter using the UTC-150, Optoelectronics also sells ready-built counters. Some hams recall the "opto" display at some hamfests; their counters are popular with hams.

**Contesting.** Have you ever gotten up on a weekend morning to do some hamming, only to find that the bands are teeming with thousands of stations, all calling the same variation of the good ol' "CQ" call? That's a contest weekend, and whether you curse or praise 'em, the contest is a favorite activity for many amateur-radio operators. This is the month of October, and guess what's just around the corner? The ARRL Sweepstakes.

The ARRL Sweepstakes is held every November, and involves amateurs in all 50 states of the USA, and all Canadian provinces. The idea is to work as many stations as possible in as many ARRL Sections as possible. Contact ARRL headquarters (225 Main Street, Newington, CT, 06111) for details about the contest. The years that I participated in it were a lot of fun—not to mention a

good way to earn an ARRL Worked All States (WAS) award in one or two weekends!

**Helpful Hint.** A "solenoid-wound" inductor is one that is longer than its own diameter. Coils for amateur-radio projects are wound from enameled covered wire and bare wire. Cylindrical objects such as wooden dowels, PVC pipe, and pill bottles can be used as coil forms. When the total number of turns just fits into the length available, then the wire can be wound directly and there is no problem.

But when you want to evenly space the turns over the length, you can run into some problems. Despite that, there are some advantages in winding your coil that way: the inductance is closer to the design value, and besides the project looks better. Further, you must space the turns evenly when using bare wire.

Here's a trick you can try when winding that type of coil: wind two windings together (or a winding and a thread or string); the other "winding" is used as a spacer. When the coil is finished, tack down the real winding, and carefully unwind the dummy or spacer winding (see Fig. 2).

**Warning About Antenna Specs.** A growing number of amateurs are operating amplitude modulation (AM), or A3 in FCC terms) on the HF bands. There seems to be a few on 75 and 40 meters.

*(Continued from page 91)*

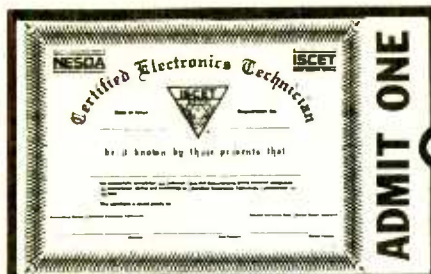

## Your Ticket To SUCCESS

Over 25,000 technicians have gained admittance worldwide as certified professionals. Let your ticket start opening doors for you.

ISCET offers Journeyman certification in Consumer Electronics, Industrial, Medical, Communications, MATV, Radar, Computer, and Video. For more information, contact the International Society of Certified Electronics Technicians, 2708 West Berry St., Fort Worth, TX 76109 • (817) 921-9101.

Name \_\_\_\_\_  
Address \_\_\_\_\_  
City \_\_\_\_\_  
State \_\_\_\_\_ Zip \_\_\_\_\_

Send material about ISCET and becoming certified.

Send one "Study Guide for the Associate Level CET Test." Enclosed is \$10 (inc. postage).



Support America's colleges. Because college is more than a place where young people are preparing for their future. It's where America — and American business — is preparing for its future.

**Give to  
the college of  
your choice.**



# Scanner Scene

By Marc Saxon

## A NEW NAME IN SCANNERS

If you've been thinking that you'd like to see some new names in the scanner market, how does a scanner called the *Yupiteru MVT-5000* grab you? Beginning with its name, it's all new from its case to its computer.

The MVT-5000 is a 100-channel wide-band handheld that covers 25–550 MHz and 800–1300 MHz. (The 550–800-MHz tuning gap represents UHF-TV channel space, so it's nothing you'll miss.) But the MVT-5000 does provide complete coverage of 800–900 MHz, and that's a welcome feature in a less-than-perfect world.

The fully-programmable MVT-5000 offers ten search-scan memory banks. Extra features include selectable single-channel priority keyboard lockout, BNC-antenna connector, and a backlit display for night use. The LCD readout offers 22 separate prompts to ensure ease of operation. All programmable information stored in the RAM is backed up by a long-life lithium battery.

The package is extremely compact, measuring 7 inches high, 2½ inches wide, and 1½ inches deep. It weighs only 13 ounces. Its measured sensitivity exceeds 0.4  $\mu\text{V}$  at 12 dB Sinad (NFM mode), and 1.0  $\mu\text{V}$  at 10 dB S/N (AM mode). Yes, you can select NFM or AM modes at any frequency.

One particularly unusual feature of the Yupiteru scanner is the energy-saving "sleep" mode. In that mode, the computer will actually power down all operating circuits and show the word "sleep" on the display, only powering up periodically to check for active transmissions.

The manufacturer's suggested retail price for the scanner is \$499. That includes a 12-VDC adapter/battery charger and a vehicle power-cord/charger that plugs into a car cigarette lighter. There's a carrying case, a full complement of AA-size rechargeable batteries, and a telescoping antenna. You might want to think about replacing that antenna with a rubberized one, as

metal telescoping types don't take well to the rigors of handheld use.

You can get more information on the Yupiteru MVT-5000 from Ace Communications, 10707 East 106th Street, Indianapolis, IN 46256.



*Not just the name is different on the Yupiteru MVT-5000 100-channel handheld scanner—it offers such unusual features as an energy-saving "sleep" mode, in addition to a host of more standard features.*

**The Answer Man.** An interesting question was posed by Burt Dantzier of Liberty, NY. Burt likes to monitor the NY State Department of Environmental Conservation (DEC) Police's repeaters on 159.225 MHz. He says that many different repeaters throughout the state operate on that one frequency. What puzzles Burt is that the mobile units can obviously pick to use any of several regional repeaters to get the best contact with another station. Sometimes one mobile unit will mention to another that communications are poor, and that he needs to "switch to another tower." In a few seconds, the other station pops up again, still on 159.225 MHz, but obviously on another repeater provid-

ing better communications. Burt is curious as to how that is accomplished, since it's all happening on 159.225 MHz: "How do the mobile signals know which repeater to hit?"

There are two approaches, as that is a common problem faced by designers of communications systems that must cover widespread areas or areas where there are mountains and similar signal-path obstacles. In the instance of the NY DEC Police, all repeaters are on 159.225 MHz, with the standard input repeater frequency being 151.43 MHz. Each repeater input is equipped with its own individual tone-access (CTCSS) requirement that is needed to activate the unit. Mobile units have the ability to transmit different combinations of control tones that can access any specific repeater selected by the operator. As far as the operator is concerned, that can all be accomplished as simply as using a front-panel control on the transceiver that offers a selection of "Centerville Repeater," "Uniondale Repeater," and "Eagle Mountain Repeater."

Another common approach, used primarily by some federal agencies, is less sophisticated, less costly, and pays little attention to optimum frequency-management techniques. That method has all of the repeaters transmitting on one frequency, but each one is set up with a different input frequency. One typical example would be the U.S. Department of Agriculture's Forestry Service. Repeater frequency 168.75 MHz is used, for instance, in some national forests. That frequency is normally paired with no less than three different input channels—168.025, 168.20, and 170.50 MHz—to allow mobile units to select specific repeaters. The USDA has many such multiple-input pairs, as do many other federal agencies, from the National Park Service to the Army Corps of Engineers.

Monitoring, of course, is best accomplished by tuning to the repeater output frequency. Most home scanners won't be able to pick up the distant and weak mobile signals on the input frequencies—and there's really no need to: In the final analysis, it all comes out over the one repeater frequency.

An unusual, but often-asked, question arrived from Mike Prohaska of Arlington, TX. Mike tells us that he's heard that it's possible to "cut a wire, or snip out a diode, or make some other minor modification" to cause a Realistic PRO-34 scanner to transmit on all the frequencies that it will receive.

Although this column has received several dozen cards and letters asking about that, it is pure fantasy. A PRO-34 can be easily modified to restore its ability to receive those portions of the 800-MHz band that the factory suppressed, but nothing short of a visit from Marconi's ghost—in a good mood, and carrying a bag full of new chips and a microphone—will turn the PRO-34 (or any other scanner) into a transceiver on any or all of the frequencies it can receive. That's just one of those weird rumors that float through scanner-land from time to time.

**Keep in Mind.** Frequency 155.475 MHz was once designated as a nationwide police inter-system channel. The intention was for it to be a universal frequency that would allow any police mobile unit to communicate with units of other agencies throughout the nation.

Scanner users have never paid much attention to that channel, so this is a reminder that it's there and sometimes offers some interesting communications. Since it's usually inactive, and few base stations monitor there, sometimes local police use it for an extra car-to-car channel. Try it! ■

Are you in

## DEFAULT

On a Student Loan?

If you're in default on a guaranteed student loan (FISL, GSL, Stafford, SLS, or PLUS loan), you may be eligible for a special program that lets you pay it back without penalty or collection charges.

**SAVE!** on penalty and collection charges

You must pay your loan in full by August 31, 1990 to take advantage of this special program. For information, call the guarantee agency that holds your loan, or call the U.S. Department of Education's toll-free number:

**Federal Student Aid  
Information Center  
(800) 333-INFO**

## ANTIQUE RADIO

(Continued from page 79)

and hard-to-obtain power rheostats R1 and R2 and (2) eliminate the very hazardous condition caused by having the tester wiring connected directly to the AC line.

### Needed: Theremin Information!

Last spring, Eric, my high-school-freshman son, made an interesting request. He's an old-time-theater buff and wanted to spend some time in New York City photographing the rich collection of legitimate theaters and movie palaces to be found there. Would I take him there on spring break?

One reason I was more than happy to comply involved a letter I'd just received from reader Tony du Bourg. Tony, who teaches physics and music at a private high school in New Jersey, offered to present me with an original RCA Theremin provided that I would (1) devote a series of columns to it and (2) pick it up at his New Jersey location.

At this point, you may well be thinking "What's a Theremin?"—so let me digress. The Theremin is an electronic musical instrument invented in the 1920's by a young Russian physicist named Leon you-know-what. The musical tones of Theremin's instrument are generated by oscillator circuits and reproduced via a loudspeaker. RCA produced a version of the Theremin for the consumer market in the late 1920's (see photo), and that was the unit Tony was offering.

One of the most interesting things about a Theremin is that it is played without being touched in any way. The player produces music by changing the position of his/her hands relative to two antenna-like electrodes: a straight one that controls pitch and a looped one that controls volume. The control principle is based on the fact that the movements of the player's hands change the capacitance of internal tuned circuits wired to the antennae.

Tony's location was close to New York City—a fairly easy two-day drive from our Midwest-area home. So when spring break rolled around, Eric and I hit the road for the East with the dual purpose of photographing theaters and picking up Tony's Theremin. We also had an opportunity to visit with Brother Patrick Dowd (by strange coincidence, another New-Jersey-based high-school physics teacher) and view his amazing vacuum-tube museum (reported on in an earlier column) located at Manhattan College. But that visit's a subject for another issue.

The Theremin now reposes in my basement, waiting to be examined, tried out, and written up. However, I could use a little more background on it. Can anyone out there in Readerland help me out with technical information on the RCA Theremin (I have the Rider Manual schematic, but that's about all), photocopies of early articles, reminiscences about performances you may have seen or heard, or anything that would be of general interest?

As an inducement, I plan to give away reprints of a neat little 1924 Gernsback publication titled *100 Radio Hookups*. It contains more than 100 schematics, with appropriate explanatory captions, that cover virtually every type of radio-receiving circuit in use at the time. You'll find the designs used by the major manufacturers as well of those most popular with the kitchen-table experimenters.

I have up to eight of those highly interesting booklets to send out to those readers who send me the most informative letters in the next couple of months. I'll pick Thanksgiving as the arbitrary cut-off date for receipt of submissions and—if I have more good letters than I have books—I'll give preference to letters received earliest. All contributions will be acknowledged in the column. So if you have information to share on Theremins, get busy and send it to me now, c/o *Antique Radio, Popular Electronics*, 500-B Bi-County Blvd., Farmingdale, NY 11735. ■



## CIRCUIT CIRCUS

(Continued from page 81)

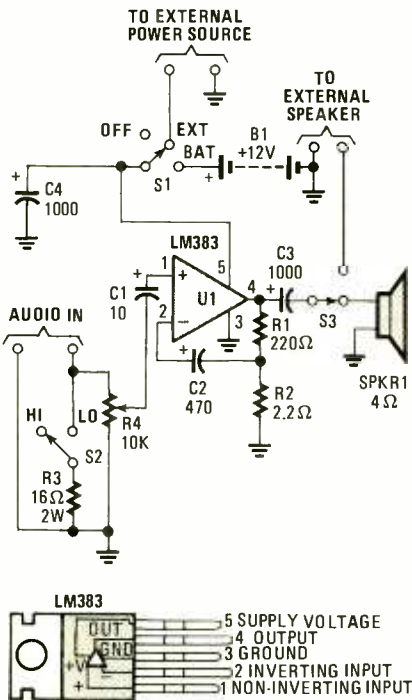

Fig. 3. This Audio Power Amp—built around an LM383 8-watt, audio power amplifier—can be used to boost an audio signal to a sufficient level so that it can be heard in a high-noise environment.

Corporation, the job of building our portable amp couldn't be easier. The very heart of the portable amp is their LM383 8-watt, audio power amplifier. The LM383 is designed to drive low-impedance loads—such as a 4-ohm speaker—with low distortion, powered from supply voltages ranging from 5 to 20 volts. Since the device is designed for automotive applications, 12 volts is an ideal operating voltage. The cost is also very modest at less than three dollars each in single quantities.

Our portable amp is designed to be a general-purpose universal amplifier that can be used for numerous applications. Switch S2 sets the amp's input impedance to a low of 16 ohms (as a speaker load for a transistor radio, etc.) and up to a high impedance of 10k. The amp's output can be switched from the internal 4-ohm speaker to an external speaker. A metal-horn paging speaker will really make the amplifier sound off like the big boys. The amp can be used in automotive applications, powered from the car's battery.

Building the amplifier is simple. The circuit can easily be built on a small

piece of perfboard and housed in a metal or tough plastic cabinet. The LM383 should be mounted on a small heat sink with an area of at least 4 square inches. A simple heat sink can be made from scrap aluminum, or you

## PARTS LIST FOR THE AUDIO POWER AMPLIFIER

### RESISTORS

(All resistors are 1/4-watt, 5% units, unless otherwise noted.)

- R1—220-ohm
- R2—2.2-ohm
- R3—16-ohm, 2-watt
- R4—10,000-ohm potentiometer

### CAPACITORS

- C1—10- $\mu$ F, 25-WVDC, electrolytic
- C2—470- $\mu$ F, 25-WVDC, electrolytic
- C3, C4—1000- $\mu$ F, 25-WVDC, electrolytic

### ADDITIONAL PARTS AND MATERIALS

- U1—LM383 8-watt, audio-power amplifier, integrated circuit
- B1—Eight C-cell batteries
- S1—SP3T rotary switch
- S2, S3—SPDT toggle switch
- SPKR1—4-ohm, 10-watt speaker
- Perfboard materials, enclosure, heat sink material, knobs, handle, battery holder and connector, wire, solder, hardware, etc.

can pick up a ready made one at a local electronic-supply house.

Mount the speaker, input/output jacks, switches, and the volume control (R4) at locations on the cabinet where they will work the best for you. Any arrangement that you are comfortable with will do, as long as you allow enough open area in front of the speaker for the sound to escape unrestricted.

Eight C-cell batteries can be used to power the circuit. A battery holder for the eight "C" cells will make the job of replacement a snap, and a handle mounted to the amp's top will add to its portability. ■



## AUTOMATED HOME

(Continued from page 40)

ner at the end of a hard day, switching to the evening TV news on the main monitor and continuing with a pre-selected menu of favorite TV programs. At the end of the day, it produces bed-time music, checks the doors and windows, and turns out the lights.

**Home Entertainment.** Much more modest are the audio/video systems being offered by Bang & Olufsen and others.

Bang & Olufsen's Beolink system is designed to shuttle audio and video signals from room to room and to command the main system with a comprehensive remote control that handles more commands and does things more quickly than any of the others that are currently on the market. The trouble is that at the moment, it is not designed to interface with more comprehensive systems like CEBus or Mitsubishi's. However, Bang & Olufsen's Beolink system can work in conjunction with Home Manager if desired.



This Beolink system in Atlanta is designed to tie audio and video components in several rooms into a simple remote-controllable package.

One of the problems with home automation, according to Mitsubishi's Bruce Abraham, is that there is a danger of combining so many functions into a single package that only an electronics engineer could operate it. In his own words, "Our engineers come up almost every day with something else they can put into the system. The problem is that these things generally add to the cost of the system and almost always to its complexity. If we're not careful, we wind up with a remote control that's too big for anyone to hold in his hand, or one that requires a manual of several hundred pages to operate (Home Manager's Owner's Manual runs 208 pages). That frightens people away." ■



## HAM RADIO

(Continued from page 87)

Unfortunately, many of our linear amplifiers and antennas are no longer rated at a real 2000 watts when AM is used. A ham friend of mine returned from duty as a radio engineer for *Adventist World Radio* in Central America. He related that during his time there he had wiped out several 1:1 balun transformers on a brand-name beam antenna.

After climbing the tower so many times, he asked the company to clarify the situation. It seems that the 2000-watt specification was a little shabby when it came to AM operation. The company specified the antenna at 2000 watts, but that was for CW and single-sideband (SSB) operation only. An AM signal will put out considerably higher voltages, and so may wipe out the balun if it is insufficiently rated.

Before you operate either your linear amplifier, antenna tuner, or antenna (if it is equipped with a balun or matching network), make sure of the maximum

AM power permissible. The "2000-watt" antenna balun was really only good for about 600 watts of AM (which opens other questions about "spec-smanship").

Note: For those interested in combining ham and computer hobbies, Howard W. Sams book, *Commodore 64 & 128 Programs for Amateur Radio and Electronics* (Sams 22516, 244 pages) is now out of print. However, I have a limited number of copies left, which I will make available on a first-come, first-served basis for \$10 each (the book originally sold for \$14.95). It contains 42 BASIC programs on subjects like antenna calculations, matching-network calculations, VSWR, transmission lines, as well as general-electronics programs like 555 IC timer calculations, power-supply ripple, op-amp circuits, and others.

The programs were written for Commodore computers, but all of them should run on any computer that recognizes any version of BASIC with little or no modification. If you are interested in obtaining a copy, contact me at: Joseph J. Carr, PO Box 1099, Falls Church, VA 22041. ■

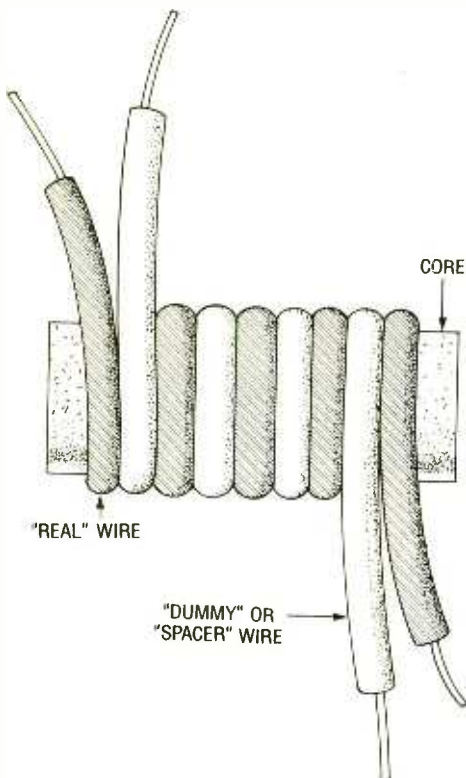

Fig. 2. Shown here is one method of winding an evenly-spaced coil using bare wire. The bare wire is wound onto the form along with an insulating material, another wire for instance. Once the coil is completely wound, the bare wire is secured to the form and the insulating wire is removed, leaving behind an evenly-spaced bare-wire coil.



One tree can make  
3,000,000 matches.



One match can burn  
3,000,000 trees.



A Public Service of This Magazine  
to The Advertising Council

# Be an FCC LICENSED ELECTRONIC TECHNICIAN!



No costly school. No commuting to class. The Original Home-Study course prepares you for the "FCC Commercial Radiotelephone License." This valuable license is your professional "ticket" to thousands of exciting jobs in Communications, Radio-TV, Microwave, Maritime, Radar, Avionics and more... even start your own business! You don't need a college degree to qualify, but you do need an FCC License.

**No Need to Quit Your Job or Go To School**  
This proven course is easy, fast and low cost! **GUARANTEED PASS**—You get your FCC License or money refunded. **Send for FREE facts now. MAIL COUPON TODAY!**

## COMMAND PRODUCTIONS

FCC LICENSE TRAINING, Dept. 100  
P.O. Box 2824, San Francisco, CA 94126  
Please rush FREE details immediately!

NAME \_\_\_\_\_  
ADDRESS \_\_\_\_\_  
CITY \_\_\_\_\_ STATE \_\_\_\_\_ ZIP \_\_\_\_\_

Make the most of your general coverage transceiver with **Monitoring Times!**

Every month *Monitoring Times* brings everything you need to make the most of your general coverage transceiver: the latest information on international broadcasting schedules, frequency listings, international DX reports, propagation charts, and tips on how to hear the rare stations. *Monitoring Times* also keeps you up to date on government, military, police and fire networks, as well as tips on monitoring everything from air-to-ground and ship-to-shore signals to radioteletype, facsimile and space communications.

**ORDER YOUR SUBSCRIPTION TODAY** before another issue goes by. In the U.S., 1 year, \$18; foreign and Canada, 1 year, \$26. For a sample issue, send \$2 (foreign, send 5 IRCs). For MC/VISA orders (\$15 minimum), call 1-704-837-9200.

## MONITORING TIMES

Your authoritative source,  
every month.

P.O. Box 98  
Brasstown, N.C. 28902

# Popular Electronics Special—Choose Electronics Hobbyists . . .

## SELECT 5 BOOKS

for only **\$4<sup>95</sup>** values to \$119.75

when you join the **ELECTRONICS BOOK CLUB<sup>SM</sup>**

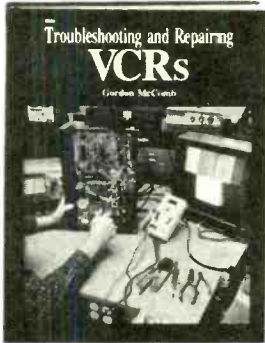
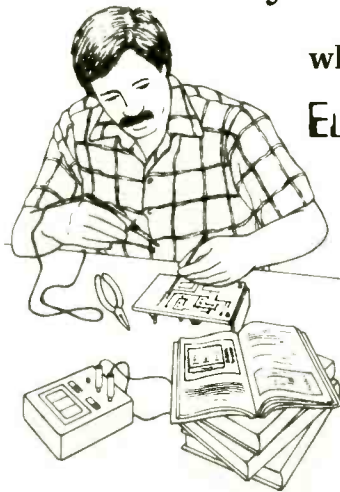

2960 \$27.95  
Counts as 2



1367P \$24.95



2867P \$18.95



804P \$21.95  
Counts as 2



1625P \$22.95



2809 \$29.95  
Counts as 2



2925P \$9.95

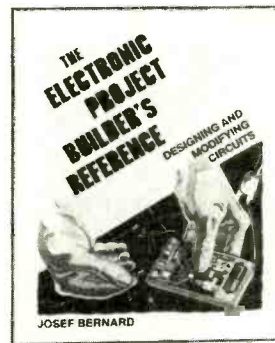

3260 \$22.95



2883P \$17.95



2831P \$15.95



3145 \$19.95



3258 \$27.95  
Counts as 2

For over 25 years, your most complete source for electronics books.

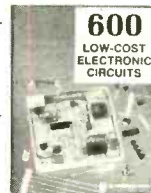

3219 \$27.95  
Counts as 2

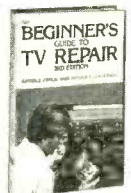

1897P \$14.95



3157 \$25.95  
Counts as 2



3165 \$17.95



2724P \$16.95



2707 \$26.95  
Counts as 2

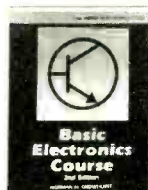

2613P \$17.95

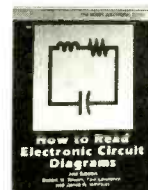

2880P \$14.95



3374 \$24.95



1599P \$17.95

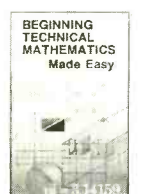

3383 \$14.95

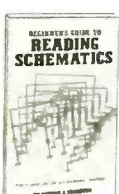

1536P \$11.95



2826P \$16.95



3275 \$22.95



3226 \$22.95

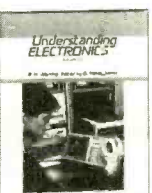

3044P \$11.55



9290 \$36.00  
Counts as 2

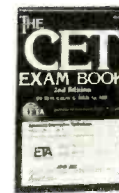

2950 \$21.95



2800P \$16.95

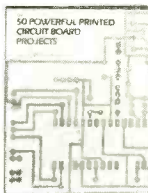

2972 \$23.95

## HOW THE CLUBS

**BIG SAVINGS:** In addition to this introductory offer, you keep saving substantially with members' prices of up to 50% off the publishers' prices.

**BONUS BOOKS:** Starting immediately, you will be eligible for our Bonus Book Plan, with savings of up to 80% off publishers' prices.

**SHOP-AT-HOME CONVENIENCE:** Every 3-4 weeks, you will receive the Book Club News, describing the Main Selections and Alternates, as well as bonus offers and special sales, with scores of titles to choose from.

**AUTOMATIC ORDER:** If you want the Main Selection, do nothing and it will be sent to you automatically. If you prefer another

All books are hardcover unless number is followed by a "P" for paperback (Publishers' Prices Shown)  
A shipping/handling charge and sales tax will be added to all orders.  
© 1990 Electronics Book Club, Blue Ridge Summit, PA 17294-0810

PE1090

# the club that suits your needs . . . Electronics Engineers & Designers . . .

Take any **3** PROFESSIONAL BOOKS for only \$ **4<sup>95</sup>**

when you join the **ELECTRONICS ENGINEERS & DESIGNERS BOOK CLUB** SM

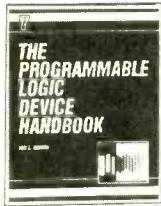

3140 \$49.95  
Counts as 2



3278 \$36.95  
Counts as 2



9243P \$12.95



3131 \$26.95

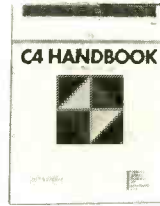

3098 \$44.50  
Counts as 2

values  
to \$168.40

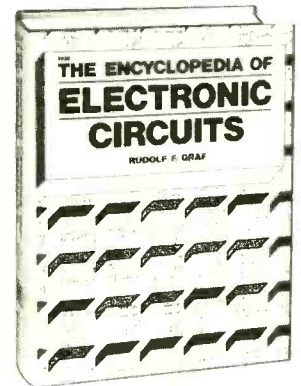

1938 \$60.00  
Counts as 2

Your source for quality, affordable, and timely authoritative engineering books.

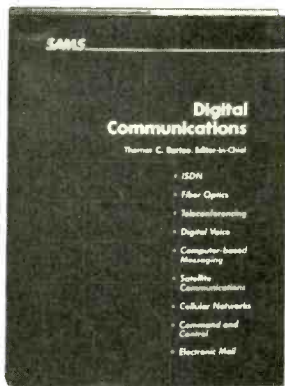

9773 \$44.95



2672 \$49.50



8225P \$19.95

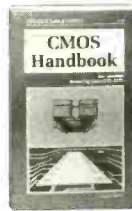

9244P \$18.95

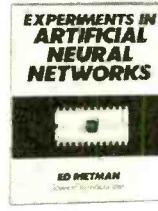

3037 \$24.95



3199 \$52.00  
Counts as 2



9781 \$68.95

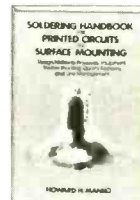

9825 \$49.95

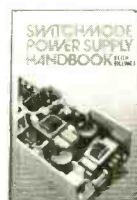

9305 \$59.50  
Counts as 2



3273 \$28.95

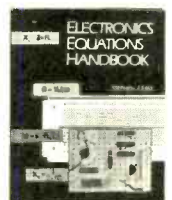

3241P \$16.95

## WORK FOR YOU!

selection, or no book at all, simply indicate your choice on the reply form provided. You will have at least 10 days to decide. As a member, you agree to purchase at least 3 books within the next 2 years and may resign at any time thereafter. Books purchased for professional purposes may be a tax-deductible expense.

**IRONCLAD NO-RISK GUARANTEE:** If not satisfied with your books, return them within 10 days without obligation!

**EXCEPTIONAL QUALITY:** All books are quality editions from the leading publishers and experts in both the electronics and engineering fields, especially selected by our Editorial Board for timeliness and accuracy to members.



3094 \$44.95  
Counts as 2

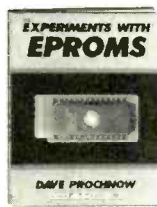

2962P \$17.95



3203 \$44.50  
Counts as 2

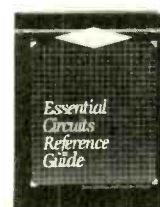

9319 \$59.50  
Counts as 2



3151 \$39.95  
Counts as 2



9813 \$39.95

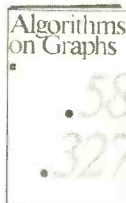

3429 \$29.95

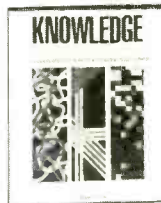

3297 \$39.95  
Counts as 2



3321 \$24.95



9246 \$33.95  
Counts as 2

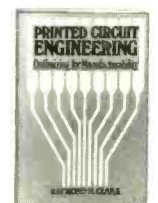

9245 \$46.95  
Counts as 2

All books are hardcover unless number is followed by a "P" for paperback (Publishers' Prices Shown)  
A shipping/handling charge and sales tax will be added to all orders  
©1990 Electronics Engineers & Designers Book Club, Blue Ridge Summit, PA 17294-0860

PEF1090

OCTOBER 1990

## PRINTER TECHNOLOGY

*(Continued from page 68)*

damage IC's, and a very wet atmosphere can cause the wiring, connectors, and printed-circuit boards to corrode and fail. A good working range for a printer is from 55 deg F to 85 deg F, with humidity ranging from 30% to 70%.

Avoid environments that are dusty, dirty, or that contain oils or caustic chemicals. Foreign particles will accumulate in the motor, gears, and belts and cause the printer to jam. Also, keep the printer still and level; excessive vibration can loosen electrical wiring and mechanical assemblies.

**Print Head Maintenance.** Under normal operating conditions, impact print heads (wheel or dot matrix type) will become dirty. The oils in the ribbon ink, combined with paper fibers, will form a paste that will clog wheel dies and jam print wires. Use a clean cotton swab to brush any buildup from the surface of the matrix or die. If the buildup is extreme, dip the swab lightly in a high-quality head cleaner. If wheel dies become seriously clogged, use an old toothbrush that has been soaked in warm, soapy water. Never use strong chemical solvents on a plastic print wheel. A good rule of thumb is to clean impact print heads each time the ribbon is replaced, or any time that you notice a buildup of dirt.

Thermal print heads essentially require no routine maintenance. The pin heaters are fixed in the face of the print head, and potted in a hard epoxy. If a thermal head fails, it must be replaced. Since no ribbon is used, though, and no impact takes place, thermal heads tend to stay much cleaner than their impact counterparts.

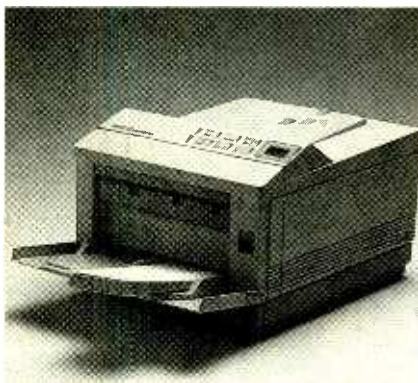

*Laser printers give the user incredible flexibility, quality, and speed, but unfortunately they have an equally incredible price tag.*

Ink must be able to flow freely through the nozzle of an ink-jet head at all times for it to work properly. Unfortunately, ink will tend to dry the moment it is exposed to the air. As a result, the nozzle will begin to clog whenever the printer is not running. It may take anywhere from several days to several weeks for idle ink to clog, depending on the design of the head and the type of ink being used. The best way to prevent an ink jet from clogging is to operate the printer several times a week.

An ink-jet printing head is little more than a small reservoir of ink with a tiny hole in the front for the ink to squirt through. Many heads hold the ink supply in a flexible bladder that can be pressed to force the ink out manually. In the event that an ink-jet head does become clogged, there are things that can be done. To clear a simple nozzle, wipe the nozzle with a clean cotton swab, then gently press on the bladder to force out fresh ink.

Some expensive ink-jet printers have a built-in cleaning cycle that automatically forces ink into the head under high pressure. That will dislodge just about any restriction. If the automatic cleaning does not work, a special ink solvent (chemically matched to the particular ink) may have to be pumped into the head and allowed to soak. Each ink-jet manufacturer may have their own particular cleaning tools and techniques.

Aside from routinely changing the toner cartridge, laser printers will require no routine maintenance. In fact, many manufacturers actually seal the laser, optics, and photosensitive drum in their own containers to prevent access. That is understandable since the optics and drum are so delicate and sensitive, any dust, marks, or nicks left on the mirrors or drum will transfer to the image on each and every subsequent print.

**Paper Feed and Carriage Maintenance.** Although paper feed mechanisms do not tend to wear out, they can become dirty and fall out of alignment very easily. If the drive train of motors, gears, and pulleys does become dirty, paper will feed intermittently or inconsistently. If the drive train must be disassembled, make a careful drawing of the location and orientation of each part. Use alcohol or some other non-solvent cleaner to clean the parts. After reassembling, lubricate the gears with the original type of lubricant. Often, a light oil is satisfactory.

The rollers in the paper feed are made of rubber. Over a period of time, rubber will lose its pliability and become hardened. Typewriter supply stores usually sell a chemical that can be applied to the surface of the rollers to keep them pliable.

Dust and dirt will build up on the long steel rails that the head rides on. Wipe any dirt or rust from the rails with a clean cloth, then use a light oil to lubricate and protect each rail. Clean the carriage assembly each time the ribbon is changed.

**Conclusion.** Computer printers have found a permanent place in both the home and office. Their low cost and high reliability have made them popular in uncounted applications.

Printers eventually need some maintenance to keep them running properly. The most common items to deal with are the print heads, paper feeder, and carriage. Use extreme caution when disassembling any portion of a printer, and make very careful drawings to indicate where each part is to go. With a little practice, anyone can understand and maintain printers. ■

## LIGHTNING

*(Continued from page 34)*

suit from connecting units in this way create a system that is very prone to lightning damage, increased radiated noise, and transient-generated data corruption. The best way to connect a computer system is to use a MOV-protected power strip. Some of these devices also provide telephone-line protection. When one such switching center is used, the telephone-to-modem connection can usually be safely left connected even when the modem is not in use. RS232 spike protectors are available from many computer suppliers and work well when inserted at the computer end of the cable.

A trick that is frequently used by people that understand lightning damage is to feed all stereo and TV sets from a common distribution amplifier. When that is done, the only item that is usually damaged is the distribution amplifier, which can simply be replaced.

Lightning is something to be respected, but not feared. A little common sense and extra care will help your electronic equipment, as well as yourself, to survive. ■

## DIGITAL COURSE

(Continued from page 59)

clock input signal for the 7476 flip-flop, which in turn causes the  $\bar{a}$  and  $\bar{b}$  outputs of the flip-flop to change states (toggle).

Note that the common-cathode terminal of DISP2 has been tied to the  $\bar{a}$  output of the flip-flop, and that the "e" and "f" terminals of the display are connected (through a 270-ohm limiting resistor, R2) to  $+V_{cc}$ . That means that whenever the  $\bar{a}$  output goes low DISP2 will indicate a decimal "1," and when  $\bar{a}$  goes high the display will be blank. The 555 timer IC that is shown just supplies pulses to the circuit as input to be counted.

### 1-1/2-Digit Counter Exercise.

Breadboard the circuit shown in Fig. 1. If you left the circuit from the previous exercise intact, all that will be necessary to do is to add a 7476 J-K flip-flop, a 7490 decade counter, and a second common-cathode 7-segment display to the circuit. When breadboarding the circuit, be sure that the +V and ground are tied to the appropriate terminals of the display and the flip-flop.

Also note that the common-cathode terminal of DISP2 is not tied to ground, but is instead tied to the  $\bar{a}$  output of the flip-flop, and that the flip-flop's clock input (pin 1) derives its input from pin 11

### PARTS LIST FOR THE 1-1/2-DIGIT COUNTER EXERCISE

#### SEMICONDUCTORS

- U1—555 oscillator/timer, integrated circuit
- U2—7490 decade counter, integrated circuit
- U3—7448 BCD-to-7-segment common-cathode display, decoder/driver, integrated circuit
- U4—7476 dual J-K master-slave flip-flop, integrated circuit
- DISP1, DISP2—7-segment, common-cathode LED display

#### RESISTORS

- (All resistors are 1/4-watt, 5% units.)
- R1—4700-ohm
  - R2—270-ohm
  - R3—10,000-ohm
  - R4—1000-ohm

#### ADDITIONAL PARTS AND MATERIALS

- 7474 D flip-flop integrated circuit, breadboard materials, 5-volt power source, wire, etc.

The Digital Microprocessor Course is reprinted here with the permission of the Electronic Industries Association/Consumer Electronic Group (EIA/CEG). The complete parts kit is available from EIA/CEG. For further information, contact EIA/CEG Product Services Department, 1722 Eye Street, NW, Suite 203, Washington, DC 20006; or call 202/457-4986.

(the  $\bar{b}$  output terminal) of the 7490 counter. In addition, since DISP2 is used as a half digit in this application, only the "e" and "f" terminals of the display—which are both tied to the +V bus—are shown. All other inputs are ignored or tied low.

Don't connect the output from the 555 oscillator/timer to the 7490 just yet, but breadboard it just the same; we'll be using it in a moment. Apply power to the circuit and use a logic pulser to send several pulses to the clock input of the 7490 counter. Clock the counter so that it counts through its entire sequence (0–9). As DISP1 makes the transition from "0" to "9," the second display should light, displaying a "1," or if a "1" was already shown on the display, it should go blank. Did the second display function as expected?

Now connect the output of a 555 to the clock input of the circuit (as shown back in Fig. 1). Apply power to the circuit and allow the counter to count through several complete sequences. Describe the behavior of the circuit. What is the maximum count obtainable with the circuit?

Next, try replacing the J-K flip-flop with a D-type flip-flop. How should the D flip-flop be configured in order to take the place of 7476 J-K flip-flop in Fig. 1? Can you make a circuit wherein the J-K flip-flop is replaced by a D flip-flop, while keeping the new circuit's operation identical to the one in Fig. 1? Here's a hint: It is obvious (if you been keeping up with this series) that the 7476 in Fig. 1 is configured as a T flip-flop. Breadboard the circuit in Fig. 1, substituting a 7474 D flip-flop for the 7476 unit. Power up the circuit, and monitor its operation. Is that circuit's operation the same as the one in the figure? It should be if you've done everything correctly.

Once you've completed the experiment, power down the circuit, but do not dismantle it at this time. Portions of that circuit will be used in a following exercise.

## ELECTRONICS PAPERBACKS



- ◀ **BP117—PRACTICAL ELECTRONIC BUILDING BLOCKS, BK-1** ..... \$5.75. Circuits for a number of useful building blocks are presented. Combine these circuits to build the devices you need.

- ◀ **BP192—MORE ADVANCED POWER SUPPLY PROJECTS** ..... \$5.95. Topics covered include switched-mode power supplies, precision regulators, dual tracking regulators and computer-controlled supplies.

More Advanced Power Supply Projects

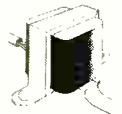

- ◀ **BP190—MORE ADVANCED ELECTRONIC SECURITY PROJECTS** ..... \$5.95. Projects include a passive infra-red detector, a fibre-optic loop alarm, computer-based alarms and an ultrasonic intruder detector.

- ◀ **BP113—30 SOLDERLESS BREADBOARD PROJECTS, BK-2** ..... \$5.95. All projects are based on CMOS logic IC's. Many components are common to several projects. Each project includes a brief circuit description, component layout and parts list.



#### Electronic Music Projects

- ◀ **BP74—ELECTRONIC MUSIC PROJECTS** ..... \$5.95. Provides a number of circuits for Fuzz Box, Waa-Waa Pedal, Sustain Unit, Reverberation and Phaser Units, Tremolo Generator and more.

\*\*\* BOUND



- ◀ **BP255—INTERNATIONAL RADIO STATIONS GUIDE** ..... \$7.95. Provides the casual listener, amateur radio DXer and the professional radio monitor with an essential reference work designed to guide him or her around than ever more complex radio bands.



MAIL TO: **Electronic Technology Today, Inc.**  
P.O. Box 240  
Massapequa Park, NY 11762-0240

#### SHIPPING CHARGES IN USA AND CANADA

\$0.01 to \$5.00	\$1.25	\$30.01 to \$40.00	\$5.00
\$5.01 to \$10.00	\$2.00	\$40.01 to \$50.00	\$6.00
\$10.01 to \$20.00	\$3.00	\$50.01 and above	\$7.50
\$20.01 to \$30.00	\$4.00		

**SORRY, No orders accepted outside of USA and Canada**

Total price of merchandise	\$ _____
Shipping (see chart)	\$ _____
Subtotal	\$ _____
Sales Tax (NYS only)	\$ _____
Total Enclosed	\$ _____

Name \_\_\_\_\_  
Address \_\_\_\_\_  
City \_\_\_\_\_ State \_\_\_\_\_ Zip \_\_\_\_\_

OCTOBER 1990

## VAN DE GRAAFF

(Continued from page 31)

A powerful static charge builds up on the spherical terminal. In a dark room, you will be able to see long, thin, bluish bolts of artificial lightning jump between the upper terminal and the base. It's a fantastic sight!

**Experiments.** Gaseous tube illumination and spark production are only two of the many interesting things you can do with your Van de Graaff generator. Here are just a few of the others:

- Obtain some foam plastic packing material and break it up into small pieces. Turn on your generator and allow it to run for a few moments. Now, drop the plastic bits, one by one, on top of the spherical terminal. They land on the aluminum, sit there for a second, and then shoot off! Some of the plastic may fly for a distance of one or two feet. When the material makes contact with the terminal, it picks up an electric charge. Since like charges repel, the plastic is thrown off the surface of the sphere.

- Find some very thin aluminum foil and carefully cut it into strips about 1/4- to 1/2-inch wide and about 8 inches long. Tape the strips to the top of the terminal. Make sure the foil is making good electrical contact with the aluminum sphere. Turn on the generator. The strips will be repelled from the terminal and from each other. Now approach the sphere slowly with the palm of your hand. The strips will be attracted magnetically to your fingers!

- You can also use your generator to create what is sometimes called an "electric wind." Locate a narrow metal rod about 9- or 10-inches long. Tape one end of the rod to the top of the spherical terminal. Make sure that this end of the rod is entirely covered with tape, and, once again, check for a good electrical contact. Turn on the machine. Next, light a household candle and approach the free end of the rod with the candle flame. As molecules of ionized air rush from the metal tip, the flame will be blown to one side.

These experiments just scratch the surface of what you can do with your generator. The book, *Nature's Electricity* by C.K. Adams (Tab Books, Blue Ridge Summit, PA 17294) contains many other interesting experiments that can be performed with your Van de Graaff generator, as well as other static-electricity experiments. ■

## BEST PRODUCTS

(Continued from page 63)

pects to introduce later this year to compete with Sony's Mavica and Canon's ZapShot. And there were a few video printers, too, although with prices still well in excess of \$1000, we don't expect there to be many takers.

And did we mention the electronic Rolodex, from the people who make the original "paper" one? It's not especially original, but at least you can call it a "Rolodex" without legal ramifications.

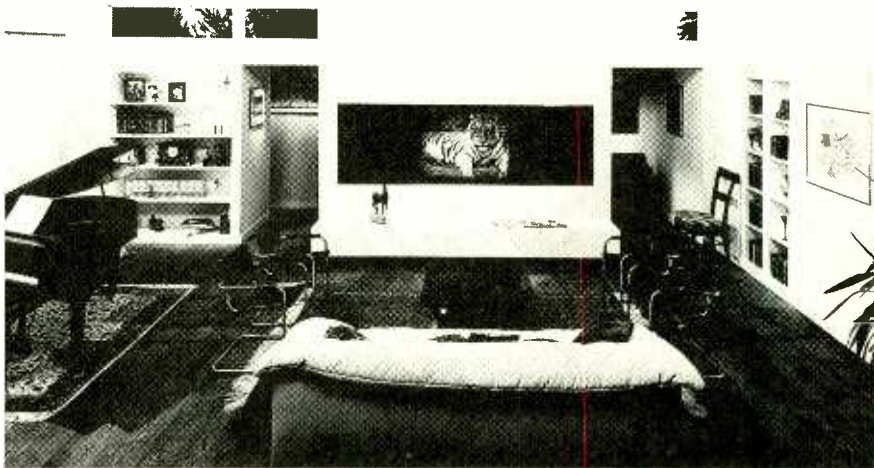

A complete Philips built-in WallVision system, such as this one, includes a 52-inch rear-projection video screen, speakers, and component cabinets for recording and playback equipment.



Franklin's Concise Columbia Encyclopedia is a portable electronic reference work that also includes a search thesaurus and spell-checker.

**Shows, No-Shows, and Trends.** As we noted earlier, there were quite a few DAT decks sitting around, and even playing, but until the copy-protection question is settled, DAT will be more show than sell in this country. There also seemed to be a marginal increase in the amount of HDTV screens at the show, but this technology, too, appears to be slow in getting off the ground. It will be interesting to watch IDTV, EDTV, and HDTV tangle over the next few

years as the technologies fight for control of the airwaves and the market.

Many products made free-and-easy—and not altogether accurate—use of the term "AI," for "Artificial Intelligence." Just about anything with a sensor or with any kind of decision-making capability was being said to use "AI." While we'll grant that the fuzzy logic showing up in some products does border on AI as it is currently being researched, a lot of the rest is just hype. If you fall for something that claims to have AI, make sure it's *real* artificial intelligence.

Something called "DSP" for "Digital Signal Processing," is quietly appearing in a number of products; we're surprised that not more ballyhoo is being made about it. DSP uses digital techniques to replace a number of less precise analog ones, and can also do lots of things that analog can't. Keep your eyes open for products making innovative use of DSP technology—they'll be worth watching for.

What you can expect to see during the next few months—at least until the holiday season has passed—pretty much boils down to this: Lots of 8mm video, more emphasis on laserdiscs and more inexpensive laserdisc-playback equipment, more home theater and other built-in equipment, and lots of fake AI. ■



# ELECTRONICS MARKET PLACE

## FOR SALE

**DESCRAMBLERS.** All brands. Special: Combo Jerrold 400 and SB3 \$165. Complete cable descrambler kit \$39.00. Complete satellite descrambler kit \$45.00. Free catalog. **MJH INDUSTRY**, Box 531, Bronx, NY 10461-0208.

**CAPACITORS, resistors and more.** Buy any quantity direct from importer. Dealers inquiries welcome. Free details. **WORLD TRADE**, 2 Sproule Drive, Brampton, Ontario, Canada L6V 4B9.

**CABLE descrambler liquidation.** Major makes and models available. Industry pricing! (Example: Hamlin Combo's, \$44 each... Minimum 10 orders). Call **WEST COAST ELECTRONICS**, 1 (800) 628-9656.

**FREE catalog.** Interfaces for IBM compatibles. Digital I/O and Analog input. Control relays, motors, lights, measure temperature, voltage. **JOHN BELL ENGINEERING, INC.**, 400 Oxford Way, Belmont, CA 94002. (415) 592-8411.

## CABLE TV DESCRAMBLERS! BARGAIN HEADQUARTERS!



- JERROLD™ •TOCOM •HAMLIN
- OAK •ZENITH
- SCIENTIFIC ATLANTA

6 month warranty! We ship C.O.D!  
Lowest retail/wholesale prices!

FREE CATALOG:  
Global Cable Network  
1032 Irving St. Suite 109  
S.F., CA 94122

NO CALIFORNIA SALES!!!

**ORDER TODAY! 800-327-8544**

**HUGE** 88 page communications catalog of shortwave, amateur and scanner equipment. Antennas, books and accessories too. Send \$1.00 to: **UNIVERSAL RADIO**, 1280 Aida Drive, Dept. PE, Reynoldsburg, OH 43068.

**LASERS** 1mw to 2kw, world's largest selection of new & used surplus. Free catalog. **MWK INDUSTRIES**, 1269 Pomona Road, Corona, CA 91720. (714) 278-0563.

**ELECTRONIC** muscle stimulator! Grow your muscles quickly and effortlessly or resale for huge profits. Complete kit - \$69.95; assembled and tested - \$98.00. **TECHNIX**, Box 55249, Bridgeport, CT 06610.

## WIRELESS CABLE RECEIVERS 1.9 TO 2.7 GHz



30 CH PARABOLIC DISH SYSTEM \$173.90  
30 CH ROD ANTENNA SYSTEM \$193.90  
30 CH CRYSTAL CONTROLLED SYSTEM \$294.95

**SUN MICROWAVE INT'L. INC.** SEND \$1.00 FOR P.O. BOX #34522 CATALOG ON THESE PHOENIX, AZ. 85067 AND OTHER FINE (602) 230-9640 VIDEO PRODUCTS QUANTITY DISCOUNTS LIFETIME WARRANTY

VISA/MC/AMEX

MEMBER OF THE BETTER BUSINESS BUREAU

**TUBES.** TV, radio and industrial. 10,000 stocked. Over 2,000 types available. Largest discounts. Free list. **CHUCK ADAMSON**, Box 640367, El Paso, TX 79904.

**PRINTED** circuit boards etched & drilled. Free delivery. **K & F ELECTRONICS, INC.**, 33041 Groesbeck, Fraser, MI 48026. (313) 294-8720.

## CLASSIFIED AD ORDER FORM

To run your own classified ad, put one word on each of the lines below and send this form along with your check to:

**Popular Electronics Classified Ads**, 500-B Bi-County Boulevard, Farmingdale, N.Y. 11735

**PLEASE INDICATE** in which category of classified advertising you wish your ad to appear. For special headings, there is a surcharge of **\$11.00**.

( ) Plans/Kits ( ) Business Opportunities ( ) For Sale  
( ) Education/Instruction ( ) Wanted ( ) Satellite Television  
( ) \_\_\_\_\_

Special Category: \$11.00

**PLEASE PRINT EACH WORD SEPARATELY, IN BLOCK LETTERS.**

(No refunds or credits for typesetting errors can be made unless you clearly print or type your copy.) Rates indicated are for standard style classified ads only. See below for additional charges for special ads. **Minimum: 15 words.**

1	2	3	4	5
6	7	8	9	10
11	12	13	14	15 (\$23.25)
16 (\$24.80)	17 (\$26.35)	18 (\$27.90)	19 (\$29.45)	20 (\$31.00)
21 (\$32.55)	22 (\$34.10)	23 (\$35.65)	24 (\$37.20)	25 (\$38.75)
26 (\$40.30)	27 (\$41.85)	28 (\$43.40)	29 (\$44.95)	30 (\$46.50)
31 (\$48.05)	32 (\$49.60)	33 (\$51.15)	34 (\$52.70)	35 (\$54.25)

We accept MasterCard and Visa for payment of orders. If you wish to use your credit card to pay for your ad fill in the following additional information (Sorry, no telephone orders can be accepted.):

Card Number \_\_\_\_\_ / \_\_\_\_\_ Expiration Date \_\_\_\_\_

PRINT NAME \_\_\_\_\_

SIGNATURE \_\_\_\_\_

**IF YOU USE A BOX NUMBER YOU MUST INCLUDE YOUR PERMANENT ADDRESS AND PHONE NUMBER FOR OUR FILES. ADS SUBMITTED WITHOUT THIS INFORMATION WILL NOT BE ACCEPTED.**

**CLASSIFIED COMMERCIAL RATE:** (for firms or individuals offering commercial products or services) \$1.55 per word prepaid (no charge for ZIP code)...**MINIMUM 15 WORDS.** 5% discount for same ad in 6 issues within one year; 10% discount for 12 issues within one year if prepaid. **NON-COMMERCIAL RATE:** (for individuals who want to buy or sell a personal item) \$1.25 per word, prepaid....no minimum. **ONLY FIRST WORD AND NAME** set in bold caps at no extra charge. Additional bold face (not available as all caps) **30¢ per word additional.** Entire ad in boldface, \$1.85 per word. **TINT SCREEN BEHIND ENTIRE AD:** \$1.90 per word. **TINT SCREEN BEHIND ENTIRE AD PLUS ALL BOLD FACE AD:** \$2.25 per word. **EXPANDED TYPE AD:** \$2.05 per word prepaid. Entire ad in boldface, \$2.45 per word. **TINT SCREEN BEHIND ENTIRE EXPANDED TYPE AD:** \$2.55 per word. **TINT SCREEN BEHIND ENTIRE EXPANDED TYPE AD PLUS ALL BOLD FACE AD:** \$2.95 per word. **DISPLAY ADS:** 1" x 2 1/4" - \$205.00; 2" x 2 1/4" - \$410.00; 3" x 2 1/4" - \$615.00. **General Information:** Frequency rates and prepayment discounts are available. **ALL COPY SUBJECT TO PUBLISHERS APPROVAL. ADVERTISEMENTS USING P.O. BOX ADDRESS WILL NOT BE ACCEPTED UNTIL ADVERTISER SUPPLIES PUBLISHER WITH PERMANENT ADDRESS AND PHONE NUMBER.** Copy to be in our hands on the 15th of the fourth month preceding the date of issue (i.e.; Sept. issue copy must be received by May 15th). When normal closing date falls on Saturday, Sunday or Holiday, issue closes on preceding work day. Send for the classified brochure. **Circle Number 49 on the Free Information Card.**

## CB RADIO OWNERS!

We specialize in a wide variety of technical information, parts and services for CB radios. 10-Meter and FM conversion kits, repair books, plans, high-performance accessories. Thousands of satisfied customers since 1976! Catalog \$2.

**CBC INTERNATIONAL**

P.O. BOX 31500PE, PHOENIX, AZ 85046

## FREE CATALOG

**FAMOUS "FIRESTIK" BRAND CB ANTENNAS AND ACCESSORIES. QUALITY PRODUCTS FOR THE SERIOUS CB'er. SINCE 1962**

**FIRESTIK ANTENNA COMPANY**  
2614 EAST ADAMS  
PHOENIX, ARIZONA 85034

**QUALITY** electronic parts at bargain prices. Free catalog with **SASE. EAGLE TRADING**, Box 341, Bigfork, MT 59911. Phone (406) 837-5409.

**CABLE TV converters and descramblers liquidation!** Zenith, Tocom, Hamlin, Oak, Jerrold, Scientific Atlanta. Quantity discount! Order now Visa/MC/COD 1 (800) 962-6836.

**CABLE** descramblers (Jerrold) from \$40.00. Tocom VIP test chip. Fully activates unit. \$50.00. Call (213) 867-0081.

**CABLE TV CONVERTERS**  
WHY PAY A HIGH MONTHLY FEE?

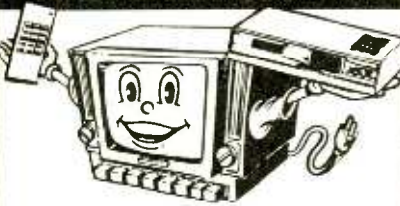

All Jerrold, Oak, Hamlin, Zenith, Scientific Atlanta, Magnavox and all specialized cable equipment available for shipment within 24 hours. For fast service MC / VISA or C.O.D. telephone orders accepted (800) 648-3030 60 Day Guarantee (Quantity Discounts) 8 A.M. to 5 P.M. C.S.T. **CLOSED WEEK-ENDS.** Send self-addressed Stamped envelope (60¢ postage) for Catalog

**MIDWEST ELECTRONICS INC.**  
P.O. Box 5000  
Suite 311 (PE)  
Carpentersville, IL 60110

No Illinois Orders Accepted

**CABLE TV converters and descramblers bargain headquarters!** Jerrold, Tocom, Zenith, Hamlin, Scientific Atlanta. Oak M35B only \$60.00. Free catalog! GEN, 1032 Irving St. #109, SF, CA 94122. Order now! Visa/MC/COD 1 (800) 327-8544.

**ELECTRONIC** parts, kits, software. No minimum orders. Free catalog. **WELSH ELECTRONICS**, 620 Olive Lane, Ambridge, PA 15003-2458.

**CABLE BOXES**  
**FREE CATALOG**  
**1-800-848-3997**  
Jerrold • Scientific Atlanta  
Many Others  
1 Year Warranty • COD's  
**NAS CABLE**

**PLANS & KITS**

**CATALOG: hobby/broadcasting/HAM/CB:** Cable TV, transmitters, amplifiers, surveillance devices, computers, more! **PANAXIS**, Box 130-H10, Paradise, CA 95967.

**BUILD** this five-digit panel meter and square wave generator including an ohms, capacitance and frequency meter. Detailed instructions \$2.50. **BAGNALL ELECTRONICS**, 179 May, Fairfield, CT 06430.

**MINIATURE FM transmitters!** Tracking transmitters! Voice disguisers! Bug detectors! Phone devices! More! Available as kits or assembled and tested! Catalog \$2.00 (refundable): **XANDI ELECTRONICS**, Box 25647, 32VV, Tempe, AZ 85285-5647.

\*\*\*\*\*PRESENTING\*\*\*\*\*  
**CABLE TV  
DESCRAMBLERS**  
\*\*\*\*\*STARRING\*\*\*\*\*  
**JERROLD, HAMLIN, OAK**  
AND OTHER FAMOUS MANUFACTURERS  
• FINEST WARRANTY PROGRAM AVAILABLE  
• LOWEST RETAIL/WHOLESALE PRICES IN U.S.  
• ORDERS SHIPPED FROM STOCK WITHIN 24 HOURS  
FOR FREE CATALOG ONLY **1-800-345-8927**  
FOR ALL INFORMATION **1-818-709-9937**

**PACIFIC CABLE CO., INC.**  
7325 1/2 Reseda Blvd., Dept. 1000  
Reseda, CA 91335

**DETECTION** — Surveillance, debugging, plans, kits, assembled devices. Latest high-tech catalog \$5. **DETECTION SYSTEMS**, 2515 E. Thomas, #16-864J, Phoenix, AZ 85016.

**SURVEILLANCE transmitter kits!** Four models of each; telephone, room, combination telephone/room transmitters tune from 65 to 305 MHz. Catalog with **Popular Communications' and Popular Electronics** book reviews of "Electronic Eavesdropping Equipment Design," \$1.00. **SHEFFIELD ELECTRONICS**, 7223A Stony Island Ave., Chicago, IL 60649-2806.

**VCR amplifier.** Transmits to any TV in the house. Complete unit only \$49.95, kit \$34.95. Miniature FM transmitter-size of postage stamp, up to 1 mile range, \$29.95, kit \$19.95. Kits include PC board and all board mounted components. **CAS ELECTRONICS**, 1525 Aviation Blvd., Suite 136, Redondo Beach, CA 90278.

**RECEIVER** plans, kits. Simple to sophisticated. Thorough explanations included. All bands. Catalog and sample schematics \$3.00. **PREMIER ENTERPRISES**, 3850 Plymouth Blvd, Suite 104, Plymouth, MN 55446.

**REMOTE CONTROL KEYCHAIN**



Complete w/mini-transmitter and +5 vdc RF receiver Fully assembled including plans to build your own auto alarm. Quantity discounts available

**\$24.95** Check, Visa or M/C Add \$3 shipping

**VISITECT INC.** /Dept. P (415) 872-0128  
PO BOX 5442, SO. SAN FRAN., CA 94080

**STRANGE stuff.** Get the advantage! Laser listener, surveillance, descrambling, underground information. Plans, kits, complete items. Informational package \$3.00 refundable. **DIRIJO/BOND**, Box 212, Lowell, NC 28098.

**LASER** lighting entertainment systems. Create your own 3-dimensional laser light shows. Detailed mechanical and electrical schematics, scanning and controls operations. \$20.00 **MILLENIUM**, 877 Saint Charles #5, Thousand Oaks, CA 91360.

**ETCH** your own printed circuit boards using the photographic method. The only inexpensive step-by-step process that every serious electronics hobbyist should have. Send \$12.95 to **ETCHING INFO**, PO Box 8064, Westfield, MA 01086-8064.

**FREE CATALOG!**  
**1-800-648-7938**  
For all Information 1-702-362-9025  
**JERROLD HAMLIN OAK ETC.**  
**CABLE TV  
DESCRAMBLERS**  
• Compare our low Low Retail Prices!  
• Guaranteed Prices & Warranties!  
• Orders Shipped Immediately!  
**REPUBLIC CABLE PRODUCTS INC.**  
4080 Paradise Rd. #15 Dept. PE-90  
Las Vegas, NV 89109

**VIDEOCIPHER II** manuals. **Volume 1** — hardware, **Volume 2** — software — either \$34.95. **Volume 3** — projects/software, **Volume 5** — Documentation or **Volume 6** — Experimentation \$44.95 each. **Volume 4** — repair — \$99.95. **Cable Hacker's Bible** — \$34.95. **Clone Hacker's Bible** — \$34.95. Catalog-\$3.00. CODs: (602) 782-2316. **TELECODE**, PO Box 6426-PE, Yuma, AZ 85366-6426.

**DAZER** personal protection device kit \$44.95. Exciting unique kits catalog \$1.00. **QUANTUM RESEARCH**, 17919-77 Avenue, Edmonton, Alberta T5T 2S1.

**SURVEILLANCE** — audio/video equipment — debugging. Industrial or private. 500 item catalog \$7.00. **SECURITY SYSTEMS**, 3017F Hudson, New Orleans, LA 70131.

**SHORTWAVE** — 1933. One-tube. Plug-in coils. DX radio. Free plans. **BOB RYAN**, PO Box 3039, Anaheim, CA 92803.

**LABORATORY** instrument schematics available. Includes parts, lists, construction and calibration instructions. All projects use readily available components. \$4.97 for a set of three plans. **DENNIS BECKNER**, Box 2003, Tonopah, NV 89049.

**SURVEILLANCE** — countermeasures! **Guaranteed lowest prices!** Huge catalog \$5.00 (refundable). **PROTECTOR**, PO Box 520294-E, Salt Lake City, UT 84152.

**NEW HE NE  
LASER TUBES \$35**  
Dealer Inquiries Invited.  
Free Catalog!

**MEREDITH INSTRUMENTS:** 6403 N. 59th Ave.  
Glendale, AZ 85301 • (602) 934-9387  
"The Source for Laser Surplus"

**AIRCRAFT:** complete plans available for master switch warning system. Circuit warns pilot when master electrical switch is inadvertently left on. For additional information, please send \$2.00 to: PO Box 12282, Hauppauge, NY 11788.

**KITS** — alarms, games and test equipment. Send \$1.00 for catalog. **RAKJAB**, PO Box 1875, Apopka, FL 32704.

**MIND reading and psychic abilities! Train your mind with electronics! Anyone can! Send \$5.00, THE DIRECT COMPANY, 5627 Clippert, Dearborn Hts., MI 48125.**

**UNIQUE** projects. Build an infrared motion detector, ultrasonic distance meter, digital rain gauge. Complete plans, PCB layout. \$4.00 each. Others available. **K. KEMP**, 6932 Westminster Blvd., #162, Westminster, CA 92683.

**EDUCATION/INSTRUCTION**

**MAGIC!** Four illustrated lessons plus inside information shows you how. We provide almost 50 tricks including equipment for four professional effects. You get a binder to keep the materials in, and a one-year membership in the International Performing Magicians with a plastic membership card that has your name gold-embossed. You get a one-year subscription to our quarterly newsletter, "IT'S MAGIC!" Order now! \$29.95 for each course + \$3.50 postage and handling. (New York residents add applicable state and local sales tax). **The Magic Course**, 500-B BiCounty Blvd., Farmingdale, NY 11735.

**LEARN** IBM PC assembly language. 80 programs. Disk \$5. Book \$18. **ZIPFAST**, Box 12238, Lexington, KY 40581-2238.

**SHORTWAVE** — ham scanner radio books. Catalog \$1.00. **TIARE PUBLICATIONS**, PO Box 493PE, Lake Geneva, WI 53147.

"**ELECTRONIC Review.**" Detailed electronics reviewing for bettering grades, interviews and promotions. Over 300 pages \$39.95 include \$4.25 shipping. **USER-GRAPHICS**, Department ED72, 7136 Everett, Boise, ID 83704-7415.

**VCR** technician secrets. Clean VCRs, stop VCRs from eating tapes. Send \$5.00 to: **WHITE'S TV**, PO Box 201-B, Hampton, TN 37658.

**TURN** your love into a living! The professional video industry needs qualified technicians. Institute of Au-



## WANTED ELECTRONIC SCRAP

PC BOARDS - IC'S - RELAYS - SWITCHES  
PLATED PINS - CONNECTORS - ETC.  
ALSO OTHER MATERIAL CONTAINING  
GOLD - SILVER - PLATINUM  
PALLADIUM - RHODIUM - IRIIDIUM  
SHIP FOR IMMEDIATE PAYMENT!  
**METALTECH**  
P.O. Box 464 • Laconia, New Hampshire 03247  
(603) 744-2991 • FAX (603) 744-8127

dio Research, the world leader in audio education, announces the **Video Technology Program** for people like you. In under a year turn your flair for electronics into highly marketable skills. Grads work in broadcast television, production companies, manufacturers, corporate communications, etc. Financial aid available if qualified. HS Diploma or GED required. **INSTITUTE OF AUDIO RESEARCH**, 64 University Place, New York, NY 10003. 1 (800) 544-2501. NY, NJ, CT (212) 777-8550.

**VCR repair** Save money — make big profits! Learn secrets from *How to Keep Your VCR Alive* book. "Problems covered account for more than 90 percent of all common VCR problems... Whether an amateur repairer or professional technician, this practical book is highly recommended for anyone anticipating doing any VCR repairs. Its thoughtful descriptive step-by-step approach will save one considerable frustration. Get it!" says *Modern Electronics*. Also highly recommended by *Popular Electronics*, *Popular Communications*, *Electronic Servicing and Technology*, *Nuts and Volts*, *Video Review*, *Video Business*, *Video Store Magazine*, plus many other national authorities. "Much better than Viejo at 1/7 the cost." Second edition, 400+ pages, 714 illustrations, plus professional head-cleaning tool, \$24.95. Send to **WORTHINGTON PUBLISHING**, 6907-202L Halifax River Drive, Tampa, FL 33617... or call (813) 988-5751 for C.O.D., Visa, or MC. Money-back satisfaction guarantee!

## COMPUTERS

**FREE!** free! IBM software catalog 2000 + disks. Toll free! 1 (800) 345-2983. 24 hours! In Colorado please call: (303) 934-5507. **MEGA-BYTE INC.**, PC Software Supply, 3601 Morrison Road, Denver, CO 80219. Fax: (303) 936-7049.

## LOTTERY

**LOTTERY**— IBM computer disk for all lotteries \$10.00. **ROBERTS**, Box 63/6025, Margate, FL 33063.

## BUSINESS OPPORTUNITIES

**YOUR own radio station!** AM, FM, TV, cable. Licensed/unlicensed. **BROADCASTING**, Box 130-H10, Paradise, CA 95967.

**EASY work!** Excellent Pay! Assemble products at home. Call for information. (504) 641-8003 Ext. 5730.

**MAKE \$50/hr** working evenings or weekends in your own electronics business. Send for free facts. **MJPI INDUSTRY**, Box 531, Bronx, NY 10461.

**UP to \$7,000** month using your VCR. USA, Canada, info \$1.00 cash, US funds. **RANDALL**, Box 2168-E, Van Nuys, CA 91404.

**KELVIN 200**

AC/DC VOLTAGE  
AC/DC CURRENT  
RESISTANCE DIODE TEST  
LOW BATTERY Warning  
ACCURACY +/- 0.5%  
CONTINUITY TEST/BUZZER  
TRANSISTOR CHECKER  
CAPACITANCE CHECKER

\$39.95

Stock No 990091

**KELVIN** Electronics  
7 Fairchild Ave. Plainville, NY 11803  
(516) 349-7620 1(800) 645-9212



# BUY BONDS

## BEST BY MAIL

Rates: Write National, Box 5, Sarasota, FL 34230

### BUSINESS OPPORTUNITIES

**BUMPERSTICKER PRINTER.** Cheap, simple, portable. Free details. **Bumper**, POB 22719(PE), Tampa, FL 33622.

**900 PHONE NUMBERS** - \$5,000 + possible weekly, little money needed, I'll teach you. Send \$9.95 + \$1.00 S/H. **RSI**, Box 660(PE), H.V., PA 19006.

### MONEYMAKING OPPORTUNITIES

**CLUE INTO PROFITS** as a Private Investigator! Details \$1.00! **PPS**, 11504 Hughes, Houston, TX 77089.

**ARE YOU ITCHING** to make more money? Details. **Grayco**, 16123 Crystalcreek, Cerritos, CA 90701.

**CLOSEOUTS EXTREMELY PROFITABLE** Postcard Program. \$5,000.00 weekly possible! 1-800-284-2625.

### OF INTEREST TO ALL

**HAVE SOME FUN!** Introductions. Confessions. Jokes. Advice. 1-900-FUN-1990. \$ .95 minute.

**BANISHED 1,500 YEARS!** Translation of Ancient Manuscript, Gospel of Jesus Rediscovered. Free details. **Rare Books(PE)**, 11246 South Postoak, Suite 306, Houston, TX 77035.

**FREE CATALOG - DESIGNER** Clothing. **OMEGA**, 101(PE) Clematis, Pensacola, FL 32503-2834.

**BASIC ELECTRICITY HOME** study course. Free info, send SASE to: Box 9, Flushing, MI 48433.

## CABLE TV "BOXES"

Converters — Descramblers  
Remote Controls — Accessories

- ★ Guaranteed Best Prices ★
- ★ 1 Year Warranty — C.O.D.'s ★
- ★ Immediate Shipping ★
- ★ FREE CATALOG ★

Call or Write  
**TRANS-WORLD CABLE CO.**  
12062 Southwest 117th Court, Suite 128  
Miami, Florida 33186  
1-800-442-9333



**MAKE \$2000.00/week** — reclaiming pure gold from scrap computers. Free report! (worth \$25.00) 1 (900) 246-2323 (\$2.00 min.).

**LET** the government finance your small business. Grants/loans to \$500,000. Free recorded message: (707) 448-0270. (KJ8)

**GUARANTEED work!** Excellent Pay! Assemble simple products at home. Nation's largest/best selection! (904) 686-3634 Ex-7190.

**WHY rent?** Homes for \$1.00, repos. Gov't give away programs! For information (504) 649-0670 Ext. R-5730.

**\$1000.00** immediately stuffing envelopes. Free supplies. Rush stamped, addressed envelope: **IBMT**, 24 Byrd, Kanata, Ontario K2L 2G5.

## WANTED

**INVENTORS!** Call **IMPAC** — we submit ideas to manufacturers! For free information package call in US/Canada 1 (800) 225-5800.

**LM379S** dual audio amp 1-1000 call Rick. 1 (800) 873-3729. **RESOURCE SYSTEMS**, 2475-F Meadowbrook Parkway, Duluth, GA 30136.

**HAVE a new idea? Invention?** Call **THE "CONCEPT NETWORK"** for free confidential kit at 1 (800) 835-2246 ext. 197 US/Canada 24 Hrs. day.

## SURVEILLANCE TELEPHONE

This is a normal functioning telephone!  
**EXCEPT** it has a secret built in monitor.  
Only **YOU** can call and monitor **ALL** conversations, using a secret code, and never be detected! **Range Unlimited.**  
\$175.00 - 6 month Warranty **Range Unlimited.**  
LISTEN ELECTRONICS, 803 Elgin, Muskogee, OK 74401

**ALARMS 1-800-633-8277 SECURITY EQUIP**



## Cable TV Descramblers



If you find a better deal,  
we'll better our deal.

*\*Jerrold \*Tocom \*Hamlin \*Oak  
\*Scientific Atlanta \*Zenith*  
Ask about our extended warranty program.

COD, Visa, M/C welcome.  
Free Call — Free Catalog.

Video Tech **800-562-6884**

2702 S. Virginia St., Ste. 160-304  
Reno, NV 89502.

## SATELLITE TV

**FREE** catalog — Do-it-yourself save 40—60% lowest prices world wide, systems, upgrades, parts, all major brands factory fresh and warranted. **SKY-VISION INC.**, 2008 Collegeway, Fergus Falls, MN 56537. 1 (800) 334-6455.

## T.V. FILTERS

T.V. notch filters, surveillance equipment, brochure \$1.00. **D.K. VIDEO**, Box 63/6025, Margate, FL 33063. (305) 752-9202.

## CABLE EQUIPMENT

**CABLE TV** secrets — the outlaw publication the cable companies tried to ban. HBO, Movie Channel, Showtime, descramblers, converters, etc. Suppliers list included. \$9.95. **CABLE FACTS**, Box 711-H, Pataskala, OH 43062.

## CABLE DESCRAMBLERS OAK M35B COMBO \$39.95

Jerrold, Zenith, Hamlin, Sci. Atlanta, Pioneer & MORE! OUR PRICES ARE BELOW WHOLESALE!

### CABLE+PLUS

14417 Chase St. #481- Panorama City, CA 91402  
1-800-822-9955 • Other info. 1-818-785-4500  
NO CALIF. SALES — DEALERS WANTED

## SERVICES

**PAL** programming. We program from your logic equations or MS-DOS media. Pay us after you get your parts back. **NEVADA COMPUTER ASSOCIATES**, Box 978, Battle Mountain, NV 89820. (213) 666-2152.

## Motion Control System → \$59.00

 Includes Computer, Monitor, Keyboard, Power supply, 4 Motors, and Software.  
Call or Send for **Free Robotics Catalog**

**Silicon Valley Surplus** 4222 E. 12th St. Serving you since 1983  
415 261-4506 Oakland Ca. 94601 8 am to 4 pm PST

## TEST EQUIPMENT

**REMOTE control tester.** Audibly detect infrared from each button of a properly functioning remote control unit. Connection to an oscilloscope is also possible. \$19.95. **SUNSET UNLIMITED**, 29 Chestnut Street, Skowhegan, ME 04976.

## ZENITH DESCRAMBLERS

**ZENITH ZTACS** will work where others have failed, fully warranted with remote. \$175.00 call (213) 478-2506.

## PIRATE RADIO

(Continued from page 58)

With these tips in mind, logging many shortwave pirates is certainly possible. Pirate listening is semi-structured, not completely haphazard.

Pirate-station programming, on the other hand, represents a mixed bag of American and "alternative" cultures. Some of the active music/talk format stations include WJDI, WLAR, WENJ, WHBH, WKZP, WYMN, Samurai Radio, Radio Mexico, Secret-Society Radio, and East-Coast Pirate Radio. The comedy-oriented stations include RCCL, Voice of Laryngitis, Voice of Stench, WXZR, RFM, Voice of Monotony, and Secret Mountain Laboratory. Radio Garbonzo and Radio Clandestine spoof legal and offshore broadcasters. The Voice of Tomorrow and Free-Radio One are right-wing political stations, while odd music/politics/comedy formats are featured on KNBS and Radio USA.

Most pirates have their mail forwarded through one of several mail-drop addresses (see Table 2) to conceal transmitter locations. Obviously, all letters from the stations would

be postmarked from their respective hometowns, so pirates send the letters back to the maildrops before being mailed out again. In order for the system to work, listeners must include three first-class postage stamps or two International Reply Coupons (IRC's). Some stations don't bother to reply to people who don't include proper postage.

Since many pirates are shortwave listeners themselves, they often respond favorably to friendly, personal letters. Some reporting techniques work especially well. For example, including your telephone number on all letters may net a few calls from station operators. Other listeners have had success by sending a cassette recording of the broadcast they'd heard, along with a few extra stamps. Occasionally, stations will record a studio copy of the program onto the tape and return it. Pennants, stickers, T-shirts, and other "goodies" have been received by listeners who send in exceptional reports.

Considering FCC activity, equipment failure, and occasional operator burn-out, it's no wonder that the pirate scene is constantly changing. In order to avoid the FCC, stations alter their broadcasting schedules and try dif-

ferent frequencies. The only way to keep abreast of the current situation is to belong to a newsletter. The Association of Clandestine Radio Enthusiasts publishes a timely monthly bulletin ("The ACE"). Sample copies are available for \$2 from P.O. Box 11201, Shawnee Mission, KS 66201.

Those near the East Coast can tune in the amateur radio ANARC SWL net on 7240 kHz LSB every Sunday morning at 10 AM Eastern time. The amateur network reads shortwave loggings of all sorts on the air. Numerous bits of pirate information are given and sometimes pirates even check in to inform those listening of a future broadcast.

Pirate radio may never change the world, but most pirates serve at least, to make shortwave listening more interesting. Certainly, there's a voice on the airwaves somewhere to proclaim the ideals of almost everyone who cares enough to listen. ■

## ADVERTISING INDEX

POPULAR ELECTRONICS magazine does not assume any responsibility for errors that may appear in the index below.

Free Information No.	Page		Page
6	AMC Sales	16	19
5	All Electronics	23	—
—	Amazing Concepts	75	11
13	C & S Sales	7	—
—	CIE	21	—
18	Chemtronics	17	—
—	Command Productions	89	15
16	Cook's Institute	85	—
—	Damark International	6	10
—	Elec. Industry Association	CV3	9
—	Electronic Tech. Today	8, CV2	12
—	Electronics Book Club	92	7
—	Global Cable Network	99	17
—	Global Engineering	15	8
—	Grantham College	3	—
	Heathkit		13
	Iscet		87
	Jensen Tools		14
	Landis Electronics		25
	MetraByte		44 A/B
	Monitoring Times		91
	Mouser		27
	NRI Schools		11
	Protel Technology		27
	Paladin Electronics		16
	Parts Express		5
	Sequoia Publishing		75
	Sintec		17
	Viejo Publications		14
	Windjammer		CV4

### ADVERTISING SALES OFFICE

**Gernsback Publications, Inc.**  
500-B Bi-County Blvd.  
Farmingdale, NY 11735  
1-(516) 293-3000

President: **Larry Steckler**

Vice President: **Cathy Steckler**

**For Advertising ONLY**  
516-293-3000  
Fax 1-516-293-3115

**Larry Steckler**  
publisher

**Arline Fishman**  
advertising director

**Denise Haven**  
advertising assistant

**Christina Estrada**  
advertising associate

**Kelly McQade**  
credit manager

**Customer Service/Order Entry**  
1-800-435-0715  
1-800-892-0753  
7:30 AM - 8:30 PM EST

#### SALES OFFICES

##### EAST/SOUTHEAST

**Becky Akers**  
Pattis/3M  
310 Madison Ave., Suite 1804  
New York, NY 10017  
1-212-953-2121  
Fax 1-212-953-2128

##### MIDWEST/Texas/Arkansas/ Okla.

**Ralph Bergen**  
540 Frontage Road—Suite 339  
Northfield, IL 60093  
1-708-446-1444  
Fax 1-312-446-8451

##### PACIFIC COAST/Mountain States

**Marvin Green**  
5430 Van Nuys Blvd., Suite 316  
Van Nuys, CA 91401  
1-818-986-2001  
Fax 1-818-986-2009

# The Importance Of Setting Standards.

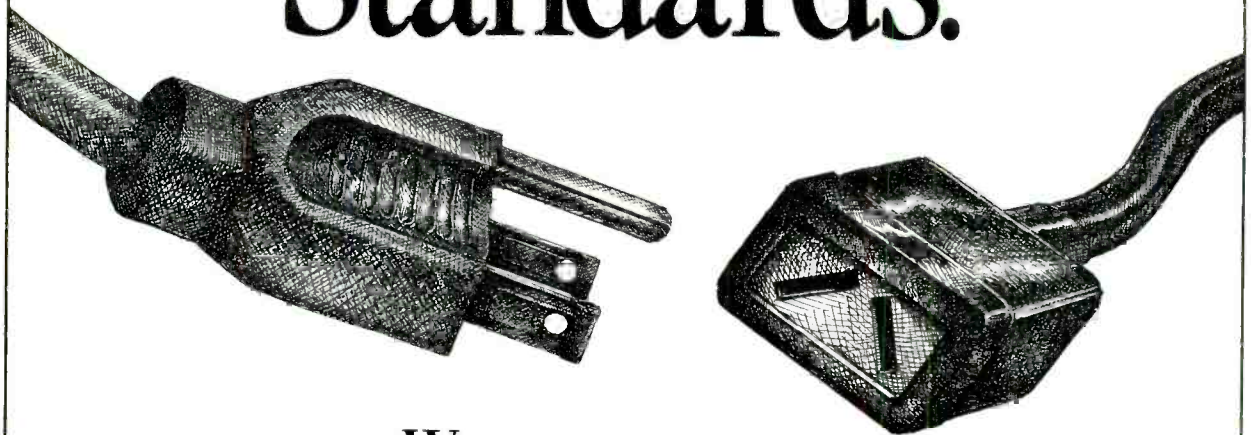

**W**ithout standardization in electronics, television wouldn't be seen, radio wouldn't be heard, computers wouldn't share information.

Fortunately the Electronic Industries Association (EIA) has been setting electronics standards since 1924 for everything from early tube radios to today's cellular telephones and stereo TV's.

Standards create *markets and jobs*. Today EIA, an internationally accredited standards making body, is helping to make HDTV a reality by working with the federal government and other industry organizations, to develop a timely, uniquely American transmission standard. For home automation,

EIA also is close to completing a standard which will permit all home electronic products to communicate with each other.

Our more than 1,000 member companies are manufacturers representing every facet of the American electronics industry—from defense to consumer products.

EIA is proud of the contributions it has made through its standards making process toward the growth and vitality of the U.S. electronics industries.

Setting the standard for more than 66 years.



**ELECTRONIC INDUSTRIES ASSOCIATION**

1722 Eye Street, N.W., Suite 300, Washington, D.C. 20006

# East of the sun. West of the moon. Windjammer.



A place to live your fantasies.  
A place to free your soul.

To cozy up to the Caribbean sun.  
To dance among a thousand stars  
to the rhythms of steel drums.  
To play on sparkling white and  
pink sand beaches.  
To discover the underwater  
paradise of the reefs.  
To find a new friend and share the  
intimacies of a sensuous night.

To come alive and live.  
To remember for a lifetime.

6 days and 6 nights. From \$675.

Reservations toll free  
1-800-327-2600  
In Florida 305/373-2090.

**Windjammer  
Barefoot Cruises**

Post Office Box 120,  
Miami Beach, Florida 33119.



"Cap'n Mike, rush me my free, full color 'Great Adventure' booklet and show  
me the way to Paradise for 6 days and 6 nights from \$675."  
Windjammer Barefoot Cruises,  
P.O. Box 120, Dept. 1642 Miami Beach, Fla. 33119.

Name \_\_\_\_\_

Address \_\_\_\_\_

City \_\_\_\_\_

State/Zip \_\_\_\_\_