

Explore the Mysteries of St. Elmo's Fire

48784

SEPTEMBER 1990

Popular Electronics

Tesla's Lightning Generator

Design and build your own version of Nikola Tesla's famous high-voltage coil



Build An Experimental AC-Hum Sniffer

Use it to test line cords, trace wiring, and more

How To Hook Up Antennas

There's lots of "action" when you install a ham or SW antenna

Build A Galvanometer

Learn about electromagnetism, and have lots of fun, too!

Super-Simple Video Titler

All you need are a handful of parts and your personal computer



A
GERNSBACK
PUBLICATION

THE GADGETER'S
12
GIZMO
pages
BUYER'S GUIDE

\$2.50 U.S.
\$2.95 CANADA

3 NEW
FactCards
IN THIS ISSUE



```
XXXXXXXXXXXX 5-DIGIT 60506
60506CHM997GADDF FEB91 42
ROBERT DAHN RESP
997 GRAND AVE D58
AURORA, IL 60506
```

Electronics Paperback Books

GREAT PAPERBACKS AT SPECIAL PRICES

BP248—TEST EQUIPMENT CONSTRUCTION \$5.95. Details construction of simple, inexpensive, but extremely useful test equipment. AF Gen, Test Bench Ampl, Audio Millivoltmeter, Transistor Tester and six more.

Test Equipment Construction



How to Use Oscilloscopes and Other Test Equipment



BP267—HOW TO USE OSCILLOSCOPES AND OTHER TEST EQUIPMENT \$6.95. Mastering the oscilloscope is not really too difficult. This book explains all the standard controls and functions. Other equipment is also described.

BP265—MORE ADVANCED USES OF THE MULTIMETER \$5.95. Use these techniques to test and analyze the performance of a variety of components. Also see how to build add-ons to extend multimeter capabilities.



BP256—INTRO TO LOUDSPEAKERS AND ENCLOSURE DESIGN \$5.95. We explore the variety of enclosure and speaker designs in use today so the reader can understand the principles involved.

BP263—A CONCISE INTRO TO dBASE \$6.95. The dBASE series of programs are probably the best known database programs for microcomputers. This book is designed to help you get started working with them.

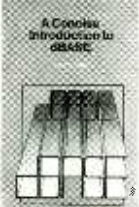

BP260—CONCISE INTRO TO OS/2 \$5.95. If you are a multitasking PC user and want to get the most out of your computer, then you must learn its OS/2 operating system. This book shows you just how to do that, quickly and easily.



BP249—MORE ADVANCED TEST EQUIPMENT CONSTRUCTION \$6.95. Eleven more test equipment construction projects. They include a digital voltmeter, capacitance meter, current tracer and more.



Digital Audio Projects



BP245—DIGITAL AUDIO PROJECTS \$5.95. Practical circuits to build and experiment with. Includes A/D converter, input amplifier, digital delay line, compander, echo effect and more.

BP247—MORE ADVANCED MIDI PROJECTS \$5.95. Circuits included are a MIDI indicator, THRU box, merge unit, code generator, pedal, programmer, channelizer, and analyzer.



BP257—INTRO TO AMATEUR RADIO \$6.95. Amateur is a unique and fascinating hobby. This book gives the newcomer a comprehensive and easy to understand guide to the subject.



PCP102—INTRODUCING DIGITAL AUDIO \$9.95. Covers all kinds of digital recording methods—CD, DAT and Sampling. Bridges the gap between the technician and the enthusiast. Principles and methods are explained.

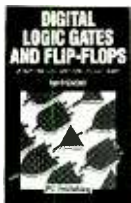

PCP107—DIGITAL LOGIC GATES AND FLIP-FLOPS \$10.00. Thorough treatment of gates and flip-flops for enthusiasts, student and technicians. Only a basic knowledge of electronics is needed.

BP251—COMPUTER HOBBYISTS HANDBOOK \$8.95. A wrapup of everything the computer hobbyist needs to know in one easy to use volume. Provides a range of useful reference material in a single source.



PCP108—COMPUTERS AND MUSIC \$9.95. Explains the basics of computers and music with no previous knowledge of computers needed. Covers types of music software and explains how to set up your own computer music studio.

- BP195—INTRODUCTION TO SATELLITE TV**..... \$9.95. A definitive introduction to the subject written for the professional engineer, electronics enthusiast, or others who want to know more before they buy. 8 x 10 in.
- BP190—ADVANCED ELECTRONIC SECURITY PROJECTS**.....\$5.95. Includes a passive infra-red detector, a fiber-optic loop alarm, computer-based alarms and an unusual form of ultrasonic intruder detector.
- BP235—POWER SELECTOR GUIDE**.....\$10.00. Complete guide to semiconductor power devices. More than 1000 power handling devices are included. They are tabulated in alpha-numeric sequence, by technical specs. Includes power diodes, Thyristors, Triacs, Power Transistors and FETs.
- BP234—TRANSISTOR SELECTOR GUIDE**.....\$10.00. Companion volume to BP235. Book covers more than 1400 JEDEC, JIS, and brand-specific devices. Also contains listing by case type, and electronic parameters. Includes Darlington transistors, high-voltage devices, high-current devices, high power devices.
- BP99—MINI-MATRIX BOARD PROJECTS**.....\$5.50. Here are 20 useful circuits that can be built on a mini-matrix board that is just 24 holes by ten copper-foil strips.
- BP82—ELECTRONIC PROJECTS USING SOLAR CELLS**.....\$5.50. Circuits with applications around the home that are powered by the energy of the sun. Everything from radio receivers, to a bicycle speedometer, to timers, audio projects and more.
- BP117—PRACTICAL ELECTRONIC BUILDING BLOCKS—Book 1**.....\$5.75. Oscillators, Timers, Noise Generators, Rectifiers, Comparators, Triggers and more.
- BP184—INTRO TO 68000 ASSEMBLY LANGUAGE**.....\$6.95. The 68000 is a great new breed of microprocessor. Programming in assembly language increases the running speed of your programs. Here's what you need to know.

BP179—ELECTRONIC CIRCUITS FOR THE COMPUTER CONTROL OF ROBOTS \$7.50. Data and circuits for interfacing the computer to the robot's motors and sensors.

- BP239—GETTING THE MOST FROM YOUR MULTIMETER**..... \$5.95. Covers basics of analog and digital meters. Methods of component testing includes transistors, thyristors, resistors, capacitors and other active and passive devices.
- BP97—IC PROJECTS FOR BEGINNERS**.....\$5.50. Power supplies, radio and audio circuits, oscillators, timers, switches, and more. If you can use a soldering iron you can build these devices.
- BP37—50 PROJECTS USING RELAYS, SCR'S & TRIACS**.....\$5.50. Build priority indicators, light modulators, warning devices, light dimmers and more.
- RADIO—100 RADIO HOOKUPS**.....\$3.00. Reprint of 1924 booklet presents radio circuits of the era including regenerative, neutrodyne, reflex & more.
- BP42—SIMPLE LED CIRCUITS**.....\$5.50. A large selection of simple applications for this simple electronic component.
- BP127—HOW TO DESIGN ELECTRONIC PROJECTS**.....\$5.75. Helps the reader to put projects together from standard circuit blocks with a minimum of trial and error.
- BP122—AUDIO AMPLIFIER CONSTRUCTION**.....\$5.75. Construction details for preamps and power amplifiers up through a 100-watt DC-coupled FED amplifier.
- BP92—CRYSTAL SET CONSTRUCTION**.....\$5.50. Everything you need to know about building crystal radio receivers.
- BP45—PROJECTS IN OPTOELECTRONICS**..... \$5.50. Includes infra-red detectors, transmitters, modulated light transmission and photographic applications.

BP185—ELECTRONIC SYNTHESIZER CONSTRUCTION \$5.95. Use this book to learn how to build a reasonably low cost, yet worthwhile monophonic synthesizer and learn a lot about electronic music synthesis in the process

CHECK OFF
THE BOOKS YOU WANT

ELECTRONIC TECHNOLOGY TODAY INC.
P.O. Box 240, Massapequa Park, NY 11762-0240

SHIPPING CHARGES IN
USA AND CANADA

\$0.01 to \$5.00	..	\$1.25
\$5.01 to 10.00	..	\$2.00
\$10.01 to \$20.00	..	\$3.00
\$20.01 to \$30.00	..	\$4.00
\$30.01 to \$40.00	..	\$5.00
\$40.01 to \$50.00	..	\$6.00
\$50.01 and above	..	\$7.50

SORRY No orders accepted
outside of USA & Canada

Number of books ordered

Name _____
Address _____
City _____ State _____ Zip _____

Total price of merchandise \$ _____
Sales Tax (New York State Residents only) \$ _____
Shipping (see chart) \$ _____

All payments must
be in U.S. funds

Total Enclosed .. \$ _____

P-990

Popular Electronics®

THE MAGAZINE FOR THE ELECTRONICS ACTIVIST!

CONSTRUCTION ARTICLES

TESLA'S LIGHTNING GENERATORS	Ralph Hubscher	29
<i>Design and build your own version of Nikola Tesla's famous high-voltage coil.</i>		
SUPER SIMPLE VIDEO TITLER	Larry Bright	37
<i>Give your home videos that professional look.</i>		
BUILD AN EXPERIMENTAL AC HUM SNIFFER	Steve Payor	59
<i>This circuit makes detecting the source of radiated AC a snap.</i>		
BUILD A MUSIC BOX DOORBELL	Walter W. Schopp	63
<i>It plays one of ten cheerful tunes whenever company comes calling.</i>		

FEATURE ARTICLES

BUILD YOUR OWN GALVANOMETER	Stanley Czarnik	34
<i>Learn about electromagnetism by recreating one of electronics' most important experiments.</i>		
HOW TO ANTENNA	Joseph J. Carr	42
<i>Installing an antenna can be an action-packed activity that's full of pitfalls for the unwary.</i>		
ST. ELMO'S FIRE	Stanley Czarnik	57
<i>Are they disembodied souls, or just a beautiful natural phenomenon?</i>		
ALL ABOUT LASERS	Stephen J. Bigelow	66
<i>Learn about the beams of light that are changing our lives.</i>		
THE DIGITAL ELECTRONICS COURSE	Robert A. Young	72
<i>Learn how BCD-to-7 segment decoder/drivers work with 7-segment displays.</i>		

PRODUCT REVIEWS

GIZMO		45
<i>Including: Vidikron Video Projection System, B.I.C. Venturi Loudspeakers, Sanyo Cordless Telephone, and much more.</i>		
PRODUCT TEST REPORT	Len Feldman	74
<i>Sansui AU-X911DG Integrated Amplifier.</i>		
HANDS-ON REPORT		77
<i>Sound Feeder Mobile Audio Connector.</i>		

COLUMNS

THINK TANK	Byron G. Wels	22
<i>"Oh, the bear went over the mountain..."</i>		
ANTIQUÉ RADIO	Marc Ellis	78
<i>The art of testing tubes.</i>		
COMPUTER BITS	Jeff Holtzman	80
<i>Getting organized, Part III.</i>		
CIRCUIT CIRCUS	Charles D. Rakes	82
<i>Using sound for detection and measurement.</i>		
DX LISTENING	Don Jensen	88
<i>Tune-in to Red Cross broadcasting.</i>		
HAM RADIO	Joseph J. Carr	90
<i>An easy-to-build receiver kit.</i>		
SCANNER SCENE	Marc Saxon	92
<i>Monitoring the military.</i>		

DEPARTMENTS

EDITORIAL	Carl Laron	2
LETTERS		3
ELECTRONICS LIBRARY		4
NEW PRODUCTS		14
ADVERTISERS INDEX		102

Popular Electronics (ISSN 1042-170X) Published monthly by Gernsback Publications, Inc., 500-B Bi-County Boulevard, Farmingdale, NY 11735. Second-Class postage paid at Farmingdale, NY and at additional mailing offices. One-year, twelve issues, subscription rate U.S. and possessions \$21.95, Canada \$26.95, all other countries \$29.45. Subscription orders payable in U.S. funds only. International Postal Money Order or check drawn on a U.S. bank. U.S. single copy price \$2.50. © 1990 by Gernsback Publications, Inc. All rights reserved. Hands-on Electronics and Gizmo trademarks are registered in U.S. and Canada by Gernsback Publications, Inc. Popular Electronics trademark is registered in U.S. and Canada by Electronics Technology Today, Inc. and is licensed to Gernsback Publications. Printed in U.S.A.

Postmaster: Please send address changes to Popular Electronics, Subscription Dept., P.O. Box 338, Mount Morris, IL 61054-9932.

A stamped self-addressed envelope must accompany all submitted manuscripts and/or artwork or photographs if their return is desired should they be rejected. We disclaim any responsibility for the loss or damage of manuscripts and/or artwork or photographs while in our possession or otherwise.

As a service to readers, Popular Electronics publishes available plans or information relating to newsworthy products, techniques and scientific and technological developments. Because of possible variances in the quality and condition of materials and workmanship used by readers, Popular Electronics disclaims any responsibility for the safe and proper functioning of reader-built projects based upon or from plans or information published in this magazine.



Larry Steckler

EHF, CET

Editor-In-Chief and Publisher

EDITORIAL DEPARTMENT

Carl Laron

Editor

Robert A. Young

Associate Editor

John J. Yacono

Associate Editor

Byron G. Wels, K2AVB

Associate Editor

Teri Scaduto

Assistant Editor

Kathy Terenzi

Editorial Assistant

Marc Spiwak

Editorial Associate

Josef Bernard

Joseph J. Carr, K4IPV

Marc Ellis

Len Feldman

Jeffrey K. Holtzman

Don Jensen

Charles D. Rakes

Marc Saxon

Contributing Editors

PRODUCTION DEPARTMENT

Ruby M. Yee

Production Director

Karen S. Tucker

Production Manager

Marcella Amoroso

Production Assistant

ART DEPARTMENT

Andre Duzant

Art Director

Russell C. Truelson

Technical Illustrator

Injae Lee

Assistant Illustrator

Jacqueline P. Cheeseboro

Circulation Director

Michele Torrillo

P-E Bookstore

BUSINESS AND EDITORIAL OFFICES

Gernsback Publications, Inc.

500-B Bi-County Blvd.

Farmingdale, NY 11735

1-516-293-3000

Fax: 1-516-293-3115

President: **Larry Steckler**

Vice President: **Cathy Steckler**

Customer Service/Order Entry

1-800-435-0715

In IL 1-800-892-0753

7:30 AM – 8:30 PM EST

Advertising Sales offices listed on page 102.

Cover photography by
Ralph Hubscher and Diversified Photo Services

Composition by
Mates Graphics



The
Audit
Bureau
of Circulation



The publisher has no knowledge of any proprietary rights which will be violated by the making or using of any items disclosed in this issue.

THE FORGOTTEN GENIUS

By the early 1880's, it was an accepted fact that DC was the only practical way to generate, distribute, and use electric power—even though that meant that a power plant was needed nearly every mile along a transmission line to overcome losses.

But a young Nikola Tesla did not believe the conventional wisdom of his day. Having developed a practical AC system in his mind, he arrived in the U.S. and eventually found a backer willing to take a chance on his “crackpot” (Edison himself called Tesla's theories a “waste of time”) scheme. The rest is history.

Unfortunately, most of that history is now forgotten, and although Tesla is responsible for, or predicted, many of the things we take for granted today, the man himself is rarely remembered.

That is, of course, except for the Tesla coil. This high-voltage AC transformer was developed by Tesla as part of his wireless power-transmission project.

Tesla ran out of money before his experiments could be completed, but the Tesla coil survived and remains popular among today's experimenters. This month, we'll show you how you can design and build your own version of that high-voltage generator.

But Tesla deserves to be remembered for more than this minor experimenter's delight. His genius and contributions permanently altered the course of technology and society. It's something to think about the next time you turn on the lights, or the TV, or...

Carl Laron
Editor



Letters

CLARIFYING TRANSPARENCY USE

Popular Electronics did an excellent job presenting my article, "Iron-On PC Patterns," in the July 1990 issue, but I'd like to clarify a point I've been asked about several times.

The materials known as clear-transparency sheets, overhead-projector sheets, or Mylar sheets are not suitable for iron-on patterns. They can be used for copying onto, and then flipping the pattern to achieve the desired mirror image on the appropriate iron-on sheets. But, if used as iron-ons, half of the toner sticks to the mylar sheets. The result is a poor pattern or porous printed-circuit traces if etched that way.

Mike Giamportone

EASY DOES IT!

I built the "Versatile Code Alarm" by Mike Giamportone from the April 1990 issue of **Popular Electronics**, and it comes in very handy. I sent for the iron-on printed-circuit pattern. It was the first time I'd tried that technique; I had always used resist ink to etch. Following the instructions included, the project was very easy to build, and works just as it's supposed to. My neighbor built another one of the author's projects, the "Programmable Garage/Yard Light controller" (**Popular Electronics**, June 1990), and he loves it.

I don't have a degree in electronics, just what I learned at San Jose High School. Electronics and radio-controlled model airplanes are my hobbies, and I enjoy building the projects in **Popular Electronics**. Keep up the good work.

W.L.
Arecibo, PR

A HOME-BREWED OPTOCOUPLER

It was brought to my attention that some of you who decided to build the "Precision Temperature Controller" (which appeared in the May, 1990 issue of **Popular Electronics**) might be having difficulty in obtaining one of the components essential to the operation of the circuit—the VTL3A26 optocoupler (it has been discontinued by the supplier mentioned in the article).

One alternative is to shake-n'-bake your own. All that's needed is a 6-7-volt, 25-35-mA, Christmas-tree lamp and a light-dependent resistor (LDR) that has a full-light resis-

tance of less than 500 ohms and a dark resistance of 1 megohm. The two devices are placed about a half-inch from each other and sealed in a light-tight package (perhaps made from opaque heat-shrink tubing). Once prepared, the home-brewed optocoupler is simply inserted in the circuit in place of the commercial unit.

Now, with a 40-watt lamp connected to SO1, an AC voltmeter connected across SO1, and the probe at ambient temperature, adjust the temperature control to full on. To prevent the home-brewed optocoupler from operating in a saturated condition, select a new value for R14 by temporarily replacing the fixed resistor with a potentiometer. Then adjust the potentiometer until the AC voltage just drops. At that point, remove the potentiometer from the circuit, measure its resistance, and place a fixed unit of equal value in the circuit at the R14 position. Seal the enclosure, and you're ready to go.

Joseph Giannelli

MIXED-UP "-ISTORS"

Thank you for the kind review of my book, *The Electronic Project Builder's Reference: Designing and Modifying Circuits* (TAB Books, #3260) in the July issue of **Popular Electronics**. Prospective readers should note, however, that in the book I do not, as the review states, deal with the question "Why are there so many resistors?" There is a chapter entitled "Why Are There So Many Transistors?"—but the answer to the resistor question remains for someone more ambitious than I to ask and answer.

Be that as it may, there's still plenty of useful material in there, such as what the letters "E," "I," and "R" used in Ohm's law really stand for, and how to scrounge parts for your projects ... not to mention the matter of transistors.

Josef Bernard

HAVES & NEEDS

I need help! I'm looking for a schematic for a Bearcat scanner, model BC-250. The two circuit boards are PC-60-VO (1978) and PC-60-01 (1979). I had the scanner repaired by a dealer a few years ago, and when it quit again I took off the cover and found some of the legs of the components soldered together. Why? Because the copper trace was no longer there! I believe I can do a better job if I had a copy of the schematics. Can anybody help? I will gladly pay for copying and mailing.

William R. Argue
180 Duncan Road
Richmond Hill, Ontario
Canada, L4C 6J8

I have searched high and low, but I cannot locate manuals for the following: a TEK 549 scope, a Gould OS-255 scope, and a Binson Echorec unit for a guitar. I hope other readers can help me out. Thanks.

Nick Oshana
101 Treble Road
Bristol, CT 06010 ■

Which symbol represents a variable inductor?

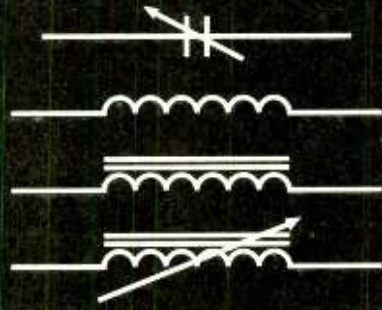

What is the principle disadvantage of neon lights?

What are out-of-phase signals?

Heath Video Courses speed your learning curve!

Learn basic electronics at home at your own pace with four, 60-minute video tapes. Know the variable inductor symbol. Recognize a PN junction. Understand oscillator fundamentals. Clearly SEE what most basic electronic books can only describe.

DC ELECTRONICS. Covers electron movement to troubleshooting and repairing a simple electronic circuit. **EV-3101-A.**

AC ELECTRONICS. Follow-up to DC Electronics. Covers the principles of AC, voltage and electrical measurement. Includes motors, generators and test instrument meter movements. **EV-3102-A.**

SEMICONDUCTORS. Complete the DC/AC videos and you're ready to learn how semiconductor devices are made, plus the principles of discrete devices, integrated circuits & optoelectronic devices. **EV-3103-A.**

ELECTRONIC CIRCUITS. Complete the basic course with amplifier configurations, biasing, coupling, audio amplifiers, closed-loop vs. open-loop operation and more. **EV-3104-A.**

An activity-filled workbook and explanation of how to solve each problem comes with each tape so you learn three ways — video, workbook and hands-on!

Order today!
Call Toll free,
24-hours a day.
1-800-253-0570.

We accept VISA, MasterCard, American Express and Heath Revolving Charge card. Use Order Code 601-017.

VIDEO TAPES
\$39.95 EACH

Heath®

Benton Harbor, MI

Call for a FREE catalog 1-800-44HEATH.

*Price does not include shipping and handling, or applicable sales tax.

©1990, Heath Company
Subsidiary of Bull Data Systems, Inc.

CIRCLE 12 ON FREE INFORMATION CARD

SEPTEMBER 1990

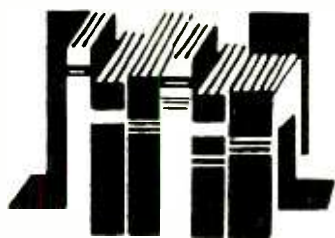

Electronics Library

To obtain additional information on the books and publications covered in this section from the publisher, please circle the item's code number on the Free Information Card

JOHN C. DVORAK'S PC CRASH COURSE AND SURVIVAL GUIDE

by John C. Dvorak with Peter Harrison and Steven Frankel

This boxed set of book and diskettes is intended as a "care package" for those who know absolutely nothing about personal computers, but need to get theirs up and running as quickly as possible. Following the "less is more" maxim, it teaches readers the absolute minimum that they must know to get started, and does so in an easy, non-technical way. The many exercises presented are designed to give readers practical experience and self-confidence as they follow the step-by-step approach to learning.

The opening chapter explores the basics of IBM PC, XT, AT, 386, PS/2, and compatible computers and their capabilities—including details and exercises on how to start up a computer. The course progresses to how to prepare diskettes for use and how to copy and delete information. After those basics are mastered, the reader can advance to more complex—but still neces-

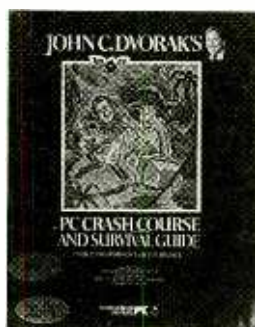

sary—commands and concepts, including the use of hard disks and understanding computer jargon. There are tips on buying hardware and software to help readers make intelligent purchases and protect their original investment in a computer. Other sections cover computer communications and the arrival of OS/2. The diskette contains a "private mastery test," a directory-listing program, a touch-typing tutor, and a

communications simulator that allows novices to practice using a modem—even if their computer doesn't have one.

John C. Dvorak's *PC Crash Course and Survival Guide* book/diskette boxed set costs \$34.95, and the book alone costs \$19.95 from Scandinavian PC Press, 51 Monroe Street, Suite 1101, Rockville, MD 20850; Tel. 301-294-7450 (orders only, 800-288-SCAN).

CIRCLE 80 ON FREE INFORMATION CARD

AC/DC ELECTRICITY AND ELECTRONICS MADE EASY: Second Edition

by Victory F. Veley

This completely revised and expanded edition of a classic introductory reference contains thorough, well-illustrated coverage of subjects ranging from basic units of measurements through complex applications of waveform analysis. The author uses a problem-solving approach to explain the important concepts and equations used in AC/DC electronics. Using standard component values throughout, several different methods are presented for solving each problem. Those various methods provide an accurate means to check the answers obtained, and offer the reader a clear choice of analytical techniques. Aimed at students as well as professional technicians, the book is well-organized, comprehensive source of information on direct- and alternating-current theory and practice.

AC/DC Electricity and Electronics Made Easy: Second Edition is available for \$17.95 from Tab Books Inc., Blue Ridge Summit, PA 17294-0850; Tel. 1-800-233-1128.

CIRCLE 98 ON FREE INFORMATION CARD

SPRING 1990 CATALOG

from All Electronics Corp.

All Electronics prints a new catalog every ten weeks, so by the time this issue of **Popular Electronics** hits the stands, a more recent version will be available. However, the *Spring 1990 Catalog*—with its 130 new surplus items and large supply of assorted instrument enclosures—is representative of their catalogs. Each is filled with bargain-priced products for electronics hobbyists and technicians, including large assortments of semiconductors, capacitors, connectors, jacks, switches, and relays. Also featured are telephone and video accessories, tools, wires and cables, breadboards, batteries and accessories, audio equipment, and an array of products for building electronic projects.

The current *All Electronics Catalog* is free upon request from All Electronics Corp.,

P.O. Box 567, Van Nuys, CA 90408; Tel. 818-904-0524 or 800-826-5432.

CIRCLE 81 ON FREE INFORMATION CARD

AN INTRODUCTION FOR VHF/UHF FOR RADIO AMATEURS

by I.D. Poole

While the bands most often associated with amateur radio are the high-frequency bands below 30 MHz, the fastest growing area in amateur radio is on the VHF and UHF portions of the radio spectrum. Most hams already have equipment for use on those bands, and this book provides the essential information they need to get the most from VHF and UHF bands. Along with

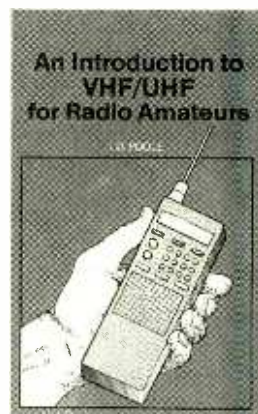

descriptions of the band plans and channels, some of the topics covered include propagation, antennas, receivers, and transmitters. Repeater and mobile operation are discussed, as well as DX'ing. Special sections on scanners and on packet radio are also included.

An Introduction to VHF/UHF for Radio Amateurs (order no. BP281) is available for \$7.25, including shipping and handling, from *Electronic Technology Today, Inc.*, P.O. Box 240, Massapequa Park, NY 11752-0240.

CIRCLE 97 ON FREE INFORMATION CARD

COMPLETE GUIDE TO RS232 AND PARALLEL CONNECTIONS: A Step-by-Step Approach to Connecting Computers, Printers, Terminals, and Modems

by Martin D. Seyer

This follow-up to the author's first book, *RS232 Made Easy*, uses tutorial modules designed to cover virtually every possible connection used today with serial and parallel interfaces, to enable the reader to connect an array of different devices together. Providing the reader straightforward steps

to follow and tools to use—including with fill-in-the-blank "port profiles"—the book teaches readers to ask—and answer—the questions necessary to analyze a port on a device. It aims to help the readers quickly and easily connect any number of different devices. A review of more than 300 devices is included in the book's extensive appendices.

Complete Guide to RS232 and Parallel Connections: A Step-by-Step Approach to Connecting Computers, Printers, Terminals, and Modems is available in hardcover for \$43.20 and in paperback for \$30.95 from Prentice-Hall, Englewood Cliffs, NJ 07632.

CIRCLE 99 ON FREE INFORMATION CARD

WORKSTATION/NETWORKING SERVICE CATALOG

from Jensen Tools, Inc.

Featuring tools, tool kits, and test equipment specifically for use in workstation and network servicing, this full-color, 32-page product guide contains complete specifications and ample illustrations. Highlighted are Jensen's top-of-the-line service kits for computer, workstation, and LAN maintenance. Other products include strippers, crimpers, connectors, and other LAN ac-



cessories. Also included are cable tools; diagnostic software; disk-storage, disk-drive, and circuit-board repair products; shipping containers, datacommunications test equipment; and static-control products.

The Workstation/Networking Service Catalog is free upon request from Jensen Tools, Inc., 7815 South 46th Street, Phoenix, AZ 85044; Tel. 602-968-6231.

CIRCLE 82 ON FREE INFORMATION CARD

MICROCHIP FABRICATION: A Practical Guide to Semiconductor Processing: Second Edition

by Peter Van Zant

The second edition of this comprehensive introductory text has been completely updated and reorganized to reflect the technological advances in semiconductor processing since the original was re-

leased—but it retains the original's broad scope and non-technical language. Requiring no math or science background, the guide is a reliable resource for non-specialists, particularly those involved in semiconductor operations, marketing, quality control, or technical services. The book provides a thorough explanation of all aspects of the fabrication process, from materials and process chemicals to commercial IC's and chip packaging. It provides detailed information on all the important processes and issues involved, and on the materials and methods of semiconductor

technology. The basic physical properties of semiconducting materials and the chemicals used to process them into fabrication-grade polished wafers are described. The book also explores modern clean-room strategies for reducing contamination and the planar operations used to create circuit components on chip surfaces. In-depth discussions on such aspects as photolithography, the doping of N/P junctions, and CVD layering techniques are included. A new chapter, "Manufacturing Technology," covers economic and production-control issues. Each chapter contains references, a

ELENCO & HITACHI PRODUCTS AT DISCOUNT PRICES

NEW! RSOs (Real-Time & Storage Oscilloscopes) From HITACHI **NEW!**

The RSO - Its the new solution
View, Acquire, Test, Transfer and Document Your Waveform Data

4-Channel, 100MS/s Model	Introductory Price
100MS/s (25MS/s on 4 channels simultaneously), 100MHz, 4k x 1ch, 2k x 2ch, 1k x 4ch	VC-6145 \$4,695.00

Compact, Full Feature Models

40MS/s, 100MHz, 4k x 1ch, 2k x 2ch	VC-6045 \$3,049.00
20MS/s, 50MHz, 2k x 2ch	VC-6025 \$2,295.00

Low Cost/High Value Models

20MS/s, 50MHz, 2k x 2ch	VC-6024 \$2,049.00
20MS/s, 20MHz, 2k x 2ch	VC-6023 \$1,749.00

RSOs from Hitachi feature such functions as roll mode, averaging, save memory, smoothing, interpolation, pretriggering, cursor measurements, plotter interface, and RS-232C interface. With the comfort of analog and the power of digital.

Compact Series Scopes

Delayed Sweep
Lightweight (13lbs)
2Mv Sens
3 Yr Warranty
Model V-1065
Shown

This series provides many new functions such as CRT Readout, Cursor measurements (V-1085/1065/665), Frequency Cir (V-1085), Sweep/Time Autoring and Trigger Lock using a 6 inch CRT. You don't feel the compactness in terms of performance and operation.

V-660 60MHz Dual Trace	\$1,195
V-665 60MHz Dual Trace w/Cursor	\$1,345
V-1060 100MHz Dual Trace	\$1,425
V-1065 100MHz Dual Trace w/Cursor	\$1,695
V-1085 100MHz Quad Trace w/Cursor	\$2,045
V-1100A 100MHz Quad Trace w/Cursor	\$2,295
V-1150 150MHz Quad Trace w/Cursor	\$2,775

20MHz Elenco Oscilloscope

\$375
MO-1251

- Dual Trace
- Component Tester
- 6" CRT
- X-Y Operation
- TV Sync
- 2 p-1 Probes

FREE DMM
with purchase of
ANY SCOPE

SCOPE PROBES

P-1 65MHz, 1x, 10x \$19.95
P-2 100MHz, 1x, 10x \$23.95

Elenco 35MHz Dual Trace
Good to 50MHz **\$495**

MO-1252

- High luminance 6" CRT
- 1mV Sensitivity
- 6KV Acceleration Voltage
- 10ns Rise Time
- X-Y Operation - 2 Axis
- Delayed Triggering Sweep
- Includes 2 P-1 Probes

All scopes include probes, schematics, operators manual, and 3 year (2 yrs for Elenco scopes) world wide warranty on parts & labor. Many accessories available for all Hitachi scopes. Call or write for complete specifications on these and many other fine oscilloscopes.

WE NOW CARRY COMPLETE LINE OF FLUKE MULTIMETERS Models

21F	83
23F	85
25F	87
27F	8050A
73	8060A
75	8062A
77F	+ More

CALL FOR SPECIAL PRICING

True RMS 4 1/2 Digit Multimeter
M-7000 **\$135**

05% DC Accuracy
-1% Resistance with Freq. Counter and deluxe case

10 Function Multimeter
CM-365 **\$65**

AC + DC Voltage & Amp
Resistance to 2000MQ
Diode, Logic, & Trans test
Capacitance to 200uF

Digital Capacitance Meter
CM-1550 **\$58.95**

9 Ranges
1p-20,000uF
5% basic acy
Zero control with case

Digital LCR Meter
LC-1801 **\$125**

Measures:
Coils 1uH-200H
Caps 1p-200uF
Res .01-20M

Function Generator
Blox #9600 **\$28.95**

Provides sine, triangle, square wave from 1Hz to 1MHz
AM or FM capability

Triple Power Supply XP-620
Assembled \$65
Kit \$45

2 to 15V at 1A,
2 to 15V at 1A
(or 4 to 30V at 1A)
and 5V at 3A

Contains all the desired features for doing experiments
Features short circuit protection, all supplies

Wide Band Signal Generators
SG-9000 **\$129**

RF Freq 100K-450MHz
AM Modulation of 1KHz
Variable RF output
SG-9500 w/ Digital Display and 150MHz built-in Counter \$249

Soldering Station
Temperature Controlled
SL-30 **\$99**

Digital display
Temp range:
300F-800F
Grounded tip
Overheat protect

Color Convergence Generator
SG-200 **\$69.95**

Finest in the industry
10 rock steady patterns

10MHz Oscilloscope
S-3000 **\$275**

10MHz DC or AC
Triggered Sweep
Calibrated Vert & Hor
Reads Volts & Freq

Temperature Probe
M-110CF **\$29.95**

Semiconductor type
Range
-58F-302F
For most digital multimeters

Autorangeing DMM
M-5000 **\$45**

9 Functions
Memory and Data hold
1% basic acc
3 1/2 digit LCD

AC Current Meter
ST-1010 **\$69.95**

1000 Amps
Data & Peak hold
8 Functions
Deluxe Case

Decade Box
#9610 or #9620 **\$18.95**

#9610 Resistor Box
47 ohm to 1M & 100K pot
#9620 Capacitor Box
47pF to 10MF

Quad Power Supply XP-580 **\$59.95**

2-20V at 2A
12V at 1A
5V at 3A
-5V at 5A

Fully regulated and short circuit protected
XP-575 without meters \$39.95

LEARN TO BUILD AND PROGRAM COMPUTERS WITH THIS KIT
INCLUDES: All Parts, Assembly and Lesson Manual
Model **MM-8000**
\$129.00

Starting from scratch you build a complete system. Our Micro Master trainer teaches you to write in BASIC, FORTRAN and on a 8085 microprocessor, which uses similar machine language as IBM PC. You will write the initial instructions to tell the 8085 processor to get started and store these instructions in permanent memory in a 2816 EPROM. Teach you all about input and output ports, computer timers. Build your own keyboard and learn how to scan keyboard and display. No previous computer knowledge required. Simple easy to understand instruction teaches you to write in machine language.
ROBOTICS KIT FOR ABOVE (MM-8010) \$71.95

Digital Triple Power Supply XP-765 **\$249**

0-20V at 1A
0-20V at 1A
5V at 5A

Fully regulated, Short circuit protected with 2 limit control, 3 separate supplies
XP-660 with Analog Meters \$175

GF-8016 Function Generator with Freq. Counter **\$249**

Sine, Square, Triangle
Pulse, Ramp, 2 to 2MHz
Freq Counter: .1 - 10MHz

GF-8015 without Freq. Meter \$179

WE WILL NOT BE UNDERSOLD!
UPS Shipping: 48 States 5%
(\$10 Max) IL Res., 7% Tax

C & S SALES INC.
1245 Rosewood, Deerfield, IL 60015
(800) 292-7711 (708) 541-0710

15 Day Money Back Guarantee
2 Year Warranty
Prices subject to change
WRITE FOR FREE CATALOG

CIRCLE 11 ON FREE INFORMATION CARD

FUN WITH ELECTRONICS

Coil Design and Construction Manual



◀ **160—COIL DESIGN & CONSTRUCTION MANUAL** \$5.95. How to make RF, IF, audio and power coils; chokes and transformers. Practically every possible type is discussed.

◀ **BP87—50 SIMPLE LED CIRCUITS, BK 2** \$5.50. Fifty more uses for the simple LED. Combine this book with BP42 and you'll have a file of 100 useful LED applications.



◀ **BP45—PROJECTS IN OPTOELECTRONICS** \$5.50. Describes a number of projects including infrared transmitters, modulated light transmission and photographic projects.

◀ **BP33—ELECTRONIC CALCULATOR USERS HANDBOOK** \$5.75. Presents formulae, data, methods of calculation, conversion factors, etc., with the calculator user especially in mind, often illustrated with simple examples.



50 (FET) Field Effect Transistor Projects



◀ **BP39—50 FET TRANSISTOR PROJECTS** \$5.50. The projects described in this book include RF amplifiers and converters, test equipment and receiver aids, tuners, receivers, mixers and tone controls and a variety of other circuits.

◀ **#219—SOLID STATE NOVELTY PROJECTS** \$4.95. How to build a number of novelty projects including a musical instrument played by reflecting a light beam with your hand, water warbler for pot plants, musical tone generator, touch switch and more.



MAIL TO: **Electronic Technology Today Inc.**
P.O. Box 240
Massapequa Park, NY 11762-0240

SHIPPING CHARGES IN USA AND CANADA

\$0.01 to \$5.00	\$1.25	\$30.01 to \$40.00	\$5.00
\$5.01 to 10.00	\$2.00	\$40.01 to \$50.00	\$6.00
\$10.01 to \$20.00	\$3.00	\$50.01 and above	\$7.50
\$20.01 to \$30.00	\$4.00		

SORRY, No orders accepted outside of USA and Canada

Total price of merchandise \$ _____
Shipping (see chart) \$ _____
Subtotal \$ _____
Sales Tax (NYS only) \$ _____
Total Enclosed \$ _____

Name _____
Address _____
City _____ State _____ Zip _____

Electronics Library

list of key concepts and terms, and review questions; a comprehensive glossary of terms is also provided.

Microchip Fabrication: A Practical Guide to Semiconductor Processing, Second Edition is available in hardcover for \$49.50 from McGraw-Hill Book Company, 11 West 19th Street, New York, NY 10011; Tel. 1-800-2-MCGRAW.

CIRCLE 96 ON FREE INFORMATION CARD

ADVANCED TECHNOLOGY SOLDERING STATIONS

from Royel Soldering Systems Inc.

A selection of soldering stations and related products, all meeting U.S. military specifications, are featured in this illustrated catalog. Among the products offered are dual-iron soldering stations with both alternating and simultaneous work stations, single-iron stations with either analog or digital temper-



ature control, a 40-watt soldering pencil, and a 60-watt soldering iron with the thermal capacity to handle large terminations. Other products include a soldering-station tester and a variety of soldering tips.

The Advanced Technology Soldering Stations catalog is free upon request from Royel Soldering Systems Inc., 744 Salem Street, Glendale, CA 91203; Tel. 213-245-1077.

CIRCLE 83 ON FREE INFORMATION CARD

TELEVISION AND AUDIO HANDBOOK: For Technicians and Engineers

written and edited by K. Blair Benson and Jerry C. Whitaker

This authoritative text presents all the basic data needed to maintain, troubleshoot, and service today's state-of-the-art television and audio systems and equipment, along with the fundamental concepts of TV- and audio-circuit design and performance. Designed as an on-the-job reference that helps service technicians, operators, and

staff engineers update their knowledge and sharpen their skills, the book is filled with practical advice and guidelines on a variety of subjects. It features contributions from 17 specialists, each writing on their areas of expertise. Full coverage is provided on such subjects as the principles of analog and digital systems, video- and audio-signal processing, loudspeaker and sound systems, the design and operation of TV receivers, compact-disc and magnetic-tape recording, and procedures for analyzing TV and audio-system performance. Throughout its pages, the handbook reflects the increasingly close relationship between picture and sound in today's industry, and the resultant need for professionals to be fully informed in both fields.

Television and Audio Handbook: For Technicians and Engineers is available in hardcover for \$39.95 from McGraw-Hill Book Company, 11 West 19th Street, New York, NY 10011; Tel. 1-800-2-MCGRAW.

CIRCLE 96 ON FREE INFORMATION CARD

PFS: FIRST PUBLISHER MADE EASY

by Greg Perry

Relatively inexpensive and uncomplicated, PFS: First Publisher is an increasingly popular desktop-publishing program, and this book is intended to help readers get the most from it as quickly as possible. The first section of the book begins with an introduction to desktop-publishing basics—including valuable tips for effective design—and then describes the specific tools included in First Publisher. It explains how to use the program to prepare text and art, design layouts, and print documents. In the second section, readers are taken one step at a time through the creation of newsletters, business cards, flyers, business forms and reports, and other documents. The fully illustrated book includes indexes of fonts and clip art, as well as a desktop-publishing glossary, installation instructions, and DOS directories.

PFS: First Publisher Made Easy is available for \$19.95 from Osborne McGraw-Hill, 2600 Tenth Street, Berkeley, CA 94710.

CIRCLE 84 ON FREE INFORMATION CARD

1990 FULL LINE CATALOG

from Sencore Electronics

The latest catalog from Sencore—developers of a 93% patented, all American-made line—includes instruments for testing video, audio, components, and cable systems. Also included are waveform analyzers, IEEE/RS232 instruments, and a complete line of instrument accessories.

Specifications are provided for all products, along with application information.

The 1990 Full Line Catalog is free upon request from Sencore Electronics, 3200 Sencore Drive, Sioux Falls, SD 57107; Tel. 1-800-SENCORE.

CIRCLE 85 ON FREE INFORMATION CARD

MUSICIAN'S MUSIC SOFTWARE CATALOG! and Buyer's Guide

from Digital Arts & Technologies Inc.

To help musicians determine which products best meet their needs and budgets, this catalog provides an overview of music software and MIDI products. Its 96 pages are filled with information on the latest in MIDI software products along with an assortment of synthesizers, thru boxes, SMPTE devices, cables, books, videos, and accessories. It covers software for IBM, Macintosh, Atari ST, Apple II, Commodore 64/128, Amiga, and Yamaha C1 computers. Offering detailed descriptions—including capabilities, compatibility, functions, features, illustrations, and pricing—of products from dozens of respected manufacturers, the catalog is intended to help consumers make informed purchase decisions based

on a product's relative price and capabilities.

Musician's Music Software Catalog! and Buyer's Guide is offered as a subscription for \$5.00 (U.S.) or \$10.00 (foreign). The main catalog is published annually and is supplemented twice a year; new subscribers immediately receive the current main catalog and the latest supplement. The subscription price is refundable with the first purchase. For more information, contact Digital Arts & Technologies Inc., Dept. BR, 21 Glen Ridge Road, Mahopac, NY 01541; Tel. 800-332-2251.

CIRCLE 86 ON FREE INFORMATION CARD

WORLD SATELLITE TV AND SCRAMBLING METHODS: The Technician's Handbook

Frank Baylin, Richard Maddox, and John McCormac

Aimed at curious do-it-yourselfers as well as technicians and satellite professionals, this book explores all the components of home satellite systems from the perspective of a technician who wants to understand their design, operation, and repair. Circuit and block diagrams of most components are presented and clearly explained throughout

World Satellite TV and Scrambling Methods
The Technicians' Handbook



FRANK BAYLIN RICHARD MADDOX JOHN MCCORMAC

the handbook. The first portion of the book is devoted to an in-depth study of broadcast formats—including NTSC, PAL, SECAM, and MAC—as well as digital audio and basic scrambling and encryption methods. That material provides the background for a discussion of all current American and European satellite technologies, including VideoCipherII, Oak Orion, RITC, Sky Channel, EuroCypher, VideoCrypt, Teleclub Payview III, and other systems. The following chapters cover troubleshooting and setting up a test bench, and include expert guidance on testing, servicing, and tuning. The book in-

(Continued on page 12)



EMINENCE



MOTOROLA

Polydax

1-800-338-0531

PIONEER

3-WAY 100W CROSSOVER

12 dB/octave rolloff. 800Hz, 5000Hz crossover points. 8 ohm. 100 watts RMS.



#260-210 \$12.50 (1-9) \$9.95 (10-up)

SPEAKER CONTROL PANEL

Panel with 50 watt L-pads for tweeter and midrange and built-in LED power meter. 5" x 2 1/2" 100 watt version available



#260-235 \$14.50 (1-5) \$12.90 (6-up)

12" POLY WOOFER

Super duty, 40 oz. magnet. 100 watts RMS, 145 watts max. 4 and 8 ohm compatible (6 ohm). 2" voice coil. fs = 25 Hz. QTS = .166, VAS = 10.8 cu ft. Response: 25-1500 Hz. Net weight: 9 lbs. Pioneer #A30GU40-51D



#290-125 \$36.80 (1-3) \$34.50 (4-up)

15" WOOFER

Original Sanyo woofer. Paper cone with vented dust cap and treated cloth surround. 12 oz. magnet. 60 watts RMS, 85 watts max. 8 ohm. Resonance: 26 Hz. Response: 25-2,500 Hz.



#291-155 \$23.00 (1-5) \$21.90 (6-up)

PIONEER HORN TWEETER

Mylar dome. 2.93 oz. barium ferrite magnet. 8 ohm. Response: 1800-20000 Hz. 35W RMS, 50W max. fs = 2000 Hz, SPL = 106 dB. Pioneer #AHE60-51F



#270-050 \$6.50 (1-9) \$5.90 (10-up)

12" SUB WOOFER

Dual voice coil sub woofer. 30 oz. magnet, 2" voice coils. 100 watts RMS, 145 watts max. fs = 25 Hz. 6 ohm (4 and 8 ohm compatible). SPL = 89 dB 1W/1M. Response: 25-700 Hz. QTS = .31, VAS = 10.3 cu. ft. Pioneer #A30GU30-55D. Net weight: 6 lbs.



#290-145 \$39.80 (1-3) \$36.80 (4-up)

15" THRUSTER WOOFER

Thruster by Eminence. Made in USA. Poly foam surround, 96 oz. magnet. 2-1/2", 2 layer voice coil. 150 watts RMS, 210 watts max. 4 ohm. fs = 23.5 Hz, QTS = .33, VAS = 17.9 cu. ft. SPL = 94.8 dB 1W/1M. Net weight: 15 lbs.



#290-180 \$43.50 (1-3) \$39.80 (4-up)

GRILL FRAME KIT

With this kit you can make speaker grill frames up to 30" x 40". Kit includes 4 corner pieces, 2 "T" brackets, and 7 frame bars. Grill mounting kit included.



#260-333 \$8.50 (1-9) \$7.80 (10-up)

18" EMINENCE WOOFER

MADE IN USA

100 oz. magnet, 3" voice coil. 250 watts RMS, 350 watts max. 8 ohm, 30 Hz resonant frequency. 22-2700 Hz response. Efficiency: 95 dB 1W/1M. Paper cone, treated accordion surround. Net weight: 29 lbs.



#290-200 \$98.90 (1-3) \$89.50 (4-up)

TITANIUM COMPOSITE TWEETER

Titanium is deposited on a polymer dome to combine the advantages of both hard and soft dome technologies. 8 ohm. Ferro fluid cooled voice coil. fs = 1200 Hz, SPL = 90 dB 1W/1M. 50 watts RMS, 70 watts max. 4" round. Polydax part #DTW100T125.



#270-047 \$27.50 (1-9) \$24.80 (10-up)

Parts Express International Inc. 1989 CATALOG
CALL TOLL FREE 1-800-338-0531
FREE CATALOG



340 E. First St., Dayton, Ohio 45402
Local: 1-513-222-0173
FAX: 513-222-4644

* 15 day money back guarantee *\$15.00 minimum order *We accept Mastercard, Visa, Discover, and C.O.D. orders *24 hour shipping *Shipping charge = UPS chart rate *\$1.00 (\$3.00 minimum charge) *Hours: 8:30 am-6:00 pm EST, Monday - Friday *Mail order customers, please call for shipping estimate on orders exceeding 5 lbs.

CIRCLE 10 ON FREE INFORMATION CARD

Join
the

Electronics and Control Engineers' Book Club®

TROUBLESHOOTING ELECTRONIC EQUIPMENT WITHOUT SERVICE DATA, Second Edition. By R.G. Middleton. 320 pp., illus. This indispensable new edition features all the information that made the first edition so successful, plus the latest developments in digital testing, phase checks, IC troubleshooting, and repair of VCRs, stereos, TVs, tape recorders, and much, much more.
585092-3 Pub. Pr., \$30.00 Club Pr., \$22.50

PRINTED CIRCUITS HANDBOOK, Third Edition. By C.F. Coombs, Jr. 960 pp., 556 illus. Here in one handy volume is all the information you need to design, manufacture, test, and repair printed wiring boards and assemblies. This new edition features ten all-new chapters, including three on SMT.
126/097 Pub. Pr., \$64.95 Club Pr., \$45.50

SOUND SYSTEM ENGINEERING, Second Edition. By D. Davis and C. Davis. 665 pp., illus. The definitive source for all professionals responsible for audio system design, covering everything from concert halls to virtually every oscillator in use today. Packed with proven strategies for solving design and engineering problems and cutting your clients' costs.
584657-8 Pub. Pr., \$39.95 Club Pr., \$31.50

MCGRAW-HILL ENCYCLOPEDIA OF ELECTRONICS AND COMPUTERS, Second Edition. S. Parker, Editor-in-Chief. 1,047 pp., 1,250 illus. Featuring 160 new and revised articles, this new edition treats the entire spectrum of applications, devices, systems, and theory in areas ranging from the flow of electricity to hardware, software, robotics, and IC fabrication.
454/99X Pub. Pr., \$79.50 Club Pr., \$54.95

COMMUNICATIONS RECEIVERS: Principles and Design. By Ulrich L. Rohde and T.T.N. Bucher. 608 pp., 402 illus. Everything you need to know if you design or work with communications receivers, from theory to practical design approaches. Coverage includes all types of receivers: shortwave, broadcast, radar, military, marine, aeronautical, and more.
535/701 Pub. Pr., \$64.95 Club Pr., \$44.50

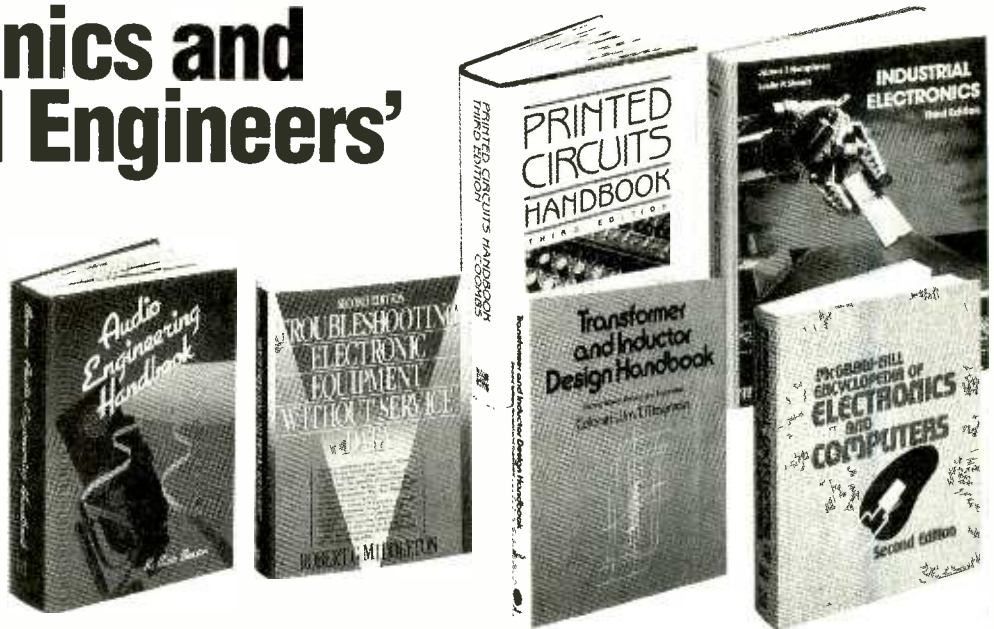

- your one source for engineering books from over 100 different publishers
- the latest and best information in your field
- discounts of up to 40% off publishers' list prices

New Members!
Take any one of these great
professional books
for only **\$289**
as a premium with your
first selection!

Spectacular values up to **\$204.95**

HANDBOOK OF TRANSDUCERS. By H.N. Norton. 554 pp., illus. Get fast answers to all of your questions about commercially available transducers. This up-to-date reference explains how they operate, how to select the right transducer for a given measurement, and the characteristics and relative merits of each category of transducer.
585142-3 Pub. Pr., \$44.00 Club Pr., \$34.50

DESIGNING WITH FIELD-EFFECT TRANSISTORS, Second Ed. By Siliconix Inc., Revised by E. Oxner. 320 pp., illus. This on-the-job guide provides page after page of practical data, tables, examples, and design and specification strategies to help you capitalize on recent breakthroughs in MOSFET design. Coverage includes FET operating principles and procedures . . . step-by-step fabrication methods . . . how to bias FETs for desired performance . . . and much more.
575/371 Pub. Pr., \$39.95 Club Pr., \$29.95

CIARCIA'S CIRCUIT CELLAR, Volume VII. By S. Ciarcia. 256 pp., 100 illus., softcover. More do-it-yourself circuits from the master—Steve Ciarcia. Step-by-step guidance on projects ranging from a gray-scale video digitizer and the Circuit Cellar AT Computer to parallel interfacing and the Neighborhood Strategic Defense Initiative.
109/699 Pub. Pr., \$19.95 Club Pr., \$15.95

THE COMPACT DISC: A Handbook of Theory and Use. By K. C. Pohlmann. 288 pp., illus. softcover. The most readable and comprehensive guide to CD technology offers clear descriptions of disc design and manufacturing . . . player circuitry . . . and comparisons of different types of players—all without complicated theoretical or mathematical discussions.
585096-6 Pub. Pr., \$29.95 Club Pr. \$22.50

MOBILE CELLULAR TELECOMMUNICATIONS SYSTEMS. By W.C.Y. Lee. 442 pp., 215 illus. A to Z coverage of state-of-the-art cellular systems, from design to implementation and troubleshooting. Clearly explains spectrum efficiency, propagation models and prediction, interference treatment, and more.
370/303 Pub. Pr., \$62.95 Club Pr., \$44.50

TRANSFORMER AND INDUCTOR DESIGN HANDBOOK, Second Edition. By Col. W.T. McLyman. 440 pp., illus. All the information you need to design today's lighter, smaller transformers and inductors, without relying on out-moded approximation methods. In ready-reference tabular format, this new edition covers the latest equations in transformer and gapped design applications.
584646-2 Pub. Pr., \$55.00 Club Pr., \$38.50

ENCYCLOPEDIA OF TELECOMMUNICATIONS. Edited by R. Meyers. 575 pp., illus. The expertise of 40 recognized leaders in the field is captured in this A to Z reference. Areas covered range from fiber optics, intelligent systems, and networking, to signal processing, mathematical relationships, and theory.
584897-X Pub. Pr. \$49.95 Club Pr., \$37.50

PROGRAMMABLE LOGIC DESIGNER'S GUIDE. By R.C. Alford. 304 pp., illus., softcover. This practical guidebook shows you how to design devices that provide all the logic functions a circuit requires and avoid the compromises inherent in conventional methods. Covers design philosophy, PLD families, hardware, software, and programming languages.
585141-5 Pub. Pr., \$29.95 Club Pr., \$22.95

SURFACE-MOUNT TECHNOLOGY FOR PC BOARD DESIGN. By J.K. Holmorn, Jr. 504 pp., illus., softcover. Get a real working understanding of SMT. This up-to-date guide provides a proven, step-by-step approach to SMT design as it thoroughly covers components, methods, and techniques for maximizing quality, reliability, and profitability.
585235-7 Pub. Pr., \$49.95 Club Pr., \$36.50

PORTABLE ELECTRONICS DATA BOOK

360 pp., 6 x 9, illus., softcover 585390-6
A-to-Z coverage of all the essential facts, figures, and formulas you need, in a format that's easy to use and easy to carry. John Douglas-Young has filled this handy on-the-job companion with equations, algorithms, calculus formulas, and BASIC programs in areas ranging from alternating current and amplifiers to transducers and waveguides . . . and they're all yours **ABSOLUTELY FREE!**

**A \$33.00
Value—Yours
ABSOLUTELY
FREE
when you join!**

INDUSTRIAL ELECTRONICS, Third Ed. By J.T. Humphries and L.P. Sheets. 651 pp., illus. A clear, convenient guide to the components and systems used in modern industry. Included is an extensive collection of manufacturers' data sheets, along with many quick-access tables and charts.

585226-8 Pub. Pr., \$41.95 Club Pr., \$31.95

BUILD YOUR OWN UNIVERSAL COMPUTER INTERFACE. By B. Chubb. 309 pp., illus., softcover. Guiding you from theory to step-by-step assembly instructions, this lively manual shows you how to construct a computer interface and hook it up to virtually any IBM or IBM compatible personal computer, including the XT, XT-286, AT, and System/2 Model 30.

585080-X Pub. Pr., \$19.95 Club Pr., \$15.95

DIGITAL FILTERS AND SIGNAL PROCESSING, Second Ed. By L.B. Jackson. 410 pp., illus. An acclaimed guide to signal processing theory, design methods, and implementation strategies. Using an intuitive approach, the author covers state-space representation, A/D and D/A conversion, the DFT, FFT, and much more.

585269-1 Pub. Pr., \$52.50 Club Pr., \$39.50

SWITCHGEAR AND CONTROL HANDBOOK, Second Ed. Edited by R. W. Smeaton. 1,056 pp., 789 illus. The only handbook that treats all aspects of switchgear control, including design, applications, safety, and maintenance. Updated to reflect the changes brought about by the use of computers, solid-state devices, and programmable controls.

584/494 Pub. Pr., \$85.00 Club Pr., \$59.95

ANTENNA APPLICATIONS REFERENCE GUIDE. Edited by R. C. Johnson and H. Jasik. 496 pp., 368 illus. and tables. Covers the major applications of antenna technology in all areas of communications and their design methods. Emphasizes important new applications such as earth station, satellite, seeker, aircraft, and microwave-relay antennas.

322/848 Pub. Pr., \$59.95 Club Pr., \$42.50

RADIO HANDBOOK, Twenty-Third Ed. Edited by W. I. Orr. 667 pp., 1,073 illus. and tables. The latest edition of the most complete, current resource on radio technology and its applications. Expert contributors show you how to select, design, build, test and operate all kinds of equipment.

584638-1 Pub. Pr., \$29.95 Club Pr., \$23.95

AUDIO ENGINEERING HANDBOOK. Edited by K. B. Benson. 1056 pp., 722 illus. The ideal on-the-job reference for professionals who design, operate, and service audio equipment. It's a one-volume source of fundamental audio acoustics engineering information and practical how-to source book covering generation, transmission, storage, and reproduction of the audio signal.

047/774 Pub. Pr., \$86.95 Club Pr., \$59.95

Be sure to consider these important titles as well!

BUCHSBAUM'S COMPLETE HANDBOOK OF PRACTICAL ELECTRONIC REFERENCE DATA, Third Ed. By W.H. Buchsbaum. 583880-X Pub. Pr., \$34.95 Club Pr., \$26.50

ON-LINE ELECTRICAL TROUBLESHOOTING. By L. Lundquist. 391/106 Pub. Pr., \$34.50 Club Pr., \$26.50

ESSENTIAL CIRCUITS REFERENCE GUIDE. By J. Markus & C. Weston. 404/623 Pub. Pr., \$59.95 Club Pr., \$47.50

INTRODUCING PC-DOS AND MS-DOS, Second Ed. By T. Sheldon. 565/651 Pub. Pr., \$29.95 Club Pr., \$19.95

ENGINEERING FUNDAMENTALS FOR THE PROFESSIONAL ENGINEERS' EXAM, Third Ed. By L.M. Polentz. 503/931 Pub. Pr., \$39.50 Club Pr., \$27.95

INTRODUCTION TO DIGITAL SIGNAL PROCESSING. By J. G. Proakis and D. G. Manolakis. 584954-2 Pub. Pr., \$50.00 Club Pr., \$37.50

AUTOMATIC CONTROL SYSTEMS, Fifth Ed. By B. C. Kuo. 583706-4 Pub. Pr., \$57.40 Club Pr., \$43.50

MICROCOMPUTER TROUBLESHOOTING AND REPAIR. By J.G. Stephenson and B. Cahill. 585106-7 Pub. Pr., \$24.95 Club Pr., \$18.95

DIGITAL AND MICROPROCESSOR TECHNOLOGY, Second Ed. By P. J. O'Connor. 585184-9 Pub. Pr., \$42.00 Club Pr., \$33.50

MICROELECTRONICS, Second Ed. By J. Millman and A. Grabel. 423/30X Pub. Pr., \$56.95 Club Pr., \$41.50



FOR FASTER SERVICE IN ENROLLING CALL TOLL-FREE 1-800-2-MCGRAW

MAIL THIS COUPON TODAY

**McGraw-Hill Book Clubs
Electronics and Control Engineers'
Book Club®**

P.O. Box 582, Hightstown, NJ 08520-9959

Please enroll me as a member and send me the two books indicated, plus the PORTABLE ELECTRONICS DATA BOOK. I am to receive one book for just \$2.89, the other at the discounted member's price, plus local tax, shipping and handling charges. I agree to purchase a minimum of one additional book during my first year of membership as outlined under the Club plan described in this ad. I understand that a shipping and handling charge is added to all shipments.

Your FREE Data Book

585390-6

Write Code No. of the \$2.89 selection here

Write Code No. for the First selection here

Signature _____

Name _____

Address/Apt. # _____

City _____

State _____ Zip _____

This order subject to acceptance by McGraw-Hill. All prices subject to change without notice. Offer good only to new members. Foreign member acceptance subject to special conditions.

ECGB-038

Here's how the Club works to serve YOU:

■ IMPORTANT INFORMATION... WE MAKE IT EASY TO GET!

In our rapidly changing world, those who perform best are those who are best informed. Designed exclusively for the practicing engineer the Electronics and Control Engineers' Book Club provides you with information that is relevant, reliable, and specific enough to meet your needs. Each Club bulletin comes your way 14-16 times a year and offers you more than 30 books to choose from — the best and newest books from all publishers!

■ DEPENDABLE SERVICE... WE'RE HERE TO HELP!

Whether you want information about a book or have a question about your membership, our qualified staff is here to help. Just call us toll-free or write to our Customer Service. We also make sure you get only the books you want. All you do is simply tell us your choice on the Reply Card and return it to us by the specified date. If you want the Main Selection, do nothing — it will be sent to you automatically. (A small shipping and handling charge is added to each shipment.)

■ CLUB CONVENIENCE... WE DO THE WORK!

Beyond the benefit of timely information, Club membership offers many other benefits. For example, you get a wide choice of books that cannot be matched by any bookstore — anywhere. And all your books are conveniently delivered right to your door. You also get the luxury of 10 full days to decide whether you want the Main Selection. If you should ever receive a Main Selection you don't want because the Club bulletin came late, just return it for credit at our expense.

■ SUBSTANTIAL SAVINGS... AND A BONUS PROGRAM TOO!

In keeping with our goal to provide you with the best information at the greatest possible savings, you will enjoy substantial discounts — up to 40%! — on every book you buy. Plus, you're automatically eligible for our Bonus Book Plan which allows you savings up to 70% on a wide selection of books.

■ EASY MEMBERSHIP TERMS... IT'S WORTHWHILE TO BELONG!

Your only obligation is to purchase one more book — at a handsome discount — during the next 12 months, after which you enjoy the benefits of membership with no further obligation. Either you or the Club may cancel membership anytime thereafter.

Electronics Library
(Continued from page 7)

cludes more than 200 photographs, diagrams, tables, and wiring schematics to help make readers easily able to understand the material.

World Satellite TV and Scrambling Methods: The Technician's Handbook is available for \$39.95 plus \$2.00 shipping and handling from Baylin Publications, 1905 Mariposa, Boulder, CO 80302; Tel. 303-449-4551.

CIRCLE 87 ON FREE INFORMATION CARD

INTEGRATED CIRCUITS ALTERNATE SOURCES, DISCRETE SEMICONDUCTORS ALTERNATE SOURCES, and DISCRETE SEMICONDUCTOR SUGGESTED REPLACEMENTS

from D.A.T.A. Business Publishing

Providing access to the industry's leading database for sourcing and selecting electronic components, these three volumes form a streamlined reference library. The "D.A.T.A. Digests" feature full descriptive names, simplifying the identification of devices and their functions. Additional information supplied includes specific suggested replacement devices (different part numbers with the same or similar specifica-



tions, direct replacement information from alternate manufacturers, and an extensive manufacturer directory with complete addresses and phone numbers. *Integrated Circuits Alternate Sources* covers 76,000 IC's; *Discrete Semiconductors Direct Alternate Sources* and *Discrete Semiconductors Suggested Replacements* include 409,000 and 159,000 devices, respectively.

Each volume (which includes a new semi-annual edition in six months) costs \$125.00, plus freight charges. The entire three-volume library costs \$295.00. They are available from D.A.T.A. Business Publishing, 8977 Activity Road, San Diego, CA 92126; Tel. 800-447-4666 or 619-578-7600.

CIRCLE 88 ON FREE INFORMATION CARD

1990 DISTRIBUTOR PRODUCTS CATALOG

from John Fluke Mfg. Co.

Along with Fluke's lines of analog/digital multimeters, digital thermometers, and multifunction counters, this 20-page catalog features an expanded selection of new leads, probes, and clips for a variety of appliances. Highlighted in this year's catalog are the rugged 80 Series handheld multimeters, which offer a combination of measurement functions and special features for applications in automotive, electrical, and electronic testing and troubleshooting. Also featured is the Fluke 45 dual-display multimeter, which allows the user to make two different measurements of a signal at the same time.

The Fluke 1990 Distributor Products Catalog available at no charge from John Fluke Mfg. Co., Inc., P.O. Box 9090, Everett, WA 98206; Tel. 1-800-443-5853.

CIRCLE 89 ON FREE INFORMATION CARD

OS/2 PRESENTATION MANAGER PROGRAMMING PRIMER

by Asael Dror and Robert Lafore

Presentation Manager is the part of OS/2 that manages windows, menus, dialog boxes, radio buttons, and the other elements of the graphics interface. This step-by-step guide to Presentation Manager (PM) programming requires no previous OS/2 programming experience—only a knowledge of the C language. Using short, clear examples to demonstrate PM's features, the book shows how to write programs that include menus, dialog boxes, and other features of the PM graphical user



interface. The powerful graphics functions built into Presentation Manager are also described in detail.

The book's early chapters cover the basics—including program development, windows, and messages—and explain how to use menus, buttons, icons, and resources. The chapters on PM graphics describe how to draw pictures, animate graphics objects, display text in different fonts, move and zoom pictures, and store

graphics to disk. Other chapters cover multitasking, the clipboard, and foreign-language support.

OS/2 Presentation Manager Programming Primer is available for \$28.95 from Osborne McGraw-Hill, 2600 Tenth Street, Berkeley, CA 94710.

CIRCLE 84 ON FREE INFORMATION CARD

E-Z BUS PRODUCT GUIDE

from National Systems, Inc.

This guide provides a description, schematic, layout drawing, and ordering information for each element of the E-Z Bus modular electronic-packaging system—including the connector base, module cards, and a wide variety of commonly used electronic components. The system, which includes fill-in-the-blank documentation, allows users to quickly produce finished,

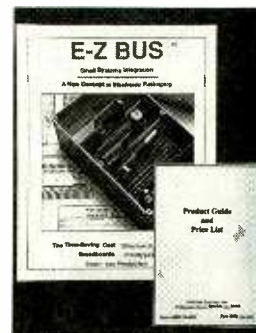

customized electronic designs without the expense and time delays associated with dedicated PC boards. The product guide also details the E-Z Bus wiring software, which automatically provides pin-number look-ups for interconnecting module cards and prints out wire-run lists.

The E-Z Bus Product Guide is free upon request from National Systems, Inc., Suite 150, 17 Hammatt Street, Ipswich, MA 01938; Tel. 508-356-1011.

CIRCLE 90 ON FREE INFORMATION CARD

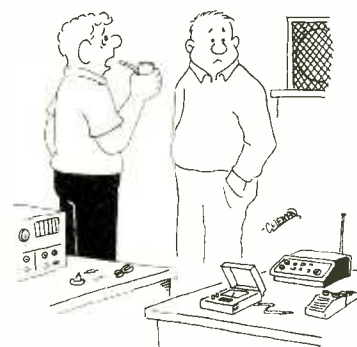

"I work three jobs to afford a hobby that I don't have time for."

Discover Your Career Potential In High-Tech Electronics...Call 1-800-776-4900!

CIE Gives You The Training You Need to *Succeed...*
At Your Own Pace...& In Your Own Home!

If you're anxious to get ahead...and build a *real* career...you owe it to yourself to find out about the Cleveland Institute of Electronics!

CIE can help you discover your career potential in the fast growing field of high-tech electronics. A career that will challenge and excite you every day...reward you with a powerful feeling of personal accomplishment...and deliver a level of financial security you may have only dreamed of before!

As the leading school in home-study electronics, CIE has helped over 150,000 students in the U.S.A. and over 70 foreign countries get started in this exciting field. To find out how CIE could be helping you...read on...then send for a CIE catalog TODAY!

A Growing Need For Trained Professionals!

The career opportunities shown here are only a few of the challenging, high-paying careers you could enjoy as an electronics technician.

You could be the "brains" behind the scenes of an exciting TV broadcast...trouble-shoot life-saving medical equipment...design exotic new aeronautics systems...CIE's job-oriented programs offer you the quickest possible path to the career of your dreams! And CIE also features military and union re-training, to build on what you already know.

Dozens Of Fascinating Careers To Choose From!

Even if you aren't sure which career is best for you, CIE can get you started with core lessons applicable to *all* areas of electronics. As you advance, CIE makes job opportunities available to you through the bimonthly school paper, *The Electron*.

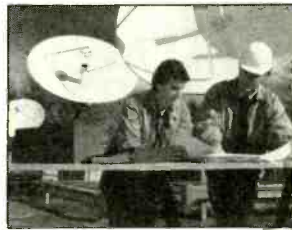

Data Communications



Automotive Electronics



Avionics



Computer-Assisted Manufacturing



Consumer Electronics



Military Electronics

Personal Training From A Renowned Faculty.

Unlike the impersonal approach of large classroom study, CIE offers you one-on-one instructional help 6 days a week, toll-free. Each CIE lesson is authored by an independent specialist, backed by CIE instructors who work directly with you to answer your questions and provide technical assistance when you need it.

Practical Training... At Your Own Pace.

Through CIE, you can train for your new career while you keep your present job. Each course allows a generous completion time, and there are no limitations on how fast you can study. Should you already have some electronics experience, CIE offers several courses which start at the intermediate level.

"State-Of-The-Art" Facilities & Equipment.

In 1969, CIE pioneered the first electronics laboratory course, and in 1984, the first Microprocessor Laboratory. Today, no other home study school can match CIE's state-of-the-art equipment. And all your laboratory equipment is included in your tuition cost. There is no extra charge—it's yours to use while you study at home and on the job after you complete your course!

Earn Your Degree To Become A Professional In Electronics!

Every CIE course you take earns you credit towards the completion of your Associate in Applied Science Degree, so you can work towards your degree in stages. And CIE is the only school that awards you for fast study, which can save you thousands of dollars in obtaining the same electronics education found in four-year Bachelor's Degree programs! Call or write for details today!

**Call TOLL-FREE
1-800-776-4900!**

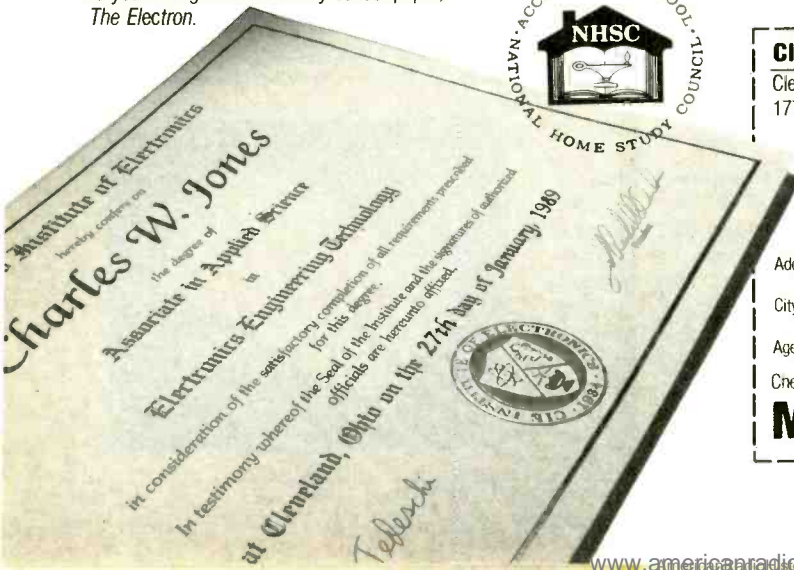

CIE World Headquarters

Cleveland Institute of Electronics, Inc.
1776 East 17th St., Cleveland, Ohio 44114

YES! Please send me your independent study catalog (For your convenience, CIE will have a representative contact you—*there is no obligation.*)

Print Name _____

Address _____ Apt # _____

City/State/Zip _____

Age _____ Area Code/Phone No. _____

Check box for G.I. Bill bulletin on educational benefits: Veteran Active Duty

Mail This Coupon Today!

AH0-152



New Products

To obtain additional information on new products covered in this section from the manufacturer, please circle the item's code number on the Free Information Card.

WIRE-WRAPPING KITS

Compactly packaged in a carrying case, each kit in *OK Industries' CSWK-120* series provides the complete means for creating wire-wrapped connections. The two kits in the series, the 120-volt AC *CSWK-121* and the 220-volt AC *CSWK-122*, are intended for use in prototyping, manufacturing, and service. Each includes the *OK-12* electric tool for 24 to 32-AWG wire, the 30-AWG *CSW30M-3916* cut/strip/wrap bit-and-sleeve set, an unwrap tool, a 100-foot roll of 30-AWG "Tefzel" wire, and a molded PVC case. By inserting Tefzel wire into the bit



CSWK-121/122

and triggering the electric gun, the bit will cut, strip, and wrap the wire in one operation. The rugged carrying case provides convenient storage, protection of tools and accessories, and neat organization of all the necessary materials in one package.

The *CSWK-121* and *CSWK-122* each have a list price of \$438.90. For more information, contact *OK Industries*, 4 Executive Plaza, Yonkers, NY 10701; Tel. 1-800-523-0667.

CIRCLE 101 ON FREE INFORMATION CARD

HAND-HELD DIGITAL MULTIMETER

Called the *Survivor*, *B&K-Precision's* model 2860 is a 26-range, drop-resistant, water-resistant, and overload-resistant DMM that was designed to survive the rigors of field service—including the ability to withstand a

five-foot drop. Its bright-yellow case will seal out rain, grease, dirt, and other environmental contaminants, and stands out at the job site, making it hard to misplace. The *Survivor* also features the protection of high-energy fusing and overload protection. Because field conditions vary, the *Survivor* has an oversized 0.8-inch LCD readout that is easy to view in many light levels.

For quick circuit tests, an audible beeper indicates continuity. Diode junctions are tested with a maximum test current of 1.5-mA and a maximum open circuit of 3.2 volts. A unique test-prod holder allows the user to hold both the DMM and the prod in one hand. DC accuracy is within 0.5%; AC accuracy is within 1.25% from 40 to 500 Hz.



Input impedance on DC and AC is 10 megohms. DC and AC current-measurement capabilities extend to a high 20 amps, with resistance measurement to 20 megohms.

The model 2860 *Survivor*—complete with a five-year limited performance warranty—has a suggested price of \$99.00. For additional information, contact *B&K-Precision*, Division of *Maxtec International Corp.*, 6470 West Cortland Street, Chicago, IL 60635; Tel. 312-889-9087.

CIRCLE 102 ON FREE INFORMATION CARD

PORTABLE CB

Offering seven watts of power, *Midland International's* model 75-777 is a portable hand-held CB with many other features usually found on mobile CB's. The 40-channel unit has a bar-type LED meter for measuring signal strength or power output. Its instant Channel-9 memory provides immediate access to emergency communications. Electronic tuning ensures accurate channel selection, and rotary and squelch controls allow maximum reception ca-



pability. The bright-green LED channel display is easy to read. Other features include a flexible antenna, a low-battery indicator, and a choice of high- or low-power modes to conserve batteries. The CB can be powered by its snap-on battery pack, or by a car battery using an optional cigarette-lighter power cord.

The model 75-777 has a suggested retail price of \$109.95. For more information, contact *Midland International Corporation*, 1690 North Topping, Kansas City, MO 64120; Tel. 816-241-8500.

CIRCLE 103 ON FREE INFORMATION CARD

CORDLESS MOUSE

Named for the recently-developed technology, called Light Emitting Static Tracking Extended Range, that it employs, *Lester the Cordless Mouse* can work with IBM PC, XT, AT, PS2, and compatible computers. The infrared mouse connects through standard RS-232 serial ports, and comes with all the necessary adaptors.

Lester's internal CPU emulates both Microsoft and Mouse systems standards, and automatically adjusts to either. The package includes software—a full-featured paint program as well as "Mouse Test" and "Menu Maker" utility programs—in both 3½- and 5¼-inch formats.

Lester consists of a low-profile, three-button hand unit containing two "AAA" batteries and a receiver that connects to the host computer's RS-232 port for power and control functions. The two pieces communi-

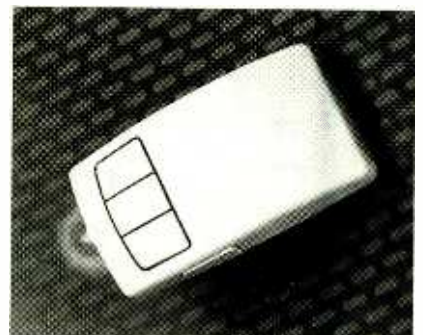

cate via infrared light. The mouse operates within a 90° cone-shaped area, from as far away as five feet from its receiver. Its batteries can provide up to 100 hours of normal use.

Lester the Cordless Mouse has a suggested retail price of \$129.00. For more information, contact *Lightwave Technologies, Inc.*, Customer Service Department, Box 599, Mundelein, IL 60060; Tel. 708-362-6555.

CIRCLE 104 ON FREE INFORMATION CARD

BOOKSHELF SPEAKERS

Pioneer Electronics' family of bookshelf speakers includes the compact, top-of-the-line *CS-G403* that can accommodate any size listening environment. The 150-watt speakers have a powerful three-way bass-reflex design for rich bass. The tweeter is placed between the midrange and the woofer for a more uniform sound field and better stereo imaging. The 22 x 13 x 7-inch speakers offer an excellent frequency response of 30–20,000 Hz and will efficiently



handle volumes of up to 92 dB without distortion.

The *CS-G403* three-way bookshelf speakers have a suggested retail price of \$190 each or \$350 a pair. For further information, contact *Pioneer Electronics (USA) Inc.*, 2265 East 220th Street, [1720, Long Beach, CA 90801-1720; Tel. 213-835-6177.

CIRCLE 105 ON FREE INFORMATION CARD

VHF MARINE TRANSCEIVER

Specially designed for pleasure boats and commercial craft, the *Realistic MTX-101* VHF marine transceiver is ideal for ship-to-ship and ship-to-shore communications. It can be used to receive weather information, to communicate with other boaters or on-shore radiotelephone stations, and to get help from the Coast Guard or nearby vessels in an emergency. The *MTX-101* is accepted and certified by the FCC and includes an FCC license application.

The radio provides 54 transmit and 99 receive channels, including nine designated weather channels. It features dual-output power settings: a one-watt setting for normal communications and a 25-watt setting for emergency or long-distance communications. The *MTX-101* also provides communications on all international chan-



nels. Other features include frequency-synthesized PLL circuitry for precise tuning, an adjustable squelch control, a large digital display with dimmer, and an emergency channel-16 "priority" button. A three-inch speaker is built in, and a jack for adding an external speaker is provided. A universal mounting bracket makes the unit easy to install in a convenient location.

The *MTX-101* VHF marine transceiver has a suggested retail price of \$229.95 at Radio Shack stores nationwide. For further

Employers

Willing workers available now at as little as 1/2 your usual cost.

This is your chance to get help you've needed, but thought you couldn't afford.

No business too large or too small. Call your private industry council or write **National Alliance of Business**, P.O. Box 7207, Washington, D.C. 20044



AMAZING NEW Pocket Reference

480 pages of tables, maps, formulas, and conversions and it fits in your shirt pocket (3.2" x 5.4" x 0.6")!

\$9.95*



* Plus \$2.00 shipping & handling. Colorado residents add 5% tax.

Small sample of contents

Air Tool CFM vs PSI	Radio Alphabet
Battery Charging	TEN Radio Codes
Tire Manufacturer Codes	Telephone Area Codes
Lumber Sizes & Grades	Lost Credit Card Phones
Concrete & Mortar	Sound Intensities
Element Tables	Wind Chill Factors
Computer ASCII Codes	Frequency Spectrum
IBM® PC Error Codes	Geology Mineral Tables
IBM® Interrupts-IO Map	Glues and Solvents
80286 Hard Disk Types	Bolt Torque Tables
Printer Control Codes	Wood Screw/Nail Sizes
Electric Wire Size vs Load	Math Formulas & Tables
NEMA Motor Frames	Plane/Solid Geometry
Wire & Sheet Gauges	Copper/Steel/PVC Pipe
Resistor/Capacitor Colors	Rope, Cable and Chain
Pilot Lamp Specs	Tap-Die-Drill Sizes
Fuse & Battery Specs	Sand Paper & Abrasives
RF Coil Winding Data	Weld Electrode & Solder
Wire Size vs Turns/Inch	3200 Conversion Factors

Money Back Guarantee - If not completely satisfied, return book postage prepaid, in mint condition for a 100% refund!

Sequoia Publishing Inc.
Dept 912, P.O. Box 620820
Littleton, CO 80162

CIRCLE 7 ON FREE INFORMATION CARD

Protel Easytrax®

Outstanding value in
Printed Circuit Board/CAD

Protel Easytrax is a new, low-cost design package for PC and Macintosh users that includes everything required to produce professional quality Printed Circuit Board artwork.

Our easy-to-learn menu-driven design system breaks the 'expert barrier' - you'll be designing in minutes, not hours.

Our comprehensive tutorials guide you through the program's extensive features that take the tedium out of board layout.

When we say professional - we mean through-hole component boards of up to 32 x 32 inches with 6 signal layers plus ground and power planes. A fully independent print/plot program is included which

supports standard plotters, dot matrix and laser printers, Gerber® photoplotters and NIC drill tapes.

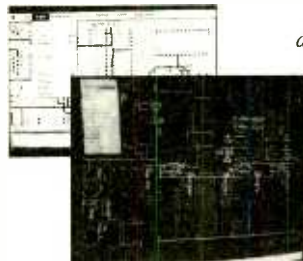

ONLY \$395

Easytrax can be run on your PC or Mac!

CALL TOLL FREE (800) 544-4186

for complete specs and FREE evaluation disks.



50 AIRPORT PARKWAY, SAN JOSE, CA 95110, USA (408) 437-7771, FAX (408) 437-4913

CIRCLE 15 ON FREE INFORMATION CARD

ELECTRONICS PAPERBACKS



□ **BP117—PRACTICAL ELECTRONIC BUILDING BLOCKS, BK-1** \$5.75. Circuits for a number of useful building blocks are presented. Combine these circuits to build the devices you need.

□ **BP192—MORE ADVANCED POWER SUPPLY PROJECTS** \$5.95. Topics covered include switched-mode power supplies, precision regulators, dual tracking regulators and computer-controlled supplies.

More Advanced Power Supply Projects

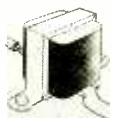

□ **BP190—MORE ADVANCED ELECTRONIC SECURITY PROJECTS** \$5.95. Projects include a passive infra-red detector, a fibre-optic loop alarm, computer-based alarms and an ultrasonic intruder detector.

□ **BP113—30 SOLDERLESS BREADBOARD PROJECTS, BK-2** \$5.95. All projects are based on CMOS logic IC's. Many components are common to several projects. Each project includes a brief circuit description, component layout and parts list.



Electronic Music Projects



□ **BP74—ELECTRONIC MUSIC PROJECTS** \$5.95. Provides a number of circuits for Fuzz Box, Waa-Waa Pedal, Sustain Unit, Reverberation and Phaser Units, Tremolo Generator and more.

□ **BP255—INTERNATIONAL RADIO STATIONS GUIDE** \$7.95. Provides the casual listener, amateur radio DXer and the professional radio monitor with an essential reference work designed to guide him or her around than ever more complex radio bands.



MAIL TO: **Electronic Technology Today, Inc.**
P.O. Box 240
Massapequa Park, NY 11762-0240

SHIPPING CHARGES IN USA AND CANADA

\$0.01 to \$5.00	\$1.25	\$30.01 to \$40.00	\$5.00
\$5.01 to 10.00	\$2.00	\$40.01 to \$50.00	\$6.00
\$10.01 to \$20.00	\$3.00	\$50.01 and above	\$7.50
\$20.01 to \$30.00	\$4.00		

SORRY, No orders accepted outside of USA and Canada

Total price of merchandise \$ _____
 Shipping (see chart) \$ _____
 Subtotal \$ _____
 Sales Tax (NYS only) \$ _____
 Total Enclosed \$ _____

Name _____
 Address _____
 City _____ State _____ Zip _____

New Products

information, contact Radio Shack, Division of Tandy Corporation, 700 One Tandy Center, Fort Worth, TX 76102.

CIRCLE 106 ON FREE INFORMATION CARD

THERMOCOUPLE CALIBRATORS

Two rugged research-grade calibrators, the *Acculex CAL-22J* and *CAL-22K*, cover the entire 0–1000°F range for J-type thermocouples and 0–2000°F range for K-type, respectively. Each unit also has a second switchable range—from –50 to +950°F on the *CAL-22J* and from +100 to +2100°F on the *CAL-22K*.

The devices can be used for precise calibration of temperature-measuring systems, from simple indicators and recorders to transmitters, temperature controllers, and computer-based data-acquisition and control systems. Each operates from two



“AA” batteries for mV output of the selected temperature. A front-panel LED pulses when the device is turned on to indicate proper battery voltage. Both models have built-in cold-junction compensation and automatic standardization. Accuracy is ±0.1% of span (±1°) with cold-junction error less than ±0.25° at 75°F (±0.25°F per degree change in ambient).

The *CAL-22J* and *CAL-22K* thermocouple calculators each cost \$184.00. An optional carrying case (*CAL-CASE*) costs \$20.00, and an optional wall adapter (*CAL-ADP*) costs \$25.00. For additional information, contact Acculex, A MetraByte Company, 440 Myles Standish Blvd., Taunton, MA 02780; Tel. 508-880-3660.

CIRCLE 107 ON FREE INFORMATION CARD

ROM EMULATOR

A comprehensive ROM-emulation system that enables hardware and software developers to test ROM images without the need to burn EPROM's—*Incredible Technologies' ROM-IT*—has three features that

set it apart from other ROM-emulation systems: speed, expandability, and software flexibility. ROM-IT downloads 128 Kbytes in less than 11 seconds with parallel interface. It can be expanded simply by adding additional cards (an additional system and/or host is not required), allowing up to eight 1-megabit EPROM's to be emulated from one host serial port. Individual bytes and blocks of bytes can be modified, making it easy to create a development tool.

ROM-IT can be loaded from any development system with a serial port and provides ROM emulation of most types of EPROM's

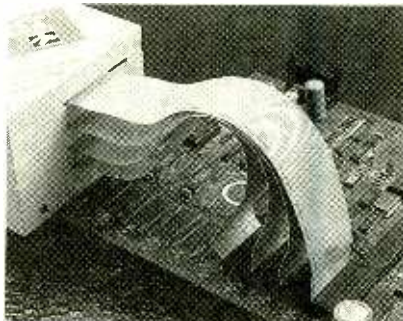

currently in use, from 64 kilobits up to one megabit. A reset control line restarts the target system under host control, and a read/write line allows the target to write to ROM-IT emulation RAM for debugging purposes. Designed for anyone trying to develop hardware or software for real-time, multitasking embedded systems or any ROM-based microcomputer system, ROM-IT lets users run test versions of programs and data without having to program EPROM's.

ROM-IT costs \$395 per 256K card system, with other configurations available. For additional information, contact Incredible Technologies, 709 West Algonquin, Arlington Heights, IL 60005; Tel. 708-437-2433.

CIRCLE 108 ON FREE INFORMATION CARD

FIBER-OPTICS COURSE

This 15-week training course, designed for vocational schools, universities, or industrial training programs, requires only a basic understanding of electronics. *Sintec's Fiber Optics Course* emphasizes practical applications with a limited use of mathematics. The course covers both classroom and lab work, and includes text, lab manual, and parts kit. The course is divided into three parts. The first covers fiber-optics theory and its advantages in transmission lines. Part two covers fibers, sources, detectors, connectors, and splices. Fiber-optic systems, link-system analysis, installation, hardware, applications, and equipment are covered in the third section.

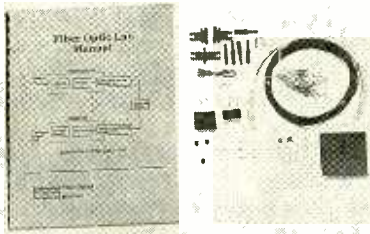

The Fiber-Optics Course costs \$64.95. For additional information, contact Sintec Company, 28 Eighth Street, Box 410, Frenchtown, NJ 08825; Tel. 800-526-5960 or 2201-996-4093.

CIRCLE 109 ON FREE INFORMATION CARD

PERSONAL GROUND TESTER

Offering a variety of test configurations, the Charleswater CP903A personal ground tester lets an operator test the safety and integrity of a wrist strap separately by the cord, or while being worn on his wrist. An optional foot plate permits testing of heel straps and conductive footwear as well. The battery-powered tester is designed for portable or permanent use. Featuring simple one-button operation, the compact test station has two red LED's that indicate bad connections or faulty transistors; a green



LED and an audible alarm validate proper grounding. Test parameters are factory set, but all indicators are adjustable. The CP903A measures only 5¼ x 3½ x 2 inches and comes with a rechargeable battery and an AC adapter.

The CP903A personal ground tester has a list price of \$175.00; the optional foot plate costs \$20.00. For further information, contact Charleswater Products, Inc., 93 Border Street, West Newton, MA 02165; Tel. 617-964-8370.

CIRCLE 110 ON FREE INFORMATION CARD

FUNCTION GENERATOR

Combining flexible controls and powerful functional capabilities in a small package, Beckman Industrial's model FG2A is a versatile, general-purpose signal source. The portable field-test instrument performs over seven frequency ranges that cover 0.2 Hz through 2 MHz. It provides a large array of signal outputs, including TTL pulse outputs as well as adjustable low-distortion sine-, square-, or triangle-wave signals. Power, frequency range, and wave form can each be selected with the push of a button. The



FG2A is packaged in a rugged case that has a combination carrying handle/tilt stand.

Flexibility is provided by various controls, including the duty cycle that allows users to change the nominal 50% duty cycle of the signal to any desired value. The DC offset control adds a variable DC offset voltage to the signal, and the VCF input permits the frequency to be controlled with an external DC control voltage—a useful feature for generating 1000.1 or 1.1000 sweep signals.

The FG2A function generator has a list price of \$215.00. For further information, contact Beckman Industrial Corporation, 3883 Ruffin Road, San Diego, CA 92123-1898; Tel. 619-495-3240.

CIRCLE 111 ON FREE INFORMATION CARD

SURGE SUPPRESSOR

Designed specifically to protect photocopy equipment against damaging power surges on the electrical line, Perma Power has introduced the models PX209.15 and PX209.20 copier surge suppressors. The 15-amp PX209.15 can be used with standard copiers; the 20-amp PX209.20 is intended for use with larger copiers. Each offers a patented fail-safe automatic-shutdown circuit that disconnects the copier from the power line, and shuts of the indicator light, in the event that the surge-suppressor filter ever burns out from large or repetitive surges. That prevents the copier from being exposed to raw, unprotected power, and eliminates the need to constantly monitor the unit to prevent damage to the equipment. Both copier surge suppressors are covered by a lifetime warranty

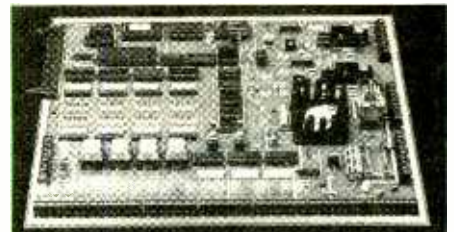

Knight Patrol™ Talking Home Alarm Kit

A high end alarm system at an affordable price!

Features include:

- ♦ State of the art PCF 8200 Speech Synthesizer
- ♦ 21 Sensor Zones, 2 Arming Circuits
- ♦ 2 Five Watt Audio Amplifiers
- ♦ Auxiliary Alarm
- ♦ Real Time 24 Hr. Clock
- ♦ A 10A & 3A Relay Circuit for Sirens, etc.
- ♦ Alert/Sleep Monitoring Modes (verbal status)
- ♦ Trigger Memory (verbal status)
- ♦ Self Diagnostics & Performance Monitoring
- ♦ Microprocessor Controlled
- ♦ Pleasant Female Voice
- ♦ Expandibility & so much MORE!

Available as a kit or pre-assembled. Send for our FREE catalog! A complete line of peripherals is also available. Complete Circuit Board kit \$220 plus \$10.50 S&H. (Ca residents add 6.75% tax)

Paladin Electronics

19425 B Salsquad Cyn Rd
Suite 333 Dept RE S
Canyon Country, CA 91351

"We protect your castle"

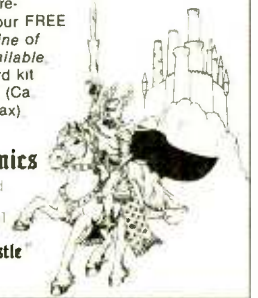

CIRCLE 9 ON FREE INFORMATION CARD

SUPER LONG PLAY TAPE RECORDERS

12 Hour Model —
USES D-120 TAPE
\$119.00*

Modified Panasonic Slimline, high quality AC-DC provide 6 continuous hours of quality recording & playback on each side of cassette • Voice level control • Digital counter, etc. TOK D-120 Cassette Furnished.



PHONE RECORDING ADAPTER

Records calls automatically. All Solid state connects to your telephone jack and tape recorder. Starts recording when phone is lifted. Stops when you hang up. \$28.50*
FCC APPROVED



VOX VOICE ACTIVATED CONTROL SWITCH

Solid state Self contained Adjustable sensitivity. Voices or other sounds automatically activate and control recorder. Uses either re-corder or remote mike. \$28.50*
*Add for ship & hdg. Phone Adapter & Vox \$1.50 ea. Recorders \$4.00 ea. Cal. Res. add tax. Mail order. VISA MIC, COD's OK. Money Back Guarantee. Qty disc avail. Dealer Inquiries invited. Free data.
AMC SALES INC. Dept. B 9335 Lubec St. Box 928. Downey, CA. 90241
Phone (213) 869-8519
FAX (213) 923-1478

CIRCLE 16 ON FREE INFORMATION CARD

New Products

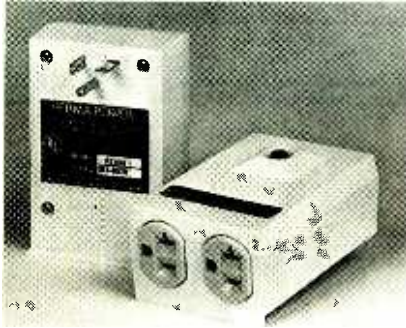

and equipment-protection guarantee, under which Perma Power will not only replace the surge suppressor if it fails, but will also reimburse the cost of repairs to equipment damaged as a result of such a failure. The two UL-listed surge suppressors are cordless, two-outlet units in tan plastic cases that measure $3\frac{1}{8} \times 4\frac{3}{4} \times 2\frac{1}{4}$ inches.

The PX209.15 and PX209.20 copier surge suppressors have suggested user prices of \$54.95 and \$59.95, respectively. For further information, contact Perma Power Electronics, Inc., 5601 West Howard Avenue, Chicago, IL 60648; Tel. 312-763-0763.

CIRCLE 112 ON FREE INFORMATION CARD

GROUNDLESS-TRANSMISSION MODEM

Offering dramatic improvement in data reliability under adverse conditions, *Telebyte Technology's* model 203 two-wire groundless line-driver/short-haul modem uses a fully differential, simultaneous drive/receive technique. (Prior technology was based upon establishing a ground link between units by using one of the wires comprising the single twisted pair; thus any AC noise or perturbations that were reflected on the grounds of either system at the ends of the link could degrade the data.) With the advantages of differential technology on two-wire links, the model 203 provides flawless operation up to 19,200 BPS over distances of two miles. The modem derives its operating power from the transmitted data line, and automatic reset circuits prevent "streaming" of the receive-data lines when the far-end system is powered down.

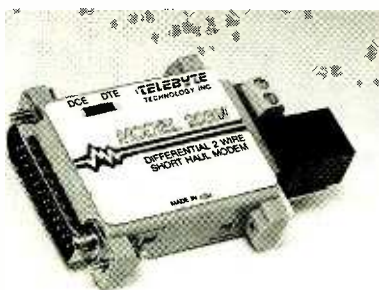

Its DTE/DCE switch allows the model 203 to be used on computers, terminals, multiplexers, and special-purpose data-acquisition systems. The user interface is a DB-25 standard RS-232 connector, and the line-side interface is a two-position terminal block and RJ-11 modular jack. The 203 is small enough to be plugged directly into the device it is serving, eliminating the need for additional cables. Surge protection is built into the two-wire interface.

The model 203 two-wire groundless short-haul modem costs \$98.00. The unit can also be purchased as model 203C, which comes with a BNC coax connector and the two-position terminal block, for \$105.00. For additional information, contact *Telebyte Technology Inc.*, 270 East Pulaski Road, Greenlawn, NY 11740; Tel. 1-800-835-3298 or 516-423-3232.

CIRCLE 113 ON FREE INFORMATION CARD

SCANNER ANTENNA

Designed specifically to prevent antenna "decapitation" from strong winds, the *Scanner Stick* antenna from *Electron Processing* combines fine reception with rugged construction. Completely encased in a continuous PVC tube, the antenna withstands weather conditions that routinely destroy other antennas. Its unique "multipole" construction allows the compact antenna to receive a wide range of frequencies, including all popular scanner frequencies between 30 and 1000 MHz. At only 35

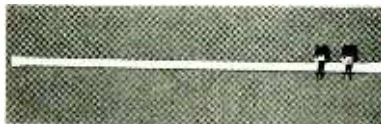

inches in length, and supplied completely assembled with mounting clamps for masts up to 2-inches in diameter, the *Scanner Stick* is easy to install. A female UHF socket (mate to PL259) is provided for connection to an antenna feedline.

The *Scanner Stick* costs \$29.95; quantity discounts are available. For additional information, contact *Electron Processing, Inc.*, P.O. Box 68, Cedar, MI 49621.

CIRCLE 114 ON FREE INFORMATION CARD

PORTABLE CELLULAR TELEPHONE

Among the many features offered by *Audiovox's PT-300* cellular phone is a dual-position retractable antenna that allows calls to be received even when the antenna is down. The portable, 0.6-watt, cellular phone also has "secret" memory, in which credit card numbers and other sensitive

numbers can be stored to be accessed only by inputting a special three-digit code. Another feature provides "silent" incoming calls; the user is visually alerted to the incoming call when the word "call" is flashed on the phone's LCD.

The PT-300 comes with a battery pack and a desk-top battery charger. Other features include multiple-city registration, 99



alpha-numeric memory locations, last-number redial, automatic storage, emergency 911 dialing in all modes, and easy-to-read graphics on the keypad. Options include a leather carrying case and a battery eliminator that allows the phone to be hooked up to a car's cigarette lighter.

The PT-300 cellular phone has a suggested retail price of \$795.00. For additional information, contact *Audiovox Corporation*, 150 Marcus Blvd., Hauppauge, NY 11788; Tel. 516-231-7750.

CIRCLE 115 ON FREE INFORMATION CARD

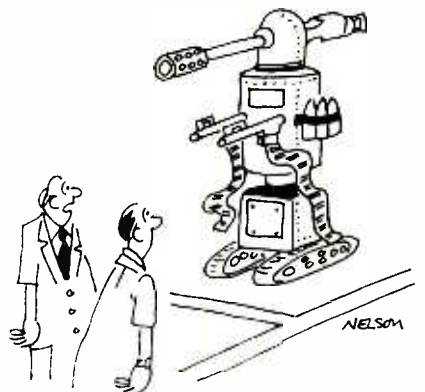

"It was developed for the Army, but they couldn't use it—it actually works."

Learn to troubleshoot and service today's computer systems as you build a fully AT-compatible micro, complete with 1 meg RAM and powerful 20 meg hard drive

NEW!
Now includes
AT-compatible
computer!

Your NRI computer training includes all this: • NRI's unique Discovery Lab® for circuit design and diagnosis • NRI's hand-held digital multimeter featuring "talk-you-through" instructions on audio cassette • A digital logic probe that lets you visually examine computer circuits • The new AT-compatible West Coast 1010 ES computer with 80286 CPU, 101-key "Intelligent" keyboard, 1.2 meg, 5 1/4" high-density floppy disk drive, 1 meg RAM (expandable to 4 meg), 64K ROM, a 20 meg hard disk drive • Bundled software including MS-DOS, GW-BASIC, word processing, spreadsheet, and database programs • Reference manuals with programming guidelines and schematics

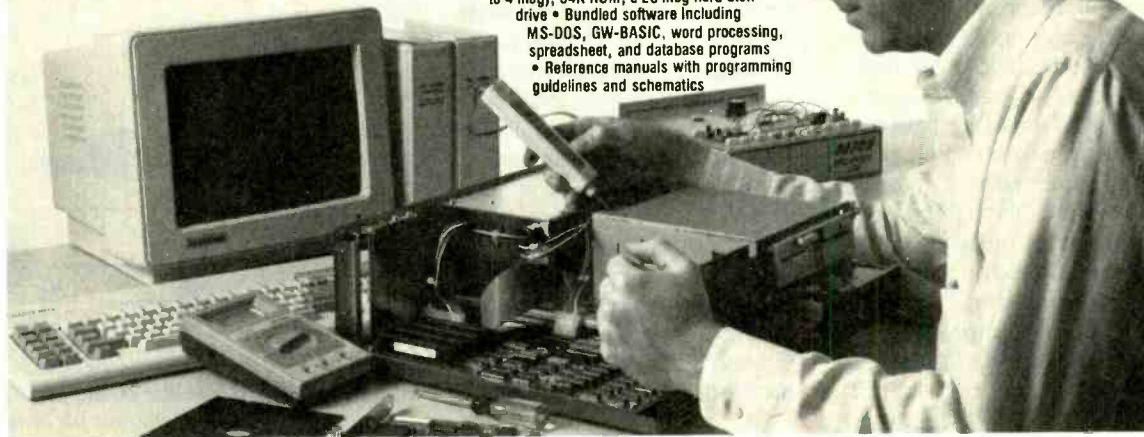

Train the NRI Way— and Earn Good Money Servicing Any Brand of Computer

Jobs for computer service technicians will almost double in the next 10 years according to Department of Labor statistics, making computer service one of the top 10 growth fields in the nation.

Now you can cash in on this exciting opportunity—either as a full-time industry technician or in a computer service business of your own—once you've mastered electronics and computers the NRI way.

NRI's practical combination of "reason-why" theory and hands-on building skills starts you with the fundamentals of electronics, then guides you through more sophisticated circuitry all the way up to the latest advances in computer technology. You even learn to program in BASIC and machine language, the essential language for troubleshooting and repair.

Get Real-World Skills as You Train With a Powerful AT-Compatible Micro—Now With 20 Meg Hard Drive!

To give you hands-on training with the absolute in state-of-the-art computer technology, NRI includes the powerful new West Coast 1010 ES computer as the centerpiece of your training. As you assemble this fully IBM AT-compatible micro from the keyboard up, you actually see for yourself how every section of your computer works.

You assemble and test your computer's "intelligent" keyboard, install the power supply and 1.2 meg, 5 1/4" floppy disk drive, then interface the high-resolution monitor. But that's not all.

Your hands-on training continues as you install a powerful 20 megabyte hard disk drive—today's most-wanted computer

peripheral—now included in your course to dramatically increase the data storage capacity of your computer while giving you lightning-quick data access. Plus you work with exclusive word processing, database, and spreadsheet software, yours to use for your own professional and personal applications.

As you build your computer, performing key demonstrations and experiments at each stage of assembly, you get the confidence-building, real-world experience you need to work with, troubleshoot, and service today's most widely used computer systems.

No Experience Needed, NRI Builds It In

This is the kind of practical, hands-on experience that makes you uniquely prepared to take advantage of today's opportunities in computer service. You learn at your own convenience in your own home.

No classroom pressures, no night school, no need to quit your present job until you're ready to make your move. And all throughout your training, you've got the full support of your personal NRI instructor and the NRI technical staff, always ready to answer your questions and help you whenever you need it.

FREE 100-Page Catalog Tells More

Send today for NRI's big, 100-page, full-color catalog that describes every aspect of NRI's innovative computer training, as well as hands-on training in robotics, video/audio servicing, electronic music technology, security electronics, telecommunications, and other growing high-tech career fields. If the coupon is missing, write to: NRI School of Electronics, McGraw-Hill Continuing Education Center, 4401 Connecticut Avenue, NW, Washington, DC 20008.

IBM and AT are registered trademarks of International Business Machines Corporation

SEND COUPON TODAY FOR FREE NRI CATALOG!

NRI

McGraw-Hill Continuing Education Center
4401 Connecticut Avenue, NW, Washington, DC 20008

McGraw-Hill

For Career courses
approved under GI Bill

check for details.

CHECK ONE FREE CATALOG ONLY

- Computers & Microprocessors
- TV/Video/Audio Servicing
- Robotics
- Electronic Music Technology
- Security Electronics
- Digital Electronics Servicing

- Electronic Circuit Design
- Computer Programming
- Telecommunications
- Basic Electronics
- Bookkeeping and Accounting
- Building Construction
- Automotive Servicing

- Air Conditioning Heating & Refrigeration
- Small Engine Repair
- Electrician
- Locksmithing
- Travel Careers
- Writing
- Paralegal

Name (Please print) _____

Age _____

Street _____

City/State/Zip _____

We'll give you tomorrow.

Accredited Member, National Home Study Council 18-090

SEPTEMBER 1990

21

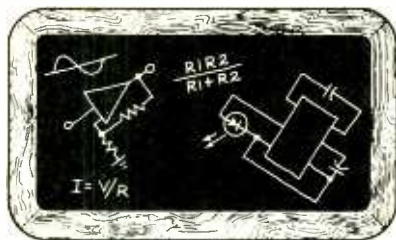

Think Tank

By Byron G. Wels, K2AVB

“OH, THE BEAR WENT OVER THE MOUNTAIN...”

The bear was *white!* He'd have to be, because the only place where you can leave a place, travel five miles south, five miles west and five miles north and be right back where you started, is at the north pole. And what kind of bear does one find at the north pole? Polar bears! And they're all white!

It kind of reminds me of the time that a polar bear cub asked mama bear, "Mom, am I *all* polar bear?" "You sure are son," she replied. "I'm a polar bear, your dad is a polar bear, and that makes you a polar bear too." "But mom," the cub protested, "You sure there's no black bear, or grizzly, or brown bear in me? Not even a little koala bear?" "Nope," she said, "You're all polar bear. Why do you ask?" "Because," the cub replied, "I'm freezing my tail off!"

As you must know if you follow this column, we're now accepting Helps & Hints as well as circuits, and are rewarding them with Think Tank II books. If you've already got one and want to submit another circuit, let us know. We've got lots of books and will find something else for you.

I remember telling you once that I worked as an electronics technician for a large R & D outfit. The engineer I worked under was designing a magnetic anomaly detector for undersea recovery of naval ordinance. Technically, the thing was called a "gradiometer" and a huge meeting was to be held with all the company big shots and the stockholders. It was to take place in the company theater.

The engineer approached me and told me he was to give a talk at the meeting to explain gradiometers in general terms. He told me the lights in the house would be dimmed, and he would walk on the stage and say "What is a gradiometer?" At that point, I was to be stationed at the back of the auditorium with half a dozen huge metal wastebaskets. I would let them fly and they'd go clattering down the aisle. Everybody in the auditorium would turn

around, and he would say, "Everybody that turned around is a gradiometer!"

The idea appealed to my sense of the dramatic, and at the appointed time, I was poised at the back of the house, loaded down with wastebaskets. The engineer was introduced, he stepped to the podium, and said "What is a gradiometer?" I let them go. They clattered and clunked down the center aisle, setting up a tremendous racket. And to my absolute chagrin, I heard him say, "Byron, why did you do that?"

They told me later that the expression on my face was classic. He quickly explained the joke (on me) and I did not get fired.

Electronic Level. Here's the first Helps & Hints of the month. Check out Fig. 1. Mount the two mercury switches on an absolutely flat board, along with the

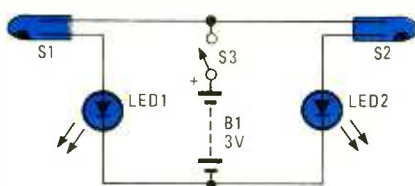

Fig. 1. The electronic level consists of nothing more than a toggle switch, two mercury switches, a pair of LED's, and a 3-volt power source.

LED's. If either of the LED's light, the surface is not level. If both LED's light, the surface is square and level. Switches S1 and S2 are both unidirectional mercury switches.

—Chet Smith, Joliet, IL

Sweet and simple Chet, and we're sending your book out today, even though you didn't explain how the circuit works!

Exercise Pacer. I built this circuit to provide steady, evenly spaced "clicks" for keeping pace while using an exercise machine, such as a ski machine or exercise bike. It can also be used as a

metronome for musicians, or as an audible timer in the darkroom for photography buffs.

See Fig. 2. Complimentary transistors Q1 and Q2 along with C1, R1, and R2 form a very slow oscillator circuit that can be adjusted to provide a pulse to light LED1 or a click to SPKR1. The pulse can be adjusted from about 2-per-second to one every two seconds or so. The values of C1, R1, and R2 can be altered to fit your own needs, or for whatever parts you might happen to have available. Current drain from a

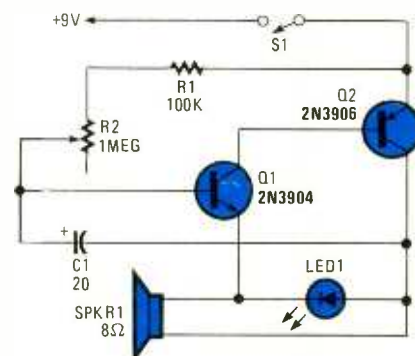

Fig. 2. Aside from its application as an exercise pacer, this circuit can also be used for other purposes: for instance, as a metronome for musicians or as an audible darkroom timer.

single nine-volt battery is low and the LED (one of a bargain-pack assortment from Radio Shack) provides sufficient brightness without overloading, even though it's connected across the terminals of the speaker without a current-limiting resistor.

All parts are available at your local Radio Shack store, and the entire circuit is extremely inexpensive to build. You'll probably wind up spending the most money on the enclosure!

—Joe Papeika, Ansonia, CT

Okay Joe, we're sending the book out—to your wife, as you suggested because she solved our monthly puzzle. Maybe she'll let you look at it!

IR Detector. Here's a good, hassle-free, and inexpensive infrared detector. See Fig. 3. Using that detector circuit, any IR pulse, even short ones, detected by Q1 causes LED1 to come on and stay on for about two seconds. Similarly, should you check a steady source of infrared, LED1 comes on each time you wave the probe in front of the IR source.

The unit is perfect for checking TV or VCR remote controls, IR-based alarm systems, etc. Standby current is less than

Put Professional Knowledge and a
COLLEGE DEGREE
 in your Technical Career through
HOME STUDY

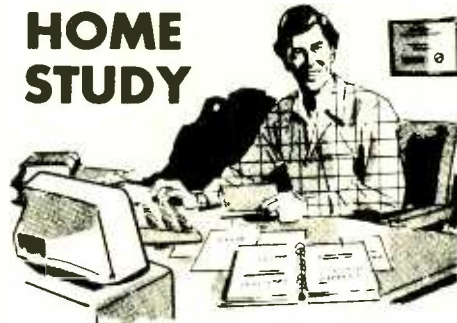

Add prestige and earning power to your technical career by earning your Associate or Bachelor degree through directed home study.

Grantham College of Engineering awards accredited degrees in **electronics and computers.**

An important part of being prepared to *move up* is holding the right college degree, and the absolutely necessary part is knowing your field. Grantham can help you both ways—to learn more and to earn your degree in the process.

Grantham offers two degree programs—one with major emphasis in **electronics**, the other with major emphasis in **computers**. Associate and bachelor degrees are awarded in each program, and both programs are available completely by correspondence.

No commuting to class. Study at your own pace, while continuing on your present job. Learn from easy-to-understand lessons, with help from your Grantham instructors when you need it.

Write for our free catalog (see address below), or phone us at toll-free 1-800-955-2527 (for catalog requests only) and ask for our "degree catalog."

Accredited by
 the Accrediting Commission of the
 National Home Study Council

GRANTHAM
College of Engineering
 250 Frontage Road
 Slidell, LA 70460

SEPTEMBER 1990

23

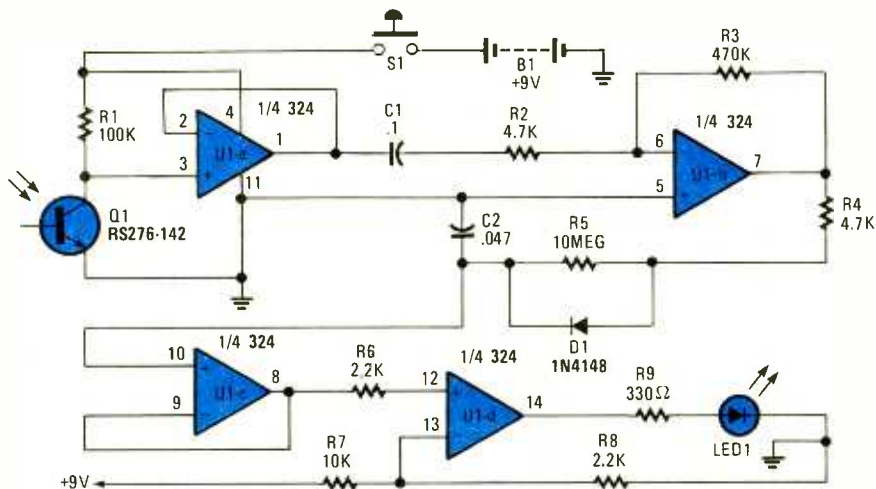

Fig. 3. Built around a 324 quad op-amp and an IR transistor, this circuit can be used to check the operation of any IR transmitter.

2 mA; by using a momentary push-button switch, battery life should be several months.

Here's how it works: IR pulses striking transistor Q1 produce negative-going pulses at Q1's collector, which are transferred through voltage-follower U1-a and C1 to the inverting amplifier, U1-b (which has a gain of 100). The now positive-going pulses charge C2 through R4 and D1. Capacitor C2 is discharged more slowly through resistors R4 and R5.

The charge on C2 is fed to another voltage follower, U1-c. The output of U3 is then fed to the non-inverting input of U1-d. The output of U1-d is high as long as the voltage on C2 is higher than the reference voltage presented to U1-d at pin 13. When U1-d's output is high, LED1 is forward biased, causing it to light. (LED1 stays on for about two seconds for a single pulse.)

With a bit of plastic carving, I was able to fit everything in a small Radio Shack 270-230 experimenters box. A 2¾-inch piece of plastic hacked from the barrel of a felt-tip pen was glued to the box. Transistor Q1 was mounted inside to make a nice, small probe. I also cemented a small piece of IR filter (a piece of unexposed and developed Kodacolor film) at the end of the probe to reduce the unit's sensitivity to ambient light).

—Jacques De Smedt, Key West, FL

Okay Jacques, your book is on the way. Watch for it! I liked the idea of this circuit, not just for the basic design and good application, but Jacques didn't just quit at the breadboarding stage. He did a nice job of packaging and finishing the unit.

Another Helps & Hints! My chassis all may look pretty colorful when I'm finished, but I depend a lot on my wife's assortment of nail polish. I put a small dab on the head of the screw of adjustables, such as capacitors, inductors and potentiometers. The stuff dries quickly and if you're careful not to overdo it, it will keep such controls from changing due to vibration, yet will permit readjustment when required. Just be careful not to allow it to seep into control surfaces.

I also, as a matter of course, take a page from the big boy's book, and put a small dab on screws that shouldn't be tampered with. Kids love to copy what their parents do, and if a youngster decided to take apart one of daddy's projects, the broken nail polish will quickly reveal that tampering has taken place!

I've also learned to apply a smear of colorless nail polish over the top of resist letters on PC boards. Do this before mounting the components and they won't rub off. The clear polish also goes over the transfer letters used on enclosures and panels.

You might want to insulate a surface and while I don't recommend nail polish for 117-volt AC, I have used it to insulate a heat sink from semiconductors. Clean the surfaces, apply polish and let it dry completely. Apply your heat-sink compound and assemble without overtorquing. There it is, a clean, hard, well-fitted insulator.

—Mike Giamportone, Yale, MI

Thanks again Mike. Your book is on the way, and we hope you've got a few more of these hints up your sleeve.

(Continued on page 25)

Enter A World Of Excitement with a Subscription to Popular Electronics®

Get the latest electronic technology and information monthly!

Now you can subscribe to the magazine that plugs you into the exciting world of electronics. With every issue of Popular Electronics you'll find a wide variety of electronics projects you can build and enjoy.

Popular Electronics brings you informative new product and literature listings, feature articles on test equipment and tools—all designed to keep you tuned in to the latest developments in electronics. So if you love to build fascinating electronics, just fill out the subscription form below to subscribe to Popular Electronics... It's a power-house of fun for the electronics enthusiast.

EXCITING MONTHLY FEATURES LIKE:

- CONSTRUCTION**—Building projects from crystal sets to electronic roulette
- FEATURES**—Educational training on digital electronics, Ohm's Law, Antennas, Communications, Antique Radio, Simplified Theory
- HANDS-ON-REPORTS**—User test comments on new and unusual consumer products
- SPECIAL COLUMNS**—Think Tank, Circuit Circus, Computer Bits, DX Listening, Antique Radio, Amateur, Scanner Scene

PLUS: ALL OUR GREAT DEPARTMENTS!

You'll get 12 exciting and informative issues of Popular Electronics for only \$18.95. That's a savings of \$11.05 off the regular single copy price. Subscribe to Popular Electronics today! Just fill out the subscription order form below.



FOR FASTER SERVICE CALL TODAY
1-800-435-0715

IN ILLINOIS 1-800-892-0753 (7:30AM-8:30PM)
EASTERN STANDARD TIME

Popular Electronics® SUBSCRIPTION ORDER FORM

P.O. Box 338, Mt. Morris IL. 61054

YES! I want to subscribe to Popular Electronics for 1 Full year (12 Issues) for only \$18.95. That's a savings of \$11.05 off the newsstand price.

Payment Enclosed Bill me later

Please charge my: Visa Mastercard

Acct. #

Signature _____

Exp. Date _____

PLEASE PRINT BELOW:

NAME _____

ADDRESS _____

CITY _____

STATE _____

ZIP _____

Allow 6 to 8 weeks for delivery of first issue. U.S. Funds only.
In Canada add \$5.00 Postage. All Other Foreign add \$7.50 Postage.

APEJO

THINK TANK

(Continued from page 23)

Duty-Cycle Detector. This circuit (See Fig. 4) looks at the time an incoming signal is high. If the incoming pulse is shorter than the adjusted pulse, the output of the second flip-flop will go high. With the values indicated in the schematic, you'll be able to detect 1- to 2-microsecond pulses.

I used this device in a radio-control receiver to determine the position of the joystick in the R/C transmitter. Note

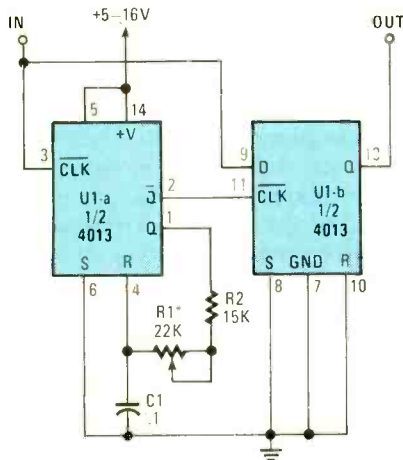

Fig. 4. The duty-cycle detector—consisting of a single 4013 D flip-flop and three support components—can detect 1- to 2-microsecond pulses.

that potentiometer R1 is a pulse adjust. It determines the length of the reference pulse established by the first flip-flop.

I realize that this is but a brief description, but the circuit is so simple and so valuable, that I thought I'd send it in anyway. I hope you like it.

—Vincent Himpe, Desselgem, Belgium

As a matter of fact, Vince, we usually need a lot more text with our circuits, but as you said, it's so beautifully simple that we couldn't just cast it aside!

Wireless Tape Player. My old buggy has an AM/FM radio in it, but no tape player. After pricing tape players, I gave up. They're just too expensive! But I got around it quite nicely with a toy FM wireless mike from Radio Shack. I connected the earphone output from my cassette player to the microphone terminals used for the wireless mike. I clipped the mike out of the circuit and placed the whole "shebang" into my glove compartment.

Then I tuned the radio to a silent spot on the dial, and tuned the mike circuit to match. I then plugged a tape into the cassette player, turned it all on, and "lo and behold," I was able to hear the tape over the car's radio! Now maybe I'm not getting the best fidelity, but it works and I'm sure saving a lot! One day I'll package the whole thing in a neat enclosure with some fancy decals and mount it under the dash.

—Sam Grodin, Pompano Beach, FL
Clever Sam. It just shows to go you,

where there's a will, there's a way! Think Tank II book is on the way.

Light Chaser. This circuit (See Fig. 5) makes a dandy controller for chase lighting displays. The six "D"-type flip-flops of the 40174 are wired to form a six-stage shift register. With switch S1-b in the PROGRAM position, a high or low is placed on pin 3 of U2-a by switch S3, while at the same time, S1-a allows U1 to operate in the monostable mode. By momentarily pressing switch S4 (ENTER),

QUALITY PARTS • DISCOUNT PRICES • FAST SHIPPING

ALL ELECTRONICS CORP.

<p>PIEZO BUZZER</p> <p>Stans HMB 06 Operates on 4-6 Vdc. TTL compatible. Draws 20 mA @ 6 Vdc. Emits high pitched signal. 0.62 diameter, 0.55" high. PC pins. CAT# PBZ-06 \$1.50 each</p> <p>PHOTO RESISTOR</p> <p>100 ohms light 16K ohms dark. 0.182" dia. X .08" high. 0.18" long leads. CAT# PRE-7 2 for \$1.00 100 for \$45.00 - 1000 for \$400.00</p> <p>SWITCHES</p> <p>ITT PUSH BUTTON ITT MOPL series 3.4" X 1/2" grey rectangular key cap. S.P.S.T. N.O. Push to close. RATED: 0.1 amp switching. 0.25 amp carry current. PC mount. CAT# PB-8 \$56 each - 10 for \$60 100 for \$500.00</p> <p>SPDT PUSHBUTTON Marquette 1843 Rated 6 amps @ 125/250 Vac Black plastic pushbutton. Switch body .92" X .64" X .65" CAT# PB-18 \$1.65 ea. - 10 for \$15.00</p> <p>PUSHBUTTON SWITCH GCThorntest 35-420 S.P.S.T. normally open momentary pushbutton switch. Red plastic. actuator 0.57" diameter. Chrome bezel 0.68" diameter. Threaded bushing mounts in .50" diameter hole. Rated 3 amp @ 250Vac. Solder loop terminals. CAT# PB-20 \$1.00 each</p> <p>THUMBWHEEL SWITCH 1 pole 10 position decimal encoded. Red plastic. switches which interlock to make up desired number of digits. Terminals to 31 pc pins (1 com- mon and 10 poles). Each section measures .31" wide X .20" high X .78" deep. End plates can be added to form a .84" high bezel. CAT# SWTH-9 \$1.25 each 10 for \$10.00</p> <p>2 END PLATES—CAT# SW-REC. \$1.00/set</p> <p>WALL TRANSFORMERS</p> <p>ALL PLUG DIRECTLY INTO 120 VAC OUTLET</p> <p>6 Vdc @ 600 ma CAT# ACTX-660 \$3.50 8.3 Vdc @ 10 ma CAT# DCTX-8318 \$1.50 12 Vdc @ 500 ma CAT# DCTX-125 \$4.50 6 Vdc @ 1 amp CAT# DCTX-951 \$5.00 24 Vdc @ 625 ma CAT# ACTX-2462 \$3.00</p> <p>TELEPHONE COUPLING TRANSFORMER</p> <p>Mult Products Intermational A19N-H-10r1 Primary: 600 ohm Secondary: 600/500 ohm 0.77" X 0.61" X 0.63" high 6 pc pins on 0.187" centers Primary inductance: 300 mH min. at 1kHz; 1 volt. CAT# TCTX-1 \$1.25 each - 10 for \$11.00</p>	<p>16 CHARACTER LCD DISPLAY</p> <p>Hitachi LM015 16 character dot matrix LCD display with built-in controller/driver. Interfaces with 4 or 8 bit MPU. Displays alphanumerics, kana characters and symbols. CMOS - low power dissipation. Operates on 5 Vdc. Module size: 3.14" X 1.40". Display area: 2.53" X 0.54". Character size: 0.25" high X 0.115" wide. Programming and hook-up instructions included. CAT# LCD-1 \$9.50 each</p> <p>NICKEL-CAD BATTERIES (RECHARGEABLE)</p> <p>AAA SIZE \$1.50 each 12 volts 180 mAh CAT# NCB-AAA AA SIZE \$2.00 each 125 volts 500 mAh CAT# NCB-AA AA SIZE \$2.20 each WITH SOLDER TABS CAT# NCB-SAA C SIZE \$4.25 each 12 volts 1200 mAh CAT# NCB-C D SIZE \$4.50 each 12 volts 1200 mAh CAT# NCB-D</p> <p>XENON TUBE</p> <p>1" long flash tube with 3 1/2" red, and black leads. Ideal for elec- tronic flash or strobe projects. CAT# FLT-3 2 for \$1.00</p> <p>RELAYS</p> <p>6 VOLT D.C. - S.P.D.T. Armal # RSD-6V Super small relay. Rated: 1 amp @ 30 Vdc. TTL direct drive possible. Operates on 4.3 to 14 Vdc. Coil: 220 ohms, 1.318" X 1.332" X .716". CAT# RSD-6V \$1.50 each - 10 for \$13.50</p> <p>12 VOLT D.C. DIP RELAY</p> <p>Miniature relay fits standard 16 pin (dip) sockets or will directly mount to pc boards. (1) Cover #M4C009- 280 ohm - 30 va switching CAT# CRLY-12 \$2.50 each</p> <p>24 VOLT D.C. COIL KUP style</p> <p>11 pin base can be soldered direct soldered or quick connect terminals can be used 1.38" X 1.12" X .21" S.P.D.T. 5 amp contacts - 470 ohm CAT# RLV-324 \$2.25 each</p>	<p>INSTRUMENT ENCLOSURES</p> <p>High quality molded ABS Instrument enclosures Integrated PC board standoffs and two sets of vertical mounting slots for front and rear sub panels. All enclosures are 6" wide X 6 1/4" deep. Choice of three heights Includes non-slip rubber feet and hardware. Available in beige, ivory, black, and blue Panel Mt. CAT# 2 1/4" CAT# MBA \$7.50 each 10 for \$65.00 2 3/8" CAT# MBB \$7.75 each 10 for \$67.50 3" CAT# MBC \$8.00 each 10 for \$75.00 Please specify color code</p> <p>0 - 6 HOUR AUTO SHUT-OFF TIMER</p> <p>M.H. Rhodes, Inc. Mark-Timed 90007 Timer fits standard 3" deep wallbox. Rated 20 amps @ 125 Vac. Turn knob to desired time. Includes hardware, beige wallplate, and knob. UL and CSA listed. CAT# TMC-4 \$5.75 each - 10 for \$50.00</p> <p>SPECIAL PURCHASE 210 MFD 330 V PHOTOFASH CAPACITOR</p> <p>Rubicon CE photoflash capacitor 0.79" dia. X 1 1/4" high. These are new capacitors that have been prepared with 1.4" black and red wire leads soldered to the terminals. CAT# PFC-210 \$2.50 each 10 for \$22.50 - 100 for \$200.00 Large quantities available. Call for pricing.</p> <p>STEPPER MOTOR</p> <p>Alipax P/N C82711-M1 7 Vdc dual coil, permanent magnet stepper. 23.25 ohm coil. 7.5 degrees per step. CAT# SMT-6 \$6.00 each - 10 for \$50.00</p> <p>ELECTRONIC GAME BOARD</p> <p>The inner workings of an electronic Scrabble game. Operates on 6 Vdc. 8 digit alpha- numeric readout, 48 button keypad, 14 transistors, 21 C's, 1 piezo element and other good- ies. Top and bottom row of keypad buttons are function keys, middle 3 rows are alpha- betical. No instructions available. 6" X 4.5" CAT# ST-4 \$1.75 each 10 for \$15.00</p> <p>RG-11U7 75 OHM VIDEO CABLE</p> <p>100 ft. or 200 ft. rolls of RG-11U7 terminated to heavy duty F connectors. Includes 75 ohm terminator and F-61 splacer on one end. New cables manufactured for IBM PC net- works. IBM P/N 1501908 COMSCOPE CAT# RG-11V 100 ft. roll \$15.00 CAT# RG-11V2 200 ft. roll \$27.50</p>	<p>LED'S</p> <p>STANDARD JUMBO DIFFUSED T1-344 size</p> <p>RED CAT# LED-1 10 for \$1.50 - 100 for \$17.00</p> <p>GREEN CAT# LED-2 10 for \$2.00 - 100 for \$17.00</p> <p>YELLOW CAT# LED-3 10 for \$2.00 - 100 for \$17.00</p> <p>FLASHING LED with built in flashing circuit operates on 5 volts</p> <p>RED CAT# LED-1 10 for \$1.00 - 100 for \$13.00</p> <p>GREEN CAT# LED-2 10 for \$1.00 - 100 for \$13.00</p> <p>YELLOW CAT# LED-3 10 for \$1.00 - 100 for \$13.00</p> <p>LED HOLDER 2 pins holder CAT# HLED 10 for \$5e</p> <p>RECTANGULAR L.E.D. SPECIAL PHLM0001 Red diffused rectangle 0.28" X 0.1" X 0.20" high. Ideal for bar graphs, charts, etc. CAT# RLED-4 10 for \$1.50 - 100 for \$12.00 1000 for \$100.00</p> <p>LED BAG 50 assorted LED'S Many different shapes, colors, sizes. Round, rectangle, square, etc. CAT# GRLED \$4.00 per assortment</p>	<p>SOUND ACTIVATED SWITCH</p> <p>PC board with electric mike responds to sounds in immediate vicinity. Originally part of sound activated light organ. Shuts off when sound is not present. Includes hook-up diagram. CAT# SAB-2 \$2.50 each</p> <p>L.E.D. FLASHER KIT</p> <p>Two L.E.D.'s flash in unison when a 9 volt battery is attached. This kit includes a p.c. board, all the parts and instructions to make a simple flasher circuit. A quick and easy project for any- one with basic soldering skills. CAT# LEDKIT \$1.75 per kit</p> <p>LED CHASER KIT</p> <p>Build this variable speed led chaser. 10 leds flash sequentially at whatever speed you set them for! Easy to build kit includes pc board parts and instructions. Ideal for special lighting effects, costumes, etc. Operates on 3 to 9 volts. PC board is 5" X 2.25". A great one hour project. CAT# AEC \$6.50 each</p> <p>STEPPING MOTOR CONTROLLER KIT</p> <p>Learn about stepping motors while building this simple circuit. Includes circuit board and all parts except 12 Vdc power supply. CAT# SMTKIT \$18.00 each</p> <p>RECHARGEABLE BATTERY PACK (USED)</p> <p>Four AA nickel cad- mium batteries con- nected in series to make a 4.8 volt pack. Batteries are in a 2 X 2 configuration with a 2 pin connector attached. The four batteries can be separated into single AA size solder tabs. CAT# NCB41AAU</p>
--	---	--	--	---

ORDER TOLL FREE 1-800-826-5432

FAX (818) 781-2653 • INFORMATION (818) 904-0524

Call Or Write For Our
Free 60 Page Catalog
Outside the U.S.A. send \$2.00
postage for a catalog.

Minimum Order \$10.00 - All Orders Can Be Charged To Visa, Mastercard
Or Discovercard • California, Add Sales Tax • Shipping And Handling \$3.50
For the 48 Continental United States - All Orders Including Alaska, Hawaii,
P.R. And Canada Must Pay Full Shipping • Quantities Limited • No C.O.D. •
Prices Subject to change without notice.

MAIL ORDERS TO: ALL ELECTRONICS CORP. • P.O. BOX 567 • VAN NUYS, CA 91408

CIRCLE 5 ON FREE INFORMATION CARD

25

THINK TANK

the flip-flops are simultaneously clocked and the data on pin 3 (and the "D" inputs of all flip-flops) are shifted to the right one stage. To enter a low, press switch S4 momentarily while simultaneously pressing S3. To enter a high, just press S4 momentarily. Use switch S2 to clear all registers before programming.

Once programmed, switch S1 to the RUN position and U1 goes to the astable mode, while the 40174 becomes a ring counter, creating the light chasing effect. You can replace LED1 with solid-state relays or optocoupler/triac combinations for 117-volt lighting.

Worth a Think Tank book Byron?

—Daniel P. Ray, Windsor, Ontario, Canada

Well worth it Dan, and the book is on the way. What appealed to me in this circuit, was the fact that any sort of display can be controlled with this device, from a small LED type to a theater marquee!

Outdoor Light Control. Not too long ago, I considered buying electronic-eye modules to control my outdoor lights. I got about as far as pricing them when I decided to build my own and pocket the money. Those things can get expensive! What I required was a dawn-to-dusk unit that would provide an adjustable threshold and hysteresis to prevent erratic switching.

The circuit that I came up with (See Fig. 6) is straightforward and can be put together for under five bucks. The heart of the circuit is an inverting comparator

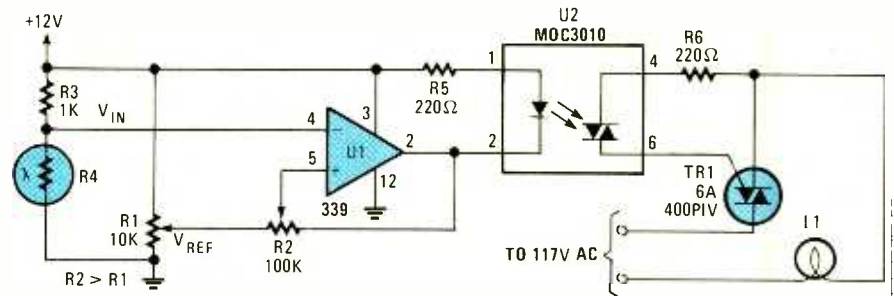

Fig. 6. Using a simple voltage-divider network (consisting of R3 and R4) and a 339 comparator, this circuit can be made to turn on a lamp or any other AC-operated device that happens to be connected across TR1.

with positive feedback (hysteresis) and an adjustable threshold. Its operation is easy to follow. The output of the comparator remains high until the voltage, V_{in} , across R4 exceeds V_{ref} .

When V_{in} becomes greater than V_{ref} , the comparator output goes low and turns on the LED in the optocoupler which, in turn, fires the Triac. This turns on the light. In order for the circuit to function properly, R2 must be much greater than R1. Do I get a book Byron?

—Jeffrey Peterson, Connellsville, PA

It's on the way Jeff. And I want to tell you also, that nice schematic you sent in made our art department quite happy!

Battery Substitute. Let's face it, batteries are convenient. But they can also be a pain. We all have battery-operated devices from tape recorders to clocks, and I'm no exception. But battery replacement can cost you, and often, the devices are used in a fixed position. The clock sits on the mantle, for

example. The transistor radio on a desk. How nice to be able to do away with all the batteries and depend on good old AC!

This circuit (See Fig. 7) uses a low-voltage programmable 3-lead regulator (an LM317) and some easy-to-obtain components. The four diodes form a bridge rectifier, but may be substituted by a bridge rectifier rated at 3 amps or more. The voltages shown at each of S1's contacts are the most common used, but can be easily changed by calculating for a new resistor value, which we'll call R_x .

The new unknown resistor value in ohms is calculated using: $R_x = R1 (V_{out}/1.25 - 1)$. Lets say, for example, that we want an output of 18 volts. We would calculate: $R_x = 220 (18/1.25 - 1) = 2948$. To check the calculated value, you would then use $V_{out} = 1.25 V (1 + R_x/R1)$ to determine the output voltage using that resistor value. The calculation should work out to the desired voltage level.

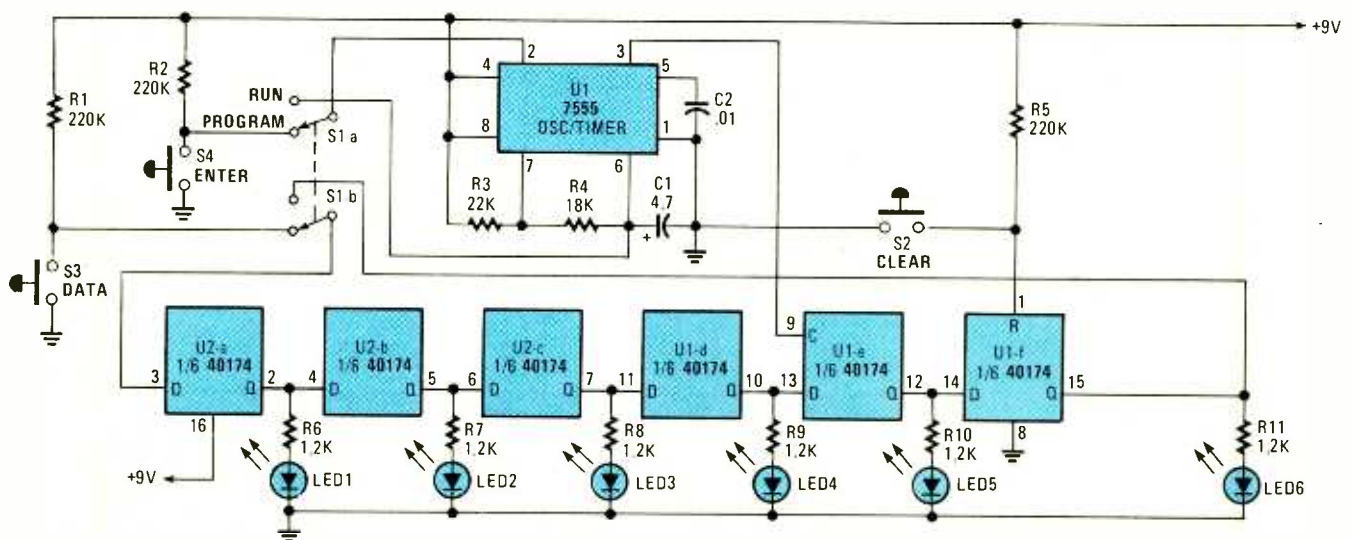

Fig. 5. In this circuit, a single, hex D flip-flop is configured as a 6-stage shift register, and derives its clock input from a 7555 oscillator/timer, to produce a flickering light show.

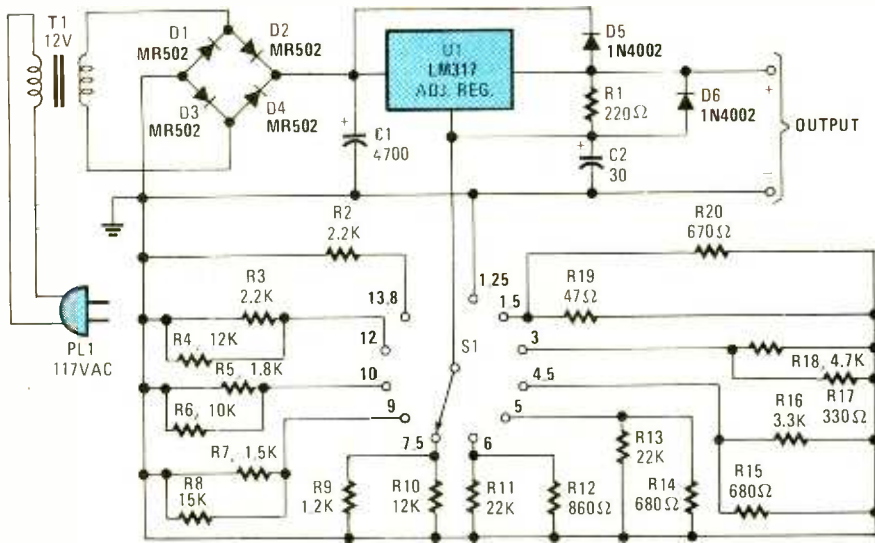

Fig. 7. If you often need fixed voltages between 1.25 and 13.8 volts, this rather unconventional power supply (based on an LM317 adjustable voltage regulator) may be just what the circuit doctor ordered.

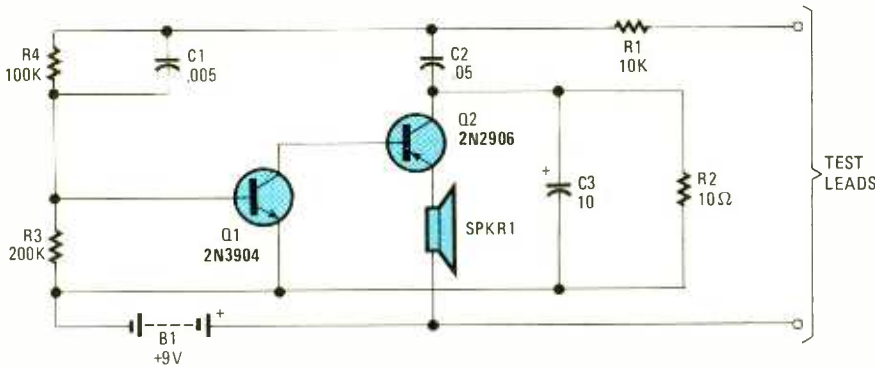

Fig. 8. The Junkbox Continuity Tester always seems to work, regardless of what parts are used!

The selector switch is fitted with a pointer knob and the voltages are marked on the front panel. The beauty of this IC is that it is protected against shorts and thermal effects, but you have to provide a heat sink for high currents. Do not eliminate the capacitor at the adjust terminal. I hope this rates a Think Tank book!

—Juan J. Martinez, Mexico, DF Mexico.

You've got it, Juan. And thank you for your submission. It's a nice job, and a useful project.

Junkbox Continuity Tester. This little continuity tester (see Fig. 8) always seems to work, regardless of what parts are used! I've literally built dozens of them as gifts for friends, and as yet, haven't had one fail.

Wiring the unit doesn't seem to present any sort of problem either. For the sake of neatness, you can use a small piece of perfboard and when the unit is

complete, just select a small plastic utility box to mount the thing in. You can mount the small speaker inside the box if you drill a few holes to allow the sound to escape. I've found that a pair of quarter-inch holes serve nicely for the red and black test leads. Just mount two small rubber grommets to the enclosure to pass the wires through, and tie a knot inside the case for each one, as a strain relief.

There's nothing critical here, it works each and every time, and you'll really have to work hard to get it *not* to work!

—John V. Craig, Bradenton, FL

John, this is an especially handy circuit for people just getting into electronics. They build it, it works, and now they have a handy piece of test equipment to boot.

That's the end of our space for this month. Remember, send your Helps & Hints and your circuits to **Think Tank, Popular Electronics** 500-B Bi-County Blvd., Farmingdale, NY 11735. ■

AMAZING SCIENTIFIC & ELECTRONIC PRODUCTS

PARTS ARE IN STOCK	PLANS ASSISTANCE PROGRAM AVAILABLE	KITS ASSISTANCE PROGRAM AVAILABLE	ASSEMBLED
GRA1 — ANTI GRAVITY GENERATOR	FMV1K — 3 MILE FM VOICE TRANSMITTER	FMV1K — 3 MILE FM VOICE TRANSMITTER	LIST10 — INFINITY XMTR Listen in via phone lines
LCT7 — 40 WATT BURNING CUTTING LASER	PFS1K — HAND CONTROLLED PLASMA FIRE SABER	PFS1K — HAND CONTROLLED PLASMA FIRE SABER	IPG70 — INVISIBLE PAIN FIELD BLAST WAVE GENERATOR
RUB4 — HI POWER PULSED DRILLING LASER	NIG7K — HI FLUX NEGATIVE ION GENERATOR	NIG7K — HI FLUX NEGATIVE ION GENERATOR	ITM10 — 100,000 VOLT INTIMIDATOR UP TO 20'
MTC5 — 1 MILLION VOLT TESLA COIL	PG5K — PLASMA LIGHTNING GLOBE	PG5K — PLASMA LIGHTNING GLOBE	TAT30 — AUTOMATIC TELEPHONE RECORDING DEVICE
MCP1 — HI VELOCITY COIL GUN	LHC2K — VISIBLE SIMULATED 3 COLOR LASER	LHC2K — VISIBLE SIMULATED 3 COLOR LASER	PSP40 — PHASOR SONIC BLAST WAVE PISTOL
LLS1 — LASER LIGHT SHOW 3 METHODS	HOD1K — HOMING/TRACKING BEEPER TRANSMITTER	HOD1K — HOMING/TRACKING BEEPER TRANSMITTER	DNE10 — ALL NEW 26" VIVID COLORED NEON STICK
EH1 — ELECTRONIC HYPNOTISM TECHNIQUES	LGU6K — 2.5 MW HAND-HELD VISIBLE LASER GUN	LGU6K — 2.5 MW HAND-HELD VISIBLE LASER GUN	LGU20 — 5 TO 1MW VISIBLE RED HeNe LASER GUN
EM1 — LOWER POWERED COIL GUN LAUNCHER	ITC3K — 250,000 VOLT TABLE TOP TESLA COIL	ITC3K — 250,000 VOLT TABLE TOP TESLA COIL	BLS10 — 100,000 WATT BLASTER DEFENSE WAND
JL3 — JACOB LADDER 3 MODELS	IOG2K — ION RAY GUN, project energy without wires	IOG2K — ION RAY GUN, project energy without wires	
SD5 — SEE IN THE DARK	TKE1K — TELEKINETIC ENHANCER/ELECTRIC MAN	TKE1K — TELEKINETIC ENHANCER/ELECTRIC MAN	
LEV1 — LEVITATION DEVICE	VWPM7K — 3 MILE AUTO TELEPHONE TRANSMITTER	VWPM7K — 3 MILE AUTO TELEPHONE TRANSMITTER	

ASSEMBLED
LIST10 — INFINITY XMTR Listen in via phone lines
IPG70 — INVISIBLE PAIN FIELD BLAST WAVE GENERATOR
ITM10 — 100,000 VOLT INTIMIDATOR UP TO 20'
TAT30 — AUTOMATIC TELEPHONE RECORDING DEVICE
PSP40 — PHASOR SONIC BLAST WAVE PISTOL
DNE10 — ALL NEW 26" VIVID COLORED NEON STICK
LGU20 — 5 TO 1MW VISIBLE RED HeNe LASER GUN
BLS10 — 100,000 WATT BLASTER DEFENSE WAND

EASY ORDERING PROCEDURE - TOLL FREE 1-800-221-1705 or 24 HRS ON 1-603-673-4730 or FAX IT TO 1-603-672-5406
VISA, MC, CHECK, MO IN US FUNDS. INCLUDE 10% SHIPPING. ORDERS \$100.00 & UP ONLY ADD \$10.00. CATALOG \$1.00 OR FREE WITH ORDER.

INFORMATION UNLIMITED
P.O. BOX 716, DEPT. P.N., AMHERST, NH 03031

Be an FCC LICENSED ELECTRONIC TECHNICIAN!



No costly School. No commuting to class. The Original Home-Study course prepares you for the "FCC Commercial Radio-telephone License". This valuable license is your "ticket" to thousands of exciting jobs in Communications. Radio-TV, Microwave, Computers, Radar, Avionics and more! You don't need a college degree to qualify, but you do need an FCC License. **No Need to Quit Your Job or Go To School** This proven course is easy, fast and low cost! **GUARANTEED PASS** — You get your FCC License or money refunded. **Send for FREE facts now. MAIL COUPON TODAY!**

COMMAND PRODUCTIONS
FCC LICENSE TRAINING, Dept. 203
P.O. Box 2824, San Francisco, CA 94126

Please rush FREE details immediately!

NAME _____
ADDRESS _____
CITY _____ STATE _____ ZIP _____

Welcome to. . .

SCIENCE **PROBE!**[®]

The Amateur Scientist's Journal

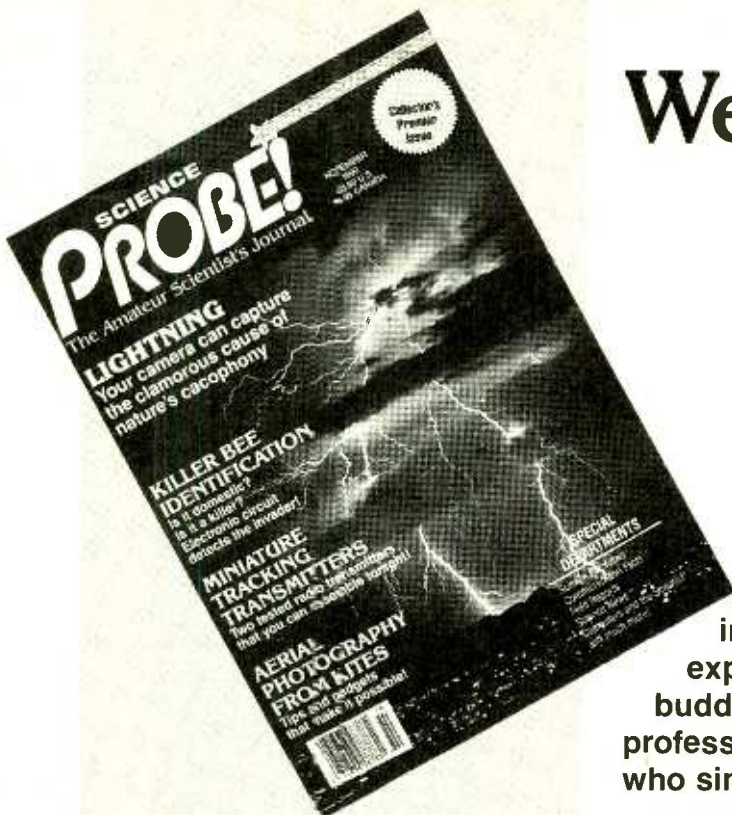

Embark on an irresistible new journey into the realm of mystery, challenge, and exploration! The perfect magazine for the budding scientist, the serious amateur, the professional who would like to relax, and those who simply want to gaze at the stars.

SCIENCE PROBE! — the *only* magazine devoted entirely to Amateur Scientists! If you are fascinated by science in all its many forms . . . if you can't stay away from a microscope, telescope, calipers, or test tube — we invite you to share the wonders in every issue of **SCIENCE PROBE!** You will join a community of Amateur and Student Scientists who enthusiastically seek scientific knowledge or follow scientific pursuits for their own sakes and not merely as a profession.

Obtain your personal *premier* edition of **SCIENCE PROBE!** by visiting a quality Newsstand, Convenience Store, or Supermarket this Fall or by reserving your personal copy through the mail by completing the coupon below.

From the very first issue of **SCIENCE PROBE!** you will be involved in a world of scientific facts, experiments, and studies pursued by amateur scientists who are university students, inventors, academicians, engineers, or office workers, salesmen, farmers—whose *quest* is to probe into the mysteries of science and reveal them to all.

Plan to become a **SCIENCE PROBE!** reader!

Articles to appear in early issues of **SCIENCE PROBE!** are:

- LIGHTNING—CAPTURE IT ON FILM**
- MONITORING ULTRAVIOLET FROM THE SUN**
- MOBILE-MOUNT EXPERIMENTAL WIND TUNNEL**
- CHECKING OUT ACID RAIN**
- AERIAL PHOTOGRAPHY FROM KITES AND BALLOONS**
- MINIATURE TRACKING TRANSMITTER**
- KILLER BEE IDENTIFICATION**
- HOW TO OBTAIN ANIMAL EYESHINE PHOTOGRAPHS**

If you're fascinated by science in all its many forms, if you are compelled to experiment and explore, then **SCIENCE PROBE!** is your kind of magazine!

SCIENCE PROBE!	7PEJ1
500-B Bi-County Boulevard Farmingdale, NY 11735	
Please forward my Premier Edition of SCIENCE PROBE! as soon as it comes off the press. I am enclosing \$3.50-U.S.A. (\$3.95-Canada) plus \$1.00 for shipping and handling. Better still, please enroll me as a charter-member subscriber and send the next four (4) quarterly issues of Science Probe. I am enclosing \$9.95-U.S.A. (Canada: \$14.95 U.S.A. Funds)	
<input type="checkbox"/> Premier Edition only <input type="checkbox"/> First Four Issues (1 Year)	
Offers valid in the U.S.A. and Canada only. No foreign orders.	
Name _____	
Address _____	
City _____ State _____ ZIP _____	
All Orders payable in U.S.A. Funds only.	

ON SALE AT QUALITY NEWSSTANDS, CONVENIENCE STORES AND SUPERMARKETS
STARTING SEPTEMBER 13, 1990 — \$3.50-U.S.A. — \$3.95-Canada

Nikola Tesla (1856–1943) was a brilliant Croatian physicist known for his research in the field of alternating current and motor development. He also had a weakness for ideas and devices that many considered exotic. Among other things, he postulated that the world could be made to blow up if its frequency could be determined, locked in, and made to reinforce itself, and proposed a motor driven by “tachyons,” particles faster than the speed of light.

He was also obsessed by the concepts of long-distance communications and the wireless transmission of electrical power and spent much time and large sums of money on his experiments in those fields. At his laboratory at Colorado Springs, Colorado, Tesla built the world’s most powerful radio transmitter. Around the base of a 200-foot mast, he placed an air-core transformer that measured 75 feet in diameter. The primary consisted of only a few turns of wire; the secondary was 10 feet in diameter and consisted of 100 turns of wire. Using the transformer, he gener-

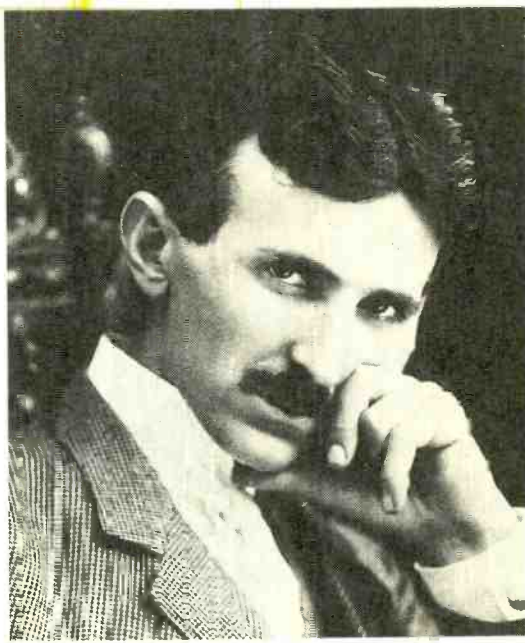

In addition to his many important contributions to electronics technology, Nikola Tesla gave us “lightning generators” that to this day fascinate and entertain.

Tesla's Lightning

BY
RALPH A. HUBSCHER

Generators

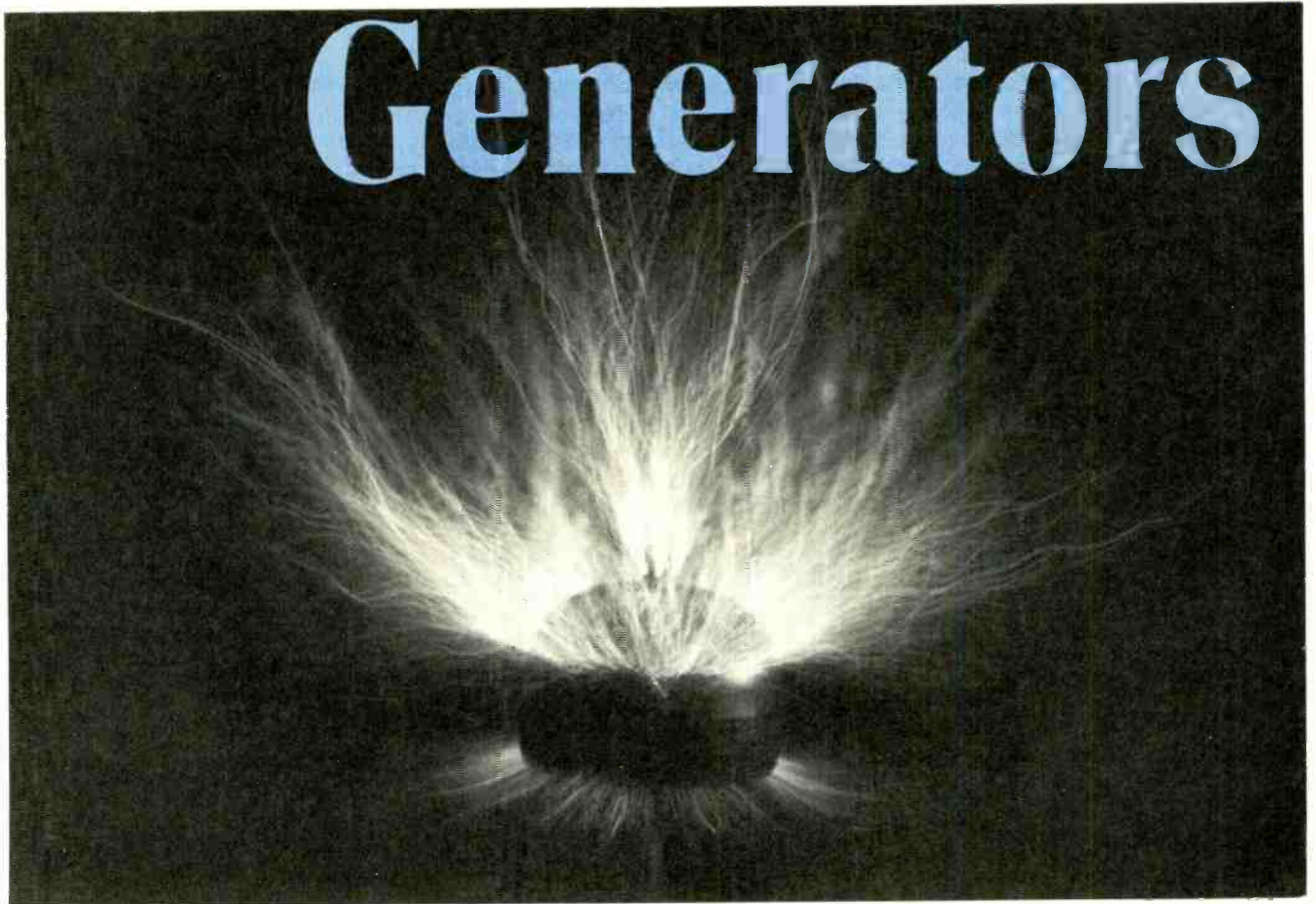

ated on the order of 100-million volts. From the 3-foot copper ball on the top of the mast, bolts as long as 100 feet leapt; Tesla had created the first man-made lightning. And with that "Tesla coil," he was eventually able to light a bank of 200 incandescent light bulbs from a distance of 26 miles.

Unfortunately, Tesla's ideas were considered nonsense by most of the reputable scientists of his time. Even today, he receives little recognition for his many important contributions to electronics and electricity. Chief among those, of course, is his development of the AC power-distribution system, which is still in use today.

And, of course, there is the high-voltage generator he used for his Colorado Springs experiments. Scaled down versions of that Tesla coil are popular among experimenters and hobbyists. When treated with care, they can provide hours of fun.

Building a Tesla Coil. Take a look at the schematic of Fig. 1. Don't let its simple appearance fool you. For the circuit to work, resonance has to be achieved and that is the catch. When dealing with high-frequency voltages (in the 200,000-volt range) exact capacitance, voltage, and frequency measurements can be difficult and dangerous to obtain without apparatus that is too expensive for the average hobby lab. Without that data, resonance formulas are of little help, and trial-and-error-methods can lead you a long way off the path of success.

Our purpose here, then, is to provide you with a framework that will help you develop your own working Tesla coil; without that framework, it could take

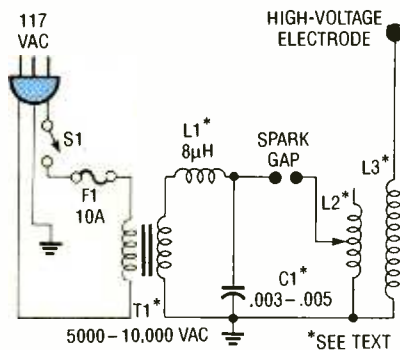

Fig. 1. For best results, the primary of the Tesla coil must be tuned to match the impedance of the secondary as closely as possible. That is done by setting the spark gap and tapping the primary winding so that maximum discharge occurs at the high-voltage electrode.

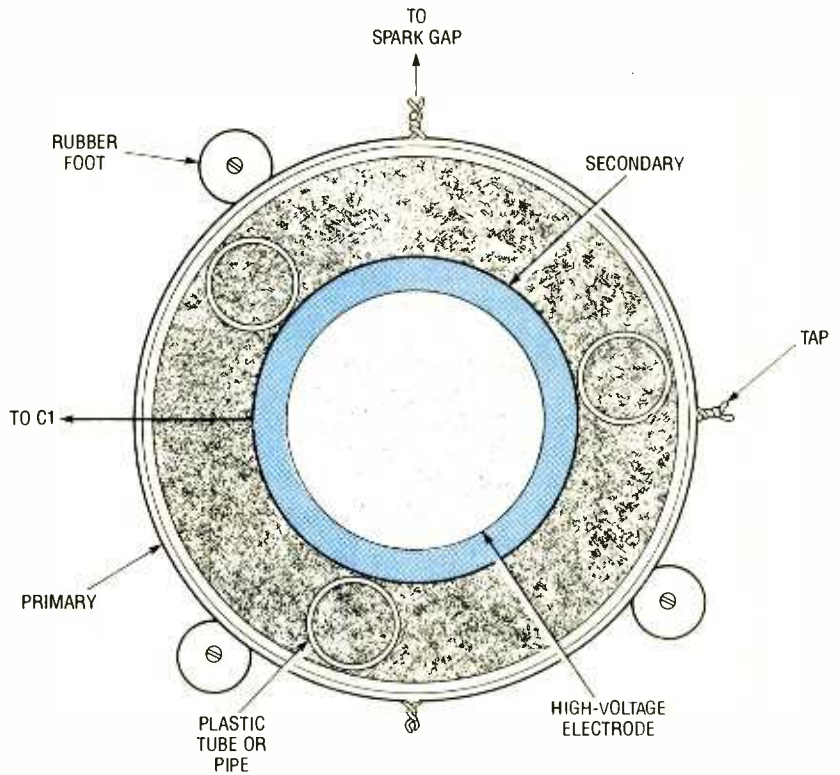

Fig. 2. When placing the wound primary on its baseboard, rubber feet are used to provide a tight-fitting friction mount; for larger coils, they can be replaced or supplemented by L-brackets for better support. The secondary is then placed within the primary and held in place by small pieces of plastic pipe or tubing; select the diameter of the pipe to provide a snug fit.

you a long time to develop a good model. With all the necessary materials on hand (more on that shortly), a Tesla coil could be built in a couple of evenings. More likely, however, it will take you over a week of evenings especially if you have no experience in winding long coils of thin wire without overlaps.

Before we go much further, we must make clear that this article is intended for experimenters. Other articles that have appeared in **Popular Electronics** and elsewhere have given step-by-step instructions for building a Tesla coil of a particular design. Our intention here is to provide a starting point for

WARNING!!! This article deals with and involves subject matter and the use of materials and substances that may be hazardous to health and life. Do not attempt to implement or use the information contained herein unless you are experienced and skilled with respect to such subject matter, materials and substances. Neither the publisher nor the author make any representations as to the accuracy of the information contained herein and disclaim any liability for damages or injuries, whether caused by inaccuracies of the information, misinterpretations of the directions, misapplication of the information or otherwise.

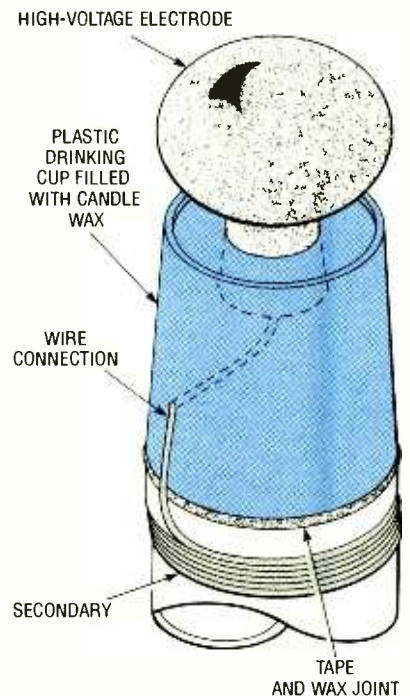

Fig. 3. The high-voltage end of the secondary is fitted with an end cap that serves as an insulator/electrode-mount. You can use the scheme shown here to create a homemade end-cap/electrode-mount for your Tesla coil.

you to develop a Tesla coil of *your* design. We will present some design criteria, point out some of the pitfalls that we discovered the hard way, give some hints that will help you along the way, and show you some interesting experiments to try. The rest is up to you.

Principles of Operation. As the schematic shows, a line transformer (T1) with a 5000- to 10,000-VAC secondary energizes the circuit.

A heavy-duty hash choke (L1) can be used to keep the high-frequency electrical energy from entering the AC line and interfering with TV's, VCR's, computers, etc. It is not always needed; we do not use one with the type of transformer that will be described later on when we discuss specific components.

A spark-gap driven resonating circuit (capacitor-coil) produces ragged high-frequency peaks that are extremely well-suited to induce high voltages in the secondary air-wound coil (L3). Depending on the diameter of the secondary coil, it's inherent capacity can vary greatly, effecting its resonant frequency. For the maximum transfer of energy, and hence best performance, the primary circuit must be tuned to match that resonant frequency as closely as possible. That is done via a series of taps in the primary coil (L2) as well as by adjusting the setting of the spark gap. Properly tuned, a Tesla coil as described here will deliver a high-frequency output in the range of 200,000 volts. Such a voltage will produce a corona—a ball of blue-glowing plasma (glowing gas)—or sparks up to 8-inches in length. We will shortly describe a series of marvelous experiments that can be conducted with your Tesla coil.

Safety Considerations. As mentioned previously, the primary winding is energized by a line transformer that delivers 5000–10,000 volts AC. **Such a transformer is potentially deadly and should be treated with utmost care. It would be more than prudent to house that transformer in an insulating plastic case to protect yourself and curious onlookers.**

Despite its 200,000-volt potential, due to the high frequencies involved, the secondary winding presents somewhat less danger. **However, while high-frequency current will not penetrate the human body, arcs will find their way to ground on the surface of the skin, causing burns.** Strangely, in

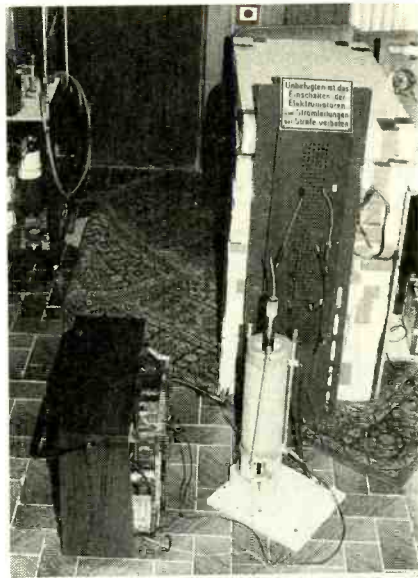

One way around the capacitor problem is to make your own. The unit described in the article is in the background of this photo. Note that this coil is powered from a TV high-voltage supply.

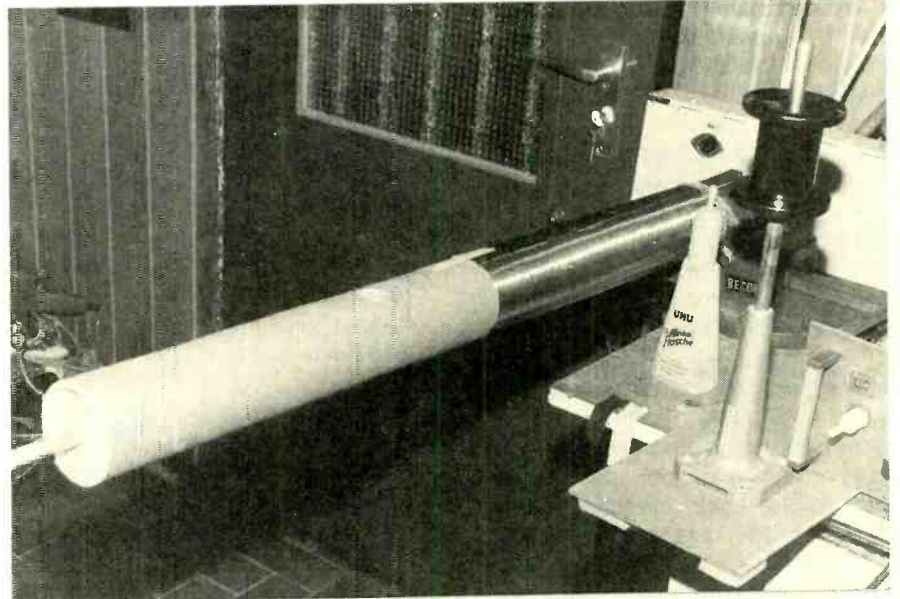

Here's the set up used by the author to wind the secondary. During winding make sure that the turns do not overlap or performance will be impaired.

our experience no blisters have formed, just little black holes—and we've had our fair share of them!

The spark gap produces ultraviolet radiation that can affect the eyes. So, it should be housed or shielded in some way. You can use a plastic project box of sufficient size for that. The author has also used pieces of PVC pipe to cover the spark gap.

Ionization of the air takes place at the spark gap and the high-voltage electrode. **That generates significant amounts of ozone that can be toxic, especially when concentrated, so a**

well-ventilated work area is a requirement. Further, the device should be turned on for a short period of time only.

Finally, even though a hash suppressor is used, air transmission of electromagnetic impulses from the coil will interfere with radio (evident as hum) and TV reception (appearing as white lines), and cause peaks on recorders or other sensitive nearby equipment.

Components. Perhaps the biggest challenge in building a Tesla coil is gathering the needed parts. High-voltage gear is not as common as it used to be, and usually can not be obtained from traditional hobbyist sources. Here are some hints to help make your hunt go a little smoother:

Line Transformer. In the author's experience, the best type of transformer for this application is an oil-burner ignition transformer. If you cannot find one

in a scrap yard, ask a plumber who installs oil burners. Normally these transformers have a 117-VAC primary and two 5000-VAC secondaries that can be used singly; they can also be used in series (if properly phased) to give you a full 10,000 VAC at roughly 20 mA.

Once again, **treat these high-voltage transformers with all due respect. They can be deadly if you are grounded.** I make it a point to stand on a dry floor with a cushion under my feet when working on high-voltage projects of any type whose performance is unknown or unpredictable, and Tesla coils

that are under development certainly fall into that category.

Also useful may be an old TV-technician's trick: That is, to keep your left hand in your pocket whenever you work with high voltages. That way you can never be connected from high voltage to ground by way of hand-body (heart)-hand. By the way, that technique was first used by Nikola Tesla!

Another possibility is to use a neon-tube transformer, the type used to illuminate signs. They normally have a 117-volt primary and two 3500-VAC, 50-mA secondaries that can again be connected in series. With neon-tube transformers, a hash choke is a good idea.

There are a few other ways to excite a Tesla coil. One is to use an automotive ignition coil. To do that, though, you need an interrupter circuit. A suitable set up was discussed in the "Solid-State Tesla Coil," which appeared in the October, 1988 issue of **Hands-on Electronics**.

You can also use a TV high-voltage supply to drive a Tesla coil. It works, but the coil is unlikely to be a spectacular performer.

Capacitor. Capacitor C1 is a .003–.005 μF (3000–5000 pF) ceramic unit with a voltage rating that's suitable for your transformer. That means if your transformer is outputting 10,000 VAC, you need a capacitor with a rating of at least 15,000 WVDC.

Such capacitors do not grow on trees, and can be expensive even when found. The author tried to get around that problem by building a unit from scratch. After some pre-trials with metal plates and rubber mats, a home-built unit fashioned from 1-inch thick, table-top sized, styrofoam sheets with aluminum foil glued to both sides yielded the needed capacitance and voltage-handling capability. Unfortunately, it also yielded a capacitor that was three-feet tall!

In all honesty, building your own capacitor should only be tried as a last resort, unless you are the sort that enjoys experimenting with such things. If so, you'll probably want to get hold of the latest catalog from Lindsay Publications (P.O. Box 12, Bradley, IL 60915-0012). Their unusual collection of books on a variety of electrical subjects includes a number that are dedicated to high-voltage experimentation. Several of those offer information on building your own capacitors.

Turning to more conventional alternatives, high-voltage ceramic "door-knob" capacitors are ideal for use in Tesla coils. Those capacitors were once commonly used in TV high-voltage power supplies, but that is no longer true. Some full-line industrial suppliers do still stock them, however, but they are very expensive. For instance Newark Electronics (stores nationwide) lists appropriate-valued units with ratings as

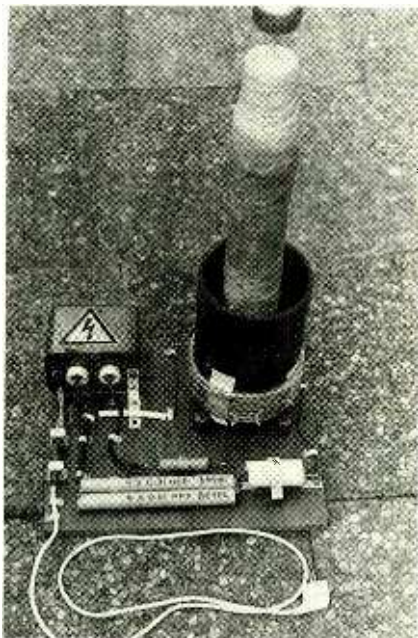

This is one of the author's best performing Tesla coils. Note that the capacitor has been formed from a parallel/series combination of .01- μF , 8000-VDC capacitors.

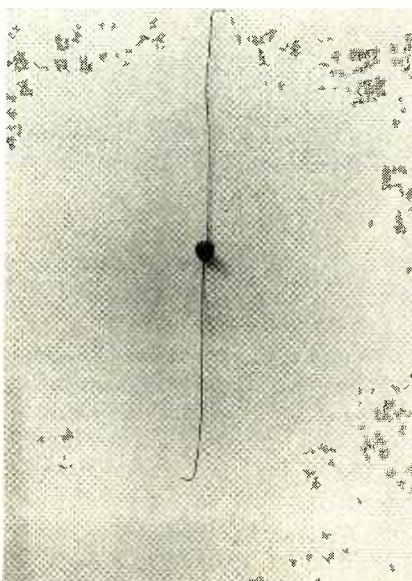

To fashion an "ion motor," create the propeller from a brass rivet and two pieces of lightweight wire.

high as 40,000 WVDC in their catalog, but they can run to over \$40 each (though lower-rated units are a bit less). A cheaper solution would be to salvage one from an early (1950's) TV set.

Another solution, and the one the author uses, is to use a series-parallel combination of ceramic capacitors to yield the needed value. For instance, by connecting four .01- μF , 8000-WVDC ceramic capacitors in series, and paralleling that combination with another string of four series-connected, .01- μF , 8000-WVDC ceramic capacitors, a .005- μF , 32,000-WVDC unit is created. Of course, there are many other combinations that will also work.

Primary Coil. Winding the primary coil is fairly simple. Place 10 turns of heavy-gauge (#10–#12) wire on a piece of 8-inch diameter plastic or PVC pipe. As you are winding, twist a small pigtail every turn or two to act as a tap; the more taps the better. The turns can be held in place by insulating tape or candle wax.

Secondary Coil. The author has wrapped dozens of secondary coils. Their diameters varied from $\frac{3}{4}$ - to 4-inches, and have ranged from 400 to 7600 turns and heights from 1 to over 6 feet. Some were built in sections and could be mounted one on top of the other. However, considering size, effort, and efficiency, the best ones were wrapped on a 10–12-inch length of $3\frac{1}{2}$ -inch O.D. PVC pipe. Wind about 400–500 turns of #24 lacquered or magnet wire. The turns must not overlap or efficiency will suffer severely.

To make the task of winding go much smoother, clamp a broomstick into a vise horizontally, place the PVC pipe over it, and turn the pipe with one hand while guiding the wire with the other. The dispensing wire coil must turn freely. Pressure must be applied to the last turn at all times, but pauses are possible if you keep a piece of insulating tape ready to secure the last turn and, with a second piece, the last 10–20 turns.

Airplane glue or rubber cement can be used to secure the wire permanently at the ends and in spots along the way. When completed, several coats of paraffin wax, molten candle wax, or bees wax should be used to cover the entire coil, especially at the high-voltage end. That will suppress corona discharge in places where it is not wanted.

The coil is assembled by placing the



Here's the "ion motor" at work in the dark.

secondary within the primary as shown in Fig. 2. The base of the coil is grounded. The high-voltage end is fitted with an end-cap that serves as an insulator/high-voltage-electrode mount. Details for a homemade end-cap fashioned from a plastic drinking cup, candle wax, and a doorknob is shown in Fig. 3; the door knob serves as the high-voltage electrode.

Spark Gap. The spark gap can be formed in many ways. The author's units use two 1-inch pieces of 1-inch diameter aluminum or brass rod. After the pieces are cut to size, one end of each is machined to a smooth ball-like sur-

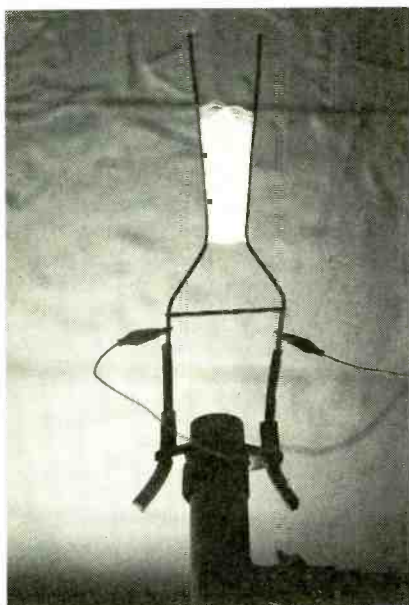

A Jacob's ladder can be powered by a Tesla coil. One side is connected to the high-voltage electrode; the other is grounded.

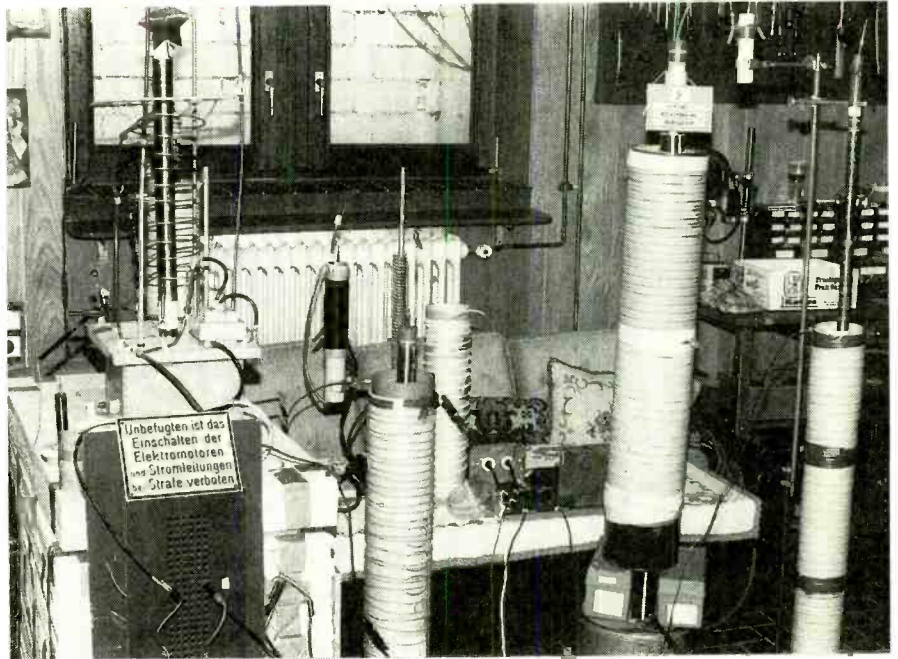

Here are a few members of the author's family of Tesla coils.

face on one side and drilled and tapped on the other for mounting in a stand with bolts and nuts for adjustment. The author has also made spark gaps by soldering large, steel ball bearings to carriage bolts.

Hash Suppressor. A hash suppressor or choke will keep impulses from your coil from getting into the electrical system from where they can be picked up by a TV/VCR or other recorder, or home computer. If no commercial product can be found, a 4-inch ferrite bar can be wrapped from beginning to end with heavy lacquered wire.

You may want to also try some EMI

(electromagnetic interference)-reduction techniques on the primary side of the transformer. You could use a commercial line filter, for instance, but the cheapest and easiest trick to try is to wrap the line cord through an iron toroid-coil form several times.

Note that using a hash choke will not eliminate the transmission of electromagnetic impulses by air. Only a Faraday cage can accomplish that.

Adjustment. There really isn't too much to do to get your coil up and running. Basically, the different primary taps must be tried out and the distance of the spark gap must be adjusted for maximum output as can be seen by size of the corona and sparks.

If something doesn't seem right, **pull the plug before attempting any troubleshooting. Also, never adjust the spark gap or the taps while power is applied to the circuit. Always power down between adjustments. Remember, a Tesla coil is a high-voltage device that could cause serious damage to life and limb if you don't treat it with the proper respect.**

Now that we have a Tesla coil, let's see what kind of interesting things we can do with it.

Experiments. By varying the shape of the high-voltage terminal, you can vary the nature of the coil's discharge. Using a round high-voltage terminal as already discussed, charges can distribute

(Continued on page 98)

PARTS LIST FOR THE TESLA COIL

- C1—.003-.005- μ F, 15,000-WVDC, ceramic capacitor, see text
- L1—8- μ F, 10-amp, heavy-duty hash choke, see text
- L2—10 turns, 10- to 12-gauge wire, see text
- L3—400-500 turns, 24-gauge magnet wire, see text
- T1—5000-volt, 20-mA, dual-secondary, oil-burner transformer
- F1—10-amp fuse
- S1—SPST power switch
- PVC pipe (see text), 3-terminal AC line cord, 1-inch diameter brass or aluminum rod stock, metal doorknob (for high-voltage electrode), plastic cup, candle wax, paraffin wax, wire, solder, hardware, etc.

Learn about electromagnetism, and have a lot of fun in the process, when you recreate one of electronics' most important experiments.

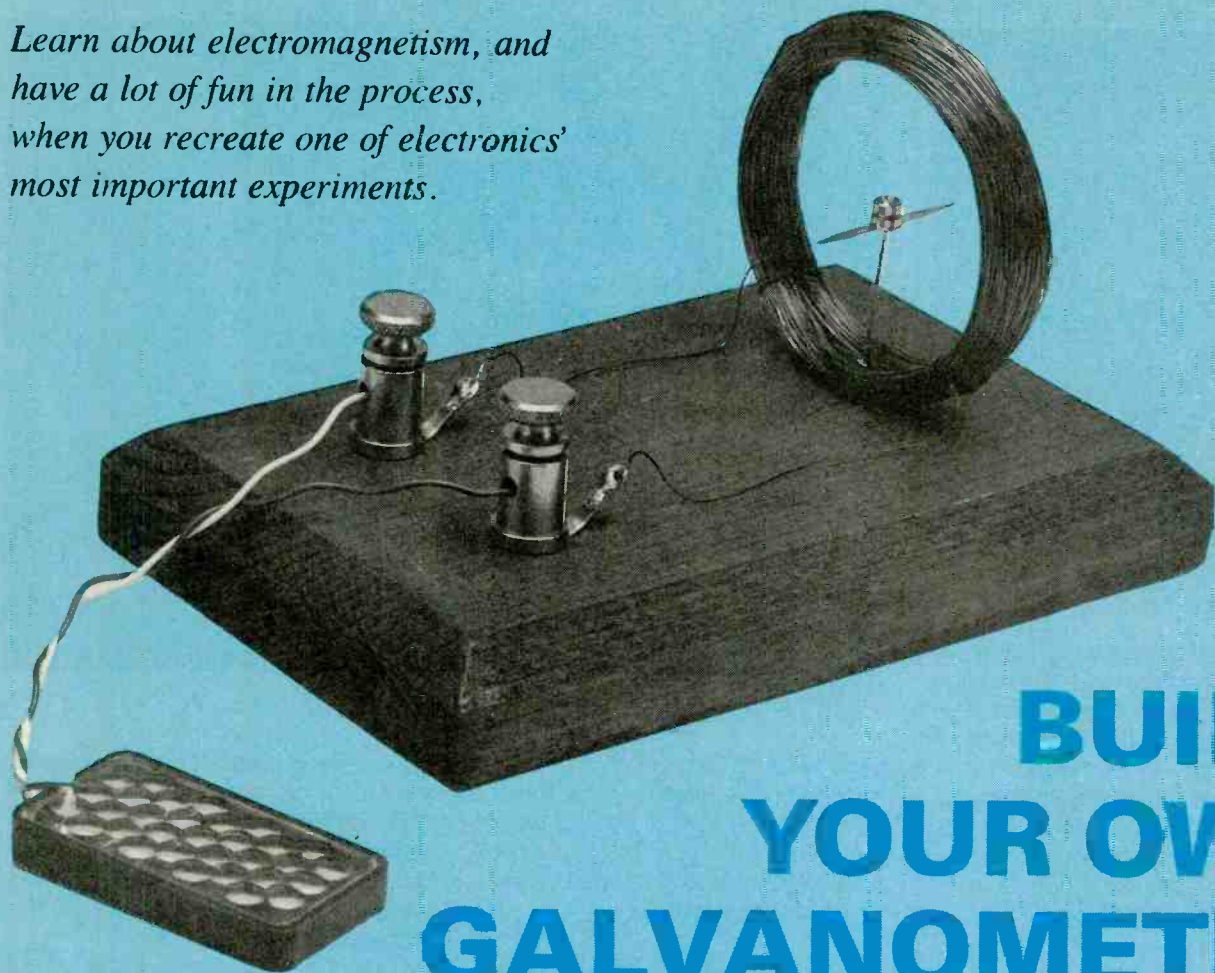

BUILD YOUR OWN GALVANOMETER

BY STANLEY A. CZARNIK

In the winter of 1820, Hans Christian Oersted, Professor of Natural Philosophy at the University of Copenhagen, noticed that a single length of wire connected to a voltaic battery and placed parallel to a magnetic needle would force the needle to move. When he disconnected the battery, the needle returned to its original position. Each time he repeated the procedure the effects were the same. He concluded that the needle was responding to what he called a "conflict of electricity" coming from the wire. In fact, of course, it was a weak magnetic field.

In July of 1820, Oersted published his experiment in Latin, and, within a few weeks, the paper was reprinted in several other languages including French, German, Italian, Dutch, and English. The news was received with a certain skepticism, but also excitement since the accuracy of Oersted's report left no doubt that the electromagnetic effect was real. All over Western Europe, Oersted's

discovery created an enormous sensation.

The Multiplier. Another step in the development of electromagnetism was taken by Johann Salomo Christoph Schweigger, a chemist at the University of Halle. What Schweigger did was simple: He replaced the single wire above or below the needle (Oersted's arrangement) with a coil of wire around it. That amplified the electromagnetic force and made it possible to detect very low levels of current.

Schweigger called his new invention a *Multiplicator*, or *Multiplier*, for obvious reasons. An alternative name was suggested by the French scientist Andre-Marie Ampere. Ampere called it a *Galvanometer*, in honor of Luigi Galvani, known for his early experiments with animal electricity. Schweigger demonstrated the operation of his Galvanometer before the local scientific society on September 16 and November 20, 1820. It is worth noting

that electromagnetic indicators similar to the one introduced by Schweigger were built at just about the same time by at least two other experimenters, James Cumming and Johann Christian Poggendorff.

The Gods. Schweigger showed little interest in the improvement of his creation. That was left to a number of other craftsmen and scientists in the later years of the 19th century. What Schweigger did do was put together some highly unusual ideas on the ancient history of electromagnetic theory.

The inventor of the multiplier believed in the ultimate unity of all knowledge. He was thoroughly familiar with the natural sciences and edited the famous *Journal fur Chemie und Physik* between 1811 and 1828. He also studied philology and was fascinated by primitive myths and secret cults.

Schweigger thought that long ago, somewhere in the north of Asia, there lived a "very informed people" with a

profound knowledge of the natural world, and that included physics and chemistry. It should be possible, he reasoned, to locate vestiges of such prehistoric wisdom in classical Mediterranean folklore and mythology.

In particular, Schweigger examined old representations of the *Dioscuri*, otherwise known as Castor and Pollux, the divine twin sons of Zeus and Leda. According to legend, the twins were transformed by Zeus into the constellation Gemini.

Schweigger suggested that Castor and Pollux were actually ancient icons of positive and negative electricity. The "inner nature" of electromagnetism, he said, is expressed in symbolic form by the bonds of divine brotherhood. In the dualism of the mythological twins, Schweigger saw the dualism of electromagnetic force: the north and south poles of a magnet, and the positive and negative poles of a battery.

Building a Galvanometer. If you enjoy experimentation and working with simple workshop materials, you will enjoy building a Galvanometer. All you need is a good supply of magnet wire as well as a few other odds and ends, depending on what sort of device you want to build.

Traditional Galvanometer design follows Schweigger's original system closely: a movable magnet inside of a stationary coil of wire. But as we'll see, there are several ways of putting such a device together, and many of you will probably come up with your own novel designs. Whatever design you use, building a Galvanometer is a very pleasant way to spend a rainy Sunday afternoon.

Tangent Galvanometer. One simple type of Galvanometer is known as a *Tangent Galvanometer*. All of the Galvanometers described in this article are, basically, Tangent Galvanometers. In devices of that type, the deflection angle of a magnetic indicator can be used to gauge the magnitude of a current.

Obtain a spool of narrow-gauge magnet wire; 26 or 28 gauge will be fine. Now wind about 200 turns of the wire around a small glass bottle (or something similar) about 2 inches in diameter. When you're finished, remove the coil carefully from the bottle and secure the windings with some tape or some string. If you wish, you can test the coil with an ohmmeter. My coil had a

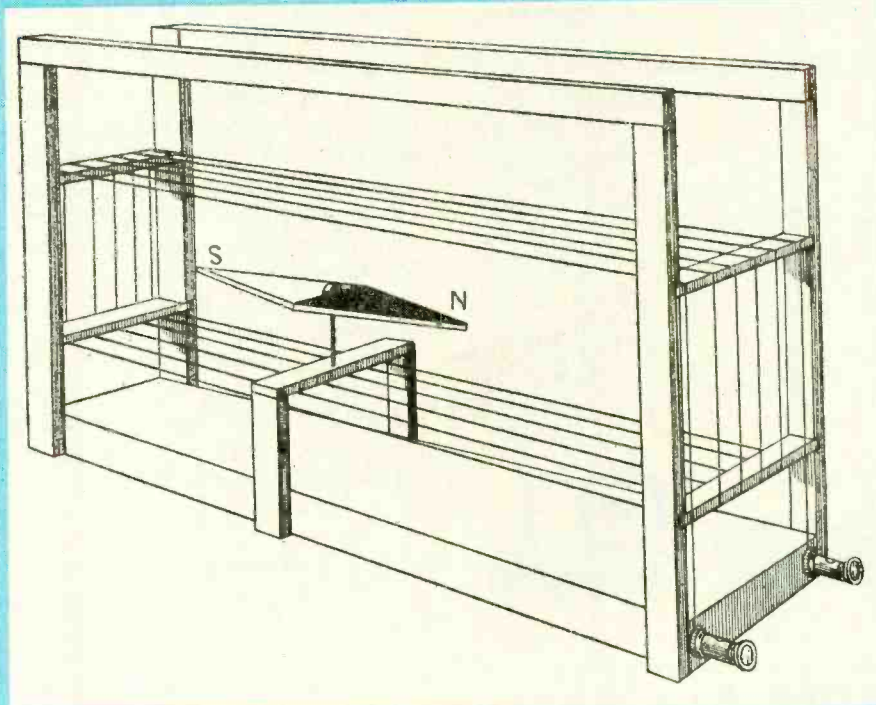

In 1820, Hans Christian Oersted discovered that a single length of wire connected to a battery and placed parallel to a magnetic needle would force the needle to move. Later that same year, Johann Schweigger wound many turns of wire around a magnetic needle which amplified the effect and made it possible to detect much smaller currents of electricity. Schweigger called his invention, which is illustrated here, a Multiplier. Today, such a device is known as a Galvanometer.

resistance of about 6.5 ohms; yours may be a bit different.

Locate a small piece of wood about 3½ inches wide and 5½ inches long. Drill two holes near one end of the block large enough to accommodate a couple of binding posts. At the opposite end of the block drill a very small hole for the magnetic-indicator support, which is, in this case, an ordinary sewing needle. The hole should be as close to perfectly vertical as possible. Push the needle into the hole and secure it with a bit of cement. Another way of holding the needle involves pushing a very narrow plastic tube into the hole in the wood and then forcing the needle into the tube.

Next, pick up the coil and very carefully flatten one small section of it with your fingers. Place the flattened side of the coil down over the sewing needle. The coil should stand upright on the wood block. The point of the needle should be very close to the center of the coil. If it isn't, try another needle.

Solder the leads coming off the coil to a couple of soldering lugs attached to the two binding posts. Make sure that the ends of the magnet wire are scraped clean of all insulation. Poor electrical connections may mean a Galvanometer that refuses to work.

Finally, you need to obtain a pivoted magnetic indicator. The easiest way to get one is to break open a good quality toy compass and remove the magnetic needle. Place the compass needle on the sewing needle, and you're finished.

Testing and Operation. In order to function properly, the Galvanometer must first be aligned with the magnetic field of the Earth. To do that, simply rotate the wood block until the plane of the coil is in a north-south position. In other words, the magnetic indicator needle (which, of course, will point north by itself) should be parallel to the windings of the coil.

Now obtain a very low voltage power source. A small solar cell (like the Radio Shack 276-124) is perfect. Most single solar cells generate about 0.5 volt in bright light.

Connect the solar cell to the Galvanometer, illuminate the cell, and the needle will move indicating the presence of the magnetic field that is created by the current in the coil. If the voltage generated is sufficient, the needle will form a 90 degree angle with the plane of the coil. Reverse polarity and the needle will swing around and point in the other direction. Place

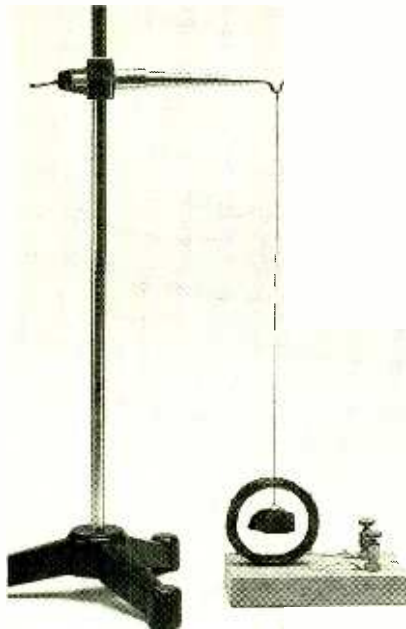

There are many ways of making a Galvanometer. Here, a lodestone is suspended by a thread and is free to move within a coil of wire. When a small DC voltage is applied to the coil, the magnetic rock will begin to revolve.

Obtain a small lodestone and suspend it in the center of the Galvanometer coil with a piece of thread or very thin string. To do that, you will need to run the thread through a small opening at the top of the coil. Make the opening by spreading the windings a bit with your fingers. You can use the coil from the previous experiment, but it may be easier to just wind another one. You can hang the lodestone from an ordinary laboratory ring stand or some other type of stable support.

When everything is ready, apply a small DC voltage to the Galvanometer coil. The rock will begin to revolve. It's a simple electromagnetic effect, but very unusual to watch.

Mirror Galvanometer. Galvanometer technology was altered, adapted, improved, and refined in a number of different ways between 1820 and the beginning of the 20th century. One ingenious improvement was suggested by the Scottish physicist and mathematician, Sir William Thomson, also known as Lord Kelvin.



A mirror Galvanometer can be made by suspending a magnetic mirror within a coil of wire. A reflected spot of light from the filmstrip projector begins to move when a small voltage is applied to coil.

your hand over the solar cell, the voltage will drop, and the needle will return to its original position.

Lodestone Galvanometer. You do not necessarily need a magnetic compass needle to make a Galvanometer. Almost any magnet or magnetic object small enough to turn freely inside the coil will work with some degree of success.

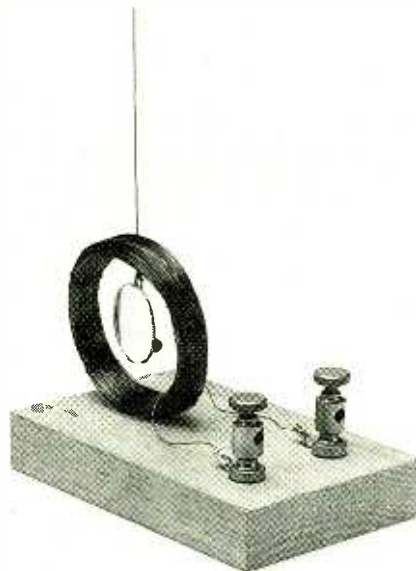

Thomson took a few small pieces of magnetized watch spring and attached them to a tiny fragment of mirror. The combination was suspended in the center of a wire coil by a single fiber of unspun cocoon silk. A suitable source of light was equipped with a lens and aimed directly at the mirror in such a way that the electromagnetic deflection of the Galvanometer indicator became a moving spot of light.

PARTS LIST FOR THE GALVANOMETER PROJECT

- Bar magnet, small
- Binding posts
- Lodestone
- Magnet wire
- Mirror
- Ringstand (or equivalent)
- Sewing needles
- Slide projector (or equivalent)
- Solar cell (Radio Shack 276-124 or equivalent) or other low-voltage DC power source
- Soldering lugs
- Thread
- Toy compass (see text)
- Wood block

Lodestones (as well as mirrors, magnets, and other useful materials) are available from JerryCo, 601 Linden Place, Evanston, Illinois 60202 (Telephone: 708-475-8440). The lodestone is catalog number C-88173 and the price is \$2.75. The company requires a minimum order of \$12.50 and a flat \$4.00 for shipping and handling. The JerryCo catalog is available for 50 cents.

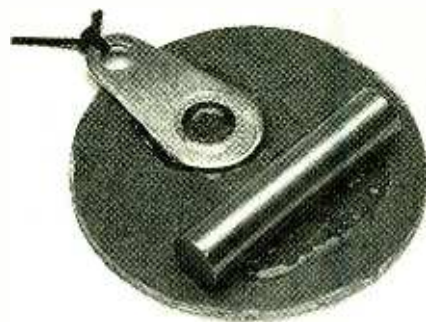

Here's one very simple yet very effective way of making a magnetic mirror for your mirror Galvanometer. A small bar magnet and a small soldering lug are glued to the back of a circular mirror about 1 inch in diameter. The mirror is suspended by a thread tied to the soldering lug.

You can make your own mirror Galvanometer. Obtain a small mirror, a small bar magnet, and a soldering lug. Attach the magnet and the soldering lug to the back side of the mirror with a few drops of glue. Position the magnet so that it hangs horizontally when the mirror is suspended (see the photo). The tiny hole in the soldering lug should extend just beyond the edge of the mirror. When the glue is dry, tie a piece of thread to the soldering lug and suspend the reflector in the center of the

(Continued on page 97)

Super Simple

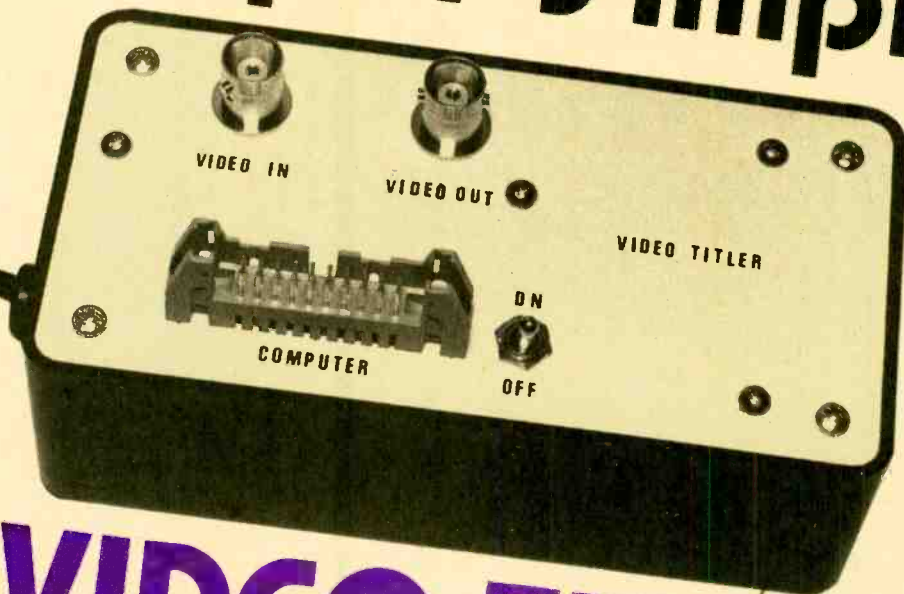

VIDEO TITLER

BY LARRY BRIGHT

Give your home-grown videos that professional look with this easy-to-build video-character insertion project and a PC-compatible computer.

Anyone who's into making videos, as either a hobby or a profession, needs a method of inserting titles and other information into video scenes. Some of the more expensive cameras come with titling capabilities, but such cameras are often cumbersome and not very convenient to use. Commercial equipment to insert alphanumeric characters in video signals is generally too expensive for casual use.

The *Super Simple Video Titler* discussed in this article is an extremely simple to build video-character inserter that attaches to any IBM compatible personal computer. The Video Titler consists of a few inexpensive, but extremely powerful chips and an interface that connects to the computer's parallel printer port. Software, written in BASIC (and shown elsewhere in this article) allows you to type directly from the computer keyboard to your video monitor, and allows the characters to be moved to any location on the monitor screen.

The characters can be superimposed on a black background and any of the characters can be made to blink. In addition, the characters can also be presented in four different sizes, in both horizontal and vertical directions.

At the heart of the Video Titler is an MB88303 video-display controller, which contains all the timing, memory, and character-generation circuitry required to insert characters into a video signal. The MB88303 has a set of 64 characters (see Fig. 1) that can be displayed in nine lines of 20 characters-per-line (for a total of 180 characters); only upper-case alpha characters are available.

The characters are displayed in a 5 x 7 dot-matrix format, and uses inter-dot filling, thereby greatly improving the quality of the displayed characters.

Backing up the MB88303 is an LM1881 video-sync separator. The LM1881 takes a standard composite-video input and provides vertical- and composite-sync outputs, thus eliminat-

ing a whole lot of chips and discrete components normally used for that purpose.

About the Circuit. A block diagram of the Video Titler is shown in Fig. 2. The input video signal (from a camera, VCR, or other source) is routed to the LM1881 where vertical- and horizontal-sync signals are stripped from the video signal and fed to the MB88303 video-display controller. The video-display controller uses those sync signals to synchronize its internal timing circuits.

The MB88303 has two video outputs; *vow* and *vob*. The *vow* output is a low-to-high going pulse that generates white characters, and the *vob* output is a high-to-low level that generates a black background (if enabled). Those signals are used to modulate the video signal.

Data and address information from the computer is transferred to the MB88303 via an 8-bit bus. The computer also outputs three additional signals that are used to control bus multiplexing.

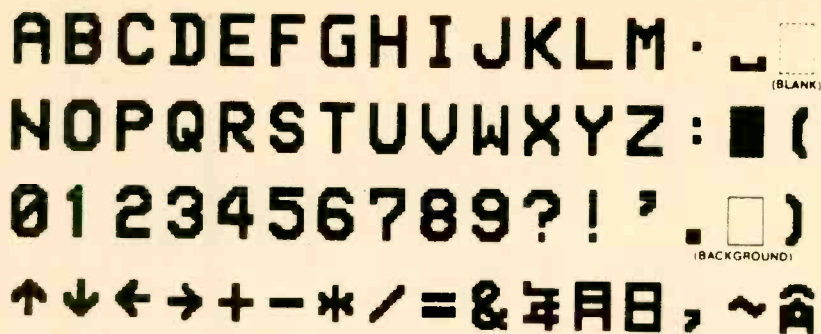

Fig. 1. The MB88303 has a set of 64 characters that can be displayed in nine lines of 20 characters-per-line (for a total of 180 characters). Only upper-case alpha characters—which are displayed in a 5 × 7 dot-matrix format—are available.

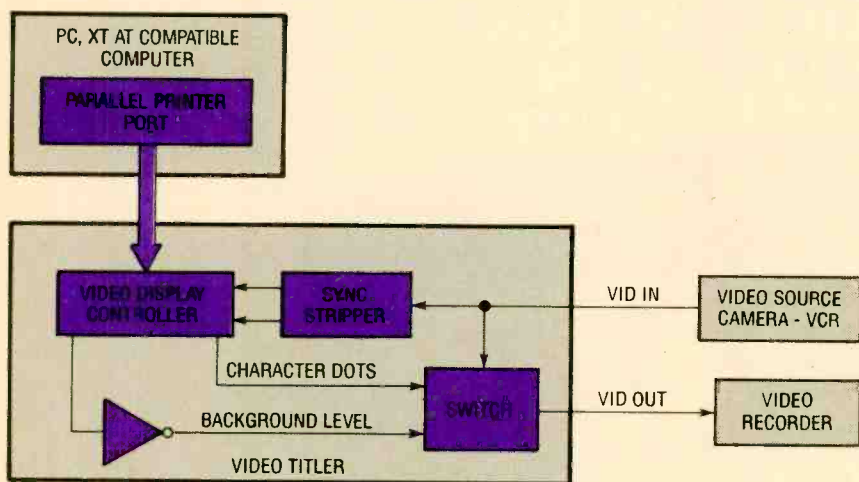

Fig. 2. Block diagram of the Video Titler. The input video signal is routed to a separator where vertical- and horizontal-sync signals are stripped from the video signal and fed to a video display controller, which uses the two signals to synchronize its internal timing circuits.

The schematic diagram of the Video Titler circuit is shown in Fig. 3. Components R1 and C1 form a low-pass filter that is used to remove noise that may be present in some video sources. The video signal, which can vary between 0.5-volt and 2-volts peak-to-peak (p-p), is coupled to the LM1881 (U2) through capacitor C2.

Resistor R2 and capacitor C3 set U2 to operate with NTSC scan frequencies. Composite- and vertical-sync signals are available at pins 1 and 3 of U2, respectively. Resistor R3 and capacitor C4 form a resonant circuit for U1's internal 6-MHz clock generator. Trimmer-potentiometer R4 is used to alter U1's clock frequency, thereby allowing you to alter the horizontal size of the characters.

Character signals generated at pin 5 (vow) of U2 are used to switch a positive voltage onto the video signal to create white characters. Character contrast can be adjusted via trimmer-potentiometer R4.

The background signal (vob) at pin 6 is an active low and must be inverted to

drive the bilateral switch (U3). Transistor Q1 functions as an inverter in this circuit and was used to conserve space; however any TTL or CMOS inverter could also be used in its place. Trimmer-potentiometer R5 can be used to adjust background intensity.

The circuit can be easily modified to generate black characters on a white background by reversing the +5-volt and ground connections at R4 and R5. Black characters can also be generated by inverting U1's pin 5 output. Address and data information are multiplexed to the MB88303 from the personal computer (PC) through pins 14–21 (DA0 to DA7) on U1.

The PC also provides three other control signals—ADM, LDI, and reset. The level of the ADM signal (U1, pin 13) determines U1's address mode. If pin 13 is low, U1 expects an address when pin 12 (LDI) of U1 toggles from low to high. If U1, pin 13 (ADM) is high, the address registers automatically increment on the low-to-high transition of U1, pin 12. The control signal at pin 12 of U1 determines whether data

PARTS LIST FOR THE VIDEO TITLER

SEMICONDUCTORS

- U1—LM1881 sync separator, integrated circuit
- U2—MB88303 video display controller, integrated circuit
- U3—CD4066 quad CMOS bilateral switch, integrated circuit
- U4—7805 5-volt, 1-amp, voltage regulator, integrated circuit
- Q1—2N918 VHF/UHF amp, mixer, oscillator NPN transistor
- BR1—1-amp, 100-PIV, full-wave bridge rectifier

RESISTORS

- (All resistors are 1/4-watt, 5% units, unless otherwise noted.)
- R1—650-ohm
 - R2—680,000-ohm
 - R3—10,000-ohm, 10-turn trimmer potentiometer
 - R4, R5—1000-ohm, 10-turn trimmer potentiometer
 - R6—220,000-ohm
 - R7—1800-ohm

CAPACITORS

- C1—470-pF, ceramic-disc
- C2, C3—0.1-μF, ceramic-disc
- C4, C5—22-pF, ceramic-disc
- C6—1000-μF, 25-WVDC, electrolytic
- C7—100-μF, 25-WVDC, electrolytic

ADDITIONAL PARTS AND MATERIALS

- T1—12.6-volt, 300-mA transformer
 - PL1—20-pin male wire-wrap header
 - PL2—117-volt molded plug with line cord
 - PL3—25-pin, male IDC, subminiature D connector
 - SO1—20-pin female IDC connector
 - J1, J2—BNC, bulkhead connector
 - S1—SPST toggle switch
- Printed-circuit or perfboard materials, enclosure, AC molded power plug with line cord, heat sink, hook-up wire, solder, hardware, etc.

*Note: The Fujitsu MB88303 display controller is available from L. B. Bright (PO Box 875, Jolon, CA 92938) for \$12 each (including postage and handling).

The MB88303 display controller is also available from Marshall Industries (9674 Telstar Ave., El Monte, CA 91731; Tel. 818-307-6000); contact Marshall Industries for pricing and shipping charges. Note: Marshall Industries has a \$25 minimum order requirement.

on the eight data/address lines is to be sent to the address register or is to be interpreted as data.

When U1 pin 12 goes from low-to-

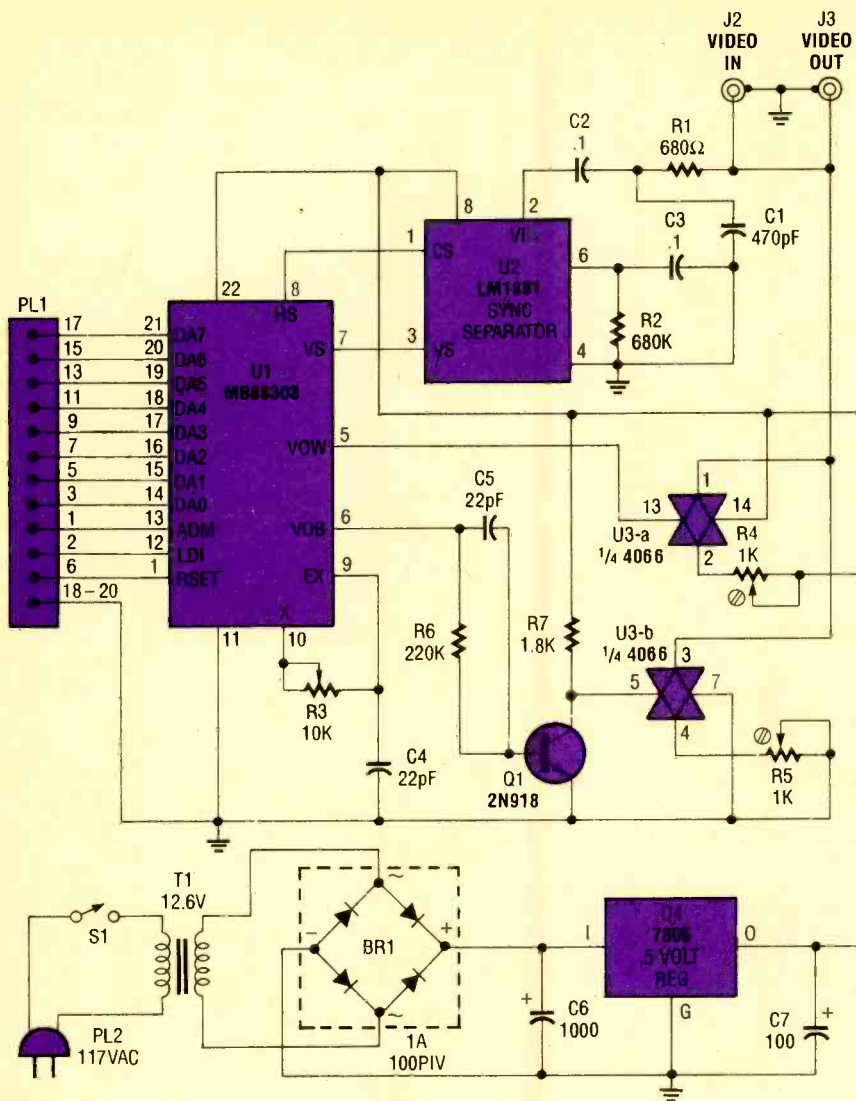

Fig. 3. At the heart of the Video Titrer is a MB88303 video-display controller that is combined with an LM1881 sync separator, a 4066 bilateral switch, and a few support components to produce an extremely simple but effective circuit.

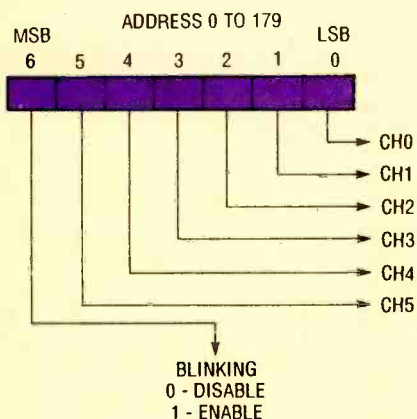

Fig. 4. Shown here is the data structure used by the display memory at addresses 0 through 179. Addresses 0-19 represent the first row of characters, addresses 20-39 are the second row of characters, and addresses 160-179 are the ninth and last row of characters.

high, information on lines DA0 through DA7 (pins 14 to 21, respectively) is interpreted as an address and is latched into the address register. On the opposite transition (high-to-low), the information is considered data and is thus, sent to the register currently specified by the address register.

Figure 4 shows the data structure used by the display memory at addresses 0 through 179. Addresses 0-19 represent the first row of characters to be displayed. Addresses 20-39 are the second row, and so forth; addresses 160-179 are the ninth and last row of character display. The sequence required to write a character to any of the 180 display locations is:

- Bring control signal LDI to a low level.
- Output an eight-bit binary number of the desired address on lines DA0-DA7.

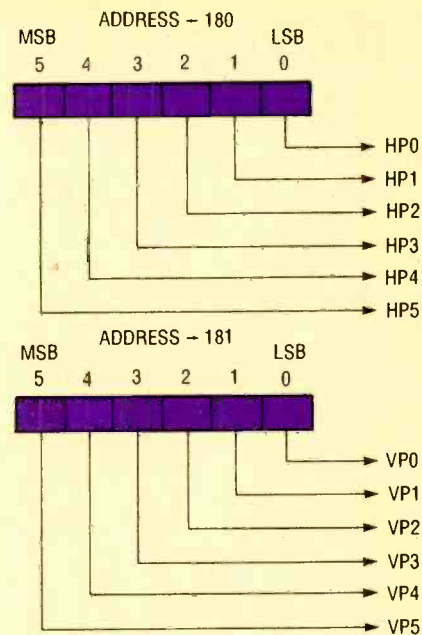

Fig. 5. Addresses 180 and 181 are the display position registers, which specify the horizontal position (HP) and vertical position (VP) of the beginning of the character display on the screen. This illustration shows how those registers are used.

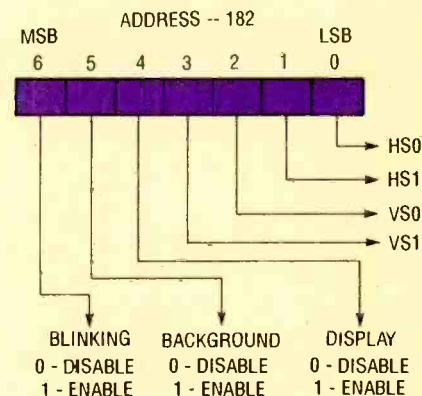

Fig. 6. Address 182 is the display control register. The horizontal size (HS) of the characters is determined by the value of bits 0 and 1; the vertical size (VS) of the character is controlled by bits 2 and 3.

- Raise LDI from low-to-high to latch the address.
- Output the desired character code on lines DA0-DA7.
- Cause LDI to change from a high to a low level.

Table 1 lists the character codes (CH) used by the MB88303. Only the least significant 6 bits (bits 0-5) are used for character codes. Bit 6 in the display memory is the blinking-enable bit. If you want a character to blink, that bit must be high. A low in bit 6 disables blinking.

Addresses 180-183 specify the MB88303 control registers. Addresses

180 and 181 are the horizontal and vertical display-position registers. Those two registers specify the horizontal position (HP) and vertical position (VP) of the beginning of the character display on the screen. Figure 5 shows how those registers are used.

Addressing and writing to those two six-bit registers is identical to the procedure used for the display memory. Note that values 0 through 6 (000000-000110) cannot be used for the horizontal-display position. The BASIC program in Listing 1 (more on that in a moment) allows you to move the character display anywhere on the screen by using your PC's cursor keys, so the exact initial positioning of the display is not important.

Address 182 is the display-control register (see Fig. 6). The horizontal size (HS) of the characters is determined by the value of bits 0 and 1; the vertical size (VS) of the character is controlled by bits 2 and 3. Horizontal and vertical size can be independently specified to be any of four different sizes.

Bit 4 of the display-control register is used to enable or disable the entire display. A high bit 4 turns the display on. Bit 5 turns the black background on and off, and bit 6 is used to activate blinking for any character that has previously had its blinking bit enabled.

The Software. A program listing (written in BASIC) for controlling the Video Titrer is given in Listing 1. The software will run on GW-BASIC or BASIC-A, but some modifications may be required in order for the program to operate under other versions of BASIC.

Using the program listing is simple; just start the program and type the information you want to insert in the video. The program will start displaying characters at horizontal and vertical location 12. The characters can be moved to any location on the display screen via the four cursor keys. Typing a back slash prior to typing a character enables the blinking bit for that character; e.g., each bit that is to blink should be preceded by a back slash.

Table 2 lists other display control functions that are made available through the program listing. The program listing provides only the basic capabilities needed to display the MB88303 character set. But with a little imagination, the program can be modified and expanded to do all sorts of neat things. For instance, it is a simple matter to modify the program to store any

LISTING 1

```

10 CLS
20 DIM A(200)
30 REM: table to convert ASCII to MB88303 character codes.
40 FOR I=65 TO 77:A(I)=I-65:NEXT
50 FOR I=78 TO 90:A(I)=I-62:NEXT
60 FOR I=48 TO 57:A(I)=I-16:NEXT
70 A(32)=15:A(63)=42:A(33)=48:A(39)=44:A(46)=45:A(93)=47
75 A(91)=31:A(43)=52:A(95)=53:A(42)=54:A(47)=55:A(61)=56
80 A(42)=54:A(47)=55:A(61)=56:A(38)=57:A(44)=61:A(58)=29
85 A:(126)=62
90 REM: enable key trapping.
100 KEY(11) ON:KEY(12) ON:KEY(13) ON:KEY(14) ON
110 KEY(1) ON:KEY(2) ON:KEY(3) ON:KEY(4) ON:KEY(5) ON
115 KEY(6) ON:KEY(7) ON
120 REM:Address & data on port 888
125 REM:ADM, LDI & reset on port 890
130 AD=888:STB=890:ADRS=5:DAT=7:HPOS=180:VPOS=181:SIZE=182
140 FOR I=0 TO 179:OUT AD, I:OUT STB, ADS:OUT AD, 15:OUT
STB, DAT
145 NEXT
150 X=0 ' X is character memory address.
160 OUT STB,0
170 GOSUB 610
175 REM:Load initial position and size
180 H=12:V=12:HS=0:VS=0:BB=0:BL=0:BLK=16
190 REM:H=horiz. position, V=vert. position, BB=background
bit
200 REM:BL=blinking bit, BLK=blanking bit
210 REM:Following are jumps to handle function and cursor
keys.
220 ON KEY(1) GOSUB 720
230 ON KEY(2) GOSUB 740
240 ON KEY(3) GOSUB 760
250 ON KEY(4) GOSUB 780
260 ON KEY(5) GOSUB 800
270 ON KEY(6) GOSUB 820
280 ON KEY(7) GOSUB 840
290 ON KEY(11) GOSUB 650
300 ON KEY(14) GOSUB 660
310 ON KEY(13) GOSUB 670
320 ON KEY(12) GOSUB 680
330 OUT AD,HPOS:OUT STB,ADRS:OUT AD, H:OUT STB,DAT
340 OUT AD,VPOS:OUT STB,ADRS:OUT AD, V:OUT STB,DAT
350 OUT AD,SIZE:OUT STB,ADRS:OUT AD,HS+(4*VS)+BB+BL+BLK:OUT
STB,DAT
360 PRINT:PRINT "write your message':PRINT
370 CS=INKEY$
380 IF LEN(CS)=0 THEN 370
390 IF CS="\'' THEN 640 ' if yes, turn on blinking bit.
400 IF ASC(CS)=13 THEN 510 'charrage return handler.
410 IF ASC(CS)=27 THEN END

```

TABLE 1—MB88303 CHARACTER CODES

CH3 - CH0	CH5 - CH4			
	0	1	2	3
0	A	N	0	◀
1	B	O	1	▶
2	C	P	2	⬇
3	D	Q	3	⬆
4	E	R	4	+
5	F	S	5	-
6	G	T	6	*
7	H	U	7	/
8	I	V	8	=
9	J	W	9	&
A	K	X	?	Kanji
B	L	Y	!	Kanji
C	M	Z	'	Kanji
D	Dot	:		
E	—	.	Background	
F	Blank	[]	Telephone

LISTING 1 (continued)

```

420 IF ASC(CS)=8 THEN 630 'backspace handler.
430 C=ASC(CS)
440 IF C>=&H61 THEN C=C-&H20 'change lowercase to uppercase.
450 REM: write character to screen.
460 OUT AD,X:OUT STB,ADRS:OUT AD,A(C)+BC:OUT STB,DAT
470 X=X+1
480 BC=0 'reset blinking bit
490 GOTO 370
500 REM:adjust character address for charage return
510 IF X>=140 AND X<160 THEN 600
520 IF X>=120 AND X<140 THEN X=140
530 IF X>=100 AND X<120 THEN X=120
540 IF X>=80 AND X<100 THEN X=100
550 IF X>=60 AND X<80 THEN X=80
560 IF X>=40 AND X<60 THEN X=60
570 IF X>=20 AND X<40 THEN X=40
580 IF X>=0 AND X<20 THEN X=20
590 GOTO 370
600 X=0:GOTO 370
610 FOR I=0 TO 179:OUT AD,I:OUT STB,ADRS:OUT AD,15:OUT
STB,DAT
615 NEXT
620 RETURN
630 X=X-1:OUT AD,X:OUT STB,ADRS:OUT AD,15:OUT STB,DAT:GOTO
370
640 BC=64:GOTO 370
650 V=V-1:RETURN 690
660 V=V+1:RETURN 690
670 H=H+1:RETURN 690
680 H=H-1:RETURN 690
690 OUT AD,HPOS:OUT STB,ADRS:OUT AD,H:OUT STB,DAT
700 OUT AD,VPOS:OUT STB,ADRS:OUT AD,V:OUT STB,DAT
710 GOTO 370
720 IF BB=0 THEN BB=32 ELSE BB=0
730 RETURN 860
740 IF BL=0 THEN BL=64 ELSE BL=0.
750 RETURN 860
760 VS=VS+1:IF VS>3 THEN VS=0
770 RETURN 860
780 VS=VS-1:IF VS<0 THEN VS=3
790 RETURN 860
800 HS=HS+1:IF HS>3 THEN HS=0
810 RETURN 860
820 HS=HS-1:IF HS<0 THEN HS=3
830 RETURN 860
840 IF BLK=16 THEN BLK=0 ELSE BLK=16
850 RETURN 860
860 OUT AD,SIZE:OUT STB,ADRS:OUT AD,HS+(4*VS)+BB+BL+BLK:OUT
STB,DAT
870 GOTO 370

```

TABLE 2—DISPLAY CONTROL FUNCTIONS

Key	Action
F1	Toggles the character background between black and white.
F2	Toggles blinking on and off.
F3	Increases vertical character size.
F4	Decreases vertical size.
F5	Increases horizontal character size.
F6	Decreases horizontal charter size.
F7	Toggles the entire character display on and off

number of pages of information and program a key to sequentially display each page. Or a word could be made to automatically zoom in size and change position to add a little animation to your titles. The astute program-

mer could probably figure out a way to scroll messages on the screen. The possibilities are many.

Construction. The Video Titler circuit is so simple that it can be assembled

using just about any type of construction that you feel most comfortable with. The author's prototype was built on two sections of perfboard; wire-wrap connections were used for the main (video) board, and point-to-point solder connections were used for the power supply.

In the author's prototype, all DIP integrated circuits (U1-U3) were mounted in wire-wrap IC sockets. (**Note:** The MB88303 display controller is not readily obtainable from the usual hobbyist parts houses. However, the chip can be purchased from the suppliers given in the Parts List.) The tab of U4 (the 5-volt regulator, which is located on the power-supply board) was mounted to a TO-220-type heat sink. All non-insulated 117-volt AC connections were then covered with RTV sealant, but any similar insulating compound may be used on the AC connections.

The prototype unit (along with its power-supply circuit) was mounted to the lid of a project box, measuring 5 x 2½ x 1½ inches. The completed Video Titler is connected to a PC-compatible computer's parallel printer port through a flat ribbon cable having a female 20-pin insulation-displacement connector (IDC) at one end and a male 25-pin subminiature D connector on the other. The subminiature D connector plugs into the PC-compatible computer's parallel printer port, and the 20-pin IDC connector is mated with a 20-pin header on the Video Titler.

The printer port has 12 bits available for output—eight bits at address 888 and four bits at address 890. Figure 7A gives the pinouts of the parallel port bits used by the Video Titler. Note that bits 0, 1, and 3 of port 890 are inverted by the hardware. Figure 7B gives assembly details for the cable that's used to connect the Titler to your computer.

Checkout and Use. Once the circuit is fully assembled and the cable has been prepared, check your work for errors. A single improper connection would, at the very least, render the project inoperative, or at worst, destroy sensitive semiconductor components. Once that's done and you are satisfied that the circuit contains no errors, the Titler circuit must be put through a simple set-up procedure.

First, connect the Titler to your computer's parallel printer port through the ribbon cable that you prepared. Then connect a video source (VCR, etc.) to

(Continued on page 99)

HOW TO ANTENNA

BY JOSEPH J. CARR, K4IPV

pecially for someone who has very few alternatives, there are critical placement questions that you must answer (or at least consider). Those questions deal with the safety, performance, and convenience of the antenna. In discussing these matters let me loosely use my own QTH (home location) as the example (Fig. 1).

Installing an antenna can be an action-packed activity, and one that's full of pitfalls for the unwary. Here are some tips that can help you and your antenna survive the experience.

With all due respect for my English teachers, let me state right now that antenna *is* a verb. Anyone who has ever installed a ham or SWL antenna (or an antenna mast) knows that there's lots and lots of action, so that means "verb" in my book—or at least it does when the teacher isn't looking!

Seriously, though, there's some missing information in a lot of articles on antennas. There are lots of articles on

dipoles, verticals, beams, long wires, and all manner of antennas. What's rarely printed, however, is how to actually put them up in the air. Having more than 30-years experience in ham radio, plus a few more in shortwave listening, I've installed my share of antennas. So let's get to the business of actually installing your ham or SWL wire antenna.

The first task when installing the antenna is to find an appropriate site for it. While that seems like a trivial issue, es-

Safety. It would be irresponsible to talk about installing antennas without mentioning safety. Rigging antennas can be a very dangerous effort if you don't plan ahead. The very first issue is electrical safety. There's one really big rule that should **NEVER** be violated: **Don't ever ever ever install an antenna so that it must cross over power lines, or will hit power lines if it comes down in an accident or storm!**

You may be tempted to scoff: "But my power line is insulated, so tossing an antenna wire over it is safe." That is just plain wrong! The insulation on power lines ages in the weather so it may easily crumble when the antenna wire hits it. In addition, the thin antenna line may well cut through even new insulation. Almost every year we hear tragic news of some ham-radio operator or SWL

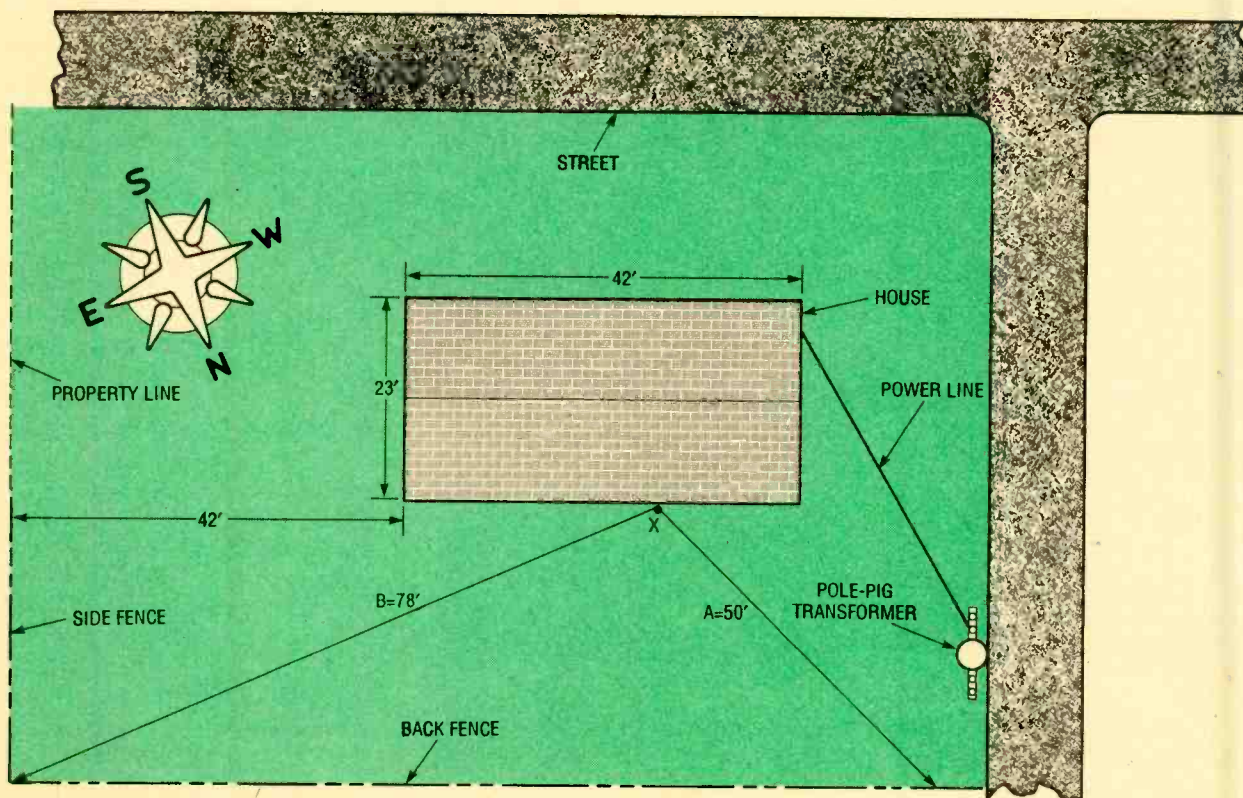

Fig. 1. The layout of your property will go a long way toward determining your antenna-installation options. Regardless of your circumstances, however, never install an antenna so that it could possibly come in contact with power lines.

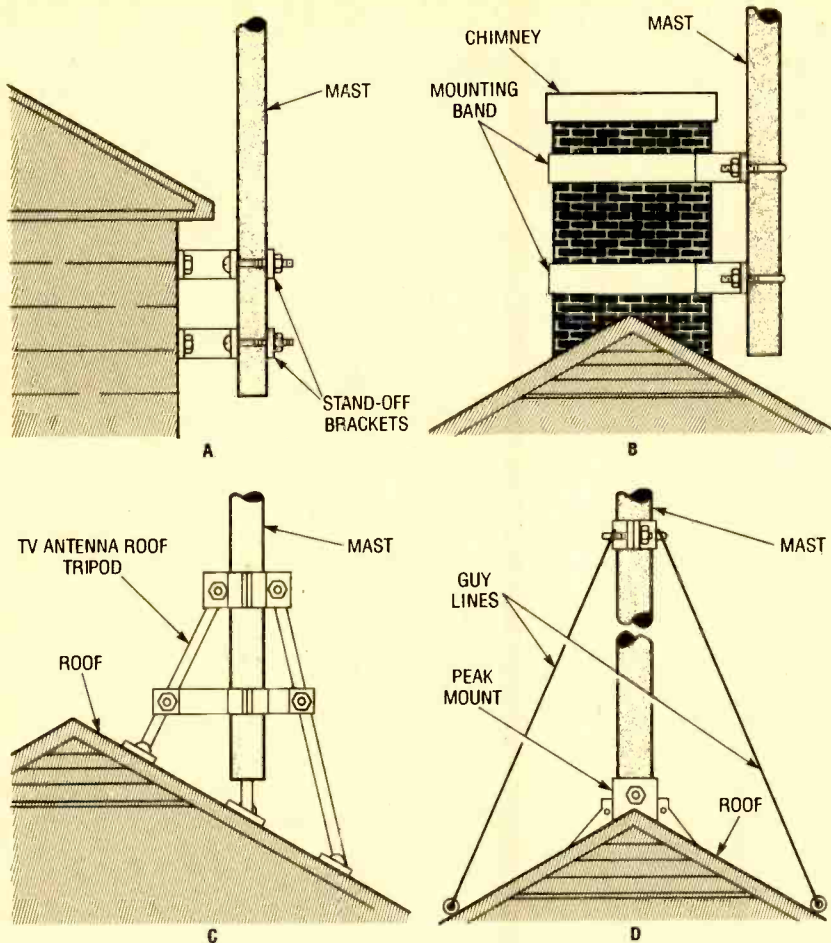

Fig. 2. In most cases, one end of your antenna will be mounted to your home. Here are four mounting options: a stand-off mount is shown in A, a chimney mount is shown in B, a tripod mount is shown in C, and a peak mount is shown in D.

being killed while erecting an antenna. Work safely!

Another safety issue is mechanical integrity. Even thin wire antennas have substantial forces acting on them, and they have a much larger "sail area" in a wind storm than you might think is possible. Install the antenna in a manner consistent with the worst weather expected at your location. I suspect that your local building inspector will have some ideas on this matter—and may actually insist on some of them with the force of law.

You must also consider the issue of lightning. An antenna does not generally "attract" lightning that wasn't already headed its way. But if the antenna is the highest object in the immediate vicinity lightning will naturally select it as the place to strike, much like it will strike a lightning rod or tree nearby if they are the highest objects. Every antenna should have a lightning arrester in the feedline. The mast and the ground terminal of the arrester must be

connected to a substantial ground rod. My locality (and probably yours too) requires the ground rod to be eight-feet long. Because the same ground rod also serves to ground the radio receiver or transmitter (which makes many antennas more effective), be sure to use the copper-clad steel rods intended for radio for that application.

Finally, when you actually erect the antenna, make sure that all ladders and other supports are in good shape, and that you are physically able to do the job. And for goodness sake use the "buddy system." Always work together with at least one other competent person. Not only is the job easier, but there will be someone close at hand to help in case you get into trouble.

Locating the Antenna. Now that we've tried our best to keep you alive and well, let's get back to my own situation and hopefully use it as a metaphor for yours. The west corner of my property is a no-no because the power lines

are there. As mentioned, I need to keep away from that section at all costs. The roof is 23-feet wide, and 42-feet long, so it makes a reasonable support for a lot of HF antennas. I can string a 20-meter dipole (33 feet) from the east end to a spot a little west of center without risking the floppy end of a broken antenna wire dropping off the roof to the power lines.

Several other spots are labelled as to distances so you can see what the possibilities are (keeping away from the front for aesthetic reasons). I selected the point marked "X" as the reference point because it is a convenient place to bring coax into the house—it's near the rig. The runs that I have used most often over the years are marked "A" and "B" (although B is favored).

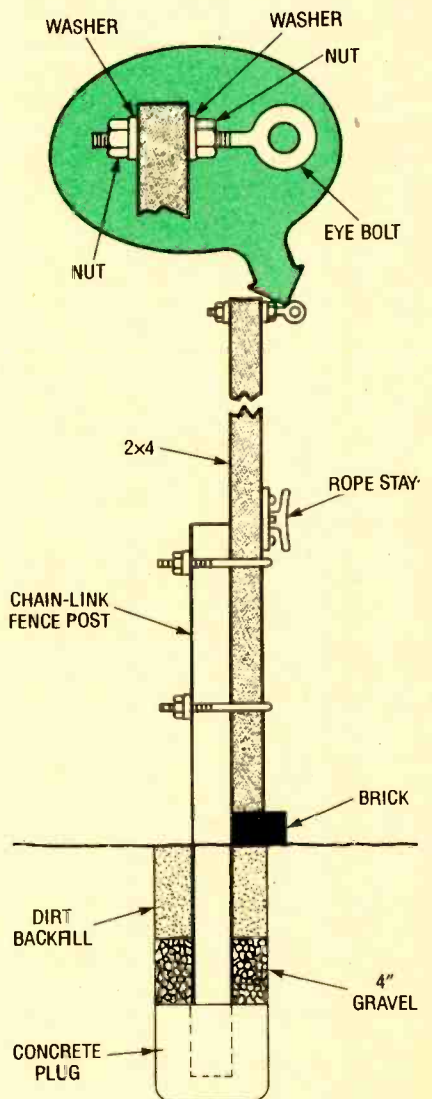

Fig. 3 A ground-mounted antenna support must be securely installed. The simplest approach is to use an existing fence post, or to install a fence post using the scheme shown. Also, use an eyebolt, not a pulley, for the antenna-support rope.

Selecting Materials. The wire selected for the antenna must be either hard-drawn stranded #14 or #12 copper wire (not the best) or Copperweld wire (preferred). The latter is steel wire that is copper coated. Because of the skin effect seen at RF frequencies, Copperweld gives the low resistance of copper and the strength of steel. Do not use solid wire for your antenna. The downlead wire should be about the same size as the antenna wire, and should be insulated.

The mast for a wire antenna can be any of several materials. Wood is popular—especially if it is treated with varnish, paint or, some other coating that protects it against weather—but only if the antenna is not too long or heavy for its strength. Most hardware and lumber outlets offer raw or partially finished semi-round, wooden-banister stock in lengths up to 20 feet. That form of lumber is usually strong and straight so it might make a viable alternative for a mast; unfortunately, it can also be a bit on the expensive side.

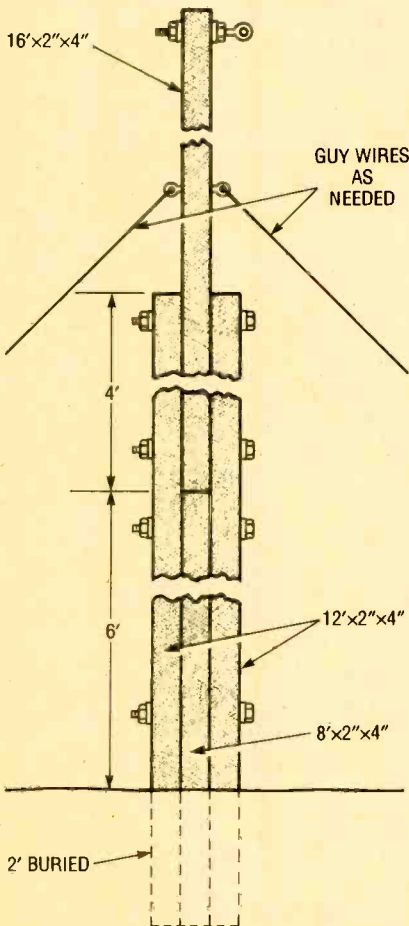

Fig. 4. Use this method if a taller, free-standing support is needed. Remember that the base of the support must be buried at least two feet deep.

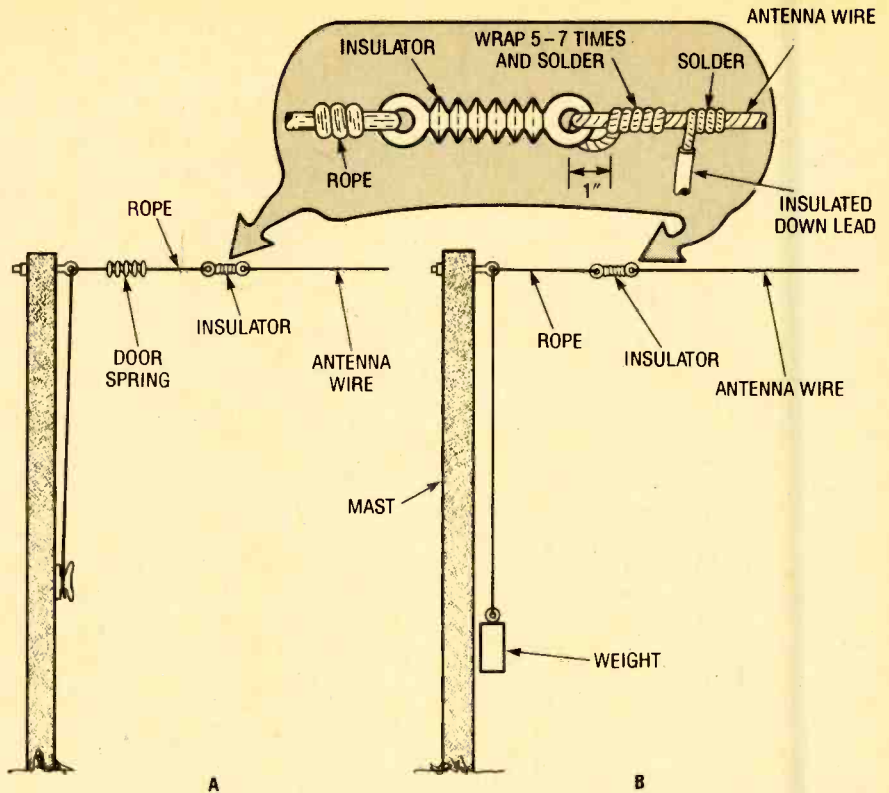

Fig. 5. To make an antenna last, some type of strain relief is needed. Use a door spring as shown in A or a counterweight as shown in B. Also, use the wrapping technique shown in the inset to provide a sound mechanical connection to the support rope.

Another popular alternative is a steel TV-antenna mast. The fixed types come in 5-foot and 10-foot lengths, and can be joined together to make longer lengths. However, guying is often required, especially for masts longer than 10 feet. Also available are telescoping TV antenna masts in lengths from 20 to 50 feet.

Modern plumbing pipe is not metal, but rather it is made of PVC. Many people use PVC pipe for antenna mounting, and indeed that's a viable alternative if two conditions are met. First, the mast isn't too long, and second only the heavy thick-walled types of PVC pipe are used. Otherwise, the mast will slash around like a lion tamer's whip.

House-Mounted Antenna Supports. Since antennas need to be located as high above the surrounding terrain as possible for best performance, many antenna builders like to mount at least one end of the antenna to the house itself. Four methods of doing that are shown in Fig. 2.

Figure 2A shows the use of TV-type standoff mounts to attach the mast to the side of the house. Those mounts usually come in lengths of 4, 6, 8, 12, and 24 inches. Select the size that will clear the edge of the roof and gutter

by a couple of inches. If you select one that is too long, then there is a longer lever arm when the mast is subjected to high winds, and that means a higher potential for failure. I prefer to space the mounts about 24 inches apart.

A chimney mount is shown in Fig. 2B. There again, TV-antenna hardware is pressed into service for ham and SWL wire-antenna mounting. The antenna mast is attached to a chimney by a pair of stainless steel straps and turnbuckle fittings. Caution: Not all chimneys are suitable for this type of mount. At my house, the "chimney" is actually a decorative sheet metal shroud around the furnace flue, and it is not mechanically strong enough to support any but the lightest antenna mounts.

A TV-antenna tripod mount is shown in Fig. 2C. Those mountings have three legs that are attached to the roof. The legs and their pods are adjustable, so this mount can be used on sloping roofs. Because it requires drilling three or more holes in the roof into the attic, be sure to buy a pint or so of roofing pitch or caulk to reestablish the waterproofing of the roof. Follow the instructions that come with the tripod on bracing the roof inside the attic, and on waterproofing.

(Continued on page 96)

GIZMO

SEPTEMBER 1990

VOLUME 3,
NUMBER 9

A CHRONICLE OF CONSUMER ELECTRONICS

Large as Life, and Twice as Bright

VIDIKRON DP7 HOME THEATER FRONT-PROJECTION VIDEO SYSTEM.
Manufactured by: Vidikron of America,
928 Broadway, New York, NY 10010.
Price: \$4995.

We first heard about the *Vidikron* projection-TV system from someone who'd tried them all and was looking for a still better way to entertain the crowd at his 120-guest Superbowl parties. This one, he told us, gave him the brightest projection-TV picture he'd ever seen, and the quality of the image was outstanding. Well, after hearing him brag about this magnificent system week after week, we finally gave in and arranged to see it for ourselves. Wow!

The *Vidikron DP7* video-projection system throws a picture onto a screen measuring seven feet (84 inches) diagonally. There's also a tiny six-foot screen available if your requirements are more modest. If you don't think seven feet is huge, consider that the area of that 4.2 × 5.6-foot screen is almost ten times that of a 27-inch CRT. And, when you're sitting in front of it, it looks even larger than that. *Vidikron* says that the TGS-One projector used in this system can project usable images measuring up to about 16 feet diagonally, and, after experiencing the seven-foot one, we can believe it.

Most large-screen TV's manufactured today use a rear-projection scheme that has several advantages for the typical home user. Since the system's an all in one package, alignment can be done at the factory and presents no difficulty for the purchaser. (Both front- and rear-projection TV systems typically use three separate light sources—one for red, one for blue, and one for green. Those have to be carefully aimed and converged to produce an in-register picture free of color fringing. The days of trying to throw the image from the face of a single CRT onto a screen are long gone.) Also, because everything in a rear-projection system comes in a single

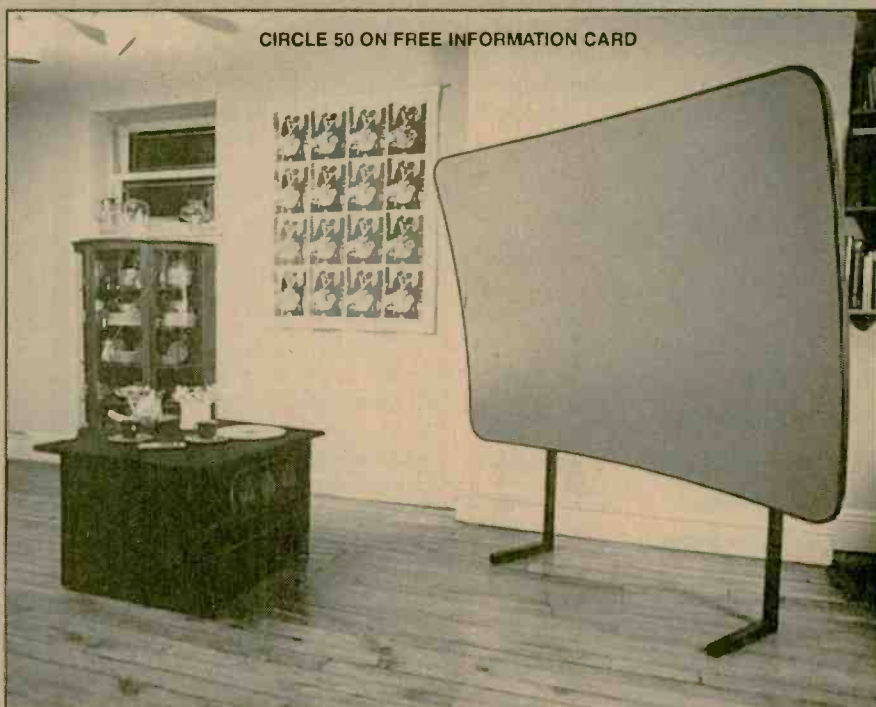

box, space requirements are reduced and simplified with regard to a front-projection system, and there is, of course, no separate projector to trip over or for people to walk in front of at just the wrong moment.

The penalty you pay for that convenience is twofold. There's a practical limit to the size of the picture you can obtain with a rear-projection system—the largest one that comes readily to mind measures 52 inches diagonally, and 40-something-inch home systems are more typical. Furthermore, the images are frequently less than sparkling bright—"dim" is the word that has sometimes been applied—and brightness falls off sharply as the viewing angle (away from "straight-on") increases.

The *Vidikron* front-projection system uses a three-tube (red, blue, and green) projector that's situated at a distance from the screen of 1½ times the screen's diagonal. That means that if you use a seven foot screen, the projector will have to be about ten or eleven feet from it. When you add in a little extra for the rest of the projector and the "coffee table" in which it sits (in-

cluded as part of the DP7 kit), and add the space *behind* the projector in which you and the rest of your invited audience will sit, that's quite a bit of room. The TGS-One is not for apartment dwellers unless, maybe, that apartment is a loft in SoHo. But, boy, is it worth it!

According to Giovanni Cozzi, president of Vidikron of America (the parent company is Italian), the company's intention with the system is to provide a true theatrical experience at home. And that, except for a few scan lines that may be visible (this is, after all, just an ordinary NTSC system, not HDTV or EDTV), is what you get. Seated at the recommended distance from the screen of two- to three-times its diagonal, the picture projected on it fills your vision—you see it not only with the center of your eye, but peripherally as well, and it is hard to ignore what's going on up there in front of you. Even somewhat lackluster program material can become engrossing. (Maybe that's why TV executives seem to think so highly of some otherwise forgettable fare—perhaps their

(Continued on page 4)

TURN PAGE FOR CONTENTS

This month in GIZMO

Vidikron DP7 Front-Projection Video System	pg. 1
B.I.C. Venturi V630 Loudspeaker	pg. 2
Cranolin Anti-Oxidant Contact Cleaner	pg. 3
Sanyo CLT 8601 Cordless Phone	pg. 5
Suono Metal-Particle Audio Cassettes	pg. 6
Elexis Calorie Watch	pg. 7
AudioSource Amplifier	pg. 8
Remote Control	pg. 8
Marine Transceiver	pg. 9
Portable Speaker System	pg. 9
Smart Typewriter	pg. 9
Surge Suppressor/Switch	pg. 9
Camcorder	pg. 10
CD Player	pg. 10
Cordless Headphones	pg. 10
See-Through Phone/Clock	pg. 10
Ambico Tape Winder	pg. 11
10-Band Equalizer	pg. 11
Casio Organizer	pg. 11
Kawai Keyboard	pg. 11
Playskool Telephone	pg. 11
Audio System	pg. 12
Car Radio	pg. 12
Laser Turntable	pg. 12
Member Alert System	pg. 12
Yamaha Amplifier	pg. 12

Gizmo is published by Gernsback Publications, Inc., 500-B Bi-County Blvd., Farmingdale, NY 11735. Senior Writer: Josef Bernard. Contributors to this issue: Dana Densmore, Bill Donahue, Melville Shavelson. Copyright 1990 by Gernsback Publications. Gizmo is a registered trademark. All rights reserved.

Nothing Venturi'd, Nothing Gained

B.I.C. VENTURI V630 LOUDSPEAKERS. Manufactured by: B.I.C. America, 895-E Hampshire Road, P.O. Box 1709, Stow, OH 44224. Price: \$599.

We've never been really partial to vented or ported speaker designs—all too often they simply don't sound right to us. Maybe we just haven't been listening to the right ones, but at lower frequencies, their sound takes on an odd, "buzzy," coloration. That is, we begin to get the impression that the speaker enclosure has been constructed out of cigar-box wood, and that one or more of those thin panels are beginning to come loose. Maybe it's an acquired taste, but we don't care for that sound.

For some reason, though, our attention was caught by *B.I.C. America's* line of *Venturi* speakers, which use a unique venting system to increase bass performance. So we obtained a pair of B.I.C.'s *V630* tower speakers to listen to for a while ... and we're glad we did, for we got a pleasant surprise. Despite their design we *liked* them.

The *V630* speakers are tall and thin, requiring considerably less than a square foot of floor space each. (Measuring 9 x 11½ inches at the base, the enclosures have a footprint of 100¼ square inches, to be exact.) The mini-towers stand 34¼ inches tall, and come with either oak- or black-laminate finishes. They are quite good looking, and it is surprising that such skinny boxes can produce so much sound. The gold-plated five-way binding posts for connection are in a roomy niche at the back of the enclosure, and are angled to make accessing them easier. We found them very convenient to use. The base plates of the speaker enclosures have provisions to accept the spiked feet often used to decouple a speaker system from the floor upon which it sits, a nice touch.

Vented designs are usually more efficient than acoustic-suspension (sealed-enclosure) ones, and the *V630* claims a characteristic sensitivity of 90 dB at one watt, one meter. Recommended amplifier power is 20–150 watts. As seems to be the case these days, there is no provision for adding or subtracting several dB of high-end response. A control for that purpose used to be common with many speaker designs, but B.I.C. figures (rightly so) that most users who want to tailor their speaker's performance to their listening area will find other, more versatile means to do so.

Now for the "Venturi principle." G.B.

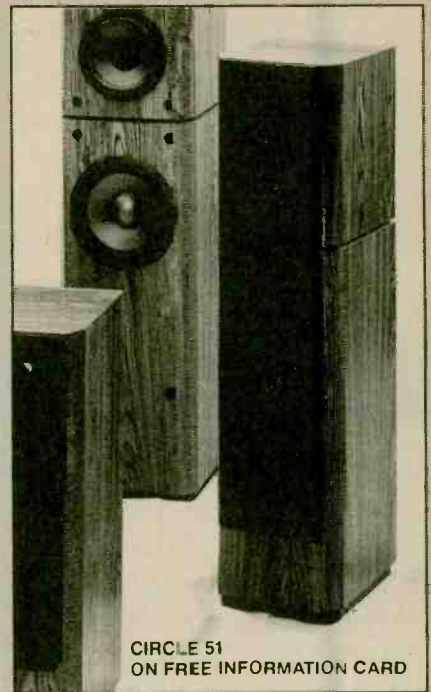

CIRCLE 51 ON FREE INFORMATION CARD

Venturi, an Italian scientist who worked around the middle of the last century, is best remembered for discovering that if you force moving air through a passage that narrows and then widens again, it speeds up as it goes through the narrow part. Both the speed and the force of the air are related to the degree of squeezing it undergoes. Wind tunnels make use of the Venturi principle to achieve high air velocities.

The *V630* speakers are divided into two sections. At the top sit a six-inch midrange driver and a one-inch soft-dome ferrofluid-cooled tweeter. Below is a separate woofer compartment containing a tapered Venturi chamber through which the output of the back of that driver, the back wave, is vented (sound emerges from the front of the driver in the normal way, directly toward the listener). That passage through a Venturi chamber, says B.I.C., can increase bass sound-pressure levels by as much as 140 times compared to those measured at the cone of the driver. That results in significantly greater bass output than might otherwise be expected from a six-inch low-frequency driver in such a relatively small enclosure. The woofers are positioned high in their chamber to prevent interaction with floor surfaces and, as we have pointed out, sound from the bass chamber is vented to the rear. That is said to improve sound dispersion by taking advantage of nearby reflecting surfaces such as walls.

The Venturi chamber is also claimed by B.I.C. to counteract the air-pressure buildup against the driver cone, said to occur in other vented designs. According to B.I.C., standard straight-tube vents can draw in more air when the speaker cone flexes outward than can be expelled when

(Continued on page 4)

Red, (Wipe), and Blue

CRAMOLIN ANTI-OXIDANT CONTACT CLEANER, LUBRICANT, AND PRESERVATIVE. Manufactured by: Caig Laboratories, 1175-O Industrial Avenue, P.O. Box J, Escondido, CA 92025-0051. Price: From \$10.95.

We were first introduced to *Cramolin* five or six years ago, when word of it was being circulated in the audiophile community as, if not a miracle product, then at least one that could improve signal flow between the connectors in your sound system, and keep their surfaces oxidation-free with little or no maintenance. The result, of course, would be cleaner, purer sound. We tried it back then, and it worked. Since that was some time ago, we thought we'd check with Cramolin's manufacturer, *Caig Laboratories*, to see what was new, and then initiate you into the Cramolin crowd.

What is Cramolin? According to its manufacturer, Cramolin is "a neutral sulphur-free mineral oil that contains a non-toxic, oil-soluble organic reagent and a group of neutral synthetic additives." Although it is available in several forms and concentrations, you will probably encounter Cramolin in spray cans containing low-concentrations (2% or 5%) dispersed in an inactive vehicle, or in tiny—two-dram (1/4-oz., or 7.1 ml.)—bottles of 100-percent concentrations of red and blue solution. Should your requirements increase, the Caig price list shows that you can buy a quart bottle of Cramolin for just \$132, and it is no doubt available in even larger quantities on special order. Since, as you shall see, a little goes a long, long way, one spray can or a couple of drams should hold you for a long, long time.

What does Cramolin do? Let's consider the red and blue varieties separately. Red Cramolin is a combination cleaner, anti-oxidant and lubricant. It dissolves and removes surface oxidation and, when wiped off, leaves behind a very thin lubricating film that also keeps out oxygen and other harmful elements. Blue Cramolin does not have Red's cleaning action, but is superior to it as a lubricant and preservative. We'll give a few examples of possible uses for each later.

Cramolin is also effective on gold-plated surfaces such as PC-board fingers and other plated connectors. While gold does not oxidize, because it is porous the base metal over which it is plated can, and the oxidation products can discolor and interfere with the conductivity of the gold surface. Cramolin removes those oxidation products and the thin film left behind when you wipe the cleaner off assists in preventing their reappearance by keeping



air out. The product's lubricating action on contacts also reduces abrasive loss of gold plating during multiple insertions.

How do you use Cramolin? As sparingly as possible. (Like Brylcreem, a little dab will do you.) You don't need much. We've used a scrap of paper toweling to hold a drop or two of 100-percent solution to wipe on such surfaces as PC-board fingers, and for heavier-duty application there are lint-free foam swabs. With the spray-can version—whose propellant, it is said, is non-injurious to the ozone layer—you can use more, since the normally supplied spray-can concentration is only two percent. You may sometimes want to use the spray version with its extension tube to get Cramolin into otherwise-inaccessible spots. There's also a steel-pin-applicator bottle available, or you can just use a toothpick. The idea is to get a little bit—just a drop or so—of Cramolin Red onto the surface to be treated, and then let it sit for a few minutes. You then wipe off the solution with a clean cloth (the Cramolin kits contain several lint-free paper wipes, and there are lint-free cloth wipes available as well from Caig), taking with it dissolved oxidation and other products not conducive to conductivity. If the oxidation layer is heavy, the red solution may take on a greenish or blackish tint as it removes impurities. For really serious crud, you're advised to leave the cleaner on for several

hours, or even overnight. Sometimes a re-application may be necessary to get rid of all the deleterious buildup. When the surface is clean, a very light wipe with Cramolin Red will keep it in good shape for a year or so. For even better protection, Cramolin Blue should be used. It is not a cleaner, but it is said to be superior in its "preservative" qualities than the Red. It is also recommended for application to brand new, or to newly cleaned, surfaces.

Does Cramolin work? It seems to. Among the firms said to be Cramolin users are such notables as Motorola, Boeing, and Nakamichi. At our own, more personal, level we've made extensive use of it in our computers. We sometimes used to be plagued by malfunctions—including random system resets that once or twice lost us the better part of a day's work—or just plain garbage data. Those were caused by dirty contacts on our system's plug-in boards. The old-fashioned cure for that was to remove the boards and take a soft pencil eraser to their gold-plated fingers and brighten them up. While that worked, and usually restored the system to proper operating condition, the process had two big drawbacks to it. First, after you'd erased the fingers a couple of times, the gold plating started to wear thin—pencil erasers are more abrasive than you might think. And, second, after a while the fingers would get dirty again and have to be

re-cleaned. (Which, of course, brought us back to the method's first drawback.)

Cramolin provided us with the means to escape that vicious cycle. Although Caig suggests reapplying Cramolin at one-year intervals (unless circumstances dictate more frequent use), computer systems that we treated with the compound gave us no trouble—at least where contact reliability was concerned—for several times that. That's why, after five or six years, we came back to tell you that the stuff really does work—not just the day after, but months and months later.

Cramolin is available at a number of stores specializing in high-end audio (it's sometimes bottled and sold under the "Monster Cable" brand name), but if you can't find it there, it can be ordered directly from Caig Laboratories. They normally have a \$25 minimum order requirement, but if you request literature from them they include with it a coupon you can submit to bypass this condition.

Whether Cramolin will make your audio system sound better, we cannot say for sure. We do know, though, that it will improve the reliability and longevity of the mechanical connections there, and in other electronics systems you use. (Cramolin also cleans and lubricates wire-wound guitar strings.) Good stuff! ■

VENTURI SPEAKERS

(Continued from page 2)

it flexes in. The tapered Venturi design, it is claimed, helps equalize air flow, keeping pressure constant and improving speaker damping.

And, while we're somewhat skeptical about *all* the claims made for the Venturi design in the B.I.C. brochure, we have to admit that something about the speakers works. While they don't have the low-end wallop that a subwoofer-assisted system would, they do have ample bass for most purposes, and it's nice and tight—not boomy at all, and with none of that buzzy quality we find so irritating.

Ascending from the bass regions, we found the V630's midrange and treble qualities quite pleasing as well. The sound had a certain crispness—not a peakiness, mind you, but a good sense of definition—that we liked and that really make individual voices and instruments stand out. That might be due in part to the fact that, according to the specifications, the system's high-frequency response extends up to 22 kHz (bass response goes down to 49 Hz, and is 6 dB down at 39 Hz). These are not "mellow" speakers. But they're not strident, either. What they do is impart a definite authority to the music they reproduce. The speakers imaged pretty well, too, although we've heard better.

All in all, we enjoyed using the V630s. They looked good, didn't take up much space, and performed well. ■

PROJECTION TV

(Continued from page 1)

viewing rooms are all equipped with large-screen projection systems.)

And when you get something worthwhile, well ... Satellite reception aside, the best video picture quality you can get these days comes from videodiscs. In anticipation of the Vidikron experience, we obtained a videodisc player from our friends at Yamaha, and rented a couple of discs for it. And it really was a theatrical experience.

No matter how good the picture is on a direct-view or rear-projection system, it just can't compare with what we got from the Vidikron. The picture was sharp (or at least as sharp as a seven-foot NTSC image would allow) and bright. Brightness, as we've mentioned, is one of the Vidikron system's virtues, and its picture is certainly the brightest we've ever seen. Our system came with a slightly curved, high-reflectivity screen (there's also a motorized-flat-screen version) that may have had something to do with it, but the picture was easily watchable even in a room well-illuminated by bright daylight. As long as the light did not fall directly on the screen, we had no difficulties with the picture. And at night we took to wearing sunglasses when watching the Vidikron picture. Seriously! (Not quite so seriously, we've suggested to Vidikron that they offer Italian designer sunglasses as a premium for purchasing a system; they're still thinking about it.)

Brightness aside, that large-screen approach is the only way to watch some films-on-video. David Lean's *Lawrence of Arabia*, for instance, or Stanley Kubrick's *2001: A Space Odyssey*. On the small screen, such films lose a lot of their impact, and the fact that their wide-screen aspect ratio has been compromised by scanning to fit the NTSC 4:3 screen makes the situation even worse. Fortunately, many videodiscs are issued in "letterbox" format with the films reproduced in their original wide-screen aspect ratio. On the small screen this would make things pretty ... well, tiny ... but up on the huge Vidikron screen, we saw productions the way their directors had intended. What an experience! What a pleasure!

Living with a large-screen TV system such as this is not all peaches and cream, though. There are a few potential problems of which you should be aware before you rush out and order your Vidikron. The first, as we discovered, is that you need plenty of room to use it properly. And the large screen is not something you put up and then take down when you're done with it. Like the projector in its coffee table, it's always there. If you have a separate "media room," a naked seven-foot screen may not seem out of place; otherwise you may want to knit a snood or other cover for it.

Setting up the Vidikron can be done by one person, but the job is a lot easier with two, especially when it comes to erecting the big screen. The company insists that whenever possible the system be shipped by air to keep potential damage and misalignment problems to a minimum, and that policy seems to work. We had no difficulty in getting a properly converged picture "first shot out of the box."

For setup, Vidikron supplies a simple tool based on a pre-measured length of string that allows you to position the projector at the proper distance from the screen, as well as to ensure that it's centered. At the back of the projector are several alignment controls (as well as a switch that displays a cross-hatch test pattern that simplifies alignment and minor touchups), and inside the case are *lots* more controls with which you will probably never have to deal. We barely had to fiddle with the external ones on our system, and that was mainly to see what they did. Not having to go through all those adjustments, and being able to turn on the system and get an eminently watchable picture the first time, made the Vidikron system a delight to use.

The projector unit includes a small stereo amplifier—but no tuner—and a pair of front-firing stereo speakers is included in the "coffee table." The sound bounces off the screen and appears to come from the region of the picture rather than from the speaker enclosure beneath the projector. Surprisingly, this arrangement still provides some stereo effect, although if you're going to do things up right, you'll use a separate amp with speakers at the sides of the screen and—of course—a surround-sound processor with its own amp and speakers for the rear. There's a remote control for the projector, but since you're no doubt going to feed it video from a another remote-controlled device, purchasing a "universal" remote might be a good idea, for the sake of convenience.

Because the projected picture is so large, any defects in it will be magnified. Any noise in an off-the-air or cable signal, or a poor signal-to-noise ratio at some point in a VCR system, is going to stand out like a sore thumb. We also noticed a small degree of dot crawl in our Vidikron picture from time to time. When we questioned the company about it, they explained that their engineers had calculated that a comb filter good enough to alleviate the problem completely would introduce more "garbage" than it would remove. The big problem, though, will come from the quality of the material fed to the Vidikron projector. A system such as this demands a satellite receiver or at least a videodisc player.

If you have the right material, however, and the space, and the money, the Vidikron DP7 front-projection system can't be beat. ■

Cordless Compander

SANYO CLT 8601 CORDLESS TELEPHONE. Manufactured by: Sanyo, 21350 Lassen Street, Chatsworth, CA 91311. Price: \$149.99.

Cordless phones are great! They liberate you from the cords and wires that hinder you from moving about the room as you try to engage in conversation and another activity at the same time. Housewives (if there are still any around) can do their cleaning while they chat with their friends, nervous types can pace to their hearts' content, and those of us who are fortunate enough to be able to work at home can, on a fine spring day, take the phone outside and conduct some business while working on our tans.

For all their convenience, though, cordless phones have had a couple of liabilities that have rendered some potential users shy of them. One such shortcoming has been the quality of their audio. In the past few years that has improved significantly, and calls originating from most cordless phones no longer have that "dead" or "hollow" quality that once typified them. The audio those phones present to their users at the earpiece frequently does not match up in quality to what goes out, but things are still a lot better than they were—incoming calls no longer sound as though you were listening to them with your ear pressed against the speaker of a cheap AM radio.

The other problem with cordless phones has been noise—not so much the "interference" type, but simply the hiss that occurs when signal levels start to drop because of distance or other circumstances that cause signal strength to deteriorate. Sanyo has a cordless phone that is pretty good in the first department, and does nicely in the second, as well. Its *CLT 8601* cordless telephone uses the same type of scheme that reduces tape hiss in cassette recorders to get rid of background noise, or at least to reduce it considerably.

"Companding" is a word of relatively recent origin derived from "compressing" and "expanding," and is the term used to describe the type of noise-reduction technique Sanyo uses in its phone. The process is simple. At the transmitting end the audio signal is compressed, or boosted to a more-than-normal level, before it goes out over the air. That "concentrated" audio signal is then transmitted conventionally, and at the receiving end it is expanded, or returned to its normal, less "concentrated" form before being turned back into sound waves. Other portions of the total signal received—portions such as the background hiss that can drown out a weak



CIRCLE 53 ON FREE INFORMATION CARD

signal—are not processed. And, when the companded audio is reduced to "normal" level, the level of any background noise that may have crept in is also reduced. The noise becomes much less noticeable and, when it finally does become unavoidable, creeps in much later in the game than it would if compansion were not used.

The Sanyo companding cordless phone performed very well for us. It is not one of those super-sophisticated devices with an IQ about as high as the number of security codes it provides (there are 256 of them, by the way, which helps keep the neighbors off your line), but sometimes less is better. That lack of heavy thinking on the phone's part made for fast response, and there were no digits lost in dialing while the phone pondered what it was going to do next, nor were the first word or two of conversations cut off.

The phone handset is compact and easy to carry about, although it would have been nice if a belt clip of some kind had been available for it.

The base unit, which does use one of those telescoping whips (but you probably won't be carrying it through a lot of low doorways, and that type of antenna gives more range), includes an intercom and a speakerphone function. However, it has no

keypad—for outgoing calls you have to dial from the handset, and then you can switch over to speakerphone mode. Since we view speakerphones mostly as a convenience to free up our hands when someone puts us on "hold" for an extended period, that worked just fine, and we have no complaints about the lack of an outgoing-call speakerphone capability.

Also missing, by the way, are hold and mute functions. Some people might be disappointed in the lack of these, but we didn't miss them. Although the manual for the 8601 mentions a mute function, when we couldn't figure out how to get at it we called Sanyo. After a little checking they called us back and told us that the manual was in error, and that for this model their engineers had opted for a "manual mute" function—that is, putting your hand over the mouthpiece.

Of course, this phone has memories—nine of them—whose contents can be dialed by pressing the recall button on the handset and the digit assigned to that number, a last-number-redial function, a flash button, and so on. A scan button on the handset moves the phone set to a new pair of frequencies should interference appear on the pair you are using. And one

(Continued on page 7)



CIRCLE 54 ON FREE INFORMATION CARD

The Tactoids'll Get You if You Don't Watch Out!

SUONO METAL-PARTICLE AUDIO CASSETTES. From: That's America, Inc., 1983 Marcus Ave., Suite 201, Lake Success, NY 11942. Price: \$15.10 (C-90 length).

We would not normally devote so much space to a new audio cassette but, rather, would include it in the **Electronics Wish List** portion of **GIZMO**. There is always, however, room for exceptions.

Our interest was piqued when we started receiving material on a new premium tape called *Suono* from a company called *That's*. For starters, design of the cassette shell had been farmed out to G. Giugiaro, the man responsible for the look of such sporty cars as the Maserati and Lotus Esprit, not to mention the more plebeian Volkswagen Golf. The shell, said the press release, had a *dome*. That we had to see! So we requested a sample of *Suono* (which, by the way, is pronounced "SWOH-no," and is Italian for "sound"). It arrived shortly by Federal Express, accompanied by a considerable amount of public-relations material.

(And, since this is **GIZMO**, we thought we'd let the *That's* PR people tell you about some of *Suono's* gizmos. Most of the quotation marks in the paragraphs that

follow indicate that the material enclosed within them came from the *Suono* press and consumer information. We couldn't make up stuff like this!)

But, before we get started, let us say that not only did we read about this Type IV metal-particle tape, but we listened to it, too. In our listening tests, it performed beautifully, so maybe there is something behind all the fuss. Keep that in mind as we go.

We'll start from the outside and work inward. The shell, as we've already noted, has a dome. Not too high a dome mind you, or you couldn't get the door of the cassette well on your deck closed, but an obvious elevation nevertheless. Now, we'd always been under the impression that the design and dimensions of a Philips-type cassette were fixed by the terms of a manufacturer's license agreement with Philips. It seems however that some of these parameters can be varied as long as they do not interfere with the functioning of the unit. In any case, Signore Giugiaro designed "... the central part of the cassette shell in a three-dimensional dome, profiled on the ancient amphitheater" to "inhibit vibratory standing waves." Says Signore Giugiaro, "The ancient amphitheater suggests a space that holds music at the core of humanity, beauty and plentifulness in human life ... for *Suono*. I decided on an image of the audio cassette tape as an amphitheater/concert hall. It is also a microcosm of the city."

What this has to do with "reducing vibratory standing waves" is beyond us. Indeed, we've always envisioned domed structures as encouraging standing waves.

Well, be that as it may, it is a pretty sexy-looking cassette.

The next claim made for *Suono* cassettes concerns the material from which the domed shell is molded—a high-density resin consisting of polymer rubber ("which excels in vibration control") and a metal "which provides high shock absorption." That material is said to offer "a vibration control effect 2.8 times higher than the conventional ratio, thus greatly reducing modulation noise" generated from the vibration of the cassette deck and speakers. Maybe so, although if the deck is vibrating, the record and playback heads are probably also vibrating, and that motion will be transmitted directly to the tape without even having to pass through the shell.

Whatever else it does, though, the new shell material adds a lot of weight to the cassette. A C-90 *Suono* cassette weighs 57 grams, compared to a more conventional C-90's 40-or-so grams. The clear window in the shell that allows you to view the amount of tape remaining on a hub is just a narrow slit; that, too—by allowing greater use of the new *Suono* resin—may contribute to "vibration control."

The shell is said to benefit from a special molding technology featuring "a limited holding face warp which provides a high parallelism of flat surfaces and guide pins." The vertical accuracy, which is what azimuth alignment is all about, is said to be measurable in microns and "... as a result, the difference in right and left phases of sound is vastly reduced ..." Good.

The friction sheet in the *Suono* cassette combines "high rigidity with a low elastic modulus," which means (we think) that it doesn't stretch or otherwise deform very easily. It is also "uniquely embossed to reduce tape friction and control clearance. This IM friction sheet"—we're still trying to find out what "IM" stands for (it's probably *not* "Intermodulation Distortion")—"allows reduction of rotation torque to 1/4 of previous values and greatly improves wow-and-flutter." We hope it *reduces* wow-and-flutter, too. The tape did seem to turn very smoothly when we rotated hubs manually.

Now for the metal tape itself. The super-fine particles make up what *That's* calls a "nano dynamic tactoid magnetic material." *Nanos* is Greek for "dwarf"; "dynamic" comes from the Greek *dynamis*, meaning "power" and later, "motion;" and *tactoid* ... well, we weren't sure about it at first. The Latin root *tact* means "touch," so we thought that maybe the magnetic medium consisted of "little moving particles that touch." Or it might have been "touching particles that move in tiny increments." (Or ... maybe tactoids were just something out of *Doctor Who*, as in *Doctor Who and the Tactoids?*)

(Continued on page 8)

CORDLESS PHONE

(Continued from page 5)

labeled "tone" temporarily switches you into the tone mode if you are using the phone on a pulse-dialing system and need to access something like a remote-control answering machine.

The phone lets you know when it's in trouble. A "batt low" light on the handset illuminates when it's time for a recharge. Sanyo has also built in an audible "out-of-range" indicator should you begin to wander too far afield while in the midst of conversation. When signal levels begin to approach unusable levels, the handset begins to beep (in quite a genteel fashion, we might add) and you have 30 seconds to do something about it before you are disconnected.

The phone's range was good, although not outstanding, and the companding system worked. Both incoming and outgoing audio were more than satisfactory. While, of course, signals did get noisy if we strayed too far from the base (and the noise usually was followed soon after by the "out-of-range" beep), we did get better performance than we have from some other cordless units. Certainly, under ordinary conditions, there was no background noise at all that we could discern.

Sanyo claims a signal-to-noise ratio of 85 dB for the Super Companding (there's a plain old 70-dB S/N ratio companding system used in its cordless phones farther down the line), and equates that with the lack of background noise on compact discs. All right, Sanyo, we'll grant you that—but we still get better music from our CD's. ■

Watch Those Calories!

CALORIE WATCH. Marketed by: **Elexis Corp., 7000 N.W. 46 Street, Miami, FL 33166. Price: \$39.95.**

What a great idea! You wear this device on your wrist as you walk or jog, and it keeps track of the calories you burn up in exercising. A pound of fat is worth 3600 calories. If you know how much energy you're expending you can get a rough idea of how much weight you can expect to burn off; working it the other way, you can get an idea of how long you have to keep going to reach your targeted energy usage. Not only that, but *Elexis Corp.'s Calorie Watch* also tells time ... and a lot more. Now we, of course, don't have to worry about burning off excess weight, but there are undoubtedly a few people with whom you are familiar who could use a gadget like this to help them get into better shape.

In its pedometer mode, the following

functions are available from the Calorie Watch: odometer (miles or kilometers traveled), pacer (steps per minute), pedometer (step counter), speedometer (in miles or kilometers per hour), average and peak speed determinations (in miles or kilometers per hour), and calorimeter (calories burned). Additionally, as a timepiece the Calorie Watch tells you the time (in 12- or 24-hour format) and date, and has an alarm, a countdown timer, and a stopwatch. That's a lot in a little package that you strap onto your wrist and that's just fractionally larger than an ordinary LCD watch!

Setting up the Calorie Watch to match your body and preferences is a good job to occupy you on one of those rainy afternoons when you can't get out to exercise (or just don't feel like going outside and getting all wet). Four buttons at the corners of the watch's squared-off case cycle you through the modes and, in various combinations or sequences, allow you to program it. Elexis provides a double-sided instruction sheet to help you; there are also some indications printed on the face of the watch, but they were too small for us to read without assistance.

The personal data you have to enter are: measurement preference (British—inches/pounds—or metric), sex, age, weight (in pounds or kilograms), and stride length (in inches or centimeters). Once it knows all that, the watch is presumably ready to start counting calories for you. Strap it onto your left wrist—apparently it won't work for lefties who wear their watches on the other side—start the stopwatch at the same time you start your walk or run, and you're off!

We encountered one problem with our

Calorie Watch ... we couldn't make it work properly. We know why, too, but the cure is—for us at least—more trouble than it's worth.

As we walked, we swung our arms vigorously as directed to by the instructions—apparently that activates some kind of tiny pendulum-type switch inside the watch that is part of the pedometer. From time to time, even though we had not activated the pacer (which is supposed to give you a beat to keep up with, sort of like the galley-slave drummer in *Ben Hur* ... or was it *Spartacus*?) the watch emitted a beep. Although it occurred only sporadically, the sound seemed to be tied somehow to our steps. Oh well, we'd check up on what it meant when we got back inside and could reread the instructions.

We discovered that things were not going as smoothly as we had thought when we paused in our exertions to check with the watch on how far we had gone and how much energy we had expended. We *knew* we'd walked more than 28 steps! And, we hoped, we'd used more than two calories in getting to where we were. It certainly felt that way. Wait a minute ... the watch had beeped at us only a few times ... about fifteen times, to put a number on it. Now, if one complete arm swing equals two steps ... *Aha!* Those beeps were indicative of arm motions of sufficient magnitude to activate the pedometer (which really doesn't measure steps, of course, but measures arm swings instead). But why did they occur only sometimes ... and why were the readings from the watch so low?

Standing still, we experimented. And we discovered that you really have to pump your arms energetically, like the pistons of an old steam locomotive, to get through to



CIRCLE 55 ON FREE INFORMATION CARD

the watch. You have to put more effort into moving your arms than you do into moving your legs! We like to think that when we go out walking we do so pretty energetically, but apparently our normal exertions weren't good enough for the Calorie Watch. It wanted more! Well, we've gone to some pretty far extremes in the name of GIZMO, but dislocating a shoulder to get a dinky little pedometer to work is above and beyond the call of duty! We're not prepared to go that far!

If you want to know how well the Calorie Watch calculates the energy you burn in walking or jogging—or in just standing still and swinging your arms back and forth hard enough to register on the watch's innards, which can use up plenty of calories in itself—you'll have to find out for yourself. We couldn't push ourselves that hard! ■

AUDIO CASSETTE

(Continued from page 6)

We have since discovered that a *tactoid* (from the Greek *taktos*, "elongated") is a narrow elongated particle. Presumably, narrow particles can be ordered, or lined up, better than *icoacervate*, or lumpy

ones. Nano tactoids, then, are tiny needle-shaped particles which, says That's, perform much better in terms of their magnetic capabilities and signal-to-noise ratio than do larger, rounder ones. The end result is a very smooth surface that permits close contact with the magnetic record and playback heads and keeps tape noise down. We'll buy that. Maybe the "dynamic" has something to do with dynamic range.

The other tape-surface innovation in the Suono cassette arises from the binder used to hold the magnetic particles on the surface of the plastic tape. The ultra-fine nano dynamic tactoids, because of their microscopic size, would tend to clump together if left to themselves, and that could inhibit the dynamic range of the tape. The Suono binder overcomes that problem: it "is comprised of a multi-functional polymer which has two apparently inconsistent functions that prevent such fine magnetic particles from cohesion with their own polarities and simultaneously firmly couples the magnetic material and the polymer by a cross-linking function."

Whew! But, as long as it works ... With all that, the tape had better be

good! And, you know what? To our ear, at least, it is very good. We transferred portions of several CD's to a Suono cassette—selections from the Charles Dutoit *The Planets* and Sir Neville Marriner's version of *The Sorcerer's Apprentice*, a couple of our favorite test passages. We also broke out our Telarc *1812 Overture*—the one that blew the cone out of one of our woofers a couple of years ago when the cannons started firing—and transcribed some of that as well.

The results were fine. With Dolby C noise reduction we could discern no tape hiss, even during inter-selection interludes, and the dynamic range of the original recordings was well preserved (the literature says you can easily go 6 dB into the red with this formulation with no apparent ill effects). No audible distortion, of course. We'll have to leave a precise analysis of how the Suono tape performs to others who have the equipment to measure its response, but to us it sounded very nice. The price is a little steep for everyday use, but for special occasions Suono sounds like the way to go. Just ignore all the hyperbole ... and don't let the Tactoids get you. ■

ELECTRONICS WISH LIST

For more information on any product in this section, circle the appropriate number on the Free Information Card.

Is It Live, or Is It ... ?

What might be the ultimate remote control has been announced by Memorex (P.O. Box 901021, Fort Worth, TX 76101). Its *CP8 Turbo* remote allows users to pre-program the operation of every component in their systems so they can be operated by remote control even when there's no one present. For example, the unit's 16-event programmability permits you to program the TV to come on at 6:30 every morning to serve as a wakeup alarm, or to have the CD player start up at 5:45 in the evening as you arrive home from work ... and then turn off and have the TV come on so you can catch the news. The CP8 Turbo can learn the infrared codes of eight audio or video components and has a memory capable of holding 156 commands. Thirty-five programmable sequences of up to 48 steps are permissible. The unit also includes a QTR (Quick Timer Recording) switch that allows "quick record" programming with durations settable in 15-minute increments. Just remember though, before you go out, to leave the remote pointed at the equipment it's to operate. Price: \$119.99.

CIRCLE 56 ON FREE INFORMATION CARD

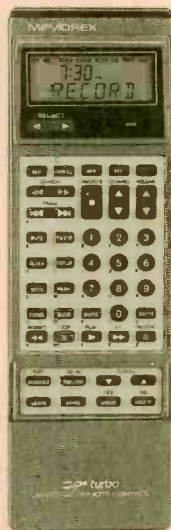

Memorex Remote Control

Amp with Meters

For those occasions when LED's are not enough, AudioSource (1327 North Carolan Avenue, Burlingame, CA 94010) has an amplifier with a pair of two-stage output meters on its front panel. The *AMP One* amplifier is rated at 60-watts-per-channel, and is bridgeable with the flick of a switch to 170-watts (mono) into a load of four or eight ohms. Frequency response is stated as 20 Hz to 20 kHz \pm 0.5 dB, with a signal-to-noise ratio of 110 dB. The amplifier uses a toroidal power transformer for high current-transfer, and includes a switchable "soft clipping" feature to reduce distortion caused by loud transients. There are separate high- and medium-level line inputs to accommodate such high-output devices as CD players, and individual left- and right-channel output-level controls assist in system balancing. Price: \$299.

CIRCLE 57 ON FREE INFORMATION CARD



AudioSource Amplifier

For more information on any product in this section, circle the appropriate number on the Free Information Card.

ELECTRONICS WISH LIST

Smart Typewriter

Many people don't require a full-blown computer word-processing system to get their letters out. A state-of-the-art typewriter will do the job very nicely, thank you. *AEG Olympia* (3140 Route 22, Box 22, Somerville, NJ 08876-0022) has what they need. The *Personal Writer*, targeted for business typing in a corporate or home office, is an electronic typewriter that features such niceties as multi-line correction with "word delete," margin- and tab-format memory, bold and underscore printing, and proportional spacing. Additional features include automatic decimal tabulation, centering, automatic carriage return, and automatic paragraph indent. The carriage can accept 15-inch-wide paper or envelopes, and the unit can print at speeds of 20 characters per second when connected to a computer via an optional parallel interface. Also available as an option is an 80,000-word spelling checker. Price: \$499 (typewriter), \$99 (parallel interface), \$129 (spelling checker).

CIRCLE 58 ON FREE INFORMATION CARD



AEG Olympia Typewriter

Sound in a Suitcase

If you're tired of tinny little sounds coming out of the headphones of your personal stereo when you travel, or from a minuscule pair of external speakers, *Cambridge SoundWorks* (154 California St., Newton, MA 02158) has a high-performance traveling speaker system that comes with its own suitcase. The *Model Eleven* consists of a miniature three-channel amplifier (36 watts total output power), a pair of compact two-way satellite speakers, and a BassCase, which is an "acoustically correct" woofer enclosure that both reproduces low bass sound through a seven-inch acoustic-suspension driver and doubles as the system's carrying case. The Model Eleven, which weighs 23 pounds and measures 16½ × 19½ × 6¼ inches, can be powered by any source of AC—domestic or foreign—or from 12 volts DC. Plug in a portable CD or tape player and you're all set to go ... unless you're already on your way! Price: \$599.

CIRCLE 59 ON FREE INFORMATION CARD



Cambridge SoundWorks Portable Speaker System

VHF Marine Transceiver

When you think of *Radio Shack* (One Tandy Center, Fort Worth, TX 76102) you usually don't think of marine radios, although the company has been marketing them for some time now. The latest in the line is the *MTX-101*. Designed for both pleasure boats and commercial craft, the transceiver provides 54 transmit and 99 receive channels, including nine designated weather channels. The small FM unit has two power-output settings: one-watt for normal communications, and 25 watts for emergency or long-distance use. Other features include frequency-synthesized PLL tuning, adjustable squelch, and an emergency Channel-16 priority button. A three-inch speaker is built in, and a jack for an external speaker is provided. A "universal" mounting bracket makes the unit easy to install. The MTX-101 is accepted and certified by the FCC, and an FCC license application is included with the transceiver. Price: \$229.95.

CIRCLE 60 ON FREE INFORMATION CARD



Radio Shack Marine Transceiver

Surge Suppressor/Switch

To protect personal computers and their peripherals from the potentially devastating effects of power surges, *Intermatic* (Intermatic Plaza, Spring Grove, IL 60081) offers the *Electra Guard 41* multi-outlet power-control center. Sized to fit beneath the base of a video monitor, the device can respond within a billionth of a second to prevent dangerous voltage surges from damaging equipment plugged into it. The *Electra Guard 41* has five outlets, and five switches located on the front panel to control various combinations of plugged-in devices. In addition, two auxiliary switches provide power to specific components and a master on/off switch controls the entire system. Finally, locating the unit beneath a computer system's monitor can aid in minimizing glare and improve the viewing angle. Price: \$89.95.

CIRCLE 61 ON FREE INFORMATION CARD



Electra Guard Power Controller

ELECTRONICS WISH LIST

For more information on any product in this section, circle the appropriate number on the Free Information Card.



Fun Products Ticktalk Phone

Timely Phone

Touch the top of the *Ticktalk* phone briefly and it will tell you the time. Rather, it will announce the time in its own voice. Touch it longer and it will tell you what time the phone's built-in alarm is set for. And when the alarm goes off, *Fun Products'* (2937 Shattuck Avenue, Suite 201, Berkeley, CA 94704) new see-through phone plays music—your choice—through its base. To turn off the alarm, just touch the phone. There's also a ten-minute snooze control, making the phone great for bedside use. And, to jazz things up even further, when the phone rings five neon lights in its interior flash at you. Some fun! Price: Under \$100.

CIRCLE 62 ON FREE INFORMATION CARD

Cordless Headphones

Unlike some cordless headphones that can be used only with devices equipped with headphone jacks, a new cordless headphone from *Arkon* (11627 Clark St., Suite 101, Arcadia, CA 91006) works regardless of whether or not the audio source is so equipped. The model *IR-200 Infrasond* cordless headphone can, of course be plugged into the headphone jack of a TV, CD player, receiver, or other device. But if no jack is available, a microphone that can be placed in front of the unit's loudspeaker (running almost inaudibly) picks up the sound and relays it to the headphones' transmitter. The lightweight (four-ounce) headset features cushioned earpieces having a frequency response of 30-18,000 Hz and contains its own built-in on/off/volume control. A switch allows the listener to use the phones in either their normal monaural mode or to hear synthesized stereo. The system's transmitter features a horizontally-oriented LED array that provides a usable range of 250 square feet. Price: \$79.95.

CIRCLE 63 ON FREE INFORMATION CARD



Arkon Cordless Headphones

Portable Car CD Player

Sony's (One Sony Drive, Park Ridge, NJ 07656) *D-180K Touring Discman* is a portable CD player designed especially for automotive use. The unit incorporates an anti-shock dual-damping suspension to prevent vibrations and road shocks from affecting the tracking and pickup mechanisms. An auto-tracking recovery mechanism disengages the laser during harsh bumps and then, when things have quieted down, returns it to its last position. The unit becomes part of a car's audio system through an adapter that slips into the car-stereo's cassette slot, taking the place of a tape. For ease-of-use while driving, it has oversize function controls and an orange-backlit display and play key. The *D-180K* is supplied with a DC cable for connection to a car's cigarette-lighter receptacle, and comes with an AC adapter as well for home use. Portable power comes from a rechargeable battery pack or from four "AA"-size cells. Both wired and wireless remote controls are available as options. Price: \$269.95.

CIRCLE 64 ON FREE INFORMATION CARD



Sony CD Player

Fuzzy Camcorder

Its horizontal design is not the only thing distinctive about *Fisher's* (21350 Lassen Street, Chatsworth, CA 91311-2329) new *FVC-880* 8mm camcorder. Inside, the camera's automatic iris and autofocus circuits use a new concept known as "fuzzy logic" to evaluate focus and lighting conditions. Fuzzy logic adds to the binary "yes" and "no" conditions a "maybe" state, for more accurate results than might be possible with conventional sensing circuitry. Fisher claims the new-style logic provides faster focusing and improved video reproduction in difficult backlit situations. The camcorder's horizontal layout allows it to be held firmly with two hands for more stable images, and also permits more convenient access to controls when the camcorder is used for dubbing or playback purposes. The 1.7-pound unit includes a 6:1 variable-speed zoom lens with macro focusing, six shutter speeds, flying erase head, digital title insertion, and a four-lux sensitivity rating. Also featured is a wireless remote control. Price: \$1299.95.

CIRCLE 65 ON FREE INFORMATION CARD



Fisher Camcorder

For more information on any product in this section, circle the appropriate number on the Free Information Card.

ELECTRONICS WISH LIST

MIDI Synthesizer/Recorder Keyboard

Kawai America's (2055 East University Drive, Compton, CA 90220) new FS680 keyboard is a five-octave, MIDI-equipped unit that has full-sized keys and can serve both the professional and the complete novice. For the experienced musician, the unit offers advanced programmability at every level (tones, accompaniments, ad-lib phrases, etc.). For the beginner, the keyboard's One-Finger Ad-Lib feature allows him to call upon a library of 1700 musical riffs in all styles; as he becomes more proficient he can program his own. A 16-bit PCM sound-generation system provides a choice of 100 different full rhythm-section accompaniments, as well as hand percussion effects and auto-accompaniment. Price: \$399.

CIRCLE 66 ON FREE INFORMATION CARD

Ten-Band Graphic Equalizer

The Soundshaper 310 from ADC (707 E. Evelyn Avenue, Sunnyvale, CA 94086) is a ten-band (-octave) graphic equalizer featuring 15 dB of boost or cut per channel. With its built-in pink-noise generator and the omnidirectional microphone supplied, the unit can automatically configure itself to provide flat response in any listening area. Manually operated sliders allow you to further tailor sound quality to your own taste. A vacuum-fluorescent display provides a readout of a ten-channel real-time spectrum analyzer; the sensitivity of the analyzer can be adjusted to provide a usable display at any signal level. With two tape-monitor record/play loops, the unit can also be used to customize cassette recordings made through it. The rack-mountable equalizer has a signal-to-noise ratio of 100 dB, and includes a switchable 18-dB/octave infrasonic filter. Price: \$199.95.

CIRCLE 67 ON FREE INFORMATION CARD

Two-Way Tape Winder

Many of today's VHS VCR's keep the tape at least partially loaded—in contact with the head drum—even when fast-forwarding or rewinding. If you do a lot of shuttling back and forth, that can lead to unnecessary wear on both the tape and the head. A rewinder such as Ambico's (50 Maple Street, P.O. Box 427, Norwood, NJ 07648-0427) V-0759 model can eliminate that source of potential trouble by allowing you to rewind or advance your tapes outside the deck or camcorder. The Ambico winder uses a belt-drive system and includes a resettable counter to help you reference specific points on a tape. To further extend the life of your tapes, the V-0759 features an end-of-tape cycle that slows the winder as the end of a tape is approached to prevent stretching or tearing. Price: \$34.95.

CIRCLE 68 ON FREE INFORMATION CARD

Capacious Business Organizer

What sets the Casio (570 Mt. Pleasant Avenue, P.O. Box 7000, Dover, NJ 07081) B.O.S.S. (Business Organizer Scheduling System) SF-9000 apart from other organizers in the Casio line is its ability to use expansion cards. There are four cards currently available: a 64K memory-expansion card, a financial/legal spell-checker, a medical spell-checker, and a "plain-vanilla" electronic dictionary. The unit, which features a familiar QWERTY-style keyboard layout, also has the ability to transfer information to (and from) other B.O.S.S. models using an accessory cable included with it, and to communicate with IBM-format and Apple Macintosh computers through optional software. Among the organizer's other features are 64K of built-in RAM; a six-line, 32-column display; separate business-card library and telephone directory; memo function; and a side-by-side two-month calendar display with schedule and daily alarms. Price: \$299.95.

CIRCLE 69 ON FREE INFORMATION CARD

Picture Phone

Kids who are too young to look up and dial telephone numbers can still make calls to their friends, relatives, and emergency services using the Little Operator PS-770 telephone from Playskool Electronics (Harborside Financial Center, 400 Plaza Two, Jersey City, NJ 07311-3962). Each of the phone's large pushbuttons holds a colorful, easy-to-understand picture (police officer, ambulance, grandparents) representing a number that has been programmed into the device's memory by an adult. For more personal calls, the drawings can be removed and replaced with photographs of friends and others. Price: \$39.99.

CIRCLE 70 ON FREE INFORMATION CARD



Kawai Keyboard

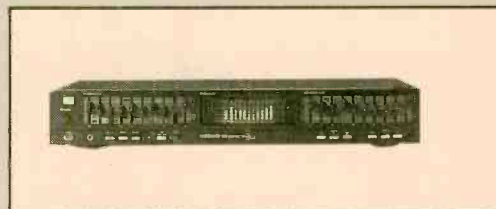

ADC Equalizer

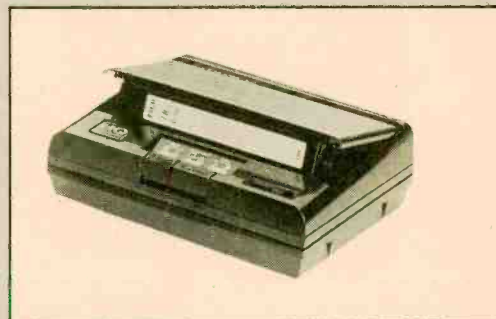

Ambico Tape Winder



Casio Organizer



Playskool Telephone

ELECTRONICS WISH LIST

For more information on any product in this section, circle the appropriate number on the Free Information Card.



Marantz Audio System

"Collectors' Edition" Audio System

Celebrating 35 years in audio, *Marantz* (PO Box 2066, Aurora, IL 60507) is producing a limited-production *Collectors' Edition* audio system featuring a full complement of gold-finished components and a personalized registration for each purchaser. The system, available in either oak (*LSX 3590*) or black lacquer (*LSX 3514*) finishes, includes a six-disc multi-play CD system, a digital tuner, an auto-reverse dual cassette deck, a semiautomatic turntable, a seven-band graphic equalizer, and a set of two 12-inch three-way speaker systems. Price: \$2000.

CIRCLE 71 ON FREE INFORMATION CARD

Emergency Helper

Member Alert Corp. (236 Highway 30 West, Mechanicsville, IA 52306) has announced what it calls "the ultimate personal emergency response system of the '90s," the *Member Alert System*. The system consists of one to four personal link transmitters (PLT's), a member terminal unit (MTU), and a professionally staffed response-alert center. The personal link transmitter is a waterproof, miniaturized digital transmitter designed to be worn on the wrist like a watch. Should the wearer require assistance, he presses a button on his PLT and a signal sent to the MTU gets the response-alert center on the line. Within seconds the voice of a professional helper is heard from the MTU's loudspeaker, and a sensitive microphone allows it to pick up voices even from across the room. Price: Unannounced.

CIRCLE 72 ON FREE INFORMATION CARD



Member Alert System

Tasteful Car Radio

One of the more irritating problems in driving across the country is locating radio stations you can stand to keep you company. *Technics* (One Panasonic Way, Secaucus, NJ 07094) can help you with its *CQ-ID90* car radio. A ROM in the tuner is programmed with the frequencies and call letters of 4500 AM and 4900 FM stations from more than 5100 U.S. cities. The stations are divided into six categories: classical, jazz, rock, easy listening, country & western, and all-talk. You indicate your musical preference, where you are, and in which direction you're travelling, and it will keep you supplied with your favorite type of program material. There's also a full-logic cassette deck with Dolby-B and -C noise reduction, and provision for connection to a CD changer. Price: \$799.

CIRCLE 73 ON FREE INFORMATION CARD



Technics Car Radio

Look Ma, No Cartridge!

If you're concerned about wear and tear on your irreplaceable—now that they have been supplanted by CD's and cassettes—black-vinyl records, *Finial Technology* (707 East Evelyn Avenue, Sunnyvale, CA 94086) can put your worries to rest with its *LT-1* cartridgeless laser turntable. There is no record wear because the only thing that touches the disk's surface is a beam of laser-generated light. The turntable also includes a noise blaster to remove clicks and pops, and an optical-system cleaner to keep the light-beam apparatus in peak working order. Using a three-beam tracking system, the laser beam can be positioned to within $\frac{1}{30}$ the thickness of a human hair and allows good tracking even on moderately warped records. A microprocessor controls the speed of the turntable system, memorizes cut boundaries, and tracks the record. Speed is adjustable from 30 to 50 rpm. If you're concerned about wear and tear on your old *stylus*, note that the *LT-1*'s laser can provide more than 10,000 hours of use—more than twenty times the life of a conventional stylus. Price: \$32,000.

CIRCLE 74 ON FREE INFORMATION CARD



Finial Technology Laser Turntable

Seven-Channel Amplifier ... Plus!

Not only does *Yamaha's* (6722 Orangethorpe Avenue, Buena Park, CA 90620) seven-channel *DSP-A700* contain two 60-watt amplifiers and five 15-watt ones, but built into it as well is that manufacturer's "Digital Sound Field Processor" circuitry. That innovation offers 12 preset listening environments and the capability for 21 user-programmed variations on those. Of course, there's Dolby Pro Logic Surround, as well. Among its other features, the *DSP-A700* counts an on-screen (video) display, "pre-out" terminals for all effects channels, front-panel microphone jacks, and a "teachable" remote control. Price: \$1099.

CIRCLE 75 ON FREE INFORMATION CARD



Yamaha Amplifier

In the second book of his "Natural History," the Roman encyclopedist Pliny recorded the appearance of small shafts of light clinging to the masts of ships and the javelins of soldiers on sentry duty. He called the manifestations "stars," and, like most other stars, they came out at night. Sometimes, the lights would hop from place to place like little illuminated birds. And sometimes, they would make a soft sound that resembled a human voice.

And on rare occasions, in the early evening the uncanny lights would come to rest on a person's head and form what was later termed a "natural beatification." Such luminous circles, much like saintly halos, were considered a fortunate prognosis and a sign of good luck.

Point Discharge. Where these visitations from another dimension, or perhaps a collection of hallucinatory episodes? It certainly sounds like it, but, in fact, what Pliny describes is neither a supernatural apparition nor some bizarre visual illusion. It is a special form of atmospheric electrical discharge related to certain kinds of lightning. It occurs in the neighborhood of points: the top of a ship, the head of a spear, or the end of a human hair.

Benjamin Franklin was one of the first to become interested in the power of a point to attract or emit electricity. In the case of emission, it's termed "point discharge." The movement of electrons away from a point is normally an inconspicuous process—both silent and invisible. But that isn't always the case. Occasionally, when the voltage gradient between the earth and ionosphere becomes large enough, the electrons leave the point with all the energy necessary to ionize the air around that point. When that happens, the air will give off light, like the gas inside a fluorescent tube. The ionized air behaves somewhat like a real burning flame. It's called St. Elmo's fire.

St. Elmo's fire is sometimes confused with another species of natural atmospheric light called ball lightning. Ball

St. Elmo's Fire

*Is it a disembodied soul,
an omen, or a spectacular
natural phenomenon?*

BY STANLEY A. CZARNIK



lightning, generally speaking, is a high-energy luminous sphere with the ability to suspend itself and move freely about in the air. St. Elmo's fire requires some sort of material electrode. There are, however, several accounts of something similar to ball lightning developing from a St. Elmo's fire-like discharge.

Clearly, the universe is under no obligation to adhere to our physical classifications.

Body of the Saint. The origins of myth and folklore are often complex and contradictory. And the development of the St. Elmo legend is no exception. According to some accounts, St. Elmo's lights were named after the martyred Bishop Elmo of Gaeta, which is located on the west coast of Italy. Or, the name may also be a corruption or mispronunciation of St. Erasmus, the patron saint of Mediterranean sailors. On the other hand, some mariners came up with a different name entirely, like St. Peter or St. Nicholas.

The Portuguese designation is, simply, Corpus Santos, or Body of the Saint. With British sailors it became Cormosant, and then Carposant. The latter is now almost synonymous with St. Elmo's fire. Whatever the name, or even with no name at all, the flickering blue lights have been granted a permanent place in English literature.

Here, for example, is one lyrical account of St. Elmo's appearance on the rigging of a ship:

*Flamed amazement; some-
times I did divide,
And burn in many places; on
the topmast,
The yard and bowsprit, would I
flame distinctly,
Then meet and join.
(Shakespeare, The Tempest)*

And another poet decided that the mysterious fire represented a bad meteorological forecast:

*Last night I saw St. Elmo's stars,
With their glimmering lanterns,
all at play
On the tops of the masts and
the tips of the spars,
And I knew we should have
foul weather today.
(Longfellow, The Golden Legend)*

Some ancient sailors believed that the lights were actually the disembodied souls of drowned crewmen returning to warn their shipmates of a coming storm and maybe a wreck.

Fire at Sea. The historical record leaves no doubt that the lights of St. Elmo have always been strongly associated with ships, sailing, and a desire to gain some sort of control over the unpredictability of conditions at sea. There is no shortage of examples. During a very violent thunderstorm encountered on the second voyage of Columbus in October, 1493, St. Elmo made an appearance. A total of seven illuminated points were seen on the topgallant mast of the ship. And immediately, all on board launched into songs of thanksgiving and happiness for it meant that the present turbulence was coming to an end.

According to yet another tradition, a single ball of fire on some part of a ship foretells a severe storm, which will be even worse if the flames dance about. Two balls of fire, on the other hand, indi-

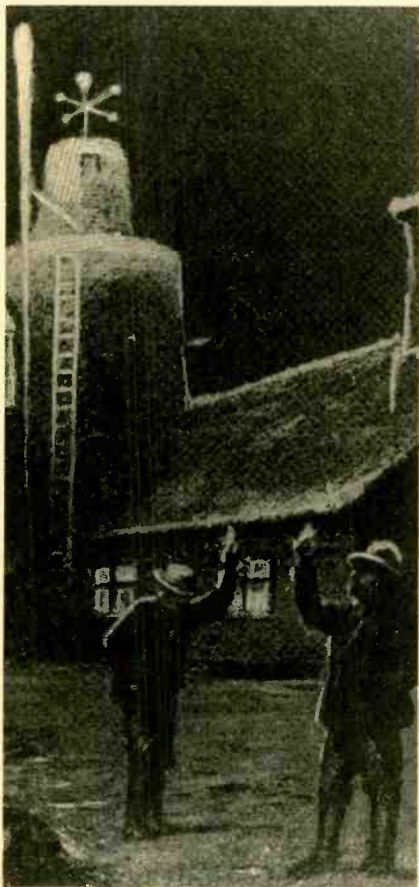

In 1888, a spectacular display of St. Elmo's fire dazzled observers at the site of an observatory on the Sonnblick, Austria. Everything with a point, an edge, or a corner became illuminated with the cold electrical glow.

cate a more auspicious situation. But three apparitions prognosticate the most frightening storm of all.

Finally, some classical sources tell us that the real mythological origin of such seafaring fireballs goes back to two Greek divinities, Castor and Pollux, son of Zeus. Castor and Pollux were considered supernatural saviors and the spheres of blue light on a ship expressed their willingness to help mariners in distress.

And there is one more very interesting connection. In a different historical context, the 19th century chemist and physicist J.S.C. Schweigger, inventor of the galvanometer, discerned a quasi-mystical relationship between Castor and Pollux and electromagnetic polarity. But, it seems probable that the original association was with the shimmering sparks of St. Elmo's fire at sea.

Illuminations. All such nautical folklore carries a fascination all its own. Yet, it remains true that some of the strangest appearances of St. Elmo's fire have occurred on land. No single pattern or location can subsume the great diversity of ways in which the eerie atmospheric glow has presented itself.

One of the earliest occurrences on record can be found in the commentaries of Julius Caesar in *De Bello Africano*. It happened over 2000 years ago. Sometime during the month of February, a large, thick cloud appeared in the dark night sky. That was followed by a hailstorm. And that was followed by the lights of St. Elmo which came to rest on the spearheads of the fifth military legion. And the spears, according to Caesar, "seemed to take fire."

There are several ancient tales about pointed things, like spears and walking sticks, suddenly surrounded with a miraculous light. But, it is almost certain that in all or most of the cases, the illumination was actually the natural glow of ionized air. Other objects visited by St. Elmo's fire include lightning rods, church steeples, tree branches, moun-



One of the earliest recorded occurrences of St. Elmo's lights can be found in the commentaries of Julius Caesar in *De Bello Africano*. It happened over 2000 years ago. Following a hailstorm, St. Elmo came to rest on the spearheads of the fifth military legion. And the spears, according to Caesar, "seemed to take fire."

tain tops, the Egyptian pyramids, the tip of a pencil, and the ears of a horse.

Mysterious Experiences. Some very unusual encounters with St. Elmo's fire were described in detail by a certain Dr. Stade of the Brocken Observatory, Germany.

About ten years earlier, in 1888, an equivalent collection of lights and corona discharges became visible at the site of another observatory on the Sonnblick, in Austria.

The following occurred on March 29, 1897 and February 16, 1898. Both times, a wet snow was falling in a thick fog; there was no lightning and no thunder:

On the evening of February 16, at about 9 p.m., St. Elmo appeared as an intense reddish white flame on the lightning conductor on top of the observatory. Short rows of light also became conspicuous on the crystals of frost that covered the corners of the roof. Then, the glow became visible on the hair, the beards, and even the clothing of the observers. One participant was able to make the light appear on the tips of his fingers. Everything around was alive with the cold electrical fire.

Finally, the lights disappeared altogether only to return a few minutes later. This time, the illumination was a pale violet and not nearly as bright.

On the evening of March 29, a similar
(Continued on page 97)

Further Reading

- "Nature's Electricity," by C.K. Adams, Tab Books, Blue Ridge Summit, PA 1987.
- "What Is Saint Elmo's Fire?" by C. Frazer, *Popular Mechanics*, July 1929, pp. 98-103.
- "Light and Electricity in the Atmosphere," by H. Hellman, Holiday House, New York, 1968.
- "Saint Elmo's Fire," by C.F. Talman, *The American Mercury*, January 1936, pp. 100-102.

These two circuits will let you check out the extent of electric fields permeating the average household, mostly originating from the AC line. Some of the things worth checking out are fluorescent lights, TV screens, appliance cords, power outlets, and electric blankets.

The circuits are not intended to be practical devices for tracing AC wiring in walls, however. Although both circuits will register strong indications when brought in proximity to appliance cords, wiring that is buried in walls is easily masked by the surface material (we'll have more to say about that later).

Still, both circuits are worth building—if only for their curiosity value. The simpler of the two lets you listen-in to power-line hum on a pair of headphones, while the other circuit uses a meter to indicate the source of the hum.

A Simple Hum Detector. Figure 1 shows a schematic diagram of the simpler of the two circuits, which consists of nothing more than a Junction Field-Effect Transistor (JFET), Q1, which is connected in series with a battery and a headphone jack, J1. The circuit is best built on a small scrap of perforated board, with the gate lead of the JFET close to one end. No on/off switch is needed since the battery is disconnected when the headphones are unplugged, and the circuit draws only about 3–5 mA of current when in use.

Without the optional ground, the probe will respond to both live and grounded objects, since your body will be picking up a certain amount of hum. If the circuit is grounded, the probe will become silent when moved close to a grounded object. Thus it can easily distinguish between correctly grounded 3-wire (e.g., a toaster) and 2-wire appliances.

Running the probe along the outside of a power cord will quickly indicate whether the cord is plugged into a live socket. In addition, you can actually pick the active lead itself. Wiring buried inside a wall is a little trickier. Often the conductivity of the wall material masks the exact location. It is not unusual for the hum to be spread over a general area of a little over a foot and a half in width.

Now let's look a little more closely at the circuit's operation. With the gate of Q1 left floating, the gate-source voltage is about zero due to leakage of the gate-source junction and surface leakage on the board between the gate and source wiring. (The source wiring acts as a guard or shield between the gate wiring and the rest of the voltages in the circuit.)

With a gate-source voltage of zero, Q1's current is at its maximum. The impedance of the gate circuit is very high,

Build An Experimental AC Hum Sniffer

BY STEVE PAYOR

In this article, we present two simple circuits for sniffing out AC hum. Both can be built using parts from your junkbox and can be quickly assembled.

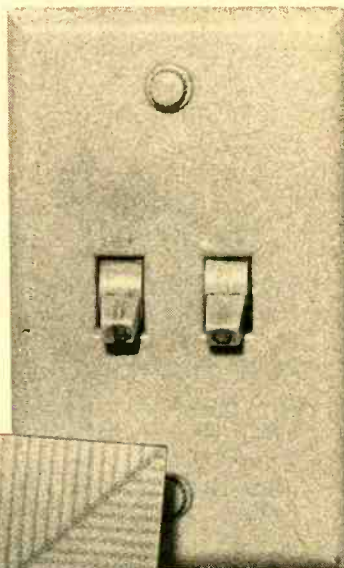

This story first appeared in *Silicon Chip*, Australia (July, 1989); reprinted with permission.

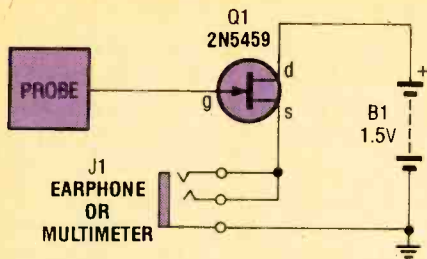

Fig. 1. This simple hum-detector circuit, consisting of a JFET that's connected in series with a battery and a pair of headphones, is by far the simplest of the two circuits presented in this article.

so the electric field from nearby 117-volt, 60-Hz wiring induces a signal of several volts into the gate of Q1. JFET Q1, being an N-channel device, is held or turned off by negative voltages (somewhere between -2 and -8 volts for the 2N5459); positive voltages can't turn it on any more than it already is, and voltages above $+0.6$ volt are clipped by the diode action of Q1's gate-source junction.

Because of that, a 10-volt peak-to-peak (p-p) signal will cause the gate voltage to swing from about 0 to -10 volts, giving a net negative bias to the gate, thereby reducing current through the JFET.

Try this simple experiment: Plug a multimeter into the headphone socket and note the zero-signal current. Now bring a 60-Hz source near the JFET (your finger will do) and watch the average DC current decrease as the signal increases.

Now back to our buried wiring problem. You could try mapping out the field strength on the wall, using the multimeter instead of the headphones to get quantitative measurements. With enough readings, a contour map could be plotted and the contours would indicate the most likely location of the buried wiring.

There is, however, a way to get a more accurate indication: Two detectors placed symmetrically on either side of the wiring will both pick up the same amount of hum, but if one is a little closer than the other, the balance will shift. A pair of detectors—each having a meter to measure hum intensity—should, in theory, enable you to zero-in on the buried wiring by noting the difference between the two detectors.

That last point indicates that a differential detector might be in order.

Differential AC Hum Sniffer. The schematic diagram for a Differential AC Hum Sniffer is shown in Fig. 2. In that

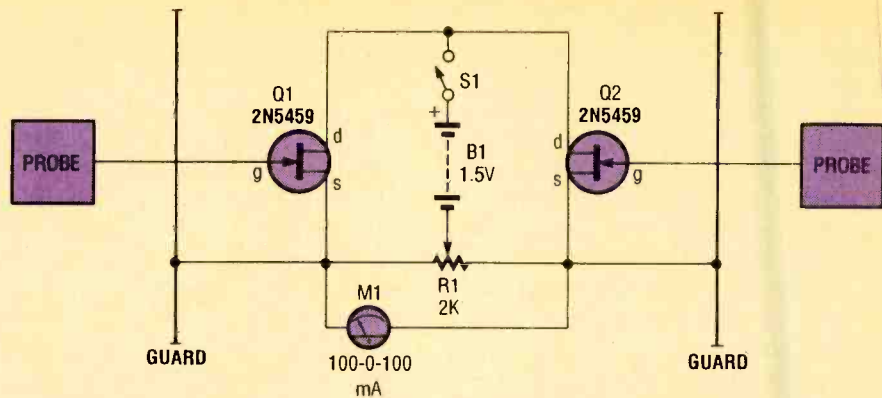

Fig. 2. The Differential AC Hum Sniffer can be considered as a dual version of the simple circuit shown in Fig. 1. In the differential version, if one probe picks up more hum than the other, the current through its associated JFET is reduced and the meter needle swings in the direction of the hum.

figure, a 2000-ohm trimmer potentiometer is used to set the initial balance between the zero-signal JFET resistances. If both probes pick up the same amount of hum, then both JFETs will turn off by approximately equal amounts and the meter needle will remain centered.

If one probe picks up more hum than the other, the current through its associated JFET will be reduced and the meter is wired so that the needle swings in the direction of the probe receiving the most hum. Thus the needle actually points to the source of the hum.

The layout of the Differential AC Hum Sniffer is very important to the operation of the circuit; symmetry of capacitance must be maintained and DC leakage currents must be controlled with guards.

Construction. A foil pattern for the Differential AC Hum Sniffer's printed-circuit board is shown in Fig. 3. Because the circuit is composed of junkbox parts, the pattern is designed to accommodate a variety of components. So dig deep into your junkbox and see what you can press into service.

Figure 4 is the parts-placement diagram for the printed-circuit pattern shown in Fig. 3. The board will accommodate a center-zero tuning meter (using the lowest two holes). Edge meters can be fitted to the middle two holes; while the upper holes will accommodate an MU45-style unit, which can be bolted directly to the board. Suitable meter sensitivities range from $\pm 50 \mu\text{A}$ to $\pm 250 \mu\text{A}$ full-scale (optimum is about $\pm 100 \mu\text{A}$).

Don't worry about which way around the positive (+) and negative (-) connections are arranged—the printed-circuit board has four pads marked B/A

(on the left, as viewed from the foil side of the board) and A/B (on the right side), which effectively form a double-pole, double-throw (DPDT) switch to reverse the meter connections if it happens to swing the wrong way. Start by connecting the two pads labeled B to the meter. If the meter subsequently swings backwards, disconnect the meter from the two B pads and connect the meter to the two A pads instead.

Type 2N5459 N-channel JFETs are recommended for use in this circuit, but that's not written in stone; lower-current units, such as the 2N5458 or 2N5457, can be used in the circuit by increasing the value of R1 to 5000 ohms and using a lower current meter (e.g., $\pm 50 \mu\text{A}$). P-channel JFETs, such as the 2N5460, can also be used by simply reversing the polarity of the battery and soldering the meter to the two A pads on the board. Note that the pin connections for P-channel JFETs are different and the leads will have to be bent so that they fit the board correctly.

When it comes to switch S1, either a toggle (SPST, SPDT, or DPDT) or a slide switch can be used. In addition, optional solder pads are provided so that moving the lever or slider of the switch up will turn the circuit either on or off, as you please.

Any trimmer potentiometer (either a horizontal or a vertical type) having a value ranging from 2000 to 5000 ohms can be used; those with a plastic knob or thumbwheel are preferred. A 5000- or 10,000-ohm potentiometer could also be used provided that a pair of 2200-ohm or 1000-ohm resistors are connected in parallel with it. A single-cell type AA battery holder was used to hold B1.

An insulating plastic handle, made from Plexiglas, can be secured to the

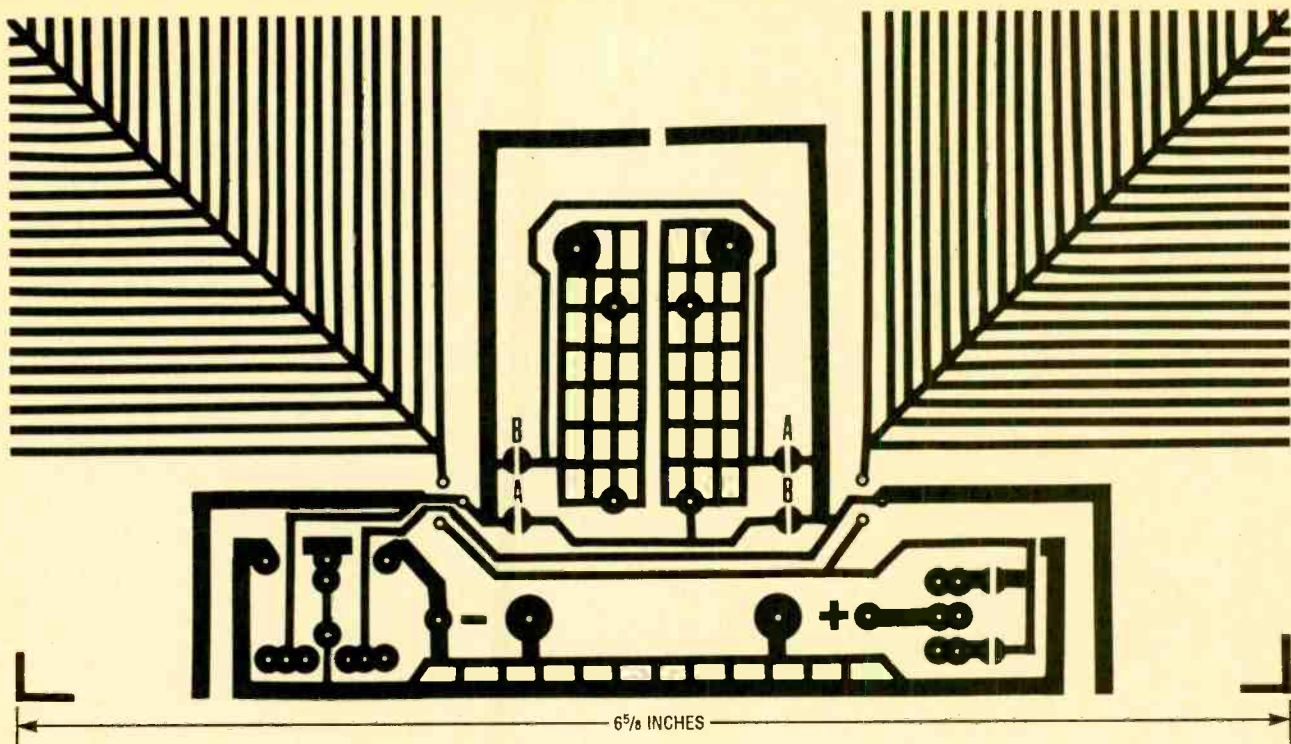

Fig. 3. The Differential AC Hum Sniffer was assembled on a printed-circuit board—the pattern for which is shown here—which is designed to accept three different meter types and virtually any size trimmer potentiometer.

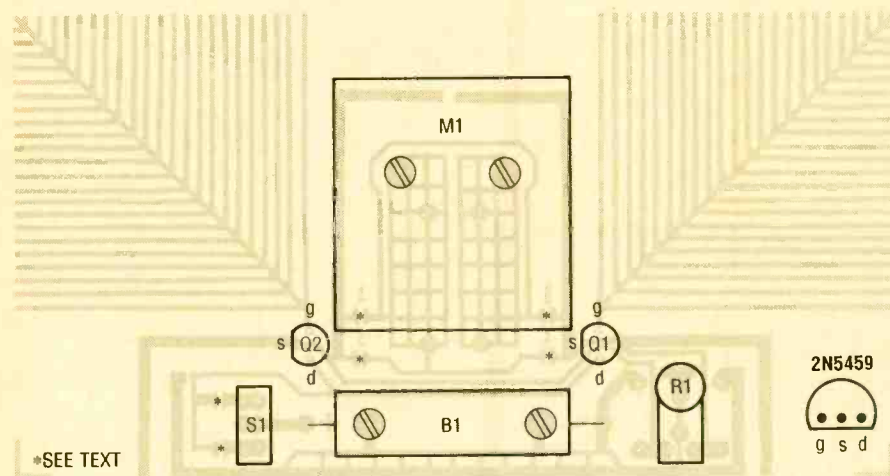

Fig. 4. Here's the parts-placement diagram for the Differential AC Hum Sniffer. When assembling the circuit don't forget to bridge the appropriate pads on the back of the board associated with the meter and the on/off switch (see text).

circuit board using the same screws and nuts that are used to secure the battery holder in place. If you have never bent Plexiglas before, don't be alarmed; it's really a simple process. Start by cutting a strip of Plexiglas to the desired width. Then heat the area where the bend is to be made to about 120°C (248°F). Heating of the Plexiglas strip can be accomplished using a hot-air gun (a heat-shrink gun, for example), an electric paint stripper, or even a hair dryer. You can also heat the Plexiglas by holding it over hot stove elements.

PARTS LIST FOR THE DIFFERENTIAL AC HUM DETECTOR

- Q1, Q2—2N5459 N-channel JFET
 - R1—2000-ohm trimmer potentiometer
 - B1—AA battery
 - M1—+/-100-mA, center-zero, D'Arsonval meter movement (see text)
 - S1—Miniature toggle or slide switch
- Printed-circuit board materials, enclosure (optional), Plexiglas, AA single-cell battery holder, wire, solder, hardware, etc.

You will also need two sheets of heat insulating material, such as heavy-gauge aluminum to mask all but the area of the intended bend from the heat. Caution: do not overheat the Plexiglas. Doing so will blister and discolor the surface, so be careful. Once the Plexiglas begins to soften, it can be molded into shape.

Whether you hold the unit by an insulated handle or by the meter case depends on what sort of field you are standing in. Sometimes you may need to ground yourself or even hold the unit by the battery to ground it as well. In short, you will have to experiment to determine the best way to hold the unit for a given situation.

Performance and Limitations. The Differential AC Hum Sniffer may give misleading readings when overloaded. Too strong a signal will cut off both JFETs, so keep the signal strength within reasonable limits by varying the way you hold it. In most cases, holding the meter case between outstretched finger tips, with no grounding, will give the best results.

Appliance cords will register at a distance of 4 inches or more, while fluorescent lights will register at 8–12 inches. Wiring in walls may be masked by metal conduits, metal plates in the wall or door frames, or uneven conductivity in

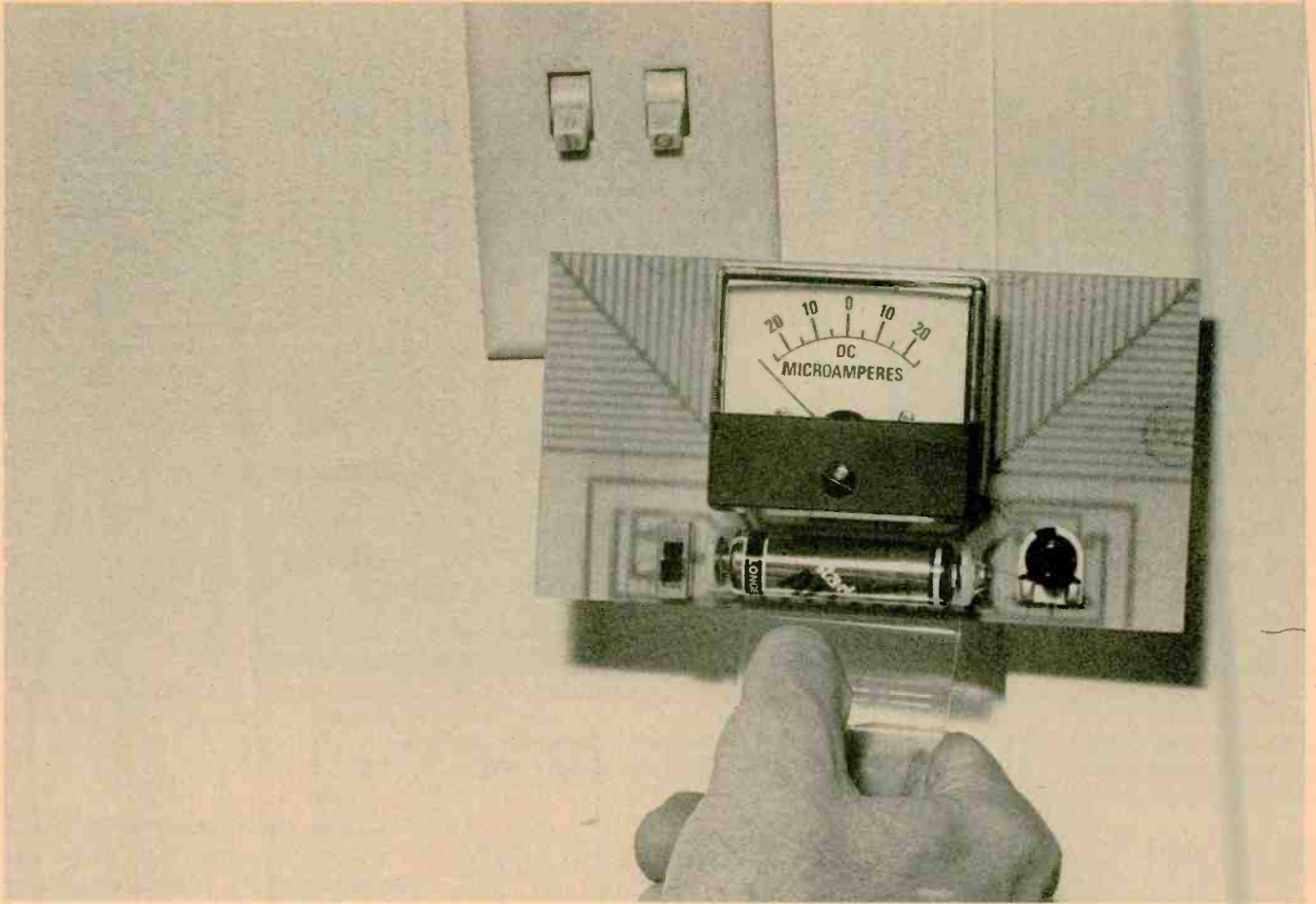

The Differential AC Hum Sniffer uses a meter to indicate the direction of the hum source. Note that misleading results will occur if the JFET's are overloaded by strong hum fields. In most cases, holding the meter case between outstretched finger tips will give the best results.

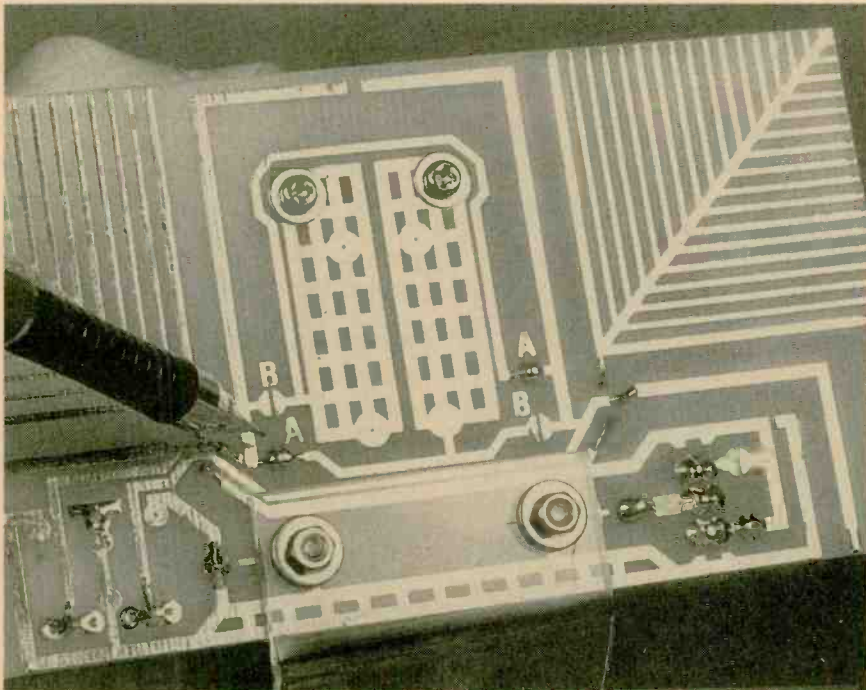

When assembling the detector, don't forget to bridge the appropriate pads on the foil side of the board. Start by bridging the B pads. If the meter swings the wrong way, desolder them and bridge the A pads instead. You must also bridge one set of pads associated with S1.

the wall material or surface coating. For those reasons, the unit should only be used to confirm the presence of AC wiring, not its absence.

Static charges on surfaces may also present a problem in dry areas. Try waving a plastic bag or pen (with plastic housing) near the electrodes. Even if those objects have just been sitting around, picking them up will probably charge them to several thousand volts.

The RC time constant of the JFET's gate circuit is determined by the board and junction leakage, and is on the order of several seconds. That means that you should move the detector very slowly when in the presence of large accumulations of static energy. Some improvement can be obtained by placing a resistor between the gate and source of each JFET; unfortunately, to maintain full sensitivity at 60 Hz, the resistor value needs to be around 2–10 gigohms. That's why we elected to use the board leakage instead.

It will be necessary to minimize the leakage by removing the solder flux around the gate connections of the JFET's (Q1 and Q2) by cleaning the board with a cotton swab moistened with methylated spirits. ■

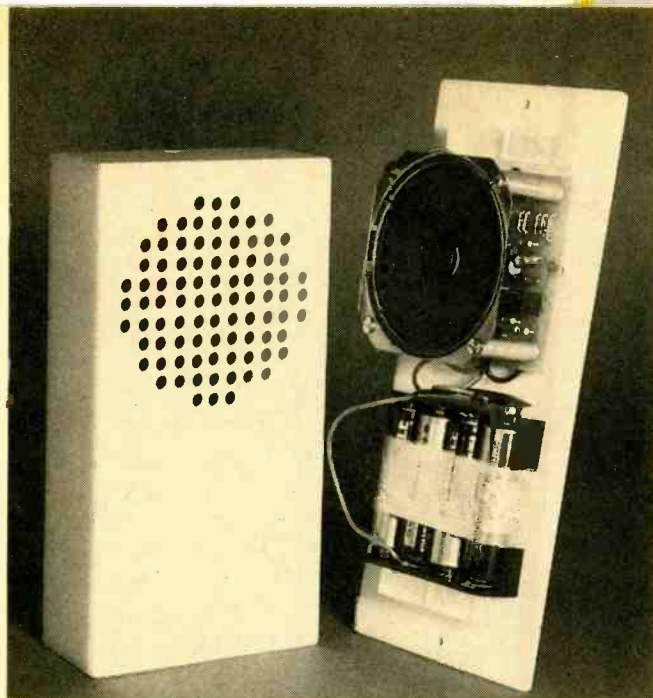

Build a MUSIC BOX DOORBELL

BY WALTER W. SCHOPP

This music box doorbell plays a different, cheerful tune each time that company comes calling.

In the beginning, bare knuckles were used to rap on the door to announce your presence. It wasn't too long afterward that polished, brass door knockers came into vogue. That natural evolution continued; polished, brass door knockers were replaced by door bells and buzzers, which were followed by fancy chimes. Now there is music to announce visitors at your door.

Musical doorbells are certainly not new and many a variation on that theme have appeared in various publications over the past few years. Some of the models had a selection of tunes, but most had to be manually switched to change the tune. Other models remained on in the standby mode making battery life short and battery costs intolerable. However, the *Music Box Doorbell* described in this article overcomes those problems.

In addition to surmounting the above shortcomings, this musical annunciator is adaptable to homes already wired with a doorbell transformer, and it is also well suited to new installations that can be wired without a transformer. It can be easily adjusted to emulate a piano, organ, or mandolin.

What's more, it is physically small enough to build into a discarded doorbell chime case, or built into a small metal or plastic case. It plays 12 different tunes. Each time the button is pressed, one tune is played to completion. At the end of each song, the unit switches off and draws only microamps of standby battery current.

How It Works. A schematic diagram for the Music Box Doorbell is shown in

Fig. 1. The circuit is a rather simple one, consisting of four integrated circuits—U1, a PS2501-1NEC optocoupler; U2, a 386 low-voltage audio power amplifier; U3, a 555 oscillator/timer; and U4, a UM3482A3 melody synthesizer—and a few support components.

The circuit has two sets of inputs: One input, the C and D terminals, accepts an 8- to 15-volt AC supply voltage (such as furnished by a doorbell transformer from an existing bell or chime installation). The other input, terminals A and B, is used for a normally-open pushbutton switch and can be used for new installations. (Incidentally, the A and B inputs might be pressed into service to be used with a back- or sidedoor doorbell switch.)

Referring to terminals C and D, AC voltage supplied through the doorbell transformer is rectified by a full-wave bridge consisting of D1 to D4, with the resulting DC voltage appearing across R2 (a 10k resistor). The DC voltage across R2 forward biases Q1, causing it to turn on. With Q1 turned on, six volts (the total of B1 and B2 in series) is applied to the rest of the circuit thereby activating it.

Battery voltage can also be applied directly to the circuit by placing a normally-open pushbutton switch across terminals A and B. If the doorbell is to be used with a pushbutton switch only, the components D1–D4, R1, R2, R16, and Q1 can be omitted.

When power is applied to the circuit (via transistor Q1 or the pushbutton switch), a negative-going spike (generated as a result of C6 initially acting as a short) is applied to U3's trigger input at

pin 2, activating it. Integrated circuit U3 is used as a latch since once it is turned on, there is no timing resistor to slowly charge C2 and turn it off. Integrated circuit U3 remains on until transistor Q2 turns on, causing C2 to charge and the timer circuit to turn off.

When U3 is turned on, a positive output voltage (at pin 3) is applied to the base of Q3, turning it on, which in turn, energizes relay K1. About 1-volt (from the 6-volt battery source) is dropped across R3, reducing the supplied voltage to 5-volts to accommodate the 5-volt relay used in the circuit. When the relay contacts close, power from the battery pack is applied to U2 and U4.

The battery voltage is applied to a voltage-divider network composed of R4 and R5, which reduces the 6-volt supply to around 3 volts (the voltage level required by U4). The reduced voltage is applied to pins 2 and 16 of U4. For the chip to remember which song is next on the agenda, a 1.5-volt power source must be maintained at pin 3 of U4 at all times. The current drain for that is in the microamp range.

The melody is initiated by applying a positive spike to pin 2 of U4. The spike is generated when the power is applied to C4 and R11. The tempo, or speed of the tune is established by components R9, R10, and C7. The tempo can be slowed by increasing the value of R9 or C7. The timbre of the tone can also be changed to emulate piano, organ, or mandolin sounds. The timbre can be changed by adjusting R12.

At the end of each tune, pin 1 (which will not accept much loading) of U4 goes positive. By using a high value re-

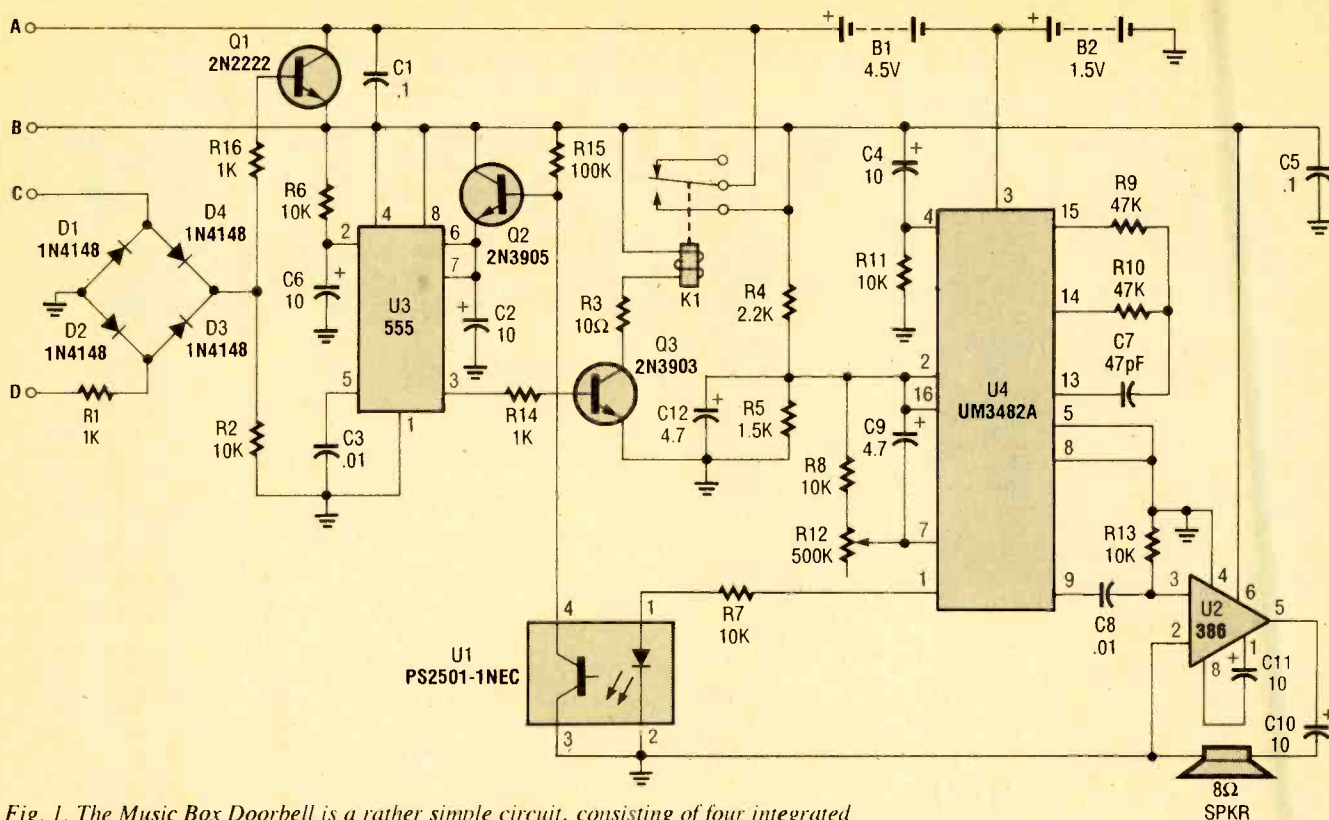

Fig. 1. The Music Box Doorbell is a rather simple circuit, consisting of four integrated circuits—U1, a PS2501-1NEC optocoupler; U2, a 386 low-voltage audio power amplifier; U3, a 555 oscillator/timer; and U4, a UM3482A3 melody synthesizer—and a few support components.

sistor, R7 and an optocoupler, U1, the end of tune voltage is used to drop out the relay by turning on Q2.

The output of U4 at pin 9 is coupled to U2—the low-voltage audio-power amplifier—via C8. Capacitor C11 has a direct effect on the volume of the final output. By reducing the value of C11, a lower volume can be achieved if the volume of the unit is too much for your area. The output of U5 at pin 5 is coupled to the speaker (SPKR1) through capacitor C10.

Construction. There is nothing particularly critical about the construction of the Music Box Doorbell. In fact, if so desired, the circuit could very easily be assembled on a section of perfboard using hard-wired solder connections. But, as most electronics hobbyists are well aware, a printed-circuit board greatly simplifies that task. The author's prototype unit was assembled on a small printed-circuit board, measuring about 2 5/8 inches square. The printed-circuit pattern used to produce the prototype unit is shown in Fig. 2.

After you obtain all the parts listed in the Parts List, construction can begin. Wherever specified, be sure to use miniature radial-lead electrolytic capaci-

tors; otherwise, it will be necessary to mount axial-lead units vertically. **Note:** The UM3482A3 (U4) is almost impossible to obtain through the normal hobbyist parts-supply houses, but is available from the source given in the Parts List. Figure 3 shows a parts-placement diagram corresponding to the pattern shown in Fig. 2.

Begin assembling the circuit by first installing IC sockets wherever IC's are indicated and then installing the two jumper connections near U4. Installing the sockets first allows them to be used as points of reference when trying to locate the proper positions for the rest of the circuit components.

PROGRAMMED TUNES

- American Patrol
- Rabbits
- My Darling Clementine
- Butterfly
- London Bridge is Falling Down
- Row, Row, Row Your Boat
- Are You Sleeping
- Happy Birthday
- Joy Symphony
- Home Sweet Home
- Wiegenlied
- Melody on Purple Bamboo

It is a good practice to get into the habit of installing (after the IC sockets and jumper connections) the passive components (resistors, capacitors, etc.) first, followed by the semiconductors (diodes, transistors, and IC's in that order), unless circumstances dictate otherwise. Handling things in that order reduces the likelihood of your destroying some expensive component due to excessive heat.

Once all the on-board components have been installed, check your work for common construction errors—cold solder joints, solder bridges, mis-oriented or incorrectly placed components, etc. Afterward, the battery holder, which houses both B1 and B2, must be prepared.

The battery holder used in the author's prototype unit is a four-"AA"-cell holder that places the cells installed in series. A length of hook-up wire was soldered to the tension spring at the negative terminal of the third cell (that lead is used to supply the 1.5 volts needed by pin 3 of U4); the other end of the wire is then connected to the appropriate pad on the printed-circuit board. The two other battery connections are then handled by a snap-on battery connector (the type used for 9-

PARTS LIST FOR THE MUSIC BOX DOORBELL

SEMICONDUCTORS

- U1—PS2501-INEC optocoupler with transistor output, integrated circuit
- U2—LM386-1 low-voltage, audio-power amplifier, integrated circuit
- U3—LM555CN oscillator/timer, integrated circuit
- U4—UM3482A melody synthesizer, integrated circuit
- Q1—2N2222 general-purpose NPN silicon transistor
- Q2—2N3905 general-purpose PNP silicon transistor
- Q3—2N3903 general-purpose NPN silicon transistor
- D1—D4—1N4148 general-purpose small-signal silicon diode

RESISTORS

(All resistors are 1/4-watt, 5% units, unless otherwise noted.)

- R1, R14, R16—1000-ohm
- R2, R6, R7, R8, R11, R13—10,000-ohm
- R3—10-ohm
- R4—2200-ohm
- R5—1500-ohm
- R9, R10—47,000-ohm
- R12—500,000-ohm miniature PC-mount potentiometer
- R15—100,000-ohm

CAPACITORS

- C1, C5—0.1- μ F, polyester
- C2, C4, C6, C10, C11—10- μ F, 25-WVDC, electrolytic
- C3, C8—.01- μ F, ceramic-disc
- C7—47-pF, ceramic-disc
- C9, C12—4.7- μ F, 25-WVDC, electrolytic

ADDITIONAL PARTS AND MATERIALS

- SPKR1—8-ohm, 2 1/2-inch speaker
- K1—HD1E-M-DC5V, 5-volt miniature PC-mount relay
- B1, B2—four "AA" batteries (see text)
- Printed-circuit materials, enclosure, battery holder and snap-on connector, wire, solder, hardware, etc.

Note: The UM3482A3 melody synthesizer (U4) is available for \$5.95 (postpaid) from Electronic Enterprises, 3305 Pestana Way, Livermore, CA 94550

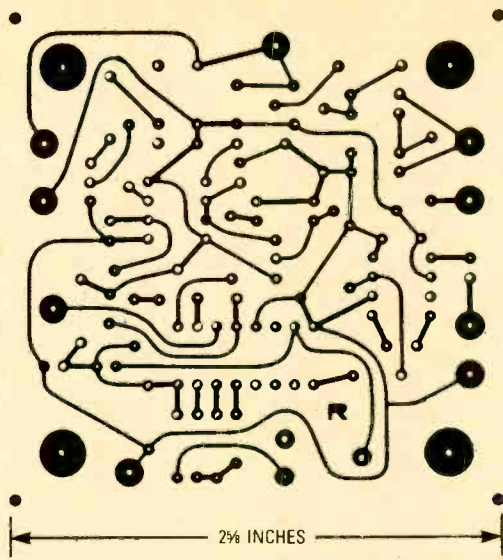

Fig. 2. The author's prototype unit was assembled on a small printed-circuit board, measuring about 2 5/8 inches square. The printed-circuit pattern used to produce that prototype unit is shown here.

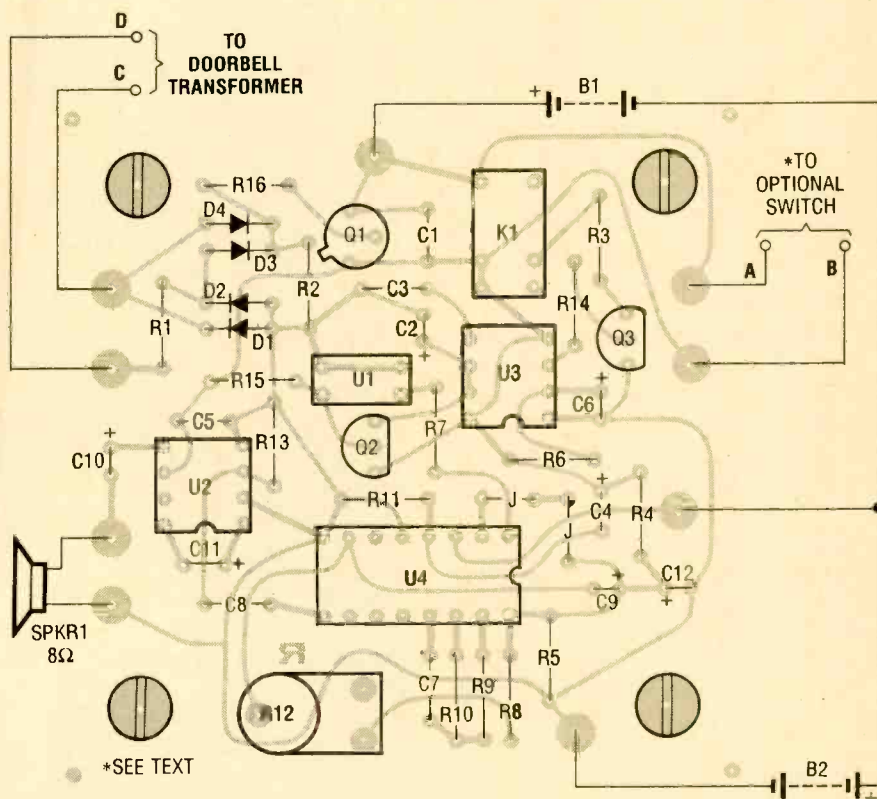

Fig. 3. This part-placement diagram corresponds to the pattern shown in Fig. 2. Because of tight space tolerances, it is recommended that miniature radial-lead capacitors be used wherever electrolytics are specified. If not, it will be necessary to mount the axial-lead units vertically.

volt transistor-radio batteries), which mates with the matching connector terminals on the battery holder.

Next, connect two lengths of hook-up wire to the speaker and the other ends of those wires to the points on the board that indicate the speaker connections. The author used a 2 1/2-inch, 8-ohm speaker in his prototype whose mounting holes match up with the mounting pads on the board. In the

prototype, the speaker was mounted (on 1-inch stand-offs) to the printed-circuit board.

For added convenience, you might want to connect both the A/B and C/D terminals to some sort of jack, thereby allowing you to plug into the set of inputs that best suits the installation.

The project's enclosure can be any

project box of sufficient size to accommodate the project and batteries. The prototype was housed in a homebrew enclosure made from opaque white 1/8-inch acrylic plastic sheeting. The sides, ends, and top piece were cut to size and glued together with acrylic cement.

(Continued on page 95)

The history of the laser industry began in 1960. Theodore Maiman invented the first laser (which stands for *Light Amplification by Stimulated Emission of Radiation*) by placing a simple photographic flash lamp beside a cylindrical ruby-crystal rod. When the lamp was fired, the rod gave off light of its own. The light that developed within the ruby rod had a variety of unique and useful characteristics.

In the years that followed Dr. Maiman's discovery, lasers have become an invaluable tool in commercial, industrial, and military applications. Commercial applications are seen every day in the form of bar-code scanners at supermarket-checkout stands, or in compact- and videodisc players. Industrial uses for lasers include cutting, welding, drilling, and marking of parts. The military has long used lasers to measure distance, designate and simulate targets, and for target ranging. Lasers are also being actively developed for use by the medical profession. This article will examine the common components found in every laser, then cover the operations and applications of the three most common designs.

Laser Light. True laser light has three very distinct and important properties. Those properties make lasers perfect for many critical uses.

Everyday "white" light is made up of all the wavelengths of the light spectrum. That can be seen when white light is sent through a prism. The prism separates the wavelengths by bending each wavelength at a slightly different angle. Laser light, however, contains only one predominant wavelength, depending on the material that is "lasing" (see Table 1). That single-wavelength phenomenon is known as *monochromaticity*.

Light spreads out as it travels away from its source. That is true for all types of light—even from lasers. The angle at which light spreads out is called the divergence (or the divergence angle). It is measured in radians. Lasers have an extremely low divergence, often less than .001 radian (1 milliradian). For example, a laser beam with .001 radian of divergence will spread out to 1 foot at 1000 feet from the laser, 2 feet at 2000 feet, and so on.

Ordinary light is incoherent. That is, light waves for each different wave-

length are not in phase. However, laser light is coherent. Ideally speaking, every light wave generated by a laser occurs in phase at every point in time. It is coherence that keeps divergence low, and makes lasers ideal for delivering concentrated energy.

Components. Every laser, regardless of its type and design, shares the same major segments. The most obvious of those is the lasing medium, which is the particular material that "lases," or produces laser light. There are four principle mediums: gas, solid, liquid, and semiconductor. Lasers are broken down into those four types.

Regardless of material type, atoms, ions, or molecules within the lasing material are excited by an external energy source. Under the right conditions, pho-

tons of light are liberated. The wavelength of light generated in the medium depends on the chosen material. Some materials can produce laser light in the visible portion of the spectrum, others in the infrared, and still others in the ultraviolet region.

In gas lasers, the lasing medium is a pure gas mixture such as argon, carbon dioxide, krypton, or helium-neon. Gases are pumped from storage tanks into a long cylindrical glass tube.

Solid-type lasers (not to be confused with semiconductor lasers) use a solid cylindrical crystal of artificial ruby, erbium, neodymium:yttrium-aluminum-garnet (Nd:YAG, or just YAG for short), or other less common types.

Liquid lasers, typically high-power devices, are a bit more exotic. They use a variety of organic dyes such as rho-

ALL ABOUT

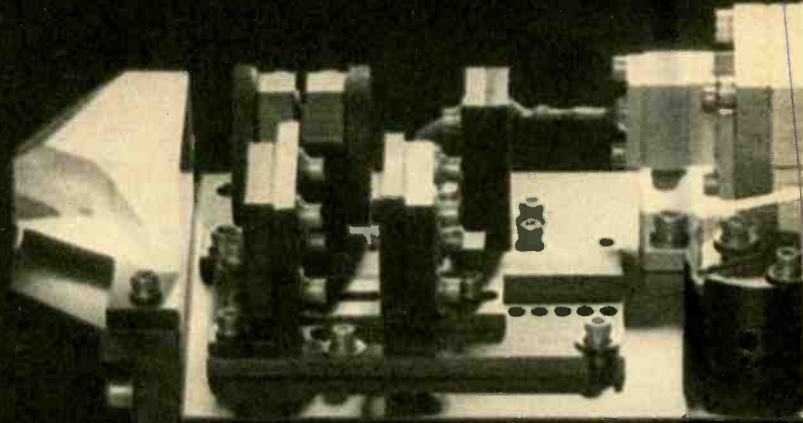

BY STEPHEN J. BIGELOW

Learn about the beams of light that are changing our lives, and explore the inner workings of the machines that produce them.

damine-B, rhodamine-6G, or sodium fluorescein.

Semiconductor materials like gallium arsenide, indium arsenide, or gallium antimonide are used to form laser diodes. They are used to drive very low-power devices like fiber-optic communication systems.

The lasing "driver" is another important segment. The lasing driver is the mechanism needed to excite the lasing medium. It imparts enough energy to the atoms, ions, or molecules of the material to support lasing. Driving the lasing material is also known as "pumping."

Laser diodes work much like ordinary LED's, so they only require a filtered DC source as a driver.

Crystals used in solid-type lasers do not conduct electricity, so bright light

sources are used to provide excitation. That technique is called "optical pumping" (see Fig. 1). A flashtube that generates only certain wavelengths of light is placed along a solid laser crystal. Nd:YAG and artificial ruby are two of the most common crystals used. A high-voltage DC power supply will ignite the lamp on command. A high-quality reflector positioned around the lamp will focus and concentrate all of the light energy into the crystal structure. Light energy from the lamp liberates photons of laser light in the crystal. Reflective coatings or mirrors at both ends of the crystal will contain the laser light and deliver a concentrated beam at the output end of the rod, which is only partially reflective. Solid lasers can also be pumped with the light energy from another laser beam.

Liquid, or "dye," lasers are pumped in much the same way as solid lasers. In one typical configuration, a thin capillary tube is filled with organic dye. A flashtube positioned along the capillary tube will light and stimulate the lasing molecules in the dye. Mirrors placed at each end of the capillary tube will direct the laser beam to the output. An alternate configuration uses another laser to excite a small jet stream of dye. Since the lasing of organic dyes generates several different wavelengths, an optical filter called a "Birefringent Element" is placed along the beam path to "tune" the laser output to the desired wavelength.

High-voltage DC power supplies usually provide the stimulation to drive gas lasers. In a gas laser, gasses such as carbon dioxide, argon, or helium-neon are circulated through a clear glass plasma tube (see Fig. 2). When a high DC potential is applied to electrodes inserted into each end of the tube, the atoms of gas absorb energy and become excited. After enough energy is absorbed by the gas (the process is almost instantaneous), the gas will become a plasma (which makes the term "gas laser" a misnomer to the technically pedantic). The plasma will glow intensely. Mirrors at each end of the plasma tube will direct the resulting laser light to the output.

Optics. Mirrors and lenses are two general optical components found in all lasers. Mirrors serve to direct a beam, and lenses are used to focus and regulate the beam diameter.

Every optical component must be held perfectly in position at all times. If a lens falls out of alignment, the beam may not deliver enough energy at the desired spot. If a mirror becomes misaligned, the path of the laser beam may wander randomly—possibly resulting in injury or damage. If either of the mirrors used at the two ends are out of alignment or at the wrong distance apart, chances are good that lasing will not take place at all. For those reasons, optical devices are usually held rigidly in place on adjustable mounts.

An optical "resonant cavity" is formed for laser light when mirrors are aligned perfectly parallel to each other at both ends of the lasing medium. The use of mirrors maximizes the excitation of the lasing medium by reflecting the laser light back and forth through the

LASERS

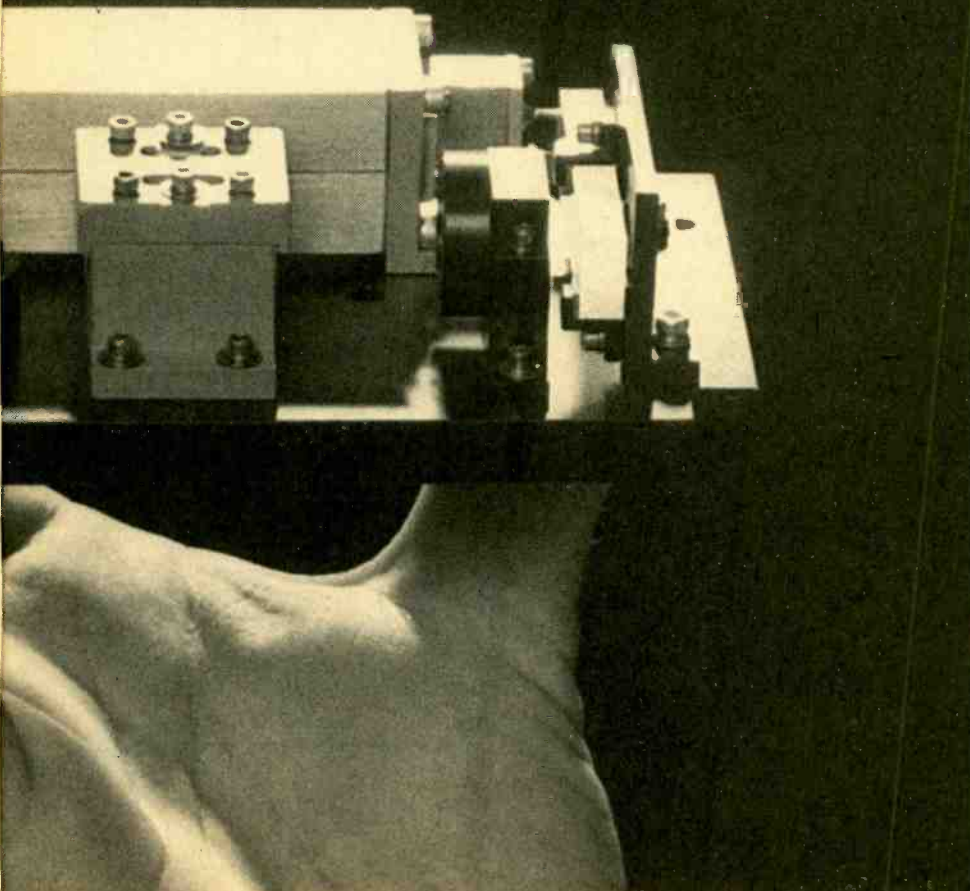

TABLE 1—
WAVELENGTHS GENERATED BY DIFFERENT LASING MATERIALS

Material	Type of Medium	Typical Wavelength(s)
Ionized Argon	Gas	488 nm (blue) and 514 nm (green)
Ionized Krypton	Gas	10,600 nm (infrared)
Helium Neon	Gas	632.8 nm (red)
Organic Dyes	Liquid	360-650 nm (most colors)
Erbium	Solid	1,612 nm (infrared)
Neodymium: glass	Solid	1,060 nm (infrared)
Neodymium: YAG	Solid	1,060 nm (infrared)
Ruby	Solid	694 nm (deep red)
Gallium Antimonide	Semiconductor	1,600 nm (infrared)
Gallium Arsenide	Semiconductor	850 nm (infrared)
Indium Arsenide	Semiconductor	3,200 nm (infrared)

medium as many times as possible before being emitted to the outside world. They also serve to create a standing wave that is phase coherent. Both curved and flat mirrors can be employed in typical laser systems. The size and shape of the mirrors used in a particular application depend on the size of the laser beam, and the distance between the mirrors.

There are normally at least two mirrors found in a laser—one at each end of the lasing material. The first is a “totally” reflective mirror that will reflect close to 100% of the light back into the lasing medium. The second, and perhaps the most important, is the output mirror. That mirror will not reflect all the lasers light back, only a certain percentage of it. The rest of the light will pass through it as the output beam.

Since mirrors can be designed in almost any shape, and their percentage of reflection can be controlled by the

proper choice of reflective coatings, it is possible to create 100%-reflective mirrors and output mirrors to suit any design of laser. Mirror coatings can also be chosen to suppress reflections of secondary (or unwanted) wavelengths.

CO₂ Lasers. Carbon dioxide lasers are efficient, high-power mechanisms that have proven to be very versatile in a wide variety of applications. They are capable of generating a range of continuous power anywhere from several watts to 10,000 watts and higher. If the output beam is pulsed, the peak beam power can be made to reach in excess of several million watts.

Normally, CO₂ lasers are about 10% to 12% efficient—that is, 10% to 12% of all the energy delivered to the laser is actually converted into a laser beam. That is considered fairly efficient for a laser. Efficiency ratings will improve as new heat-resistant materials are em-

ployed in future CO₂ designs. The lasing that takes place within the molecules of carbon dioxide liberate photons of laser light in the infrared region of the light spectrum at about 10,600 nm (*i.e.* nanometers, which is 10.6 microns). Like most lasers, divergence is very small, around 5 milliradians. Typical CO₂ lasers create beam widths anywhere from 2 to 150 mm, depending on the needed output power. The power range and beam characteristics of CO₂ lasers make them ideal for industrial duties such as welding, cutting, and drilling. In low-power situations, they have sparked interest as surgical instruments.

The power supply for a gas laser is not a terribly complex device (see Fig. 3), but it must be capable of handling several important functions to drive a laser properly. First, when a gas laser is initially turned on, a “breakdown” voltage greater than 3000 volts DC is needed to ionize the gas and create a plasma. A voltage-multiplier network made of diodes and capacitors can be used to achieve that starting voltage. Second, when the gas becomes a plasma, current begins to flow. The supply must be able to reduce its DC voltage output to prevent excessive current flow, yet still provide a stable operating voltage. In the design shown, that happens automatically when current begins to flow in the plasma. Direct current flow will effectively remove the voltage-multiplier capacitors (C3–C6) from the network, so the output voltage will drop back to the base voltage of the supply. Finally, a current-limiting resistor must be placed in series with the voltage output. That will stabilize the current flowing into the laser at some optimum value.

CO₂ Configurations. There are a number of different methods used to build CO₂ lasers. Each approach uses a slightly different technique to achieve a flow of gas in the laser tube.

The bellows-tube design (shown in Fig. 4A) is perhaps the most accepted general-purpose design ever developed. In that design, a “two-wall” tube is used. Cooling water, usually a mixture of water and ethylene glycol, is circulated into the tube in the outer jacket by means of a refrigerated circulator pump (also called a “chiller”). That cooling scheme is needed to carry away the tremendous heat generated by the lasing of the gas in the inner tube.

The CO₂ gas mixture enters the inner

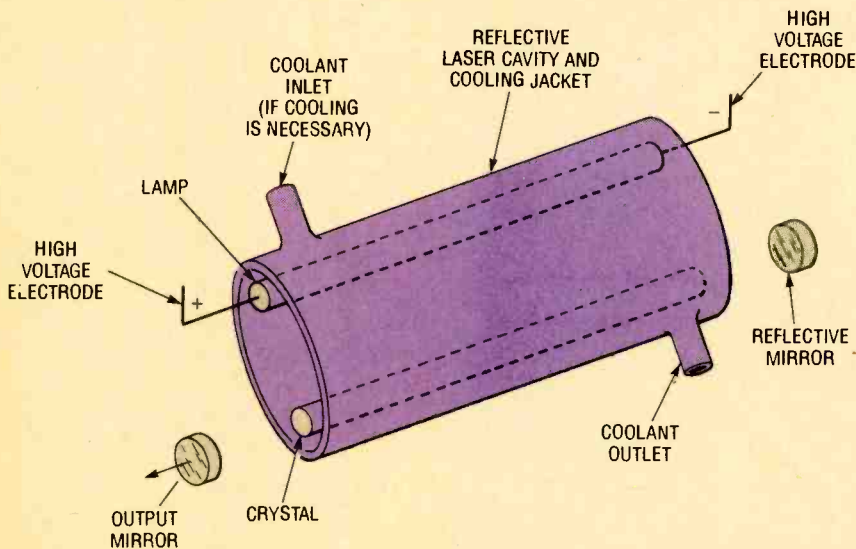

Fig. 1. This is a rough diagram of a solid-type laser cavity. Its cross section is an ellipse with the lamp and crystal rod placed at the foci. Sometimes coolant is forced to flow through the cavity to keep the crystal rod from cracking.

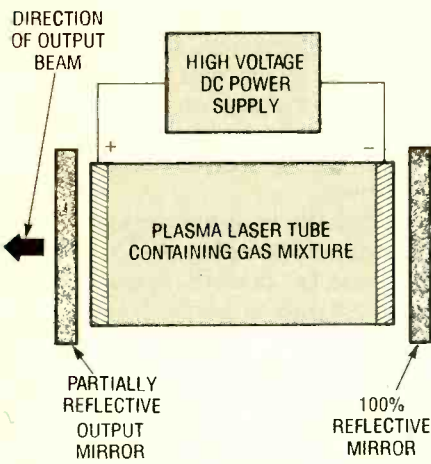

Fig. 2. This is the basic arrangement of a gas-type laser driver. Oftentimes, the mirrors are attached right to the surface of the tube.

tube at one end. A strong vacuum draws the gas through the tube to the gas outlet at the other end. High voltage is provided by a DC power supply connected at each end of the inner tube. When the DC supply is activated, the gas flowing through the inner tube between the anode and cathode ionizes into a current-carrying plasma. The far-infrared light generated by the excitation is contained by the reflective mirror at one end of the tube assembly, and the output mirror at the other end. The coating on the output mirror will allow a portion of the beam to escape to form the output beam. Both mirrors are often fixed on adjustable optical mounts to allow for occasional realignment of the system. Exhausted CO₂ is then harmlessly vented through the vacuum pump into the atmosphere.

A closed-tube CO₂ laser is not quite

as common as the bellows tube. In that design, a certain limited volume of carbon-dioxide gas is sealed inside a glass cylinder (see Fig. 4B). Each end of the tube is sealed with an angled piece of glass called a "Brewster window." The entire tube assembly is positioned between a reflective and output mirror. The advantage of the closed-tube design is portability and ease of use. It does not require an external gas supply. The main disadvantage of the design is its limited useful life. As the limited gas supply lases, the power output will gradually fall until the gas supply is exhausted. To overcome that limitation, the tube will often have a fill port that will allow the tube to be "recharged," or filled with fresh gas.

Closed-tube lasers are usually pumped with either high-voltage DC or RF (radio-frequency) energy. DC excitation for a closed-tube laser is identical to that for a bellows tube design. Unfortunately, if DC is used to pump a closed tube, a sophisticated cooling system has to be used.

However, the energy from an RF source may be coupled through a matching transformer chosen to permit maximum power transfer, so the RF energy will be absorbed readily by the plasma with very little rise in temperature. That means that a separate cooling system may not be needed. The disadvantage here is that an RF driver with proper matching circuitry is more complex than a regular high-voltage supply.

Other configurations that should be mentioned include the fast-flow and tubular-flow designs. The fast flow CO₂ laser is very similar in many respects to

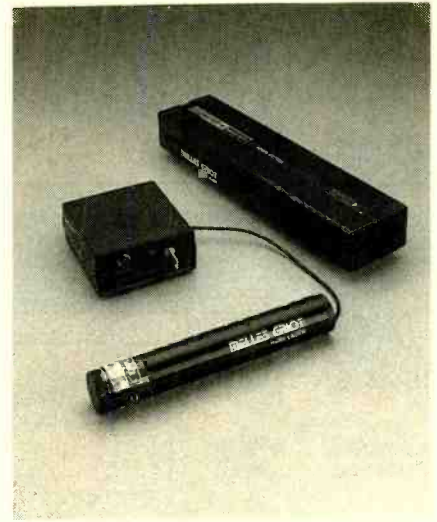

Here are two typical He-Ne lasers. The model with the separate power supply (front) is a type favored by most high school labs. It can be used for basic demonstrations of laser light's attributes. The other laser is designed to fit right on a rail mount to help align optical assemblies. (Photo provided through the courtesy of Melles Griot Inc., Irvine, California.)

the bellows tube. However, the actual laser tube is much shorter, and the CO₂ gas is circulated at speeds near the speed of sound. The gas is not cooled in the laser tube, but is cooled through a series of heat exchangers in the high-velocity blower network. The cooling system is so efficient, 200 watts or more per meter of laser-tube length can be extracted.

A tubular-flow laser circulates gas at high speed around the inside of the tube. The gas moves through a heat exchanger mounted within the tube itself. That cooling scheme is very efficient, and tubular-flow CO₂ lasers can produce more output power than any other CO₂ design for the same length of laser tube. DC excitation is usually used with tubular-flow lasers. A series of reflective mirrors bend the laser beam back and forth along the length of the laser tube prior to the output mirror. That maximizes the effective length of the laser beam inside the tube, further improving output power. The disadvantage of the design is the mirror network, which is extremely delicate and difficult to align.

CO₂ Applications. Carbon dioxide lasers are the most versatile tools ever developed. Their wide-ranging power levels have made them tremendously useful for industrial applications. The wavelength of infrared energy gener-

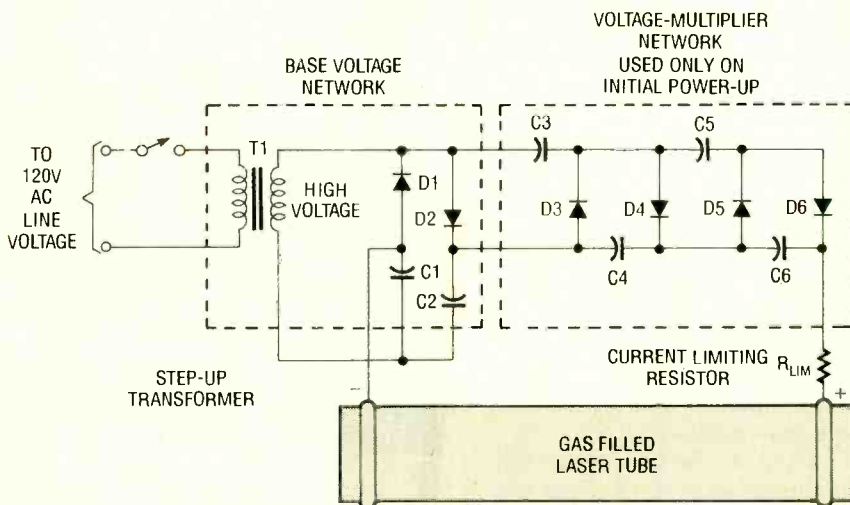

Fig. 3. This is a simple gas-laser power supply. The voltage-multiplier section only operates long enough to ionize the gas into conduction.

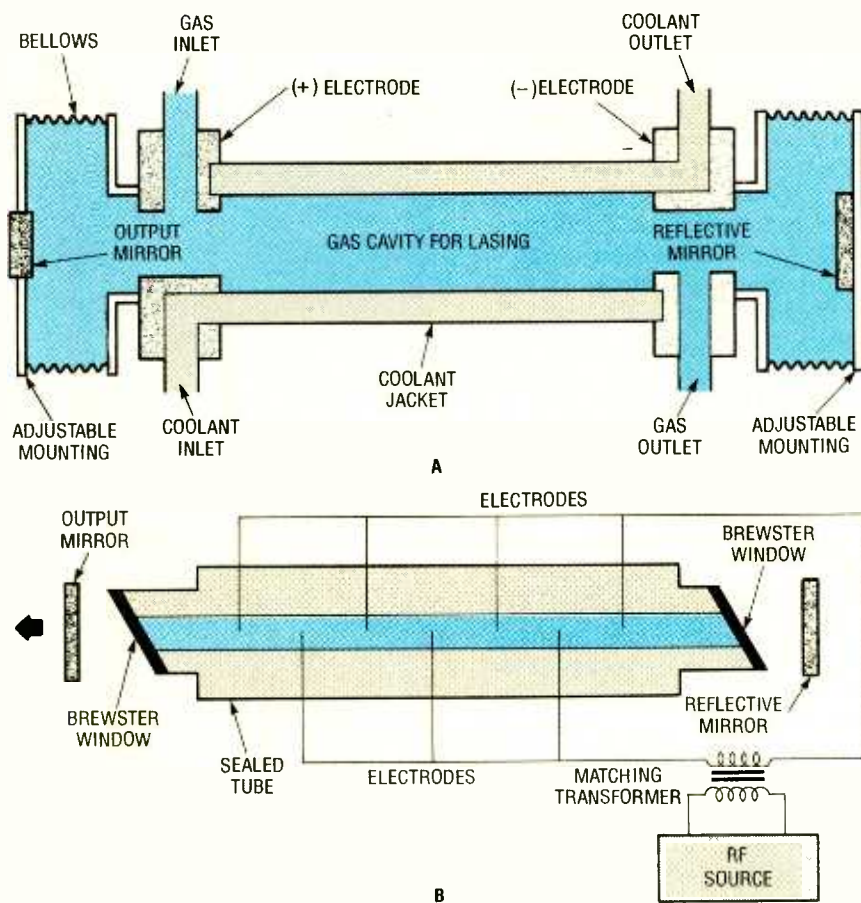

Fig. 4. Here we show you the basic outline of a bellows-tube (A) and a closed-tube (B) CO₂ laser. The main difference between the two is that the mirrors on the bellows-tube design are a part of the gas cavity.

ated by CO₂ lasers is readily absorbed by many different metals and plastics. That makes CO₂ lasers ideal for heat-treating and hardening objects that are small or irregularly shaped. Laser welding with high-power CO₂ devices has gained wide acceptance in heavy industry. Automobile manufacturers have used lasers in key points along their assembly lines for years. Mild steel, stainless steel, titanium, and aluminum are just some of the metals that can be welded with such lasers. CO₂ lasers can be made to cut incredibly intricate patterns into a variety of metals and non-metals. Non-metal materials like plastics and ceramics can be drilled handily with a CO₂ laser. They can drill metals, but the high-power pulses from solid-type lasers are usually more effective at punching holes in metals. Certain configurations of the CO₂ laser are excellent for making permanent marks on non-metals. New industrial applications are constantly being perfected.

Medical uses for CO₂ lasers are limited at this time to making surgical incisions. Living tissue absorbs the wave-

length generated by CO₂ lasers, causing cells to vaporize. Medical lasers of up to 100 watts are now commercially available. The very small spot size that is possible allows medical lasers to be used in delicate, extremely precise applications.

Helium-Neon Lasers. Helium-neon lasers are currently the most common type produced. They are commercially available with power outputs up to just 10 milliwatts, although some devices can be found up to 50 milliwatts in power. It is the low-power output that makes He-Ne lasers so safe and so popular among schools and hobbyists. The optimum wavelength generated by He-Ne lasers is 632.8 nm, which is visible red light. They are used whenever extremely low divergence (usually below 2 milliradians) and excellent coherence are important.

The mixture of helium and neon gases is generally about 10:1, but that ratio varies as the tube ages. The He-Ne laser is thought to be an atomic laser since it is the neon atom that actually lases. The

helium atoms just support the lasing process by absorbing the energy from the pumping source and transferring that energy to the neon atoms. The helium and neon atoms do not combine to form a molecule such as in a carbon dioxide laser.

Since a He-Ne laser is a gas laser, its most common DC pumping source is a high-voltage DC power supply similar to the circuit used to drive a CO₂ laser. The major difference is the physical size of the supply. A He-Ne laser power supply does not need to produce as much voltage or current as a CO₂ power supply. That results in a much smaller supply package.

A He-Ne laser actually produces 3 wavelengths of light during excitation: two minor wavelengths at 3.391 microns and 1.152 microns (both far infrared), and the major wavelength at 632.8 nm. It is necessary to suppress the infrared wavelengths through the use of special mirror coatings that inhibit infrared light. An infrared filter can also be used to suppress any infrared wavelengths in higher-power units.

He-Ne Configurations. The most common configuration of a helium-neon laser uses a large glass tube containing an ample supply of helium and neon (see fig. 5). The gas moves from the supply tube into a thin glass capillary tube connected to it (see Fig. 5). The narrow capillary tube can be up to 100 centimeters long, and allows a high density of current along its length. The anode of the high-voltage DC power supply is usually inserted into the capil-

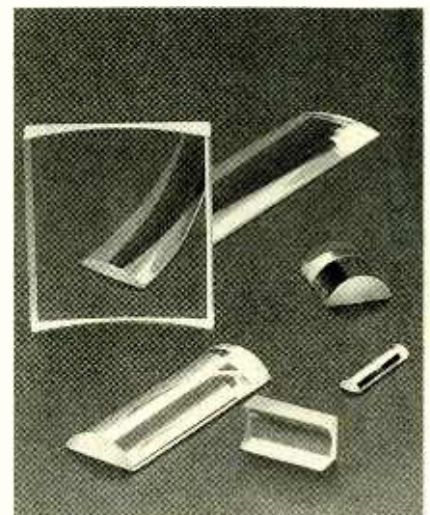

This is a photo of assorted optical lenses. They must be made of high-grade materials, which is why they appear so clear. (Photo provided through the courtesy of Melles Griot Inc.)

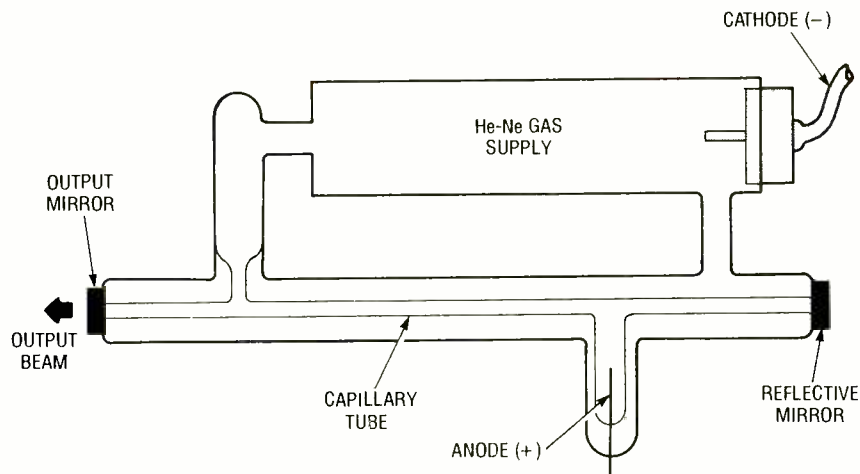

Fig. 5. This is the basic structure of a helium-neon gas laser. The capillary tube acts as the actual laser cavity and the rest of the tube is the gas supply.

lary tube, while the cathode is often positioned in the gas-supply tube. A reflective mirror is placed at one end of the tube and an output mirror is placed at the other end. This type of small, low-power laser tube can sustain more than 15,000 hours of service.

An alternate configuration is sometimes used with higher-power He-Ne lasers, or if the output beam needs to be polarized. Each end of the capillary tube is cut and sealed-off with a Brewster window. The mirrors are then

mounted externally to the laser tube on fixed mounting assemblies. The assemblies can be adjusted to align the mirrors. Alignment can be simplified by using a slightly curved reflective mirror instead of a flat mirror.

Helium-neon lasers are almost always "ambient-air cooled." That means that the laser tube should stay cool as long as free standing air is available around it. No forced-air or liquid-jacket cooling should be needed to control the laser's temperature..

Laser Glossary

Beam profile—The pattern or shape of a laser beam. A common beam profile is circular, but other patterns such as squares or multiple points can also be generated.

Brewster windows—Polished glass windows used to seal the ends of gas laser capillary tubes.

Coherent waves—Light waves that travel together in phase.

CW or Continuous-wave laser—A laser that is being excited 100% of the time. Such a laser produces a steady output beam.

Diffuse reflection—The tendency of light to scatter randomly when it strikes an object. Photons of laser light that reflect diffusely from an object may carry enough energy to be dangerous.

Divergence—The dispersal of light waves as they travel away from their source.

Irradiance—The optical power density over any given surface area often measured in watts per cm. sq.

L.A.S.E.R.—Light Amplification by Stimulated Emission of Radiation. A generic acronym describing a device that produces a well-defined wavelength of coherent light with low divergence.

Lasing—The act of generating a laser

beam. When a material is excited into generating laser light, that material is said to "lase."

Monochromatic—Lasers that generate light at only one primary (i.e. monochromatic) wavelength of the electromagnetic spectrum.

Nd:YAG—Neodymium yttrium, aluminum, garnet. A common solid lasing medium used in moderate- to high-power lasers.

Optics—All lenses, prisms, or mirrors found in a laser system.

Optics Bench—Also called a "laser rail" A firm metal framework upon which the lasing medium and all optics are mounted.

Plasma—A term used with gas lasers to describe the ionized state of lasing gases in the laser tube after high voltage is applied.

Pumping—The act of imparting energy to a lasing medium in order to stimulate lasing. A laser may be pumped electrically, optically, or chemically.

Retina—The rear surface of the eye containing light-sensitive nerves. The nerves are connected to the brain to form vision. The retina is the part of the human body most easily damaged by laser light.

He-Ne Applications. Low-power helium-neon lasers have been extensively used in an array of alignment and construction applications. They produce a narrow, visible beam of light that remains perfectly straight over long distances.

A He-Ne laser can project a straight beam that is commonly used as a reference line to align underground pipes. It can also be used to level a large surface area quickly and easily. A laser mount is leveled and its beam is made to rotate through complete circles. That makes a perfectly level light plane. Contractors often use that type of system to install hanging ceilings. It can also be used to align entire walls.

Outdoors, this type of system is often used for grading a large surface area. A laser is placed in the general area to be graded. A detector on the grading machine detects the laser beam and informs the operator when the grade is right. Those types of construction systems are generally accurate to within fractions of a centimeter.

He-Ne lasers are also used in surveying. A "transmitter" projects a laser beam to a corner reflector at some unknown distance. The corner reflector then returns a parallel beam back to the transmitter. Knowing the speed of light and compensating for the atmospheric effects of temperature and humidity, the distance can be easily calculated by circuitry in the transmitter. The results can then be displayed for the operator.

YAG Lasers. The Nd:YAG (Neodymium:yttrium, aluminum, garnet) laser is the most common type of solid laser. In this system, the lasing medium is a solid crystal of ultra-pure material that is commercially made. Artificial ruby, erbium, and Nd:glass are some other crystal materials normally used in solid lasers.

All solid lasers are "optically pumped" devices that can reach an efficiency of 3%. Unlike gas/plasma lasers, a solid laser's lasing medium does not conduct electricity, so energy must be delivered to the lasing medium by some other means. In this case, an intense external light source is placed along the length of the crystal. Arc lamps and flash lamps can usually generate enough light at wavelengths that enhance lasing. The light in an Nd:YAG crystal excites the neodymium ions to lase in the near-infrared region at 1.06

(Continued on page 94)

THE DIGITAL ELECTRONICS COURSE

BCD TO 7-SEGMENT DECODERS AND 7-SEGMENT DISPLAYS

Driving displays is very easy with today's integrated circuits.

BY ROBERT A. YOUNG

It is possible to place a number of LED's on a single, chip-like structure to form various geometrical patterns. One such "array" is the seven-segment display, which is available in two configurations: common anode and common cathode. In a common-anode display, all the anodes are connected together and share a pin that connects them with the outside world. In a common-cathode display, the cathodes share a common pin.

Such displays are usually controlled (driven) by a BCD-to-7-segment decoder, such as the 7447 (for common-anode displays) and the 7448 (for common-cathode displays). The BCD (binary-coded decimal) to 7-segment decoder accepts numbers in the BCD format and produces an output that is fed to a seven-segment display. The seven-segment display then displays a decimal number that corresponds to the BCD input.

As you may have guessed by noting the polarity of the displays they drive, the 7448 display driver is an active-high output decoder, and the 7447 is an active-low decoder. Figure 1 shows common circuit configurations for both the common-anode (Fig. 1A) and com-

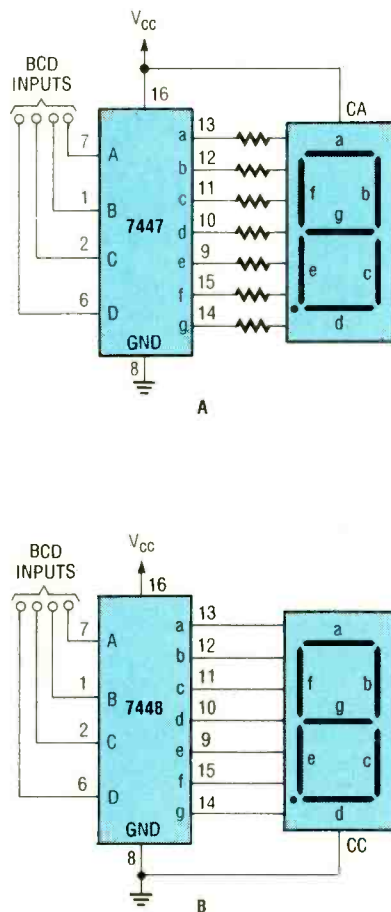

Fig. 1. It is common practice to pair a common-cathode display with an active-high output decoder, such as the 7448, and an active-low decoder, such as the 7447, with a common-anode display.

mon-cathode (Fig. 1B) displays when driven by the 7447 or 7448 decoder, respectively. The 7447 is an open-collector device, thus requiring that resistors be placed in series with the outputs of the device.

The 7448, on the other hand, has internally connected resistors, allowing it to be connected directly to the seven-segment display.

Figure 2 shows a circuit that can be assembled for experimentation on a breadboard. The BCD input to the circuit can be supplied by a four-position DIP switch (S1 in Fig. 2). In addition to the four-input and seven-output lines, there are three active-low lines, labeled \overline{LT} (lamp test), \overline{RBI} (ripple-blanking input), and $\overline{BI}/\overline{RB\overline{O}}$ (blanking input/ripple-blanking output). Lamp test (\overline{LT}) is just what its name implies, a way of testing the display "lamps" (actually LED's).

The $\overline{BI}/\overline{RB\overline{O}}$ terminal of the 7448 serves as the "blanking input" and/or the "ripple-blanking output". The blanking input must be held high when you want to display numbers zero to 15 (a single digit can display up to 15 in hexadecimal). When $\overline{BI}/\overline{RB\overline{O}}$ is held high or is open and a low is applied to the \overline{LT} input, all segment outputs go low. Table 1 gives the output level of each segment under all possible input conditions.

When a logic low is applied directly to the blanking input (\overline{BI}) of the 7448, all-segment outputs go low regardless of

*Our gratitude is extended to the EIA/CEG for the creation of this course, especially to the consultants who brought it to fruition: Dr. William Mast, Appalachian State University; Mr. Joseph Sloop, Surry Community College; Dr. Elmer Poe, Eastern Kentucky University.

PARTS LIST FOR THE SEVEN-SEGMENT DISPLAY/DECODER/DRIVER EXERCISE

- U1—7448 BCD to 7-segment common-cathode, decoder/driver, integrated circuit
- DISP1—7-segment, common-cathode LED display
- R1-R4—220-ohm, 1/4-watt, 5% resistor
- S1—Four-position DIP switch
- Breadboard materials, 5-volt power source, wire, etc.

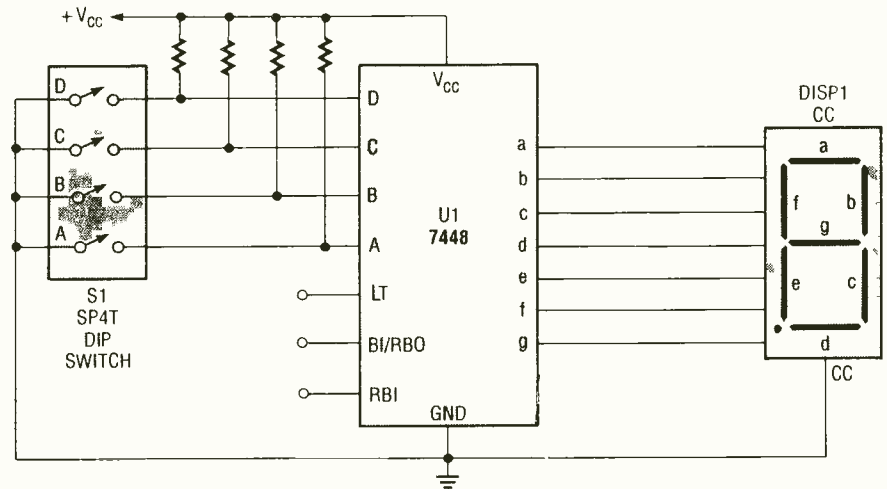

Fig. 2. Here the 7448 is used to directly drive a common-cathode display, with the input data supplied by a combination of a 4-position DIP switch, four resistors, and the power supply.

TABLE 1—TRUTH TABLE FOR THE 7448

Decimal or Function	Inputs						BI/RBO (1)	Outputs							Note
	LT	RBI	D	C	B	A		a	b	c	d	e	f	g	
0	H	H	L	L	L	L	H	H	H	H	H	H	L	L	(2)
1	H	X	L	L	L	H	H	L	H	H	L	L	L	L	
2	H	X	L	L	H	L	H	H	H	L	H	L	L	H	
3	H	X	L	L	H	H	H	H	H	H	H	L	L	H	
4	H	X	L	H	L	L	H	L	H	H	L	L	H	H	
5	H	X	L	H	L	H	H	H	H	L	H	L	H	H	
6	H	X	L	H	H	L	H	L	L	H	H	H	H	H	
7	H	X	L	H	H	H	H	H	H	H	L	L	L	L	
8	H	X	H	L	L	L	H	H	H	H	H	H	H	H	
9	H	X	H	L	L	H	H	H	H	H	L	L	H	H	
10	H	X	H	L	H	L	H	L	L	L	H	H	L	H	
11	H	X	H	L	H	H	H	H	L	L	H	H	L	H	
12	H	X	H	H	L	L	H	L	H	L	L	L	H	H	
13	H	X	H	H	L	H	H	H	H	L	L	L	L	L	
14	H	X	H	H	H	L	H	L	L	L	H	H	H	H	
15	H	X	H	H	H	H	H	H	L	L	L	L	L	L	
BI	X	X	X	X	X	X	L	L	L	L	L	L	L	L	(3)
RBI	H	L	L	L	L	L	L	L	L	L	L	L	L	L	(4)
LT	L	X	X	X	X	X	H	H	H	H	H	H	H	H	(5)

H = High; L = Low; X = Don't care

Note 1: BI/RBO is a wired AND logic serving as blanking input (BI) and/or ripple-blanking output (RBO).
Note 2: The blanking input (BI) must be opened or held at a high logic level when output functions zero to fifteen are desired. The ripple-blanking input must be open or high if blanking of a decimal zero is not desired.

Note 3: When a low logic level is applied directly to the blanking input (BI), all segment outputs are low regardless of the level of any other input.

Note 4: When the ripple-blanking input (RBI) and A, B, C, and D, are at a low logic level with lamp-test (LT) input high, all segment outputs go high, and the ripple-blanking output goes low.

Note 5: When the blanking input/ripple-blanking output is open or held high and a low is applied to the lamp-test input (LT), all segment outputs are low.

Table 1 as a guide, set DIP switch S1 to each number from 0 to 9. For example, according to Table 1, to produce the number five in the readout, \overline{LT} must be tied high or left floating, and the A, B, C, and D inputs must be high, low, high, low, respectively. Try each of the input

combinations shown in Table 1 and note whether those input combinations produce the specified display.

Have someone disconnect a line from the DIP switch to the 7448 decoder without letting you see which one. Using
(Continued on page 99)

the logic level at any other input. When the ripple-blanking input (\overline{RBI}) and inputs A, B, C, and D are at logic low, and the \overline{LT} input is high, all segment outputs go high, while the ripple-blanking output goes low.

When the blanking input/ripple-blanking output ($\overline{BI/RBO}$) terminal is open or held at logic high and a logic low is applied to the \overline{LT} terminal, all segment outputs go high.

Experimental Circuit. We will use Fig. 2 (mentioned previously) as the schematic diagram for a simple demonstrate circuit to familiarize you with the operation of the 7448 BCD-to-7-segment common-cathode decoder/driver in conjunction with a 7-segment display. Four resistors (R1 through R4) and a four-position DIP switch provide the four-digit BCD number that is to be decoded by the 7448. The resistors tie the BCD inputs (A, B, C, and D) high, while closing a switch pulls its corresponding input low.

First determine the pinouts of the 7-segment display, using the technique outlined in the LED exercise, which appeared in the August 1989 issue of this publication. The EIA Kit (see the small boxed text in this article for more information) comes with an unmarked 7-segment display, making this step necessary. Make a pinout diagram to help you. Once that's done, breadboard the circuit shown in Fig. 2, and connect a +5-volt source to the +V bus. Using

The Digital Microprocessor Course is printed here with the permission of the Electronic Industries Association/Consumer Electronic Group (EIA/CEG). The complete parts kit is available from EIA/CEG. For further information, contact EIA/CEG Product Services Department, 1722 Eye Street, NW, Suite 200, Washington, DC 20006; or call 202/457-4986

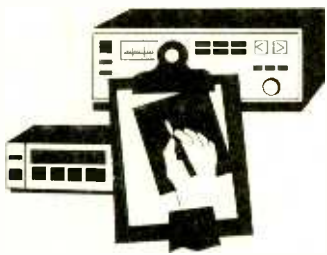

Product Test Reports

By Len Feldman

SANSUI AU-X911DG INTEGRATED AMPLIFIER

Originally a "high tech" company whose products represented state-of-the-art audio technology, some years ago the Sansui Electronics Corporation (1250 Valley Brook Ave., Lyndhurst, NJ 07071) embarked upon a program to change the direction of the company. Thousands upon thousands of relatively low-cost "rack" systems were produced and sold, while the high-quality image for which the company was noted suffered. All the while, however, the engineering know-how was maintained and, when Sansui decided to reverse course and return to their original priorities, consumers had forgotten just how sophisticated Sansui's audio designs could be.

A few months ago, a major interest in Sansui was bought by the British firm of Poly-Peck. Happily, freed from the financial stresses that plagued the company in recent years, Sansui's engineers were able to concentrate on producing top-grade audio equipment once more. The AU-X911DG, the flagship amplifier of Sansui's prestigious "Vintage" line of audiophile components is just such a product. Rated at 100-watts-per-channel when driving 8-ohm speaker loads, its sophisticated features include both "digital direct" and "source direct" operation as well as a separate "Record Selector" that lets you record one program source while listening to another.

Another unique feature of this amplifier is called "Direct-Access Switching." This feature causes the program-switching function to take place right at the point of input rather than at the front-panel selector. Instead of conventional IC controls, Sansui uses a motor-driven, remote-switching system. Depressing an input pushbutton activates the motor to complete the switching function.

The amplifier includes stereo Digital-to-Analog (D/A) converters, so that if your CD player (or your future DAT recorder) is equipped with digital outputs, you can connect from those outputs directly to the AU-X911DG. Furthermore, the D/A conversion process used in the amplifier is of the latest 1-bit variety, for improved low-level linearity and lower overall distortion. The digital inputs (both optical and coaxial) of the amplifier can handle digital data at any of the three currently used sampling rates (48 kHz used for DAT and professional applications, 44.1 kHz used in CD's and in pre-recorded DAT tapes, and 32 kHz used in direct-broadcast satellite transmissions).

The amplifier accommodates one video-input source as well as a wide variety of audio-input signals (five analog pairs, three coaxial digital inputs, and one optical digital input), and can therefore be used as the central com-

ponent in an audio/video home entertainment system. A video-output jack can feed the signal connected to the video input to a TV monitor. A "processor" input/output loop lets you add an external equalizer or other sound-processing component "in series" with the signal path.

The internal design of the amplifier uses a construction technique that places the power supply at the middle of the chassis, flanked by independent circuitry for the left and right amplifiers. An infrared remote control is supplied with the amplifier, so that most control functions can be accessed and adjusted from the user's listening position.

The Controls. The upper section of the all-black front panel of the amplifier houses a main power switch; a large, calibrated, master volume control; and eight program-source selector push-buttons (4 digital, 3 high-level, and 1 phono). A row of rectangular push-buttons about two-thirds of the way down on the front panel includes a tone-control on/off button; a loudness-control on/off button; and subsonic filter, muting, processor loop, and phono moving-magnet/moving-coil cartridge selector buttons. When any of those buttons is pressed, an associated indicator light illuminates. Other indicators along this level of the panel show the sampling frequency of any incoming digital signal.

Additional controls along the lower section of the panel include a speaker-selector switch (up to two sets of speakers can be connected and used); a stereo phone jack; bass, treble, and channel-balance controls; three tape-monitor switches; a source/tape switch; a record-selector switch (with settings for recording from any connected program source as well as from one tape deck to another); and a switch labeled "Source Direct Operation." That last control, when set to source, bypasses some intermediate circuitry of the amplifier to provide a more direct signal path for analog input signals. The same holds true for digital signals when the control is set to digital direct. The functions available on the supplied remote control are limited to program-source selection, tape-recording selection, and master volume adjustment.

The rear panel of the AU-X911DG is equipped with the requisite number of pairs of audio-input jacks, the processor-loop output and input jacks, and the video input/output jacks. Also



CIRCLE 119 ON FREE INFORMATION CARD

The Sansui AU-X911DG integrated amplifier.

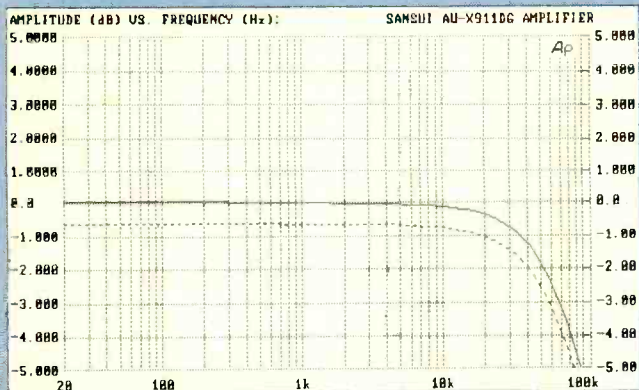

Fig. 1. Here is a plot of the frequency response of the amplifier using any one of the high-level analog inputs. The solid-line plot is for the left channel, while the dashed line represents response of the right channel.

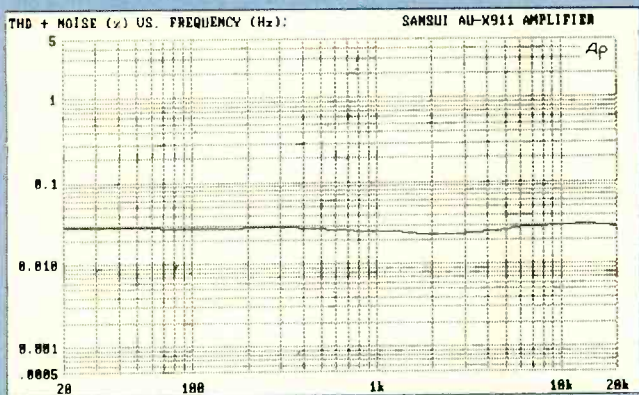

Fig. 2. While the amplifier's distortion was slightly higher than claimed in the published specification, it was certainly at inaudible levels of between 0.02% and 0.03% at all test frequencies from 20 Hz to 20 kHz.

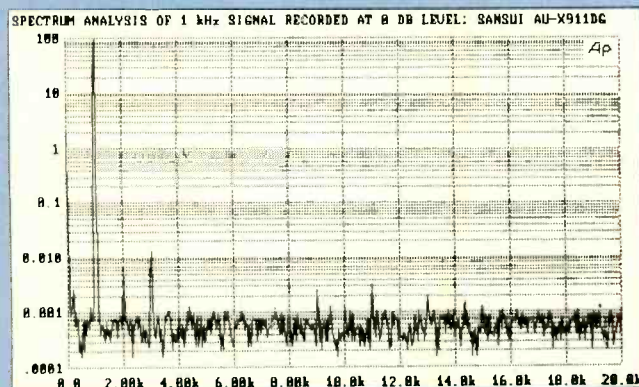

Fig. 3. The tall spike at left is the 1-kHz test signal. The shorter spikes at 2 kHz, 3 kHz, 9 kHz, 11 kHz, etc. represent harmonic-distortion components, the largest of which, at 3 kHz, represents about 0.015% distortion.

located there are the optical- and digital-input jacks; a coaxial digital-output jack; two sets of large, color-coded speaker terminals; and three sets of convenience AC outlets to which other

audio- or video-component power cords can be connected.

The Test Results. Figure 1 is a plot of the frequency response of this amplifier,

TEST RESULTS—SANSUI AU-X911DG AMPLIFIER

Specification	Mfr's claim	PE Measured
Power per Channel		
8 ohms	100 watts	110 watts
4 ohms	120 watts (DIN)	125 watts
THD, Full Power, all freq.	0.02%	0.03%
IM Distortion	0.02%	0.109%
Frequency Response		
High Level, +0, -3 db	DC to 125 kHz	DC to 75 kHz
Phono ± 0.2 dB	20 Hz to 20 kHz	See text
Input Sensitivity (for rated output)		
High Level	150 mV	160 mV
Phono (MM)	2.5 mV	2.5 mV
Phono (MC)	300 μ V	260 μ V
Signal-to-Noise Ratio (re: rated output)		
High Level	110 dB	112 dB*
Phono (MM)	86 dB	87.5 dB**
Phono (MC)	N/A	64.9 dB**
Controls & Filter		
Bass	± 6 dB @ 50 Hz	Confirmed
Treble	± 6 dB @ 15 kHz	Confirmed
Subsonic	-3 dB @ 16 Hz	Confirmed
Loudness at -30 dB	+6 dB @ 50 Hz +3 dB @ 15 kHz	+4 dB @ 50 Hz +2 dB @ 15 kHz
Digital Audio Section		
Frequency Response,	4 Hz to 20 kHz, ± 0.5 dB	-1 dB @ 20 kHz
Signal-to-Noise Ratio	100 dB	103 dB
Dynamic Range	98 dB	100 dB
Distortion (1 kHz)	0.003%	N/A
Input/Output Level	0.5 V p-p	Confirmed
Power Requirements	120V AC 60 Hz, 720 W Max	Confirmed
Dimensions (W \times H \times D, in.)	17 \times 6-1/2 \times 17-3/4	Confirmed
Weight (net)	40.1 lbs	Confirmed
Suggested Price:	\$1250.00	

* Referred to rated output
** Referred to 1 watt output

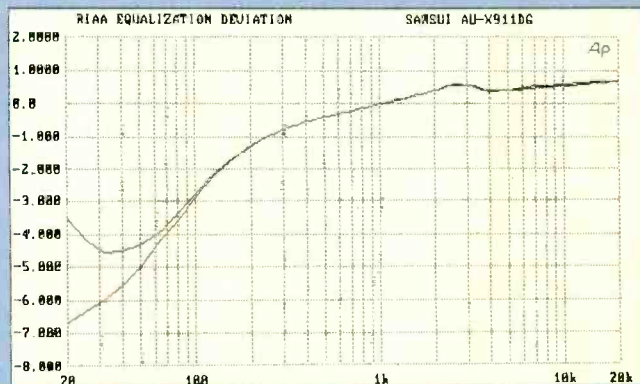

Fig. 4. The only problem encountered with the phono section was its deviation from proper RIAA playback equalization. While high-frequency equalization was less than 0.5 dB off at 50 Hz, bass response was attenuated by around 5 dB.

using any one of the high-level analog inputs. The solid-line plot is for the left channel, while the dashed line represents the response of the right channel. There was a difference of around 0.65

dB between channels, which can easily be compensated for by a slight rotation of the balance control. The -3 -dB roll-off point was reached at 70 kHz.

Frequency response using one of the digital inputs was also tested. Since the signal used had a sampling rate of 44.1 kHz (the same as that of a CD), the frequency response could not be expected to go much beyond 20 kHz; at that point, frequency response was down approximately 1 dB.

Figure 2 is a plot of distortion plus noise versus frequency, with the power output maintained at a constant 100-watts-per-channel, the rated output of the amplifier. While the amplifier's distortion under those conditions was slightly higher than claimed in the published specification, it was certainly at inaudible levels of between 0.02% and 0.03% at all test frequencies from 20 Hz to 20 kHz. Unlike many other amplifiers we have tested, there was no significant increase in distortion at the frequency extremes. Although no standard specification is given for operation with 4-ohm loads, we determined that the amplifier was able to deliver around 120- to 130-watts-per-channel under those load conditions with virtually the same level of distortion as that shown in Fig. 2.

We also took a look at how distortion plus noise varied with power output levels for a 1-kHz test signal. Results of that test were consistent with those of the one plotted in Fig. 2 in that at rated output (100-watts-per-channel) total harmonic distortion plus noise was around 0.03%.

It is important to note that the plot in Fig 2 shows distortion *plus noise*. Using the recently incorporated spectrum-analysis capability of our Audio Precision test equipment, we were also able to conduct a spectrum analysis of a 100-watt, 1-kHz output signal. The results are shown in Fig. 3, and enable us to pick out the actual harmonic-distortion components and separate them from the noise components.

The tall spike at the left in Fig. 3 represents the desired, 1-kHz test signal. The shorter spikes at 2 kHz, 3 kHz, 9 kHz, 11 kHz, etc. represent harmonic-distortion components, the largest of which, at 3 kHz, represents about 0.015% distortion. To determine the actual harmonic distortion of the amplifier (without regard to noise) you have to take the square root of the sum of the squares of all the distortion peaks. Doing so, I came up with a true harmonic distortion figure

for this frequency (1 kHz) and output level (1 watt) of 0.0153%.

A spot check of intermodulation distortion (IM) revealed that it was about 0.1% at rated output. Signal-to-noise level, referred to 0.5 volts of input and a 1-watt output, using the high-level inputs, was a superb 92.24 dB for the left channel and 92.38 dB for the right channel. The damping factor for the amplifier measured 90 dB, referred to 8-ohm loads.

The dynamic headroom, or the ability of the amplifier to deliver short-term power peaks beyond its continuous power rating was a relatively high 2.26 dB. That means that with a musical signal having short bursts of loud sounds, the amplifier can actually put out peak power levels of around 170-watts-per-channel.

Input sensitivity for 1 watt of output measured 16 mV. Sansui (and many other companies) quote sensitivity relative to rated output, and if we translate our reading to that reference, it would turn out to be 160 mV as against 150 mV claimed by Sansui. As far as this reviewer is concerned, that's close enough!

We were pleased to see that the tone controls provided moderate boost or cut of no more than about 6 or 7 dB at 50 Hz and 15 kHz. Many amplifier manufacturers provide far too much boost capability, which, unfortunately, inexperienced users tend to turn up to maximum, thereby introducing high levels of distortion and amplifier overload. In our view, if you need more than just a few dB of tonal compensation, you'd better look to the rest of your system (or room acoustics) to find out why.

The loudness control, which is useful when listening at lower than lifelike levels, was also moderate in its action. It offered no more than about 4 dB of boost at 50 Hz, and just a couple of dB of treble boost when the master volume control was set to -30 or -40 dB below its maximum setting.

Since the phono input accommodates both moving magnet (MM) and moving coil (MC) cartridges, we measured input sensitivity and signal-to-noise ratio for both types. Input sensitivity for the MM mode measured 0.25 mV for 1 watt of output, which is exactly equivalent to Sansui's stated sensitivity of 2.5 mV at the rated (100-watt) output. Moving-coil input sensitivity measured 260 μ V.

The overload level for the MM mode was 230 mV as against the 200 mV

claimed by Sansui. The signal-to-noise ratio for the MM inputs was a very excellent 87.5 dB, referred to 5 mV of input and with the volume control set to deliver 1 watt of output. As expected, the MC-input mode yielded a poorer signal-to-noise ratio of only 65 dB, again referred to 1-watt output with an input of 0.5 mV.

The only problem we encountered with the phono section was its deviation from proper RIAA playback equalization. While high-frequency equalization was not off by more than around 0.5 dB at 50 Hz, bass response was attenuated by around 5 dB. Even if one assumes that Sansui was trying to follow the European IEC playback curve rather than the U.S. RIAA curve, the error at 50 Hz was still in excess of 4 dB. We cannot imagine why Sansui would deliberately deviate from either of these recommended playback curves and wonder if the error exists only in our sample. In any case, if you encounter a noticeable absence of adequate bass when playing LP records through this amplifier, there is enough bass boost available in the previously discussed tone controls to compensate for that deficiency.

Hands-On Tests. The Sansui AU-X911DG integrated amplifier is easy to operate, and a joy to listen to. We coupled it to our relatively inefficient reference loudspeakers and found that the amplifier had plenty of power to drive those speakers to lifelike, concert-hall levels. But, more than adequate power, the amplifier exhibited a clean, transparent quality that many audio-equipment makers aim for, but only a few achieve.

To be sure, Sansui seems to go a bit overboard in their quoted performance specifications. No doubt they attempted to "beat the competition" on "specs." Frankly, however, an amplifier that has 0.03% distortion at rated power sounds no worse than one that actually has only 0.02%, as claimed by Sansui. The important things to consider are flexibility, adequate control range, enough inputs and outputs to meet the demands of a modern audio/video home-entertainment system, and a component that is good to look at and listen to. Sansui's AU-X911DG meets all of those requirements, and then some!

For more information on the Sansui AU-X911DG integrated amplifier, contact the manufacturer directly or circle no. 119 on the Free Information Card. ■



SOUND FEEDER MOBILE AUDIO CONNECTOR

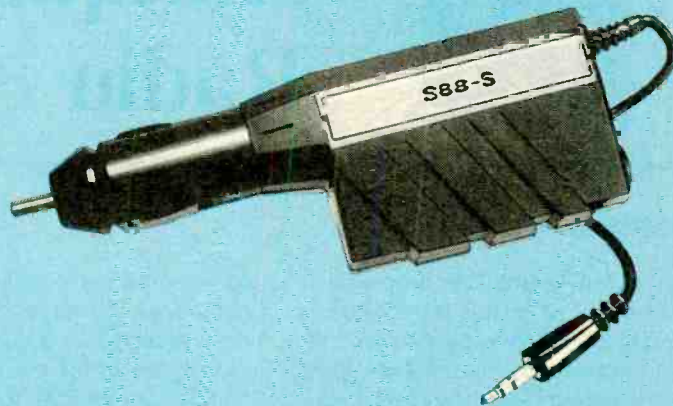

CIRCLE 120 ON FREE INFORMATION CARD

A quick and easy way to add tape or CD sound to your car's audio system.

The Sound Feeder from Arkon is an FM-stereo transmitter designed to be plugged into the cigarette lighter of a vehicle or boat. A cable from the Sound Feeder plugs into the earphone jack of a portable compact-disc or cassette player.

The stereo-audio output of the player is then broadcast to your FM radio and plays through the regular vehicle speaker system. That eliminates the dangerous use of earphones or headphones while driving, which is prohibited in many states. It allows you to play cassettes in a vehicle that has a defective cassette player or none at all, (which is true of many rental cars). Also, the Sound Feeder replaces an in-dash player, thus saving expense and reducing the risk of theft.

In my case, I have a particular interest in the Sound Feeder since one of my cars has only an 8-track player, and the other car has a cassette player that doesn't work properly. I have lots of cassettes I could be playing in the car with a portable cassette player. However, most portable players have small speakers, are hard to hear in traffic, have poor sound quality, and are battery hogs.

Which brings me to an additional feature of the Sound Feeder. It has a built-in DC-to-DC converter to supply 3, 6, or 9 volts from the car battery to many portable devices.

Although no claims are made for the device to be voltage regulated, I was

surprised to find only a small change in voltage from no load to 300 milliamperes using any of the three voltages.

The installation only involves inserting the Sound Feeder into the cigarette-lighter socket and sticking its "earphone" plug (at the end of a three foot cord) into the player. A power cord, also supplied, can be plugged in between the Sound Feeder and the player. (More on that later.) The whole operation can be done in less than a minute.

The center of the cigarette-lighter plug is looking for positive polarity from the cigarette lighter socket, with a negative ground. **The Sound Feeder will not work with a rarely-found positive-ground cigarette lighter socket.**

A very nice feature is a red LED on the back of the Sound Feeder that lights only when the unit is properly inserted into the cigarette lighter, and the polarity is correct. That is important since cigarette-lighter connections are often poor, and you may think you are getting power when you are not.

You may need to tune the Sound Feeder to a "dead" spot between broadcast stations on your local FM band. That is easily done with a small, plastic tuning tool provided with the unit.

Another possible adjustment may be required if you are using the Sound Feeder to power a portable player. You can, of course, use the player on its own batteries. But why not use the powerful

vehicle battery instead? A power cord is supplied with the Sound Feeder. It has four plugs to accommodate different power jacks. You simply use the one that fits your player. Then, using a plastic tool supplied, you set the voltage output of the Sound Feeder to either the 3-, 6- or 9-volt position, depending on the voltage required by the player.

The Sound Feeder is approximately 5-inches long, 2-inches wide and 1-inch high. The signal cable and power adapter cables are each 3-feet long. Clearly illustrated and simple instructions are provided. The plastic tuning tool is a circular ring that is captured on the earphone cord so it doesn't get misplaced. The tool has one specially shaped projection for frequency tuning, and a small screwdriver-like tip for voltage adjustment.

Although I was pleased with the end result, I found the Sound Feeder not as universally adaptable as I had expected. For example, the plug at the end of the Sound Feeder input cable is intended to fit into the player earphone jack (sometimes labeled "Monitor.") While most modern players use a miniature (1/8-in.) monaural or stereo phone jack for the earphone output, some use other types of jacks. The Sound Feeder has only a 1/8-in. stereo phone plug, and no adapters are provided. Fortunately, Radio Shack and other outlets have various stereo and monaural adapters. If your player does not have a 1/8-in.

(Continued on page 95)



Antique Radio

THE ART OF TESTING TUBES

Over the years, I've received a number of letters from readers who would like to see a tube-tester construction project in this column. Up to now, my position was that such an undertaking would be impractical. I've always advised that it would be better to look for a good buy in a top-quality, commercially-made instrument. Those are always turning up at flea markets and swap meets, and a person who is persistent can usually acquire one at the right price.

That's still an excellent piece of advice. Since semiconductors have all but replaced vacuum tubes in radio receivers, TV sets, hi-fi equipment, and other consumer-electronics equipment, service-shop tube testers are definitely obsolete—particularly the older models of interest to us antique-radio buffs. And you couldn't even come close to home-building a sophisticated tube tester for the price at which good commercial equipment is usually available today.

Actually, even in the heyday of the tube era, when you could easily lay out a few hundred dollars for a high-quality tester, it was considered foolhardy to home-build one. Such a project required special switches, meters, transformers, and other exotic parts, as well as complex, labor-intensive wiring. And when construction was completed, you still faced the near-impossible task of calibrating the instrument to give accurate "good-bad" readings for the hundreds of tube types in use. Tube-tester construction was definitely better left in the hands of the test-equipment companies!

When Home-Building Makes Sense. Being a firm believer in following my own advice, I check tubes using an older commercial tester of sophisticated design. It can handle almost any tube type manufactured from the mid 1920's through the early 1960's. Yet there are times when it can't help me.

There's no test data available for

some of the earlier dry-cell tubes, such as the type 12. And even in cases where there is available data, the tester may lack a socket for the tube I need to check. For example, though I can test 01-A's that have the more recent long-pin base, I can't accommodate (except by making a temporary clip-lead hookup) the older short-pin, bayonet-mount version.

For some time, now, I've been thinking that it would be handy to have a small tester, equipped with all of the necessary specialized sockets, that would check those early tubes. And, while researching last month's article on tube rejuvenation, I came across some construction data for a couple of different testers that looked quite promising.

Designed in the early 1930's, when tubes were simple and there were relatively few types available, those testers do not require myriad sockets, elaborate switching circuits, or complicated wiring. And they can be calibrated in satisfactory fashion just by taking readings from a few samples of tubes known to be good. A unit modeled after one of those, and equipped with all of the proper sockets, would be an ideal supplement to the more sophisticated instrument with which I do most of my checking.

My plan is to put together a tester combining the best features of the ones I found in my research and adapted to make use of current, readily-available components. I'll be reporting my progress to you in this column as I build and test the prototype. And, if you like the way it turns out, you may decide to put together a version for your own use. But before beginning the "hands-on" phase of the project, let's review some of the principles of tube testing.

Emission Testing. As was discussed in last month's column, the operation of most vacuum tubes depends upon a stream of electrons released by the action of heat on the tube's filament or

cathode. As the tube is used, the electron-emitting material in the filament or cathode is slowly exhausted. Eventually the tube becomes so weak that its function in the radio is impaired.

The simplest method of judging tube quality is to measure its emission under standard conditions. Testers based on that principle are called, quite logically, "emission testers."

A simplified schematic diagram of an emission tube tester is shown in Fig. 1. As you can see, there's not much to it. The "A" battery provides the correct voltage for lighting the tube under test; the "B" battery places an appropriate

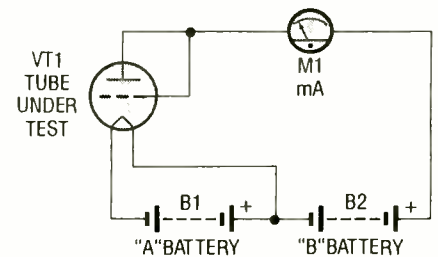

Fig. 1. A simplified schematic of an emission tube tester. In making this type of test, all elements other than the filament or cathode are tied directly to the plate.

positive voltage on the tube's plate as well as on any other elements connected to it. (For the purpose of the emission test, all tube elements, other than the filament or cathode, are wired to the plate.)

The electrons emitted by the filament or cathode, being negatively charged particles, are attracted by the positive charge on the plate and other elements that may be connected to it and flow to them, creating a current flow that is measured by a milliammeter wired into the circuit. And, for a given plate voltage—the greater the emission, the greater the current indicated on the milliammeter. To set up a standard that can be used to judge tube quality, it's only necessary to test a number of tubes known to be good (and, if possible, a number of tubes known to be weak), recording the indicated currents.

While that type of test is easy to set up, it does have some important disadvantages. For one thing, a tube can have good emission and still be a poor performer because of other functional defects. For another, the test might not even provide a true indication of emission. Gassy tubes, for instance, might show high plate currents even when emission is weak, because the gas pro-

vides a good pathway for current to flow through the tube. And, far from improving tube performance, the presence of gas might very well significantly degrade it.

Grid-Shift Testing. The grid-shift test, also known as the mutual-conductance test, is only a little more difficult to set up than the emission method of testing, yet the results are much more reliable. That's because the grid-shift test actually provides an estimate of the tube's ability to perform as an amplifier (which, after all, is the job we're basically interested in having it do in most receiver circuits).

It's an elementary principle of electronics that a tube's ability to amplify comes from the fact that a small change in its grid voltage can cause a large change in its plate current. And the greater the change in plate current caused by a given change in grid voltage, the greater the amplification of the tube.

Figure 2 is a simplified version of a grid-shift test circuit. Just as in the emission-test circuit, there's a battery to light the tube and another to provide plate voltage. There's also a milliammeter to

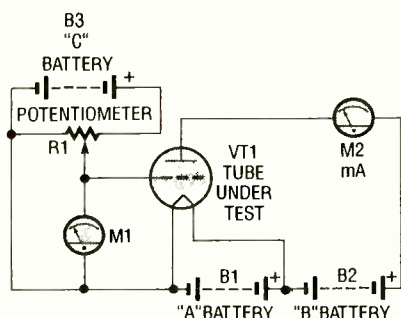

Fig. 2. This circuit measures the change in plate current for a given change in grid voltage.

measure plate current. But the grid is no longer tied to the plate. Instead, it's connected to a separate, adjustable voltage source consisting of a third battery and a potentiometer. And a voltmeter connected in the grid circuit shows the voltage impressed on the grid at any given time.

Testing a tube for mutual conductance is a matter of placing two different voltages on the grid and measuring the plate current at each of those voltages. (Of course, the grid and plate voltages applied have to be carefully chosen so that they are within the normal operating range of the tube.) The difference between the two

plate currents is then calculated, as is the difference between the two grid voltages.

Dividing the plate-current difference by the grid-voltage difference gives a number that is a measure of the *mutual conductance* of the tube. And, of course, the greater the current difference for a given voltage difference, the greater the mutual conductance (or "amplification ability") of the tube.

The mathematically-oriented folks in the crowd might notice that mutual conductance (which is expressed as current over voltage) is the reciprocal of resistance (which, by Ohm's well-known law, is expressed as voltage over current). And that makes intuitive sense because, as an amplifying device, a tube boosts the current entering it rather than impeding it as a resistor would.

When the current difference is given in amperes and the voltage difference is given in volts, the calculated mutual conductance (symbol, G_m) is expressed in *mho's*. And I know I don't have to tell you "A" students what that is spelled backwards! Actually, the values of mutual conductance encountered in tube measurements are usually very small fractions of a mho. In fact, they are usually given in *micromhos* (millionths of a mho).

Testing for Gas. As we've already said, the presence of gas in a vacuum tube can definitely be a problem. Most receiving tubes have an internal coating of evaporated metal (that silvery material you can see through the glass) intended to trap gases not pumped out during manufacturing. But even if all the gas is trapped at the outset, improper operation of the tube—especially if it causes overheating—can cause liberation of gases from the tube's internal parts, or even from the evaporated metal "getter," as the gas-trapper is called.

No matter what method is used to judge quality, most tube testers also include a circuit designed to give an indication of gas content. A simplified schematic of such a circuit is shown in Fig. 3. Note that there is an "A" battery to light the tube, a "B" battery to provide plate voltage, and an additional ("C") battery wired between the filament and the grid via a parallel resistor and switch.

If gas is present and the switch is closed, an electric current will flow from the battery, through the grid and the

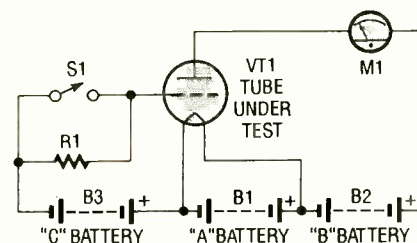

Fig. 3. A simple test for gassy tubes. The presence of gas will allow current flow through the tube, creating a voltage drop in the grid resistor—thus changing the plate current—when the switch is opened.

gas in the tube, into the filament, and back to the battery. Opening the switch would allow the current to also flow through the resistor and create a voltage drop across it (by Ohm's law the voltage drop would be equal to the value of the resistance in ohms times the current through it expressed in amperes). That voltage drop would change the voltage on the grid of the tube, causing a change in the plate current indicated on the milliammeter.

Testing for gas, then, is simply a matter of opening the switch. With no gas, there would be no grid current flowing through the tube. Thus, there would be no voltage drop across the resistor

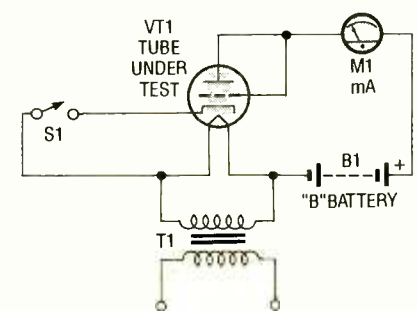

Fig. 4. To check for cathode-heater leakage, the cathode is disconnected from the heater by opening the switch. If the plate current continues to flow, there's a problem.

when the switch was opened, no change in the voltage on the grid, and, therefore, no change in the plate current indicated on the milliammeter. Conversely, should gas be present, there *would* be grid current. And opening the switch would cause a voltage drop in the resistor and a noticeable change in the indicated plate current.

Cathode-Heater Leakage. Tubes equipped with cathodes need also be
(Continued on page 93)



Computer Bits

Getting Organized, Part III

By Jeff Holtzman

The past few months we have been talking about some of the principles of database design. Actually, we've already done all the hard work—defining the logical structure of the database. Now it's simply a matter of telling the database manager what we want to do. In case you're tuning in late, the database is a catalog of jazz records, with fields for album title, band, label, category, 12 fields for song titles, six fields for artist names, a boolean field that specifies whether there are more than 12 songs on the album, a memo field for notes, another memo field for extra song titles, and a field for recording date. Details were shown in the August 1990 installment of Computer Bits.

Not counting memo fields (which occupy no space unless they're used), each record occupies 561 bytes. We estimated that a 400-album collection would fit on a single 360K floppy disk with room to spare.

PC-File 5.0. I implemented this database using PC-File 5.0. There are more powerful database managers, but they cost more and are harder to use. You can do a lot before outgrowing this product, and outgrowing it is hard because the company keeps improving it every year or so.

To create a database with PC-File is simple. While in DOS, create a subdirectory where all files related to this database will be collected. (You could store it in the PC-File directory, but you'll find it hard to keep track of which files belong to which database.) Then start the program. It will ask for a drive and path for the database you want to use; enter the appropriate information. Then supply a name for the database; I used "Jazz."

PC-File then asks whether you want to paint the data-input screen, or just supply the field names and let the program do it. Painting the screen is as easy as

using a word processor, so choose that option. Using Fig. 1 as a model, type each field name (maximum of 12 characters, no spaces) in the appropriate position, followed by opening and closing square brackets separated by a number of spaces equal to the desired field length. A logical field has a length of 1; a date field has a length of 8. You can specify any convenient length less than 65 for a memo field.

PC-File then takes you to a screen in which you specify field types. Enter the appropriate type by each field (C for character, D for Date, L for Logical, M for Memo, N for Numeric). For our Jazz database, RecDate is a date field, Category is a numeric field, MoreThan12 is a logical field, and Notes and Extra are memo fields; all others are character fields.

Next the program will ask whether any field is a window field; answer no.

The next screen allows you to specify the order in which the cursor will move from field to field. The default is left to right, top to bottom. In this case, it is convenient to access all the Songxx fields followed by all the Artistx fields, and then the Notes and Extra fields.

Next you specify a field (or several) that will be indexed. In this case, I chose to index by band; album title would be another good choice. PC-File then asks for a name for the index file. The program suggests a name identical to the name of the main database file; this is not a good choice, especially if you use more than one index. So I usually specify the name of the field being indexed. Last you enter a short description of the database.

Don't worry about getting everything perfect the first time around. You can return to the same screens later (using the Clone command) and modify field names, lengths, screen positions, types, etc., to your heart's content.

Now you're ready to enter data. One trick to remember: When entering data in a memo field, press <CTRL-E> and an editing window pops up, as shown in Fig. 2. It's much easier to enter data in that window than in the single line PC-File allows for each memo field.

Finding Data. Finding data is easy. From the Main Menu, press F; a subsidiary menu pops up. It provides two ways of finding data and two ways of viewing

```
Index: Band ascending MOD
Title >The Uerve Years (1948-1959) 4
Band [Charlie Parker (with strings, etc.) ]
Label [Uerve ] Category [ 81
RecDate [09/01/48] MoreThan12 [Y]

Song01 [Repetition ] Artist1 [Charlie Parker ]
Song02 [The Bird ] Artist2 [Ray Brown ]
Song03 [Cardboard ] Artist3 [Shelly Manne ]
Song04 [Visa ] Artist4 [Hank Jones ]
Song05 [Segment ] Artist5 [Dizzy Gillespie ]
Song06 [Passport ] Artist6 [Thelonius Monk ]
Song07 [April in Paris ]
Song08 [Summertime ]
Song09 [If I Should Lose You ]
Song10 [I Didn't Know What Time ]
Song11 [Everything Happens To Me ]
Song12 [Just Friends ]

Notes [
Extra [Star Eyes ]

Please respond. (F10) when complete. (Alt)H for help.
```

Fig. 1. Using this screen as a model, type each field name in the appropriate position, followed by opening and closing square brackets separated by a number of spaces equal to the desired field length.

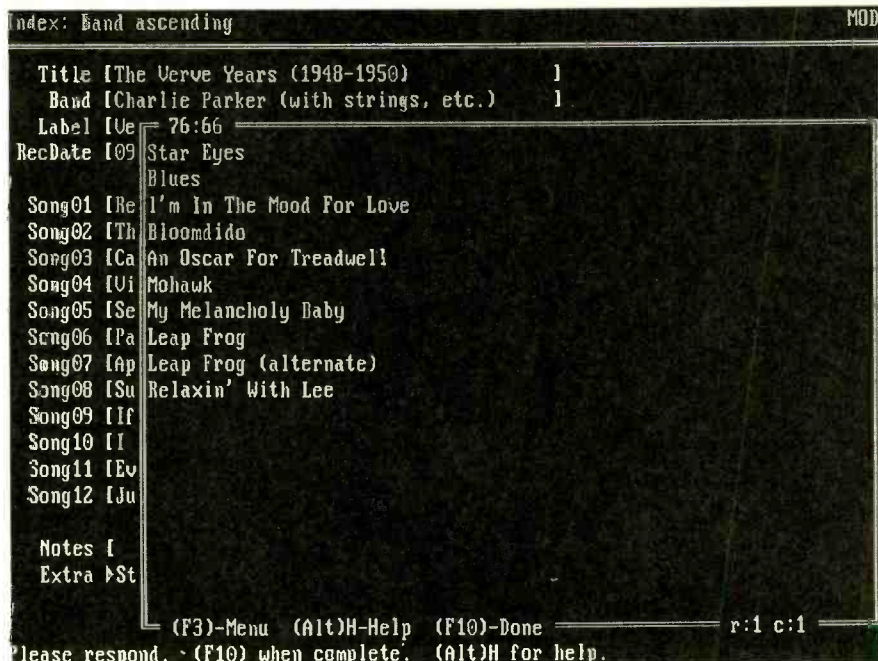

Fig. 2 To make entering data in a memo field easier, press <CTRL-E> and an editing window pops up, as shown here.

it. You can view data either in a form resembling the data-entry screen or in a table (row/column) form. You can find data either by searching for specific information or by browsing through the file.

If you choose to browse, you can move through the file record by record until you find the one you want. In the table display, you see about 20 records per screen, but you may have to scroll the data "window" right or left to see the desired field. Unfortunately, you can't edit in the table mode.

If you want to search for a specific record, you can do so in one of three ways. You perform a simple search by filling out a data-entry form, entering data in the field(s) that you are trying to match, and leaving the other(s) blank. PC-File will then scan the database, comparing each record to the form you filled out. If it finds a match, it stops and lets you modify the record, print it, etc., or continue the search.

You perform a complex search by typing in a mathematical expression of the form: (RecDate > 01/01/48) & (Artist1

= "Parker" or Artist2 = "Parker" or Artist3 = "Parker" or Artist4 = "Parker" or Artist5 = "Parker" or Artist6 = "Parker"). That example would find all records recorded after January 1, 1948 that Charlie Parker played on. (Note: You would actually use the vertical bar character, not the word or.)

You can also perform what PC-File calls a Global search; this variety scans the entire record for the string you specify, irrespective of field boundaries. Generally speaking, a global search will be less efficient than the other types, but in cases like the previous example, it may be more efficient—or easier to type in, anyway.

Reports. To create a printout of your data, you follow a procedure similar to creating the input form. The program will create simple report formats for you; you can also do some pretty fancy formatting by mastering a report command language. You'll have to learn the language if you want to list things like all Parker records after 1948. For really fancy printouts, you'll want to export your data (or subset thereof) in ASCII format and then import it into a word processor.

Conclusion. This has been a somewhat long introduction to databases. Although I've hardly scratched the surface, I hope you've gotten some idea of the principles involved, and some appreciation of PC-File.

Vendor Information

PC-File 5.0 (\$129.95 plus \$5 shipping)
ButtonWare, Inc.
 P.O. Box 96058
 Bellevue, WA 98009-4469
 (206) 454-0479, (800) JBUTTON

ATTENTION! ELECTRONICS TECHNICIANS



EARN YOUR B.S.E.E. DEGREE

THROUGH HOME STUDY

Our New and Highly Effective Advanced-Placement Program for experienced Electronic Technicians grants credit for previous Schooling and Professional Experience, and can greatly reduce the time required to complete Program and reach graduation. No residence schooling required for qualified Electronic Technicians. Through this Special Program you can pull all of the loose ends of your electronics background together and earn your B.S.E.E. Degree. Upgrade your status and pay to the Engineering Level. Advance Rapidly! Many finish in 12 months or less. Students and graduates in all 50 States and throughout the World. Established Over 40 Years! Write for free Descriptive Literature.

COOK'S INSTITUTE OF ELECTRONICS ENGINEERING

4251 CYPRESS DRIVE
 JACKSON, MISSISSIPPI 39212

CIRCLE 14 ON FREE INFORMATION CARD

New AOR Scanner



**1000 Channels.
8-600MHz,
805-1300
MHz**

- Continuous coverage (except UHF TV 600-805)
- AM, FM and wide band FM tuning modes.
- 10 Scan Banks, 10 Search Banks
- Selectable Priority Channel.
- Selectable Search Increments, 5-955KHz
- Permanent memory backup
- 25 Day Satisfaction Guarantee. Full refund if not Satisfied.
- No Frequencies cut out.
- All normal accessories included
- Size 6 7/8" H x 1 3/4" D x 2 1/2" V. Wt. 12 oz.

AR1000
 Total Price, Freight Prepaid
 (Express Shipping Optional)
\$499

ACE
 COMMUNICATIONS

10701 E. 106th St. Indpls., IN 46256
 Toll Free 800-445-7717

Visa and Mastercard
 (COD slightly higher)
 FAX (317) 849-8794

CIRCLE 13 ON FREE INFORMATION CARD

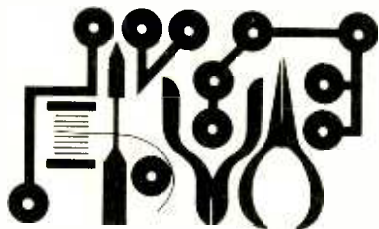

Circuit Circus

By Charles D. Rakes

USING SOUND FOR DETECTION AND MEASUREMENTS

This month we're going to play around with a number of circuits that use audible and inaudible sound to detect objects, measure distance, and perform some other interesting experiments.

The velocity of sound traveling in air is slower than a snail on an incline when compared to the speed of light and electrical energy traveling through free space. Sound travels through the air at a rate of about 1100-feet-per-second—depending on the temperature, which effects the speed of sound by about 1-foot-per-second per degree Fahrenheit. Near freezing (0°C or 32°F) sound travels at a speed of about 1100-feet-per-second; and at a more sultry 100°F, sound speeds up to about 1175-feet-per-second.

In water sound travels at over 4000-feet-per-second; but through most metals and glass, its speed jumps to a rate of over 1-mile per second. Frequency has no effect on the speed at which sound travels; i.e., two sounds of different frequencies traveling through the same medium will move at the same rate of speed.

Knowing the affect of various mediums on the movement of sound waves makes it possible to detect objects in a given area or measure distances. The simplified block diagram of a distance-measuring system—consisting of a pulse generator, an amplifier, and an oscilloscope—that allows you to use sound as an "electronic tape-measure" is shown in Fig. 1. In essence, we are talking about is an extremely simple and limited-distance system.

The pulse generator sends out a narrow pulse of energy to a transmitting transducer. The sound travels from the transmitter to a solid object and is reflected toward the receiver. The reflected signal is then picked up by the receiver transducer, sent to the amplifier, and finally to the vertical input of the oscilloscope.

The scope's horizontal sweep is triggered by the pulse generator, which is set up to start the sweep at the same time the sound leaves the transducer. The time it takes the sound to travel to the solid object and return to the re-

ceiver's pickup can be determined by simply measuring the distance between the two pulses that are displayed on the scope's screen.

The Transmitter. Figure 2 shows the transmitter portion of our measuring system. The transmitter, which is nothing more than a pulse-generator circuit feeding a piezo transducer, is capable of supplying enough output power to operate our simple distance-measuring system. In Fig. 2, a 555 timer (U1) is configured as a bistable multivibrator (flip-flop) and is placed between trigger-switch S1 and the pulse generator. The bistable circuit is used to prevent contact bounce from sending multiple

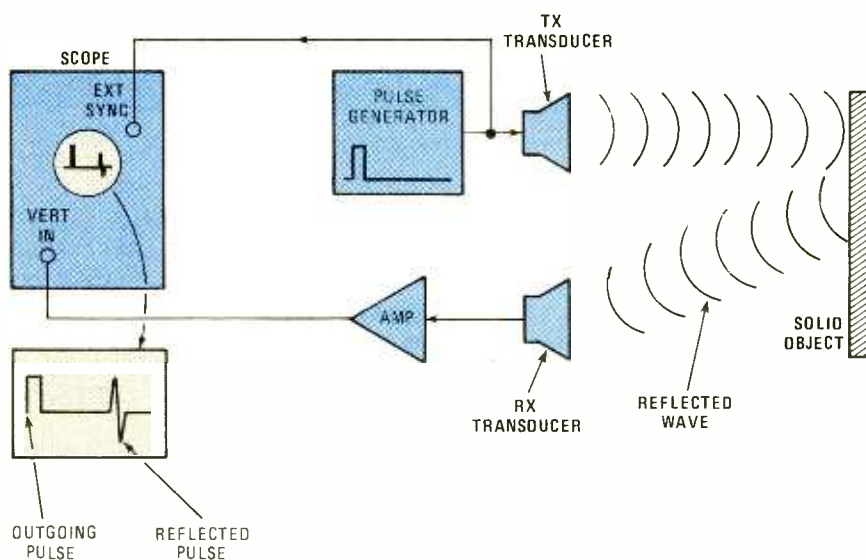

Fig. 1. Here's a simplified block diagram of a distance-measuring system—consisting of a pulse generator, an amplifier, and an oscilloscope—that allows you to use sound as an "electronic tape-measure"—in essence, it's an extremely simple radar system.

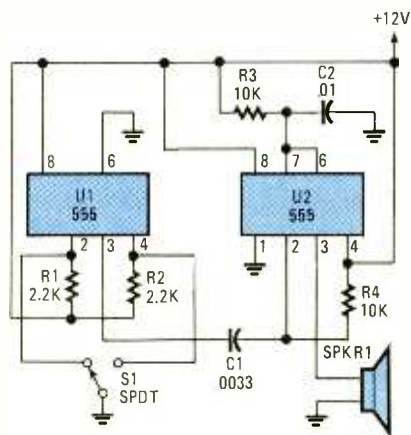

Fig. 2. The transmitter is nothing more than two 555 oscillator/timers: one is configured as a monostable multivibrator (U2) and the other is configured as a bistable multivibrator (U1).

trigger pulses to U2 and, thereby, causing erroneous output pulses.

A second 555 timer, U2, and its associated components make up a pulse-generator circuit that produces a single positive output pulse for each negative trigger received. The values of R3 and C2 set the pulsewidth of the output signal. The formula for setting pulsewidth is $T = 1.1RC$; where T is time in seconds, C is capacitance in microfarads, and R resistance in megohms. With the values shown in Fig. 2, the output pulsewidth is 0.00011 second or .11 millisecond.

It takes one second for sound to travel 1100 feet; 100 milliseconds (ms) for a trip of 110 feet; 10 ms for 11 feet; and only .909 ms to travel 1 foot. The formula for determining the time for sound to travel a given distance is $T = D/1100$;

PARTS LIST FOR THE TRANSMITTER

U1, U2—555 oscillator/timer, integrated circuit
 R1, R2—2200-ohm, ¼-watt, 5% resistor
 R3, R4—10,000-ohm, ¼-watt, 5% resistor
 C1—0.0033-μF ceramic-disc capacitor
 C2—0.01-μF ceramic-disc capacitor
 BZ1—Piezo speaker (RS 40-1383 or 40-1397)
 S1—SPDT toggle switch
 Printed-circuit or perfboard materials, enclosure, 12-volt power source, wire, solder, hardware, etc.

where T is time in seconds and D is distance in feet. And if the time of travel is known, the distance can be determined by: $D = T \times 1100$.

The circuit in Fig. 2 can be modified to automatically transmit pulses at a given rate by adding the low-frequency oscillator shown Fig. 3 (which, with the component values shown, has an output frequency of about 2 Hz) to the pulse-generator circuit shown in Fig. 2. That would eliminate the need to manually key the pulse generator for each output pulse.

Adding the low-frequency oscillator to the transmitter circuit is easy. Simply remove C1 from the circuit in Fig. 2, and connect C2 of Fig. 3 to pin 2 of U2 in Fig. 2. If you want to raise the pulse rate, just lower the value of R2; to lower the rate increase the value of R2.

The Receiver. Figure 4 shows the receiver section of the distance-measuring system. In that circuit, a single 741 op-amp (U1) is wired as an inverting amplifier and is used to boost the level of the incoming signal by a factor of about 100. That pushes the operating range of the receiver to well over 12

PARTS LIST FOR THE RECEIVER

U1—741 op amp, integrated circuit
 R1—1000-ohm, ¼-watt, 5% resistor
 R2, R3—10,000-ohm, ¼-watt, 5% resistor
 R4—100,000-ohm, ¼-watt, 5% resistor
 C1—0.01-μF ceramic-disc capacitor
 C2—0.1-μF ceramic-disc capacitor
 C3—47-μF, 16-WVDC, electrolytic capacitor
 BZ1—Piezo speaker (RS 40-1383 or 40-1397)
 Printed-circuit or perfboard materials, enclosure, 12-volt power source, etc.

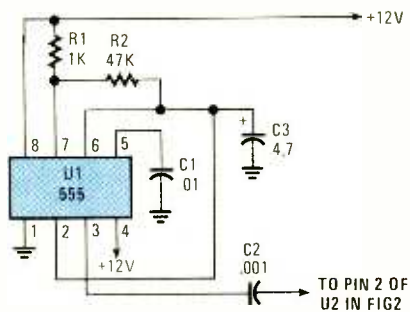

Fig. 3. By adding this low-frequency oscillator to the transmitter circuit in Fig. 2, the transmitter can be made to automatically transmit pulses at a given rate.

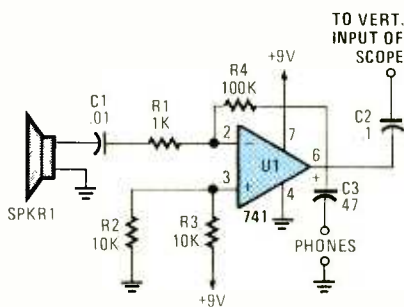

Fig. 4. In the receiver section of the distance-measuring system, a single 741 op-amp (U1) is wired as an inverting amplifier and is used to boost the level of the incoming signal by a factor of about 100.

feet. The output of the receiver is fed to the vertical input of an oscilloscope through a 0.1-μF capacitor (C2). Headphones can be connected to U1's output to monitor the return pulses.

The presence of fair-size objects can be detected from several feet away using that method, but will not give an indication of the actual distance between the transducers and the detected object. The system could be made portable to assist in night time navigation by sending out a pulse and listening for the return. Walls and other large objects would easily be detected. However, small items would likely be missed. That is an area that seems tailor-made for experimenting.

After assembling the two halves of the circuit, it must be checked for proper operation. Start by feeding several trigger pulses to the circuit, either by flipping S1 back and forth or by enabling the oscillator. As trigger pulses are received, a brief click should be heard coming from BZ1—one for each trigger pulse. If so, connect the scope's EXTERNAL-SYNC input to pin 3 of U2, and the

PARTS LIST FOR THE MOTION DETECTOR

SEMICONDUCTORS

U1—567 phase-locked loop, integrated circuit
 U2—1496 balanced modulator/demodulator, integrated circuit
 U3—386 low-voltage audio-power amplifier, integrated circuit
 Q1, Q2—2N3904 general-purpose NPN silicon transistor

RESISTORS

(All resistors are ¼-watt, 5% units, unless otherwise noted.)
 R1-R5—1000-ohm
 R6-R10—10,000-ohm
 R11-R13—2200-ohm
 R14, R15—100-ohm
 R16-R18—270-ohm
 R19—10-ohm
 R20—220,000-ohm
 R21—50,000-ohm potentiometer
 R22—25,000-ohm potentiometer
 R23—5000-ohm potentiometer

CAPACITORS

C1-C8—0.1-μF ceramic-disc
 C9—0.0018-μF, 100-WVDC, mylar
 C10, C11—0.05-μF, 100-WVDC, mylar
 C12—47-μF, 16-WVDC, electrolytic
 C13—220-μF, 16-WVDC, electrolytic
 C14—470-μF, 16-WVDC, electrolytic
 C15, C16—4.7-μF, 16-WVDC, electrolytic

ADDITIONAL PARTS AND MATERIALS

BZ1, BZ2—Piezo speaker (RS 40-1397 or similar)
 SPKR1—8-ohm, 4-inch speaker
 Perfboard materials, enclosure, 9-volt power source, wire, solder, hardware, etc.

vertical input across the receiving piezo transducer.

Set the vertical input of the scope for maximum gain and position the horizontal sweep for 1-ms-per-division. Place the two piezo transducers about one foot apart and facing each other. Activate S1 and a pulse should occur on the scope's screen about one millisecond (one division) after the trace begins. Separate the two transducers by two feet and the pulse will take about 2 milliseconds to make the trip.

Distances of over four feet can be measured with this simple set up. Place the two transducers side by side facing the same direction and directed away from any object or close by wall. Partition a piece of solid material that is about 1-foot square parallel to about one foot in front of the two transducers. Activate S1 and the reflected pulse should occur about 2 r

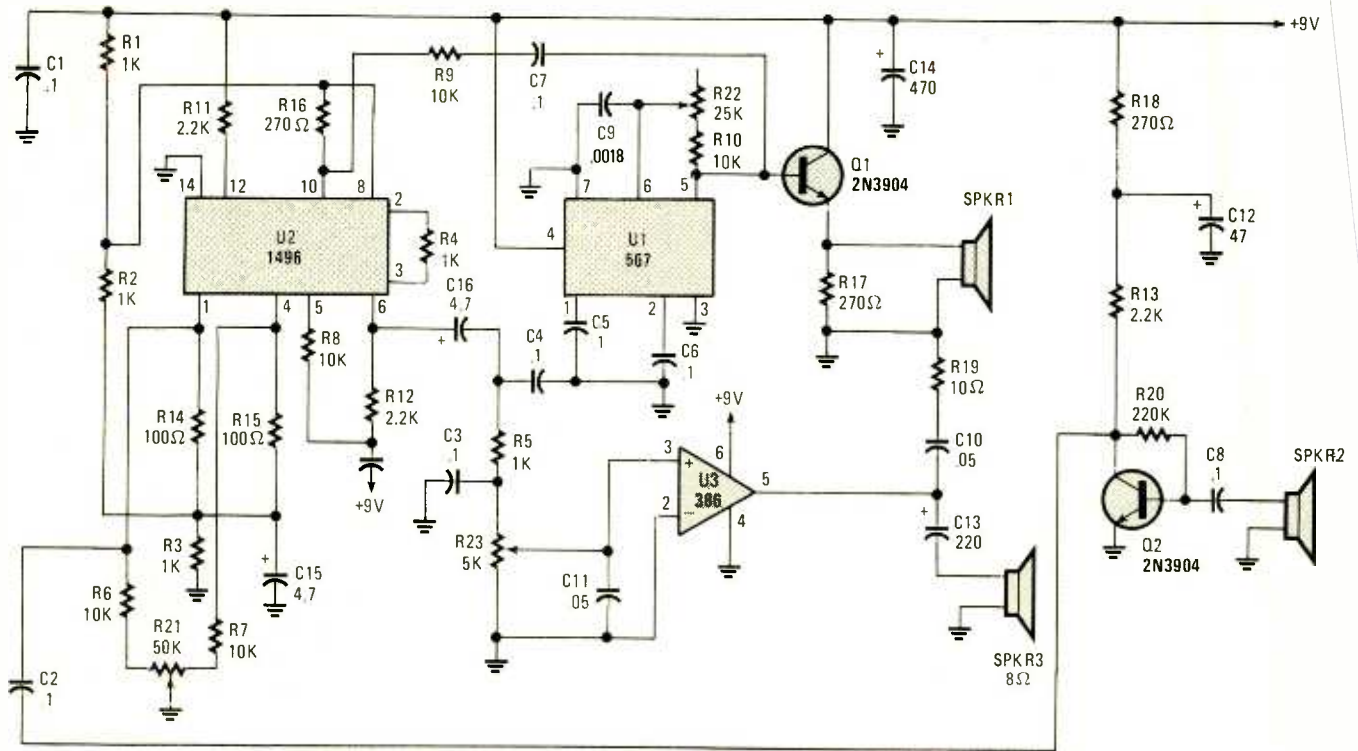

Fig. 5. The motion detector is based on the Doppler effect. If the sound source or the detected object is in motion, as they approach each other the sound increases in frequency and level; and as they pass, the frequency and level decrease.

conds after the start of the trace. That's 1 millisecond for the pulse to go from the transmitter's transducer to the solid object, and another 1 millisecond for the return trip, for a total distance of 2 feet.

Motion Detector. Another interesting characteristic of sound is the Doppler effect. The Doppler effect occurs when the source that's generating the sound is in motion. As the source approaches, the sound increases in frequency and level; and as it passes, the frequency and level decrease. If the sound source is stationary and you move toward or away from the source, the same Doppler effect occurs.

The circuit in Fig. 5 uses the Doppler effect to detect movement within a given area. A high-frequency sound source (15 to 25 kHz) is directed toward the desired area, and a sensitive transducer is positioned close to and aimed in the same direction as the transmitter's transducer. As long as there is no movement within the area, the reflected sound and transmitted sound will be of the same frequency. Any movement will cause a slight frequency shift to be detected by the receiver.

U1 (a 567 phase-locked loop) is configured as a tunable oscillator with an output-frequency range of 15 to 25 kHz. Potentiometer R22 is

**PARTS LIST FOR THE
LOW-FREQUENCY OSCILLATOR**

U1—555 oscillator/timer, integrated circuit
 R1—1000-ohm, 1/4-watt, 5% resistor
 R2—47,000-ohm, 1/4-watt, 5% resistor
 C1—0.01- μ F, ceramic-disc capacitor
 C2—0.001- μ F, ceramic-disc capacitor
 C3—4.7- μ F, 16-WVDC, electrolytic capacitor

used to adjust the output frequency of the oscillator. The output of U1 is buffered by Q1 and fed to BZ1 (the transmitter transducer).

The reflected sound is picked up by BZ2 (in the receiver portion of the circuit) and applied to the base of Q2. The amplified output of Q2 is fed to U2 (a double balanced mixer) at pin 1. Another signal (taken from the output of U1) is fed to U2 at pin 10. Resistor R21 (a 50k potentiometer) which is used as a carrier-balance control that can be adjusted to keep the oscillator's signal from appearing in the mixer output at pin 6 of U2.

The mixer's output at pin 6 of U2 is fed through a low-pass filter to the input of U3 (a 386 low-voltage audio power amplifier). A speaker or headphones can be used to monitor the output of

U3. Potentiometer R23 is used as a volume control.

Nothing about the circuit is critical. In fact, the circuit can be built on a section of perfboard. And if you follow a neat layout scheme (keeping all leads as short as possible), you should have no trouble. It would be a good idea to separate the receiver's input and the transmitter's output circuitry as much as possible in the layout, and to socket all IC's.

Once the circuit has been assembled, it will be necessary to check its operation. Start by positioning the two transducers about 4 inches apart, facing in the same direction, and away from any close objects. Set R21, R22, and R23 to mid position and apply power to the circuit. If you can hear the transmitter's output, the oscillator's frequency is set too low; adjust R22 to the point where you no longer hear it.

Adjust R21 for the quietest output in SPKR1. Wave your hand back and forth in front of the transducers and you should hear a varying low-frequency tone. The faster the movement, the higher the output frequency. For really slow moving objects, you might want to connect an analog DC meter to the output of U3 at pin 5. The meter's needle will vary up and down the scale as the slow-moving object passes in front of the transducers. ■

POPULAR ELECTRONICS

SELECT 5 BOOKS for only \$4⁹⁵

(values to \$131.70)
and get a **FREE Gift!**

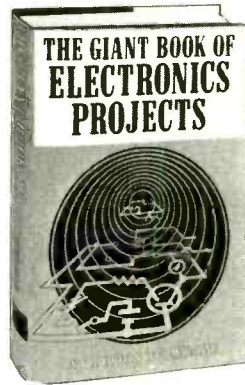
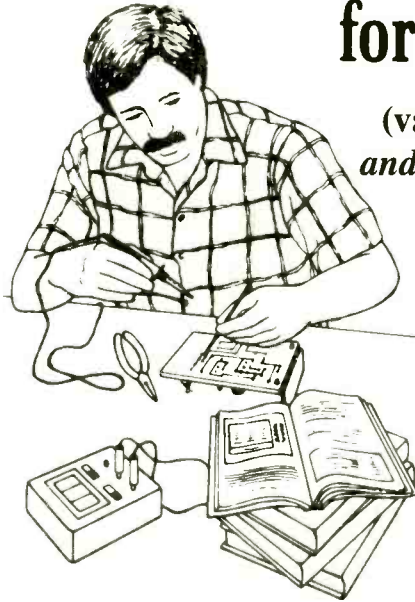

1367P \$24.95



2883P \$17.95

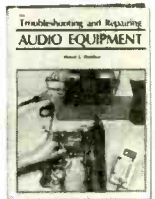

2867P \$18.95



2826P \$16.95



2613P \$17.95



1625P \$22.95

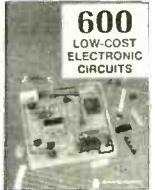

3219 \$27.95
Counts as 2

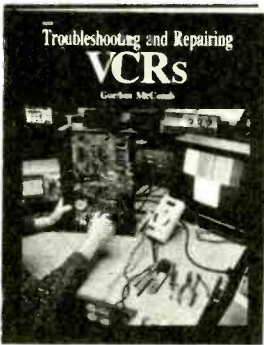

2960 \$27.95
Counts as 2



2950 \$21.95

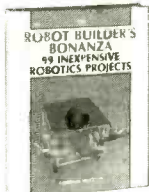

2800P \$16.95

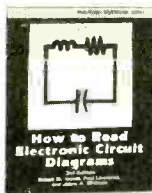

2880P \$14.95



3044P \$11.95



2331P \$15.95



3072P \$16.95



3260 \$22.95

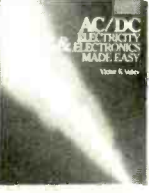

3285 \$25.95
Counts as 2

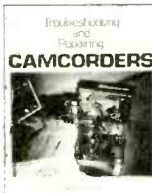

3337 \$35.95
Counts as 2



3226 \$22.95

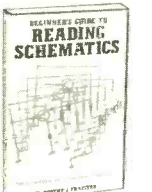

1536P \$11.95



3205 \$24.95

For 25 years, your most complete source for electronics books.



3165 \$17.95



1897P \$14.95

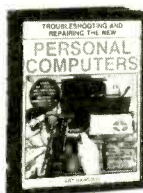

2809 \$29.95
Counts as 2



804P \$21.95
Counts as 2



3267 \$24.95



3145 \$19.95

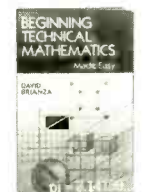

3383 \$14.95



1599P \$17.95

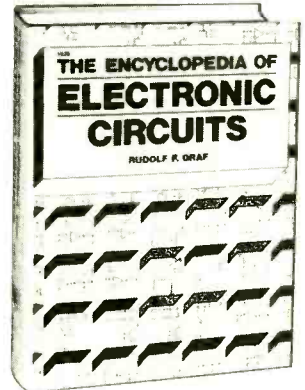

1938P \$29.95



3155 \$19.95



3258 \$27.95
Counts as 2



3358 \$28.95
Counts as 2



1133P \$14.95



2925P \$9.95



2926 \$25.95

FREE when you join!

15 Easy Electronic Projects From Delton T. Horn
Projects you can build—some unique, some old favorites—from the author's vast treasury of electronics know-how.



A \$7.95 Value!

Delton T. Horn's
All-Time Favorite
Electronic Projects

Membership Benefits • Big Savings. In addition to this introductory offer, you keep saving substantially with members' prices of up to 50% off the publishers' prices. • **Bonus Books.** Starting immediately, you will be eligible for our Bonus Book Plan, with savings of up to 80% off publishers' prices. • **Club News Bulletins.** 15 times per year you will receive the Book Club News, describing all the current selections—mains, alternates, extras—plus bonus offers and special sales, with scores of titles to choose from. • **Automatic Order.** If you want the Main Selection, do nothing and it will be sent to you automatically. If you prefer another selection, or no book at all, simply indicate your choice on the reply form provided. You will have at least 10 days to decide. As a member, you agree to purchase at least 3 books within the next 12 months and may resign at any time thereafter. • **Ironclad No-Risk Guarantee.** If not satisfied with your books, return them within 10 days without obligation! • **Exceptional Quality.** All books are quality publishers' editions especially selected by our Editorial Board. PE990

If card is missing, use this address to join:
ELECTRONICS BOOK CLUB, Blue Ridge Summit, PA 17294-0810

©1990 ELECTRONICS BOOK CLUB

All books are hardcover unless number is followed by a "P" for paperback (Publishers' Prices Shown)

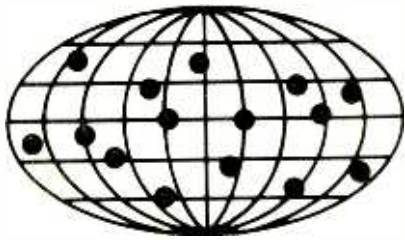

DX Listening

By Don Jensen

TUNE IN TO RED CROSS BROADCASTING

For nearly 130 years, in war and peace, the International Committee of the Red Cross has been dedicated to bringing medical help, aid, and comfort to suffering humanity around the world. Red Cross workers can be found on battlefields, in hospitals and prisoner-of-war camps, and at the scene of natural disasters including floods, earthquakes and hurricanes.

The international relief organization, headquartered in Geneva, Switzerland, operates under seven basic principles—humanity, impartiality, neutrality, independence, voluntary service, unity, and universality. It takes no sides in political disputes and military conflicts. Its only job is to alleviate suffering.

Although many SWLs don't know it, the International Red Cross has, for the past 45 years, spoken to the world via shortwave radio.

The ICRC began broadcasting from Geneva in May 1945, at the end of World War II. With normal communications disrupted, the Red Cross in neutral Switzerland aired lists of displaced persons and released prisoners-of-war. For their families elsewhere in Europe, these transmissions brought welcomed news that their loved ones were alive and coming home. In less than four years, some 600,000 names were broadcast by the Red Cross.

The International Broadcasting Conference, meeting in Mexico City in 1948, took an unusual step. Putting aside differences and recognizing the universal good accomplished by the Red Cross, the broadcasting delegates from around the globe granted the ICRC its own shortwave frequency.

Shortwave test transmissions, ori-

ginating from borrowed radio facilities, began three years later and continued irregularly until 1965. The purposes of these broadcasts was to determine worldwide reception coverage. In 1965, the ICRC obtained its own broadcasting studio at its Geneva headquarters and formed the Red Cross Broadcasting Service.

The Swiss postal and radio authorities in 1978 made more-powerful shortwave transmitters available to the ICRC on a monthly basis. Regular, though limited, programming in English, French, German, Spanish, Arabic, and, later, Portuguese, began.

Today, the Red Cross Broadcasting Service still has a very limited programming schedule. That is why many SWLs not only have not heard this station, but haven't even heard of it.

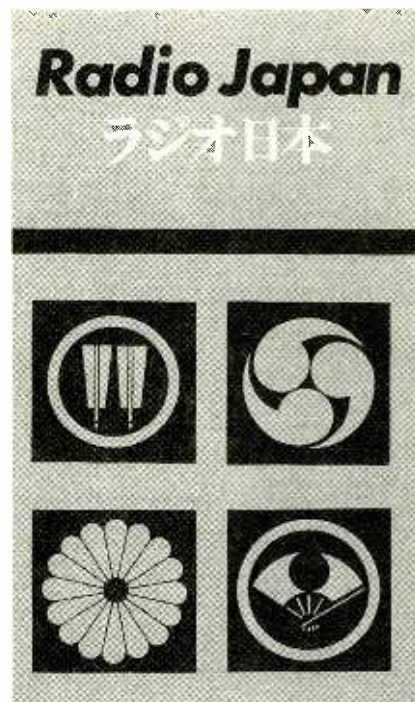

This attractively designed program schedule leaflet was sent to SWL's by Radio Japan, one of the more popular international shortwave broadcasters.

ICRC's radio broadcasting staff consists of only two program producers, plus a studio technician. But programming is also supported by other Red Cross personnel in Geneva and by freelance part time broadcast journalists. Twice a month, using a 100-kilowatt transmitter and omni-directional antenna at Beromunster, Switzerland, programs in four languages are aired on 7,210 kHz.

A better bet for American and Canadian shortwave listeners are the English-language transmissions beamed to north America, normally two or three days each month, from 250-kilowatt Swiss transmitters at Schwytzenburg. This North American "beam" is usually broadcast on Tuesdays and Fridays during the last week of the month.

For instance, try tuning the Red Cross broadcast on Oct. 2 and 5, Oct. 30 and Nov. 2, and Nov. 27 and 30, at 0310 UTC. Remember that 0310 UTC Tuesday/Friday is actually Monday/Thursday night in North America.

At the time of this writing, the frequencies in use were 6,135, 9,725, 9,885, and 12,035 kHz. The programs, only 17 minutes in length, include Red Cross news, interviews, informational briefs, and actuality tapes and answers to listeners' letters.

Listener reports are welcomed by the Red Cross Broadcasting Service. Its address is 19 Avenue de la Paix, 1202 Geneva, Switzerland. To receive a QSL card, don't forget to include return postage in the form of one or several International Reply Coupons.

Feedback. I always enjoy hearing from you with your shortwave listening comments and questions, along with information about what stations you're hearing. You can send your letters to me in care of "DX Listening," **Popular Electronics**, 500-B Bi-County Blvd., Farmingdale, NY 11735.

This month's mail included several questions about published station lists. Henry Ward, Philadelphia, PA, inquires about an old time list of radio stations called *White's Radio Log*. This listing really dates back to the 1920's, but in more recent times appeared in the no-longer-published magazine, *Communications World*. *White's* contained an abbreviated listing of worldwide shortwave stations, plus a rather complete compilation of U.S. and Canadian AM, FM, and TV stations, arranged by frequency, by call letters, and by city.

"Do you know if *White's Radio Log* is

still published," asks Henry. "It has not been seen on the newsstands."

The magazine which included White's Log has not been published in a number of years, Henry. But the rights to the *White's Radio Log* later were acquired by another company which published the listing in book form about five or six years ago.

With the passage of time, some of the information is outdated, but much of it, particularly that dealing with domestic AM/FM stations, probably is still accurate. The publisher is Worldwide Publications Inc., P.O. Box 5206, North Branch, NJ 08876.

"Help, please!" writes Bruce Gilreath, Fountain Inn, SC. "Where can I get a comprehensive schedule of shortwave broadcasts? I've searched libraries and bookstores with no success.

"Would there be a reference source available that would include addresses for the major overseas broadcasters? I have seen such books in stores in England, but nothing similar in the USA. I realize that stations give their addresses at the close of the broadcasts, but this would be a tedious process, compiling a list from scratch."

In my opinion, Bruce, the best and

most comprehensive schedule of shortwave broadcasts, presented in a very useful chart form, is the annual *Passport To World Band Radio*.

The 1991 edition should be off the presses in September. You can find copies in bookstores and electronics dealers. The 1990 edition was priced at \$14.95 in the U.S., \$19.95 in Canada. The publisher is IBS Ltd., Box 300, Penn's Park, PA 18943.

For the addresses of worldwide SW stations, I prefer the *World Radio TV Handbook*, published annually since 1947, originally in Denmark, although its editorial offices now are in the Netherlands. Doubtless this is the book that you saw in British stores, Bruce.

The 1990 edition, priced at \$19.95, has been available since January, with the next issue due out early next year. It, too, can be found in some electronics stores and book shops. Or you can write to its U.S. sales office, Billboard Publications Inc., 1515 Broadway, New York NY 10036.

Down The Dial. What can you hear on the shortwave bands? Here are some of the stations being reported by listeners recently.

Haiti—4,930 kHz. The religious broadcaster, *4VEH* in Cap Haitien is the only shortwave station operating from this poverty-ridden West Indian nation. The best time to try for this one, programming in the French Creole language, is about 1100 UTC.

Paraguay—9,735 kHz. This is one of the rarer of the South American nations to log on shortwave. But Spanish language programming from *Radio Nacional* in Asuncion can be heard on this frequency during the early morning hours, say around 0900 UTC.

Saipan—17,780 kHz. *The Christian Science Monitor*, which operates shortwave stations in Maine and South Carolina, also has another SW outlet in the Pacific in the Commonwealth of the Northern Mariannas. This formerly used the call letters KYOI but is now known as KHBI. Look for this one at 0400 UTC sign on.

Tunisia—12,005 kHz. *Radio TV Tunisienne* is logged here, parallel to 7.475 kHz, with Arabic programming around 2000 UTC.

United Arab Emirates—13,605 kHz. Abu Dhabi, in the Persian Gulf, is reported airing an English program called "The Holy Prophet" at 2330 UTC. ■

Make the most of your general coverage transceiver with *Monitoring Times*!

Every month *Monitoring Times* brings everything you need to make the most of your general coverage transceiver: the latest information on international broadcasting schedules, frequency listings, international DX reports, propagation charts, and tips on how to hear the rare stations. *Monitoring Times* also keeps you up to date on government, military, police and fire networks, as well as tips on monitoring everything from air-to-ground and ship-to-shore signals to radioteletype, facsimile and space communications.

ORDER YOUR SUBSCRIPTION TODAY before another issue goes by. In the U.S., 1 year, \$18; foreign and Canada, 1 year, \$26. For a sample issue, send \$2 (foreign, send 5 IRCs). For MC/VISA orders (\$15 minimum), call 1-704-837-9200.

MONITORING TIMES

Your authoritative source,
every month.

P.O. Box 98
Brasstown, N.C. 28902

Improve Your Form.

3-Part

A continuous feed form used for customer c.o.d. service or parts/accessory sales receipts (N3CN). Not for warranty billing. Computer generated software to be available soon.

5-Part

Available in snapshot (N5SN) or continuous feed (N5CN). Matching fields with N3SN, except for customer estimate and receipts. For warranty billing.

7-Part

A universal snapshot form (N7SN) designed for both customer service c.o.d. and manufacturer warranty billing. Complies fully with the requirements of state and local ordinances, including California.

Discounts

Carbonless NESDA Forms are available to NESDA members at additional savings. For pricing information and samples, or information regarding other NESDA membership benefits, write to NESDA, 2708 W. Berry St., Ft. Worth, TX 76109; or call (817) 921-9061.

The NESDA Form

NESDA, 2708 W. Berry St.
Fort Worth TX 76109
Phone: (817) 921-9061



Ham Radio

By Joseph J. Carr, K4IPV

AN EASY RECEIVER KIT

Construction projects have long been part of the ham-radio hobby. Today, a number of companies make small kits that are readily built in an evening or over a weekend, making it easier to build at least some of your own gear than ever before.

But few of these "one-nighters" are so grandiose as to be called receivers. However, Ramsey Electronics (793 Canning Parkway, Victor, NY, 14564; 716-924-4560) does offer the SR-1, a battery operated unit that covers a selected 2.5-MHz band in the range between 4 and 10.5 MHz. That means that the receiver can be used to cover the 40-meter amateur band, the 8-MHz utilities band, the marine and aviation band, and the 9-MHz international-shortwave broadcast band.

For those of you who are unfamiliar with the company, Ramsey makes several kits for hobbyists, as well as an excellent line of frequency counters (I use a Ramsey 600-MHz counter on my workbench). The cost of the receiver with a black plastic cabinet is in the \$40 range; it can also be purchased without the cabinet for less. Contact the company directly for their current prices, as well as necessary ordering information, etc.

Inside the Receiver. The SR-1 short-wave receiver (see Fig. 1) is based on the Signetics NE-602 RF-converter chip. That chip provides the local oscillator and a double-balanced mixer in a single, eight-pin miniDIP. In the case of the Ramsey SR-1, the input is untuned. The signal from the antenna is coupled to the broadband input transformer through a 5000-ohm "RF-gain" control that actually functions as an attenuator (note: direct antenna-circuit RF attenuation is an antique method that Ramsey resurrected).

The local oscillator circuit is inside the NE-602 chip, but requires external tuning components. In the case of the SR-1, Ramsey elected to use a series-tuned, variable-frequency oscillator. The inductor in the LC-tuning network consists of an IF transformer with its internal capacitor disconnected. Only one winding of the transformer is used, but I suspect that the other winding would make a dandy alternative output for the oscillator in case one wished to drive a digital frequency-counter display. The capacitor in the LC network is D1, a Varactor diode. For those unfamiliar with those devices, a Varactor produces a capacitance that is proportional to the applied voltage, and

therefore can be used to electrically tune a resonant circuit. The tuning voltage is provided via a potentiometer.

The NE-602 is designed to operate from between +4.5- and +6-volts DC, so the 1k resistor in series with the +V terminal (pin 8) is absolutely required. The DC power supply is a 9-VDC transistor-radio battery mounted directly to the printed-circuit board. If you want to make this radio receiver into an AC-operated model then you will need to build an external power supply. A type 7809 three-terminal voltage-regulator IC will provide a 9-VDC regulated output from a +12-volt DC power supply.

The use of a voltage-regulated power supply, as described above, will also help one problem with this design: Since tuning is a function of applied voltage, the receiver will unavoidably drift as the battery voltage drops.

The receiver is a superheterodyne model, meaning that it converts the input RF frequency to a lower, intermediate frequency (IF). The IF frequency is the difference between the RF frequency and the local oscillator (LO) frequency; that is: $IF = RF - LO$. In this project, the IF frequency is 260 kHz, so components from Japanese AM car radios can be used. However, there is a built-in limitation because of that 260-kHz IF frequency: The image frequency is too close to the RF frequency, so one can expect a terrible image response above about 10 MHz or so. That's why, even though the chip itself will convert up to 200 MHz, the receiver is not suitable for higher-frequency operation.

In the model that I received, the audio-output stage is a single 2N3904 transistor driving a set of earphones (not included). But the Ramsey people tell me that the design will be changed probably by the time that you read this article. The new circuit is the same as the old except that the AF-output amplifier will be replaced with a high-gain LM386 IC audio stage, shown in Fig. 2. That design provides higher gain and higher audio-output power—a complaint that Ramsey tells me some builders made.

You can either build the receiver as is, or use it as the basis for a project of your own. For example, you can replace the 260-kHz IF transformer and the tuning-circuit components to make the circuit work at higher frequencies. You could also alter the tuning circuit to change the range. Adding some capacitance in parallel with the Varactor will reduce the minimum frequency below 4 MHz.

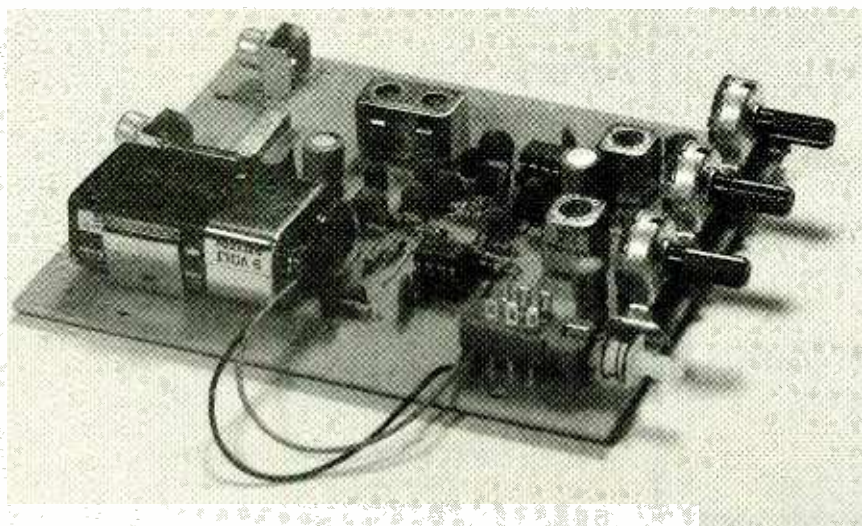

The Ramsey SR-1 receiver kit is simple enough to build in an evening or two.

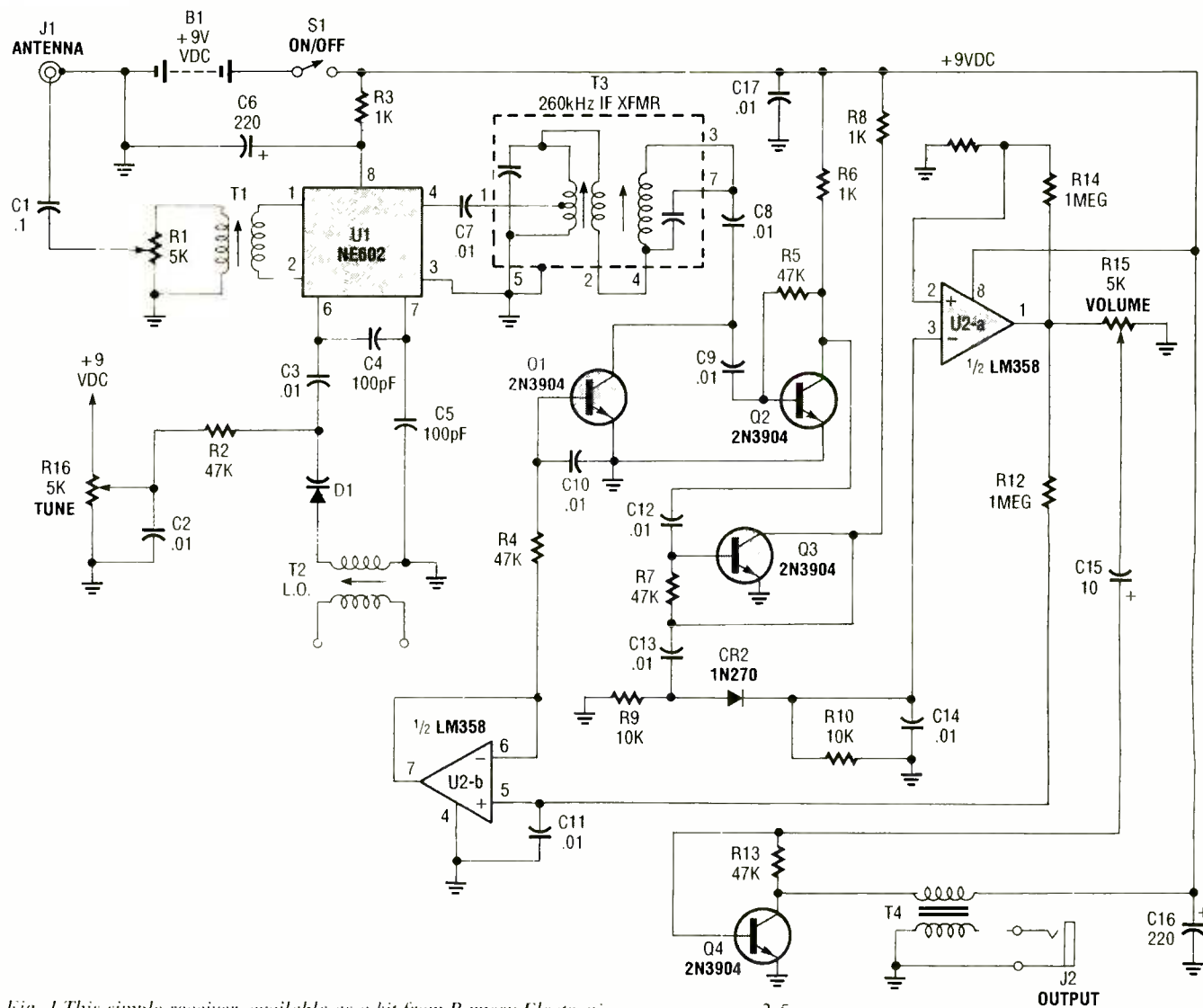

Fig. 1 This simple receiver, available as a kit from Ramsey Electronics, can cover any 2.5-MHz band between 4 and 10 MHz.

Winding new input and LO coils will also change the range. You can add a beat-frequency oscillator at the detector diode to make CW/SSB reception possible.

Alternatively, you can replace the IF tuning with a low-pass filter that cuts off everything above about 3 kHz and use the circuit as a direct-conversion receiver. In direct-conversion circuits, the LO operates on the RF frequency, so the difference is the modulating audio. The direct-conversion technique works well on CW and SSB, but for AM it must be exactly zero-beat with the received carrier or a beat note will be heard.

More on Computers and Ham Radio. MFJ Enterprises, Inc. (POB 494, Mississippi State, MS, 39762; 601 323-5869) announced the release of a software package for hams called *Easy-DX* (Cat. No. MFJ-1281) that allows you to organize your DX activity. It provides a log, a

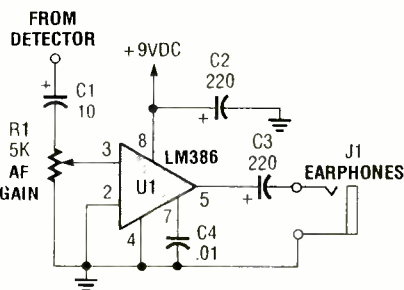

Fig. 2. By the time you read this, the receiver will be available with this new, higher-gain output stage.

terminal program, and a packet-cluster program for only \$39.95.

The program allows you to enter a call sign that you hear on the band, and it tells you immediately if you've worked that station before and whether you need that country on that band or mode (or both). If you enter a call sign or prefix, it will give the name of the country, azimuth from your QTH to a

major city in that country, and local sunset/sunrise times.

For those interested in packet radio, the program includes the *PacketCluster* software. There are two packet screens: receive only and receive/transmit.

The *Easy-DX* program will even print the QSL-card labels for you, prints out a summary of DXCC activity (including band and mode), prints out daily log sheets, and lets you update the log as QSL cards arrive.

The *Easy-DX* software comes on two 5.25-inch floppy disks and requires an IBM-PC compatible computer with at least 512K of RAM memory, and a hard disk is "strongly recommended."

We are always pleased to hear from you with your thoughts on ham radio and this column. Our address is: *Ham Radio, Popular Electronics*, 500-B Bi-County Boulevard, Farmingdale, NY 11735



Scanner Scene

By Marc Saxon

MONITORING THE MILITARY

Handheld scanners have come into their own, having rapidly grown in popularity in recent years. Still, one of the universal complaints about handhelds has been that some operators find the compactness of the control panel to be just a wee bit too tiny for man-sized hands and fingers.

Cobra Electronics addressed that problem when they designed their new SR-11 handheld. The unit features a totally uncluttered control panel that operates with the company's new "Express Tuning System." The SR-11 is a fully-programmable 10-channel scanner that requires only ten (mostly large-sized) pushbuttons to program and operate all its functions. Yet it offers squelch, individual channel lockouts, dual-speed scanning, and the other features you'd look for in a quality handheld.

The frequency range is ample—29–54 MHz, 136–174 MHz, and 400–512 MHz. That takes in the most popular public-safety, industrial, maritime, federal, transportation, and VHF ham bands. The antenna connector is a BNC type, and the LCD readout is large and bright enough to see even if you can't remember where you left your specs. The SR-11 uses four "AA" alkaline or NiCd batteries.

There are some other things that we liked about the SR-11: It's good looking, it's well-made by a company known for quality products, it's easy to operate, and—at \$189.95 suggested retail—it's quite reasonably priced.

For more information on the Cobra SR-11, call Cobra's toll-free consumer hot-line, at 1-800-COBRA-22, or write to Cobra Electronics Group, Dynascan Corp., 6500 West Cortland St., Chicago, IL 60635.

Across the Bands. The many excellent features of the Realistic PRO-2004 and PRO-2005 scanners made those units enormously popular. Both offer scanner owners the ability to monitor the 225–400-MHz band. However, the

questions we receive about that band make it apparent that at least a few words about that corner of the spectrum are in order.

Although there are military-communications satellites using that band, scanner owners should generally be most interested in monitoring the military-aeronautical traffic found there. Note that you'll want to make certain that your scanner is programmed to receive in AM mode in that band when you're monitoring aeronautical communications. With the PRO-2004 and PRO-2005, that will require that you manually override the natural inclination of both models to operate in NFM mode when scanning or searching within that range.

There is a lot to monitor there. Even



With its uncrowded control panel and oversized buttons, Cobra's SR-11 is one hand-held that's easy to operate, even if your hands are large. It features ten programmable channels, and accesses weather, police, fire, and emergency bands.

though it is a military band, most civilian-airport control towers are assigned one or more frequencies between 255 and 400 MHz in addition to their basic VHF aeronautic-band (118- to 137-MHz) frequencies. Most FAA Flight Service Stations can operate on 255.4 MHz, with some also capable of using 272.7 MHz. The emergency frequency in that band is 243.0 MHz.

Command posts and aircraft of the USAF's Strategic Air Command use 311.0 and 321.0 MHz. A similar frequency used by the USAF's Tactical Air Command is 381.3 MHz, with the Military Airlift Command using 349.3 MHz for its command posts. Many U.S. Navy control towers operate on 340.2 MHz and/or 360.2 MHz, and 236.6 MHz is commonly used at numerous USAF bases. Although there are many variations, you'll find that 257.8 MHz is popular with civilian-airport control towers.

The North American Aerospace Defense Command (NORAD) usually can be heard on 364.2 MHz, and if you tune to 235.1 MHz, you're likely to hear a USAF tanker aircraft engaged in refueling another aircraft. Frequency 372.2 MHz is used by the USAF for aircraft working ground-station dispatchers; it's similar to a unicom-type operation. Military air/ground communications relating to weather conditions take place on 239.8, 342.5, 344.6, or 375.2 MHz at various U.S. Air Force and Navy air bases.

U.S. Coast Guard operations can often be heard on 381.7, 381.8, and 383.9 MHz; search-and-rescue activities are on 282.8 MHz.

Of course, there are many more things to hear, including training missions, war games, and other military pursuits. The frequencies given here are just a sampling to point you in the right direction and get your appetite charged up. You might want to try searching out additional frequencies; set your scanner at 50-kHz frequency "steps."

Let us know what you hear!

By the way, any time that we mention scanning aeronautical frequencies the reader response is very enthusiastic. Typical is a letter we received recently from John Hammerly, an instructor at Rhinelander High School in Rhinelander, WI. John tells us that one of the main reasons he bought his scanner was to monitor aircraft frequencies. As a student pilot, he finds that listening is not only more interesting, but educational as well.

We never ceased to be amazed at

the rather phenomenal interest our readers have displayed in monitoring their local McDonalds' drive-in windows. A continual flow of letters arrives on that subject. But until the letter from Jim Conerty of Palos Heights, IL, arrived not long ago, we never knew what was so interesting to hear.

John reports that a nearby McDonalds uses a small repeater system with the low-power output on 154.57 MHz. He suspects that the input to the system might be 35.02 MHz. He says that monitoring 154.57 MHz permits you to hear everything said by the employees inside—and sometimes their comments about the customers and the orders they place are hilarious. Although 154.57 MHz is a 2-watt (maximum power) frequency, John can receive those transmissions from a half mile away. His scanner uses an indoor antenna.

A letter from Mark Gregory of Battle Creek, MI, arrived in the same mail delivery as John Conerty's. Mark also reports that in his area the McDonalds drive-in activities are monitored on 154.57 MHz. Although we have received letters from several other areas mentioning various other frequencies, certainly 154.57 and 35.02 MHz seem to be the two channels that are most often reported.

Now that I've finally learned why fast-food monitoring has so many supporters, I'll probably give it a try myself—although it's hard for me to imagine how witty an order for a hamburger and fries can get. We'll see!

Don McNulty of Sayville, NY, writes that on 164.55 MHz he often receives transmissions with the voice obscured by some sort of noise. The noise seems to be deliberate, and, although he can hear the voice beneath it, the voice is rendered useless. Don asks if we know who or what might be causing that problem.

That particular frequency is used nationally by the U.S. Coast Guard for tactical and enforcement purposes. I have monitored digital voice scrambling there, in the past, but not the type of transmissions described by Don. However, I would assume that they represent a communications-security technique of some type.

Your letters, photos of stations, comments, questions, and frequency listings are always welcome here. Write to *Scanner Scene*, **Popular Electronics**, 500-B Bi-County Blvd., Farmingdale, NY 11735.

ANTIQUE RADIO

(Continued from page 79)

tested for heater-cathode leakage. Since the heater and cathode are in very close association, a small breakdown in the insulation between them could easily create a leakage path. Even if the leakage isn't great enough to cause the tube to stop functioning, it will almost certainly make it noisy—a very undesirable effect.

Figure 4 is a simplified schematic of a cathode-heater leakage circuit. Since tubes with cathodes are generally lit by AC rather than DC, I've substituted a step-down transformer for the battery used to heat the tubes in our previous examples. As usual, there's a battery to provide plate voltage and a milliammeter to show plate current. The grid is tied to the plate, as it would be in an emission-type tester, but it could just as well be wired as in our "grid-shift" testing example.

Notice that the cathode of the tube is connected to the heater through a switch shown in the closed position. With the switch closed, plate current flows through the tube in the normal manner and is indicated on the milliammeter. Opening the switch, however, will break the cathode-heater connection, and that should stop the current flow through the tube, causing the milliammeter to drop to zero.

If there is leakage between cathode and heater, however, plate current would continue flowing through the tube via the leakage path. The current would probably have a much lower value than with the switch closed. But, whatever its value, any current indication on the meter with the switch open is a sign of cathode-heater leakage.

See You Next Month. At that time we'll discuss practical circuitry for a simple tube checker that will carry out all of those tests. Until then, I'd like to hear from you! Write *c/o Antique Radio*, **Popular Electronics**, 500-B Bi-County Blvd., Farmingdale, NY 11735.

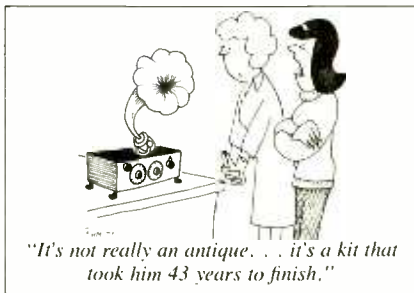

ATTENTION SCANNER & CB USERS

Radio Call Sign/Frequency Information

*Difficulty finding who
you want to hear?*

Easy to read listings of:

Police	Fire
Local Gov't.	Emergency Medical

*All information is indexed
by both call sign & name.*

Available: by county, within state
Only \$12.50 for first county.
\$6.00 for each additional county
• \$5.00 for freight & C.O.D.
• Advance payment we pay the freight

call or write
ACTION DATA PROCESSING INC.
817 Silver Spring Ave.
Silver Spring, MD 20910
1-800-526-8270

CIRCLE 17 ON FREE INFORMATION CARD

LEARN VCR

CLEANING/MAINTENANCE/REPAIR
EARN UP TO \$1000 A WEEK, WORKING
PART TIME FROM YOUR OWN HOME!



THE MONEY MAKING OPPORTUNITY OF THE 1990'S

IF you are able to work with common small hand tools, and are familiar with basic electronics (i.e. able to use voltmeter, understand DC electronics)

IF you possess average mechanical ability, and have a VCR on which to practice and learn... then we can teach YOU VCR maintenance and repair!

FACT: up to 90% of ALL VCR malfunctions are due to simple MECHANICAL or ELECTRO-MECHANICAL breakdowns!

FACT: over 77 million VCRs in use today nationwide! Average VCR needs service or repair every 12 to 18 months!

Viejo's **400 PAGE TRAINING MANUAL** (over 500 photos and illustrations) and **AWARD-WINNING VIDEO TRAINING TAPE** reveals the **SECRETS** of VCR maintenance and repair—"real world" information that is **NOT** available elsewhere!

Also includes all the info you'll need regarding the **BUSINESS-SIDE** of running a successful service operation!

FREE INFORMATION
CALL TOLL-FREE 1-800-537-0589

Or write to: Viejo Publications Inc.
3540 Wilshire BL. STE. 310
Los Angeles, CA 90010 Dept. PE

CIRCLE 8 ON FREE INFORMATION CARD

ALL ABOUT LASERS

(Continued from page 71)

microns. An Nd:YAG laser typically creates a true circular beam with a diameter less than 5 mm and a power up to 600 watts. The divergence of the beam will change as the crystal rod heats and expands, but a well-designed solid laser can hold divergence to less than 2 milliradians.

A powerful cooling system is needed to remove the tremendous heat created by constant optical pumping. A "chiller" can be used here, just as for a gas laser, to circulate a mixture of water and ethylene glycol through a cooling manifold around the laser cavity. A high-voltage power supply will also be needed to supply energy to drive the light source.

The output beam will usually follow the pumping source—that is, a constant light source will pump the laser 100% of the time and produce a con-



Here are some laser lenses. Like diamonds, their clarity is an important characteristic. Depending on their application, a small imperfection could lead to a lens cracking, which is very hazardous. (Photo provided through the courtesy of Melles Griot Inc.)

stant output beam. If a flash lamp is pulsed at a regular rate, it is possible to generate a pulsed laser beam. Not

Laser Safety

The energy released by certain lasers can very easily cause damage to skin and eyes. Lasers are generally classified by their hazard potential. The American National Standards Institute (ANSI) standard Z136 is a voluntary laser safety guide that suggests techniques and standards for safe use and construction. The legal standard is called 21 CFR 1040, and is published by the Federal Government in the Code of Federal Regulations. It breaks lasers down into four safety categories.

A Class I laser is not known to cause any type of injury at all. The beam power is below several milliwatts, which is too low to cause any appreciable reaction by the skin. Even though a Class I laser is considered safe for exposure to the eye, do not take any chances. Never look at any laser beam, no matter how it may be classified. Semiconductor lasers and very low-power He-Ne lasers are usually found in this category.

Class II lasers all produce light at some visible wavelength. They are more powerful than Class I devices, and can produce eye injury if the beam is viewed directly for more than a fraction of a second—even less if the beam is viewed through optics such as a magnifying glass. Skin is typically not damaged by a Class II laser. The maximum power output of a Class II laser is 1 milliwatt. General-purpose helium-neon lasers are usually considered Class II.

Any wavelength of laser light with 1 to 500 milliwatts of power is a Class III laser. The laser beams generated from those devices can cause serious eye injury. The skin can also be damaged if it is exposed to the beam for more than a split second.

A Class IV laser can generate laser light at more than 500 milliwatts of power. They can be extremely dangerous devices. Eyes and skin can be damaged instantly from a Class IV beam. They can also cause fires in porous materials. Even the reflections of a Class IV beam can be hazardous. Many CO₂ and YAG lasers—essentially all industrial lasers—are in this class.

There are several precautions that can be taken to improve laser safety. First, use laser-protective goggles to protect the eyes. Glass used in the goggles acts to filter out the wavelength of the beam. A different pair of goggles may be needed for work on various lasers with different wavelengths. Second, keep all laser enclosures in place. Never operate a laser with a covering or shroud removed. Similarly, never shine a laser at a reflective surface. Random reflections can be dangerous to bystanders as well as the operator. Third, wear protective clothing such as gloves or a hood. While they may offer little protection from the direct effects of a Class IV laser, any diffusion or reflection provided by clothing may help to minimize the depth or severity of a possible burn. ■

only can a higher peak power be created by pulsing, but the crystal does not get as hot. That can simplify cooling.

YAG Configurations. Most solid-type lasers manufactured today are built just about the same way. A high voltage DC power supply provides the voltage and current needed to drive a high-energy krypton-arc gas lamp. A laser crystal, usually in the shape of a rod, is placed parallel to the lamp within an extremely reflective enclosure. There are several crystals that can be used, but Nd:YAG is often chosen for its desirable wavelength and integrity at high temperatures. The reflective enclosure is formed to resemble an ellipse-shaped cylinder with the lamp at one focal point and the crystal at the other. The elliptical shape guarantees that a maximum amount of light leaving the lamp will be reflected into the crystal. High-temperature ceramics are currently being explored for use as the reflective surface. The low cost and high durability of ceramics is preferred over the conventional coatings of gold or silver.

Coolant is circulated through a water-jacket manifold, which is built into the reflective enclosure. Cooling is absolutely critical in a YAG laser. Without proper cooling, the extreme heat from the pumping source will quickly cause the crystal to warp and distort. It would not take much distortion to result in a dramatic loss of output power. Under prolonged thermal stress, the crystal could also fracture and fail entirely.

A reflective mirror is fixed to adjustable mounts at one end of the laser cavity, and the output mirror is installed in adjustable mounts at the other end of the cavity. General-purpose optical glass with standard reflective coatings will usually make good mirrors in Nd:YAG lasers.

YAG Applications. Solid-type lasers have readily established themselves in industry right alongside of many CO₂ lasers. Nd:YAG lasers are often pulsed for use as very effective spot welders. Pulsed YAG systems can also weld a complete seam with various types of metals, as long as each pulse point is overlapped with the next consecutive pulse. Pulsed-laser welding is sometimes preferred over continuous-laser welding since it results in a lower temperature increase in the welded material.

Nd:YAG systems are not very efficient at cutting metals. Their wavelength is

much more easily reflected by metals than the wavelength of CO₂ lasers. However, the incredible peak power levels that a pulsed Nd:YAG laser can produce is useful for performing very precise drilling operations on metals. Perhaps the most popular uses for Nd:YAG lasers is in marking applications. The laser beam is manipulated by a series of two external mirrors—one moving along the X axis, the other moving along the Y axis. Each axis is controlled by a computer. When the computer is made to direct the movements of the X and Y mirrors, the beam can be deflected to produce just about any pattern, even words and symbols.

Nd:YAG lasers have also become an accepted tool in medical applications. These lasers are often used to treat cataract patients. They are also used to perform laser endoscopy—surgery within the body without the need to actually open the body.

Optical Instruments. The most critical parameter of a useful laser beam is its optical power. An optical power meter is an instrument commonly used in laser applications to measure the power of a beam. The beam to be measured is directed into a heat-dissipating fixture often called a "thermopile." There, the laser energy is converted into heat in proportion to the beam's power. A sensor mounted inside the thermopile detects the heat and converts it to an equivalent DC voltage level. A calibrated meter reads the voltage and displays a power reading that corresponds to the measured heat. A high-quality meter can detect power levels to within .01 watt.

Another device, called an autocollimator, is used to align the reflective and output mirrors of an adjustable laser assembly. A low-power (usually incandescent) light source illuminates a "reticle" that sends a crosshair pattern to an optical-beam splitter. A small amount of light with that pattern is sent to the eyepiece, and the remainder is projected to the mirror that is to be aligned.

The pattern that is reflected from the mirror returns to the beam splitter and forms a second crosshair pattern in the eyepiece. The mirror is then carefully adjusted vertically and horizontally as required until both of the patterns are superimposed upon each other. When that is done, the mirror is perfectly aligned.

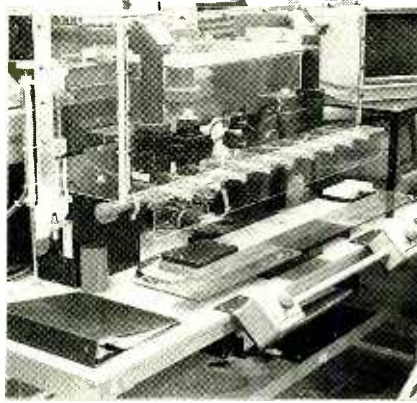

This is a view of a CO₂ laser in an industrial cutting application. Note the use of "dead-man" safety switches on the front of the bench. Such a laser is no toy.

Finally, the beam pattern itself may be seen by using a set of phosphorescent plates. The coating on those plates is sensitive to laser light, and will glow brightly where a beam strikes them. A technician can examine the shape of energy distribution in the beam, and align the optics if needed to achieve the desired distribution pattern.

Conclusion. Dye and semiconductor lasers have undergone some of the most significant growth in the past few years. Dye lasers can be made to lase very efficiently at wavelengths from the ultraviolet (390 nm), through the visible wavelengths of the light spectrum (up to 650 nm) with great amounts of power. That type of laser is showing promise in medical research and surgical procedures.

Semiconductor lasers will soon be responsible for transmitting the majority of analog and digital information over the extensive fiber-optic network currently being built around the world. Their safety, reliability, and ruggedness make them ideal for many diverse communications uses. Their output power and efficiency will continue to improve as semiconductor materials and fabrication techniques become more refined.

Since their inception more than 20 years ago, lasers have become an indispensable tool in commercial, industrial, and military systems. They have been made to measure, cut, mark, drill, weld, transmit data, perform surgery, and track military targets. New uses will be developed in the near future as laser materials become better and cheaper. ■

SOUND FEEDER

(Continued from page 77)

phone jack for the earphone output. Incidentally, if your player is monaural instead of stereo, the Sound Feeder will transmit monaurally.

There are a variety of different power-input jacks on tape and CD players. Not to worry; the 3-foot power cord, which plugs into a jack on the back of the Sound Feeder, terminates in a multi-plug that mates with four types of power input plugs: 3/32-inch subminiature phone plug; 3.5mm-O.D., 1.3mm-I.D. coaxial plug; 5.5mm-O.D., 2.1mm-I.D. coaxial plug; 5.5mm-O.D., 2.5mm-I.D. coaxial plug. That covers the vast majority of devices except those that use 1/8-in. miniature phone jacks, and those can be accommodated with a 3/32-in. subminiature jack to 1/8-in. miniature plug adapter, which you must get elsewhere.

However, even if the plug and jack match, the polarity may be reversed! The Sound Feeder provides positive voltage on the outer sleeve, with negative (ground) for the center hole or tip. No provision is made to reverse that polarity.

Although it violates the unit's warranty, physical and electrical mating differences can be resolved by cutting off the power cable's multi-plug output and soldering on the appropriate plug, using the proper polarity.

I found one other problem in using the Sound Feeder. I tested it with six different cassette players. They all transmitted beautifully to the FM radio. However, two of the six players produced a strong background hiss when I used the Sound Feeder to power the player. When I disconnected the Sound Feeder's power cord and used internal batteries on the players, the signal was clear. Apparently some players are not well shielded and motor noise gets into the power cable and back to the transmitter.

Don't get me wrong. I liked the unit, and will be using it to play micro-cassettes as well as standard cassettes in my cars. The 3-volt output and 1/8-inch earphone-input plugs supplied with the Sound Feeder work perfectly with my Panasonic microcassette recorder, which never sounded so good!

The Sound Feeder is manufactured by Arkon, 11627 Clark St., Suite 101, Arcadia, CA 91006. Write them for more information or circle No. 120 on the Free-Information Card. ■

HOW TO ANTENNA

(Continued from page 44)

A peak mount, again from the TV antenna trade, is shown in Fig. 2D. That type of mount is used on the peak, although some models are flexible enough to be used at other points on the sloping roof as well. Guying in at least two directions should be supplied for the mast. Again, follow the instructions regarding bracing and water-proofing.

Ground-Mounted Antenna Supports.

Once one end of the antenna is attached to the house, the other end of the antenna must be attached to some other support. If there is a convenient building, tree, or some other support nearby, then your problem is solved. Many a dipole has been terminated on the neighbor's tree or house. But if that's not possible, Fig. 3 shows a method for installing a ground-mounted antenna support (mast) along a line of chain-link fence posts. Alternatively, you can install a single fence post for the purpose of securing the mast. The fence post is installed in a post hole that has a concrete plug poured into the bottom, holding the pole. Earth and gravel is then backfilled over the plug.

The mast in this case is made of 2 × 4 lumber. Lengths up to 24 feet are available, although for practical purposes the longest that should be used is about 16 feet. A telescoping TV-mast can also be mounted to the fence post, and those can go up to more height than most of us need. The mast is fastened to

the fence post with at least two heavy U-bolts.

At the top of the mast is an eyebolt that is used to hold the rope that in turn supports the antenna. Don't replace the eyebolt with a pulley, even though that seems like the smart thing to do. Pulleys have a way of binding, or failing in other ways. A large eyebolt has no moving parts, so it is inherently more reliable than a pulley. Also, the rope should be considered a permanent part of the installation, so install the rope prior to raising the mast. A flag-pole rope stay can be used to secure the rope at the lower end. Tie the rope ends together and leave it that way to prevent the rope from slipping through the eyebolt when the heavy antenna wire is attached.

Figure 4 shows a means for making a tall, free-standing antenna mast using multiple 2 × 4's. In this case, a base section is formed with a series of three 2 × 4 segments, and then the mast 2 × 4 is installed on top of, and sandwiched between, the base lumber. As with all cases where 2 × 4 lumber is used, it should be weather and pressure treated. The bottom of the base section should be buried at least two feet deep and in a concrete plug similar to the fence post described earlier. It is necessary to either use lumber treated for burial in the ground (fence or deck lumber, for example), or treat it yourself with Creosote or some other preparation.

Antenna Strain Relief. Antennas move around in the wind, and that puts strain on the wire element and rope. In addition, when the mast is flexible (like a tree), the antenna will be tugged along with the mast. If steps aren't taken to compensate for that, after a little while the antenna is sure to break—and it will break a lot sooner if a high wind comes along.

There is no sure-fire means for protecting the antenna, but the strain relief methods of Fig. 5 can go a long way towards fixing the problem. In Fig. 5A a door spring (or similar spring) is used as a strain relief. A counterweight method is shown in Fig. 5B. The weight (W) is selected to keep the antenna barely taut in no more than a gentle breeze.

Electrical Connections. The electrical connections to the antenna are usually made using insulators that double as mechanical supports (see the inset in Fig. 5). The rope, either cotton or

nylon (preferred), is tied off to one end, while the antenna wire is connected to the other. Always cut the antenna wire about one foot longer than needed in order to make the connections. Pass the wire through the hole in the insulator, and then wrap it back on itself tightly five to seven times. The down-lead wire is attached just ahead of the twisted antenna wire, and is also twisted several times.

After sound electrical and mechanical connections are made, solder both with 50/50 or 60/40 lead-tin electronic solder (not plumber's solder). The purpose of the solder is not to provide mechanical integrity, but to prevent corrosion and maintain the electrical connection.

The same sort of insulator also works for the center point of dipoles. Alternatively, use either a special dipole center insulator, or a 1:1 impedance-ratio Balun transformer (Fig. 6).

Wire antennas are very popular among amateur-radio operators and shortwave listeners. In order to get the most out of such antennas, one must install them correctly. Following the guidelines presented above will permit you to optimize your installation. ■

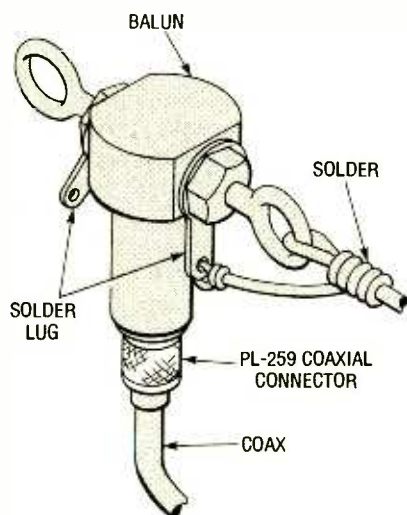

Fig. 6. Use the technique shown here to connect a dipole to a center insulator or Balun.

"The family suggests
that memorial
contributions be made
to the American
Heart Association."
When people want to
honor a loved one
and fight heart disease.

THE AMERICAN HEART
ASSOCIATION
MEMORIAL PROGRAM®



American Heart
Association 

This space provided as a public service.

ST. ELMO'S FIRE

(Continued from page 58)

thing happened. The only difference was that during and after St. Elmo's visit, "a peculiar shadowless twilight" appeared in the atmosphere. The light



There are several accounts of St. Elmo's fire becoming visible around the head of a human being. In this illustration, such a "natural beatification" is shown around the head of an Alpine climber. These luminous circles, much like saintly halos, were considered a fortunate prognosis and a sign of good luck.

was so strong that objects more than 300 feet away could be clearly seen. There was no moonlight. Dr. Stade tells us that it was as if he were standing "within a feebly self-luminous cloud." Just imagine, looking out from inside an electrical mist of ionized air! ■



GALVANOMETER

(Continued from page 36)

Galvanometer coil so that the mirror turns freely without hitting the inside of the coil.

Further Reading

Dunsheath, P., *A History of Electrical Engineering*, London: Faber & Faber, 1962.

MacLaren, M., *The Rise of the Electrical Industry During the 19th Century*, Princeton, NJ: Princeton University Press, 1943.

Snelders, H., "Schweigger: His Romanticism and His Crystal Electrical Theory of Matter," *Isis*, September 1961: pp. 328-338.

Wright, J., "The Development of the Galvanometer," *Cassier's Magazine*, September 1902: pp. 601-607.

Now locate a small slide or filmstrip projector. A good flashlight will also work. Aim the beam of light at the mirror and apply a DC voltage to the Galvanometer. Keep your eyes on the reflected spot of light. A small voltage will cause the mirror to turn and the spot to move. With a slightly higher voltage, the beam of light will spin around the room!

Experiment with different mirrors, different magnets, different coils, and different sources of light. You will find that this simple and inexpensive device makes for a great project and a lot of electromagnetic fun. ■

MUSIC BOX DOORBELL

(Continued from page 65)

The base or bottom piece was cut an inch longer than the case to provide room for mounting holes. All the parts were mounted on the base so the cover could be completely removed to change batteries. And be sure to drill holes in the enclosure to vent sound from the cabinet.

Installation. When the unit is completed, which terminals you use for input will be determined by your wiring. If pushing the doorbell gives you 8 to 17 volts of AC at your doorbell or chimes, use the D/C input terminals. If it is just a shorting pushbutton (that does not supply an external voltage, as would be the case if you were to use an existing doorbell transformer), use the A/B terminals.

Finally, adjust R12 to achieve the tonal quality that you desire; mandolin, piano, or organ sounds. ■

SPECIAL FROM ETT

SAVE \$\$ TODAY

□ **2617T—BUILD A REMOTE-CONTROLLED ROBOT** regular \$9.95 **SPECIAL \$8.95.** Fool-proof instructions for putting together your own full-size working robot at a fraction of the commercial cost.



□ **2645T—117 PRACTICAL IC PROJECTS YOU CAN BUILD** regular \$10.95 **SPECIAL \$9.95.** Dozens of fully tested ready-to-build circuits you can put together from readily available, low-cost ICs.



□ **BP53—PRACTICAL ELECTRONICS CALCULATIONS AND FORMULAE** regular \$6.95 **SPECIAL \$5.95.** Six basic sections: Units and Constants, Direct Current Circuits, Passive Components, Alternating Current Circuits, Networks and Theorems, Measurements.



□ **2706T—BUILDING METAL LOCATORS** regular \$9.95 **SPECIAL \$8.95.** A treasure hunter's project book. Build your own high-quality metal detector for a fraction of the factory-built cost.

□ **BP234—TRANSISTOR SELECTOR GUIDE** regular \$10.00 **SPECIAL \$9.00.** Offers a range of selection tables compiled so as to be of maximum use to all electronics engineers, designers and hobbyists.



Electronic Technology



□ **ETTCAT—ELECTRONIC TECHNOLOGY TODAY INC. CATALOG** **\$2.00.** 36-pages list a wide variety of electronics books. Included with catalog is a coupon good for \$3.00 off your first purchase.

MAIL TO: **Electronic Technology Today, Inc.**
P.O. Box 240
Massapequa Park, NY 11762-0240

SHIPPING CHARGES IN USA AND CANADA

\$0.01 to \$5.00	... \$1.25	\$30.01 to \$40.00	\$5.00
\$5.01 to 10.00	... \$2.00	\$40.01 to \$50.00	\$6.00
\$10.01 to \$20.00	\$3.00	\$50.01 and above	\$7.50
\$20.01 to \$30.00	\$4.00		

SORRY, No orders accepted outside of USA and Canada

Total price of merchandise \$	_____
Shipping (see chart) \$	_____
Subtotal \$	_____
Sales Tax (NYS only) \$	_____
Total Enclosed \$	_____

Name _____
Address _____
City _____ State _____ Zip _____

VIDEO TITLER

(Continued from page 41)

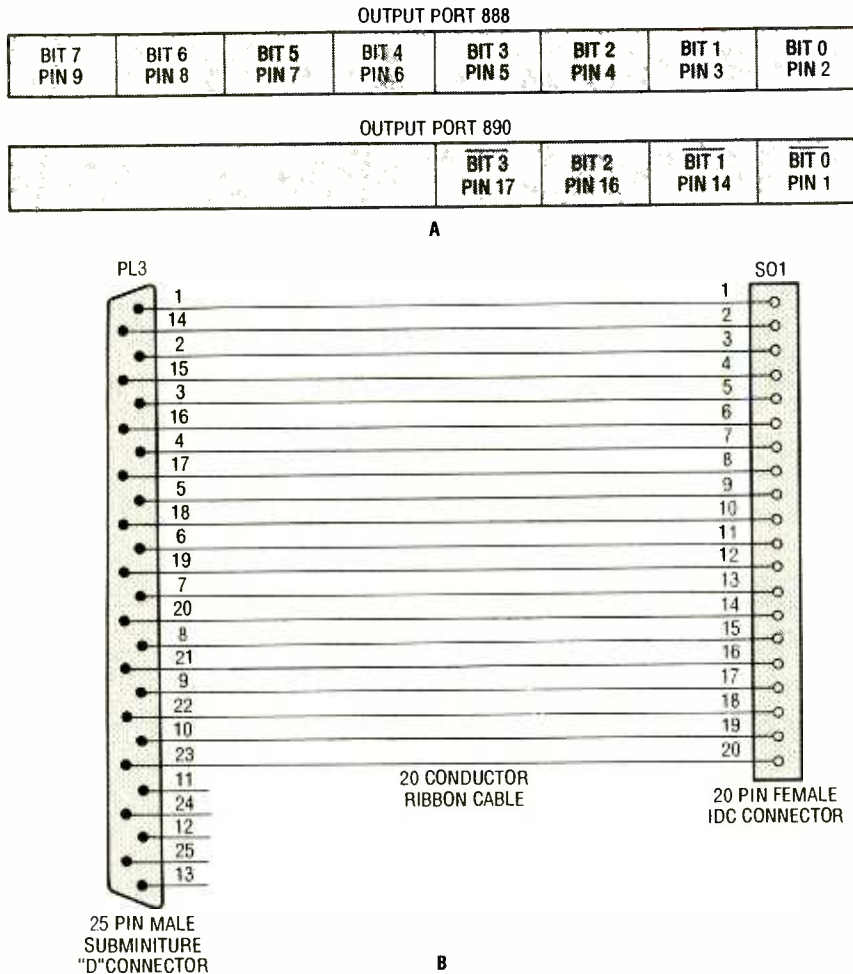
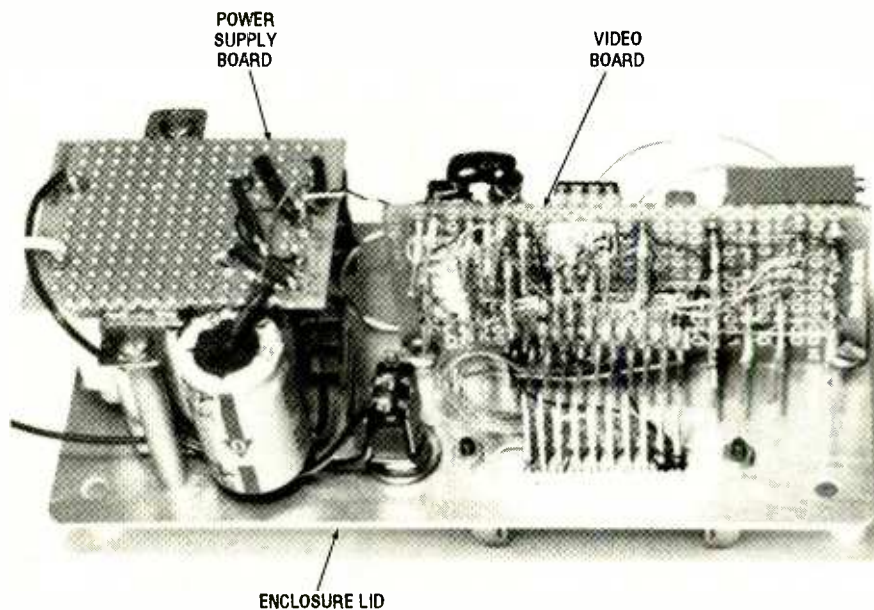

Fig. 7. The pinouts of the parallel port bits used by the Video Titler is shown in A. Note that bits 0, 1, and 3 of port 890 are inverted by the hardware. Assembly details for the cable that's used to connect the Titler to your computer is shown in B.



In the author's prototype unit, the power supply and video portions of the circuit were assembled on separate boards.

the unit's video input and an NTSC-compatible video monitor to its video output. Load the BASIC program and type a line of characters. Adjust potentiometer R3 to obtain a horizontal-display size to your liking. The length of the line (20 characters) should be adjustable from about one half the display screen to nearly full-screen width. Resistor R4 sets the white intensity of the characters, while R5 adjusts black level of the background.

The Video Titler is now ready for use. Use the set-up shown in the block diagram of Fig. 1. to make your titling dubs. While the Super Simple Video Titler does not have the versatility of some multihundred-dollar units, it also does not cost nearly as much. Because of that, it may be just what you need to add just the right finishing touch to your amateur-video productions. ■

DIGITAL COURSE

(Continued from page 73)

a logic probe, try to locate the problem. Note the behavior of the circuit and how you located the problem. The knowledge gained will prove quite useful in the long run. A hint: Open (floating) TTL inputs assume a high logic level.

After correcting the fault, have someone disconnect a line from the output of the decoder to the 7-segment display, again without letting you see which one. As before, locate the problem using your logic probe, again noting the behavior of the circuit and how you located the problem.

The \bar{L} input may be used to test not only the operation of the decoder, but also all segments of the display. With the \bar{B} / \bar{R} \bar{O} and the \bar{R} \bar{B} terminals high, set the \bar{L} input line low (ground). All segments should be displayed. Were they? When the \bar{L} input line is low, do the data inputs from the DIP switch have any effect on the numerical display?

As stated earlier, the \bar{B} / \bar{R} \bar{O} terminal is wired as AND logic to serve as a blanking input and/or as a ripple-blanking output. Set the \bar{B} / \bar{R} \bar{O} terminal low; the segment display should go out. Did it? With the \bar{B} / \bar{R} \bar{O} low, do any of the other input lines have any effect on the decoder?

Power down the circuit, but do disassemble it. You may, however, move the four-position DIP switch.

ELECTRONICS MARKET PLACE

FOR SALE

DESCRAMBLERS. All brands. Special: Combo Jerrold 400 and SB3 \$165. Complete cable descrambler kit \$39.00. Complete satellite descrambler kit \$45.00. Free catalog. **MJH INDUSTRY**, Box 531, Bronx, NY 10461-0208.

CAPACITORS, resistors and more. Buy any quantity direct from importer. Dealers inquiries welcome. Free details. **WORLD TRADE**, 2 Sproule Drive, Brampton, Ontario, Canada L6V 4B9.

CABLE descrambler liquidation. Major makes and models available. Industry pricing! (Example: Hamlin Combo's, \$44 each... Minimum 10 orders). Call **WEST COAST ELECTRONICS**, 1 (800) 628-9656.

FREE catalog. Interfaces for IBM compatibles. Digital I/O and Analog input. Control relays, motors, lights, measure temperature, voltage. **JOHN BELL ENGINEERING, INC.**, 400 Oxford Way, Belmont, CA 94002. (415) 592-8411.

DIGITIZER for IBM compatible PCs 640 by 480 resolution from VCR video camera \$85.00. Demonstration disk \$3.00. **CODEWARE**, Box 3091, Nashua, NH 03061.

CABLE TV DESCRAMBLERS!



BARGAIN HEADQUARTERS!

• JERROLD • TOCOM • HAMLIN
• SCIENTIFIC ATLANTA • ZENITH
Oak M35B ONLY \$60
6 month warranty! We ship C.O.D.!
Lowest retail/wholesale prices!
FREE CATALOG:
Global Cable Network
1032 Irving St. Suite 109
S.F., CA 94122

ORDER TODAY! 800-327-8544

STOP the electronic thieves! Techniques, equipment, laws. Free information. **SVS**, 198 N. 2nd Street, Suite 6, Porterville, CA 93257. (209) 781-2834.

HUGE 88 page communications catalog of shortwave, amateur and scanner equipment. Antennas, oaks and accessories too. Send \$1.00 to: **UNIVERSAL RADIO**, 1280 Aida Drive, Dept. PE, Reynoldsburg, OH 43068.

SERS 1mw to 2kw, world's largest selection of v & used surplus. Free catalog. **MWK INDUSTRIES**, 1269 Pomona Road, Corona, CA 91720.) 278-0563.

B RADIO OWNERS!

pecialize in a wide variety of technical nation, parts and services for CB radios. er and FM conversion kits, repair books, igh-performance accessories. Thousands ied customers since 1976! Catalog \$2.

IBC INTERNATIONAL
OX 31500PE, PHOENIX, AZ 85046

ams!! Free disks!! Choose game, ulti- ss. And we will send one program free OK disk. You choose category, we im. Also get our electronics surplus/ log and rental/commercial disk cata- disk free! Just enclose \$2.00 (refun- ing!! **BEACH RADIO**, PO Box 548, 12-0548.

CABLE descramblers (Jerrold) from \$40.00. Tocom VIP test chip. Fully activates unit. \$50.00. Call (213) 867-0081.

PRINTED circuit boards etched & drilled. Free delivery. **K & F ELECTRONICS, INC.**, 33041 Groesbeck, Fraser, MI 48026. (313) 294-8720.

WIRELESS CABLE RECEIVERS 1.9 TO 2.7 GHz



30 CH PARABOLIC DISH SYSTEM \$173 90
30 CH ROD ANTENNA SYSTEM \$193 90
30 CH CRYSTAL CONTROLLED SYSTEM \$294 95
SUN MICROWAVE INT'L. INC. SEND \$1.00 FOR
P.O. BOX #34522 CATALOG ON THESE
PHOENIX AZ. 85067 AND OTHER FINE
(602) 230-0640 VIDEO PRODUCTS
QUANTITY DISCOUNTS LIFETIME WARRANTY
MEMBER OF THE BETTER BUSINESS BUREAU

ELECTRONIC muscle stimulator! Grow your muscles quickly and effortlessly or resale for huge profits. Complete kit - \$69.95; assembled and tested - \$98.00. **TECHNIX**, Box 55249, Bridgeport, CT 06610.

FREE CATALOG

FAMOUS "FIRESTIK" BRAND CB ANTENNAS AND ACCESSORIES. QUALITY PRODUCTS FOR THE SERIOUS CB'er. SINCE 1962
FIRESTIK ANTENNA COMPANY
2614 EAST ADAMS
PHOENIX, ARIZONA 85034

BEST BY MAIL

Rates: Write National, Box 5, Sarasota, FL 34230

OF INTEREST TO ALL

INSTANT POSTCARDS!! SAMPLE, send \$25 stamp. Box 171(PE), Ashland, OR 97520.

JOIN THE NEW Products Club. Send SASE: T&S Enterprises, 930(P) Ziegelmuller, Burlington, IA 52601.

VACATIONS NATIONWIDE 50% SAVINGS!
1-900-988-3636, Ext. 44. \$3 per call.

BE A PROFESSIONAL. Learn how! Send \$1.00 to: Pro-7(PE), Box 620190, San Diego, CA 92162.

BUSINESS OPPORTUNITIES

EARN EXTRA INCOME mailing brochures for national companies! No experience needed! Mail \$1: Finance Publications, Box 1678(PE), Arvada, CO 80001.

I MAKE \$2,000 WEEK Recycling Gold! Easy home business! Free booklet! 1(900)246-2323 (\$2/min).

\$250 WEEKLY! IMMEDIATE home income! Photograph data forms! Experience unnecessary. Free details! PHILLIPS(PE), Garrett, PA 15542-0051.

MINI STUN GUNS. 5" long, 65,000 volts. Distributors needed. 800-627-1739.

AUTOMOTIVE

GOVERNMENT SEIZED VEHICLES Low as \$100! Amazing recorded message reveals details! (708)705-2324.

EDUCATION/INSTRUCTION

MAGIC! Four illustrated lessons plus inside information shows you how. We provide almost 50 tricks including equipment for four professional effects. You get a binder to keep the materials in, and a one-year membership in the International Performing Magicians with a plastic membership card that has your name gold-embossed. You get a one-year subscription to our quarterly newsletter, "IT'S MAGIC!" Order now! \$29.95 for each course + \$3.50 postage and handling. (New York residents add applicable state and local sales tax). **The Magic Course**, 500-B BiCounty Blvd., Farmingdale, NY 11735.

LEARN IBM PC assembly language. 80 programs. Disk \$5. Book \$18. **ZIPFAST**, Box 12238, Lexington, KY 40581-2238.

SHORTWAVE — ham scanner radio books. Catalog \$1.00. **TIARE PUBLICATIONS**, PO Box 493PE, Lake Geneva, WI 53147.

"ELECTRONIC Review." Detailed electronics reviewing for bettering grades, interviews and promotions. Over 300 pages \$39.95 include \$4.25 shipping. **USER-GRAPHICS**, Department ED72, 7136 Everett, Boise, ID 83704-7415.

CHALLENGE yourself! Do you have what it takes to pass my electronics test? Find out, mail \$4.00 to **BOX 16035**, Philadelphia, PA 19154.

VCR repair Save money — make big profits! Learn secrets from *How to Keep Your VCR Alive* book. "Problems covered account for more than 90 percent of all common VCR problems... Whether an amateur repairer or professional technician, this practical book is highly recommended for anyone anticipating doing any VCR repairs. Its thoughtful descriptive step-by-step approach will save one considerable frustration. Get it!" says *Modern Electronics*. Also highly recommended by *Popular Electronics*, *Popular Communications*, *Electronic Servicing and Technology*, *Nuts and Volts*, *Video Review*, *Video Business*, *Video Store Magazine*, plus many other national authorities. "Much better than Viejo at 1/7 the cost." Second edition, 400 + pages, 714 illustrations, plus professional head-cleaning tool. \$24.95. Send to **WORTHINGTON PUBLISHING**, 6907-202L Halifax River Drive, Tampa, FL 33617.. or call (813) 988-5751 for C.O.D.. Visa, or MC. Money-back satisfaction guarantee!

CABLE TV DESCRAMBLERS

***** PRESENTING *****
***** STARRING *****
JERROLD, HAMLIN, OAK
AND OTHER FAMOUS MANUFACTURERS
• FINEST WARRANTY PROGRAM AVAILABLE
• LOWEST RETAIL/WHOLESALE PRICES IN U.S.
• ORDERS SHIPPED FROM STOCK WITHIN 24 HOURS
FOR FREE CATALOG ONLY **1-800-345-8927**
FOR ALL INFORMATION 1-818-716-5914

PACIFIC CABLE CO. INC.
7325H RESEDA BLVD., DEPT. 1000
RESEDA, CA 91375

SATELLITE TV

FREE catalog — Do-it-yourself save 40—60% lowest prices world wide, systems, upgrades, parts, all major brands factory fresh and warrantied. **SKY-VISION INC.**, 2008 Collegeway, Fergus Falls, MN 56537. 1 (800) 334-6455. MN & International (218) 739-5231.

K.U. band satellite system. Perfect for R.V. or patio use. For information call (317) 742-6346 or write to **NEW HORIZON ELECTRONICS**, 345 Burnett Road, West Lafayette, IN 47906.

T.V. FILTERS

T.V. notch filters, surveillance equipment, brochure \$1.00. **D.K. VIDEO**, Box 63/6025, Margate, FL 33063. (305) 752-9202.

CABLE EQUIPMENT

CABLE TV secrets — the outlaw publication the cable companies tried to ban. HBO, Movie Channel, Showtime, descramblers, converters, etc. Suppliers list included. \$9.95. **CABLE FACTS**, Box 711-H, Pataskala, OH 43062.

BUY BONDS

SEPTEMBER 1990

CABLE TV "BOXES"

**Converters — Descramblers
Remote Controls — Accessories**

- * Guaranteed Best Prices *
- * 1 Year Warranty — C.O.D.s *
- * Immediate Shipping *
- * FREE CATALOG *

Call or Write
TRANS-WORLD CABLE CO.
12062 Southwest 117th Court, Suite 126
Miami, Florida 33186
1-800-442-9333



TEST EQUIPMENT ACCESSORIES

LOW cost oscilloscope probes and multimeter test leads. Save over 50%. Call 1 (800) 772-1519 for free catalog. **PROBE MASTER INC.**, 4898 Ronson Ct., San Diego, CA 92111.

PLANS & KITS

CATALOG: hobby/broadcasting/HAM/CB: Cable TV, transmitters, amplifiers, surveillance devices, computers, more! **PANAXIS**, Box 130-H9, Paradise, CA 95967.

BUILD this five-digit panel meter and square wave generator including an ohms, capacitance and frequency meter. Detailed instructions \$2.50. **BAGNALL ELECTRONICS**, 179 May, Fairfield, CT 06430.

VIDEOCIPHER II manuals. **Volume 1** — hardware, **Volume 2** — software — either \$34.95. **Volume 3** — projects/software, **Volume 5** — Documentation or **Volume 6** — Experimentation \$44.95 each. **Volume 4** — repair — \$99.95. **Cable Hacker's Bible** — \$34.95. **Clone Hacker's Bible** — \$34.95. Catalog \$3.00. CODs: (602) 782-2316. **TELECODE**, PO Box 6426-PE, Yuma, AZ 85366-6426.

MINIATURE FM transmitters! Tracking transmitters! Voice disguisers! Bug detectors! Phone devices! More! Available either as kits or assembled and tested! Catalog \$2.00 (refundable): **XANDI ELECTRONICS**, Box 25647, 32TT, Tempe, AZ 85285-5647.

REMOTE CONTROL KEYCHAIN

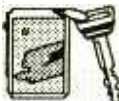

Complete w/mini-transmitter and +5 vdc RF receiver
Fully assembled including plans to build your own auto alarm
Quantity discounts available

\$24.95 Check, Visa or M/C
Add \$3 shipping

VISITECT INC./Dept. P (415) 872-0128
PO BOX 5442, SO. SAN FRAN., CA 94080

ALARMS. Simple and Easy to build. Plans for cars \$5.00. **GEMTEC**, 9300 Mansfield Road, Suite 100, Shreveport, LA 71118.

EQUIP push mower for radio control. Plans \$15.00. **SCHNELL ENTERPRISES**, c/o Randall Schnell, 11351 T-70 Drive NE #9, Columbia, MO 65202.

BUILD working 68000 single board computer — under \$100! Complete step-by-step manual includes schematic, circuit board layout, parts list. Plans incorporate same CPU chip as Macintosh, Amiga, Atari ST. \$24.95. Catalog of robotic and varied CPU projects, \$1.00. **HTC TECHNOLOGIES**, 9 Union Square, Ste. 129, Southbury, CT 06488. (203) 263-3958.

CONNECT your IBM/Apple computer to the outside world. Set of manuals for 10 experiments \$16.00. Specify IBM or Apple. **TECH-LINK, INC.**, 520 Lorena SW, North Canton, OH 44720.

DETECTION — Surveillance, debugging, plans, kits, assembled devices. Latest high-tech catalog \$5. **DETECTION SYSTEMS**, 2515 E. Thomas, #16-864J, Phoenix, AZ 85016.

SURVEILLANCE TELEPHONE



This is a normal functioning telephone!
EXCEPT it has a secret built in monitor
Only YOU can call and monitor ALL conversations, using a secret code, and never be detected! Range Unlimited,
\$175.00 - 6 month Warranty Catalog \$3.00
LISTEN ELECTRONICS, 603 Elgin, Muskogee, OK 74401
ALARMS 1-800-633-8277 SECURITY EQUIP

SURVEILLANCE transmitter kits! Four models of each; telephone, room, combination telephone/room transmitters tune from 65 to 305 MHz. Catalog with **Popular Communications'** book review of "Electronic Eavesdropping Equipment Design," \$1.00. **SHEFFIELD ELECTRONICS**, 7223A Stony Island Ave., Chicago, IL 60649-2806.

VCR amplifier. Transmits to any TV in the house. Complete unit only \$49.95, kit \$34.95. Miniature FM transmitter-size of postage stamp, up to 1 mile range, \$29.95, kit \$19.95. Kits include PC board and all board mounted components. **CAS ELECTRONICS**, 1525 Aviation Blvd., Suite 136, Redondo Beach, CA 90278.

RECEIVER plans, kits. Simple to sophisticated. Thorough explanations included. All bands. Catalog and sample schematics \$3.00. **PREMIER ENTERPRISES**, 3850 Plymouth Blvd, Suite 104, Plymouth, MN 55446.

NEW HE NE LASER TUBES \$35

*Dealer Inquiries Invited.
Free Catalog!*

MEREDITH INSTRUMENTS: 6403 N. 59th Ave.
Glendale, AZ 85301 • (602) 934-9387
"The Source for Laser Surplus"

STRANGE stuff. Get the advantage! Laser listener, surveillance, descrambling, underground information. Plans, kits, complete items. Informational package \$3.00 refundable. **DIRIJO/BOND**, Box 212, Lowell, NC 28098.

LASER lighting entertainment systems. Create your own 3-dimensional laser light shows. Detailed mechanical and electrical schematics, scanning and controls operations. \$20.00 **MILLENIUM**, 877 Saint Charles #5, Thousand Oaks, CA 91360.

ETCH your own printed circuit boards using the photographic method. The only inexpensive step by step process that every serious electronics hobbyist should have. Send \$12.95 to **ETCHING INFO**, PO box 8064, Westfield, MA 01086-8064.

FREE CATALOG! 1-800-648-7938

For all information 1-702-362-9026
JERROLD HAMLIN OAK ETC.
**CABLE TV
DESCRAMBLERS**

- Compare our low Low Retail Prices!
- Guaranteed Prices & Warranties!
- Orders Shipped Immediately!

REPUBLIC CABLE PRODUCTS INC.
4080 Paradise Rd. #15 Dept. PE-90
Las Vegas, NV 89109

BUSINESS OPPORTUNITIES

YOUR own radio station! AM, FM, TV, cable. Licensed/unlicensed. **BROADCASTING**, Box 130-H9, Paradise, CA 95967.

EASY work! Excellent Pay! Assemble products at home. Call for info. (504) 641-8003 Ext. 5730.

MAKE \$50/hr working evenings or weekends in your own electronics business. Send for free facts. **MJPI INDUSTRY**, Box 531, Bronx, NY 10461.

UP to \$7,000 month using your VCR. USA, Canada, info \$1.00 cash, US funds. **RANDALL**, Box 2168-E, Van Nuys, CA 91404.

MAKE \$2000.00/week — reclaiming pure gold from scrap computers. Free report! (worth \$25.00) 1 (900) 246-2323 (\$2.00 min.).

LET the government finance your small business. Grants/loans to \$500,000. Free recorded message: (707) 448-0270. (KJ8)

GUARANTEED work! Excellent Pay! Assemble products at home. Nations largest selection of home-work. (904) 686-3634 Ex-7910.

WANTED

INVENTORS! Call **IMPAC** — we submit ideas to manufacturers! For free information package call in US/Canada 1 (800) 225-5800.

LM379S dual audio amp 1-1000 call Rick. 1 (800) 873-3729. **RESOURCE SYSTEMS**, 2475-F Meadowbrook Parkway, Duluth, GA 30136.

ANTIQUE RADIO CLASSIFIED

Free Sample!

Antique Radio's
Largest Circulation Monthly.
Articles, Ads & Classifieds.

6-Month Trial: \$13. 1-Yr: \$24 (\$36-1st Class).
A.R.C., P.O. Box 802-L5, Carlisle, MA 01741

COMPUTERS

BRAND name computers from \$299.00 factory fresh complete systems. Laser, Emerson, Magnavox closeouts **DIGITECH**, (602) 722-4215.

FREE! free! IBM software catalog 2000 + disks. Toll free! 1 (800) 345-2983. 24 hours! In Colorado please call: (303) 934-5507. **MEGA-BYTE INC**, PC Software Supply, 3601 Morrison Road, Denver, CO 80219. Fax: (303) 936-7049.

SOFTWARE for pennies. 8700 IBM programs, modem: (602) 721-2175 or catalog & 5 sample programs \$9.95 (606) 722-4215. **DIGITECH**, 9430 Golflinks #170, Tucson, AZ 85730.

Motion Control System

\$159.00



Includes Computer, Monitor, Keyboard,
Power supply, 4 Motors, and Software.
Call or Send for **Free Robotics Catalog**

Silicon Valley Surplus 4222 E. 12th St. Serving you since 1983
415 261-4506 Oakland, CA 94601 8 am to 4 pm PST

BEST BY MAIL

Rates: Write National, Box 5, Sarasota, FL 34230

BOOKS · CATALOGS · MAGAZINES

FREE CATALOG - DESIGNER Clothing. **OMEGA**, 101(PE) Clematis, Pensacola, FL 32503-2834.

BUSINESS OPPORTUNITIES

BUMPERSTICKER PRINTER. CHEAP, simple, portable. Free details. Bumper, POB 22719(PE), Tampa, FL 33622.

TWO PAGES of Classified information. Seventy hottest money making ideas available. Free details. Grayco, 16123 Crystalcreek, Cerritos, CA 90701.

OF INTEREST TO ALL

WIN A FREE Bahamas vacation for two. Write: Vacation, Box N-4126, Nassau, Bahamas.

ROBOTS! FULLY ASSEMBLED and kits, robot arms, PC interfaces, motor sensors. \$30.00 to \$80,000.00. Catalog \$5.00 refundable with order. HTO, PO Box 3084, RSF, CA 92067.

BASIC ELECTRICITY HOME study course. Free info, send SASE to: Box 9, Flushing, MI 48433.

REAL ESTATE

BUILDING? CONTRACT TYPES simplified - \$3.00. Box 1544, Kenia, AK 99611-1544.

VIDEOS

BETA MOVIE VIDEO SALES. \$5.95-\$9.95 each. Vast inventory & all kinds. Send \$5.00 (refundable) for catalog. Absolute Beta, PO Box 130, Remington, VA 22734.

CABLE T.V. CONVERTERS
WHY PAY A HIGH MONTHLY FEE?

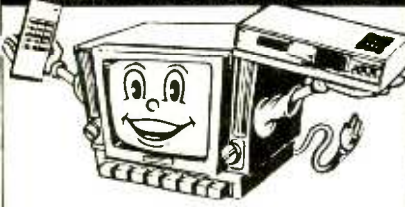

All Jerrold, Oak, Hamlin, Zenith, Scientific Atlanta, Magnavox and all specialized cable equipment available for shipment within 24 hours. For fast service MC / VISA or C.O.D. telephone orders accepted **(800) 648-3030** 60 Day Guarantee (Quantity Discounts) 8 A.M. to 5 P.M. C.S.T. **CLOSED WEEK-ENDS.** Send self-addressed Stamped envelope (60¢ postage) for Catalog.

MIDWEST ELECTRONICS INC. P.O. Box 5000
 Suite 311 (PE)
 Carpentersville, IL 60110

No Illinois Orders Accepted

LOTTERY

LOTTERY— IBM computer disk for all lotteries \$10.00. **ROBERTS**, Box 63/6025, Margate, FL 33063.

SECURITY EQUIPMENT

WIRELESS security systems headquarters. Low cost complete systems, telephone dialers, infrared detectors, wireless medical and panic buttons etc. Visa/Mastercard. Free catalog. **HACHEN SECURITY**, 1904 Plymouth, Independence, MO 64058. 1 (800) 869-0483.

CABLE TV DESCRABLERS!



BARGAIN HEADQUARTERS!

- JERROLD
- TOCOM
- HAMLIN
- SCIENTIFIC ATLANTA
- ZENITH

Oak M35B ONLY \$60
 6 month warranty! We ship C.O.D.!
 Lowest retail/wholesale prices!
FREE CATALOG:
 Global Cable Network
 1032 Irving St. Suite 109
 S.F., CA 94122

ORDER TODAY! 800-327-8544

CABLE BOXES
FREE CATALOG
1-800-848-3997
 Jerrold • Scientific Atlanta
 Many Others
 1 Year Warranty • COD's

NAS CABLE

ADVERTISING INDEX

POPULAR ELECTRONICS magazine does not assume any responsibility for errors that may appear in the index below.

Free Information No.	Page		Page		
6	AMC Sales	17	7	Sequoia Publishing	15
13	Ace Communications	81	—	Science Probe	28
17	Action Data Processing, Inc.	93	—	Silicon Valley Surplus	101
5	All Electronics	25	—	Sun Microwave	100
—	Amazing Concepts	27	—	TransWorld	101
—	Antique Radio Classified	101	8	Viejo Publications	93
11	C&S Sales	5	—	Visitect	101
—	CB City	100			
—	CIE	13			
—	Command Productions	27			
14	Cook's Institute	81			
—	Elec. Industry Association	CV3			
—	Electronic Tech. Today	6, 16			
—	Electronic Tech Today	97, CV2			
—	Electronics Book Club	87			
—	Firestik II	100			
—	Global Cable Network	100			
—	Grantham College	23			
12	Heathkit	3			
—	Listen Electronics	101			
—	McGraw Hill Book Club	8			
—	Meredith Instruments	101			
—	Midwest Electronics	102			
—	Monitoring Times	89			
—	NRI Schools	21			
—	NESDA	89			
—	North American Services	102			
15	Protel Technology	15			
—	Pacific Cable	100			
9	Paladin Electronics	17			
10	Parts Express	7			
16	Radio Shack	CV4			
—	Republic Cable	101			

ADVERTISING SALES OFFICE

Gernsback Publications, Inc.
 500-B Bi-County Blvd.
 Farmingdale, NY 11735
 1-(516) 293-3000

President: **Larry Steckler**
 Vice President: **Cathy Steckler**

For Advertising ONLY
 516-293-3000
 Fax 1-516-293-3115

- Larry Steckler**
publisher
- Arline Fishman**
advertising director
- Denise Haven**
advertising assistant
- Christina Estrada**
advertising associate
- Kelly McQade**
credit manager

SALES OFFICES
EAST/SOUTHEAST

Becky Akers
 Patts/3M
 310 Madison Ave., Suite 1804
 New York, NY 10017
 1-212-953-2121
 Fax 1-212-953-2128

MIDWEST/Texas/Arkansas/Okla.

Ralph Bergen
 540 Frontage Road—Suite 339
 Northfield, IL 60093
 1-708-446-1444
 Fax 1-708-446-8451

PACIFIC COAST/Mountain States

Marvin Green
 5430 Van Nuys Blvd., Suite 316
 Van Nuys, CA 91401
 1-818-986-2001
 Fax 1-818-986-2009

The Importance Of Setting Standards.

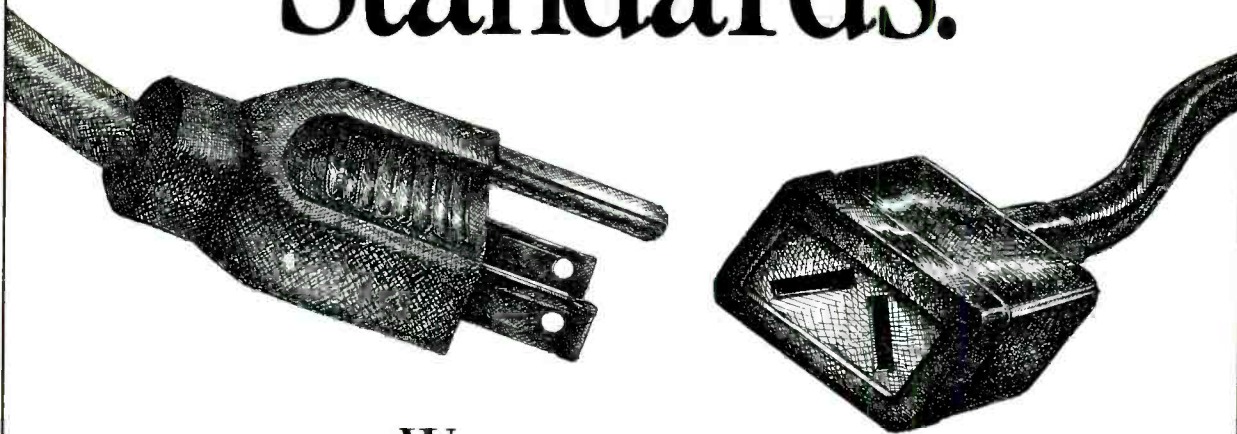

Without standardization in electronics, television wouldn't be seen, radio wouldn't be heard, computers wouldn't share information.

Fortunately the Electronic Industries Association (EIA) has been setting electronics standards since 1924 for everything from early tube radios to today's cellular telephones and stereo TV's.

Standards create *markets and jobs*. Today EIA, an internationally accredited standards making body, is helping to make HDTV a reality by working with the federal government and other industry organizations, to develop a timely, uniquely American transmission standard. For home automation,

EIA also is close to completing a standard which will permit all home electronic products to communicate with each other.

Our more than 1,000 member companies are manufacturers representing every facet of the American electronics industry—from defense to consumer products.

EIA is proud of the contributions it has made through its standards making process toward the growth and vitality of the U.S. electronics industries.

Setting the standard for more than 66 years.



ELECTRONIC INDUSTRIES ASSOCIATION

1722 Eye Street, N.W., Suite 300, Washington, D.C. 20006

Radio Shack Parts Place SM

YOUR SOURCE FOR PROJECT AND REPAIR ELECTRONICS
Try Our Special-Order "Hotline"



ICs, Crystals, Tubes, Much More

Your Radio Shack store manager can special-order a wide variety of parts and accessories from our main warehouse. Over 200,000 items are available including vacuum tubes, ICs, microprocessors, phono cartridges and styli, crystals for scanners and computers, even SAMS Photofacts® manuals. Best of all, there are no handling charges or minimum order requirements. Your order is sent directly to the Radio Shack near you and we notify you when it arrives. Delivery time for most items is about a week.

Battery Special-Order Service



Hundreds of Types Available

In addition to our large in-store stock, Radio Shack can now supply almost any currently manufactured consumer-type battery—for cordless phones, computer memory, camcorders, walkie-talkies, pagers and more. Batteries are sent from our main warehouse to the Radio Shack near you. We notify you when they arrive and there's no postage or handling charge.

Infrared Module

Complete, Easy-to-Use IR Detector



Heart of a remote-control project! Combines detector, limiter, band-pass, demod, integrator and comparator in a compact 3-lead module. #276-137 3.49

Neater Wiring

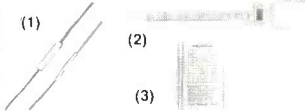

(1) Heat-Shrink Tubing, 1/16 to 1/2" Sizes. #278-1627 Pkg. of 7/1.79
 (2) Cable Tie/Markers. For cables up to 3/8" dia. #278-1648 Pkg. of 10/2.49
 (3) Wire Markers. 630 "peel and stick" characters. #278-1650 Set/1.79

Tantalum Caps



High capacitance in a tiny size

µF	WVDC	Cat. No.	Each
0.1	35	272-1432	59
0.47	35	272-1433	59
1.0	35	272-1434	59
2.2	35	272-1435	69
10	16	272-1436	79
22	16	272-1437	1 19

"Snap" RFI Choke

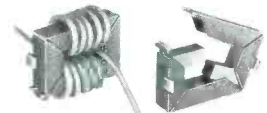

Snap-Together Toroid Cores. Effective "roadblock" to radio-frequency interference. Just wind on AC, phone, computer, coax or audio cable, then snap choke together. #273-104 Set of 2/7.95

Resistance Items

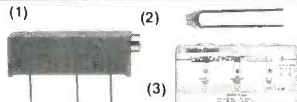

(1) 15-Turn Trimmers. 1k, #271-342, 10k, #271-343, 20k, #271-340. Each 1.49
 (2) Precision Thermistor. Resistance changes in proportion to temperature -50 to +110° C. #271-110 1.99
 (3) Color-Code Decoder. #271-1210 79c

Shielded D-Sub Hoods

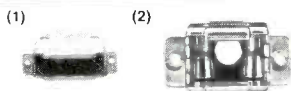

Fig.	Description	Cat. No.	Each
1	9-Position Metal	276-1508	2 19
	25-Position Metal	276-1510	2 79
2	9-Pos. Metalized	276-1513	1 49
	25-Pos. Metalized	276-1536	1 99

"Ding-Dong" Chime

Great Entry Alserter



This IC and mini-speaker combo has a pleasant chime output and it's ideal for a customer-entry alert, doorbell or event indicator. Operates from 6 to 18 VDC. Produces 80 dB sound pressure at 12 VDC. 5" leads. #273-071 8.99

Rod Antennas



For projects or replacing damaged antennas on cordless handsets and bases, walkie-talkies and radios. We have over a dozen styles in stock. For example:

Sections	Extended	Cat. No.	Each
5	13"	270-1407	2 79
6	17 3/4"	270-1409	2 59
4	34 3/4"	270-1402	3 79

TNC and Mini-UHF Connectors



(1) TNC Twist-On Male for RG-58 Cable. #278-140 1.99
 (2) TNC Double-Female. #278-142, 1.99
 (3) PL-259 Female. #278-118 3.49
 (4) BNC Male. #278-145 4.99
 (5) Mini-UHF Double-Female. Joins two male Mini-UHFs. #278-172 2.49
 (6) Mini-UHF T Adapter. Female-male-female power divider. #278-173 3.99
 (7) UHF Adapter. Accepts PL-259. Fits female Mini-UHF. #278-174 3.99

Solderless IDC-Type Connectors

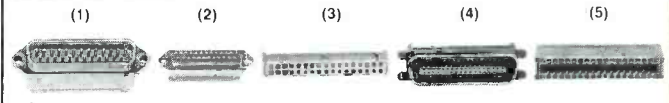

Fig.	Description	Cat. No.	Each
1	25-Position D-Sub Male	276-1559	3 99
2	25-Position D-Sub Female	276-1565	3 99
3	34-Position Header	276-1525	2 49
4	36-Position Male Printer Connector	276-1533	4 99
5	34-Position Card-Edge Connector	276-1564	1 99

Electronic Counter Module



Prewired! Great for a traffic or event counter. Counts up to 99,999. Advanced (or reset) by external switch closure or digital circuit. Accepts count rate up to 7 Hz. Has 1/2" liquid crystal display. Requires "AA" battery. With data. #277-302 16.95

Foldup Autoranging DVM



Select the function and this precision Micronta® meter sets the range. Has automatic power-off when shut, detented hinge for best viewing angle. Measures to 1000 VDC, 500 VAC, 10A AC/DC, 2 megohms resistance. Requires 2 "AA" batteries. #22-193 69.95

Dual-Power Soldering Iron



Go from 15 to 30 watts with the flick of a switch. Has replaceable tip. 8 1/4" long. UL listed AC. #64-2055 9.49
 Replacement Tip. #64-2065 1.19
 Chisel Tip. #64-2056 1.19

Since 1921 Radio Shack has been the place to obtain up-to-date electronic parts as well as quality tools, test equipment and accessories. Today, with our big in-store selection and convenient special-order service, Radio Shack continues its tradition of supplying high-tech products at competitive prices. We're America's Technology Store with over 7000 locations—NOBODY COMPARES

Prices apply at participating Radio Shack stores and dealers. Radio Shack is a division of Tandy Corporation

Radio Shack
 AMERICA'S
 TECHNOLOGY
 STORE SM

CIRCLE 16 ON FREE INFORMATION CARD