

Keep Your **TURNTABLE** Out Of The **REPAIR SHOP!**

48784

# Popular Electronics

SEPTEMBER 1989

THE MAGAZINE FOR THE ELECTRONICS ACTIVIST!

COMBINED WITH **Hands-on Electronics**

## The HDTV Revolution

What is High-Definition TV, how will it affect us, and when will it be here? Find out inside!

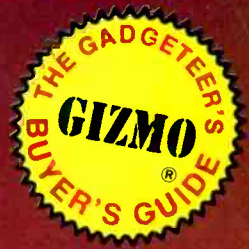

## Photoflash Power System

Charge up your flash in a flash

## The Exciting World of Ham Radio

It's your "ticket" to adventure!

## Servicing Security Systems

It's easy to fix them yourself and save big dollars!



A GERNSBACK PUBLICATION

**Shaky!**

Born on the workbench, it's an electronic playmate for the young—and the young-at-heart!



## Logic Probe/ Logic Pulser

Build them yourself for commercial-quality performance at a fraction of the cost

\*\*\*\*\*ALL FOR STATE  
AUG 1990  
60505DHM997GADOH RESP 046  
ROBERT DAHM STA  
997 GRAND AVE BCT  
AURORA IL 60505

**DX Listening**  
Ahoy matey—here's the low-down on "pirate" radio

# For **SUCCESS** in your Vocation or Profession *LEARNING is Where It's At!*

You'll need a "*Learning Environment*" in your home (or office) to work on your degree with "*the college that comes to you,*"

## **GRANTHAM COLLEGE OF ENGINEERING**

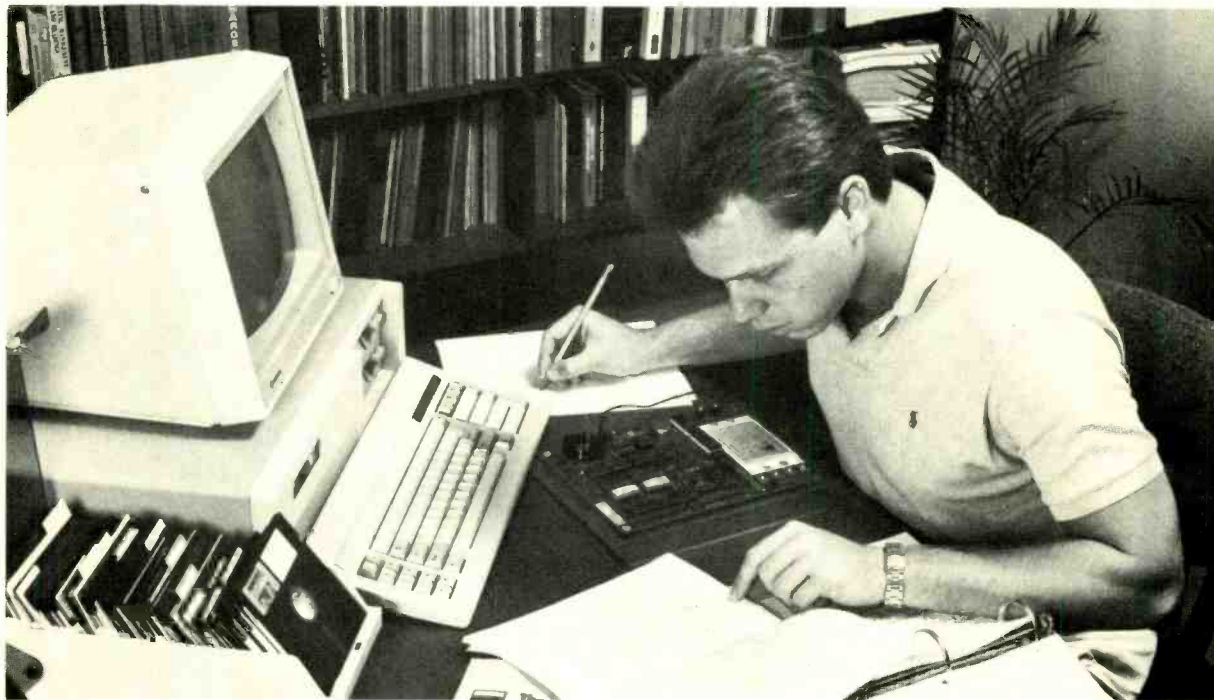

Grantham makes your **understanding** of electronics and computers its most important teaching objective. You are never rushed or held back; you study at your own pace. Learn more by self-paced home study, with Grantham instructors standing by to help you.

*Accredited*  
***A.S. and B.S. Degrees***  
*Awarded*

Now in Our 39th Year

Phone or write for our Home Study Degree Catalog:

Phone 213-493-4421 (no collect calls)

or write

**Grantham College of Engineering**  
10570 Humbolt Street  
Los Alamitos, California 90720

Grantham College of Engineering is accredited by the Accrediting Commission of the National Home Study Council in Washington, D.C.

***Grantham College of Engineering***

P.O. Box 539, Los Alamitos, CA 90720

Please mail me your free catalog with gives details of your home-study degree programs, including enrollment information.

NAME \_\_\_\_\_

ADDRESS \_\_\_\_\_

STATE and ZIP \_\_\_\_\_

P-989



# Popular Electronics®

THE MAGAZINE FOR THE ELECTRONICS ACTIVIST!

## CONSTRUCTION ARTICLES

**SHAKY: THE Popular Electronics ELECTRONIC PLAYMATE** ..... Charles D. Rakes 33  
*A loyal and true friend to delight the young—and the young at heart!*

**THE EXPERIMENTER'S LOGIC PROBE** ..... Jan Axelson 37  
*When it comes to digital troubleshooting, a logic probe is hard to beat!*

**THE EXPERIMENTER'S LOGIC PULSER** ..... Jan Axelson 41  
*Add this digital signal source to your collection of troubleshooting aids*

**PHOTOFLASH POWER SYSTEM** ..... W. E. Babcock 67  
*Never miss a shot with this high-capacity power system for your flash unit*

**MERCURY SWITCH ALARM** ..... Walter W. Schopp 72  
*Make a simple theft alarm with a mercury switch and a few support components*

## FEATURE ARTICLES

**THE EXCITING WORLD OF HAM RADIO** ..... Arthur R. Lee, WF6P 44  
*Ham radio lets you communicate with people all over the world*

**THE HDTV REVOLUTION** ..... Robert Angus 61  
*High-definition TV is coming, and nothing (not even politics) can stop it*

**SERVICING SECURITY SYSTEMS** ..... Isaac Szlechter 69  
*End false-alarm misery with your multimeter in one evening*

**PUTTING RC NETWORKS TO WORK** ..... Joseph J. Carr 74  
*Keep time with circuits you can design using just one equation*

**TURNTABLE REPAIRS YOU CAN DO** ..... Homer L. Davidson 76  
*Put your turntable back on track with these simple troubleshooting secrets!*

**THE DIGITAL ELECTRONICS COURSE** ..... John Yacono 79  
*A new way of counting*

## SPECIAL FEATURE

**GIZMO** ..... 49  
*Including: Spica Stereo Speakers; Sharper Image Sound Soother 2 Clock Radio; Sharp Electronic Organizer; and more!*

## HANDS-ON REPORTS

**CANON RC-250 STILL-VIDEO CAMERA** ..... 46

## COLUMNS

**THINK TANK** ..... Byron G. Wels 22  
*Footprints in the sands of time*

**ANTIQUE RADIO** ..... Marc Ellis 82  
*Solving the "Wasp's" worst problem!*

**COMPUTER BITS** ..... Jeff Holtzman 84  
*Just CAD'ing around*

**DX LISTENING** ..... Don Jensen 86  
*Pirates of the airwaves*

**CIRCUIT CIRCUS** ..... Charles D. Rakes 88  
*Build a touch circuit, and more!*

**SCANNER SCENE** ..... Marc Saxon 90  
*Checkout AOR's new and improved model AR-2515*

**HAM RADIO** ..... Joseph J. Carr 94  
*How to find interference sources*

## DEPARTMENTS

**EDITORIAL** ..... Julian S. Martin 2

**LETTER BOX** ..... 4

**ELECTRONICS LIBRARY** ..... 6

**NEW PRODUCTS** ..... 14

**FACTCARDS** ..... 47

**FREE INFORMATION CARD** ..... 65

**ADVERTISER'S INDEX** ..... 108

Popular Electronics (ISSN 1042-170X) Published monthly by Gernsback Publications, Inc., 500-B Bi-County Boulevard, Farmingdale, NY 11735. Second-Class postage paid at Farmingdale, NY and at additional mailing offices. One-year, twelve issues, subscription rate U.S. and possessions \$21.95, Canada \$26.95, all other countries \$29.45. Subscription orders payable in U.S. funds only, International Postal Money Order or check drawn on a U.S. bank. U.S. single copy price \$2.50. © 1989 by Gernsback Publications, Inc. All rights reserved. Hands-on Electronics and Gizmo trademarks are registered in U.S. and Canada by Gernsback Publications, Inc. Popular Electronics trademark is registered in U.S. and Canada by Electronics Technology Today, Inc. and is licensed to Gernsback Publications. Printed in U.S.A.

Postmaster: Please send address changes to Popular Electronics, Subscription Dept., P.O. Box 338, Mount Morris, IL 61054-9932.

A stamped self-addressed envelope must accompany all submitted manuscripts and/or artwork or photographs if their return is desired should they be rejected. We disclaim any responsibility for the loss or damage of manuscripts and/or artwork or photographs while in our possession or otherwise.

As a service to readers, Popular Electronics publishes available plans or information relating to newsworthy products, techniques and scientific and technological developments. Because of possible variances in the quality and condition of materials and workmanship used by readers, Popular Electronics disclaims any responsibility for the safe and proper functioning of reader-built projects based upon or from plans or information published in this magazine.



**Larry Steckler**

*EHF, CET*

*Editor-In-Chief & Publisher*

**Art Kleiman**

*Editorial Director*

**Julian S. Martin, KA2GUN**

*Editor*

**Carl Laron**

*Managing Editor*

**Robert A. Young**

*Associate Editor*

**John J. Yacono**

*Associate Editor*

**Byron G. Wels, K2AVB**

*Associate Editor*

**Teri Scaduto**

*Assistant Editor*

**Kathryn Campbell**

*Editorial Assistant*

**Joseph J. Carr, K4IPV**

**Marc Ellis**

**Jeffrey K. Holtzman**

**Don Jensen**

**Charles D. Rakes**

**Marc Saxon**

*Contributing Editors*

**Ruby M. Yee**

*Production Director*

**Karen S. Tucker**

*Production Manager*

**Robert A. W. Lowndes**

*Editorial Associate*

**Marc Spiwak**

*Editorial Associate*

**Marcella Amoroso**

*Production Assistant*

**Andre Duzant**

*Technical Illustrator*

**Russell C. Truelson**

*Assistant Illustrator*

**Injae Lee**

*Assistant Illustrator*

**Jacqueline P. Cheeseboro**

*Circulation Director*

**Michele Torrillo**

*P-E Bookstore*

## BUSINESS AND EDITORIAL OFFICES

Gernsback Publications, Inc.

500-B Bi-County Blvd.

Farmingdale, NY 11735

1-516-293-3000

Fax: 1-516-293-3115

President: **Larry Steckler**

Vice President: **Cathy Steckler**

Advertising Sales Offices listed on page 106.

Cover photography by  
Diversified Photo Services

Composition by  
Mates Graphics  
and  
Magtype



The publisher has no knowledge of any proprietary rights which will be violated by the making or using of any items disclosed in this issue.

## THAT MAKES SENSE TO ME!

"Tax us to help pay for what we need" is an unusual position for any industry or individual to take. But that's exactly what one electronics-industry spokesman—Jerry K. Pearlman, chairman and president of Zenith Electronics Corporation—has proposed to the U.S. Senate Subcommittee on Science, Technology, and Space. And it makes good sense.

Mr. Pearlman proposed that Congress amend the Trust Fund Code of 1981 to create a new trust fund to pay for the federal contribution to HDTV (High-Definition TV) research by U.S. companies. This new HDTV Trust Fund would be fueled by a \$5.00-per-unit excise tax on TV-set sales in the U.S. With total TV sales in the U.S. of about 20-million units annually, such a trust fund would raise \$100 million per year. The fund would satisfy the acknowledged need for HDTV research-and-development subsidies, without placing any additional strain on the national budget.

This is not a free handout. Mr. Pearlman proposed that the fund disbursements should be administered by the Commerce Department and the Defense Advanced Research Projects Agency (DARPA). Additionally, after three or four years, the tax would be replaced with a self-replenishing program based on HDTV sales to encourage U.S. production.

Japanese and European governments have been investing in HDTV technologies for years, and Americans have been subsidizing those foreign governments and industries when they purchase imported TV's. But before we can "buy American," it will first be necessary to "build American."

If we are ever to return consumer electronics production, and the jobs it creates, back to our side of the great ponds, our government and industries must learn to work as a team, as they do overseas. Then will we be able to compete on a level field, and that makes sense to me!

Julian S. Martin, KA2GUN  
Editor

Editor's Note: To explain Y For Q, see page 28.



# Take any 3 PROFESSIONAL BOOKS for only \$4.95

when you join the **ELECTRONICS ENGINEERS & DESIGNERS BOOK CLUB™** values to \$168.40

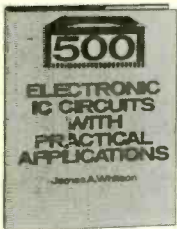

292# \$29.95



3212 \$34.95  
Counts as 2

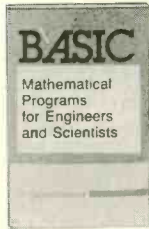

8225P \$19.95



2727 \$24.95



9773 \$44.95

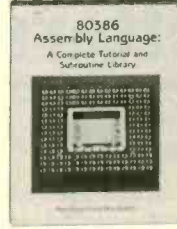

3047 \$34.95  
Counts as 2

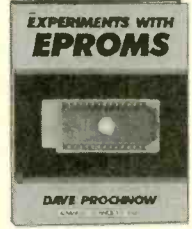

2962 \$24.95



9762P \$21.95



3002 \$49.50



3035P \$14.95



9152 \$39.95  
Counts as 2

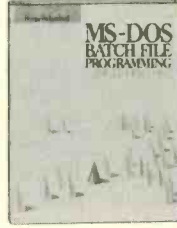

3028 \$28.95



3115 \$21.95



3094 \$42.95  
Counts as 2

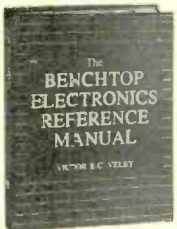

2785 \$39.95  
Counts as 2



9825 \$49.95



2897 \$27.95



9788 \$49.50



2720 \$32.50

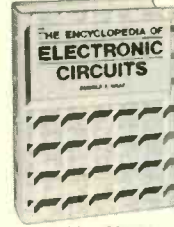

1938 \$60.00  
Counts as 2



2672 \$49.50



3089 \$26.95



9798P \$29.95



9813 \$39.95



2989 \$39.50  
Counts as 2



9781 \$68.95

## How the Club Works

**YOUR BENEFITS:** You get 3 books for \$4.95 plus shipping & handling when you join. You keep on saving with discounts up to 50% as a member.

**YOUR PROFESSIONAL BOOKSTORE BY MAIL:** Every 3-4 weeks, you will receive the EE&D Book Club News describing the Main Selection and Alternates, as well as bonus offers and special sales, with scores of titles to choose from.

**AUTOMATIC ORDER:** If you want the Main selection, do nothing and it will be sent to you automatically. If you prefer another selection, or no selection at all, simply indicate your choice on the reply form provided. As a member, you agree to purchase at least 3 books within the next 2 years and may resign at any time thereafter. Books purchased for professional purposes may be a tax deductible expense.

**BONUS BOOKS:** Starting immediately you will be eligible for our *Bonus Book Plan* with savings of up to 80% off publishers' prices.

**IRONCLAD NO-RISK GUARANTEE:** If not satisfied with your books, return them within 10 days without obligation!

**EXCEPTIONAL QUALITY:** All books are quality publishers' editions, from the leading publishers and experts in the electronics and engineering fields, especially selected by our Editorial Board for timeliness and accuracy.

**Your source for quality, affordable and timely authoritative engineering books.**



**ELECTRONICS ENGINEERS & DESIGNERS BOOK CLUB™**  
Blue Ridge Summit, PA 17294-0860

YES! Please accept my membership in the *Electronics Engineers & Designers Book Club* and send me the volumes I have listed below, billing me only \$4.95 plus shipping and handling charges. I understand that the books are sent on a 10-Day Free Examination basis. If dissatisfied in any way, I may return the books within 10 days and incur no further obligation. Otherwise, I agree to pay the provided invoice promptly. To complete my membership obligation I need only purchase 3 additional books at regular members' prices during the next 2 years, and may resign at any time thereafter.

NAME

ADDRESS

CITY

STATE  ZIP  PHONE

SIGNATURE

Valid for new members only. Foreign applicants will receive special ordering instructions. Canada must remit in U.S. funds. This order is subject to acceptance by the *Electronics Engineers & Designers Book Club*. PEF-989

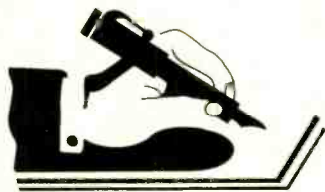

## Letters

### ULTRA-ULTRASONIC RECEIVER

I built "The Ultrasonic Receiver" that appeared in the February 1989 issue of **Popular Electronics**, because I needed a tool to locate the source of power-line noise that was interfering with my shortwave and VHF receivers.

Using my ultrasonic receiver, I have listened to sounds I could not otherwise hear from these emitters: televisions, older ultrasonic TV remote-control transmitters, computer terminals, a VCR, and a metal-detector search coil. It was especially interesting to listen to the ultrasonic sounds emitted by running water!

The receiver works fairly well for its simplicity. Although it is sensitive, there are a few shortcomings. Moderately loud noises in the sonic range can leak through the re-

ceiver and be heard. Since the receiver is not shielded, it can detect some electromagnetic fields as well as acoustic signals.

The oscillator was supposed to tune 15–35 kHz, but mine would only tune 12–21 kHz using the specified components. I substituted a 2200-ohm resistor for R5 (originally 15,000 ohms), which expanded the tuning range to 15–66 kHz.

Using a handful of coins and an old television remote-control transmitter for ultrasonic sources, I demonstrated the receiver to my colleagues at AT&T Bell Laboratories, and they were quite impressed. Thanks for a fun project.

B.P.  
Oswego, IL

### MORE HAM, PLEASE!

Great magazine you have there! I'm building "Grandpa's Shortwave Receiver" (**Popular Electronics**, February 1989), and I'm really having a ball.

How about some articles that feature ham radio? I'd especially love to see some ham-related construction projects.

B.S.  
Wheatland, WY

We aim to please! Check out "The Exciting World of Ham Radio" in this issue for an

introduction to the fascinating amateur-radio hobby. In addition, our "Ham Radio" column features topics and projects of interest to hams each and every month.

### HAVES AND NEEDS

Finding a serviceable tube tester at a reasonable price isn't easy. Once you've found one, getting a schematic for it can be just about impossible, as I've discovered. I have a SECO Series 1100 tube tester with 128 sockets that needs calibrating information and a schematic. Can anyone help me?

Samuel Zuckerberg  
578 Fifth Avenue  
New York, NY 10036

### KEEPING IN CONTACT

I loved your article "Winning the Relay Race" in the August 1989 issue. But, there is one thing that is bothering me: The linear-expansion relay shown in Fig. 10 doesn't seem to work the way described in the article. Am I missing something?

J.S.  
Brooklyn, NY

No, we did. The illustration is inaccurate—the heater coil should be located on the right-hand member, not the left as shown.

### FOND REMEMBRANCES

In April 1964, I was a short and quite skinny fifth grader. It was also the time that I received my very first issue of **Popular Electronics** magazine. Twenty-five years later, I still have that issue, and though it is now cover-less and quite worn, it still brings me pleasure. I learned a lot from those old **Popular Electronics** magazines, and they brought me a tremendous amount of satisfaction and enjoyment along the way. To me, that's the true essence of reading for a person, whether they are young or old. Those magazines had a very positive influence on me as a youngster and as a young adult.

While I must admit that over the years I very rarely actually built any of the construction projects (due to lack of money and guidance) I still waited anxiously each month for the new issue to arrive. I studied almost every article and project with great intensity and tried my best to learn what I could. Finally, when I would come close to figuring things out, I'd start some really serious day-dreaming about building whatever project had caught my eye. As a young boy I found some of those projects to be quite fantastic—the aircraft receiver in the custom-made aluminum box, the ultrasonic communicators, the people detector, and that incredible HeNe laser (Wow!). For me, that was some very powerful stuff.

Well, now it is 25 years later, and today I am a short but not-so-skinny kid. I hold graduate and undergraduate degrees in electrical engineering, am a registered Professional En-

## Master the skies with the RC Flight Simulator

Learn the ups and downs of RC aircraft and helicopter flight right on your computer screen. Exciting new software designed expressly for Heath Co. by Dave Brown Products lets you take the time you need to become a master pilot. You'll save on heartache and save on dollars when you perfect your skills before you ever put your plane in the air.

Menu-driven software gives you a constant read-out of plane distance, true air speed, throttle setting and altitude. Even a dollar estimate of damage flashes on screen each time you crash.

Use with Heath/Zenith and IBM PC, XT, AT and compatibles.

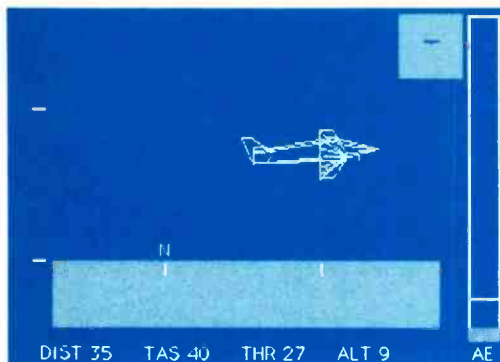

Comes with dual joystick controller. Order required gameport adapter separately.

To order your Flight Simulator for only \$129.95 call 1-800-253-0570 24 hours a day.

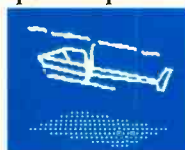

Includes flight simulation for helicopters, too!

## Heath Company

Benton Harbor, MI 49022

A subsidiary of Zenith Electronics Corporation.

Prices, product availability and specifications are subject to change without notice. © 1989, Heath Company.

CIRCLE 19 ON FREE INFORMATION CARD



gineer, and have spent most of the last 14 years as an analog-circuit designer. I guess I must be a big boy now, because I devote a lot of time to reading professional technical journals; but, like many others, I still read and enjoy the hobby magazines. **Popular Electronics** has always offered a good deal of learning, even for professionals, and I'm sure that tradition will be carried on into the future.

I'm very glad to see that my old friend **Popular Electronics** is back. I hope that you'll try to include some of the less sophisticated and less expensive projects that were part of your early roots. A project the size of building a VAX is fine once a year, but even the tenthousandth slow kick of a windshield-wiper project would be more palatable on a monthly basis.

L.D., N5KNV  
Austin, TX

### SPELLING BEE

I found your article, "Wein Bridge Oscillators" (July, 1989) extremely informative. I do have one question, however: Is it a "Wein" bridge or a "Wien" bridge?

D.G.  
Flushing, NY

The proper spelling is, of course, "Wien."

The editor responsible for that "typographical error" has been assigned a special task—he must write "i before e except after c" 100 times, or until he gets it right. Our apologies to author Courtney Hall, and to all our readers.

### THE "PAGE-RITCHIE" COIL?

I enjoyed Stan Czarnik's article, "Fun With Induction Coils," (**Popular Electronics**, June 1989). However, I feel compelled to point out a few historical errors.

Charles Grafton Page (1812–1868), a Harvard graduate, actually invented what is now called the "Ruhmkorff Coil" long before Ruhmkorff did. As the article noted, Page's first induction coil produces a 1/16-inch-long spark. Page soon thereafter made several improvements on his design. He was the first to use a mixture of alcohol and mercury to shorten the time of contact during the interrupter break, which increased the output potential considerably. He later used platinum contacts to produce an induction coil with a 4 1/2-inch-long spark in 1841. In 1850 (8 years prior to Ruhmkorff's work) Page produced a coil yielding a spark through air measuring 8 inches in length.

In 1851, Edward Samuel Ritchie (1814–1895), an American philosopher and instrument manufacturer, divided the secondary coil into separate segments, each insulated

from the other with rubber discs. That dramatic improvement in induction-coil design enabled him to produce a coil that developed 10-inch-long sparks. Ritchie displayed the coil at an exhibit in England in 1857. He did not know Ruhmkorff at that time.

Ruhmkorff saw Ritchie's coil and copied it to secure the first prize of 50,000 francs at the French Exposition of Electrical Apparatus in 1858. Although he developed his induction coil long after Page and Ritchie did their work, Ruhmkorff received the recognition. Page's and Ritchie's work remained relatively unknown in Europe even after Ritchie's English display.

In 1861, Page developed a coil that produced 42-inch-long sparks in open air!

D.C.C.  
Baraboo, WI

### SWAP MEET

During the preparation of the July 1989 installment of "Electronics Library," the gremlins got their hands on two pairs of photographs and transposed them. The books involved were "Make Money From Home Recording" and "Dictionary of Audio, Radio, and Video," and "How To Keep Your VCR Alive" and Contact East's "1989 General Catalog." We're sorry for any inconvenience that this has caused. —Editor

		<b>EMINENCE</b> 					
<b>1-800-338-0531</b>							
<b>3-WAY 100W CROSSOVER</b> 12 dB/octave rolloff. 800Hz, 5000Hz crossover points. 8 ohm. 100 watts RMS. 		<b>WALNUT SPEAKER CABINET KIT</b> Super quality, genuine walnut veneer cabinet. Kit includes: routed and mitred top, sides, and bottom in unfinished 3/4" walnut veneer. Cut your own custom holes in the front and rear to match your drivers. 15" x 24" x 11". Volume: 1.9 cubic feet. 		<b>12" SUB WOOFER</b> Dual voice coil sub woofer. 30 oz. magnet, 2" voice coils. 100 watts RMS, 145 watts max. fs = 25 Hz. 6 ohm (4 and 8 ohm compatible). SPL = 89 dB 1W/1M. Response: 25-700 Hz. QTS = .31, VAS = 10.3 cu. ft. Pioneer #A30GU30-55D. Net weight: 6 lbs. 		<b>18" EMINENCE WOOFER</b> MADE IN USA 100 oz. magnet, 3" voice coil. 250 watts RMS, 350 watts max. 8 ohm, 30 Hz resonant frequency. 22-2700 Hz response. Efficiency: 95 dB 1W/1M. Paper cone, treated accordion surround. Net weight: 29 lbs. 	
<b>#260-210</b> <b>\$12.50</b> <b>\$9.95</b> (1-9)            (10-up)		<b>#260-350</b> <b>\$22.50</b> <b>\$19.95</b> (1-3)            (4-up)		<b>#290-145</b> <b>\$39.80</b> <b>\$36.80</b> (1-3)            (4-up)		<b>#290-200</b> <b>\$98.90</b> <b>\$89.50</b> (1-3)            (4-up)	
<b>SPEAKER CONTROL PANEL</b> Panel with 50 watt L-pads for tweeter and midrange and built-in LED power meter. 5" x 2 1/2" 100 watt version available 		<b>PIONEER HORN TWEETER</b> Mylar dome. 2.93 oz. barium ferrite magnet. 8 ohm. Response: 1800-20000 Hz. 35W RMS, 50W max. fs = 2000 Hz, SPL = 106 dB. Pioneer #AHE60-51F 		<b>15" THRUSTER WOOFER</b> Thruster by Eminence. Made in USA. Poly foam surround, 96 oz. magnet. 2-1/2", 2 layer voice coil. 150 watts RMS, 210 watts max. 4 ohm. fs = 23.5 Hz, QTS = .33, VAS = 17.9 cu. ft. SPL = 94.8 dB 1W/1M. Net weight: 15 lbs. 		<b>TITANIUM COMPOSITE TWEETER</b> Titanium is deposited on a polymer dome to combine the advantages of both hard and soft dome technologies. 8 ohm. Ferro fluid cooled voice coil. fs = 1200 Hz, SPL = 90 dB 1W/1M. 50 watts RMS, 70 watts max. 4" round. Polydax part #DTW100T12S. 	
<b>#260-235</b> <b>\$14.50</b> <b>\$12.90</b> (1-5)            (6-up)		<b>#270-050</b> <b>\$6.50</b> <b>\$5.90</b> (1-9)            (10-up)		<b>#290-180</b> <b>\$43.50</b> <b>\$39.80</b> (1-3)            (4-up)		<b>#270-047</b> <b>\$27.50</b> <b>\$24.80</b> (1-9)            (10-up)	
<b>12" POLY WOOFER</b> Super duty, 40 oz. magnet. 100 watts RMS, 145 watts max. 4 and 8 ohm compatible (6 ohm). 2" voice coil. fs = 25 Hz. QTS = .166, VAS = 10.8 cu. ft. Response: 25-1500 Hz. Net weight: 9 lbs. Pioneer #A30GU40-51D 		<b>GRILL FRAME KIT</b> With this kit you can make speaker grill frames up to 30" x 40". Kit includes 4 corner pieces, 2 "T" brackets, and 7 frame bars. Grill mounting kit included. 					
<b>#290-125</b> <b>\$36.80</b> <b>\$34.50</b> (1-3)            (4-up)		<b>#260-333</b> <b>\$8.50</b> <b>\$7.80</b> (1-9)            (10-up)		<b>FREE CATALOG</b> 1989 CATALOG CALL TOLL FREE 1-800-338-0531			
		* 15 day money back guarantee * \$15.00 minimum order * We accept Mastercard, Visa, Discover, and C.O.D. orders * 24 hour shipping * Shipping charge = UPS chart rate * \$1.00 (\$3.00 minimum charge) * Hours: 8:30 am - 6:00 pm EST, Monday - Friday * Mail order customers, please call for shipping estimate on orders exceeding 5 lbs.					
340 E. First St., Dayton, Ohio 45402 Local: 1-513-222-0173 FAX: 513-222-4644							

CIRCLE 11 ON FREE INFORMATION CARD

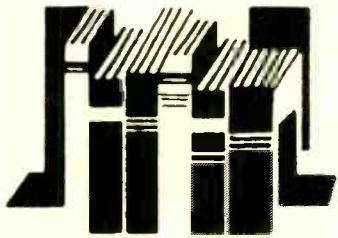

## Electronics Library

To obtain additional information on the books and publications covered in this section from the publisher, please circle the item's code number on the Free Information Card

### THE MAKE-OVER BOOK: 101 Design Solutions for Desktop Publishing

by Roger C. Parker

Roger Parker, who teaches seminars in desktop publishing, teamed with professional designers to prepare this book. As increasing numbers of small businesses take advantage of desktop publishing to create their own advertising, brochures, newsletters, and corporate logos, such a guide becomes a valuable business tool.

After an opening chapter that describes evaluation techniques and outlines 25 common design mistakes to avoid, the book confronts the subject visually, presenting 101 "before-and-after" examples. Each illustrated example is accompanied by brief caption-style text, explaining what was wrong with the "before" picture and how the

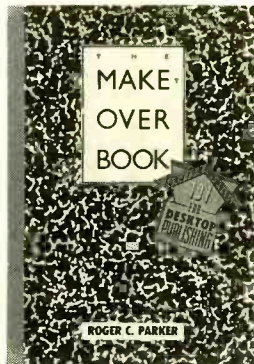

changes lead to the "after" picture. The book is divided into categories based on the most commonly created documents: newsletters, advertising copy, charts, price lists, order forms, resumes, etc. Each section offers a few pages of text concerning the most effective ways to present a particular type of document—defining what must be expressed and explaining how to do it well—and then presents the examples.

While readers can turn to a particular section for specific advice, the elements of good design transcend those bounda-

ries. Readers are likely to find the solution to a sticky design problem for their newsletter in the chapter on flyers, and will pick up constructive pointers throughout the book.

*The Make-Over Book: 101 Design Solutions for Desktop Publishing is available for \$17.95 from Ventana Press; P.O. Box 2468, Chapel Hill, NC 27515.*

**CIRCLE 80 ON FREE INFORMATION CARD**

### APPLE CARE MANUAL: Diagnosing and Maintaining Your Apple II+, IIe and IIC Computers

by Chris Morrison and Teresa S. Stover

Regardless of your level of experience with computers and electronics, if you own an Apple computer, you'll find useful, money-saving techniques in this book. It presents preventive maintenance, troubleshooting tips, and simple repairs that are all designed to keep your computer out of the service shop—yet require no skills other than the ability to use a screw driver and to follow directions.

Following a basic system overview and descriptions of general maintenance, troubleshooting, and repair techniques, the book is divided into separate sections for each part of the system—keyboard, monitor, disk drive, modem, cables, etc. Those sections contain the procedures and instructions needed to diagnose a problem and to fix it. (Some repairs should not be attempted at home; the book also indicates what circumstances call for professional servicing.)

A "System Diagnostic Program" is provided with the book to facilitate troubleshooting. The BASIC program includes eight modules that are each designed to perform a series of tests on a specific part of the system, and a "System Exerciser Module" that tests the entire system after a repair. The program can be purchased separately or keyed in manually; a chapter is devoted to how to load and run it, even if you have no experience with BASIC. If you are familiar with BASIC, the program listings and line-by-line explanations of the program code that are included in the corresponding chapters will come in handy for modifying the program to suit your own purposes. Another chapter provides instructions for developing your own diagnostic programs for additional peripherals.

*Apple Care Manual: Diagnosing and Maintaining Your Apple II+, IIe, and IIC Computers is available for \$17.95 from Windcrest, Division of Tab Books Inc., Blue Ridge Summit, PA 17294-0850; Tel. 1-800-233-1128.*

**CIRCLE 98 ON FREE INFORMATION CARD**

### GOLDEN CLASSICS OF YESTERYEAR

by Dave Ingram, K4TWJ

This book is sure to stir fond memories for amateur-radio enthusiasts who have been around the hobby for a while—and provide some interesting historical glimpses for new hams. It is filled with stories; old advertisements; and descriptions of favorite circuits, transmitters, receivers, bugs, and telegraph keys. The book is a light-hearted—this is not a textbook—but an informative and highly descriptive collection of tales and circuits culled from the author's (and his friends') personal experiences, and from old written materials.

Easy-to-build weekend projects include designs for transmitters and receivers from the 1920's, 30's, and 40's. The book even

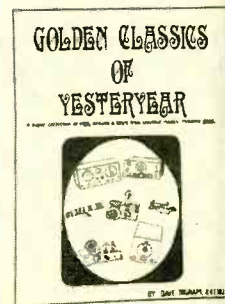

provides instructions for building a classic "Tailender," an early DX memory keyer that requires no power supply or other electronic parts, yet works like a pro. For collectors of classic radio equipment, the book explores how to track down, restore, and operate antique gear.

*Golden Classics of Yesteryear is available for \$9.95 from MFJ dealers. Contact MFJ Enterprises, Inc., P.O. Box 494, Mississippi State, MS 39762; Tel. 800-647-1800 for orders.*

**CIRCLE 81 ON FREE INFORMATION CARD**

### OSCAR SATELLITE REVUE

by Dave Ingram, K4TWJ

This anthology of articles that were previously published in CQ magazine show readers how to set up and operate various types of OSCAR (Orbiting Satellite Carrying Amateur Radio) stations to DX via the OSCAR satellites, as well as Japanese and Russian satellites. Each article is followed by an update that covers new information since its original publication. The articles cover everything from the launching of the first OSCAR amateur satellite in 1961 right up to late-breaking news on the upcoming PHASE IV "Super System."

The book takes readers from setup to successful operations, in easy-to-under-





Join  
the

# Electronics and Control Engineers' Book Club®

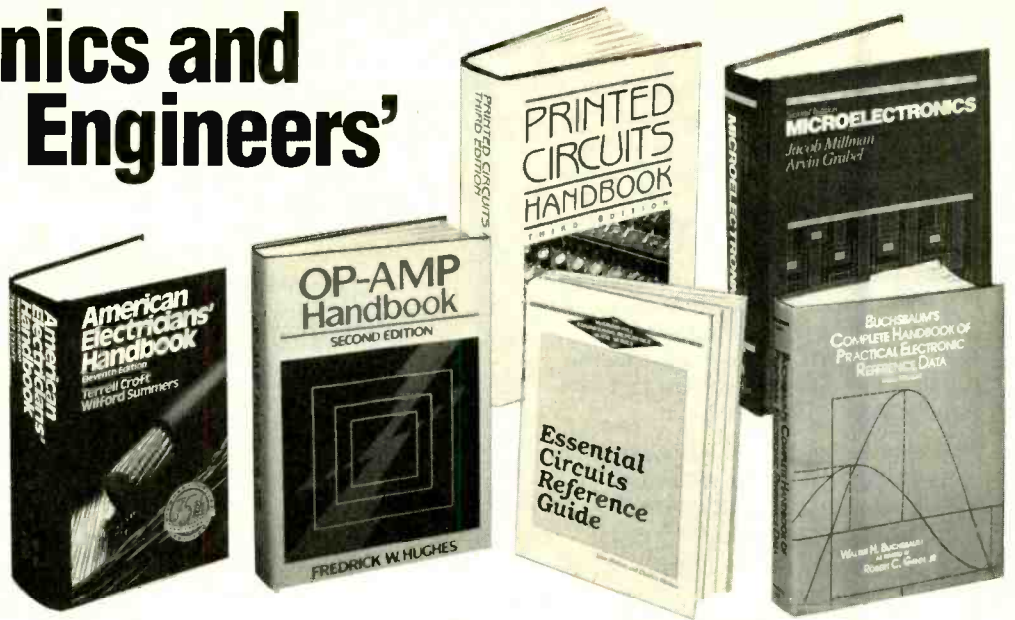

**BUCHSBAUM'S COMPLETE HANDBOOK OF PRACTICAL ELECTRONIC REFERENCE DATA, Third Ed.** By W. H. Buchsbaum, revised by R. C. Genn, Jr. 635 pp., 357 illus. & tables. This best-selling reference is invaluable for engineers whose work involves going outside their own area of expertise. Coverage includes digital logic; optoelectronics; antennas and transmission lines; RF and microwave fundamentals; communications systems; television systems; computers; radio; recording; and more. 583880-X Pub. Pr., \$34.95 Club Pr. \$26.50

**PRINTED CIRCUITS HANDBOOK, Third Edition.** By C. F. Coombs, Jr. 960 pp., 556 illus. Here in one handy volume is all the information you need to design, manufacture, test, and repair printed wiring boards and assemblies. This new edition features ten all-new chapters, including three on SMT. 126/097 Pub. Pr., \$63.50 Club Pr., \$45.50

**32-BIT MICROPROCESSORS.** Edited by H. J. Mitchell, 248 pp., 104 illus. and tables. A complete survey of the architecture, operation, and applications of today's most important new devices from AT&T, Inmos, Intel, and Motorola. 425/85X Pub. Pr., \$48.50 Club Pr., \$35.00

**MICROWAVE AMPLIFIERS AND OSCILLATORS.** By C. Gentili, 150 pp., 79 illus. A thorough, practical introduction to the theory and design of microwave amplifiers and oscillators, with coverage of the scattering matrix, the gallium arsenide field-effect transistor, and microstrip technology. 229/953 Pub. Pr., \$39.95 Club Pr., \$27.95

**COMMUNICATIONS RECEIVERS: Principles and Design.** By Ulrich L. Rohde and T.T.N. Bucher, 608 pp., 402 illus. Everything you need to know if you design or work with communications receivers, from theory to practical design approaches. Coverage includes all types of receivers: shortwave, broadcast, radar, military, marine, aeronautical, and more. 535/701 Pub. Pr., \$62.50 Club Pr., \$44.50

- your one source for engineering books from over 100 different publishers
- the latest and best information in your field
- discounts of up to 40% off publishers' list prices

New Members!  
Take any one of these great professional books **\$289** for only as a premium with your first selection!

Spectacular values up to **\$99.90**

**ENGINEERING FUNDAMENTALS FOR THE PROFESSIONAL ENGINEERS' EXAM, Third Ed.** By L. M. Polentz, 432 pp., 170 illus. Features worked-out solutions and full explanations for all sample problems so you can learn how to solve them. It's a dependable way to prepare for the exam or a perfect on-the-job reference. 503/931 Pub. Pr., \$39.50 Club Pr., \$27.95

**AUTOMATIC CONTROL SYSTEMS, Fifth Ed.** By B. C. Kuo, 736 pp., illus. Provides an overview of automatic control systems, including in-depth coverage of classical control techniques, optimal control theory, and analog and digital control system design. This up-dated edition discusses the latest ideas on the use of computers to design control systems and as components of such systems. 583706-4 Pub. Pr., \$51.00 Club Pr., \$36.95

**OP-AMP HANDBOOK, Second Ed.** By F. W. Hughes, 320 pp., 231 illus. Organized for on-the-job reference, this handbook covers all facets of op-amps, from stability and protection to signal processing using op-amps. Includes a collection of over 60 practical circuits for a variety of applications, procedures, and experiments. 583651-3 Pub. Pr., \$39.00 Club Pr., \$27.50

**HANDBOOK FOR SOUND ENGINEERS: The New Audio Cyclopedia.** Edited by G. Ballou, 1,247 pp., over 1,200 illus. This giant handbook gives you truly comprehensive coverage of sound — and the methods of producing, reproducing, controlling, changing, reinforcing, and measuring it. 583913-X Pub. Pr., \$79.95 Club Pr., \$55.95

**ESSENTIAL CIRCUITS REFERENCE GUIDE.** By J. Markus & C. Weston, 528 pp., illus. Collects into one convenient volume more than 1,000 ready-to-use circuit diagrams for today's electronics applications. Now you can have the circuit you need in a matter of seconds — without having to reinvent the wheel. 404/623 Pub. Pr., \$59.50 Club Pr., \$47.50

**CIRCUIT DESIGN FOR ELECTRONIC INSTRUMENTATION: Analog and Digital Devices from Sensor to Display, Second Ed.** By D. Wobschall, 400 pp., 365 illus. Brings you the entire process of circuit design in a comprehensive, easy-to-follow format. This new edition reflects the latest in IC technology, including CMOS and ECL devices. 712/31X Pub. Pr., \$49.50 Club Pr., \$36.95

**AMERICAN ELECTRICIANS' HANDBOOK, Eleventh Ed.** By T. Croft and W. Summers, 1,824 pp., 1,560 illus. This newly updated handbook shows you how to select, install, maintain, and operate all the latest electrical equipment and wiring. It includes the most recent code requirements, basic formulas, and a wealth of circuit diagrams and illustrations. 139/326 Pub. Pr., \$69.50 Club Pr., \$49.50

**MICROELECTRONICS, Second Ed.** By J. Millman and A. Grabel, 1,001 pp., 646 illus. Takes you from the basics of semiconductor properties to an understanding of the operation of solid-state devices, and then to more advanced topics. Its up-to-date coverage, real-life examples, and practical data make this an ideal reference for the working engineer. 423/30X Pub. Pr., \$53.95 Club Pr., \$41.50

**ENGINEERING MATHEMATICS HANDBOOK, Third Ed.** By J. J. Tuma, 512 pp., illus. This best-selling handbook gives you the essential mathematical tools—formulas, definitions, theorems, tables, and models for computer programming — that you need for your day-to-day engineering calculations. 654/433 Pub. Pr., \$49.50 Club Pr., \$34.50

## ELECTRONICS SOURCEBOOK FOR TECHNICIANS AND ENGINEERS

592 pp., 800 illus., softbound 335/591

This condensed, paperback version of the *Handbook for Electronics Engineering Technicians* is the perfect on-the-job reference for all electronics professionals. From fully worked-out examples, explanations, tables, and graphs ... through up-to-date coverage of active filters, microwaves, and fiber optics ... to using the full spectrum of technical equipment, the *Sourcebook* is the single most convenient professional electronics reference available.

**A \$24.95 Value—Yours ABSOLUTELY FREE when you join!**



**BASIC TELEVISION AND VIDEO SYSTEMS, Fifth Ed.** By B. Grob. 592 pp., illus. Provides the clearest picture of how television and video systems work, and what to do when they don't. Covers television receivers, VCR's, video cameras, and cable systems — all in readable, practical detail.  
249/334 Pub. Pr., \$35.95 Club Pr., \$24.95

**ANALOG ELECTRONIC CIRCUITS.** By G. M. Glasford. 480 pp., 350 illus. Gives you the detailed information and equations you need to create and analyze top quality circuit designs or effectively utilize the designs of others.  
583768-4 Pub. Pr., \$55.00 Club Pr., \$39.50

**HANDBOOK OF ELECTRONIC NOISE MEASUREMENT AND TECHNOLOGY, Second Ed.** By C. A. Vergers. 440 pp., 213 illus. Provides answers to all your questions about noise origins, causes, effects. Also shows you how to predict and measure noise, and how to design low-noise circuits.  
583947-4 Pub. Pr., \$39.95 Club Pr., \$29.95

**SWITCHGEAR AND CONTROL HANDBOOK, Second Ed.** Edited by R. W. Smeaton. 1,056 pp., 789 illus. The only handbook that treats all aspects of switchgear control, including design, applications, safety, and maintenance. Updated to reflect the changes brought about by the use of computers, solid-state devices, and programmable controls.  
584/494 Pub. Pr., \$79.50 Club Pr., \$56.95

**ANTENNA APPLICATIONS REFERENCE GUIDE.** Edited by R. C. Johnson and H. Jasiak. 496 pp., 368 illus. and tables. Covers the major applications of antenna technology in all areas of communications and their design methods. Emphasizes important new applications such as earth station, satellite, seeker, aircraft, and microwave-relay antennas.  
322/848 Pub. Pr., \$56.95 Club Pr., \$42.50

**RADIO HANDBOOK, Twenty-Third Ed.** Edited by W. I. Orr. 667 pp., 1,073 illus. and tables. The latest edition of the most complete, current resource on radio technology and its applications. Expert contributors show you how to select, design, build, test and operate all kinds of equipment.  
584638-1 Pub. Pr., \$29.95 Club Pr., \$23.95

**BOB MIDDLETON'S HANDBOOK OF ELECTRONIC TIME-SAVERS AND SHORTCUTS.** By R.G. Middleton. 378 pp., illus., softbound. Packed with little-known tricks of the trade and brand-new techniques, this popular handbook makes it easier than ever to troubleshoot radio, TV, audio equipment, CCTV, and more.  
583865-6 Pub. Pr., \$29.95 Club Pr., \$22.50

**Be sure to consider these important titles as well!**

**INTRODUCTION TO RADAR SYSTEMS, Second Ed.** By M. I. Skolnik. 579/891 Pub. Pr., \$54.95 Club Pr., \$42.50

**ELECTRONIC TEST EQUIPMENT: Principles and Applications.** By T.J. Byers. 095/221 Pub. Pr., \$44.95 Club Pr., \$29.95

**OPERATIONAL AMPLIFIERS AND LINEAR INTEGRATED CIRCUITS, Third Ed.** By R. F. Coughlin and F. F. Driscoll. 583754-4 Pub. Pr., \$40.00 Club Pr., \$25.95

**McGRAW-HILL'S NATIONAL ELECTRICAL CODE HANDBOOK, 19th Ed.** By J. F. McPartland. 457/077 Pub. Pr., \$46.50 Club Pr., \$31.95

**HANDBOOK OF ELECTRONICS CALCULATIONS FOR ENGINEERS AND TECHNICIANS, Second Ed.** Edited by M. Kaufman & A. H. Seidman. 335/281 Pub. Pr., \$49.50 Club Pr., \$37.50

**PROBABILITY, SIGNALS, NOISE.** By J. Dupraz. 183/309 Pub. Pr., \$49.95 Club Pr., \$34.95

**POWER GENERATION CALCULATIONS REFERENCE GUIDE.** By T. G. Hicks. 288/003 Pub. Pr., \$41.00 Club Pr., \$27.50

**HUMAN FACTORS REFERENCE GUIDE FOR ELECTRONICS AND COMPUTER PROFESSIONALS.** By W. E. Woodson. 717/664 Pub. Pr., \$39.95 Club Pr., \$29.50

**REFERENCE DATA FOR ENGINEERS: Radio, Electronics, Computer, and Communications, Seventh Ed.** Edited by E. C. Jordan. 583619-X Pub. Pr., \$69.95 Club Pr., \$49.95

**THE LASER GUIDEBOOK.** By J. Hecht. 277/338 Pub. Pr., \$55.95 Club Pr., \$41.50

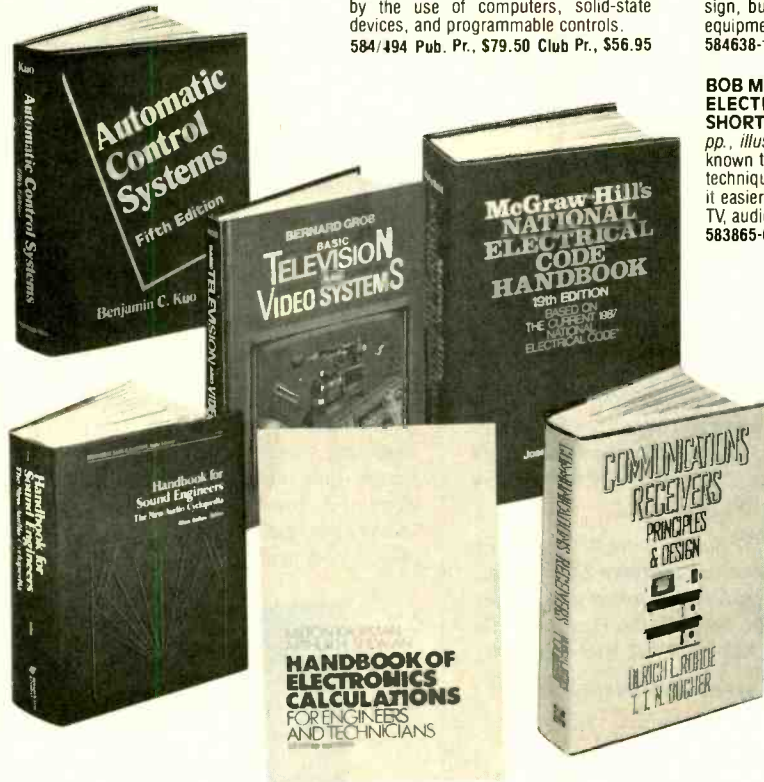

**FOR FASTER SERVICE IN ENROLLING CALL TOLL-FREE 1-800-2-MCGRAW**

## Here's how the Club works to serve YOU:

### ■ IMPORTANT INFORMATION ... WE MAKE IT EASY TO GET!

In our rapidly changing world, those who perform best are those who are best informed. Designed exclusively for the practicing engineer the Electronics and Control Engineers' Book Club provides you with information that is relevant, reliable, and specific enough to meet your needs. Each Club bulletin comes your way 14-16 times a year and offers you more than 30 books to choose from — the best and newest books from all publishers!

### ■ DEPENDABLE SERVICE ... WE'RE HERE TO HELP!

Whether you want information about a book or have a question about your membership, our qualified staff is here to help. Just call us toll-free or write to our Customer Service. We also make sure you get only the books you want. All you do is simply tell us your choice on the Reply Card and return it to us by the specified date. If you want the Main Selection, do nothing — it will be sent to you automatically. (A small shipping and handling charge is added to each shipment.)

### ■ CLUB CONVENIENCE ... WE DO THE WORK!

Beyond the benefit of timely information, Club membership offers many other benefits. For example, you get a wide choice of books that cannot be matched by any bookstore — anywhere. And all your books are conveniently delivered right to your door. You also get the luxury of 10 full days to decide whether you want the Main Selection. If you should ever receive a Main Selection you don't want because the Club bulletin came late, just return it for credit at our expense.

### ■ SUBSTANTIAL SAVINGS ... AND A BONUS PROGRAM TOO!

In keeping with our goal to provide you with the best information at the greatest possible savings, you will enjoy substantial discounts — up to 40%! — on every book you buy. Plus, you're automatically eligible for our Bonus Book Plan which allows you savings up to 70% on a wide selection of books.

### ■ EASY MEMBERSHIP TERMS ... IT'S WORTHWHILE TO BELONG!

Your only obligation is to purchase one more book — at a handsome discount — during the next 12 months, after which you enjoy the benefits of membership with no further obligation. Either you or the Club may cancel membership anytime thereafter.

MAIL THIS COUPON TODAY

### McGraw-Hill Book Clubs Electronics and Control Engineers' Book Club®

P.O. Box 582, Hightstown, NJ 08520-9959

Please enroll me as a member and send me the two books indicated, plus the ELECTRONICS SOURCEBOOK FOR TECHNICIANS AND ENGINEERS. I am to receive one book for just \$2.89, the other at the discounted member's price, plus local tax, shipping and handling charges. I agree to purchase a minimum of one additional book during my first year of membership as outlined under the Club plan described in this ad. I understand that a shipping and handling charge is added to all shipments.

Your FREE Sourcebook	
335/591	
Write Code No. of the \$2.89 selection here	Write Code No. for the First selection here
<input type="text"/>	<input type="text"/>

Signature \_\_\_\_\_

Name \_\_\_\_\_

Address/Apt. # \_\_\_\_\_

City \_\_\_\_\_

State \_\_\_\_\_ Zip \_\_\_\_\_

This order subject to acceptance by McGraw-Hill. All prices subject to change without notice. Offer good only to new members. Foreign member acceptance subject to special conditions.

E34088

## Electronics Library

(Continued from page 7)

investing, and library cataloging. Reflecting the fast pace of software development, the 1989 version has been fully revised with 4,000 new entries and 6,000 updated ones.

The book is organized for easy access with four indexes: Title Index, Guide to Systems, Guide to Applications, and System Compatibility/Applications Index. The alphabetic Title Index contains a full description of each entry, including number of disks included, version, authors, release date, price, compatible hardware, microprocessor types, requisite operating system, memory capacity, language, ISBN identification number, order number, and publisher's name. (Complete contact and ordering information is included in an additional Publisher's Index.) The Systems Index lists software for 14 different microcomputer-hardware manufacturers and related generics. The Applications Index is divided into 38 major categories—from Accounting to Word Processing—which are further divided into over 500 specific application areas.

*The Software Encyclopedia 1989 is available for \$179.00 from R.R. Bowker Company, P.O. Box 762, New York, NY 10011; Tel. 800-521-8110 (212-337-6934 in NY, AK, and HI).*

**CIRCLE 83 ON FREE INFORMATION CARD**

## THE RADIO STATION: Second Edition

by Michael C. Keith  
and Joseph M. Krause

Written by two professionals in the field, this book offers insights into what it's really like to work at a radio station. Drawing on their own experience and that of dozens of their colleagues, the authors bring to life each aspect of radio—painting a clear picture of the struggle for ratings and profits, and the interplay between station management, programming, sales, news, research, promotion, production, and engineering. Those vivid descriptions will help those who plan to work in radio, or who are already working in the industry but want to alter

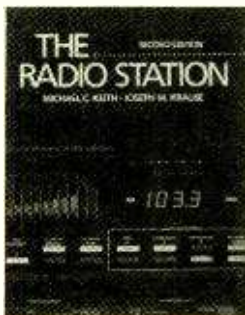

or improve their career tracks, to make informed career choices.

The second edition has expanded, contemporary coverage of buying and selling stations, satellite and syndication programming, the music industry, and noncommercial radio. It also explores recent technological advances, including digital radio and improvements in AM broadcasting. The book is amply illustrated, and includes a comprehensive glossary.

*The Radio Station: Second Edition is available for \$24.95 from Focal Press, 80 Montvale Avenue, Stoneham, MA 02180.*

**CIRCLE 84 ON FREE INFORMATION CARD**

## HD150 SERIES HEAVY-DUTY DIGITAL MULTIMETERS

from Beckman Industrial

This full-color selection guide describes Beckman's newest line of heavy-duty DMM's. The models HD151, HD152, and HD153 3½-digit, autoranging digital multimeters are designed to go anywhere and are exceptionally rugged. Details of their features are included in this brochure.

*The HD150 Series Selector Guide No. 50 is free upon request from Beckman Industrial Corporation, Instrumentation Products Division, 3883 Ruffin Road, San Diego, CA 92123-1898; Tel. 619-495-3200.*

**CIRCLE 85 ON FREE INFORMATION CARD**

## THE ART OF DIGITAL AUDIO

by John Watkinson

While the field of digital audio is still developing rapidly, it has moved beyond the world of R&D labs out into the recording industry and the marketplace. Standards have evolved and been adopted, and a vast amount of data and theory exists. This book describes both the essential theory of digital audio, and how it is put into practice. To keep the book accessible to a wider audience, the author presents the information in words, rather than mathematically, and introduces each concept with the basic mechanism involved and a plain-English definition of its terminology. Students and music buffs, as well as professional recording, broadcast-sound, and audio-design engineers, will find this book to be a handy reference source.

The book builds upon basic introductory information to deal with more advanced topics—including descriptions of laser optics, channel coding, error correction, and digital filtering as they relate to audio. Compact discs and RDAT (Rotary-head Digital Audio Tape) are fully covered, along with their mastering recorders. Professional mas-

tering recorders are also covered, and the increasingly important use of magnetic disks in audio editing is discussed in depth.

*The Art of Digital Audio is available in hardcover for \$49.95 from Focal Press, 80 Montvale Avenue, Stoneham, MA 02180.*

**CIRCLE 86 ON FREE INFORMATION CARD**

## McGraw-Hill Dictionary of Scientific AND TECHNICAL TERMS: Fourth Edition

edited by Sybil Parker

In its 2,137 pages, this comprehensive reference includes 100,100 terms and 117,500 definitions in 102 scientific and technical disciplines. Reflecting the rapid developments and expanding vocabulary in those fields over the past few years, 7,600 of those entries are new to this edition (which, for the first time, includes pronunciations for all terms.)

Although such highly specialized fields as atomic physics, molecular biology, engineering acoustics, and petrology are represented, the dictionary entries use language that non-specialized people can grasp. For further clarification, the entries identify the field or fields in which the term is used and give synonyms, acronyms, and

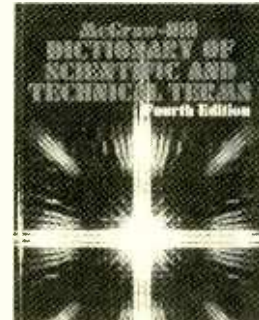

abbreviations. Each entry was carefully checked for accuracy, comprehensiveness, and clarity by a team of consulting editors. More general fields—electronics, chemistry, mathematics, etc.—are also covered in the book.

To make the entries more easily accessible, the dictionary is thumb-indexed. Appendices include the periodic table; schematic symbols; the classification of living organisms; scientific and technical organizations; elementary particles; and mathematical signs, symbols, and notation. The dictionary is generously illustrated with photographs, drawings, tables, and diagrams.

*The McGraw-Hill Dictionary of Scientific and Technical Terms is available for \$95.00 from McGraw-Hill Book Company, 11 West 19th Street, New York, NY 10011; Tel. 1-800-2-MCGRAW.*

**CIRCLE 96 ON FREE INFORMATION CARD**



## TEACH YOURSELF dBASE IV

by Mary Campbell

For beginners who have never used a database program, and for current dBASE users who are upgrading to dBASE IV, this book provides all the instructions needed to successfully navigate that challenging program. Arranged in a series of 15-minute computer sessions that each contain a specific learning objective with a thorough explanation of techniques, the learn-

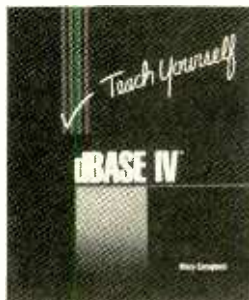

ing process becomes a simplified progression between steps. The book begins with the basic skills needed to create and use dBASE databases, and continues with more complex features of dBASE IV, including macros, the expanded menu system, the applications generator, and the improved report generator. The text accompanying each learning session contains clear examples, and the answers to the hands-on computer exercises appear at the back of the book. By reaching a thorough understanding of each session before proceeding to the next, readers should become proficient intermediate-level users of dBASE IV by the end of the book—with a minimum of frustration.

*Teach Yourself dBASE IV is available for \$19.95 from Osborne McGraw-Hill, 2600 Tenth Street, Berkeley, CA 94710.*

**CIRCLE 93 ON FREE INFORMATION CARD**

## IBM XT CLONE BUYER'S GUIDE AND HANDBOOK

by Edwin Rutsch

With the large number of low-cost IBM-XT clones on today's computer market, choosing the best one for your particular needs and budget can be a difficult task. This book takes on the task of educating consumers about the many types of inexpensive XT clones that are available, and also serves as a user's manual once a purchase has been made.

The "reader-friendly" book opens with a historical overview of the microcomputer, with emphasis on future trends and a discussion of the differences between various

generations of computers. It then delves into more practical areas, evaluating 8088-, 80286-, and 80386-based computers in terms of prices and technical features such as speed, memory, multiuser and multitasking capability, and operating modes. The book continues with a section on how to determine which XT is best for you, and includes reviews of actual XT computers—including the IBM XT, the IBM PS/2 models 25 and 30, and clones from various manufacturers. Which computer to buy seems to be just part of the budget-conscious consumer's dilemma—where to buy it is another important consideration that is covered in detail.

The book is also a user's manual that describes the different parts of a computer and how they work, and includes buying recommendations for peripherals and tips on expansion. Comprehensive directions for assembly are included, as is a section on how to troubleshoot your computer when problems arise.

The book concludes with useful appendices that include listings of computer manufacturers, national and regional computer magazines, and computer-show and swapmeet promoters, as well as IBM diagnostic error codes. The book is filled with photos and illustrations and interspersed with humorous drawings.

*IBM XT Clone Buyer's Guide and Handbook is available for \$19.95 from Modular Information Systems, 431 Ashbury St., San Francisco, CA 94117.*

**CIRCLE 87 ON FREE INFORMATION CARD**

## BUYER BEWARE: Six Points to Consider Before You Buy a Fax Machine

from Sharp Electronics Corporation

This brief flyer from Sharp Electronics Corporation—the manufacturer that's led the market in facsimile machines for the past two years—gives a simple overview of features to look for when buying a fax machine. It doesn't describe specific models, but explains in general what each feature does and how to determine higher-quality models. The pamphlet is intended to help consumers choose the fax machine that is best suited for their individual needs and requirements.

*Buyer Beware: Six Points to Consider Before You Buy A Fax Machine is available from authorized dealers of fax machines made by Sharp Electronics Corporation, Facsimile Division, Sharp Plaza, Mahwah, NJ 07430-2135.*

**CIRCLE 88 ON FREE INFORMATION CARD**

# Finally! All-band scanner antennas with great 800 MHz performance.

Exclusive A/S MICRO-CHOKE™ provides pinpoint resonance at 800 MHz scanning frequencies

Leave it to The Antenna Specialists to develop all-band scanner antennas with excellent performance up to 1000 MHz—unheard of in an all-band antenna. Now your scanner can hear all police, fire and emergency communications you may be missing. Choose trunk lid mount, Model MON-52, or Model MON-58, base station antenna.

Send now for the new 16-page A/S Personal Communications Antennas catalog. Free!

**the antenna specialists co.**  
a member of The Allen Group Inc.  
30800 Bruce Industrial Parkway  
Cleveland, OH 44139-3996  
TEL: 216/349-8400

© 1988 by The Antenna Specialists Co.

**CIRCLE 15 ON FREE INFORMATION CARD**

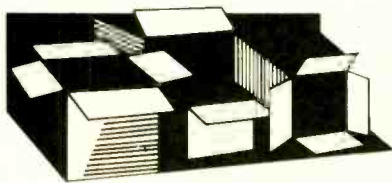

## New Products

To obtain additional information on new products covered in this section from the manufacturer, please circle the item's code number on the Free Information Card

### RF SIGNAL GENERATOR

Leader Instruments' Model 3215 is an AM/FM synthesized RF signal generator that features a user-friendly keypad to control frequency, modulation, and output level. The unit has a frequency range of 100 kHz to 140 MHz, so it is useful as a source for both AM and FM (RF and IF) frequencies. Its resolution is 100 Hz for frequencies below 30 MHz, and 1 kHz between 30 and 140 MHz. The RF-output range is -20 to 126 dB $\mu$  in 0.1-dB steps, and stable carrier-frequency outputs are ensured to within 50-ppm accuracy.

The semi-automatic 3215 eliminates setup time by pre-programming up to 100



different user-defined test conditions. Edit functions make it easy to modify recalled test conditions for any digit of RF frequency, output level, and modulation without disturbing the unit's memory. A GPIB interface allows computer control of all settings.

The 3215 AM/FM synthesized RF signal generator costs \$2,850. For further information, contact Leader Instruments Corporation, 380 Oser Avenue, Hauppauge, NY 11788; Tel. 1-800-645-5104 (in NY, 516-321-6900).

**CIRCLE 101 ON FREE INFORMATION CARD**

### SPEAKER SYSTEM

Ohm Acoustics' Series-2 Sound Cylinders are cylindrical speakers that offer enhanced power-handling capability, improved efficiency, sharper imaging, and a smoother and wider frequency response—all thanks to the addition of a 60%-more-powerful magnet and changes in the crossover and acous-

tic damping that have significantly upgraded Ohm's highly praised Coherent Line Source (CLS) driver system.

The Series-2 line includes the SCS, the SCT, and the SCT+. Each delivers full-room stereo sound, because the CLS System controls the speakers' radiation patterns as the frequency increases. The listener isn't limited to a small "sweet spot" but can enjoy full stereo from anywhere in the room. A bass-port-tuning adaptor lets the bass response be adjusted for rooms with solid floors or walls, which are very acoustically transparent at deep bass frequencies. The cylindrical shape of the enclosures resists flexing far more effectively than a conventional speaker's flat cabinet walls. All three models also have lead linings to further reduce enclosure sound radiation.

The SCS, SCT, and SCT+ have sug-



gested retail prices of \$650/pair, \$850/pair, and \$1,100/pair, respectively. They come in walnut, light-oak and black finishes; for an additional \$175.00 and 2 yards of fabric, the company will prepare individual finishing sleeves that can match any decor. For more information, contact Ohm Acoustics, 241 Taaffe Place, Brooklyn, NY 11205.

**CIRCLE 102 ON FREE INFORMATION CARD**

### HOME-ENTERTAINMENT FURNITURE

Bush Industries' Innovations Collection includes complete home-entertainment centers in either a light, champagne-oak finish (model AV0810) or a high-tech, black finish (model AV1410, shown). Each model has a TV/VCR cart adjacent to glass-fronted audio-component shelves; beneath those are closed-storage cabinets to hold CD's, tapes, records, and accessories.

The unit can hold a 25-inch TV plus a VCR and cable box. A pull-out top shelf and two adjustable shelves, all protected by tempered-glass doors, can handle a complete sound system. Two sets of wooden doors front the bottom portion of the unit.

The suggested retail prices for the oak-



finished AV0810 and the black AV0410 are \$289.00 and \$299.00, respectively. For more information, contact Bush Industries, Inc., One Mason Drive, P.O. Box 460, Jamestown, NY 14702-0460; Tel. 1-800-228-BUSH, in NY, 1-800-248-BUSH.

**CIRCLE 103 ON FREE INFORMATION CARD**

### SIGNAL GENERATOR

Elenco's SG-9000 is a high-frequency signal generator that is capable of AM modulation. It has a stable RF oscillator with a frequency range of 100 kHz to 150 MHz; frequencies of 455 kHz, 4.5 MHz, and 10.7 MHz are specially noted for easy setting. An internal 1-kHz audio frequency is available for AM or external use, and external crystals can be used to lock the oscillator to a certain frequency (1-15 MHz, for instance). The RF output voltage is variable

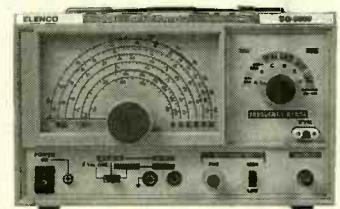

and has a 20-dB attenuator switch.

The SC-9000 comes with an instruction manual with circuit description, block diagram, and schematic. The unit costs \$195.00. For additional information, contact Elenco Electronics, 150 West Carpenter Avenue, Wheeling, IL 60090.

**CIRCLE 104 ON FREE INFORMATION CARD**

### 386 PERSONAL COMPUTER

Tandy's 4000 SX personal computer is based on the versatile 16-MHz Intel 386SX microprocessor. Its high performance and reasonable price make it particularly well-



suiting as a stand-alone business system, a powerful workstation in a network, or a basic desktop-publishing system.

In its standard configuration, the 4000 SX includes one 3.5-inch, 1.44-MHz floppy-disk drive with 3 additional device slots; a socket for an optional 16-MHz 387SX math coprocessor; four 16-bit expansion slots; VGA graphics; a 200-watt power supply; a 101-key enhanced keyboard with



tactile feedback; an asynchronous serial port; and a bidirectional parallel port to support scanning devices in a desktop-publishing environment.

A 40-pin "SmartDrive" Intelligent Device Electronics (IDE) connector allows hard drives with integrated AT-type controllers to be plugged directly into the system, without using an expansion slot for a controller. Embedded controllers provide increased performance and assure compatibility between the drive and the controller.

One megabyte of RAM is standard; two high-speed memory slots support up to 16-Mb of system memory with faster data-transfer rates than conventional 16-bit expansion slots. Expandability is provided through three (one 3.5- and two 5.25-inch) front-accessible half-height device slots.

The Tandy 4000 SX computer has a suggested list price of \$2,599 for the base system without a hard drive, \$3,248 for a 40-Mb system, and \$3,498 for an 80-Mb system. For further information, visit your local Radio Shack store, or contact Tandy Corporation, 1800 One Tandy Center, Fort Worth, TX 76102.

CIRCLE 105 ON FREE INFORMATION CARD

### CAR RADIO/CASSETTE PLAYER

The RX728, which is the top of *Coustics'* 700 Series of ergonomic car radio/cassette decks, tackles the problem of providing high-quality sound in the hostile audio environment of an automobile's interior. The "Auto-Aligned Azimuth" (or A<sup>3</sup>) virtually eliminates the problem of high-frequency loss due to misalignment of the tape mecha-

nism—a very common trouble in car-audio systems.

The RX-728 has Dolby-B/C noise reduction for low-noise music reproduction. Its high/low impedance outputs make it easy to expand the system by adding on preamps, electronic crossovers, and amplifiers, and a CD input is included. Other standard features of the RX-720 include superior FM reception from PLL quartz-synthesizer tuner and FM-optimizer systems; auto seek; 12 preset stations (6 AM and 6 FM);



locking fast forward and rewind; auto reverse; tape-program search; metal-tape equalization; and automatic loudness control, active bass and treble tone controls, and high-power fader control.

## ★ QUALITY PARTS ★ DISCOUNT PRICES ★ FAST SHIPPING

# ALL ELECTRONICS CORP.

<h3>3 to 6 Vdc MOTOR with GEARBOX</h3> <p>Probably designed for child's toy. Lever selects 2 forward and one reverse speed. 1st gear approx. 120 rpm/vdc. 2nd gear approx. 300 rpm/vdc. Reverse approx. 120 rpm/vdc.</p> <p>3.35" X 1.75" X 3.25" CAT# DCM-10 \$6.00</p>	<h3>CASSETTE MECHANISM</h3> <p>Apino cassette transport mechanism. Includes stereo tape head, Mitsubishi # MET-3RF2B 13.2 Vdc motor, belt, pulleys, capstan, fast-forward, rewind and eject actuator. Does not include amplifier section.</p> <p>6 1/2" X 5 1/4" X 1 3/4" CAT# CMEC-5 \$7.50 each 10 for \$65.00</p>	<h3>6 VOLT D.C. 9.5 AMP/HOUR GEL-CELL</h3> <p>Eipower# 695 6 volt, 9.5 amp-hour rechargeable gel-cell battery. 4.25" X 2.75" X 5.5". Quick connect terminals.</p> <p>CAT# GC-695 \$15.00 each</p>	<h3>12-36 VDC GEAR-HEAD MOTOR</h3> <p>Brevell# 780-963075 Rated for 36 Vdc; 96 rpm. 0.6 amp no load, 65 rpm. 1.5 amp @ 12 lb/in torque. Gearbox is 3 1/4" X 3 1/4" X 1 15/16" deep. Motor is 1 1/2" diameter X 3 1/2" long with double flanged 5/16" X 1" shaft. Ideal for pumps, lift mechanisms, robotics and other high torque applications.</p> <p>CAT# MOTG-11 \$15.00 each • 2 for \$25.00</p>
<h3>WALL TRANSFORMERS</h3> <p>ALL PLUG DIRECTLY INTO 120 VAC OUTLET</p> <p>6 Vdc @ 200 ma. CAT# DCTA-430 \$2.26 6 Vdc @ 780 ma. CAT# DCTA-476 \$3.80 9 Vdc @ 250 ma. CAT# DCTA-488 \$2.80 12 Vdc @ 500 ma. CAT# ACTX-1983 \$3.80 18 Vdc @ 1 amp. CAT# ACTX-1988 \$3.80</p>	<h3>LED'S</h3> <p>STANDARD JUMBO DIFFUSED 1 1/4" size</p> <p>RED CAT# LED-1 10 for \$1.80 • 100 for \$19.00 GREEN CAT# LED-2 10 for \$2.00 • 100 for \$17.00 YELLOW CAT# LED-3 10 for \$2.00 • 100 for \$17.00 FLASHING LED with built in flashing circuit operates on 6 volts.</p> <p>RED CAT# LED-4 10 for \$8.00 GREEN CAT# LED-5 10 for \$8.00 BI-POLAR LED Lights RED one direction, GREEN the other. Test leads CAT# LED-4-2 10 for \$1.70 LED HOLDER Two piece holder. CAT# HELD-10 for \$1.00</p>	<h3>DOOR/WINDOW ALARM</h3> <p>Protects doors and windows from intruders. Opening of door or window pulls pin from alarm module and triggers loud buzzer. Simple installation. Operates on 2 AA batteries (not included). Plastic case is 3.32" X 2.29" X 1.19". Ivory with brushed aluminum face.</p> <p>CAT# BWA \$9.00</p>	<h3>WIDE BAND AMPLIFIER</h3> <p>NECH LFC1845L 1200 mhz @ 3 db. Gain: 18db @ 1450 khz. 5 watt operation. Small package form fits. X 2.5 mm thick. CAT# LFC1845L 2 for \$1.00 10 for \$4.80 • 100 for \$35.00</p> <h3>N-CHANNEL MOSFET</h3> <p>RF-511 TO-220 case CAT# RF511 \$1.00 each • 10 for \$8.00 LARGE QUANTITY AVAILABLE</p>
<h3>SWITCHES</h3> <p>TTY PUSH BUTTON TTY MCR series. 20" X 1 1/2" grey rectangular key cap. 8 P.P.T. N.D. Push to close. RATED: 0.1 amp switching, 0.25 amp carry current. P.C. mount. CAT# P5B-86a each • 10 for \$9.00 • 100 for \$80.00</p>	<h3>RELAYS</h3> <p>12 VOLT D.C. COIL S.P.D.T. Omron# G2E-184P 4 Amp contacts 236 ohm coil. Ruger data sheet P.C. mount with pins on DIP spacing CAT# RLX-287 \$1.50 each 6 VOLT D.C. SP RELAY Omron# A4D-120P SR-1A-BVDC SPT normal open SPT med relay. 85 ohm coil. 2 amp contacts. 8" X 2" X 3" high. Housing includes flexible fluorocarbon and color-matched commercial solvents. CAT# RLX-287 \$1.00 each • 10 for \$8.50</p>	<h3>SOUND AND VIDEO MODULATOR</h3> <p>The UM1281-1. Designed for use with T.I. computers. Can be used with video cameras, printers or other audio/video sources. Built in A/B switch enables user to switch from T.V. antenna without disconnection. Operates on channel 3 or 4. Requires 12 Vdc. Hook-up diagram included.</p> <p>CAT# AVMOB \$6.00 each</p>	<h3>PIEZO WARNING DEVICE</h3> <p>Musica Elex# PZM-300 High pitched audible alarm. Operates on 3-20 Vdc @ 30 ma. 1" high X 7/8" dia. P.C. board mount. CAT# PZM-300 \$1.75 each</p> <h3>NICKEL-CAD BATTERIES (RECHARGEABLE)</h3> <p>PERMANENT F. HAAK 1.2 volt @ 180 MAH CAT# NCB-AAAR \$1.80 each 10 for \$15.00 • 100 for \$125.00</p>
<h3>10 POSITION MINI-ROTARY</h3> <p>Grayhill# 68P98-01-1-10N-C Mini rotary switch. Non-wetting. 1 deck, 10 positions. 12P" dia. shaft X 27P" long. .377" behind the panel depth. P.C. pins CAT# MRS-10 WAG \$2.80 NOW \$1.50 each</p>	<h3>SPDT PUSHBUTTON</h3> <p>Marquardt# 1843 Rated @ 500 ma @ 125/250 Vdc. Black plastic pushbutton Switch body: 30" X 24" X .80" CAT# P5B-18 \$1.00 each • 10 for \$1.50 each</p>	<h3>TELEPHONE COUPLING TRANSFORMER</h3> <p>Multi Products International# A19N-HC-1D1 Primary 400 ohm Secondary: 600/800 ohm 37" X .81" X .807" high 6 p.u. pins on 18P" centers Primary isolation. 300 mA min. at 14Vdc, 1 volt. CAT# TCTE-1 \$1.25 each 10 for \$11.00 • 100 for \$95.00</p>	<h3>STROBE KIT</h3> <p>Variable rate strobe kit. Flashes between 80 to 120 times per minute. Will operate on either 6 or 12 Vdc depending upon how you wire the circuit. Comes complete with P.C. board and instructions for easy assembly.</p> <p>CAT# STROBE-1 \$7.50 each</p>
<h3>A.C. LINE CORDS</h3> <p>Black 6ft. 1822, 1827 NON POLARIZED PLUG CAT# LCAC-2 for \$1.00 • 100 for \$45.00 POLARIZED PLUG CAT# LCP-1 \$0.80 each • 100 for \$50.00</p>	<h3>10 AMP SOLID STATE RELAY</h3> <p>ELECTROLUX# SR11 CONTROL: Rated 6.5 by 10 Vdc Full power on 3-32 Vdc LOAD: 10 amp @ 240 Vdc 2 for \$1.249 X 75P CAT# SSR1L-100 \$9.50 each QUANTITY DISCOUNT 10 for \$81.00 • 25 for \$175.00 80 for \$500.00 • 100 for \$500.00</p>	<h3>1/4 WATT RESISTOR KIT</h3> <p>Ideal for the workshop. This 1/4 watt resistor kit contains 10 pieces each of 42 of the most popular values (420 pieces total). Includes a divided box and a parts locator.</p> <p>VALUES in ohm list are: 1 ohm, 10 ohm, 30 ohm, 47 ohm, 51 ohm, 82 ohm, 100 ohm, 120 ohm, 150 ohm, 180 ohm, 220 ohm, 230 ohm, 470 ohm, 560 ohm, 680 ohm, 1K, 1.2K, 1.5K, 2K, 2.2K, 2.7K, 3K, 4.7K, 5.1K, 5.6K, 10K, 15K, 22K, 30K, 33K, 39K, 47K, 56K, 68K, 100K, 120K, 150K, 220K, 470K, 1 MEG, 1.1 MEG, 1.0 MEG The resistors alone would cost for \$21.00. Complete kit = CAT# REKIT-14 \$17.00</p>	<h3>TRANSISTORS</h3> <p>ORDER BY PART #</p> <p>PN2222 NPN TO-18 5c for 75c PN2907 PNP TO-18 5c for 75c 2N3055 NPN TO-18 5c for 75c 2N3055 PNP TO-18 5c for 75c MJE2955 PNP TO-220 75c each MJE2955 PNP TO-220 75c each MJE3055 NPN TO-220 75c each TIP31 NPN TO-220 75c each TIP32 PNP TO-220 75c each TIP21 NPN TO-220 75c each TIP126 PNP TO-220 75c each</p>
<h3>LOOK WHAT \$1.00 WILL BUY</h3> <p>200 ASSORTED 1/4 WATT RESISTORS Best leads, carbon comp. and carbon film. CAT# GR8 \$1.00 per assortment</p> <p>200 ASSORTED 1/2 WATT RESISTORS Best leads, carbon comp. and carbon film. CAT# GR8B \$1.00 per assortment</p> <p>50 ASSORTED DISC CAPACITORS Most are out (p.c. leads) Same to 500 volts CAT# GRACDC \$1.00 per assortment</p> <p>15 VALUES OF ELECTROLYTICS Conforms both lead and radial styles from 1 mfd. CAT# GRACPC \$1.00 per assortment</p>	<h3>XENON TUBE</h3> <p>1" long flashlamps prepared with a 1/2" lead and black leads. Ideal for electronic flash or media projects.</p> <p>CAT# FLT-3 \$1 for \$20</p>	<h3>1/4 WATT RESISTOR KIT</h3> <p>Ideal for the workshop. This 1/4 watt resistor kit contains 10 pieces each of 42 of the most popular values (420 pieces total). Includes a divided box and a parts locator.</p> <p>VALUES in ohm list are: 1 ohm, 10 ohm, 30 ohm, 47 ohm, 51 ohm, 82 ohm, 100 ohm, 120 ohm, 150 ohm, 180 ohm, 220 ohm, 230 ohm, 470 ohm, 560 ohm, 680 ohm, 1K, 1.2K, 1.5K, 2K, 2.2K, 2.7K, 3K, 4.7K, 5.1K, 5.6K, 10K, 15K, 22K, 30K, 33K, 39K, 47K, 56K, 68K, 100K, 120K, 150K, 220K, 470K, 1 MEG, 1.1 MEG, 1.0 MEG The resistors alone would cost for \$21.00. Complete kit = CAT# REKIT-14 \$17.00</p>	<h3>OPTO SENSOR</h3> <p>U shaped package with mounting ears 18P" spacing. 3rd mounting hole. CAT# OSB-4 \$20 each 10 for \$4.80 • 100 for \$40.00</p> <h3>12 VOLT DC SOLID STATE BUZZER</h3> <p>Start CMB-12 fits 14 pin DIP socket. CACOS compatible. Operates on 7-17 Vdc @ 1 ma. PC pins. Fits rigging terminal 70 dB @ 20 cm. 0.888" X 0.887" X 0.575" high CAT# CMB-12 \$1.25 each</p> <h3>14P VOLT TRANSFORMER</h3> <p>Series Industries# SC5-110A, 14.7 volt, 80 ma, 8.82 Vdc, 1.81" high X 1.88" X 1.47". Mounting holes on 2.32" centers. CAT# TX-147 \$3.00 each 10 for \$27.00 • 100 for \$250.00</p>

**CALL OR WRITE FOR OUR FREE CATALOG OVER 4000 PARTS!** Now 60 pages!

MAIL ORDERS TO:  
**ALL ELECTRONICS**  
P.O. BOX 567  
VAN NUYS, CA 91408  
TWX-510101163 (ALL ELECTRONIC)

OUTSIDE THE U.S.A. SEND \$2.00 POSTAGE FOR A CATALOG!

**ORDER TOLL FREE 800-826-5432**  
INFO: (818)904-0524  
FAX: (818)781-2653  
MINIMUM ORDER \$10.00  
QUANTITIES LIMITED  
CALIF. ADD SALES TAX  
USA: \$3.00 SHIPPING  
FOREIGN ORDERS INCLUDE SUFFICIENT SHIPPING. NO C.O.D.

CIRCLE 5 ON FREE INFORMATION CARD



## New Products

The unit's front panel has a simple, user-friendly design that is easy to operate while driving. Dual-function buttons control different operations, depending on the unit's settings. Installation is also easy in most foreign and domestic cars.

The RX-728 car radio/cassette player has a suggested retail price of \$315.00. For more information, contact Coustic, 4260 Charter Street, Vernon, CA 90058-2596; Tel. 800-227-8879.

**CIRCLE 106 ON FREE INFORMATION CARD**

## COMPUTER-TOOLS KIT

Model 47-ZCD-B from Contact East contains a complete assortment of tools for servicing computer systems, personal computers, terminals, printers, monitors, and RS-232 cables. The tools include an array of small-size nutdrivers, hexdrivers, and wrenches, as well as a duplex-outlet tester, a key-cap puller, IC inserter/extractors, and reversible retaining-ring pliers. A black Cor-



dura case neatly holds over 40 tools, a small-parts storage box, and optional test equipment. The case has one document pocket and two other pockets—all with flaps and Velcro fasteners.

The model 47-ZCD-B has a suggested price of \$275.00. For more information, write to Contact East, 335 Willow Street South, P.O. Box 786, North Andover, MA 01845.

**CIRCLE 107 ON FREE INFORMATION CARD**

## CC/CV DC POWER SUPPLY

The VIZ/KAPPA model WP-775 is an automatic constant-current (CC), constant-voltage (CV) power supply that can be set for 0–32 volts DC and 0–5 amps via front-panel current and voltage controls. Two front-panel analog meters monitor voltage and current output with an accuracy of  $\pm 2.5\%$ . The instrument has very stable voltage output and low noise and ripple, making it suitable for all critical design and electronic lab situations. It has no overshoot when turned on or off, and is fully protected against reverse-polarity usage. The WP-



775 can be used in series with another, similar power supply to double the output capability. The compact, rugged WP-775 can be used for a wide range of applications, including production-line testing, design and development lab work, circuit design, quality-assurance checks, diagnostic testing, battery charging, and educational and instructional purposes.

The WP-775—complete with WP-413A test leads with dual banana plugs, instruction manual, spare parts list, and function and operation/procedure directions—has a suggested user price of \$275.00. For additional information, contact VIZ Test Equipment, A Kappa Networks Division, 175 Commerce Drive, Fort Washington, PA 19034-2496; Tel. 1-800-523-3696.

**CIRCLE 108 ON FREE INFORMATION CARD**

## PULSE-COUNT MOTION SENSOR

Many motion-sensor light controls can be falsely triggered by blowing leaves or falling snow, and tricked into turning the lights on when they should be off. The REFLEX SL-5315A pulse-count motion-sensor light control from Heath/Zenith, with its "pulse-count technology," reduces false triggering by as much as 75%. The sensors "take a second look" to verify the object before switching the lights on.

The motion sensor detects people in motion from up to 70 feet away, providing more than 4,500 square feet of coverage. Its

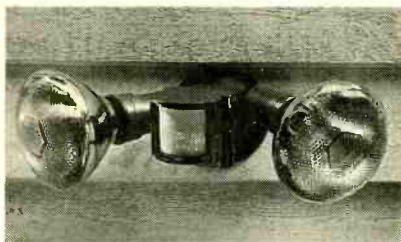

swivel-mount hardware lets the user aim it in any direction, and the multi-zone lens provides overlapping detection zones for both downward and outward coverage. A built-in photocell deactivates the sensor to keep the lights off during the day. Another energy-saving feature is the variable shut-off delay, which allows the user to adjust the period of time the lights stay on from one to 20 minutes. Adjustable sensitivity helps to provide the most effective sensor operation. The motion sensor is UL listed for wet locations and is designed for a maximum lighting load of 500 watts incandescent.

The REFLEX SL-5315A pulse-count motion-sensor light control—sold complete with wall plate and lamp holders—retails for \$59.97. For further information, contact Heath/Zenith, Hilltop Road, St. Joseph, MI 49085.

**CIRCLE 109 ON FREE INFORMATION CARD**

## TELEPHONE-ANSWERING MACHINE

The Code-A-Phone Model 163 phone-answering system includes the popular voice time/day feature—which actually "tells" the time and day that each incoming message is recorded—at an affordable price. A talking clock audibly provides the proper time as well.

The system's other features include one-touch message playback, which plays messages and resets the unit to receive new



ones at the touch of a single button; call screening; and "power-fail protection," which preserves both the outgoing announcement and incoming messages during everyday power surges and any major power outages. The model 163 has six remote commands, including message repeat and message save or cancel.

The model 163 telephone-answering system will be available in September 1989 at a suggested retail price of less than \$70.00. For further information, contact Code-A-Phone Corporation, 16261 S.E. 130th, Clackamas, OR 97015.

**CIRCLE 110 ON FREE INFORMATION CARD**



### BOOKSHELF STEREO

Providing a complete audio system in a compact package, Sharp's SYS-302 bookshelf stereo system contains a full-featured CD player and a surround-sound processor, along with a dual cassette deck, a 5-band graphic equalizer, and a digital AM/FM tuner.

The CD player has random-access programming that allows listeners to preset up to 20 tracks in any order. When used with two extra (optional) speakers, the 2-mode matrix surround-sound processor provides live-concert ambience. The cassette deck offers high-speed dubbing, continu-



ous playback, and Dolby-B noise reduction; and the digital receiver offers auto-scan tuning and 30-station preset memory. Two-step "X-Bass" circuitry provides powerful bass reproduction, and the amplifier produces 25-watts per channel through a pair of two-way speakers with 8-inch woofers.

The SYS-302 bookshelf stereo system has a suggested retail price of \$799.95. A belt-driven turntable (RP-302) is available for \$79.95. For further information, contact Sharp Electronic Corporation, Sharp Plaza, Mahwah, NJ 07480-2135.

CIRCLE 112 ON FREE INFORMATION CARD

### MARINE SECURITY ALARM

Crimestopper Security's MS1000MX Mariner remote-control alarm system was specifically designed to protect boats from theft. The Mariner includes a "Space Guard" passive infrared sensor for interior protection, and contact sensors that can be used on hatches and windows to protect the vessel's perimeter. A manual day/night feature allows the owner to keep the alarm armed to protect the perimeter while the interior sensor is disarmed for convenience.

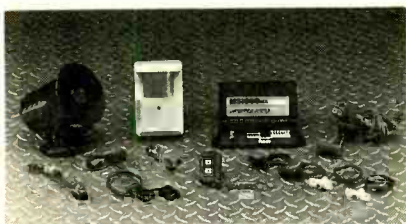

The unit is specially sealed for protection from harsh marine conditions. Featuring the company's MX coding system, it can be programmed with one of billions of personal security codes. The Mariner includes a valet override, a remote panic feature, an automatic starter-kill circuit, a 6-function diagnostic LED status indicator, a passive-arming bypass switch, emergency override, 4 closed-loop circuits to protect canvas covers or ornaments, and a 117-dB siren. An audible chirp signals a defective trigger; the damaged trigger is auto-

matically bypassed when the alarm is armed. Intrusion memory allows the system to recall the last four intrusion points. The system also includes a 3-channel remote transmitter that can arm or disarm remote alarms on as many as three boats.

The MS1000MX Mariner remote-control alarm system will be available in September. For the suggested list price and further information, contact Crimestopper Security Products, Inc., 1770 South Tappo Street, Simi Valley, CA 93063.

CIRCLE 113 ON FREE INFORMATION CARD

## HITACHI SCOPES AT DISCOUNT PRICES

<p><b>V-212</b> <b>\$419</b> List \$560 Save \$141</p> <p><b>20MHz Dual Trace Oscilloscope</b> All Hitachi scopes include probes, schematics and Hitachi's 3 year warranty on parts and labor. Many accessories available for all scopes.</p>	<p><b>V-425</b> List \$995</p> <p><b>\$835</b></p> <ul style="list-style-type: none"> <li>• DC to 40MHz</li> <li>• Dual Channel</li> <li>• CRT Readout</li> <li>• Cursor Meas</li> <li>• DC Offset</li> <li>• Alt Magnifier</li> <li>• Compact Size</li> </ul>	<p><b>V-1060</b> List \$1595</p> <p><b>\$1,325</b></p> <ul style="list-style-type: none"> <li>• DC to 100MHz</li> <li>• Dual Channel</li> <li>• Delayed Sweep</li> <li>• CRT Readout</li> <li>• Sweep Time</li> <li>• Autoranging</li> <li>• Trigger Lock</li> <li>• 2mV Sensitivity</li> </ul>
<p>V-223 20MHz D.T. 1mV sens. Delayed Sweep, DC Offset, Vert Mode Trigger</p> <p>V-422 40MHz D.T. 1mV sens. DC Offset, Vert Mode Trigger, Alt Mag</p> <p>V-423 40MHz D.T. 1mV sens. Delayed Sweep, DC Offset, Alt Mag</p> <p>V-660 60MHz D.T. 2mV sens. Delayed Sweep, CRT Readout</p> <p>V-1065 100MHz D.T. 2mV sens. Delayed Sweep, CRT Readout, Cursor Meas</p> <p>V-1100A 100MHz D.T. 1mV sens. Delayed Sweep, CRT Readout, DVM, Counter</p> <p>V-1150 150MHz D.T. 1mV sens. Delayed Sweep, Cursor Meas, DVM, Counter</p>	<p>LIST PRICE SAVE</p> <p>\$770 \$695 \$75</p> <p>\$875 \$725 \$150</p> <p>\$955 \$625 \$330</p> <p>\$1,195 \$1,025 \$170</p> <p>\$1,895 \$1,670 \$225</p> <p>\$2,295 \$2,045 \$250</p> <p>\$3,100 \$2,585 \$515</p>	

## ELENCO PRODUCTS AT DISCOUNT PRICES

<p><b>20MHz Dual Trace Oscilloscope</b></p> <p><b>MO-1251</b> <b>\$359</b></p> <ul style="list-style-type: none"> <li>• 6" CRT</li> <li>• Built-in component tester</li> <li>• TV Sync</li> <li>• X-Y Operation</li> </ul> <p>Top quality scopes at a very reasonable price. Contains all desired features. Two 1x, 10x probes, diagrams and manual. Two year guarantee.</p>	<p><b>SCOPE PROBES</b></p> <p>P-1 65MHz, 1x, 10x \$19.95</p> <p>P-2 100MHz, 1x, 10x \$23.95</p> <p>Fits all scopes with BNC connector</p>	<p><b>35MHz Dual Trace Good to 50MHz</b></p> <p><b>MO-1252</b> <b>\$495</b></p> <ul style="list-style-type: none"> <li>• High luminance 6" CRT</li> <li>• 1mV Sensitivity</li> <li>• 6KV Acceleration Voltage</li> <li>• 10ns Rise Time</li> <li>• X-Y Operation + Z Axis</li> <li>• Delayed Triggering Sweep</li> </ul>		
<p><b>Autoranging DMM</b></p> <p><b>M-5000</b> <b>\$45</b></p> <p>9 Functions Memory and Data hold 1/2% basic acc 3 1/2 digit LCD</p>	<p><b>True RMS 4 1/2 Digit Multimeter</b></p> <p><b>M-7000</b> <b>\$135</b></p> <p>.05% DC Accuracy 1% Resistance with Freq. Counter and deluxe case</p>	<p><b>Multimeter with Capacitance and Transistor Tester</b></p> <p><b>CM-1500</b> <b>\$55</b></p> <p>Reads Volts, Ohms, Current, Capacitors, Transistors and Diodes with case</p>	<p><b>Digital Capacitance Meter</b></p> <p><b>CM-1550</b> <b>\$58.95</b></p> <p>9 Ranges 1-101,200,000pF 5% basic accy Zero control, with case</p>	<p><b>Digital LCR Meter</b></p> <p><b>LC-1801</b> <b>\$125</b></p> <p>Measures Coils 1uH-2000uH Caps. 1pF-200uF Res. 0.1-20M</p>
<p><b>AC Clamp-On Current Adapter</b></p> <p><b>ST-265</b> <b>\$22</b></p> <p>0-1000A AC Works with most DMM</p>	<p><b>Bench DMMs</b></p> <p><b>M-3500</b> <b>\$125</b></p> <p>3 1/2 digit 3% acy</p> <p><b>M-4500</b> <b>\$175</b></p> <p>4 1/2 digit .05% acy</p>	<p><b>SOLDERING STATION TEMPERATURE CONTROLLED</b></p> <p><b>SL-30</b> <b>\$135</b></p> <p>Digital display Temp range: 300F-900F Grounded tip Overheat prot</p>	<p><b>Solderless Breadboards</b></p> <p><b>9436</b> <b>\$15</b></p> <p>1,100 pins 15 9434 2,170 pins \$25 9436 2,860 pins \$35 All have color coded posts</p>	<p><b>Low Cost Multimeter</b></p> <p><b>M-1600</b> <b>\$25</b></p> <p>3 1/2 digit LCD 1% DC Accuracy 10A Scale Auto zero /polarity</p>
<p><b>Wide Band Signal Generators</b></p> <p><b>SG-9000</b> <b>\$129</b></p> <p>RF Freq 100K-450MHz AM Modulation of 1KHz Variable RF output</p> <p><b>SG-9500 with Digital Display and 150MHz built-in Freq Ctr</b> \$249</p>	<p><b>3 1/2 Digit Probe Type DMM</b></p> <p><b>M-1900</b> <b>\$39</b></p> <p>Convenient one hand operation with batteries and case Measures DCV, ACV, Ohms Audible continuity check, Data hold</p>	<p><b>Function Generator</b></p> <p><b>#9600</b> <b>\$28.95</b></p> <p>Provides sine, tri, sq wave Form Hz to 1MHz AM or FM capability</p>	<p><b>Decade Box</b></p> <p><b>#9610 or #9620</b> <b>\$18.95</b></p> <p>#9610 Resistor Box 47 ohm to 1M &amp; 100K pot #9620 Capacitor Box 47pF to 10uF</p>	
<p><b>Digital Triple Power Supply</b></p> <p><b>XP-765</b> <b>\$249</b></p> <p>0-20V at 1A 0-20V at 1A 5V at 5A Fully Regulated, Short circuit protected with 2 Limit Cont. 3 Separate supplies XP-669 with Analog Meters \$175</p>	<p><b>Quad Power Supply</b></p> <p><b>XP-580</b> <b>\$59.95</b></p> <p>2-20V at 2A 12V at 1A 5V at 3A 5V at 5A Fully regulated and short circuit protected XP-575 without meters \$39.95</p>	<p><b>10MHz XT 100% IBM® Compatible</b></p> <p><b>GF-8016 Function Generator with Freq. Counter</b> <b>\$239</b></p> <p>Sine, Square, Triangle Pulse, Ramp, 2 to 2MHz Freq Counter, 1-10MHz</p> <p><b>GF-8015 without Freq. Meter</b> \$179</p>	<p><b>5 Year Warranty</b></p> <p><b>MODEL PC-1000</b> <b>\$595</b></p> <ul style="list-style-type: none"> <li>• 510MHz Motherboard</li> <li>• 8 Expansion Slots</li> <li>• Math Compressor Slots</li> <li>• 360K Floppy Drive</li> <li>• AT Style Keyboard</li> <li>• 150W Power Supply</li> <li>• 256K RAM</li> <li>• Expandable to 640K</li> <li>• Monochrome Monitor</li> <li>• Monographic Video Card</li> <li>• Parallel Printer Port</li> </ul> <p>FREE spreadsheet and word processor 3.XXMS DOS and GW Basic add \$75</p>	

WE WILL NOT BE UNDERSOLD!  
UPS Shipping: US 5%  
(\$10 Max) IL Res., 7% Tax

**C & S SALES INC.**  
1245 Rosewood, Deerfield, IL 60015  
(800) 292-7711 (312) 541-0710

15 Day Money Back Guarantee  
2 Year Warranty  
WRITE FOR FREE CATALOG

CIRCLE 9 ON FREE INFORMATION CARD



## OSCILLOSCOPES

Beckman's models 9202 and 9204 are, respectively, 20- and 40-MHz oscilloscopes. Both feature "Numeric Readout Displays," which provide on-screen readouts of cursor positions and scale settings, considerably increasing the ease and accuracy of waveform analysis.

The cursors measure amplitude, time, frequency, duty cycle, and phase shift. The readout has two sets of cursor pairs. Each pair has a reference and a delta cursor, and each cursor can be moved individually or as a pair in eight different directions. With two sets of cursors, voltage and frequency readings can be taken simultaneously.

Both models have "A" and "B" sweeps with delayed sweep and segment magnification; TV-sync coupling for video servicing; Z-axis input for blanking or intensified markers; and camera-mount CRT bezel, variable-scale illumination, and single-sweep operation for waveform photography. Each of the models also feature variable hold-off control to ensure proper triggering on complex signals.

The 9202 and 9204 oscilloscopes have



suggested retail prices of \$865.00 and \$1095.00, respectively. For further information, contact Beckman Industrial Corporation, 3883 Ruffin Road, San Diego, CA 92123-1898.

**CIRCLE 118 ON FREE INFORMATION CARD**

## TREASURE-HUNTING VIDEO

A 22-minute video tape titled *Fischer M-Scope, the X Series: How to Get the Most Out of Your Fisher 1200-X Series Metal Detector* has been released by *Fisher Research Laboratory*. It gives advice on how best to use the popular 1200-X Series of land metal detectors in actual field conditions.

The tape is hosted by Joe Henderson, who also hosts the South Carolina TV show "The Treasure Hunter" and is knowledgeable about tuning, searching, pinpointing, and recovering targets. While the tape was produced for Fisher X-Detector users, much of the information it presents will prove valu-



able to owners of other brands of metal detectors.

The videotape costs \$15.95 from Fisher dealers, or by mail (please add \$2.00 shipping; CA residents add \$0.96 sales tax) from Fisher Research Laboratory, 1005 I Street, Dept. HOE, Los Banos, CA 93635. ■

**CIRCLE 119 ON FREE INFORMATION CARD**

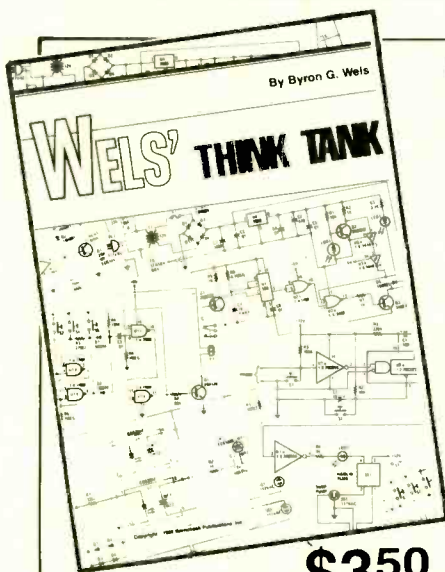

**\$3.50**

## THINK TANK

**53 PAGES, OVER 130 PROJECTS!**

**SIMPLE, EASY-TO-BUILD AND USEFUL IDEAS FOR YOUR HOME, HOBBY, CAR.**

■ **HERE'S THE ANSWER** to that eternal question among electronics hobbyists—"What will I do?" In **WELLS' THINK TANK** you'll find over 53 pages jam-packed with over 130 one-evening projects that will keep you absorbed. These are tantalizing devices that you can quickly put together and then use immediately. There are projects for your car, your home, your work bench, other hobbies, such as photography, music, and stereo. Telephone projects, light controls, and a vast assortment of miscellaneous do-it-yourself items. Flipping through the pages of this book, the question becomes "Which one will I start with!"

■ **THE THINK TANK** originally appeared in

Hands-On Electronics Magazine, and immediately won a good deal of reader acceptance. The mail poured in as readers offered their own circuits or asked for assistance with electronics projects they worked on.

■ **WHAT KIND OF PROJECTS** will you find in the **WELLS' THINK TANK** BOOK? The index, which occupies the entire back page, lists them. Choose from nearly a dozen amplifiers, an assortment of automotive projects from automatic parking lights to electronic air horns, battery chargers to battery monitors. You'll find fuzz boxes for your guitar to a tremolo unit. A darkroom timer for you photo buffs. And at a price of only \$3.50, you can't go wrong!

## THINK TANK—Circuits for Experimenters and Project Builders!

- 169—Please send one copy of THINK TANK at \$3.50. Shipping \$1.25 (U.S. and Canada only).
- 169—Please send \_\_\_\_\_ copies of THINK TANK. Total cost is sum of copy price and shipping cost multiplied by number of copies ordered.

Allow

Please print

\_\_\_\_\_  
(Name)

\_\_\_\_\_  
(Street Address)

\_\_\_\_\_  
(City)

\_\_\_\_\_  
(State)

\_\_\_\_\_  
(Zip)

Detach and mail today:  
Popular Electronics Bookstore  
P.O. Box 4079  
Farmingdale, NY 11735

All Payment must be in U.S. Funds!

**P-989**



# No other training—in school, on the job, anywhere—shows you how to troubleshoot and service computers like NRI

## HARD DISK

20 megabyte hard disk drive you install internally for greater data storage capacity and data access speed.

## PACKARD BELL COMPUTER

NEC V40 dual speed (4.77 MHz/8 MHz) CPU, 512K RAM, 360K double-sided disk drive.

## MONITOR

High-resolution, non-glare, 12" TTL monochrome monitor with tilt and swivel base.

## DIGITAL MULTIMETER

Professional test instrument for quick and easy measurements.

## LESSONS

Clearcut, illustrated texts build your understanding of computers step by step.

## SOFTWARE

Including MS-DOS, GW BASIC, word processing, database and spreadsheet programs.

## TECHNICAL MANUALS

With professional programs and complete specs on Packard Bell computer.

## DISCOVERY LAB

Complete breadboarding system to let you design and modify circuits, diagnose and repair faults.

## DIGITAL LOGIC PROBE

Simplifies analyzing digital circuit operation.

Only NRI walks you through the step-by-step assembly of a powerful XT-compatible computer system you keep—giving you the hands-on experience you need to work with, troubleshoot, and service all of today's most widely used computer systems. You get all it takes to start a money-making career, even a business of your own in computer service.

No doubt about it: The best way to learn to service computers is to actually build a state-of-the-art computer from the keyboard on up. As you put the machine together, performing key tests and demonstrations at each stage of assembly, you see for yourself how each part of it works, what can go wrong, and how you can fix it.

Only NRI—the leader in career-building, at-home electronics training for 75 years—gives you such practical, real-world computer servicing experience. Indeed, no other training—in school, on the job, *anywhere*—shows you how to troubleshoot and service computers like NRI.

**You get in-demand computer servicing skills as you train with your own XT-compatible system—now with 20 meg hard drive**

With NRI's exclusive hands-on training, you actually build and keep the powerful new Packard Bell VX88 PC/XT compatible computer, complete with 512K RAM and 20 meg hard disk drive.

You start by assembling and testing the "intelligent" keyboard, move on to test the circuitry on the main logic board, install the power supply and 5 1/4" disk drive, then interface your high-resolution monitor. But that's not all.

**Only NRI gives you a top-rated micro with complete training built into the assembly process**

Your NRI hands-on training continues as you install the powerful 20 megabyte hard disk drive—today's most wanted computer peripheral—included in your course to dramatically increase your computer's storage capacity while giving you lightning-quick data access.

Having fully assembled your Packard Bell VX88, you take it through a complete series of diagnostic tests, mastering professional computer servicing techniques as you take command of the full power of the VX88's high-speed V40 microprocessor.

In no time at all, you have the confidence and the know-how to work with, troubleshoot, and service every computer on the market today. Indeed you have what it takes to step into a full-time, money-making career as an industry technician, even start a computer service business of your own.

**No experience needed, NRI builds it in**

You need no previous experience in computers or electronics to succeed with NRI. You start with the basics, following easy-to-read instructions and diagrams, quickly

moving from the fundamentals to sophisticated computer servicing techniques. Step by easy step, you get the kind of practical hands-on experience that makes you uniquely prepared to take advantage of every opportunity in today's top-growth field of computer service.

What's more—you learn at your own pace in your own home. No classroom pressures, no night school, no need to quit your present job until you're ready to make your move. And all throughout

your training, you have the full support of your personal NRI instructor and the NRI technical staff always ready to answer your questions and give you help whenever you need it

**Your FREE NRI catalog tells more**

Send today for your free full-color catalog describing every aspect of NRI's innovative computer training, as well as hands-on training in robotics, video/audio servicing, electronic music technology, security electronics, data communications, and other growing high-tech career fields.

If the coupon is missing, write to NRI School of Electronics, McGraw-Hill Continuing Education Center, 4401 Connecticut Avenue, Washington, DC 20008.

PC/XT and XT are registered trademarks of International Business Machines Corporation

NRI

School of Electronics



McGraw-Hill Continuing Education Center  
4401 Connecticut Avenue, Washington, DC 20008

For career courses approved under GI bill  
 check for details

Check one FREE catalog only

<p><input type="checkbox"/> Computers and Microprocessors</p> <p><input type="checkbox"/> Robotics</p> <p><input type="checkbox"/> TV/Video/Audio Servicing</p> <p><input type="checkbox"/> Computer Programming</p>	<p><input type="checkbox"/> Security Electronics</p> <p><input type="checkbox"/> Electronic Music Technology</p> <p><input type="checkbox"/> Basic Electronics</p> <p><input type="checkbox"/> Data Communications</p>
--	--

Name \_\_\_\_\_ (please print) Age \_\_\_\_\_

Address \_\_\_\_\_

City/State/Zip \_\_\_\_\_

Accredited by the National Home Study Council **18-099**

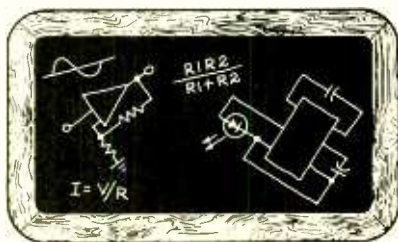

# Think Tank

By Byron G. Wels

## FOOTPRINTS IN THE SANDS OF TIME

I was wondering just what it is that induces people from diversified walks of life to build their own electronic devices? Essentially, it's probably the yen to explore. It's the yen to explore that has beguiled mankind since antiquity. It's the same force that compelled Magellan to circumnavigate the world; spurred Ponce de Leon to seek the Fountain of Youth; and brought Christopher Columbus to our shores. And it hasn't ended yet!

Do you realize that for under ten dollars, you can assemble a small transmitter and your own voice can be the first to speak on a never-before used frequency? It's true!

There's also the lure of money. I remember a friend who worked as a locksmith and who explained that he had a "new invention" he wanted to show me, but first I had to swear all kinds of promises to reveal it to no-one, and sign all sorts of legal documents stipulating that I wouldn't reveal his secret.

Finally, we went into his bedroom, and on top of the television was a small, plastic-cased, five-tube broadcast receiver. He explained it this way: "You see, the TV antenna comes in and connects to the broadcast receiver, which, in turn, will connect to the antenna terminals of the television set. You simply turn on the receiver, and then the TV set. The radio pre-amplifies the TV signal, and feeds a much-stronger signal to the TV."

I started to explain that it wouldn't work, because of the different frequencies, but that was the last thing he wanted to hear. He wanted me to "take it from there," and make it work. Of course, I declined. But the point is that this man, with no knowledge of electronics, was *trying!* And the truth is that one never knows. Right now, somebody reading these very words, might be another Nicola Tesla, or a Marconi, or a Maxwell! Right around the corner, your own big idea might be ready to come to fruition.

Whatever you're working on, stick with it, don't give up, and your future might just be about to pay off. (I wish you the best of luck!)

**Third Brake Light.** It seems that there are still a lot of cars out there that date back to when third brake lights were unknown. And it seems that a third brake light is a valuable asset. Fortunately, almost any auto parts store can sell you an inexpensive and attractive third brake light to mount in the rear window of your car. This circuit (see Fig. 5) is small enough to fit inside that housing, and is a sure-fire unit that won't ever fail you.

Refer to Fig. 1. The SCR's are easily obtainable at any Radio Shack store, identified as 276-1067 (GE C123B1) and

are rated at 6-amps, 200-PIV. The diodes, D1 and D2 are 1N4148 small signal types. The circuit can easily be assembled on perfboard.

The circuit operates on 12-volt, negative-ground systems. When the brake pedal is depressed, 12 volts is applied to the left and right brake lights. The gates of the two SCR's are triggered and current flows through the SCR's, turning on the third brake light.

—L. J. Patelunas, Langhorne, PA.

Thanks Larry. And as you requested, your Fips book was sent out. I'd like to remind our readers however, that the third light should be mounted flush against the glass. At night, reflection can often block out your rear vision when you apply the brakes.

**Slide Timer.** This circuit will permit you to record commentary and/or music on one track of a tape and put the beeps that change the slides on another track. The result is a simple way to present a professional slide show with sound in an all-automated fashion.

A schematic diagram for the circuit—which is built around a 7400 quad two-input NAND gate, a 74121 monostable multivibrator, and several transistors—is shown in Fig. 2. Gate U2-a is used to trigger U1 (which is configured as a timer) when a pulse is received from either the tape input or via push-button switch S1. The timer (U2) outputs one pulse for every input pulse received no matter how long S1 is depressed.

The Q output of U2 at pin 1 is fed to U2-b, which is set up as an inverter. When pin 1 of U1 goes low, Q3 is activated, lighting LED1. The Q output of U1 at pin 6 is tied to the base of Q2, through R5, so that when pin 6 goes high, Q2 is turned on. When Q2 is turned on, relay K1 is energized, and a signal is fed to the tape input through J2. The second set of contacts of K1 are used to trigger the projector.

Power for the circuit is provided by a 7805 regulator. The unregulated 12-volt output of BR1 is used to power the relay. The 12-volt relay needs to have two sets of contacts as shown, to advance the projector and to supply the beeps when recording. The LED indicates projector advance.

To record the beeps, connect the beeper jack (J2) to the input of the tape recorder and connect the controller to the projector-advance plug. The 60-Hz line frequency is used to produce beeps that are recorded on half of the

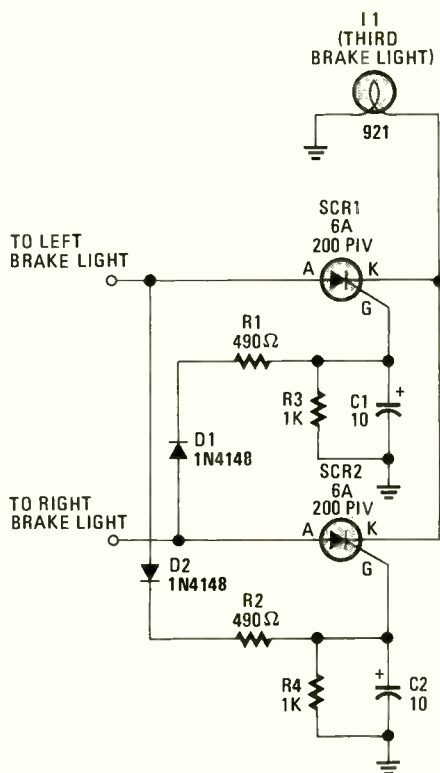

**Fig. 1.** The third brake light circuit is designed so that it lights (via SCR1 and SCR2) only when both the left and right brake lights are activated.



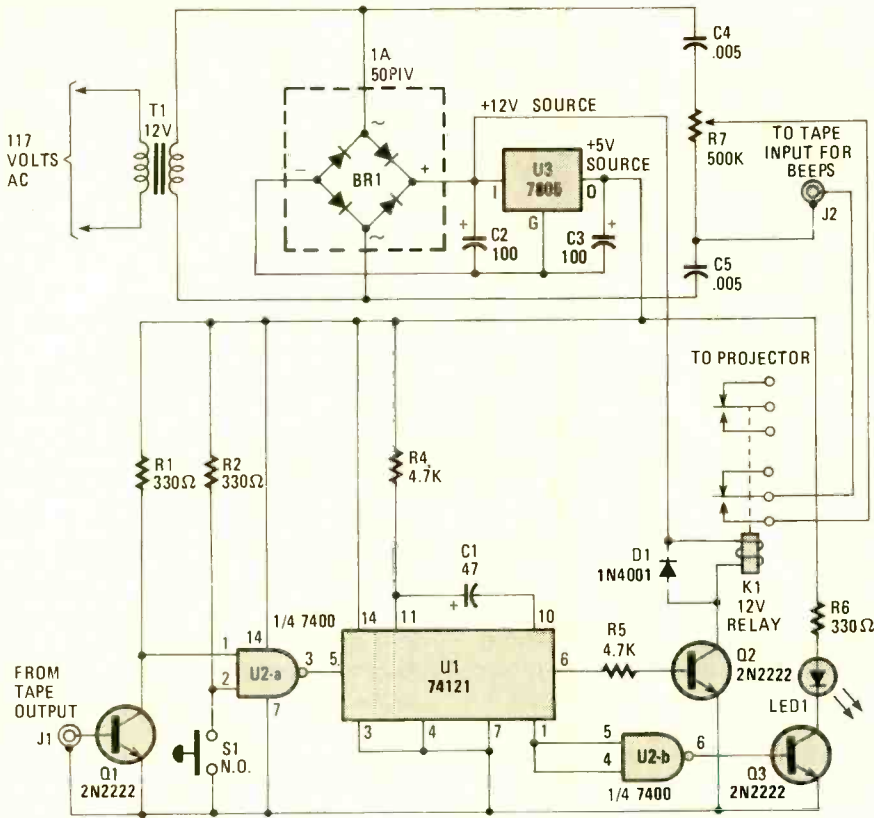

Fig. 2. The Slide Timer circuit permits you to record commentary and/or music on one track of a tape and put the beeps that change the slides on another track.

stereo tape. The other track is used for commentary. The beeper output is controlled via the 500k potentiometer (R6).

Use pushbutton switch S1 to put the beeps on the tape where required to advance the projector. The beep length is automatic, and the projector will advance once for every push of S1.

When presenting your program, disconnect one speaker from the recorder and connect the recorder to the jack on the controller or plug into the ear-phone jack. Connect the controller to the projector. The beeps will not be heard and the projector will advance at precisely the correct time.

I hope that you agree that this is worthy of a Fips Book!

—W. R. Wood, Saskatoon, Saskatchewan, Canada.

Sure is, Bill. I'd make one suggestion. Instead of disconnecting that second speaker in the stereo system each time you want to run a slide show, why not insert an SPDT switch in the speaker line to cut it out the easy way?

**Alternating LED Flasher.** "Remember the first circuit you ever built," writes

Aaron Morris, 12 years old. "I'll bet it was an LED flasher, right?" No Aaron, it was a type-30 Hartley-oscillator BC radio! Back in the dark ages, we didn't have LEDs!

Anyway, Aaron goes on to say that his circuit (see Fig. 3) is different; it alternately flashes two LEDs, and even has a practical application; on railroad gates of a model train set-up.

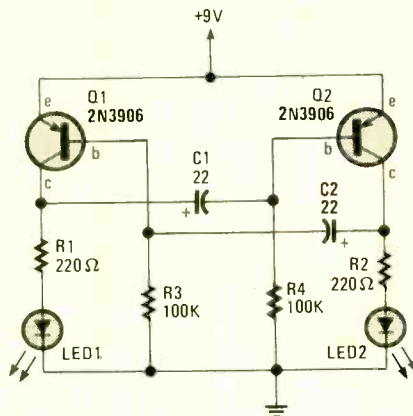
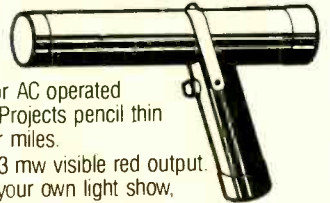

Fig. 3. The alternating LED flasher is simply a two-transistor oscillator with LEDs connected to the collector of each transistor so that they light in time with the circuit's oscillations.

# AMAZING KITS

Our fascinating electronic kits are designed to challenge your imagination and allow you to construct projects as described below.

## Helium Neon Laser



Battery or AC operated system. Projects pencil thin beam for miles.

- Up to 3 mw visible red output.
- Make your own light show, illuminate clouds
- Laser gun for creative and fun games.
- Optical experiments in the lab or classroom.

LGUM1K Kit & Plans (without laser tube) \$59.50  
LTD1R Full Spec Class II Laser Tube . . . \$99.50

## Simulated Laser for Beginners



Construct a low cost 3 color simulated-laser device, variable pulsed or continuous light.

- Visible high intensity 2000 mCD
- Small spot is excellent for pointer or shooting gallery.
- Optical experiments and alignment.

LHPM1K Kit, Lens, & Plans (3 Emitters) . . . \$54.50

## Plasma Fire Saber



Construct a fascinating plasma saber that produces a piercing red beam of neon. Length and intensity controlled by hand grip.

- Excellent special effects and display demonstration.
- High-visibility safety baton for jogging or cycling.
- Semaphore signaling and pointing.

PFS1 Plans . . \$6.00 PFS1K Kit & Plans . . \$49.50

## Plasma Lightning Globe

Construct a plasma globe that creates the spectacular extraordinary effect of a lightning storm. Experiment with other lightbulbs and receptacles to achieve unique and astonishing effects.

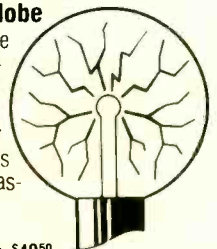

PG5 Plans \$6.00  
PG5K Kit, Globe & Plans \$49.50

## Human Energy Forcefield

Become an electric man! Construct a novel device that transforms your body into a walking power source.

- Energize lights, objects and "other people."
- Demonstrate feats of magic and mystery.
- Enhances "apparent" telekinetic motion.

HEF1 Plans . . \$6.00 HEF1K Kit & Plans . . \$89.50

CALL 1-800-221-1705 to order.

VISA, M/C Accepted. Or send Check or M.O. in U.S. funds (include \$3.00 S&H per kit; \$1.00 per plan). Assembled kits are available. Send \$1.00 for catalog.

**INFORMATION UNLIMITED**

Box 716, Dept. PE Amherst, NH 03031 (603)673-4730

## THINK TANK

Transistors Q1 and Q2 are 2N3906 general-purpose, PNP units, which are easy to find. It costs only about \$5.00 to build, and attracted a lot of attention at school. Assembled easily on a piece of perfboard, it makes a nice conversation piece. And Aaron wants to know if he can get a Fips Book!

—Aaron Morris, Troutdale, OR.

The book is on the way, Aaron. You also asked if we had a good down-counter circuit. Alright guys, can we help Aaron?

**Relay Debouncer.** This circuit grew out of a need to electrically isolate a sensitive switching circuit that terminated in a DPDT relay. Somehow, spikes were coming back through the relay coil, causing false triggering. Solid-state relays were tried to no avail. (The only ones available were SPST.) Silicon-controlled rectifiers (SCR's) were also tried, but they either wouldn't turn on, or if they did, would not turn off.

The circuit in Fig. 4 (which uses an optoisolator to drive a transistor) finally did the job. The 4N26 optoisolator (U1)

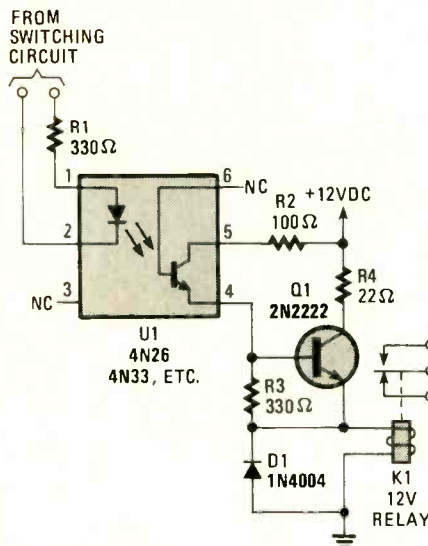

Fig. 4. The Relay Debouncer uses a 4N26 optoisolator, U1, which contains an LED and a photo-sensitive transistor.

contains an LED and a photo-sensitive transistor. When an input R2 is applied to U1 pin 1 (through R1) and pin 2, the internal LED of the unit turns on, producing light radiation that is focused on the light-sensitive junction of the photo-transistor and causing it to turn on, feeding +12 volts (minus the voltage

drop across R2) to the base of transistor Q1.

The positive voltage at the base of Q1 causes it to turn on, thereby applying a voltage to the coil of relay K1, energizing it. That causes the relay's normally-open contacts to close, energizing the device or circuit connected to it. It's inexpensive and extremely effective. But is it worth a Fips book?

—Ed Nordheim, Bemidji, MN.

Okay, Ed. Short and sweet. I would have opted to look for a circuit using two SPST relays, but yours is a much-safer way to go. That's what our hobby is all about, too. If you can't make a circuit work, work on it 'till it does! Enjoy the Fips book!

**Electronic Combination Lock.** By, my wife says I'm always making things harder than they have to be, and I suppose she's right. So when I started to design an electronic combination lock, I looked at shift registers, flip-flops, timers, and logic gates. Then I thought of my wife's accusation, and went the simple route—rotary switches!

The idea is to protect electrical equipment from unauthorized use. The

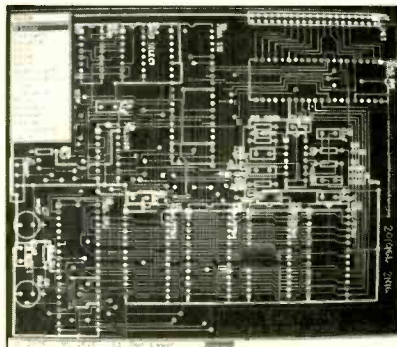

# EASY LOW-COST PCB DESIGN

PROTEL-EASYTRAX ~~\$495~~

INTRO  
PRICE  
**\$395**

Easy to learn, easy to use manual PCB design package. Capable of producing professional artwork for multi-layer, through-hole boards to 32 x 32 inches. Host of powerful editing features make efficient PCB lay-out a breeze. Gerber and NC Drill output.

Protel offers other fine programs: PROTEL-SCHEMATIC, the easy to use schematic capture program, and PROTEL-AUTOTRAX, the full-featured PCB layout program.

HARDWARE: IBM PC/AT/XT/PS2 or compatibles..... 640K RAM..... 2 floppies or a hard disk..... PC or MS-DOS greater than version 2.0

ORDER TOLL FREE, CALL: (800) 544-4186  
If you are in CA, HI, AK, or Canada, call: (408) 437-7771

PROTEL TECHNOLOGY INC.  
A Member Company of Critic Corporation

50 Airport Parkway (408) 437-7771  
San Jose, CA 95110 fax (408) 437-4913



CIRCLE 20 ON FREE INFORMATION CARD

**HSC Halted SINCE 1963!** Electronic Components & Test Equip. Prototyping & Hobby Supplies Computers, Games, Drones

**SPECIAL!**

**HSC #4715** ONLY \$7.50  
5K OHM BOURNS KNOBPOT  
LOOKS LIKE A DIGITAL  
SWITCH, BUT IT'S A POT!  
SNAPS INTO PANEL,  
LESS THAN 1" SQUARE

**IRF-122** ONLY \$7.50  
TO3 PACKAGE  
100 VOLT (100 VOLT  
8 AMP PERFE)  
HSC #9834D PART NUMBER  
MARKED WITH HEWLETT PAKET  
INCLUDES DATA SHEET

Send \$1.00 for Giant Flyer  
40 Pages of great finds!

**SALE!**

**SANGEAN**  
A World of Listening

ATS-803A \$198.00

**BioMetal from Mondo-tronics...**  
...Electric Movement Without Motors Or Solenoids!

**BioMetal™** - The Electronic Motion Breakthrough

Mondo-tronics presents BioMetal, a highly improved nickel-titanium Shape Memory Alloy (SMA) that shortens in length when electrically activated. Pulling with only 3 Newtons (10 ounces) of force, the thin BioMetal wire offers an entirely new way of making things move.

Compared to Nitinol, a popular SMA developed in the 1960's, BioMetal has a much longer lifetime and greater reusability. BioMetal samples have been operated over 20 million cycles with virtually no change in performance. With BioMetal, SMAs can compete with the lifetimes demanded of motors and solenoids.

In many instances BioMetal outperforms motors and solenoids thanks to its long lifetime, smaller size and very low mass. BioMetal's direct linear action can simplify designs, reduce costs, and increase overall performance. BioMetal has vast potential for use in everything from toys to robotics, almost any place requiring electrically driven action.

Shape Memory Alloys have crystal structures that can assume radically different forms at distinct temperatures. When passing an electric current, BioMetal's internal resistance causes it to heat, and activate the "phase change". The wire shortens in length, and pulls with a usable amount of force. When cooled, BioMetal returns to its original shape. If not overheated or overstressed, BioMetal will perform for millions of repeated cycles.

As performance depends on the heating and cooling rate, BioMetal's small diameter provides optimum results. BioMetal can be heated by electric current, with higher currents providing faster activation. Caution must be used to prevent overheating the wire. Cooling speed can be increased by coating the BioMetal wire with silicone rubber (which acts as a heat sink to draw the heat away), or even by immersing the wire in a fluid such as water with a small amount of glycerine.

In applications requiring greater strength, several BioMetal wires can be used in parallel. This gives much faster response than would a single large wire having an equal cross sectional area. Many unique and clever devices are possible using groups of wires - one only needs look at nature for examples of linear muscle connections and their applications.

**3 CONVENIENT LOCATIONS:**

HSC of Santa Rosa 6819 S. Santa Rosa Ave Santa Rosa, CA (707) 792-2277	HSC of Sacramento 5549 Hemlock St Sacramento, CA (916) 338-2545	
---	--	--

**3500 RYDER ST. SANTA CLARA, CA 95051**

Call CA Residents & In-States Toll Free Order Line  
**NOW! 408-732-1573 800-4-HALTED**

ORDERS ONLY, PLEASE...

CIRCLE 12 ON FREE INFORMATION CARD



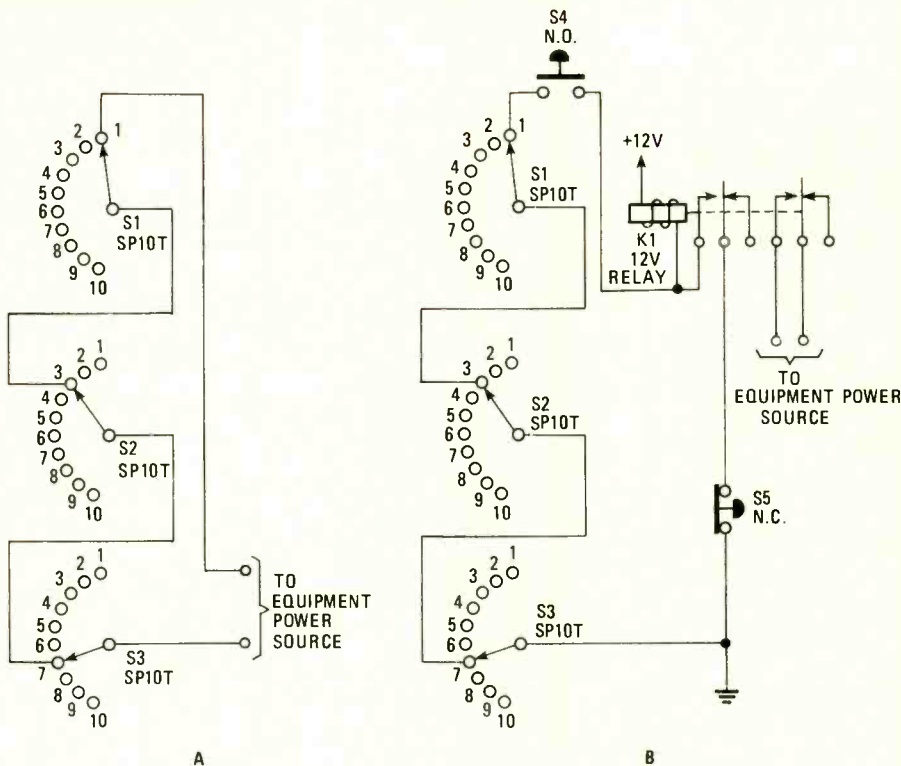

Fig. 5. The Electronic Combination Lock (A) uses rotary switches to prevent unauthorized use of electric-powered equipment! By adding a double-pole, double-throw relay to the circuit (as in B) a latching-type combination circuit is produced.

circuit (see Fig. 5A) uses three 12-position rotary switches connected in series with the wiper of one switch going to one of the 12 contacts of the following switch. (Note that only 10-contacts per switch is shown.) When all three switches are set so as to form a series circuit, power (or an activating signal) is applied to whatever device is connected. In the schematic diagram, a combination of 1-3-7 is shown.

If you want a latching-type combination circuit see Fig. 5B, which is essentially the same as the previous circuit except that a latching-relay circuit has been added. After energizing the relay, you can scramble the combination set by the switches and the relay contacts will remain closed. Pressing S5 (a momentary-contact switch) releases the relay.

The lock has a possible 1728 different combinations, more than sufficient for most applications.

—Rick Myers, Goleta, CA.

The only comment I'd make, Rick, is that readers should carefully select components that are rated with sufficient current-handling capacity to avoid problems. Look for a Fips book in your mail, and thanks.

**Outdoor Light Controller.** This circuit

(see Fig. 6) has proven excellent for controlling an outdoor light. The circuit is connected in series with the lamp to be controlled (represented by L1 in Fig. 4). When light strikes the photoresistor (R1), its resistance is almost zero. The voltage developed across capacitor C2 is about zero due to the conducting of TR2 that is triggered via R1 and R2. When the voltage across C2 is at zero volts, TR1 is off as no signal is developed to trigger it. When outside light is not present, the resistance of R1 is too high, (in thousands of ohms) and the current through it and R2, and the gate of TR2 is too low to induce conduction.

If TR2 is off, the current flow through the C1/C2 network develops a voltage across C2 and when it reaches the breaking voltage of the diac (D1) it puts Q1 in an "on" condition and energizes the load.

The coil, L1, and C3 form an RF filter to bypass any possible interference to radios, TV's etc. The circuit is inexpensive, and consumes almost no power, whether the circuit is off or on.

Instead of TR1 and the diac (D1), it is possible to use a quadac (a triac and a diac in a single package).

—Ricardo Flores Bello, San Luis Potosi, Mexico.

(Continued on page 27)

## MORE AMAZING KITS:

...to challenge your imagination and allow you to construct projects as described below.

### High Potential Force Field Generator

Construct a multi-functional HV module intended for the laboratory researcher, hobbyist, educator and science fair enthusiast.

- Build a directional ion ray gun, etc.
- Build a high speed ion motor
- Blast or drill sub-micron holes
- Build a lightning ball
- Create an anti-gravity effect
- Experiment with static electricity



HVM7 Plans \$8<sup>00</sup> HVM7K Basic Kit & Plans \$99<sup>50</sup>

### 100,000 Volt Stun Gun



Construct your own high energy personal protection unit.

- Intimidating effect up to 20 feet away
- Research into muscle building

STG2 Plans \$7<sup>00</sup> STG2K Kit & Plans \$49<sup>50</sup>

### Solid State Tesla Coil

Construct a multi-functional electronic HF Energizer Module.

- Create swirling plasma tornado, and a plasma globe
- Build a "Jacob's Ladder"
- Experiment with high frequency energy



TCL4 Plans \$6<sup>00</sup> TCL4K Kit & Plans \$49<sup>50</sup>

### Miniature FM Wireless Mike

Construct a device that transmits sound to your FM radio, over considerable distances (up to 3 miles).

- Become your neighborhood disc jockey
- Monitor children/invalids
- Build a security system



FMV1 Plans \$6<sup>00</sup>

FMV1K Kit & Plans \$34<sup>50</sup>

### Sound Activated Neon Beacon

Highly visible ignited plasma length varies with volume of sounds and music.

- Visual enhancement of music
- Excellent amusement for bars, recreational areas
- Attention getting for point of sale

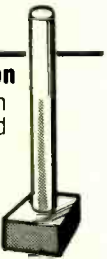

SAN1 Plans \$6<sup>00</sup>

SAN1K Kit & Plans \$49<sup>50</sup>

### Ultrasonic Acoustical Generator

Build a pocket-size device capable of warding off aggressive dogs, other animals and intruders.

- Uses complex sonic shock waves as an intrusion deterrent
- Experiment in acoustical ultrasonics
- Deter rodents and other garden pests

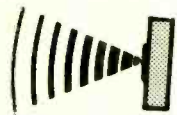

UAG1 Plans \$6<sup>00</sup>

UAG1K Kit & Plans \$49<sup>50</sup>

CALL 1-800-221-1705 to order.

VISA, M/C Accepted. Or send Check or M.O. in U.S. funds (include \$3<sup>00</sup> per kit; \$1<sup>00</sup> per plan). Assembled kits are available. Send \$1<sup>00</sup> for catalog.

**INFORMATION UNLIMITED**

Box 716, Dept. PE Amherst, NH 03031 (603)673-4730

# SELECT 5 BOOKS for only \$4.95 (values to \$117.75)

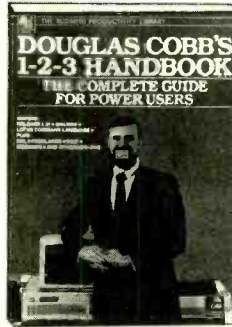
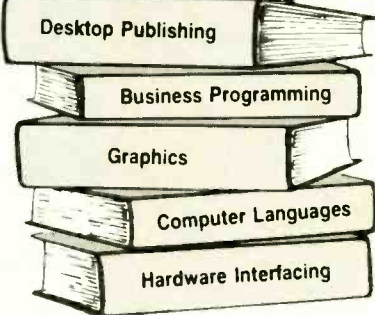

9779P \$22.95

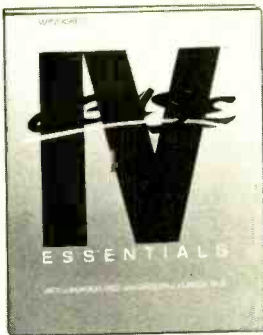

3116 \$27.95  
Counts as 2



2807P \$14.95



3032P \$12.95



3047 \$34.95  
Counts as 2



3119P \$21.95



3146P \$17.95



9762P \$21.95



9168P \$22.95  
Counts as 2



1752 \$18.95



2852P \$17.95



3049 \$26.95  
Counts as 2



2913P \$15.95



2812P \$14.95

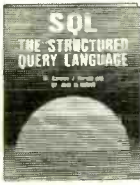

3016P \$17.95

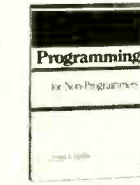

8226 \$29.95  
Counts as 2

When it's new and important in business or personal computing, The Computer Book Club® has the information you need . . . at savings of up to 50% off publishers' prices!



2791P \$14.95



2856P \$18.95



2870 \$24.95



2879P \$22.95

**Membership Benefits • Big Savings.** In addition to this introductory offer, you keep saving substantially with members' prices of up to 50% off the publishers' prices. • **Bonus Books.** Starting immediately, you will be eligible for our Bonus Book Plan, with savings of up to 80% off publishers' prices. • **Club News Bulletins.** 14 times per year you will receive the Book Club News, describing all the current selections—mains, alternates, extras—plus bonus offers and special sales, with scores of titles to choose from. • **Automatic Order.** If you want the Main Selection, do nothing and it will be sent to you automatically. If you prefer another selection, or no book at all, simply indicate your choice on the reply form provided. As a member, you agree to purchase at least 3 books within the next 2 years and may resign at any time thereafter. • **Ironclad No-Risk Guarantee.** If not satisfied with your books, return them within 10 days without obligation! • **Exceptional Quality.** All books are quality publishers' editions especially selected by our Editorial Board.



**The Computer Book Club®**

Blue Ridge Summit, PA 17294-0820

Please accept my membership in The Computer Book Club® and send the 5 volumes listed below, billing me \$4.95 plus shipping and handling charges. If not satisfied, I may return the books within ten days without obligation and have my membership cancelled. I agree to purchase at least 3 books at regular Club prices (plus shipping/handling) during the next 2 years and may resign any time thereafter.

Name \_\_\_\_\_  
 Address \_\_\_\_\_  
 City \_\_\_\_\_  
 State \_\_\_\_\_ Zip \_\_\_\_\_ Phone \_\_\_\_\_  
 Signature \_\_\_\_\_

Valid for new members only. Foreign applicants will receive special ordering instructions. Canada must remit in U.S. currency. This order subject to acceptance by The Computer Book Club® PPIC989



2859P \$20.95



2890 \$34.95  
Counts as 2



2968P \$19.95



2997 \$25.95



2767P \$21.95



3109 \$28.95  
Counts as 2



3128P \$22.95  
Counts as 2



9826P \$16.95

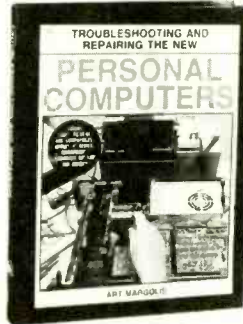

2809 \$27.95  
Counts as 2



2838 \$19.95



2841P \$15.95



3030P \$17.95



3084 \$29.95  
Counts as 2



2817P \$14.95



3031P \$16.95

All books are hardcover unless number is followed by "P" for paperback. (Publishers' Prices Shown)



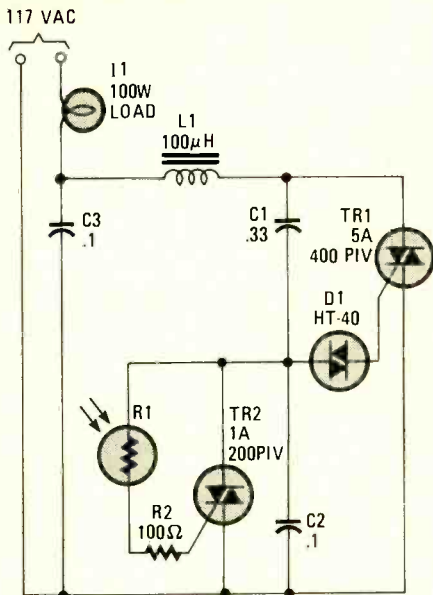

Fig. 6. The Outdoor Light Controller is designed to be connected in series with the lamp to be controlled.

Thank you Ricardo. I'm pleased, not only with the circuit you submitted, but by the fact that this proves that the love of electronics is truly international! I hope that others in foreign countries will offer circuits for the "Tank." Besides, our Editor collects stamps!

**Flashlight Finder.** Pow! And all the lights went out. Obviously, the fuse had to be changed, and there was a flashlight to light the way, but the flashlight was in the tool box in the basement. And in the dark, how do you find the basement, let alone the flashlight? Simple. Your wife gives you a candle (she's more organized and knows where the candles are). So you use the candle to find basement, tool box, and flashlight.

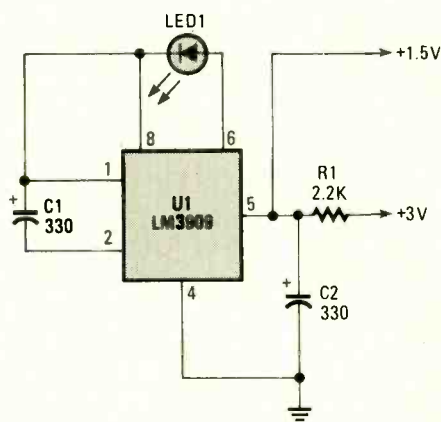

Fig. 7. The Flashlight Finder is an LED flasher circuit that can be attached to your flashlight to make it easier to locate in the dark.

You change the fuse, the lights come on, and you return to the basement to construct the flashlight finder!

Figure 7 shows a simple, constantly-flashing LED circuit. The circuit's drain on the battery is so small that the circuit runs indefinitely. It's essentially a relaxation oscillator in which capacitor C1 is charged almost to the supply voltage. The charge on C1 discharges across LED1 until the charge is almost depleted. At that point, the circuit returns to its original state and C1 begins to recharge. An internal resistor in U1 (a 3909 LED flasher/oscillator) prevents too-large a current from flowing in LED1 when C1 discharges. The slow flash rate keeps the batteries going for quite a while. All you have to do is mount the circuit to your flashlight and you won't be kept in the dark anymore. Fips book Byron?

—Paul Anton, Kearny, NJ.

Yup Paul, Fips Book! And readers, with a little judicious surgery on the flashlight's case, you can tap into the batteries of the flashlight for power to make things compact.

**Scratch The Radio.** Just got a note from Bob Mansel, of Seattle, WA. Bob, an amateur rocket scientist, picked up on my comment about somebody building a radio-controlled rocket-launching device. Bob says "Don't Do it!" Such controls are subject to radio interference, and can cause serious accidents. To thank Bob, I'm sending out a Fips Book today.

**Ringer Relay.** I've found this to be an excellent device, especially if somebody in the home is hard of hearing, like my father who uses a hearing aid. I've already wired up a remote listener to his TV set, and he loves it. But just try to telephone him while he's watching TV! The phone rings and rings, and he doesn't answer. With this device, simply wire a lamp to the relay, and when the phone rings, the lamp flashes. He picks it up before it rings three times!

Look at Fig. 8. When the phone rings, the ring signal from the telephone company lights a neon lamp within a CLM3120 optocoupler. That causes a drop in the resistance of the CdS cell output of the device, turning on transistor Q1. When Q1 turns on, relay K1 is energized. The circuit should be connected in series with the lamp that is to be activated. It's that simple!

Since there is no direct connection between the telephone and the supply

# AMAZING PLANS:

Step-by-step plans allow you to construct useful and amazing devices. Sources for all parts are included.

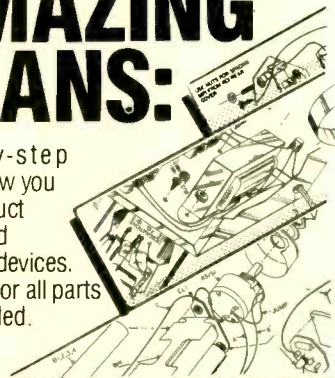

**EML1 Electronic Coil Gun Launcher.** Propels a projectile using a pulse of magnetic energy. EML1 Plans (parts indiv. available) ..... \$8<sup>00</sup>

**GRA1 Gravity Generator.** Electrical phenomena produces effect of anti-gravity. Great for science fair. GRA1 Plans (parts indiv. available) ..... \$10<sup>00</sup>

**RUB4 Ruby/Glass Laser.** Portable unit generates up to a 3000 watt pulse capable of piercing the hardest steel. RUB4 Plans (parts indiv. available) ..... \$20<sup>00</sup>

**LC7 CO<sub>2</sub> Laser.** 35 watts continuous burning or etching wood, cut plastics, drill, heat treat. LC7 Plans (parts indiv. available) ..... \$20<sup>00</sup>

**BTC3 Easy to Build Table Top Tesla Coil.** Produces 10-14" streamers. BTC3 Plans (parts indiv. available) ..... \$10<sup>00</sup>

**TCC7 Tesla Coil.** Engineering designs on 3 systems presently being operated in museums. TCC7 Plans ..... \$25<sup>00</sup>

## Hard to Find Specialized Components

**FLBKB** - Three separate flyback transformers available for the price of one. Intended for hundreds of projects. Order #FLBKB with free plans ..... \$24<sup>50</sup>

**VG20** - 20KV rectifier diode used in many projects ..... \$3<sup>50</sup>

**HVC1** - 1000 pfd at 15KV ceramic capacitor used in many projects ..... \$3<sup>50</sup>

**CD25B** - 25 to 50,000 volt miniature transformers used in stun guns, pulsers, etc. .... \$16<sup>50</sup>

**LE1HP** - 2000 MCD high intensity narrow beam light emitter. Intended for use with simulated lasers, remote control communications and other optical applications ..... \$5<sup>50</sup>

**LT4R** - 4 to 5 MW helium neon laser tube. Includes plans for power source. .... \$149<sup>50</sup>

**PB12** - 12" dia. brilliant museum quality plasma balls with plans for power supply. .... \$195<sup>00</sup>

CALL 1-800-221-1705 to order.

VISA, M/C Accepted. Or send Check or M.O. in U.S. funds (include \$1<sup>00</sup> S&H per plan). Send \$1<sup>00</sup> for complete catalog.

**INFORMATION UNLIMITED**

Box 716, Dept. PE Amherst, NH 03031 (603)673-4730

## THINK TANK

circuit, you won't induce hum into the line. And the neon lamp behaves like an open circuit when it isn't lit. It also offers a very high resistance that's in series with a 220k resistor. None of the parts are critical. Now does that rate me a Fips Book Byron?

—Roger Braun, Manassas, VA.

Sure does Roger, and you're going to love it. Incidentally, if you can't find that Clairex "Photomod," don't let it throw you. Just tape a neon lamp (an NE-2 or NE-2H) to any cheap CdS photocell. It will work just as well.

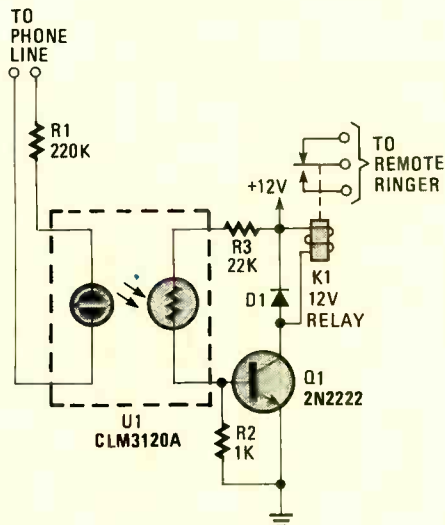

Fig. 8. Although the Ringer Relay is designed to flash a lamp in cadence with the telephone's in-coming ring signal, any type of signaling device may be used.

**Tool Magnetizer.** Electronics keeps getting smaller. Components are now so tiny, I've got to use a jeweler's loupe to read parts values. And when it comes to mounting parts with teeny-weeny screws, forget it. I've even tried to use a tweezer with bad results. But then I got hold of a small screwdriver with a magnetic tip, and decided to magnetize *all* my tools for the added convenience. The simple circuit in Fig. 9 gives wonderful results.

To magnetize a ferrous metal, all you have to do is place it in a strong magnetic field. The circuit in Fig. 9 dumps a large current from a charged capacitor through a coil, creating a magnetic field. The intensity of the magnetic field is proportional to the current and the number of turns in the coil.

My coil was wound on a hollow plastic tube about half an inch in diameter and two and one-half inches long. I wound 200 turns of #22 magnet wire

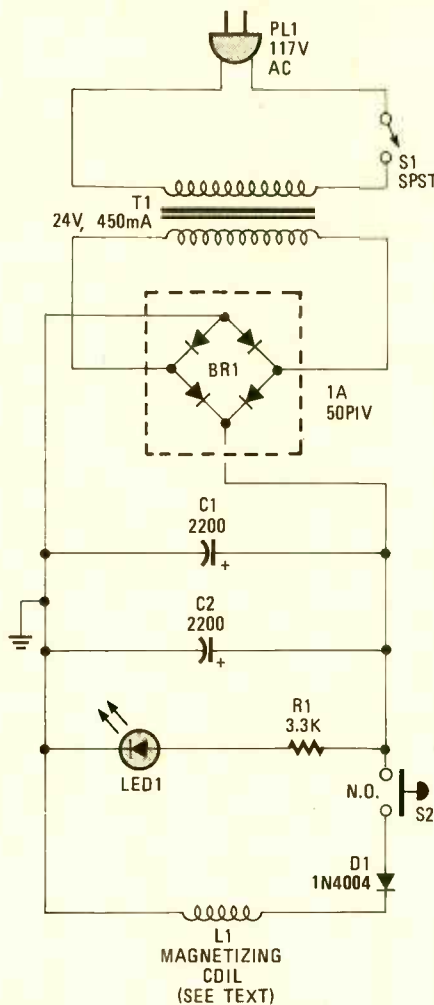

Fig. 9. Generally speaking, the Tool Magnetizer is little more than a large coil, that when energized with a ferris metal object placed in the core of the coil, magnetizes the object.

around the plastic form, but if you have the patience, you can put more turns on the coil.

The circuit uses a transformer to step-down the AC line voltage to 24 volts. The output of the transformer is fed to a bridge rectifier (BR1), which in turn outputs a DC (about 34 volts) voltage. The DC output of BR1 is filtered by C1 and C2, and fed through S1 and D1 to the magnetizing coil.

When S1 is depressed, the charge on C1 and C2 is dumped across the coil (L1), resulting in a brief but intense magnetic field in the coil. Diode D1 is included so back-EMF generated in the coil won't try to re-charge the capacitors. LED1, connected in series with R1, is used as an indicator lamp.

To magnetize the tip of your screwdriver, place it inside the coil form and when the LED's light, press S1. The unit shown here is so strong, that the screw-

driver even moved! I used a pair of 2200- $\mu$ F capacitors, but any large value will do. You can also alter the value of the transformer. The LED is a good idea too, because it will discharge the capacitors when you turn off the AC and forget to discharge them through the coil. All the parts are available from Radio Shack. I hope this gets me a copy of the Fips Book.

—John Wetork, Santa Barbara, CA.

It does indeed, John. Your circuit reminds me that in the "old days," we used to clip the old tip off a soldering gun, and form a pair of heavy copper wires, parallel and fasten them into the gun. Push the on button, and touch the nether end of the wires with some solder. It would melt and come flying off the ends of the wires like a hot, melted bullet to splat against your wall. What triggered this was the possibility of your screwdriver flying out of the coil! But obviously, you've tried it, and it barely makes the screwdriver move.

Well, that ought to do it for this month. And I've got some good news and some bad news for you. We're running out of Fips Books, and when those are gone, there won't be any more. Those who have received them will be well-advised to save them. They're going to rapidly become collector items. Don't worry, we'll come up with another award for your efforts as soon as Fips runs out. There are still a goodly quantity left, but if you've been putting off sending your circuits in, this would be an excellent time to do so! Send your circuit ideas to *Think Tank*, **Popular Electronics**, 500-B Bi-County Blvd, Farmingdale, NY 11735. ■

### Why Y, I ask Q?

In the last issue's editorial I gave the call CQ as Da-Di-Da-dit Da-Di-Da-Dah when it should have been Da-Di-Da-Dit Da-Da-Di-Dah. For non-Morse readers, the first is CY (which is incorrect) and the latter is CQ—the correct Q-signal for "Calling all stations."

How did this happen? Did dyslexia strike? Maybe our typesetter operates phone only? Nevertheless, the buck stops here. The Editor gets the blame for this goof and there is no way I can shirk the responsibility. As penance, I will re-train myself by using a Morse code cassette in my Walkman for the next few weeks until my speed is back to 16-wpm.

Julian S. Martin, KA2GUN  
Editor



# EXPAND YOUR CAREER HORIZONS...

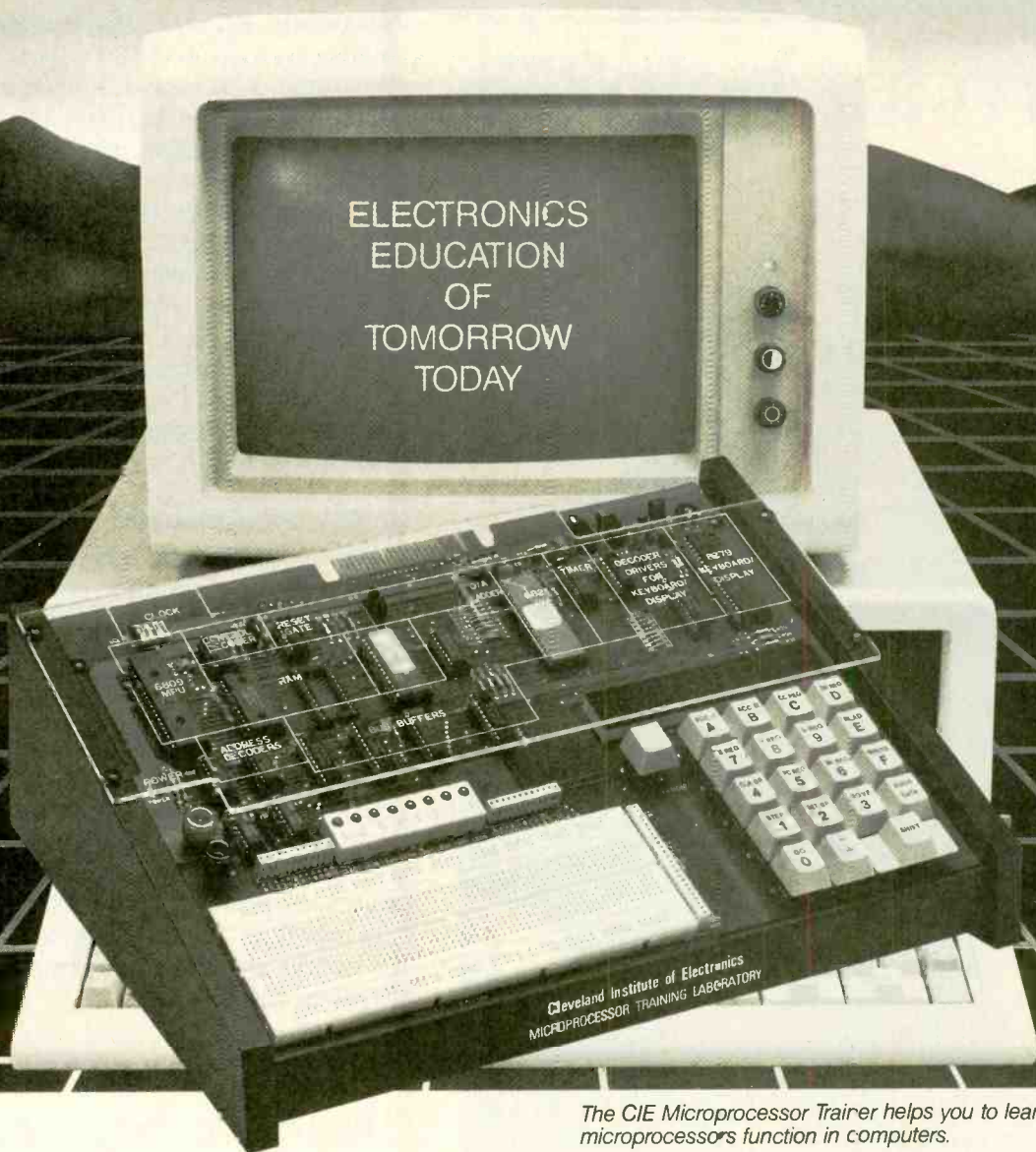

*The CIE Microprocessor Trainer helps you to learn how circuits with microprocessors function in computers.*

## START WITH CIE.

Microprocessor Technology. Satellite Communications. Robotics. Wherever you want to go in electronics... start first with CIE.

Why CIE? Because we're the leader in teaching electronics through independent study. Consider this. We teach over 25,000 students from all over the United States and in over 70 foreign countries. And we've been doing it for over 50 years, helping thousands of men and women get started in electronics careers.

We offer flexible training to meet your needs. You can start at the beginner level or, if you already know something about electronics, you may want to start at a higher level. But wherever you start, you can go as far as you like. You can even earn your Associate in Applied Science Degree in Electronics.

Let us get you started today. Just call toll-free **1-800-321-2155** (in Ohio, 1-800-362-2105) or mail in

**CIRCLE 7 ON FREE INFORMATION CARD**

the handy reply coupon or card below to:  
Cleveland Institute of Electronics,  
1776 East 17th Street, Cleveland, Ohio 44114.

**CIE** World Headquarters

AHO-128

**Cleveland Institute of Electronics, Inc.**  
1776 East 17th Street • Cleveland, Ohio 44114

Please send your independent study catalog. For your convenience, CIE will try to have a representative contact you — there is no obligation.

Print Name \_\_\_\_\_

Address \_\_\_\_\_ Apt. \_\_\_\_\_

City \_\_\_\_\_ State \_\_\_\_\_ Zip \_\_\_\_\_

Age \_\_\_\_\_ Area Code/Phone No. \_\_\_\_\_

Check box for G.I. Bill bulletin on Educational Benefits

Veteran  Active Duty **MAIL TODAY!**

Just call toll-free **1-800-321-2155** (in Ohio, 1-800-362-2105)



# “Where can I turn for help?”



There is a way to get help when you need it. The American Home Satellite Association. An organization created exclusively to protect and enhance your enjoyment of your satellite TV system.

Take our toll free “Helpline,” for example. From locating satellite signals to locating a reputable dealer, help is just a phone call away. AHSA provides educational videotapes and informative books, too. At very special member prices.

Plus, 10 times a year, AHSA’s official newsletter, *Sky Report*, will bring you the latest word on products, legislation, programming, and more. Not to mention reviews of new products and services. And that’s not all AHSA has in store for you.

## Programming shouldn’t cost a fortune.

With AHSA’s group buying power, you can save on premium services, superstations and basic programming services. Enjoy savings on accessories, equipment, and programming guides, too.

## You’re not alone anymore!

With your voice behind us, AHSA is promoting legislation to guarantee fair access at reasonable prices. Addressing zoning and piracy issues. Even sending expert witnesses to Congressional hearings. Join other dish owners around the nation, and become a force to be reckoned with.

---

### Rush my free information kit.

Name \_\_\_\_\_

Address \_\_\_\_\_

City \_\_\_\_\_ State \_\_\_\_\_ Zip \_\_\_\_\_

### Sign me up right away and send my complete membership kit.

Check enclosed for \$36 (made out to AHSA)

Bill my  VISA  MasterCard

Card # \_\_\_\_\_

Exp. Date \_\_\_\_\_

Authorized Signature

X \_\_\_\_\_

30-day Money Back Guarantee



**American Home  
Satellite Association**  
CA

Return completed coupon to:  
American Home  
Satellite Association, Inc.,  
Suite 800, 500 108th Ave. NE,  
Bellevue, WA 98004-5560  
Or call Toll Free  
1-800-321-AHSA (2472).



# SHAKY :

## The Popular Electronics Electronic Playmate



BY CHARLES D. RAKES

*Here's a loyal and true friend that's sure  
to delight the young—and the young at heart!*

**H**ave you ever had the feeling that your friends were going out of their way to avoid you? Has Rover, your constant canine companion, just dampened your spirits by mistaking you for a fire hydrant? If you're fed up with that "no respect attitude" that you've been getting lately and just won't take it anymore, but would still enjoy the company of a true friend, then consider building your own version of our friendly electronic playmate, *Shaky*.

Shaky doesn't eat often or very much, never needs to go outside at 5 in the morning, and would never consider taking a nip at the mailman or snap back at verbal abuse; all qualities sure to nurture a unique and long-lasting friendship. But, as with most mortal creations—all is not perfect in Shaky's simple world; even Shaky likes a little bit of attention now and then.

When neglected for long periods of time, he (it) will respond out of character at your first contact; and after a brief warming period, he'll behave as the usual friendly but bashful pet that he is.

Bridging the left and center "antennae" with your hand causes Shaky to respond with a two-tone *be-boop* sound, while displaying a row of 10 LED's stepping around in a circle with two giant LED's flashing on and off in the center. Bridging the right and center antennae produces a friendly little shake and shudder routine to let you know he's alive and alert to your commands.

After a short period of time Shaky returns to an inactive state ready for another hands-on experience. The two touch circuits that activate Shaky can also be triggered by a static charge deposited on the touch plate when contacted by a hand. (That assumes that a sufficient charge has been stored by the body's capacitance.)

**Inside Shaky.** The schematic diagram of the circuit is shown in Fig. 1. A touch plate (TP1) is connected to the base of Q1 and to ground through two 22-megohm resistors, R1 and R2. Transistors Q1 and Q2 are connected as a Darlington configuration, which offers a very high input impedance to TP1.

The collector terminal of the Darlington amplifier is coupled through R7 to the base of Q7, and is also tied to TP3. A timing capacitor (the C1/C2 combination) is connected between the junction of R1 and R2 and to the collector of Q7 to set the on time for the function that the touch switch controls.

When TP1 and TP3 are momentarily bridged by placing a hand across the two touch plates, the Darlington turns on pulling the base of Q7 low, causing it to conduct. With Q7 turned on, a bias voltage is applied to the gate of Q9, triggering it into conduction. Turning on Q9,

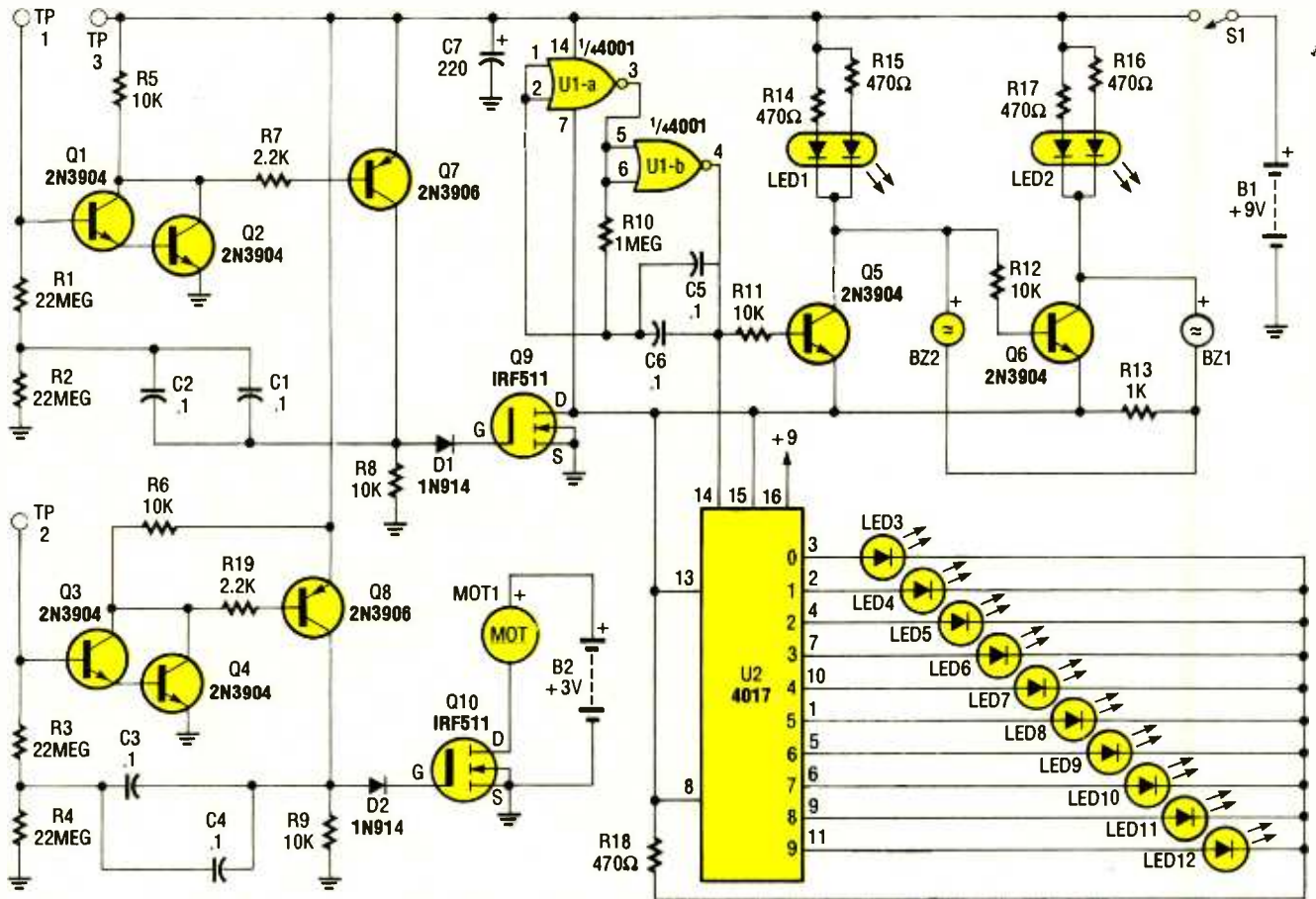

Fig. 1. Here is the schematic diagram of Shaky's inner workings, which contain no exotic parts. In fact, the giant LED's and the hexFET's used in the project are available locally from Radio Shack stores.

places pin 7 (the ground input of U1) at ground potential, thereby activating a square-wave oscillator, consisting of U1-a and U1-b (½ of a 4001 quad 2-input NOR gate). Resistor R10 combined with capacitors C5 and C6 set the oscillator's operating frequency.

The output of the oscillator is fed through R11 to the base of Q5. Transistor Q5, in turn, toggles on and off in time with the output of the oscillator. When Q5 is turned on by the positive transition of the oscillator's output, LED1 is forward biased, causing it to light. With Q5 turned on no bias is delivered to the base of Q6, so it remains off; therefore, LED2 remains off.

But, on the negative transition of the square wave, Q5 turns off and a bias voltage is delivered the base of Q6 through LED1. That causes Q6 to turn on, completing a path to ground for LED2, causing it to light. As the two LED's toggle on and off, two piezo buzzers (BZ1 and BZ2) sound in time with the LED's.

The LED and sound producing circuitry (negative side) are tied to Q9's drain and are switched to battery negative (circuit ground), so that it remains acti-

vated until the charge on the C1/C2 combination decays enough to turn off that hexFET.

The output of the oscillator is also fed to the clock input of U2 (a 4017 decade counter/divider). For each positive transition of the square wave, U2 advances one count, causing its outputs to sequentially go high. The ten outputs of U2 are connected to LED3 to LED12, so that as each output goes high, the LED connected to it is forward biased, causing it to light.

TP2 is connected to a clone of the touch circuit just discussed with its output controlling a small DC motor that has an eccentric (off-centered) weight connected to its shaft. When TP2 is bridged to TP3, transistor Q3 and Q4 (which forms a second Darlington amplifier) are triggered into conduction, pulling the Darlington's collector to ground potential. That causes Q8 to turn on, applying a positive bias to the gate of Q10, causing it to turn on. When transistor Q10—which is connected as a switch in series with the motor (MOT1) and a 3-volt power source—turns on, the motor is activated.

The motor is mounted to Shaky's base and when it turns everything shakes for a period of about 10 seconds, a time that is set by the values of C3 and C4. When at rest Shaky requires almost no operating current, so a power switch isn't really needed once he is completed; but during testing and while adding the final touches, a power interrupting system is suggested.

**Birth of a Playmate.** Since the circuit for Shaky is quite simple and the component layout isn't critical, just about any construction method will do, but for neatness and ease of construction, the printed-circuit board approach would be the best way to go. No matter what approach you follow, take ample time to study the schematic diagram, photos, and the parts layout before heating up the soldering iron.

The author's prototype was first built on perfboard and then converted to a printed-circuit layout; if you decide to go the printed-circuit route too, use the template shown in Fig. 2. Once you've obtained the parts and etched your printed-circuit board (or purchased



one from the supplier listed in the Parts List), construction can begin.

Install the components on the printed-circuit board using Fig. 3 for parts placement and orientation. The author's model was housed in and built around a plastic, 60-ounce, microwaveable bowl with a plastic lid. Any similar 8 or 9-inch diameter bowl with a height of at least 3 inches and a lid should do as well.

The completed circuit board is mounted to the bottom of the bowl (see Fig. 4) with two small metal angle brackets and 6-32 hardware. (Note that the bottom portion of the bowl becomes the upper portion of Shaky's body.) Ten equally spaced holes are

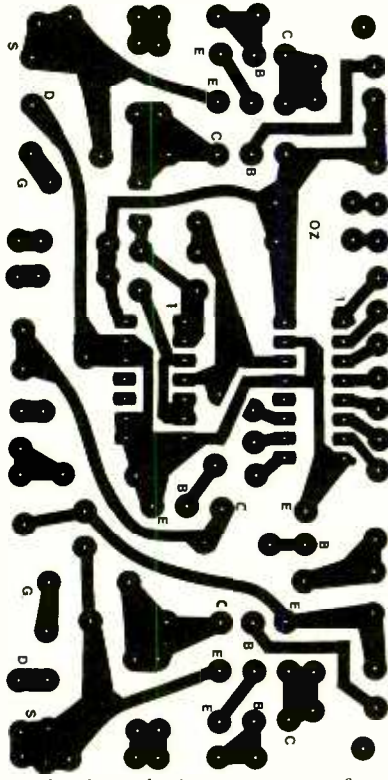

Fig. 2. The author's prototype was first built on perfboard and then converted to the printed-circuit layout. The template of the printed-circuit board foil pattern used by the author in his final version is shown here.

drilled around the bottom of the bowl for the LED's. The two giant LED's are located in holes about 2½-inches apart near the center of the bottom of the bowl. The two piezo sounders are mounted in place near the bowl's rim with silicon rubber. To allow sound to escape, two small holes are drilled in the bowl to match the sound-output ports on the piezo sounders.

The TP1, TP2, and TP3 top contacts are chrome-plated metal drawer pulls that can be found in most hardware stores.

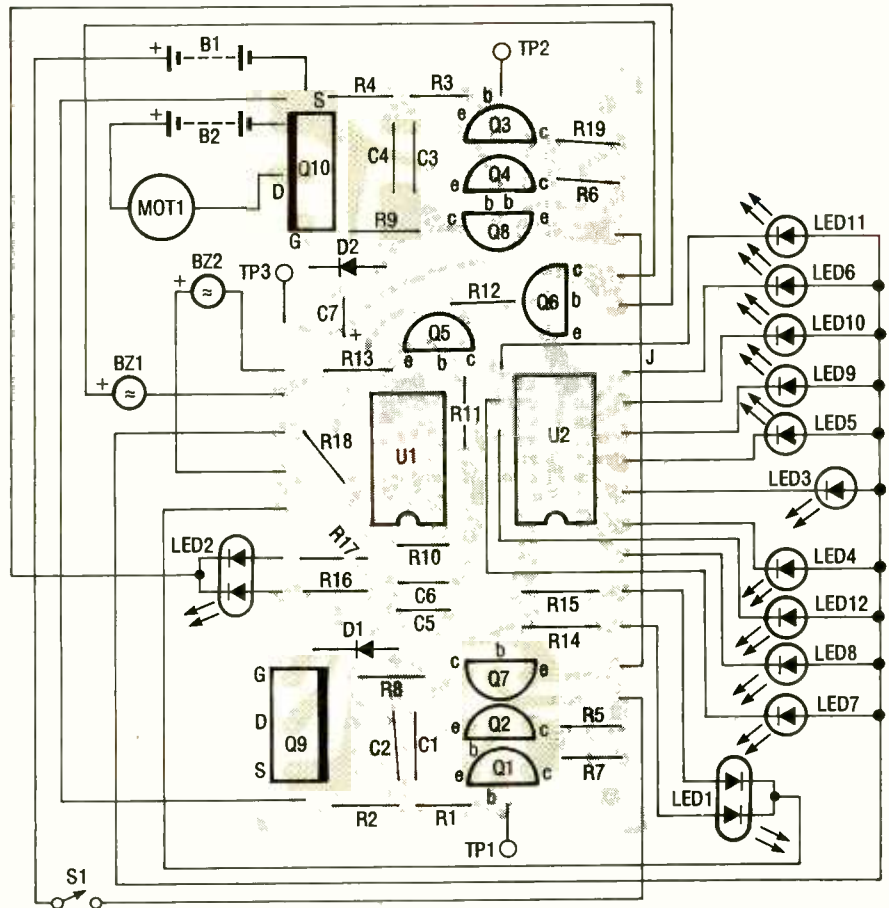

Fig. 3. Install Shaky's board-mounted components using this parts-placement diagram as a guide. Insulated hook-up wire is used for the interconnections between the board and the off-board components.

### PARTS LIST FOR SHAKY

#### SEMICONDUCTORS

- U1—4001 quad 2-input NOR gate, integrated circuit
- U2—4017 decade counter/divider, integrated circuit
- Q1—Q6—2N3904 general-purpose NPN silicon transistor
- Q7, Q8—2N3906 general-purpose PNP silicon transistor
- Q9, Q10—IRF511 hexFET (Radio Shack 276-2072)
- D1, D2—1N914 general-purpose silicon diode
- LED1, LED2—Dual giant red LED
- LED3—LED12—Jumbo red LED

#### RESISTORS

- (All resistors are ¼-watt, 5% units, unless otherwise noted.)
- R1—R4—22-megohm
- R5, R6, R8, R9, R11, R12—10,000-ohm
- R7, R19—2200-ohm
- R10—1-megohm
- R13—1000-ohm
- R14—R18—470-ohm

#### ADDITIONAL PARTS AND MATERIALS

- C1—C6—0.1-µF, ceramic disc or mylar capacitor
- C7—220-µF, 16-WVDC, electrolytic capacitor
- B1—9-volt transistor radio battery
- B2—Two "AA" batteries
- BZ1, BZ2—Piezo buzzer
- MOT1—3- to 12-volt DC motor
- S1—SPST toggle switch
- Printed-circuit or perfboard materials, plastic microwaveable bowl with lid, IC sockets, chrome-plated draw pull, non-metallic draw pulls, door-stop springs, motor bracket, dual "AA" cell battery holder, knobs, button eyes, fuzz, wire, solder, hardware, etc.

**Note:** The following items are available from Krystal Kits, PO Box 445, Bentonville, AR 72712; printed-circuit board and all board-mounted components, \$27.99. Arizona residents add applicable sales tax. Please allow 6-to-8 weeks for delivery.

TP1 and TP2 are mounted on door-stop springs (that can also found at local hardware or discount stores), which are mounted to the bottom portion of the

bowl. TP3 mounts directly to the bottom of the bowl.

The exact location of any of the LED's, antennas, eyes, ears, or any of the dec-



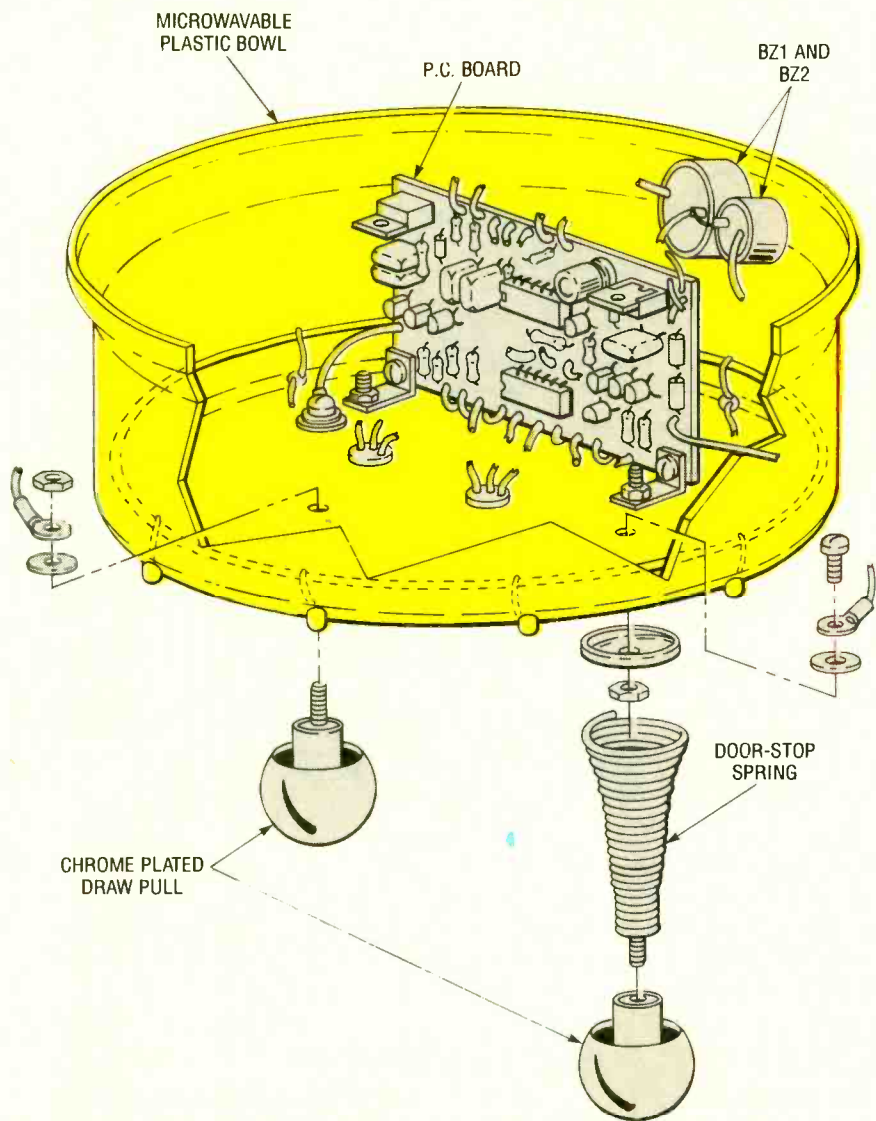
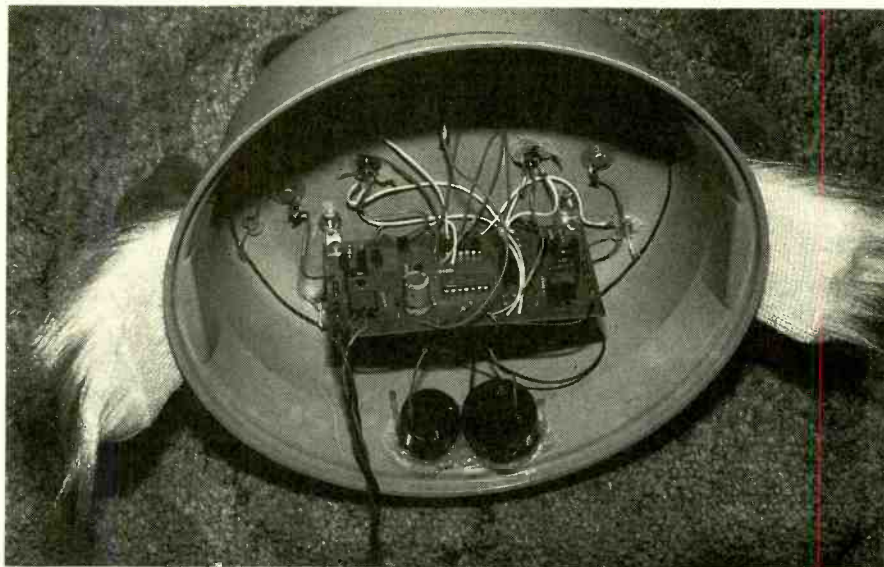

Fig. 4. The completed circuit board is mounted to the bottom of the bowl with two small metal angle brackets and 6-32 hardware. Note that the bottom portion of the bowl is the upper portion of Shaky's body.



Here is Shaky's printed-circuit board assembly shown mounted to the bottom portion of the bowl (which serves as the upper portion of the project's body). Shown below the circuit board are the two buzzers (BZ1 and BZ2), which are mounted to the side of the bowl.



Antennas are mounted to the outside of the bottom half of the bowl. Two giant LED's are mounted near the center of the bowl between the antennas, and jumbo LED's are ringed around the bowl's perimeter.



Mounted to the lid of the bowl that houses Shaky's circuit board are the motor (MOT1) with off-balanced weight and the batteries that provide power for the circuit.

operations is entirely up to the pet's creator. The bowl's plastic lid is reinforced with a 6-inch circle of 1/8-inch hard plastic, wood, or similar supportive material. The motor (MOT1) can be just about any small 3- to 12-volt DC, brush-type motor that can be purchased for a few bucks, either by mail order or from a local electronic parts outlet.

The author's motor was mounted to the base of the lid with an angle bracket using a cable tie and binding tape to hold the bracket to the motor; 8-32 hardware was used to mount the assembly to the bowl's lid.

The eccentric weight for the motor is cut from a piece of 1/2-inch steel rod to a length of 1 1/2-inches. About 1/4-inch from one end drill a hole just large enough to clear the motor's shaft. Drill another hole perpendicular to the first on the

(Continued on page 97)



**F**or convenient testing of digital circuits, a logic probe is hard to beat. To use a logic probe, you just clip the probe's power-supply leads to the supply bus of the circuit under test, then touch the probe tip to the point in the circuit you want to monitor.

Light-emitting diodes on the probe tell you if the point being monitored is a logic high, low, or in-between, as well as showing changes in logic state. Because the LED's are on the probe itself, you can easily see your results without having to shift your attention from circuit to test equipment and back.

The *Experimenter's Logic Probe* described in this article is one that you can build for yourself, using readily available parts. In reading about and building the probe, you'll also learn how the probe works, what its capabilities (and limits) are, and how to use the probe in testing and troubleshooting digital circuits.

**Logic Basics.** A review of some of the

basic logic standards for electronic devices will aid in understanding the operation of the logic probe. Digital-logic circuits include circuits that are built out of logic gates (such as AND, NAND, OR, etc.), as well as circuits that include other digital IC's such as latches, counters, or even microprocessors.

The inputs and outputs of digital IC's are considered to be either high or low, with the high and low levels represented by voltages. The actual voltage required for a high or low depends on the family of IC's being used: TTL (Transistor-Transistor-Logic) and CMOS (Complementary-Metal-Oxide-Semiconductor) are the most popular types in use today.

TTL devices require a power-supply voltage of +5 volts, with a high input defined as 2.0 volts or greater, and a low input defined as 0.8 volt or less. Inputs that fall between 0.8 volt and 2.0 volts are undefined—there's no guarantee of how an input will respond to them. Those standards apply to just

about all TTL devices, including standard TTL (the 7400 series), Schottky TTL (74S), and low-powered Schottky TTL (74LS).

In contrast to TTL, most CMOS devices can be powered by a wide range of supply voltages. Because of that, high and low logic levels for CMOS are defined as a proportion of the power-supply voltage. In most cases, a high input to a CMOS device must be at least seven tenths of the supply voltage, and a low input to a CMOS device must be less than or equal to three tenths of the supply voltage.

For example, when a CMOS IC is powered at 5 volts, an input of 3.5 volts or greater is a high, while an input of 1.5 volts or less is a low. But with a supply of 15 volts, 10.5 volts are required for a high, and 4.5 volts for a low. As with TTL, CMOS inputs between the high and low limits are undefined. Our *Experimenter's Logic Probe* uses those logic-level constraints in detecting various logic levels.

# Experimenter's Logic Probe

*Build a digital logic probe that has all the bells and whistles of commercially available units for under 10 bucks!*

BY JAN AXELSON

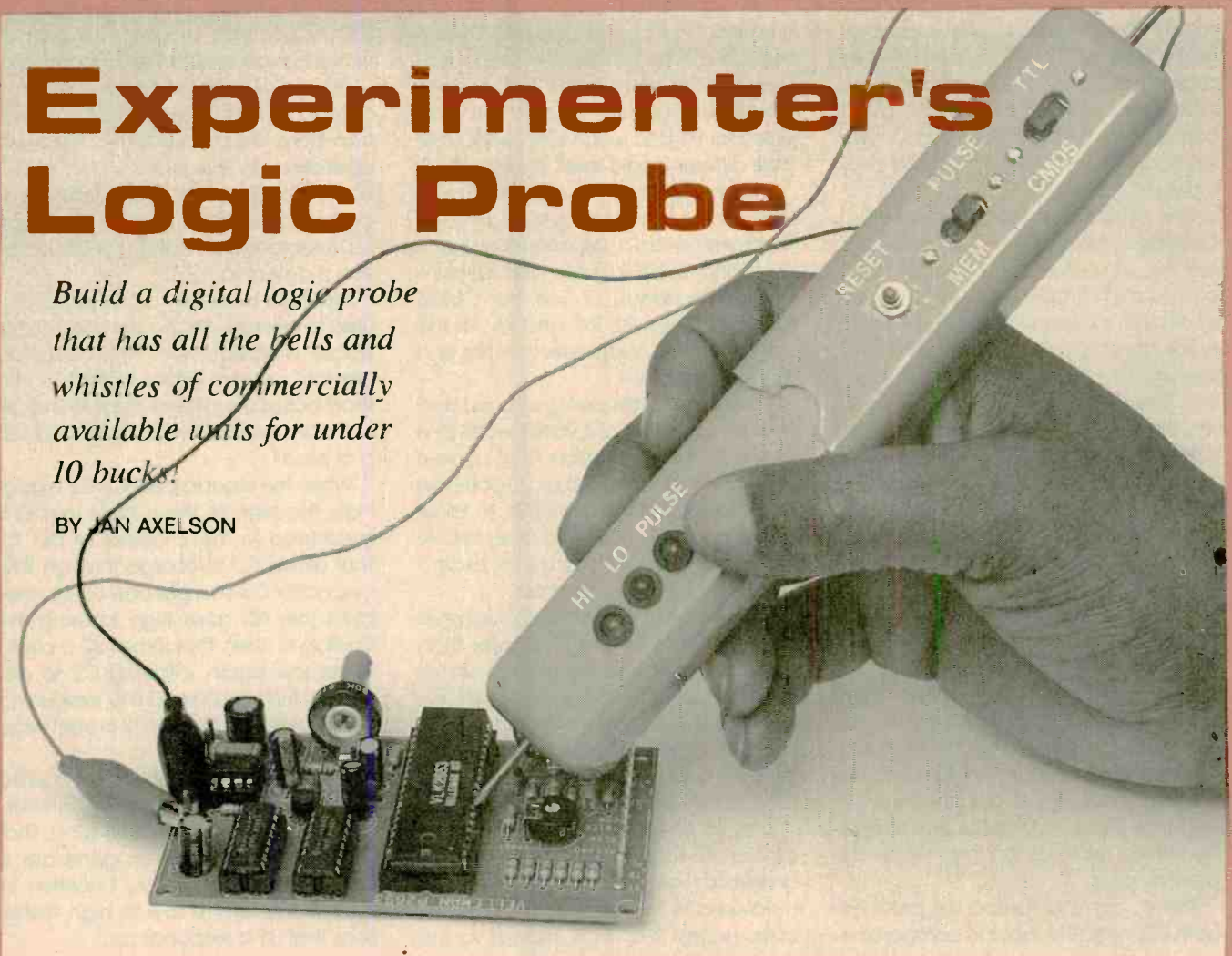

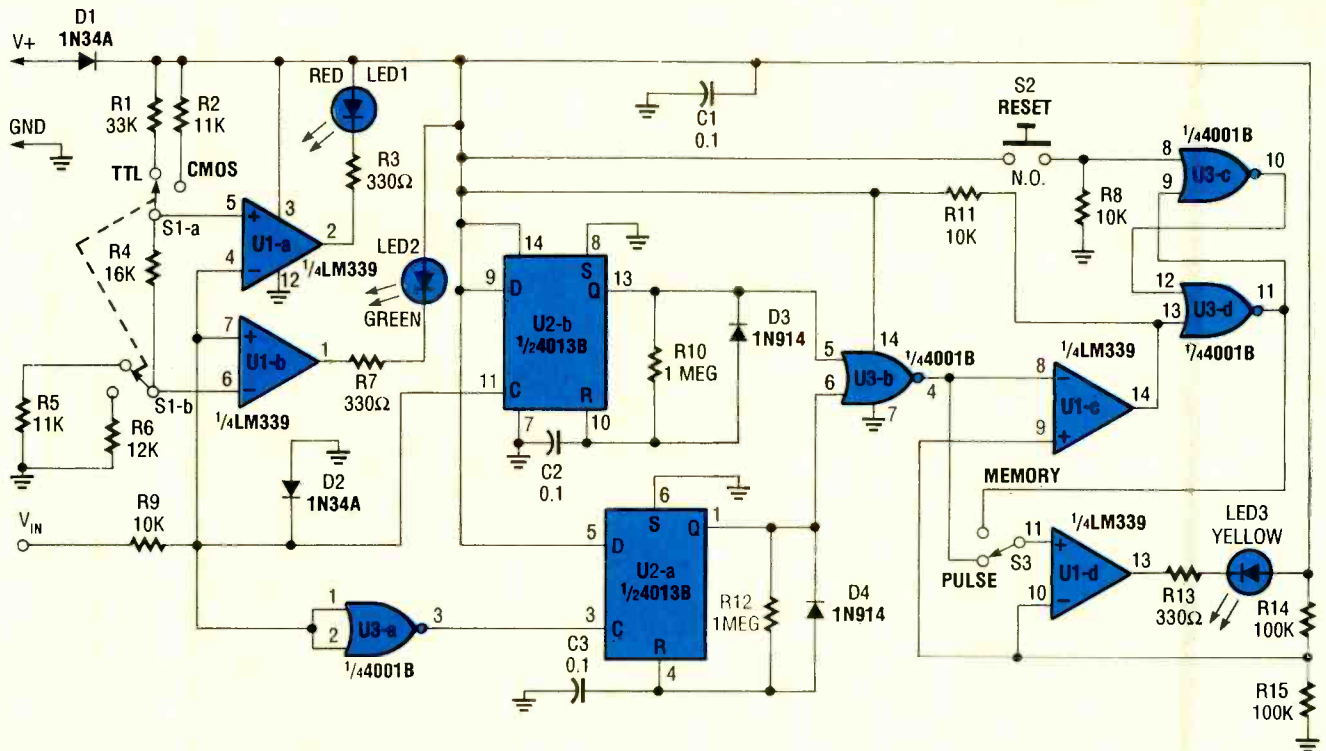

Fig. 1. The Experimenter's Logic Probe detects high and low logic levels, and level transitions for both TTL and CMOS integrated circuits.

**Inside the Probe.** Figure 1 is a schematic diagram of the Experimenter's Logic Probe. The circuit contains three integrated circuits—an LM339 quad comparator (U1), a 4013B dual D-type flip-flop (U2), and a 4001B quad two-input NOR gate (U3).

The circuit receives its power from two leads that clip to  $V_+$  and ground of the circuit under test. Because logic probes are normally used with a variety of circuits, mistakes in hooking up the leads are possible. To protect the probe's circuitry, diode D1 is added in series with the  $V_+$  bus to prevent supply current from flowing in the wrong direction if the power-supply leads are accidentally reversed. A germanium diode is used because of its lower forward voltage drop compared to that of a silicon diode. Capacitor C1 provides power-supply decoupling.

For circuit protection at  $V_{in}$  (the probe tip), resistor R9 limits the input current and diode D2 prevents the inputs to U1 through U3 from going negative.

Comparators U1-a and U1-b sense high and low logic levels at  $V_{in}$ . Each comparator's output is high when its positive input (+) is greater than its negative input (-), and low when its negative input is greater than its positive input.

The  $V_{in}$  terminal (probe tip) provides both the negative input to comparator

U1-a and the positive input to U1-b. A voltage divider sets the reference voltages for the other inputs to the comparators. Separate dividers are provided for TTL and for CMOS, because of their different logic-level standards.

Switch S1 selects the appropriate divider for the circuit being tested. For TTL measurements, R1, R4, and R5 set pin 5 of U1-a to about 2.0 volts, and set pin 6 of U1-b to about 0.7 volt. For CMOS measurements, R2, R4, and R6 set the same inputs to about seven-tenths and three-tenths of  $V_+$ .

For example, let's say  $V_{in}$  is connected to a TTL input of +2.4 volts. Switch S1 is moved to the TTL position. At U1-a, pin 4 is greater than pin 5, so pin 2 goes low and the red LED (LED1) lights, to show that a logic high has been detected. At U1-b, pin 7 is greater than pin 6, so pin 1 is high and LED2 remains off.

If  $V_{in}$  drops to 0.4 volt, the situation is reversed. Pin 5 of U1-a is greater than pin 4, and LED1 is off. But at U1-b, pin 6 is now greater than pin 7, so the green LED (LED2) lights, to show that a logic low has been detected. Resistors R3 and R7 limit the current through the LEDs to safe levels.

If  $V_{in}$  is between 0.8 and 2.0 volts, neither LED lights, indicating that  $V_{in}$  is at an invalid logic level. CMOS circuits are measured in the same way as TTL circuits, except that S1 is moved to the

CMOS position to give the proper switching voltages for the comparators.

The rest of the logic probe's circuitry is used to detect and display logic-level transitions. The probe has two modes of operation. In the PULSE mode, LED3 is flashed briefly each time a transition is detected, while in the MEMORY mode, LED3 is latched on when a single transition is detected.

Flip-flops U2-a and U2-b are configured to operate as one-shots, or monostable multivibrators. The one-shots "stretch" any transitions detected into short pulses. The signal input to the circuit at  $V_{in}$  is fed to the clock input of U2-b at pin 11.

When the input to pin 11 of U2-b goes high, the high at the D input (pin 9) is transferred to the Q output at pin 13. That allows C2 to charge through R10. Capacitor C2 charges until U2-b's reset input (pin 10) goes high, causing the flip-flop to reset. That forces U2-b pin 13 to go low again, allowing C2 to discharge through D3 and R10, producing a high pulse at pin 13 of U2-b each time the flip-flop is clocked.

The other flip-flop, U2-a, is configured much like U2-b, except that  $V_{in}$  is inverted by U3-a before it clocks U2-a. That causes pin 1 of U2-a to generate a pulse after a high-to-low transition of  $V_{in}$ , instead of the low-to-high transitions that U1-b responds to.



The  $Q$  outputs of the two flip-flops (U2-a and U2-b) are fed to NOR gate U3-b. Pin 4 of U3-b is low whenever the  $Q$  output of either U2-a or U2-b is high.

Switch S3 selects the PULSE or MEMORY mode. In pulse mode, pin 4 of U3-b is the negative input to comparator U1-d. Resistors R14 and R15 set pin 10 of U1-d midway between  $V+$  and ground. Each time pin 4 of U3-b pulses low, pin 13 of U1-d also goes low and causes LED3 to flash briefly. Resistor R13 limits the current through LED3.

When switch S2 selects the MEMORY mode, comparator U1-c inverts the pulses at pin 4 of U3-b. Pull-up resistor R11 enables pin 14 of U1-c to drive pin 13 of U3-d. Cross-coupled NOR gates U3-c and U3-d create a set/reset flip-flop, with pin 13 of U3-d as the set input and pin 8 of U3-c as the reset input. Resistor R8 pulls pin 8 of U3-c low until momentary switch S2 is pressed.

When pin 14 of U1-c goes high, the flip-flop (U3-c/U3-d) is set. Pin 10 of U3-c is high and pin 11 of U3-d is low. The low level at pin 11 of U1-d causes its pin 13 output to go low, lighting LED3. The LED remains lit until switch S2 is pressed, bringing pin 8 of U3-c high. Pin 11 of U3-d can then go high, which causes pin 13 of U1-d to go high, turning off LED3 until another transition is detected.

**Building the Probe.** The first step in building your logic probe is to gather the components and select an enclosure for them. The ideal project case is something roughly in the shape of a pencil or probe, yet large enough to hold the switches, LED's, IC's, and other assorted components it requires. An interior that's easily accessible is helpful, too, to make project construction (and maintenance) convenient.

The logic probe in the photos uses a

plastic toothbrush case as an enclosure. If you come up with another idea, feel free to go ahead and use that for your case instead. When selecting components for your logic probe, think small. For switches S1-S3, choose subminiature types. Resistors with 1/8-watt ratings can be used for all except R3, R7, and R13, and will help to keep the project compact. (Current-limiting resistors R3, R7, and R13 should be rated at 1/2 watt for use at 15 volts.)

The circuitry for the Experimenter's Logic Probe can be assembled on a small piece of perfboard with point-to-point wiring used to make the interconnections between the components. A board with solder-ringed holes is recommended for ease in mounting and wiring the components. Wire-wrapping is less suitable as a means of construction for this project, because of the extra space required for the wire-wrap sockets.

Because compact size is important for the Experimenter's Logic Probe, advance planning is essential. Carefully plan the positioning of all components before you proceed with any irreversible steps (such as drilling holes in the case). All of the circuitry except switches S1-S3 will fit on a board measuring about 1 x 3 inches. Resistors R1, R2, R5, and R6 can be soldered directly to S1 if space permits, or they can be mounted on the circuit board. Sockets are recommended for U1-U3.

Mount LED1-LED3 on the circuit board at the correct placement and height so that they'll match up with their planned openings when the circuit board is inserted in the case. Use narrow-gauge wire, such as AWG #30, to make connections between components in the circuit, again to keep the circuit as compact as possible.

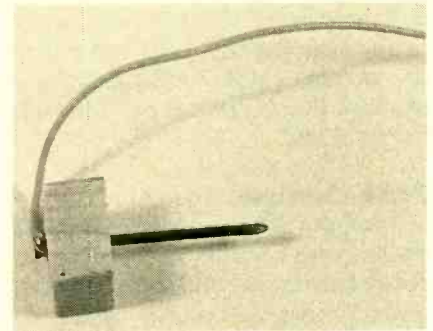

*The probe tip is nothing more than a nail driven into a small wooden block. A length of wire connects the nail to the circuit board.*

Begin by installing the sockets for U1-U3, but don't plug the IC's into their sockets until all circuit wiring has been completed. Use Fig. 1 as a guide when wiring the circuit to the board, installing the components as required. Be sure to observe the proper polarity for D1-D3 and LED1-LED3.

Use 6-inch lengths of #30 wire to make the connections between S1-S3 and the components on the circuit board. Use any convenient method to label the switch positions of S1 and S2, so that you'll know how to orient them when it's time to install them.

For the power-supply leads, cut 40-inch lengths of red and black stranded hook-up wire and strip about a 1/2-inch of insulation from the ends of each. Solder the red wire to  $V+$  and the black wire to ground on the circuit board. Leave the other ends of those wires free for now.

To construct the probe's tip, you'll need a nail (4d or similar), a small block of wood, and a 6-inch length of stranded hook-up wire. Strip about 1/2-inch of insulation from each end of the wire. Cut a block of wood small enough to fit inside the tip of your project case, then drive a nail about half-way through the center of the block.

Before driving the nail all the way in, wrap the bare end of the prepared wire tightly around the nail, just below the nail's head. Then drive the nail into the block, making a sound electrical and mechanical connection between the nail and the wire as you do so.

The project case requires an opening at one end for the probe tip, an opening at the opposite end for the power-supply leads, and holes for LED1-LED3 and S1-S3. Make the openings as required for your components. Now is a good time to label the switches and LED's on the probe's case. You can use rub-on transfer labels followed

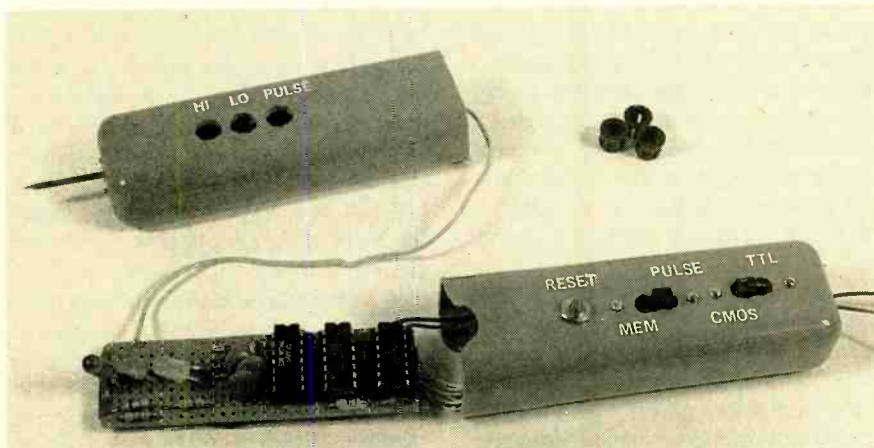

*The Experimenter's Logic Probe is wired on a small piece of perfboard that neatly fits inside a toothbrush case.*



by three coats of clear spray-on acrylic, or any other method that's convenient and durable. Install U1-U3 in their sockets, observing the proper pin-1 orientation for each.

**Probe Checkout.** When all of the circuit components are wired, but prior to installing the circuit in its case, stop to check out the operation of your probe. Figure 2 shows a simple test circuit that allows you to test the probe by varying  $V_{in}$ . Just about any value potentiometer can be used in the circuit. As you adjust the wiper of the potentiometer, use your voltmeter to verify that the red and green LED's light at the appropriate voltages of  $V_{in}$ , as described above. Test the probe in both the CMOS and TTL positions of S1.

When S2 is set to the PULSE mode, the

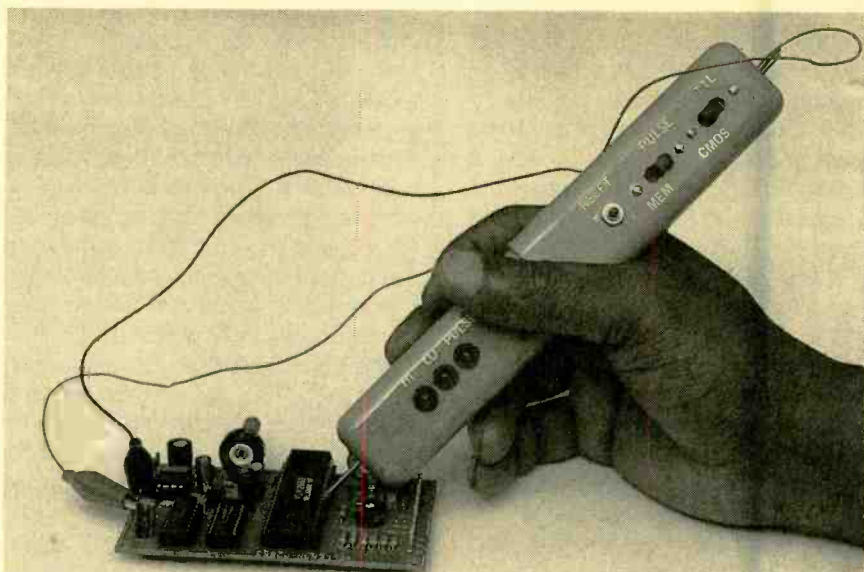

*Because operational power for the Experimenter's Logic Probe is derived from the circuit-under-test, you must connect the alligator clips of its power-supply leads to the +V and ground buses of the circuit to be monitored.*

### PARTS LIST FOR THE EXPERIMENTER'S LOGIC PROBE

#### SEMICONDUCTORS

- U1—LM339 quad comparator, integrated circuit
- U2—4013B CMOS dual D-type flip-flop, integrated circuit
- U3—4001B CMOS quad 2-input NOR gate, integrated circuit
- D1, D2—1N34A general-purpose germanium diode
- D3, D4—1N914 general-purpose silicon diode
- LED1—light-emitting diode, red
- LED2—light-emitting diode, green
- LED3—light-emitting diode, yellow

#### RESISTORS

(All resistors are 1/8-watt, 5% units, unless otherwise noted.)

- R1—33,000-ohm
- R2—11,000-ohm
- R3, R7, R13—330-ohm, 1/2-watt
- R4—16,000-ohm
- R5—11,000-ohm
- R6—12,000-ohm
- R8, R9, R11—10,000-ohm
- R10, R12—1-megohm
- R14, R15—100,000-ohm

#### SWITCHES

- S1—DPDT slide switch
- S2—SPST normally-open momentary-contact pushbutton switch
- S3—SPST slide switch

#### ADDITIONAL PARTS AND MATERIALS

- C1, C2, C3—0.1- $\mu$ F, ceramic-disc capacitor

Perfboard material, enclosure, LED holders, alligator or mini test clips, nail, small piece of wood hookup wire, solder, hardware, etc.

yellow LED should flash each time  $V_{in}$  changes from high to low or from low to high. When set to the MEMORY mode, a single transition should cause the LED to light, and pressing S3 should turn the LED off until the next transition takes place at  $V_{in}$ .

If you detect any problems in your probe's operation, carefully look over your wiring, checking especially for missing or incorrect connections, or solder shorts. (It's too bad you don't—yet—have a logic probe to help you troubleshoot!) When all is working as it should, you're ready to install the circuitry in the case.

Insert the prepared block of wood into the case so that the nail extends through the probe-tip opening. With a project case that pulls apart in the middle (like a toothbrush holder), use this method to hold the block in position as you fasten it in place: Slide a small-diameter post into the half of the case containing the probe tip. Stand the post on end so that the probe tip points up and the post holds the wood block against the end of the case. With the case in this position, drive two small nails or wire brads through the end of the project case and into the wood block.

Remove the case from the post and solder the free end of the wire connected to the nail to  $V_{in}$  on the circuit board. Now you're ready to install the circuit board. Trim all leads on the bottom of the board to minimize the height of the board assembly. Cover the bottom of the circuit board with electrical

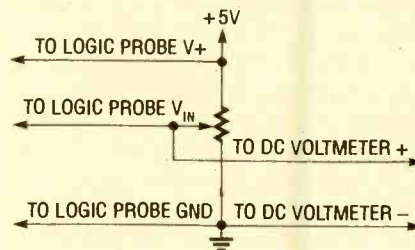

*Fig. 2. This circuit can be used to test the operation of the Experimenter's Logic Probe. By varying the voltage across the potentiometer, you can check the response of the unit to different values of  $V_{in}$ .*

tape, to help protect the wiring from damage as you install the board. Carefully bend the legs of the LED's toward the probe-tip end of the circuit board until the board can slide into the case.

Gently push the board into the case until the LED's are directly below the appropriate holes. Use a small screwdriver or other pointed tool to pry the LED's upward into position, gently sliding the circuit board into place as you do so.

At the other end of the case, tie a knot to act as a strain relief in the V+ and ground leads and route the leads out the opening prepared for them. Solder or crimp an alligator or mini test clip to the end of each wire.

To install the switches, use long-nose pliers to hold each switch as you insert it into the case and screw on the mounting hardware. Be sure to orient S1 and S2 so that the labels on the probe case match the ones on the switches. When all three switches are mounted, close

*(Continued on page 100)*





# Experimenter's Logic Pulser

*Add this digital signal source to  
your collection of troubleshooting aids*

BY JAN AXELSON

**A** logic pulser is a tool for "active" testing of digital circuits. The pulser injects a series of pulses into an input and allows you to track down any components that aren't responding as they should.

The *Experimenter's Logic Pulser* described in this article generates pulses at a user-selected frequency of 0.5 or 500 Hz, with a pulse width of around 5 microseconds. If the input to be pulsed is already being driven high or low by another output, the pulser automatically pulses the input to the opposite logic state.

The pulser is powered by the circuit under test, and operates from supplies of from +5 to +15 volts DC. To use the pulser, you just connect its supply leads to the circuit's power-supply bus, select your pulse frequency, and touch the probe tip to the input you want to pulse. A logic probe or oscilloscope can then be used to monitor the circuit's response.

**Pulser Circuitry.** Figure 1 is a schematic of the *Experimenter's Logic Pulser*. The circuit contains three IC's—U1, a 556 dual oscillator/timer; U2, a 4013B CMOS dual D-type flip-flop; and U3, a 4066B CMOS quad bilateral switch—all of which are commonly available from local electronics hobbyist outlets and through mail-order electronics suppliers.

Diode D1 is placed in series with the +V power lead of the circuit to prevent "wrong-way" supply current from flowing into the pulser if the supply leads are accidentally connected in reverse. A germanium diode is used for D1 (instead of silicon) because of its lower forward voltage drop.

Timer U1-a is configured to operate in

the astable mode—its output at pin 5 alternates high and low at a frequency determined by C1, R1, R2, R3, and S1. With switch S1 open, R1 and R2 are the timing resistors for U1-a and pin 5 oscillates at about 0.5 Hz. With S1 closed, R3 is placed in parallel with R2, bringing the circuit's oscillating frequency to about 500 Hz.

Capacitor C2 provides noise immunity at pin 3, which is otherwise unused. Pin 5 of U1-a clocks both halves of a dual flip-flop (U2). The logic state of U2-b's D input (pin 9) matches  $V_{out}$ , the point being pulsed. When pin 11 of U2-b goes high, the logic state at pin 9 is transferred to pin 13, and the logical complement of pin 9 is transferred to pin 12.

At the same time, the low-to-high transition at pin 3 of U2-a causes pin 1 to go high. Capacitor C5 charges through R6 until a sufficient charge is developed across C5 to force pin 4 (RESET) of U2-a high, causing the flip-flop to reset. Pin 1 then goes low and C5 discharges through D2. The result is a short, high pulse at pin 1 of U2-a each time the flip-flop is clocked.

Integrated circuit U3 contains four electronically controlled CMOS switches. A high at a switch's control pin (pin 5, 6, 12, or 13) closes the switch; a low opens it. When closed, each switch acts like a resistor of 90 to 250 ohms (depending on the supply voltage). The four switches are wired in two parallel sets, to give a lower combined resistance and to make full use of the four switching elements within the quad IC package.

When pin 1 of U2-a is high, all four switches are closed, allowing the bases of transistors Q1 and Q2 to be driven by pins 12 and 13 of U2-b. Transistors Q1

and Q2 form a push-pull amplifier that can pulse  $V_{out}$  either high or low as required by the circuit under test.

If  $V_{out}$  is connected to an input that's normally high, pin 13 of U2-b will also be high. When the switches close, Q2 turns on, Q1 remains off, and  $V_{out}$  pulses low. If  $V_{out}$  is connected to an input that's normally low, pin 12 of U2-b goes high. In this case, when the switches close, Q1 turns on, Q2 remains off, and  $V_{out}$  pulses high.

When  $V_{out}$  is connected to an input that is already being driven by another output, Q1 or Q2 may draw a considerable amount of current in forcing  $V_{out}$  to the opposite state. To prevent damage to the circuit being tested, the pulses are kept very short in relation to the pulse frequency. Even at 500 Hz, the pulser is actively pulsing for just 5 out of every 2000 microseconds—about 0.25% of the time.

Transistors Q1 and Q2 are 2N3904 saturated-switching types, which have the fast response required for creating the *Experimenter's Logic Pulser's* sharp output pulses.

Resistor R5 provides a path for Q2's collector current when  $V_{out}$  is connected to an open input. Resistor R4 limits current in case  $V_{out}$  is accidentally connected to a voltage that is greater than +V.

The final element in the pulser's circuitry is a pulse indicator. Pin 2 of U2-a provides the trigger input for timer U1-b. Each time pin 8 of U2-b goes low, pin 9 generates a high pulse that turns on LED1. The pulse width at pin 9 (as set by R7 and C6) is about a  $\frac{1}{10}$  second, long enough to provide a visible flash of the LED. When the *Experimenter's Logic Pulser* operates at 0.5 Hz, the LED flashes once every 2 seconds. At 500 Hz, the



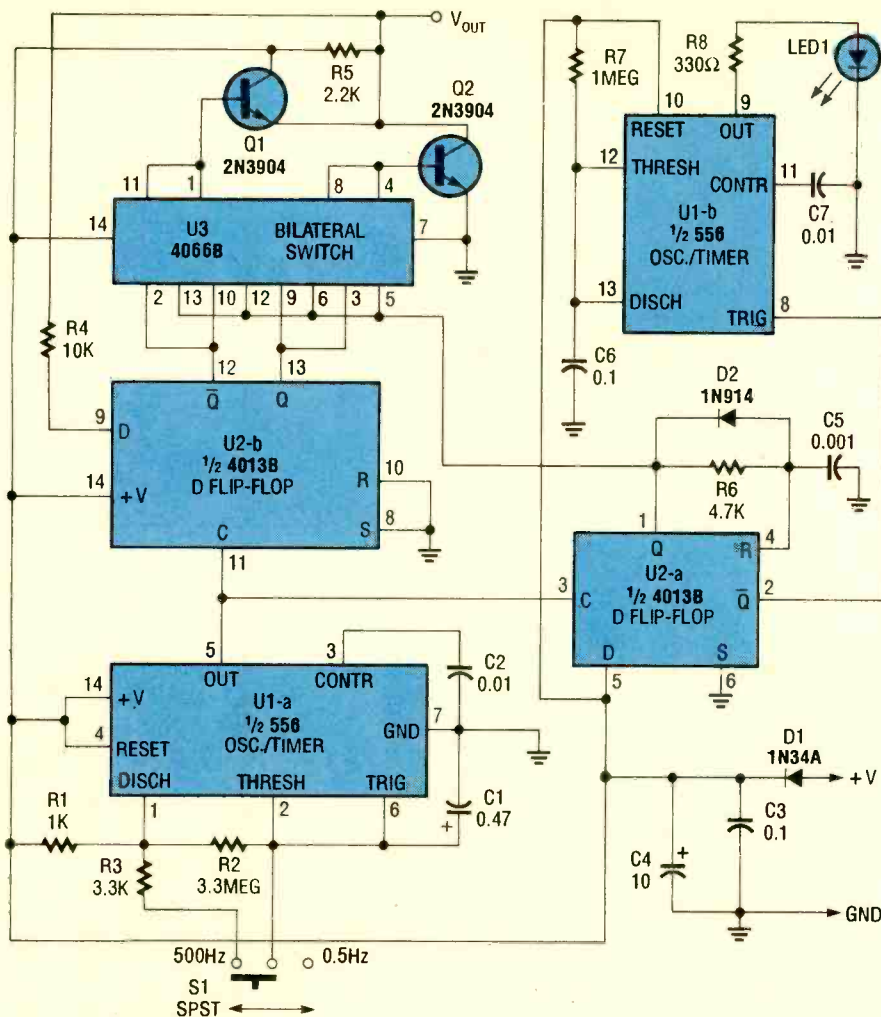

Fig. 1. The logic pulser generates pulses at 500 Hz or 0.5 Hz. When the pulser's tip connects to an input that is already being driven high or low, the pulser senses the logic state and automatically pulses the input briefly to the opposite state.

LED flashes so fast that it appears constantly lit.

Capacitor C1 provides noise immunity at pin 11 of U2-b, and R8 limits current through LED1. Capacitors C3 and C4 provide power-supply decoupling.

Let's look at an example of the pulser in operation. Say that we want to pulse an input that is normally driven high.

Pin 9 of U2-b senses the logic high at  $V_{out}$ . Pin 5 of U1-a oscillates at the frequency selected via S1. As pin 5 of U1-a goes high, the high at pin 9 of U2-b is transferred to pin 13, and a low is transferred to pin 12. At the same time, pin 1 of U2-a goes high, closing the switches in U3.

The high at pin 13 of U2-b turns on Q2, which pulls  $V_{out}$  low. After a few microseconds, pin 1 of U2-a goes low again, the switches in U3 open, base current is removed from Q2, and  $V_{out}$  can go high again.

If the input to be pulsed is normally low, the pulser responds in much the same way, except that pin 13 of U2-a

goes low and pin 12 goes high, causing Q1 to turn on and bring  $V_{out}$  high. When the pulser drives an open input, R5 pulls  $V_{out}$  high, and the Experimenter's Logic Pulser pulses it low.

**Building the Pulser.** It may not be a conventional project enclosure, but a plastic toothbrush case is just about the right size and shape to house the Experimenter's Logic Pulser. Whatever you choose, aim for a case that's conveniently shaped for use as a handheld tester.

Because you'll want the project to be as compact as possible, choose components that are physically small when possible. For example, switch S1 can be a subminiature type. For C1, use a Tantalum or other type of capacitor suitable for timing applications. Current-limiting resistor R8 should be rated at 1/2 watt for use at 15 volts.

Point-to-point soldering on perf-board is fine for wiring the Experimenter's Logic Pulser's circuitry. Use a

board with solder-ringed holes to make the installation and wiring of the components easier.

A small circuit board, say about 1 by 3 inches will hold all of the pulser's circuitry except switch S1, which mounts directly to the case. Sockets are recommended for U1-U3. Plan your layout before beginning to wire the circuits. LED1 must be mounted at the correct height and position so that it fits its planned opening in the case when the circuit board is installed. Use narrow-gauge wire, such as AWG #30, to wire the connections between components, again to help reduce the circuit assembly's bulk.

Begin by installing the sockets for U1-U3 (but don't insert the IC's in their sockets until the circuit-board wiring is complete). Use Fig. 1 as a guide as you insert and wire the components of the

### PARTS LIST FOR THE EXPERIMENTER'S LOGIC PULSER

#### SEMICONDUCTORS

- U1—556 dual oscillator/timer, integrated circuit
- U2—4013B CMOS dual D-type flip-flop, integrated circuit
- U3—4066B CMOS quad bilateral switch, integrated circuit
- Q1, Q2—2N3904 general-purpose NPN silicon transistor
- D1—1N34A general-purpose germanium diode
- D2—1N914 general-purpose silicon diode
- LED1—light-emitting diode

#### CAPACITORS

- C1—0.47- $\mu$ F, Tantalum
- C2, C7—0.01- $\mu$ F, ceramic-disc
- C3, C6—0.1- $\mu$ F, ceramic-disc
- C4—10- $\mu$ F, Tantalum
- C5—0.001- $\mu$ F, ceramic-disc

#### RESISTORS

(All resistors are 1/4-watt, 5% units, unless otherwise noted.)

- R1—1000-ohm
- R2—3.3-megohm
- R3—3300-ohm
- R4—10,000-ohm
- R5—2200-ohm
- R6—4700-ohm
- R7—1-megohm
- R8—330-ohm, 1/2-watt

#### ADDITIONAL PARTS AND MATERIALS

- S1—SPST slide switch
- Perfboard materials, enclosure, IC sockets, alligator or mini test clips, nail (4d), LED holder, hookup wire, solder, hardware, etc.



circuit. Observe the proper polarity for D1, D2, C1, C4, and LED1, and be mindful of the orientation of Q1, Q2, and the IC sockets as you wire them.

Cut 40-inch lengths of red and black stranded hookup wire for the power-supply leads, and strip a ½ inch of insulation from the ends of each lead. Solder the red wire to +V and the black wire to ground on the circuit board. Wire S1 to the appropriate points on the circuit board using 6-inch lengths of #30 wire.

The probe tip can be constructed from a nail (4d or similar), a small block of wood that fits inside the tip of the case, and a 6-inch length of wire.

Strip about a ½ inch of insulation from the ends of the wire. Drive the nail part-way through the center of the wooden block, then wrap one end of the prepared wire tightly around the nail, just under the nail's head. Drive the nail into the block to form a sound mechanical and electrical connection between the wire and the nail.

On the project case, make openings for LED1 and S1, and make an opening on each end of the case for the probe tip and power-supply leads. Label the switch positions on the case with rub-on transfer labels followed by three or four coats of clear acrylic spray.

**Pulsar Checkout.** It's a good idea to check the circuit's operation before installing the circuit board in its case. Install U1–U3 in their sockets, observing the pin-1 orientation for each. Connect a DC supply of from +5 to +15 volts to +V and ground on the board. (A nine-volt battery is fine for this test.)

The pulser's LED should flash about once every 2 seconds with S1 set at 0.5 Hz and should appear constantly lit at 500 Hz. If you monitor  $V_{out}$  with a logic probe or oscilloscope,  $V_{out}$  should be

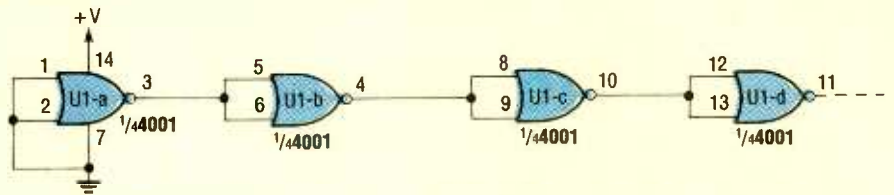

Fig. 2. Use this circuit to test the operation of the logic pulser. Points A and C are normally high, so the pulser will pulse them low. Point B is normally low and so will be pulsed high.

normally high, with short, low-going pulses about every 2 seconds or 2 milliseconds, depending on S1's setting.

The exact output frequencies of the pulser aren't critical. Frequencies within 20 percent of the specified values are fine.

Figure 2 shows a simple circuit for testing the pulser in an active circuit. Points A and C in the circuit are normally high, and point B is normally low.

If you connect the  $V_{out}$  on the pulser to point A or point C, the pulser should generate short, low pulses at the frequency selected. If  $V_{out}$  goes to point B, the pulser should generate high-going pulses. You can also try this test with a TTL IC such as a 7402. (Be sure to use a 5-volt supply with TTL.)

If you detect any problems in the operation of your Experimenter's Logic Pulsar, stop now to find and fix them. Look the circuit over for incorrect or missing connections or solder bridges. When all is working, you're ready to finish putting the pulser together.

The first step is to fasten the probe tip inside the case. To do that, insert the prepared wooden block into the case with the nail extending out its opening. To hold the block in place as you fasten it, find a block or post that fits into the case, and is longer than the case.

Insert the block or post into the case and stand it on end so that the block is pushed against the end of the case. Drive two small nails or wire brads

through the case and into the wooden block. Solder the free end of the wire that connects to the pulser tip to  $V_{out}$  on the circuit board.

Before installing the circuit board, trim all leads on the bottom of the board and cover the bottom with electrical tape to protect the wiring as the board is inserted. Carefully bend the legs of the LED toward the probe-tip end of the circuit board and slide the circuit board into its case.

When the LED is directly below its opening, gently pry it up into place with a small screwdriver or other pointed tool, pushing the circuit board into the case slightly as you do so.

Tie a knot in the +V and ground leads to act as a strain relief, and insert the leads through their hole in the end of the case. Crimp or solder an alligator or mini test clip to the end of each wire. When mounting switch S1, be sure to orient it so that the "open" switch position matches your 0.5-Hz label on the case. Use a long-nose pliers to hold the switch in position inside the case as you fasten its mounting screws.

Finally, carefully close the case and check the operation of the pulser once more, to be sure that the final installation did no damage. When all is functioning correctly, complete your project by pressing the top half of a two-part LED holder around the LED on the case. The pulser is now ready for use.

**Using the Pulsar.** To use the pulser to verify that a logic gate in a circuit is operating properly, clip the power leads of the Experimenter's Logic Pulsar to +V and ground buses of the circuit under test and touch its tip to an input. Use a logic probe, oscilloscope, or other logic monitor to observe the outputs of the gates in question.

Because the Experimenter's Logic Pulsar is powered by the circuit under test, it automatically generates pulses of the correct amplitude for your circuit. Use the 0.5-Hz setting when you want to watch the effect of a single pulse on an input, and 500 Hz when you want to see the effects of a pulse train. ■

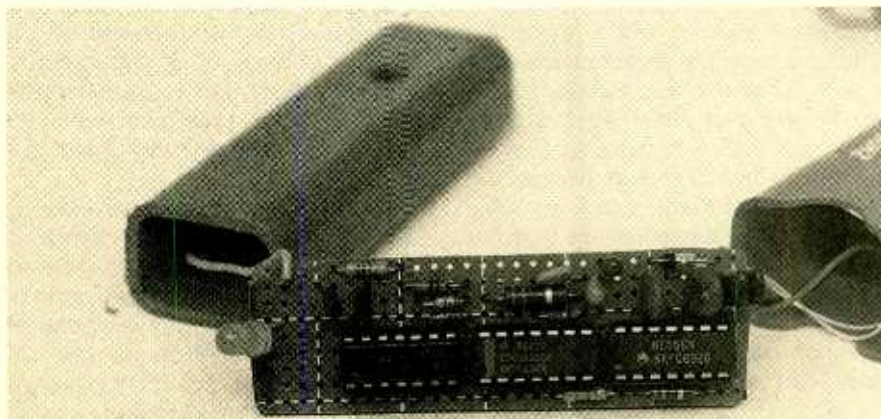

Most of the circuitry for the logic pulser is wired on a small circuit board that fits neatly inside of an ordinary toothbrush case.

# The Exciting World of HAM RADIO

*Ham radio lets you  
communicate with fascinating  
people from all over the world.  
It's fun, and the new rules make it easier.*

BY ARTHUR R. LEE, WF6P

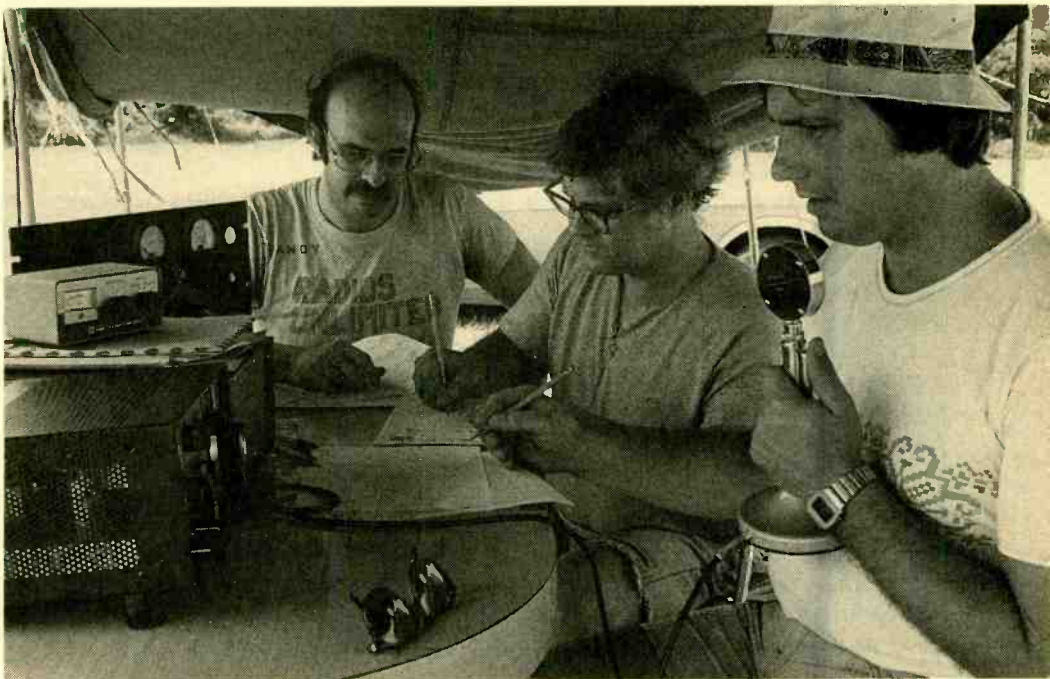

**H**ow would you like to expand your horizons, learn a simple new skill, and make hundreds of new friends—all from your home? You can, and at little cost. Age is no barrier, and no physical strength or academic prowess is required. All that is needed is a desire to be friendly and to explore, via the airwaves, the world around us.

Hams, as amateur-radio operators call themselves, come in different sizes and packages and from diverse walks of life. All share the common interest of talking to each other on the air and the lifetime friendships that ensue.

**What is Ham Radio?.** In case you're not sure, ham radio is the by-name or label given, over the years, to amateur-radio operators communicating from and to locations anywhere in the entire world, and other worlds too! Astronomers like Carl Sagan, UCSC Professor Frank Drake, and Stanford's Ronald Bracewell have been working with the National Aeronautics and Space Administration (NASA) on the Search For Extra Terrestrial Intelligence (SETI) study for

many years. Hams have a small part in the program, but that is the subject of another discussion.

As a ham you can talk to your next-door neighbor, a friend in the next town, and a ham in a country on the other side of our planet—all at the same time.

As I write this article, my ham-radio receiver is turned on and a girl in Cambodia is trying to reach fellow hams in the United States. Last week it was an interesting fellow in Idaho whose son lives here in my city. Yesterday, I talked to a ham operator in Bougainville, a South Pacific Island of WWII fame; an hour ago I was talking to a young married couple on their 37 foot yacht at sea off the island of Molokai, Hawaii. The wife's mother was on the air with me from her own ham station located in Carmel, California. Her daughter and son-in-law are both hams and were returning from an adventurous cruise to Tahiti where we were all in daily contact.

**Yesterday and Today.** Since radio first came into being at about the turn of

the century, people have been in communication with other men and women on the ground, in the air, and on the sea. Few can recall that in the early 1930's, Anne Morrow Lindbergh was her famous husband's communicator from the cramped rear cockpit of their seaplane. In her fascinating book, *Listen! The Wind*, Anne tells how all of her position reports and other vital messages were made using Morse code and pioneer radio equipment. She described the steps she had to take to change coils and antenna length to account for the frequency differences when talking to the shore-based Pan American radio operators in South America.

No longer is ham radio a mysterious science, belonging in the domain of experimenters or radio engineers. About 40 years ago, a person had to be able to solder odd bits of wire between electron tubes, coils, condensers, and resistors. In fact, building a radio transmitter was the only possible way to obtain one for personal use.

In today's world, high quality, state-of-



the-art amateur-radio equipment controlled by internal processors is available from manufacturers at about the cost of a moderately priced color-television set or VCR. Modern electronics has transformed ham radio into a convenient, easy-to-use and easy-to-understand medium that is better than ever. With a minimum of investment, hams need only purchase a radio transceiver, take it from its box, attach a simple antenna and ground lead, and plug the power cord into any household outlet. Instantly, the operator can be in touch with other hams throughout the world.

Is becoming an amateur radio operator as simple as I have made it out to be? Not quite, but the incremental licensing program instituted two decades ago by the Federal Communications Commission has made it nearly so. The recently enacted Novice Enhancement Program, in which newly licensed hams can talk on several frequencies, as well as use Morse code, is a boost to the hobby and a tremendous inducement to join the growing numbers of amateurs.

**Licensing.** Prospective hams must learn a new "language," Morse code. Samuel FB. Morse developed the code in 1838 for use by commercial telegraphers. The basic principles of the code have not changed significantly over the years.

Many of us have been exposed to



*Here's a fellow ham using slow-scan television to view Voyager 2 pictures of Saturn. The images are retransmitted to ham radio operators worldwide by members of an amateur radio club at The Jet Propulsion Laboratory in Pasadena, California moments after scientists there received the images from space. (Photo courtesy of American Radio Relay League.)*

Morse code during our lifetimes. The code was once popularly taught by both the Boy and Girl Scouts, and other organizations including the military. Despite the advancement of computer communications, the Armed Forces still train about 100 code operators each year, and merit badges in communications can still be earned by Boy Scouts. Over the years, millions of people have learned and used Morse. Once mastered, using the code on the air is fun and exciting.

Is the code easy to learn? Decidedly, yes. Is age a barrier to learning? Absolutely not. My granddaughter, at age 7, easily picked up Morse after a few weeks of training over her morning cereal. A fellow ham taught a 77-year old grandmother to send code and to pass her novice-class license test.

So, with a little bit of help from pre-recorded cassette tapes and a low-cost telegraph key with a training oscillator (available at most electronics-supply stores or by mail order) the code can be easily mastered in a short time. The practice key helps develop sending skills and reinforces learning from the code tapes.

A complete and greatly simplified self-learning course, *Tune In The World With Ham Radio*, is available from the American Radio Relay League (or ARRL) Headquarters at 225 Main Street, Newington, Connecticut, 06111, for \$15.00. After the code, what is next? Only the learning of a few simple, common-sense rules laid down to protect and guide hams in the exercise of their new-found hobby.

Lastly, a novice code-receiving test at 5 words per minute and a 30-question multiple-choice test must be taken. The tests can be administered anywhere. They can be given in schools, your home, the home of a volunteer examiner, and even at bedside in the case of handicapped persons. One candidate I know of took his novice test on the tailgate of a station wagon during an

*(Continued on page 96)*



*Rex Kiser, W0GLU, is shown here at the helm of the 20-meter position at Courage Handi-Ham System headquarters. Notice the number of home-made modules in the system; proof that ham radio is an excellent extension of the electronics hobbyist's art.*





# CANON RC-250 STILL-VIDEO CAMERA

*A new generation of electronic still cameras will revolutionize the way we take photographs.*

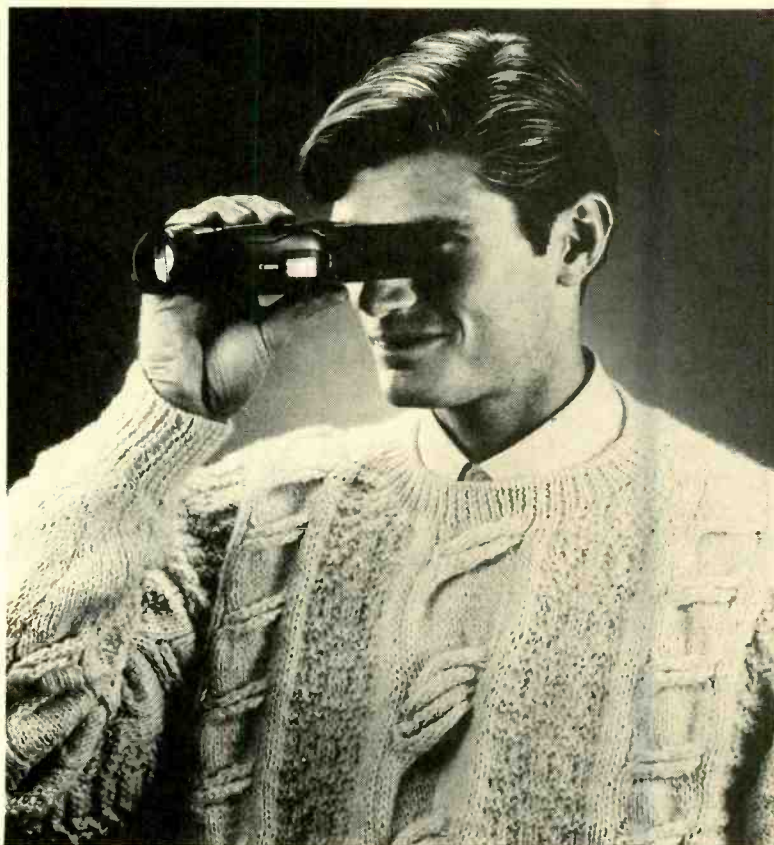

CIRCLE 116 ON FREE INFORMATION CARD

**C**onsider all the disadvantages of film photography. For one thing, film is consumable—you only get one shot to a frame; if you are unhappy with it, your only option is to throw it away. Also, with film you must wait for your prints to develop. Even with the fastest self-developing (Polaroid) film, you must wait ten seconds or longer to see the results of your efforts, just long enough to miss forever that once-in-a-lifetime shot of your grandchild or a dazzling bride.

Actually, film-type cameras are not really bad. It's just that Canon's RC-250 Still-Video Camera offers so much more in user convenience.

Canon's RC-250 camera is the first electronic still-image camera to incorporate the recently-approved, high-band still-video standard for enhanced image quality (that standard is compatible with the latest 8mm Video, Super-VHS, and HDTV technologies). The high-band still-image standard features an overall bandwidth of 7.7 MHz, rather than the conventional 6 MHz, for improved resolution.

The camera offers a completely new way for consumers to make and view photographs, offering instant playback on any color-television receiver. That makes it more convenient than ever for

entire families to enjoy looking at their photographs together.

Looking more like a sleek pair of compact binoculars than a camera, the RC-250 camera is comfortable to hold and easy to use—all you do is point and shoot. Everything is handled automatically, including the flash.

**Operation.** This reviewer is as impatient as any consumer, so I unpacked the RC-250 camera rapidly and did not read the manual. Fortunately, I found that operating the camera is extremely simple. Taken straight out of the box, I pushed the EJECT button and the hinged cover on top of the RC-250 popped open. After inserting a 2-inch disk, the cover pressed closed. With the blank disk in place, the camera automatically advanced to the first frame. The unit's main slide switch was advanced to the REC position and the flash-selector switch was advanced to the AUTO position. I then looked through the viewfinder, composed the picture, and pressed the shutter button. Thus was born a first-generation, electronic-still-image-camera mavin!

Playback with the Canon RC-250 camera is a snap. One end of a supplied video cable is plugged into the video out jack on the camera, the other

connects to a TV set's video-input jack. If you don't have a video input jack on your television receiver, use the one on your VCR. Select PLAY on the camera and the first frame appears on the television screen in full color. Press the camera's FWD button to advance through the frames. Press REV to review earlier frames.

To erase an image, slide the main switch to ERASE, press the FWD or REV button to locate the desired image, then press the ERASE MODE button and the SHUTTER button. This three-step procedure is a safety precaution to prevent accidental erasures. When erasing a track, the track number flashes twice to confirm erasure.

When a partially recorded disk is loaded into the camera, the disk automatically advances to the blank track that follows the highest-numbered already recorded track. Instant access to blank tracks on a disk containing randomly recorded tracks is possible by pressing the SHUTTER button half way down, and then pressing either the FWD or REV button to locate an empty track. A picture is taken when the SHUTTER button is pressed all the way down!

**Display Panel.** A liquid-crystal display  
*(Continued on page 99)*



# GIZMO

SEPTEMBER 1989

VOLUME 2,  
NUMBER 9

A CHRONICLE OF CONSUMER ELECTRONICS

## Super (Duper) VHS

**PIONEER VH-930SD SUPER-VHS VCR.** Pioneer Electronics (U.S.A.) Inc., 2265 E. 220th Street, P.O. Box 1720, Long Beach, CA 90801-1720. Price: \$1500.

It seems as though whenever a new technological innovation is brought to market, it always appears along with a lot of other new high-tech stuff. It's like buying a new car and trying to get a light in the glove compartment—you have to buy a \$250 "options package" just to get that one little bulb. Similarly, in high-end electronics equipment you usually wind up paying for a lot of stuff that you don't really want or need, and that you'll abandon once you've mastered it.

So seems to be the story with Super-VHS, the latest of the advances in high-quality video reproduction. If you want S-VHS, and its better-than-broadcast-quality video, you also have to take all the riders attached to it, whether or not you want them.

The *Pioneer VH-930SD* is a case in point. For someone who just wants to sit back and enjoy a good movie presented in the highest fidelity available, this is a case of overkill. (Not that there are many movies available in S-VHS format yet, especially for rental. If you want to see a Super VHS movie, you generally have to buy it. Just how badly do you want to own *Robocop*?)

That is not to say that the VH-930SD is a bad machine. Far from it, the quality of the video is very good, as is that of the hi-fi sound. Its just that the VCR does so *much*. It's hard to imagine how anyone could use it all.

Let's accept that the VH-930SD performs satisfactorily in recording and reproducing video and audio material and look at its other features. And boy, are there features! The remote control that comes with the deck has 42—count 'em, 42—buttons *and* a switch. As if that weren't enough, some of the buttons perform different (albeit related) functions depending on the number of times they're

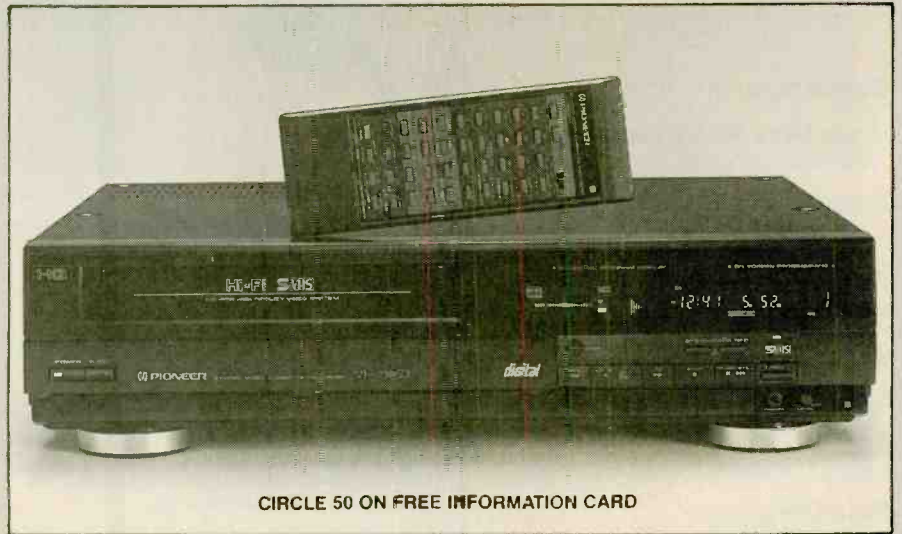

CIRCLE 50 ON FREE INFORMATION CARD

pressed. We suppose Pioneer had to do it that way because there wasn't enough space to add more buttons. There are so many features that the operating manual ought to come with an index. We kept finding ourselves knowing what we wanted to do, but unable to remember how to make the deck do it. An index would have saved us a lot of wasted time searching through the instructions for the paragraph we remembered having read ... somewhere in there.

Anyway, most of those special features are made possible by the fact that the VH-930SD contains one megabyte of solid-state video memory, not to mention a few thousand bytes more for such trivial things as the on-screen display of channel and other numbers, programming for unattended recording, and remembering things such as what the deck settings were when it was last used. All that video RAM makes it possible for the VCR to store in digital form—for an instant, or for however long you want until the machine is turned off—a frame of video, the equivalent of a single frame on a piece of motion picture film. The conventional analog video is converted into digital form, with each picture element, or pixel, being stored as two digital numbers—an eight-bit one representing luminance, or brightness, and a six-bit one representing chrominance, or color. Once a frame has been digitized and

is in memory the numbers representing it can be manipulated in any number of ways—and that is what's responsible for the VH-930SD's special features.

One of the things made possible by all that memory is "picture-in-picture." "P-in-P," as it's referred to, allows you to view video material from one source on your monitor or TV set while also watching, in a corner of the screen, a reduced-size image of what's coming from another source. Thus you can see a Super-VHS video (assuming you can find one to rent) while at the same time keeping track of the progress of Monday night's football game. If you have a second TV tuner, you can keep your eye on two programs at once. The audio you hear belongs to whatever main video is being displayed, and the main and secondary programs can be reversed at the press of a button.

All that memory also allows you to freeze a frame of video for closer scrutiny, much as you would using the VCR's PAUSE button. The video frame that happens to be in memory when you press the MEMORY button is held there and read out over and over again until you've had enough of it. Meanwhile, of course, the program goes on; you can hear it but can't see it until you release the MEMORY function. In fact, we suspect that the deck's STILL (pause) function, while it does stop the tape transport,

*(Continued on page 8)*

TURN PAGE FOR CONTENTS



# This month in GIZMO®

- Pioneer Super-VHS VCR ..... pg. 1
- Lloyd's Micro AM/FM Personal Stereo..... pg. 2
- Northgate OmniKey/102 Keyboard ..... pg. 3
- Spica Stereo Speakers ..... pg. 4
- Micrologic's Tornado Database . pg. 5
- Sharp Electronic Organizer . . . . pg. 6
- Sharper Image Sound Soother 2 Clock Radio..... pg. 7
- Child's Computer ..... pg. 9
- Deluxe Headphone ..... pg. 9
- Portable Sound System ..... pg. 9
- Recipe Calculator..... pg. 9
- Telephone Handset Cord ..... pg. 9
- Color LCD TV ..... pg. 10
- Designer Telephone..... pg. 10
- Etch-a-Sketch Animator ..... pg. 10
- Replica Cathedral Radio..... pg. 10
- Surf Watch..... pg. 10
- CD Carry Case ..... pg. 11
- Denon AM/FM Tuner ..... pg. 11
- Electronic Battleship Game.... pg. 11
- Electronic Typewriter ..... pg. 11
- Quartz Video Light ..... pg. 11
- Bondwell Mouse ..... pg. 12
- JBL Overhead Video Projector . pg. 12
- ORA Cellular Phone Antenna . pg. 12
- Sima Sound Mixer ..... pg. 12

GIZMO is published by Gernsback Publications, Inc., 500-B Bi-County Blvd., Farmingdale, NY 11735. Senior Writer: Josef Bernard. Contributor to this issue: George Arthur. ©Copyright 1989 by Gernsback Publications. All rights reserved.

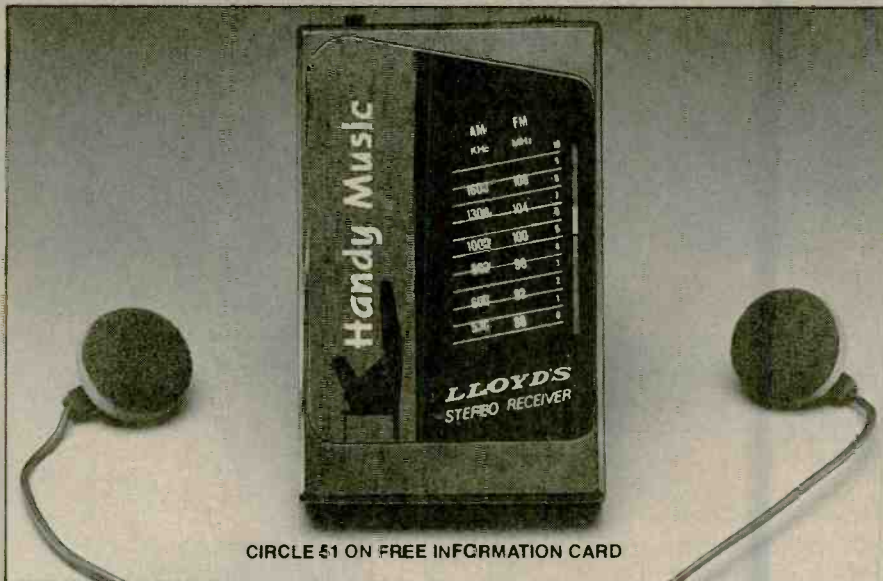

CIRCLE #1 ON FREE INFORMATION CARD

## A Little Light Music

**LLOYD'S HANDY MUSIC MICRO AM/FM STEREO RADIO.** Lloyd's Electronics, A Division of Dynascan Corp., 200 Clearview Road, Edison, NJ 08818-7811. Price: \$19.95.

What can you say about a radio so small that if you put it down and turn your back on it you may have trouble finding it again? How about, "It sure is cute!" That accurately describes Lloyd's little *Handy Music* AM/FM stereo radio. About the size of half a small Hershey bar, it weighs only 35 grams (1¼ ounces) without the single AAA-size battery it requires. That's just a little over twice the weight of the headphones that come with it, which weigh in at 14 grams (½ ounce).

For a radio of its diminutive size—2¾ × 1¼ × ¾ inches—the *Handy Music* is surprisingly easy to operate. A slide switch at the top left turns it on and selects either the AM mode or FM stereo. At the front of the radio, at the upper-right of the case, is a rotary volume control, and behind it at the back is a similar tuning knob. Both offer enough resistance to movement to withstand the minor nudges that occur in use and might otherwise cause them to change position.

Station frequencies are somewhat vaguely indicated on a slide-rule type dial, which might make it hard for you to find an unknown station whose frequency you know but whose "sound" you don't. However, since you will probably use the *Handy Music* for casual listening to your favorite station, which you can almost certainly identify without even looking at the dial, that shouldn't present a great problem. The small size of everything makes one-handed operation a bit tricky, but with

two there's no problem in accurately setting the controls where you want them.

The tuner in the *Handy Music* is considerably more sensitive and selective than we would have expected in a unit of its size and price. We took the radio out for a walk in an area where we know other radios using a similar type of antenna—namely, the wires leading to the headphones—have had difficulties in holding onto the signal of an FM station located some distance away. While reception was not perfect, it was considerably better than we've encountered with other units. The station still tended to drop out from time to time, but the dropouts were less frequent than we had expected, and not as severe when they did occur.

Being so small and lightweight has its advantages. One nice thing about such a lilliputian radio is that if you drop it while you are listening to it, the tug on the earphones when it reaches the end of the cord is less than painful. You'll feel the radio come to a sudden stop at the end of its "rope," but what you feel will be more an annoyance than anything else.

There are also disadvantages to being small. The problem arises as to how to carry a radio this size. Where do you put it? Do you stick it in your shirt pocket? In your purse? Tucked into your belt? What about if you go out jogging? We solved the problem by fastening a clip to the radio with a rubber band, and then using the clip to secure it to our clothing.

We're not sure what market the *Handy Music* is intended for. The sound from the radio was acceptable. It wasn't great sound, but the quality was adequate, and there was more than enough of it. If sold for about half the price, it would be the sort of thing you'd pick up for the kids "just because." On the other hand, the radio is a little primitive in design to be an adult item, much the way Japanese electronic devices were 30 years or so ago.

It sure is cute, though. ■



## Type Right

**NORTHGATE OMNIKEY/102 KEYBOARD.** Manufactured by: Northgate Computer Systems, 13895 Industrial Park Blvd., Suite 110, Plymouth, MN 55441. Price: \$99.00.

You can get used to anything. As tens of thousands of IBM PC-clone users would be able to testify, you can even learn to live with the no-feel keyboards that are usually supplied with those computers. Some of those users may even maintain that they've never typed faster or more accurately than on their made-in-Taiwan input devices. (That is probably because they never used any keyboard before that one. It's like the man who asked his doctor, "Doctor, will I be able to play the piano after the operation on my hand?" When told that he would he responded, "That's nice—I couldn't before!")

Many people, though, find those clone keyboards sorely lacking in both response and, perhaps, in features as well. We, for instance, were giving serious thought to going back to a typewriter(!) for some of our work—there's a certain satisfaction to hearing the solid *thwack* of keys hitting paper and in feeling the keys respond beneath your fingers, that provides a sense of accomplishment you can't get from a weak-sprung and silent clone-computer keyboard.

Instead of a typewriter, we got ourselves an *OmniKey/102* keyboard from *Northgate Computer Systems*.

What makes the *OmniKey/102* different from the ones it's intended to replace? First, and possibly most important for touch typists, is the way the keys respond. To some hunt-and-peck users, that might not be important—much as some drivers don't care what kind of car they drive as long as it gets them there—but to someone who spends a substantial portion of his day at, and makes a living from, the keyboard attached to his computer, the way that keyboard feels is very important.

Those no-feel Taiwanese keyboards, with the wimpy little springs under the keys, do nothing but lie there passively. Like a car whose shock absorbers need replacement, they just sort of bottom out when struck, providing all the tactile response of a bowl of oatmeal (which, at least, is warm). On a cold morning, before your fingers have warmed up and become limber, it's very easy to get lost on such a keyboard and type whole lines of nonsense that consist of characters whose keys are offset on the keyboard by one position from those you thought you were striking. Sometimes you can't even tell whether you pressed a key or just brushed it in passing across to another one without looking over to the screen.



CIRCLE 52 ON FREE INFORMATION CARD

The *OmniKey/102* keyboard uses Alps brand keyswitches, which are manufactured in Japan. These are serious switches, and are obviously engineered to do more than just open and close an electrical circuit. They have a feel to them that's missing from their clone counterparts. The keys resist slightly when you press them down, and you can feel them spring back up again beneath your fingers as you release them. That adds a certain liveliness—and possibly a bit of speed and authority—to your typing. And, while the *OmniKey/102* does not have an electronic key-click device (thank Heaven for that!) the keyswitches do make a satisfying sound as they are pressed and released, murmuring to you that you are making progress in your writing.

The *OmniKey/102*'s other important selling point is the layout (and variety) of its keys. First, let's discuss the function keys. The original IBM keyboard had ten function keys arranged vertically in two columns of five at the left. Later IBM designs moved these keys to the top of the keyboard, where they were arrayed horizontally from left to right, with additional F11 and F12 keys. Many protested that change, saying they wanted the function keys "back where God intended them to be." IBM, being IBM, paid no heed to this request; nor did its many imitators in the Far East.

Northgate's keyboard, though, keeps those keys where so many people expect to find them, on the left side. In fact, the new F11 and F12 keys are located above, and at a distance from, the other ten so that they cannot be confused with them. Across the top of the board are what look like 12 membrane-switch function keys. What these are, though, are a dozen spaces in which you can pencil in the functions of the function keys for your most-used application. [You have to write small, though, or learn to abbreviate concisely.] We should note in passing that the function-key templates that are sometimes supplied with software packages may not fit on the *OmniKey/102*. We found barely enough clearance between the function

keys and the rest of the keyboard for our Microsoft Word template, and it overhung the left side of the keyboard.

The "102" in "*OmniKey/102*" refers to the number of keys on the board... almost. There are actually only 101 keys, but Northgate also manufactures a keyboard designated "101," so this is as close as they could get. IBM XT-style keyboards have only 84 keys. Northgate's "extra" keys do not do anything new, they just duplicate keys that already exist, but in different (and more convenient) locations. Thus Northgate hopes to please both those seeking convenience, and those looking for a familiar layout with better performance.

Some of the layout features of the *OmniKey/102* are disconcerting at first. The original-style numeric keypad is farther to the right than we were accustomed to, making it necessary for us to peer in that direction to make sure our fingers were in the right place. The *ESC* key is found at the upper left, a position it frequently assumed in pre-IBM days. It took us a while to reaccustom ourselves to looking for it there, but finding it soon became second nature. There are also two *CONTROL* keys—one in its customary position to the left of the *A* and the other down below the right-hand *SHIFT* key. That arrangement could make using *WordStar* into a both-hands-at-once operation and really speed things up! (Northgate tells us that they will soon be releasing an *OmniKey/Plus* keyboard. There will be some slight rearrangement of key positions, as well as the inclusion of a second *ALT* key at the right. With that addition, *XyWrite* and *Word* users will also be able to become "two-fisted" typists.)

We found very little about the revised layout upsetting, with one exception. The *CAPS LOCK* and *TILDE/BACK-APOSTROPHE* keys are situated right off the ends of the space bar. While the layout of the Northgate keyboard seems to contribute to good typing practice (such as keeping the fingers arched over the keys), we were still slovenly enough to find our palms occa-

(Continued on page 8)



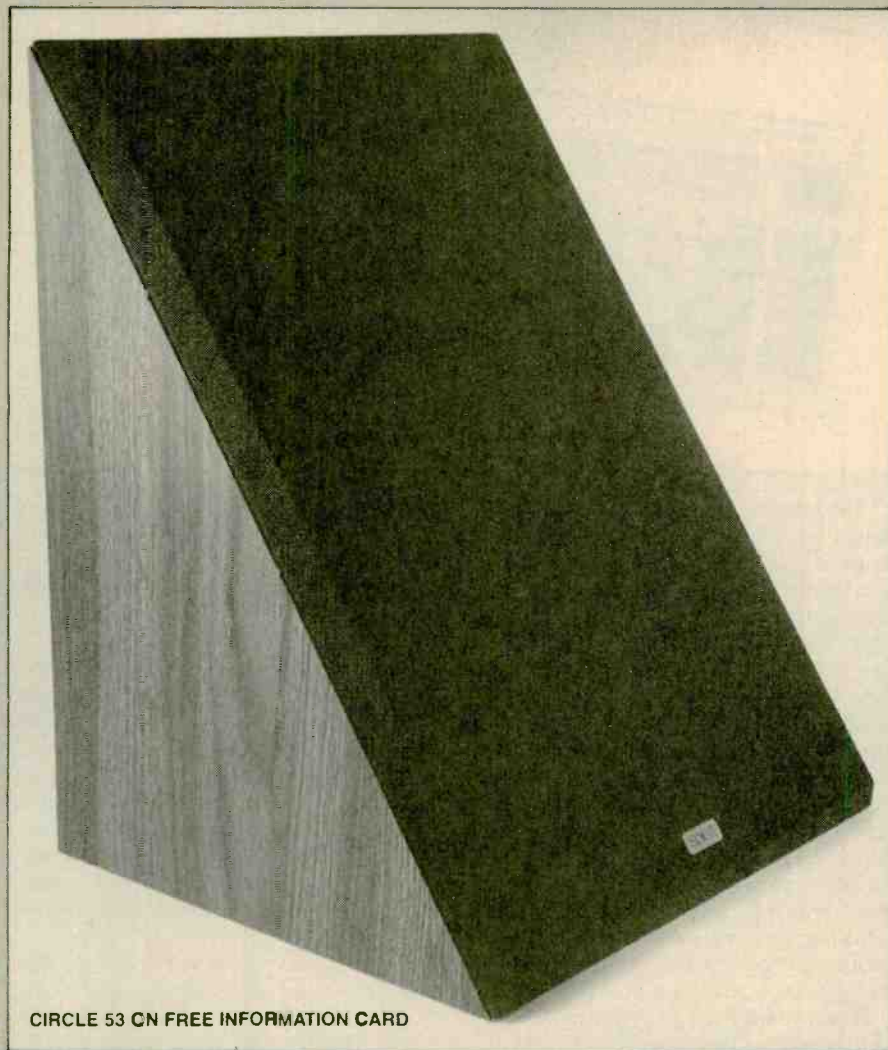

CIRCLE 53 ON FREE INFORMATION CARD

## The Spica That Came in from the Cold

**SPICA TC-50 LOUDSPEAKER.** Manufactured by Spica, 1601 Paseo de Peralta, Santa Fe, NM 87501. Price: \$550.00.

We heard our first pair of *Spica TC-50* loudspeakers late one night in a chilly walk-up apartment in Philadelphia. Despite the hour and circumstances (don't get us wrong, though, we like Philadelphia) we were impressed. And, having now had the opportunity to live with a pair of TC-50's ourselves for a while, we can happily report that we're still impressed, and tell you more about these small wonders.

The Spica (pronounced to rhyme with "mica") TC-50 is small—what some might term a "mini speaker." Its solidly built, wedge-shaped enclosure measures 13 (W) by 15½ (H) by 11½ (D) inches, small enough for almost any listening en-

vironment. Each unit weighs 20 pounds. An easily removable black grille cloth covers a sloping front that is angled to provide optimum high-frequency dispersion. Its impedance is four ohms. The designer of the Spica line, John Bau, has done extensive research into the behavior of two-way speaker systems (which is what the TC-50 is). The drivers consist of a 6½-inch woofer and a 1-inch dome-type tweeter. The sound belies the apparent simplicity of the design.

TC-50's, which are sold in pairs, arrive in a single, nearly cubical box. Inside, the two wedges are packed face-to-face. The instructions that come with the speakers are well detailed, and provide many suggestions for setting up the speakers to get the most out of them in your particular listening environment.

Except for some slight awkwardness that may, perhaps, be experienced by fat-fingered installers in connecting cable from their amplifiers to the speakers' recessed binding posts, installation presents no problem.

Included in the setup instructions is a section on Mr. Bau's theory that, like automobiles, loudspeakers require a break-in period. And, considering that at their heart

speakers can be considered a kind of piston/cylinder mechanism, he does seem to have a point. Mr. Bau suggests that over an initial period of eight hours or so the sound from the TC-50's will improve, becoming smoother and more natural. Our experience bears that out. Our brand new TC-50's did not have quite the fine qualities of a pair of broken-in ones we had auditioned previously, but after several days of intermittent listening it was apparent that they were well on their way to "maturing" into providing the kind of sound we had expected.

Listening to the TC-50's is a delight. It should be the goal of every speaker designer to make the speakers "disappear" from the listening room—to make them so transparent that the sound seems to come from the air between and behind them where the instruments or vocalists would be in a live performance, rather than being referenced to this or that speaker. That's what the Spicas do—they seem to vanish and let the music speak for itself.

That air of transparency is the result of extensive computation and work in designing a crossover network that would allow the woofer and tweeter in the system to work together in perfect harmony, as it were. Spica claims that phase relationships in the midrange frequencies are maintained to within 15 degrees. To the uninitiated that might not sound like much (15 is still an appreciable part of 360, a bit over 4%) but in the world of speaker design that small degree of error represents a significant accomplishment.

The lack of phase distortion shows in the way the Spicas image instruments and vocalists. It is easy to pinpoint the source of a particular instrument or of a singer, speaker, or portion of a chorus. And the location never wavers—if the recorded source stays in one place, so does its apparent origin on the soundstage created by the speakers. A particular instrument is always heard from the same location, from passage to passage, and from listening session to listening session. Again, if you don't think this is something to brag about, see how your own speakers perform in that regard!

The Spica design also results in reproduction of a remarkably solid sonic image. Instruments seem not to be located simply between the speakers, but also some distance behind them on an imaginary soundstage. Those qualities make listening to the TC-50's an effortless and truly enjoyable experience. You can relax and, without strain, let the music caress your ears.

Despite this glowing report, the Spica TC-50 is not for everyone. A speaker this size can move only so much air, and there are certain types of music that are simply beyond it. If you listen only to loud, loud "hard-punk-acid" rock, TC-50's are not for you.

*(Continued on page 8)*



# Caught up in a Whirlwind

TORNADO DBMS. Produced by Micro Logic, P.O. Box 174, Hackensack, NJ 07602. Price: \$99.95.

When personal computers first made their appearance about a dozen years ago, one of the first uses envisioned for them was as a method of storing and retrieving all those little pieces of information that were too much trouble to otherwise write down and keep track of, and that certainly were too much trouble to try to remember. Alas, the programs that would do that sort of thing were slow in coming, and when they did arrive, they were not exactly what was expected.

People who expected to be able to toss their thoughts into the computer any which way, and have them returned on demand all neatly laundered and ironed, were sorely disappointed. The programs didn't work that way. They were very highly structured, and you could enter information only in specific ways and according to very strict rules. Even the *types* of information that you were permitted to enter were constrained by the structure of the DBMS (Database Management System—in other words, the program) that you used.

One of the first programs to break out of the mold and to make an attempt at managing a free-form database was one called *WHATSIT*, which stood for "Wow, How'd All That Stuff [Get] In There." *WHATSIT* required you to present your data in the form of simple sentences, such as, "Ivan's wife is Katherine." You could have the program retrieve for you all it knew about Ivan, about Katherine, or about wives. It wasn't great, but it was a start. (*WHATSIT* was also cute, beginning each response with something like, "Got it!" That did not endear it to business users.)

Later there was a program called *SeekEasy*, which allowed a bit more flexibility. Entries could consist of anything you could fit on two 80-column lines. *SeekEasy* would search its records for the key word or words you typed in and displayed everything that matched. Also, through what its creators termed an "heuristic programming accident," the program would also bring up near matches, so even if you misspelled the search key, there was a good chance of the program's locating what you had been looking for. *SeekEasy* was nice, but its two-line limit was restrictive. So was the fact that when you wanted to use it (in the middle of writing a letter on your word processor, for example) you had to exit from that other program, start up *SeekEasy*, and then restart the first one again after you'd found what you wanted.

Welcome to

# TORNADO™

---

Corp. (C) 1986,87,88 by Micro Logic Corp.  Press Alt-J  
POB 174, Hackensack, NJ 07602 USA to activate

---

Orders only: 800-342-5930 Support: 201-342-6518 Modem: 201-342-8101

---

Schedule meeting with supervisors for next Wednesday.	Harry 555-4422	Mr. Client (999) 555-2122 123 Main St. Your Town, USA 98765
---	----------------	--

---

MAIN m Windows f 3c 32t 1p 916s 1-30-89 5:06p Ser#040355 INS

CIRCLE 54 ON FREE INFORMATION CARD

On the other hand, there were big-time DBMS's such as *dBASE*, but those for the most part had the rigid structure of big mainframe database-management software. They were very powerful, but not very friendly or forgiving.

The latest entry on the free-form DBMS scene is a program called *Tornado*, from *Micro Logic Corporation*. *Tornado* is a free-form database management system with a number of refinements. While it is far from being a big-league program that can prepare detailed reports all by itself, it is the best of the free-form variety that we have seen so far.

*Tornado* works like a pile of notes on your desk. In fact, the name the manual assigns to collections of data is "piles." Each note in a pile (one entry, or record, in other words) appears on screen in a window, with the "topmost" note highlighted. You can arrange the notes according to their importance to you, so that the most important is on top and the least so is buried on the bottom. When you ask the program to search for a key word or phrase, it will bring up a number of windows on the screen. Sometimes the windows will overlap, and by using the down- or up-arrow cursor-control keys, you can leaf through the pile of notes. The *PGUP* and *PGDN* keys permit you to move through the notes more quickly, a screen at a time.

*Tornado* is a *TSR* (Terminate-and-Stay-Resident) program, which means that through the use of a "hot key" you can relegate it to the background while running another program in the foreground. Another touch of the hot key brings *Tornado* up front when you need it. That is great when you're writing a letter (or a *GIZMO* review) and need a little piece of information such as a name or address that you'd filed away for just that purpose. Also, since the program is memory-resident and doesn't have to keep looking for things on your disk drive, it is *fast*.

*Tornado* seems to have been created by a former CP/M programmer. For those of you unfamiliar with CP/M, it is an operat-

ing system that was the MS-DOS of its day (in fact, much of MS-DOS is derived from CP/M), when 8-bit computers were king, and memory size—for programs and data—was limited to 64K. Programs were written "tight" and it helped if, when you used a program, you were able to think like a programmer. Lots of special features often were available to you, if you knew how to access them. *Tornado* is like that—it can be customized in any number of ways if you want to take the trouble to do so; otherwise you can use it pretty much as it comes off the disk. There are several levels of customization, allowing you to set such things as screen colors, the maximum number of windows permitted on screen at one time, and whether the "help" information—there are two levels of on-screen help as well as a detailed manual—will stay in one place or appear on screen on a space-available basis, wherever it will fit.

Besides allowing you to search for items in the straightforward manner you would expect, *Tornado* can also be instructed to *Get* data matching several different keys (for instance, all the notes on elephants, plus all those on llamas): to *Keep* only certain matches (Get all the animals, but Keep only the llamas); or to *Return* a certain class to the main pile (Get all the animals, but Return the elephants) getting them out of your way.

You can, of course, direct the output of *Tornado* to your printer, as well as command the program to print the contents of a specific window. And you can transfer data from a window to a foreground program such as a word processor, or from the foreground to a *Tornado* window. You can also move data to and from disk files.

*Tornado* allows you to maintain a number of different piles (one for each letter of the alphabet, for the digits 0 through 9, and piles for special forms as well). That means that you can maintain several entirely different databases. Keeping them small makes maintenance sim-

(Continued on page 7)





CIRCLE 55 ON FREE INFORMATION CARD

## Wizard of Giz

**WIZARD OZ-7000 ELECTRONIC ORGANIZER.** Sharp Electronics Corporation, Sharp Plaza, Mahwah, NJ 07430. Price: \$299.

A pocket organizer used to consist of a pad in a leather case, with a ball-point pen, and maybe a two- or three-year calendar already halfway out of date. The really fancy ones also had personal phone directories with little alphabetizing tabs on the pages. Youngsters would get them as gifts from distant relatives upon graduation from sixth grade, and the perpetually disorganized, in the throes of *this-year-I'll-get-organized* resolutions, tended to buy them each January. In this age of electronic miniaturization, things certainly have changed. Sharp Electronics' Wizard electronic organizer, Model OZ-7000 bears about as much resemblance to the pocket organizers we used to bury in our closets as does an *X-Men* comic book to *The Brothers Karamazov*. The Wizard is an electronic Swiss army knife for yuppies. The device, which is about the size of a thin paperback book, has built-in functions for time (local and world clocks) and

date (calendars for 1901-2099), along with a 10-function calculator, a personal telephone and address directory, a memo pad, and a schedule organizer with alarms. As the advertisements say, "You've come a long way, Baby!"

In addition to the built-in programming that keeps track of all your information, the Wizard contains 32K of RAM in which to store it. By comparison, the Apollo Guidance Computer (that's the computer aboard the Apollo Lunar Lander) had only 38K of memory, of which only a scant 2K was RAM. "Big deal!" you may very well say. "Mine has that much memory, too." Well, we're not done yet. Remove one small cover and a little card-edge connector is exposed—its purpose is to connect the Wizard to an accessory printer or cassette recorder for more permanent storage of records than the Wizard itself provides. Remove another cover, just slightly larger, and a miniature 15-pin connector (mating connectors with cables attached are available from Sharp) reveals itself. This is for connecting the Wizard to the serial port of an IBM PC-type computer. Although we did not get to try it, software should be available by the time you read this that will allow you (or your secretary) to use the computer with its full-size keyboard to enter scheduling or other infor-

mation and then download it to the Wizard so you can take it with you.

And wait—there's more. The Wizard can be taught new tricks. Beneath the organizer's LCD screen (which can display information using either large or small letters, depending on whether you are more concerned with legibility or with showing as much as possible at once) is a cavity into which you can insert little ROM cartridges that add special functions such as that of an eight-language translator or a 42,000-word dictionary/spell-checker/thesaurus. Those ROM cartridges measure only 2½ by 3¾ inches and are about as thick as a nickel. Sharp informs us that an accessory 32K RAM module, for those of us with *lots* of phone numbers to keep track of, will soon be available to plug in here. The transparent face of the cartridge compartment is actually a touch screen. By touching the ROM cartridge at labeled points, you can call up functions (such as the thesaurus) that are not available from the built-in keyboard on the right.

Well, after all that hype, what's it like to use the Wizard? We were a little leery of it at first—we don't take well to being organized and prefer to make our notes on index cards. (Maybe if Sharp were to have called it something less threatening than "organizer" we would have been more receptive.) Furthermore, we were not encouraged when we discovered that we had a hard time opening the unit, which is hinged so it opens like a book, only backwards, from back to front. And the latch release, at least to our hands, was in an unusual position—we kept having trouble finding it.

Finally, the device's cramped keyboard—with its pee-wee keys arranged in alphabetical, not "Q-W-E-R-T-Y," order—reminded us of something we couldn't quite put our finger on, but knew that we didn't really want to recall. Eventually we remembered that several years ago there had been a series of pocket computers manufactured and—not-too-successfully—marketed by, of all people, Sharp (as well as by Radio Shack under their own label). They, too, had those minuscule hunt-and-poke keyboards.

We overcame our initial reluctance to use the Wizard and, after getting it open, turning it on, and setting the time and date, began to put stuff into it. Lo and behold, we almost started to like being organized, and even began to depend on the unit a little. It was convenient to have all that stuff in one place—the time and date, a calculator, an automatic reminder that we had an appointment to keep at 4:30, and so on. We can't say that it became indispensable to our daily lives, but we did become quite fond of the Wizard.

The Wizard is not perfect. The thesaurus/dictionary module—to get more on the screen, we suppose—allows words to

*(Continued on page 8)*



## Lullaby of Boardwalk

**THE SHARPER IMAGE SOUND SOOTHER 2 CLOCK RADIO.** The Sharper Image, 650 Davis Street, San Francisco, CA 94111. Price: \$89.

We've always wondered about those clock radios that are supposed to lull you to sleep with the sounds of surf pounding on the beach, gentle spring rainstorms, waterfalls, and the like. When our *Sound Soother 2* clock radio arrived from *The Sharper Image*, we couldn't wait to hit the sack and try it out. Here's what happened:

**10:00 PM:** Got into bed and turned on the "waves." Sounded quite realistic. Visualized surf crashing against the shore. Saw line of seaweed washed up at high-water mark. Smelled rotting seaweed. Tasted mouthful of gritty salt water ...

**10:18 PM:** Still awake. Surf's still crashing. Notice dead fish being washed up the beach and back down by waves, moonlight glittering from its belly as it turns ... Start wondering—where do fish go to the bathroom? What does it smell like to them? What does feel like to drown ...

**10:32 PM:** Maybe surf's not for us. Let's try "gentle rain." Nice, but kind of monotonous. Sounds sort of like the noise you hear after a TV station has gone off the air for the night. Picture of little Heather O'Rourke in her nightgown comes to mind, her face illuminated by the flickering electronic snow on the screen of the Sony as she turns to look out into the camera and coo, "They're h-e-e-e-re ..."

**10:48 PM:** Turn off the "soother" and tune to our favorite station. Much better. Good thing Sharper Image put a radio in their clock radio!

**10:52 PM:** Up comes a really irritating piece of music. Should we go back to the surf? No, we'll try another station. Turn on RADIO function so we can see the dial. Find station, turn off dial light, and reset sleep timer. Hey, what's this button over here? Oh, the snooze alarm. Now how do we turn the radio back on ...?

**11:40 PM (Or thereabouts):** Finally fall asleep.

Well, sometimes the magic works, and sometimes the magic doesn't work. Maybe we weren't meant to be soothed—something with a little more spirit seems to do the job for us. Perhaps, though, that sort of thing will work better for you than it did for me.

How does the Sound Soother 2 work? Of course, there's no rainstorm being broadcast over the air, nor is there one taking place inside the radio. Nor will you find a miniature beach with tiny little combers breaking on it if you open up the case. The rain and surf sounds are a form of "white noise." (So is the TV set's after-



CIRCLE 56 ON FREE INFORMATION CARD

hours hiss—see "10 32 PM," above—come to think of it.) White noise consists of a random distribution of sounds from all over the audible spectrum. The higher the frequency of the sound, the more energy it contains. A similar type of noise, called "pink noise," also consists of sounds from across the spectrum, but with the sound from each frequency containing the same amount of energy as all the others. It is "warmer" in quality than white noise.

A popular source of white noise is a device called a Zener diode, which is probably what the Sound Soother 2 uses. The output of the diode, after being amplified several hundred thousand times, can be passed through a simple audio filter and an electronic volume control to simulate the variations in sound intensity as the surf comes in, or left alone to sound somewhat like a constantly falling rain. In the latter case, emphasizing the lower frequencies makes the rain sound heavier.

While we had no luck with the Sound Soother 2 as a tranquilizer, as a clock radio it performed nicely. The sound is adequate and there is a tone control, which also works to modify the character of the wave and rain sounds somewhat.

The Sound Soother 2 includes several features (in addition to the white-noise generator) not normally found in clock radios. The first is an audio-input jack. You can use the radio's amplifier and speaker to reproduce material from, say, a cassette recorder—not a bad idea if all the radio stations where you live go off the air at 11:30 P.M. or so. Of course, the recorder will have to have some auto-turn-off feature of its own since the radio will not take care of that for you.

The next extra is a speaker-output jack, which presumably enables you to listen to the rain and surf with greater fidelity than the radio can provide through its own speaker. However, since the instructions for the radio did not include explicit instructions for preparing a cable to plug into this jack, we did not try it.

Finally, for those who can't get enough

of a good thing (or who maybe want to throw a beach party in the middle of February ... indoors) the output of the radio, including the "soother" section, can be fed to the line input of a larger audio system. That, we had to try. Fortunately there is a provision for a nine-volt backup battery to keep the clock running in the event of a power failure, so when we moved the radio from the bedroom to the living room we didn't lose anything more than a few minutes of our own time. Playing the surf sound through our large sound system, which includes a sometimes overzealous subwoofer, the results were spectacular. A little artificial sounding, perhaps, but spectacular nonetheless. C'mon, everybody, into bed—surf's up! ■

## TORNADO DBMS

(Continued from page 5)

pler and speeds up things in general and searches in particular, since not as many spurious entries will be turned up.

One of the things you can do with Tornado is to create forms to be filled in and filed away ... and recalled, of course. Telephone-message forms are one example given in the manual, order blanks are another. In a way, it can act like a more conventional DBMS, where information is arranged in strictly organized records and fields. That is a very useful feature to have.

Tornado is not the be-all and end-all of database-management systems. It does not have all the fancy search-and-sort capabilities of its bigger and more expensive brethren, nor can it output the result of its searches in any form more complicated than what appears on the screen. However, as a receptacle into which information can be tossed on the spur of the moment, to be retrieved as needed, Tornado is hard to beat. About the only thing better would be being able to enter information into your database without having to turn the computer on at all. ■



## SUPER DUPER

(Continued from page 1)

also uses the digital memory to store and display the frozen image.

As if that weren't enough, you can "strobe" the video so that it appears as a series of still pictures at  $\frac{1}{6}$ -,  $\frac{1}{3}$ -, or  $\frac{1}{2}$ -second intervals. You've undoubtedly seen that effect in sports broadcasts, commercials, or music videos—and, as far as we're concerned, a little goes a long, long way. For those who can't get enough of it, though, a multi-strobe function allows you to display strobed video as a series of pop-ons in a three-by-three array. By pressing the MULTI STROBE button a second time you can select one of the nine pictures to be the "live" one, while the others remain frozen. You can also view still images of what's happening on all the TV channels that the tuner is set to receive.

Finally, all that memory, together with some clever programming, makes possible a form of digital noise reduction. Operated in one of its three digital noise-reduction modes, the VCR "improves" noisy (snowy or otherwise imperfect) pictures by a technique known as line averaging. It compares the current line of video information with the previous one(s), and what it displays is a line combining what it thinks are the best features of both. When operated in its most extreme noise-reduction mode, the unit gets so busy and wrapped up in itself that it sometimes appears to forget what's happening on-screen, and a kind of ghosting appears in which images may smear or exhibit other persistence-of-vision effects.

Our main criticisms of this unit have to do with its remote control and the orange-colored display on the VCR itself. The control, with its plethora of buttons, is difficult enough to operate. But under normal lighting conditions for viewing TV, its gray-on-gray labels can be impossible to make out except at very close range or with a flashlight. And, while some of the deck's functions include an easily legible on-screen display (showing tape timing, record-programming, channel selection, and other information), the only confirmation available for the operation of other functions is the tiny—and dim—display on the VCR itself.

We're somewhat at a loss to figure out just what any one person would want with all the features included with the VH-930SD, unless he were inclined to set up his own video-production company, perhaps. Our best guess as to why they are all there is that, with all that RAM available, some engineer was set the task of figuring out "what *else* he could do with it." The VH-930SD does what it does simply because it *can*! Pioneer may not sell a lot of these VCR's, but whoever buys one is going to get an awful lot for his money. ■

## TYPE RIGHT

(Continued from page 3)

sionally resting on, and depressing those keys. It took a while to figure out how all those "" were creeping into our words (we thought at first that maybe the keyboard was defective and generating garbage all by itself), but we finally found the problem. Anyway, that's what spelling checkers are for, right?

We experienced no difficulty in setting up the keyboard (a matter of turning the computer off and plugging it in) or in using it. You have to set a switch on the bottom of the keyboard to the A or X position, depending on whether you're using it with an AT- or XT-type computer. The instructions don't explain that too clearly, but it shouldn't be too hard to figure out.

When we powered up our system and it performed its POST (Power-On Self Test), we received a "Keyboard Error" message on the screen. After that initial protest, however, everything worked normally, so now we just ignore the message when it appears. Northgate also includes a warning that the keyboard may occasionally "get out of sync" with some XT-type systems, but we suspect that the problem arises only with some early IBM units. The Omnikey/102 worked just fine with our clone. We like it. ■

## SPICA SPEAKERS

(Continued from page 4)

Similarly, if your listening consists mainly of massive orchestral works, Beethoven symphonies and the like, the TC-50's are not going to be able to keep up with the demands made on them in terms of the volume of the music and the "bottom end" required. Our listening tastes tend toward the classical and, at first, we found the sound of the TC-50's disappointing on big orchestral works. The addition of an inexpensive subwoofer to the system fixed that, though. Now the subwoofer takes care of the really low frequencies, giving the music the "bottom" that it lacked with the TC-50's alone, and the Spicas take care of the rest. Shifting some of the work to the subwoofer also relieves the TC-50's of having to do it all and makes them sound less strained.

Where the TC-50's really shine is in reproducing music performed by small groups—jazz, chamber music, classical guitar, and solo performances both instrumental and vocal. Each musical voice is reproduced faithfully both in sound and in position, and if you close your eyes you can easily imagine the soundstage extending into a dimension beyond the physical boundaries set by the speakers. What a pleasure it is. The Spica TC-50 has qualities that would be difficult to find in many systems at three times the price. ■

## WIZARD OF GIZ

(Continued from page 6)

run all the way to the end of a line and then break, unhyphenated, wherever they may. That is a little disconcerting at first, but you get used to it in the name of convenience. More serious, perhaps, is the fact that the thesaurus/dictionary, which is based on Houghton Mifflin's *The American Heritage Dictionary* and *Roget's II: The New Thesaurus* does not recognize some words ... such as "thesaurus." (To be fair, it does *recognize* it, and knows how it's spelled, but it can't define it.) Well, what do you want from something with a volume of just over 1½ cubic inches? Oh yes, you can use the thesaurus dictionary not just for reference, but also to look up and correct words over in the memo, schedule, and telephone sections of the organizer.

The 8-language translator IC card we tried out would be useful to the sort of person who requires an electronic organizer that can tell him what time it is in more than 200 cities around the world. The translator handles English (American and British), French, German, Italian, Spanish (European and Latin American), Swedish, Japanese, and Chinese—and it does so at least as well as most pocket phrase books.

The translator knows about 450 sentences and 760 words in each language and can work either way—from English, say, to Swedish, or from Swedish to English. And, while it can't translate Chinese or Japanese into any of the others, it can display words translated into those languages either in their native alphabets or phonetically in the Roman alphabet, to aid pronunciation.

Getting around in the translator is a bit awkward at first—you have to scroll through lists of words or sentences to find what you want to translate. (Fortunately, those lists are usually subdivided into categories that you can get to quickly.) Once you know where things are, you can find what you want pretty quickly. Also, the vocabulary seems to be oriented toward Western civilization. For instance, if you found yourself and your Wizard at a 7-course dinner in Beijing, you'd be able to ask for a knife, fork, or spoon, but not for chopsticks. Similarly, you'd have a tough time ordering spring rolls, although you'd be able to try asking for a T-bone steak (*ding zi gu niu pai*). Although some of the sentence translations are not quite on the mark, they will undoubtedly get your point across.

In short, we were pleasantly surprised by the Wizard and the accessory IC cards for it that we looked at. Much as we were prepared to resist it, we found ourselves regarding it as a very useful, if not indispensable, implement for making a busy life a little easier. ■



For more information on any product in this section, circle the appropriate number on the Free Information Card.

# ELECTRONICS WISH LIST

## Portable Sound System

For consumers who like a choice of musical formats, the *Portable CD Player (4955)* from *Soundesign* (400 Plaza Two, Jersey City, NJ 07311) incorporates a compact-disc player, a dual cassette deck, and an AM/FM radio in one unit. The front-loading CD player uses three-beam, one-laser pick-up for stable tracking, and a six-digit LCD shows track number, total time, time remaining, program number, pause, and repeat. Various taping options are offered on the cassette decks, and you can record off the radio or the CD player. The AM/FM radio can be adjusted with slide controls, and an auto frequency control gives better FM reception. "Extra Bass Sound" provides dynamic quality through 4-inch woofers and piezo tweeters. Price: \$229.95.

CIRCLE 57 ON FREE INFORMATION CARD

## Child's Computer

Bring your youngster into the computer age with the *Precomputer (1000)* available from *The Sharper Image* (650 Davis St., San Francisco, CA 94111). This friendly machine is recommended for children 9 years old and up and uses 9 example programs to introduce the user to BASIC programming. It has a 2K memory that stores practice problems. A math tutor offers five math activities and another tutor quizzes the user in history, geography, science, and general knowledge. It also has a built-in touch-typing course, two speed-typing drills, a four-function calculator, and two games—Hangman and Word Scramble. Price: \$99.

CIRCLE 58 ON FREE INFORMATION CARD

## Recipe-Conversation Calculator

Both those who know their way around a kitchen and those who don't will appreciate the *Kitchen Whiz (SII)* from *Seiko Instruments USA Inc.* (2990 West Lomita Blvd., Torrance, CA 90505). It offers a quick and easy way to enlarge or reduce recipe portions, control meal servings, and translate metric measurements. The Kitchen Whiz also converts cooking time for roasts and game, and acts as a food-preparation timer, a temperature converter, a clock, and a mathematical calculator. Price: \$59.95.

CIRCLE 59 ON FREE INFORMATION CARD

## Telephone Handset Cord

The *Fun Phone Cords* from *Fun Products* (24211 Fulton St., Berkeley, CA 94704) are available in a variety of styles, colors, prints, and patterns and come in 18- and 25-foot lengths. Manufactured for Fun (which says it's the company that introduced the Swatch watch to the U.S. market) by AT&T, the cord features a "special top coat that provides for better elasticity and longer life." If you don't want to go the cordless route, here's another way to stretch your reach while on the phone. Price: \$7.95-\$9.95.

CIRCLE 60 ON FREE INFORMATION CARD

## Deluxe Headphone

Ever more sophisticated sounds are coming from the headphones of America and this product from *Sony Corporation of America* (Sony Dr., Park Ridge, NJ 07656) takes the trend to its ultimate ... and then some. The *Audio Headphone (MDR-R10)* is a micro-dynamic receiver that combines the latest CAD/CAM technology with a computer-aided design for ideal balance between sound and comfort. This luxury model features specially selected sheepskin earpads and two-century-old Zelkova wood (lightweight but rigid) in the housing. Also, a newly developed bio-cellulose fiber diaphragm—just 2 mm thick but offering 10 times the rigidity of conventional paper-cone materials—is used. Hardly a mass-market item, Sony fabricates the MDR-R10 on a per-order basis. Price: \$4,000.

CIRCLE 61 ON FREE INFORMATION CARD



Soundesign Portable Audio System



Child's Computer



Seiko Instruments Kitchen Whiz



Sony Stereo Headphones



# ELECTRONICS WISH LIST

For more information on any product in this section, circle the appropriate number on the Free Information Card.



GE Cathedral Radio Reproduction

## Cathedral Radio Replica

In 1932, the typical table radio featured a wooden cabinet, weighed 40 pounds, consumed 100 watts of electricity and required a 50 feet of outdoor antenna. They were also beautiful examples of the cabinet maker's craft. Now *General Electric Consumer Electronics* (Thompson Electronic Products, 600 N. Sherman Dr., Indianapolis, IN 46201) has recreated what it calls "the classic living room radio of the '30s," in a 3/4-scaled replica of the *GE J100*, introduced in 1932. The new *Cathedral-Style Radio Reproduction (7-4100J)* features a real-wood cabinet, a cloth grill, and glowing, back-lit dial. Inside, glass vacuum tubes have given way to integrated AM/FM circuitry, a high-performance chassis, high-sensitivity speaker, and a 700-mW RMS audio output. The volume control boosts bass response at lower listening levels. Price: \$76.95

CIRCLE 62 ON FREE INFORMATION CARD



Eurotel Parisienne Telephone

## European-Design Telephone

The *Parisienne Telephone* from *Eurotel* (25500 Hawthorne Blvd., Suite 1150, Torrance, CA 90505) has won two of France's more prestigious design awards. Manufactured in Europe, the *Parisienne* features a lightweight, curved handset, shaped to fit easily in the user's hand or comfortably between ear and shoulder. One of several models from Eurotel, the instrument is available in glossy red and black or in solid white. Features include alphanumeric keypad, flash button, automatic redial, pulse/tone switch, and ringer-volume control. Hearing-aid compatible, the *Parisienne* can be wall-mounted, although it "provides a stunning tabletop silhouette." Price: \$139.95

CIRCLE 63 ON FREE INFORMATION CARD



Etch-A-Sketch Animator 2000

## Etch-A-Sketch Animator 2000

An old friend from many childhoods has updated itself right into the consumer-electronics era. The new *Etch-A-Sketch Animator 2000* from the *Ohio Art Co.* (P.O. Box 111, Bryan, OH 43506), described as an "ingenious lap-top drawing and animation system," uses a stylus and touch pad instead of its predecessor's knobs. With 30 computer-aided drawing functions, 22 drawing screens, and up to 99 frames of animation at eight different forward and reverse speeds, the *Animator 2000* has 196,000 bits of memory which can be stored in an optional 8K memory cartridge. Ohio Art also offers a trio of game cartridges that transform the drawing toy into a game system. Power is supplied by 6 "AA" batteries. Price: \$149.95.

CIRCLE 64 ON FREE INFORMATION CARD



Timex Surf Watch

## Color LCD Mini-TV

Casio, Inc. (570 Mt. Pleasant Ave., P.O. Box 7000, Dover, NJ 07801), long a leader in the mini-television market, has introduced the new *TV-7500 Color LCD Mini-TV*, which incorporates the company's "high quality (HQ) picture technology." With some 96,000 pixels, the *TV-7500* delivers a clear, quality picture on its 3.3 inch (measured diagonally) screen. Other features include external antenna jack, audio/video jack, earphone jack, and a built-in rod antenna. Price: \$399.95

CIRCLE 65 ON FREE INFORMATION CARD

## Surf Watch

"Life's a beach." Apparently the *Timex Corp.* (P.O. Box 2126, Waterbury, CT 06722) has taken that slogan to its corporate heart; its *K-28 Surf Watch* is designed for life on the beach. Named after a famous surf break in Baja, the *K-28* is equipped with a tiny plastic container, dubbed *Zebug*, for storing zinc oxide or lip balm for protection from the elements as the wearer soaks up sun and surf. The watch features large control buttons, a digital/bar-graph thermometer, and a chronograph. The *K-28* is water resistant to 50 meters. Price: \$65.

CIRCLE 66 ON FREE INFORMATION CARD



For more information on any product in this section, circle the appropriate number on the Free Information Card.

# ELECTRONICS WISH LIST

## Quartz Video Light

Video enthusiasts take note: *Arkon* (11627 Clark St., Suite 101, Arcadia, CA 91006) has introduced an integrated *Quartz Video Light (CL-510)* with the emphasis on flexibility. Instead of building a nickel cadmium battery into the light itself, *Arkon* has placed the power pack into a "sturdy grip bracket that attaches to a camcorder's tripod socket," affording improved stability. The CL-510's 20-watt bulb delivers brightness equivalent to a 50-watt bulb. For further versatility, the light can be detached from the grip bracket and mounted on a standard camcorder shoe mount. The battery will power the light for 210 continuous minutes, and *Arkon* furnishes a battery charger as well as a power cord for use with a car cigarette lighter. The CL-510 weighs just 20 ounces, including its grip power-pack bracket. Price: \$129.95.

CIRCLE 67 ON FREE INFORMATION CARD

## Tuner with RF Attenuator

A reasonably priced AM/FM tuner, the model *TU-460* from *Denon* (222 New Road, Parsippany, NJ 07054) includes an amenity that anyone who lives near powerful radio transmitters will appreciate—an RF attenuator. The attenuator can be switched in as needed to prevent the grating distortion resulting from front-end overload caused by strong signals. Attenuator settings can be "memorized" for all 30 station presets. The tuner has signal-to-noise ratios on a par with much more expensive tuners: 78 dB in stereo, and 82 dB in mono. Other features include a "quick" manual-tuning mode (entered by holding down the tuning switch), one-touch presetting, auto-scan tuning, and the display of the station preset number as well as its frequency. Price: \$240.

CIRCLE 68 ON FREE INFORMATION CARD

## Compact Disc Carry Case

CD's may indeed be compact, but that doesn't mean an accumulation of them can't be difficult to store or tote around. *Case Logic, Inc.* (6930 Winchester Circle, Boulder, CO 80301) offers one answer to the CD-storage quandary with its soft-sided *Compact Disc Carry Case (CD-60)*. A rugged, zippered, nylon outer shell surrounds sturdy plastic trays that organize and store 60 discs individually. Extra-thick foam padding encloses the CD's snugly and helps ensure their safety. The CD-60 is available in black, gray, or a vivid "electric blue." Price: \$39.95.

CIRCLE 69 ON FREE INFORMATION CARD

## Home Electronic Typewriter

We imagine that, if figures were available, a high percentage of typing in the U.S. would turn out to be done at home, especially during the school year. *AEG Olympia Inc.* (3140 Route 22, Box 22, Somerville, NJ 08876-0022) must have reached the same conclusion, as it has introduced a new line of *Home Electronic Typewriters*. The top-of-the-line *XL 512*, aimed at students and home users, features a 10,000-character text memory; 20-character display; and search and document-editing capabilities including store, edit, print, and delete. The XL 512 will also do bold-face typing and underscoring, as well as right-margin justification. Price: \$349.

CIRCLE 70 ON FREE INFORMATION CARD

## Battleship Command Electronic Game

Nothing less than a "new, talking version of that age-old game of strategy on the high seas," *Electronic Talking Battleship Command* offers a full range of sound effects—including exploding missiles, warning sirens, and human voices calling out maneuvers. *Video Technology Industries, Inc.* (400 Anthony Trail, Northbrook, IL 60062), claims that it's "the first battleship game to allow a player to match strategies against either a computer or another human player." The game is suitable for players six years old and up. Price: \$41.

CIRCLE 71 ON FREE INFORMATION CARD



Arkon Quartz Video Light



Case Logic CD Carry Case



AEG Olympia Electronic Typewriter



Video Technology Talking Battleship Command



# ELECTRONICS WISH LIST

For more information on any product in this section, circle the appropriate number on the Free Information Card.



Sima SoundMixer

## Stereo Sound Mixer for VCR's

You can add a new audio dimension to your videotape productions with the *Stereo SoundMixer* from *Sima Products Corporation* (8707 North Skokie Boulevard, Skokie, IL 60077). The unit allows videomakers to add narration and background music in stereo to their home productions if they have a stereo VCR and television or monitor. (According to Sima, it can be used to create a stereo videotape even if the camcorder involved is mono.) In copying videos, the *Stereo SoundMixer* is connected between the camcorder or VCR playing the tape and the one recording it. As the video signal is transferred, modifications can be made in it, including changes in volume. If you aren't satisfied with the results, you can do it over, since the original videotape remains unaffected. You can add music, narrations, or sound effects from a source such as a stereo-tape deck, or from two high-fidelity omnidirectional microphones that are included with the mixer. During the sound-mixing process, a television set acts as the monitor, allowing the narration and music to be matched to the video portion of your program. The mixer features sliding volume-level controls for controlling original soundtrack, narration, and background-music input levels. It can also be used to enhance the soundtracks of videos when using a monophonic VCR, but the result will be in mono. Price: \$99.95.

CIRCLE 72 ON FREE INFORMATION CARD



Bondwell Mouse

## Rapid Mouse

If you're looking for a little "something extra" from a mouse, *Bondwell Industrial Co., Inc.* (47845 Seabridge Drive, Fremont, CA 94538) offers its *QuickShot QS-125 Rapid Mouse*, an ultra-high-speed controller for IBM PC-compatible computers. According to Bondwell, it is the only controller to incorporate FINE MOVE and TURBO MOVE mode buttons, in addition to three "standard" mouse-command buttons. The *Rapid Mouse* features a tracking speed of 195 millimeters per second, with a resolution of 200 dots per inch. The mouse works with IBM PC-, XT-, AT-, and PS/2-compatible computers, and comes with both DB-9 and DB-25 serial-port connectors. Price: About \$60.

CIRCLE 73 ON FREE INFORMATION CARD



JBL Overhead Video Projector

## Ceiling-Mount Video Projector

If you're planning to build or renovate a "media room" you'll be interested in looking into the *JBL Model 6850* ceiling-mount video projector from *Harman Electronics Inc.* (8400 Balboa Blvd., Northridge, CA 91325). High-brightness, liquid-cooled CRT's provide a light output rated at 515 lumens peak white. The model 6850 provides a wide range of inputs and outputs, including an "S" input connector for use with S-VHS, ED-Beta, and HiBand 8mm. Along with fixed-level audio outputs, a variable-level audio output lets you remotely control the volume level of an external audio-amplifier feed. The unit features a 178-channel, cable-compatible tuner with wireless remote control; on-screen graphics; MTS and SAP audio; and a 10-watt-per-channel stereo amplifier. There is also a 12-volt output that can be used to power a relay that automatically lowers or raises an electric screen when the projector is turned on or off. The device may be used for front or rear projection, and can optionally be floor-mounted. Price: \$6495.

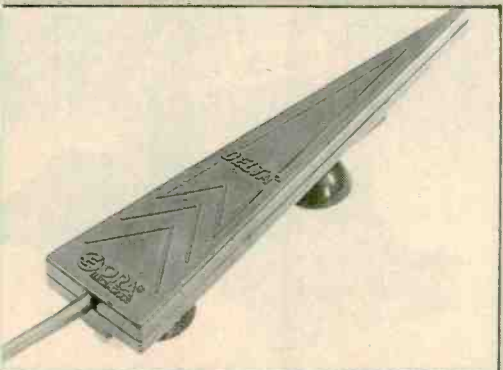

ORA Cellular-Phone Antenna

## Cellular Antenna

A unique cellular antenna, known as the *Delta model CMS808*, is now being marketed by *ORA Electronics* (20120 Plummer Street, Chatsworth, CA 91313). The antenna, which boasts an "aerospace" design, is intended for temporary installation on glass surfaces *inside* a vehicle. It attaches to the glass by means of detachable rubber suction cups. The antenna—for use with mobile, portable, and transportable cellular telephones—comes with six feet of low-loss RG-58 cable with a TNC connector, and double-sided tape for more permanent installations. Price: \$31.95.

CIRCLE 74 ON FREE INFORMATION CARD





BY  
ROBERT ANGUS

# THE HDTV REVOLUTION

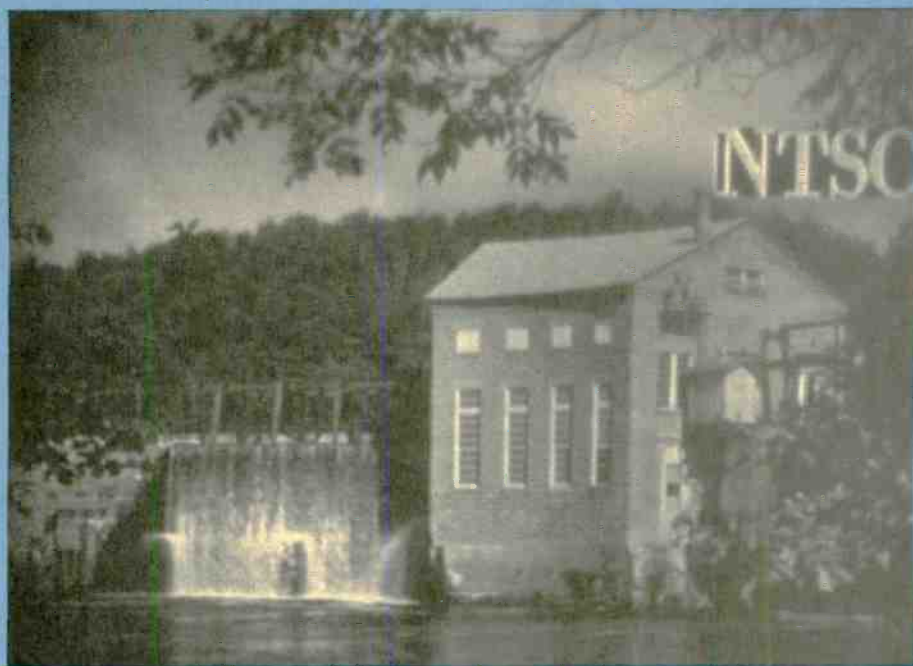

*High-definition TV is coming, and nothing—including politics—is going to stop it. When will HDTV get here, how will it effect the TV sets we now own and use, how much better will be the images it displays, and how much might it cost? Read on and find out!*

**T**he hottest topic in Washington these days isn't taxes, balancing the budget, or fighting drugs. HDTV—High Definition Television—has the Departments of Commerce and Defense fighting over who's going to be responsible for it. A Pennsylvania Congressman wants to spend half a million dollars on it while a variety of government agencies argue about how to regulate it.

HDTV, in case you haven't heard, is the most dramatic thing to happen to television since the introduction of color more than a quarter of a century ago.

It's a picture one-third wider and twice as sharp as those you're used to, with stereo sound comparable to that from a compact disc. And it's on the way.

Japan's government-owned NHK TV network has been working on HDTV since 1970. Sometime later this year, they're going to launch it commercially, using satellites to deliver signals to more than one million homes already equipped with tiny rooftop antennas. Instead of the conventional TV picture width-to-height ratio of 4:3, NHK's MUSE system uses a band-compression technique to deliver pictures with a width-

to-height ratio of 16:9, or roughly one-third wider, comparable to the dimensions of a movie theater screen.

**Improving Definition.** TV pictures are made up of hundreds of parallel lines—525 so-called scan lines in the case of normal North American NTSC television. In fact, however, most TV sets deliver only about 330 lines. Standard VCR's produce even less—about 200—while Super VHS (S-VHS) increases the horizontal resolution (actually a more accurate indicator of picture quality than scan lines) to about 430. By com-



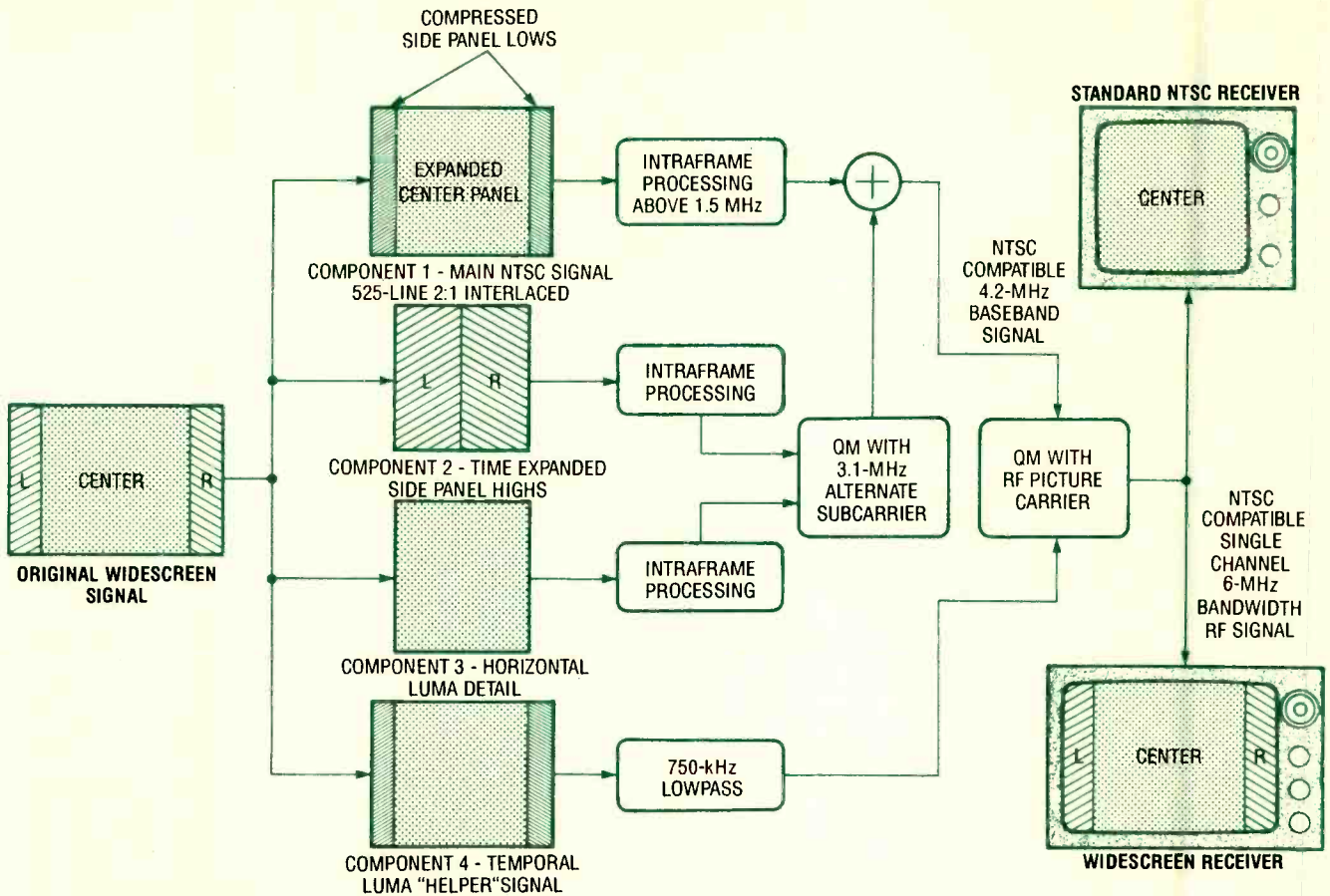

Fig. 1. The Advanced Compatible Television System (ACTV) uses complex signal processing to deliver HDTV signals to suitable sets while retaining full NTSC compatibility.

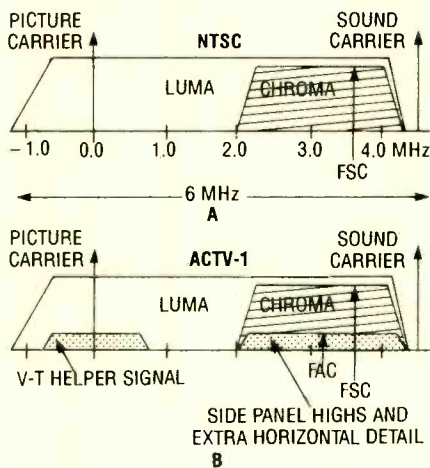

Fig. 2. The composition of an NTSC signal is shown in A. To achieve compatibility, and retain a 6-MHz bandwidth, ACTV-1 (B) modulates a 4.2-MHz baseband signal onto a standard TV signal and a helper signal onto the picture carrier.

parison, HDTV pictures consist of 1050 to 1250 scan lines, depending on the system used, with horizontal resolution in the neighborhood of 625 lines, or roughly double that of present-day TV.

There's more than one way of achieving high-definition TV—at least 19, in

fact, at last count. Some of those are designed for delivery directly to homes by satellite, others are better suited to cable delivery or over-the-air broadcast. In general, those with the best pictures also require extra bandwidth. NHK's original MUSE system, for example, produces pictures comparable to 35mm movie film—but it would require the equivalent of five broadcast channels to transmit (30-MHz). Fortunately, there are less ambitious versions of MUSE, including one that uses just 1½ cable or broadcast channels and another that fits—perhaps uncomfortably—into a single 6-MHz channel.

MUSE is an acronym for *M*ultiple *S*ubNyquist sample *E*ncoding. That refers to the digital bandwidth-compression technique MUSE uses to save valuable spectrum space. MUSE subsamples the 1125-line picture, transmitting every other pixel of every other line in the first field. The missing samples of those lines are transmitted in the next field. The alternate samples of the omitted lines are transmitted in the third field. All thus-far omitted samples are transmitted in the fourth field, and then the process repeats.

NHK has developed three different, lesser versions of MUSE that overcome the wide bandwidth requirements of HDTV, but also deliver lower-levels of image improvement. MUSE-6 is a 6-MHz, NTSC-compatible system that achieves image improvement by inserting high-resolution data into the standard-width signal via MUSE band-compression techniques. It delivers a noticeable, though substantially reduced level of image improvement.

MUSE-9 is a 9-MHz, NTSC-compatible system. In it, additional high-resolution data is transmitted in an additional 3-MHz band. It provides a higher level of image improvement. Narrow Muse is another proposed 6-MHz system. It provides the greatest level of image improvement, although still less than wide-bandwidth HDTV, but it is not compatible with NTSC receivers.

There are, as we said earlier, many other proposed approaches to improving TV resolution. The David Sarnoff Research Center (formerly part of RCA) has developed two systems, ACTV-1 and ACTV-2, which use one and two channels respectively, while companies like Zenith, Philips, and others pro-



pose sending conventional NTSC pictures on one channel with audio and video enhancement information on part of another. All of the systems rely on certain compromises to squeeze the 30 MHz normally required to deliver true high definition down to 12-MHz or less. Let's examine some of the systems.

**ACTV.** The ACTV system is actually composed of two proposals: ACTV-1 and ACTV-2. ACTV-1 is a single 6-MHz channel, fully NTSC-compatible system that delivers significantly improved picture definition. ACTV-2 is also fully NTSC compatible, and is downward compatible with ACTV-1. It delivers picture quality that is comparable to studio high-definition production standards, but requires two 6-MHz channels.

How does ACTV work? Take a look at Fig. 1. The original high-definition TV signal is digitized and encoded into four components. The first component is the main NTSC-compatible, color-encoded signal. It consists of the time-expanded center part of the picture and two time-compressed side panels. The side panels, which are located in the right and left overscan regions where they would be hidden from view on standard NTSC sets, contain the low-frequency horizontal information.

The second component is an auxiliary 2:1 interlaced signal that contains high-frequency horizontal information in a time-expanded format. Using time expansion reduces the bandwidth of that information to about 1 MHz. The third component is another auxiliary signal that contains the horizontal luminance detail between 5 and 6.2 MHz.

The fourth component consists of the V-T (vertical-temporal) luminance detail. Called the "helper" signal, it is used to reconstruct missing lines and to reduce flicker or other problems on ACTV receivers.

Components 2 and 3 undergo special signal processing, and are then quadrature modulated onto a 3.1-MHz subcarrier. That signal is then added to component 1, which also undergoes special signal processing, to form a 4.2-MHz signal that is RF modulated onto a standard 6-MHz signal. See Fig. 2. The fourth (helper) component is quadrature modulated onto the main picture carrier.

When the ACTV signal is received on a standard NTSC receiver, only the center part of the main signal is displayed. On an ACTV receiver, the center part of the signal is displayed along with two

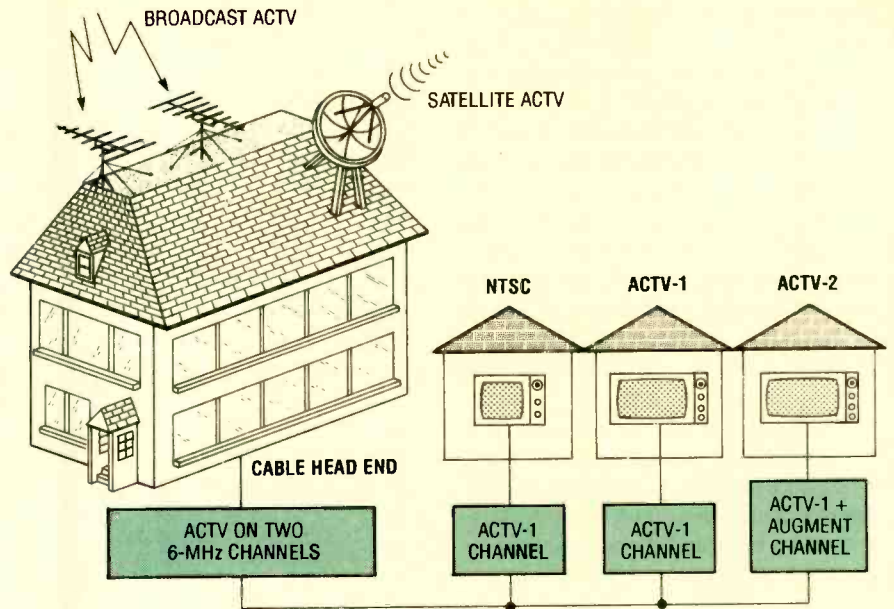

Fig. 3 A cable-TV company could combine a terrestrial ACTV-1 signal and a satellite-delivered ACTV-2 signal to serve customers with NTSC, ACTV-1, and ACTV-2 equipment.

side panels, offering a 5:3 aspect ratio like that of a motion picture. Not all of the image is high-resolution, however. The center section offers high-definition resolution in stationary (non-moving) parts of the picture, while the side panels offer NTSC-level resolution.

If additional spectrum space were available, ACTV-2 offers considerable improvement over ACTV-1. By using a second 6-MHz "augmentation" channel, luminance resolution could be improved to 650-lines horizontal, 800 vertical (as opposed to 410 horizontal, 480 vertical for ACTV-1), and chrominance resolution could be doubled. Note that there is no appreciable chrominance improvement in ACTV-1 over NTSC.

The need for a second 6-MHz channel may pose a problem for ACTV-2. However, another promising avenue is cable or direct-satellite delivery. Figure 3 shows one way that a cable programmer could combine a terrestrial ACTV-1 signal, plus a satellite-delivered augmentation ACTV signal to deliver NTSC, ACTV-1, and ACTV-2 programming to appropriately equipped homes.

**SC-HDTV.** One problem facing HDTV proponents is the lack of available spectrum. Even though there are apparent unused channels in all areas, those channels are not available to broadcasters due to various FCC rules regarding interference. Those channels are called "taboo" channels.

Zenith has proposed an NTSC-com-

patible HDTV system, called Spectrum Compatible HDTV, or SC-HDTV, that makes use of those taboo channels in a way that prevents interference to other broadcasters. It does that by reducing transmitter power used to broadcast the HDTV information to about 0.2% of that used by an NTSC transmitter, yet with the same coverage area.

A block diagram of the Zenith system is shown in Fig. 4. The major feature of the SC-HDTV system is the separation of video-frequency information into two bands. Frequencies below 200 kHz are transmitted in a digital format, while all frequencies above that point are transmitted in the normal, analog way.

In video signals, the energy associated with the high-frequency components is less than 1% of the total energy; in other words, virtually all of the power in a video signal is concentrated in the low-frequency video, the sync signal, and the carrier. That means, if you remove the carrier, the sync, and the low-frequency video, you can transmit the high-frequency information at substantially lower power levels. Further, since a lot of the low-frequency information is repetitive (such as the sync signal and the carrier), it can be transmitted less frequently. That means that the low-frequency information can be sampled at a low rate, digitized, and transmitted during the digital blanking interval.

One drawback to the Zenith system is that it requires a great deal of signal processing to prevent interference to or from NTSC signals. As shown in Fig. 5, the signal undergoes companding, time



dispersion, temporal (time) pre-emphasis, and other processes. That means that extensive digital signal processing must be done in an SC-HDTV receiver. Zenith estimates, however, that "only" one megabyte of memory will be needed to facilitate that.

The basic technique used to make the Zenith system work takes advantage of the properties of human sight. Since the detail-resolving capabilities of the eye is considerably less for objects in motion than for stationary scenes or objects, stationary video is transmitted at higher resolution than motion video. According to Zenith, when that strategy is appropriately applied, it allows the 30-MHz normally required for HDTV to be compressed into a 6-MHz channel.

**Avoiding Obsolescence.** NTSC compatibility, as you may have surmised, is a real HDTV problem. In its original form, MUSE would not be viewable on this nation's 100 million present-day TV sets or recordable on the more than 60 million VCR's, leading the Federal Communications Commission to require that any system intended for use in North America be NTSC-compatible.

That makes sense from an economic point of view. Japanese wishing to watch MUSE programs will have to invest upwards of \$4000 each for new TV sets, or \$140 or so for set-top converters that downscale the widescreen programming to fit onto existing TV screens. Unless programs are viewable on today's receivers, it will be years before there's an audience large enough to interest advertisers in supporting HDTV.

Strictly speaking, single-channel systems like ACTV-1, MUSE-6, and Faroudja Laboratories SuperNTSC aren't true HDTV at all. The first two are widescreen media like true HDTV, but the first lacks the definition to qualify as anything more than Enhanced Definition TV (EDTV), an interim step, and MUSE-6 still is an unknown quantity. SuperNTSC is nothing more than an upgrading of present-day TV using noise-reduction and digital signal-processing techniques to produce an NTSC picture that's very sharp indeed. Its inventor refers to it as Improved Definition TV (IDTV).

**Better, and Bigger.** One of the things about HDTV is that pictures are likely to be bigger, along with price tags. And you're going to find yourself sitting much closer to the screen in order to enjoy it. One of the reasons large-

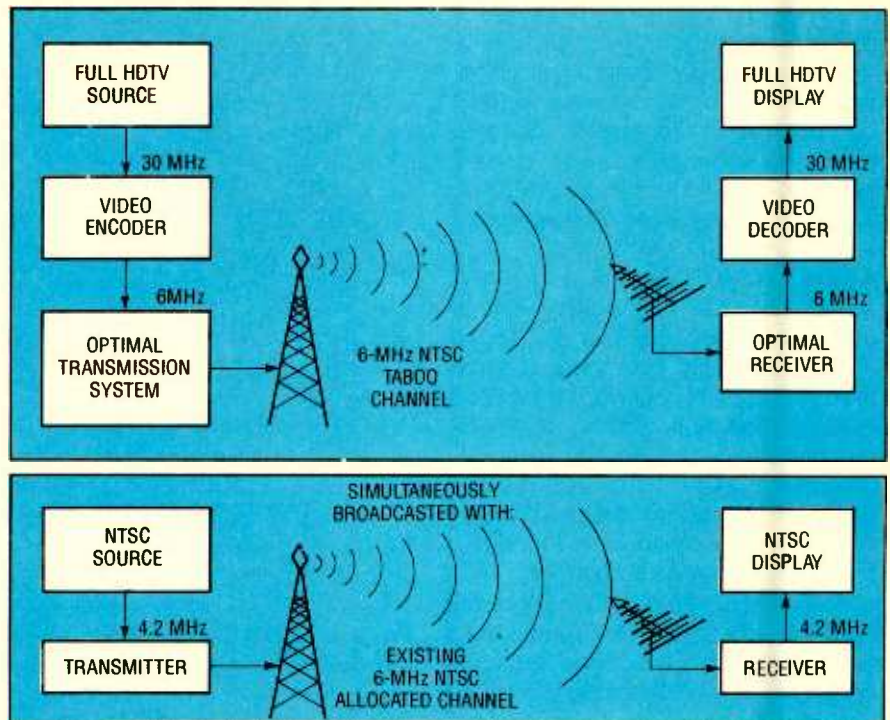

Fig. 4. The Zenith SC-HDTV system uses taboo channels to overcome spectrum-related problems. By only transmitting high-frequency information in an analog form, and by using special signal processing, very low power can be used.

screen TV (including projection models) hasn't really taken off so far is that the large picture seems to lack sharpness. Size merely seems to magnify the defects of the NTSC system, including those scan lines. It makes no difference whether the NTSC picture you're watching is on a screen that's nine inches high or one that's 27 inches high, it's still made up of the same 525 lines. If you sit too close, you become painfully aware of the space between lines and the lack of detail in just about any object on the screen.

By doubling the number of lines, as the various HDTV systems do, it's possible to make them virtually disappear, even on a giant screen. At the same time, details become crisp and sharp. There's a rule of thumb in the TV business that the proper viewing distance for NTSC is one foot for every inch of screen height. In fact, in most living rooms containing 25-inch sets, viewers usually sit no more than 12 to 15 feet away. In several field tests last year, researchers discovered that the optimum viewing distance for HDTV viewing from the equivalent of a 25-inch diagonal-measure set is only six to eight feet—and that viewers farther from the screen had trouble perceiving any difference between HDTV and regular TV pictures. If you want to view HDTV from a distance of 10 to 12 feet, you're going to need a screen that's at least 21

to 27 inches high, the equivalent of a 35- to 45-inch diagonal-measure TV receiver.

Since you're not likely to notice much difference in picture sharpness on a screen that's less than 12 inches high, don't look for small or inexpensive HDTV receivers when they do begin to appear—which now looks like 1993 at the earliest, and could be good deal later. The first receivers will not only be large-screened, but full-featured as well, with such digital features as picture-in-picture, strobe effects, frame-memory storage, and the like. And that, in turn, means big ticket. Toshiba recently showed a 31-inch direct-view model in Tokyo, equivalent in picture height to a 25-inch NTSC model, which it expects to sell for \$4000 once mass production begins.

**Politics.** Somehow, during the process of testing the various systems and selecting one for use beginning in the early 1990's, questions like picture quality, cost, and even the amount of spectrum space each would consume got lost in a debate over competitiveness, national security, and U.S. manufacturing jobs. Chairman Ed Markey (D-MA) led the way, calling for an American-developed, American-made HDTV system which would guarantee jobs for

(Continued on page 104)



# Photoflash Power System

BY W. E. BABCOCK

**H**ow often have you missed that "once in a lifetime" indoor shot because the batteries in your electronic flash unit had gone dead at the most inopportune time; or missed a shot because the time required for the flash unit to charge was 20 seconds or longer?

Most modern flash units are powered from four "AA" size batteries. Although the manufacturer's specifications may state that 75 flashes or more can be obtained from one set of alkaline batteries, the recycling time becomes very long after a relatively small number of flashes. Heavy-duty units (with larger batteries and/or a higher voltage capacity) are readily available, but they are very expensive.

Recently, I became aware of the availability of compact, gelled-electrolyte, lead-acid storage batteries. Such gell-cell batteries can be used in any position with no danger of spilling the electrolyte, and are available in a fairly wide range of ampere-hour capacities and physical sizes. So I decided to adapt one such battery to power my flash unit.

It seemed to me that I should be able to fashion a battery holder that would allow the battery to be clipped to my belt; then a flexible cable could be used to connect the battery to the flash unit.

**A Successful Venture.** The conversion of my flash unit so as to allow it to operate from the gelled-electrolyte storage battery was, in my opinion, a great success. I have just returned from a 2-week tour of Germany and Austria, where I used the unit every day of the tour. There were many occasions when the flash unit was left on continuously for periods of up to 2 hours.

In no case was the recycle time after a flash longer than 3 seconds; and when the unit was operated in the "au-

*Build a high capacity power system for your electronic flash unit and never miss a shot!*

tomatic" mode, the recycling time was essentially instantaneous. The battery used weighed 23.2 ounces, but, with it clipped on my belt, I was hardly aware of it at all.

My flash unit is a Vivitar model 283. Other makes and/or models may require some modification of the following instructions, however it should be relatively easy to adapt the instructions to almost any flash unit. However, before you dive head-on into converting your flash unit, a word of caution is in order: If your flash unit is still under warranty, you should consider the fact that altering the unit (no matter how slight) in all likelihood will void the warranty.

**Making the Change.** The gelled-electrolyte lead-acid battery used for the conversion is available (as part P129) from Digi-Key Corporation, PO Box 677, Thief River Falls, MN 56701, for \$15 (plus shipping and handling). The battery's dimensions are 4 $\frac{5}{8}$  inches high by 2 $\frac{3}{16}$  inches wide by 1 $\frac{3}{16}$  inches thick.

The battery has quick-disconnect type terminals similar to those used in an automobile's electrical wiring system. In my case, all the other parts used were taken from my moderately stocked junkbox, but if you don't have such parts in your junkbox, they can be purchased and are readily available from local electronics stores.

Prepare the battery by connecting a short length of cable to the battery terminals. Those terminals, and the bare ends of the cable, are then covered with black-vinyl electrical tape. A 30-



inch length of cable, with an appropriate connector attached to one end, is plugged into the jack on the short cable when the battery is used to power the flash unit.

When the battery is in need of charging, another length of cable from a suitable battery charger plugs into the jack. For the connecting cable, I used a length of shielded cable salvaged from



an old tape recorder. The cable was only about 1/8 inch in diameter and already had a phono plug at one end. I merely soldered a phono jack to the other end to complete the cable.

Figure 1 shows details of the home-made belt clip, which was glued on the back of the battery to allow it to be hung from a belt. The clip was cut, using tin snips, from a piece of aluminum flashing material (any other thin sheet metal that may be available can also be used) and bent as shown. About a dozen 3/16-inch holes were drilled through the end that attaches to the battery in order to increase the holding power of the adhesive.

The author used Duco cement, an

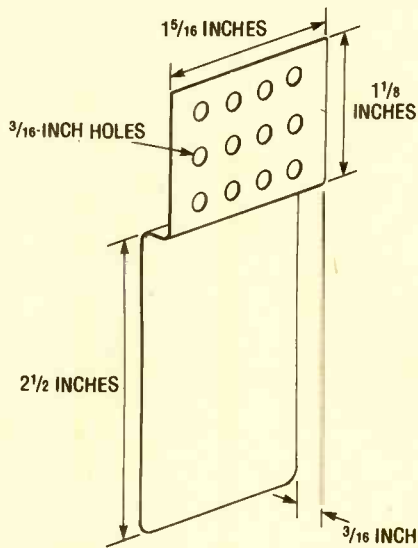

Fig. 1. Here are the construction details of the home-made belt clip, which was glued on the back of the battery so as to allow it to be hung from a belt.

adhesive that bonds very well to the outer casing of the battery. A liberal quantity of the cement was first spread on the battery case so that when the clip is put in place, the adhesive oozes through the holes in the clip. Then a liberal quantity of cement was spread on the back of the clip so that the area where the holes are drilled is completely covered. That makes for a more secure bond between the battery casing and the belt clip.

Allow the cement to dry overnight before attempting to hang the battery on your belt. If you wish, you can paint the clip black so it will blend with the case of the battery.

If you examine the battery compartment of your flash unit, you will see that metal straps are used to connect the batteries in series, so that four 1.5-volt batteries provide 6 volts to the internal

circuitry of the flash unit. The battery case, which fits into the flash unit's battery compartment, has cavities (see Fig. 2) to hold four "AA" cells.

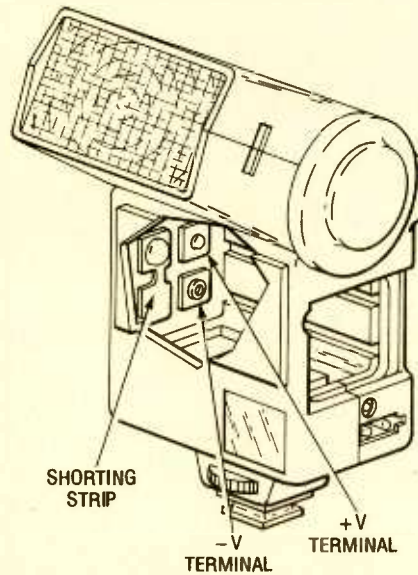
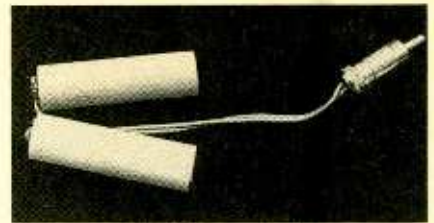

Fig. 2. The battery compartment within the flash unit contains a holder having four cavities with metal shorting strips to place the batteries in series.

The two cavities corresponding to the shorting strap in Fig. 2 can be left empty. The other two cavities correspond to the positive and negative 6-volt terminals of the flash unit. Half-inch wooden dowels, cut to the length of an "AA" battery (about 1 1/8 inch) are placed in those two cavities. A #6 round head, brass wood screw is screwed into the end of each dowel.

A short length (about 4 1/2-inch) of cable is soldered to the two screw heads. In my conversion, I used a short length of 2-conductor loudspeaker wire as the connecting cable, but almost any type of insulated wire could be used.

However, remember that the wire must be fed around the battery case and through the gap around the cover, which secures the battery holder in



To connect the high-capacity battery to the flash unit, speaker wire with a phono plug at one end is connected to a couple of wood dowels (cut to the length of "AA" batteries) with screws.

place, so the outer diameter of the wire should be as small as practical.

To ensure good flexibility of the cable and to prolong its life, the wire should be of the stranded variety. When the dowels are inserted into the battery holder within the flash unit, the heads of the screws contact the positive and negative terminals, so that power is applied to the flash-unit circuitry in the usual manner.

Note: You may need to file a little of the plastic from the edge of the battery compartment, and possibly from the battery cover, in order to bring the wire out of the flash unit and still be able to keep the battery holder and cover in place.

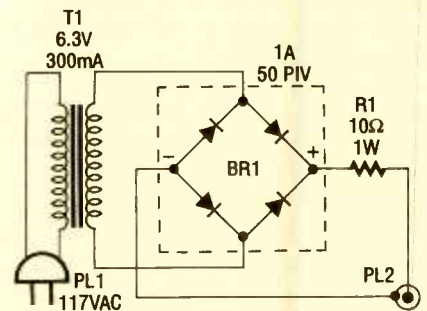

Fig. 3. Although rather simple in design, this circuit can be used to charge the gelled-electrolyte, lead-acid battery used to convert the flash unit.

**Battery Charger.** A charger for the battery can be made from a 6.3-volt filament transformer, a bridge rectifier (or 4 individual rectifier diodes with the proper rating), and a current-limiting resistor. A schematic diagram of the charging circuit used by the author is shown in Fig. 3.

The high-capacity power source for your flash unit should pay for itself in a remarkably short time, since you will no longer need to buy any more "AA" batteries. More important, you will be saved the aggravation and missed shots resulting from low or dead batteries.

#### PARTS LIST FOR THE ELECTRONIC FLASH UNIT

- BR1—1.5-amp, 50-PIV, full-wave bridge rectifier
- T1—6.3-volt, 300-mA, filament transformer
- R1—10-ohm, 1-watt, 5% resistor
- PL1—117-volt AC plug with line cord
- PL2—Plug selected to mate with battery connector (J1)
- J1—See text
- Gelled-electrolyte lead-acid battery, wire, solder, hardware, etc.



# Servicing Security Systems

*Learn how to track down even the most elusive problems and end the misery of false-alarms forever!*

BY ISAAC SZLECHTER

**H**aving a false alarm is a frightening experience that unnerves your neighbors and annoys the police. To make matters worse, many causes of false alarms do not show up under routine tests or inspections. Oddly, troubleshooting alarms is usually not a difficult task, except when you have a "swinger" in the line. A swinger is an intermittent short or break that can cause a false alarm any time the system is armed, and yet it does not show up when you or a serviceman check out the alarm system.

**Cause of Swingers.** The problem lies in the fail-safe principle on which alarm systems are based. Since an alarm is designed to sound when current through the house circuit is interrupted, such as by opening a window, any accidental break in the circuit will set the alarm off no matter how slight or brief it is. Such short, intermittent breaks, called swingers by professional installers, may not occur for weeks after installation and they may last only a second or so when they do.

Frequently, a swinger is the result of poor installation, defective materials, or damaged components. The cause of the bad connection could be one of many things:

- A corroded wire in a screen or skylight that periodically breaks or shorts.
- Dust or corrosion preventing a contact from closing.
- A connecting wire with broken strands that occasionally separate due to vibration or temperature changes.
- A loose terminal connection at the battery, detector contacts, or control circuit intermittently breaking the circuit.

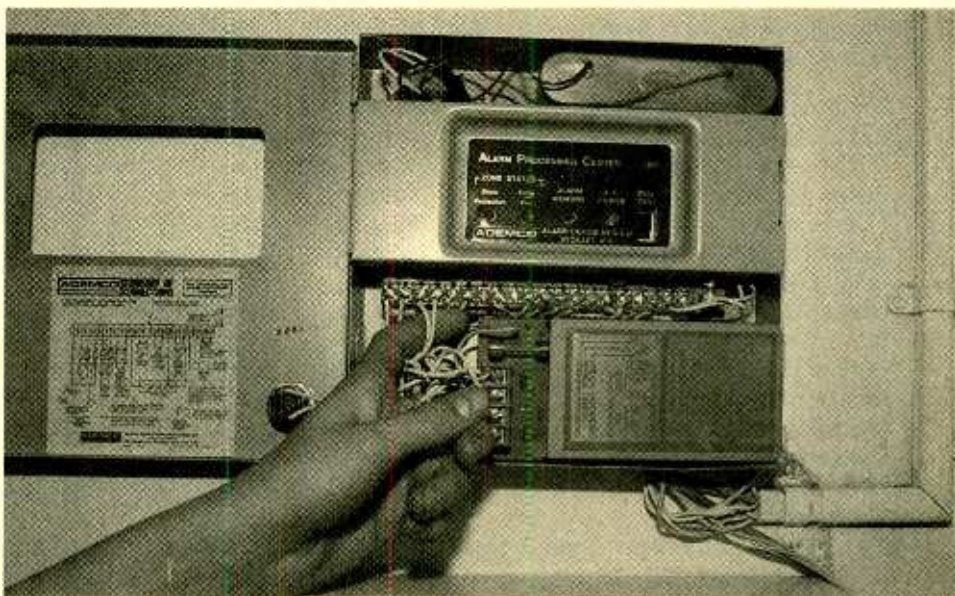

- Bad splices.
- A vibration contact that is set too sensitive.
- A hairline crack in a strip of window foil, at a foil connection, or at a crossover point that's not properly insulated and intermittently grounds to the window or door frame due to changes in temperature or humidity.
- Wire breaks inside the insulation.
- Window rattling causing a foil to break.

**Alarm Operation.** Swingers occur almost exclusively in the "protective circuit" (see Fig. 1) that runs throughout the protected area. The protective circuit consists of intrusion detectors (such as magnetic-reed switches, window foil, photocells, ultrasonic beams, microwave devices, etc.), a source of voltage (for instance, a dry cell, AC energy pack, or rechargeable battery), a sensitive relay located in the control circuit, and wires connecting all the components together in series.

The voltage source drives current

over the connecting wires through all the intrusion detectors and back to the relay. The sensitive relay, sometimes an electronic detector, links the protective circuit with the control circuit, which is located inside the main control panel.

The control circuit is made up of a voltage source (possibly the same one used for the protective circuit); an electronic circuit, a second relay known as a latching or drop relay; and a key-operated, push-button, or electronic control switch used to enable and disable the whole system.

Under normal conditions the protective circuit is closed and current from the voltage source energizes the sensitive relay or electronic detector. When a point of entry is opened, a photocell beam is broken, an ultrasonic unit is tripped, or any other device in the protective circuit is disturbed, the current is interrupted. The sensitive relay drops out and activates the latching relay and the control circuit, which sounds the alarm. The latching relay keeps the alarm circuit activated and the output



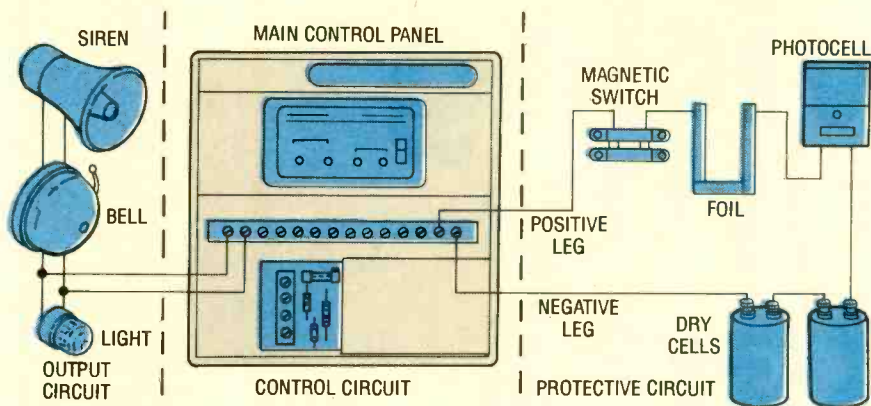

Fig. 1. Alarms are made up of three circuits: the protective, the control and the output circuit. A sensitive relay links the protective circuit with the control circuit. When the protective circuit is disturbed, the sensitive relay causes the latching relay in the control circuit to activate and the output circuit to turn on.

circuit operating even if the protective circuit is closed again by the closing of a door, the unblocking of a photo beam, etc.

Note that a short circuit between protective-circuit wires of opposite polarity will also cause the same result. The protective circuit in Fig. 1 is shown as a pair of wires with intrusion detectors connected to the positive leg only. Although that helps prevent swingers that short out, troubleshooting an alarm is always easier when both the positive and negative legs are available at each detector.

In general, the control panel is seldom the source of the problem, and even if it were, troubleshooting one is best left to a qualified technician. Just to check a control panel to see if it is malfunctioning, disconnect the protective circuit from the main control panel and measure its resistance in ohms. In place of the protective circuit install a resistor of similar or greater resistance on the panel and turn it on. Leave the alarm like that while you search for a swinger in the protective circuit. If the alarm goes off, the control circuit in the main panel is the problem, and it has to be replaced.

**Ohmmeter Testing a Circuit.** A visual examination of the whole protective circuit should be performed as the first step in locating a short or break. Close scrutiny may reveal a break in some window foil or a wire. If that reveals nothing, you must "shake down" the protective circuit. It is important that you disconnect the protective-circuit battery or power supply before doing that to avoid current flow that would affect the results of the readings you will take.

According to a prominent electrical

engineer "The secret of troubleshooting an alarm system is to divide it into small segments, so the problem can be isolated." With that in mind, you'll need to perform a continuity test, so set a conventional multimeter to read resistance.

Because sneaky swingers come and go so unpredictably, they must be tricked into showing themselves by simulating the conditions that bring them out. Starting with one of the windows, connect your meter across the foil terminal blocks and attempt to rattle the glass with your hand.

The meter should read "0," but if the needle jumps when you push on any of the glasses or touch the connections, you just found the swinger. Now, zero in on the trouble by dividing the foil into a few smaller circuits and testing the resis-

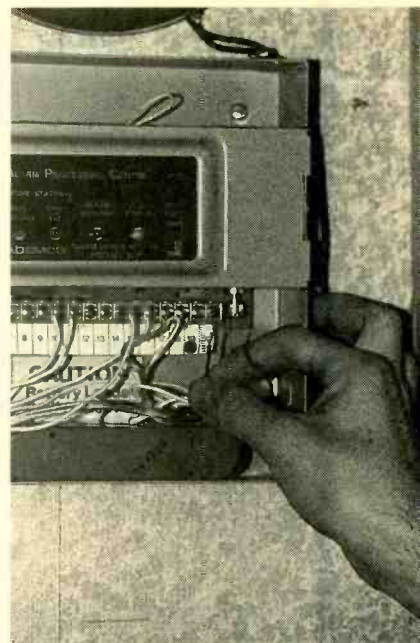

*To rule out the control circuit as a suspect cause of false alarms, disconnect the protective circuit from the main control panel and connect a similar or greater resistance in its place.*

tance of each just as you tested the whole foil. When you find the problem, replace the damaged section.

If you do not locate the swinger in any of the foil blocks, recheck vibration contacts with the meter by rapping the walls along the connecting wires. A gentle rap should not cause the contacts to open. A wire broken inside its insulation may show up on your meter as you pound the walls along the wire run. That type of swinger is unusual and

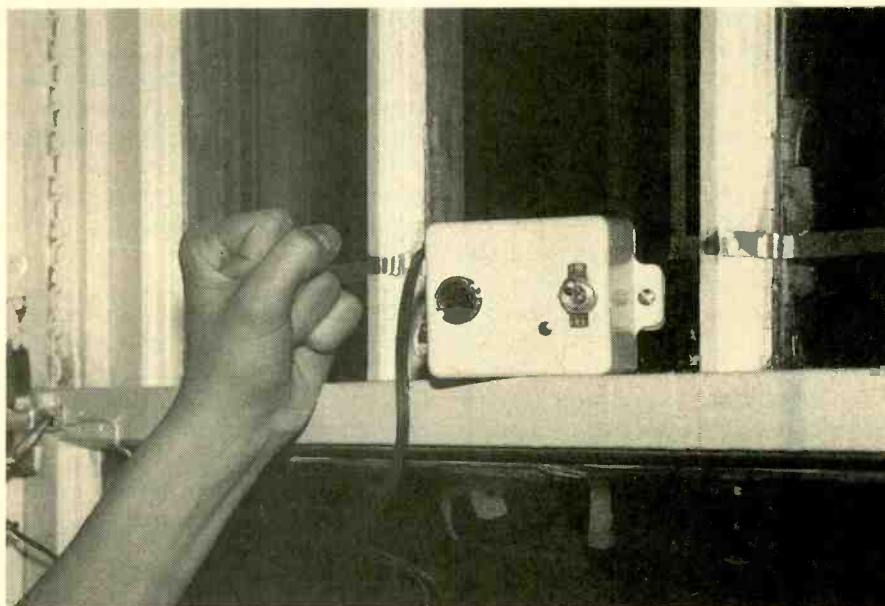

*To check a foil loop with the tester, disconnect the loop from the rest of the system, then clip the tester to the terminals. Pound on the window sash to jar the foil. If the loop is a swinger, the tester will light.*



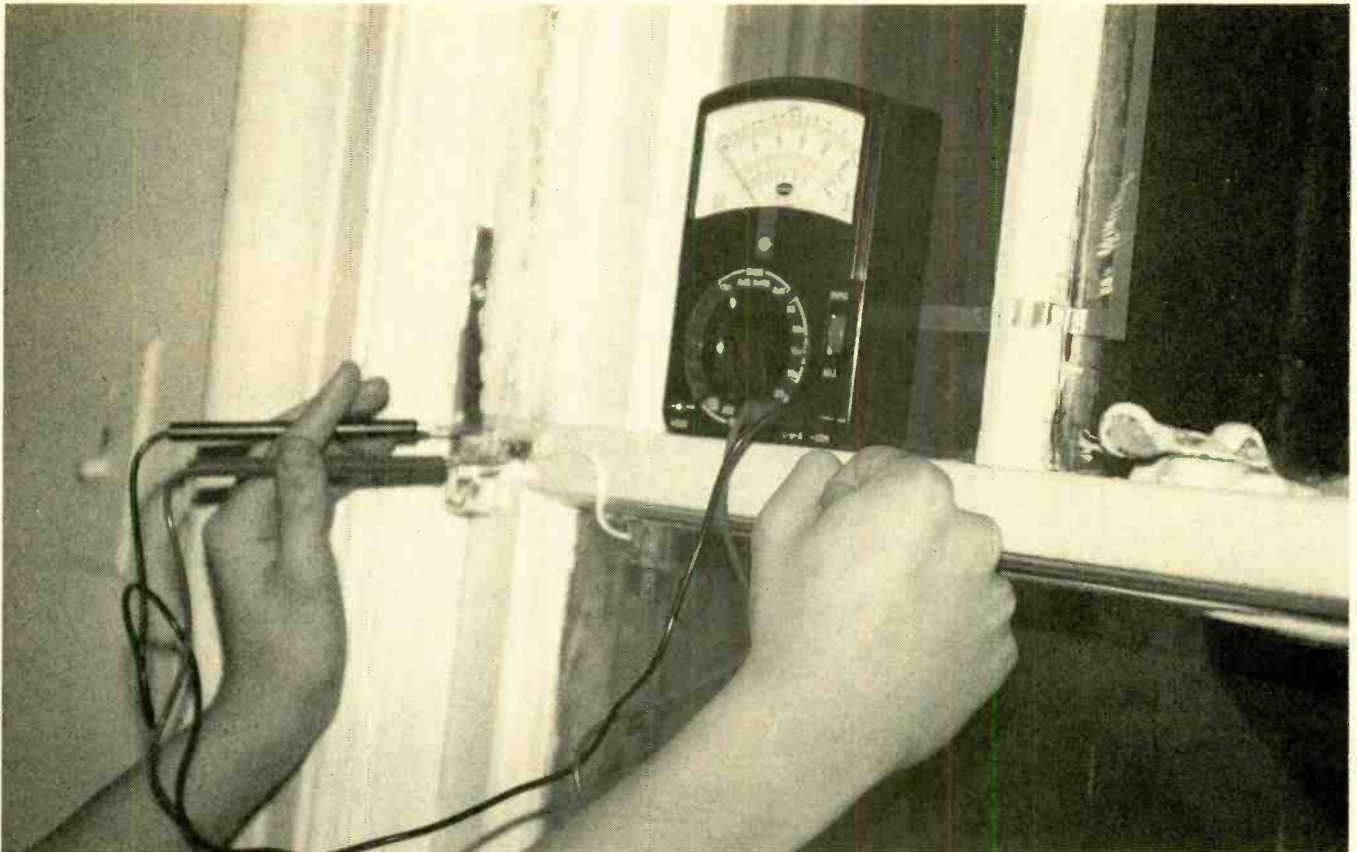

*To check each foil loop on a window individually, disconnect the loop from the rest of the system. The meter should read "0" ohms. If the needle jumps when you pound on the glass or touch the connections, you've found the swinger.*

the most difficult to find. You should also investigate whether any unusual vibration has occurred around the house. For example, construction work may be taking place in an adjacent area, or perhaps you have a new major appliance.

**A Helpful Tool.** If you can not track down the trouble that way, your best bet is to use an Ademco No. 12 tester, which is available in alarm and electronic stores, or by using a continuity meter with memory. The tester is good because it can spot swingers that open for only a fraction of a second. Unlike a conventional meter, the tester remembers the occurrence of a break because once the indicator light goes on, it stays on.

You would use the tester in the same manner as the ohmmeter. You must first disconnect the protective circuit battery or, if the power is derived from the panel screws, remove the protective circuit wiring from the screws.

To check for swingers in the window foil, clip the tester leads to the screws on the terminal blocks and tap the window. The tester will light if a break occurs.

With screens and laced wire, you must check both legs of the protective circuit if the detectors use both of them. For screens, the tester can be attached to the screen hangers, while on skylight lacing, the leads can be clipped to the splice between the lacing wire and the protective circuit. After you connect the tester, tap the window glass, shake the screens, or tap the skylight firing strips. If a swinger opens, the lamp will light.

**Overnight Testing.** If all else fails, you can install one or more testers overnight with the alarm system on in order to isolate a swinger. If you do not want to be bothered by the bell during the night in the event the swinger breaks, disconnect the bell circuit. Once you do this, no local protection is offered, of course, by the burglar or fire alarm. During the day set up testers across test posts throughout the circuit and turn them all on after you have turned the alarm system on.

When installing testers across the protective circuit, proper polarity must be observed. To make certain that the polarity is correct, attach the alligator clips of the tester across the protective circuit, move the switch on the tester to

the ON position. If the lamp does not light, the tester is installed correctly. If it does light, reverse the leads of the tester. Then reset the tester by sliding the switch to the RESET position and then to the ON position. If the circuit is closed, the lamp will then go out and the tester will be properly installed.

The next day, examine the testers and note which ones have lit before turning off the system. The testers' lamp will remain off as long as a closed circuit is maintained between the tester and the "end of line batteries." When a break occurs, all testers located between the break and the batteries will continue to monitor a closed circuit and their lamps will remain off. On the other hand, all testers located between the break and the control panel will indicate an open circuit with a light.

If you do spot a break, don't assume it is the only culprit. Note its location and replace the damaged part, but keep on testing the rest of the system for another day or so. Other swingers may be lurking elsewhere.

If your troubleshooting is thorough, you can be sure your system will never again wake you at night without reason. You have eliminated any short or break in the system, so the alarm won't go off unless it is the real thing. ■



# MERCURY SWITCH ALARM

*Make a simple but effective theft alarm with a mercury switch and a few support components.*



BY WALTER W. SCHOPP

Nothing discourages thieves more than a loud unexpected noise emanating from the article they want to steal; so even simple alarms are an effective deterrent to crime. That is why so many alarm circuits appear in electronics books and magazines. Many such circuits have piqued my interest in the past, but the *Mercury Switch Alarm* is special, not because of the circuit, but because of the sensing device. It contains a very special mercury switch that can be used as a sensing device for many off-the-wall alarm circuits.

A standard mercury switch must be properly oriented to remain on or off depending on its particular application. However, the new switch used in this alarm can be oriented in any position, only completing the circuit when moved from its initial position. That means that the protected object can be in any position without regard to the sensors orientation at the time the alarm is set. The sensor will be an open circuit until it is bumped or jarred. A very small amount of vibration or shock will momentarily turn it on. Once the alarm is energized, it makes enough noise to cause any would-be thief to abandon

his efforts. After a while, the alarm automatically resets and waits to be disturbed again.

**How It Works.** The alarm is based on a simple timing circuit shown in Fig. 1. Using a switch to disable the unit would make it very easy to turn off, so a miniature three-terminal shorting phone jack (J1) was used as the power switch. When the phone plug is removed, the alarm is set to go off. Unless the thief happens to have a miniature phone jack in his pocket, he cannot disable the alarm.

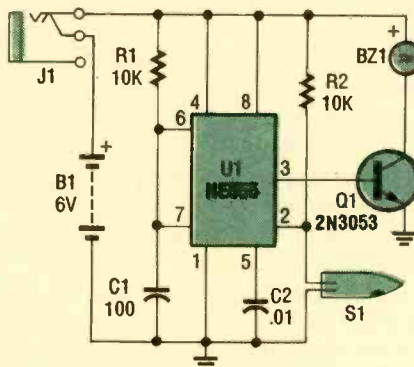

Fig. 1. When pin 2 goes low pin 3 goes high, which switches Q1 on and activates the buzzer for a period of time.

The 555 timer IC is triggered by grounding pin 2. Resistor R2 keeps that pin high until the mercury switch closes to start the timing cycle. When the timer is triggered, a positive voltage at pin 3 is applied to the base of Q1, which then completes the buzzer circuit sounding the alarm.

Meanwhile, C1 starts to charge through R1 until it reaches  $\frac{2}{3}$  of the supply voltage. Capacitor C1 is then discharged through the chip and pin 3 goes low.

Pin 3 remains high for some time T determined by R1 and C1, which you can calculate using the formula:

$$T = 1.1R1C1$$

where: T is given in seconds, R1 is in ohms, and C1 is in farads.

The buzzer specified in the Parts List draws approximately 200 milliamps when operating at 6 volts, and makes a lot of noise for its size. It is a three-wire unit that can produce three different alarm sounds depending on the way it is wired. The choice of the sound is up to you.

Mounted inside a sturdy enclosure, the alarm case should be fastened securely to the item to be protected. Any



## PARTS LIST FOR THE MERCURY SWITCH ALARM

U1—NE555 timer, integrated circuit  
 Q1—2N3053 switching transistor,  
 (Radio Shack No. 276-2030 or  
 equivalent.)  
 C1—100 $\mu$ F, 16 WVDC electrolytic  
 capacitor  
 C2—.01 $\mu$ F ceramic-disc capacitor  
 R1—10,000–100,000-ohm, 1/8-watt  
 resistor (see text)  
 R2—10,000-ohm 1/8-watt resistor  
 BZ1—3-tone alarm, Radio Shack  
 273-072 or equivalent  
 J1—Shorting, three-terminal mini phone  
 jack  
 S1—Vibration-sensitive mercury switch  
 Mini phone plug, printed-circuit or  
 perfboard materials, 4 “AA”  
 batteries, battery holder, enclosure,  
 wire, solder, etc.  
 The mercury switch part No. 4008-4, is  
 available for \$10.00 (shipping  
 included, but add tax if you’re in  
 California), from Electronic  
 Enterprises, 3305 Pestana Way,  
 Livermore, CA 94550.

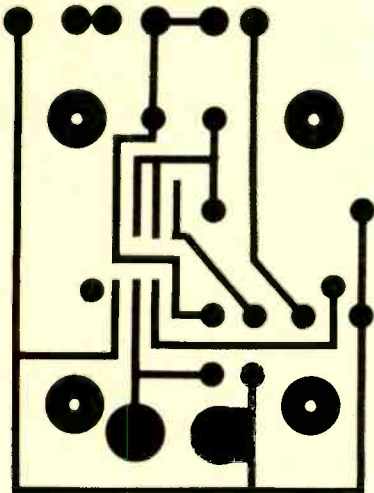
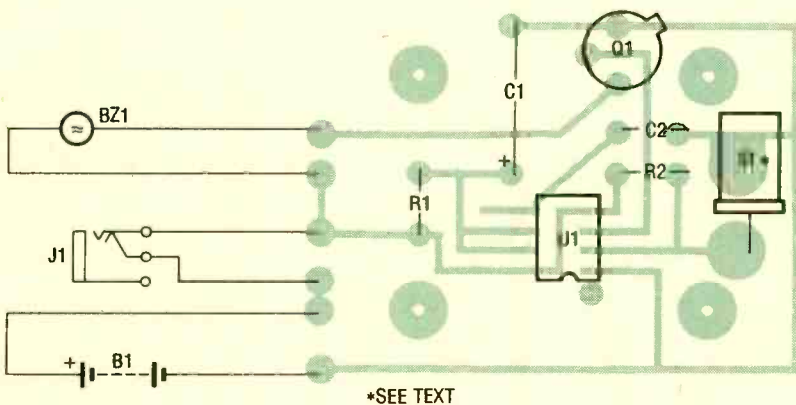

Fig. 2. This foil pattern will make your work neater. Use it foil-side up.



\*SEE TEXT

Fig. 3. Place the parts on your printed circuit board using this as a guide. Be sure that all polarized components are oriented properly.

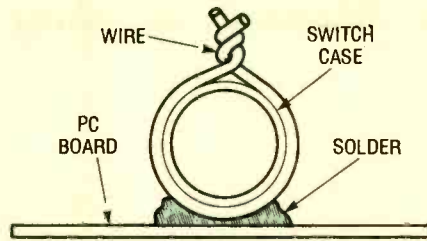

Fig. 4. To install the mercury switch you must first solder a small piece of wire to one solder pad. Wrap the loose ends of the wire around the switches case securely.

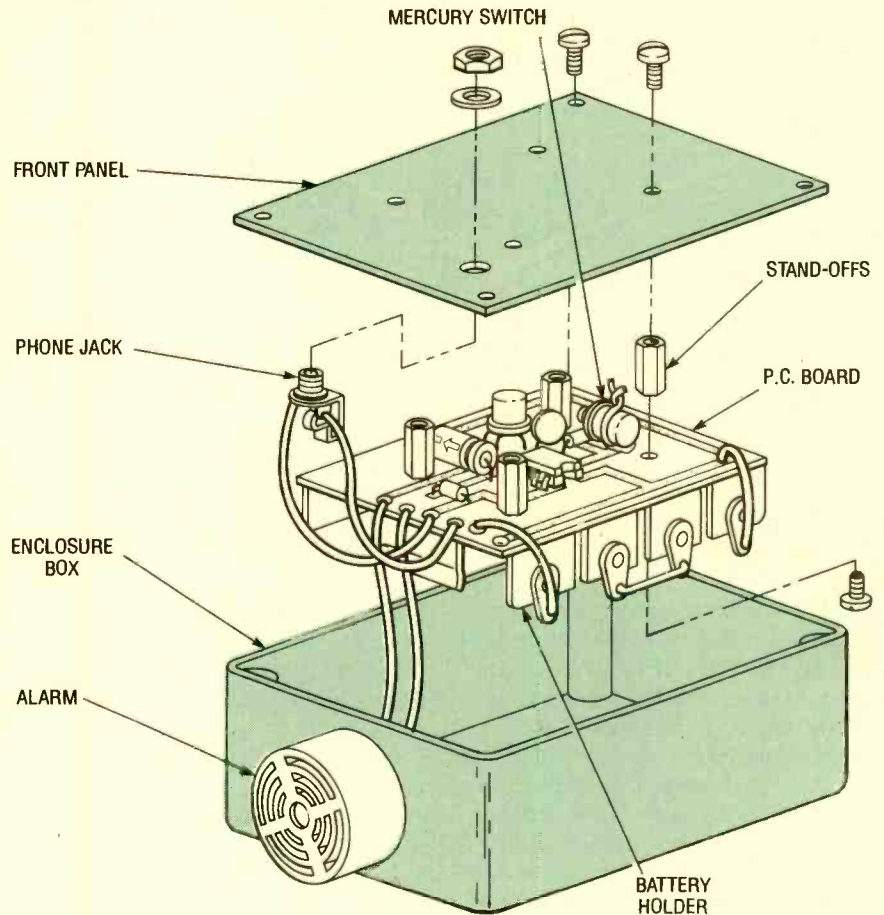

Fig. 5. After attaching the battery holder to the unclad side of the circuit board, the lid can be attached to the clad side by using stand offs.

movement of the object will activate the alarm.

**Building the Alarm.** The circuit can be hard wired or built on a small PC board. A pattern for the PC board is shown in Fig. 2. It should be mounted copper-side up because the components are to be mounted on that side, just as though they were surface-mount units. The parts placement diagram is shown in Fig 3.

The special mercury switch must be mounted solidly to receive the vibration from the protected item. To do that, start by soldering a “U” shaped piece of wire to one of the switch’s solder pads, as shown in Fig. 4. Solder a piece of wire to the switch’s protruding rod and solder the wire to the other pad for the switch. Rest the switch’s case between the two ends of the U-shaped wire and twist the wire’s ends tightly together. If you have a very good flux such as Stay Clean, the case can be spot soldered to the wire. If you do solder the case, do it very quickly and be careful not to overheat it.

(Continued on page 98)



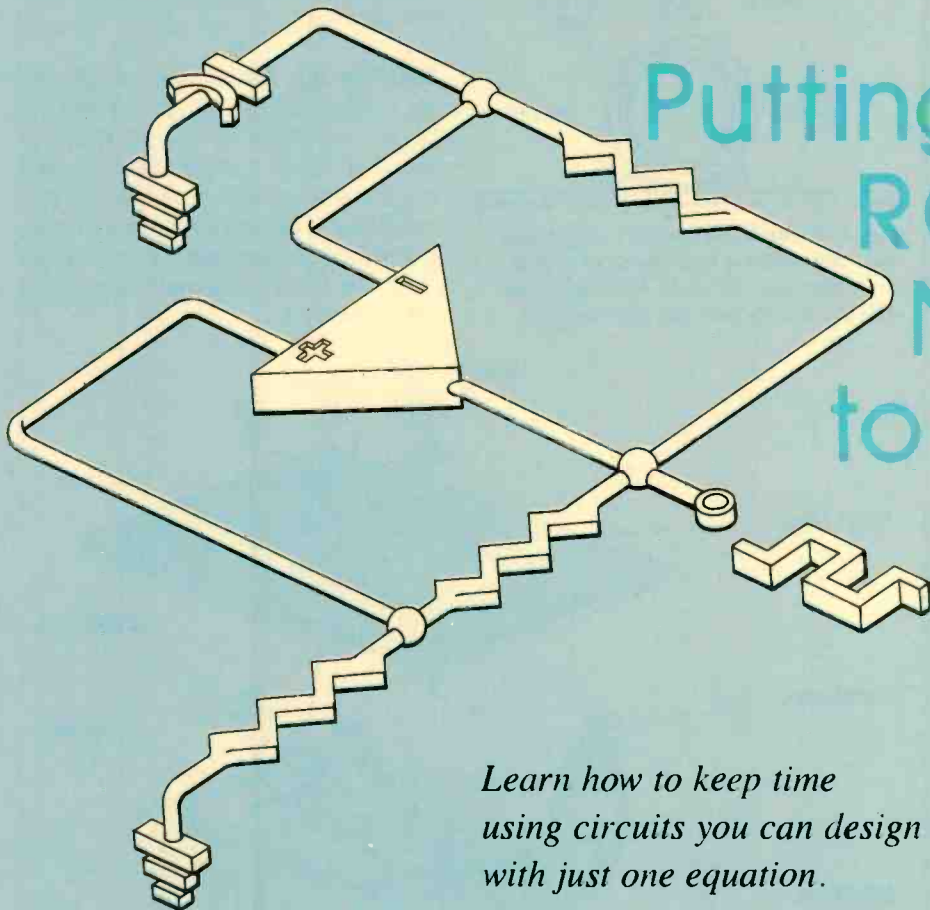

# Putting RC Networks to Work

BY JOSEPH J. CARR

*Learn how to keep time using circuits you can design with just one equation.*

**M**ost readers of electronic hobby magazines are activists, so it comes as no surprise that the circuits and projects we present are actually built by our readership. But our magazine tries to do more than simply give "how to clone-it" information about circuits to our readers. Part of my mission as a technical writer is to empower readers to do things he or she could not do before reading an article of mine. If I'm successful, then I get a letter with that ultimate compliment "I built a circuit just like your's except..." followed by a description of how a circuit I wrote about was used as the mere basis for something bigger or better. In that spirit, this article will show you how resistor-capacitor (commonly denoted RC) charging and discharging networks operate so that you can use them more easily in timing circuits of your own design.

Many circuits depend on the characteristics of RC networks for their operation, so it is prudent to learn how those circuits work. Such simple networks can be used to form timers, multi-vibrators, oscillators, alarms, and a host of other practical, well-behaved circuits.

**From the Beginning.** Consider Fig. 1. Assume that switch S1 is in position A so the circuit is open, as shown, and there is initially no charge stored in capacitor C (i.e.  $V_C = 0$ ). If switch S1 is moved to position B, voltage V is applied to the RC network. The capacitor begins to charge through resistor R with current from the battery, and  $V_C$  begins to rise towards V (see curve  $V_{CB}$  in Fig. 2). Electronics textbooks tell you that the instantaneous capacitor voltage is found from:

$$V_C = V(1 - e^{-t/RC})$$

Where  $V_C$  is the instantaneous capacitor voltage, V is the applied voltage from the source, t is the elapsed time (in seconds) after charging begins, R is the resistance in ohms, and C is the capacitance in farads. That equation isn't in its most useful form for circuit designers; it merely describes the action of such circuits.

The product "RC" in the above equation is called the RC time-constant of the network, and is often abbreviated T (in which  $T = RC$ ). If R is in ohms, and C is in farads, then T is specified in seconds. The capacitor voltage rises to approximately 63.2% of the final value after

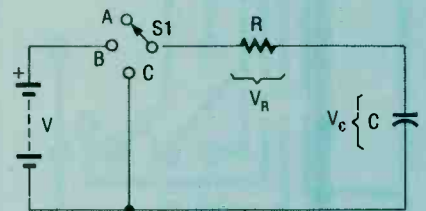

Fig. 1. Depending on the position of S1 the capacitor will either do nothing (A), charge (B), or discharge (C).

1RC, 86% after 2RC, and over 99% after 5RC. A capacitor in an RC network is considered to be "fully charged" after five time-constants of time have passed, by definition.

If switch S1 is then set to position C, the capacitor will begin to discharge through the resistor. Textbooks tell us that during discharge, the instantaneous capacitor voltage is:

$$V_C = Ve^{-t/T}$$

Voltage  $V_C$  drops to 36.8% of the full charge level after one time constant (1RC), and to very nearly zero after 5RC.

**Determining Values.** Now that we've seen both of the equations commonly published in electronics textbooks, let's take a look at one that's published in



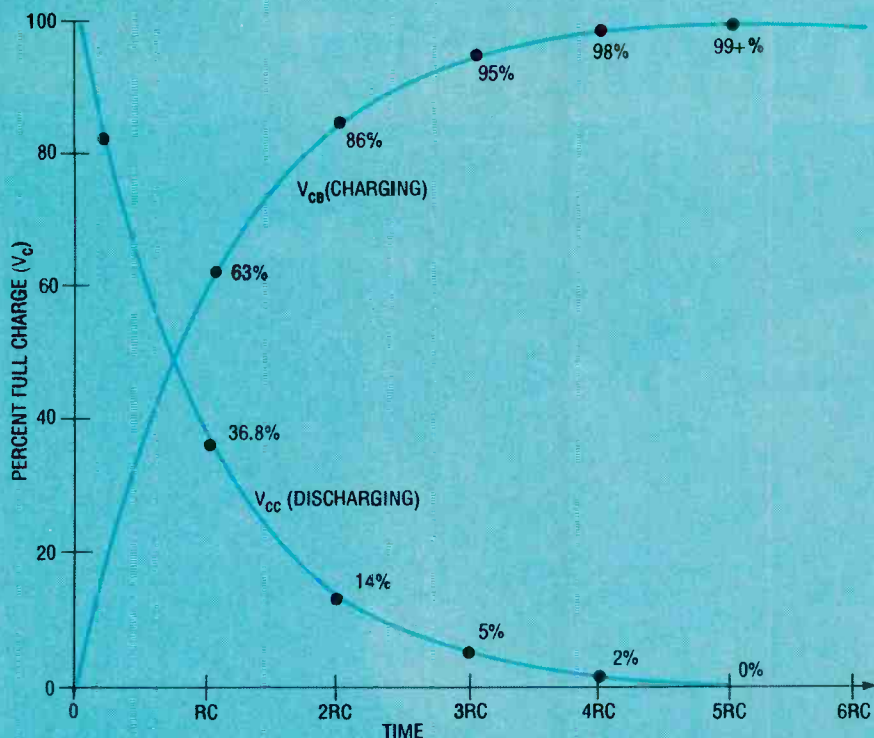
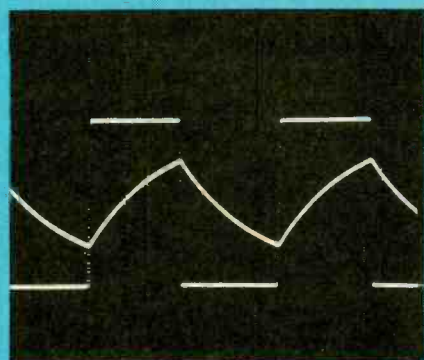

Fig. 2. A capacitor initially charges and discharges quickly, but the change in its voltage decreases as time goes on. A capacitor is said to "fully" charge or discharge after 5 time constants, although that is not really the case.

only a few (but that's a lot more useful). First look at Fig. 3. In the graph the capacitor is required to charge from some initial voltage ( $V_{C1}$ ), which may or may not be 0 volts, to a final voltage ( $V_{C2}$ ), which may or may not be the "fully charged" voltage, in a specified



This is an actual oscilloscope trace of an RC timing circuit in action. The square wave is the circuit's output, while the somewhat ungraceful curve shows the charging and discharging of the capacitor.

time interval,  $t$ . With that information let's determine what RC time constant will force  $V_{C1}$  to rise to  $V_{C2}$  in time  $t$  with applied voltage  $V$ . Assuming that  $V_{C1} < V_{C2} < V$

$$V - V_{C2} = (V - V_{C1})e^{(-t/RC)}$$

or, after a little algebra:

$$RC = -t / \ln[(V - V_{C2}) / (V - V_{C1})] \quad (1)$$

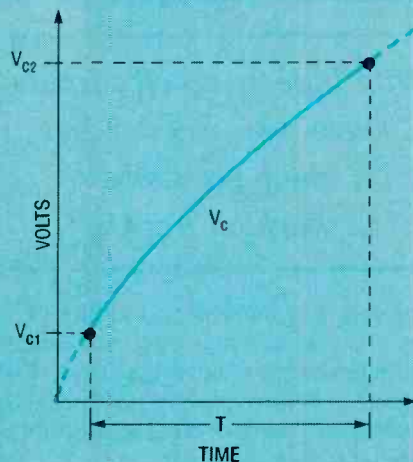

Fig. 3. This is an actual situation encountered in real circuits: The capacitor will charge from some initial voltage to some final voltage in time  $T$ .

The last equation tells us the time-constant required to make the transition from the initial voltage to the final voltage in time  $t$ .

Let's try answering a simple question to show us how to use Equation 1. Assume an RC network (like the one in Fig. 1) is connected to a 12-volt source. What RC product will permit capacitor voltage,  $V_C$ , to rise from 1 to 4 volts in 200 ms? From the way the question is phrased we know that:  $V = 12$  volts,  $V_{C1} = 1$  volts,  $V_{C2} = 4$  volts, and  $t = 0.2$  seconds. Plugging those values into Equation 1 we get:

$$\begin{aligned} RC &= -0.2 / \ln[(12 - 4) / (12 - 1)] \\ &= -0.2 / \ln[8/11] \\ &= -0.2 / \ln[0.727] \\ &= -0.2 / -0.319 \\ &= 0.627 \text{ seconds} \end{aligned}$$

Equation 1 can be used to derive the time delay or frequency of many different RC-based waveform-generator circuits. The key voltage levels ( $V_{C1}$  and  $V_{C2}$ ) will, most often, be trip points or critical voltages in the circuit you wish to design. Now that we understand the math of such timing circuits, let's look at a practical circuit: an operational-amplifier square-wave generator.

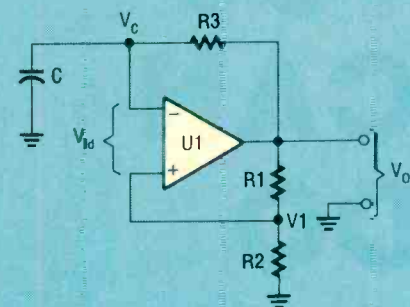

Fig. 4. The op-amp output indirectly charges  $C$  until its inverting input voltage becomes too high. Then the op-amp goes low and discharges  $C$  through  $R3$ .

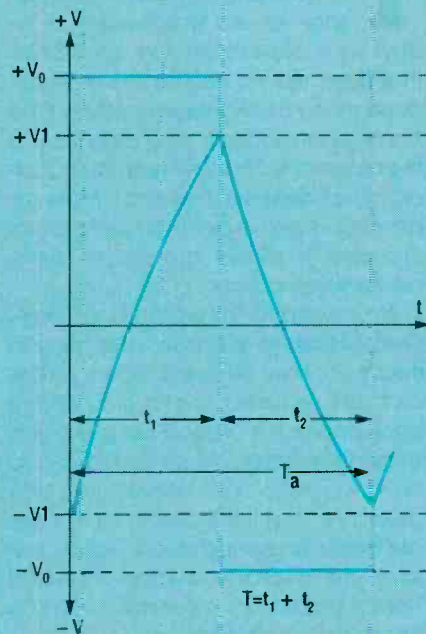

Fig. 5. The square-wave output of the op-amp remains high for  $t_1$  seconds and goes low for  $t_2$  seconds. That means the total period is their sum.

**A Square-Wave Generator.** Figure 4 shows the usual textbook circuit for an astable op-amp square-wave generator. The op-amp is used as a voltage comparator in the circuit and is

(Continued on page 108)



# Simple Turntable Repairs That YOU CAN DO

BY HOMER L. DAVIDSON

**T**he record player has been around since the last days of Edison—an era which many of today's youth view as the dark ages. Since that time, record players have undergone many changes; progressing from the original manually operated type to the automatic changer (with auto shut-off, direct-drive systems, etc.). More recently, linear-tracking units have claimed a place alongside high-powered amplifiers.

But no matter how simple or complex, turntables all have one thing in common: they all break down. Often, all that's required to put a turntable back on track is a good cleaning and some lubrication. At other times, you have to roll up your sleeves and play detective. And it is those times that we are most concerned about. So let's see what the average audiophile—with limited electronics know-how—can do to correct the situation.

**Clean Up.** One of the most common problem generators for electronic equipment is dust and dirt—not the stuff that collects on the surface, but the debris that gathers on the chassis. To clean those areas, the turntable must be removed from its mount. Most turntable platters can be removed over the top spindle. With the turntable re-

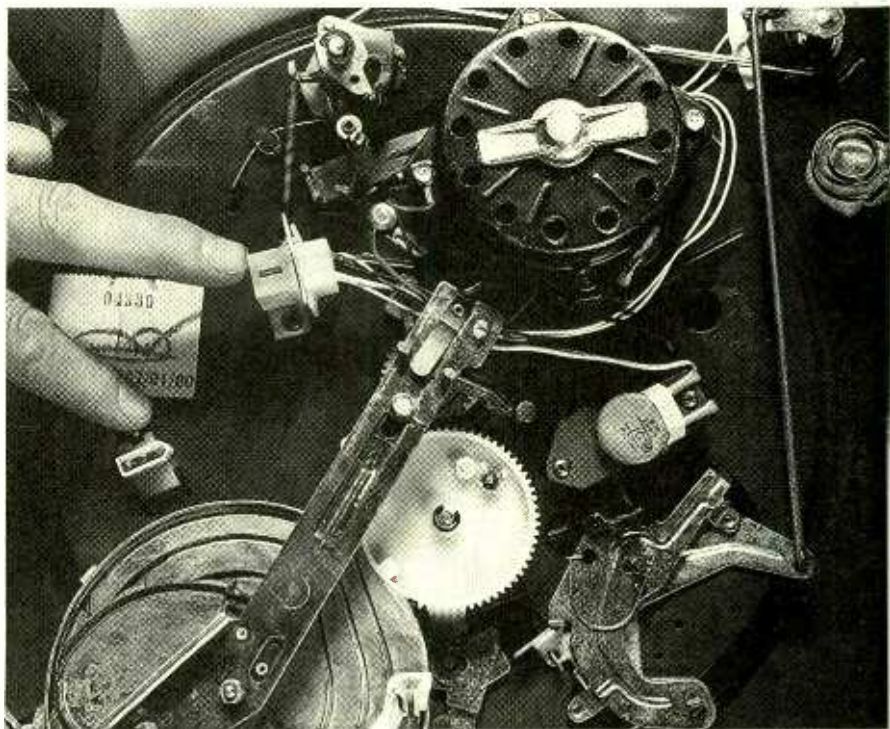

---

*With little or no electronics know-how, you can put your turntable back on track!*

---

moved, adjustment and lubrication may be easily performed. And aside from the dust and dirt that's likely to be found, you may also find coins, gum wrappers, strands of hair, excess rubber from the drive pulley, etc.

So the first task on the road to putting the unit back on track is to brush away all dust and remove residue from the top pan of the changer. Use window spray to clean up the outside parts of the changer, making sure to wipe all excess spray and oil from the moving pulleys and parts. The rim of the turntable should also be wiped clean with an alcohol-moistened cloth.

Clean up the center spindle. Be careful not to pull or break off any phono-cartridge connecting wires.

**Motor Rotation.** Listen for the sound of turntable motor rotation. The motor may be rotating with no movement of the turntable. In such cases, look for a broken drive belt, or slippage due to

lost elasticity in that belt (more on that later). If the motor fails to rotate when power is applied to the turntable, suspect a poor connection, defective changer switch, or dead motor. Rotate the motor pulley by hand to see if the motor takes off.

Make sure that the motor and phono plugs are pushed all the way in if the motor is not rotating. Remove the motor plug, disconnect the AC plug, and take a resistance measurement of the motor windings. Make sure the winding has good continuity (the motor resistance is very low and will vary with type). Also check the resistance across the motor switch.

To make sure you have the right connections, bare the connecting wires, and check the continuity between the switch contacts and bared ends of the wire. After determining whether the switch or the motor winding is open, tape up the bare spots, and replace the defective components. If the unit is not too old, replacement parts can be obtained through the dealer and manufacturer's depots.

Slow speeds may be caused by a defective belt, worn idler wheel, oil on drive surfaces, and/or a gummed-up motor. First clean up all moving parts, and power up the unit to see if the problem has been corrected. If not, in-





Here is a linear-tracking automatic turntable where the arm tracks electronically across the record.

spect the belt for worn or cracked areas. Wipe off the inside rim of the turntable. Replace the idler wheel if worn.

Place a drop of light oil on the bearing. Check the hub bearing for sticky grease buildup and clean, if necessary, with an alcohol-treated cleaning stick. If, after replacing the idler wheel, the turntable speeds are not quite up to par, suspect a sluggish motor. First brush a coat of liquid rosin onto the inside rim of the turntable and let dry. If the speed shows no sign of improvement, clean the motor bearings, and check the speed-selection control and associated circuitry for additional motor-related problems.

**Belts and Pulleys.** Like the human body, the turntable drive belt develops bulges, cracks, and worn areas. Check for a broken drive belt when there is no turntable rotation. Clean any gunk from the belt and motor pulley rotating surfaces with an alcohol-moistened cloth. Check the drive belt for loss of elasticity, which can cause the belt to slip.

Inspect the motor and pulley areas for bits of rubber and/or shiny or worn areas, indicating belt slippage. Notice whether the belt is riding high on the motor pulley. A turntable turning too fast may result from the belt riding high on the rim or raised area of the motor pulley.

Replace the belt if it has lost its elasticity, or has cracked or broken. To measure the belt for a replacement, hold the ends together and lay the belt flat (folded in half) along side a ruler. When selecting your new belt, purchase one that's about a 1/4-inch shorter than the measured length.

**No Speed Change.** When a turntable does not change speeds, suspect a broken, loose, or bent lever link. Inspect the shaft and cam area. Sometimes the idler-wheel assembly cannot rise when the cam area is gummed up. Remove the idler wheel assembly, remove the

gunk with a cleaning spray, and apply a drop of oil to the bearings.

Apply light grease or phono lube to the cam area. Always clean away excess fluid with alcohol and a cleaning stick; use an alcohol-moistened cloth to wipe off the idler-wheel drive area.

If the turning speed does not change, suspect that the belt lever is not raising or lowering to change the speed of the unit. Move the arm lever

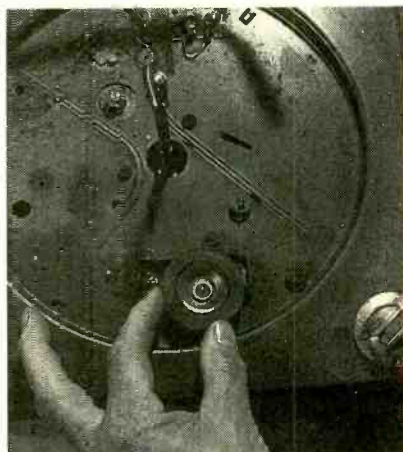

Inspect the idler wheel for worn or slick parts on the rubber tire area. replace with the same rubber size and hole diameter.

up and down to see if it travels freely. Notice if the arm raises when the speed selector is changed to 45 rpm; the speed lever will raise or lower the belt to alter the speed from 33 1/3 and 45 rpm. The belt is placed on the smaller motor pulley, at the top, for slower speeds; or on the larger pulley for the fast speed.

**Won't Shut Off.** The turntable may continually rotate in an automatic changer when the arm does not come

over and shut off the motor. With a direct-drive turntable, the arm may come over and set down on the arm rest, but the turntable may not shut off. If the turntable is left on overnight, the motor bearings may overheat and the motor armature might freeze, burning up the phono motor.

Check for a defective on/off switch; its contacts may burn open or the lift lever may not be engaging the on/off switch (the lever might be bent out of line). If bent, remove and straighten it. If the lever isn't bent, rotate the turntable by hand and check to see if the lever touches the shut-off switch assembly. If the lever engages the switch assembly, but does not shut off the motor, suspect that the switch is defective.

**Motor Problems.** A motor may have worn or sluggish bearings, burned coils, and frozen or noisy bearings. Suspect frozen bearings when you cannot twirl the motor shaft by hand. Check the motor winding for burned areas. Some-



Replace the rubber drive belt with one that's a 1/4-inch smaller than the old belt. Fold it or combine the pieces along side the roller for correct size.

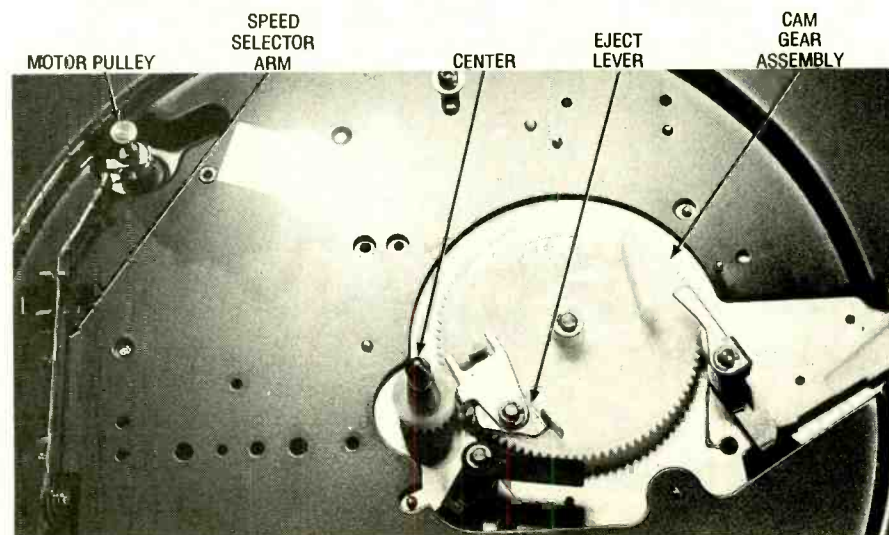

Check the lift or speed-selector arm of the belt assembly to see if it raises the belt to the high and low area of the motor pulley. Check for a bent lever.



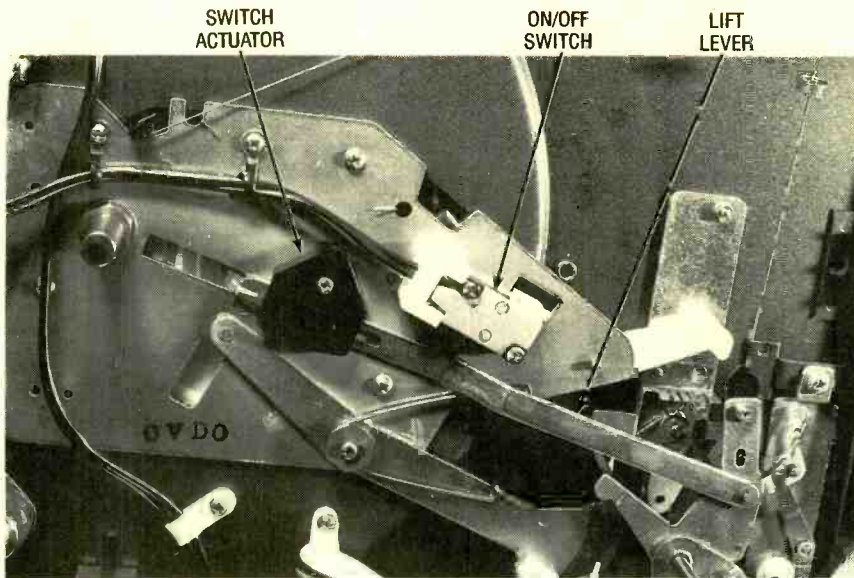

Rotate the turntable by hand and notice if the lift lever moves the on/off switch in turn on or shut off position. Check for a bent lever or broken AC switch.

times you can save motors by taking them apart, washing out bearings and properly lubricating them before reassembly.

The motor must be replaced if the bearings show signs of excessive wear or if it has burnt field coils. (Call for an estimate before ordering one; motors can be very expensive.) Remove the "C" washers holding the motor to the flexible mounting area. Take the motor apart and lay the parts in line so you know where each piece goes.

Clean the armature shafts with an alcohol-moistened cloth. Spray cleaning fluid inside the bearings and remove any debris with a cleaning stick. Often you'll need several attempts to completely remove residue, dirt, or grease. Before replacing the armature,



This portable turntable motor has a separate winding to power the audio amplifier. The motor acts as a transformer and the AC voltage is full-wave rectified.

place a couple of drops of oil inside the motor bearings.

Motor-noise problems are often caused by a lack of lubrication, and can be eliminated by applying a small amount of oil to the motor bearings. In direct-drive turntables, the motor is often of the DC type, and is controlled via potentiometers—often a thumb adjustment at the bottom of the unit's enclosure.

Measure the voltage at the motor terminals with no motor rotation. Suspect a power supply supply if an improper voltage level is found there.

**Wow and Flutter.** Erratic or intermittent speed may cause "wow or flutter" in the audio output of the unit. Check for warped records causing a slippage in a stack of records. Inspect the motor for a bent shaft, a worn belt, or oil on the idler wheel. Oil or a worn belt may produce uneven speeds. Check whether the idler wheel is intermittently riding on the 45 rpm motor shaft in the 33½ rpm setting. Check the tension spring on the intermediate or idler wheel.



Notice if the arm keeper is locked over the pickup arm when it will not play or reject. Also check for a broken lever.

**Tonearm Assembly.** If the turntable won't eject, check the lever attached to the bottom pivot post of the tonearm that comes over and pushes the trip lever. The trip lever is supposed to activate a panel-type lever on the gear cam. When the panel lever strikes the hub of the turntable, the arm is returned to its resting post, where it remains until the unit shuts off.

If the pickup arm is not adjusted properly, it may travel too far and not engage the panel lever. Often, the small catch on the trip lever gets bent out of line or it may not touch the trip. Grease is another possible problem generator. If the trip lever gets bogged down in grease, it may not reach the trip assembly. Move the pickup arm by  
(Continued on page 96)

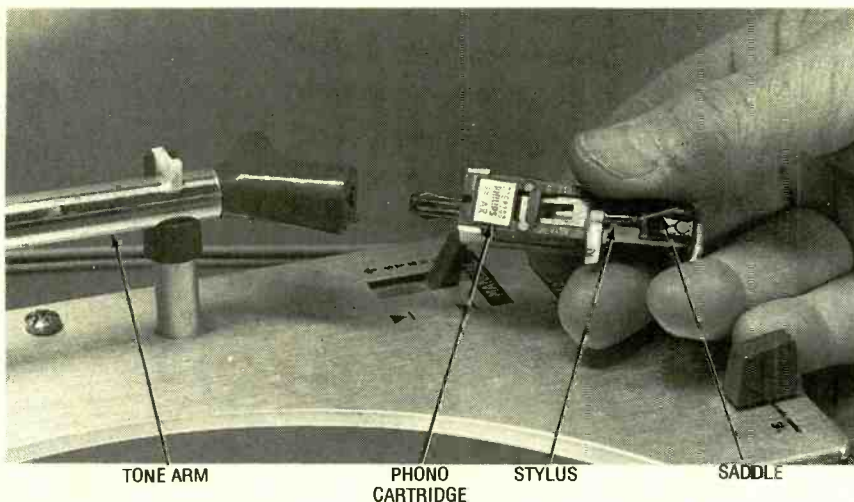

Make sure the stylus is riding in the saddle area of the cartridge. Do not place pressure on the saddle or the crystal may be damaged.



# THE DIGITAL ELECTRONICS COURSE

## A NEW WAY TO COUNT

Explore the binary number system for yourself  
by following this hands-on training exercise

BY JOHN YACONO

**D**igital logic circuits use voltages to represent numbers in a number system called *binary*. In the binary system there are only two digits (called binary 1 and binary 0). In fact "binary" literally means "two numbers" in Latin. Logic circuits use two voltage ranges to represent those digits, one range for a binary 1 and another for binary 0. The two logic *states*, as they are called in electronics, are given various names, including on and off, yes and no, true and false, high and low, 1 and 0, etc.

The word "bit" is an abbreviation for *binary digit*, and it means a *single* binary digit (either a binary 1 or binary 0). Groups of bits can be used to represent numbers greater than 1 in binary. If you have N bits you can represent  $2^N$  numbers in binary.

In computer terms, a set of four bits taken together is called a *nibble* and a group of eight bits is called a *byte*. The groups of bits can be used in many ways. In computers, they are used to store data. In a computer's memory, pieces of information such as numbers, letters, special codes, etc., are stored in binary form.

Computers also do math in binary.

\*Our gratitude is extended to the EIA/CEG for the creation of this course, especially to the consultants who brought it to fruition: Dr. William Mast, Appalachian State University; Mr. Joseph Sloop, Surry Community College; Dr. Elmer Poe, Eastern Kentucky University.

translating the results to decimal form before we see it. Computers even keep track of where data is stored by using binary codes called *addresses*. Computers make use of addresses just the way we humans do; they use them to indicate where something can be found or where to send something.

**Counting.** Let us learn about the binary-number system by learning to count in binary. When we count in decimal, we start at zero and proceed in order through the digits until we come to the last digit, 9, and then we carry on the process by resetting the ones digit to zero, and carrying a 1 into the next (tens) column. The digit in the ones column (called the least-significant digit) then progresses as before until 9 is reached again. There are only two numbers in binary, so counting in binary you would start at binary 0, progress to binary 1, and then, since you've run out of digits, you'd reset the least-significant digit back to binary 0 and carry a binary 1 into the next column.

There is another numbering system in common use today called *hexadecimal*, or *hex* for short. Hex is used to help humans analyze what is taking place in a digital circuit and is not used by digital equipment itself. Unlike binary, the hex system has *more* digits than the decimal system; 16 in all.

Hex is represented by numbers 0 through 9 and letters A through F.

Counting is similar, but instead of carrying a digit after you count to 9, you go on to A, B, C, etc. You only get two-digit numbers after you've reached the "number" F; for example, 1A would be the next higher number after F. Of course there are many number systems possible, but decimal, binary, and hex are among the most commonly used today.

**Conversion.** Each digit of a number in decimal mathematics represents some multiple of the power of ten. The position of the digit tells us what power of ten to multiply it by. The right-most or least-significant digit is multiplied by ten to the zero power, the next digit to the left is multiplied by ten to the one, and so on.

When the multiples are added, they are equal to the number we wish to represent. For instance, we can say that the number 6791 is the sum of the following:

$$6 \times 10^3 = 6000$$

$$7 \times 10^2 = 700$$

$$9 \times 10^1 = 90$$

$$1 \times 10^0 = 1$$

Of course that is:

$$1 + 90 + 700 + 6000 = 6791$$

Since all the numbers are based on some power of ten, ten is called the "base" of the decimal number system.



In binary, the base is the number two, so if you had to write the binary number 1101 in decimal form, you could convert the number as follows:

$$\begin{aligned} 1 \times 2^3 &= 8 \\ 1 \times 2^2 &= 4 \\ 0 \times 2^1 &= 0 \\ 1 \times 2^0 &= 1 \end{aligned}$$

The binary 1's and 0's tell us what powers of two, when summed together, will equal the desired value. Summing to get the final result yields:

$$8 + 4 + 0 + 1 = 13$$

Converting numbers from decimal to binary is a bit more involved than that. There are many methods of converting decimal numbers to binary, most of which are either long-winded or require some practice to get used to. The approach we'll discuss will fall somewhere in the middle. To sum up the procedure:

1. Find the highest power of 2 that is less than or equal to the number in question.
2. Subtract it from the number in question.
3. Go back to step 1 until your result is zero.
4. Starting with the highest (first) power you used, write a 1 for each used power and a 0 for each power you did not use. The result will be the binary equivalent of the number you started with.

To start, you'll need a little familiarity with the powers of two. The powers of two can be quickly written down if you remember that they are nothing more than the numbers you would get if you start with one, double it, then double its result, then double that, and so on. You'll get a list that goes: 1, 2, 4, 8, 16, 32, etc.

Notice that the numbers are all powers of two in size order:  $2^0, 2^1, 2^2, 2^3, 2^4, 2^5, 2^6$ , etc. If you list the powers of two before you start converting, it will help the procedure move very quickly.

Let's take the number 243 for example. Starting with step 1, we must find the largest power of two less than or equal to 243. That would be 128, which is  $2^7$ . That tells us that  $2^7$  is a part of the sum which will make up 243 in binary. Moving on to step 2, we now subtract 128 from the 243 to find out what other powers of 2 are summed to make up 243:

$$243 - 128 = 115$$

Now we perform the same two steps

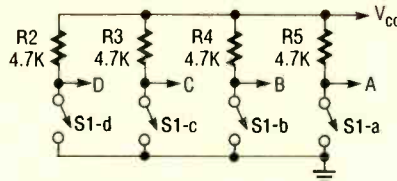

Fig. 1. This bank of switches can simulate the on/off states of four bits.

for the number 115 as we did for 243. The largest power of two less than or equal to 115 is 64, so  $2^6$  also makes up a part of 243 (as well as 115). Subtracting as before yields:

$$115 - 64 = 51$$

The highest power of two less than or equal to that is  $2^5$  (or 32), and when we subtract that from the new result we get:

$$51 - 32 = 19$$

Of course, 16 is less than that, so  $2^4$  makes up a part of 243 in binary. Subtracting as before, we get:

$$19 - 16 = 3$$

The next-highest number in the progression is 2 or  $2^1$ , so we subtract 2:

$$3 - 2 = 1$$

Notice that we had to skip the second and third powers. The place of those powers will be held by a zero, as you will see. To put it another way, we could say that  $0 \times 2^2$  and  $0 \times 2^3$  help make up the number 243. Since 1 is the only number in the series less than or equal to our last result,  $2^0$  (which is 1) must also make up 243, so:

$$1 - 1 = 0$$

Now we know what powers of two are used to make up 243. Moving on to step 3, if we write a 1 for each used power of two and a 0 for each unused power, starting with  $2^7$  and ending with  $2^0$ , we'll get 11110011. That is the binary equivalent of 243. To prove that to yourself, multiply each bit by its corresponding power like we did when we

The Digital Microprocessor Course is reprinted here with the permission of the Electronic Industries Association/Consumer Electronic Group (EIA/CEG). The complete parts kit is available from EIA/CEG. For further information, contact EIA/CEG Product Services Department, 1722 Eye Street, NW, Suite 200, Washington, DC 20006; or call 202/457-4986.

converted a binary number into decimal:

$$\begin{aligned} 1 \times 2^7 &= 128 \\ 1 \times 2^6 &= 64 \\ 1 \times 2^5 &= 32 \\ 1 \times 2^4 &= 16 \\ 0 \times 2^3 &= 0 \\ 0 \times 2^2 &= 0 \\ 1 \times 2^1 &= 2 \\ 1 \times 2^0 &= 1 \end{aligned}$$

If you now sum the results together you'll get 243.

**Data Representation.** Simply speaking, a digital circuit is a combination of switches, each of which is either on or off. The switches are really transistors that operate in the saturated (on) state or cut-off (off) state. If a switch is on, it is said to represent a 1; if a switch is off, it is said to represent a 0.

The speed of a digital system depends to a large extent on how fast a transistor can make the transition from a saturated to a cut-off state, and vice versa. Bipolar transistors can make the transition faster than MOS (Metal-Oxide Semiconductor) transistors; therefore TTL (Transistor-Transistor Logic) chips, which contain bipolar transistors, are inherently faster than CMOS (Complementary Metal Oxide Semiconductor) chips. However, CMOS chips are very popular because they consume little energy, they aren't picky about their

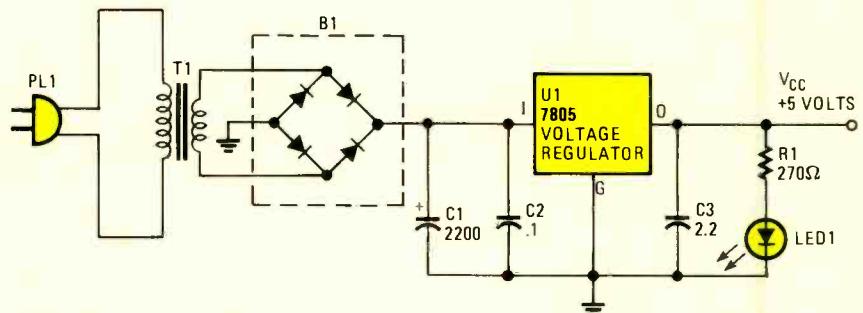

Fig. 2. You will need to build this power supply before proceeding with the experiment.



TABLE 1—NUMBERS AND SWITCHES

Decimal	Hex	D	C	B	A	D	C	B	A
0	0	0	0	0	0	closed	closed	closed	closed
1	1	0	0	0	1	closed	closed	closed	open
2	2	0	0	1	0	closed	closed	open	closed
3	3	0	0	1	1	closed	closed	open	open
4	4	0	1	0	0	closed	open	closed	closed
5	5	0	1	0	1	closed	open	closed	open
6	6	0	1	1	0	closed	open	open	closed
7	7	0	1	1	1	closed	open	open	open
8	8	1	0	0	0	open	closed	closed	closed
9	9	1	0	0	1	open	closed	closed	open
10	A	1	0	1	0	open	closed	open	closed
11	B	1	0	1	1	open	closed	open	open
12	C	1	1	0	0	open	open	closed	closed
13	D	1	1	0	1	open	open	closed	open
14	E	1	1	1	0	open	open	open	closed
15	F	1	1	1	1	open	open	open	open

supply voltage, and they don't load down the circuits to which they are connected. However, there are some high-speed CMOS devices on the market now and improvements in CMOS speed are being made all the time.

In place of transistors, a DIP (Dual Inline Package) switch can be connected as shown in Fig. 1 and its on/off states used to represent a binary number as follows: When a switch is open, no current flows through its corresponding resistor, and without current flow there can be no voltage drop across the resistor. That means that both its sides must be at the same potential, so the switch output will be at  $V_{CC}$ . But when the switch is closed, the output sinks to ground for obvious reasons. The on/off states that the switch generates is just like the fully-on/fully-off action of a transistor.

If  $V_{CC}$  is used to represent a binary 1 and ground is used to represent a bin-

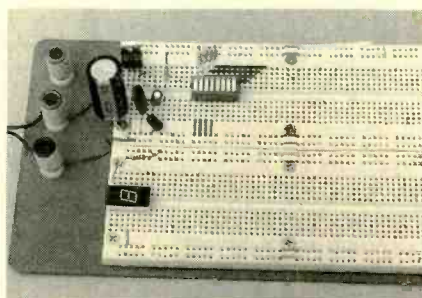

The layout of the circuit was made like this to save space and to mimic the schematic diagram in Fig. 1.

ary 0, then the voltage at each switch output can be used to represent the value of a bit. Another common way of putting that is to say that the switch "contains" or "holds" a bit. So, four switches can be used to contain a nibble (four bits) and the many combinations of on and off states possible with those switches can be used to represent 4-bit numbers in binary. In Table 1, the MSB (Most-Significant Bit) is represented by switch D, and the LSB (Least-Significant Bit) is held by switch A. For the four-switch circuit shown  $2^4 = 16$  combinations are possible. So the switches can represent numbers 0 through 15 in binary. If you doubt that, count to 15 in binary as described earlier and check each binary value against the value in Table 1. (Remember to start at binary 0.)

**Procedure.** If you've just started the series, you must build the power supply specified for a previous experiment before you can proceed with this one. It is shown in Fig. 2.

The circuit should be built on a breadboard. You will be required to keep some of the circuits (including this one) on the board for the following experiments, so good wiring practices are

TABLE 2—SWITCH TESTS

Setting	D	C	B	A
All Switches Down:	—	—	—	—
All Switches Up:	—	—	—	—

a must to conserve space.

Strive to keep all leads and wires short and direct or they may interfere with troubleshooting. Also, do not place wires over IC's. Replacing an IC that is buried under a pile of wires is not something you would look forward to doing. Further, you can end up making a lot of mistakes while rewiring the mess you've made.

Along with the parts in the Parts List, you will also require a multimeter to perform some of the steps. If you do not have one, you can't read the voltages in the circuit; but if you have a logic probe and know how to use it, you can at least check the logic levels.

Note: For those who have neither of the instruments mentioned above, it might be in your best interest to build the Digital Logic Probe and Logic Pulser presented elsewhere in this issue of **Popular Electronics**. While the pulser is not needed at this time, it will come in handy in the future, when you will be required to build and operate some of

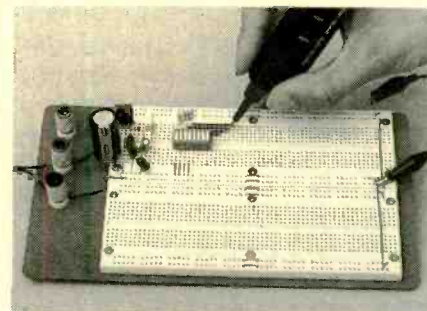

A logic probe was used to check the switches for highs and lows, but you can use a simple voltmeter or LED if you wish.

the circuits presented. A logic probe is a device specifically designed to monitor logic levels at the input and output of digital circuits; its lesser-known cousin, the logic pulser, is simply a signal injector for digital circuits.

Even if you have neither (and choose not to build either of the units mentioned above), you can still get a lot of electronic-wiring and -math experience from the experiment by skipping the monitoring procedure.

- Position the DIP switch on the board close to the power supply, and connect one side of each of four switches to ground (refer to Fig. 1).

(Continued on page 100)

**PARTS LIST FOR THE BINARY EXERCISE**

- U1—7805 5-volt, 1-amp, voltage regulator, integrated circuit
- B1—2-amp, 50-PIV, full-wave bridge rectifier
- LED1—Light-emitting diode
- R1—270-ohm, 1/4-watt, 5% resistor
- R2-R5—4700-ohm, 1/4-watt, 5% resistor
- C1—2200-μF, 15-WVDC, electrolytic capacitor
- C2—0.1-μF, 50-WVDC, ceramic disc capacitor
- C3—2.2-μF, 15-WVDC, tantalum capacitor
- T1—6.3-volt, 1.5-amp, power transformer
- S1—SPST 8-station DIP switch
- PL1—AC line cord
- Breadboard, ohmmeter, and No. 22 wire





# Antique Radio

By Marc Ellis

## SOLVING THE "WASP'S" WORST PROBLEM

This month, we continue a project that was begun two months ago in the July issue: the study and restoration of a *Pilot A.C. Super-Wasp* receiver. Actually, "restoration" might be too strong a word. As I received it, the set was in excellent cosmetic condition and virtually complete. All it seemed to need was checking, cleaning, and correction of a few problems.

The most serious problem I've encountered so far is a tuning capacitor that was modified by an early owner and thus needed to be replaced or rebuilt. This month, I'll report on how that difficulty was overcome. But first, let's do a quick flashback for readers who may not have seen the earlier columns.

The *Pilot A.C. Super-Wasp* is a 1929-vintage set that was sold only in kit form. It is a 4-tube, 5-band regenerative receiver designed for operation from the AC power line. Essentially an update of an earlier battery-operated model (the *Pilot Wasp*), the set embodies a fascinating mixture of older and newer technologies.

In the last couple of columns, we explored the the history of this most interesting radio—a product of the *Pilot Radio and Tube Corporation* of Brooklyn, NY. We also gave the set a thorough inspection, reporting on some of its unusual construction features and on the few problems that would need to be corrected.

**Why a Gap-Toothed Capacitor?** I didn't notice it right away, but near the end of my initial inspection of the radio it dawned on me that the antenna-tuning capacitor had a strange gap-toothed look. On closer inspection, it turned out that four of the original six plates had been removed from the rotor. In addition, an extra variable capacitor, mounted near the top of the RF amplifier's shield can, was wired in parallel with the antenna capacitor.

Since the set's schematic diagram in-

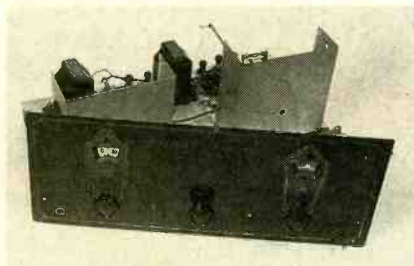

*Separating the Wasp's front panel from the chassis was a bit of a bear! Capacitor to be repaired was removed from U-shaped enclosure at upper right.*

dicated that both the antenna-tuning capacitor and the RF amplifier stage's plate-tuning capacitor should be the same size, I knew that I was looking at a modification. The latter capacitor, otherwise identical to the antenna capacitor, is a stock model that has all of its plates intact. On top of that, the extra, shield-mounted capacitor does not appear on any early magazine photos of the radio.

I believe that the clue to that modification can be found in some advertising copy for the *Universal Super-Wasp Receiver* (which replaced the *A.C. Super-Wasp*), quoted in the July column. The copy stated that the original *A.C. Super-Wasp* (with its simpler, easier-to-modify construction) would continue to be made available for those "... who want to spread the tuning range on their pet wave bands and add their own audio features."

After the modification, then, the extra capacitor probably served as a "band-set" control that could be roughly tuned to the frequency range of interest. Fine tuning would be accomplished using the cut-down antenna capacitor—now functioning as a "bandspread" control and providing greater station separation than possible with the original system.

Though the modification had been carefully done, and was probably a very typical one, I decided to reverse it.

When the time comes to test the radio, I'd like it to be as close to stock condition as possible. The set would be worth more that way, and it would certainly be more fun to use without the complication of having to operate an additional control that's located inside the cabinet.

**Getting at the Capacitor.** At the outset, I wasn't too sure how I was going to reverse the modification. But, since I obviously wouldn't be able to get very far without removing the stripped-down capacitor, I decided to go for that first. It turned out to be a fairly difficult undertaking.

The capacitor was hemmed in by components that had been installed and wired behind it. That made it impossible to remove the capacitor by simply dismounting and disconnecting it. It wouldn't be possible to slide the unit back far enough so that its control shaft could clear the mounting hole.

The best bet seemed to be to remove the front panel. That would make it possible to remove the shield-can assembly on which the capacitor was mounted—and through which the control shaft passed. Then, with its leads disconnected, the capacitor could easily be slid out of the set.

The problem with removing the front panel centered on the eight screws holding the panel to the chassis. I don't know what made those simple 6-32 screws so difficult to loosen. It's true that there was a lockwasher behind each nut, but that in itself wouldn't account for the difficulty.

Perhaps the original kit instructions cautioned the builder to get the screws extra tight so as to achieve good electrical bonding between the metal panel and the chassis (and hence good shielding against the hand-capacity effects that typically made this type of set so difficult to tune). Or maybe it was some mild internal corrosion in the threads that made it so difficult to back the screws out of the positions that they had maintained for 60 years. Maybe both.

What made the problem worse was that the screwheads had a dark finish to blend in with the color of the front panel. A slipping screwdriver—even if it didn't actually chew up the slot in the screw—could easily scratch the finish, exposing bright metal beneath. And almost to a one, the nuts behind the screws were located in such tight spots that it wasn't possible to get a straight-





*Here's how the capacitor looked after being dismantled for rebuilding. Frame is at upper left; stator at right; rotor (with most of its plates missing) is in foreground.*

forward grip on them with a nutdriver or pair of pliers.

I found that I could get the most secure grip on a screw by using a stubby screwdriver whose blade was a good fit for the slot. The short handle made it easier to apply inward pressure while attempting to turn the screw—minimizing the chances of the blade slipping and causing scars. By exerting firm, steady pressure in this manner, and by not trying to hurry the process, I was able to loosen more than half of the screws.

When a screw wouldn't budge, I went for the nut instead—using needle-nose pliers to get the best possible grip on it and not worrying about leaving scars. No harm in replacing chewed-up nuts with contemporary types; they don't show anyway. In that way, I was able to loosen all of the remaining screws enough so that they could be backed out. And I'm happy to say that I managed to avoid significant damage to any of the screwheads.

With the panel off, the shield assembly was easily removed, and I soon had the capacitor out of the radio. In the process, though, I noticed that the rubber covering of the hook-up wire used in the construction of the set had become dry and brittle. If a wire was disturbed, its insulation would crack and fall off. Luckily, I didn't have to disturb too many of those wires. About the only ones I had to deal with were the power leads for the dial lights mounted on the front panel.

For a truly meticulous restoration, all of the original wiring should probably be removed (after making careful sketches of its layout) and replaced with new material of the same type. Not having that kind of time, however, I plan to take the lazy way out and replace only what I damage. I may live to regret

that move. If so, maybe I can take on the rewiring project after reaching retirement age!

**Fixing the Capacitor.** Correcting the problem with the capacitor turned out to be almost easier than getting the capacitor out of the radio. Examining the rotor assembly, I saw that the brass plates were very easy to remove and replace. They're held in place only by friction; the U-shaped openings at their hubs are press-fitted into matching slots

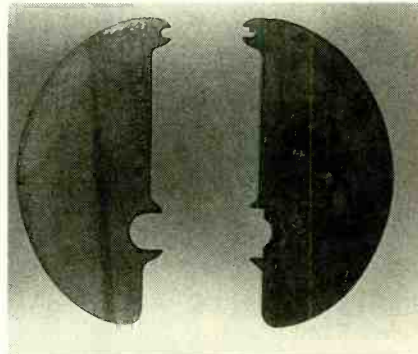

*Rotor plate (left) removed from Pilot 3-gang capacitor was identical to rotor plate (right) used in Wasp capacitor, except for having wider and shallower hub opening. A little file work minimized the difference.*

on the rotor shaft. Each plate also has a much smaller U-shaped opening at one end. That opening is pressed into one of the matching slots in a comb-like cylindrical separator that helps maintain proper plate separation and alignment.

At first I toyed with the idea of getting some sheet brass of the proper thickness and, using an old plate as a pattern, cutting out the necessary new plates. I finally rejected that approach, though, because I felt that my fairly limited metal-working skills wouldn't be up to the task.

Plan "B" was to check my junkbox for a capacitor with similar specifications that might be substituted for the cut-down unit. I thought I might have something that—if not manufactured by Pilot—would at least be from the right era. What I actually *did* find, though, was something even better!

I discovered a partially dismantled chassis of a home-made radio from about the same era as the A.C. Super-Wasp. I'd picked it up at a flea market several years ago and hadn't looked at it since. Mounted on the chassis was a 3-gang Pilot variable capacitor whose plates looked like duplicates of the

ones I needed. Quickly removing one, I compared it with one of the remaining plates on the Wasp's stripped-down capacitor.

Sure enough, the outlines were virtually identical. But the *bad* news was that the hub openings of the plates from the junkbox were wider and shallower than those of the plates from the Wasp. They wouldn't fit into the slots on the shaft.

That problem turned out to be fairly easily solved, however. Using an original plate as a template, I pencil-marked the hub area of the replacement plates to show where material should be removed to get the best possible match. That would at least enlarge the hub opening to the proper depth. A few strokes of a rat-tail file did the job, and I now had a set of plates that would seat properly on the shaft of the Wasp's capacitor.

They didn't seat tightly, since they were being gripped only near the bottom of the "U" opening. But they stayed in place well enough so that I could completely assemble the rotor and verify that I had a good fit. (By now I had removed the rotor assembly from the

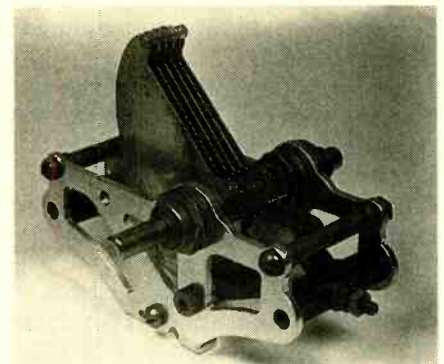

*Rebuilt antenna tuning capacitor, once again in possession of all its plates, is ready for re-installation in A.C. Super-Wasp.*

capacitor frame, which was held together only by a few screws.)

Finally I disassembled the rotor again, cleaned the rotor shaft and the hub area of each plate with steel wool, and reassembled it. Mounting the rotor assembly in a vise, and using a propane torch with a very low flame, I sweat-soldered the modified rotor plates into their slots in the shaft. The plates are now very firmly locked into place on the shaft and—with the capacitor reassembled—the repair is virtually unnoticeable.

Now, looking original again, the ca-  
*(Continued on page 101)*





# Computer Bits

By Jeff Holtzman

## CAD'ing around

The arrival of a new baby forced my wife and me to reconsider the use of space in our house. It was clear that the spare bedroom that I'd been using as an office was no longer "spare;" it was also clear that there was lots of wide-open space in the basement.

That left me with an exciting opportunity: I could design and build an office exactly the way I wanted it. Of course that meant lots of w-i-d-e bench space for computers, lots of bookshelves, room for lots of file and storage cabinets, lots of light, lots of electrical outlets, a couple of phone lines...The list went on and on, and it quickly became clear that I was going to have to do a lot of planning before buying a single sheet of plywood.

I started making some sketches on quadrille paper, but that got old fast. So I figured it was time to learn how to do my design work electronically, using a CAD (Computer Aided Design) program—which ranges in price from less than \$100 to \$3000 and more.

For professional use, you'd probably want one of the full-blown packages, but even the low-priced ones provide surprising power. I used a low-cost program called *AutoSketch* to create overall drawings of each wall in my office, as well as detailed views of the workbenches, bookshelves, printer stands, etc.

*AutoSketch* is a baby sister to *AutoCAD*, the premier CAD program for PC's, Macs, UNIX workstations, and others. Actually, there are two versions of *AutoSketch*: The enhanced version, which runs about three times faster than the unenhanced version, requires a math coprocessor (8087, 287, or 387); the unenhanced version doesn't. I used enhanced version 1.04.

**Setting Up.** Installing *AutoSketch* is simple: just copy files from a floppy disk to the desired subdirectory on your hard disk and then run the program.

function keys (F1–F10) in various combinations with the <SHIFT>, <CTRL>, and <ALT> keys to execute the most common functions. (I wish Autodesk had made the choices programmable, though.)

The top of the screen contains the menu titles, current time, and percent of memory used. The bottom lists the name of the current drawing, and provides an area for messages.

**Using *AutoSketch*.** To give you an

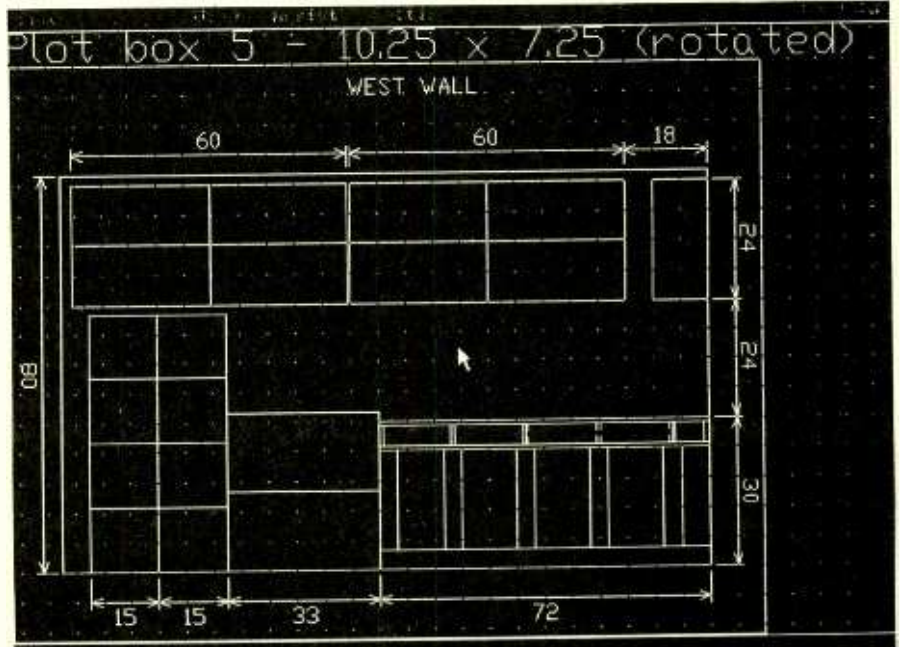

Fig. 1. *AutoSketch* is a low-cost CAD program that's just right for remodeling or planning that new addition. A stretch command and automatic dimensioning allow you to modify your layout quickly.

(*AutoSketch* will run from floppy, but it's very slow.) The first time you run the program, it asks you questions about your hardware (type of mouse, video adapter, and printer).

You can use the program without a mouse, but doing so is difficult at best. I prefer the Microsoft mouse; I also like the PC-Trac trackball from MicroSpeed. As for video, of course you need a graphics card: Hercules, CGA, EGA, and VGA are all supported, as is Autodesk's ADI driver. For hard copy, Epson, IBM, and Okidata dot-matrix printers are supported; also supported are HP and PostScript laser printers, and plotters from HP and Houston Instruments.

Using *AutoSketch* is easy. You move the cursor with the mouse (or keyboard keys) to the top of the screen, highlight one of the menu titles, and then click the mouse. A menu of choices drops down; again move the cursor to the desired one and click the mouse; the process is fairly quick. You can also press

idea of the processes involved, I'll describe my technique for creating drawings with *AutoSketch*. (If I had understood some of these points before beginning, my first couple of drawings would have rolled off the press much smoother!)

The first thing to do is set up *limits*, which define the overall boundaries of your drawing. Those boundaries are not strictly enforced—your drawing can extend beyond them. Rather, they give you a frame of reference. *AutoSketch* uses the limit values you establish to accomplish certain tasks (zooming and showing the optional on-screen grid, for example). If you find that your limits are too small, you can expand them as necessary later.

In my case, I generally used limits of about 200 (horizontal) by 200 (vertical). I chose those values because all my dimensions were specified in inches, and the room measures roughly 154 × 141 × 80. My first drawing was located



too close to the lower left corner of the boundaries I had set, so I changed the left and bottom boundaries to negative numbers (e.g., the horizontal dimensions were roughly 50 to 150). Remember, the numbers themselves mean nothing; they're just a convenience for the user and for the program.

Next I set up a *grid*. The grid shows up on the screen, but does not print on paper; its purpose is to aid you in placing drawing elements (circles, lines, boxes, etc.). You specify the X and Y spacing of the grid; for my drawings, I used grid values of 6. In other words, a dot shows on the screen every 6 units (every half a foot) horizontally and vertically. (See Fig. 1.)

Related to the grid is *snap*. When snap is off, the cursor is free to move continuously in any direction. When snap is on, the cursor jumps from point to point based on intervals that you specify. Generally, the snap value will be an integral multiple or sub-multiple of the grid value. For my project, I usually used a snap value of 1, although for some detailed work I used a value of 0.5.

Next I created a *plot box*. As the

name suggests, it's a box that indicates what will be plotted (or printed if you're not using a plotter). You can move the box and stretch its size using the normal AutoSketch tools. For example, you might simply want to make a drawing print as large as possible on a sheet of paper.

On the other hand (as in my case), you might want an exact mathematical relationship between building units and drawing units. I found that a ratio of 16:1 allowed the whole drawing to fit in the plot box nicely (see Fig. 1); it also allowed me to take measurements directly off the printed copy (a sixteenth of an inch on paper equaled one building inch).

#### VENDOR INFORMATION

AutoSketch (\$79.95), AutoSketch Enhanced (\$99.95), Autodesk, Inc., 2320 Marinship Way, Sausalito, CA 94965; 415/332-2344.

Serial mouse (\$150), Microsoft Corp., 16011 N.E. 36th Way, Box 97017, Redmond, WA 98073-9717; 206/882-8080.

PC-Trac Serial version (\$119), MicroSpeed, Inc., 5307 Randall Place, Fremont, CA 94538; 415/490-1403.

At this point, all the basics are in place; now it's time to create an actual drawing. AutoSketch provides tools for drawing arcs, boxes, circles, curves, lines, and polygons, as well as text. The program also provides tools to move, copy, and erase drawing elements, to stretch them (tricky to use but extremely powerful), to rotate them, to create a mirror image, etc.

You can define a group of elements as a single image, and then copy it, move it, etc., as one piece. You can then break it back down into its constituent elements. In addition, you can insert one drawing into another. An "undo" feature allows you to counteract the last action—if you erased half of your drawing by mistake, for example. You can also "redo" whatever you just "undid."

Another powerful feature is automatic dimensioning. With a few swipes of the mouse, you mark two horizontal or vertical points, and AutoSketch measures and displays the distance between them. Later, if you use the Stretch command to change the size of an object, any dimensions associated with that object will change accordingly.

(Continued on page 98)

## ROBOTIC ARM - FOR LESS!

Our low-cost system allows you to explore this exciting field using your Apple II computer. Includes robot arm, an interface card, programming software and video.

The Arm provides motion along five axes. The base can move forward and reverse, and the arm itself can rotate left and right. In addition, the arm can rotate up and down at front (wrist) and rear (arm) joints, and the jaw can open and close.

The Interface Card plugs into any unused expansion slot of an Apple II, II+, IIe, or IIgs. The card provides five motor outputs, and five Hall-effect switch inputs for detecting the home position of each joint.

Software you can program the robot arm in either Applesoft BASIC or Terrapin LOGO. Commands are provided for stopping and starting each motor, waiting for a specified period of time, for sensing, etc.

Stock No.	Description	YOUR COST
840361	Complete System	\$285.00

NEW!

## Kelp Interface Card

The Kelp Card is designed to interface small 3 volt DC motors directly to the Apple II computer. The Kelp Interface Card is capable of controlling eight motors in the forward and reverse directions.

The onboard power supply generates all the power necessary to run all eight motors thereby eliminating the need for batteries.

Stock No.	Description	YOUR COST
840362	Kelp Card	\$ 179.00

NEW!



**KELVIN** Electronics

7 Fairchild Ave.  
Plainville, NY 11803

(516) 349-7620

A Controller Card  
for Your  
Robotic Project!

## HITACHI



V-422	40MHZ SCOPE	\$ 795.
V-660	60MHZ COMPACT, DELAYED	\$1195.
V-665	60MHZ COMPACT, DELAYED, w/CURSOR	\$1395.
V-1060	100MHZ COMPACT, DELAYED	\$1495.
V-1065	100 MHZ COMPACT, DELAYED, w/CURSOR	\$1795.

## FLUKE

### FLUKE - Meters



27	INDUSTRIAL, HEAVEY DUTY, PRO.	\$239.
73	HANDHELD, ANALOG DIGITAL	\$ 69.
77	HANDHELD, ANALOG DIGITAL, PRO.	\$139.
83	HANDHELD, ANALOG/DIG., DMM	\$159.
87	HANDHELD, ANALOG/DIGITAL w/DMM 4000 COUNT, TRUE RMS	\$245.
8050A	BENCH METER, DMM, 4 1/2 DIG.	\$369.

YOUR BIDS ARE WELCOME!

M/C & VISA Welcome



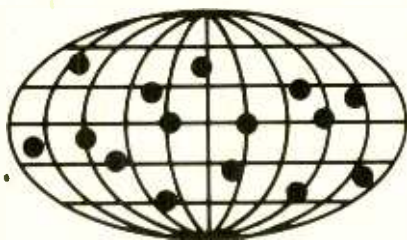

# DX Listening

By Don Jensen

## PIRATES OF THE AIRWAVES

It is a touchy subject, *pirate radio*, and every time I write about those unlicensed shortwave operations, I get quite a few letters. Some come from those who feel that no public attention should be paid to those illicit low-powered broadcasters, claiming that mentioning pirate stations in this column only encourages others to violate government radio regulations.

But letters also come from those who, apparently, operate the stations, which they prefer to call "free radio," and from some of their fans. They argue that they must operate in violation of the rules because they cannot get on the air legally. They say they are really doing no harm. Many of them feel the FCC ought to provide some legal alternative for those who wish to broadcast their own programs.

While I don't condone illicit activities, my view is that such stations have been on shortwave for years, with or without publicity in radio magazines. Mentioning them neither encourages nor discourages more unlicensed shortwave stations. And to ignore their existence on the air deprives readers of information about one category of SW broadcasts they may wish to tune in.

I should also point out that authorities periodically do electronically track down the illegal broadcasts, levy substantial monetary forfeitures, and confiscate equipment.

Pirate station, CBOR, which adopted a Canadian guise and claimed, falsely, to be transmitting from western Canada, was traced to Connecticut. The FCC fined its operator \$750 in late 1988.

If the operator holds a valid FCC ham ticket or radio-telephone license, that

permit may be in jeopardy when he is caught. Those who merely listen to the programs violate no laws. Pirate broadcasters themselves do face genuine legal risks.

As a result, pirates tend to operate irregularly, at various hours, usually with low-power (under 10 watts) transmitters. But the best opportunities to find those stations seem to be weekends and especially during holiday periods; Christmas, New Years, Thanksgiving, The 4th of July, Halloween, etc.

Despite the risks, a number of illegal broadcasters continue to turn up on shortwave. Author George Zeller in his *Pirate Radio Directory* (\$7, Tiare Publications, Box 493, Lake Geneva, WI 53147) says about 50 such stations were heard in 1988.

Zeller says about two-thirds of the pirates use the 41 meter band, roughly 7,355 to 7,500 kHz. Lately a number of them have chosen 7,415 or 7,425 kHz. Other frequencies to check are 6,200–6,300 kHz, with 6,240 kHz being a frequent choice lately. In addition, pirates turn up just above the regular AM band, at about 1610–1630 kHz.

Programming? Well it depends on your taste. *Radio Clandestine*, which has been on the air sporadically for 16

years, favors comedy parody programs, which are genuinely funny. Some other would-be comedy programs are, at best sophomoric and at worst, really offensive.

Music, ranging from *avant garde* to folk, is a staple of the pirate stations. With some exceptions, however, there is little music aired by those outlets that cannot also be heard, with far better fidelity and more talented announcers, on the regular FM bands.

Probably the best known pirate of recent times was *Radio Newyork International*, which in 1987 caught the attention of New York City AM listeners and shortwave fans across the U.S. and Canada by broadcasting on several frequencies from a ship off the coast of Long Island, New York.

Federal authorities boarded the vessel and shut down the station, which claimed exemption from FCC regulations because it operated from international waters. In late 1988, a federal judge in Boston ruled against the station's operators, permanently enjoining them from returning to the air.

Listeners suspect that another pirate, *Falling Star Radio*, which came on around Thanksgiving 1988, may have some connection with the now-silenced Radio Newyork International.

So, the ever shifting pirate-radio scene sees unlicensed operations come and go every year. In 1988, the shortwave pirate crew included, Zeller notes, stations like KAOS, and the seemingly unrelated *Radio Chaos*, KNBS (which touts legalization of cannabis, or marijuana), *Radio Atlantic*, *Radio USA*, *Radio Lymph Node International*, *Radio Mouser Worldwide*, *Radio North Star* and many others.

## 中華民國 REPUBLIC OF CHINA



The colorful flag of the Republic of China on Taiwan is seen on this decal sent to listeners by the Voice of Free China. VOFC is easy to hear in North America because its English-language programs are relayed by WYFR's shortwave transmitters in Florida.



**Feedback.** It's time to set things right. And reader Segundo P.I. Acuna, who writes from San Jose, Costa Rica, is the one to do it. Apparently it has taken a long time for our March-April 1986 column to reach Mr. Acuna, but, though it "may be old stuff," he says, "nevertheless and for the sake of truth, I believe it should be rectified."

In that column, so long ago, I noted that U.S. shortwave stations, KGEI, which now is operated by a religious organization as *La Voz de la Amistad*—the *Voice of Friendship* (VOF)—moved its transmitter site from Belmont, California to Redwood City, near San Francisco.

Not so, says our letter writer, who once served as KGEI's Spanish-language news director.

"The 50-kilowatt transmitter—old, but of a very good and efficient design—was never moved from its original location, which has been and remains a 'micro-peninsula,' jutting east into San Francisco Bay. That location is closest to the city of Belmont, south of San Francisco, though outside its city limits.

"Belmont was the place from which KGEI received its mail. But later, Redwood City, about three miles further south on the peninsula, wanting to expand its tax base, annexed the shoreline lands. And so KGEI's transmitter site was not moved. It was swallowed up."

Thanks, Segundo, for correcting the record.

Reader Acuna, by the way is a certified legal translator and court interpreter in San Jose. His radio interests date back to 1924, when he was a radio ham in Argentina and vice president of *Radio Club Argentino*.

Speaking of radio clubs, one of the common questions in our mailbox continues to be: How can I join an SWL club? I've answered that one before, but since it keeps coming up, let's consider it again.

There are a number of SWL clubs in North America. There also are other organizations that specialize in other aspects of the listening hobby. Besides shortwave listening to broadcast programs, some listeners hunt the non-broadcast shortwave signals, point-to-point communications, military, maritime communications, and the rest. There are those who tune the medium- and long-wave bands, are VHF/UHF scanner fans, or hunt for distant FM and TV signals.

Some clubs are regional, focusing on members in specific states or

provinces. Most of the clubs in the U.S. and Canada are affiliated with an "umbrella" organization known as the *Association of North American Radio Clubs* (ANARC).

ANARC, 25-years old in 1989, serves as a spokesman for the various member clubs, lobbies for listener interests, stages an annual convention, and provides information about its affiliates to listeners considering joining one or more of the clubs. Each club publishes a regular newsletter, monthly or, in some cases, more frequently, filled with useful and interesting listener-related information.

The "ANARC Club List," describing the activities of the various clubs, their newsletters, membership fees, and addresses, is available for a business-size, self-addressed, stamped envelope. Send your request to ANARC Publications, PO Box 462, Northfield, MN 55057. Readers outside the U.S. should send two International Reply Coupons (IRC's; available from your post office) in place of the SASE. And be sure to tell them that **Popular Electronics** sent you!

**Down The Dial.** Next on the agenda is our monthly segment devoted to those shortwave stations that listeners have heard lately. The times noted are Coordinated Universal Time (UTC), which is equivalent to EDT + 4 hours, CDT + 5 hours, MDT + 6 hours or PDT + 7 hours. Why not tell the rest of us what you're hearing on shortwave. Drop me a line at *DX Listening*, **Popular Electronics**, 500-B Bi-County Blvd., Farmingdale, NY 11735.

**Australia**—9,720 kHz. On the North American west coast, you can hear *Radio Australia* signing on in Chinese. After opening announcements there is a Chinese-English language lesson.

**Finland**—9,635 kHz. *Radio Finland* is heard on this frequency at 0330 UTC with an English language ID and news.

**Ghana**—4,915 kHz. From West Africa, the *Ghana Broadcasting Corp.* (GBC) outlet at Accra is heard here with identification, anthem, and talk in an African language at about 0530 UTC.

**Mexico**—5,985 kHz. *Radio Mexico International*, XERMX, is the international service from our southern neighbor. Look for it shortly after 1300 UTC.

**Zaire**—7,203 kHz. *La Voix du Zaire* broadcasts from Lubumbashi in the interior of Africa. Sometimes it can be heard with decent signals at sign on in French shortly before 0400 UTC. ■

## NEW SUPER LONG PLAY TAPE RECORDERS

12 Hour Model — \$119.00\*  
USES D-120 TAPE

Modified Panasonic Slimline, high quality, AC-DC Recorders provide 6 continuous hours of quality recording & playback on each side of cassette for a total of 12 hours.  
Built-in features include:  
• Voice level control • Digital counter, etc. TOK DC 120 Cassette Furnished.



### PHONE RECORDING ADAPTER

Records calls automatically. All Solid state connects to your telephone jack and tape recorder. Starts recording when phone is lifted. Stops when you hang up. **\$28.50\*** FCC APPROVED



### VOX VOICE ACTIVATED CONTROL SWITCH

Solid state Self contained. Adjustable sensitivity. Voices or other sounds automatically activate and control recorder. Uses either recorder or remote mike. **\$28.50\***



\*Add for ship & hdg. Phone Adapter & Vox \$1.50 ea. Recorders \$4.00 ea. Cal. Res. add tax. Mail order, VISA M/C, COD's OK. Money Back Guarantee. Qty. disc avail. Dealer Inquiries Invited, Free data.

AMC SALES INC. Dept B 9335 Lubec St., Box 978, Downey, CA 90241 Phone (213) 869-8519

CIRCLE 6 ON FREE INFORMATION CARD

## Be an FCC LICENSED ELECTRONIC TECHNICIAN!



No costly School. No commuting to class. The Original Home-Study course prepares you for the "FCC Commercial Radiotelephone License". This valuable license is your "ticket" to thousands of exciting jobs in Communications, Radio-TV, Microwave, Computers, Radar, Avionics and more! You don't need a college degree to qualify, but you do need an FCC License. **No Need to Quit Your Job or Go To School** This proven course is easy, fast and low cost! **GUARANTEED PASS**— You get your FCC License or money refunded. **Send for FREE facts now. MAIL COUPON TODAY!**

### COMMAND PRODUCTIONS

FCC LICENSE TRAINING, Dept. 203 - P.O. Box 2824, San Francisco, CA 94126

Please rush FREE details immediately!

NAME \_\_\_\_\_  
ADDRESS \_\_\_\_\_  
CITY \_\_\_\_\_ STATE \_\_\_\_\_ ZIP \_\_\_\_\_



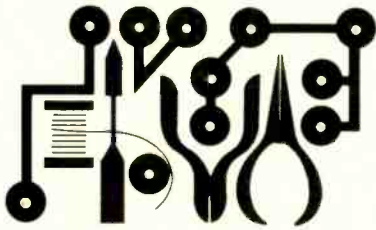

# Circuit Circus

By Charles D. Rakes

## TOUCH CIRCUITS AND MORE

This month we're placing a few inexpensive multi-purpose CMOS IC's in a variety of basic, but useful circuits that can be used alone or combined with other circuitry to produce a more-complex project.

Before we get started let me give out the electronic Miranda warning for working with CMOS devices. Don't shuffle your feet on a carpeted floor, or wiggle around in a plastic-covered chair while working with a CMOS device. Use common sense while working with CMOS devices and you'll get by without a hitch.

### Negative-Triggered Touch Circuit.

Our first circuit is built around a 4047 low-power CMOS, monostable/astable multivibrator (which can be purchased from Digi-Key, and other **Popular Electronics** advertisers, for less than a buck).

In Fig. 1, the 4047 is configured as a monostable multivibrator circuit (or one-shot) that is set up to trigger on a negative-transition of the signal ap-

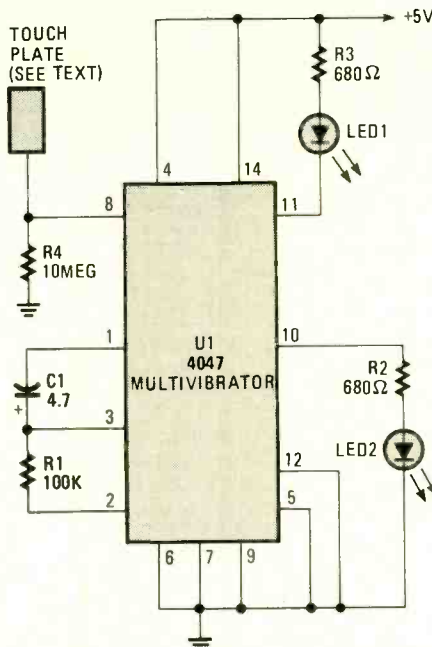

Fig. 1. The Negative-Triggered Touch Circuit is built around a 4047 monostable/astable multivibrator.

### PARTS LIST FOR THE TOUCH CIRCUITS

- U1—CD4047BCN monostable/astable multivibrator, integrated circuit
- LED1, LED2—Jumbo LED (any color)
- R1—100,000-ohm, ¼-watt, 5% resistor
- R2, R3—680-ohm, ¼-watt, 5% resistor
- R4—10-megohm, ¼-watt, 5% resistor
- C1—4.7-µF, 16-WVDC electrolytic capacitor
- Perfboard, IC socket, power source, etc.

plied to its pin 6 input. The multivibrator's on time is determined by the values of R1 and C1. Although R1 is shown to be a 100k unit, its value can be anything between 10k and 1 megohm. Capacitor C1 can be a non-polarized capacitor of any practical value above 100 pF. (Good-quality, low-leakage, non-polarized electrolytic capacitors also performed okay in our test circuit.)

By making R4's value extremely high, the circuit can be used as a "touch" triggered one-shot multivibrator. If the value of R4 is reduced to a much lower value, say 10k, the circuit can be triggered with a negative pulse through a 0.1-µF capacitor connected to pin 6.

With a 100k resistor for R1 and a 4.7-µF electrolytic capacitor for C1, the circuit's on time is about 0.6 second. When R1 is increased to 470k, the on time of the circuit is increased to over 6 seconds. The maximum resistor value for R1 is limited by the leakage resistance of the capacitor used for C1. If a high-quality, oil-filled or paper capacitor is used, the circuit's on time can be extended for much longer periods.

### Positive-Triggered Touch Circuit.

If you wish to trigger the multivibrator with a positive pulse use the circuit in Fig. 2. All of the component values are the same for this circuit as those used in Fig. 1, and both circuits perform in the same manner.

LED1 and LED2 in both circuits are indicators that come on, and remain on, each time the circuit is triggered. During the timing cycle, U1's Q output at

pin 10 goes positive as the  $\bar{Q}$  output at pin 11 goes negative. The two LED's can be removed and the Q and  $\bar{Q}$  outputs (pins 10 and 11, respectively) can be used to trigger some other circuit.

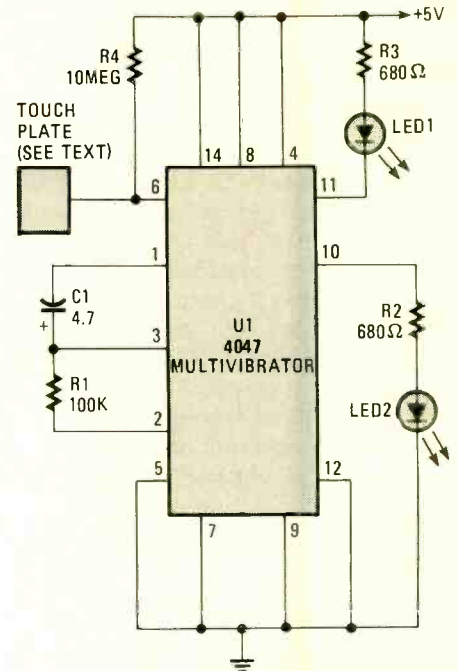

Fig. 2. The Positive-Triggered Touch Circuit is nearly identical to the negative version.

**Astable Multivibrator.** In our third circuit (see Fig. 3), the 4047 is configured as a free-running, astable-multivibrator (oscillator) circuit. That configuration, offers three different outputs. The output pulses at the Q and  $\bar{Q}$  output (pins 10 and 11, respectively) are the same as in

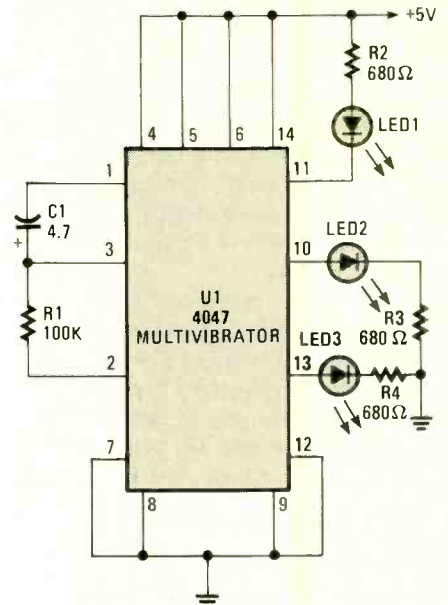

Fig. 3. In this circuit, the 4047 is configured as a free-running, Astable Multivibrator (oscillator), and offers three different outputs.



## PARTS LIST FOR THE ASTABLE MULTIVIBRATOR

U1—CD4047BCN monostable/astable multivibrator, integrated circuit  
 LED1-LED3—Jumbo LED (any color)  
 R1—100,000-ohm, ¼-watt, 5% resistor  
 R2-R4—680-ohm, ¼-watt, 5% resistor  
 C1—4.7- $\mu$ F, 16-WVDC electrolytic capacitor  
 Perfboard, IC socket, power source, etc.

the previous two circuits. The third output at pin 13 pulses twice as often as the outputs at 10 and 11. So the circuit can be used to simultaneously provide both positive- and negative-trigger signals (the Q and  $\bar{Q}$  output are never in the same state) and a clock frequency, thereby allowing it to replace both a simple oscillator (the 555, for instance) and flip-flop in some applications.

**Square-Wave Generator.** Our next circuit also uses a 4047, this time configured as square-wave generator circuit. As shown in Fig. 4, a five-position rotary switch, S1, is used to select the generator's frequency range (and could be considered as a coarse frequency adjustment). Potentiometer R2 (acting as a fine-frequency adjustment) tunes the free-running multivibrator to the desired frequency.

Switch S2 (a three-position rotary switch) selects the output waveform. The inputs of U2-a and U2-b (½ of a

4049 hex inverting buffer) are connected to the wiper of S2. Inverter U2-a provides the inverse of the input signal at its output, while the inverted output of U1-b is inverted again by U2-c to provide a mirror image of the signal input to U2-b.

When S2 is in position 1 or position 2, the output waveforms at points "A" and "B" (the outputs of U2-c and U2-a, respectively) are of opposite polarity. Switch S2's third position places the circuit in a turbo (souped-up) condition to double the output frequency.

With S1 set to position 1 the output frequency range, while operating in "turbo," varies from a low of 880 Hz to over 38 kHz; in position 2, 80 Hz to 4 kHz;

## PARTS LIST FOR THE SQUARE-WAVE GENERATOR

U1—CD4047BCN monostable/astable multivibrator, integrated circuit  
 U2—4049 hex inverting buffer, integrated circuit  
 R1—10,000-ohm, ¼-watt, 5% resistor  
 R2—500,000-ohm potentiometer  
 C1—.001- $\mu$ F, mylar or similar capacitor  
 C2—.01- $\mu$ F, mylar or similar capacitor  
 C3—.1- $\mu$ F, mylar or similar capacitor  
 C4—1- $\mu$ F, mylar or similar capacitor  
 C5—10- $\mu$ F, 15-WVDC (or more), non-electrolytic capacitor  
 S1—SP5T rotary switch  
 S2—SP3T rotary switch  
 Perfboard, IC sockets, cabinet, power source (9-volt battery), knobs, etc.

in position 3, 5 Hz to 440 Hz; in position 4, 0.5 Hz to 44 Hz; and in position 5, the frequency varies from about 2 cycles per minute to 2 Hz. With S2 in either the first or second position the output frequency would be cut in half.

Since the parts count is low, the generator circuit can be assembled on a piece of perfboard and housed in a small plastic utility box. When using perfboard construction, IC sockets are a must. For a professional-looking instrument, take a little extra time and make an escutcheon for the two switches, potentiometer R2, and the output terminals.

**Motion Detector.** Our next event features another extremely versatile CMOS IC, a CD4046BCN micropower phase-locked loop (PLL). Within that 16-pin chip, there's a voltage-controlled oscillator (VCO), two phase comparators, and a source follower.

Figure 5 shows how the 4046 can be used in an ultrasonic transmitter/receiver that can detect moving objects. The circuit will pick up a person crossing in front of its two piezo speakers at a distance of five feet and will detect a dime-sized object as far a way as one foot. Of course the objects must be in motion to be detected by the circuit.

Here's how the IC and its associated components shuffle the ultrasonic signals around to detect and indicate that something out there is in motion. The values of R1 and C1 set U1's internal VCO oscillating at a frequency of about 20 kHz. The exact operating frequency isn't critical and can be anything between 15 kHz and 25 kHz.

The square-wave output of U1 at pin 4 (which is also tied to pin 3) is fed to the base of Q1, causing it to toggle on and off in time with the output-signal frequency. That produces voltage pulses at the emitter of Q1, which are input to SPKR1 (a piezo speaker), causing it to send out a wave front of ultrasonic sound. The two piezo speakers are placed side-by-side, separated by about 1-inch, and facing the same direction. Any reflected ultrasonic signal is picked up by SPKR2 and amplified by Q2 and Q3. The amplified signal is fed back to U1's internal phase comparator at pin 14.

As long as there is no movement in range of the two piezo speakers, the output of the comparator and its internal signal are of the same phase. But when there is movement, the reflected

(Continued on page 102)

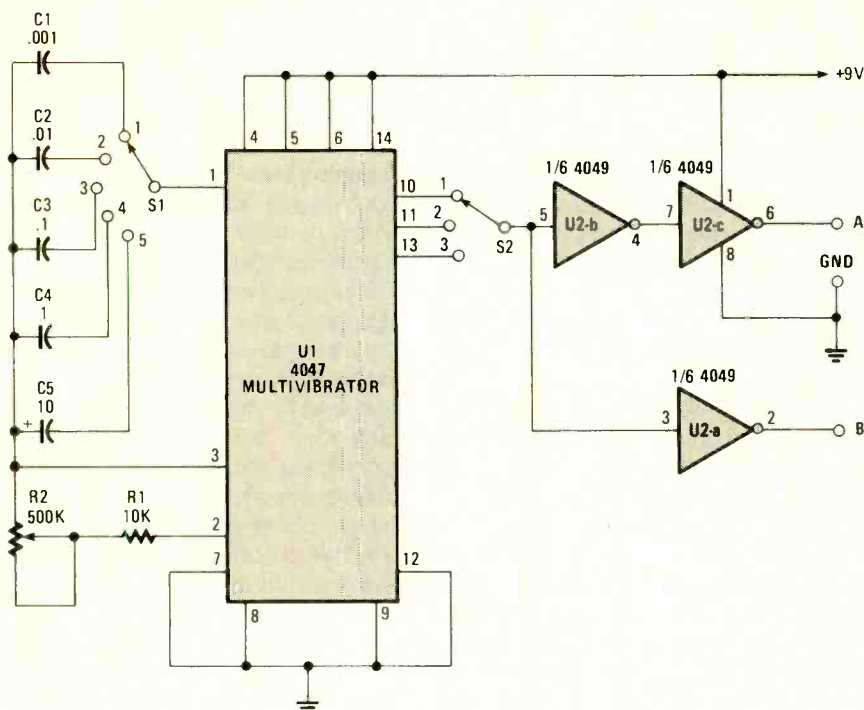
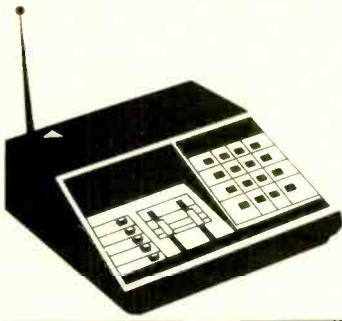

Fig. 4. This Square-Wave Generator is also built around a 4047.





# Scanner Scene

By Marc Saxton

## NEW AND IMPROVED

Not only is the AOR model AR-2515 an exciting new scanner in its own right, but owners of the older model AR-2002's can send them in (along with \$250) to get them retrofitted and upgraded into the newer unit. And, what a scanner it is!

For starters, it covers 5 MHz through 1500 MHz, and narrow- and wide-band FM, as well as AM. It is capable of scanning 62 banks of 32 frequencies each, for a total of 1984 scanned frequencies. An additional 16 memory locations are set aside for beginning and ending search-limit pairs. You can designate Bank #1 as a priority bank, which gives higher priority to 32 different frequencies out of the almost 2000 in the AR-2515's huge memory. The scan rate is 36 channels per second (which is faster than a greased snake).

For scanner fans who are into computers, there's an RS232 interface port for programming, unattended control, and frequency-activity logging.

The ultra-wide frequency-coverage range of the AR-2515, which dips into the 60-meter shortwave-broadcasting band and then soars all the way into the lower fringes of the microwave spectrum, is well handled by the technical specifications. Sensitivity is typically better than  $.35 \mu\text{V}$  at 12 dB; sinad in NBFM mode above 10 MHz is  $>1.2 \mu\text{V}$  for 10-dB S/N. User-selectable tuning increments are 5, 10, 12.5, and 25 kHz. For those who wish to tune SSB signals—a desirable feature for monitoring below 30 MHz—an optional BFO with finer tuning resolution is available as an option.

As you may have guessed, this deluxe scanning receiver is tagged with a price commensurate with its many features and operating tricks—\$695. Well, we never said that one of those features was a low price! But this truly is an impressive receiver for the serious monitoring enthusiast.

The AOR model AR-2515 comes from Ace Communications, 10707 East 106th



*The AOR AR-2515 really needs its huge, 2000-frequency memory—it can scan 1984 frequencies! And its scan rate is a swift 36 channels per second.*

Street, Indianapolis, IN 46256. The toll-free landline number (outside of Indiana) is (800) 445-7717.

**Dust In Yer Ears?** Scanner monitors sometimes complain that despite improving their antenna systems, they just can't seem to pull in those weaker signals. Well, there is the matter of the sensitivity of the scanner itself; changing or elevating your antenna can do only so much toward overcoming receiving limitations caused by a scanner with "bad ears." Some scanner owners have reported getting help from various boosters intended for TV-signal improvement, even though those units were intended to be used with 75-ohm TV-type coaxial cable, and not the 52-ohm coaxial cable used for scanners, CB's, and most other HF/VHF communications gear.

Although TV-signal boosters do help, the approximately 30% impedance mismatch does tend to produce a "3 steps forward, 1 step backward" type of benefit. Still, they're certainly much better than nothing!

Let's keep in mind that there are signal preamplifiers available that are designed to be hooked to receiving systems that use 52-ohm coaxial cable, and thus deliver their full signal-improvement potentials. One such unit,

for instance, is the RFP-45 battery-operated signal booster, which provides 15 dB of amplification to everything heading down from the antenna into the receiver. The RFP-45 requires no internal wiring; it just gets placed in-line where the coaxial enters the scanner, and it's available with your choice of connector types (SO-239, BNC, or F). The amount of gain in one of those should get the signal into your scanner, no matter how hard of hearing it might be. The RFP-45 sells in the \$100 ballpark.

For more information on the RFP-45, contact Electron Processing, Inc., P.O. Box 708, Medford, NY 11763. Their phone number is (516) 764-9798.

Also keep in mind that most types of coaxial cable hardly approach immortal status. After several years of exposure to sun, rain, humidity, temperature extremes, polluted air, and whipping around in the wind, they begin to do their job with decreasing efficiency. Your best bet is to replace the coaxial cable after 3 or 4 years, regardless of what a nuisance the job may be.

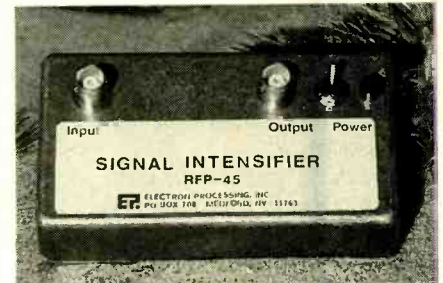

*Boost those weaker signals by improving your scanner's sensitivity with the RFP-45 battery-operated signal booster, which provides 15 dB of amplification and needs no internal wiring.*

**Teaching New Tricks** Our offer to provide readers with some modifications on the Realistic PRO-2004 and PRO-34 scanners continues to bring in requests that include the requisite stamped, self-addressed return envelopes. However, we also get numerous requests for modifications for various other scanners, and for modifications such as SSB reception, or eliminating a built-in scan-delay, etc. We would like to be able to accommodate all of those requests, but at present we can furnish only the specific modifications for the two scanners mentioned.

Lloyd Anderson of Spokane, WA, writes to say that he lives near a USAF base and would like to find a handheld programmable that can receive the

*(Continued on page 98)*



# Enter A World Of Excitement with a Subscription to Popular Electronics®

## Get the latest electronic technology and information monthly!

Now you can subscribe to the magazine that plugs you into the exciting world of electronics. With every issue of Popular Electronics you'll find a wide variety of electronics projects you can build and enjoy.

Popular Electronics brings you informative new product and literature listings, feature articles on test equipment and tools—all designed to keep you tuned in to the latest developments in electronics. So if you love to build fascinating electronics, just fill out the subscription form below to subscribe to Popular Electronics... It's a power-house of fun for the electronics enthusiast.

### EXCITING MONTHLY FEATURES LIKE:

- CONSTRUCTION**—Building projects from crystal sets to electronic roulette
- FEATURES**—Educational training on digital electronics, Ohm's Law, Antennas, Communications, Antique Radio, Simplified Theory
- HANDS-ON-REPORTS**—User test comments on new and unusual consumer products
- SPECIAL COLUMNS**—Think Tank, Circuit Circus, Computer Bits, DX Listening, Antique Radio, Amateur, Scanner Scene

### PLUS: ALL OUR GREAT DEPARTMENTS!

You'll get 12 exciting and informative issues of Popular Electronics for only \$18.95. That's a savings of \$11.05 off the regular single copy price. Subscribe to Popular Electronics today! Just fill out the subscription order form below.

FOR FASTER SERVICE CALL TODAY

**1-800-435-0715**

IN ILLINOIS 1-800-892-0753 (7:30AM-8:30PM)

EASTERN STANDARD TIME

## Popular Electronics® SUBSCRIPTION ORDER FORM

P.O. Box 338, Mt. Morris IL. 61054

**YES!** I want to subscribe to Popular Electronics for 1 Full year (12 Issues) for only \$18.95. That's a savings of \$11.05 off the newstand price.

Payment Enclosed  Bill me later

Please charge my:  Visa  Mastercard

Acct. #

Signature \_\_\_\_\_

Exp. Date \_\_\_\_\_

PLEASE PRINT BELOW:

NAME \_\_\_\_\_

ADDRESS \_\_\_\_\_

CITY \_\_\_\_\_

STATE \_\_\_\_\_

ZIP \_\_\_\_\_

Allow 6 to 8 weeks for delivery of first issue. U.S. Funds only.  
In Canada add \$5.00 Postage. All Other Foreign add \$7.50 Postage.

APE-J9



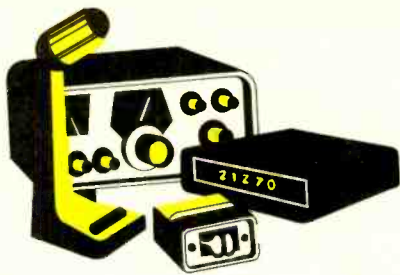

# Ham Radio

## FINDING THE INTERFERENCE

By Joseph J. Carr, K4IPV

**O**ur bands are a mess! Tune across almost any amateur band and you'll be hard pressed to find a clear spot to set down and have a good, old-fashioned "ragchew." Even some ham-rig manufacturers recognize the problem, and are making available narrower band filters (for interference rejection) and panadapters (special oscilloscopes that find holes in the band).

With all the amateurs jabbing their electronic elbows into each other, the last thing we need is a lot of interference from non-amateur sources.

**Interference Sources.** There are four kinds of interference that we must contend with. First, there is the interloper. The interlopers are regularly constituted radio stations, usually broadcasters or communications stations overseas, who use our frequencies.

While some of those interlopers are legal (such as the Radio Moscow signal that shows up in the 40-meter amateur band), others are illegal. Although those stations are probably licensed, or otherwise legally constituted in their own countries, their operation violates the *International Telecommunications Union (ITU)* agreements for band use as contained in the latest *World Administrative Radio Conference (WARC)* treaty. Such illegal operations must be reported to the FCC with a demand for an official complaint to the foreign government involved.

Second, there are the illegal operators pretending to be hams. Those *goofballs* are a lot more common than one might like to think. Whether "HF'ers" on 10-meters (or the space between the 11-meter CB and the lower end of 10-meters) or simply pretend-hams, they are illegal and their continued existence threatens our hobby.

In that category are also the illegal CB'ers who output extremely high-power signals using amateur-radio linear amplifiers. It was those guys who forced the FCC to limit manufactured

linear amplifiers to frequencies below 25-MHz. If you buy an amateur linear, then the 10-meter band will have to be added by retrofit later (by you!).

Third, there is power-line-generated noise. Such interference can be due to either defective power-company equipment, or defective homeowner equipment (such as those hash-generating Triac-based light dimmers). If you find a noisy, RF-generating, power-line pole (usually caused by a defective tie wire, cracked insulator, or bad transformer), then write down the pole number and call the power company.

Fourth, there is a large mishmash of electronic noise from a lot of different electronic devices. Have you noticed that raucous signal on 80-meters? It spreads out from about 3,578-kHz up and down the band. It seems to be most vicious on nights when HBO or the networks are running a very popular film. What is the source of such interference? Color TV's and VCR's radiating the color subcarrier signal—that's the real TV!

The color subcarrier oscillator in TV sets and VCR's operate on approximately 3.58-MHz...and those oscillators sometimes radiate illegally. There are other sources of such interference, too.

The FCC, in its infinite wisdom, allows cable TV companies to operate in the 2-meter amateur band. That's fine, so long as shielding is maintained. But when there is a fault in the shielding, the signal radiates outward, ripping the dickens out of amateur operations in that band.

**Locating the Source of Interference.** Last month we dealt with the topic of radio direction finding, and recommended a book on the subject. That discussion was on the theme of hidden-transmitter hunting (fox-hunting, a hobby activity), but the skills developed also serve in tracking down interference sources.

For local (neighborhood) inter-

ference (or otherwise portable) receiver or field-strength meter is needed. For VHF/UHF problems (50 MHz and up) a television-style, field-strength meter is best.

The television-style instruments are used by cable companies and consumer-TV shops to locate problems on lines (or MATV systems) and to help design antenna installations. They typically tune from Channel 2 (54 MHz) up to the highest UHF channels (around 800 MHz). Some models are channelized, while others are continuously tuned. The latter are the most useful for locating local interference.

For some cable problems (mostly for power-line problems), an ordinary AM transistor radio is useful. The older type with relatively large loopstick antennas can be bought at yard sales for around a buck. (I've seen working AM-only radios going for \$0.25).

You must open the radio to find the direction and location of the loopstick. The direction of the null used to locate the interfering source is along the axis of the loopstick. That's why it's important to know the geometry of the loopstick! Mark the directional axis along the outer case of the radio.

When using the loopstick-AM radio to locate interference, it's best to use an earphone to keep down distractions. Rotate the antenna until the sound nulls out. That is the direction of the source. But keep in mind that the interference might be in either direction, so go a few "score" yards and make the measurement again from a different angle. Plot the directional bearings on a map. The "triangulation" of the source will be evident: the location is close to the point on the map where the bearings cross.

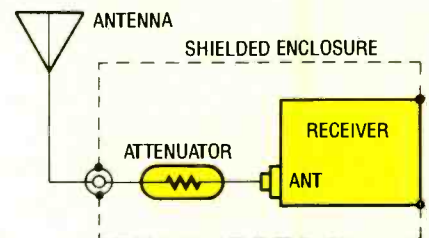

*Fig. 1. When using shortwave radios to locate interfering signals, it might be necessary to use a shielded enclosure and an attenuator in order to prevent overload of the receiver.*

For other forms of interference, including a cable-TV leakage problem, a TV receiver can be used. If a portable shortwave or VHF monitor/receiver is used, then it may be necessary to mount it inside a shielded box (Fig. 1) to prevent leakage from overloading the

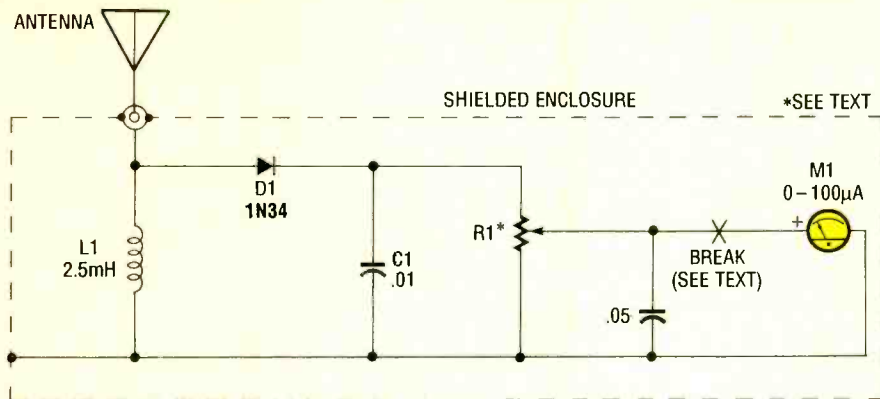

Fig. 2. A passive, homebrew, untuned field-strength meter can be used to home-in on interference sources operating up to 40 MHz or so.

receiver. A fixed or variable attenuator is also useful in that regard. It will reduce the strong signal as you get closer to the source in order to prevent overload of the receiver from obscuring the nature and location of the signal source.

A homebrew field-strength meter can be used to home-in on an interference source operating up to 40 MHz or so. The basic circuit is shown in Fig. 2. The circuit is placed inside a shielded enclosure to prevent RF interference from obscuring the readings. The antenna is connected to a 2.5-µH RF choke (L1), which develops a signal voltage from the antenna currents. That voltage is rectified by D1 (a germanium diode), filtered by C1, and then applied to a DC ammeter through a sensitivity control, R1 (the value of which can be anything in the 20k-100k ballpark).

The diode used in the field-strength meter must be germanium for low signal levels. That requirement derives from the fact that the junction potential for a germanium diode is 0.2 volt, or about a third of the voltage drop for silicon diodes. Typical germanium diodes include: 1N34A, 1N60, 1N63, ECG-109, NTE-109, etc.

A more sensitive version of the metering circuit is shown in Fig. 3. In that circuit, a transistor DC amplifier is used to amplify the signal developed by the diode. The original circuit is broken at the point indicated by an "X" in Fig. 2, and the new metering circuit is inser-

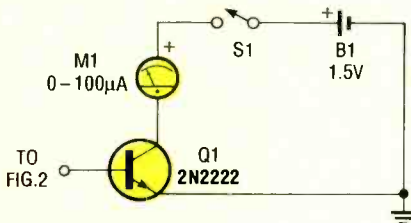

Fig. 3. Adding a transistor amplifier to the passive circuit of Fig. 2 makes the FSM more sensitive.

ted. A single 1.5-volt battery will power the amplifier.

Tunable field-strength meters are more sensitive than the untuned FSM of Fig. 2. In Fig. 4 we see a modification that will make the circuit in Fig. 2 tunable. Remove the original RF choke, and replace it with the LC resonant tank circuit shown in Fig. 4.

The variable capacitor can be almost any handy capacitor with a maximum value between 100-pF and 400-pF. The best bet for most readers might be to use the standard 365-pF broadcast, variable unit. Those units are cheap when salvaged from old radios, or bought at a hamfest or flea market.

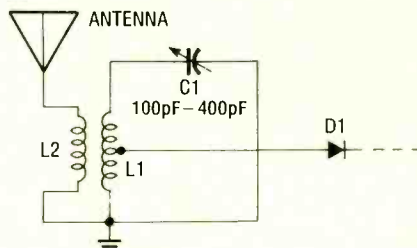

Fig. 4. This tuning circuit can be added to both the active and passive versions of the FSM.

The coil is intended to resonate with the capacitor on the frequency of interest, and can be either store-bought or custom wound. The coil value required can be found from:

$$L = 1/39.5f^2C$$

where L is inductance in henrys, f is frequency in hertz, and C is capacitance in farads. For example, for 3.58 MHz (3,580,000 Hz), assuming that the capacitor has a value of 300 pF, the inductor will be 6.58 µH.

The tap on L1 should be about 1/3 the number of overall turns in the coil. The tapped design allows the low impedance of the diode to be matched

(Continued on page 98)

# ATTENTION! ELECTRONICS TECHNICIANS



## EARN YOUR B.S.E.E. DEGREE

### THROUGH HOME STUDY

Our New and Highly Effective Advanced-Placement Program for experienced Electronic Technicians grants credit for previous Schooling and Professional Experience, and can greatly reduce the time required to complete Program and reach graduation. No residence schooling required for qualified Electronic Technicians. Through this Special Program you can pull all of the loose ends of your electronics background together and earn your B.S.E.E. Degree. Upgrade your status and pay to the Engineering Level. Advance Rapidly! Many finish in 12 months or less. Students and graduates in all 50 States and throughout the World. Established Over 40 Years! Write for free Descriptive Literature.

## COOK'S INSTITUTE OF ELECTRONICS ENGINEERING



4251 CYPRESS DRIVE  
JACKSON, MISSISSIPPI 39212

CIRCLE 8 ON FREE INFORMATION CARD

## LEARN VCR

### CLEANING/MAINTENANCE/REPAIR

**EARN UP TO \$1000 A WEEK, WORKING PART TIME FROM YOUR OWN HOME!**



Secrets Revealed!

NO Special Tools or Equipment Needed

EARN UP TO \$60 AN HOUR AND MORE!

#### THE MONEY MAKING OPPORTUNITY OF THE 1990'S

**IF** you are able to work with common small hand tools, and are familiar with basic electronics (i.e. able to use voltmeter, understand DC electronics). . . .

**IF** you possess average mechanical ability, and have a VCR on which to practice and learn. . . . then we can teach **YOU** VCR maintenance and repair!

**FACT:** up to 90% of ALL VCR malfunctions are due to simple MECHANICAL or ELECTRO-MECHANICAL breakdowns!

**FACT:** over 77 million VCRs in use today nationwide! Average VCR needs service or repair every 12 to 18 months!

Viejo's **400 PAGE TRAINING MANUAL** (over 500 photos and illustrations) and **AWARD-WINNING VIDEO TRAINING TAPE** reveals the **SECRETS** of VCR maintenance and repair—"real world" information that is **NOT** available elsewhere!

Also includes all the info you'll need regarding the **BUSINESS-SIDE** of running a successful service operation!

**FREE INFORMATION**  
CALL TOLL-FREE 1-800-537-0589  
Or write to: Viejo Publications  
3540 Wilshire BL. STE 310  
Los Angeles, CA 90010 Dept HO

CIRCLE 13 ON FREE INFORMATION CARD



## TURNTABLE REPAIRS

*(Continued from page 78)*

hand and make sure that the lever pushes the trip into the turntable hub area. Improper ejection may be cured by straightening levers and proper arm adjustment.

Often the tonearm may come out too far and set down in the middle of a selection on the record, while at other times, it may miss the record all together. Such problems are sometimes caused by holding the arm during its cycling period, thereby throwing off the adjustments. Most turntables have an arm adjustment under the tonearm; in others, the adjustment is made through a hole in the chassis beneath the tonearm assembly.

In such cases, a slight adjustment is all that's needed. Turn the adjustment screw clockwise to move the pickup arm inward and counter-clockwise to move it outwards.

When the tonearm comes over and falls directly on the record, suspect a defective rest lever. The tonearm should lower slowly, so that the stylus touches the record groove without jarring or bouncing. Look under the turntable chassis and inspect the arm lowering mechanism. The lift-up lever adjustment may be improper (or the spring may be missing). Also check for improper weight adjustment at the rear of the tonearm assembly.

If the tone arm fails to move over the record, check to see if the keeper lever is locked down over the arm. Suspect a damaged trip on the cam assembly. Inspect the function lever on the main cam assembly. It may be loose or broken away from the arm assembly underneath the turntable.

**Cracking or Frying Noises.** Suspect a dull stylus or dirty record when frying and cracking noises are heard. The frying noise might also be caused by a worn or dirty record. If the frying noise is heard when the arm isn't on the record, check the amplifier for a faulty transistor or IC.

Clean off the record using a record cleaner. Replace the stylus if the pickup arm jumps the grooves. If noise is still heard after replacing the stylus, suspect a worn record. If in doubt, try the record on another machine.

Distortion in one channel may be caused by a stylus filled with dirt and dust particles. Clean off the stylus with a soft brush, and check to see if that

solves the problem; if not, reverse the phono cable leads. If distortion is still present, replace the stylus and cartridge. If the distortion lingers, determine which channel has a problem, and check that channel of the amplifier.

**Riding High in the Saddle.** A turntable needle or stylus can get bent, so that it does not set in the small saddle, causing distorted or no music to be heard. It is also possible that the diamond end of the stylus is broken, resulting in scratching sounds, or causing the stylus to gouge your favorite record.

In such instances, the stylus or needle (in crystal units) must be replaced. Be careful when replacing the stylus and do not put pressure on the saddle where the stylus operates. Replace the stylus or needle when scratchy sounds are heard or the arm keeps jumping tracks.

In crystal cartridges, the stylus may be held in place with a small screw or clip. Select a tiny blade screw driver to remove the screw. In other units, it will be necessary to pry the clip down and pull the stylus out. Sometimes it's easier to remove the cartridge and then remove the stylus.

Make sure that the cable leads or plugs are secure before replacing the cartridge. Handle the cartridge (both crystal or magnetic) by its sides so as not to damage the saddle area. The magnetic cartridge must have another amplification stage for adequate sound. Check the magnetic cartridge with an ohmmeter when one channel is dead or intermittent. And always replace the stylus and/or cartridge with an exact replacement.

**A Drop Will Do.** Too much lubrication is worse than none at all. Place light grease or phono-lube on sliding lever areas. Place only a drop of oil on the motor or pivot bearing. Most motors found in modern equipment have self-contained bearings and do not need lubrication.

If a motor bearing is noisy or a sliding lever is erratic, it requires lubrication. Clean off the old grease with alcohol before applying a new coat. Wipe off all motor pulleys, idler wheels, and belt surface areas with an alcohol-moistened cloth. Keeping a turntable in shape is fairly easy, and preventive maintenance can often make the difference between listening enjoyment and a turntable disaster. ■

## EXCITING WORLD OF HAM

*(Continued from page 45)*

amateur-radio club picnic. Any two amateur-radio operators over the age of 18 with a general-class amateur license, or higher, can administer the test. However, FCC rules prohibit the giving of the test by a close relative or someone engaged in the sale or manufacture of amateur-radio equipment.

How do you find someone to volunteer and help you get started? Just call your local Red Cross Chapter, public library, or newspaper office. They usually have the name and telephone number of the local ham club and the president will gladly assign a volunteer to call on you. If you cannot reach a ham through those sources, simply write to the American Radio Relay League and they will be happy to contact hams in your area, informing them of your request for assistance.



*Hams love to share their interest in their hobby with everyone, especially the young.*

**Ham Life.** Ham radio is more than a hobby to hams. It is a world-wide fraternity. Hams in every country are friendly people bonded together by the common desire to talk to and help one another. Hams need each other; As it was once put to me, "Have you ever tried to talk to yourself on the telephone?" Life would be very empty without our fellow human beings.

After attaining a Novice license, most hams soon want to get their technician- or general-class license. Those higher licenses allow a greater choice of frequencies and permit the operator to use a microphone for voice transmissions on a greatly expanded basis. Others enjoy the use of a key, and choose to remain Morse-code operators for life.

Once you get started in this exciting hobby, your life will take on new meaning. Just imagine! There are tens of thousands of interesting people out there in the world, all anxiously waiting to talk to you. ■

## SHAKY

(Continued from page 36)

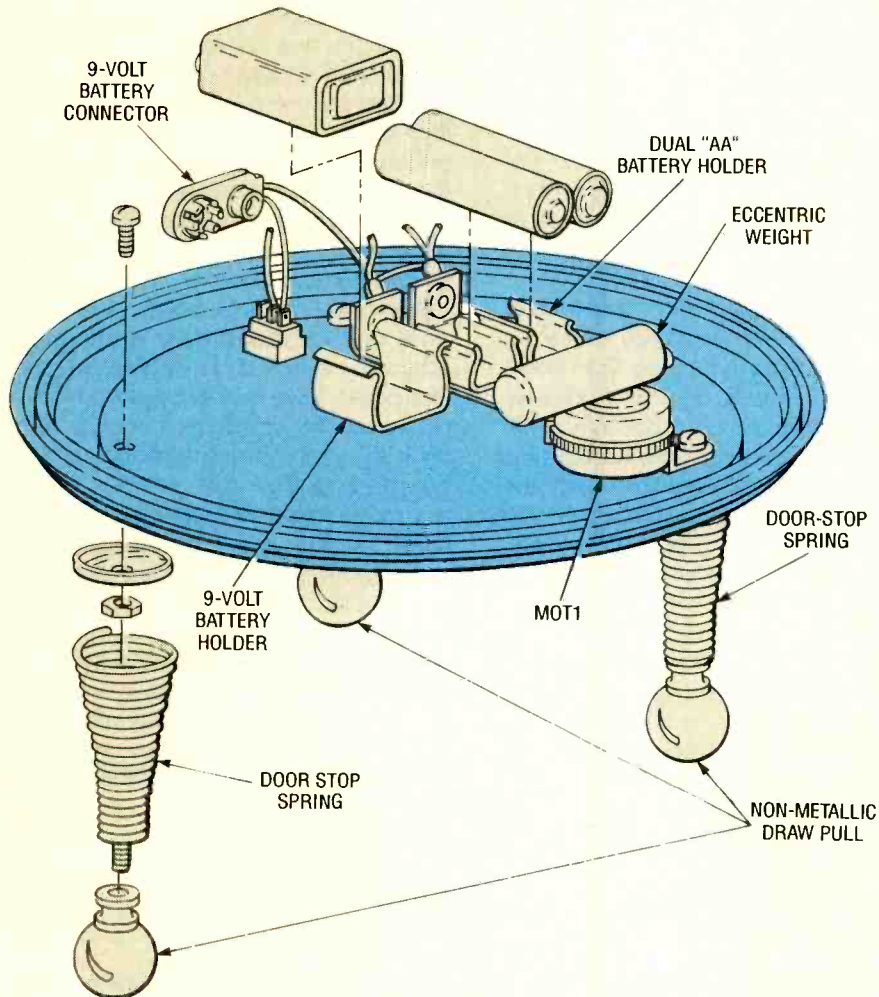

Fig. 5. The motor assembly is mounted to the inside of the lid, which serves as Shaky's base. Shaky's feet were made from non-metallic draw pulls mounted on three door-stop springs, attached to the base in a triangular pattern.

same end of the rod and thread it for an 8-32 screw to lock the eccentric weight in place on the motor's shaft.

If duplicating the eccentric weight proves to be a problem don't give up on the project, because just about any off-centered object will give similar results. Just be sure that the weight is firmly attached to the motor's shaft or it might come flying off at some inopportune moment. The motor assembly is mounted to the inside of the lid (see Fig. 5), which serves as Shaky's base.

The three feet were made from non-metallic draw pulls mounted on three door-stop springs. The feet were mounted to the base of the project in a triangular pattern.

**A Slap on the Antenna.** After you've completed the construction, it is time to see if you've created a friend or a Fran-

kenstein monster. With power applied to the circuit, touch TP1 and TP3, and the LED's should begin to flash and the two buzzers should sound. When the two antenna are bridged, the voltage at the collector of Q7 should rise to about 8 volts, if not check to make sure that see if all of the transistors are connected properly.

Bridge TP2 and TP3 and a friendly shudder should occur. If not, check the voltage at the collector of Q8, which should also be near 8 volts; also make sure that the transistors are properly connected. Once you get the circuit to operate properly, close up the project's enclosure, and begin applying the decorations. What type of decorations are used and how they are laid out is up to the builder. You can create a one-of-a-kind pet and have a friend and a playmate for life. ■

MOUSER ELECTRONICS

## consider the SOURCE

Make  
MOUSER Electronics  
your factory-authorized source  
for over 80 quality electronic  
component manufacturers  
like:

**AUGAT,  
TECCOR, AMP, GE,  
& SGS-Thomson.**

And then add:  
coast-to-coast distribution,  
same-day shipping, toll-free  
ordering and the full support  
of MOUSER's 25 years of  
proven customer service  
experience.

Call today  
for your complimentary  
subscription to the latest  
MOUSER Electronics Catalog.  
Just dial:

**1-800-992-9943**

CIRCLE 14 ON FREE INFORMATION CARD

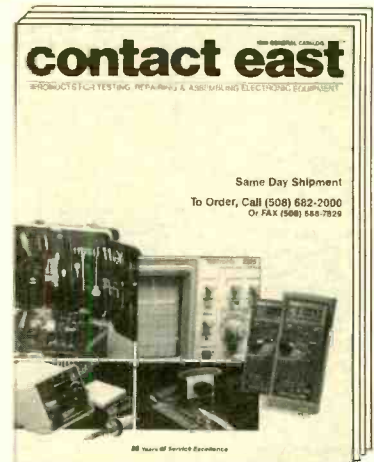

## FREE CATALOG TEST INSTRUMENTS & HARD-TO-FIND TOOLS

Packed with over 10,000 quality products for test ing, repairing, and assembling electronic equip- ment. A full selection of test instruments, power protection equipment, precision hand tools, tool kits, soldering supplies, and much more. Products are shown in full color with detailed descriptions and pricing. All products come with a 100% satis- faction guarantee. SAME-DAY shipment program.

*In a hurry to receive your catalog?*

Call (300) 225-5370

In Massachusetts call (508) 682-2000

Contact East, Inc., Dept. R440  
P.O. Box 786, No. Andover, MA 01845

CIRCLE 16 ON FREE INFORMATION CARD

SEPTEMBER 1989

97



## NEW FROM ETT



□ **TELE—THE INVENTION OF TELEVISION** ..... \$9.95. How television came to be. Packed with history, 36-pages of photos and illustrations of early equipment. A collector's delight.

□ **PCP105—MAKE MONEY FROM HOME RECORDING** ..... \$10.00. Now that you've spent a fortune on all that recording gear, MIDI and all, wouldn't you like to get some of it back? This book shows you how.



□ **PCP106—SYNTHESIZERS FOR MUSICIANS** ..... \$10.00. All current popular forms of synthesis explained. LA, additive, phase distortion, FM and sampling. Get the sounds you want.

□ **BP182—MIDI PROJECTS** ..... \$6.95. How to interface popular home computers with MIDI systems. Also covers interfacing MIDI gear to analog and percussion synthesizers.

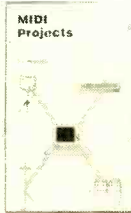

□ **BP255—INTERNATIONAL RADIO STATIONS GUIDE** ..... \$8.95. Essential reference work for the casual listener, amateur radio DXer and the professional radio monitor.

□ **BP85—INTERNATIONAL TRANSISTOR EQUIVALENTS GUIDE** ..... \$7.50. Find possible substitutions for a popular user-oriented selection of modern transistors made by more than 100 manufacturers.



MAIL TO: **Electronic Technology Today, Inc.**  
P.O. Box 240  
Massapequa Park, NY 11762-0240

### SHIPPING CHARGES IN USA AND CANADA

\$0.01 to \$5.00	... \$1.25	\$30.01 to \$40.00	\$5.00
\$5.01 to 10.00	... \$2.00	\$40.01 to \$50.00	\$6.00
\$10.01 to \$20.00	\$3.00	\$50.01 and above	\$7.50
\$20.01 to \$30.00	\$4.00		

**SORRY, No orders accepted outside of USA and Canada**

Total price of merchandise	..... \$	_____
Shipping (see chart)	..... \$	_____
Subtotal	..... \$	_____
Sales Tax (NYS only)	..... \$	_____
Total Enclosed	..... \$	_____

Name \_\_\_\_\_  
Address \_\_\_\_\_  
City \_\_\_\_\_ State \_\_\_\_\_ Zip \_\_\_\_\_

## SCANNER SCENE

(Continued from page 90)

225- to 400-MHz UHF military aeronautic band. He says he knows that some base/mobile scanners can receive that band, but which handhelds are capable of doing the same, or can be modified for such operation? We can't help you on that one, Lloyd. As far as we can find out, none are made or can be modified for that excellent band.

A card from R.W.N. of Los Angeles asks if there's a known frequency for the U.S. Attorney's office in his area. Our understanding is that, on a national basis, repeaters operate on 415.85 MHz, with the input frequency being 416.175 MHz.

For those with a scientific bent, the Soviet space program frequently can be monitored with success on 143.625 MHz, at least when the space vehicle is passing overhead. Most of what you can expect to hear is telemetry, which is appreciated solely to the extent that you're hearing signals from *space*. Our own Space Shuttle may provide some AM voice opportunities on 296.8 and 259.7 MHz after reentry, and before and during landing operations. ■

## COMPUTER BITS

(Continued from page 85)

With complex drawings, you can place different objects on different layers, use different colors, and use different line types. However, there's no way to vary line width.

You can adjust the height of text after you've typed it in, but not the height of dimensional text; you must make sure that text height is set correctly before adding dimensions. You can also convert AutoSketch files to AutoCAD format.

The program comes with a short manual (about 100 pages) that is well written, well illustrated, and contains a brief tutorial.

I just learned that a new version of the program (2.0) is due to be released before you read this. New features will include: area fill (a much-needed command for shading areas), architectural dimensioning, a variety of text fonts (version 1.04 has a single rather ugly font), fillet and chamfer commands, and more direct AutoCAD compatibility. Prices have not been fixed, but should remain in the same general range as the prices quoted here. ■

## MERCURY SWITCH

(Continued from page 73)

The alarm can have any type of enclosure. The one chosen by the author was a small plastic box slightly larger than the four AA-cell holder used. The final assembly is shown in Fig. 5. The battery holder was mounted against the unclad side of the PC board. The PC board was mounted to the inside of the lid of the case using four ¼ × ½-inch long threaded standoffs.

After you complete a unit, you may want one for your children's tricycle, your own bicycle, and maybe even for that power lawn mower parked in the backyard. The unit is small enough to be built in almost any enclosure and can be disguised quite easily. A thief working in the dark has to locate the alarm first, then turn it off. As was mentioned earlier, that can prove to be a problem for a thief.

As simple and inexpensive as the unit is, it can save you many dollars by deterring thefts in the future. New uses for the special switch used in the project are unlimited since it overcomes most of the inherent orientation problems associated with mercury switches. ■

## HAM RADIO

(Continued from page 95)

closer than the previous designs. The antenna coil (L2 in Fig. 4) should be from 3 to 10 turns wound around the cold end of the main coil (use fewer turns in the higher frequency range than in the lower).

The coils used in the FSM can be wound on any cylindrical coil form: PVC pipe, plastic tubing, or, if you want to get really classy, on ferrite toroids. Perhaps the most sensitive homebrew FSM is one that uses both the transistor meter amplifier and the tuned circuit. In any event, all three circuits are easy to put together in just about an evening's time.

Interference on our bands from unauthorized sources, whether actual radio signals or leakage from other equipment, must be suppressed if we intend to keep our bands clean. So go get 'em.

As always, your tips, comments, questions, and suggestions for this column are welcome. Send all correspondence to *Ham Radio*, **Popular Electronics**, 500-B Bi-County Blvd., Farmingdale, NY 11735. ■

## CANON RC-250

(Continued from page 46)

(LCD) on the top of the camera body indicates the shooting mode (single frame and continuous frames), disk condition (unloaded, full, or loaded with a write-prohibited disk), track number, battery condition, and self-timer (10-second delay) operation. When the 10-second delay period is triggered, a red, flashing self-timer indicator comes on with the flashing speed increased for the last two seconds.

**More on Features.** The Canon RC-259 camera features include a half-inch CCD (charge-coupled device) image sensor coupled with high-band recording technology for good image quality, built-in electronic flash, automatic exposure, intelligent automatic white balance for accurate color rendition, a long-life rechargeable battery, and continuous shooting at three frames per second.

The Canon RC-250 camera features a fixed-focus, 11-mm, *f*/2.8 lens (equivalent to a 60-mm lens in the 35-mm format) that provides sharp images of subjects at a distance from the lens of 3.3 feet (1 meter) to infinity. A built-in macro mechanism focuses as close as 12 inches (30 cm).

Accurate exposure is assured through the use of a feedback automatic-exposure system that accounts for the fact that CCD image sensors have a somewhat smaller exposure latitude than film. An SPC-type (Silicon Photo Cell) external metering sensor, as used in many 35-mm film cameras, determines the appropriate aperture value and shutter speed. But before the shutter is opened, the exposure value is checked to see if it's correct. If the exposure value exceeds the CCD's latitude, the shutter speed is slightly adjusted to provide the correct exposure. The camera has a metering range of EV 8 to 18 at an equivalent of ISO 100. A backlight-compensation button provides an extra 1.5 EV where required.

Accurate color reproduction is assured through the use of an on-chip RGB (red-green-blue) pure color-stripe filter and *intelligent* automatic white balance. Our test indoor pictures displayed on a standard color television receiver revealed a slight difference in color tone in pictures shot with and without the built-in flash. However, when shown to a test panel of viewers, the



*The Canon RC-250 camera uses a miniature magnetic disk instead of film to record the images, so no processing is required.*

difference in color tone was not mentioned by them.

**Camera Mechanics.** The camera's built-in flash automatically fires at light levels of EV 8 or lower when set in the AUTO mode. The flash can also be manually turned on for fill-flash, or turned off for low-light pictures without flash. That technique produced excellent photos in overhead sunlight where shadows in the subject's eye sockets were eliminated. Flash recycling time ranges from a minimum of 0.3 seconds to a maximum of 3 seconds. The guide number is 23 feet based on an ISO-100 equivalent.

The RC-250's shutter is a compact, two-blade design consisting of a single motor and a single magnet. Shutter speed ranges from  $\frac{1}{30}$  to  $\frac{1}{500}$  of a second. The flash sync speed is  $\frac{1}{125}$  of a second. The action of the shutter is automatically programmed by the camera electronics.

Another contribution to the camera's small size and light weight is a new disk-drive unit that is smaller than that used in Canon's industrial electronic still cameras.

The Canon RC-250 camera is powered by a rechargeable battery that is good for shooting up to 500 images (without flash). Playback with a fully charged battery is approximately 10 minutes. To conserve battery power, there's a built-in automatic shut-off mechanism that turns the camera off when the same track is played for two minutes when the camera is powered from the battery pack. It shuts off after

15 minutes when the camera is AC powered.

**What You Can Buy.** The Canon RC-250 can be purchased alone, or as part of the RC-250 package that includes an accessory kit. The accessory kit contains everything needed for recording and playback, including a BP-4P battery pack, a pin cable, a BA-24P battery charger, and an AV-CC25 AC coupler.

Available optional accessories include an RF-301 RF unit; a 1.33x teleconverter-lens adaptor, model TC-C2513; an AG-C25 *action grip* that provides a larger, firmer grip for photographing action, and to which the teleconverter attaches; an SP-C25 sports pack that encases the camera in a water-resistant housing and includes a sports finder for easily framing fast action; an MF-C25 macro frame; a stand that holds the camera for macrophotography; and the SB-C system bag. There is no threaded hole for a tripod attachment on the camera itself; the action grip must be used for tripod mounting.

The Canon RC-250 camera measures 5.6- x 1.3- x 4.2-inches and weighs just over one pound. The camera's suggested list price is less than \$800 for the camera only; less than \$1,000 for the RC-250 package. Considering prior marketing practices in the photographic field, you can expect those prices to be reduced. For more information on the Canon RC-250 Still Video Camera circle number 116 on the Free Information Card. ■



# BUILD-IT BOOKS FOR EXPERIMENTERS



□ **BP106—MODERN OP-AMP PROJECTS** . . . \$5.75. Wide range of build-it projects that use op-amps. Easy to build board layouts provided for most. A variety of projects of all kinds are included.



□ **# 223—PROJECTS USING THE CA3130** . . . \$5.00. 50 different ways to put this op-amp to work including audio, RF, test equipment, household and miscellaneous projects.



□ **BP44—IC 555 PROJECTS** . . . \$5.95. Included are basic and general timer circuits, automobile and model railroad circuits, alarms and noise makers, as well as a section on 556, 558, and 559 timers.



□ **# 224—50 CMOS IC PROJECTS** . . . \$5.25. These ICs are suitable for an extraordinary range of applications. This book shows you just how much you can do with them.



□ **BP59—2ND BOOK OF CMOS IC PROJECTS** . . . \$5.50. Still more ways to use these versatile devices. None of these projects overlap those in book #224. The pair make a wonderful circuit reference set.



□ **BP84—DIGITAL IC PROJECTS** . . . \$5.50. Both simple and more advanced projects to help the reader develop a knowledge of the workings of digital circuits. A number of board layouts are included.

MAIL TO: **Electronic Technology Today Inc.**  
P.O. Box 240  
Massapequa Park, NY 11762-0240  
**SHIPPING CHARGES IN USA AND CANADA**

\$0.01 to \$5.00 . . . \$1.25  
\$5.01 to 10.00 . . . \$2.00  
\$10.01 to \$20.00 \$3.00  
\$20.01 to \$30.00 \$4.00  
\$30.01 to \$40.00 \$5.00  
\$40.01 to \$50.00 \$6.00  
\$50.01 and above \$7.50

**SORRY, No orders accepted outside of USA and Canada**

Total price of merchandise . . . \$ \_\_\_\_\_  
Shipping (see chart) . . . \$ \_\_\_\_\_  
Subtotal . . . \$ \_\_\_\_\_  
Sales Tax (NYS only) . . . \$ \_\_\_\_\_  
Total Enclosed . . . \$ \_\_\_\_\_

Name \_\_\_\_\_  
Address \_\_\_\_\_  
City \_\_\_\_\_ State \_\_\_\_\_ Zip \_\_\_\_\_

## DIGITAL COURSE

(Continued from page 81)

- Connect the other side of those switches to  $V_{CC}$  with 4700-ohm resistors.
- Apply power to the circuit and turn all the switches on. Check the output from each switch with the voltmeter. Record your results in Table 2. Then turn all the switches off, check their outputs again, and record the results in Table 2.
- Once that's done, remove power, but do not disconnect the circuit. To see how well you've retained the information presented in this article, answer the following questions:
  1. What is the output of the circuit in Fig. 1 when all switches are closed; what is the output when all switches are open?
  2. Some microprocessors have eight data lines that are used to move information eight bits at a time. How many different data patterns can be sent on eight lines?
  3. Some microprocessors have sixteen address lines. Memory locations are selected by binary numbers on those lines. How many memory locations can be selected?

TABLE 3—PRACTICE CONVERSIONS

Decimal	Binary	Hexadecimal
12		
	1110	
	00101010	A
		2B

4. What is the number of bits in a byte?
5. Make a list of the hexadecimal numbers 0–15.
6. Use what you've learned about number systems to fill in the blanks of Table 3.

Hexadecimal	Binary	Decimal
43	101011	
42	00101010	
10	1010	
14	1110	
12	1100	

TABLE 4—ANSWERS

1. With all the switches closed, their outputs are at 0 volts; with all the switches open, their outputs are at +5 volts.
2.  $2^8 = 256$
3.  $216 = 65536$
4. There are 8 bits to a byte.
5. See Table 1 for the correct answer.
6. See Table 4 for the correct answer.

## LOGIC PROBE

(Continued from page 40)

the case, carefully folding any loose wires inside as you do so. Check the operation of the probe once more, to be sure all of the connections have survived the installation procedure.

When all has checked out, press the top half of a plastic LED holder in place around each LED to complete your project's construction.

**Using the Probe.** Here are some tips on using the Experimenter's Logic Probe: The probe can be used in circuits with power supplies of between +5 and +15 volts. To use the probe, connect its power-supply leads to V+ and ground of the circuit you'll be testing. Your first test each time you use the probe should be to verify that the power-supply leads have been hooked up correctly. Do so by touching the probe tip to V+ and ground in your circuit and observing the red and green LED's as you do so.

You can then proceed to monitor the inputs and outputs of digital IC's by touching the probe tip to the points of interest. The red and green LED's will show whether or not you have valid and correct logic levels at inputs and outputs. The pulse indicator will show transitions in logic levels.

The pulse-stretching feature of the Probe's pulse detector allows you to detect pulses that occur too quickly to cause visible indications on the red and green level-detecting LED's. For example, assume that  $V_{in}$  is high. A single low-going 1-microsecond pulse at  $V_{in}$  is too short to cause a visible flash of the green LED. But the pulse-detector circuit stretches the pulse, causing the yellow LED to flash. The Experimenter's Logic Probe should respond to pulses as short as 0.25 microsecond.

Set the probe to the MEMORY mode when you want to be sure not to miss seeing a transition—you might use it to monitor for noise spikes at an input, for example. Whatever the situation, the next time you need to test the operation of a digital circuit, just reach for your Experimenter's Logic Probe, and you'll be well on your way to quick and accurate diagnosis of your circuit's operation.

You've now completed one half of your digital-electronics troubleshooting toolkit. Turn to page 41 to begin building the second half—the *Experimenter's Logic Pulser*.



## ANTIQUÉ RADIO

(Continued from page 83)

pacitor is ready for reinstallation on the chassis. Stay tuned for more developments next month!

**Music on a Beam of Light.** Back in the May issue, I devoted most of this column to a discussion of the mail received from readers about a little Philco device I'd asked you to identify. It was a microphone that (among other things) was supplied with the Philco Model 41-608 *Radio-Phono-Recorder Console*. One of the letters was from Ray Ives (Cameron Mills, NY). Ray shared some of his fond personal memories of the console and included a description of the "Music on a Beam of Light" tone arm used in the phono playback system.

At the time, I asked if anyone could send additional information about this unit. In reply, three readers sent me photocopies of an article about the "beam of light" system, written by C. Douglas Houston, that had appeared in the October, 1988 issue of *Radio Age*. Many thanks to Bartholomew Lee (San Francisco, CA), Harry Goldman (Glens Falls, NY), and another reader who didn't sign his letter. Harry also sent along a shot of his own Philco "beam-of-light"



Reader Harry Goldman's Philco console. Tilt-down front is open to show phono-recorder unit.

console with the tilt-front open to display the phono-recorder unit.

The *Radio Age* article is very interesting and complete, and readers who are interested in it might still be able to obtain a copy of the issue. Send inquiries to *Radio Age*, 636 Cambridge Rd., Augusta, GA 30909.

**Spratley's Free-Power Radio.** Also in the May column, we ran a photo of a mysterious-looking hookup sent in by Richard Spratley (Chesapeake, VA). Since many of you seem to enjoy answering "What is it?" questions, I withheld the accompanying explanation and challenged you to figure it out. Four readers to date have sent in correct answers: Bill Digel (Wilmington, DE), C.R. Marson (Sacramento, CA), Frank Krantz (Somerdale, NJ), and George Trudeau (Sandwich, MA). But here's Dick's explanation in his own words:

"... I noticed by the voltmeter that my homebrew crystal radio was receiving a lot of power from radio station WJQI, Virginia Beach, VA. So I hooked my 30-year-old transistor radio up to the crystal radio and, to my surprise, it worked. In fact, I am getting good speaker volume on six AM radio stations. I hooked up my pocket calculator, and that also

works well. Enclosed is a picture of the transistor radio and calculator on a special stand. With the knife switch to the left, I can fine-tune the crystal radio for peak output on the meter. Then I throw the switch to the right and send power to the radio and calculator."

C.R. Marson and George Trudeau both mentioned experiments of their own using "free power" from AM stations, and George tells us that he once ran a code oscillator that way. Bill Digel sent in a very complete, and accurate, explanation of Dick's project, but he just couldn't believe that there'd really be enough power to run the transistor radio. I was surprised at that myself, Bill!

**That's it for Now.** Let me hear from you! Address your correspondence to *Antique Radio*, **Popular Electronics**, 500-B Bi-County Blvd., Farmingdale, NY 11735. ■

# Windjammin'

It's everything  
you've always fantasized

Sail aboard traditional Great Sailing Ships to exotic ports of call in the Caribbean, unspoiled by civilization. Stroll along hidden coves and beaches where your footprints are the only ones in the sand. Move to the beat of native steel drums and Reggae music. Lose yourself to a whole other world where time is measured by sunrises and sunsets.

*That's Windjammin'.* And there's nothing like it.

Windjammin' is also congenial shipmates. Great food and drink. And all the swimming, snorkeling, sunning and partying you can handle. All for as little as \$675 for six days and we'll share your airfare.

Call or write for your free *Great Adventure Booklet*.



**Windjammer**  
Barefoot Cruises LTD.

800-327-2601 (IN FLA. 800-432-3364) (305) 373-2090

Name \_\_\_\_\_

Address \_\_\_\_\_

City/State/Zip \_\_\_\_\_

P.O. BOX 120, DEPT. 1642 MIAMI BEACH, FL 33119-0120





## PARTS LIST FOR THE ULTRASONIC RECEIVER

U1—CD4046BCN phase-locked loop, integrated circuit  
 Q1—Q3—2N3904 general-purpose NPN silicon transistor  
 R1—3300-ohm, 1/4-watt, 5% resistor  
 R2—220,000-ohm, 1/4-watt, 5% resistor  
 R3, R7—4700-ohm, 1/4-watt, 5% resistor  
 R4, R8—120,000-ohm, 1/4-watt, 5% resistor  
 R5—1000-ohm, 1/4-watt, 5% resistor  
 R6—10,000-ohm, 1/4-watt, 5% resistor  
 R9—20,000-ohm potentiometer  
 C1—.0036- $\mu$ F, mylar or similar capacitor  
 C2—.015- $\mu$ F, mylar or similar capacitor  
 C3, C4—0.1- $\mu$ F, ceramic-disc capacitor  
 C5—4.7- $\mu$ F, 16-WVDC, electrolytic capacitor  
 C6—220- $\mu$ F, 16-WVDC, electrolytic capacitor  
 T1—1000- to 8-ohm audio-output transformer  
 SPKR1—Piezo speaker  
 Perfboard, IC socket, 5-volt power source, low-impedance headphones, etc.

and amplified by transistors Q1 and Q2. The output is fed to the phase comparator input of U1 at pin 14. The chip's internal VCO is made variable by the tuning control, potentiometer R9.

If a 20-kHz signal is picked up by SPKR1 and the VCO is tuned to produce a 19-kHz signal the difference output at pin 2 will be 1 kHz. That 1-kHz signal is amplified by Q3 and coupled through T1 to a pair of headphones. If the received frequency increases to 22 kHz, a 3-kHz tone is heard in the headphones. With the values given in the Parts List for C1, R1, and R9, the VCO can be tuned from a low frequency of 12 kHz to well over 42 kHz, which should cover just about anything the piezo sensor can respond to.

Once again we've come to the point where we must sign off. But, you be sure to join us here next month when we'll gather another group of circuits for your perusal. So until then, good vibes and may the flow be with you. ■

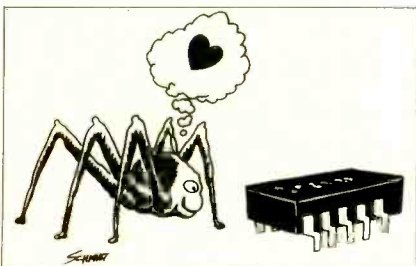

One tree can make  
3,000,000 matches.



One match can burn  
3,000,000 trees.



A Public Service of This Magazine  
to The Advertising Council

## World's Largest Treasure Hunting Equipment Expo In A Book — *Treasure Hunters Buyers Guide*



Complete Comparison Charts & Guide To Electronic Metal Detecting Equipment:

- Over 90 metal detectors with photos, descriptions & specs;
- Chapters on how to choose the right detector for you;
- Glossary of new technical terms;
- In-depth charts that compare every detector by price, search modes, weight, special features, controls, power, uses, and warranties.

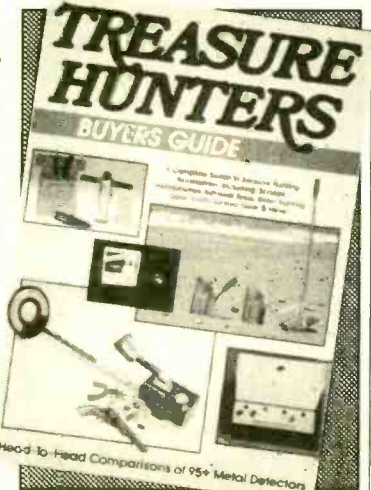

Send check or money order for \$7.95 plus \$1.50 postage & handling for each copy to: People's Publishing Co., P.O. Box 1095 Dept. PE, Arcata, CA 95521.  
 (U.S. only. Send street address - no P.O. Boxes please. CA residents add 6% tax.)



## Your Ticket To SUCCESS

Over 25,000 technicians have gained admittance worldwide as certified professionals. Let your ticket start opening doors for you.

ISCET offers Journeyman certification in Consumer Electronics, Industrial, Medical, Communications, MATV, Radar, Computer, and Video. For more information, contact the International Society of Certified Electronics Technicians, 2708 West Berry St., Fort Worth, TX 76109 • (817) 921-9101

Name \_\_\_\_\_  
 Address \_\_\_\_\_  
 City \_\_\_\_\_  
 State \_\_\_\_\_ Zip \_\_\_\_\_

Send material about ISCET and becoming certified.

Send one "Study Guide for the Associate Level CET Test" Enclosed is \$5 (+ \$1 postage).

## FIBER OPTIC KITS

Low cost kits ideal for all situations requiring immunity from electrostatic, electromagnetic, and RF interference. Also eliminates ground loop problems.

Experimenter's Kit 1 meter data link with matched LED and phototransistor. Includes fiber and data sheets.  
 IFO-108 \$9.95

Educational Kit Same as above, plus printed circuit boards and electronic components to build a complete optical link. Assembly and tutorial information included.  
 IFO-104 \$24.95

Project Kit Includes the book "Fiber Optic Communications, Experiments, & Projects" by Waldo T. Boyd with necessary optic components and fiber to complete 8 experiments and 5 projects. An ideal tool to gain theoretical and hands-on experience in fiber optic data communications.  
 IFO-106 \$54.95

Fiber Optic Lab Manual & Hardware Kit 7 Experiments + Final Project covers all the principles of fiber optics suitable for schools & science projects.  
 IFO-107 \$49.95

## CALL FOR FREE CATALOG

Components, Kits, Tools & Sockets.

### Sintec Company

28 8th St., Frenchtown, NJ 08875  
 1-800-526-5960

Visa/MasterCard accepted

CIRCLE 21 ON FREE INFORMATION CARD



## HDTV

(Continued from page 64)

American workers in the electronics and semiconductor industries. That immediately touched off an argument over just what is an American company in the age of international conglomerates. MUSE's principal backers, companies like Sony, Sanyo, Hitachi, and Panasonic, pointed out that all of them produce television sets in factories in the United States, and that high-definition equipment for North America most likely would be manufactured here. One industry insider indelicately mentioned that because manufacturing costs now are lower in the U.S. than in parts of the Far East, that some of these factories are exporting TV sets to Japan and Taiwan.

The companies with the largest share of the U.S. TV market—Thomson Electronics' GE and RCA brands and Philips' Magnavox, Philco, Philips, and Sylvania brands—both maintain full manufacturing and research facilities in the U.S. But Thomson is French-owned and Philips is a Dutch electronics giant. The only true American-owned TV manufacturer left is Zenith, which may help to explain why the Defense Department and members of Congress are pressing cash on the company to conduct research and development on its SC-HDTV system.

At the moment, SC-HDTV is still in its early stages of development—the first public display of SC-HDTV images took place late last April—but Zenith has announced a consortium with AT&T to design and make chips for Zenith's HDTV receiver. It has also applied for \$13 million from the Defense Advanced Research Projects Agency (DARPA) to help

pay for the development of the receiver and an additional \$10 million from DARPA to help pay for the development of a large-screen picture tube.

In another part of the forest, a move is afoot to rethink the production standard for the HDTV, known in the trade as 1125/60 (1125 scan lines, 60 Hz) or SMPTE 240M. While it seems unlikely that Europe, North America, and Japan are going to be able to agree on a single system for transmitting HDTV—and it's possible that the U.S. could end up with two or three—there has been a *de facto* agreement among the world's program producers on 1125/60 because it can be converted readily and with minimum loss of quality to any of the world's existing transmission systems.

Proposed originally by the Japanese, 1125/60 has undergone extensive revision in the U.S. before its adoption by SMPTE (the Society of Motion Picture and Television Engineers), and before the State Department proposed it to the International Radio Consultative Committee (CCIR) in 1984. It's being challenged by, among others, NBC, ABC, Paramount Pictures, Zenith, the Commerce Department, and Congressman Markey. Supporters include NHK, Toshiba, Sony, CBS and PBS, along with SMPTE and most producers of HD programming. They argue that a single worldwide standard is necessary in order to make their products marketable anywhere in the world. Larry Thorpe, manager of Advanced Systems for Sony Corporation, says that multiple production systems like multiple transmission systems, means that none will be able to effect the economies of manufacture that could come with a single system. Thorpe suspects that the

furor over 1125/60 may be nothing more than a delaying tactic to slow HDTV down until the critics get their act together in terms of an all-American transmission system.

Another roadblock seems to be the proposal by TCI vice president, John Sie, that the U.S. adopt some interim (and thoroughly compatible) system like IDTV (which requires no modification to the standard NTSC signal) or EDTV (which requires some modification, but retains full compatibility) until true digital HDTV comes along, perhaps in 20 to 30 years. Both IDTV and EDTV require extensive signal processing to be done by the receiver and rely on digital techniques to remove scan lines and other NTSC defects. IDTV and EDTV are similar, and both deliver substantial image improvements, but neither is true HDTV. TCI is the nation's largest operator of cable systems, and Sie's proposal has won varying degrees of support from Capital Cities/ABC and NBC/Sarnoff Laboratories.

What Sie has in mind is quick adoption of SuperNTSC, a picture-enhancement technique that's completely compatible with existing equipment and that requires no approval from the FCC. SuperNTSC's specifications are similar to those for S-VHS, the VCR format that shares many of the same Faroudja patents.

It was, in fact, S-VHS that launched the current round of enthusiasm for improved TV pictures. When cable companies like HBO and TCI got a look at the S-VHS' improved clarity and better sound, they realized that here was a potent new competitor. If video rental shops could offer the same movies as the premium channels for \$2 or \$3 a night with picture quality that was ob-

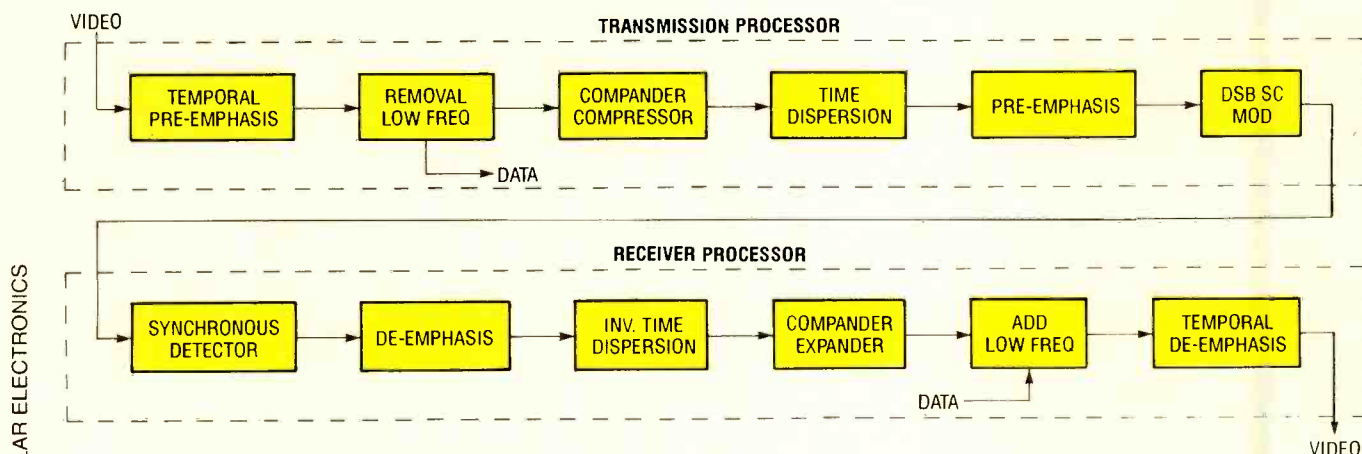

Fig. 5. The Zenith system requires sophisticated digital signal processing to work. Here is a block diagram of the processing stages used at the transmitter and receiver.

viously better, they figured, they'd lose subscribers. So two years ago the cable industry launched a crash program to do something about picture quality. What they did, in addition to studying the already-proposed systems, was to fund Faroudja Laboratories' development of SuperNTSC.

Cable companies enjoy an edge over terrestrial broadcasters because they don't need FCC permission to implement innovations like SuperNTSC or, for that matter, true HDTV. It could—and at one point HBO planned to—beat broadcasters to the punch by introducing dramatically better pictures delivered from satellite via cable. Broadcasters, knowing that all else being equal, viewers tend to prefer the channels with the best picture quality, worried that they'd lose what's left of their audience to the cable channels. Congress quickly let it be known that it wasn't going to stand still for any HDTV system that put the commercial broadcasters at a disadvantage, and the current political turf wars were under way.

One suggestion has been the so-called open-architecture TV receiver—a set that could handle any of several HDTV systems. That idea is resisted by set manufacturers on the grounds that even a single-system HDTV receiver is going to be expensive, and that ability to handle others simply adds to the cost. Sony's Thorpe adds that a multi-system HDTV receiver would face the same problem as the multisystem AM-stereo receiver: that no single system would gain a clear superiority, and that the cost of producing both programming and transmission equipment for the different systems would keep costs artificially high.

Nonetheless, there are hints here and there that media like direct-to-home satellite- and cable-programmers may not wait for Congress or the broadcasters; that set makers may find one system for over-the-air broadcasts, a second for satellite and cable, and a third for videocassette and videodisc. Dr. Ron Katz-Nelson, technical director of General Instrument's Videocipher Division, points out that MUSE was developed with satellites in mind, and that Philips' HDS-NA (another system that makes use of taboo channels to get around spectrum problems) is equally at home on satellite, cable, or over-the-air. Thus, it could be that backyard dish owners and cable subscribers could be enjoying HDTV while the politicians and broadcasters are still slugging it out. ■

# WATCH <sup>FOR</sup> THIS ISSUE

## ON SALE AUGUST 3, 1989

# Radio- Electronics

TECHNOLOGY - VIDEO - STEREO - COMPUTERS - SERVICE

### BUILD THIS SPECTRUM MONITOR

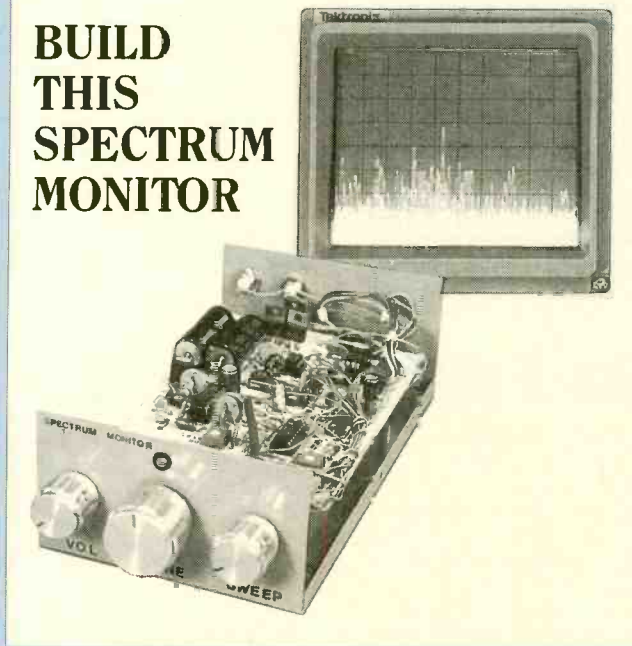

## OUR SEPTEMBER ISSUE FEATURES:

### BUILD A SPECTRUM MONITOR

*Convert your oscilloscope into a no-frills 20-600 MHz spectrum analyzer!*

### BUILD A VLF ACTIVE ANTENNA AND CONVERTER

*Tune in to the world below the broadcast band.*

### BUILD A VLF TRANSMITTER

*Explore VLF conditions with this license-free transmitter!*

### SRS—THE SOUND RETRIEVAL SYSTEM

*New technology lets you hear Stereo like you've never heard it before.*

### VCR REPAIRS YOU CAN DO

*How to solve tape-loading problems.*

**PLUS: Hardware Hacker  
Audio Update  
Hardware Reviews  
Software Reviews  
And lots more!**



# ELECTRONICS MARKET PLACE

## FOR SALE

**DESCRAMBLERS.** All brands. Special: combo Jerrold 400 and SB3 \$165. Complete cable descrambler kit \$39.00. Complete satellite descrambler kit \$45.00. Free catalog. **MJH INDUSTRY**, Box 531, Bronx, NY 10461-0531.

**CABLE descrambler liquidation.** Major makes and models available. Industry pricing! (Example: Hamlin Combs, \$44 each... minimum 10 orders). **Dealers only!** Call **WEST COAST ELECTRONICS**, (818) 709-1758.

**CABLE TV descramblers,** Jerrold, Scientific Atlanta, Zenith. Most major brands. Dealer inquiries welcome. Visa-M/C accepted. **E & O VIDEO**, 9691 E. 265th Street, Elko, MN 55020. 1 (800) 638-6898.

**LISTEN to the world!** Huge catalog of shortwave receivers, antennas, accessories, plus radioteletype and facsimile decoding equipment. Send \$1 to: **UNIVERSAL RADIO**, 1280 Aida Drive, Dept. PE, Reynoldsburg, OH 43068.

## CB RADIO OWNERS!

We specialize in a wide variety of technical information, parts and services for CB radios. 10-Meter and FM conversion kits, repair books, plans, high-performance accessories. Thousands of satisfied customer since 1976! Catalog \$2.

### CBC INTERNATIONAL

P.O. BOX 31500PE, PHOENIX, AZ 85046

**SURPLUS ELECTRONICS.** New giant wholesale catalog. Hundreds of incredible bargains. \$2. Box 840, Champlain, NY 12919.

**LASER Listener II,** other projects. Surveillance, descrambling, false identification, information. Plans, kits, other strange stuff. Informational package \$3.00 refundable. **DIRIJO/BOND ELECTRONICS**, Box 212, Lowell, NC 28098.

**CABLE TV converters.** Jerrold, Oak, Scientific Atlantic, Zenith & many others. "New" MTS stereo add-on: mute & volume. Ideal for 400 & 450 owners! 1 (800) 826-7623. Amex, Visa, M/C accepted. **B & B INC.**, 4030 Beau-D-Rue Drive, Eagan, MN 55122.

**ENGINEERING software,** PC/MSDOS. Hobbyists — students — engineers. Circuit design, FFT analysis, mathematics, logic simulation, circuit analysis. Free catalog, (614) 491-0832, **BSOFT SOFTWARE**, 444 Colton Rd., Columbus, OH 43207.



## TUBES - 2000 TYPES DISCOUNT PRICES!

Early, hard-to-find, and modern tubes. Also transformers, capacitors and parts for tube equipment. Send \$2.00 for 24 page wholesale catalog.

**ANTIQUE ELECTRONIC SUPPLY**  
688 W. First St. • Tempe, AZ 85281 • 602/894-9503

**CONTROLLERS Z80 based systems.** Write **CUSTOM COMPUTER APPLICATIONS**, 22639 Rosedale Street, St. Clair Shores, MI 48080.

**HARD to find surplus.** Low prices. Inductors, transformers, diodes, semiconductors, power supplies, capacitors, ferrites, chokes and more. Catalog \$1.00 (refunded first order). **JSP**, Box 160113, Cupertino, CA 95016.

**FLOOD your mailbox!** You get 100's of radio & electronic & computer specialty catalogs. Send \$10 with your name & address to: **ELECTRONIC LIST SERVICE**, PO Box 1683, Brookline, MA 02146.

**CONTENTS electronic store.** Service equipment, transistors, IC's, computers. **SASE WEYMOUTH**, Box 637, W. Haverstraw, NY 10993.

**ROOM surveillance telephone,** \$175.00. Monitor room or telephone conversations. **Range unlimited.** 1 (800) 633-8277. Catalog \$3.00. **LISTEN ELECTRONICS**, 603 Elgin, Muskogee, OK 74401.

**ELECTRONIC components.** Free 192 page catalog including capacitors, resistors, relays, connectors, soldering equipment and supplies. **BOX 699, Mansfield, TX 76063.** 1 (800) 992-9943.

## CLASSIFIED AD ORDER FORM

To run your own classified ad, put one word on each of the lines below and send this form along with your check to:

**Popular Electronics Classified Ads, 500-B Bi-County Boulevard, Farmingdale, N.Y. 11735**

**PLEASE INDICATE** in which category of classified advertising you wish your ad to appear. For special headings, there is a surcharge of **\$11.00**.

( ) Plans/Kits ( ) Business Opportunities ( ) For Sale  
( ) Education/Instruction ( ) Wanted ( ) Satellite Television  
( ) \_\_\_\_\_

Special Category: \$11.00

### PLEASE PRINT EACH WORD SEPARATELY, IN BLOCK LETTERS.

(No refunds or credits for typesetting errors can be made unless you clearly print or type your copy.) Rates indicated are for standard style classified ads only. See below for additional charges for special ads. **Minimum: 15 words.**

1	2	3	4	5
6	7	8	9	10
11	12	13	14	15 (\$23.25)
16 (\$24.80)	17 (\$26.35)	18 (\$27.90)	19 (\$29.45)	20 (\$31.00)
21 (\$32.55)	22 (\$34.10)	23 (\$35.65)	24 (\$37.20)	25 (\$38.75)
26 (\$40.30)	27 (\$41.85)	28 (\$43.40)	29 (\$44.95)	30 (\$46.50)
31 (\$48.05)	32 (\$49.60)	33 (\$51.15)	34 (\$52.70)	35 (\$54.25)

We accept MasterCard and Visa for payment of orders. If you wish to use your credit card to pay for your ad fill in the following additional information (Sorry, no telephone orders can be accepted):

Card Number \_\_\_\_\_

Expiration Date \_\_\_\_\_

PRINT NAME \_\_\_\_\_

SIGNATURE \_\_\_\_\_

**IF YOU USE A BOX NUMBER YOU MUST INCLUDE YOUR PERMANENT ADDRESS AND PHONE NUMBER FOR OUR FILES. ADS SUBMITTED WITHOUT THIS INFORMATION WILL NOT BE ACCEPTED.**

**CLASSIFIED COMMERCIAL RATE:** (for firms or individuals offering commercial products or services) \$1.55 per word prepaid (no charge for ZIP code)...**MINIMUM 15 WORDS.** 5% discount for same ad in 5 issues within one year; 10% discount for 12 issues within one year if prepaid. **NON-COMMERCIAL RATE:** (for individuals who want to buy or sell a personal item) \$1.25 per word, prepaid...no minimum. **ONLY FIRST WORD AND NAME** set in bold caps at no extra charge. Additional bold face (not available as all caps) 30¢ per word additional. Entire ad in boldface, \$1.85 per word. **TINT SCREEN BEHIND ENTIRE AD:** \$1.90 per word. **TINT SCREEN BEHIND ENTIRE AD PLUS ALL BOLD FACE AD:** \$2.25 per word. **EXPANDED TYPE AD:** \$2.05 per word prepaid. Entire ad in boldface, \$2.45 per word. **TINT SCREEN BEHIND ENTIRE EXPANDED TYPE AD:** \$2.55 per word. **TINT SCREEN BEHIND ENTIRE EXPANDED TYPE AD PLUS ALL BOLD FACE AD:** \$2.95 per word. **DISPLAY ADS:** 1" x 2 1/4" — \$175.00; 2" x 2 1/4" — \$350.00; 3" x 2 1/4" — \$525.00. General Information: Frequency rates and prepayment discounts are available. **ALL COPY SUBJECT TO PUBLISHERS APPROVAL. ADVERTISEMENTS USING P.O. BOX ADDRESS WILL NOT BE ACCEPTED UNTIL ADVERTISER SUPPLIES PUBLISHER WITH PERMANENT ADDRESS AND PHONE NUMBER.** Copy to be in our hands on the 15th of the fourth month preceding the date of issue (i.e.; Sept. issue copy must be received by May 15th). When normal closing date falls on Saturday, Sunday or Holiday, issue closes on preceding work day. Send for the classified brochure. **Circle Number 49 on the Free Information Card.**



## PLANS & KITS

**BUILD** this five-digit panel meter and square wave generator including an ohms, capacitance and frequency meter. Detailed instructions \$2.50. **BAGNALL ELECTRONICS**, 179 May, Fairfield, CT 06430.

**ELECTRONIC kits!** Transmitters! Recorders! Phone devices! Bug detectors! Surveillance items! More! Catalog \$1.00: **XANDI ELECTRONICS**, Box 25647, 32FF, Tempe AZ 85285-5647.

**SPEAKERS** — subwoofers, woofers, midranges, tweeters for auto, home, MI, commercial applications. 88 page color catalog — \$2.00. Amplifiers, microphones, DJ equipment. **McGEE RADIO**, 1501 McGee, Kansas City, MO 64108.

**PRINTED** circuit boards etched & drilled. Free delivery. **K & F ELECTRONICS, INC.**, 33041 Groesbeck, Fraser, MI 48026. (313) 294-8720.

**SURVEILLANCE transmitters:** crystal controlled and tuneable, as used by law enforcement agencies. Match box sized 158 Mhz. crystal controlled voice transmitter, sugar cube sized VHF transmitter, micro UHF transmitter. Complete plans, including board layouts. Catalog \$2.00. **RANDOM TECHNICAL PRODUCTIONS**, Box 7396, Saskatoon, Saskatchewan, Canada S7K 4J3.

## NEW HE NE LASER TUBES \$35

Dealer Inquiries Invited.  
Free Catalog!

MEREDITH INSTRUMENTS: 6403 N. 59th Ave.  
Glendale, AZ 85301 • (602) 934-9387  
"The Source for Laser Surplus"

**DETECTION** — surveillance, debugging, plans, kits, assembled devices. Latest high-tech catalog \$5. **DETECTION SYSTEMS**, 2515 E. Thomas, #16-864J, Phoenix, AZ 85016.

**AMAZING Tesla Coil!** 1,000,000 volts! 4' arcs! Easily built using locally obtained parts. Best design out! Plans \$10.00. **JAMES PERKINS**, PO Box 30217, Stockton, CA 95213.

**CATALOG: hobby/broadcasting/HAM/CB: Cable TV, transmitters, amplifiers, surveillance devices, computers, more!** **PANAXIS**, Box 130-F9, Paradise, CA 95967.

**VIDEOPHILIP II** manuals. Volume 1 — hardware, Volume 2 — software. Either \$32.45. Volume 3 — projects/software — \$42.45. Volume 4 — repair/software — \$97.45. CODs — (602) 782-2316. Catalog — \$3.00. **TELECODE**, Box 6426-H, Yuma, AZ 85366-6426.

**DAZER** protectors, ionizers, Tesla, radio, surveillance, illusions, more! Catalog \$1.00. **QUANTUM RESEARCH**, 17919-77 Avenue, Edmonton, Alberta T5T 2S1.

**CIRCUIT** boards for projects in this magazine (and past issues) about half price. **KLAY-CORPORATION**, 106 Mark Drive, Syracuse, NY 13209-1808.

**SURVEILLANCE**, debugging, protection. Worlds largest new catalog — \$5.00 kits — assembled — all price ranges. **TECHNOLOGY SERVICES**, 829 Ginette, Gretna, LA 70056.

**QUALITY electronic index card club.** Send \$1.00 for introductory kit or write us. **RS MARKETING**, 414 Teresa Road, Elizabethtown, KY 42701.

**PROJECTION TV** Convert your TV to project 7 foot picture... Easy!... Results comparable to \$2,500 projectors... **Plans and 8" Lens \$24.95**... Professional systems available... Illustrated catalog free. **MACROCOMA**, 15HA Main Street, Washington Crossing, PA 18977. Creditcard orders 24 hrs. (215) 736-3979.

## GLOBAL CABLE NETWORK

**YOUR** cable TV converters and descramblers bargain headquarters: Zenith, Jerrold, Tocom, Scientific Atlanta, Hamlin. Oak M35B only \$60.00. Order yours today. (415) 584-1627.

## CABLE-TV BOXES

Descramblers • Converters  
FREE CATALOG

TRANS-WORLD CABLE CO.  
12062 Southwest 117th Ct., Suite 126  
Miami, Florida 33186  
800-442-9333

## SATELLITE TV

**FREE** catalog systems, Upgrades. Houston, Uniden, Chapparral, etc. Save \$\$\$\$\$. **SKYVISION**, 2008 Collegeway, Fergus Falls, MN 56537. (218) 739-5231.

**FREE** 36 page catalog. America's largest! All major brands. Save 40 — 60%. Since 1977 nobody under-sells **WEST INC.**, 1741 Cedardale Road, Mt. Vernon, WA 98273. Visa/MC/Disc/Amex/COD. 1 (800) 222-9064.

## EDUCATION/INSTRUCTION

**MAGIC!** Four illustrated lessons plus inside information shows you how. We provide almost 50 tricks including equipment for four professional effects. You get a binder to keep the materials in, and a one-year membership in the International Performing Magicians with a plastic membership card that has your name gold-embossed. You get a one-year subscription to our quarterly newsletter, "IT'S MAGIC!" Order now! \$29.95 for each course + \$3.50 postage and handling. (New York residents add applicable state and local sales tax). **The Magic Course**, 500-B BiCounty Blvd., Farmingdale, NY 11735.

**LEARN IBM PC assembly language.** 80 programs. Games, quizzes, animation, utilities. Includes license. 360K \$5.00, 720K \$6.00, Book \$18.00. **ZIPFAST**, Box 12238, Lexington, KY 40581-2238.

**F.C.C. Commercial General Radiotelephone License.** Electronics home study. Fast, inexpensive! "Free" details. **COMMAND**, D-178, Box 2824, San Francisco, CA 94126.

**ANTIQUE** radio collectors/historians, join Antique Wireless Association — meets, flea markets, historical conference, quarterly bulletin. \$10.00 yearly. **ANTIQUE WIRELESS ASSOCIATION**, PO Box E-A, Breesport, NY 14816.

**LET** your computer teach you electronics. Our home-study courses include computer movies and on-screen lab experiments. Our products are used in hundreds of community colleges and technical institutes. Now, you can have the same high-tech approach to learning in your own home. Low cost, pay as you go. **MALVINO INC.**, 229 Polaris Ave, Suite 17P, Mt. View, CA 94043.

## BUSINESS OPPORTUNITIES

**EASY** work! Excellent pay! Assemble products at home. Call for information. (504) 641-8003 Ext. 5730.

**YOUR own radio** station! AM, FM, TV, cable. Licensed/unlicensed. **BROADCASTING**, Box 130-F9, Paradise, Ca 95967.

**INVENTIONS**, ideas, technology wanted for presentation to industry/exhibition at national innovation exposition. Call 1 (800) 288-IDEA.

**LET** the government finance your small business. Grants/loans to \$500,000 yearly. Free recorded message: (707) 448-0270. (KJ8).

**MAKE** big profits! Sell over 2500 fast-selling items at work, parties, etc. \$3.00 brings giant catalog — refundable with first order. **JAMES THAMES**, 5320 Blanco, San Antonio, TX 78216.

## CABLE EQUIPMENT

**CABLE TV** Secrets — the outlaw publication the cable companies tried to ban. HBO, Movie Channel, Showtime, descramblers, converters, etc. Suppliers list included. \$8.95. **CABLE FACTS**, Box 711-H, Pataskala, OH 43062.

## CABLE TV CONVERTERS

WHY PAY A HIGH MONTHLY FEE?

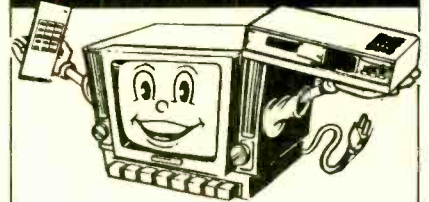

All Jerrold, Oak, Hamlin, Zenith, Scientific Atlanta, Magnavox and all specialized cable equipment available for shipment within 24 hours. For fast service MC / VISA or C.O.D. telephone orders accepted (800) 648-3030 60 Day Guarantee (Quantity Discounts) 8 A.M. to 5 P.M. C.S.T. **CLOSED WEEK-ENDS.** Send self-addressed Stamped envelope (60¢ postage) for Catalog.

MIDWEST  
ELECTRONICS INC.

P.O. Box 5000  
Suite 311 (PE)  
Carpentersville, IL 60110

No Illinois Orders Accepted.

## DO IT YOURSELF

**INSTALLING**, adding or troubleshooting, your own telephone cabling can save you \$50.00HR. Simple, fully illustrated booklet \$12.50. **PHONES**, PO Box 13071, Albuquerque, NM 87192-3071.

## TV FILTERS

T.V. tunable notch filters. Free brochure. **D. K. VIDEO**, Box 63/6025, Margate, FL 33063. (305) 752-9202.

## ATTENTION CABLE BROKERS

**SURPLUS** CATV converters and descramblers at wholesale prices. Unmodified units only. Oak M35B \$30, Hamlin CRX5000 w/remote \$80, Jerrold 400DRX3NIC w/remote \$85. (415) 337-8301.

## CABLE TV CONVERTERS IN STOCK

Stocking all types of converters — Panasonic, Jerrold, Tocom, Pioneer, Scientific Atlanta, Zenith, Oak, Hamlin, Eagle, and others brands available.

Call or write for **FREE CATALOG**  
10 am - 6 pm Eastern, Mon. - Fri.

**VIDEO-LINK Enterprises, Inc.**

165 WEST PUTNAM AVE.  
GREENWICH, CT 06830  
Phone (203) 622-4386

A  
Disability  
Can Be  
An Asset.

The President's Committee  
on Employment of the Handicapped  
Washington, D.C. 20036



# ADVERTISING INDEX

POPULAR ELECTRONICS magazine does not assume any responsibility for errors that may appear in the index below.

Free Information No.	Page
6	AMC Sales ..... 87
5	All Electronics ..... 15
—	Amazing Concepts ..... 23, 25, 27
—	American Hme. Sat. Assoc. .... 32
—	Antique Electronic Supply .... 106
9	C & S Sales ..... 17
—	CB City ..... 106
7	CIE ..... 31
—	Command Productions ..... 87
16	Contact East ..... 97
8	Cook's Institute ..... 95
10	Digi Key ..... CV3
—	Electronics Book Club ..... 26, 3
—	Electronic Tech. Today ..... 98, 100,
—	Electronic Tech. Today ..... CV4
—	Grantham College ..... CV2
12	Halted Specialties ..... 24
19	Heathkit ..... 4
—	ISCET ..... 103
17	Kelvin ..... 85
—	McGraw Hill Book Club ..... 8
—	Meredith Instruments ..... 107
—	Midwest Electronics ..... 107
14	Mouser ..... 97
—	NRI ..... 21
20	Protel Technology ..... 24
—	Pacific Cable ..... 7
11	Parts Express ..... 5
—	People's Pub. Co. .... 103
21	Sintec ..... 103
15	The Antenna Specialists ..... 13
—	Trans World ..... 107
—	Video-Link ..... 107
13	Viejo Publications ..... 95

## ADVERTISING SALES OFFICE

**Gernsback Publications, Inc.**  
 500-B Bi-County Blvd.  
 Farmingdale, NY 11735  
 1-(516) 293-3000  
 President: **Larry Steckler**  
 Vice President: **Cathy Steckler**

**For Advertising ONLY**  
 516-293-3000  
 Fax 1-516-293-3115  
**Larry Steckler**  
 publisher

**Arline Fishman**  
 advertising director  
**Christina Estrada**  
 advertising assistant  
**Shelli Weinman**  
 advertising associate  
**Lisa Strassman**  
 credit manager

**SALES OFFICES**  
**EAST/SOUTHEAST**  
**Becky Akers**  
 Pattis/3M  
 310 Madison Ave., Suite 1804  
 New York, NY 10017  
 1-212-953-2121  
 Fax 1-212-953-2128

**MIDWEST/Texas/Arkansas/ Okla.**  
**Ralph Bergen**  
 540 Frontage Road—Suite 339  
 Northfield, IL 60093  
 1-312-446-1444  
 Fax 1-312-446-8451

**PACIFIC COAST/Mountain States**  
**Marvin Green**  
 5430 Van Nuys Blvd., Suite 316  
 Van Nuys, CA 91401  
 1-818-986-2001  
 Fax 1-818-986-2009

## RC NETWORKS

(Continued from page 75)

powered by a dual supply (not shown) with voltages  $+V_O$  and  $-V_O$ . The rules for such a circuit are simple, and depend on the difference in voltage ( $V_{id}$ ) at the op-amp's inputs, which in the circuit is the difference between capacitor voltage  $V_C$  and voltage  $V_1$ . The rules are as follows: when  $V_C > V_1$ , then  $V = -V_O$ ; when  $V_C < V_1$ , then  $V = +V_O$ . The trick is to use  $V_C$  to cause  $V$  to flip back and forth between  $+V_O$  and  $-V_O$  at a fixed frequency. The timing diagram in Fig. 5 reflects those rules.

Because of the voltage divider formed by  $R_1$  and  $R_2$ , voltage  $V_1$  is determined by this equation:

$$V_1 = VR_2 / (R_1 + R_2)$$

As was mentioned, voltage  $V_C$  is the voltage across the capacitor, which is charged by  $V_O$ . Using Equation 1 we can find the time ( $t_1$ ) for  $V_C$  to rise from  $-V_1$  to  $+V_1$ :

$$RC = \frac{-t_1}{\ln \left[ \frac{V_O - V_1}{V_O - (-V_1)} \right]}$$

$$RC = \frac{-t_1}{\ln \left[ \frac{1 - R_2 / (R_1 + R_2)}{1R_2 / (R_1 + R_2)} \right]}$$

And in the simplified case where  $R_1 = R_2$ :

$$RC = -t_1 / \ln[(1 - 0.5) / (1 + 0.5)]$$

$$RC = -t_1 / -1.1$$

$$t_1 = 1.1RC \quad (2)$$

If the voltages are symmetric, then the charge time ( $t_1$ ) and discharge time ( $t_2$ ) are equal, so the period ( $T$ ) is:

$$T = t_1 + t_2 = 2t_1$$

$$= 2(1.1)RC$$

$$= 2.2RC$$

and the frequency, which is one over the period, is:

$$f = 1/T$$

$$= 1 / (2.2RC) = 0.455 / RC$$

Equation 2 is the one usually published in textbooks without an explanation of where it came from; now you know.

**555 Applications.** The 555 timer IC is one of the most widely used integrated circuits today. It is well behaved, and its circuits are easy to design. Figure 6

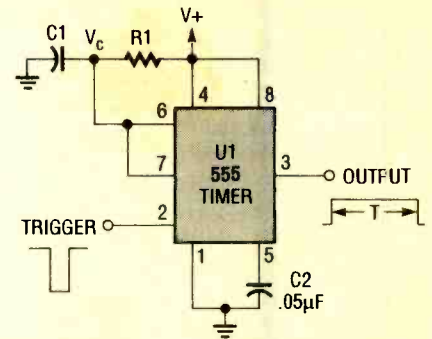

Fig. 6. In this monostable circuit a negative-going trigger pulse causes the output to remain high for a time determined by  $R_1$  and  $C_1$ .

shows the 555 as part of a monostable circuit commonly called a "one-shot." A one-shot produces a single output pulse of fixed duration,  $T$ , in response to an input trigger pulse. Let's see if we can use Equation 1 to determine  $T$ .

The rules for the timing circuit are simple: when the one-shot is in the dormant state (i.e. the output is low), then  $V_C = 0$ . When a negative trigger pulse is received, the 555 output goes high and  $C_1$  begins charging from zero volts in a positive direction. When  $V_C$  reaches  $2/3 V_+$  ( $V_+$  being the DC power supply potential), the 555 is designed so its output drops low again. If you take Equation 1 and set  $t = T$ ,  $V = V_+$ ,  $V_{C1} = 0$ , and  $V_{C2} = 2/3 V_+$  we get:

$$R_1 C_1 = \frac{-T}{\ln \left[ \frac{V_+ - .667V_+}{V_+ - 0} \right]}$$

$$R_1 C_1 = -T / \ln(0.3333)$$

$$R_1 C_1 = -T / -1.1$$

$$T = 1.1R_1 C_1$$

The result is the same as for the square-wave generator. The timing equation will not always reduce down to  $1.1RC$ , but regardless of the trip points that your particular circuit will use, you can always use Equation 1 to figure out the correct timing equation. Enjoy the equation and happy experimenting. ■



"All he ever does is homework—why can't he break into bank computers like other kids."





AK, Puerto Rico - 218-881-6674 Telex - 628279-314 FAX - 218-881-3330 TWX - 913-508862 DIGI KEY CORP

344-4539

INTEGRATED CIRCUITS

Table with columns: Part, Price, Description. Includes 7400 TTL, 7400 CMOS, 7400 TTL, 7400 CMOS.

INTEGRATED CIRCUITS

Table with columns: Part, Price, Description. Includes 7400 TTL, 7400 CMOS, 7400 TTL, 7400 CMOS.

SILICON TRANSISTORS

Table with columns: Part, Price, Description. Includes 2N series, 2N series, 2N series.

1/4 METAL OXIDE FILM RESISTORS

Table with columns: Part, Price, Description. Includes 1/4 Watt, 1/2 Watt, 1 Watt.

DISC CAPACITORS

Table with columns: Part, Price, Description. Includes 100pF, 200pF, 500pF.

PANASONIC V SERIES

Table with columns: Part, Price, Description. Includes Panasonic V Series components.

4000 CMOS

Table with columns: Part, Price, Description. Includes 4000 CMOS series.

A/D & D/A

Table with columns: Part, Price, Description. Includes A/D & D/A converters.

Memory

Table with columns: Part, Price, Description. Includes memory chips.

TRANSFORMERS

Table with columns: Part, Price, Description. Includes various transformer models.

PANASONIC B SERIES

Table with columns: Part, Price, Description. Includes Panasonic B Series components.

QUARTZ CRYSTALS

Table with columns: Part, Price, Description. Includes quartz crystals.

7400 CMOS

Table with columns: Part, Price, Description. Includes 7400 CMOS series.

Interface

Table with columns: Part, Price, Description. Includes interface chips.

SILICON TRANSISTORS

Table with columns: Part, Price, Description. Includes silicon transistors.

1 AMP SILICON RECTIFIERS

Table with columns: Part, Price, Description. Includes 1 amp silicon rectifiers.

5V CARBON FILM RESISTORS

Table with columns: Part, Price, Description. Includes 5V carbon film resistors.

TANTALUM CAPACITORS

Table with columns: Part, Price, Description. Includes tantalum capacitors.

74LS00 TTL

Table with columns: Part, Price, Description. Includes 74LS00 TTL series.

Linear

Table with columns: Part, Price, Description. Includes linear ICs.

5V CARBON FILM RESISTORS

Table with columns: Part, Price, Description. Includes 5V carbon film resistors.

1/4 METAL OXIDE FILM RESISTORS

Table with columns: Part, Price, Description. Includes 1/4 metal oxide film resistors.

PANASONIC OPTOELECTRONICS

Table with columns: Part, Price, Description. Includes Panasonic optoelectronics.

7400 CMOS

Table with columns: Part, Price, Description. Includes 7400 CMOS series.

7400 CMOS

Table with columns: Part, Price, Description. Includes 7400 CMOS series.

5V WIREWOUND REC. RESISTORS

Table with columns: Part, Price, Description. Includes 5V wirewound resistors.

1/4 METAL OXIDE FILM RESISTORS

Table with columns: Part, Price, Description. Includes 1/4 metal oxide film resistors.

DISC CAPACITORS

Table with columns: Part, Price, Description. Includes disc capacitors.

PANASONIC V SERIES

Table with columns: Part, Price, Description. Includes Panasonic V Series components.

PANASONIC B SERIES

Table with columns: Part, Price, Description. Includes Panasonic B Series components.

74500 TTL

Table with columns: Part, Price, Description. Includes 74500 TTL series.

1/4 METAL OXIDE FILM RESISTORS

Table with columns: Part, Price, Description. Includes 1/4 metal oxide film resistors.

DISC CAPACITORS

Table with columns: Part, Price, Description. Includes disc capacitors.

PANASONIC V SERIES

Table with columns: Part, Price, Description. Includes Panasonic V Series components.

PANASONIC B SERIES

Table with columns: Part, Price, Description. Includes Panasonic B Series components.

PANASONIC V SERIES

Table with columns: Part, Price, Description. Includes Panasonic V Series components.

74500 TTL

Table with columns: Part, Price, Description. Includes 74500 TTL series.

1/4 METAL OXIDE FILM RESISTORS

Table with columns: Part, Price, Description. Includes 1/4 metal oxide film resistors.

DISC CAPACITORS

Table with columns: Part, Price, Description. Includes disc capacitors.

PANASONIC V SERIES

Table with columns: Part, Price, Description. Includes Panasonic V Series components.

PANASONIC B SERIES

Table with columns: Part, Price, Description. Includes Panasonic B Series components.

PANASONIC V SERIES

Table with columns: Part, Price, Description. Includes Panasonic V Series components.

Fin Dip Key volume discount and service charges are simple to apply. Most items sold by Dip Key may be combined for a volume discount. Items that are not combinable are identified by the suffix ND following the part number. After entering your order, total of all the discountable items and apply the appropriate discount. To this subtotal, add the non-combinable items and the service charge. We pay all shipping and insurance to addresses in the U.S.A., Canada and Mexico when check or money order accompanies order. Dip Key only ships orders with the continental U.S.A. Hawaii, Canada and Mexico.

WHEN ORDERING BY PHONE, CALL 1-800-344-4539 (CALL 218-881-6674 BY MAIL SEND ORDER TO: DIGI KEY, P.O. Box 677, Thief River Falls, MN 56701) WHEN ORDERING BY MAIL, SEND ORDER TO: DIGI KEY, P.O. Box 677, Thief River Falls, MN 56701. You may pay by check, money order, MasterCard, VISA or A/C. DIGI KEY GUARANTEE: Any parts or products purchased from Dip Key that are defective will be replaced or returned at a refund within 90 days from receipt with a copy of your invoice. \*PRICES SUBJECT TO CHANGE WITHOUT NOTICE.

CIRCLE 10 ON FREE INFORMATION CARD

AmericanRadioHistory.com

SERVICE CHARGES \$ 0.00-\$2.99 \$25.00 and up No Charge. VOLUME DISCOUNT \$ 0.00-\$99.99 NET \$ 100.00-\$249.99 Less 10% \$ 250.00-\$499.99 Less 15% \$ 500.00-\$999.99 Less 20% \$ 1000 & Up Less 25%



# Electronics Paperback Books

GREAT PAPERBACKS AT SPECIAL PRICES



BP173—COMPUTER MUSIC PROJECTS ..... \$6.95. Shows how to use your home computer to produce electronic music. Many circuits. Mostly jargon free.



BP233—ELECTRONIC HOBBYISTS HANDBOOK ..... \$9.95. Single source of easily located info that the electronics hobbyist needs in his day-to-day pursuit of this fascinating hobby.



PCP103—PRACTICAL MIDI HANDBOOK ..... \$9.95. Explains what MIDI (the Musical Digital Interface) can do and how you can put it to work. Covers keyboards, drum machines, sequencers, mixers, guitars and computer music.



RF120—RADIO'S FIRST TWO DECADES ..... \$3.50. This story of radio's early days makes for fascinating reading. Spark-gap transmitters, KDKA's beginnings, and much more.



PCP192—INTRODUCING DIGITAL AUDIO ..... \$9.95. CD, DAT, and sampling. What is involved in the digital part of audio signals. Principles and practices of digital audio techniques.



BP195—INTRODUCTION TO SATELLITE TV ..... \$9.95. A definitive introduction to the subject written for the professional engineer, electronics enthusiast, or others who want to know more before they buy 8 x 10 in.



TELE—THE INVENTION OF TELEVISION ..... \$9.95. Everything you never learned about television from its start as a dream in the 1800s to the promise of tomorrow.



BP239—GETTING THE MOST FROM YOUR MULTIMETER ..... \$5.95. Covers basics of analog and digital meters. Methods of component testing (includes transistors, thyristors, resistors, capacitors and other active and passive devices).



PCP107—DIGITAL LOGIC GATES & FLIP-FLOPS ..... \$10.00. What they do and how to use them. You'll probably never need another book on this subject.



BP143—INTRO TO PROGRAMMING THE ATARI 600/800 XL ..... \$5.95. Perfect complement to the Atari user's manual. Even shows how to use animated graphics.



RADIO—100 RADIO HOOPUPS ..... \$3.00. Wonderful reprint of this 1924 book that presents 100 schematics of radio circuits of that era. The antique radio lover will label this one a "must own" book.



BP152—INTRO TO Z-80 MACHINE CODE ..... \$5.95. Speed up your programs. They may be harder to write, but it's worth learning how. Some demo programs are included.



BP105—ANTENNA PROJECTS ..... \$5.50. Practical radio antenna designs that deliver good performance and are relatively simple and inexpensive to build.



BP198—AN INTRODUCTION TO ANTENNA THEORY ..... \$6.95. Basic concepts relevant to receiving and transmitting antennas.



BP144—FURTHER PRACTICAL ELECTRONICS CALCULATIONS AND FORMULAE ..... \$9.00. Companion volume to BP53. Book carries on with new data not found in earlier edition. 450 pages.



BP125—25 SIMPLE AMATEUR BAND ANTENNAS ..... \$5.50. All kinds of antennas for all kinds of amateur radio reception.



BP175—ELECTRONIC CIRCUITS FOR THE COMPUTER CONTROL OF ROBOTS ..... \$7.50. Data and circuits for interfacing the computer to the robot's motors and sensors.



PCP105—MAKE MONEY FROM HOME RECORDING ..... \$10.00. For recording enthusiasts and musicians. Packed with money making ideas.



BP110—HOW TO GET YOUR ELECTRONIC PROJECTS WORKING ..... \$5.75. How to find the faults in your projects, repair them and get them working.



BP121—DESIGN & MAKE YOUR OWN PCB BOARDS ..... \$5.75. Everything you need to know before you make printed-circuit boards for your projects.

## Quality Paperbacks



PCP106—SYNTHESIZERS FOR MUSICIANS ..... \$10.00. Covers principles of modern synthesis—linear arithmetic, phase distortion, frequency modulation, sampling.



BP127—HOW TO DESIGN ELECTRONIC PROJECTS ..... \$5.75. How to use standard circuit elements to make custom electronic projects.



BP110—HOW TO GET YOUR ELECTRONIC PROJECTS WORKING ..... \$5.75. How to find the faults in your projects, repair them and get them working.



BP121—DESIGN & MAKE YOUR OWN PCB BOARDS ..... \$5.75. Everything you need to know before you make printed-circuit boards for your projects.



BP256—INTRO TO LOUDSPEAKERS & ENCLOSURE DESIGN ..... \$5.95. Explore all the aspects of speaker design including speakers, enclosures, and crossovers. Wind up with a description of a state-of-the-art speaker system.



BP85—INTERNATIONAL TRANSISTOR EQUIVALENTS ..... \$7.50. Locates possible substitutes for a popular user-oriented selection of modern transistors. Japanese, European and American types.



BP117—PRACTICAL ELECTRONIC BUILDING BLOCKS, Book 1 ..... \$5.75. Build the blocks and then combine them to form almost any custom project of your choice.



BP118—PRACTICAL ELECTRONIC BUILDING BLOCKS, Book 2 ..... \$5.75. Amplifiers for all kinds to add to the circuits from Book 1 of this series.



BP169—HOW TO GET YOUR COMPUTER PROGRAMS RUNNING ..... \$5.95. Have you ever written your own programs only to find that they do not work? This book shows you how to find errors.



BP177—MICRO-PROCESSING SYSTEMS AND CIRCUITS ..... \$5.95. Guide to the elements of micro-processing systems. Teaches all the fundamentals.



BP177—MICRO-PROCESSING SYSTEMS AND CIRCUITS ..... \$5.95. Guide to the elements of micro-processing systems. Teaches all the fundamentals.



BP177—MICRO-PROCESSING SYSTEMS AND CIRCUITS ..... \$5.95. Guide to the elements of micro-processing systems. Teaches all the fundamentals.

## Affordable Prices



BP248—TEST EQUIPMENT CONSTRUCTION ..... \$5.95. Details the construction of simple, inexpensive, yet extremely useful test equipment. 10 different instruments are included.



BP108—MODERN OP-AMP PROJECTS ..... \$5.00. Includes a Slide Timer, AF Signal Gen, Mike Pre-amp, Scratch Filter, and much more.



BP89—SECOND BOOK FOR CMOS IC PROJECTS ..... \$5.50. Multivibrators, amplifiers, triggers & gates; special devices including reaction timer, simple electronic organ, and more.



BP182—MIDI PROJECTS ..... \$6.95. Details of how to interface many popular home computers with MIDI music systems.



BP65—SINGLE IC PROJECTS ..... \$5.75. All projects in this book are based on one IC and are simple to construct. Great way to get started with IC's.



BP49—POPULAR ELECTRONIC PROJECTS ..... \$5.95. A collection of a wide range of electronic projects and circuits for the experimenter.



BP97—IC PROJECTS FOR BEGINNERS ..... \$5.50. Written especially for the less experienced experimenter. Complete parts layouts and wiring diagrams.



BP260—CONCISE INTRO TO OS/2 ..... \$5.95. Learn how the OS/2 operating system is structured and how to use it effectively. Written with the non-expert busy person in mind.



BP90—POPULAR ELECTRONIC CIRCUITS, Book 1 ..... \$5.95. More circuits for hobbyists. Audio, radio, test, music, household and more.



BP98—POPULAR ELECTRONIC CIRCUITS, Book 2 ..... \$5.95. More useful circuits. None of these projects duplicate those in Book 1 of this series.



BP98—POPULAR ELECTRONIC CIRCUITS, Book 2 ..... \$5.95. More useful circuits. None of these projects duplicate those in Book 1 of this series.



BP98—POPULAR ELECTRONIC CIRCUITS, Book 2 ..... \$5.95. More useful circuits. None of these projects duplicate those in Book 1 of this series.

CHECK OFF THE BOOKS YOU WANT

ELECTRONIC TECHNOLOGY TODAY INC.  
P.O. Box 240, Massapequa Park, NY 11762-0240

Name \_\_\_\_\_  
Address \_\_\_\_\_  
City \_\_\_\_\_ State \_\_\_\_\_ Zip \_\_\_\_\_

SHIPPING CHARGES IN USA AND CANADA

\$0.01 to \$5.00	... \$1.25
\$5.01 to 10.00	... \$2.00
\$10.01 to \$20.00	... \$3.00
\$20.01 to \$30.00	... \$4.00
\$30.01 to \$40.00	... \$5.00
\$40.01 to \$50.00	... \$6.00
\$50.01 and above	... \$7.50

SORRY, No orders accepted outside of USA and Canada

Total price of merchandise ..... \$ \_\_\_\_\_  
Sales Tax (New York State Residents only) ..... \$ \_\_\_\_\_  
Shipping (see chart) ..... \$ \_\_\_\_\_

All payments must be in U.S. funds Total Enclosed . . . \$ \_\_\_\_\_