

Computers

OCTOBER 1984 \$1.95

& ELECTRONICS

SMART MODEMS:
■ HARNESSING THEIR POWER
■ BUYER'S GUIDE TO 45

**MANAGE YOUR DATA IN
MAINFRAME STYLE**

**REVIEWS: TALLGRASS
70MB DISK, SORD
LAPSIZE, NEC APC III**

**TELELEARNING:
COLLEGE CREDIT
BY MODEM**



*****5-DIGIT 60506
390736 DHM 09976093 6410 SEP85
F284V20007
MRS EDNA DAHM
997 GRAND AV
BURORA IL 60506

THE NEW COMPUTERS FROM AT&T. FLEXIBLE. RELIABLE. AND VERY COMPATIBLE.



They're new in every sense of the word. New in conception, new in design, new in their ability to deliver unprecedented levels of computer performance. After over 40 years of designing and manufacturing computers, AT&T is proud to introduce a whole new line of innovative computers for business...AT&T Computers.

MEET THE FAMILY

The 3B2, 3B5, and the AT&T Personal Computer make up the new AT&T family of flexible business computers.

The AT&T 3B2 is one of the most advanced super microcomputers you can buy today. It packs all the power of a much larger system in a size small enough to sit on your desk top. This UNIX* System V-based multi-user, multi-tasking computer can accommodate up to 18 terminals.

For larger family gatherings, the AT&T 3B5 mini-

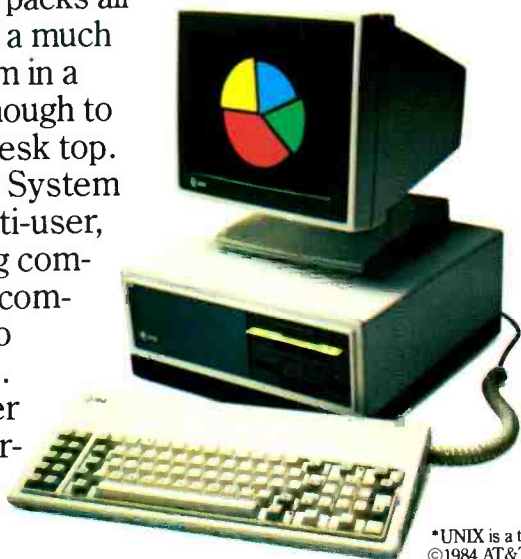

computers make great hosts, because they can accommodate up to 60 users.

And meet the new AT&T Personal Computer. What makes it special is its ability to combine high performance with excellent



graphics capabilities, an adjustable display monitor, and non-glare screen. Its flexibility allows it to operate as a stand-alone unit or as part of an integrated computer network. And its compatibility allows it to run most popular business software, including most available MS-DOS** applications.

THE FAMILY THAT WORKS TOGETHER

One big advantage of AT&T Computers is that when there's work to be done, everyone pitches in.

Each family member works together in a coordinated system, making tasks easier

*UNIX is a trademark of AT&T Bell Laboratories. **MS-DOS is a trademark of Microsoft Corporation.
©1984 AT&T Information Systems.

and users more productive. All AT&T Computers are based on our Information Systems Architecture, an open, communications-based structure that can accommodate and integrate not only our products, but also those of other manufacturers.

Another reason

between terminals, workstations, and computers of all sizes. This local area network allows you to connect departments, buildings, industrial parks, or even campuses. And gives you fast response time and centralized administration and control.

Regardless of the equipment you might own or

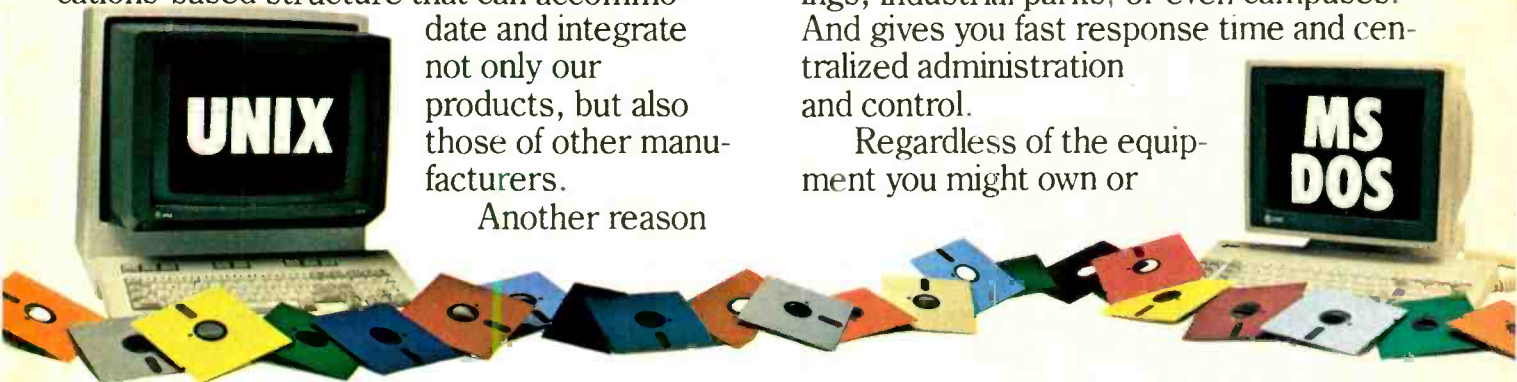

AT&T family members work so well together is our unique PC Interface. It bridges the MS-DOS and UNIX Operating Systems, allowing you to use your PC as part of a larger 3B network. Several PC users can thus share peripherals and files stored on the central 3B2 machine.

Yet another reason AT&T Computers are such a close-knit family is our UNIX System V Operating System, developed by AT&T Bell Laboratories. It's an operating system so flexible, it's rapidly becoming an industry standard. And because UNIX software is upwardly compatible, 3B2 software can run on 3B5 computers, thus protecting your investment and eliminating costly and time-consuming retraining.

THEY GET ALONG FAMOUSLY WITH MOST EVERYONE

AT&T Computers get along so well with each other, they can't help but get along with just about everyone else. The AT&T Information Systems Network links AT&T Computers with those of other manufacturers. It's a flexible, cost-efficient link

acquire, with AT&T Computers it will be like one big happy family.

BUILT-IN RELIABILITY AND SERVICE

Judging by the way they're made and cared for, this family will be around for generations. AT&T Computers meet the toughest design standards and most rigorous testing procedures.

And should you ever require service, we offer around-the-clock maintenance, and one of the industry's largest service forces.

For more information call your AT&T Information Systems Account Executive or 1 (800) 247-1212. Then make arrangements to meet the family: the 3B2, 3B5 and the AT&T Personal Computer. When it comes to meeting your needs, AT&T Computers couldn't be more compatible.

**AT&T INFORMATION SYSTEMS.
WHEN YOU'VE GOT TO BE RIGHT.**



THE GREAT UNKNOWN

The great new personal color computer that nobody knows about.

Yet.

It's the next step in the evolution of personal computer technology, not just another copy of the IBM® PC.

The Leading Edge Personal Color Computer is far faster (50%) and compatible with all industry-standard software (like Flight Simulator, Lotus 1-2-3, Leading Edge™ Word Processing, dBASE II, Nutshell,™ etc.); comes standard in color with 256K (expandable to 640K). Includes all the software you need to get up and running instantly (MS-DOS and GWBasic) and it's fully covered by a mind-boggling full-year warranty backed by a nationwide network of service centers—yet sells for far less than computers that give you far less: \$2,995 complete. (\$3,995 with 10 Megabyte Hard Disk).

The Leading Edge Personal Color Computer.

Always buy the best, regardless of cost. Even if it's cheaper.



LEADING EDGE PRODUCTS, INC.
LEADING EDGE DIVISION, 225 TURNPIKE STREET, CANTON, MA 02021 800-351-6811 (617) 898-8150
SOFTWARE DIVISION, 21 HIGHLAND CIRCLE, SHELTON HEIGHTS, MA 02194 800-341-1436 (617) 419-1655
FORTUNE DIVISION, 225 TURNPIKE STREET, CANTON, MA 02021 800-351-6811 (617) 898-8150

IBM is a registered trademark of International Business Machines Corporation.

Circle No. 20 on Free Information Card

Computers

& ELECTRONICS

Features

56 Modems Get Smarter

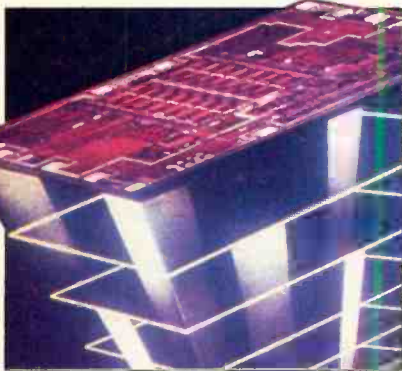

By TJ Byers

Manufacturers are raising the IQs of smart modems.

60 Harnessing Your Modem's Native Intelligence

By Robin Webster

New applications made possible by smart modems.

63 Buyer's Guide to Smart Modems

66 Micro Data Managers Get Mainframe Power

By Michael K. Guttman

Heavy duty database management systems

74 Motorola's Muscular 68020

By Les Solomon

A true 32-bit microprocessor that runs at 2.5 million instructions per second.

80 The Electronic University

By Robin Webster & Leslie Miner

Now college accredited courses can be taken on your personal computer.

84 Uninterruptible Power Supplies

By Al Frankel

Protecting your computer from the dangers of power outages.

88 Keeping Your Micro Cool

By D'Arlyn C. Appeboen-Fromme

Ways to prevent problems caused by heat build-up.

Reviews

28 Tallgrass 70-Mb Hard Disk

By Michael K. Guttman

32 Sord Lapsize

By Charles Rubinstein

40 NEC APC III

By Jon Pepper

44 key tronic 5151 Keyboard

By Dexter R. Hart

46 PC/Focus

By Barbara E. and John F. McMullen

A micro version of a mainframe classic.

COVER PHOTO BY M. TCHEREVKOFF



52 Mini Jini

By John Smith-Richardson

A good record keeper for the Commodore 64 and VIC-20.

Columns

8 Bits & Bytes



By Sol Libes

12 Les Solomon on Computer Hardware

Limited only by your imagination.

16 The Computer Scientist

By Forrest M. Mims, III

Analog techniques for digital computers, II.

Departments

4 Editorial

By Seth R. Alpert

When easy becomes hard.

6 Letters

92 New Products

118 Computer Mart/ Electronics Classified

128 Advertisers' Index

COPYRIGHT © 1984 BY ZIFF-DAVIS PUBLISHING COMPANY. All rights reserved. Computers & Electronics (ISSN 0032-4485) October 1984, Volume 22, Number 10. Published monthly by Ziff-Davis Publishing Co., at 3460 Wilshire Blvd., Los Angeles, CA 90010. Richard P. Friese, President; Selwyn Taubman, Treasurer; Bertram A. Abrams, Secretary. One year subscription rate for U.S. and Possessions, \$16.97; Canada, \$21.97; all other countries, \$23.97 (cash orders only, payable in U.S. currency). Second Class Postage Paid at Los Angeles, CA 90052 and at additional mailing offices. Authorized as second class mail by the Post Office Dept., Ottawa, Canada, and for payment of postage in cash. POPULAR ELECTRONICS including ELECTRONICS WORLD trademark registered. Indexed in the Reader's Guide to Periodical Literature. Ziff-Davis also publishes Boating, Car and Driver, Cycle, Flying, Popular Photography, Skiing, Stereo Review, Electronic Experimenter's Handbook, and Tape Recording & Buying Guide. POSTMASTER: Send address changes to COMPUTERS & ELECTRONICS, Circulation Dept., P.O. Box 2774, Boulder, CO 80302. Please allow at least eight weeks for change of address, enclosing, if possible, an address label from a recent issue. Permissions. Material in this publication may not be reproduced in any form without permission. Send requests for permission to Jean Lamensdorf, Rights and Permissions, Ziff-Davis Publishing Co., One Park Ave., New York, NY 10016.

SETH R. ALPERT EDITORIAL

WHEN EASY BECOMES HARD



PHRASES like "ease of use" and "user friendly" have become slogans of a new faith that believes vast new markets will open up to anyone who can provide software and hardware that even neophytes can readily use. Certainly there is some truth to this tenet, and indeed products are becoming more and more accessible, with very significant commercial implications.

There is something going on here, however, that troubles me, and I would like to share it with you. Making products easier to use is just fine, but in the rush to apply a sugar coating around the bitter pill of having to learn something new, many companies are neglecting those of us who are not computerphobes. The problem is that the sugar coating that makes microcomputing easier to swallow for the new user tends to choke more sophisticated users.

Many of the new easy-to-use products quickly run out of steam after your first blissful encounter. For example, how easy is it really to use a word processor that won't do a hanging indent when you need it? Or a package whose documentation requires you to wade through 100 pages of introduction starting with what a floppy disk is when all you want to know is how to configure the system and get started? Or a computer that comes without a technical reference manual when you need to get into the hardware?

Ease of use is important, of course, but the real name of the game is productivity. And productivity—which is what

those of us who have been around computing for a while are really after—cannot be obtained from products that have no real substance. Naturally, measuring the difficulty of learning and using a product is part of measuring how much it increases one's productivity.

Please do not conclude that I am some sort of Spartan purist or computing he-man who objects to using products that mere mortals can understand. Far from it—I am just as lazy as the next guy. Friendly products are just fine, but they must remain friendly as the user progresses up the learning curve. And if new hordes are brought into the microcomputing fold by the hype generated by such products, so much the better. Sooner or later though, many of today's newcomers will find that the products they learned on are like cars with undersized engines—fine for beginners but maddening when you are ready for the thrill of the open road.

As another case in point, consider the increasing use of menus to make software easier to use. When you first begin using a product, menus perform a function similar to that of training wheels for someone learning to ride a bike. Simply, they keep you from falling on your face. But as your skills and product familiarity grow, there comes a time when they inhibit more than they help. You just can't go as fast or corner as smoothly while the training wheels are still attached.

The smartest software developers recognize this and build short cuts such as macro facilities or command languages into their menu-driven products. By doing so they serve all users, from novices to experts.

Ultimately, of course, there is a conflict between ease of use and power—you really can't have it both ways. Nevertheless, I hope that some vendors will remember to give some substance as well as accessibility to their products: that is, that they will try to maximize the productivity they offer the buyer. And I hope that others will remember that, as the large number of WordStar fanatics so eloquently attest, many of us are willing to do a little work and learning if the capabilities provided by a product warrant the effort. ♦

PHOTO BY STEVE BORNAS

WORLD'S LARGEST COMPUTER MAGAZINE

Computers & ELECTRONICS

WILLIAM S. DAVID *Publisher*

SETH R. ALPERT *Editor*

PETER COSTA *Executive Editor*

LESLIE SOLOMON *Technical Director*

JOHN R. RIGGS *Managing Editor*

ROBERT LASCARO *Associate Art Director*

JOSEPH DESPOSITO *Technical Editor*

JOSEF BERNARD *Technical Editor*

DANIEL GLADSTONE *Senior Copy Editor*

ANDRE DUZANT *Technical Illustrator*

JEFF NEWMAN *Editorial Assistant*

AMY MADWED *Art Assistant*

Contributing Editors: Sol Libes, Forrest M. Mims, III, Barbara E. McMullen, John F. McMullen

Editorial and Executive Offices
One Park Avenue, New York, N.Y. 10016.
212-503-3500

Advertising Sales Offices

Eastern

Ken Lipka, 1 Park Ave., New York, N.Y. 10016.
212-503-5029

Linda M. Holbrook, 160 State St., Boston, MA
02109. 617-367-7190

Midwestern

Robert Vanek, Suite 1400, 180 N. Michigan Ave.,
Chicago, IL 60601. 312-346-2600

Western

Janet Bish, 11 Davis Dr., Belmont, CA 94002. 415-
594-2290

Anne Abeln, 3460 Wilshire Blvd., Los Angeles, CA
90010. 213-387-2100

Southeastern

Mark Browning, PO Box 81306, 2511 Carroll Ave.,
Atlanta, GA 30366. 404-455-3430.

Consumer Computers & Electronics Magazine Division

Larry Sporn	President
Jeff Hammond	Vice President, Marketing
Carole Mandel	Vice President, Circulation
Eileen G. Markowitz	Vice President, General Manager
Jerry Schneider	Vice President, Licensing & Special Projects
Herbert Stern	Vice President, Creative Services
Jonathan D. Lazarus	Editorial Director
Peter J. Blank	Creative Director

Ziff-Davis Publishing

President Richard P. Fries; President Consumer Magazine Division Albert S. Traina; Executive Vice President, Marketing and Circulation Paul H. Chook; Senior Vice President Phillip T. Heffernan; Senior Vice President Sidney Holtz; Senior Vice President Edward D. Muhlfeld; Senior Vice President Philip Sine; Vice President Baird Davis; Vice President George Morrissey; Vice President Rory Paris; Vice President William L. Phillips; Treasurer Selwyn Taubman; Secretary Bertram A. Abrams

Editorial correspondence: COMPUTERS & ELECTRONICS, 1 Park Ave., New York, NY 10016. Editorial contributions must be accompanied by return postage and will be handled with reasonable care; however, publisher assumes no responsibility for return or safety of manuscripts, art work, or models submitted.

The publisher has no knowledge of any proprietary rights which will be violated by the making or using of any items disclosed in this issue.



Member Audit Bureau
of Circulations

Silent/Scribe[®]

Go Quietly.



In these modern times, you have to go all out to stay ahead of the competition. And going with our up-to-date Silent/Scribe printers can help keep you there: because Silent/Scribe quietly goes about your business reports, letters, charts and graphs, while you quietly go about your business.

Unruffled. Undisturbed. And assured that the letter you signed on the first day of the month and the final monthly report will both have

the same crisp high-quality look.

All Silent/Scribe printers feature snap-in long life ribbon cartridges, easy-to-use controls, and Logic/Card[™] interfacing to fit virtually any computer.

And they come in a variety of models to fit your specific needs and budget.

Call us today and discover how going quietly can quickly get you ahead.

Outside California: (800) 4-ANADEx
In California: (800) 792-9992

Copyright 1984 Anadex, Inc.

Circle No. 13 on Free Information Card



Anadex ... When you know printers.

ANADEx, INC. • 1001 Flynn Road • Camarillo, CA 93010 • Tel: (805) 987-9660 • TWX: 910-494-2761
ANADEx, LTD. • Weaver House, Station Road • Hook, Basingstoke, Hants RG27 9JY, England • Tel: Hook (025672) 3401 • Telex: 858762 ANADEx G

LETTERS

Leadin' Lizards

I have just finished reading your review of the Chameleon Plus in your June 84 issue. I thought it was a very fair review, but there were some inaccuracies I would like to point out.

The author states that the documentation does not provide pinout for the serial or parallel ports. The users' manual provided with the computer contains diagrams of these pinouts in Appendix E. The author also stated that no instructions were provided for disconnecting the "chirping sound" emitted when the keys are pressed. The users' manual (Appendix L-Options) gives very clear instructions for altering the keyboard tone (or turning it off altogether). Mr. Rubenstein went on to state that the Chameleon would not run IBM BASIC or BASICA programs. After having received my GWBASIC (acquired free of charge by sending in the certificate), I have had no problem running any of the

IBM BASIC programs which I have come across, including an IBM dealer graphics demo. Finally, in regard to the problem with display in Supercalc 3, I had similar problems when I first purchased my system. I found that using the same Option program mentioned above, I simply had to change the video setting from color to b&w. I have since used SuperCalc 3 extensively and have had no further problems. I agree with Mr. Rubenstein that the technical documentation provided with the Chameleon is very poor in regard to customizing or upgrading the system, but overall it's a good buy, almost completely compatible with the IBM PC I use at work.

—JERRY RUSSELL
Colorado Springs, CO

One More Driver, Sanyo

I was very interested to find Bill Barden's column on the Sanyo MBC-550 computer in your May 84 issue. I

agree with much of his analysis of the system and would like to add a couple of points that he missed.

Bill must have used a dual-drive machine because, if he had tried the single-drive 550, he might have noticed that the beast will not recognize B: as a "logical" drive; i.e., when you tell DOS to copy A:FILE.EXT to B:FILE.EXT, you should be prompted to swap diskettes in the drive to complete the copy procedure. This can put severe limitations on the serious user who only bought a single-drive system. Needless to say, I have purchased a second drive. Which brings me to my next point. As Bill noted, there exists a dilemma for the single-drive owner: Do you buy a single-sided drive with the extra software for \$399 or get a double-sided drive sans software? I took an alternative approach, purchasing a TEAC drive from a mail-order outfit and saved some money over what the Sanyo dealer was offer-

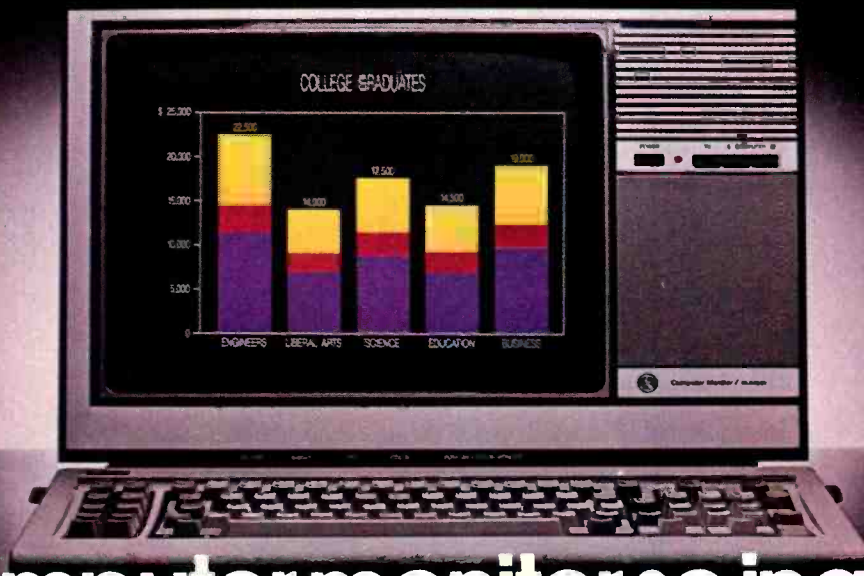

The computer monitor so ingenious,

If you're torn between buying a dedicated monitor and making do with your regular TV, there's a smarter alternative. The General Electric Monitor/TV.

First and foremost, it's a computer monitor.

Compatible with all major computer brands, it combines these advanced features to sharpen text and graphics and deliver a display that's easy-on-the-eyes: Direct and split video inputs; 320-line resolution via a comb filter; plus a computer grade, .5mm-pitch Neovision™ picture system.

For the name of your nearest dealer, call The GE Answer Center™ Information Service, 1-800-626-2000.

ing. If you don't want the software, which I can live without, you're better off going that way. Overall, I agreed with the conclusion that for the money, the system is fine. To do any serious work with it, however, plan on buying the second drive.

—RICK EMERLING,
Poughkeepsie, NY

When the Big Blunder, the Smalltalk

I feel I must comment on your item "Smalltalk Goes OEM" (August 84). Beware! Xerox has said before that they would "release" the Smalltalk language—but they have a peculiar way of using the word that bears little resemblance to the more normal usage.

Smalltalk was intended as an easy-to-learn yet powerful language for the masses, but Xerox has forgotten this audience in favor of the high-priced office automation and CAD/CAM markets. It is a pity that the mice and windows have

been taken "out of contest" by so many but that the powerful object-oriented programming metaphor pioneered by Alan Kay has been all but ignored. For instance, if Apple had included another 128K of RAM and another 64K of ROM containing the Smalltalk-80 byte code interpreter in the Macintosh, we could have had a system worth the price they are charging and not an overpriced toy. Instead, all we get is another version of Microsoft's drivel BASIC (taking up user RAM at that).

Smalltalk is the best general purpose language yet invented. It is user extensible like FORTH and LISP but has the readability of Pascal. Its objects are superior to ADA's packages or MODULA's modules. It is light years beyond BASIC; what a pity it will probably never be seen by the audience originally intended for it.

I am forming a Smalltalk-80 NON Users' Group for all of us who will prob-

ably never see the language of our dreams.

Apple has had an OEM licence for over 2 years and has had internal implementations on LISAs for almost as long, why they didn't use them is beyond me.

—James W. Bisso
Collinsville, IL

Knowledge Manager Can

Just a note to thank you for the coverage you gave our Knowledge Manager integrated software package in John Light's article, "Helping Managers Manage" (July 1984).

I thought you might be interested to know that the article erred in one respect. In the chart on page 54, it showed that the Knowledge Manager does not have the capability to review cell definitions on screen, a capability that it most emphatically does have.

—SCOTT D. PALMER
Lafayette, IN

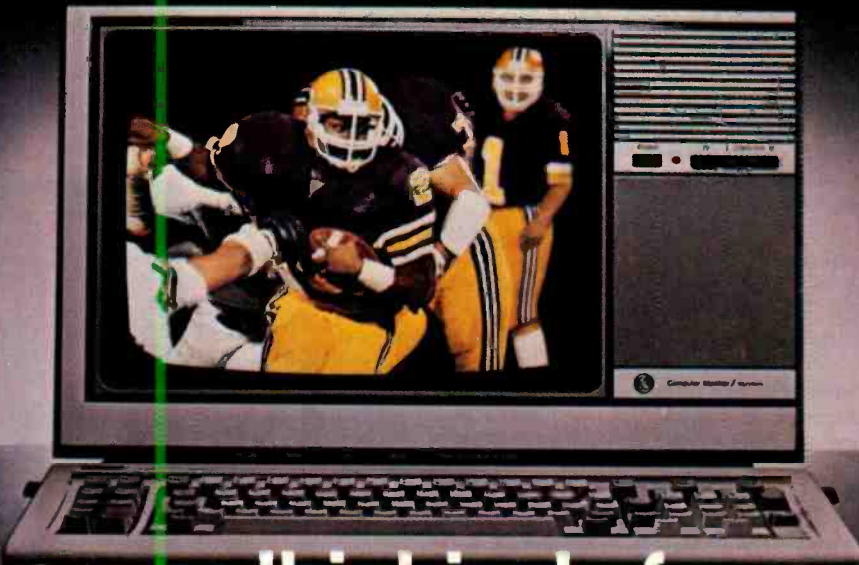

it even runs this kind of program.

Secondly, it's a first class TV.

Flick a switch and these same advanced electronics give you an outstanding TV, with a high-contrast picture and rich, true colors.

And you get all this for about the same price as an ordinary monitor. Another piece of ingenuity we thought you'd appreciate.

We bring good things to life.



SOL LIBES BITS & BYTES

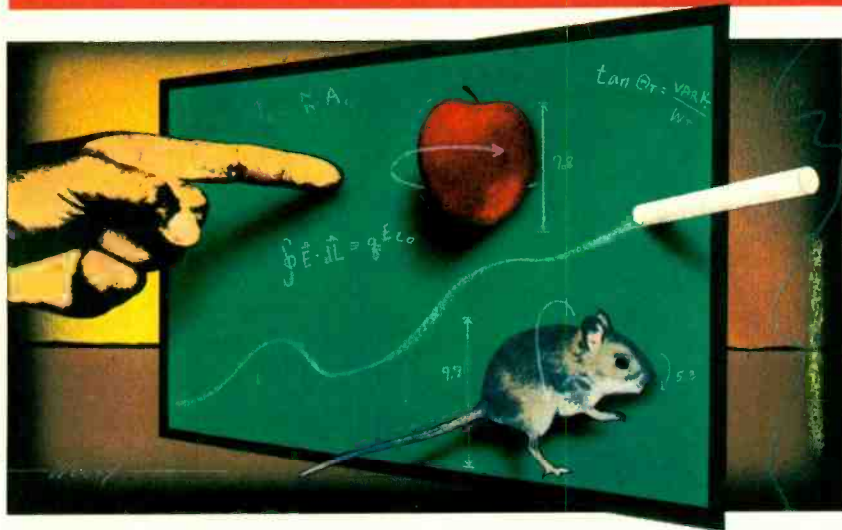

MacApplications

► When Apple announced the Macintosh, back in January, it proudly declared that over 100 third party software houses were developing software for the system. So far, there is little beyond Microsoft's Multiplan spreadsheet and BASIC language.

Recognizing the problem, Apple is running three-day seminars (cost \$500) to help independent software developers prepare application software.

Apple predicts that at least 50 application packages will be available by this fall, including Apple's own MacDraw, MacProject, MacBasic, MacPascal, MacTerminal, and an assembler/debugger.

Delays appear to be because developers, still unsure about Mac's future, are waiting and watching. The success of Mac in business environments is still a big question.

Secondly, Mac is an entirely new system and developers are not used to dealing with icons, mice and pulldown menus. Although Mac has 400 ROM calls to make this task easier, learning to use these routines still takes time. Further, the development tools from Apple are based on Pascal, but most developers are used to working in assembler and C.

And last, only 83K of RAM space is available for application programs. Because the 68000 is word-oriented rather than byte-oriented, like the 8088s it makes a less efficient use of memory. The result is that programmers have to devote considerable time and effort to compress code into the limited memory space. Lotus Development Corp., which

had promised to introduce a version of 1-2-3 for the Mac, has said that it will hold off until the 512K Mac becomes available some time next year. A cancellation is reported to be coming from Cullinet Software, which had previously announced its intention to develop a Mac version of its IDMS/R database system, used on mainframes.

Microsoft had promised to release Chart, File and Word implementations for the Mac last March. It has now slated the release for fall. Mac versions of pfs:File and pfs:Report were promised by Software Publishing for the second quarter, but they also have been pushed back to the fall. And BPI Systems Inc. has delayed introduction of four accounting and three personal productivity packages previously announced.

MSX—Where Are You?

► Microsoft's MSX operating system for home computers is beginning to gain acceptance in Japan and Europe. In Europe, M. V. Philips is expected to introduce an MSX machine in time for Christmas. In Japan, over one-quarter million MSX machines have already been sold by such companies as Panasonic, JVC, Sanyo, and Hitachi.

The Japanese have not begun selling MSX machines in the U.S. for two reasons: First, the Japanese machines are game oriented, have small amounts of memory, cassette storage and I/O. Second, they cost more than the Commodore 64, which has a very high ratio of relative performance to price, a low-cost disk drive option and excellent software support.

The expectation is that several Japanese companies will introduce MSX-based systems next spring. However, they will be different from the MSX machines selling in Japan. They will have disk drive options, 64K of RAM and I/O expansion. They are also expected to have facilities for working with electronic home appliances (such as stereos and videodisc players) and for mixing video and data on the TV screen. Users will be able to record from a video camera, mix computer action graphics, and add titles to the video scene.

MSX is designed for a Z80-based system with specific video and sound controller ICs. The Japanese are currently working on developing a single chip that integrates the three functions plus the MSX operating system ROM. This is expected to reduce substantially the manufacturing cost of the MSX-based computers. The likelihood is that such a system will contain no more than three or four ICs and will eventually be integrated down to a single IC.

No Homes for Orphan Computers

► *The New York Times* reports that, since the beginning of the year, sales of home computers retailing under \$1000 have been 20 to 30 percent fewer than they were last year. Toys R Us, one of



the largest mass merchandisers (170 stores) of low-cost home computers and video games, reported that revenues for these items had declined 16 percent from last year's level.

Among the big three manufacturers in home computers (Commodore, Atari and Coleco), Atari last year lost over

\$500 million, cut its employees from 7000 down to about 1000, closed several of its plants, and was dumped by Warner Communications (see story on Jack Trameil that follows). Coleco, still hanging in there, has also had employee cut-backs. Franklin Computer, another large producer, which recently began selling systems via mass merchandisers, has filed for Chapter 11 protection after laying off 75 percent of its workforce.

Rumors & Gossip

► A new wave of low-power, lightweight PC compatible portables, for under \$1000, is expected from Sharp, Epson, Sanyo and Pansonic early next year . . . Rumors are circulating that Tandy is getting set to carry systems of other manufacturers in its Radio Shack stores. Most likely they will sell products from the Far East . . . At least one system compatible with the Apple Macintosh is expected from the Far East next year . . . AT&T may begin selling its new personal computer line via its 900 Phone Center stores . . . Sony, we hear, is readying a 5-megabyte version of its 3½" floppy disk drive for introduction before the end of 1985 . . . Sony says it is developing a "universal medium" capable of working with both laser and magnetic recording drive systems . . . and Philips is rumored developing a magneto-optic medium with a 2" diameter.

Random News

► With Osborne Computer's Chapter 11 plan approved, the company is back in business. It is likely to sell off approximately 4000 Osborne Executive portables currently in inventory, mainly in Europe, where Osborne is still very popular. It is also expected to produce three new products this fall, one an IBM PC compatible . . . Alexander Haig, former Army General, Secretary of State, head of NATO and Richard Nixon advisor, has become a director of Commodore International. Is that what Jack Trameil, former Commodore president, meant when he said that "business is war?" . . . Computerland, the largest chain of computer retail stores, has dropped the Digital Equipment Corporation Rainbow and Professional personal computers after a year of "jackcluster" sales . . . "Trintex" is the name chosen by IBM, Sears Roebuck and CBS for its new videotex joint venture.



Is the 3½" Floppy Now a Standard?

► The 3½" microfloppy appears to have attained the status of a standard. The drive makers and OEMs currently using it far outnumber the users of 3" and 3¼" microflopies.

If, as rumored, IBM adopts the 3½" drive for its next generation of PCs, the 3½" will definitely be home free. Apple and Hewlett-Packard have recently adopted the drive Sony introduced in 1981 and still manufactures along with Tandon, Shugart, Alps Electric, Epson, Mitsubishi and Teac.

IBM had introduced a 4" microfloppy drive in 1981 but withdrew it from the market last year. The 3" microfloppy is proving very popular in several current products that are being developed in the Far East.

Jack Is Back!

► Jack Trameil, founder and former president of Commodore, is doing it all over again! Back in 1976 he took over a company called MOS Technology. MOS was in financial difficulties as a result of a patent infringement suit and limited financial resources. But the company was manufacturing an IC called the 6502 and a single-board microcomputer called the KIM.

The president of the company, Chuck Peddle, had designed both the 6502 and the KIM and also had developed an integrated microcomputer prototype called the PET. Despite its terrific products MOS was close to shutting its doors for good. At that point, Trameil bought MOS for a song and merged it into Commodore, and we all know what happened afterward.

Last January, Trameil resigned from Commodore after a dispute with the chairman of the board (and chief stock-

holder) and founded a home-computer company, Trameil Technology. He staffed it with executives from his old company: his sons Gary, Sam and Leonard; Gary Sommers (former head of the Commodore Technology Group); Don Richards (former Commodore president); Joe Spitari (former Commodore manufacturing chief); John Feagans (former Commodore software director); and several other key Commodore people.

Now we learn that Trameil has masterminded another takeover coup, acquiring no less than Atari. Warner Communications, Atari's parent company, after struggling for the last year and a half to stem Atari's huge losses (\$538 million last year), decided to unload the home-computer and game division and keep the arcade game and telecommunications divisions.

Warner received no cash for Atari. Instead it got \$240 million in long-term notes and a 32 percent interest in the new venture. In effect Atari cost Trameil nothing.

Trameil is expected to put about \$100 million in Atari, most of it coming from investors, and to revamp the company completely, as he did many times at Commodore. Trameil built up a reputation for being an aggressive cost-cutting president. At Commodore, he initiated price-cutting wars that caused most of Atari's problems and drove companies like Texas Instruments, Mattel and Timex out of the home-computer business.

The question now is who will Trameil be gunning for this time? Will it be his old company, Commodore, or the likes of IBM and Apple? Trameil moves quickly; I am sure we will know the answer by year-end.

Laps Are Waiting

► The sales of lapsize machines are predicted to increase fourfold over the next year; but whose? The Sharp 5000 and Teleram Bubble memory systems are rumored having poor sales and Tandy says that owing to soft sales of their lapsize portable, they do not plan to introduce an upgraded replacement this year.

Further, Convergent Technology, after 10 months of disappointing sales of its Workslate lapsize has suspended production of the unit. ♦

Introducing the most powerful

The new IBM Personal Computer AT.

Hold on to your hat.

The new IBM Personal Computer AT (for Advanced Technology) is based on the advanced 80286 16-bit microprocessor. This remarkable computer will run many of the programs written for the IBM PC, up to three times faster. You'll be able to recalculate large spreadsheets in seconds and retrieve files in a flash.

It's got the power (and price) to surprise you. In many ways.

Compatibility, expandability, networking too.

With the IBM Disk Operating System, the IBM Personal Computer AT can use many programs from the fastest-growing library in the personal computer software industry.

The IBM Personal Computer AT is also available with up to 3 million bytes of user memory to run multiuser, multitasking operating systems such as XENIX™. Volume upon volume of information is available at your fingertips. You can customize your system to store up to 20,000 pages of information at one time. And its keyboard helps you use all of this computing power more easily.

This new member of the IBM PC Family is a powerful stand-alone computer that can also be both the primary file server and a station on your

network. With the new IBM PC Network (which is so easy to connect you can do it yourself), the

IBM Personal Computer AT Specifications

User Memory 256KB-3MB*	Diagnostics Power-on self-testing* Parity checking* CMOS configuration table with battery backup*
Microprocessor 16/24-bit 80286* Real and protected modes*	Languages BASIC, Pascal, FORTRAN, Macro Assembler, COBOL, APL
Auxiliary Memory 1.2MB and 360KB diskette drives* 20MB fixed disk drive* 41.2MB maximum auxiliary memory*	Printers Supports attachment of serial and parallel devices
Keyboard Enlarged enter and shift keys 84 keys 10-foot cord* Caps lock, num lock and scroll lock indicators	Permanent Memory (ROM) 64KB Clock/calendar with battery*
Display Screen IBM Monochrome and Color Displays	Color/Graphics Text mode Graphics mode
Operating Systems DOS 3.0, XENIX*	Communications RS-232-C interface
	Networking High-performance, high-capacity station on the IBM PC Network*

*Advanced Features for Personal Computers

IBM Personal Computer AT can share information with IBM PCs, PC/XTs and IBM *Portable* PCs.

Get a hands-on, hats-off demonstration.

The new IBM Personal Computer AT has the power, compatibility and expandability many PC users need, at a very appealing price.

For more information contact your authorized IBM PC dealer, IBM Product Center or IBM marketing representative. For a store near you call 1-800-447-4700. In Alaska or Hawaii call 1-800-447-0890.

IBM®



personal computer IBM has ever made.



Little Tramp character licensed by Bubbles Inc., s.a.
XENIX™ is a registered trademark of Microsoft Corporation.

CIRCLE NO. 49 ON FREE INFORMATION CARD
www.americanradiohistory.com

LES SOLOMON ON

COMPUTER HARDWARE

LIMITED ONLY BY YOUR IMAGINATION

DURING the past few months, I have been hearing stories about which manufacturer has sold the most microcomputers.

Some say Commodore, some say Apple, while most feel that Sinclair takes the prize. In fact, it was a Sinclair proponent who boastfully said to me, "There are more Timex/Sinclair's gathering dust in closets than some manufacturers have made." It was his pride in the statement that bothered me—and resulted in this column.

The idea that all over this country there are unknown thousands of low-cost unused computers sitting in the dark, doing nothing but getting old, is sad.

When I ask, "Why don't you use this still workable machine?", the answer most often given is, "It is not powerful enough for my present needs." The second most popular answer is "I have outgrown it."

So there they sit, digital computers, some more powerful than the "large" systems used just a couple of decades ago, rusting away in the dark. Surely, there must be something we can do about this waste.

If you really have no further use for the computer, first make sure that it still works and that the documentation is still available; then donate it to a school that could put it to good educational use. Not only will you feel good knowing that you have helped some children, but also think of the tax deduction next April!

In my July 1984 column, I discussed both data-line and memory-mapped I/O. I mentioned that systems with data-line I/O and 8-data and 16-address lines (typical of the low-cost Sinclairs) could handle up to 256 I/O ports, while systems with memory-mapped I/O could cope with up to 65,536 ports.

Now, if you have a working system, all you need is a low-cost hardware interface that plugs into the bus, the same way you interface with printers, modems, other terminals, more memory, disk interface, etc., via the I/O ports (several companies sell such items).

Consider what you could do with 256

I/O ports besides connecting them to a printer or modem! Remember that BASIC is built into most of these small machines, and all you need do is couple the computer to a TV receiver to write, debug, and check program operation. Once you get the program running, you no longer need the video display.

Just for openers, how about controlling air conditioners, heaters, watering devices, dog feeding and the many lights

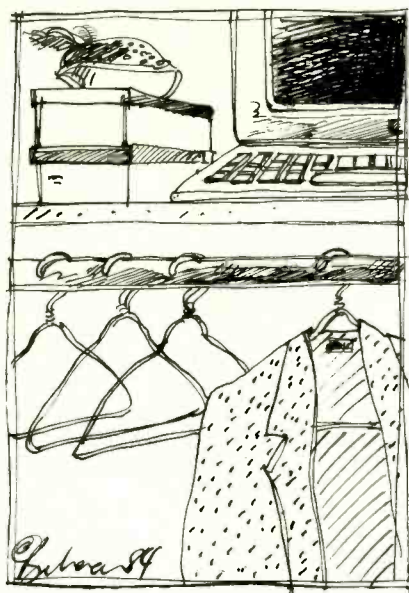

around a house or apartment or turning on the coffee pot in the morning just before you wake? How about keeping an "eye" on intrusion, fire, smoke, and water sensors. What about robot control, if that's what you're into? How about almost anything that can be done by dedicated controller?

Its Greased Lightning Time

Just when we thought that semiconductors had reached their ultimate operating speed, along comes something to jar us again.

Before we get to speed, let's take a look at some fast time intervals. First, we have the old standby *microsecond*—(10^{-6}) one millionth of a second. The next is *nanosecond*—(10^{-9}) one billionth of a second. It is followed by *pico-*

second—(10^{-12}) one trillionth of a second. The current fastest is *femtosecond*—(10^{-15}) one quadrillionth of a second. Note that each step is 1000 times faster than its predecessor.

Now be prepared to read about GaAs (gallium arsenide) logic. This new technique allows a 100-ps gate delay and a 1-ns access time for a static RAM. Another "el rapido" characteristic is a typical length of 150 ps for rise and fall times. Such fast goings-on allow for clock rates up to 4 GHz (yes, that is 4 GHz—4000 MHz!).

To give you an idea of how fast a picosecond goes by—light, traveling at approximately 186,000 miles per second, in 1 ps will travel a mere 0.02".

Farad Power

Down in Lancaster, PA, RCA has found a novel way to maintain data in a CMOS RAM without the use of batteries in their APT terminal.

They use a Matsushita EECW5R5-D105 Gold Capacitor having a value of 1 farad (yup, 1 million microfarads) at 5.5 volts to deliver power to the RAM. As long as operating power is supplied to the host system, the capacitor is trickle-charged. When charged, the capacitor is guaranteed to maintain the CMOS RAM for at least 48 hours after the host is disconnected from the ac power line—although an RCA spokesman claims that typical data maintenance time is much longer. When the line power is removed from the host system, the CMOS RAM chip-select is disabled, so the CMOS RAMs "float" in their high-impedance state.

This state-of-the-art 1-farad capacitor is 1.7" wide, 1.3" high, and 0.5" thick. A 3.3-farad device is also available with approximately the same dimensions.

If you want to know just how much a farad is, take a look at the largest-valued capacitors in your computer or any other power supply. You will usually see these capacitors expressed as so-many thousands or tens of thousands of microfarads. Remember that one microfarad is only *one-millionth* of a farad. ◇

ART BY YVONNE BUCHANON

**WHAT WOULD YOU SAY
TO A NEW LAP-SIZE COMPUTER
WITH SEXY GOOD LOOKS
LIKE THE APPLE IIc AND
BONE CRUSHING POWER LIKE
THE \$3000 H-P PORTABLE,
ALL FOR \$995?**

“GIMM

Of course you want it.

The Epson® Geneva™. A full-function, battery powered lap-size computer with 64K of memory, an 80 character 8-line screen, a big, responsive keyboard, cassette storage, plus four powerful, popular programs on ROM capsules, all included free.

All Epson quality. All for \$995.

Now that's technology.

If the Geneva is small where it counts, it is also big where it counts. In software, you get the big advantage of a universal operating system—

CP/M®. And to start you off at freeway speed, the Epson Geneva comes complete with WordStar®.

Also included is Portable Calc, an electronic spread-

sheet, Portable Scheduler,

and Microsoft® BASIC.

Want more?

The Epson Geneva offers a complete collection of advanced, battery-powered mini-peripherals. Customize your perfect computer

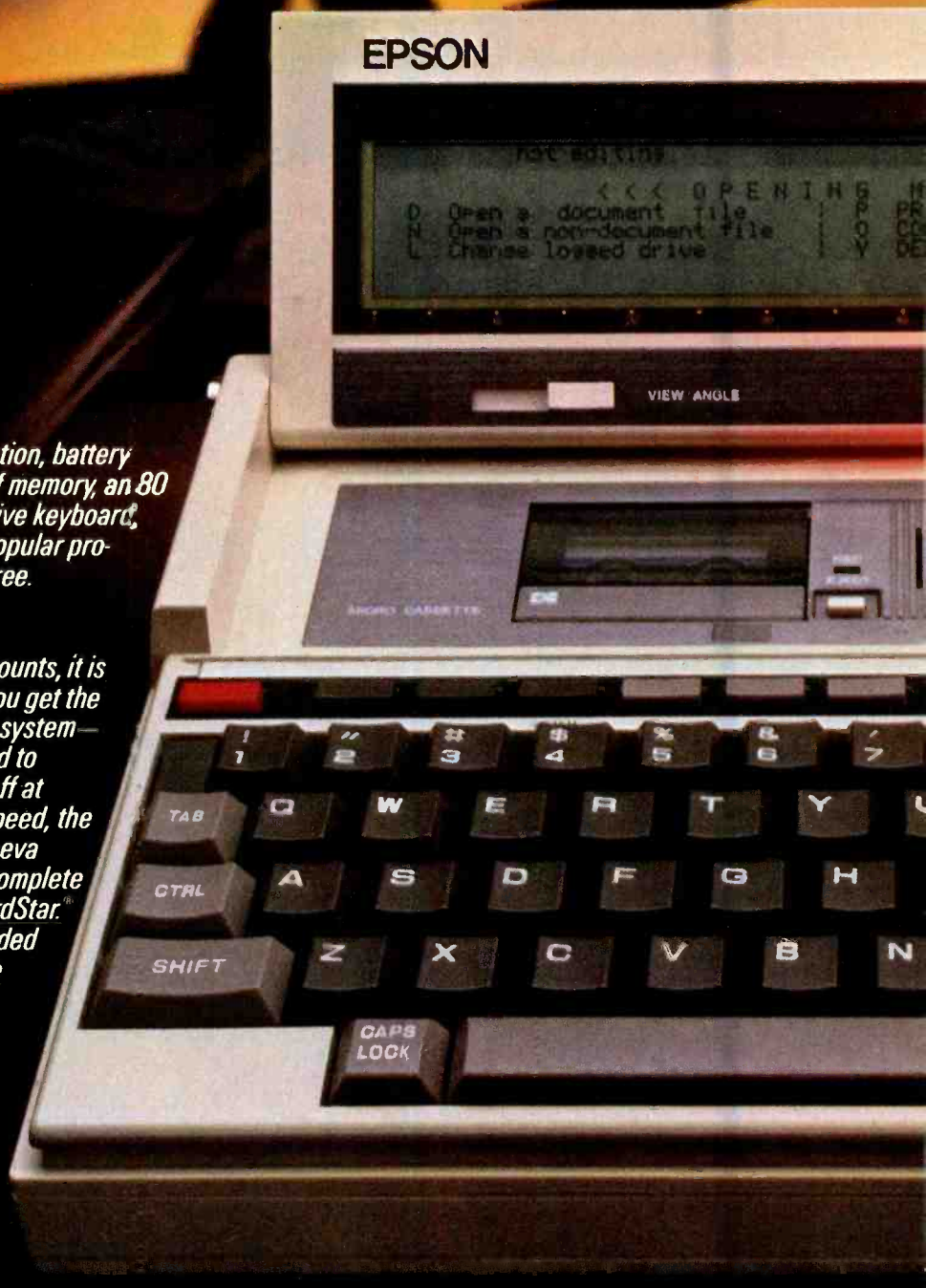

E P S O N

WME™

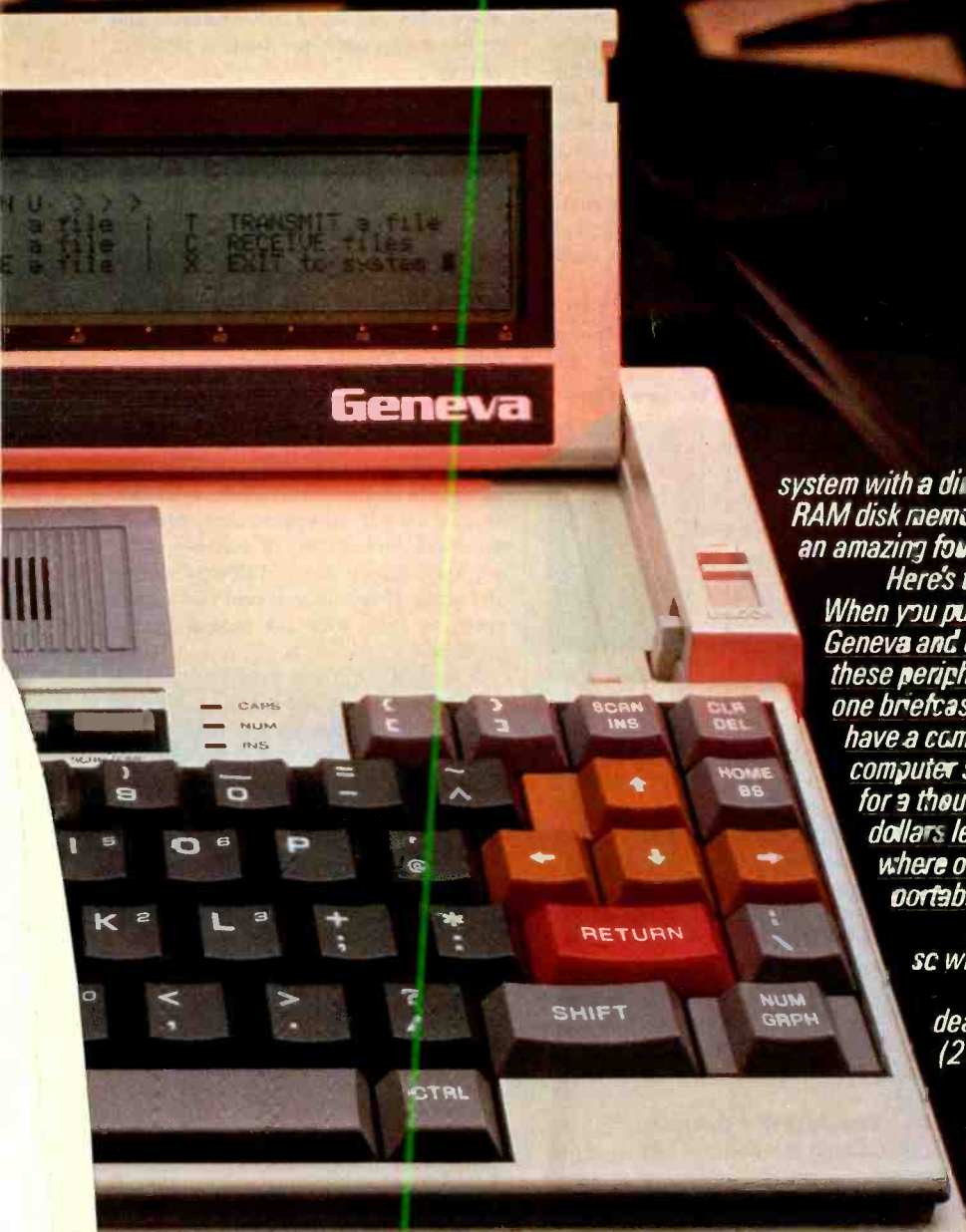

system with a direct connect modem; an extra 120K of RAM disk memory; a 320K 3 1/2" disk drive; there's even an amazing four pound 30-column printer.

Here's the best part. When you put an Epson Geneva and every one of these peripherals into one briefcase, you have a complete computer system for a thousand dollars less than where other powerful portables begin.

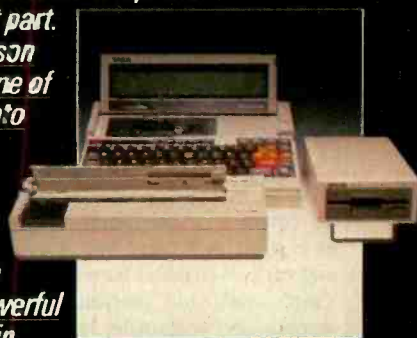

The Epson Geneva. You know you want it, so when are you going to get it?

For the name of your nearest Epson dealer, call (800) 421-5426. In CA, call (213) 539-9140.

NEVER HAS **\$995** **BOUGHT SO MUCH. AND SO LITTLE.**

Epson, Apple, WordStar, CP/M, and Microsoft are registered trademarks of Epson Corporation, Apple Computer, Inc., MicroPro, Digital Research, and Microsoft Corporation, respectively. Geneva is a trademark of Epson America, Inc.

E N E V A

FORREST M. MIMS III

THE COMPUTER SCIENTIST

ANALOG TECHNIQUES FOR DIGITAL COMPUTERS, II

In Part I of this two-part column I covered the basics of electronic analog computers and presented a method of using a personal computer equipped with joystick ports as a digitally simulated analog machine. In this installment, I'll explain additional ways to develop programs that employ analog input methods similar to those of analog computers. First, let's examine a futuristic analog-digital *hybrid* microcomputer.

An Analog-Digital Microcomputer

Just as a microprocessor CPU can be etched onto the surface of a single silicon chip, so can a single-chip hold an analog computer. Indeed, in the past five years several companies have taken major steps in this direction by producing single-chip analog circuits capable of performing basic arithmetic operations.

Among the most powerful of such chips is Analog Device's AD534. This 10-lead chip adds, multiplies, divides, squares, extracts square roots, computes percentages, and generates sine functions! The highest-quality AD534 performs these functions with an accuracy of ± 0.25 percent.

Like a digital microprocessor, the AD534 must be properly *programmed* to perform a particular mathematical operation. A typical way is by connecting various resistors between some of the chip's leads and rearranging interconnections between other leads.

Many microcomputers are permanently dedicated to a single task by unchangeable microcode stored in an on-chip ROM. Likewise, most AD534 chips are externally *hardwired* for a particular application. There is no reason, at least theoretically, why a chip with the capabilities of the AD534 cannot include an array of analog switches and a decoding matrix. This would permit various operating modes to be selected by closing and opening the relevant analog switches.

The control signal for an analog processing chip would correspond to the machine language microcode of a digital microprocessor. Indeed, control codes could be stored in a RAM and cycled to the analog processor chip at a rate deter-

mined by an external clock circuit. The result would be a true stored-program *hybrid analog-digital microcomputer*.

Several years ago I made a preliminary design for a single-chip hybrid microcomputer. Thus far, however, I am unaware of a commercial version. Though a hybrid microcomputer would be less accurate than its digital counterpart, it would be considerably easier to program. Moreover, it would possess all the problem-solving advantages of traditional analog computers.

I intend to continue designing a true hybrid microcomputer in anticipation of its commercial manufacture. In the

Fig. 1. ADVIP collector program.

```
SOLAR COLLECTOR PANEL
Collector Area = 76
Given Length = 7
Required Width = 10.86
(Dimensions in Feet)
```

meantime, as demonstrated in Part I, it's possible to gain an appreciation of the advantages of such a machine by developing, for personal computers, BASIC programs in which variables are entered via analog controls.

To distinguish them from conventional BASIC listings, I label such programs *ADVIP* routines (*Analog-Digital Variable Input Program*). While the advantage of ADVIP methods are well-known to engineers who use computers professionally, comparatively few ADVIP programs have appeared in magazines aimed at users of home and business personal computers.

The ADVIP Advantages

Traditional methods of analog input can greatly simplify numerical problem solving with a personal computer. For instance, it's often easier and faster to change variables by simply rotating a knob than by keying new numbers into a keyboard.

Moreover, in many applications analog input methods encourage computer users to experiment with the effects, on a

previously programmed equation, of changes in both minor and major variables. This permits a more natural and intuitive approach to creative problem solving.

As a long-time analog computer enthusiast, I'm convinced many unanticipated applications will be developed by computer users and programmers who add an analog input capability to their machines and begin using ADVIP programming methods. Even non-programmers might eventually be able to exploit the advantage offered by an analog input panel as suitable ADVIP software is developed and made variable.

Analog versus Digital Problem Solving

Assume you're planning a solar collector panel that must have a surface area of exactly 32 square feet. Also assume you have plenty of suitable building supplies in many different shapes and sizes. How can you best use a computer to help with the design of the panel?

A typical approach would be to write a program that prints a table giving *all* possible combinations of length and width that provide a total surface area of 32 square feet. Here's one solution in BASIC:

```
10 'SOLAR COLLECTOR
   (TABLE)
20 CLS
30 PRINT " X", " Y"
40 PRINT
50 FOR Y=1 TO 32
60 X=32/Y
70 PRINT X, Y
80 NEXT Y
```

When run, this program will show a boring string of figures on the computer's monitor. You can use this table to determine which of your existing supplies best matches a pair of dimensions that provides an area of 32 square feet. First, however, you'll have to use a printer to make a hard copy of the table since the first ten dimensions will be scrolled out of sight by most standard computer monitors.

GUARANTEE HEAD

LOWEST APPLE & IBM PRICES

What's the catch?

Yes, there is a catch. The guaranteed lowest prices in America on hardware and software for your IBM and Apple computer are now available only to members of The Micro ExchangeSM. But, the good news is it costs only \$25 to join, and you can earn that back *plus much more!*

Computerized Bidding

The Micro ExchangeSM is linked by computer with a nationwide network of suppliers who are eager to bid on your order. Through bidding, we're able to purchase products for you at prices which are guaranteed to be the lowest in America. Simply call the toll-free number, available to members only, with the makes and model numbers of the items you wish to purchase. We'll handle the transaction and arrange for the delivery of our merchandise right to your doorstep. All done quickly and efficiently so we keep you as a satisfied member of The Micro ExchangeSM.

OUR INCREDIBLE GUARANTEE

If you find that any item you purchased through The Micro ExchangeSM was available at the time of your purchase at a lower nationally advertised price, send us appropriate proof of the lower price, including sales tax, shipping, and other charges, within 21 days of your purchase, and we will refund the purchase price and the merchandise is yours!

Call toll-free today to join...

THE MICRO EXCHANGESM

A Service of MicroVision, Inc.

1-800-34M-ICRO
(In Florida Call: 1-800-35M-ICRO)
Ask for operator 23

Earn More Than You Spend

You'll want to tell all your friends and associates about the guaranteed savings at The Micro ExchangeSM. And for every new member you refer, we'll thank you by paying you \$10 cash! Not only will you easily cover the cost of your membership, but you can even earn hundreds of dollars more through this unlimited offer.

Hardware, Software, You Name It.

We'll furnish you with virtually everything you need for your IBM and Apple system, including products from these leading manufacturers:

- Amdek • Apple • Ashton-Tate • AST • BPI • Broderbund • CDC • Digital Research • Dow Jones • Epson • Hayden • Hayes • IBM • IUS • Lotus • MicroPro • Microsoft • NEC • Peachtree • Quadram • Rana • Software Publishing • Tandon • Teac • Tecmar • Visicorp

Yes, I want to be guaranteed that I'm purchasing my hardware and software at the absolute lowest prices in America.

Charge my Visa Master Card Check or Money Order enclosed

Credit Card No. _____ Expiration Date _____

Name _____

Address _____

City _____ State _____ Zip _____

Telephone (____) _____

Signature _____

MicroVision, Inc.
8663 Baypine Road, Dept 23
Jacksonville, Florida 32216
904 737-8400

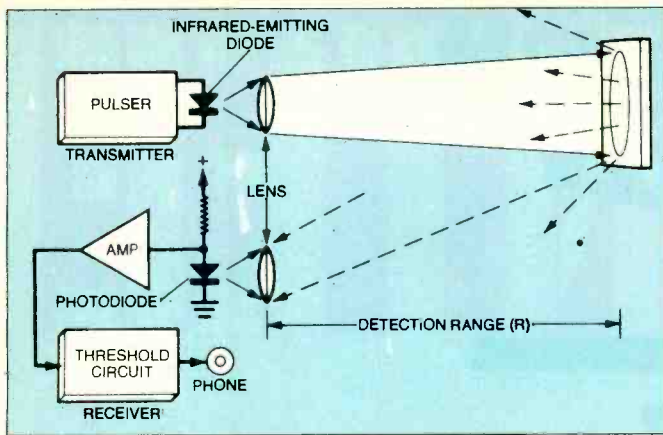

Fig. 2. An infrared travel aid for the blind.

Of course there are other ways to solve this problem. Here's one that's interactive:

```

10 'SOLAR COLLECTOR
  ( INTERACTIVE )
20 CLS
30 INPUT "What is the
  length";X
40 PRINT "A panel "X"
  feet long must"
50 PRINT "be"32/X"feet
  wide to give"
60 PRINT "an area of
  32 square feet."
70 GOTO 30
  
```

When run, this program asks you to specify the length of a piece of material then informs you how wide the material must be to provide the proper area.

While both these programs serve the intended purpose, analog input dials and ADVIP programming methods provide a better, more flexible, approach. You would dial one input to the required area of the panel and then dial the other to one dimension of a piece of material. The monitor would then display both these values plus the necessary second dimension of the material.

Any computer with analog joystick ports can be used in this mode. Ideally, one of the joysticks should be replaced by a pair of potentiometers equipped with suitable dial knobs. The basic idea can be first evaluated with an unmodified joystick. Here's one approach for the PCjr (that can be easily adapted for other machines);

```

10 'SOLAR COLLECTOR
  ( ADVIP VERSION )
20 SCREEN 1,0:COLOR 1
30 CLS:KEY OFF
40 LOCATE 10,10
50 PRINT "SOLAR
  COLLECTOR PANEL"
60 LOCATE 20,10
70 PRINT "(DIMENSIONS
  IN FEET)"
80 A=STICK (0):X=
  STICK(1)
  
```

```

90 LOCATE 12,10
100 PRINT "COLLECTOR
  AREA=";A
110 LOCATE 14,12
120 PRINT "GIVEN
  LENGTH=";X
130 LOCATE 16,10
140 PRINT "REQUIRED
  WIDTH ="
150 LOCATE 16,27
160 PRINT USING
  "##.##";A/X
170 GOTO 80
  
```

Figure 1 is a screen photograph showing a typical display provided by the ADVIP program. Incidentally, the PRINT USING statement in line 160 eliminates the on-screen REQUIRED WIDTH line floating digits left over from prior calculations.

Though the ADVIP listing is longer than the conventional programs, it nicely demonstrates the simplicity of changing variables by means of analog controls rather than via the keyboard or under program control. The keyboard approach requires on-screen prompts. Preprogrammed variable changes may provide more information than you require to solve the problem at hand.

More Advanced Problem Solving

Though these simple examples show some of the advantages of entering variables by means of analog controls, the technique can best be appreciated by looking at more complex applications. For instance, analog variable entry can often be a fast and convenient way to solve problems involving low-drag sports car design, aerodynamic trajectories, fluid flow through channels and pipes, mechanical stress, thermal transfer and electronic circuit design.

Recently I applied analog variable entry and ADVIP programming to a PCjr to solve one form of the optical radar range equation. This range equation allows the design of a miniature travel aid for the blind to predict its capability to detect obstacles before the device is actually built.

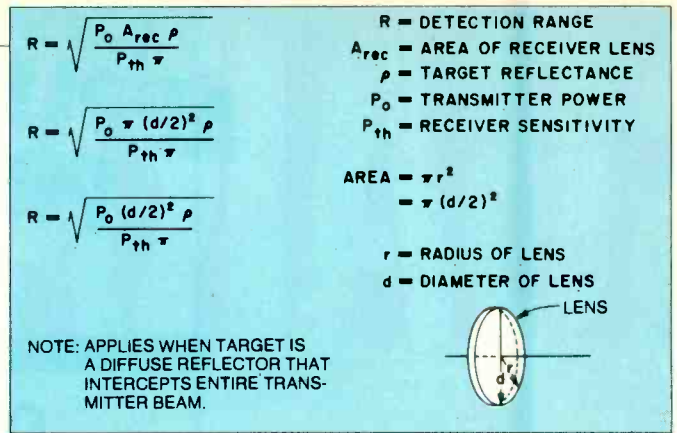

Fig. 3. The optical radar range equation.

This application is ideally suited for analog variable entry. It also suggested some possible application for the PCjr's infrared keyboard. Therefore, let's look at it in some detail.

Designing a Travel Aid for the Blind

Figure 2 is the block diagram of one kind of electronic mobility aid. When it is in use, an infrared emitting diode in the transmitter emits a train of closely spaced pulses. The infrared, whose wavelength is just above the visible region of the spectrum (usually 880 or 940 nanometers), is focused into a narrow beam by a small lens. If the infrared beam strikes an object, some of it is reflected back toward a detector installed behind a second lens in the mobility aid's receiver. If the intensity of the reflected infrared beam is sufficiently high, the receiver generates an audible signal to notify the blind user that it has detected an object.

The detection process in an actual aid is usually more complex. For instance, several transmitter diodes or receiver detectors may be used to indicate the approximate range to a detected object (the target). In any case, in the design of an infrared mobility aid it's very helpful to be able to predict the aid's detection range for various kinds and combinations of infrared emitting diodes, detectors and targets.

The variety of targets is immense but most can be categorized as diffuse or specular reflectors. Diffuse reflectors reflect oncoming lightwaves in a broad pattern; specular reflectors are mirror-like and reflect oncoming radiation in a beam having the same divergence (spread) as the oncoming beam.

Most mobility aid targets are diffuse reflectors with surface areas larger than the transmitted beam's cross section. For these targets the detection range (R) is given in Fig. 3.

Over the years I've successfully used this and related range equations in the design of several experimental infrared travel aids, some of which are installed in modified eyeglasses and weigh only a

The Fallacy of Working for a Living

Mention a man who's become a self-made millionaire and the world sits up and takes notice.

You suppose he's either incredibly lucky or a genius. Or both. Thereby ruling this out for yourself. But promising, nevertheless, to work harder and longer.

As though hard work ever brings anyone more than a good living. Ignoring what you've always known—the power of money to make money*—because you don't know what you can do about it.

Where, when, how to invest

What if I told you, though, that mastering the process by which money makes money was easy—provided you've got a good education, make an above-average salary and are willing to work about two hours a week on your own good fortune? That you could learn where and when and how to invest, generating the kind of wealth you always thought only a fortunate few could accumulate. And that you could start to dramatically improve your financial future now with a free, no-risk opportunity.

I doubt if you'd really believe me. Yet this is *exactly* what you can learn to do with our self-study program *Successful Investing & Money Management (SIMM)*.

Extraordinary profits

It took hundreds of thousands of dollars to develop and perfect our course and unique method of training people in the art of acquiring wealth.

Of all our innovations, the one I think most responsible for our successful method is enlisting the help of self-made millionaires like Andrew Sarlos, who started with \$500 and built a multimillion dollar investment group; and Morton Shulman, best-selling author and self-made multimillionaire.

It's no surprise, then, that *SIMM* can teach you to take advantage of opportunities that seem to occur every few months—as interest rates rise or fall, the

*Consider this. Anyone of 30 can retire with over a million dollars, over a million, by investing just \$119 a month at 13% interest.

value of the dollar goes up or down—with the potential for doubling or tripling your money as currencies are devalued, OPEC raises or lowers the price of oil, or military spending increases.

When interest was rising to 17%, don't you suppose you could have done better, much better, if you were one of the few who knew how the system would react to interest rates going as high as this?

Controlling \$1,000,000

What if you knew the potential of going short Treasury bills while a high interest situation was developing? Controlling a million dollars with each \$3,000 T-bill contract. *SIMM* teaches you to look for these types of relationships.

You can expect situations like this, when the signal is clear, the direction steady, once, twice, perhaps three or four times a year. But they're the icing on the cake, the heavy-hitting, homerun part of the plan you'll develop with *SIMM*.

The big breakthrough

We'd like to start you on the road to success by sending you Lessons 1 and 2 **FREE**.

They'll show you how to increase the money you have to invest with certain surprisingly

easy techniques that could give you up to an *additional* \$2,500 a year to invest—without reducing your standard of living.

Say your savings come to no more than \$5,000 a year. Invested at 13% compounded daily, you'll have \$251,850 in 15 years. But the big breakthrough, your real *wealth multiplier*, will come as you learn to invest with *other people's money*.

Returns of 30 per cent

Investing like this, using other people's money, it's possible to raise your return on some investments as high as 30 or 40 per cent. Here's an example.

Suppose a newly issued convertible bond went from \$1,000—the issue price—to \$1,170. Say you bought the bond when it was issued, investing \$5,000 in five bonds. Quickly, you'd have had a profit of \$850.

But with *SIMM*, you'd have known you could buy these bonds on 50% margin (a way of borrowing from your broker) with as little as \$500 per bond of your own money.

Now, you could have made \$1,700 on a \$5,000 investment. That's 34% (less interest and brokerage fees) on your money instead of the 17% on the bonds paid for in full. That's leverage. That's *Successful Investing & Money Management!*

A no-risk opportunity

Now, I'd like to invite you to see the program for yourself. Without risking one cent. Simply mail the No-Risk Enrollment Form along with your \$5 Registration Fee, and we'll send Lessons 1 and 2 **FREE**. Shortly thereafter, we'll send you Lessons 3 and 4. If you decide not to continue the program, after reviewing Lessons 3 and 4 for 15 days, simply return these two lessons—pay nothing, owe nothing. We'll refund your \$5 Registration Fee promptly.

If you wish to continue, pay for lessons 3 and 4 and we'll send you the remaining 25 lessons at the rate of two approximately every three weeks (always on 15 day approval). Each of the lessons accepted will be billed at only \$10.00 (plus a small charge for shipping and handling). Naturally, you may cancel this arrangement at any time, but in any case Lessons 1 and 2 are yours to keep free of charge.

Course counseling

For our part, we'll help you any way we can. When you enroll we'll assign a counselor to you. He'll be available to talk over the course and provide any help that's needed as often as you like.

You'll get a commanding understanding of how money makes money and how to turn the way the system works to your advantage. You'll learn how to accumulate money more surely and quickly than you ever imagined possible. That's financial independence.

Statement of Principles

We are an independent educational service offering a unique course and successful method for acquiring wealth. We are not a brokerage or insurance company, nor do we make any financial offerings to the public.

Tax Deductible

All payments are tax-deductible if the program is used to make investment or business decisions.

Hume Advisory Board

WILLIAM E. SIMON
63rd Secretary of the U.S. Treasury.
LOUIS RUYEYSER
Host of "Wall Street Week".
DR. MORTON SHULMAN
Self-made investment millionaire
ARCHIE R. BOE
Past President of Sears Roebuck.
J. TREVOR EYTON, Q.C.
A Director and Officer of many prominent public corporations.

No-Risk Enrollment Form

To: Hume Financial Education Services,
835 Franklin Court, Box 105627, Atlanta, Georgia 30348

YES I accept your invitation to evaluate *Successful Investing & Money Management* for myself without risk, or obligation to continue, according to the terms described above. Please send me Lessons 1 and 2 **FREE**.

Mr., Miss, Mrs., Ms. (Please print)

Address 42812

City State Zip

\$5 Registration Fee enclosed (payable to Hume Financial Education Services)

Or, I prefer to use my

VISA MasterCard American Express Diners Club

Account Number Expiration Date

Signature (For credit card users only)

689F



Hume Financial
Education Services
835 Franklin Court
Box 105627
Atlanta, Georgia 30348

INFRARED TRAVEL AID FOR THE BLIND

SOLUTION OF OPTICAL RADAR RANGE EQUATION
VIA ANALOG JOYSTICK PORT VARIABLE ENTRY

VARIABLES:

TRANSMITTER POWER = 55 MILLIWATTS
RECEIVER THRESHOLD = 26 NANOWATTS
TARGET REFLECTANCE = .42 (42 PERCENT)
RECEIVER LENS DIA. = 1.2 CENTIMETERS

PREDICTED RANGE = 5.7 METERS

Fig. 4. Listing 1 results.

few ounces. Prior to designing a specific aid, I program a calculator or computer or print a family of curves or a table showing the performance of the aid for different parameters.

The ADVIP method provides a much more flexible approach to solving the range equation. Since the PCjr has two

Moreover, the variables can be entered by joysticks or the knobs of four potentiometers.

When the program is run, the monitor displays the value of each variable as well as the resulting range. Figure 4 is a screen photograph of a typical range calculation.

While it's true that families of performance curves can also be very helpful in the design of a mobility aid, Listing 1 is particularly convenient since known variables can be quickly entered and their effect determined. For instance, the program will quickly reveal the differ-

in mind, the program in Listing 1 can provide plenty of helpful hints. You can use it as a guide if you develop a program that solves any straightforward algebraic equation. Though Listing 1 is specifically for the PCjr, you can easily adapt the basic principles for other computers with analog joystick ports.

Most of the program is taken up by housekeeping and formatting instructions that tell the PCjr how to display the results. The key portions of the program are both simple and straightforward. Let's look at them.

Lines 80 and 90 sample the joystick values (approximately 3-128) and assign them to variables for the transmitter's power (PO), the receiver's sensitivity (PT), the diameter of the receiver's lens (Y) and the reflectance of the target (RHO). Since RHO cannot exceed 1 (100 percent), line 90 traps values exceeding 100.

Line 100 converts the raw joystick value for the lens diameter (3-128) into a practical centimeter range (0.3-12.8). Similarly, line 110 converts the raw joystick values for RHO (3-100) into a coefficient of reflectance (0.03-1.0).

Line 350 supplies additional correctional factors that enable the final calculation to be made using common units. For instance, line 350 specifies both PO and PT in watts. Finally, line 390 calculates the predicted range according to the range equation in Fig. 3 and displays the result. The program then recycles to line 80 to again sample the joystick ports.

Making an Analog Input Control Panel

You can enter variables by means of joysticks alone, but would obtain much better results by substituting four potentiometers installed upon a control panel. Though the potentiometers should have

(Continued on page 22)

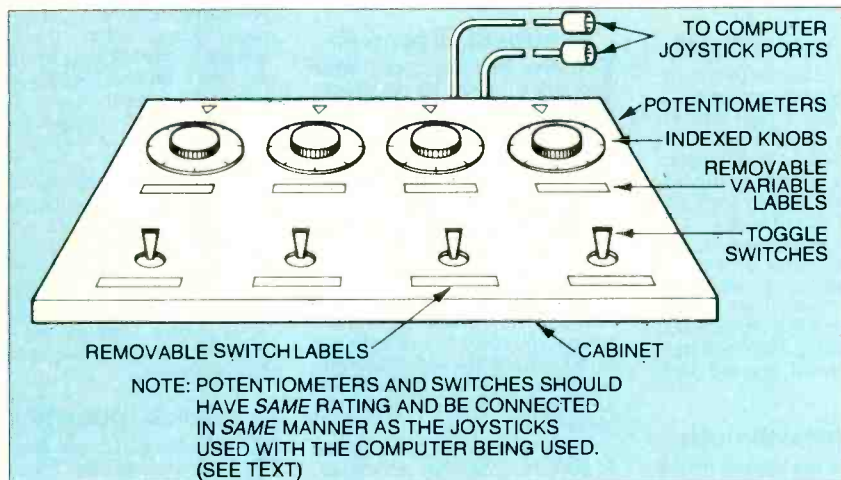

Fig. 5. Typing analog input panel for a personal computer.

joystick ports, all four variables in the equation can be represented by a potentiometer. Simple correction factors will allow a BASIC program to convert the joystick values into the desired range.

Listing 1 is a BASIC program for the PCjr that solves the range equation. This program is in many ways more practical than the more traditional programs I previously used. With it, the range capability of a specific, hypothetical mobility aid can be determined in a few seconds.

ence in detection range when a cheap infrared emitting diode that emits 15 milliwatts is substituted for an expensive diode that emits 35 milliwatts. If a printer is connected to the PCjr, a printout of the results displayed on the screen can be obtained by pressing simultaneously the keys FN and PRN.

Developing Your Own ADVIP Software

No matter what application you have

LISTING 1—BASIC PROGRAM FOR DESIGNING TRAVEL AID

```

10 'OPTICAL RADAR RANGE EQUATION
20 'COPYRIGHT 1984 BY FORREST M. MIMS III
30 'REFERENCE: "LED CIRCUITS & PROJECTS"
40 '(FORREST MIMS, SAMS & CO., 1973, pp. 138-153)
50 'PCjr SOLUTION
60 SCREEN 1,0:COLOR 1
70 CLS:KEY OFF
80 PO=STICK(0):PT=STICK(1):Y=STICK(2)
90 Z=STICK(3):IF Z>100 THEN 80
100 D=Y*.1
110 RHO=Z*.01
120 LOCATE 2,3
130 PRINT "INFRARED TRAVEL AID FOR THE BLIND"
140 LOCATE 5,1
150 PRINT "SOLUTION OF OPTICAL RADAR RANGE EQUATION"
160 LOCATE 7,1
170 PRINT "VIA ANALOG JOYSTICK PORT VARIABLE ENTRY"
180 LOCATE 10,1
190 PRINT "VARIABLES."
200 LOCATE 12,1
210 PRINT "TRANSMITTER POWER =";PO
220 LOCATE 12,26:PRINT "MILLIWATTS"
230 LOCATE 14,1
240 PRINT "RECEIVER THRESHOLD =";PT
250 LOCATE 14,26:PRINT "NANOWATTS"
260 LOCATE 16,1
270 PRINT "TARGET REFLECTANCE =";RHO
280 LOCATE 16,26:PRINT "(" RHO*100
290 LOCATE 16,31:PRINT "PERCENT)"
300 LOCATE 18,1
310 PRINT "RECEIVER LENS DIA. = "
320 LOCATE 18,21
330 PRINT USING "##.##";D
340 LOCATE 18,27:PRINT "CENTIMETERS"
350 PO=PO*.001:PT=PT*.1E-09:D=D*.01
360 R=D/2
370 LOCATE 22,4:PRINT "PREDICTED RANGE = "
380 LOCATE 22,21
390 PRINT USING "##.##";SQR((PO*(R*R))*RHO)/PT
400 LOCATE 22,26:PRINT "METERS"
410 GOTO 80

```



The Computer Book Club®

Recognized as the authoritative source for micro users!

Superior Performance, Practical Price!

More programs, projects, ways to use your micro for home, hobby, education, and business!

Select 5 Books for Only \$2⁹⁵



1539
List \$19.95

1748
List \$16.95

1389
List \$15.95



1535
List \$17.95

1712
List \$13.95

1633
List \$19.95



1195
List \$13.95

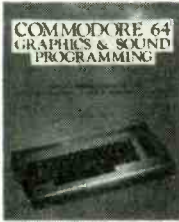

1640
List \$21.95



1746
List \$17.95



1754
List \$12.95

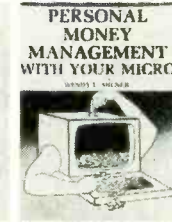

1709
List \$18.95



1451
List \$16.95



1501
List \$14.95 (paper)



1428
List \$17.95

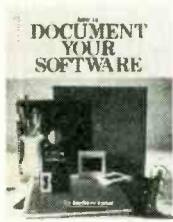

1724
List \$19.95



1427
List \$21.95



1394
List \$15.95

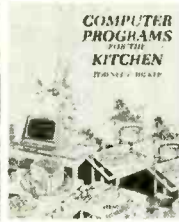

1707
List \$18.95



1607
List \$21.95



1399
List \$15.95



1840
List \$16.95

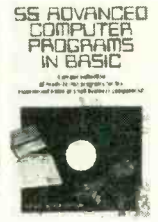

1295
List \$16.95



1743
List \$16.95



1722
List \$16.95



1506
List \$13.95

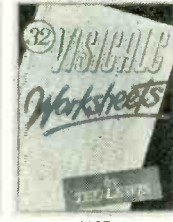

1637
List \$26.95



1710
List \$19.95



1190
List \$14.95

Free guide to BASIC Statements & Commands



Plus FREE For Joining

7 very good reasons to join The Computer Book Club®

- **Big Savings.** Save 20% to 75% on books sure to increase your computer know-how
- **No-Risk Guarantee.** All books returnable within 10 days without obligation
- **Club News Bulletins.** All about current selections—mains, alternates, extras—plus bonus offers. Comes 13 times a year with hundreds of up-to-the-minute titles you can pick from
- **"Automatic Order."** Do nothing, and the Main selection will be shipped automatically! But . . . if you want an Alternate selection—or no books at all—we'll follow the instructions you give on the reply form provided with every News Bulletin
- **Bonus Books.** Immediately get a Dividend Certificate with every book purchased and qualify for big discounts of 60% to 80%
- **Extra Bonuses.** Take advantage of added-value promotions, plus special discounts on software, games, and more
- **Exceptional Quality.** All books are first-rate publisher's editions selected by our Editorial Board and filled with useful, up-to-the-minute information

The Computer Book Club®

P.O. Box 80, Blue Ridge Summit, PA 17214

Please accept my membership in The Computer Book Club® and send the 5 volumes circled below, plus my FREE copy of *BASIC Statements, Commands and Functions*, billing me \$2.95 plus shipping and handling charges. If not satisfied, I may return the books within ten days without obligation and have my membership canceled. I agree to purchase 3 or more books at reduced Club prices (plus shipping/handling) during the next 12 months, and may resign any time thereafter.

- 1160 1195 1295 1389 1394 1398 1427 1428 1453
1501 1506 1533 1539 1607 1633 1637 1640 1707 1709
1710 1712 1722 1724 1743 1746 1748 1754 1840

Name _____ Phone _____
Address _____
City _____
State _____ Zip _____

Valid for new members only. Foreign applicants will receive special ordering instructions. Canada must remit in U.S. currency. This order subject to acceptance by The Computer Book Club®

PECC-1084



PREVENT THE DISASTER OF HEAD CRASH AND DROPOUT.

The war against dust and dirt never ends. So before you boot-up your equipment, and everytime you replace a cassette, disk or drive filter, be sure to use Dust-Off® II; it counteracts dust, grit and lint. Otherwise you're flirting with costly dropouts, head crashes and downtime.

Dust-Off II is most effective when used with Stat-Off II. Stat-Off II neutralizes dust-holding static electricity while Dust-Off II blasts loose dust away. There's also the Dual Extender and Mini-Vac for vacuuming dust out of hard-to-reach places.

Photographic professionals have used Dust-Off brand products consistently on their delicate lenses and expensive cameras for over ten years. They know it's the safe, dry, efficient way to contaminant-free cleaning.



Cleaning not provided by liquid cleaners.

Dust-Off II's remarkable pinpoint accuracy zeros in on the precise area being dusted. And you have total control—everything from a gentle breeze for



Stat-Off II neutralizes dust-holding static electricity from media and machines.

delicate computer mechanisms to a heavy blast for grimy dirt.

Don't let contamination disrupt your computer operation. Stock up on Dust-Off II—the advanced dry cleaning system, at your local computer or office supply dealer.

Or send \$1.00 (for postage and handling) for a 3 oz. trial size and literature today.



Dust-Off II

The safe dry cleaning system

Falcon Safety Products, Inc. 1064 Bristol Road, Mountainside, NJ 07092

Computer Scientist (Continued from page 20)

knobs, they don't need calibrated scales since the computer monitor will display the selected value.

The control panel can also include toggle switches in place of the joystick's trigger buttons. This substitution will allow preprogrammed parameters to be switched in or out of a running program.

Figure 5 shows one possible design for an analog input control panel.

Be sure to use potentiometers having the same resistance as those in the computer's joysticks. The joysticks supplied with my PCjr and Color Computer both use 100K potentiometers. Also, you must connect the potentiometers to the computer in the same way the joystick potentiometers are connected. Consult your machine's technical manual.

Some joysticks use standard connectors available at most electronics stores.

The joystick connectors for the PCjr, however, are *not* easy to find. Following a full day of phone calls, I was unable to locate a retail or mail-order source for the Berg-type connectors used by the PCjr. Apparently the connector uses Berg MiniPV™ receptacles designed to mate with 0.48-mm pins. Though suitable connectors are available from Berg Electronics (30 Hunter Lane, Camp Hill, PA 17011) and its distributors, the company does *not* sell small quantities of its products.

You can bypass the connector entirely by connecting your control panel to the PCjr with wrapping wire applied with a hand-held wrapping tool. Though this method doesn't provide the versatility of removable connectors, it does work.

Another option is to add miniature phone jacks to a pair of PCjr joysticks.

Incidentally, be careful when designing an analog control panel. If a wiring error or improper component value causes damage to your computer, its warranty may be voided.

Going Further

These two columns on analog computer techniques are merely an introduction to a wide-ranging topic. In future columns I'll discuss several related topics, including graphics and analog sensors and interfaces for ADVIP programs.

In the meantime, you can find out much more about analog and hybrid (analog-digital) computers by visiting a good library. One of the very best recent references is the second edition of the *Encyclopedia of Computer Science & Engineering* (Van Nostrand Reinhold, 1983). See especially the articles on analog computers (pp. 63-85) and hybrid computers (pp. 695-700). ♦

BIG FOUR

NEW 128K —MEGA BYTE DUAL DISK DRIVE—80 COLUMN

COMPUTER SYSTEM SALE!

HOME • BUSINESS • WORD PROCESSING

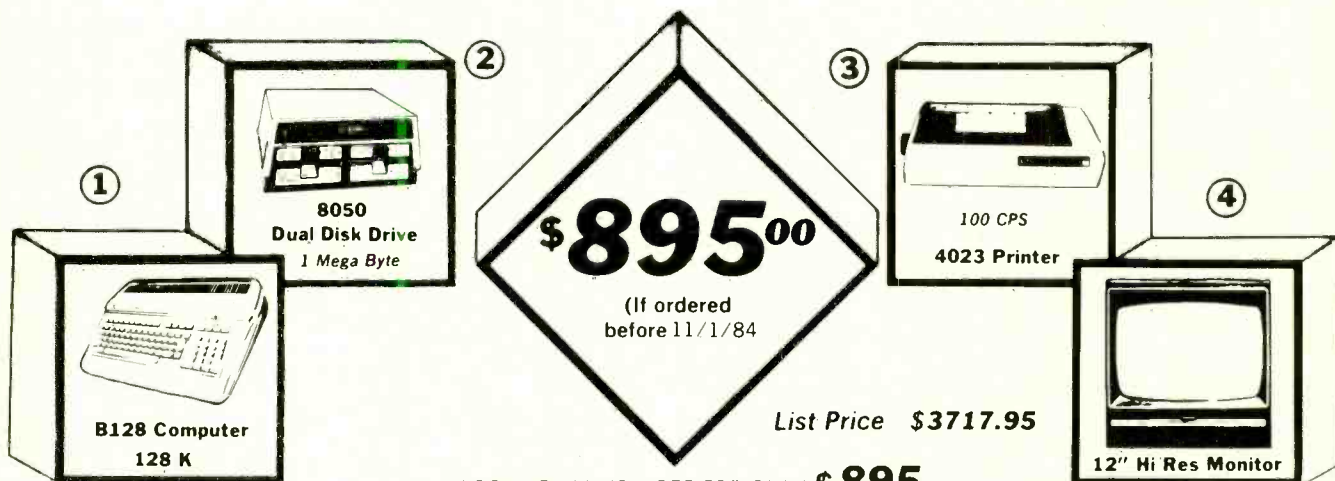

\$895⁰⁰
(If ordered before 11/1/84)

List Price \$3717.95

LOOK AT ALL YOU GET FOR ONLY \$895.

①	B128 COMMODORE 128K 80 COLUMN COMPUTER	LIST PRICE	\$ 995 00
②	8050 DUAL DISK DRIVE (over 1 million bytes)		1795 00
③	4023 100 CPS 80 COLUMN BIDIRECTIONAL PRINTER		499 00
④	12" HI RESOLUTION 80 COLUMN GREEN OR AMBER MONITOR		249 00
	• BOX OF 10 LORAN LIFETIME GUARANTEED DISKS		49 95
	• 1100 SHEETS FANFOLD PAPER		19 95
	• ALL CABLES NEEDED FOR INTERFACING		102 05
	TOTAL LIST PRICE		\$ 3717.95



Printer replacement options (replace the 4023 with the following at these sale prices)

	LIST	SALE
* Olympia Executive Letter Quality Serial Printer	\$ 699 00	\$ 399 00
* Comstar Hi-Speed 160 CPS 15" Serial-Business Printer	\$ 779 00	\$ 499 00
* Telecommunications Deluxe Modern Package	\$ 199 00	\$ 139 00

Plus You Can Order These Business Programs At Sale Prices

	LIST	SALE		LIST	SALE
Professional 80 Column Word Processor	\$149 95	\$99 00	Payroll	\$149 95	\$99 00
Professional Data Base	149 95	99 00	Inventory	149 95	99 00
Accounts Receivable	149 95	99 00	General Ledger	149 95	99 00
Accounts Payable	149 95	99 00	Financial Spread Sheet	149 95	99 00
			Program Generator	149 95	99 00

15 DAY FREE TRIAL We give you 15 days to try out this SUPER SYSTEM PACKAGE!! If it doesn't meet your expectations, just send it back to us prepaid and we will refund your purchase price!!

90 DAY IMMEDIATE REPLACEMENT WARRANTY If any of the SUPER SYSTEM PACKAGE equipment or programs fail due to faulty workmanship or material we will replace it IMMEDIATELY at no charge!!

Write or Call For Free Catalog and Spec Sheets!!

Add \$50.00 for shipping and handling!!
\$100.00 for Canada, Puerto Rico, Hawaii orders.
WE DO NOT EXPORT TO OTHER COUNTRIES.
Enclose Cashiers Check, Money Order or Personal Check. Allow 14 days for delivery, 2 to 7 days for phone orders, 1 day express mail! Canada orders must be in U.S. dollars. We accept Visa and MasterCard. We ship C.O.D. to U.S. addresses only.

PROTECTO ENTERPRISES (WE LOVE OUR CUSTOMERS)

BOX 550, BARRINGTON, ILLINOIS 60010
Phone 312/382-5244 to order

Circle No. 40 on Free Information Card

ONLY NRI TOTAL COMPUTER



**COMPUTER • MONITOR •
DISC DRIVE • PRINTER • AND
SOFTWARE...**

**It's all included with NRI at-home
training in Microcomputers and
Microprocessors. And only with
NRI training.**

If you really want to learn how to work on computers, you have to learn how to work on computer systems. Only NRI includes a complete system with your training... total training that gives you hands-on experience with computers, peripherals, and software. Training that builds the knowledge, skill and confidence you need to become a computer professional.

Get Inside the Famous TRS-80 Model 4 Computer

You'll work with one of the most popular computers ever designed. And explore it inside and out. You'll learn programming techniques for troubleshooting. You go inside to expand its RAM from 16K to a powerful 64K. You'll even install a double density floppy disc drive.

You'll become familiar with computer languages... BASIC, the most popular microcomputer programming language, and machine language for diagnosis and repair work. You'll run software that demonstrates computer operation, even learn to do your own programming. You'll become proficient at

modifying programs to fit your business or family computing needs.

Add High Performance Peripheral Printer

Only NRI gives you a total system training by including the flexible Gemini 10X printer as part of your hands-on learning. Working with it, you'll get practical experience in adding peripherals, learn maintenance and servicing operations like adjusting the printer head gap or replacing the 100-million-character head. You'll learn how to create computer graphics, change type faces, even create your own characters.

And you'll use it for hard copies of important programs, business records, and word processing.

Understanding You Build Only Through Experience

You need no experience or previous knowledge to succeed with NRI. You start with the basics, rapidly build on the fundamentals of

Built-in monitor displays up to 80 characters in six modes. Offers the flexibility and capacity for easy word processing and spread sheet programs.

Electronics comes to life on your NRI Discovery Lab®. You set up and modify prototype circuits, demonstrate action of components, gain valuable bench experience in construction, diagnosis, and repair of circuitry.

Professional 3½ digit multimeter features liquid crystal display and four key functions. Action Audio Cassette talks you through operation and professional use of your meter.

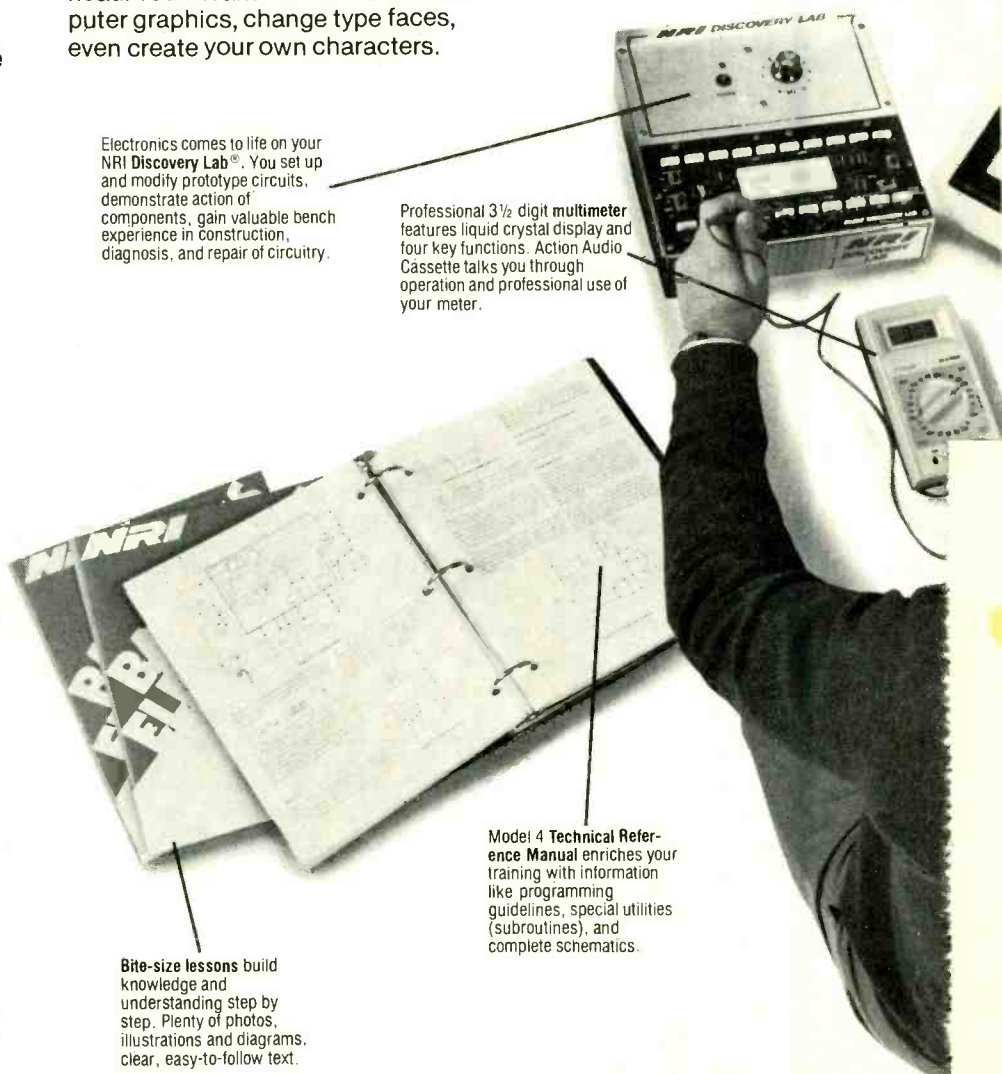

Bite-size lessons build knowledge and understanding step by step. Plenty of photos, illustrations and diagrams. clear, easy-to-follow text.

Model 4 Technical Reference Manual enriches your training with information like programming guidelines, special utilities (subroutines), and complete schematics.

GIVES YOU SYSTEM TRAINING

electronics with bite-size lessons to master advanced concepts like digital logic, microprocessors, and computer memories.

You'll reinforce this new understanding with hands-on, practical demonstrations

and experiments that give you real-world experience and build almost intuitive skills. You'll use the exclusive NRI Discovery Lab® to see what makes transistors tick, build and test working electronic circuits that duplicate key computer circuitry, construct digital logic circuits that

by your own NRI instructor and the entire NRI staff of educators and engineers. They're always ready to answer questions, give you guidance, follow your progress and help you over the rough spots to keep you moving toward your goal.



Your hands-on training takes you inside your TRS-80 Model 4 computer to install integrated circuits and enlarge memory to 64K. Full-function keyboard includes number pad and single-stroke data entry.

More practical experience as you install double-density floppy disk drive. Each disk stores up to 180,000 characters of information.

9x9 dot matrix printer completes your computer system to give you training with peripheral hardware installation, operation, and maintenance. Prints graphics, scientific symbols, and foreign languages in four type sizes.



NRI-supplied software includes TRSDOS® operating system, DOSPLUS® operating system, NBUG machine language monitor, and two game programs.

demonstrate computer performance. And, you'll probe into the very heart of your computer using the Discovery Lab and professional digital multimeter included in your training program.

Do It at Home in Your Spare Time

NRI trains you in your own home at your convenience. You learn at your own pace, backed at all times (TRS-80 is a trademark of the Radio Shack division of Tandy Corp.)

Free Catalog Tells Much More . . . Send Today

See all the interactive training equipment you get in this state-of-the-art course in today's technology. Look over the lesson outlines and descriptions of the exciting experiments you'll perform. And look at other high-tech career fields like Robotics, TV/Video/Audio Servicing and Data Communications.

Mail the postage-paid card today to see how NRI can give you the skills and confidence you need to start a good-paying career as a microcomputer technician. If the card has been used already, please write.

NRI SCHOOLS
McGraw-Hill Continuing
Education Center

3939 Wisconsin Ave.
Washington, DC 20016



WE'LL GIVE YOU TOMORROW.

HARDWARE REVIEWS

TALLGRASS 70 MB HARD DISK

*Vast storage
and integrated
tape backup*

BY MICHAEL K. GUTTMAN

MICROCOMPUTERS now routinely perform tasks once reserved for mini or mainframe systems. One result is a need for larger mass storage capacity than that supplied by the usual dual-floppy-disk drives. Hard disks meet this need with storage capacities from 5M bytes up, at a relatively low cost. For users who require vast amounts of mass storage, Tallgrass Technologies manufactures a 70M-byte hard disk, the Model 3170, that retails for \$7683.95. The product also includes an integrated 45M-byte cartridge tape drive for backup.

Setting Up the 3170

Adding a 70M-byte hard disk to a floppy-disk computer can be awe-inspiring. Fortunately, the 3170 is physically unassuming, measuring about two-thirds the length and width of an IBM PC, with approximately the same height. In addition, the unit matches the PC in color and style. The 3170 requires no assembly and is ready to be plugged in and turned on just as it comes out of the box. Included with the system are a manual, an IBM interface card, and one cartridge tape.

Installing the half-size interface card into a bus slot is easy, requiring no special handling. After installation, the card is connected to the main unit by the supplied ribbon cable. One minor complaint we have is that the cable was too short to place the unit far from the PC, which would make it difficult to fit it in some computer furniture.

Configuring the Hard Disk

A diskette contains the software necessary to configure and operate the 3170. Ours was for PC-DOS 2.0.

The first step in configuring the disk is



creating a working diskette by formatting a system disk and copying all the files from the original. On this disk, the Config.sys file invokes a device driver for the hard disk that configures it for seven logical drives with labels "C" through "I," each 10.09M bytes.

The next step is to run the program Tgsys, which allows the user to resize the storage for each drive and alter the sizes of the allocation unit and the directory. The storage size is limited by the operating system; in the case of PC-DOS, no drive can exceed 38M bytes. The allocation unit size indicates the size of each "chunk" of storage added to a file as it expands. Small allocation sizes waste less file space but require a larger file allocation table (FAT) to keep track of the increased number of units. The directory size determines the number of files that will fit in a drive's directory.

While running Tgsys, the user can also alter four important system-wide parameters—verify, duplicate directory, cache memory, and landing zone. Activating the verify parameter causes the unit to read back and verify data immediately after it is written on the disk. It gives added protection against disk errors, but obviously slows down performance during write operations. Similarly, activating the duplicate directory parameter causes the system to maintain an extra directory for increased security, but at the cost of slower performance.

The cache memory, which can reserve two 10K areas of RAM for disk buffers, can improve the performance of some applications at a relatively small cost in RAM. The final option, landing zone, automatically retracts the read/write head of the hard disk to a "safe" unused track after 6 seconds of inactivity. It significantly reduces the possibility of a de-

structive head crash over valuable data.

Tallgrass also provides a utility program for testing the performance of the disk drive. The program contains read, write and interface tests, and also allows the user to reinitialize a directory or reformat the entire disk. In addition, the program will display a list of "bad" tracks, to which the user can add if required.

Once the unit is installed and running, operation of the extra logical drives is transparent to the user. As with all hard disks, however, some software previously configured for floppies must be modified to run properly. In addition, some add-on hardware and certain software may conflict with the 3170 on the PC bus, requiring modifications to either the 3170 interface card or the other hardware. Tallgrass provides instructions for effecting the modifications in the user's manual, but most users should expect their dealers to handle such problems.

The Tape Backup Unit

Although progress is now being made on other technologies, particularly removable hard disks, tape backup is currently the only reliable and economical method of large-scale hard-disk backup for small computers. Many years of cartridge tape backup like that of the 3170 on a variety of minicomputers has established it as a very stable and proven technology.

The Tallgrass tape cartridge is divided into nine tracks of 5M bytes each. Generally speaking, the user specifies a starting track for each backup, and the backup proceeds from track to track as space requires. It takes about 10 minutes to fill one 5M-byte track. The tape cartridge has a physical write-protect screw that can be set by the user, and the software

PHOTOS BY BOB LORENZ

BASF QUALIMETRIC™ FLEXYDISKS.® A GUARANTEED LIFETIME OF OUTSTANDING PERFORMANCE.

BASF Qualimetric FlexyDisks feature a unique lifetime warranty, firm assurance that the vital information you enter on BASF FlexyDisks today will be secure and unchanged tomorrow. Key to this extraordinary warranted performance is the BASF Qualimetric standard... a totally new set of criteria against which all other magnetic media will be judged.*

You can count on BASF FlexyDisks because the Qualimetric standard reflects a continuing BASF commitment to perfection in magnetic media. One example is the unique two-piece liner in our FlexyDisk jacket. This BASF feature traps damaging debris away from the disk's surface and creates extra space in the head access area for optimum media-head alignment. The result is a guaranteed lifetime of outstanding performance.

For information security that bridges the gap between today and tomorrow, look for the distinctive BASF package with the Qualimetric seal. Call 800-343-4600 for the name of your nearest supplier.

Circle No. 33 on Free Information Card

*Contact BASF for warranty details.



ENTER TOMORROW ON BASF TODAY.

© 1983 BASF Systems Corp., Bedford, MA



BASF

Tallgrass

(Continued from page 28)

will not proceed with a write while it is in the "safe" setting.

Tallgrass supplies two methods of backing up to tape. The first method copies the contents of an entire logical disk to or from tape. The second copies selected files only. The difference is similar to the difference between the Diskcopy and Copy routines supplied with PC DOS for floppy backup. Once files have been copied to tape using one method, they cannot be retrieved using the other.

The Tallgrass program, Tape, handles disk copies and includes commands for testing and certifying tapes. The programs Tgbackup and Tgrestore handle file copying, while the program Tapedir provides a directory of files on tape stored using file copying. Only the file copying routines will allow the user to copy files to and from another medium, such as a floppy disk or a foreign disk drive.

Performance and Evaluation

Unfortunately, our initial experience with the 3170 was marred by some startup problems. When we went to test the tape drive, we discovered that the cartridge tape included was not correct for the 3170. With this problem resolved, we were ready to do a comprehensive test, but the unit went dead—apparently the victim of a power supply problem. Tallgrass was very prompt about sending us a replacement unit, on which we experienced no further mechanical difficulties.

Once we were up and running, we were generally quite pleased with the performance of the hard disk. Its speed seemed comparable to those of other such drives. For example, we copied 10M bytes from one logical disk to another in about 6 minutes. We experienced no problems or errors reading or

writing. Indeed, we were able to create very large files and move them at will among seven different drives at high speed. All the various options worked as described, although some could not be tested without inducing a potentially damaging system failure.

At first, we were also pleased with the tape unit. We did, however, come to feel that the software was rather inadequate and cumbersome and might well be confusing to a new user. Our first complaint was that you must invoke each backup program separately instead of having a common interface menu. You have to remember the name of each program and the proper syntax for its parameters. In addition, you can only work with files from one logical drive at a time. It is simply not possible, for instance, to give a single command that backs up the entire physical disk.

Some of these problems can be remedied by creating DOS batch files that cover an overall backup procedure. Even here, however, it is necessary to start each backup at the beginning of an unused tape track. This requirement makes it practically inevitable that large portions of tape will be wasted if the backup does not fill the entire track. In addition, it is not possible to invoke a disk copy from a batch file; for no obvious reason this program absolutely requires operator intervention.

While testing the file copying utility, we encountered a rather serious problem that could foul up even the best backup plans. It seems that, if a file is too big to fit on the remainder of a track, the system begins to copy it over again on the next track. The result is that, in effect, files over 5M bytes cannot be backed up using the file copy method, since the system will continue to look unsuccessfully for sufficient contiguous space until it runs right through the entire tape. Since the disk copy method (which works properly for large files) cannot be invoked from a batch file, it seems that the user with large files is stuck with using a completely manual backup procedure.

We were also disappointed by the apparent absence of any disk partitioning routine that would allow the user to keep files for different operating systems on the same physical unit. This lack is particularly frustrating given that the 3170 is exactly the sort of hardware that would lend itself well to this purpose.

Keep in mind that these problems are due to software deficiencies. When we contacted Tallgrass about them, we were

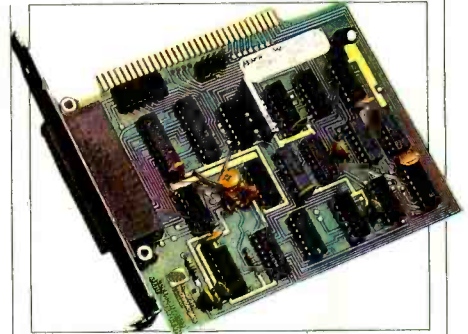

The disk controller board.

informed of updated software that purports to alleviate the problems we encountered. However, due to time constraints we could not fully test the revised programs.

Documentation

In general, the quality of the documentation mirrors the performance of the unit. The sections covering installation and operation of hard disk are adequate and readable, but the sections covering backup are comparatively confusing and unhelpful.

The manual contains only the most rudimentary examples of using the backup routines, and therefore provides very little assistance to a new user attempting to develop a reasonable backup strategy for an installation. It also fails to explain adequately the relative advantages of the various backup options offered. Furthermore, the problems and inadequacies discussed above were not documented at all, even though they become glaringly obvious whenever the backup software is put to any significant use.

Our experience with the software and documentation suggests that no one at Tallgrass has ever examined the problems of data backup from the eyes of a typical computer user. Once again, an excellent piece of hardware has been crippled by a lack of attention to the details of its use in the real world.

To Buy or Not

Even with these problems, we think the 3170 could be very useful to a serious PC user with large data storage requirements. The 3170 costs over \$7000, but the cost per unit of on-line storage (\$100 per megabyte) makes it a good deal for those who need it. It is particularly economical for installations that will have only one hard disk unit. For those with

(Continued on page 119)

Specifications

Product: TG-3170 Cartridge Tape/Hardfile System

Mfr: Tallgrass Technologies
11100 W. 82nd St.
Overland Park KS 66214

Dimensions: 14 $\frac{3}{4}$ "W × 11 $\frac{7}{8}$ "D × 5 $\frac{1}{4}$ "H

Weight: 20 lb

Price: \$7683.95

Features: 70M-byte hard disk with 45M-byte cartridge tape backup; runs under MS-DOS, PC-DOS, or CP/M86 for IBM PC and compatibles

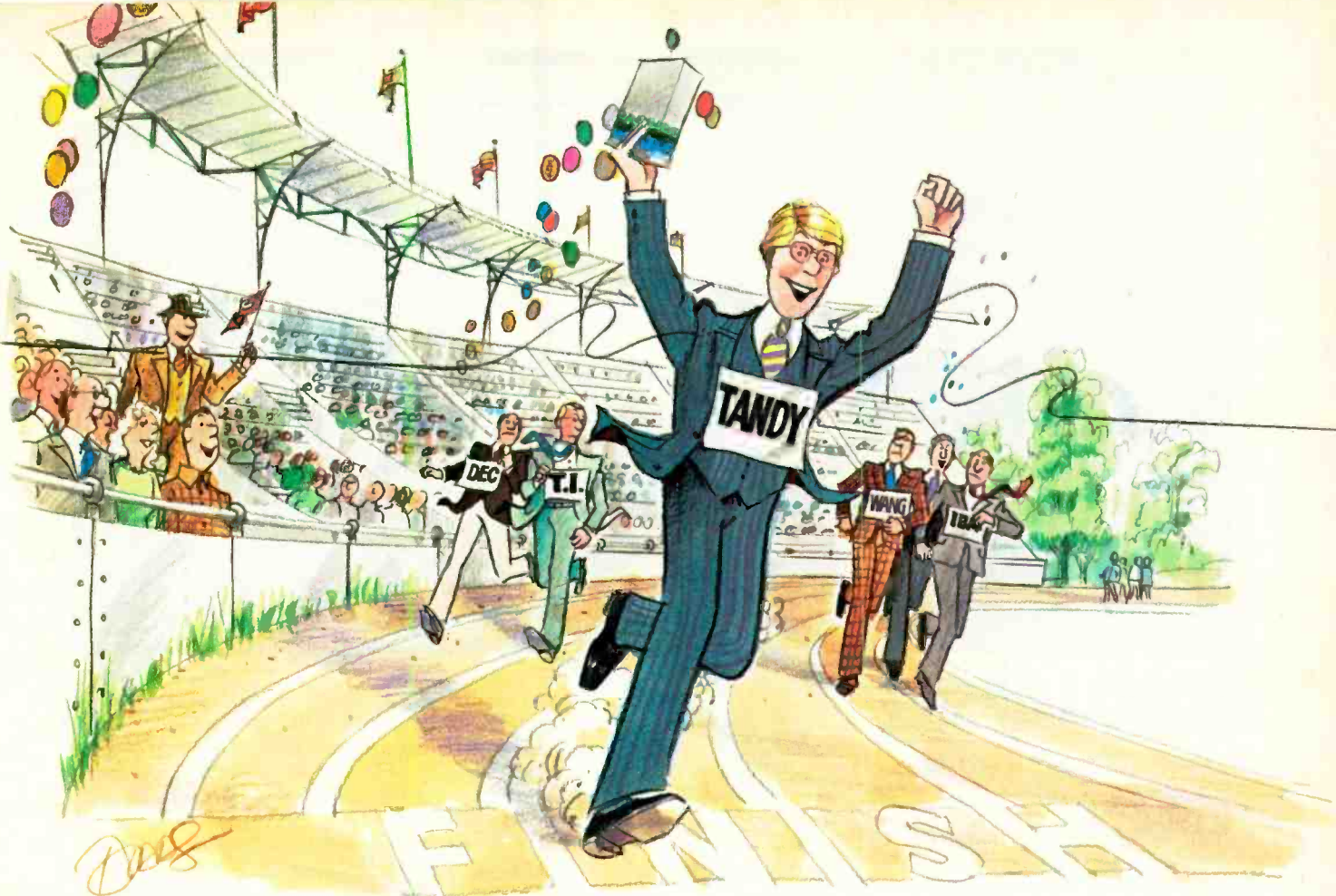

Lotus 1-2-3™ on the Tandy® 2000 Outruns IBM's PC!

If your job seems like a constant race against the clock, you need Lotus 1-2-3. This versatile "integrated" software package combines spreadsheet analysis with graphics and information management in a single program.

Lotus 1-2-3 can help you get the job done right. But if you want the job done fast, make sure your computer is a Tandy TRS-80 Model 2000.

With a Tandy 2000, you can sort through your Lotus database in less than half the time it takes on an

IBM PC. And if you need to recalculate your spreadsheet, you can do it in less than a third of the time!

A complete two-disk Tandy 2000 system with monitor and 1-2-3 sells for \$3793, and can be leased for only \$130 per month.* For those of you who already own a 256K Tandy 2000, Lotus 1-2-3 can be yours for \$495.

So tonight, jog by your nearby Radio Shack Computer Center and see how a Tandy 2000 lets you race right by IBM. And IBM compatibles, too.



Available at over 1200
Radio Shack Computer Centers and at
participating Radio Shack stores and dealers.

Radio Shack® COMPUTER CENTERS

A DIVISION OF TANDY CORPORATION

**New! 1985 TRS-80 catalog.
Send me a copy.**

Mail To: Radio Shack, Dept. 85-A-230
300 One Tandy Center, Ft. Worth, TX 76102

NAME _____
COMPANY _____
ADDRESS _____
CITY _____
STATE _____ ZIP _____
TELEPHONE _____



We Invite Comparison!

In speed, graphics, disk storage and support, the Tandy 2000 offers more than IBM's PC. Come in and see!

*Plus applicable use/sales tax. Prices apply at Radio Shack Computer Centers and participating stores and dealers. Comparisons based on database sorting of 172 records with four heads using a primary and secondary key, and a spreadsheet recalculation of 3 columns by 200 rows. Lotus 1-2-3/Registered TM of Lotus Development Corp. IBM/Registered TM International Business Machines Corp. TUI/Registered TM Texas Instruments, Inc. Wang/Registered TM Wang Laboratories, Inc. DEC/Registered TM Digital Equipment Corp.

SORD LAPSIZES

Integrated spreadsheet, word processing, graphics, and communications software in a 5-lb package

BY CHARLES RUBENSTEIN

ALTHOUGH not well-known in this country, the Japan-based Sord Computer Corporation has been in the microcomputing business for more than a decade in Europe and Asia. It is trying to capture some of the U.S. market with its latest product, the IS-11 lapsed computer.

At first glance, the IS-11 appears to be just another notebook-sized micro. However, the Sord includes integrated spreadsheet, graphics, communications, text editor, and calculating software in a 64K ROM. Additionally, a ROM-cartridge-based word processor and microcassette tape of "Desk Organizer" files and programs come standard with the unit.

The IS-11 weighs 4.5 lb and measures 12" W × 8.5" D × 2" H. It has a standard keyboard, 8-line by 40-character liquid-crystal display, and integrated microcassette drive. Power is supplied by six internal C-type nickel-cadmium batteries or an external adapter. Suggested retail price of the IS-11 is \$995.

The Keyboard

The Sord uses a 57-key keyboard that is gently sloped about 10 degrees. There is a linear cursor-key cluster in the up-

per right-hand corner, ESC and RESET buttons on the upper left, and a set of six (F1-F6) function keys centered above the keyboard. The function of these special keys is displayed on the last LCD line; unfortunately it is not centered above the keys.

The Mitsumi keyboard is a well-designed, solder-masked, single-sided, metal reinforced, epoxy fiberglass board with keytop-activated membrane switches. Unfortunately the keys have a plastic, somewhat wobbly, feel. Only the function, ESC and RESET keys have tactile feedback; auditory feedback for all keys is provided by an almost imperceptible click. On either side of the space bar are CAPS keys that toggle the upper-case lock, and on the right below RETURN is a NUM key that toggles a numeric keypad composed of marked keys on the right side of the keyboard.

The Display

The IS-11 uses a Hitachi 40-character by 8-line liquid-crystal display. Although the capacity of the display is sim-

ilar to Radio Shack's Model 100 or NEC's PC 8201, both the display size and height of individual characters are considerably smaller. (The display measures 5 $\frac{5}{8}$ " W × 1 $\frac{3}{8}$ " H, while character height is $\frac{1}{8}$ ".) The display has a bit-mapped 256 × 64 dot graphics capability. CTRL P or the Hcopy command dumps the screen contents onto a graphics printer. (With an Epson MX-100 printer, it took about 75 seconds for a screen dump as this is a graphics rather than a text printout.)

There is no provision for automatic shutoff of the screen display. Thus, inadvertently leaving the unit on can be disastrous if you haven't saved files to tape.

What's Inside

Opening up the RAM/ROM compartment on the bottom of the system exposes a standard set of expansion sockets. Two EPROMs contain the Sord's 64K operating system and built-in software. There is space for one additional ROM and four 32K RAM chips.

The unit is separated electronically into two halves. On the top half are the

Ports, left to right: ROM, PPI, RS-232, SIO, bar code and ac adapter.





Planes don't guard America's skies. People do.

The people and planes of the Air National Guard stand ready, 24 hours a day, seven days a week, to Guard America's skies. It's a job that's growing in importance and complexity every day. A job that demands first-rate technology. And most importantly, first-rate people. People like you.

To find out more about the challenges and opportunities waiting for you in the Air National Guard, fill out and mail the coupon below. Or call toll-free 800-638-0936.* Because planes don't Guard America's skies. People like you do.

*In Alaska, Hawaii, New Jersey, Puerto Rico, Guam and the U.S. Virgin Islands, consult your local directory.

**We Guard
America's Skies.**



Complete and mail to:

Air National Guard, P.O. Box 6000, Clifton, NJ 07015.

MALE
 FEMALE

NAME (Please Print) _____

ADDRESS _____ APT _____

CITY _____ STATE _____ ZIP _____

AREA CODE: PHONE _____

OCCUPATION _____

BIRTH DATE _____

PRIOR MILITARY SERVICE _____ YES _____ NO _____

BRANCH _____ RANK _____ A2CPTD** 104NP _____

Circle No. 15 on Free Information Card

If you have put off learning more electronics for any of these reasons, act now!

- I don't have the time.*
- High school was hard for me and electronics sounds like it may be hard to learn.*
- I can't afford any more education.*
- I have a family now.*
- I'm here. You're there. I've never learned that way before. I'm not sure it will work for me.*

Read the opposite page and see how you can get started today!

Be honest with yourself. Are the reasons really excuses? You already know enough about electronics to be interested in reading this magazine. So why not learn more? If you need encouragement, read on and see how excuses can be turned into results.

You don't have the time.

Be realistic. All you have in life is a period of time. Use it. Try to know more tomorrow than you do today. That's the proven way to success.

Electronics sounds like it may be hard to learn.

You already know something about electronics or you wouldn't be reading this. Now, build on that. CIE Auto-Programmed® Lessons help you learn. Topics are presented in simple, logical sequence. All text is clear and concise for quick, easy understanding. You learn step by step, at your own pace. No classes to attend. Nobody pressures you. You *can* learn.

You can't afford any more education.

Actually, you can't afford NOT to gain the skills that can put you ahead of the others. It makes sense to invest in yourself through education — learning a skill. If you are not able to pay full tuition now, convenient monthly payments can be arranged.

You have a family now.

All the more reason why you have the responsibility to advance yourself. For the sake of your family. Do you want them to have what you had or have *more* than you had? The choice is yours. Electronics is a rewarding career choice. CIE can help you to get started on that career.

You're there. We're here. How does CIE help you learn?

First, we *want* you to succeed. You may study at home, but you are not alone. When you have a question about a lesson, a postage stamp gets you your answer fast. You may find this even better than having a classroom teacher. CIE understands people need to learn at their own pace. When CIE receives your completed lesson before noon, it will be graded and mailed back to you the same day with appropriate instructional help. Your satisfaction with your progress comes by return mail. That's how CIE helps you learn.

NOW, IF YOU AGREE CIE TRAINING CAN WORK FOR YOU, HOW ELSE CAN CIE HELP YOU?

CIE is one of the largest independent home study schools in the world that specializes in electronics. Although "big" does not always mean "best," it is evidence that CIE is a strong, successful institution with the people and resources to help you succeed.



Step-by-step learning includes "hands-on" training.

The kind of professional you want to be needs more than theory. That's why some of our courses include the Personal Training Laboratory, which helps you put lesson theory into actual practice. Other courses train you to use tools of the trade such as a 10MHz, solid-state, triggered-sweep oscilloscope. Or a Digital Learning Laboratory to let you apply the digital theory that's essential today for anyone who



wants to keep pace with electronics in the eighties. Or a Microprocessor Training Laboratory you learn to program and interface with displays, memories, switches, and more.

Your credentials can impress employers.

One of the best credentials you can have in electronics — or any other career field — is a college degree. That's why CIE gives you the opportunity to earn an Associate in Applied Science in Electronics Engineering Technology. Any CIE career course can offer you credit toward the degree...more than half the number needed in some cases.

You can also prepare for the government-administered FCC (Federal Communications Commission) Radiotelephone License, General Class. It can be a real mark in your favor...government-certified proof of your specific knowledge and skills.

Find out more! Today. Now.

There's a card with this ad. Fill it in and return. If some other ambitious person has already removed it, use the coupon.

You'll get a copy of CIE's free school catalog, along with a complete package of personal home study information.

For your convenience, we'll try to arrange for a CIE representative to contact you to answer any questions you may have.

If you are serious about a rewarding career, about learning electronics or building on your present skills, your best bet is to go with the electronics specialists — CIE. Mail the card or coupon today or write CIE (please mention the name and date of this magazine), 1776 East 17th Street, Cleveland, Ohio 44114.

This could be the best decision you've made all year.

CIE Cleveland Institute of Electronics, Inc.

1776 East 17th Street, Cleveland, Ohio 44114
Accredited Member National Home Study Council

YES...I want to learn from the specialists in electronics — CIE. Send me my FREE CIE school catalog...including details about the Associate Degree program... plus my FREE package of home study information.

Print Name _____

Address _____ Apt. _____

City _____ State _____ Zip _____

Age _____ Area Code/Phone No. _____ / _____

Check box for G.I. Bill bulletin on Educational Benefits: Veteran Active Duty

MAIL TODAY!

PE-21

Sord

(Continued from p. 32)

LCD display and VLSI CMOS electronics, the keyboard assembly, and a socket for the detachable microcassette unit. The bottom assembly contains six C size nickel cadmium batteries, a small pc board that houses a 3.4-MHz CMOS Z80A microprocessor and its various input/output circuits. The main board consists chiefly of a dc-dc converter, 32K of CMOS RAM, the rear-mounted ROM and RAM chips and sockets, relays and support chips. There is a piezo-electric resonator attached to the bottom case that is used as the system's speaker.

In addition to the connector for the microcassette and the ROM cartridge, there is a 20-pin connector for an external numeric keypad (\$119), and a 16-pin connector for a Sord PT-11 (\$169) 40-column Centronics compatible thermal printer. (Sord includes a cable with a standard Centronics connector that can be used with any Centronics compatible printer.) The Sord, SOFTWARE and HARDWARE, is very much a coordinated system, as can be seen in Fig. 1.

Inputs and Outputs

Any good computing system has to communicate with the outside world via peripherals. As a complete or turnkey system it must possess a variety of I/O



Bottom: RAM/ROM compartment (c), Centronics port (r), keypad port (l), and ROM cartridge (top).

port capabilities. For starters, the IS-11 fills the bill with its ROM cartridge socket, microcassette drive, a 34-pin connector for micro floppy disk drive, and CRT monitor expansion. Additionally, it includes a Centronics compatible parallel port, an 8-pin DIN socket RS-232 port (an 8-pin DIN to standard RS-

232 DB-25 male adapter cable is included), a 6-pin modular telephone type socket modem port, a 3-pin (stereo plug) bar-wand socket, and the external keyboard connector.

The Operating System

When you turn on the IS-11 a series of tests and setup programs is executed so that the proprietary operating system "knows" which peripherals and options are in place. The procedure also sets up the main menu structure. In the roughly seven seconds before you can begin to use the system, the Sord clears and resets the LCD display, checks for and rewinds a tape in the data cassette (add 50 seconds if the tape has to be completely re-wound), and verifies the presence of the ROM pack and any RAM/ROM expansion chips. It then checks the internal RAM for machine language programs to be included in the main menu and displays the first five function-key-controlled programs (F6 is used for the Help function). Since the operating system has five built-in programs (I-Pips, I-Edit, I-Calc, I-Comm, System), additional programs are displayed on the menu line by pressing the RETURN key. The RETURN key can be pressed yet again to see the next five machine language programs, and eventually to return to the initial menu. Conspicuously absent from the built-in program set is any programming language. (Microsoft BASIC is expected to be available shortly as either a ROM pack or on cassette.)

There are 25 commands built into the operating system. Simply pressing the appropriate function key allows you to

(Continued on page 111)

Fig. 1. The Sord coordinated system.

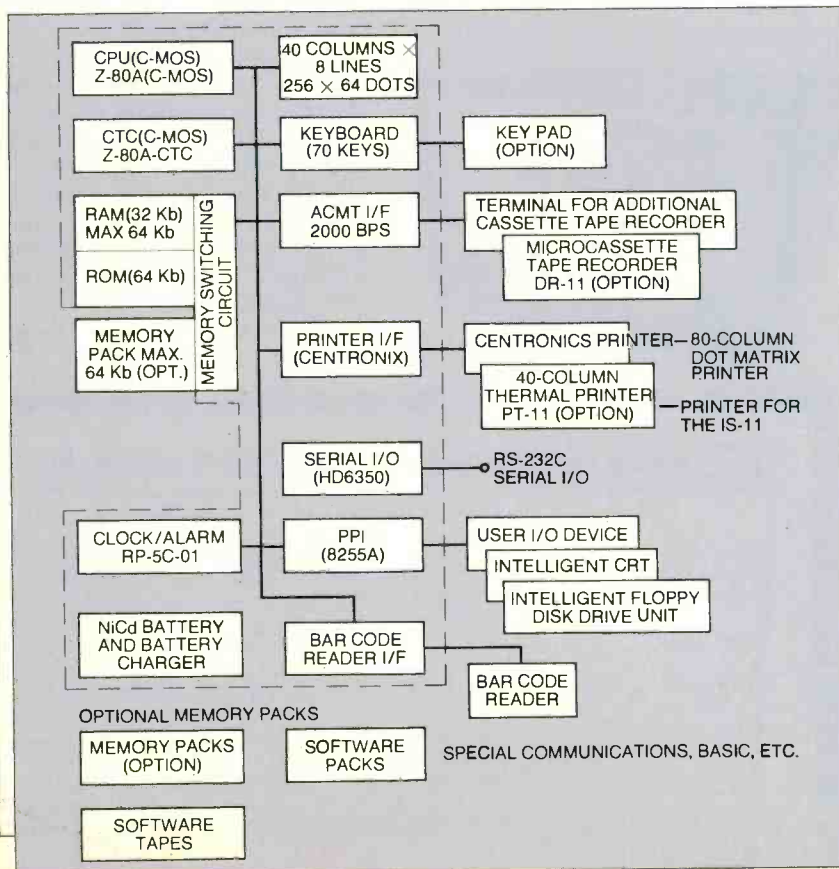



Panasonic Printers.

We help you get it out of your system.

Panasonic can help you get the maximum performance from your computer system. The computer *has* the capabilities you need, but to get the most out of the system, a *quality* professional printer is vital.

And that's a Panasonic printer.

Look to Panasonic for a full line of printers, compatible with most popular computer systems. They feature speeds of up to 180cps, correspondence and near-letter quality, graphics capabilities, bi-directional printing with logic-seeking capabilities, proportional printing, carriages accepting paper 4" to 15" wide, cartridge ribbons, and adjustable tractor and friction feeds.

At Panasonic, we're very serious about the performance of our printers. Their reliability and our extensive

service network are a direct result of our commitment to quality. We offer a one-year limited warranty*, a nationwide regional technical support network, and a toll free number. When you use a Panasonic printer, you have an established high tech manufacturer behind you.

It's our business to offer you high quality peripherals—printers, computer displays, plotters, and data entry terminals. Find out how Panasonic can help you get it out of your system. Contact: Computer Products Division, Panasonic Industrial Company, Division of Matsushita Electric Corporation of America, One Panasonic Way, Secaucus, N.J. 07094. Call TOLL FREE 800-222-0584, in New Jersey (201) 348-5337.

Panasonic® Industrial Company

Circle No. 36 on Free Information Card

*1-Year Limited Warranty. (Carry-in or mail-in service.)

Atlanta, GA - (404) 925-6830; Chicago, IL - (312) 364-7900; Dallas, TX - (214) 258-6400; Cypress, CA - (714) 895-7413.

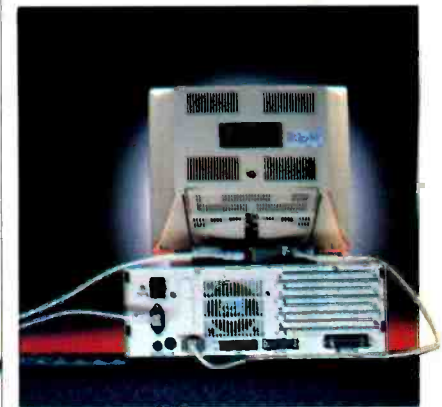
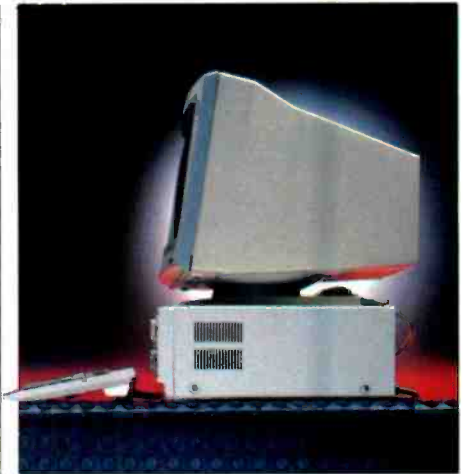
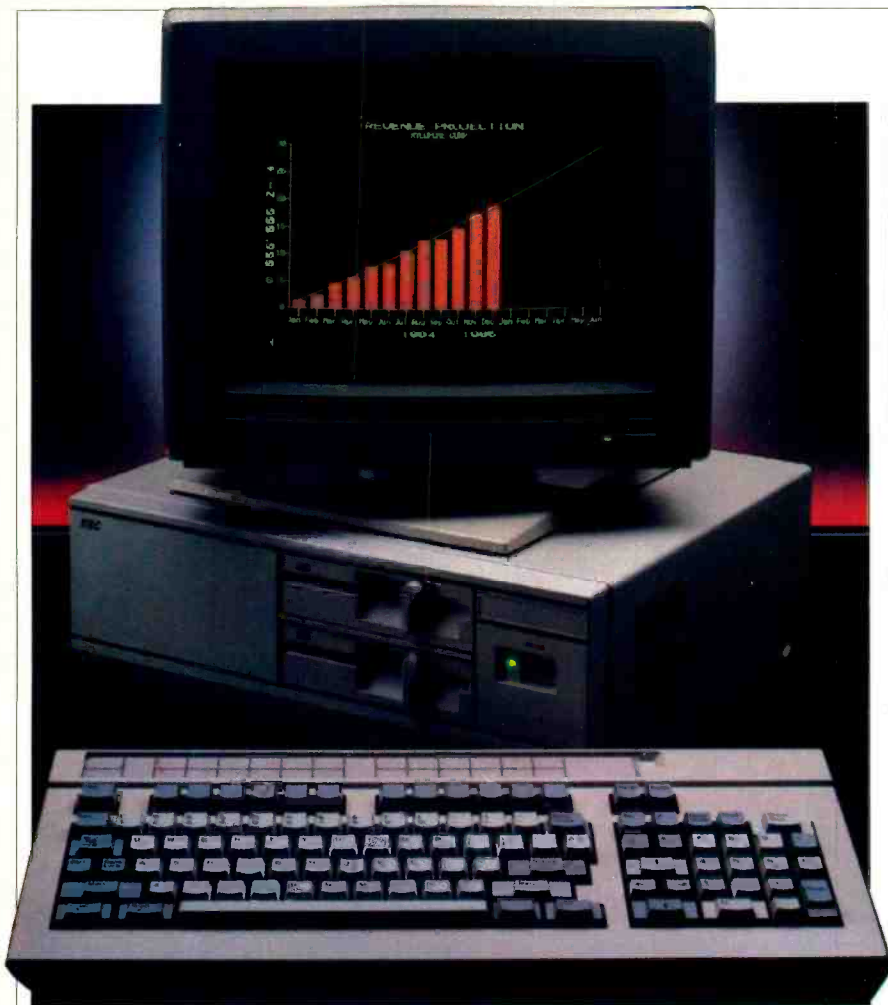

NEC APC III

An 8086-based MS-DOS machine with advanced graphics

BY JON PEPPER

Nippon Electric Company (NEC), the \$6-billion Japanese giant, is best known here for its Spinwriter printers and 8201 lap portable. Now NEC has introduced a desktop unit, the APC III. With this computer, NEC hopes to garner the kind of share of the American market that it enjoys in other countries. (NEC is number three worldwide in sales of \$1000-5000 systems.)

The APC III features 128K of RAM, one disk drive, monochrome display, and has a suggested retail price of \$1995.

With this computer NEC has made some concessions to the dominance of the IBM PC—5¼" drives (earlier APC models used 8" drives) and an MS-DOS operating system—but adds some tech-

nical improvements and an attractive price. Though the entry-level system will appeal to some, most serious users will probably opt for additional features. A typical configuration (and the one used for this review) has 128K RAM, dual drives, a 128K video RAM board and color display. It retails for \$3095.

Although the APC III is not directly IBM-compatible (you can't boot up an IBM application program), NEC seems able to get major software developers to support the computer. Already available are more than 100 programs of all sorts, including many of the best-sellers for the IBM PC, such as WordStar, dBase II, the PFS series, and Multiplan.

The Basic Machine

The APC III has a 16-bit 8086-2 microprocessor, manufactured by NEC, a functional equivalent to the Intel 8086. The 8-MHz clock is almost twice as fast that of the IBM PC. Basic system memory (128K RAM) is expandable to a maximum of 640K.

Also included with the system are 32K ROM, 8K of text video display RAM, MS DOS version 2.11 and GW-BASIC.

The system unit, housed in a stylish cream/beige case with grey trim, has a

power switch on the right front and a reset button on the left. The reset button is an example of NEC's thoughtful engineering. It is easy to reach but hard to push accidentally as it is recessed into the case with a protective lip. Two slimline drives are stacked vertically on the right side of the main unit, with the boot drive (drive A) on top. The drives, which are manufactured by Teac, are double-sided. Each has a capacity of 320K. The disk controller resides on the mother-

Specifications

- Product:** NEC APC III
- Manufacturer:** Nippon Electric Company
Tokyo
- Distributor:** NEC Information Systems, Inc.
1414 Massachusetts Ave.
Boxborough, MA 01719
- Price:** \$3095
- Dimensions:** 16 $\frac{5}{8}$ " W × 13 $\frac{5}{8}$ " D × 5 $\frac{5}{8}$ " H
- Operating Systems:** MS-DOS 2.11, Unix
- Features:** 8086-2 CPU, dual slimline 5¼" floppy disk drives, 128K RAM, RS-232 and Centronics parallel connectors, four expansion slots, color graphics display card, color monitor

board, so an expansion slot doesn't have to be used.

Located at the rear of the unit are four expansion slots and connectors for the keyboard, monochrome video, RGB color video, and Centronics parallel and RS-232C ports. Also at the rear are ten DIP switches. Although they are factory set, they can be altered for various system options. All connectors, clearly marked with their functions, are designed so that there is only one way to hook them up, making even a first setup very simple. A cable cover fits over the back of the system unit to route all cables neatly.

The APC III includes a fan inside the rear panel, which is extremely quiet in operation. When the APC III does make noises, they're generated with a piezo-electric beeper.

The NEC Display

Both the NEC color and monochrome monitors offer 25 lines of 80 columns each, with a resolution of 640 x 400. The color display can produce eight colors simultaneously with no tradeoff of resolution or clarity. Both units have 14" screens, which makes the character sets large and very readable.

The color display is flicker-free, even when large areas of the screen are filled in with a solid color. A tilt and swivel stand comes with the monitor.

The APC III comes standard with the necessary hardware to produce high-quality graphics: 64K of video RAM and two NEC state-of-the-art 7220 graphic display controllers. If you want to produce color graphics, an additional 128K of video RAM is necessary, which is supplied with an option card (\$200) that fits right onto the motherboard without taking an expansion slot.

The graphics capabilities of the 7220 controller are stunning. Resolution, clarity and color brilliance are all excel-

lent, and graphics drawing is very fast. Currently available graphics software includes BPS:Graphics, GraphPlan, PFS:Graph.

Any character may have six display attributes: underline, underline, vertical strike-through, reverse video, blink and color. The APC III has an eight-color palette: black, red, blue, purple (magenta), green, yellow, light blue (cyan) and white.

The Keyboard

The APC III keyboard is well laid out and very comfortable to use. Its 102 keys are low-profile; 90 are standard alphanumeric and symbol keys and 12 are function keys that each can be programmed five ways. Included are separate keys for page up, page down, and special keys for BREAK/STOP and PRINT. The separate numeric keypad includes a cursor control diamond, obviating the need for the number lock found on the IBM PC keyboard.

The feel of the keys gives just enough resistance to confirm that you are hitting them. Although you can toggle a keyclick on with software (at the system level), the sound is actually a beep, and users might prefer to leave this feature turned off.

There are adjustable legs to provide a better typing angle and a storage area for templates (for the function key assignments) in a slot above the top row of keys.

Expansion Capabilities

The APC III has many expansion options, but currently they are available only from NEC (there are no third-party expansion boards yet).

A 128K memory expansion board, which lists for \$325, includes sockets for an additional 128K of RAM chips (\$175), making each board capable of holding 256K RAM (a maximum of two

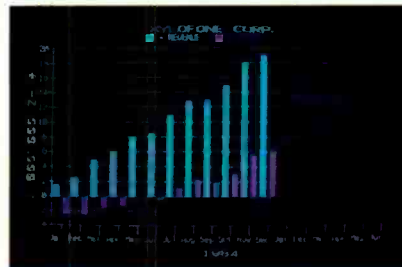

The APC III uses two NEC 7220 controllers for graphics display.

memory boards may be added). Boards install easily into the expansion slots at the rear without removal of the cover of the system unit. Instructions for the installation are straightforward enough to give even an inexperienced user no trouble.

A 10M-byte hard disk can be substituted for one of the floppy drives. Like the floppy drive controller, the hard disk controller is contained on the motherboard. If you wish to keep both floppy drives and add one or two outboard 10M-byte hard drives, you attach the drive(s) to the controller through a slot opening on the rear panel. Another option is a Unix hardware board (\$299) for use with the Unix operating system (which requires the hard disk for full utilization). However, the Unix operating system and "memory management" hardware board were not available at the time of this review.

Other options include a joystick/
(Continued on page 127)

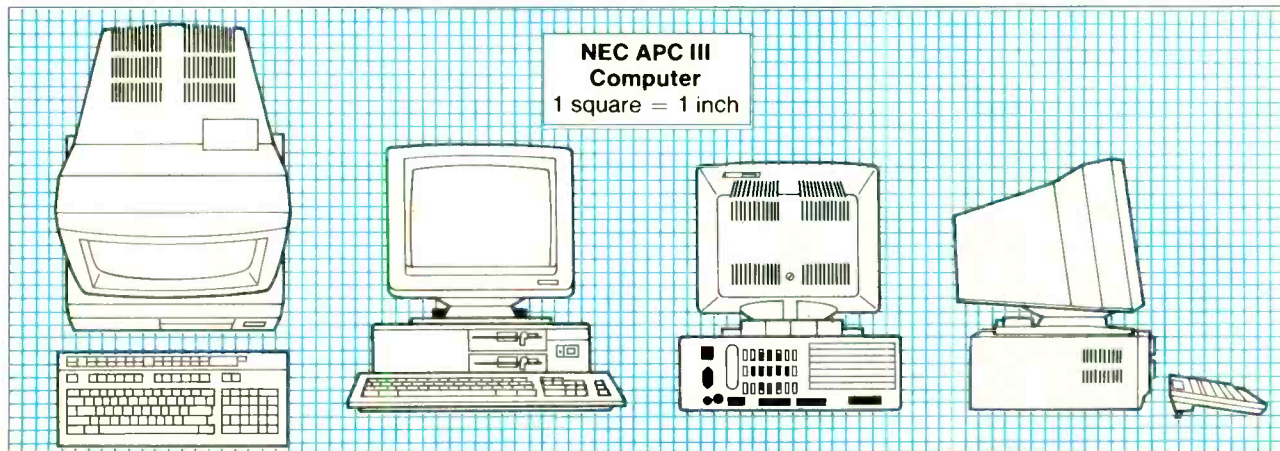

The new IBM DisplayWrite



Little Tramp character licensed by Bubbles Inc., s.a.

*Prices apply at IBM Product Centers and may vary at other stores.

** Available in July, 1984.

Series is here. Spread the word.

In 1980, IBM introduced the Displaywriter System. Today, it's become the best-selling stand-alone text processor in the world. One reason for this success is the Displaywriter's function-rich software.

If you're looking for software like that, but working on an IBM personal computer, you don't have to look any further. Because the IBM DisplayWrite Series is here.

And it will put many of the features and capabilities of a dedicated word processor to work for you when you're writing.

It runs in the family.

You'll find two word processing programs in this series: There's DisplayWrite 1, for IBM personal computers — including PCjr. And DisplayWrite 2, with added functions for your PC, PC/XT or *Portable* PC.

You'll also find DisplayWrite Legal, a dictionary of about 16,000 words that a lawyer might need to check.

And you'll find DisplayComm, which lets your IBM PC send and receive text to and from other IBM PCs. If you're writing at the office, this program could also let you send text to an IBM Displaywriter down the hall. (From there, it could be sent on to an IBM host computer for distribution.)

Some words on high function.

The DisplayWrite word processing programs give you the time-saving features you'd expect from IBM. Justified margins, centered lines and pagination, for example. You'll even have prompts and messages to help guide you along.

But there are also some features in DisplayWrite 2 you might not expect. Like easy column formatting, four-function math capability *plus* a spelling checker based on a dictionary of about 100,000 words.

Yet the biggest surprise of all may be the price.* DisplayWrite 1,** \$95. DisplayWrite 2, \$299. DisplayWrite Legal, \$165. DisplayComm, \$375.

Where you can find all four.

Get more information about the IBM DisplayWrite Series at your authorized IBM Personal Computer dealer or IBM Product Center. To find one near you, call 800-447-4700. In Alaska or Hawaii, 800-447-0890.

Stop there first and get the last word.

Circle No. 41 on Free Information Card

The IBM logo, consisting of the letters 'IBM' in a bold, sans-serif font with horizontal stripes through the letters.

Personal Computer Software



KEY TRONIC 5151 KEYBOARD

A deluxe IBM replacement with the right touch

BY DEXTER R. HART

THE IBM PC has created a large market for peripherals, plug-in boards and accessories made by other manufacturers. But one unexpected demand is for an alternative to the PC keyboard. For the PC, IBM used a keyboard with a layout different from its Selectric standard. One hears the rationale that IBM wanted to conform to a "European standard;" nevertheless, many touch typists find the PC keyboard unsuitable.

IBM could have offered a choice of keyboards, of course, but it hasn't. It's been two years now, and office workers find it difficult to switch back and forth from a Selectric to a PC. I have used a Selectric-style keyboard on typewriters (and on my Superbrain CP/M system since 1980); I'm a good touch typist, but when I thought of buying an IBM, I was stopped cold by the idea of trying to adjust. I use (and love) the original Magic Wand, which I can only run on my Superbrain system, and I need to be able to switch comfortably back and forth between it and the PC. A quandary.

I knew key tronic had quickly brought out a compatible keyboard (model 5150, suggested retail \$209) that looked exactly like the IBM but corrected the most-mentioned complaints, specifically, the locations of the return and left shift keys. The 5150 put the left shift key next to the Z as God intended, but still did not separate the numeric keypad from the main body of keys and still had small, hard-to-

read cursor direction arrows sharing keytop space with numbers. It was an acceptable layout, however, even though it was not at the Texas Instrument/Televideo level.

A problem in buying a replacement keyboard is what do you do with the old one? Since everybody buying a PC gets the IBM version, there is not a thriving market for used IBM keyboards. Fortunately, I had a relative who wanted my IBM keyboard. He maintains two residences and, with the addition of my keyboard, can have a keyboard, printer, and monitor at each location; he only needs to ferry the system unit back and forth. The rest of you are on your own, however, as this small market has dried up.

Another way to obtain an improved key layout is to buy an IBM-compatible computer. Even here, one must be careful, because some clones have slavishly copied the IBM keyboard without regard to the well-publicized complaints. Key tronic supplies a lot of the keyboards used on other machines and makes them with good or bad layouts as requested. Somewhere along the line, even though business has obviously been booming, key tronic found the time to bring out version 2 of its IBM-compatible keyboard, the model 5151. I bought one.

I first saw the 5151 in April at an IBM user group meeting. I hadn't bought the IBM then, so I got to try both keyboards at the same time, with no preconceptions. Loved the IBM touch; disliked the key tronic touch. Took me four tries on the 5151 to get through "Now is the time . . ." without an error. No keystroke errors on the IBM except that I started out with "\ now is the time . . ." because of the reverse-backslash location. (IBM also puts keys directly adjacent to the space bar, which gives you even more ways to make mistakes.)

I called key tronic to complain about the feel (*light* was too mild a word). I was

told that my complaint was familiar, but that most users quickly learned to adjust. If I did *not* adjust, for \$25 they would send a keycap removal tool, instructions, and a hundred heavier springs. I passed this info on to the user group 5151 owner; he ordered the kit, installed it, and was quite happy. You can combine original and replacement springs to achieve other ends, such as distinctly heavier force for selected command keys, a potentially useful arrangement. I wasn't overjoyed at the prospect of playing with little springs or of paying extra for them. But being cost conscious, I thought I might be able to adjust to the lighter touch.

Ordering by mail, I received the 5151 in late June, as the pipeline didn't really fill till then. Suggested retail is \$255; some current ads indicate mail availability at \$199, a few even lower. I plugged the 5151 into my IBM, tried the touch, and surprise! It did feel light, but I wasn't making mistakes. I surmised key tronic had increased the spring loads just a bit, but a call to Spokane revealed no design change. I can only confirm that my sample is fully satisfactory. In case you're wondering, in my opinion the IBM touch is still better. I like the over-center feel and the audible click, but the key tronic is going to be just fine, and I can switch between the Superbrain and the IBM without trauma. Key tronic will supply on request assembly language code for a short program with which you get an audible key-click from the PC speaker, adjustable for volume.

OK, so the 5151 is usable. What's improved? This time, a *lot*. The 10 function keys are straight-lined across the top, which makes them easier to label (space is provided). A set of dedicated editing keys with easy-to-see big black arrows are between the numeric keypad and the letter-key area. You can edit and use the key pad for number entry at the same time (lovely for spreadsheet work). Each of the three key clusters is clearly set off from the other. No keys adjacent to the space bar. Plain English for key labels (the 5150 does this too). The tab key says "Tab;" the shift key says "Shift," etc.

(Continued on page 115)

Specifications

Product: KB 5151 keyboard

Mfr: key tronic

PO Box 14687

Spokane, WA 99214

Dimensions: 8 $\frac{5}{8}$ " × 20 $\frac{1}{4}$ "

Price: \$225

Features: Can be plugged into IBM PC and XT. Available with Dvorak and foreign layouts.

**IT'S A SMALL MIRACLE HOW HEWLETT-PACKARD
PUT 656K OF MEMORY, LOTUS 1-2-3, WORD
PROCESSING, A TELECOMMUNICATIONS MODEM
AND COMPLETE IBM CONNECTABILITY INTO**



THE PORTABLE.

For years business people had to choose between the power of a desktop computer and the limited capabilities of the first portables. That problem was solved when Hewlett-Packard introduced The Portable.

The Portable is designed with more total memory than most leading desktop personal computers...656K in fact. That includes 272K of user memory. So, The Portable's built-in business software can work with enormous amounts of data.

1-2-3™ from Lotus,™ America's most popular spreadsheet, file management and business graphics program, is permanently built into The Portable. So is Hewlett-Packard's word processing program, MemoMaker. Just press the key and you're ready to work.

The Portable even has a built-in modem and easy-to-use telecommunications software to send

or receive data using a standard telephone jack.

If you use a Hewlett-Packard Touchscreen PC, IBM® PC, XT or an IBM compatible you'll be glad to know that your desktop and The Portable can talk to each other with the simple addition of the Hewlett-Packard Portable-Desktop Link.

The Portable's rechargeable battery gives you 16 hours of continuous usage on every charge.

Finally, you can work comfortably on a full size keyboard and an easy-to-read 16-line by 80-column screen. And it all folds shut to turn The Portable into a simple nine-pound box.

The Portable. A small miracle...perhaps. But then consider where it came from.

See The Portable and the entire family of personal computers, software and peripherals at your authorized Hewlett-Packard dealer. Call (800) FOR-HPPC for the dealer nearest you.

Setting You Free

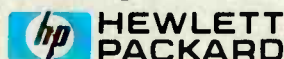

209H

IBM is a registered trademark of International Business Machines Corporation. 1-2-3 and Lotus are trademarks of Lotus Development Corporation.

SOFTWARE REVIEWS



PC/FOCUS

A micro version of a mainframe classic

BY BARBARA E. AND JOHN F. MCMULLEN

To call PC/Focus a database management system is about as accurate as referring to a Lamborghini as just another car. While PC/Focus covers all the ground that data management systems do, it goes much further. It is, to quote the first sentence of the Users' Manual, "a comprehensive information control system." With it you can define and maintain simple, relational or hierarchical files and manipulate several files at once. You can also prepare reports and do statistical analysis, financial modeling, telecommunications (both asynchronous and 3270) and graphics. Since it provides a powerful high-level procedural language, PC/Focus is an excellent development tool for system designers.

Unfortunately, you cannot just sit down and drive away with PC/Focus. Reference material or instruction is necessary even if you are versatile with VisiFile or PC-File. The developers, Information Builders, have attempted to maintain all the functionality of their mainframe system, Focus (see sidebar). The result is an extremely powerful, complex system that, in our judgement, does not lend itself to use by the uninitiated. Users will need some understanding of the theory of database management and of the concept of stored

programs and some familiarity with computers in general before they can begin to harness the raw power of the system. Users must also be able to resist intimidation by documentation. The users' manual is in two volumes with well over 1000 pages, including an index of 64 pages and an "Appendix of Error Messages," in very small print, of 30 pages. The documentation contains such statements as "This option is analogous to the CMS and TSO syntax of DISP MOD to determine the disposition of the file's records." That's hardly a sentence to inspire confidence in the brand new computer user.

By pointing out the complexity of PC/Focus we do not mean to depreciate it, but merely to locate its appropriate niche in the marketplace. A potential user whose application fits comfortably into PC-File, VisiFile or even dBase II would be better served by purchasing one of those products than spending \$1595 on PC/Focus and then making a very significant investment of time to be able to utilize the program competently. If, on the other hand, the potential user is a systems developer, has a complex data management requirement or has mainframe experience, then PC/Focus is a wise choice.

A Powerful System

The power of PC/Focus becomes apparent as soon as you get into the system, which is contained on 11 floppy diskettes that must be loaded out to the computer's hard disk. Each time you load the system, you must put the Activator Disk in PC disk drive A. (This procedure is Information Builders' "protection" scheme.) The system maintains files of up to 250 fields per record, each record having a maximum size of 4096 characters. There is no maximum number of records per file; the file size is limited only by the disk space available to the program. (Information Builders states that a 5M-byte hard disk is the minimum system configuration; we feel that the system requires at least 10M bytes to be useful. As for memory, "the bigger the better.")

In addition to the functions intrinsic to the program, the authors of the system have provided a number of powerful tools:

1. TED—an editor built into the system that allows the user to develop command or program files (called FEX files) that may be stored on disk and executed through the use of the EX command.

2. TableTalk—a built-in utility that allows the rapid definition of reports through menu selection. This utility actually generates the lower-level Focus commands to produce the reports. The generated commands may be saved in a file and utilized by the aforementioned EX command.

3. FileTalk—a built-in utility that allows the rapid definition of simple relational and hierarchical files through menu selection.

4. AutoMod—a built-in utility that defines a painted screen for file maintenance and provides a menu of maintenance choices (Add, Add & Update, Update, Delete) to the user.

5. Dialogue Manager—the portion of the system that allows the stored commands (.FEX files) to obtain system variables (such as time & date), set default variables and interact with the user by prompting for required variables. New stored Focus programs are tested through the use of the Dialogue Manager.

6. User Structured Language—allows, through the use of the LET command and utilities, the native syntax of the Focus language to be restructured. This feature is useful, in particular, when the user is incorporating special occupational jargon (engineering, accounting) and foreign languages into the system.

Using these tools, systems developers can work up applications far more rapidly than they would using individual Focus commands.

Using PC/Focus

To put PC/Focus through its paces, we converted 527 records from a dBase II Name & Address File that we maintain and processed them through a large variety of tasks. We used Filetalk to define the file and, through the use of that

Overview

Product: PC/Focus
Mfr: Information Builders, Inc.
1250 Broadway
New York, NY 10001

Price: \$1595

Requirements: IBM PC or compatible with 512K, 5M-byte hard disk, one 320K floppy drive under DOS 2.x.

Optional Hardware

Supported: 8087 math coprocessor, IRMA 3270 interface, clock.



LAST NIGHT WE EXCHANGED LETTERS WITH MOM, THEN HAD A PARTY FOR ELEVEN PEOPLE IN NINE DIFFERENT STATES AND ONLY HAD TO WASH ONE GLASS...

That's CompuServe, The Personal Communications Network For Every Computer Owner

And it doesn't matter what kind of computer you own. You'll use CompuServe's Electronic Mail system (we call it Email™) to compose, edit and send letters to friends or business associates. The system delivers any number of messages to other users anywhere in North America.

CompuServe's multi-channel CB simulator brings distant friends together and gets new friendships started. You can even use a scrambler if you have a secret you don't want to share. Special interest groups meet regularly to trade information on hardware, software and hobbies from photography to cooking and you can sell, swap and post personal notices on the bulletin board.

There's all this and much more on the CompuServe Information Service. All you need is a computer, a modem,

and CompuServe. CompuServe connects with almost any type or brand of personal computer or terminal and many communicating word processors. To buy a Starter Kit, see your nearest computer dealer. To receive our informative brochure or to order direct, call or write:

CompuServe

Consumer Information Service
5000 Arlington Centre Blvd., Columbus, OH 43220
800-848-8199
In Ohio call 614-457-0802.

An H&R Block Company

Circle No. 56 on Free Information Card

RACE STATISTICS BY STATE				
State	Last Count	Con-count	Money	Attendee
	3	1	20.00	1
AZ	3	1	20.00	0
CA	12	2	40.00	1
CO	2	0	.00	0
CT	30	10	200.00	9
FL	5	1	20.00	1
GA	1	1	20.00	0
KS	1	0	.00	0
LI	1	1	20.00	0
MA	12	7	140.00	6
MD	5	0	.00	0
MI	2	0	.00	0
MT	1	0	.00	0
NJ	89	24	480.00	19
NY	341	118	2,360.00	87
OH	1	1	20.00	1
PA	8	2	40.00	1
RI	1	0	.00	0
TN	1	0	.00	0
TX	6	3	60.00	3
VA	3	2	40.00	1
WI	1	0	.00	0
TOTAL	529	174	3,480.00	130

Fig. 1. Printer output generated by Rststats program.

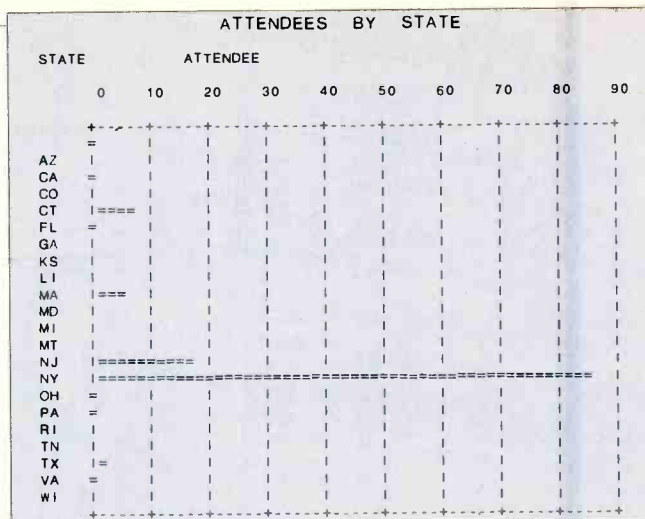

Fig. 2. Example of graph generated by PC/Focus on printer.

menu-driven utility, we generated the following Focus commands in under 5 minutes:

```

FILENAME=DIRECT, SUFFIX=FOC
SEGNAME=ONE, SEGTYPE=S2
FIELDNAME=LAST, ALIAS=LAST,
  FORMAT=A25,
  FIELDTYPE=I, $
FIELDNAME=FIRM, ALIAS=FIRM,
  FORMAT=A35,
  FIELDTYPE=I, $
FIELDNAME=FIRST, ALIAS
  =FIRST, FORMAT=A12, $
FIELDNAME=SALUATION, ALIAS
  =SAL, FORMAT=A4, $
FIELDNAME=TITLE, ALIAS
  =TITLE, FORMAT=A12, $
FIELDNAME=FADDRESS1, ALIAS
  =FADD1, FORMAT=A30, $
FIELDNAME=FADDRESS2, ALIAS
  =FADD2, FORMAT=A30, $
FIELDNAME=FCITY, ALIAS
  =FCITY, FORMAT=A20, $
FIELDNAME=FSTATE, ALIAS
  =FSTATE, FORMAT=A2, $
FIELDNAME=FZIP, ALIAS
  =FZIP, FORMAT=A9, $
FIELDNAME=FAREA, ALIAS
  =FAREA, FORMAT=A3, $
FIELDNAME=FPHONE, ALIAS
  =FPHONE, FORMAT=A8, $
FIELDNAME=MCMACCT, ALIAS
  =MCMACCT, FORMAT=A5, $
FIELDNAME=HADDRESS1, ALIAS
  =HADD1, FORMAT=A25, $
FIELDNAME=HADDRESS2, ALIAS
  =HADD2, FORMAT=A25, $
FIELDNAME=HCITY, ALIAS
  =HCITY, FORMAT=A20, $
FIELDNAME=HSTATE, ALIAS
  =HSTATE, FORMAT=A2, $
FIELDNAME=HZIP, ALIAS
  =HZIP, FORMAT=A9, $
FIELDNAME=HAREA, ALIAS
  =HAREA, FORMAT=A3, $

```

```

FIELDNAME=HPHONE, ALIAS
  =HPHONE, FORMAT=A8, $
FIELDNAME=SPOUSE, ALIAS
  =SPOUSE, FORMAT=A12, $
FIELDNAME=CHILDREN, ALIAS
  =CHILDREN, FORMAT=A25, $
FIELDNAME=CODE1, ALIAS
  =CODE1, FORMAT=A1, $
FIELDNAME=CONTRIBUTION,
  ALIAS=CODE2, FORMAT=A1, $
FIELDNAME=MAILING, ALIAS
  =CODE3, FORMAT=A1, $
FIELDNAME=XMASCODE, ALIAS
  =XMASCODE, FORMAT=A1, $
FIELDNAME=XMASSAL, ALIAS
  =XMASSAL, FORMAT=A5, $
FIELDNAME=XRCVD, ALIAS
  =XRCVD, FORMAT=A1, $
FIELDNAME=SOURCEID, ALIAS
  =SOURCEID, FORMAT=A7, $
FIELDNAME=COMPUSERVE, ALIAS
  =COMPUSERV, FORMAT=A10, $
FIELDNAME=BAUG, ALIAS
  =BAUG, FORMAT=A1, $
FIELDNAME=NYPC, ALIAS
  =NYPC, FORMAT=A1, $

```

We then used the TED editor to develop a stored program to read the file that we had written from dBase (as a DOS text file) into the Focus environment.

```

FILEDEF TRANS DISK
  JTEST.DAT
MODIFY FILE DIRECT
FIXFORM LAST/25 FIRST/12
  SAL/4 TITLE/12 FIRM/35
  FADD1/30 FADD2/30
FIXFORM FCITY/20 FSTATE/2
  FZIP/9 FAREA/3
  FPHONE/8 MCMACCT/5
FIXFORM HADD1/25 HADD2/25
  HCITY/20 HSTATE/2
  HZIP/9 HAREA/3
  HPHONE/8
FIXFORM SPOUSE/12 CHILDREN

```

```

/25 CODE1/1 CODE2/1
CODE3/1 XMASCODE/1
FIXFORM XMASSAL/5 XRCVD/1
SOURCEID/7 COMPUSERV/10
BAUG/1 NYPC/1
DATA ON TRANS
END

```

We then executed this command file and built the 527 record file.

Once the file was built, we developed some programs to define additional fields relating to the file and to prepare a report analyzing the concentration of names and addresses and other records by state. To perform the activities, we developed two files, Setstate.fex and Rststats.fex. Setstate contains the instructions necessary to perform the additional field definition:

```

DEFINE FILE DIRECT
STATE/A2=IF HSTATE NE
  THEN HSTATE ELSE
  FSTATE;
CONCOUNT/13=IF CONTRIBU-
TION EQ 'M' THEN 1
  ELSE 0;
MONEY/D8.2=CONCOUNT
  * 20.00;
ATTENDEE/13=IF CODE1 EQ
'Y'
  THEN 1 ELSE 0;
END

```

Rststats performs the analysis and prepares the report (the Offline command in the program directs the output to the printer rather than the screen).

```

- INCLUDE SETSTATE
OFFLINE
TABLE FILE DIRECT
HEADING CENTER
  'RACE STATISTICS BY
  STATE'

```

Now! Tek quality and expert advice are just a free phone call away!

100 MHz dual time base scope. Easy-to-read CRT; bright, full-sized 8x10 cm; 14 kv accelerating potential complete with BEAM FIND; separate A/B dual intensity controls, FOCUS and TRACE ROTATION.

Wide range vertical sensitivity. Choose from 2 mV/div (1x probe) to 50 V/div (10x probe); color-keyed for 1x and 10x probes; variable control increases scale factor by 2.5 to 1.

Two 100 MHz, high sensitivity channels. 3.5 ns risetime; dc to ≥ 100 MHz bandwidth from 5 V/div to 5 mV/div; extended sensitivity of 2 mV/div at ≥ 90 MHz.

A/B sweep selection. Calibrated A sweeps from 50 ns/div to 0.5 s/div; B sweeps from 50 ns/div to 50 ms/div; variable control for up to 2.5 to 1 reduction and 10x magnification for sweeps to 5 ns/div.

Dual time base measurements. Select either A or B sweeps, or both alternately with A intensified by B.

B trigger slope and level. Use B trigger level to select B-triggered or run-after-delay modes; use B TRIGGER SLOPE to select transitions.



1-800-426-2200

Our direct order line gets you the industry's leading price/performance portables... and fast answers from experts!

The 60 MHz single time base delay 2213A, the 60 MHz dual time base 2215A and the 100 MHz dual time base 2235 offer unprecedented reliability and affordability, plus the industry's first 3-year warranty* on labor and parts, CRT included.

The cost: just \$1200 for the 2213A, \$1450 for the 2215A, \$1650 for the 2235.† Even at these low prices, there's no scrimping on performance. You

have the bandwidth for digital and analog circuits. The sensitivity for low signal measurements. The sweep speeds for fast logic families. And delayed sweep for fast, accurate timing measurements. All scopes are UL Listed and CSA approved.

You can order, or obtain literature, through the Tek National Marketing Center. Technical personnel, expert in scope applications, will answer your questions and expedite delivery. Direct orders include comprehensive 3-year warranty*, operator's

manual, two 10X probes, 15-day return policy and worldwide service backup.

Order toll free: 1-800-426-2200, Ask for Rick.

In Oregon, call collect: (503) 627-9000. Or write Tektronix, Inc. P.O. Box 1700 Beaverton, OR 97075

Tektronix
COMMITTED TO EXCELLENCE

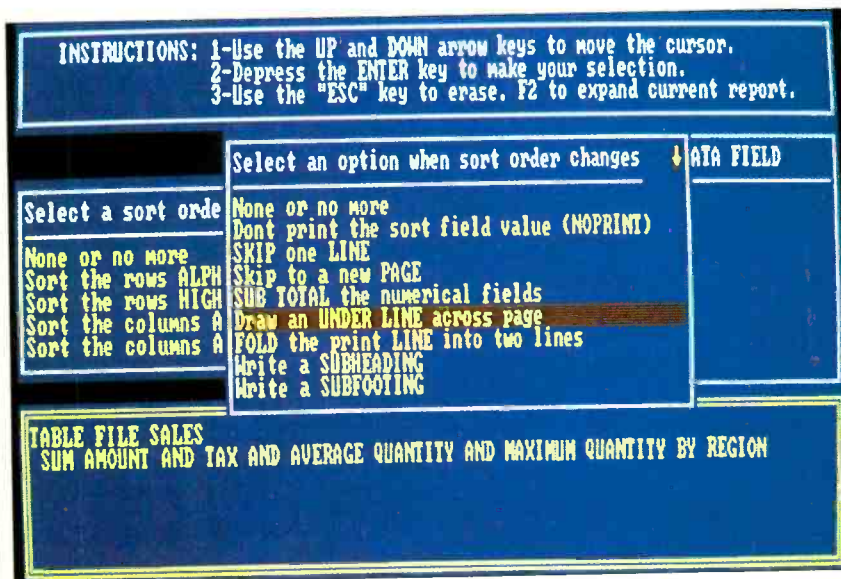

Fig. 3. A Typical TableTalk menu.

```
LIST FNAME , LNAME , HAREA ,
      HPHONE FOR HSTATE
      = ' NJ '
```

while the Focus commands for the same task, developed in 3 minutes in Tabletalk are:

```
TABLE FILE DIRECT
PRINT FIRST AND LAST
      AND HAREA AND HPHONE
IF HSTATE EQ 'NJ'
END
```

Figure 3 shows a typical TableTalk menu. Note the generated Focus commands in the lower part of the screen. It is obvious from this example that PC/Focus is more verbose than dBase II and, for such trivial applications, demands more of the user's time. The strengths of the system only become prominent as the tests become more complex. As they do, the value of PC/Focus increases proportionately.

Because of the many functions, it is tempting to consider PC/Focus another of the integrated systems currently on the market (such as Symphony I, Framework, Ovation, etc.). This classification is not accurate and is not fair to either PC/Focus or the integrated packages. PC/Focus, in actuality, is a type of programming language rather than a program. It contains a large number of very powerful functions that can only be activated by the user/programmer. When viewed as a development tool for an experienced user, it ranks as the best we've seen to date, and we recommend it to anyone needing such a powerful database management system. ♦

```
COUNT LAST AND COLUMN
-TOTAL BY STATE
SUM CONCOUNT AND COLUMN
-TOTAL BY STATE
SUM MONEY AND COLUMN
-TOTAL BY STATE
SUM ATTENDEE AND COLUMN
-TOTAL BY STATE
END
```

The -Include statement causes the Setstate "program" to be executed whenever the Rststats program is executed (Ex rststats causes execution). The output of the analysis is shown in Fig. 1.

After producing the report, we performed one of the analyses graphically and produced the graph shown in Fig. 2.

```
-INCLUDE SETSTATE
OFFLINE
SET GRID=ON
GRAPH FILE DIRECT
HEADING CENTER
''ATTENDEES BY STATE''
SUM ATTENDEE BY STATE
END
```

PC/Focus also has available pie charts, scatter diagrams, trend lines through scatter plots, histograms and line charts.

The statistical and financial modeling features of the system are as comprehensive and powerful as the graphic portions and are too numerous to treat in depth here. The communications subsystem (activated by the Link command) is quite flexible and, as mentioned earlier, provides for both asynchronous and 3270 (through the use of an IRMA board) protocols. The 3270 protocol capability is aimed at the mainframe Focus

user who may now utilize a PC as an IBM 3278-type terminal and may process the same Focus files centrally (on the mainframe) or locally (on the micro) as appropriate.

Summary

In performing the detailed tests, we found PC/Focus runs much more rapidly than dBase II when performing similar functions and contains so many more features that it makes comparison odious. On the negative side, we found that, when a feature was available in both systems, the dBase command was easier to utilize. For example, to print the first and last names and home telephone numbers for all in the data base who live in New Jersey, the dBase command is

FROM MAINFRAME TO MICRO

INFORMATION Builders introduced Focus for mainframes in May 1976. Since then, with 1300 copies sold (at a base price of \$66,000), it has become one of the best-selling database management systems in the mainframe world. It has competed successfully with such well-known systems as IMS, IDMS and ADABAS.

Donald J. Wszolek, director of marketing for Information Builders, reports that the company quite early saw the potential for adapting Focus for micros and began the implementation process in Spring 1982. They chose the IBM PC as the target system because IBM had a firm position in the market they saw for a PC/Focus and because mainframe Fo-

cus is IBM-resident. Information Builders hoped to benefit from the compatibility between the various IBM systems.

A year later, May 1983, the first version of PC/Focus was ready. It was distributed to clients (mainly users of mainframe Focus) as a "pre-release version." While these clients used the system, Information Builders spent another year improving it. In May 1984, it released the "production version" of PC/Focus.

Wszolek says the conversion went very well, but it was difficult and lengthy. (The year between commencement and the initial product actually occupied over 4 person-years.)

An early decision determined which languages would be used. Mainframe

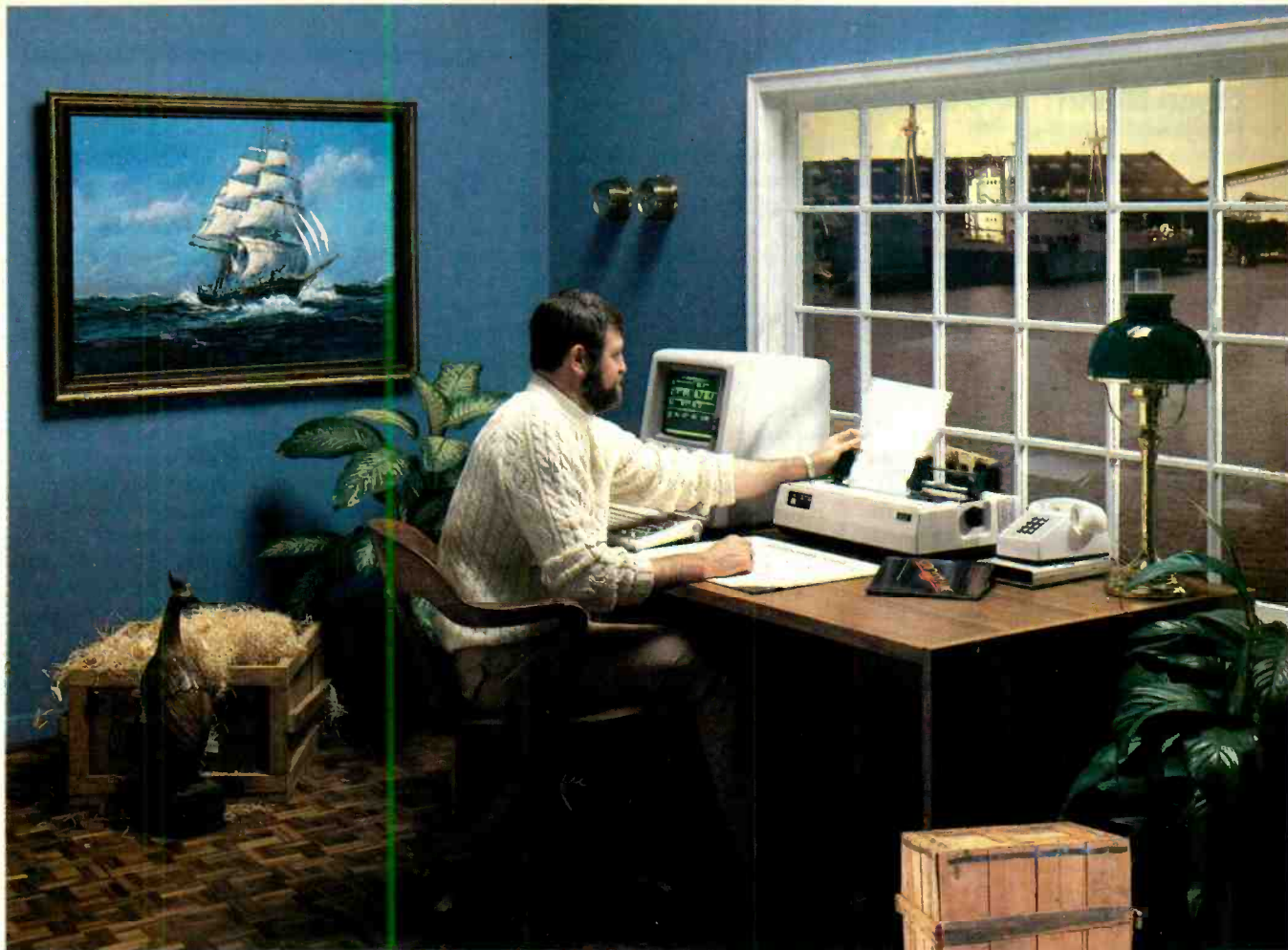

International Connections

With the industry's most popular data communications program, the world is at your command.

An import/export office in New Jersey can instantly check the London market for current dollar exchange rates ... send Hong Kong an updated production schedule ... print-out the week's sales results from the Dallas branch.

There's virtually no limit to how far you can reach with your microcomputer, ordinary telephone lines, and CROSSTALK.

Even if your own business and personal needs are closer to home, you'll appreciate CROSSTALK's compatibility with a wide user base ... smart terminal characteristics ... total modem control ... and the ability to capture data at a high speed for later off-line editing. CROSSTALK has extras you may not find in other programs. Data capture to memory buffer (and on-line display). Protocol error-checking file transfer. Modem/telephone hangup, and display of elapsed time of call. Command file power and flexibility. Remote takeover and operation. And much more.

There is a CROSSTALK version for almost every CP/M, CP/M-86, or IBM DOS based microcomputer system. See your dealer, or write for a brochure.



CROSSTALK™

MICROSTUF®

1000 Holcomb Woods Parkway / Roswell, Georgia 30076

CROSSTALK is a trademark of Microstuf, Inc., CP/M and CP/M-86 are trademarks of Digital Research, Inc., IBM is a trademark of International Business Machines, Inc.

Circle No. 2 on Free Information Card

From Mainframe to Micro

(Continued from page 50)

Focus is written in a combination of Fortran and Assembly language. The same languages would be utilized for PC/Focus both to maintain continuity between the systems and to ease the conversion effort. In fact, even using the same languages did not eliminate the problem of language compatibility; the Fortran used for Focus is Fortran 66, while the Fortran to be used for PC/Focus was a later and slightly different version, Fortran 77. While this difference did not cause major difficulty, it did require many detailed programming changes.

With the design work done and the languages determined, the program code was introduced into the PCs for "compiling" and testing. The most efficient method was to "port" (transport electronically) the source program code from mainframe Focus to the PC and then make all changes to that code. Other methods of program introduction would have (1) had the programmers begin anew and write an original program code to meet the requirements defined for the system or (2) had the programmers or clerical staff key the mainframe Focus program code into the PCs. Both methods were rejected.

To accomplish the porting, a commu-

nications program had to be used. Since communications capability was to be a part of PC/Focus, the designers developed first that module, LINK which they used to transfer the program code to the PC. Then began the long and tedious task of testing and correcting the code, so that it performed satisfactorily.

One of the difficulties constantly encountered in the conversion was the difference between mainframe and micro support provided by the hardware architecture and operating system. The larger systems utilize "virtual memory," which is transparent to the programmer or user. The system allocates memory use and "pages" data back and forth to the disk drive as required. The absence of such an asset in micros meant Information Builders had to spend a great deal of time restructuring code to provide for program overlays and memory management.

The availability of Focus for micros has provided Information Builders with a wide range of marketing opportunities. Its mainframe client base continues to expand since mainframe clients are all potential purchasers of PC/Focus. Moreover, PC/Focus shows fine prospects on its own merits. The fact that Information Builders introduced a second micro

product, FocTalk, in July 1984 suggests that the firm believes it has found a viable market in the micro world. (FocTalk, which will sell for \$450.00, has the many features of Focus (TED editor, TableTalk, FileTalk, LINK and the DIF and Lotus interfaces) and is aimed at professionals and managers with mainframe/micro communications needs. To support the widening market, Information Builders has divided its technical staff into three groups: a mainframe group, a mid-range group that will support Focus versions for minicomputers (including the Wang VS and VAX) and a micro group. (Since the installation of the IBM PC version, which runs on such "vanilla" compatibles as Compaq and Columbia, the system has migrated to the Wang Professional and the Texas Instruments Professional.)

What Information Builders has achieved in its conversion seems well worth the extensive effort. The initial demand for PC/Focus so far justifies the firm's investment, an investment the firm's substantial size and capital could support. Moreover, by supporting clients who are supplementing their mainframes with micros, Information Builders is cementing its relationships. ◇

MINIJINI

A good record-keeper for the Commodore 64 and VIC-20

BY JOHN SMITH-RICHARDSON

NOT everyone has the time required to learn how to program and use a super database such as Condor, dBASE II, or Personal Pearl. Nor does everyone need such a database management system. And not everyone who needs a super database has a computer that can run it. The plain fact is that there are more "family" computers, such as those from Atari, Commodore and Radio Shack, in use than there are "desktoppers."

All that many users of family computers need in the way of a database is some form of easy-to-use electronic record keeping (data file). Unfortunately, the typical family computer database generally lacks so many features as to be almost useless or is too complex for most users because it takes the "long way



round" trying to duplicate the performance of a \$3000 desktopper on a \$200 entry-level computer.

One record keeper for family computers that strikes a good compromise between ease-of-use and sophistication is Mini Jini, written expressly for the Com-

modore 64 and VIC-20 computers. (Its performance is supposedly identical for both, but we can only vouch for our comments as they concern the 64. Also, although the program can utilize either disk or cassette tape storage, the Commodore tape system is so frustratingly slow we cannot recommend its use. Hence, our comments apply only to disk storage.)

Description

Mini Jini is not a database in the usual sense that the user can create any number of fields with specific restrictions on the length of the fields, the kind of data that can be entered in the fields, and the relationship between the individual fields. Mini Jini is more like an electronic card-file system. It accepts up to ten user-selected variable-length fields per data file and any kind of data entry within a field. You can select any part or all of the information within an individual record and display it or feed it to a printer or both. You can print selected fields as labels or reports or print all the information in a datafile record by record.

Both field names and field data can be up to two lines long, and almost any-

**WHEN HEWLETT-PACKARD
DEVELOPED A PERSONAL COMPUTER
PRINTER THAT USES A QUIET JET OF INK,
PRINTS 150 CHARACTERS PER SECOND
AND COSTS ONLY \$495,**

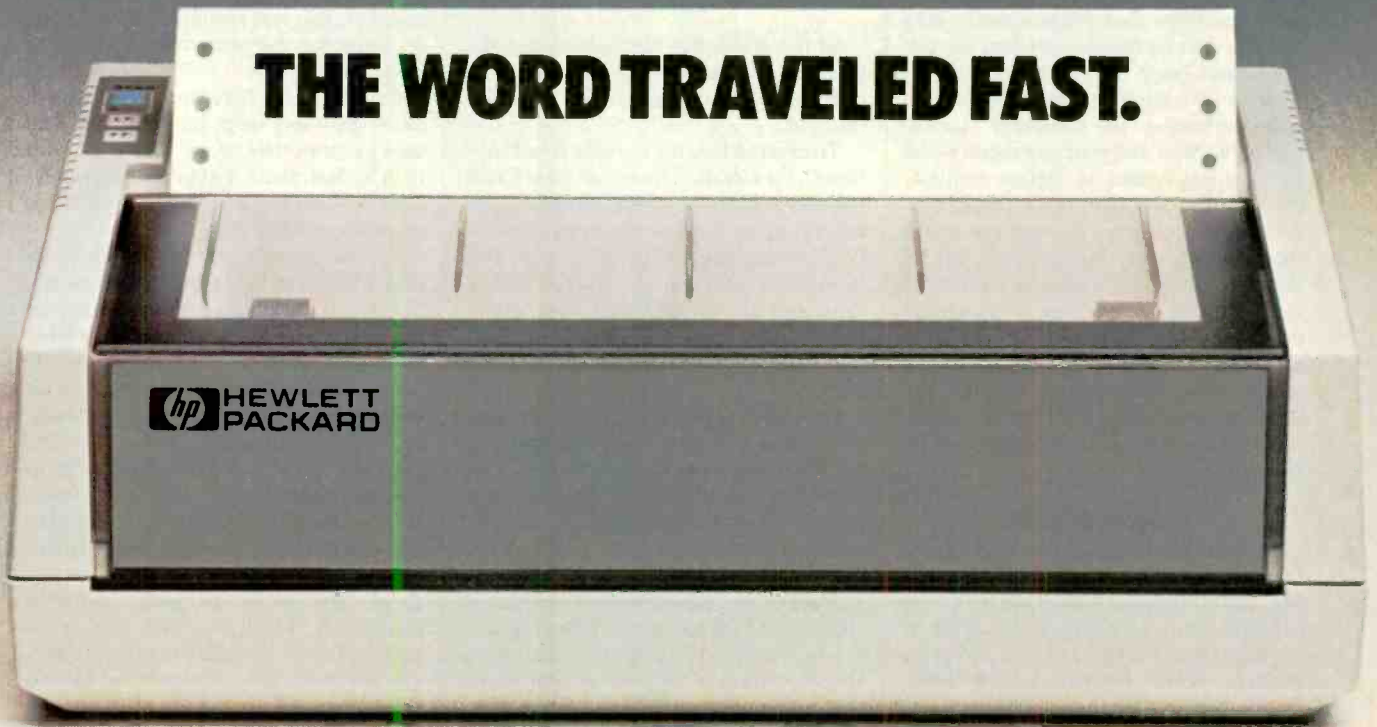

THINKJET.

Hewlett-Packard research has used inkjet technology to make the ThinkJet personal computer printer surprisingly quiet while printing 150 high quality, dot-matrix characters per second for text or graphics. The ThinkJet printer weighs only 6½ pounds and it takes up just a bit more room than your telephone. So, it can work right on your desk. There's even a battery-powered model that lets you print anywhere. And, the ThinkJet printer's ink supply and printhead are designed in one neat disposable unit that simply clicks out when it's time to change.

The ThinkJet printer will work with most popular personal computers, including Hewlett-Packard, IBM®, COMPAQ™, TI® or Apple IIe®.

Finally, as quiet, fast and compact as the ThinkJet printer is, it still has one more feature that's going to cause a commotion; its price... \$495.00*

See the entire family of personal computers, software and peripherals at your authorized Hewlett-Packard dealer.

Call (800) FOR-HPPC for the dealer nearest you.

Setting You Free



IBM is a registered trademark of International Business Machines Corporation. COMPAQ is a trademark of COMPAQ Computer Corporation. TI is a registered trademark of Texas Instruments, Inc. APPLE is a registered trademark of Apple Computer, Inc. *Suggested retail price.

209M

thing goes, up to the maximum length of almost 800 bytes per record. Since the field length is variable, the actual number of bytes per record will depend on the entered data rather than on a preset value. A warning, "low memory," appears when the computer's memory is almost filled.

Mini Jini consists of a disk and a program cartridge. The disk contains a demonstration program, approximately 75 sample datafiles, and a utility for formatting disks and deleting files. The program itself is supplied in a ROM program cartridge that plugs directly into the user port on the Commodore 64, the same port used for game cartridges. Typical of computers that accept program cartridges, the computer "comes up" in the Mini Jini program mode when the power is turned on. Before continuing with the program, or at almost any point in the program, the user can select the border and background colors through use of the computer's function keys. The color selection is translated into a gray scale for black-and-white TV sets and standard monochrome monitors, an important feature because the black-and-white equivalents of certain color combinations would otherwise be indistinguishable.

Keeping Records

Because Mini Jini is an *in memory* system, the program itself, a user-created file, and all the data associated with that file are entirely within memory as a package, and it is utilized as a complete package. While this arrangement limits the amount of data that can be associated with a particular data file, it provides for extremely fast processing because everything is simultaneously resident in memory.

For example, a file loads from disk along with its own prompt screen and its complete field structure—there is no separate load of a "field mask" followed by a load of the data. If a field structure and prompt screen do not exist, the user must create them before entering data.

It works this way. When the program first "comes up" it displays the main menu, which provides the following features:

- Create
- Look Thru
- Order (Alphabetize)
- Search (Global, Specific)
- Fix (Add, Delete, Change)
- Print (Labels, Reports, All Records)
- Mathpack (Arithmetic between fields)
- Write (File to disk or printer)
- Read (From disk)

Mini Jini strikes a good compromise between ease of use and sophistication

- Exit (Closes program safely)
- Records
- Option

In the above list, Records means the number of records in the selected datafile. Option means the function selected.

To create a new file the user selects option C, for Create. The screen clears, and the user is asked to assign prompting labels for up to 10 fields arranged vertically down the left side of the screen. The label for a field can be changed at any time, and unused fields can be activated (labeled and used) at a future time without disturbing the previously entered data.

Only after a prompt screen is created can the user enter (Add) data through the Fix option—which also permits data to be deleted or changed. Each prompt screen, with its associated data records, is stored as a file, and each record within the file is assigned a record number; however, the prompt screen itself is stored first as Record #0. When all data has been entered (or updated), the entire file, consisting of the prompt screen and the individual records, is saved to disk. When the data file is later loaded from disk to memory, it loads along with the

prompt screen.

Record numbers are assigned in order of physical entry, which is not necessarily the actual order entered. For example, if you enter five records and then delete Record #3, the program will automatically renumber the records to close up the gap; i.e., Record #4 will become #3, and Record #5 will become #4. If you "order" (alphabetize) the records, you will find the record numbers are out of sequence because their positions in the queue have been shifted around. However, if the new queue is saved to disk, it is renumbered in the latest sequence the next time it is loaded into memory.

Ordering can only apply to a single data field—any field, but only one. The user cannot order by, say, zip code, and then by last name within each zip code. This is obviously a severe limitation for extensive mailing lists.

On the other hand, the Search function is first rate, as is typical of in-memory systems, because all information is in the computer; there's no time wasted looking for data on a disk.

You can send any data record seen on the screen to a printer by simply pressing the letter P. A special function key lets you send a user-selected printer control code if needed (such as for pitch selection). The entire data file is printed through the Print function, as are labels.

The Report function is somewhat unusual. The format is created prior to printing; it cannot be saved. You select which of up to 10 fields are to be printed. The computer then prints the field labels as headings across the top of the paper, automatically determining column size—which is one character more than the maximum used for the data in a particular field. For example, if the longest name uses five characters (Smith), the report's name field will be six columns, the extra column providing the space between column headings. If the longest name is 11 characters (Petrokowski), the program automatically stretches the report field to 12 characters. Regardless of the information in the data fields, the computer automatically uses the least number of columns per field when printing reports.

The information from each record is printed out in columns under the field names. If, by some chance, the field names require more columns than the width of the paper contains, the printer can run off the paper because there is no direct program control of the margins. If, however, the paper is positioned against the printer's right hand stop, the

(Continued on page 127)

Overview

Product: Mini Jini Record Keeper
Manufacturer: Jini Microsystems, Inc.
Box 274
Riverdale, NY 10463

System Requirements: Commodore 64 or VIC 20 with 1541 disk drive or Datasette cassette recorder.

Price: \$49.95

Features: Mini Jini is one of the better, if not the best, of the in-memory data file programs for low-end computers. What limitations has, such as relatively slow loading, are more a function of the computer for which it is written than those of the software itself.

"My Apple's[®] telephone just called up the home office!"

you want to do. The program guides you along the way. You can create, list, name, send, receive, print or erase files right from the menu. From the very first time you use it, you'll find telecomputing with Hayes as easy as apple pie!

We've got your number! We know that you want a system that's flexible, versatile and accommodating. The Smartmodem 300/Smartcom I system accepts ProDOS,[™] DOS 3.3, Pascal and CP/M[®] operating systems. The Micromodem IIe/Smartcom I system accepts DOS 3.3, Pascal and CP/M operating systems.

Smartcom I also provides you with a directory of the files stored on your disk. And will answer calls to your system, without your even being there.

Your Apple's telephone goes anywhere the phone lines go. Hayes modems allow your Apple to communicate with any Bell-103 type modem over ordinary telephone lines. You simply connect directly into a modular phone jack, to perform both Touch-Tone[®] and pulse dialing. Hayes Smartmodem 300 and Micromodem IIe both transmit at 110 or 300 bits per second, in either half or full duplex.

Follow the leader. Over the years we've built our reputation as the telecomputing leader by developing quality products that set industry standards. Now we invite you to see for yourself just how simple it is to add powerful, easy to use telecomputing capabilities to your Apple computer with a complete, ready-to-go system from Hayes. Visit your Hayes dealer for a hands-on demonstration. And get on line with the world.

Hayes. We're here to help.



Hayes

Hayes Microcomputer Products, Inc.
5923 Peachtree Industrial Blvd.
Norcross, Georgia 30092. 404/441-1617.
Circle No. 8 on Free Information Card

Communicating is so easy with a complete telecomputing system from Hayes. Just plug it in—and the world is your Apple. Hayes Smartmodem 300[™] is the convenient direct-connect modem for the Apple IIc. And Hayes Micromodem IIe[®] is the easily installed board modem for the Apple II, IIe, III, and Apple Plus. Packaged with Smartcom I[™]

companion II software, both provide a complete telecomputing system. And best of all, both systems are from Hayes, the established telecomputing leader!

We connect you to all the right places. Bulletin boards, databases, information services—naturally. And that's just the beginning. Let your Apple plan your travel itinerary, including flight numbers, hotel and rental car reservations. Watch it retrieve and analyze daily stock and options prices. Work at home and send reports to and from your office. You can even do your gift shopping by computer!

Would you care to see our menu? Make your selection. Really. With Smartcom I, you just order up what

Hayes, you really know how to help."

MODEMS GET SMARTER

Manufacturers are raising the IQs of smart modems

BY TJ BYERS

AFTER processing words, playing games, and eventually growing bored with the standard programs supplied with personal computers, micro users look for other brave new binary worlds to conquer. They plug into community bulletin boards, financial services, and hundreds of other databases by using a rather simple and inexpensive device: a modem.

The modem (MODulator/DEModulator) is a communications device that lets your computer talk over a telephone line. In May 1984, we discussed budget modems and how to use them as low-cost tickets into the communications world. This time we will look at top-of-the-line "smart" modems to see what

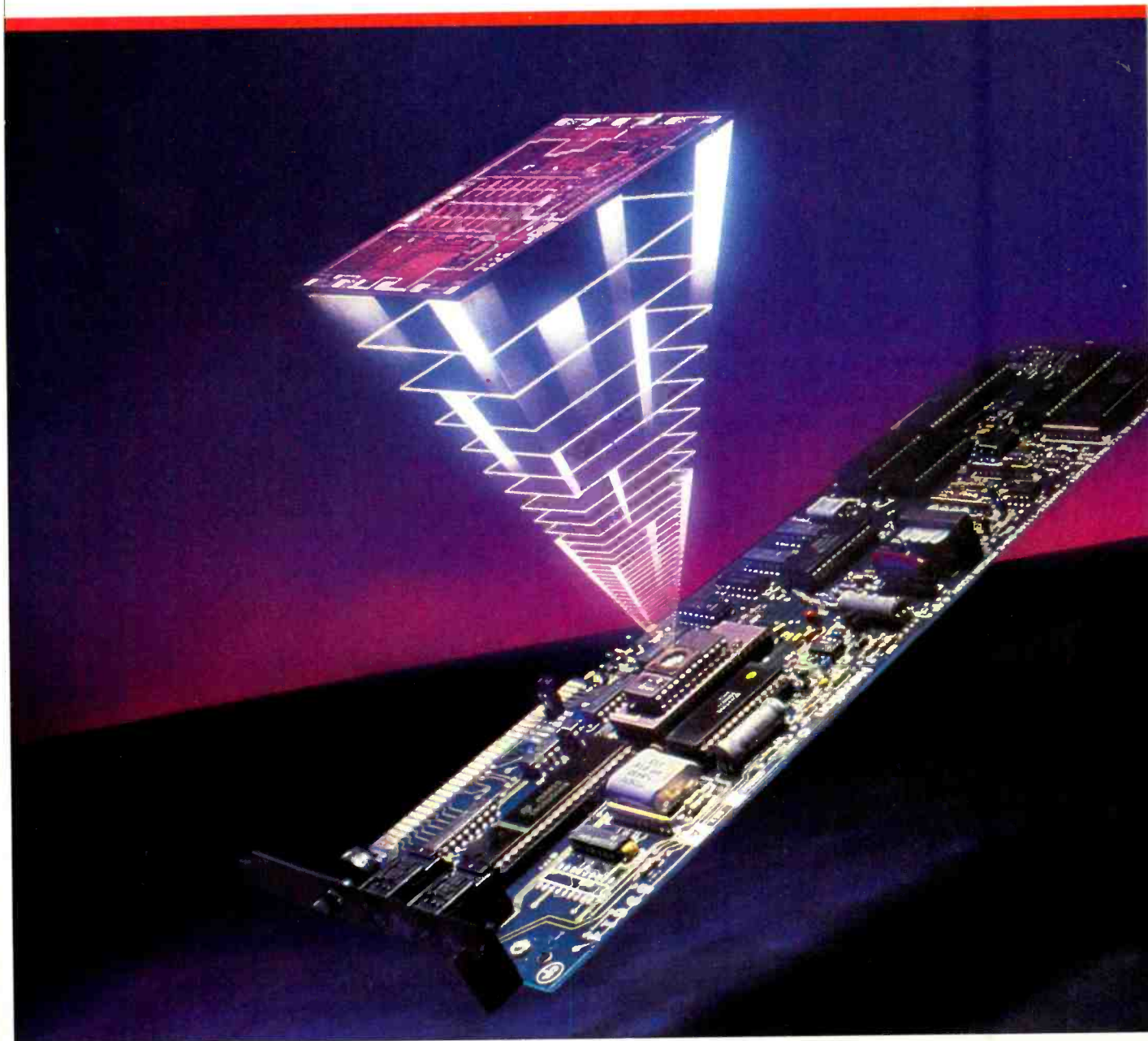

smart modems

makes them tick and why they warrant higher price tags.

How They Work

Modems communicate over phone lines by means of carrier frequencies. Although it would be easier to send digital signals directly over the lines, it is almost impossible to do so. The phone lines were not designed to accommodate the high frequencies of digital signals. They were instead designed for the lower frequencies of human voices, between 300 and 3500 Hz.

The modem works by using digital pulses to modulate a carrier wave whose frequency lies within this narrow range. The speed at which the pulses are sent is

called the *baud* (bits per seconds) rate.

There are two standard baud rates currently used for modem communications. The most common one (and the one used by most inexpensive modems) is 300 baud. That rate amounts to 30 characters per second, or just about 300 words per minute.

Most smart modems, on the other hand, operate at 1200 baud, which is 120 characters per second and 1200 words per minute. In other words, what takes 5 minutes to transmit at 300 baud can be done in slightly over 1 minute at 1200. This difference could save you a lot of money if you transmit data long distance frequently. But this fourfold increase in transmission speed wasn't accomplished

simply by making a 300-baud modem work faster. There is a lot more to the story.

When communicating at 300 baud, the carrier is modulated by frequency-shifted keying (FSK), a form of frequency modulation explored in the May issue of *COMPUTERS & ELECTRONICS*.

At 1200 baud, though, FSK is not effective. Due to increasing losses in the phone line at higher speeds and high noise levels, frequency modulation just won't work. Instead, the carrier must be phase modulated.

TJ Byers has written numerous books and articles on electronics and computers.

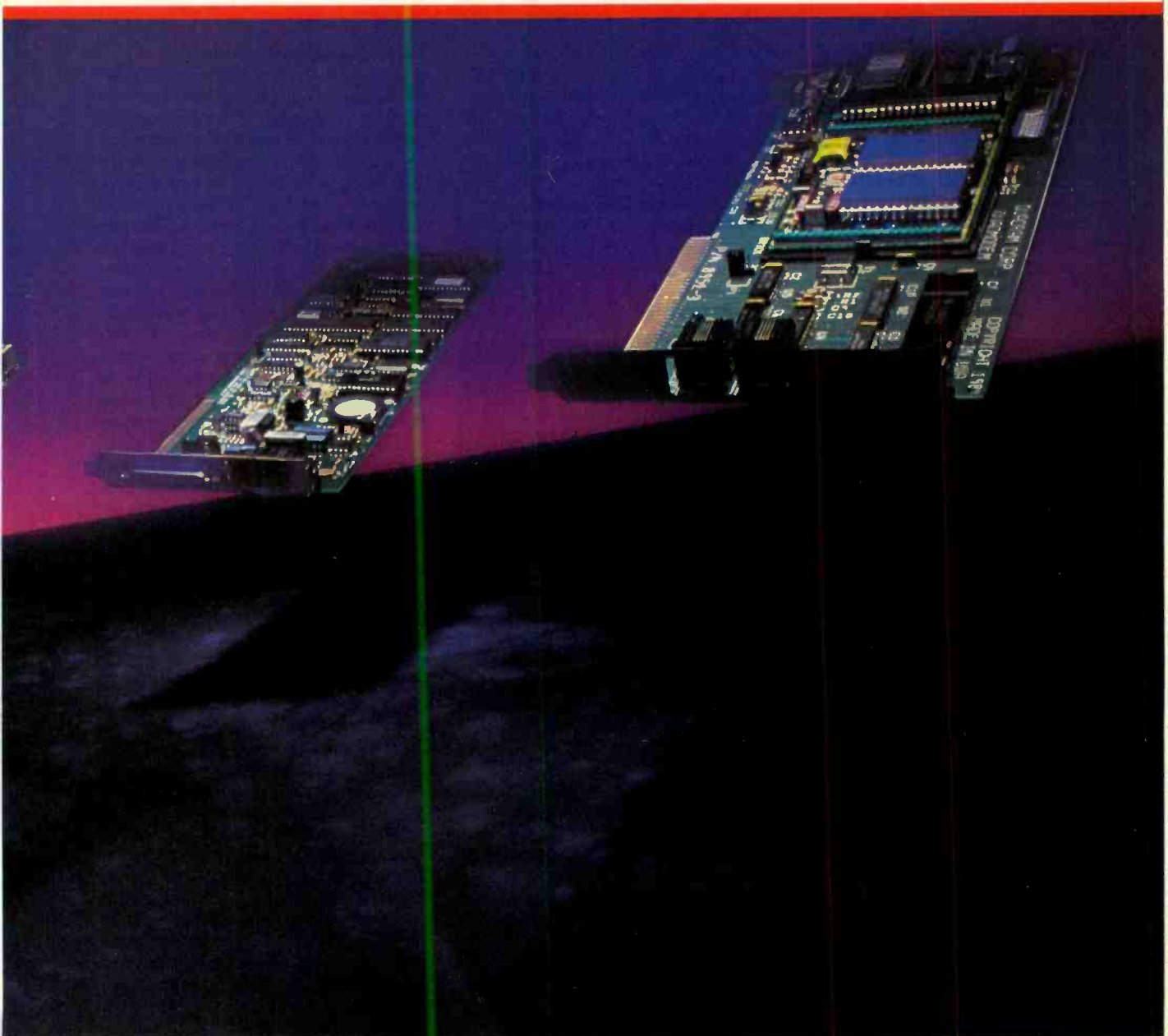

PHOTO BY MICHAEL TCHEREVKOFF

Phase modulation encodes the digital bits on the carrier by shifting the phase of the sine wave back and forth, as illustrated in Fig. 1. The process thus earns the name phase-shifted keying (PSK). Unlike FSK modulation, PSK uses a constant carrier frequency, the relative phase of the carrier indicating the value of the binary data bit. Because the relative phase of the carrier is important and not its absolute phase, most PSK schemes use differential phase encoding (DPSK). The latter measures the phase

complete a link. With the Bell 212A standard, 1200 Hz is outgoing and 2400 Hz is incoming for the modem in the originate mode. In the answer mode, the 1200-Hz carrier is incoming and the 2400-Hz carrier is outgoing.

Modem Operation

To originate a call, first you put the smart modem in the originate mode. You dial up the receiving modem on the phone line. Of course, the modem automatically does the dialing for you once

long as both carriers are on line.

A modem ready to receive input is set in automatic answer. In this state, the modem is "sleeping" with its "ear" on the phone line. A ring wakes the modem up to a full answer state so it can lift the handset from the cradle—electronically, of course—and begin the linking procedure. It then broadcasts its 2400-Hz carrier tone over the line, informing the originating modem that it is ready to receive data. As before, the link is established when the originating modem replies with its 1200-Hz carrier. All this takes place in less than a second. If the originator doesn't respond within a few seconds, though, the answer modem assumes the caller isn't another modem and hangs up.

During the conversation, both modems constantly monitor the phone lines for carrier signal level. If the carrier begins to fade or becomes clogged with noise, either modem can take action to suspend communications. The threshold level is usually set around -50 dBm. Any data received below this level is considered untrustworthy and is discarded. Should the carrier disappear for longer than 700 ms, automatic disconnect procedures begin.

Automatic disconnect also occurs at the end of a transmission. Normal disconnect procedure relies on the detection of a space character of 150 ms or longer. At the completion of the call, the originating modem broadcasts a signal to notify the receiver that it is hanging up the phone. After this notice—usually a space character of about 3 seconds—the originating modem hangs up. This sequence is not encountered in normal communications, and it makes a very effective hang-up command. Not all modems make use of it though. Some simply go off line when "talking" is finished.

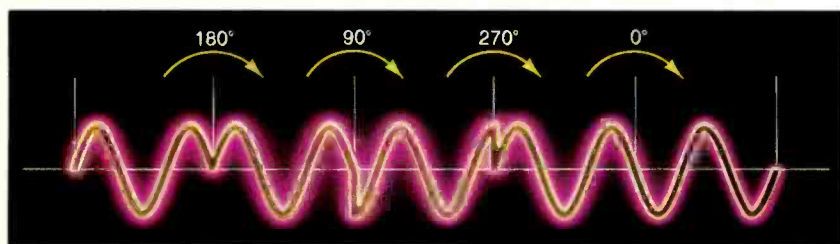

Fig. 1. Example of phase coded modulation.

of the carrier in two successive bit frames in order to determine the phase change.

Originate/Answer

A modem can either *originate* the communications line or *answer* to receive data. These terms came about in the early days of mainframe computers. Then, when computer time was shared, instead of having a personal computer on your desk, you had a terminal. Since it was up to you to contact the mainframe when you needed computer power, your modem was called the originating modem. In turn the mainframe's modem was always the answer modem.

Now, however, the words "originate" and "answer" distinguish between the two carrier frequencies needed to com-

plete a link. While you dial, you monitor the progress of the call either by listening to the phone line or by watching the video screen. Some modems are even smart enough to recognize ring tones and busy signals and relieve you of the job of monitoring.

After the call goes through, the originating modem searches for the 2400-Hz carrier tone generated by the answer modem. The modem will search for the carrier for about 30 seconds. If it hasn't been detected by then, the modem hangs up. Reception of the 2400-Hz carrier tone for at least 600 ms, on the other hand, prompts the originator to respond with its own 1200-Hz tone. The link is now established, and data transmission can begin. The link remains intact as

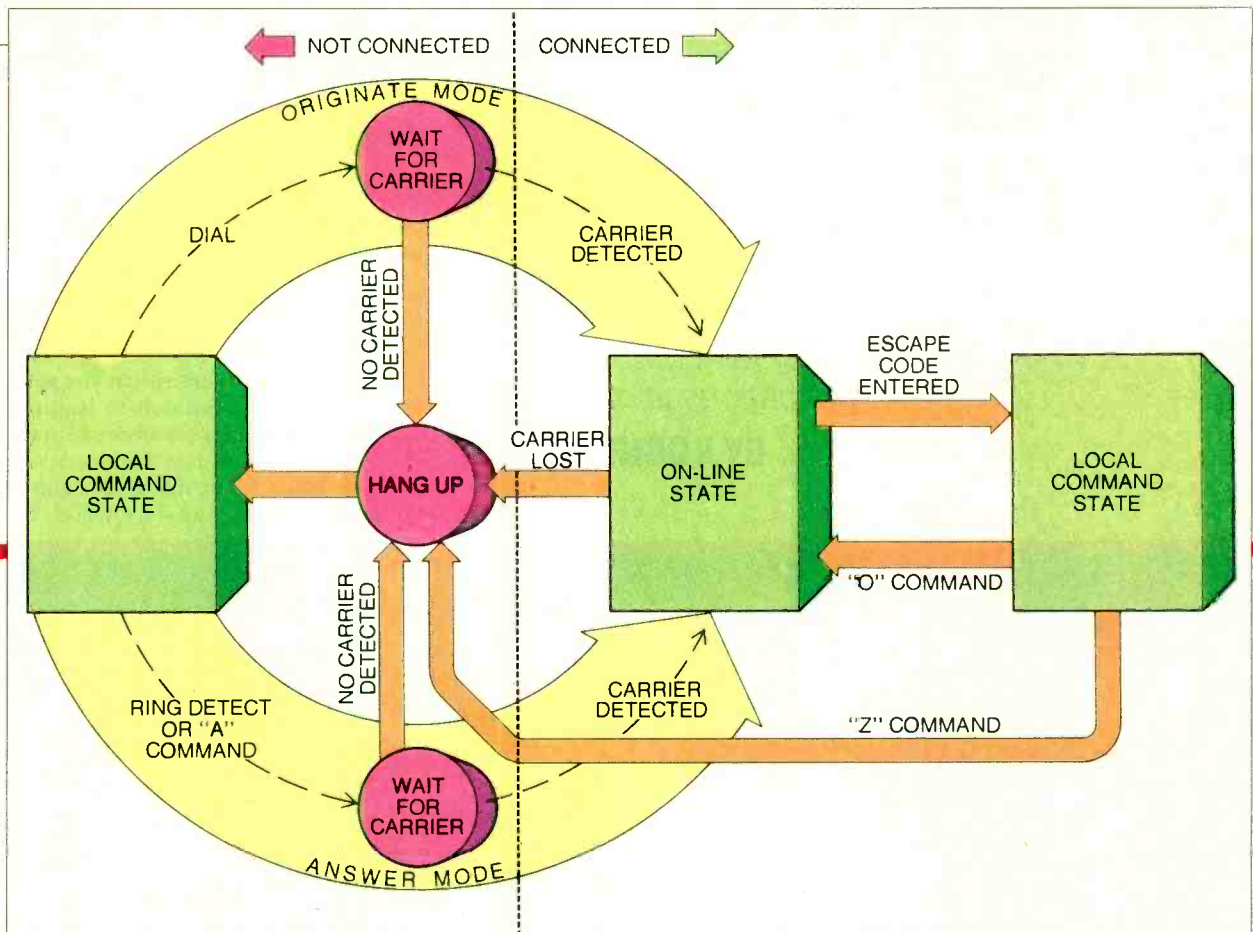

Operating a smart modem is a very logical affair, as this diagram of the commands and states of the Hayes Smartmodem illustrates. At any one time the modem is in one of two states. Upon power up the modem is in the Local Command State, from which you can issue modem commands from your computer's keyboard. The commands you issue change communication parameters or initiate or terminate communications. Actual communications takes place in the On-Line State, which is entered after a connection with another modem has been made. No modem commands can be given during the time the modem is in the On-Line State. By entering an escape code, however, the Local Command State can be re-entered while the modem is connected.

What Makes a Modem Smart?

The automatic sequencing procedure, by itself, should be cause enough to call a modem smart. But most smart modems are smarter yet. Besides being automatic, a truly smart modem is versatile and programmable. For example, everything the Hayes Smartmodem needs to know about telecommunications it has stored in memory on a Z8 microcomputer chip and executes automatically under your command. You can tell the modem which number to dial, when to dial it, how long to wait before hanging up, and a host of other operations.

For instance, when used in the originate dialing mode, the Smartmodem can choose between pulse dialing or Touch-Tone. It can even mix the two while dialing! This feature is particularly attractive for those who use the new commercial long distance services. If you are dialing from a PBX switch-

board, you must use pulse dialing. Once you have reached the long distance company, however, your dialing must be Touch-Tone encoded. The Smartmodem can execute these maneuvers for you automatically.

The modem even places messages on the video screen as the commands are executed and results analyzed. If the modem can't locate a carrier tone, for instance, it flashes a NO CARRIER message on the screen.

But, that's still not all. The Smartmodem also contains 16 registers that hold all the timing instructions for its operations. If you are having trouble dialing out because the dialing sequence is too fast, you can slow it down with a simple keystroke. If all you want to do is transmit data, not receive it, you can place the modem in a simplex mode that disables the carrier detect circuits. You can control all modem functions right at the keyboard.

The method the Hayes Smartmodem uses to end a conversation is worth noting. It simply hangs up the phone with no advance warning, thereby breaking the link through carrier default. Although this is not the way automatic disconnect was envisioned, it does work, and most U.S. manufacturers have followed Hayes's lead.

Hayes Compatibility

Which brings us to compatibility. Long ago, when AT&T controlled the phone lines, Bell Laboratories created standards for modem communications, which are still maintained. Originally only Bell-certified equipment was permitted on the lines.

Hayes, on the other hand, has set a *de facto* standard with its Smartmodem. Hayes's software commands are copied throughout the modem industry, and

(Continued on page 116)

HARNESSING YOUR MODEM'S NATIVE INTELLIGENCE

*A whole new range of telecommunications
applications is open to you*

BY ROBIN WEBSTER

MOST smart modems come with a wide range of talents, including the abilities to autodial, autoanswer, and automatically log-on to remote systems. With these features you can use a smart modem (in conjunction with relevant communications software) to place calls to remote computers automatically and send files for storage or further processing and, alternatively, "answer the phone" when a remote computer wants to download some data.

The key point here is that the autodial/autoanswer/autolog-on facilities remove the need for somebody to stand around and oversee data transfers, a very time-consuming task if large amounts of data are involved. And since nobody has

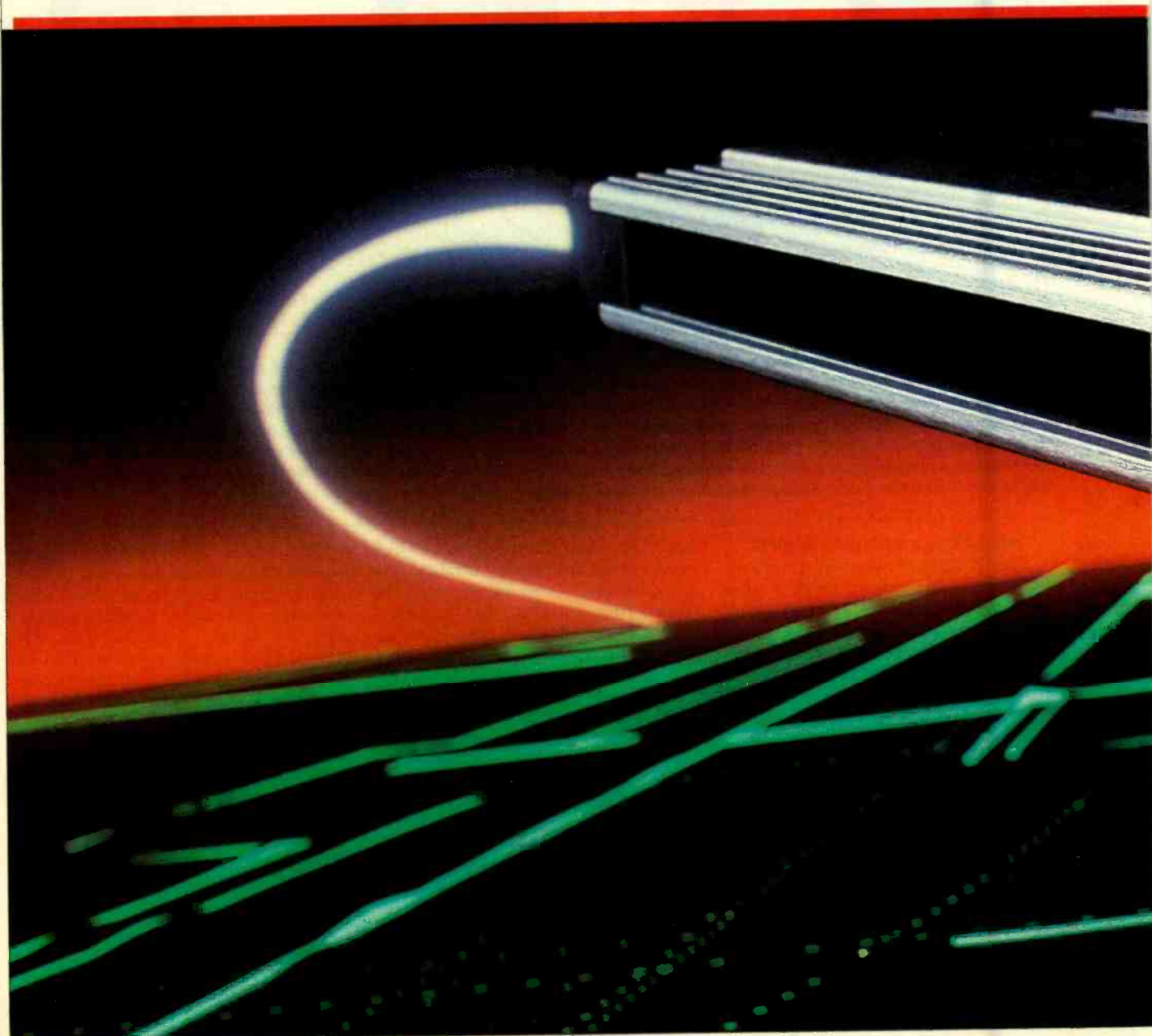

smart modems

to be around, such transfers can take place overnight when telephone rates and computer access charges tend to drop significantly.

Let's assume you have a personal computer, communications software, and a smart modem. What kind of applications can you consider that would be tough to tackle with a basic dumb modem?

Unattended Transfer of Data

At the simplest level a smart modem can be used for the unattended transfer of data between two computers. In one organization, the loan approval staffs in two geographically separate offices were having trouble keeping each other post-

ed on the state of loan applications. Although they used computers for word processing, financial data was normally communicated by mail or verbally by telephone.

Delays in the delivery of mail and loss of important documents were problems. Also, trying to track down the right person by phone was troublesome. Consequently, loan reviews were taking much longer than necessary.

A first solution was to provide each office with a copy of a spreadsheet package, a communications package, and a smart modem. Worksheet files (and text files) could then be sent to either office in a few minutes, even if the receiving machine was unattended.

In this case, the use of the smart modem was blatantly simple—it operated in the role of a phone answering machine when nobody was around or when staff members were too busy to just sit at their pcs and watch data flowing in. The period for loan approval was shortened, and everybody was just a little less anxious.

Computer Bulletin Boards

One widespread and useful element of computer networks is the bulletin board. You access a bulletin board in its simplest form by dialing up the network on

Robin Webster is a frequent contributor to computer magazines.

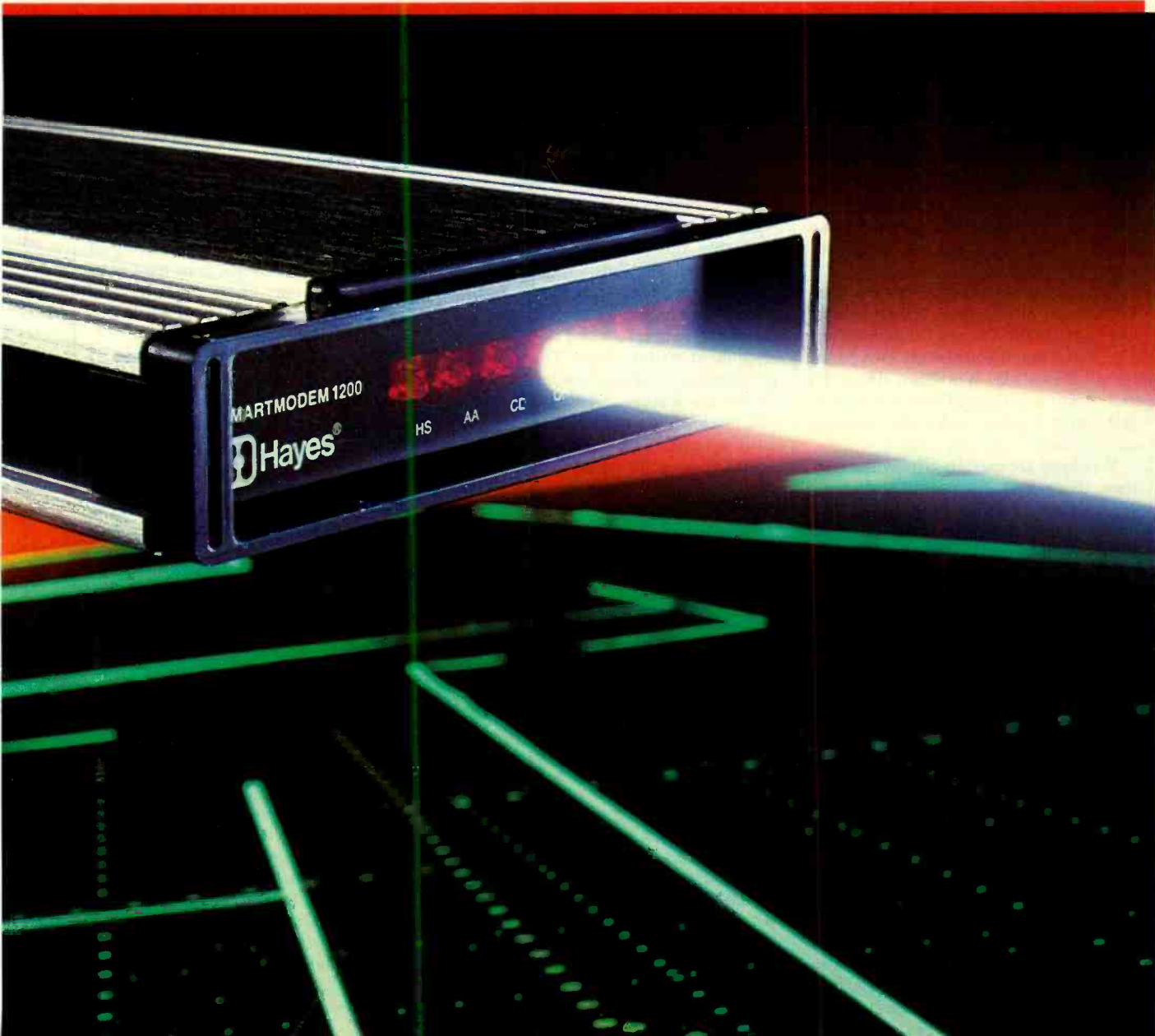

smart modems

which it exists and entering a particular ID name/number. Having logged onto the bulletin board, you can view the collective wisdom of all the other users of the service or, if you feel strongly about some relevant topic (sometimes comments on BB's aren't relevant to anything), you can enter a brief message. If it's the right kind of bulletin board, you can even download a wide selection of "public domain" software onto your machine, free of charge. You can also use your own personal computer to set up a small bulletin board operation. In addition, to a smart modem you would need a communications package that allows your pc to work in "host mode" (putting in an extra phone line would be a good idea too).

Communications and Windows

Further sophistication comes when, instead of just sending text or data files between similarly equipped machines (sending a WordStar document to another system equipped with WordStar), you install one of the windowing/integrated software packages new on the market. Consider a product like Desq, from Quarterdeck.

Desq is a windowing system that works with off-the-shelf MS-DOS software on the IBM PC and PC workalikes. The idea is that if you already own popular programs like WordStar, dBase II, and Multiplan, Desq allows you to integrate them together under one operating environment.

Windows are used to display the contents of various documents (text files, spreadsheets, database reports, etc.) simultaneously. More importantly, most MS-DOS-compatible communications packages will work within Desq and obviate the need to "go outside" Desq to set up a telecommunications session.

In keeping with other windowing systems, Desq allows data to be transferred from window to window (and therefore between various types of application programs) by means of a cut and paste facility. But one of the most powerful features of Desq, and the one most relevant for this article, is known as the Scripts function.

Once the Scripts function is on, Desq will keep an accurate record of every move you make: which commands you type in at the keyboard, how data is manipulated within various programs, which selections you make with an attached mouse (making particular windows active and doing cut and paste operations, for example), and which names of files you created or changed. Such com-

mand strings, or scripts, are then saved to disk in the form of a name file that can be loaded and run at some later date.

Imagine that you want to obtain business data from a central computer system at some regular interval—say the end of each month. After obtaining the data, you want to transfer some part of it into a database program. You then want to take the rest of the data and massage it in all sorts of ways: enter and manipulate it in a spreadsheet program, take some totals from that spreadsheet and place them into a graphics package to produce a set of business charts, and finally combine some of the numerical/graphics data with a previously created text file.

The idea is that you want to produce some type of standard end-of-the-month report on a particular topic. Doing all this manually at the end of each month is altogether possible but terrible to contemplate.

A better way is to use the combination of a smart modem, a communications package, the Desq Scripts functions, and all the necessary applications programs. Via Scripts, the whole procedure could be highly automated after it was completed manually (and accurately) the first time. Such a report could be produced overnight and be waiting for you in the morning (providing there were no equipment malfunctions). There are other integrated products besides Desq with Script-like features. And it should be possible to configure any of them to cope with the task. The level of automation achieved depends entirely on the limits of the software/hardware involved. One limitation to bear in mind is that most windowing systems are not multi-tasking systems. Although they give the appearance of working with many applications simultaneously, they can only deal with one program at a time.

Multi-Tasking Possibilities

True multi-tasking software suggests uses of the smart modem, but I would play it safe and place such applications in the "almost there" category. Not all the problems involved in supporting multiple applications simultaneously have been overcome.

Whenever you use a multi-tasking operating system, such as Digital Research's Concurrent CP/M or Microsoft's yet-to-be-released MS-DOS V3.0, you give your personal computer a split personality. With this split personality, the pc can share its attention among multiple applications at the same time.

In a multi-tasking environment, you might want to run a very complex

spreadsheet problem or sort a muddled database file alphabetically at the same time you are writing a letter. With a number of time-consuming tasks being completed in the "background," you work in real-time in the "foreground."

In the high-speed world of currency or commodity trading such a set-up might prove indispensable. If a user needs to know financial data (present prices vs. future price, for example) on a very regular basis, the multi-tasking system could automatically dial up a trading database and download the information in the background every 10 or 15 minutes. Unless the trader's pc is hard-wired to the database computer, a smart modem would be an absolute necessity.

With the growing availability of multi-tasking, multi-user multi-tasking, and multi-user multi-tasking networked operating systems the idea of what a personal computer can do will change radically. Rather than being a word processor, a spreadsheet machine, or a database machine, the personal computer will be able to live up to its "general-purpose" tag. And, unless you're part of some large corporate computer project where pc-to-host connections tend to be hard-wired, the smart modem will definitely have a role in your work.

Obstacles to Communications

Though the aforementioned applications can be handled with smart modems, two obstacles still constrain communication of host computer to pc in the business world.

The first obstacle is the unwillingness of central computer managers to allow just anyone with a modem to gain access to central files. The image of such files being mistreated by hordes of pc users must be quite frightening to even the toughest MIS manager. The reaction has been to restrict severely the types of activities in which pc's can become involved. With file and system security techniques becoming more sophisticated, such fear should abate and better interaction between MIS manager and pc user should be possible.

Even if you do manage to gain access to a central system of your choice, the second obstacle might block the way ahead. The data you are interested in obtaining will probably not be in a format that is easy to handle (i.e., ASCII). And trying to render such data usable is probably more trouble than it's worth. Conversion methods are being developed, but don't look for immediate solutions to this impediment.

(Continued on page 116)

BUYER'S GUIDE TO SMART MODEMS

THE chart on the following pages is an overview of smart modems. To limit the size of the chart, we have included only modems that support automatic dialing and answering, have direct phone line interfaces, and have top speeds no greater than 1200 baud. We've tried to mention at least one model from each of the key manufacturers. The following explains headings on the chart that might be unfamiliar to some readers.

- Modems are external or internal (board type).
- Auto speed describes the ability to detect and adjust automatically to the baud rate of another modem on an incoming call.

• "AT-compatible" modems use the same command set as Hayes modems. Modems that are AT-compatible can be used with communications software designed to work with Hayes modems; some minor incompatibilities can still prove frustrating.

• Auto redial will enable a modem, upon detecting a busy signal, to redial automatically the same number after a set interval. In some cases the modem can be programmed to dial an alternate number if it detects a busy.

• A voice/data switch makes it easy to use a modem phone line for voice calls when the modem is not in use.

• An auxiliary jack permits a telephone handset to be plugged into the

modem to support manual dialing and/or voice communications.

• Line monitoring facilities follow the progress of a call from dial tone to carrier detect and connection. The three types available are audio monitoring through an onboard speaker (Sp), message transmission by the modem to your computer's screen (Sc), and LED indicators on the modem itself (L).

• A dialing directory, which comes with some communications software, permits you to build a directory of phone numbers. If this facility isn't present in your software, you will probably want it to be available in your modem. Numbers in the chart indicate the size of any modem-resident directory supported.

MODEM MANUFACTURERS' ADDRESSES

Anchor Automation, Inc.

6913 Valjean Ave.
Van Nuys, CA 91406

Apple Computer, Inc.

20525 Mariani Ave.
Cupertino, CA 95014

Bizcomp

532 Mercury Dr.
Sunnyvale, CA 94086

Bytcom, Inc.

2169 Francisco Blvd
Suite H
San Rafael, CA 94901

Cermetek Microelectronics, Inc.

1308 Borregas Ave.
Sunnyvale, CA 94089

Code-A-Phone Corporation

PO Box 5656
Portland, OR 97228

Codex

20 Cabot Blvd.
Mansfield, MA 02048

Datec, Inc.

Suite 116
200 Eastowne Dr.
Chapel Hill, NC 27514

Develcon Electronics, Inc.

744 Nina Way
Warminster, PA 18974

Gandalf Technologies, Inc.

109 South Noel Ave.
Wheeling, IL 60090

Hayes Microcomputer Products, Inc.

5923 Peachtree Industrial Blvd.
Norcross, GA 30092

IDE Associates, Inc.

7 Oak Park Dr.
Bedford, MA 01730

Lockheed-GETEX

Suite 945
1100 Circle 75 Parkway
Atlanta, GA 30339

Micom Systems, Inc.

20151 Nordhoff St.
Chatsworth, CA 91311

Multi-Tech Systems, Inc.

82 Second Ave. SE
New Brighton, MN 55112

Novation, Inc.

20409 Prairie St.
Chatsworth, CA 91311

Prentice Corp.

266 Caspian Dr.
Sunnyvale, CA 94088-3544

Prometheus Products

45277 Fremont Blvd.
Fremont, CA 94538

Quadram Corp.

4355 International Blvd.
Norcross, GA 30093

Qubie

4809 Calle Alto
Camarillo, CA 93010

Racal-Vadic

1525 McCarthy Blvd.
Milpitas, CA 95035

Radio Shack

1700 One Tandy Center
Fort Worth, TX 76102

Rixon, Inc.

2120 Industrial Parkway
Silver Spring, MD 20904

Tecmar, Inc.

6225 Cochran Rd.
Cleveland, OH 44139

Transend Corp.

2190 Paragon Dr.
San Jose, CA 95131

Tri-Data

505 East Middlefield Rd.
Mountain View, CA 94043

Tymshare

20705 Valley Green Dr.
Cupertino, CA 95014

Universal Data Systems

5000 Bradford Dr.
Huntsville, AL 35805

U.S. Robotics, Inc.

1123 West Washington
Chicago, IL 60607

Ven-Tel, Inc.

2342 Walsh Ave.
Santa Clara, CA 95051

MICRO DATA MANAGERS GET MAINFRAME POWER

*Mainframe-like database management systems
are now available for personal computers*

BY MICHAEL K. GUTTMAN



STORING and providing access to information has long been a function of mainframe computers. For several years programs have been available that allow microcomputers to perform these tasks, although on a somewhat less grandiose scale. Today's microcomputers, with their substantially enhanced processing capacities and ability to access large amounts of solid-state and disk memory can manipulate data in mainframe style.

Any substantial collection of data is generally referred to as a *database*. The software that assists the application designer (who must decide how the data will be stored, accessed, displayed, etc.) and that later allows a computer user to enter, retrieve, and manipulate the information in the database is called a *database management system*, or *DBMS*.

As an example of the uses of a sophisticated DBMS, consider the requirements of an in-

formation system for a medical clinic. The clinic has patients who must be admitted, scheduled and then billed and a staff whose work must be scheduled and whose salaries must be paid. Some scheduling must meet special criteria, as in cases where specific test equipment must be available.

The system will be used by a variety of staff members for different purposes. The receptionist must collect information on new patients and schedule appointments. The doctors must be able to inquire into their own schedules and into the status of their patients. The accounting department must be able to bill the patients and their insurance companies and compensate the doctors, nurses, and technicians for services rendered. Management must be able to assess work flow, costs, performance and profitability in order to make key decisions about future operations.

Each different

way of using or looking at the database is called a *logical view*. In a system such as the one described above, the scheduling of a single appointment is likely to affect virtually all the various parts of the system and the information requested by most of the users of the system. As each transaction is made, the data must be collected and added to the database, and the addition must be reflected in each user's logical view of the database.

DBMSs on Micros

DBMSs were first developed to support such applications on mainframe computers. Early microcomputer hardware was too low-powered to support DBMS software or the large-scale applications for which it was intended.

In order to handle the data management needs of micro users, software vendors developed new packages that would allow simple manipulations of relatively small amounts of data. Although they may vary widely in their features and capabilities, such popular products as dBaseII, PFS-File, Personal Pearl and the like all fall into this general category. These micro packages

a plus for your apple...

Are you depending more on your Apple? Are you already using an Apple in your business or home, but want to get more out of it? When upgrading your system, do you rely entirely on the retailer's claims? Do you find that other magazines don't go beyond simplistic programming ideas?

**LOOK NO FURTHER!
A+ IS HERE!**

A+ will teach you how to maximize the functions of your Apple. It brings to life new and innovative program applications for the Apple II series and the *new* Macintosh microcomputers . . . features you won't find anywhere else! You'll find reviews of new software packages and in-depth evaluations of new hardware and peripherals for the Apple.

A+ is a useful tool to help you get the most out of your Apple in both the office and the home!

A+ is not written for computer technicians, nor is it a simple magazine written for new users...A+ is written for *you*, covering...the programs *you* can adapt for your office and home...the products *you* can purchase to expand your Apple II series or Macintosh microcomputer...the applications *you* can implement to increase your productivity...the topics *you* want *and* need, month after month!

**SUBSCRIBE TODAY
AND SAVE UP TO 26%!**

A+ IS THE BUSINESS GUIDE FOR APPLE COMPUTING!

Get the reviews and evaluations of the newest releases for business and finance... which of the three leading Dow Jones Market analyzers is right for you...how to use the Apple as a crystal ball to predict the future of your company...financial forecasting and analysis programs to meet your needs...inventory control programs that aren't losers...patient- and client-profile packages that tell a story...and ways to increase the efficiency of your word processor, in the office or at home!



Tablets for IIs—new relief for the creative professional and student.

A+ IS THE CONSUMER'S GUIDE TO NEW SOFTWARE!

Each issue of A+ gives you unbiased evaluations of the

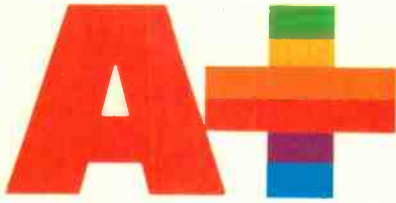

THE INDEPENDENT GUIDE FOR apple COMPUTING



latest software releases for home and office...programs that teach you how to use video games to help children learn...which modems will make your Apple a great communicator...the software solution to combine graphics, animation and text...problem solving with artificial intuition...software that gives you *all* of your money's worth ...and games that challenge your mental faculties and *not* your good nature!

A+ IS YOUR MONTHLY 'FACT SHEET' ON NEW HARDWARE AND PERIPHERALS!

A+ covers what you need to expand your Macintosh or Apple II series...current advances in telecommunications and networking...new ways to augment memory...how to



Modem Magic—Reach out and access an information service.

access a wider variety of peripherals with greater ease ...what debugging aids *really* work...how to expand your RAM...ink-jet printers or dot-matrix printers...and the

hardware you'll need to accomplish the jobs in your business and home!

You'll get this and so much more in each monthly issue of A+! Regular columns and features covering Graphics, Programming, Education, Games and Entertainment make A+ the source for new applications and ideas...and Rescue Squad, Thoughtware and Product News round out all the facts you need for your Apple!

A+ is the complete guide for Apple computing, *the* magazine you can't do without!



Dictionary Disk—It's new, it's hot and makes word processing a snap.

A+ THE INDEPENDENT GUIDE FOR apple COMPUTING

P.O. Box 2964 • Boulder, Colorado 80322

YES! I don't have to look any further, A+ is here! Please enter my subscription to A+ for:

- 9 issues for only \$15.97—SAVE 15%!
 - One year for only \$19.97—SAVE 20%!
 - Two years for only \$36.97—SAVE 26%!
- Savings based on full one-year subscription price of \$24.97.

AM82029

Mr./Mrs./Ms. _____ please print name in full

Company _____

Address _____

City _____ State _____ Zip _____

Check one: Payment enclosed Bill me later
Charge my: American Express Visa MasterCard

Card No. _____ Exp. Date _____

Add \$12 a year in Canada and all other foreign countries. Please allow 30 to 60 days for delivery of first issue.

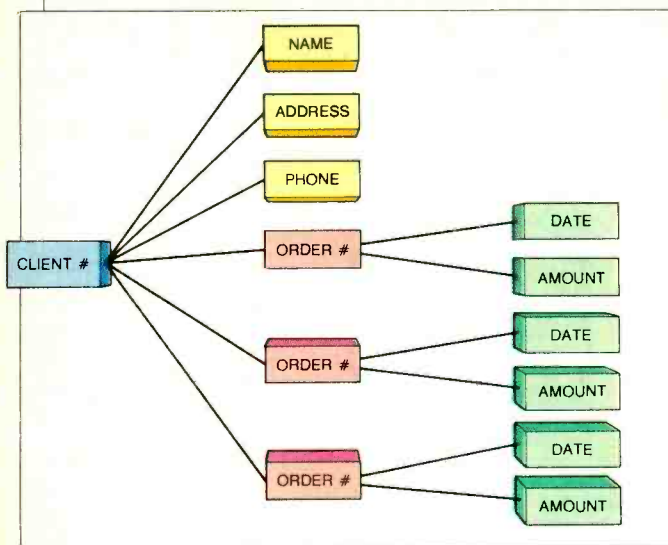

Fig. 1. A hierarchical database organization.

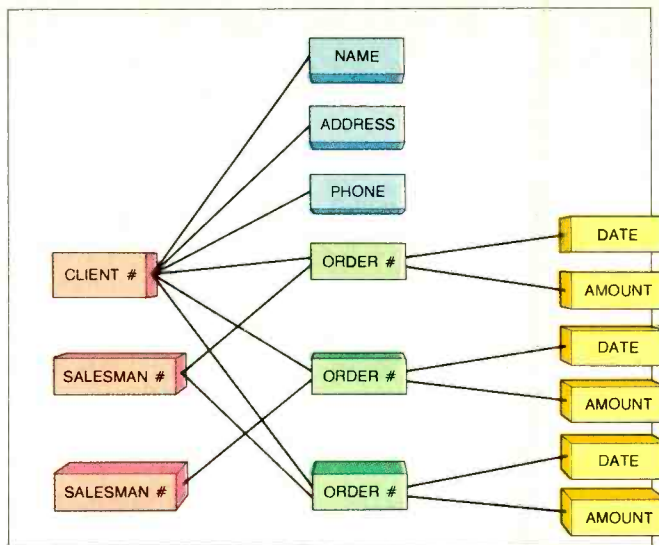

Fig. 2. A network database organization.

offer nowhere near the power of main-frame DBMSs. Although such products dominate the micro marketplace, this article concerns their more powerful cousins, which have their roots in the main-frame world.

DBMS Structure and Terminology

Most databases are made up a collection of individual data elements, sometimes referred to as *fields*. A simple database might, for example, have a NAME field, an ADDRESS field and a TELEPHONE field. Generally, related fields are further grouped together into *records*, which are still further grouped into *files*.

This kind of database structure is analogous to a typical office filing system, where a file is a particular file drawer, a record is a particular file folder in that drawer, and a field is a particular piece of information in the folder.

A typical DBMS will allow the user to create a file by giving it a name and defining the characteristics of each field in a record. The user is then free to add or delete records, or to modify the contents

of fields within an existing record. The DBMS will normally have commands that allow the user to “browse” through the file, going backward and forward through the records much as you would with folders in a file drawer.

The user usually retrieves a particular record by referring to its *key*. A key is a field (or set of fields) that uniquely identifies a record in a file. When you build a database application it is often convenient to choose keys that are also used to identify the record in real life. For example, a social security number would make a likely key in a list of college students.

Often it is important to be able to find a particular record using a secondary key, such as, following the above example, a student’s last name. Since records cannot be stored in two different orders at once, a DBMS takes care of this by creating an *index*. This is simply a special file that contains a list of secondary keys in order, each with a pointer to its associated data record. The DBMS searches the index for a particular secondary key, and then retrieves the data

record pointed to by the index entry.

All DBMSs provide a means for selecting a subset of records based on certain criteria. For example, you might want to extract a list of all records having a certain ZIP code from a mailing list file. The criteria for such a selection are typically defined using an English-like *query language*. Many query languages allow you to use the selected records to create a new database file or to join information extracted from two different files on matching keys to create a new file.

Database Organization

Complex applications require the designer to define relationships between or among files in order to deal with many common data management problems. The types of interfile relationships supported by a DBMS constitute its *database organization*. The effectiveness of a DBMS in supporting a particular application is profoundly affected by its underlying database organization.

The simplest form of database organization is known as *hierarchical* (Fig. 1). In this form, each data element is a *child*, dependent and irrevocably connected to a *parent* data element. The highest element has no parent and is called the *root*.

For example, you may wish to create a list of clients and their transactions. Each client has a unique client number, the ultimate parent. Directly connected to each parent element are a number of dependent data elements such as the client’s name, address, phone number, and other descriptive information—the children of the client number.

Each transaction can also be maintained in a similar tabular form. In this scheme, the data elements of a particular transaction are children of the transaction number and grandchildren of the client number. For convenience, the

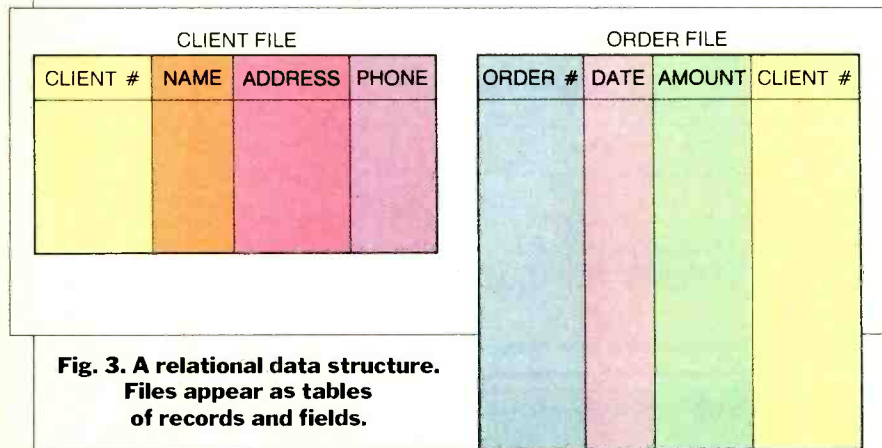

Fig. 3. A relational data structure. Files appear as tables of records and fields.



transactions for a particular client can be connected by daisy-chaining, where each transaction contains a pointer to its parent and to the next transaction.

This sort of hierarchical structure solves a number of data management problems. First of all, it is easy to find all transactions associated with a particular client. Second, changes to client information, such as address or phone number, are automatically related to all the other client data, including transactions in the related transaction file. Another benefit is that such information need only be stored once for each client, instead of redundantly with each transaction.

The example above could be expanded upon by relating each transaction to a particular salesman. In addition, each salesman could be assigned to a particular sales manager within a particular sales office. This new organization would be more complicated than the

simple hierarchy described above. Each child might have more than one parent, which might or might not be related to each other through other parents. This type of database organization is called a *network*, and it is intended to overcome inherent limitations of a hierarchical structure (Fig. 2).

Another form of database organization, called *relational*, has been developed based on a branch of mathematics called relational algebra that describes the rules for operating with sets of data arranged in a tabular structure (Fig. 3). These rules are too complex to describe adequately in this article.

The important thing to know about relational DBMSs is that their organization is less restrictive than others and is particularly useful for databases that will be searched according to a wide variety and combination of criteria. For example, you might want to first retrieve a list of all books printed prior to 1981 in the United States that deal with the

French Revolution and then retrieve a list of all articles by the same authors. It is unlikely that such a request could have been anticipated if the database had been implemented with hierarchical or network organization.

Unfortunately, the term relational, like the term database manager, has become fashionable and so is frequently applied to products that do not really follow a relational model of data organization or support a full range of relational operations. Because the term is so often misapplied you will have to examine the capabilities of a given product carefully rather than rely on the manufacturer's description of its database organization.

Defining a Database

Many DBMSs require that you create a database by using a data description language (DDL). All the data elements and their attributes are defined in a

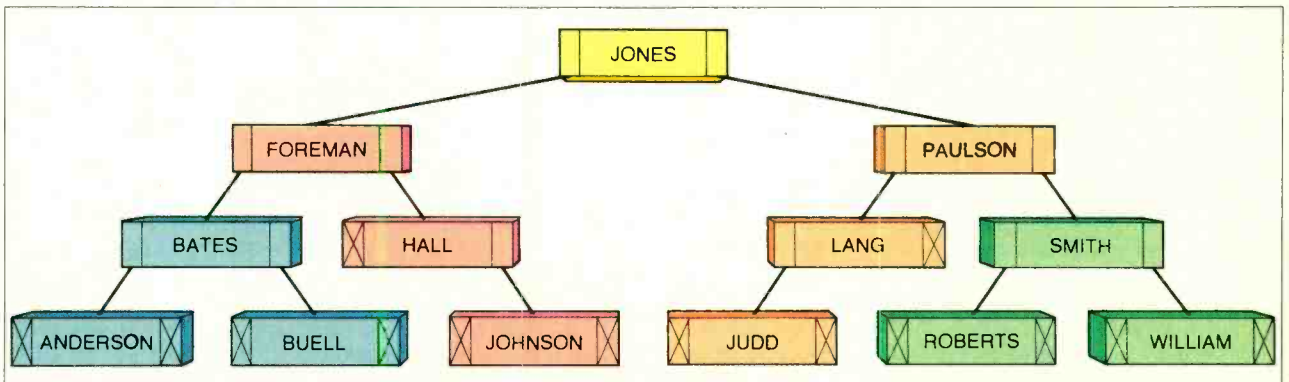

Fig. 4. A B-tree index. Each key is stored with a left pointer to the key next below, a right pointer to the next key above, and a pointer to the associated record in the database.

Database Management

DDL program. When the program is executed, the DBMS checks the definitions for logical consistency and allocates the optimum file structure. The net result is compiled into a *data dictionary*, which contains a description of this file structure and the attributes of each data element. It will be used by the DBMS to control all subsequent operations on the database.

This rigorous approach is necessary to implement demanding applications, but its complexity usually limits the market for such a package to professional software developers. To accommodate the popular market, many of the new DBMSs simplify the DDL drastically into a set of commands that allow a database to be created on the fly. As a result, a new user can quickly create a simple database and later expand it as needs and expertise grow.

Programming with the Database

Once you have described a database to the DBMS and the necessary file structures have been allocated, you need a method to enter, delete, modify, and report data to and from it. In early

Expect to see more support for windowing, multitasking, and high-resolution screen graphics

DBMSs, this meant writing programs in a traditional programming language such as FORTRAN, COBOL, or P/LI and making subroutine-like calls to the DBMS for data management functions. Some modern micro DBMSs still provide extensive support for interfacing to such languages.

The programming language approach has several advantages. First, programmers have great flexibility, picking the language that most suits the application while still being able to utilize the DBMS. Second, existing applications written in traditional programming lan-

guages can be enhanced or integrated with new applications using the DBMS without the need to reprogram them totally. Finally, the vendor of the DBMS is relieved of the task of inventing, debugging and supporting a whole new language.

Since the market for DBMSs includes individuals with little or no programming experience, most packages now offer some sort of proprietary command language with which complete applications can be written. Such command languages are easier to use for data management applications than the traditional programming languages but offer less in the way of overall capability. They also tend to be less efficient in their use of computer resources.

A database command language will typically also provide support for a number of auxiliary functions. For example, it may include simple commands for drawing graphs; for interfacing with

(Continued on page 108)

Michael Guttman has his own software company, Chicosoft, and has written numerous articles for C&E.

SOME MAINFRAME-STYLE DBMSs

THE following is a sampling of mainframe-style database management systems on the market with versions for personal computers like the IBM PC.

PC/Focus—Information Builders, Inc.
1250 Broadway
New York, NY 10001
(212) 736-4433

Price: \$1595.00

Requires IBM PC or compatible, DOS 2.0 or higher, minimum 512K RAM (768K recommended), and minimum 5M-byte hard disk.

This is a microcomputer version of the popular database manager Focus developed for IBM mainframes. The database supports both hierarchical and relational models and offers a command language with extensive support for graphics, statistics, financial modeling, report generation and mainframe-micro communications. Documentation is extensive and includes a thorough users' manual and a getting-started guide. PC/Focus includes a simplified user interface called TableTalk intended to allow new users to both familiarize themselves with Focus and immediately become productive using it.

[PC/Focus is reviewed in this issue of C&E. -Ed.]

Informix—Relational Database Systems, Inc.
2471 East Bayshore Rd.
Suite 600
Palo Alto, CA 94303
(415) 424-1300

Price: \$795.00 to \$12,000.00, depending on computer.

Fully implemented, runs under MS-DOS and Unix, Xenix, PC/IX and compatible operating systems on a variety of computers from micros to superminis.

Informix is a relational DBMS aimed at systems integrators. It has a command language, a query language, and a report generator. In its Unix versions it provides extensive support for multi-user and multi-tasking applications.

Relational Database Management Systems also markets an Informix compatible file manager called File-it! that is aimed at business professionals and casual users. File-it! runs under the same operating systems as Informix and costs \$295 to \$3750.

Optimum—Uveon Computer Systems, Inc.

899 Logan St., Suite 111
Denver, CO 80203
(303) 831-7000

Price: \$595.00

Optimum runs under Unix, MS-DOS, CP/M and CP/M-based multi-user systems such as MPM and Turbo-DOS. MS-DOS version requires 128K, CP/M version, 64K.

Optimum provides extensive facilities for data entry and report generation, a query language and a command language with support for relational operations. Documentation consists of a detailed programmer's guide as well as an executive's guide aimed at nonprogrammers that includes a tutorial and sample systems provided on disk.

Revelation—Cosmos
P.O. Box AH
Morton, WA 98356
(800) 422-2511 (inside
WA (206) 824-9942)

Price: \$950.00

Runs multi-user under PICK operating system with single-user version for IBM PC and compatibles. PC version requires 320K and has performance benefits if an 8087 math coprocessor is present.

A BRIEF HISTORY OF DATABASE MANAGEMENT SYSTEMS

Early programming languages, such as FORTRAN and ALGOL, were developed primarily to support scientific applications. As a result, they lent themselves poorly to the burgeoning demands of business. Business-oriented programming took a step forward with the introduction in the early 1960s of COBOL, a business oriented language that increased support for file and record management.

As business applications continued to grow in size and complexity, however, limitations inherent to all traditional programming languages made it increasingly difficult to develop, maintain and upgrade these applications. Changes in the structure of the application database might require the rewriting and retesting of hundreds of programs that accessed the data. Not only was time consumed, but also the probability of introducing new bugs in the application was increased.

The first step in dealing with these problems lay in standardizing and isolat-

ing the program code that read and wrote data. In this way, each application program would access the same code, making for easier changes. In addition, this "data access" programming code could be optimized for more efficient operation of all the programs that utilized it.

Application programmers soon developed generalized modules of data access code that could be quickly customized to virtually any application. As these utility modules evolved, they gradually took on a life of their own. Programmers assigned specifically to develop and improve them integrated these utilities into complete systems, the forerunners of modern DBMSs.

Initially, DBMSs were developed independently at each computer installation. Soon, however, enterprising companies saw the opportunity to market their proprietary DBMSs to new users, who could then produce custom applications without having to go through the process of creating their own DBMS.

Business boomed, and soon a number of competing products were on the market.

Beginning in the late 1960s, attempts were made to standardize the implementations of all DBMSs. By 1971, the Conference on Data Systems Languages (CODASYL) developed a set of standards for database implementation and interfacing to programming languages that utilized a network model of data organization. At the same time, numerous books and articles appeared, proposing standards for DBMSs following a variety of models.

Mainframe DBMSs continue to evolve, proliferate and spawn imitators on minis and micros. Some of the better known products include IBM's IMS, Cullinet's IDMS, Honeywell's IDS, Digital Equipment Corporation's DBMS, Software AG's ADABAS, Cincom's Total, Burrough's DMS and Informatics General's Mark IV. Microcomputer versions of at least some of these products will almost undoubtedly become available in the coming years. ◇

Revelation provides support for data entry and report generation and features an extended version of BASIC including commands for database support. Supports variable-length and multi-valued fields. Documentation is extensive, including a substantial tutorial user's guide. Special utilities allow PC version to communicate with PICK-based computer systems both as a terminal and as a means to transfer data and program files.

DataFlex—Data Access Corporation
8525 SW 129 Terrace
Miami, Florida 33156
(305) 238-0012

Price: From \$750 for the 8-bit single-user version to \$1250 for the 16-bit multi-user version. DataFlex runs under MS-DOS, CP/M and CP/M-based multi-user operating systems. Requires 128K under MS-DOS and 64K under CP/M.

DataFlex is designed to allow programmers and sophisticated end-users to create complete database applications. A powerful command language handles screen formatting, data entry, report generation and transaction processing. Also included are menu-driven

code generation routines for database building, data entry, and report generation. Database organization is hierarchical, with command language support for some relational operations. Users may interface DataFlex library routines with Pascal/MT+ program code.

MDBS—Micro Database Systems, Inc.
P.O. Box 248
Lafayette, IN 47903
(312) 981-9200

Price: \$3125.00 to \$7000.00
MDBS runs under MS-DOS, CP/M, CP/M-based multi-user systems, Xenix and Unix. It requires 128K under MS-DOS and 64K under CP/M.

MDBS is targeted exclusively at sophisticated applications programmers. The system provides extensive support for data description, screen definition, query processing, report generation, and system recovery. It supports an advanced network database organization and a variety of relational operations. MDBS is designed to be interfaced with programming languages that make calls to desired routines. MDBS, Inc., also markets Knowledgeman, a simplified data management program aimed primarily at end users and novices.

MicroMUMPS—Division of Computer Science
University of California
Davis, CA 95616
(916) 752-7004

Price: \$56.00
MicroMUMPS runs under CP/M or MS-DOS, with multi-user versions for CP/M-based systems under development. The MS-DOS version requires 128K, and the CP/M version needs at least 64K.

MicroMUMPS is the microcomputer version of MUMPS, an application development and database management environment running under a variety of mainframe and minicomputer operating systems.

MUMPS is capable of supporting and interrelating a variety of database organizations through its interactive command language. Since MUMPS is an ANSI Standard language, applications can be ported between microcomputers and minicomputers; MicroMUMPS provides utilities to accomplish this purpose. MicroMUMPS is also in the public domain, allowing users to copy freely the product for distribution with their applications. ◇

MOTOROLA'S MUSCULAR 68020

The newest true 32-bit microprocessor runs at a sizzling 2.5 million instructions per second

BY LES SOLOMON

BACK in the ancient days of microcomputing, there was a microprocessor manufactured by Motorola called the MC6800. It gave the Intel 8080 a run for its money as the basic 8-bit CPU of the then-new personal computer market.

One rather quiet member of that family, the 6809, is still viable and forms the basis for many powerful computers, such as the TRS-80 Color Computer, the Gimix machines, etc.

Then came 16 bits. In 1979, the 6800 family blossomed into the 68000 family that went on to power many well-known microcomputers, including the Apple Macintosh, the Sinclair QL, etc. At this time, the 68000 is possibly the best known and most widely used 16-bit CPU.

There may be some confusion as to how many bits the 68000 handles. As I mentioned in my June, 1984 column, if you are a software person who lives in 32-bit registers, then the 68000 is a 32-bit processor. However, since the 68000 has only 16 data lines, it can only grab 16 bits of "real world" data at a time. This feature makes the 68000 a real-world 16-bit microprocessor.

But, as they say, the times are changing and we are now looking forward to the world of 32 bits.

When 32 bits are mentioned, most people automatically think of a mainframe or a super minicomputer. Now, however, many capabilities that were heretofore available only to large corporations may be within the reach of the common folk.

Some New Capabilities

Here are some of the possible applica-

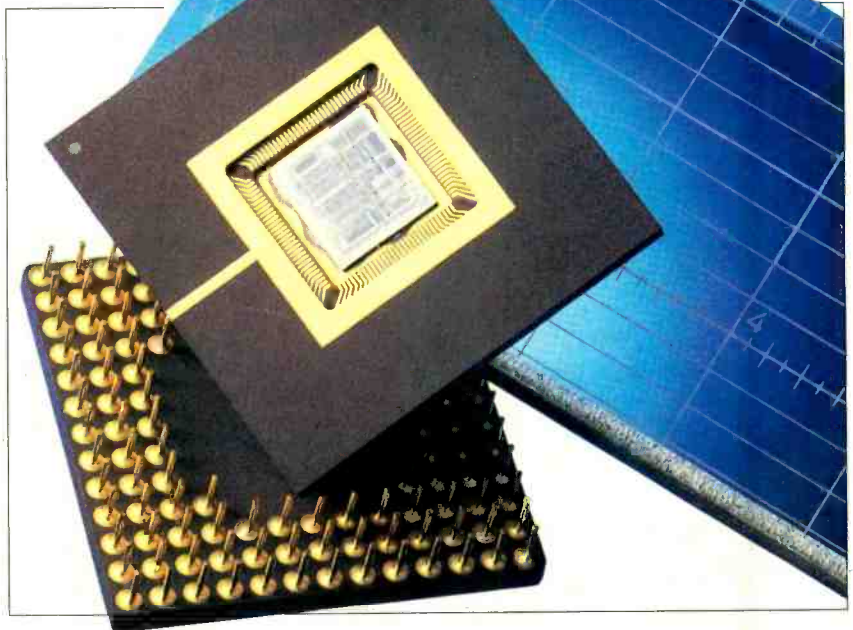

tions for the 68020: CAD (computer-aided design) workstations that employ multi-user, real-time software to produce complex graphics; next-generation personal computers that can emulate the operation of mainframes; large-scale small business computing systems that feature Unix business packages; fault-tolerant systems (multiprocessors); and "super micros," a new generation of personal business systems that put mainframe performance in small and affordable packages.

Other 32-bit applications include high-performance graphics controllers that require larger linear (nonsegmented) memory space and powerful bit manipulation; robotic and numerical controllers for factory automation; and such noncomputing applications as high-volume, high-reliability telecommunications switching systems.

200,000 Transistors

Using the latest 2-micron HCMOS process, the recently introduced Motorola 68020 contains some 200,000 transistors on a $\frac{3}{8}$ " square piece of silicon and

is 32 bits throughout its internal and external architecture.

Physically, the 68020 breaks with the conventional DIP concept (dual inline package) of a row of pins on each side of a plastic carrier in that it uses a $1\frac{1}{25}$ " square pin-grid array package. As shown in the accompanying photograph, the pins are arranged in a 13×13 grid with the center 7×7 pins removed. This allows for 120 pins, but only 114 are used by the 68020.

The new processor has 32-bit non-multiplexed address and data lines, sixteen 32-bit general-purpose registers, a 32-bit program counter, a 16-bit status register, a 32-bit vector base register, two 3-bit alternate function code registers, and two 32-bit cache handling (address and control) registers.

With its 32 nonmultiplexed address lines the 68020 can directly address 4,294,967,296 bytes of memory!

Seven basic data types are supported. These include bits, bit fields (string of 1 to 32 consecutive bits), BCD digits (packed at 2 digit/byte and unpacked at 1 digit/byte), 8-bit byte integers, 16-bit

word integers, 32-bit long-word integers, and 64-bit quad-word integers.

The 18 addressing modes include nine basic types: register direct, register indirect, register indirect with index, memory indirect, program counter indirect with displacement, program counter memory indirect, absolute, and immediate. Included in the register indirect addressing mode is the capability to post-increment, predecrement, offset, and index. The program counter relative mode can also be modified by an index and offset.

Operating at a 16.67-MHz clock rate and requiring 1.5 watts of power (less power than the 16-bit 68000), the CPU can process instructions at a sustained rate of 2 to 3 MIPS (million instructions per second), and can reach 8 MIPS in bursts. This puts the microprocessor in the same speed ballpark as some main-frame systems.

To summarize, the 68020 (at present a \$487 piece of silicon) can access more than 4-billion bytes of data and manipulate or process 32 individual pieces of information every 180 nanoseconds.

The Cache

Some of this speed comes from an on-chip 256-byte "cache" that allows simultaneous data and instruction accesses and execution. A cache was included because studies show that typical programs can spend quite a bit of their execution time in a few subroutines or loops. A cache allows executing the loop constantly. Another reason for the cache is that it allows instruction stream fetches and operand accesses to proceed in a parallel manner. For example, if the system requires both an instruction stream access and an operand access and the instruction is resident in the cache, the operand fetch will proceed unimpeded rather than being queued behind the instruction fetch.

The 256-byte cache is organized as 64 "long word" entries (byte is 8 bits, word

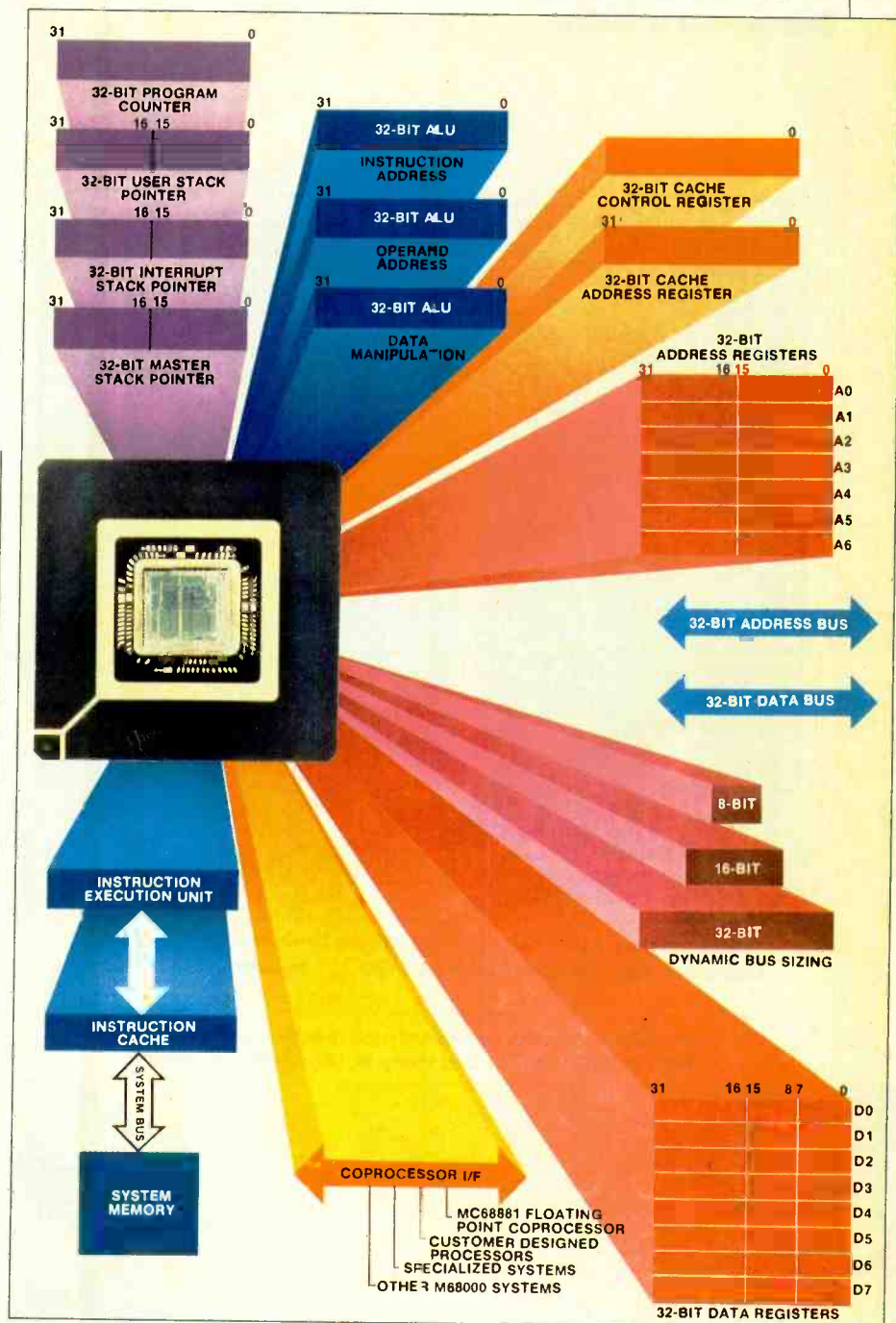

Internal make-up of the 68020 shows why it is such a powerful processor.

is 16 bits, long-word is 32 bits, and quad-word is 64 bits).

Interestingly enough, the 68020, although a full 32-bit CPU, is upward user-object code compatible with earlier members of the 68000 family, so your 68000 software will run on this new CPU. Many instruction extensions have been made on the 68020 to take advantage of the 32-bit operation where, on the predecessor 68000 family members, only 8- and 16-bit values were used.

In fact, it is possible to build a socket converter so that the 32-bit 68020 can replace the 16-bit 68000 in a computer.

This will work, but you will lose all the powerful 32-bit instructions of the 68020 unless you change the software. To save money, the 68020 will support all the languages and software available for the 68000, besides its own 32-bit software. It may well be that this compatibility in both hardware and software will make the 68020 a very popular CPU.

To operate at the full speed of the 68020, you will also have to change the clock rate and, of course, make sure that RAM, ROM, and the support chips are fast enough.

To show its compatibility with its 8-

Motorola 68020

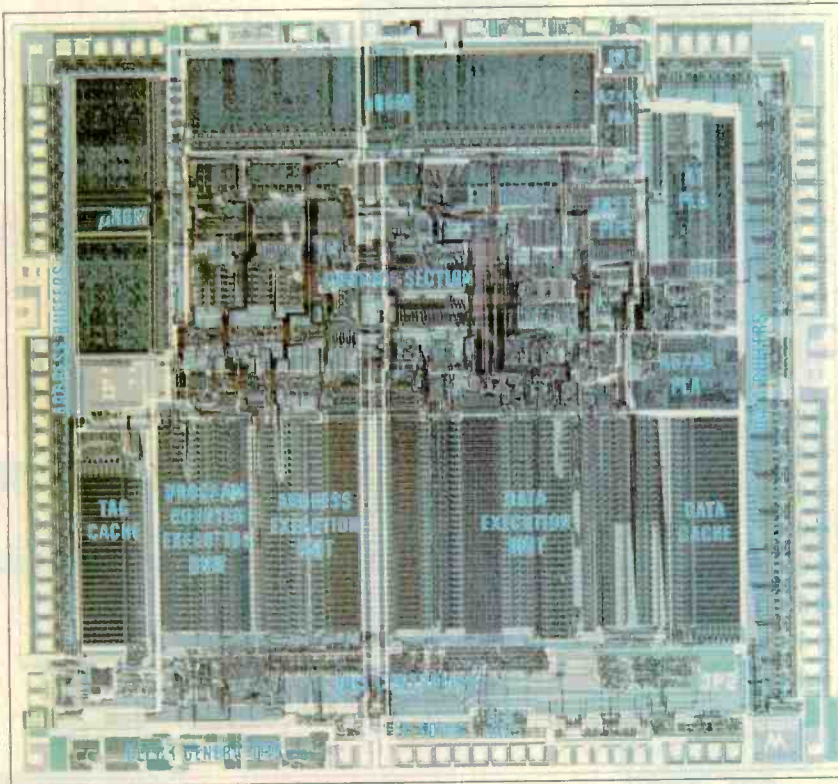

Photomicrograph of the 68020 shows the density of the chip. There are 200,000 transistors on the $\frac{3}{8}$ " square piece of silicon.

Specially designed, computerized machines are used to test the 68020s in this room at the Motorola plant.



and 16-bit predecessors, the 68020 also features dynamic bus sizing. This allows operand transfer to or from 8-, 16-, or 32-bit ports by dynamically determining the port size during each bus cycle. For example, if the processor is executing an instruction that requires reading 32 bits during the first bus cycle and the port responds that it is 32 bits wide, then the 68020 accepts all 32 bits and goes on its way. If, however, the port "says" that it is only 16 bits wide, the 68020 will accept the 16 bits on that cycle, then run another cycle to work with the other 16 bits. If the port responds that it is 8 bits, the 68020 takes four read cycles.

The 8-, 16-, and 32-bit ports have their own locations on the data bus. A 32-bit port obviously requires all 32 data lines, a 16-bit port uses data lines 16 through 31, while an 8-bit port uses data lines 24 through 31. This particular approach was selected because it minimized the number of bus cycles needed to transfer data to the 8- and 16-bit ports.

As a consequence, the programmer is no longer required to develop programs that are bus dependent. It also allows the use of low-cost non-32-bit devices.

Another feature of the 68020 is a built-in means to extend its architecture off-chip through a coprocessor interface. This allows an external device, such as the new MC68881 Floating Point Coprocessor, to execute instructions as part of the main instruction stream.

A technician loads a 68020 chip into the diffusion operation.



WAITING FOR 32

BY SETH R. ALPERT

WHEN Motorola recently announced the availability of the first true 32-bit microprocessor in their 68000 family, the 68020, my overactive imagination got me dreaming about the implications.

The new processor is available in sample quantities at a fairly hefty \$487—the popular 68000 sells for around \$50 in quantity. Actually \$487 isn't totally outlandish for a CPU that can power one of today's super micros, machines that are most typically used in high-end applications like engineering design. But it does price the chip out of the mass market. Dreams of new, powerful personal computers (such as upgrades to Apple's Macintosh and Lisa 2 computers) will remain just that for a while.

But not forever. Motorola says that, as a result of increased volume and more efficient manufacturing, the price of the 68020 will fall within two years to around the 68000's price today. Of equal importance to seeing the 68020 in a new class of affordable personal computers is

the fact that other chip technology will have caught up with the new CPU by then. I am thinking, in particular, of the support chips that Motorola has announced as well as a new generation of fast RAM chips that can keep pace with a 16-MHz clock rate.

The net message is that a dramatically more powerful microprocessor has been brought to market, but you and I won't be able to get our hands on a system that uses it for a few years. It's a frustrating fact of life for those of us who keep an eye on new technology that even the seemingly tangible things aren't always as close to hand as we'd like.

The good news is that the 68020 and its competitors ought to justify the wait. They will permit software designers to exercise their imaginations without having to make as many compromises to achieve acceptable performance.

Just what improvements will the new generation of 32-bit micros offer? Well, there are some obvious things, like support for much higher-resolution graph-

ics, effective support for multiple-user applications, spreadsheets larger and faster than today's, and so on. Two slightly less obvious improvements are the moving of mainframe and minicomputer applications into a new affordable arena and the development of expert systems for mass markets.

We are currently in a period in the industry in which software is beginning to push the limits of hardware. Once true 32-bit performance in a modestly priced machine is available, the hardware will beg for more advanced software to take advantage of its capabilities. And someone's imagination somewhere will be fired and he will think of something no one else has yet conceived of. It could be a new application of micros or a new user interface or a combination of the two. Perhaps there will be more than one such breakthrough.

What will it be, the new software I am dreaming of? If I knew, I'd run out and try to develop it. It seems that we will just have to wait and see. ◇

The Supervisor

Like its predecessor, the 68020 has two processing states—user and supervisor. The supervisor level has a higher privilege than the user, which means that not all processor instructions are permitted to execute in the lower-privileged user state, but all instructions are available in the supervisor state. The privilege level can be used by external memory management devices to control and translate accesses and by the internal processor to choose between the user stack pointer and the supervisor stack pointer. The 68020 can invoke up to 256 privilege levels within the user level.

The 68020 is supported by an array of peripheral devices that support standard microcomputer functions like memory management, synchronous and asynchronous data communication, local area network interface, local/global bus interface and arbitration, general purpose I/O (serial and parallel), floppy and hard disk controller, and direct memory access devices. ◇

Les Solomon is Technical Director for COMPUTERS & ELECTRONICS.

A direct wafer stepping photo-lithography process is used in making the 68020 at Motorola.



THE ELECTRONIC UNIVERSITY

Now users of personal computers can take accredited college courses via their machines

BY ROBIN WEBSTER & LESLIE MINER

MANY students around the world are accustomed to taking lessons from absent teachers. The teachers may be hundreds of miles away and communicate their lessons via live or recorded TV or over the radio. At worst, in correspondence courses, the teacher is never seen or heard.

While remote or long-distance teaching has been quite successful, it suffers from major flaws. There is no way that students can personally interact with teachers in "real-time," and students usually only have limited opportunities to view or listen to a lesson before the next one takes place.

A San Francisco-based company, TeleLearning Systems, is attempting to overcome such obstacles by linking students with instructors via a personal computer network called The Electronic University.

Currently, there are about 8000 Electronic University students. They regularly dial up TeleLearning's central prime computers to take lessons, converse electronically with their course instructors (by appointment only), or send or receive electronic messages to/from their instructors.

About 200 courses—credit and non-credit—are offered right now. Five hundred should be available by year end if all goes as planned.

Some courses prepare students for the College Level Examination Program (CLEP) exams (including "College Composition," "American History," "General Psychology," and "Algebra"). Professional/career development topics include "Time Management," "Getting the Executive Job You Want," "Moon-

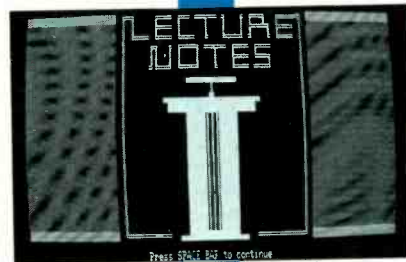

light with Your Microcomputer," and "Handling Stress: A Skill for Managers and Employees." Others deal with personal achievement: "Memory Training," "Right Brain Drawing," "Know Your Body" and "Get the Most for Your Medical Dollar."

When Ron Gordon, founder of TeleLearning, decided to develop the idea of network-delivered education, he and his engineers saw two main difficulties.

"The problem seemed to be that if you could use a modem, such as they are, you could just as well design one," said Gordon. "We took a look at what was out in the marketplace and were stunned. What was going on here? The technology was based on the idea that you took your personal computer and made it look like a dumb terminal so that it could connect up to a central computer over the telephone."

"Then to overcome the shortcomings of this approach people started putting microprocessors into modems to make them smarter. They would put in some ROM, and then they would add some RAM . . . They started making modems that were expensive, but which had none of the power of the personal computer. That's crazy."

Gordon's background includes being chief executive officer at Atari (during the time Nolan Bushnell—of Androbot and Pizza Time Theatre fame—headed the company). He is also the inventor of a hand-held computer and a language translator produced by Friends Amis, another company that he once owned. It was during the development of the translator that the inspiration for the Electronic University came.

"The question was 'How do we teach

SCREEN SHOTS BY STEVE BORNS

PHOTOGRAPH BY MICHEL TCHEREVKOFF

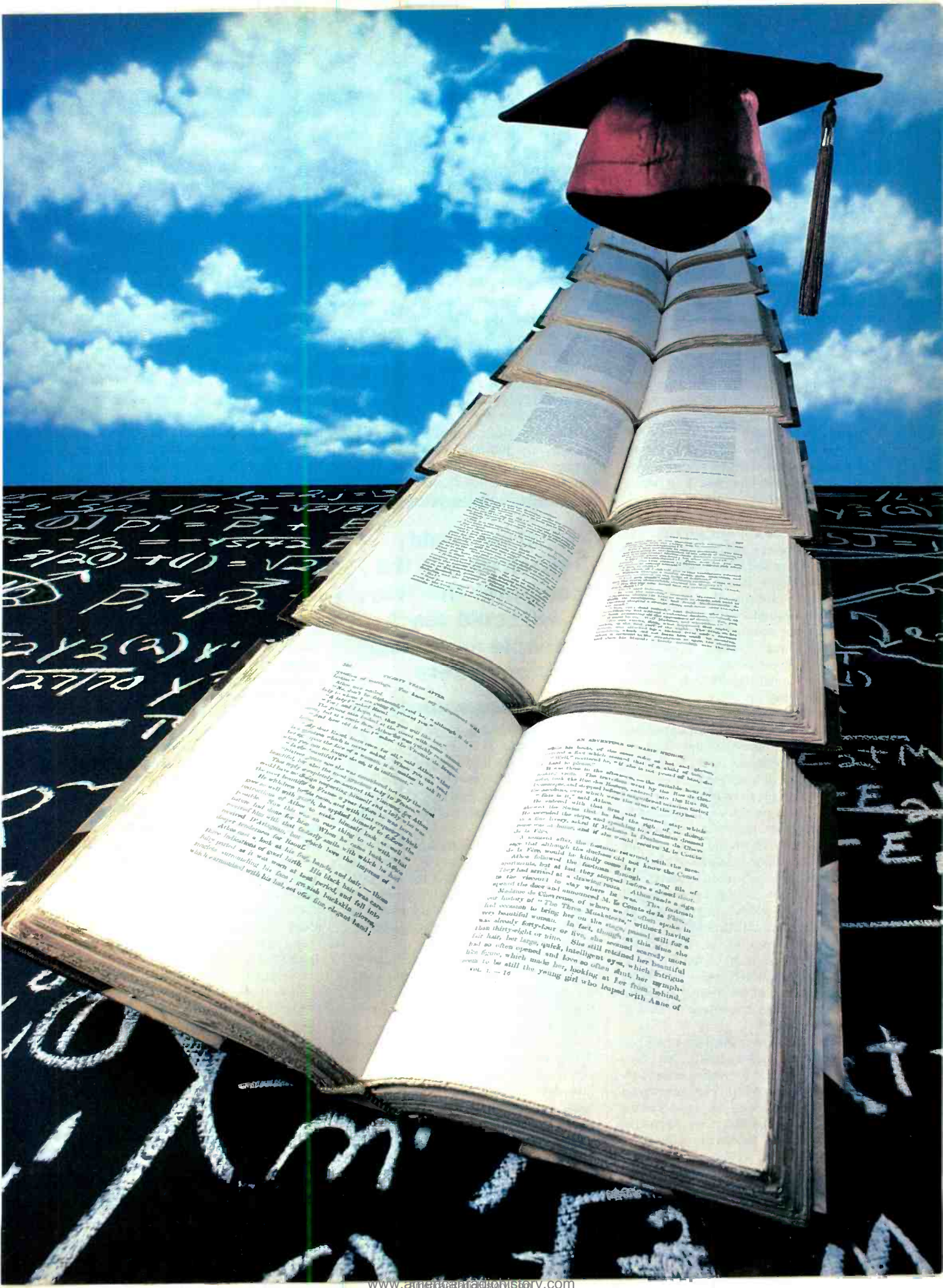

people to use this hand-held computer?" said Gordon. "Somebody suggested that we use the built-in modem to enable us to teach people over the telephone. . . . I woke up at 3 a.m. one day and had the thought: 'If we could get people to use the hand-held computer this way, we could teach people anything, anywhere.'"

The Electronic University differs from traditional computer networks like The Source or CompuServe. While those online services provide access to large amounts of data via the telephone, it is entirely up to users to find what they need. Electronic University students access courses prepared by accredited instructors.

A problem for novice users is the act of linking up to traditional online services; it can seem complex. You need a modem to link your computer physically to the telephone network; you need a communications software package; and you need to figure out such things as odd and even parity and baud rates.

TeleLearning's Knowledge Module—a special modem plus software—completely automates the log-on procedure for three computer networks used by TeleLearning: Tymnet, Telenet and Uninet. If problems occur on one network, the Knowledge Module is smart enough to hang up the phone, dial up one of the alternatives and actually keep the student informed of its own progress.

In addition, conventional telecommunications networks like The Source, CompuServe and Lockheed's Dialog can be relatively expensive to use. You are billed for the time you are connected to these computer networks—something that is difficult to minimize if you are searching an online database or chatting with someone electronically across the nation. One way around this problem is to use such networks only during off-peak hours when rates are lower.

However, if you do use them at off-peak times, the central computer sometimes responds slowly since everybody else in your part of the country is probably trying to take advantage of the off-peak rates as well.

Users of the Electronic University can expect to pay substantially less than might be expected for online communications. To begin with, TeleLearning has negotiated deals with the time-sharing services for special user rates. Secondly, students of the Electronic University work mainly offline. Rather than sending each lesson over the network when

required, TeleLearning provides students with floppy disks that contain almost all of the course materials. The information is "locked," in that it cannot be read by normal means; a special software "hook" must be sent by the main computer to release the material in whatever sequence the instructor desires. Any files that are sent, are sent in a specially compressed form that is made possible by use of TeleLearning's Course Translator software. This takes the course, as created by an instructor, and compresses it so that it can be stored in a compact electronic form.

For \$279.95, students get the Knowledge Module and a Computer Literacy course. With this package they can sign on for any number of TeleLearning courses after paying the relevant fees. Courses vary in price, depending on a

If we could teach people the computer this way, we could teach people anything, anywhere

number of criteria, but typically cost between \$50 and \$150. For \$229.95, students can get the Knowledge Module and communications software only. With the purchase of either package, the student becomes a life member of the Electronic University.

In addition to taking a full course, people will be able to "attend" electronically online seminars that are being arranged by TeleLearning. These seminars will both augment classes and enable an individual to tune into meetings of special interest.

"We want to make the Electronic University more than just taking classes," said Gordon. "A university is many things, and ours will be like a real university in every way possible."

Another major feature announced by TeleLearning recently was that the students will be able to have "libraries;" low-cost access to major online databases such as Lockheed's Dialog. Normally, five or ten minutes work with Dialog might cost as much as \$50, but Gordon says that special rates are being negotiated.

There are four markets for TeleLearning's service according to Gordon: the consumer or retail market; the collegiate class or academic market; and the business or corporate market; and the professional market.

The retail market is the most straightforward in that people can walk into a store and purchase TeleLearning hardware and software to connect to the Electronic University. Students can then gain access to the wide variety of courses mentioned earlier (the first lesson is downloaded via the telephone network while their course disk is in the mail).

In many instances, courses are run in conjunction with a book—possibly written by the instructor. In this sense TeleLearning takes on the role of a publisher, since the instructors/authors receive royalty payments for each lesson delivered. A number of colleges (including the Universities of Ohio, Nebraska and Wisconsin) are now developing their own courses for delivery via the Electronic University, using TeleLearning's facilities almost as if it were a telephone network.

The corporate market, according to Gordon, is ripe for a service like TeleLearning's. Presently, elaborate courses are set up for employees, but business or family pressures tend to reduce the number of attendees, he says.

With TeleLearning they don't have to be specially flown across country to meet at some appointed seminar venue. Instead they can pursue their training at their own pace but also have the support and guidance of an instructor.

Another market being actively explored is the professional. Teachers, doctors, dentists, says Gordon, must take continuing education courses at regular intervals to keep up to date; TeleLearning intends to meet this demand. They have already developed courses for teachers about computer applications including word processing, databases, and spreadsheets.

Eventually, Ron Gordon believes that the Electronic University will "become the largest teaching system in the country." As a measure of the interest, Gordon is currently speaking to the US Army about providing training to servicemen.

(Continued on page 128)

Robin Webster writes frequently for PC and PC Week; Leslie Miner is a freelance writer who specializes in science and technology.

COURSE REVIEW: UNDERSTANDING ECONOMIC NEWS

Since it usually takes a month or two to complete a TeleLearning course, the company made a special version for the IBM PC available for this review.

The course, "Understanding Economic News," falls under the personal achievement category. Written by James Pinto, associate professor of economics at Northern Arizona University, it is based on the book *What Is Economics?* by Jim Eggert. The course (\$75), like the book (\$4.95), is not designed to compete with the heavy-duty economics texts. Instead, it is a narrative of economic ideas.

The course was provided on two floppy disks (one has the operating software,

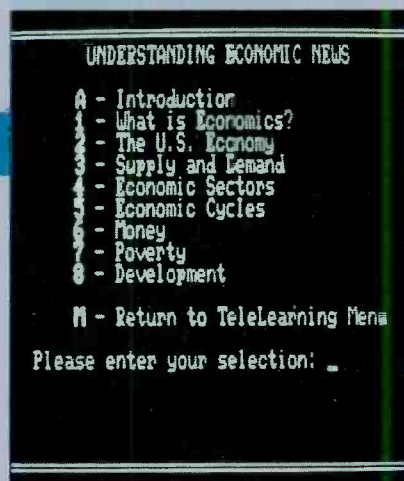

while the second contains all the lessons and associated files). Although we weren't able to interact with the instructor as intended, we can give some description of what taking the course would be like.

After booting up the operating software disk—amid strains of computer-generated *Also Sprach Zarathustra*—we were presented with the main TeleLearning menu. This features four main options plus "Exit from TeleLearning."

The first option, "Communicate with TeleLearning," allows the student to log onto the Electronic University via the Telenet, Tymnet, or Uninet networks. For the first-time computer and computer network user, the TeleLearning method of logging on is a major step forward.

The second main menu option is "Take a Lesson." Selecting it, we found that "Understanding Economics" was divided into an introduction followed by eight lessons. The introduction is an interactive "getting acquainted" session during which the student is invited to supply details of interests and prior

knowledge of the subject. It enables the lecturer to tailor the course to the individual as much as possible. (Again, we had no way of checking how this course refinement really occurred.) Students even get to see a digitized picture of the instructor.

Each lesson has three parts: lecture notes, electronic workbook, and progress evaluation. Each of these is interactive in a different way.

Lecture notes (preceded by a graphic of a podium) occasionally asks students thought-provoking questions—but their responses do not seem to be recorded. The course supplies answers as soon as the student completes a response. Within the lecture notes, information is broken down into "important terms," "key

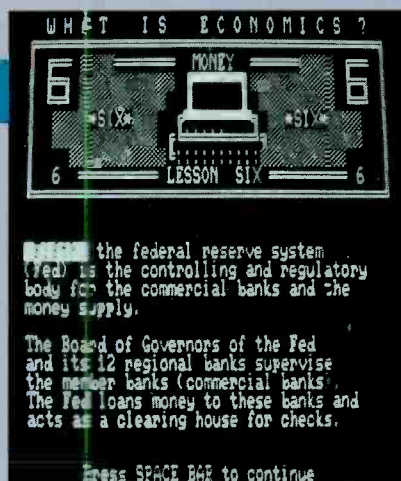

concepts" and "important points." At first we found these divisions artificial, but they did turn out to be helpful. Important terms was simply a list of terms from the assigned book chapter that the student had to be familiar with to discuss economic ideas. Key concepts provided slightly more definition, and important points was an elaboration in outline form of main points in the chapter. For example, *supply* and *demand* are economic terms; the "law of diminishing returns" is a key concept; and the trade-offs between recession and inflation are important points.

The next part, the electronic workbook, is used by the students for practicing and testing their assimilation of information presented during the lecture notes. Typically, the workbook contains five or more questions to which there are immediate responses. The questions are true/false or multiple choice. Students do their own grading.

The progress evaluation requires the student to input one-line or multiple-line

responses to questions. At certain points up to even 20 lines may be provided within a boxed-off area so that the student can write a mini-essay. On one occasion the question seemed too complicated to respond to in 15 lines: "Give the pros and cons of the three main economic systems—traditional, command, and market." Other questions were quite good, such as "Draw from your personal experience to elaborate on why there is no such thing as a free lunch."

At the end of the progress evaluation is a special essay box in which the students can make comments or enter any questions to ask the lecturer. When this section is completed, or bypassed, the

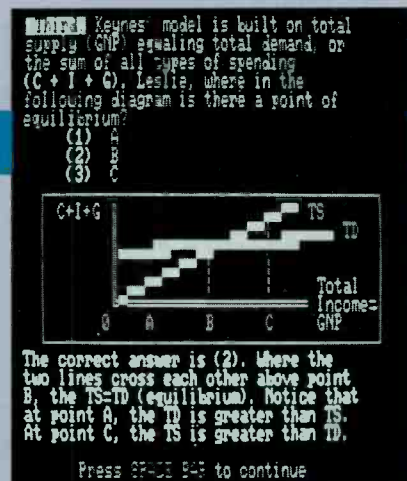

next assignment is displayed. Students may not progress to the next lesson until they have taken the previous progress evaluation. We were not under this constraint, so we just went to the main menu to pick up the next lesson.

In reviewing this economics course, we did manage to do all the reading assignments and to follow the disk-based lecture notes. Although we lacked the interactive element of the TeleLearning system, we found the course met its goal of helping us understand how economic principles affect our everyday lives and the problems of nations.

The course includes a good deal of historical material, from Adam Smith to John Maynard Keynes, Milton Friedman and John Kenneth Galbraith. It puts equal reliance on storytelling and graphs. There is also an intelligent progression through degrees of difficulty. As with any course, the student must be motivated to take it all in. The mere fact that the course appears on a computer screen instead of in a heavy textbook does not automatically mean that no effort is required of the student. ◇

UNINTERRUPTIBLE POWER SUPPLIES

Devices that protect you from the ravages of sudden voltage drops or power outages

BY AL FRANKEL

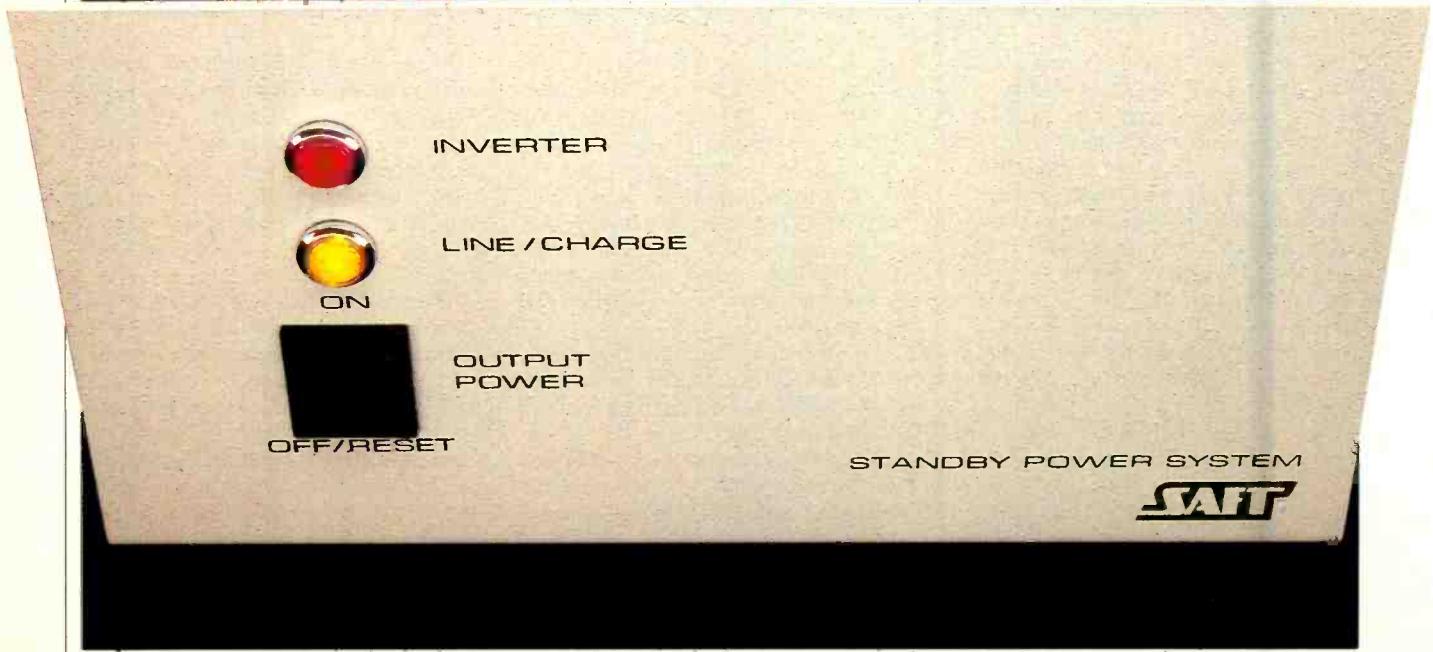
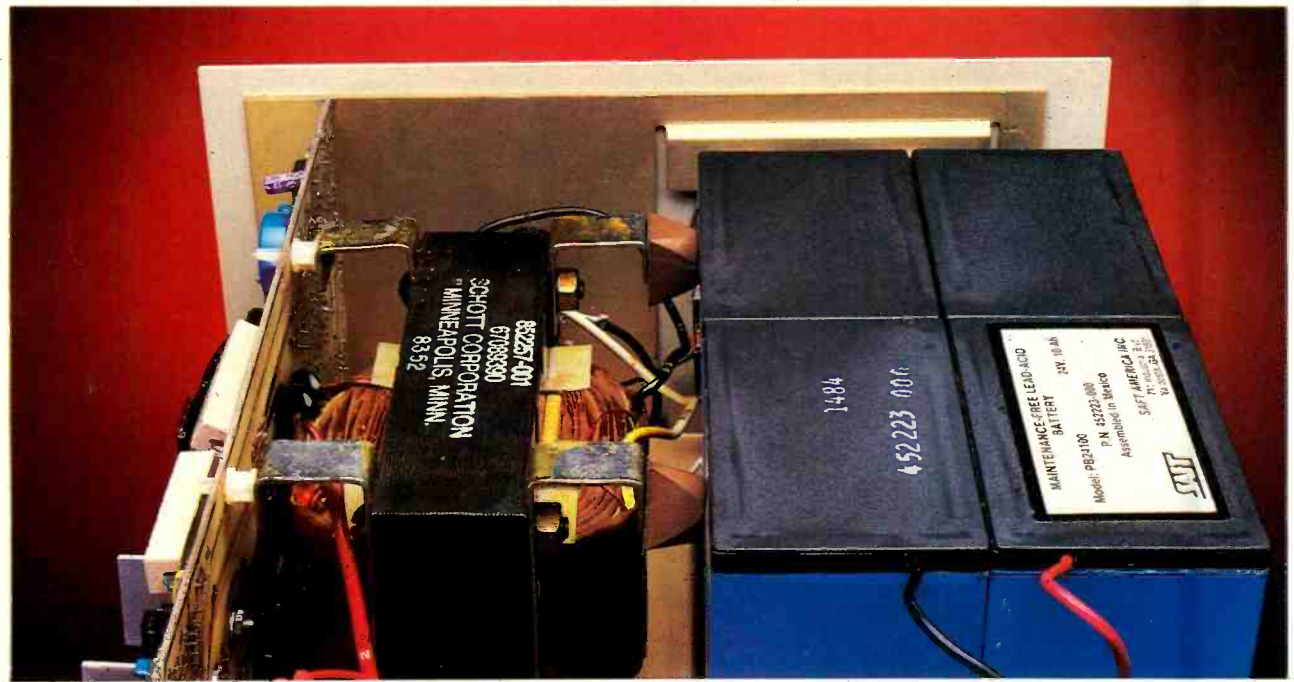

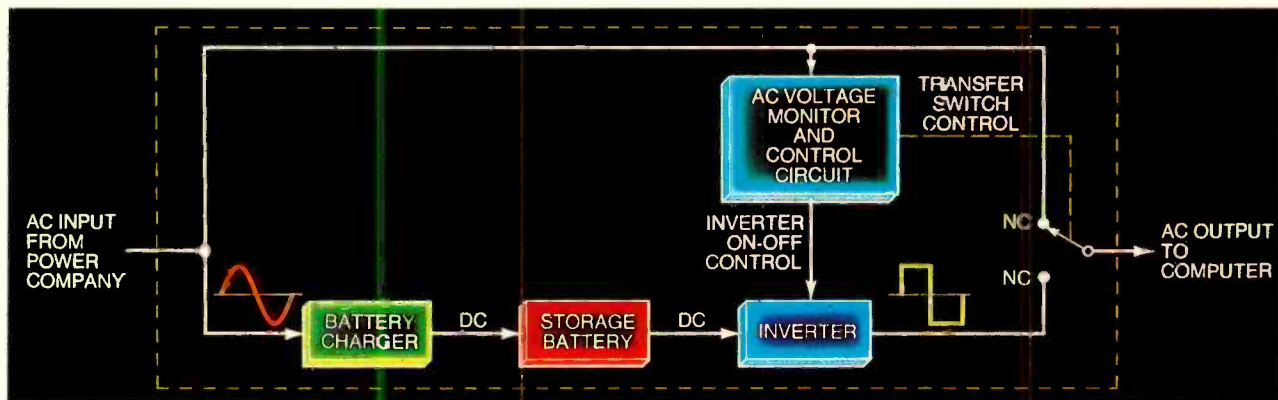

Fig. 1. Simplified block diagram of off-line battery backup UPS.

YOU'RE hunched over your computer keyboard, sweating your way through a long program with pages and pages of listings. You've been at it all night. Now at sunrise, the end is finally in sight. Just a few more bugs to work out and it will be finished. Just then, the lights seem to blink. You look up—everything appears okay—it must have been your imagination. You return to the CRT. Wait! Your program isn't there! Instead, all you see is a message that a boot is in progress. You stare in disbelief at the screen. What happened to the program? And why?

What happened is that the ac line voltage disappeared for a split second. But it was long enough for the dc power supply built into your computer to lose its output—the output that powers the random access memory (RAM) your program was being stored in. The instant the RAM lost its dc power, it lost its contents. It didn't matter that the power came back on just a fraction of a second later. The RAM had been turned off. Being turned back on a few tenths of a second later was no different from being turned on a few weeks later.

So what? you say. It's never happened to you. Well, the only reason you haven't suffered it yet is that you've been lucky. Did you know that the voltage provided

by your local power company drops out several times a day, every day?

An Uninterruptible Alternative

Although there is nothing you can do to prevent the ac line from dropping out, you can protect your computer with an uninterruptible power supply (UPS), or battery backup, as it's sometimes called. You simply plug your computer's power cord into the UPS and its power cord

brownout, the off-line UPS automatically comes on line: The inverter circuit turns on, and the output sockets are switched, or transferred, from the ac line to the UPS inverter output. Examples of off-line UPS products are the Datasavers from Cuesta Systems, Mayday Standby units from Sun Research, Standby Power Systems from Saft, the 200W Grizzly from Electronic Protection Devices, and SP5 units from Sola Electric.

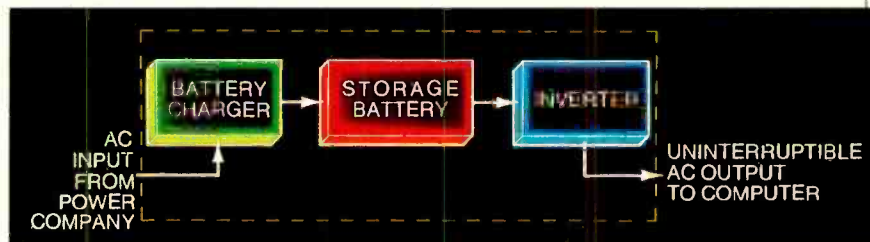

Fig. 2. Simplified on-line UPS block diagram.

into the ac wall socket. If the ac drops out, the UPS powers your computer by converting the dc energy stored in its internal battery into the ac power your computer needs.

There are several types of UPS; all have a battery charger powered by the ac line, a battery, and an inverter—the circuit that converts dc into ac. The inverters are designed to maintain a 120-V ac output over the full range of voltages produced by the battery as it discharges. There are many differences, however, among UPS models.

The "Off-Line" UPS

Some UPS models, classified as "off-line" and usually called battery-backup systems (Fig. 1), do nothing more than maintain a full charge on their batteries if the ac line voltage operates normally. However, when the ac voltage drops below a preset threshold or trigger level, because of either an outage or a deep

The time it takes for the UPS to start up and switch over the computer's power input from the ac line to the inverter ranges from manufacturer to manufacturer, up to about 10 ms. This is well under the duration of one full 60-Hz ac cycle, which is 16 ms. Sun Research specifies the switchover time for its Mayday models at no more than 8 ms; Cuesta Systems claims its Datasavers switch over in less than 10 ms; Saft rates its units at 4 to 6 ms; EPD, the Grizzly at 8 ms (max); Sola Electric, its SPS models at 4 to 10 ms.

Because the switchover takes no longer than the minimum holdup time of the computer's internal dc power supply, the internal dc voltages remain unaffected, and you won't even know the switching has occurred. If however, the computer's power-supply holdup time is relatively short or if the outage occurs just as the disk drive motors are starting (when power demand is at its highest),

Fig. 3. A rectangular wave with a 75% duty factor compared to a sine wave.

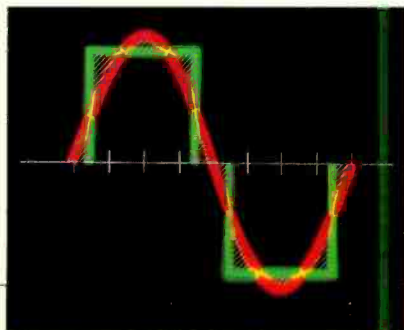

Power Supplies

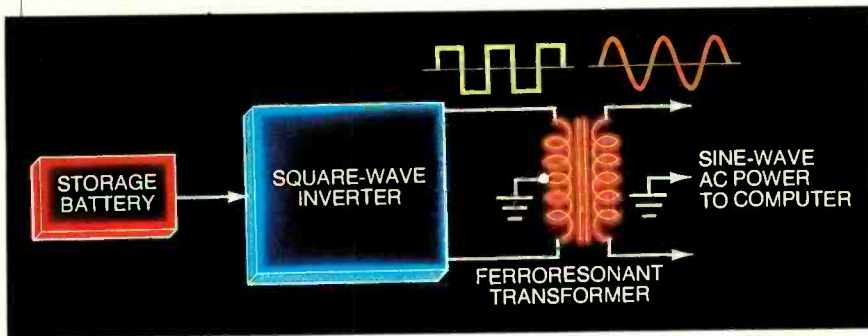

Fig. 4. A ferroresonant transformer is used to generate a true sine wave.

the dc voltages might drop out before the UPS completes its switchover. If that happens, the contents of the computer's memory will disappear just as if you had no UPS in the line. Well-designed equipment, however, will rarely fail this way. Even so, it's a good idea to check with the UPS manufacturer to determine whether any problems have been reported from other owners of your model of computer.

Continuously Available Power

If you need to make certain you won't lose memory and if you can't risk the UPS switchover time exceeding the power supply's holdup time, you can use an "on-line" UPS. It differs from the off-line battery-backup type in that its inverter is always on and supplying power to the computer's ac input (Fig. 2). Because the computer is always drawing power from the backup battery, a power outage or brownout would have no effect on the immediate operation of the inverter or the computer connected to it. In the event of an outage the battery charger would stop recharging the backup battery. Since no switchover is required, no memory loss could occur. Most industrial-grade UPS systems—RTE Deltec units, Sola Electric's UPS models, EPD's 500W Grizzly, Sun Research's continuous-type Mayday—are on-line designs.

Time Limitations

Regardless of the UPS type, with a power outage of more than a few minutes, the backup battery might completely discharge. In that case, the inverter will stop, and the UPS output will disappear. The result will be the same as if there were no UPS. Consequently, almost all UPS models have alarms to signal the loss of the ac line.

On some models, the alarm is just a panel indicator. On others, it is a buzzer or other audible alarm. Still others have special relays that permit you to add your own buzzer circuit. Although you

may have to pay a little more for a UPS with an audible alarm or alarm contacts, it's well worth it, especially if you put the UPS under a desk or table where you're not likely to see the panel indicator.

The amount of time the UPS can maintain your computer's operation after the AC line voltage drops out depends on how much power the computer is consuming and the capacity of the backup battery. Cuesta's Datasavers, for example, are rated for between 2 and 5 minutes at full output; Sola's SPS carries a 12-minute full-load rating; Saft's Standby Power Systems provide power for 10 or 20 minutes, depending on the model; and EDP's units have a full-load time of 15 (500W) or 20 (200W) minutes.

Another factor in the time equation is the difference between the full-rated UPS output power and the power your computer is actually consuming. The bigger the difference, the longer the UPS will power the computer. The relationship is nonlinear because of the battery's discharge characteristics. As a rule of thumb, operating time is inversely proportional to discharge rate.

Just how much UPS operating time you need depends on what you're doing with your computer. If you're performing a task that can easily be interrupted

at any point, you'll only need enough time to write the contents of the computer's memory onto disk. If, however, you're in the middle of a long debugging program that must be completed before shutting down, you'll need much more backup time.

In effect, extended battery capacity becomes insurance. In most cases, you'll only need a UPS to ride through an outage of a few seconds or a minute or two. Rarely will your power be out for very long. Since you'll have to pay a significant amount for the extra battery capacity, you'll have to decide just how important it is to have insurance against an extended outage.

If you decide you need extended battery capacity, you can buy either a UPS with the required backup time—one with a considerably higher power rating than you need—or one to which you can add external batteries in parallel with the internal battery. Many UPS manufacturers make no mention of adding external batteries in their literature. If you're interested in extending the operating time of a particular UPS, contact the manufacturer and ask for advice. If you can add an external battery, and you have the room, you can put together a battery pack with enough storage capacity to run your computer for several hours, or even days. But—and it's a big but—the battery charger built into the UPS may not be able to handle the demands of the battery you add. Adding external batteries may also mean adding an external battery charger.

Square or Sine Wave Power

Choosing between on-line and off-line battery-backup designs and determining backup operating time are only two of the factors that you must consider when selecting an UPS. Another factor is the kind of ac power it provides. Most inexpensive UPS systems produce a square-

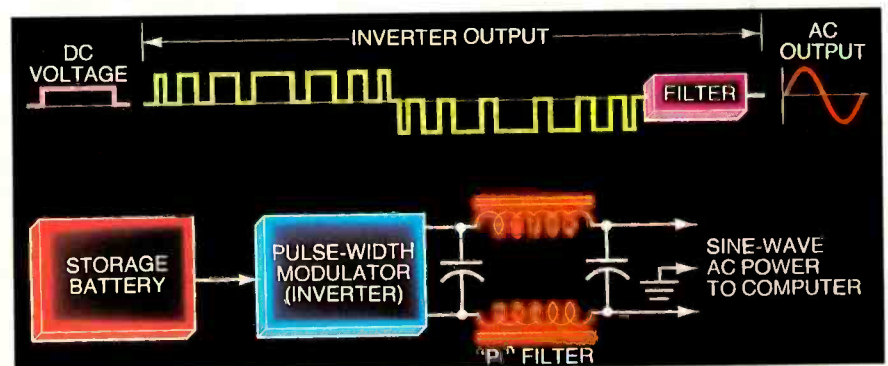

Fig. 5. Simplified diagram of pulse-width modulated UPS output circuit used to produce sine wave output.

like output waveform, not a sine wave—which is the waveform engineers usually conceive for ac power and which is the kind supplied by the power company.

Sine wave power has some interesting characteristics that affect the way things are rated. For example, all commonly used ac electrical ratings—volts, amperes, and watts—are based on the root-mean-square, or RMS value. In a sine wave, the RMS value is equal to approximately 0.707 of the peak value. Conversely, the peak value equals approximately 1.41 times the RMS value. The peak of a square wave, on the other hand, is equal to the RMS value. This

UPS Suppliers

Clary Corporation
320 W. Clary Ave.
San Gabriel, CA 91776

Cuesta Systems
3440 Roberta Ct.
San Luis Obispo, CA 93401

Deltec Corporation
2727 Kurtz St.
San Diego, CA 92110

Electronic Protection Devices
P.O. Box 673
Waltham, MA 02254

Saft America, Inc.
2414 W. 14th St.
Tempe, AZ 85281

Sola Electric
1717 Busse Highway
Elk Grove Village, IL 60007

Sun Research, Inc.
P.O. Box 210
New Durham, NH 03855

means that a 120-V sine wave peaks at around 170 V, while a 120-V square wave peaks at 120 V.

While the ratio of peak to RMS doesn't matter in lighting lamp bulbs, it makes a big difference to a switch-mode regulated power supply, or switcher, as it is more commonly called. A switcher is the kind of dc power supply that virtually all personal computers use. It contains an input rectifier circuit that converts the line voltage into a dc voltage that is usually twice the peak ac value. Using a switcher means that a 120-V sine wave input will be converted into 340 V dc. This relatively high dc voltage is then reduced by the switch-mode regulator to the 5, 12, 15, and/or 24 V dc your computer needs. However, since a 120-V square wave is converted into only 240 V

dc, the regulator may not be able to produce the required outputs. It all depends on the regulator's input window—the range of input voltages within which it can operate. If the window is wide enough, it will work anyway. But, the window may not be wide enough or, if it is, it may just be marginally so.

The only way to overcome this problem is to raise the square wave's amplitude to about the peak value of the sine wave. This increase however, also raises the RMS value to about 170 V, which is far too high for the switches to handle. The result is that the outputs produced by most inexpensive UPS are not true square waves.

An exception is Sun Research's line of 120-Hz square wave models. Sun claims that by doubling the line frequency, the flux density within the core of a 60-Hz transformer is reduced to 70% of its nominal value. As a result, the RMS value of the transformer's output will be the same as it would be with a 60-Hz sine wave input. However, these models can be used only with transformer-input power supplies. If you're not sure you can use a 120-Hz square wave UPS with your computer, contact Sun Research before making your purchase.

Square "Sine" Waves

Most UPS models that don't generate sine waves generate in one way or another what is known as quasi-sine-waves. While these square-like waveforms don't look anything like sine waves, their ratio of peak to RMS is relatively close. As a result, switching power supplies work quite well with them. In fact, switchers often work better with a quasi-sine-wave than with a true sine wave because the peak value is present for a longer period of time.

Some manufacturers use stair-step ramps to produce a waveform that roughly approximates the shape of a sine wave. Others, such as Cuesta Systems, use a simple rectangular waveform, which can be obtained much less expensively. By reducing the duty factor—the percentage of the time voltage is present—the amplitude can be increased without changing the RMS value. (See Fig. 3, which shows that a rectangular wave with a 75 percent duty factor closely approximates the peak-to-RMS value of a sine wave. The shaded areas inside and outside the sine wave are approximately equal.) In other words, a 160-V

(Continued on page 117)

Al Frankel is a California-based freelance author who writes frequently for technical magazines.

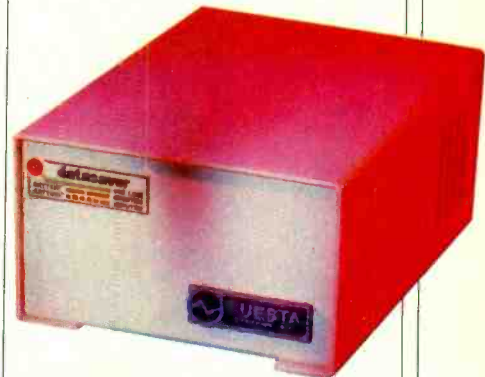

From top: Sola SPS, EPD Grizzly, Cuesta Datasaver, Sola Mini UPS with auxiliary battery.

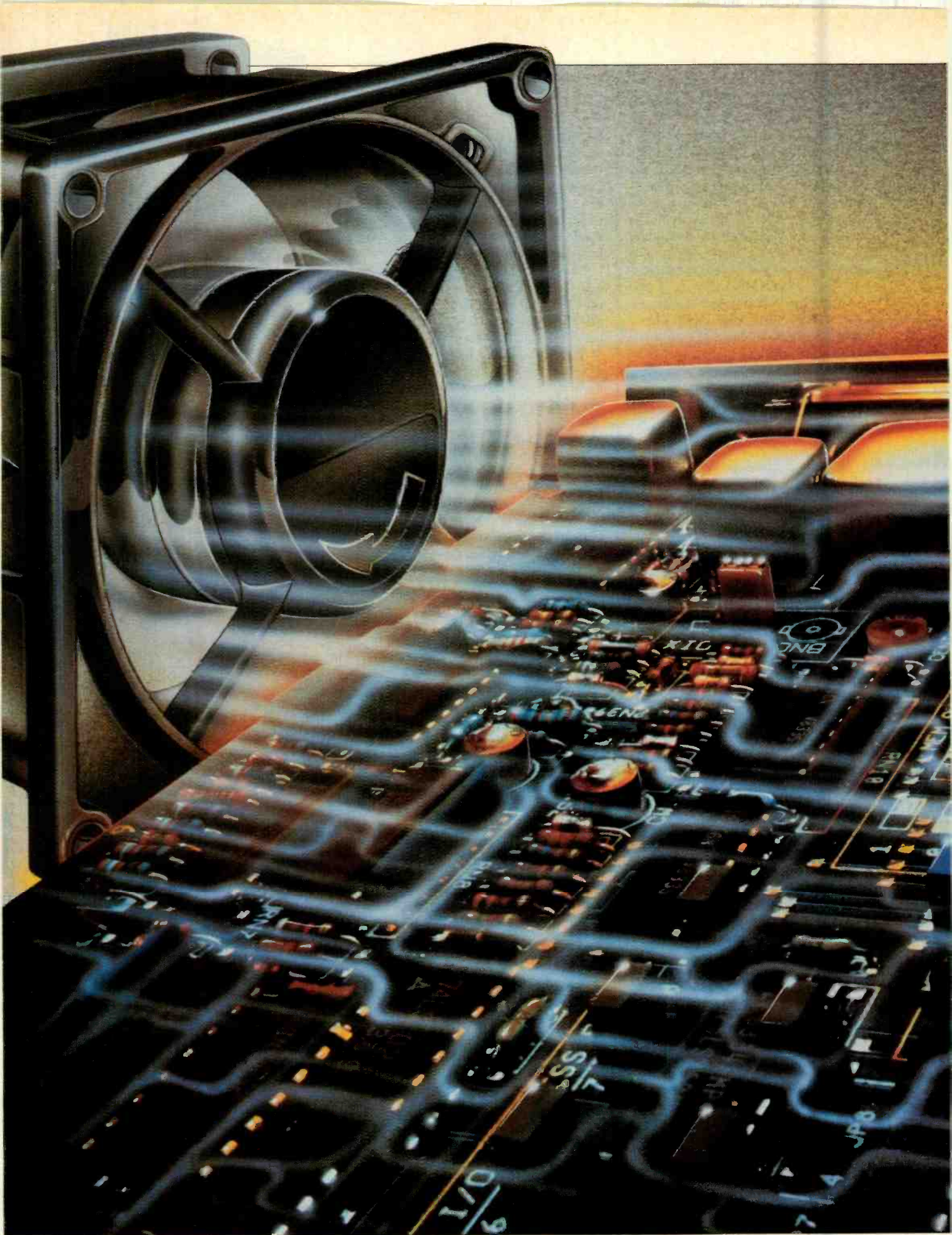

HOW TO KEEP YOUR MICRO COOL

Ways to prevent the problems due to heat build-up in your micro

BY D'ARLYN C. APPEBOEN-FROMME



As more people become familiar with their personal computers, they look forward to expanding their systems by adding circuit boards and devices from various manufacturers. This not only gives them the exact configurations they need, but also provides a measure of economy. Heat problems can develop, however, when expansion cards and other devices are added. Heat can cause errors and system failures, which are frequently hard to diagnose. If a system fails after hours of operation, the frustrated user may turn the computer off and stalk away, planning on coming back later. Of course, when he does return and finds that the problem has disappeared, he tends to believe that it was his fault when, in fact, it may have been a system error.

This scenario is typical of an overheated computer, which, after cooling down, again functions normally.

Overheating can arise from a number of causes. In all of them the end result is that the computer's case acts like an oven by trapping the heated air. As the computer's internal heat builds up, the likelihood for software (or hardware) failures increases.

Most manufacturers work hard at designing the enclosures and internal configurations of their computers to ensure good circulation. Some manufacturers even include fans. And, as long as the initial configuration of the computer is not altered, the cooling arrangements they provide are generally adequate to keep the computer operating comfortably. But when additional circuit boards are placed in a computer's expansion slots, several things can happen.

The first is a restriction of airflow. This occurs

when the added boards block air vents, reducing or eliminating air movements. Figure 1 is a top view of an IBM PC with arrows showing the manufacturer's intended air paths. Air is drawn in through the slots at the front of the computer by the fan built into the power supply.

Note that when expansion cards are added they tend to restrict the airflow within the computer. IBM's original designers probably did not intend for the expansion cards to fill the entire space allocated for them. However, whenever space exists, it will be used.

Large expansion cards add to the problem in two ways: the larger the card, the more heat-producing components it will contain and, the bigger it is, the more it will restrict airflow.

Once the airflow has been slowed within a computer, heat gradually increases in localized areas causing "hot spots." These hot spots arise from components that operate at high temperatures (the 8087 math co-processor is a good example).

As the stagnant air heats it begins to circulate locally due to natural convection and tends to cool the component to a certain degree. As the air within the computer reaches thermal equilibrium, the natural convection process slows and eventually stops, and the component begins to heat up again. If the local temperature increases above a safe operating level for the components involved, errors in processing or a system crash can occur.

Add-on circuit boards can block airflow in a second way. There is usually a space of approximately $\frac{1}{4}$ " to $\frac{3}{4}$ " allowed between the top of the circuit boards and the cover of the computer. This space is essential for proper airflow. When something (such as a monitor) is set on top of the computer, this gap can narrow, restricting air circulation. Care must also be taken to avoid set-

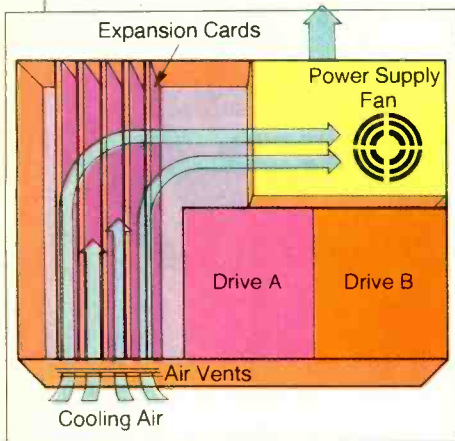

Fig. 1. Airflow in the IBM PC.

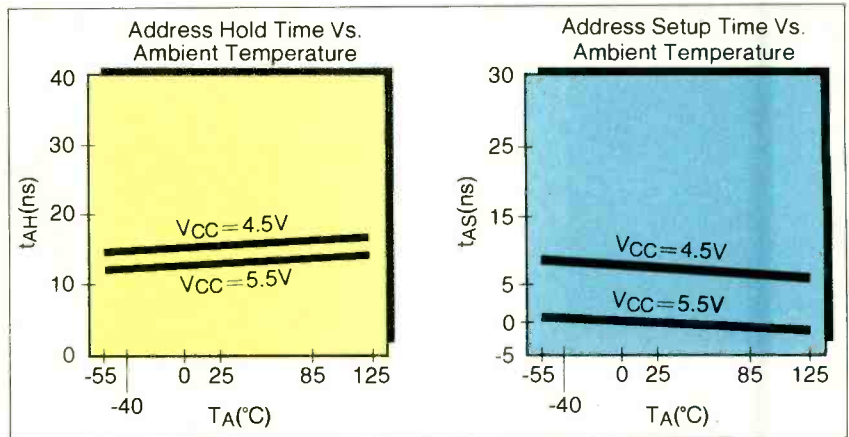

Fig. 2. Time of operation plotted against temperature.

ting anything in front of the vents used for air intake.

In early microcomputers memory chips ran hot—very hot. Today's low-power CMOS RAMs are cooler, but heat can still be a factor in their operation. In their quiescent state, CMOS RAMs consume virtually no power and thus generate very little heat. If they are accessed frequently, however, their power consumption increases, and their temperatures rise.

This phenomenon baffles many users. They may run their computer on a hot day for hours and have it function normally. On a cooler day, after just a few

runs, the system may crash. Why? The reason may be that the program that was run on the cooler day made much more frequent memory accesses, thereby adding more heat to the system than on the hot day after long hours of operation.

Effects of Overheating

High operating temperatures can change the operating characteristics of semiconductor memory and other digital components of a computer system. These changes can lead to errors arising from random or incorrect operation of the digital switches they contain.

High temperatures can degrade per-

formance by moving the logic-0 or logic-1 voltage closer to the switching thresholds of the devices, and in changing the switching thresholds themselves, resulting in spurious triggering or changes in address hold-time or address setup-time for semiconductor memory. Billionths of a second are critical to a properly operating computer. The relation between time of operation and temperature is shown in Fig. 2. Since proper operation of the entire computer is highly dependent on accurate timing, any deviation can send it straight into "never-neverland."

In addition to the problems that arise from the effects of heat on semiconductor circuitry, high temperatures can bring about other effects that may be responsible for computer failure.

Electronic components have finite lifetimes, which to a great extent depend on the temperatures at which they are operated. Overheating decreases the MTTF (Mean Time To Failure). In view of this, even if there is no immediately apparent computer failure due to overheating, the computer may be slow-cooking itself to a premature grave.

When the computer heats up and then cools down and does so repeatedly, the circuit boards expand and contract. This can, over time, lead to poor contact between the boards and their connectors. The hotter the computer is allowed to run, the more the boards expand. This is why jiggling the boards or pulling them out of their slots and then replacing them can sometimes reestablish electrical contact and "cure" an apparent failure.

Moreover, integrated circuits can, over the course of time, "walk"—and sometimes literally *pop*—out of their sockets because of thermal expansion and contraction. It's a good idea, from

Fig. 3. The IBM PC has a fan built into its power supply. Another (bottom) can be added for better air circulation.

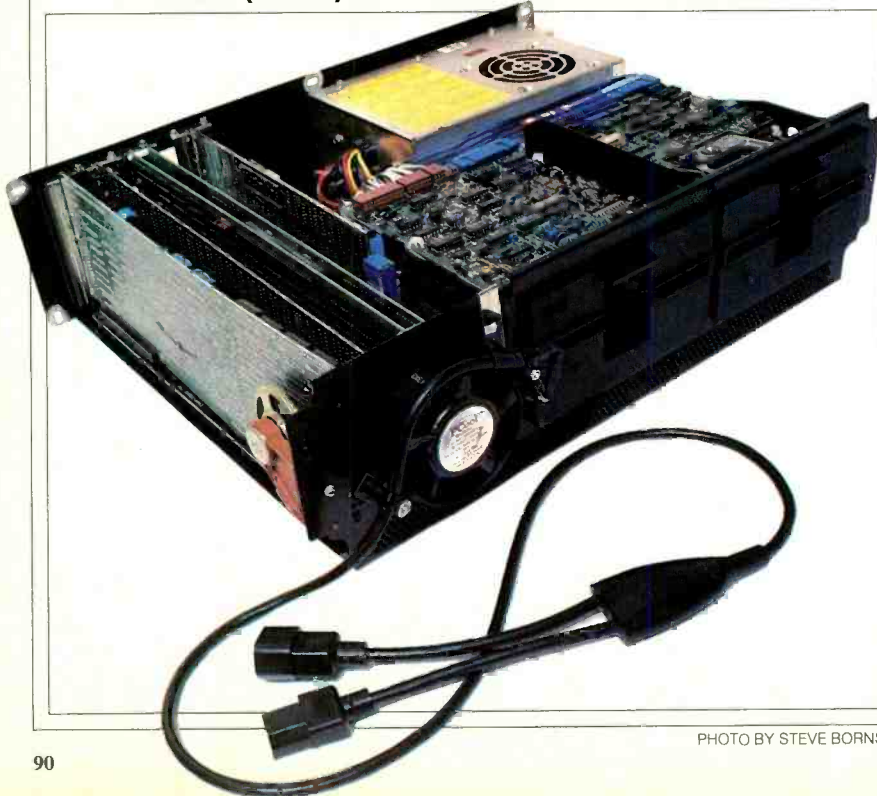
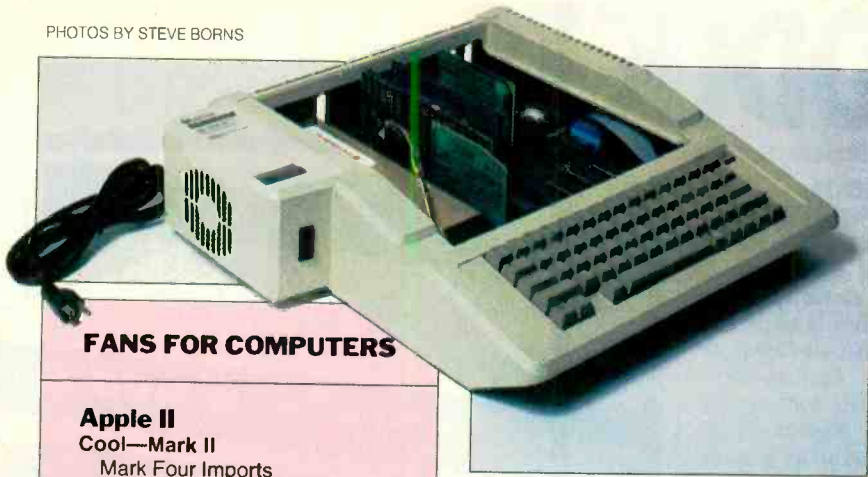

PHOTO BY STEVE BORNIS



FANS FOR COMPUTERS

Apple II

Cool—Mark II
 Mark Four Imports
 P.O. Box A
 San Gabriel, CA 91776
 213-287-9945

Cool + Time™
 Tencal, Inc.
 9525 DeSoto Avenue
 Chatsworth, CA 91311
 213-988-4850

Cooling Fan
 Shellner
 P.O. Box 26
 Loma Linda, CA 92354-0026

Super Fan II™
 RHElectronics, Inc.
 566 Ireland Street
 Buellton, CA 93427
 805-688-2047

System Saver™
 Kensington Microware Ltd.
 300 East 54 Street, Suite 3L
 New York, NY 10022
 212-486-2802

IBM PC
PCool™
 Analytic Information Processing
 P.O. Box 966
 Danville, CA 94526
 415-837-2803

PC Airflo™
 ABC Computer Peripherals, Inc.
 77 Columbia Street
 New York, NY 10002

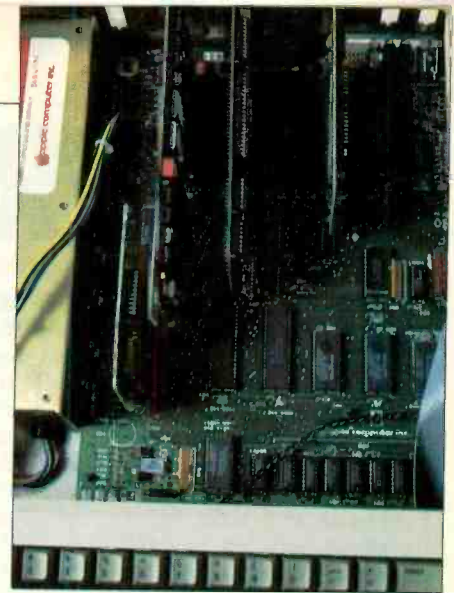

Too many boards impede the natural flow of air.

Fig. 4. The Apple II, with System Saver on the left side.

board by rubbing gently with a soft pencil eraser. This procedure should not be performed too frequently, though, since it can lead to the erosion of whatever plating may be on the finger contacts. A product that has proven to be of some value in preventing oxidation and corrosion is Cramolin (Monster Cable Products, Inc., 101 Townsend St., San Francisco, CA 94107). Cramolin is available at stores that handle high-end audio products and accessories.

Is It Overheating?

There is no way to list all the possible ways in which heat can cause a computer to fail. In fact, such failures many times go unnoticed. However, if a computer crashes and its case is hot, the cause of the crash is likely to be overheating.

Besides a complete and catastrophic system crash, symptoms of thermal fail-

ure can include wrong or senseless results, random printer or video display activity, and—worst of all—spontaneous disk accesses.

Should any of these occur, there are ways to determine whether the problem is due to overheating. The simplest way is to remove the cover of the computer and see whether the problem disappears. With the cover removed, the trapped heat can dissipate, and the airflow may be enhanced. Operating a computer with its cover removed can, however, create other problems that will be discussed below.

A second method involves putting a fan in front of the computer's air-intake
(Continued on page 114)

D'Arlyn C. Appeboen-Fromme is an engineer/analyst for Analytic Information Processing, Inc.

Clockwise from left: System Saver for the Apple, PCool for the IBM, and a fan of the type built into many computers.



PHOTO BY BOB LORENZ

time to time, to make sure that all ICs are firmly seated in their sockets by pressing on them gently with a finger.

Under certain conditions corrosion and oxidation that affect the quality of the electrical connections at jumpers, plugs and IC sockets can occur. The process that forms these products is accelerated in the long run by high heat. This problem can also be cured temporarily by jiggling the boards or connectors, which wears through the corrosion products and restores the circuit.

Corrosion and oxidation can be removed from the finger contacts of a PC

NEW PRODUCTS

MULTIBUS COMPATIBLE SINGLE BOARD COMPUTER

The iAPX-186 single-board, Multibus-compatible, computer from Monolithic Systems Corp. features Intel's iAPX-186 16-bit processor operating at 8 MHz, and is available with up to 512K bytes of onboard dynamic RAM. There are sockets for up to 128K bytes of EPROM, and 24 programmable parallel I/O lines controlled by a PPI chip enable these lines to be used as either unidirectional or bidirectional ports. Two iSBX connectors enable I/O expansion and use of Multimodule boards. Other features include three additional software-programmable 16-bit interval timer/event counters for external use, operating in either BCD or binary mode. A programmable interrupt controller handles up to eight bus or non-bus vectored interrupts that can be

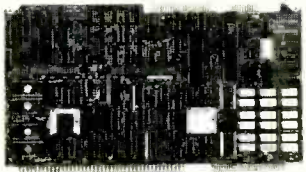

expanded via external devices to handle up to 64 interrupts. \$2280.

Circle No. 71 on Free Information Card

TRIPLE-MODE MATRIX PRINTER

The new TRS-80 Model DMP triple-mode impact dot-matrix printer from Radio Shack offers both parallel and TRS-80 Color Computer interfaces. It features correspondence- and draft-quality, as well as high-resolution graphics, printing modes. Built-in is a wide range of character fonts, including cursive-italic and micro styles, as well as fonts for correspondence and data processing, all of which can be elongated and/or underlined. Pitch in the correspondence mode can be 10 or 12 cpi or



proportionally spaced, and speed is 25 cps. Half-height characters and super/subscripts are obtained using a microfont type style. Pitch in draft mode can be 10, 12, or 17 cpi, at a 50-cps throughput, in standard, elite, or condensed monospaced characters. The graphics mode produces up to 960 dots per horizontal 8" line, with 7- or 16-dot columns. The DMP printer measures 16 1/2" W x 12 7/16" D x 4 5/16" H and weighs 12 lb. \$399.95.

Circle No. 72 on Free Information Card



MULTIPLEXER WITH MODEM

The TriMux.212 from Complex Systems is a three-channel switching statistical multiplexer having a built-in autodial/autoanswer 212A modem that allows three computers and/or peripherals to share a single dial-up telephone line simultaneously. Multiplexing the three inputs over a common 1200-bps telephone line increases the throughput and also provides

automatic retransmission in case of line errors. When the computers or peripherals are not using the TriMux.212, any of the devices can use the modem to call any other 212A modem. When not communicating with a modem, the three local devices can access and communicate with each other. It can be used where two PCs share a printer. The two need not run at the same speed. \$1495.

Circle No. 73 on Free Information Card

TYPEWRITER MODEM

The model 300 from California Micro Computer enables a conventional IBM Model 50, 60, 65, 75, 85, or 95 electronic typewriter to be connected to a standard modular telephone for electronic mail, news messages, and database access. The typewriter can transfer

data at 300 baud and includes a buffer memory to speed up the data transfer. No modifications are required of the typewriter. Features include autodial, autoanswer, and redial. The desired phone number is typed on the typewriter keyboard. \$449.

Circle No. 74 on Free Information Card

SOFTWARE SOURCES

Keyboard Improver. Q-Vert from Q.A.D. Systems is a program designed to help Commodore C-64 and VIC-20 (with 8K expansion) users to master the more efficient Dvorak keyboard. Typing improvement with this software is claimed to be 30% to 80% over the standard QWERTY keyboard, offering speeds up to 182 wpm. Q-Vert Mentor tutorial converts the keyboard to the Dvorak layout through software and takes the user through 26 programs in five levels. The user sets his own speed, while Mentor gives feedback on progress. The programs make use of sound and graphics. The Q-Vert package consists of a Q-Sub subroutine that can be copied and incorporated into any user program and permits Dvorak input to the program. \$29.95 + \$2.00 S/H. Address: Q.A.D. Systems, 342 E. Schrock Rd., Waverly, OH 43081.

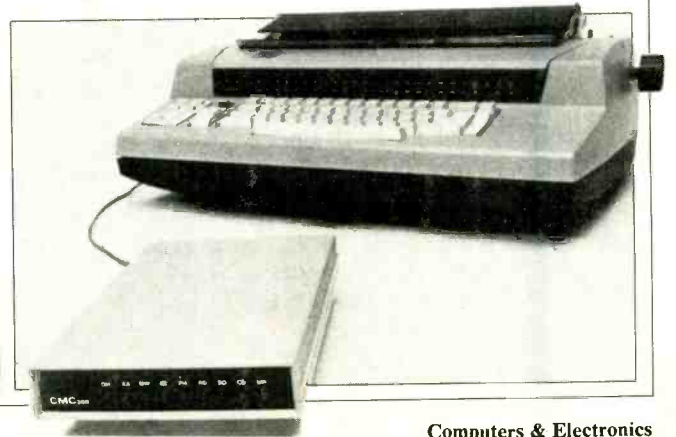

Build your own IBM PC compatible and save hundreds of dollars.



Heath proudly announces the NEW HS-151 Desktop and HS-161 Portable computers.

One of the world's largest software libraries has IBM's name on it. Now you can run that software on Heath's new IBM PC compatible computers, available in easy-to-build kits.

Can you build one of these computers? 85% of our first-time customers ask the same question. And the answer is 100% yes. You can.

In fact, you *should* build one. You'll save a lot of money while learning about computers in general and the Heath PC's in particular.

Build confidence... and your new computer... one step at a time. Two main circuit boards come to you pre-assembled and factory-tested. So that you can build the three other boards, we include a test soldering board plus helpful soldering instructions to make sure you get it right.

Our instructor manuals are easy to understand, thorough and packed with cogent illustrations. And once it's built, the computer guides you

through a full range of included disk-based diagnostics.

Expert advice is only a phone call away, should you need it. You'll reach a trained consultant whose specialty is talking sense, not jargon.

We'll do whatever's necessary to make our pledge come true: "We Won't Let You Fail." Our entire business depends on that simple promise.

Experience a little wonder and a lot of pride. Save

money, too, by building the highest quality personal computer. The Heath PC's have 128K RAM standard (expandable to 640K), a professional keyboard, dual 360K disk drives and optional Winchester.

These machines are truly complete. Both are color capable and MS-DOS is included.

Check out the Heath PC computers today. IBM compatibility means they'll run the most popular software. And, with the money saved by building a kit, think of all the peripherals and software you can buy!

HS-151 Desktop PC with standard floppy disk drive or optional hard disk.

CRCLE READER SERVICE CARD. Get more information on the most rewarding personal computers. The HS-151 Desktop PC and HS-161 Portable PC.

*MS is a registered trademark of Microsoft Corporation.

For computing on the go... the HS-161 Portable.



The HS-161 has the same features as the HS-151. Amber Monitor included. Convenient keyboard folds up, two disk drives fold down.



Heathkit[®]
Heath
Company

A subsidiary of Zenith Radio Corporation

Circle No. 26 on Free Information Card

CP-230

SOFTWARE SOURCES

Computer/Printer Linker. SoftKey's Keyprint is a software utility that gives users of Apple II and IIe, IBM PC and PC-XT, and PC-compatibles complete menu control of the character sets and font capabilities of Epson MX, RX, and FX dot-matrix printers. The package is designed to provide nontechnical computer users with access to all the capabilities of his printer with the unique features of any applications software packages for their computers. More than 20 options are available on the menu, including double strike, compressed, italics, and other enhanced character sets. It is claimed that Keyprint can make the Epson printer series produce correspondence and near-letter-quality (NLQ) characters. \$59.95. **Address:** SoftKey Software Products, Inc., 2727 Walsh Ave., Santa Clara, CA 95051.

IBM PC/XT HIGH SPEED MODEM

The FAXT-96 modem board from Gamma Technology allows IBM PC/XT and compatible equipment to communicate at 9600 baud over conventional telephone lines. This reduces the waiting time for a typewritten page from 22 seconds at 1200 baud to under 3 seconds. Thus if 50 pages were transmitted in batch mode once per day, the FAXT-96 could save about

\$2000 per year in telephone charges. The modem board plugs into an adapter slot and features autodial, auto-answer, and multiple speed selection. The product is a synchronous, half-duplex unit that conforms to CCITT V.29 and V.27 standards and comes bundled with support software. The minimum IBM PC/XT configuration is DOS 2.0, 128K memory, and 160K disk drive. \$1995.

Circle No. 75 on Free Information Card

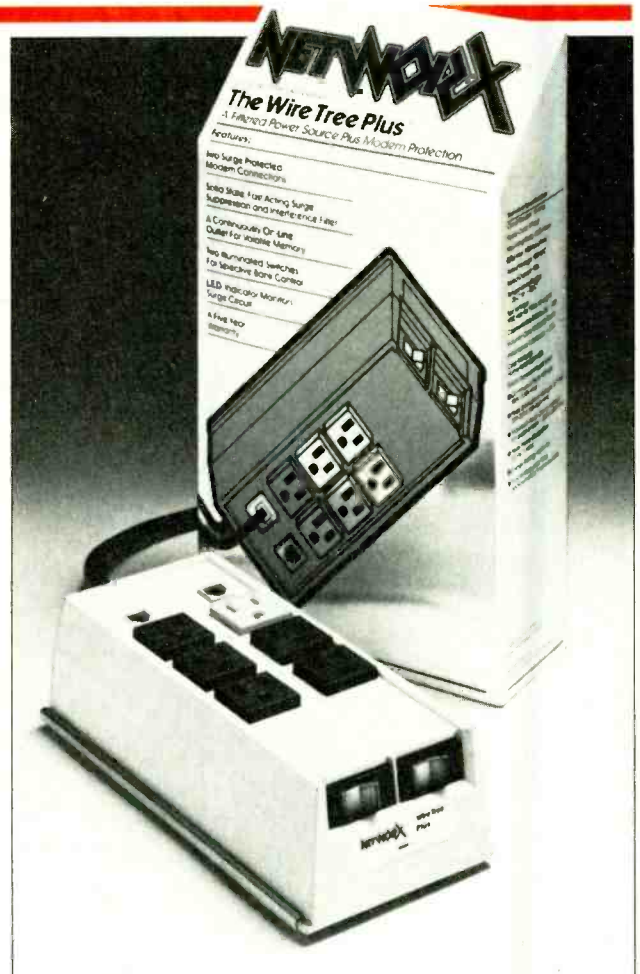
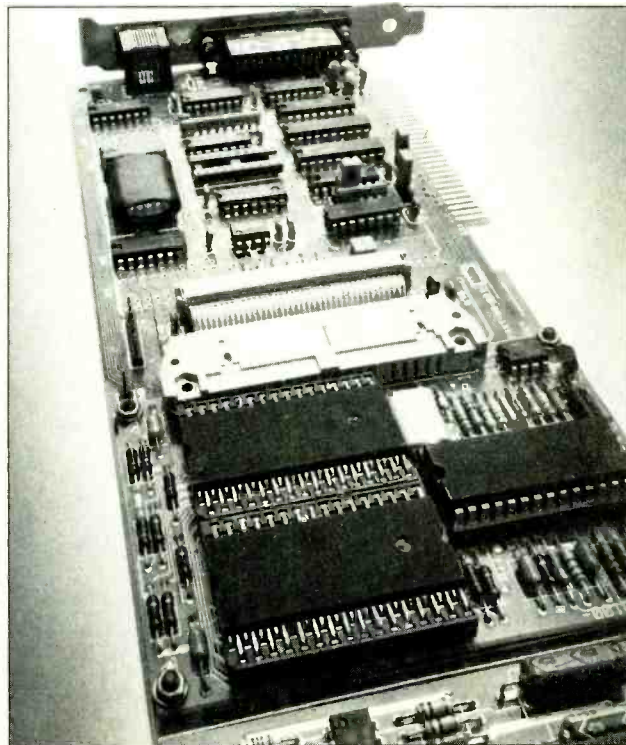

FILTERED POWER SOURCE

The Wire Tree Plus from Networkx minimizes the voltage surges, spikes, and radio frequency interference components that, according to statistics, cause up to 65% of all computer service calls.

The Wire Tree Plus handles up to six outlets and can be mounted in any available space. Two illuminated switches control power for five of the outlets, while the sixth is continuously on line. \$99.95.

Circle No. 76 on Free Information Card

IBM COMPATIBLE KEYPAD

The Touchstone I, from Touchstone Technology, Inc., is a dedicated 29-key, 8" square numeric keypad for the IBM PC and XT systems designed to improve productivity for numeric data entry and manipulation in spreadsheets, accounting, and other number-intensive applications. It features dedicated cursor controls, SPACE, BACKSPACE, HOME, ENTER, and a full set of math keys including percent and brackets.

All keys have autorepeat. One of its two cables connects directly to the computer, while the other mates with the computer-provided keyboard to allow both keyboard and keypad to be used concurrently. \$169.95.

Circle No. 77 on Free Information Card

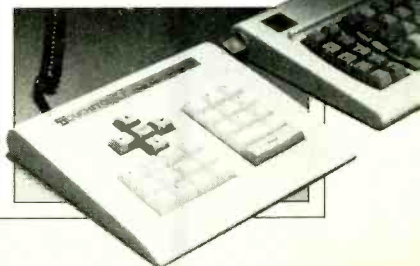

MASTER THE NEW ELECTRONICS WITH MCGRAW-HILL'S

Contemporary Electronics Series

The fast, easy and low cost way to meet the challenges of today's electronic innovations. A unique learning series that's as innovative as the circuitry it explains, as fascinating as the experiments you build and explore.

From digital logic to the latest 32-bit microprocessor, the McGraw-Hill Contemporary Electronics Series puts you into the electronic picture one easy step at a time. Twelve unique *Concept Modules*, sent to you one every 4-6 weeks, give you a handle on subjects like optoelectronics, transistors, integrated circuits, logic circuits, and more.

Each Concept Module goes right to the heart of the matter. You waste no time on extraneous material or outdated history. It's a fast, efficient, and lively learning experience... a non-traditional approach to the most modern of subject matter.

Unique Interactive Instruction

With each module, you receive a McGraw-Hill Action Audio Cassette. Each tape is a dynamic discussion that drives home the key facts about the subject. Your learning

With your first module, you get this solderless breadboarding system. You'll use it throughout the series to build electronic circuits and bring concepts to life.

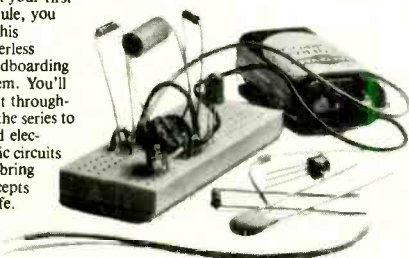

experience is reinforced through interaction with vividly illustrated text, audio cassettes, and actual electronic experiments. Indexed binders preserve backup material, notes, and tapes for convenient referral.

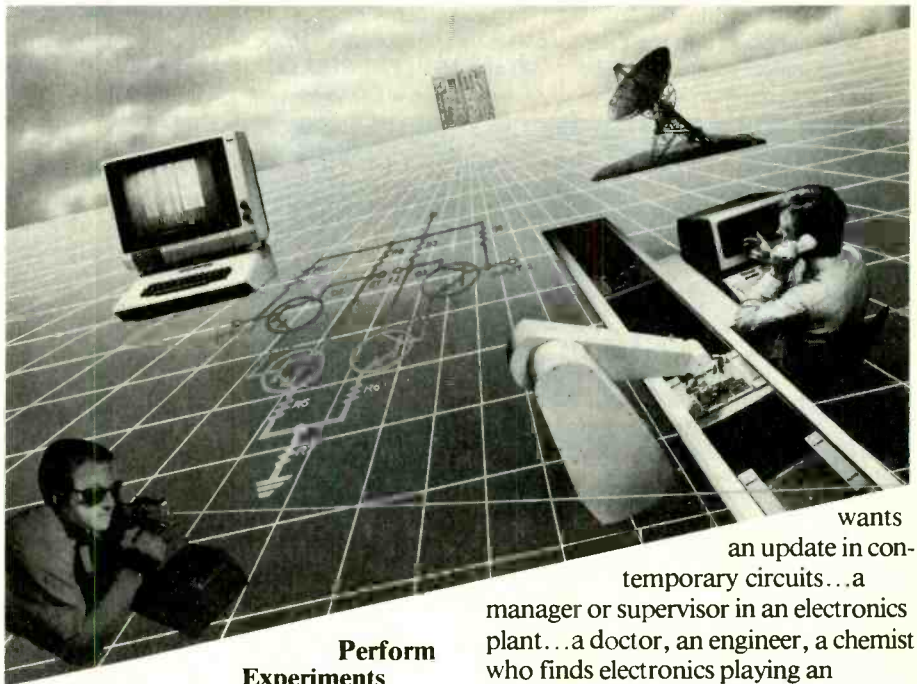

Perform Experiments in Contemporary Electronics

Throughout your series, laboratory experiments reinforce every significant point. This essential experience... dynamic, hands-on demonstrations of theory in practice... will help you master principles that apply all the way up to tomorrow's latest VLSI (Very Large Scale Integrated) circuitry.

In your very first module, you'll use integrated circuits to build a digital oscillator, verifying its operation with a light emitting diode (LED). You'll learn to identify passive and active components, understand concepts common to all electronic circuits.

For Anyone Interested in Electronics

The Contemporary Electronics Series is designed for anyone from hobbyist to professional. It's for you if you're looking for new fields of interest... if you're a teacher who

wants an update in contemporary circuits... a manager or supervisor in an electronics plant... a doctor, an engineer, a chemist who finds electronics playing an increasingly important role in your work. It's even for electronics engineers or technicians who feel their training needs freshening up. It's the quickest, most convenient, probably least expensive way to do it. And the only one that gives you hands-on experience.



15-Day No-Risk Trial

To order your first module without risk, send the postage-paid card today. Examine it for 15 days under the terms of the order form and see how the Contemporary Electronics Series gets you into today's electronics. If card has been used, write us for ordering information.



McGraw-Hill
Continuing Education Center
3939 Wisconsin Ave.
Washington, D.C. 20016

NEW PRODUCTS

TRS-80 HIGH RESOLUTION GRAPHICS

The Grafyx Solution from Micro-Labs, Inc., is an add-on board for the TRS-80 Model 4 computer that allows a video resolution of 640 by 240 (153,600) individually accessible pixels. The board fits completely within the computer and plugs into the TRS-80 graphics connector. The software contains over 40 pro-

grams and files, is compatible with TRSDOS 1.3, 6.1, LDOS, NEWDOS80, and DOSPLUS, and features Extended Graphics BASIC, which adds over 20 commands to BASIC. Sections of the screen can be saved to disk without leaving BASIC. It also prints labels in any direction and dot densities to 640×240, 320×240, 160×240 and 160×120. \$199.95.

Circle No. 78 on Free Information Card

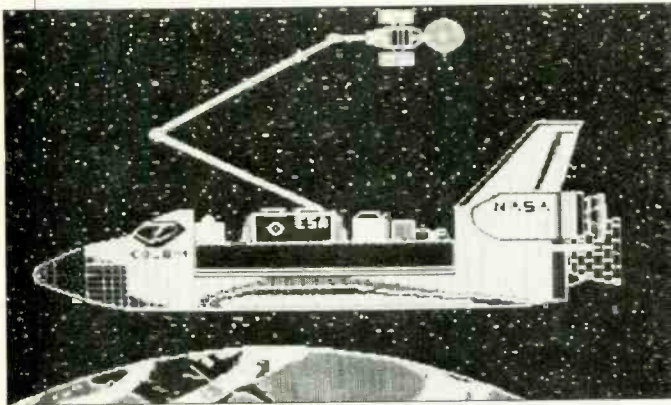

TAPE STORAGE SYSTEM

The TG-4060 from Tallgrass Technologies Corp. allows users to store and access up to 60M bytes of data on a tape

storage system. It uses 11-track ANSI-standard DC-600A or DC-615A tape cartridges with a transfer rate of 720K bytes/second. \$1995.

Circle No. 79 on Free Information Card

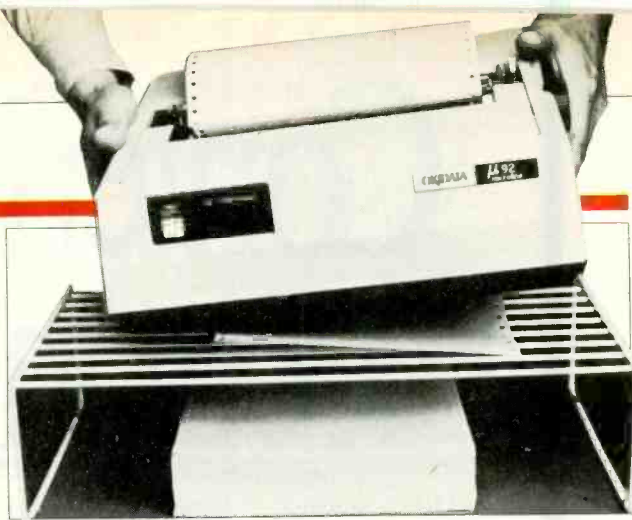

PRINTER PEDESTAL

The Pedestal from Zavie Enterprises is a desktop printer stand designed to eliminate desktop clutter and save space. It can accommodate a rear- or bottom-feeding printer, with the paper below. Fabricated from 1/4" welded met-

al rods, the stand can support up to 100 lb. Models are available for 80-column (9 1/2"), or 132-column (15") paper. It can accommodate about 1000 sheets of paper. The 80-column is \$19.95, and the 132-column is \$24.95.

Circle No. 80 on Free Information Card

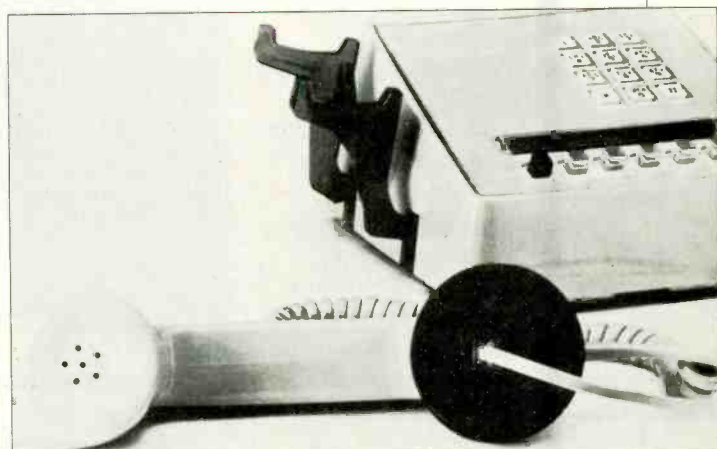

PORTABLE MODEM

The Black Jack device facilitates the use of a telephone modem for computer-to-computer access in hotels, offices, or other places on the road. To use the device, the conven-

tional telephone mouthpiece is unscrewed, the microphone removed, and the Black Jack device put in its place. A line cord is inserted between modem and Black Jack. \$50.

Circle No. 81 on Free Information Card

SOFTWARE SOURCES

Sprite Editor. The Animator is a sprite graphics editor from Dynacomp for the Commodore C-64 computer. For each sprite created and edited by this program, the user can specify color, location, magnification, and priority. The program is particularly useful for setting up sequences of sprites that, when animated, indicate motion. These sprites can be saved on-disk and recalled as desired. Up to 256 views can be placed in each of four banks. Editing features include duplicating, for building long sequences; inserting; expanding horizontally, vertically, and horizontally and vertically; fill; test views; and more. In addition a command has been added to BASIC to permit the sprites to be used in programs. \$29.95 on diskette. Address: Dynacomp, Inc., 1427 Monroe Ave., Rochester, NY 14618.

USING?...BUYING?... UPGRADING?...

A GRAPHICS PACKAGE FOR YOUR PC

You have to create graphs and charts to tell your story. Your needs vary from financial statements and personnel benefits to inventory records...presentations are made on printouts, slides and tele-monitors...and for the most part, a salesman or a representative other than yourself makes the presentation. You really need a good and simple graphics package, one that will help you tell the story, without using a lot of your valuable time. You need **DESKTOP GRAPHICS FOR THE IBM PC: PRINTERS, PLOTTERS, CHARTS AND GRAPHS**, the fully illustrated guide to the preparation, design and production of business graphics. This is a book written with you in mind, the business or professional user with little technical or statistical knowledge, using or planning to purchase a graphics package.

Topics include: • What hardware options you have • What software will best meet your needs • What charts are available to you and your IBM PC • What data works best with each chart • What is the difference between a mean, mode and median • How to shoot slides directly from the screen • Visitrend - Peachtree - BPS - 1, 2, 3—what's right for you.

Author Corey Sandler gives you clear and non-technical introductions to graphing theory and statistics, explaining and evaluating your hardware options (including printers, plotters and monitors), plus so much more!

If you've been contemplating buying a new graphics package or just want to get more out of your current package, this book is for you!

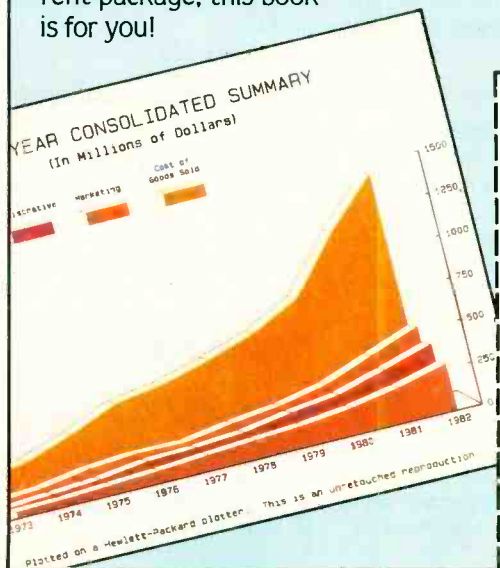
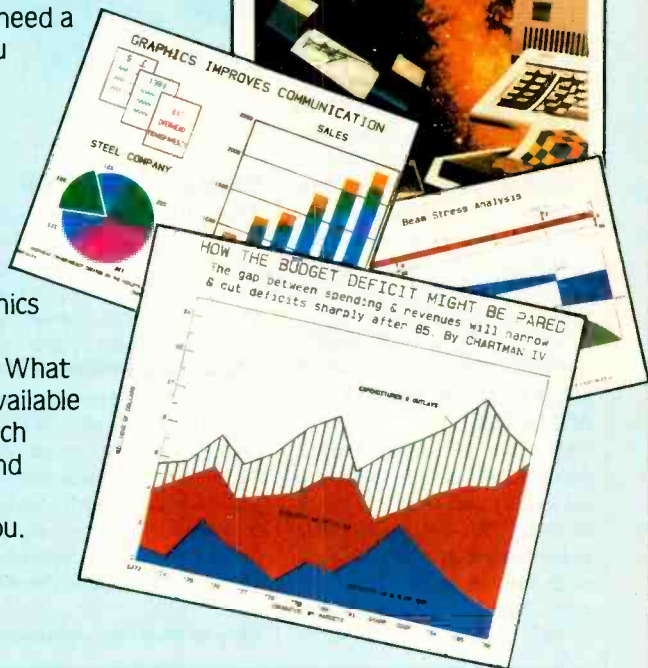
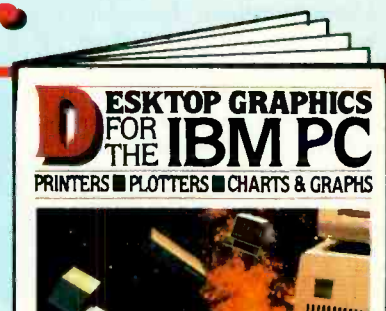

**For faster delivery,
PHONE TOLL FREE 9 am-5 pm E.S.T.:
1-800-631-8112
(In NJ only: 201-540-0445)**

Also available at your local bookstore or computer store.

CREATIVE COMPUTING PRESS

Department FE8F 39 East Hanover Avenue, Morris Plains, NJ 07950

Please send me _____ copies of **DESKTOP GRAPHICS FOR THE IBM-PC: PRINTERS, PLOTTERS, CHARTS AND GRAPHS** at \$14.95* plus \$2.00 postage and handling (\$5.00 outside USA) each. Item #60-7.

Payment Enclosed \$ _____ * Residents of CA, NJ and NY State add applicable sales tax.

Charge My: AmEx MC Visa

Card No. _____ Exp. Date _____

Mr./Mrs./Ms. _____ print full name

Address _____

City/State/Zip _____

Please send free catalog.

NEW PRODUCTS

ETHERNET LINK

The CS/100-14 communications server from Bridge Communications, Inc., acts as a terminal server to link an Ethernet LAN to 14 devices equipped with RS-232C interfaces. The network can be expanded by adding additional CS/100s, the 32-port CS/1, or other compatible Bridge gateway servers that link remote Ethernets over x.25 public data networks or point-to-point communications links. The CS/100-14 is based on a 68000 CPU and supports Xerox Network System (XNS) high-level network protocols. Connection between devices is executed through user command software. \$5400.

Circle No. 82 on Free Information Card

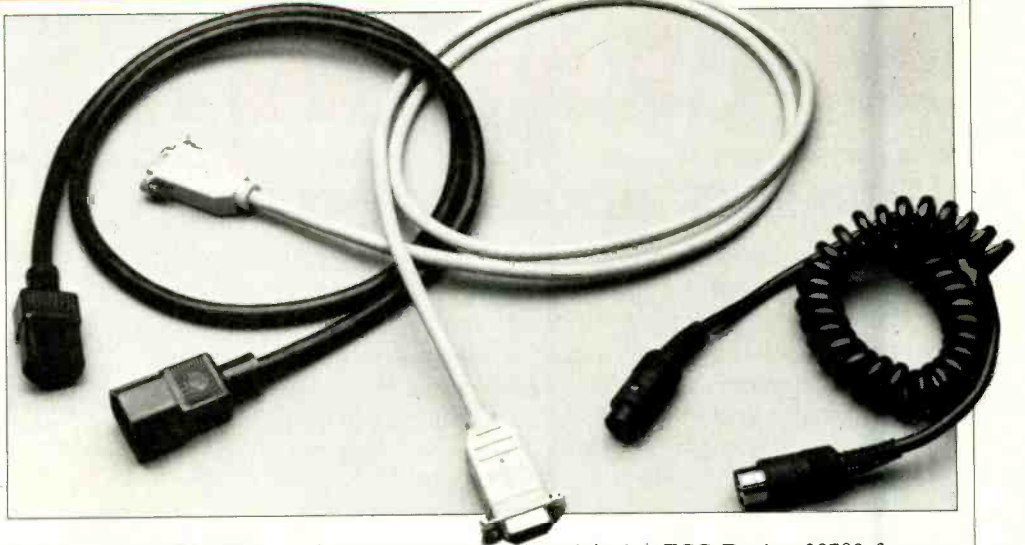

CABLE EXTENDER

The C500 series from Computer Accessories is a three-piece "6-foot extension cable" set for the IBM PC/XT and TI PC monitor, power, and keyboard cables. Each cable

connects between the original cable and the system connector. The extension cables will not loosen or disengage from normal tugs and pulls. They meet or exceed Underwriters Laboratories UL-2464 and

FCC Docket 20780 for controlling RFI/EMI emission. The C500 for TI PC monochrome, \$29. The C501 for the TI color and the C502 for IBM monitors, \$59.

Circle No. 83 on Free Information Card

RGB COLOR VIDEO MONITOR

The Color 600 from Amdek features 640 dots per horizontal line by 240 lines in a black matrix CRT. A switchable color matrix allows it to provide full 16 colors for IBM and Apple. A front-panel switch changes text color

from white to green for easier reading. The Color 600 can provide up to 80 columns by 25 lines of alphanumeric display. A built-in audio amplifier and loudspeaker are also provided, with a headphone jack for individual listening. \$650.

Circle No. 84 on Free Information Card

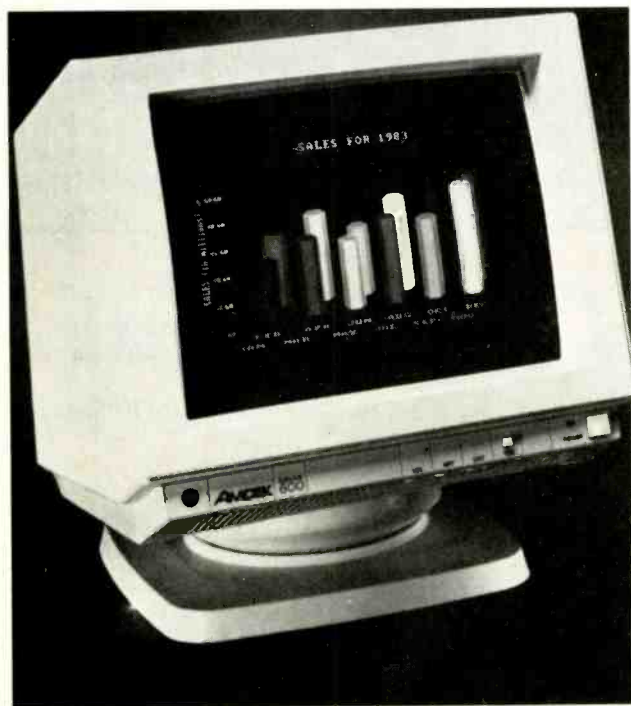

SOFTWARE SOURCES

Pascal Development Package. SofTech Microsystems now has a bundled Pascal-based software development package for the DEC Rainbow computer. It consists of three parts. The first is a fully developed UCSD Pascal compiler, with extensions for systems development and commercial applications programming. The second is the p-System, which is designed for text processing and application execution with a full-screen editor and integrated development tools. The last is the Insight Window programming productivity tool kit, which provides windowing capabilities and enhancements for multiple applications integration, including a text-based window editor, hierarchical main menus, and on-line help services in an open applications programming environment. \$399.

Circle No. 93 on Free Information Card

VERSABUS/ETHERNET INTERFACE

The V/EIU (Versabus/Ethernet Interface Unit) from Advanced Computer Communications allows mini- and microcomputers using the 68000-based Versabus to interface with Ethernet-like (IEEE 802.3) local area networks. The unit provides controller logic and performs physical and data link layer protocol functions in accordance with Ethernet and IEEE 802.3 requirements.

The unit consists of a single pc board that plugs into the Versabus host backplane and appears as a set of memory-mapped I/O ports with a 32K byte block of dual-ported memory. \$3000.

Circle No. 85 on Free Information Card

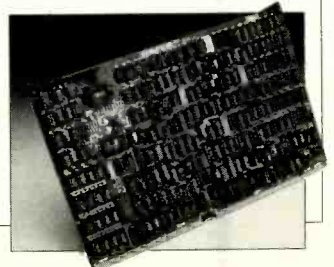



LAST NIGHT, COMPU SERVE TURNED THIS COMPUTER INTO A TRAVEL AGENT FOR JENNIE, A STOCK ANALYST FOR RALPH, AND NOW, IT'S SENDING HERBIE TO ANOTHER GALAXY.

No Matter Which Computer You Own, We'll Help You Get The Most Out Of It.

If you've got places to go, CompuServe can save you time and money getting there. Just access the Official Airline Guide Electronic Edition—for current flight schedules and fares. Make reservations through our on-line travel service. Even charter a yacht through "Worldwide Exchange."

If your money's in the market,

CompuServe offers a wealth of prestigious financial data bases. Access Value Line, or Standard and Poor's. Get the latest information on 50,000 stocks, bonds or commodities. All on line with CompuServe.

Or if, like Herbie, intergalactic gamesmanship is your thing, enjoy the best in fantasy, adventure, and space games. Like MegaWars, the ultimate computer conflict.

To get all this and more, you'll need a computer, a modem and

CompuServe. CompuServe connects with almost any personal computer, terminal, or communicating word processor. To buy a Starter Kit, see your nearest computer dealer. To receive our informative brochure or to order direct, call or write:

CompuServe

Consumer Information Service
5000 Arlington Centre Blvd., Columbus, OH 43220
800-848-8199
In Ohio call 614-457-0802.

An H&R Block Company

Circle No. 60 on Free Information Card

NEW PRODUCTS

IMPACT DOT-MATRIX PRINTERS

Centronics is now marketing two new impact dot-matrix printers for personal computers. The Models H80 and H136 differ from each other mainly in the size paper they can handle. Common features include: draft and letter-quality print modes at 160 and 27 cps, respectively; ability to produce enhanced, over-strike, condensed, pica, elite, expanded, and true super/subscript print; built-in ad-

justable tractor; pin-addressable graphics in seven densities; downline loading of character sets; and italics and international character sets. The H80 handles pages up to 8½-in. wide and prints up to 80 characters per line, while the H136 handles pages up to 15.6-in. wide and prints up to 156 characters per line at 10 characters per inch (266 in condensed mode for spreadsheet applications). \$699 for H80; \$899 for H136.

Circle No. 86 on Free Information Card



ARCADE SOUNDS FOR APPLE COMPUTERS

Soundmaster II from Kearsarge gives Apple II series computers sophisticated arcade-type stereo sound capabilities. Supplied in the package are a Soundmaster II plug-in card and a demo disk with sample sounds and pre-programmed output routines. Programmed by BASIC or assembly-language, Soundmaster II can produce an almost unlimited variety of

sounds. Two on-board audio amplifiers can directly drive 8-ohm speakers or feed a hi-fi system. Once addressed, Soundmaster II latches the data and frees the computer for other activities. Contained on the card are two sound-generating circuits that provide a total of six tone generators, two noise sources, six mixers, amplitude controls, two envelope generators, and six D/A converters. \$119.95.

Circle No. 88 on Free Information Card

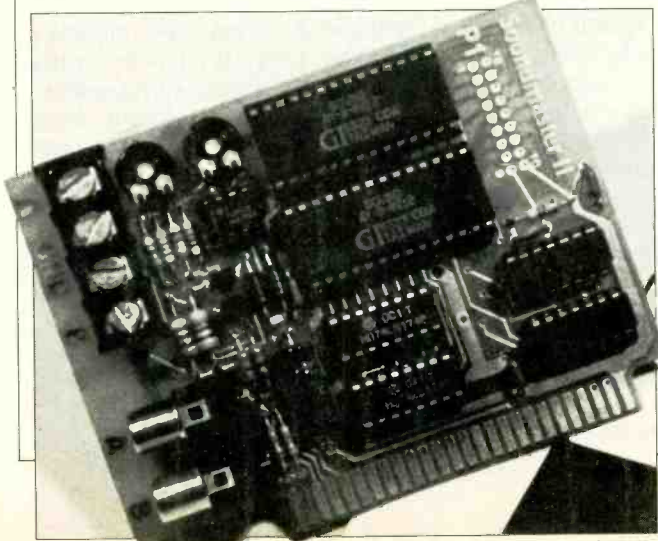

ADVANCED GRAPHICS COMPUTER

Software compatibility with the IBM PC and advanced color graphics are featured in the Mindset Personal Computer from Mindset Corp. Two custom-designed coprocessors used for the graphics and color display system back up the main 80186 processor. The operating system for the computer is MS-DOS. Features include: 32K to 256K of RAM; up to two 360K 5¼" floppy-disk drives; detached keyboard; standard TV receiver and RGB outputs; bit-mapped display format of 320 × 200 pixels in any 16 of 512 available colors or 640 × 400 pixels in two colors. The computer also ac-

cepts inputs from an optional mouse, joystick, or standard digitizing pad. A complete Mindset consists of a System Unit with keyboard, CPU, 64K of RAM, and two cartridge ports, plus an optional Expansion Unit that provides RAM expansion to 256K and one or two minifloppy drives. Available options include a mouse, joysticks, RS-232 serial and printer I/O modules, stereo sound module, 300- and 1200-baud modems, MS-DOS, GW BASIC, business graphics generator and professional graphics packages, and communications software. \$1099 to \$2398 (not including RGB monitor or software).

Circle No. 89 on Free Information Card

SOFTWARE SOURCES

Accounting Software. Three business accounting software packages from BPI have been announced for the Mindset Personal Computer. They are General Accounting, Accounts Receivable, and Accounts Payable. General Accounting features queuing capability, a flexible chart of accounts, and fast data entry. It permits double-entry bookkeeping with just a single journal entry, automatically debiting or crediting the appropriate accounts. Accounts Receivable offers the choice of either balance-forward or open-item account detailing. It can provide an alphabetical listing of all accounts, cross-indexed to their account numbers and lets the user analyze the activity of any account at any time. The system can handle an unlimited number of customer accounts on multiple disks and automatically produces an Aged Accounts Receivable report. Accounts Payable gives the user the choice of cash or accrual accounting methods and prints checks, with three payment options, and offers double-entry accounting. \$595 each package. Address: BPI Systems, Inc., 3423 Guadalupe, Austin, TX 78705.

HARNESS THE FULL POTENTIAL OF YOUR HOME COMPUTER

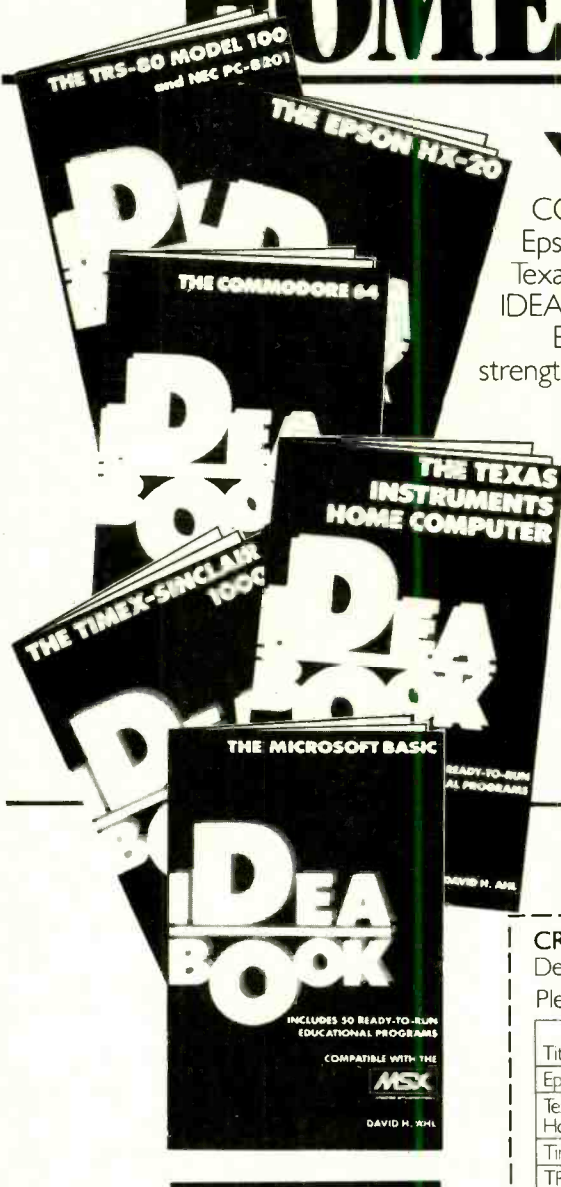

**ONLY
\$8.95
EACH**

You can increase your knowledge and harness all the power your home computer system has to offer with CREATIVE COMPUTING PRESS' IDEABOOKS. If you're an owner of an Epson HX-20, TS 1000, TRS-80 Model 100, Commodore 64, Texas Instruments or work with Microsoft Basic, you'll find an IDEABOOK written for you!

Each IDEABOOK helps you discover your computer's hidden strengths and overcome its weaknesses! As soon as you open to chapter one, you'll begin to get more out of your system with:

- 50 tested, ready-to-run programs that will help you solve everyday problems in math, science and business.
- Problem solving formulas with repetitive trials, convergence, recursion, compounding, probability, simulations, geometry, science and drill and practice.
- Ways to identify any shortcomings and targeted applications that are best suited for your system.

Supplement your user manual with the IDEABOOK that's just right for you! Gain the knowledge and confidence you need to make the most of your system—**ORDER YOUR COPY TODAY!**

**For faster delivery, PHONE TOLL FREE
9 am-5 pm E.S.T.: 1-800-631-8112 (In NJ only: 201-540-0445)**

Also available at your local bookstore or computer store.

CREATIVE COMPUTING PRESS

Dept. FE7F 39 East Hanover Avenue, Morris Plains, NJ 07950

Please send me the following books:

Title	Book No.	Qty.	Price Each	\$2.00 Postage & Handling Each	Total Price
Epson HX-20 Ed.	3S		\$8.95		
Texas Instruments Home Computer Ed.	3R		\$8.95		
Timex-Sinclair 1000 Ed.	3P		\$8.95		
TRS-80 Model 100 Ed.	4A		\$8.95		
Microsoft Basic Ed.	67-4		\$8.95		
Commodore 64 Ed.	68-2		\$8.95		
CA, NJ and NY State residents add applicable sales tax					
Total Amount Due					

Payment Enclosed \$_____ Outside USA add \$3.00 per order.

Purchase orders \$50 minimum.

Charge My: American Express Visa Mastercard

Card No. _____ Exp. Date _____

Mr./Ms./Mrs. _____ (print full name)

Address _____

City/State/Zip _____

Please send me a Free Creative Computing Press Catalog.

NEW PRODUCTS



UNIVERSAL CONTROLLER/BUFFER

Interfazer from Quadram is designed to keep data flowing in a modern computerized office and eliminate problems with peripherals before they arise. The 128K buffer can handle the printing jobs of up to eight computers and permits the use of two printers in a network without the need for making mechanical changes. As a print buffer, Interfazer stores data and then feeds it to one printer at a time. It can accept outputs from one to eight computers

through either serial or parallel I/O cards. The product is controlled by an 8085 microprocessor and contains eight slots for input and two slots for output. LEDs on the front panel indicate activity status and error messages. Interfazer operates on a priority port system and functions as an incompatible-device interface, computer I/O expander, data transfer-rate converter, and additional peripheral buffer. \$295 for base unit; \$295 for each additional 64K of RAM; \$65 for parallel I/O card; \$65 for serial card.

Circle No. 90 on Free Information Card

SOFTWARE SOURCES

Financial Decision System. Strategic Software Systems' Bottomline-V is a corporate financial decision system for business planning, raising venture capital, increasing lines of credit, or obtaining an SBA loan. The system begins with a 12-month detailed budget and cash flow analysis. The user then inputs basic data variables, after which Bottomline-V performs more than 9000 calculations to produce five-year pro formas of P&L, balance sheet, changes of financial position, and financial ratio analysis. The software package runs on the IBM PC/XT, DEC Rainbow, Kaypro, Apple, and most MS-DOS and CP/M systems with compatible spreadsheet programs, such as Lotus 1-2-3, Multiplan, Supercalc, and VisiCalc. \$295. Address: Strategic Software Systems, Inc., 1300 Dover St., Suite 200, Newport Beach, CA 92660.

Utility Program. Power Plus from Educomp is a low-cost utility program for the Commodore C-64 that adds more than 40 new commands. It is designed to make it easier for the user to send disk commands, write and debug programs, and write code in machine and assembly language. Features include: screen dump; automatic line numbering; renumbering; finding/changing; changing of colors; etc. An un-new feature, used with a reset switch, permits the user to reset the computer without losing programs in memory. \$19.95. Address: Educomp, 2139 Newcastle Ave., Cardiff, CA 92007.

TELEPHONE/MODEM

The new Tel-A-Modem from Code-A-Phone is an intelligent modem integrated into a two-line desk telephone. Compatible with RS-232C interfaces, it can directly replace other modems and add two-line capability to a data communications system. It offers both tone and pulse dialing capabilities. Telephone features include: audible and visible phone status indication; hold function for both lines; last number automatic

redial; and individual volume controls for ring signals and line monitor. The built-in direct-connect modem couples either line to the telecommunications network with the press of a button. Modem features include: 300- and 1200-baud transmission rates; full duplex operation; automatic answer and status indication; automatic baud rate selection and answer/originate tone; and programmable signal interchange. \$695.95.

Circle No. 87 on Free Information Card

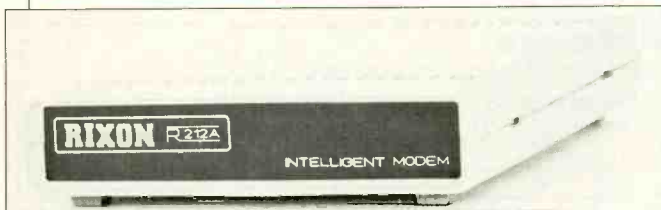

INTELLIGENT MODEMS

Rixon has a pair of intelligent modems for use with personal computers. The Model PC212A is for the IBM PC and the Model R212A is for other computers with serial interfaces. Both are Bell 212A compatible and offer operation at the standard 300- and 1200-baud speeds. The PC version stores up to 10 telephone numbers. The R212A version stores up to 10 tele-

phone numbers, each including a 30-character field description for designation of each number, and can automatically link to an alternate number if the first number dialed is busy. The modem allows all optional settings and test features to be controlled from the terminal keyboard. Both modems have built-in battery protection for all numbers and options stored in memory.

Circle No. 91 on Free Information Card





Creative Computing

the #1 magazine of computer applications and software

December 1983
Vol. 9, No. 12
\$2.95

CREATIVE COMPUTING

VOL. 9, NO. 12

DECEMBER 1983

In-Depth Evaluations:

- Kaypro 10
 - Casio FX-700P
 - Quadlink
 - Kealpad
 - Pixy Plotter
 - Percom TI Disk Drive
 - Apple Mechanic
 - The Tool
 - DiversiDOS
 - XEdit
 - Memory / Shift
 - MULE
 - Witness and Planetfall
 - Games for TS 1000
 - Arcademic Learning Series
 - Spacediscs
 - Controller Update
- High Precision Functions in Basic
- CBasic Clinic
- Basic Debugging
- Input Line Editor
- Plotting Tutorial
- Preventive Maintenance Primer



SOFTWARE TO STIMULATE

Stimulate your mind every month with the #1 magazine of computer applications and software... CREATIVE COMPUTING! There is no other magazine like CREATIVE COMPUTING... WE TALK YOUR LANGUAGE! ... Any make...any model... whether it's Apple, IBM, Radio Shack, TI, Mattel, Atari, Commodore... CREATIVE COMPUTING has monthly departments and articles you can use! You will receive a continuing education on *everything* related to personal computing with intriguing and useful applications for your personal computer. This is a magazine that will help you get more out of your computer—versatility, function and enjoyment—in easy-to-read and fully illustrated articles!

Subscribe to CREATIVE COMPUTING today and save up to 26%!



YES creative computing

P.O. Box 5214, Boulder, Colorado 30322 CC8Z037

Please enter my subscription to CREATIVE COMPUTING for:

- | | | |
|--|--|---|
| <input type="checkbox"/> 8 issues
for \$13.97.
I SAVE 16%. | <input type="checkbox"/> 1 year (12 issues)
for \$19.97.
SAVE 20%! | <input type="checkbox"/> 2 years
for \$36.97.
I SAVE 26%! |
|--|--|---|

Mr/Mrs/Ms _____ (please print name in full)

Company _____

Address _____

City _____ State _____ Zip _____

Check one: Payment enclosed Bill me later

Charge my: American Express Visa MasterCard

Card No. _____ Exp. Date _____

Savings based on full one-year subscription price of \$24.97.
Please add \$5 per year in Canada, \$10 per year in all foreign countries.
Please allow 30 to 60 days for delivery of first issue.

NEW PRODUCTS

COLOR MONITOR FOR JUNIOR

IBM is now offering a moderately priced direct-drive (RGBI) color video monitor for its PCjr computer. The IBM PCjr Color Display is designed to sit atop the computer's system unit without causing interference to normal operation. The monitor

offers both 40- and 80-column by 24-line display capability on its 13-in. nonglare screen. Standard features include: 320 x 200 lines graphics resolution; 16-color palette; internal speaker and earphone connector; and brightness, contrast, and volume controls upfront. \$429.

Circle No. 61 on Free Information Card

RIBBON RE-INKER

Mac Inker from Computer Friends is a device that automatically re-inks ribbons for computer printers, extending almost indefinitely the life of ribbons. Operation of the device is very simple. The user

simply loads the ribbon cartridge onto the Mac Inker and presses the start button. The correct amount of ink is then metered out automatically and evenly distributed on the ribbon. \$54.95.

Circle No. 62 on Free Information Card



DATA SYSTEM SECURITY LINK

ADM Concepts' Commlock Model-96A is a new low-cost data system security link that is compatible with all standard asynchronous data communications. It is user programmable to create up to 1024 unique encryption codes and provides separate encryption codes for both transmit and receive. Using this dual-encryption scheme, a successful illegal entry will not be known to the violator unless both levels of encryption are broken. The Commlock security link is programmable for data rates from 300 to 9600 baud, word length from 5 to 8 bits, parity, and number of stops bits. \$600.

Circle No. 63 on Free Information Card

COMPUTER PROTECTOR

Isobar from Indus-Tool is a new surge suppressor and noise filters for personal computers. It protects sensitive computer equipment by isolating it from equipment interaction, damaging high-voltage spikes, and ac line

noise. Exclusive filter banks isolate each outlet so that each load is isolated from all other loads. High-voltage spike protection handles up to 2000-ampere spikes and starts suppressing at 140 volts ac rms. High-frequency noise suppression is greater than 6 dB at 500 kHz and greater

than 30 dB from 5 MHz to 100 MHz. Isobar is rated at a maximum of 1875 watts, has a lighted on/off switch and resettable circuit breaker, and is available with two, four, or eight outlets. Plugs into any 115-V ac outlet. \$54.95 to \$97.95.

Circle No. 64 on Free Information Card



SOFTWARE SOURCES

Word Processor. Howard W. Sams' Pen-Pal word processor for the Apple II, II+ and IIe and Franklin Ace 1000 and compatibles is designed to be usable by people who are unfamiliar with computers. It keeps keypresses needed to instruct the computer to a minimum and provides on-line help menus. The program can produce a simple letter using very few commands or produce a thesis with tables and forms using a wide variety of capabilities. The Thinks mode permits entry of text without concern for how it will finally appear, using the Apple 40-column card. This is the mode in which most editing is performed. The Looks mode permits the text to be viewed as it will be printed, using horizontal and vertical scrolling. Pen-Pal utilizes standard Apple files and multiple disk drives, and supports 16K RAM cards, modems, a cassette tape deck, and an Applesoft editor. It requires 48K of RAM, at least one disk drive, and DOS 3.3. \$59.95. Address: Howard W. Sams & Co., Inc., 4300 W. 62 St., Indianapolis, IN 46206.

Business Software. The Desk Organizer for the IBM PC, developed by Conceptual Instruments Co. and available from Warner Software, is an integrated software package for business users. It provides seven functions, including: filing, dialing telephones, data organization, numerical calculations, appointment scheduling, time and work flow management, correspondence, and memo writing. A unique Meta capability allows Desk Organizer to co-reside in the computer with virtually any other applications program. The user can work on the Desk Organizer alone or switch back and forth between it and any IBM-compatible software with a single keystroke. Meta also enables the software to interrupt another program with chimes and an on-screen display to present previously scheduled reminders or call-up. \$250.

Circle No. 64 on Free Information Card



Heathkit instruments. Some buy them for pride... some, to save money.

Professional specs for serious users

Whether you're pursuing a proud hobby...or earning a living, don't trust the accuracy of your measurements to anything less than Heathkit instruments.

Our kits are a little bigger, more rugged than "disposable" instruments that discourage self-servicing. Performance is superior, too. Just check the specs on our new IO-4360 Scope and IOA-4200 Time-Voltage Module.

Get to know our full line of instruments. They're built by experienced hands. Your hands. So they'll save money and help you do a better job. Heathkit instruments. Don't trust your pride or money to anything less.

- 1 IG-4244 Scope Calibrator. <math>< 1\text{ ns}</math> rise time. 0.015% tolerance.
- 2 IO-4205 Dual-Trace 5 MHz Scope. 10mV/cm sensitivity.
- 3 IT-2232 Component Tracer. Checks circuits without power.
- 4 IP-2718 Power Supply. Fixed or adjustable supply. 5 to 20 VDC.
- 5 IG-1271 Function Generator. Sine, square, triangle waveforms. 0.1 Hz to 1 MHz.
- 6 IG-1277 Pulse Generator. 100 ns to 1 sec width pulses.
- 7 IT-5230 CRT Tester. Tests, cleans, restores CRT's.
- 8 IM-2264 DMM. True RMS readings. Analog metering, too.
- 9 IM-2420 Frequency Counter. 5Hz to 512 MHz. Ovenized oscillator. Includes period and frequency modes.
- 10 IM-2215 Hand-held DMM. Five DC ranges. Accuracy: $\pm 0.25\%$ of reading + 1 count.
- 11 IT-2250 Capacitance Meter. 199.9 pF to 199.9 mF. Auto ranging.
- 12 IO-4360 Scope and IOA-4200 Time-Voltage Module. Triple trace, 60 MHz, <math>< 7\text{ ns}</math> rise time. IOA-4200 controls CRT cursor and multi-function display.

**Heathkit instruments.
The professional instruments.
more measurement
for your money**

Heathkit®
Heath
Company

A subsidiary of Zenith Electronics Corporation
Circle No. 10 on Free Information Card



Take another look at the instruments you should be building.

FREE
COLOR HEATHKIT CATALOG

Mail this coupon to:
Heath Company, Dept. 010-226
Eaton Harbor, MI 49022

Name _____

Address _____

City _____

State _____ Zip _____

GX-393

Micro Data Managers (Continued from page 72)

word processors, spreadsheets, or other multi-purpose programs; for providing password protection for any part of the database; and for allowing easy definition of input and output formats that will mimic paperwork forms on the computer's video display. Implementing such functions would be very time-consuming and technically difficult with a traditional programming language.

Some DBMSs offer the best of both worlds by supporting both a command language and a programming interface. End users can write simple programs to handle their problems and programmers can handle more demanding tasks if the need arises.

Data Processing Capabilities and Hardware Requirements

DBMSs designed for large computer environments are naturally able to handle very large databases, up to millions or even billions of data elements and to perform great numbers of sophisticated operations and calculations at high speed. Database managers developed exclusively for micros, on the other hand, have tended to place significant limitations on the maximum size of a database and the kind of operations that can be performed.

Addressing large numbers of records effectively requires greater processing power, more random access memory, and larger storage capacities than are even now commonly available on most micros. Sophisticated packages may require a 16-bit or even 32-bit CPU, a lot of memory, and a hard disk. These can drive the cost of a minimum configuration to over \$10,000. The more popular micro data management products generally require much less memory and only dual floppy drives, and some will even run on 8-bit processors.

The maximum size of fields, records and keys, and the maximum number of files and indexes that can be processed simultaneously by a DBMS are all affected by the capabilities of the hardware it runs on. Also affected may be the number of variables and the type and sophistication of operations supported by the command language.

Data Access Methods

At the heart of any application is the speed and ease with which it can add, delete, modify, and retrieve data elements, commonly known as "data access." The most common data access methods are sequential, hashed, and indexed sequential.

Sequential access involves the familiar process of adding new records to the bot-

tom of a file and finding a particular record by searching the file one record at a time from top to bottom. This method is acceptable only for small files.

Hashing and indexed sequential methods assume that information is to be accessed by a key, such as a customer number. In hashing, the key is numerically transformed to generate a number that points to a physical location in the database where the record will be located. This method allows extremely fast access to a particular data record by its key but does not allow direct access by any secondary keys.

In order to support secondary key access, the database manager must maintain an index in which each entry contains both the secondary key and a pointer to the actual data record. A technique of this type is called an *indexed sequential access method*, or *ISAM*.

Most DBMSs now use some sort of ISAM. Each implementation seeks to reduce the disk accessing necessary to search the index for a particular key, the amount of file restructuring necessary to add and delete records, and the amount of physical disk storage required to maintain an index. One particular ISAM now gaining popularity is the so-called B-tree (Fig 4.).

The effect of each of these factors on the overall performance of the DBMS increases dramatically with the size and complexity of the applications implemented. If you have only relatively simple applications, you will probably not require the efficiency of a sophisticated data access method and, in general, need not be concerned with these issues. Larger applications will, however, often stand or fall on the ability of the DBMS to access data efficiently.

Fixed- and Variable-Length and Multivalued Fields

Locating a particular record in a database file is easiest for the DBMS software if all records have the same length. For example, if all records are 100 bytes long, then a simple computation shows that the 215th record begins at byte 2151. Because of this, many database managers only support fixed field lengths.

Very often, though, real world applications involve information of varying length, such as a name or address field. If the database manager only supports fixed length fields, then shorter or empty fields will be padded with blanks, wasting disk space. Another problem that arises in practice is that some fields require multiple values, as in the case of a customer with several phone numbers.

For these reasons, some DBMSs provide support for variable-length fields and records and multivalued fields.

DBMS Feature

Data Entry and Editing. Most DBMSs support extensive functions for controlling the entry and editing of data. One feature often provided is the ability to draw data entry screens and interface them with the data descriptions of the elements being entered. The net result is a data entry form that can be invoked whenever the data in question is to be entered. These forms can be drawn to match paper forms designed to be used with the system.

A related feature in some products is the ability to do edit checks of the data as it is entered and to generate appropriate messages when errors are detected. Typical data masks that may be supported include fixed-point decimal numbers, dates, times, ranges, yes/no and true/false, multiple choice, and upper-and lower-case character sets. Some packages also support checking data against another file in the database.

Report Generation. Nearly all DBMSs provide facilities for the simple generation of reports and for making specific inquiries into the database. These can be used by the developer to provide a set of preprogrammed reports and queries or by the end user on an ad hoc basis.

Many of the report and query facilities are similar to those supported for data entry, including on-screen layout drawing, time and date masking, range checking and table and file lookups. In addition, support may be offered for totaling and subtotaling, special pagination, and output of charts and graphs.

Error Detection and Recovery. The most common type of error that arises in database applications is due to some sort of corruption of the database structure. This could occur due to programming errors, hardware errors, or power failures while updating critical data.

DBMSs operating primarily through their own command languages typically offer error handling facilities that can be invoked to protect the application from destruction due to an unanticipated problem. Nearly all DBMSs also provide utilities that allow reconstruction of corrupted files or data dictionaries.

System and Data Security. Not everyone using an application requires the same level of access to it. For example, certain individuals may be allowed to enter accounting transactions, but not to view privileged financial information intermingled in the same database. Similarly, some individuals may be allowed

BEFORE YOU BUY ANOTHER PIECE OF SOFTWARE

CONSULT THIS BUYER'S GUIDE

Selecting the programs, systems and games for your personal computer can be an ordeal. You want the best package that's compatible with your system—at the right price!

LOOK NO FURTHER. THE OLYMPIC EDITION OF THE CREATIVE COMPUTING 1984 SOFTWARE BUYER'S GUIDE IS HERE!

The Editors of CREATIVE COMPUTING have awarded the Olympic Gold, Silver and Bronze medals to the leading software packages in the following categories:

- Full-feature word processors
- Home word processors
- Education: Pre-school, Elementary and Secondary
- Spreadsheets
- Database packages
- Games

Full descriptions, product reviews and screen photos of each award winner make this the definitive guide to the leading software of 1984!

In addition to the Olympic Ratings Guide, you'll find:

- A complete directory of software products with full program descriptions, system requirements and prices, PLUS
- A full listing of software



manufacturers, with names, addresses, types of software made and compatible hardware for each product!

If you own an Apple, Atari, Commodore 64, TRS-80 Color Computer, or any IBM PC, and you're in the market for new business, educational, personal productivity, recreational and utility programs, take the ordeal out of shopping...save money and get the best package for your system at the best price!

Order your copy of the CREATIVE COMPUTING 1984 SOFTWARE BUYER'S GUIDE today!

Also available at your local newsstand and computer store.

Creative Computing 1984

SOFTWARE BUYER'S GUIDE

CN 1914, Morristown, NJ 07960

FB5F

YES!

I'm enclosing \$4.95 (\$3.95* plus \$1 postage & handling) for the 1984 SOFTWARE BUYER'S GUIDE. (Outside USA \$6.)

Mr./Mrs./Ms. _____
print full name

Address _____

City/State/Zip _____

*Residents of CA, NJ and NY State add applicable sales tax.

WHY PAY MORE?

BUY AT DEALER PRICES

30 DAY SATISFACTION GUARANTEE

(ALL ITEMS 100% APPLE & FRANKLIN COMPATIBLE)



ZEUS 2001 — \$999.00 **NOW \$524⁰⁰**

ZEUS 3005 (Detachable Keyboard) **\$549⁰⁰**
APPLE + CP/M + 64K

- * 8 Expansion Slots
- * Auto Repeat Keys
- * 69 Function Keys
- * Built-in Cooling Fan
- * Numeric Key Pad
- * Expandable To 128K
- * Color Graphics
- * Break + Pause Keys
- * Runs Apple and CP/M Software

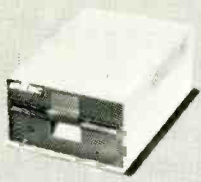

DISK DRIVE* — \$275.00 **NOW \$159⁰⁰**

- * 35 Track SS-DD
- * Quiet + Reliable
- * Shuggart Mechanism
- * 90 Day Warranty



YANJEN MONITOR — \$179.00 **NOW \$119⁰⁰**

- * 20 MHZ
- * 1,000 Lines At Center
- * Amber or Green
- * Super High Resolution

ACCESSORIES

(100% COMPATIBLE TO APPLE AND FRANKLIN)

	WAS	NOW
1. Disk Drive Interface Card	\$159.00	\$ 59.00
2. TEAC Slimline Disk Drive	\$285.00	\$199.00
3. Z-80 CP/M Softcard	\$199.00	\$ 79.00
4. 80 Column Card w/S.W.	\$299.00	\$ 99.00
5. 16K RAM Card	\$159.00	\$ 59.00
6. 128K RAM Card	\$499.00	\$199.00
7. RS-232 Serial Interface	\$169.00	\$ 79.00
8. Integer Card	\$149.00	\$ 49.00
9. Communication Card	\$149.00	\$ 79.00
10. Parallel Printer Interface	\$159.00	\$ 49.00
11. 16K To 64K Buffer Printerface	\$289.00	\$139.00
12. Epson Printer Card	\$149.00	\$ 29.00
13. Prowriter Printer	\$395.00	\$379.00
14. Super 5 Printer — 900 W.P.M.	\$499.00	\$289.00
15. T.V. Interface	\$ 35.00	\$ 15.00
16. Modem Apple Cat II (with S.W.)	\$399.00	\$249.00

If it works or runs on an Apple® it works or runs on ours

DISCOUNT COMPUTERS

3500 S. Orange Ave., Suite #102
 Orlando, Fla. 32806

(305) 425-7770

Ask About Our \$3.00 Phone Credit

Micro Data Managers

to view certain information, but not to alter it.

To meet such needs, some DBMSs have built-in security procedures, usually involving a system of passwords. In a relatively simple security system, some users may be prohibited from accessing a particular database entirely or prevented from invoking certain processes. In a more sophisticated system, users may be selectively restricted from individual data elements. In effect, these users have a logical view of the database that simply does not include the restricted elements.

Multiuser and Multitasking Capabilities. The advent of multiuser and multitasking operating systems and local area networks creates a new set of challenges for DBMS developers. In such environments conflicts can arise if different individuals doing different tasks try to modify a database at the same time. Typically, these problems are handled through operating system facilities that allow a particular file or record to be locked while it is being updated by a task. Other tasks requiring access to the same data will be kept waiting until the first task is complete.

Interfacing with Mainframe Computers and Databases. Some DBMSs offer the ability to interface a micro-based application with a mainframe database. This ability is most attractive in a corporate environment where important information has already been centralized and a significant investment in software has already been made in mainframe equipment.

The greatest support for mainframe linkage is usually found in products that were originally developed on mainframes. These allow files to be transferred from the mainframe to the micro, where they can be manipulated at will without consuming valuable mainframe resources. Some products offer the ability to develop an application on a micro and transfer it in toto to a mainframe. This ability is particularly useful to a developer, who can do work without tying up expensive mainframe resources.

Ease of Use and Documentation. Despite claims to the contrary, it is nearly impossible to implement a DBMS that meets the needs of sophisticated users and is also easy for first-timers to learn. Remember also that an "easy to use" product without the features required to implement a required application effectively is not really easy to use. However, even a complex product can be organized to simplify its operation.

One technique commonly employed to simplify use is the choice of meaningful English words as command names.

Another helpful feature is an on-line help facility that describes the features and commands that can be invoked and gives meaningful examples. Another important factor in the ease of using a product is the quality of the error messages that it generates.

Good documentation includes a readable and substantial "getting started" section, a complete reference manual with clear examples for every command and function, and a section with a good variety of sample applications. It is particularly helpful to have sample applications on a diskette to allow for close examination and experimentation.

Dealer and Vendor Support

Very few software products are completely bug-free. Database managers, especially high-end products, are quite complicated and therefore particularly susceptible to errors and omissions in both the software and documentation. Many of these problems occur only under specific and apparently intermittent and unrelated circumstances. Analyzing a problem can be difficult since mistakes in the user's own work must be ruled out before tracking the problem down to the DBMS itself.

The vendor of a good DBMS should offer regular updates for both software and documentation and provide a hotline for user inquiries and complaints. The vendor or dealer may offer training seminars or provide specialized technical support for a fee. In addition, some popular products generate users' groups and newsletters that can be sources of secondary support.

The Future

Improvements in database management software can be expected to parallel new developments in microcomputer hardware and operating systems. Expect to see more support for such popular features as windowing, multitasking, and high-resolution screen graphics. DBMSs will also give additional support to pointing devices (such as the mouse), voice recognition and synthesis, and graphics printers and plotters.

As more powerful hardware becomes available, size limitations will tend to disappear and more systems will support multi-user and multitasking capabilities. There will also be increased support for integrating micro-based applications with mainframe databases. These trends will be encouraged by a new class of users who have grown up with the current database software and have gained the sophistication and hunger for more advanced capabilities. ◇

Sord

(Continued from page 38)

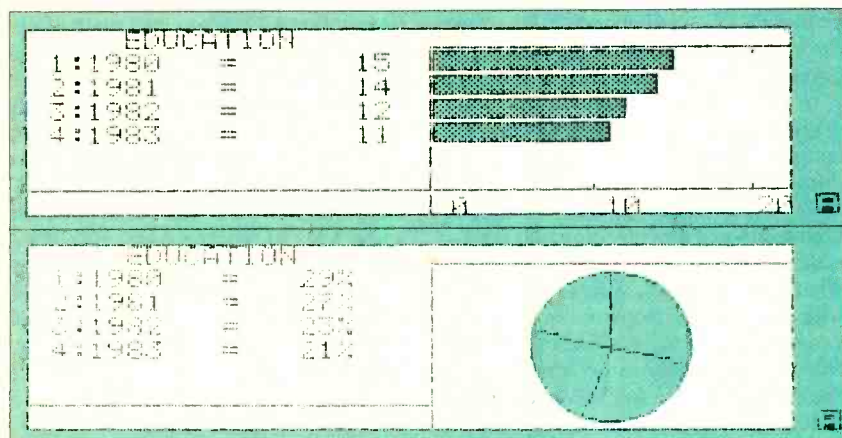

Fig. 2. The Sord can print graphic displays of data.

preview the commands available in each program. If you already know the commands (e.g., Hcopy to do a screen dump to the printer), you can type them in directly. Pressing the return key always displays any additional commands, pressing ESC allows you to go back to a previous (higher level) menu. Command menus can also be accessed by initial letter. For example, entering a "C" would display all commands that begin with "C." The full command set is also available as a series of five reference menus invoked by entering an asterisk (*). Most, but not all screen displays can be dumped onto the printer using the Control P technique. At almost every level F6 is shown as a Help key. Pressing it yields a one-line explanation of the commands on that menu.

Using a series of menus to perform an action can sometimes become tedious, especially when you are familiar with the system. To circumvent the menus, the user can enter at once several commands separated by semicolons. After RETURN is pressed, the unit automatically exe-

cutes these commands. This type of command entry makes the unit a pleasure to operate and creates the illusion that a demonstration of the program is occurring.

The ROM Integrated Software Package

The five built-in software programs offer nearly every sort of application program that the user should need (other than machine or higher level language). I-Pips is a spreadsheet program that allows for the processing of data in what Sord calls Table form, that is, in rows and columns. Not only does I-Pips have the usual spreadsheet capabilities of calculating, sorting and selecting data, but it can also produce a graphics display of the data. I was able to quickly create a spreadsheet and display and print it in both pie chart and bar graph formats (Fig. 2).

The I-Edit mode configures the IS-11 as a simple text editor. Used mostly for quick memos or for enhancing the spreadsheet tables, it creates files com-

Specifications

Product: IS-11 Computer
Mfr: Sord Computer of America
723 W. 7th St.
Los Angeles, CA 90017

Price: \$995

Dimensions: 12"W x 8½"D x 2"H

Weight: 4.5 lb

Operating System: Proprietary

Features: Z80A microprocessor, 32K RAM, 64K ROM, 8 line x 40 char. liquid crystal display, integrated software (spreadsheet, word processor, communications), RS-232 serial port, Centronics parallel port

patible with the I-WP word processing ROM. I-WP allows for creating, editing, filing and printing documents. It has move, copy, recall, delete, and search capabilities. I-WP uses the cursor keys for screen editing and creates a paste buffer as well as a workspace for the file in memory. Though its operation is relatively simple, it lacks sophistication. For example, there is no provision for altering the line spacing of a document.

You can print files from either the I-Edit or I-WP programs. Line width defaults to 40 columns but can be defined for up to 80. In the same way you return to a higher level menu, you exit the word processor by pressing the ESC key.

The I-Calc mode turns the IS-11 into an on-screen 10-digit, 4-function calculator with memory. The numeric keypad can be used in this mode for more rapid data entry. You can save the calculations in a file and also update/recalculate instantaneously for repeated calculations using different numbers, for trend analysis, etc. This feature displays a calculator graphic on the screen during calcula-

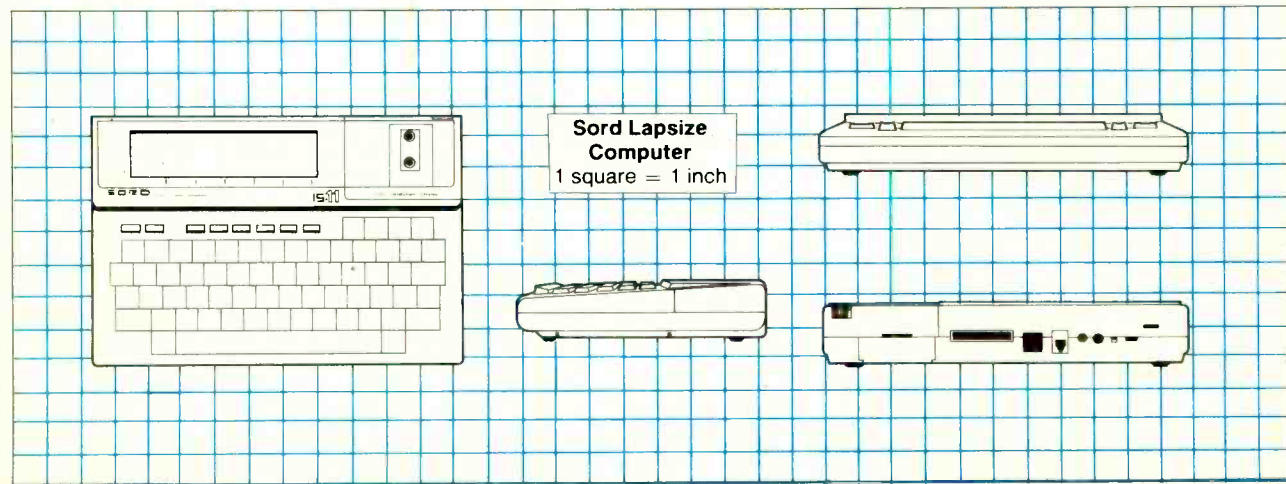

ANNOUNCING

creative computing's

1984 BUYER'S GUIDE

TO PERSONAL
COMPUTERS &
PERIPHERALS



Advice you can trust on selecting personal computers, peripherals and electronic games

Unless you have the memory of a computer there's no way you can keep track of all the games, programs and peripherals available for your computer. And even if you could, you'd still have a problem figuring out what's best for your needs and how to get the most for your money.

That's why you need the *1984 Buyer's Guide to Personal Computers & Peripherals*. It's a comprehensive collection of product reviews and consumer-oriented shopping advice put together by the experts at *Creative Computing* magazine.

You'll get a rundown of what's new on the market. Analysis of new product performance, reliability, operation, applications, cost—even what kind of repair service you can expect. Easy-to-understand comparisons between different models. Tips on bugs and design problems. Plus "inside" information you won't get from manuals or salespeople.

Don't buy until you've consulted the *1984 Buyer's Guide to Personal Computers & Peripherals!* Order your copy today.

Send to: NY8C
Creative Computing Buyer's Guide
CN 1914, Morristown, NJ 07960

YES! Please rush me *Creative Computing's 1984 Buyer's Guide to Personal Computers & Peripherals*. Enclosed is my check or money order for \$3.95 plus \$1 for postage and handling.

Mr./Mrs./Ms. _____
(please print)

Address _____

City _____

State _____ Zip _____

Please make check payable to Creative Computing Buyer's Guide. CA, NJ and NY State residents please add applicable sales tax. Price outside U.S.A. is \$6.

Sord

tions and can be tracked by setting the printer to "on" during calculations. One drawback here is the limited number of functions that are available.

In the I-Comm mode, the IS-11, in conjunction with an RS-232 acoustic coupler or modem, can handle half/full duplex serial transmissions at 300 to 9600 baud with various protocols. Uploading and downloading files is possible. However, the software is somewhat limited. If you wanted to dial up with an autodial modem, for example, you would have to issue commands specific to the modem rather than choose the function from an I-Comm menu. Also, when you connect to a network like CompuServe, the screen doesn't

Anyone could master this unit in a few hours

scroll in the usual way. Instead, it fills up, goes blank and then begins filling again.

There is an optional ROM pack that allows the IS-11 to function as a telecommunications device for use with time-sharing services (I-TSS). Another ROM pack (I-Trans) includes the routines for data and file conversion and transfer to CP/M and MS-DOS computers via the RS-232 port.

The Desk Organizer Software Tape

Included on the Desk Organizer tape are five machine language utilities and eight demo files that illustrate the organization and use of a travel diary and telephone directory.

Programs can be accessed using Auto files, which are text versions of concatenated command strings that work like a CP/M Submit file. The utility files included with the Desk Organizer tape include a calendar generator; a program to right-, left- or center-justify data in columns; a program to copy, move and otherwise manipulate the rows and columns of the spreadsheet tables; a routine to perform data accumulations in the tables; and a transfer program to send Sord tables to spreadsheet programs on other computers. These utilities are loaded into memory and appear on the main menu along with the ROM pack and built-in programs.

The Sord Manuals

Perhaps the greatest breakthrough that the Sord has made is its very readable manuals. There is barely a hint of

the garbled language often found in documentation accompanying imports from Japan. They have really done their homework well. The various commands are well documented and are profusely illustrated with sample screens. There are a few mysteries: how and why there is a 50-line maximum file length for I-Edit files; how to access the ROM pack and RAM/ROM expansion capabilities. There is also only a minimal explanation of the hardware aspects of the machine. However, the connector pins are all broken out to indicate their general if not specific functions.

Comments

Makers of lapsed computers often position them as stand-alone terminals for remote use and subsequent up or downloading to or from a main computer in the office. This approach works best if the unit is quite similar to the office computer, to minimize the learning of the new commands. Sord has actually done this! Unfortunately, the main system it has emulated is not common in the US. However, the Sord is also a self-contained, full-function microcomputer and just as any other similarly capable machine has the right to experiment with an operating system (e.g. CP/M, Apple DOS, TRS-DOS, MS-DOS, etc.). As an *integrated* system, one would actually expect this departure, rather than be concerned about it.

Conclusions

I was pleasantly surprised with the ease with which Sord's unique operating system could be learned. Its power didn't get in the way of its use. I feel that anyone could, as Sord claims, master this unit in a few hours. The manuals are well designed, with many examples and illustrations. Though it offers very little for a programmer, most business needs are addressed by this unit's built-in software.

I was disappointed when I realized that I couldn't write my own programs for the machine. However, how many business people have the time to learn to do this or even care to? A more serious deficiency of the machine is in the level of sophistication of its software. If you aren't satisfied with a particular package, such as the word processing, there are no alternatives.

To sum up, the Sord IS-11 has a super operating system concept, integrated spreadsheet, word processing, graphics, calculating, and telecommunications software, and tape drive, which makes for a good, but not great system, at a good but not great price. ◇

YOUR LINK TO THE FUTURE OF MICROCOMPUTING

New hardware that will change the way you do business

Novel applications of existing technology

Who are the leaders and what are they doing?

Technologically advanced—User literate

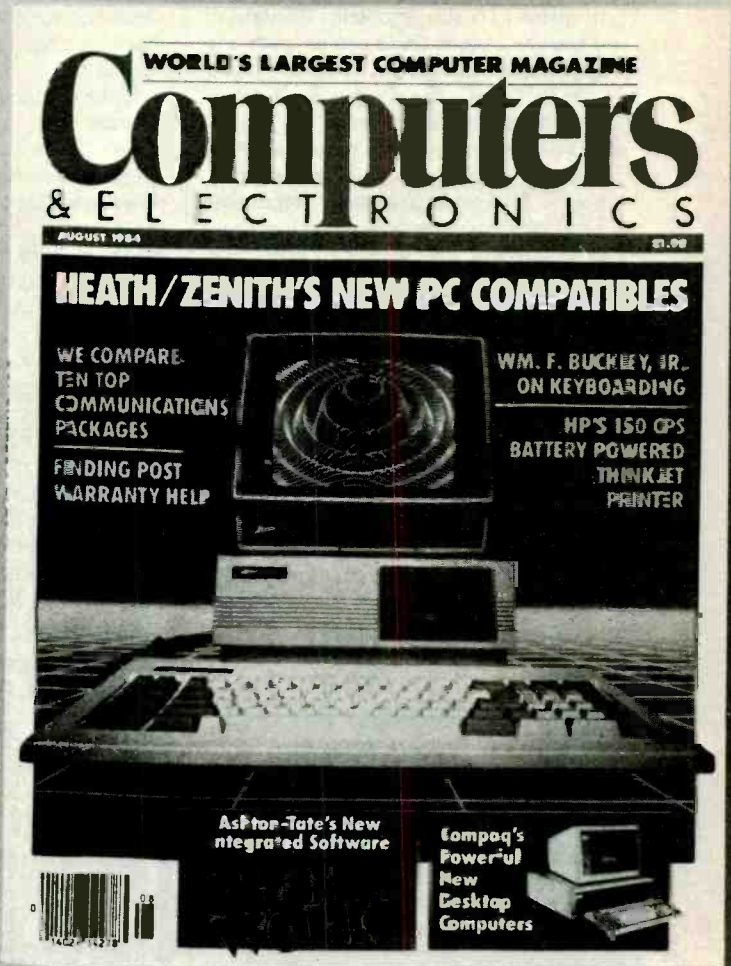

COMPUTERS & ELECTRONICS

is your state-of-the-art link to technology and innovations of micro-computing. No other magazine ties you into the developments and the developers of the future of microcomputing quite like COMPUTERS & ELECTRONICS.

Your subscription to COMPUTERS & ELECTRONICS brings you the latest developments in hardware, software and peripherals—and the impact these products will have on you, today, and in the future! You'll have an open forum with the developers of new worlds of technology and processing! You'll be an active part of today, while blazing new paths towards tomorrow!

Open your link to the future of microcomputing the way you want it—the way you need it!

**SUBSCRIBE TO
COMPUTERS & ELECTRONICS
AND SAVE UP TO 37%!**

Computers & ELECTRONICS

P.O. Box 2774
Boulder, Colorado 80322

YES! I want a direct link to the future of microcomputing.

Please send me COMPUTERS & ELECTRONICS for:

1 year for \$12.97 2 years for \$22.57 3 years for \$31.37.

SAVE 24%! SAVE 32% SAVE 37%!

Savings based on full one-year (12 issue) subscription price of \$16.97.

Mr./Mrs./Ms. _____ please print full name

Company _____

Address _____

City _____ State _____ Zip _____

Check one: Payment enclosed Bill me later
Charge my: American Express Visa MasterCard

Card No. _____ Exp. Date _____

Add \$5 per year in Canada. Add \$8 per year in all other foreign countries.
Please allow 30 to 60 days for delivery of first issue. CE-42015

Micro Cool (Continued from page 91)

vents. This will improve air circulation greatly.

Third, if a hot spot or hot component is suspected, freeze mist or spray can be applied to the questionable area to determine whether this is really the root of the problem. If the problem disappears when the area is force-cooled and only one component seems to be to blame, then very likely the component is defective and should be replaced.

The fourth method is rather involved and may be impractical for many. It involves fitting the computer with temperature measuring devices such as thermocouples or thermistors to areas that are actually running hot. This procedure is probably best left for the laboratory.

Keep It Cool

If you suspect your computer has a thermal problem, the first thing to do is to make sure that there is nothing that routinely sits on top of or near the computer that could block its air vents' circulation. If there are vents on the bottom, make sure that they are in the clear too.

Sometimes all that's necessary to

eliminate thermal problems is clearing a space around and above the computer or repositioning its monitor away from the expansion-board side of the enclosure. This does not mean that those clever and attractive computer desks and tables cannot be used; it just means that an auxiliary means of ventilation may be needed.

If the problem still exists, a possible solution is to remove the computer's cover. There are several hazards involved in this, though. First, many computers use the cover as part of their cooling systems. Without it, air may be drawn in from the outside by a fan and immediately exhausted to the open without ever coming near the components it is supposed to cool. You can check for this possibility by blowing a little smoke into the air intake vents and watching its path. If it doesn't go near the parts of the computer that have to be cooled, you're probably better off with the cover on.

A second danger is that of foreign materials (like coffee and paper clips) finding their way into the computer's exposed innards. No food, drink, or any type of work that could introduce any

foreign materials into the computer or dust into the disk drive should be allowed in the same room as a naked computer.

Finally, a computer's metal cover is used as an electromagnetic shield both to contain r-f fields generated by the computer, so they do not interfere with other equipment, and to protect the computer from external interference.

If, with the cover removed, your computer problems disappear, they are almost certainly heat related. It's best, though, to put the cover back on and find a reliable cooling method.

The most economical solution is probably an auxiliary fan for the computer. It could be an ordinary desk or floor fan aimed at the air vents in the computer case or a small fan made especially for the purpose. Figures 3 and 4 show typical dedicated fans for the IBM PC and for the Apple II family of computers, respectively. Note that the PCool unit shown for the PC is enclosed inside the case of the computer, while the System Saver in Fig. 4 is designed to fit outside the Apple.

A fan of either design is a permanent

Be a MICROCOMPUTER SERVICE TECHNICIAN

Train at home in spare time...
No previous experience needed
Sales of small computers are running over a billion dollars a year. That's why a whole new business is starting up—devoted entirely to small computer repair. And right now is the time to get in on the ground floor—either working for someone else or in your own computer repair business.

Start making money in electronics

No need to quit your job, change your daily routine or take time from family responsibilities. And you don't waste time going to and from class because you train at home in spare time. The ICS Microcomputer Repair Course is designed for beginners—people with no previous experience who want to get started fast. And you should be ready for an entry-level job repairing small computers even before you finish this course.

Experts show you what to do...
how to do it! We start you fast with the basics, and everything is explained in easy-to-understand language complete with plenty of diagrams and drawings.

GET INTO
SMALL
COMPUTER
REPAIR

SEND FOR FREE FACTS!

ICS School of Computer Repair, Dept. PD094
SINCE 1981 Scranton, Pennsylvania 18515

Send free facts and color brochure telling how I can get into computer repair at home in my spare time. No obligation. No salesman will call.

Name _____ Age _____
Address _____
City/State/Zip _____

CALCULATOR SAVINGS

hp HEWLETT
PACKARD



HP-11C Programmable \$64.99	82160A HP-IL Module \$99.99
HP-12C Financial 99.99	82161A Cassette Drive 359.99
HP-15C Programmable 99.99	82162A HP-IL Printer 359.99
HP-16C Hexadecimal 99.99	82164A RS-232 Interic 249.99
HP-41Cv Alpha Progrmb 189.99	92198A 80 col Video Int 269.99
HP-41CX Extnd Functn 259.99	7470A HP-IL Plotter 699.99
82104A Card Reader 149.99	82180A Extnd Functns 59.99
82143A Printer 299.99	82181A Extnd Memory 59.99
82153A Wand 99.99	82182A Time Module 59.99
HP-97 Desk Progrmb 599.99	2225B Think Jet Pr 419.99
82169A HP-IB Interic 359.99	HP-41 System Case 49.99
82400A Card Reader Cali	Port-X-Tender to 10 pts 129.99
82401A HP-IL Interface 107.99		
82420A 4K Mem for 71B 59.99		
HP-75D Computer 699.99		
HP-75D Computer 929.99		
82700A 8K Mem for 75 149.99		

Call for Low Prices on all Accessories and Software

TI	TI-66 Advanced Programmable, 500 steps \$59.99
	TI-35 Student Scientific Calculator 19.99
	TI-55-II Scientific Calculator w/ Statistics 34.99
	LCD-Programmer Hexadecimal Converter 59.99
	BA-II Business Analyst Financial 36.99
	BA-55 Advanced Handheld Financial 49.99

Sharp	EL-7050 Graphwriter 4-color Printing Calc \$79.99
	EL-7001 Memowriter with 40 word memories 39.99
	EL-5500 II Handheld Computer/Calculator 79.99
	PC-1250A Pocket-size BASIC Computer 89.99
	PC-1261 Two-line 10K Pocket Computer 159.99
	PC-1500A Expandable 8K Handheld Computer 179.99
	CE-125 Printer/Microcassette for 1250A/1261 139.99
	CE-126P Cassette Interface/Printer for 1250A/1261 79.99
	CE-150 Cassette Intfc/Plotter for 1500A 179.99
	CE-158 RS-232C & Parallel Interface for 1500A 179.99
	CE-161 10K Memory Expan with Battery Back-up 139.99

Casio	FX-700P Handheld Computer, 1568 steps \$59.99
	FA-3 Cassette Adapter for FX-700P 34.99
	FP-12 20-column printer for FX-700P 59.99
	FX-98 Credit card Solar Scientific Calculator 24.99
	FX-450 Scientific Calculator with Hexadecimal 29.99
	FX-720P Expandable Handheld Computer 79.99
	FX-750P Expandable 4K Handheld Computer 109.99
	SL-800 Film Card 22.99

Use cashier's check, postal money order, VISA, or M/C. Personal checks take five weeks to clear. Add shipping, 1% of your order (\$3.95 minimum). East of Missp Rv extra \$1.50 CA res add 6%. Subject to availability. USA prices

ORDER 800-421-5188 Outside
TOLL-FREE Information line (213) 633-3262 CA, AK, HI

tam's
INCORPORATED

Tam's Inc, Dept CE
14932 Garfield Ave.
Paramount, CA 90723
(213) 633-3262

Circle No. 42 on Free Information Card

DON'T BLAME THE SOFTWARE!

Our Isolators eliminate equipment interaction, clean up interference, curb damaging power line spikes and lightning bursts.



ISO-1 ISOLATOR

3 isolated sockets; quality spike suppression; basic protection. . . \$81.95

ISO-3 SUPER-ISOLATOR

3 dual isolated sockets; suppressor; commercial protection. . . . \$122.95

ISO-17 MAGNUM ISOLATOR

4 quad isolated sockets; suppressor; laboratory grade protection. . \$213.95

ESP Electronic Specialists, Inc.

171 S. Main, Natick, MA 01780 (617) 655-1532

Toll Free Order Desk 1-800-225-4876
MasterCard, VISA, American Express

Circle No. 51 on Free Information Card
Computers & Electronics

Micro Cool

addition to the computer system and allows the user the flexibility of having any system configuration he desires while relieving him of worry about thermal problems.

Personal computer users who plan to exploit their machines' full capabilities should be aware of heat's detrimental effects. Instead of waiting for an overheating problem to occur (which can be very expensive in terms of computer processing errors) they should take preventive measures. A little fan can be extremely cheap assurance of cool and dependable computing. ◇

key tronics

(Continued from page 44)

The return key not only says "Return" (instead of the shoot-around-the-corner arrow), but is large and in the normal position on the home-key row.

The 5151 is 8 $\frac{5}{8}$ " by 20 $\frac{1}{4}$ "—about an inch larger than the IBM in each direction. A pair of flip-down rear legs tilt the unit in the manner of the IBM but without adding to the width. Color is IBM beige (including the coil-cord, a minor improvement over the black IBM cord). Buyers won't need to be ashamed of the looks; if anything, it's a bit more impressive than the IBM—more keys, spread out a bit, and those little glowing lights.

LED's indicate CAPS LOCK, NUM LOCK, and whether the cursor pad is active. If the cursor pad is not active, the numeric keypad works just as it does on the IBM, so no sweat even if you encounter some software that insists NUM LOCK be off (Lotus tries to insist, but it's just that they believe you'll screw up if you shift the IBM NUM LOCK on and off; the 5151 and 1-2-3 work just fine with the numeric key pad active). There's a PAUSE key to stop scrolling (easier than CONTROL-NUM LOCK). CONTROL-RESET replaces the awkward three-key IBM reset sequence. All this is fully compatible and is easier to find and use. In a perfect world, IBM would have done it this way; I'm just happy somebody did.

Most users adjust to the IBM keyboard. Such an outcome is a foregone conclusion if they use that keyboard exclusively. People adjust to almost anything—special perception-test glasses that turn the visual world upside down, for example. When wearing the glasses continuously, the test subjects adjust quite well. They can walk around, even drive vehicles—just don't ask them to switch back and forth.

For those like me who love the IBM PC but hate the PC keyboard there is now a fully satisfactory solution—for a price, of course. ◇

CALL TOLL FREE
800-221-8180
IN NEW YORK STATE
CALL (212) 752-8600

RATED #1 FOR SERVICE & RELIABILITY

J&R MUSIC WORLD

23 PARK ROW
NEW YORK CITY,
NEW YORK
10038

COMMODORE 64



•64K RAM
•MicroSoft Basic
•High Resolution Graphics

\$19995

COMMODORE 64 SOFTWARE

ENTERTAINMENT

SUBLOG Flight Simulator II	39.95
ACCESS Beach Head II	24.95
ACCESS Neutral Zone II	24.95
EPYC Baseball II	27.95
COMMODORE Deadline II	27.95
COMMODORE Music Machine	14.95
AUTOMATED Summer Games II	24.95
AUTOMATED Temple of Asphai	27.95
COMMODORE Wizard of War	14.95
HOUSE Castle Wolfenstein II	119.95
COMMODORE Kickman	14.95
MUSICFORME Musical Pinball II	119.95
ELECT. ARTS Pinball Const. II	27.95

APPLE COMPATIBLE DISK SOFTWARE

SERENA Dark Crystal	24.95
SERENA Wizard and Princess	19.95
INFOCOM Deadline	29.95
INFOCOM The Manager	24.95
BIRDSEEDING Choplifter	24.95
SUBLOG Chess Simulator II	24.95
ELECT. ARTS One on One	24.95
DOSEIA Chess	14.95
AUTOMATED Temple of Asphai	24.95

FLOPPY DISKS

SINGLE SIDE/DOUBLE DENSITY 24.99/10

CHOOSE FROM: VERBITAM 500K 5.25
ORANGE SCOTCH 400K 5.25
ORANGE SCOTCH 400K 5.25

MONITORS

COMMODORE C1702 14" Color	229.95
TAKAN 210 12" Color RGB	159.95
PARANOSK 18" 12" 13" Gray	129.95
PARANOSK DT1300D 13" RGB	129.95
MADDER 300A 12" Amber Super HiRes	149.95
ZEMTH 2M12 12" Amber 40 80 11H 95	129.95
TAKAN 915 RGB Super HiRes	129.95

ACCESSORIES

EVC 5.25" Disk maker holes 3	3.29
CARDIO PC 4 Printer interface 64	64.95
VERBITAM Disk drive cleaner 46	9.95
VERBITAM Spring for 8000L 12	7.29
CLASSIC Cover for Apple II 24	5.99
PT 1000 Card port for 106 14	149.95
PT 1000 Card port for 99 24	129.95
DISK WASHER 30000rpm 64	149.95
APP 64 External Floppy Drive 109	95.95

THIS MONTH'S SUPER SPECIALS

APPLE II 512K D II DRIVE & CONTROLLER

IBM PC1 256K D II DRIVE GREEN MONITOR

IBM PC2 256K D II DRIVE

EPSON OX10 256K 2 D II DRIVES

SARVO ACCESS 256K 2 DRIVES

SEPA SOFTWARE

APPLE COMPATIBLE DISK SOFTWARE

IBM PC COMPATIBLE DISK SOFTWARE

ENTERTAINMENT	39.95
INFOCOM Planetfall	29.95
CYBERIA Murder by the Dozen	24.95
STRATEGIC Tigers in the Snow	29.95
STRATEGIC Galactic Gladiator	29.95
BLUE CHIP Barron	149.95
BARON'S S.A.T. Study Course	24.95
SCARBOROUGH MasterType	29.95
S.E.I. S.A.T. Math Skills Pack	19.95
S.E.I. S.A.T. Verbal Skills Pack	19.95
S.E.I. Word Anomaly	24.95
S.E.I. Sentence Completion	24.95
BUSINESS	129.95
CBIS MultiMate 3.2	229.95
CBIS Spreadsheet	229.95
SORMIC Friday (old) Manager	249.95
SORMIC SuperCalc 1	249.95
ELECT. ARTS Cut & Paste	129.95
THINKTANK Image Processor	149.95

ATARI SOFTWARE

ATARI 2600	154.95
ATARI Pac-Man	154.95
ATARI Football	154.95
ATARI Pole Position	154.95
ATARI Donkey Kong II	154.95
AUTOMATED Presto	24.95
AUTOMATED River Edge	24.95
ACTIVISION Megamania	24.95
AUTOMATED Gateway Arch II	154.95
ATARI Touch Tonic	154.95
ATARI VISION II	154.95
ATARI TOUCH TONIC II	124.95
ATARI EDUCATIONAL	154.95
ATARI ArtWarrior	154.95
ATARI INK TO PROZ 1.2 or 3.1	119.95
SCARBOROUGH MasterType	24.95
ATARI Microscope Basic & Color	154.95
ATARI Touch Typing	119.95
ATARI VISION II	119.95
ATARI Photo Package	119.95
ATARI Home Film Recorder II	119.95
MICRO PERIF. MicroPort	24.95

ATARI SOFTWARE

VOX INK TO PROZ 1.2 or 3.1	119.95
SCARBOROUGH MasterType	24.95
ATARI Touch Typing	119.95
ATARI VISION II	119.95
ATARI Photo Package	119.95
ATARI Home Film Recorder II	119.95
MICRO PERIF. MicroPort	24.95

ATARI SOFTWARE

VOX INK TO PROZ 1.2 or 3.1	119.95
SCARBOROUGH MasterType	24.95
ATARI Touch Typing	119.95
ATARI VISION II	119.95
ATARI Photo Package	119.95
ATARI Home Film Recorder II	119.95
MICRO PERIF. MicroPort	24.95

FREE GIANT CATALOGS:

CALL TOLL FREE 800-426-6027 • 288 PAGE AUDIO/VIDEO/COMPUTER CATALOG
• 64 PAGE RECORD AND CASSETTE CATALOG • 80 PAGE VIDEO MOVIE CATALOG

Circle No. 23 on Free Information Card

Tired of video games? Want to do more with your computer? You could be ready for

HACK ATTACK*

HACK ATTACK is a series of programming problems of increasing difficulty. You write programs to solve problems. HACK ATTACK tells you if your program has produced the correct answer. Beginners can build their programming skills, while accomplished "hackers" can see just how good they are. Anyone who has done some simple programming in BASIC can learn from these problems. All solutions except one can be verified by the checker program included in every packet. Your solution to the final problem must be submitted to us for verification.

And if you need just a little more incentive,

WE WILL PAY \$1000 TO THE FIRST PERSON WHO CORRECTLY ANSWERS ALL PROBLEMS!

This is not a contest. We simply feel the problems offer enough challenge that the first person to solve them all DESERVES \$1000.

Your packet is GUARANTEED to be complete and functional when received. If not, just return the entire packet to us within 30 days for FREE REPLACEMENT! So how can you go wrong? Order today and also SAVE \$4! Use the order blank below.

Each HACK ATTACK packet consists of instructions, a list of problems, answer-card, and software program on either disk or tape for verifying answers. The answer card is to be used for submitting solutions to ACTS, Inc. for verification and consideration for the \$1000 award. The answer card received by us with the earliest postmark and all the correct answers will be the winner. In case of ties the award amount will be split. ACTS, Inc. reserves the right to discontinue this offer at any time without notice. The GUARANTEE is valid only if the entire packet is returned, and only covers replacement with a new packet. Because of the nature of software and the ease of duplication, no refunds can be made. Dealer/School inquiries only, call (503) 643-4988. No phone orders accepted.

* HACK ATTACK is a product of Applied Creative & Technical Services, Inc. of Beaverton, Oregon. All rights reserved.

REGULAR PRICE \$21.95 + \$2.00 POSTAGE AND HANDLING. ORDER TODAY AND PAY ONLY \$19.95 INCLUDING POSTAGE AND HANDLING. SAVE \$4.00!

Mail your order to: ACTS, Inc. 4720 SW 139th Beaverton, OR 97005

Name _____ Address _____ City _____ State _____ Zip _____

Check Money order Visa MasterCard

Card No. _____ Exp. Date _____

Signature _____

Name and signature above must be the same for all Visa and MasterCard orders.

Send me the following: copies of
 HACK ATTACK: _____
 Commodore 64 Disk _____
 Commodore 64 Tape _____
 Apple IIe Disk _____
 Apple IIc Disk _____
 IBM PC Disk _____
 Total _____
 \$19.95 ea. \$ _____

Circle No. 32 on Free Information Card

SLASH YOUR DISKETTE COST BY 50%!



Make use of the back of your 5 1/4" Diskettes and SAVE.

- **NIBBLE NOTCH** tools make it easy
- Adds the precise notch where it's needed.
- Doubles diskette space or MONEY BACK.

NIBBLE NOTCH I

Cuts square notch for Apple, II, II+, IIe, III, Franklin and Commodore.

only **\$14.95**

add \$1.50 each P&H / (\$4.50 each foreign P&H)

DISK OPTIMIZER® SYSTEM

SOFTWARE FOR APPLE, II, II+, IIe, III & Franklin

- 469% FASTER Than Similar Programs!
- Certifies your "new" disk 100% Error Free
- Removes Bad Sectors • Adds 36th Track
- Performs Disk Drive Speed Check
- Adds DOS and More

only **\$24.95** each

add \$1.50 each P&H / (\$4.50 each foreign P&H)

— **OR BUY BOTH** —

only **\$29.95**

add \$2.50 each set P&H / (\$6.50 foreign P&H)

SATISFACTION GUARANTEED OR YOUR MONEY BACK

Florida Residents Add 5% Sales Tax

ORDER TODAY!

CALL TOLL FREE 1-800-642-2536

OR SEND CHECK OR MONEY ORDER TO:

NIBBLE NOTCH

COMPUTER PRODUCTS

DIVISION OF CORTRAN INTERNATIONAL

4211 NW 75th TERRACE, DEPT. 8 4

LAUDERHILL, FL 33319

PAT. PEND.

ALL TRADEMARKS ARE ACKNOWLEDGED

Circle No. 5 on Free Information Card

PRINTERS

QUALITY BRANDS...

...DISCOUNT PRICES

- ANADEK
- BROTHER
- C-ITOH
- EPSON
- JUKI
- OKIDATA
- SMITH-CORONA
- TOSHIBA
- TRANSTAR

CALL OR WRITE FOR THE PRINTER & PRICE TO MEET YOUR NEEDS. YOUR SATISFACTION GUARANTEED.

CRAFTSMAN CORPORATION

3116 BAY to BAY — BOX 18966
TAMPA, FL 33679

813/831-5681

IN FLORIDA

ALL OTHERS 1-800-237-4044

VISA & MASTERCARD ACCEPTED

Circle No. 7 on Free Information Card

Smarter Modems

(Continued from page 59)

other producers aim at achieving Hayes compatibility.

Because all Hayes commands begin with the prefix "AT," modem users soon adopted it as a shorthand to express Hayes compatibility. Eventually, the term worked its way into general usage, and today the expression "AT compatible" means the same thing as Hayes-compatible. Not all Hayes-compatibles, however, can run with Hayes software. Certain commands are sometimes modified to meet the hardware demands of the compatible. When this is the case, the Hayes software doesn't run exactly as intended. Neither are all modems Hayes-compatible. Both Cermetek and Racal-Vadic have devised their own sets of commands, neither of which resembles Hayes or each other.

Hayes, as an industry standard bearer, is not ashamed to admit that it has one of the highest-priced modems on the market. And just as IBM sparked an entire generation of PC look-alikes, Hayes compatibles are making their way to the marketplace. U.S. Robotics, with its Auto-Dial 212A, and Password are two lower-cost Hayes compatibles.

On the other hand, there are modems that claim to be smarter than the Hayes, while retaining the Hayes command structure. These modems, like the Prometheus Top Modem, have extended commands in addition to the basic

Hayes commands and can perform tasks that are beyond the scope of the Smartmodem. For example, Top Modem can recognize a busy signal.

Future Modems

Modems have opened up a vast world of communications for PC users. The introduction of the 1200-baud smart modem is one big step toward faster, more reliable communications. If you need to receive or transmit information and if you can afford the price, I strongly suggest you invest in one. Whether it be a Smartmodem or one of its worthy competitors, you stand to save money in the long run.

What's in store for the future? Why, better modems, of course. Already commercial modems are operating at 9600 baud, which is a quantum leap for the communications industry. There is little doubt that these new products will be offering their own brand of modem intelligence.

And there appears to be no limit to the speed. AT&T recently announced that on some existing phone lines they can achieve rates of 56K baud. (See COMPUTERS & ELECTRONICS, Sept. 1984).

In the near future, modems will link the far corners of the world. Using satellite repeaters, the world will shrink in size as international access becomes as common as interstate calls are today. ◇

Modem Intelligence

(Continued from page 62)

Conclusion

If you are only planning to flit among the services offered by dial-up computer networks such as The Source and CompuServe, then you probably don't need much in the way of a communications package or modem. There are public domain communications packages readily available for most machines (via the bulletin boards mentioned earlier), and there are many low-cost, dumb modems that won't leave too big a hollow in your wallet (see COMPUTERS & ELECTRONICS, May 1984). If, on the other hand, you intend to use telecommunications for more demanding tasks, a smart modem may be an absolute necessity.

Choosing between a dumb modem and a smart modem is rather like deciding between a clever phone-answering machine with many advanced features (including, say one that allows you to replay all recorded messages from any telephone in the world) and another that

simply records messages. There is no difference in the basic abilities of the two answering machines—after all, they both record telephone messages when you are not around. But if you travel a lot, the more sophisticated, and more expensive, product would be a better investment than the standard item.

Some factors to consider in buying a modem are: How often will data be sent/received by you? How time-sensitive is the work you do (how long a data delivery delay can you put up with)? Is it likely that data will be transmitted to you outside work hours (from branch offices or from overseas, perhaps)?

Consider the needs of your applications well. While there are a number of overpriced dumb modems available, you shouldn't expect to find any real bargains among the smart modems. But you should expect to find real value—sophisticated hardware that you can mate with sophisticated software—to solve your communications problems. ◇

Power Supplies (Continued from page 87)

rectangular wave present only 75% of the time is equivalent to a 120-V square wave present all the time ($160 \times 0.75 = 120$). By using a rectangular wave with a 75% duty factor, Cuesta is able to approximate much more closely a sine wave than it could with a true square wave, without using a costly stair-step waveform generator.

A UPS with a 60-Hz quasi-sine-wave output will work just fine with most personal computers. However, in some situations a true sine wave is needed, particularly when ac transformers or induction motors are involved. Square-like waves tend to saturate the core material more quickly than sine waves and, as result, lower the efficiency. This lowered efficiency results in more waste heat, which drives operating temperatures up and reduces output. If your computer uses a power supply equipped with a transformer of the linear series pass type or has a separate isolation transformer or an induction motor, chances are that you'll need a true sine wave UPS.

If you're not sure whether or not you can use a quasi-sine-wave UPS with your computer, ask the manufacturer. Most have customer-service technicians you can telephone or write to. Make sure, though, that you include the model and serial number of your computer. Sometimes the manufacturer makes changes in the designs that can affect the answer, and unless you give the serial number, the service technician won't know which version of the design you have.

True Sine Wave Power

If you must use a true sine wave UPS, be prepared to spend considerably more for it than you would for an equivalent quasi-sine-wave model. The increased cost is due to the added circuitry needed to produce the sine wave output.

There are two commonly used approaches to generating sine waves from the square-like wave produced by a dc-to-ac inverter. The older of the two methods involves the use of a ferroresonant transformer, which converts the wave shape through the effects of its core on the magnetic flux generated by the signal applied to it (Fig. 4). Since the waveform conversion occurs within a transformer, it is a relatively simple method that requires few other components. You might say that it has no moving parts. Sun Research's sine wave Mayday units are examples of the ferroresonant UPS.

A newer method uses pulse width modulation (PWM) to generate a series of very short pulses that are uniform in amplitude but vary in width. The prod-

#1 Rating (spreadsheets configuration)
Auerbach's Index
... a terrific machine...
Microcomputing May 1984
... a great bargain!
Computers and Electronics

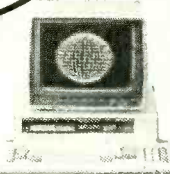

We have the
lowest prices for

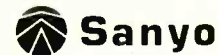

550's / 555's ❖

*Our prices this month are at least \$10 less than any other bona-fide advertised price in this magazine for Sanyo 500/555's. The 386K-2's and our new 720K dash-4's. Plus we'll include a free games disk. Of course, low prices aren't the only reason we've sold more Sanyo's than any other dealer in the United States. To find out why these "under \$1000" MS-DOS machines are selling so fast call or write for our 12-page brochure.



Columbia

Still much more compatibility for much less money! Each system includes MS-DOS, CP/M-86, Basic, Perfect Writer, Speller, Calc, and Filter, Fast Graphs, Space Commanders, Home Accountant Plus, a tutorial and nationwide Bell and Howell service. (prices include color video cards, keyboards, 128K dual drives and more).

1600-1V \$1899 VP's \$1899
1600-4V (with 10 Megabytes) \$3239



Scottsdale Systems Ltd.

617 N. Scottsdale Road, Suite B, Scottsdale, Arizona 85257



(602) 941-5856



Call 8-5 Mon-Fri. **Our 5th Year**

We participate in arbitration for business and customers through the Better Business Bureau

SERVICE/ORDERING

TELEMARKETING ONLY: If you plan to visit please call first for an appointment. Prices listed are for cash and include 3% discount. We sell on a Net 30 basis to Fortune 1200 companies and universities. No C.O.D.'s or A.P.O.'s. P.O.'s add 2%. Visa, Mastercard add 3%. Az. residents add 6%. Prices subject to change, product subject to availability. Personal/company checks take 3 weeks to clear. All items listed are new with manufacturer's warranty. 0-20% restocking fee for returned merchandise. Shipping extra-products are f.o.b. point of shipment. Software is not warranted for suitability. Registered trademarks: Teletideo-Teletideo Systems, Inc.; Unix-ATGT Technologies, Inc.

COMPUTERS

Sanyo 1150	\$1495
Sanyo 4050	\$1995
Zenith 151-52	\$2244
Apple Macintosh	call

PRINTERS

Tally Spirit 80	\$259
Oki 82 w/Ok Writer	\$419
Okidata 92	Same
Okidata 93	\$350 OFF
Epson	call
Toshiba 1351	\$1299
Gemini 10X	\$258
Power Type	\$338
Radix 15	\$699

300 / 1200 MODEMS

Password	\$309
Mark X11	\$255

Now available to everyone!

Computel Publishing Society

a unit of the Computel System presents

The one you've all
been waiting for
Computel
PUBLISHED MONTHLY

A subscription
to Computel
brings all
of these
exciting en-
titlements for the
duration of the membership:

ONE YEAR SUBSCRIPTION: \$14.00
CANADIAN: \$18.00 FOREIGN: \$24.00
(EXAMPLE COPY: \$1.00) (BACK ISSUE: \$2.00)

- The **Membership Print Certificate**—an honorable-looking medallion worth framing, created by the Computel staff to signify membership to the Computel System!
- Hundreds of **WHOLESALE** and below-wholesale priced electronic gift items available for your own personal use or for use with the **Computel Merchandise Distribution Plan**—a marketing technique you can use in a business of your own!
- Group discounts when buying computer systems, supplies, and components with the other members of the Society. From huge closeouts and factory shutdowns that we are constantly seeking as they occur!
- **Discounted** prices on computer hardware and software purchased through the Society at affiliated outlets around the world!
- A comparison of the computer systems and equipment on the market **BEFORE** you make an investment, through Computel's advisory panel of members whose dedication in your locality will assist you on where to buy and where to get help!
- A multi-national magazine bulletin board for students, Computer Enthusiasts, Computer Hackers, Phone Phreaks, management, and any party so interested—spanning the world of Computers, Electronics, and Communications, joining the hobby and profession in a spectacular display of creativity you won't want to miss!
- **FREE** advertising in Computel for members who wish to trade or sell their equipment, leave messages, or just want to find out what's going on with other members—we can print any message you send in, and forward all replies!

SEE HOW EASY IT IS TO BECOME PART OF THE COMPUTEL SOCIETY?

... 24 hours a day... 7 days a week

JUST DIAL OUR TOLL-FREE NUMBER AND HAVE YOUR CREDIT CARD NUMBER READY. GET IT WHILE IT'S HOT—THE PUBLICATION FOR YOU!

1 800 6-COMPUTEL
CALLS OUTSIDE CALIFORNIA

1 800 5-COMPUTEL
CALLS WITHIN CALIFORNIA

ORDER THIS GREAT OFFER BY MAIL OR PHONE TODAY!

The History of Computing	\$14.95
The History of the Telephone	\$6.95
The Phone Phreaks' Guide to Computers	\$19.95
Telephone Engineering Course	\$24.95
Computer Repair—Do it Yourself and SAVE!	\$24.95

ALL 5 REPORTS PLUS A SUBSCRIPTION TO COMPUTEL: \$69.00.

Computel Publishing Society

6354 Van Nuys Blvd., 161-CG / Van Nuys, CA 91401-2696

Don't miss out. **Subscribe now!**

Circle No. 67 on Free Information Card

Put Professional Knowledge and a
COLLEGE DEGREE
in your Electronics Career through

**HOME
STUDY**

**Earn Your
DEGREE**

No commuting to class. Study at your own pace, while you continue your present job. Learn from Grantham easy-to-understand lessons, with help from your home-study instructors.

You can earn your B. S. Degree in the Grantham electronics degree program, offered by independent home study and accredited by the NHSC Accrediting Commission.

Our free bulletin gives details. Write for *Bulletin E-84*.

Grantham College of Engineering
2500 So. LaCienega Blvd.
P. O. Box 35499
Los Angeles, California 90035

Power Supplies

uct of amplitude and width of each pulse equals the amplitude of the corresponding points along a true sine wave. This pulse train is passed through a large iron-core choke that inductively converts it into a true sine wave (Fig. 5). Although both the ferroresonant and pulse width modulator designs use magnetic action to produce sine waves, the latter requires considerably more circuitry because it must generate the modulated pulse train. As examples, the RTE Deltec and Sola Electric sine-wave models use PWM designs.

For personal computers there really is no practical difference in performance between the ferroresonant and PWM models. For example, RTE Deltec specs the voltage regulation of its PWM model at $\pm 3\%$; Sola Electric specs its at 2%. Sun Research specs its ferroresonant models at ± 3 V centered around 118 V, which works out to $\pm 2.5\%$. All three claim the total harmonic distortion is no more than 5%.

Some people believe the ferroresonant design is inherently more reliable because it has so few parts. Although that may have been true before very-large-scale integration (VLSI), newly developed integrated circuits have reduced the number of parts of PWM inverters to just a few. For personal computers, any differences in reliability between the two are insignificant.

Final Comments

One last thing to keep in mind when thinking about uninterruptible power supplies: They also fail! Because they are electronic devices, they can stop functioning at any time. Most, in fact, are very reliable and provides years of trouble-free service. Still, you must be prepared for a failure. Always check the UPS panel indicators when you begin working on your computer. Although the conditions these indicators monitor vary from model to model, they should at the very least indicate that the battery is charged and that the unit is working. On-line models usually have indicators monitoring the inverter's output as well.

Although we could suggest here that you back up your backup power with yet another UPS, we won't yield to the temptation. We will mention, however, that one company has developed an interesting campaign along these lines. Electronic Protection Devices has stated that they will "back up your back-up" to the tune of \$2500—any hardware you plug into their Grizzly UPS is insured for that amount! Now if we can only find a company that will insure your priceless data. ◇

Tallgrass

(Continued from page 30)

multiple hard disks, however, a strong case could be made for having just one tape backup unit that is shared among users, an option not currently available from Tallgrass. Both of these solutions could be viable alternatives for a PC-based network.

We want to emphasize that individ-

uals should not be lulled by the convenience and power of hard disks into relaxing backup procedures, even if they may be onerous and time-consuming. For backup in particular, the direct integration of a tape drive into the 3170 makes it a very attractive alternative to stand-alone hard disks. ◇



Active



The One Stop Electronic Shop!

Call Toll FREE 1-800-343-0874

In the United States:

Mail Orders

P.O. Box 8000
Westborough, Mass.
01581
(Mass) (617) 366-0500

Boston

133 Flanders Road
Westborough, Mass.
01581
(617) 366-9684

Seattle

13107 Northrup Way
Bellevue, Wash.
98004
(206) 881-8191

In Canada:

Montréal

5651 Rue Ferrier
Montréal, Québec
H4P 1N1
(514) 731-7441

Toronto

14 Carlton Street
Toronto, Ontario
M5B 1K5
(416) 977-7692

Downsview

86 St. Regis Cr. N.
Downsview, Ontario
M3J 1Y8
(416) 630-0400

Ottawa

1023 Merivale Road
Ottawa, Ontario
K1Z 6A6
(613) 728-7900

Calgary

3220-5th Ave. N.E.
Bay 2
Calgary, Alberta
T2A 5N1
(403) 235-5300

Vancouver

3070 Kingsway
Vancouver, B.C.
V5R 5J7
(604) 438-3321

Visit your nearest Active store, call, write or circle the Reader Service Card for your copy of Active's new catalog.

Circle No. 50 on Free Information Card

Computer Mart

RATE: Ads are "by 3". 1 insertion: \$935.00. 6 insertions: \$900.00 ea. 12 insertions, \$865.00 ea. Closing date: 1st of the 2nd mo. preceding cover date. Send order and remittance to Computer Mart, Computers & Electronics, 1 Park Ave., N.Y., N.Y. 10016. Direct Inquiries to: Lols Price (212) 503-5115. For Customer Service (212) 503-5115. For Customer Service, call (212) 503-4506.

COMMODORE 64 INTERFACING BLUE BOOK

Written by a college professor in a friendly and informative style, this book is a gold mine of practical information on how to build a variety of useful interfaces for your computer. Over 30 projects including cassette interface, printer interface, expansion bus, light pen, RS-232 interface, more user ports, thermometer, speech synthesizer and two other voice projects, A/D and D/A converters, 5 telephone interfaces including a sophisticated voice mail project, motor controllers, AC power control, logic analyzer, capacitance meter, spectrum analyzer, home security system and many more. \$16.95 postpaid. Foreign orders add \$3 for AIR MAIL shipping.

VIC 20 INTERFACING BLUE BOOK

30 hardware interfacing projects for the VIC 20. Similar to the 64 book above. See what your VIC can do with a little interfacing. \$14.95 postpaid.

microsignal

Dept. B, P.O. BOX 22
MILLWOOD, NY 10546

Thanks to YOU . . . We're Growing . . .
with YOU and your Computer . . .
LEO ELECTRONICS, INC.
P.O. Box 11307
Torrance, CA. 90510-1307
Tel: 213/212-6133 800/421-9565
TLX: 291 985 LEO UR

We Offer . . . **PRICE** . . . **QUALITY**
PERSONAL SERVICE

64K UPGRADE

9 Bank (IBM PC)	\$43.65	(150ns)
	\$41.85	(200ns)
4164 (150ns)	\$4.85 ea.	
	\$4.65 ea.	
8 Bank (other PC)	\$38.80	(150ns)
	\$37.20	(200ns)
4164 (150ns)	\$4.85 ea.	
	\$4.65 ea.	

256K "Mother Saver" Upgrade

8 - 256K - (150ns)	\$400.00	
6116P-3 -	\$4.40	2732 - \$3.95
2716 -	\$3.20	2764 - \$7.00
TMS-2716 -	\$4.95	27128 - \$24.00

We accept checks, Visa, Mastercard or Purchase Orders from qualified firms and institutions. U.S. Funds only. Call for C.O.D. California residents add 6% tax. Shipping is UPS. Add \$2.00 for ground and \$5.00 for air. All major manufacturers. All parts 100% guaranteed. Pricing subject to change without notice.

Marymac
INDUSTRIES

800-231-3680

Pan American
ELECTRONICS

800-531-7466

Radio Shack TRS-80's

People you Trust to give you the very best!



- Lowest Price
- Reliable Service
- Quality Products

22511 Katy Fwy., Katy (Houston) Texas 77450
(713) 392-0747 Telex 774132

CIRCLE NO. 98 ON FREE INFORMATION CARD

NEW!

SURGE-STOP

Give any circuit 4500 AMPS of surge protection by just plugging it in! \$9.95

Surge Suppressor,
With EMI/RFI filtering, 6 plug switched-15 Amp circuit breaker

\$29.95

Build Your Own 68000 System
with 128KB, 3-RS232 ports for about \$250

FREE CATALOG

Digatek Corporation
2723 W. Butler Dr., Suite 7
Phoenix, AZ 85021
602-995-8371

CIRCLE NO. 99 ON FREE INFORMATION CARD

BUILD YOUR OWN COMPUTER!!

68000 BASED MULTI-BUS COMPATIBLE KIT

4 BOARD SET INCLUDES:

- 1 6 SLOT MOTHER BOARD
- 1 CPU CARD
- 1 I/O with UPD 765 FLOPPY CONTROLLER
- 1 128K RAM CARD

SCHEMATICS PARTS LIST & ASSEMBLY DRAWINGS

KT 1001 COMPUTER KIT (FLATBOARDS ONLY)	\$189.99
KT 1004 COMPUTER KIT (UNTESTED BOARDS POPULATED)	\$399.99
KT 1002 COMPUTER KIT (DOCUMENTATION ONLY)	\$35.00
KT 1003 PAL FOR RAM BOARD	\$16.99
KT 1005 CP/M FOR KIT (INCLUDES BIOS)	\$350.00

WE CARRY A COMPLETE LINE OF ELECTRONIC COMPONENTS
SEND FOR A FREE CATALOG!!!



NICORN ELECTRONICS
1000 CANOGA AVE. UNIT B 8
CHATSWORTH CALIF. 91311
(818) 341 8833

CIRCLE NO. 100 ON FREE INFORMATION CARD

ELECTRONIC COMPONENTS



FREE CATALOG
160 PAGE

MANUFACTURERS OF QUALITY ELECTRONIC COMPONENTS

OVER 15,000 DIFFERENT ITEMS IN STOCK!

MOUSER ELECTRONICS
11433 WOODSIDE AVE., SANTEE, CA 92071
PHONE (619) 449-2222 TWX 910-331-1175

CIRCLE NO. 101 ON FREE INFORMATION CARD

★MICROCOMPUTER★ BUSINESS SOFTWARE

MEDICAL MGMT...
DENTAL MGMT...
INSURANCE AGENT
LEGAL BILLING....
PROPERTY MGMT..
AND MUCH MORE!

UNIVAIR INTERNATIONAL
9024 St. Charles Rock Road
ST. LOUIS, MISSOURI 63114

(314) 426-1099

CIRCLE NO. 102 ON FREE INFORMATION CARD

GREAT DISKETTES Super Low Prices BIG NAME, NO NAME

You've used these diskettes a hundred times... and never knew their name. They're used by many of the major software manufacturers... and now you can buy them.

\$119 ea. 5 1/4" SSDD Qty. 50
\$159 ea. 5 1/4" DSDD Qty. 50

5 1/4" SSDD-96TPI \$1.89 ea. 5 1/4" DSDD-96TPI \$2.14 ea

*** LIFETIME WARRANTY! ***

These are bulk packed diskettes with white Tyvek sleeves. No user identification labels or write-protect tabs are included.

Shipping: 5 1/4" DISKETTES—Add \$3.00 per 100 or fewer diskettes. Payment: VISA or MASTERCARD accepted. CDD orders only, add \$3.00 handling charge. Taxes: Ill. residents only, add 8% sales tax.

WE WILL BEAT ANY NATIONALLY ADVERTISED PRICE ON THE SAME PRODUCT AND QUANTITIES!

For orders only: 1-800-621-6827
(In Illinois: 1-312-944-2788)

(All other calls: 1-312-944-2788)
Hours: 9AM-5PM Central, Mon.-Fri.

DISK WORLD!, Inc.
Suite 4806 • 30 East Huron Street • Chicago, Illinois 60611

DISK WORLD!

BIG NAME.
NO NAME
DISKETTES

CIRCLE NO. 103 ON FREE INFORMATION CARD

Computers & Electronics

Now we can make any computer
sing as well as talk, for only \$219.



As featured in Garcia's
Circuit Cellar,
BYTE Magazine,
September,
October 1982.

Microvox.

MICROVOX is a completely self contained professional voice quality text-to-speech synthesizer. MICROVOX may be easily interfaced to any computer, modem, RS-232C serial or parallel output device.

- 6502 Microprocessor based text-to-speech algorithm
- SC-01A phoneme based speech synthesizer
- 64 crystal controlled inflection levels
- 3000 character buffer
- RS-232C and parallel port interfaces
- On board power supply
- Music and sound effects capability

MV01 Microvox Assembled & Tested \$299.00
MV02 Microvox, complete kit \$219.00



To Order: Call Toll Free
1-800-645-3479
In N.Y. 1-516-374-6793
MICROMINT, INC.
561 Willow Avenue
Cedarhurst, NY 11516

CIRCLE NO. 104 ON FREE INFORMATION CARD

TOROIDAL POWER TRANSFORMERS
Small size • Low noise • Easy mounting

Made in U.S.A.

Custom sizes: 15VA-3,000VA at 50/60 Hz
40 standard transformers with
117V-60Hz primaries in stock
for 20VA, 40VA, 70VA, 100VA,
150VA, 340VA, 600VA
Call or write for data sheets



Size	Secondaries* Volts/Amps	Price Each		
		1	2-4	5-24
20VA	2x8.5V/1.18A	\$24.30	\$20.40	\$17.90
OD - 2.4"	2x12V/.83A	24.30	20.40	17.90
H - 1.2"	2x15V/.67A	24.30	20.40	17.90
Wt. - .7 lbs	2x18V/.56A	24.30	20.40	17.90
	2x24V/.42A	24.30	20.40	17.90
	Multivoltage**	29.30	25.20	22.40
100VA	24V/4.15A	\$29.10	\$24.80	\$22.10
OD - 3.7"	2x8.5V/5.8A	30.00	25.70	23.00
H - 1.4"	2x12V/4.15A	30.00	25.70	23.00
Wt. - 2.2 lbs	2x15V/3.3A	30.00	25.70	23.00
	2x18V/2.8A	30.00	25.70	23.00
	Multivoltage**	37.00	32.50	29.50
600VA	220V/2.73A	\$59.00	\$50.00	\$44.50
OD - 5.5"	2x24V/12.5A	59.90	50.90	45.40
H - 2.4"	2x30V/10.0A	59.90	50.90	45.40
Wt. - 8.2 lbs	2x33V/9.1A	59.90	50.90	45.40
	2x38V/7.9A	59.90	50.90	45.40

* Dual secondaries may be used separately, in parallel or in series.
** For 5V and .12V or 5V and .15V regulated DC.
Terms: VISA, MASTERCARD, COD or money orders—
UPS charges added.

301-464-2100 TOROID CORPORATION OF MARYLAND
6000 Laurel Bowie Rd., Bowie, MD 20715-4037

CIRCLE NO. 107 ON FREE INFORMATION CARD

ICs PROMPT DELIVERY!!!
SAME DAY SHIPPING (USUALLY)

DYNAMIC RAM			
256K	150 ns	\$35.77	
64K	200 ns	4.87	
64K	150 ns	4.87	
64K	120 ns	5.59	
16K	200 ns	1.21	
EPROM			
27256	32Kx8	300 ns	\$49.97
27128	16Kx8	250 ns	26.50
2764	8Kx8	250 ns	7.97
2732	4Kx8	450 ns	5.40
2716	2Kx8	450 ns	3.60
STATIC RAM			
5565P-15	150 ns	\$35.97	
6264LP-15	150 ns	35.97	
6116P-3	150 ns	6.36	

Open 6 1/2 days, we can ship via Fed-Ex on Sat.
MasterCard/VISA or UPS CASH COD
Factory New, Prime Parts
MICROPROCESSORS UNLIMITED
24,000 South Peoria Ave
BEGGS, OK 74421 (918) 267-4961
Prices shown above are for July 30, 1984.
Please call for new discount & current prices. Prices subject to change. Please expect
higher prices on some parts due to world wide shortages. Shipping and Insurance extra.
Cash discount prices shown. Small orders received by 8 PM CST can usually be delivered to
you by the next morning, via Federal Express Standard Air @ \$5.99!

CIRCLE NO. 110 ON FREE INFORMATION CARD

TOTAL CONTROL

For the
Timex-Sinclair
Computer

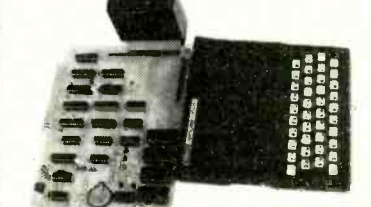

Built & Tested \$174.95
Bare Board \$49.95

1/O
16 lines IN, 16 lines OUT
Real Time Clock/Calendar
with Battery Back-up
Analog to Digital Converter:
4 channel - 8 bit
8K Non-Volatile RAM
RAM or EPROM
Compatible with
ZX-80, ZX-81, TS 1000 & TS 1500

TERMS: Check or Money Order
Call: Res. Add 6%
SHIPPING: Inside U.S. \$4.00
Outside U.S. \$10.00

JK AUDIO
P.O. Box 3295
Escondido, CA 92029-0580
(619) 741-5132

CIRCLE NO. 105 ON FREE INFORMATION CARD

SAVE MORE THAN EVER ON 3M Scotch® DISKETTES

SALE PRICES ON 5 1/4" DISKETTES
Prices good thru 9/30/84.

\$149 ea. 5 1/4" SSDD **\$195** ea. 5 1/4" DSDD
Qty. 20 Qty. 20

LIFETIME WARRANTY!

5 1/4" SSDD-96TPI \$2.19 ea. 5 1/4" DSDD-96TPI \$2.75 ea.
8" SSDD \$2.05 ea. 8" DSDD \$2.50 ea.
8" DSDD \$3.10 ea.

All diskettes are boxed in 10's with Tyvek sleeves, reinforced hubs on 5 1/4" user identification labels and write-protect tabs
Shipping: 5 1/4" DISKETTES—Add \$4.00 per 100 or fewer diskettes
8" DISKETTES—Add \$4.00 per 100 or fewer diskettes. Payment: VISA and MASTERCARD accepted. COD orders only, add \$3.00 handling charge. Taxes: Illinois residents only, add 6% sales tax.

WE WILL BEAT ANY NATIONALLY ADVERTISED PRICE ON THE SAME PRODUCT AND QUANTITIES!

For orders only: 1-800-621-6827
(In Illinois: 1-312-944-2788)
(All other calls: 1-312-944-2788)
Hours: 9AM-5PM Central, Mon-Fri.

DISK WORLD!, Inc.
Suite 4806 • 30 East Huron Street • Chicago, Illinois 60611

Authorized Distributor
Information Processing
Products

CIRCLE NO. 108 ON FREE INFORMATION CARD

20 PROGRAMS on 2 cassette tapes

for 16K
TS1000,
TS1500,
& ZX81
only
\$19.95

*for TS2068, C-64, VIC-20, ATARI, TI99/4A, CoCo & MC-10 only \$29.95

Save money, learn about the exciting world of home computing and have fun doing it with the new HOME-PAC™

The HOME-PAC™ with 21 page user manual covers educational, graphics, recreational, home finance and utility applications.

Great tool for learning to program in BASIC. Programs are listable and manual includes section on modification tips.

10 DAY MONEY BACK GUARANTEE

Please add \$2.00 shipping and handling to order.

Simplex Software, Dept CE2
62 Crestview Drive
Willingboro, NJ 08046
MC, VISA & Checks Accepted
Orders & Inquiries State Computer Type
Dealer Inquiries Invited

CIRCLE NO. 111 ON FREE INFORMATION CARD



FLOPPY DISK DRIVE DIAGNOSTIC

Do it yourself and save time and money. No special training needed.

All tests made WITHOUT REMOVING DRIVES. Additional equipment not needed. Our kit also includes users guide that shows how to do the drive adjustments.

OUR DRIVE DIAGNOSTIC WILL HELP YOU PREVENT COSTLY DATA ERRORS.

APPLE II® DRIVE DIAGNOSTIC \$119
KAYPRO® DRIVE DIAGNOSTIC \$119

Sheepshead Software™
P.O. Box 486
Boonville, CA 95415
(707) 463-1833

Phone orders Mon.-Sat. 9 a.m. to 9 p.m. Pacific Coast Time.
MASTER/VISA Card or C.O.D. add \$2.
Calif. add 6% UPS Blue Label add \$5.

CIRCLE NO. 106 ON FREE INFORMATION CARD

MULTI-CHANNEL current carrier transceiver 2-WAY COMMUNICATION with any BSR type device

- Switch selectable for 8 channels transmit & 3 channels receive OR 3 channels transmit & 8 channels receive + 1 channel for on/off cmd.
- Switch selectable for any of the 16 BSR 'house codes' A thru P.
- To transmit a BSR signal, take the assigned TTL input port high momentarily.
- Upon receiving a BSR 'on' signal, the TTL output port goes high and stays high until reset by BSR 'off' signal.
- An interrupt driven Z-8 micro, complete with power supply (requires 24 vac ct @ 200 ma) on a 4 1/2" card with 44 pin connector, \$187.00.
- Optional RS-232 interface capable of sending and receiving all 256 channels, \$49.00.

HYDRUS CORPORATION dept. C
(214) 350-8766
6218 Cedar Springs Rd. Dallas, Texas 75235

CIRCLE NO. 109 ON FREE INFORMATION CARD

ELECTRONIC COMPONENTS



MANUFACTURERS OF QUALITY ELECTRONIC COMPONENTS
OVER 15,000 DIFFERENT ITEMS IN STOCK!

MOUSER ELECTRONICS
11433 WOODSIDE AVE., SANTEE, CA 92071
PHONE: (619) 449-2222 TWX: 910-331-1175

CIRCLE NO. 112 ON FREE INFORMATION CARD

PUBLIC DOMAIN SOFTWARE

Lots of it available in these formats:

- Single sided formats
- Actrix (SSDD)
- Cromemco CDOS (SSDD)
- Cromemco CDOS (SSSD)
- Cromemco
- w/intl Term CPM
- DEC VT180 (DD)
- Health w/ Magnolia (DD)
- IBM PC (CP/M-86 SSDD)
- Kaypro 11
- LOGO MAX-80 (DD)
- MS-DOS/PC-DOS (Ver. 1)
- MS-DOS/PC-DOS (Ver. 2)
- Morrow MD2
- NEC PC-801A
- Osborne 1 (DD)
- Osborne 1 (SD)
- Superbrain (40 tk SS)
- Superbrain (JR)
- T1 Professional (DD)
- TRS-80 I (Omikron CP/M)
- TRS-80 Mod III (MM CP/M)
- Xerox 820 (SD)
- Xerox 820-II (DD)
- Zenith Z-90 (48 tp SS)

- Double sided formats
- Actrix (DSDD)
- Cromemco CDOS (DSDD)
- Cromemco CDOS (DSDD)
- Cromemco
- w/intl Term CPM
- Datavue (DSDD)
- EPSON QX-10
- Hewlett Packard HP-125
- IBM PC (CP/M-86 DSDD)
- IMS 5000
- Kaypro 4-10
- MAGIC Computer
- MS-DOS/PC-DOS (Ver. 1)
- MS-DOS/PC-DOS (Ver. 2)
- Morrow MD3
- NEC PC-801A
- Ortona Attache
- Sanyo
- Superbrain (QD)
- TeleVideo
- Toshiba T100
- Zenith Z-100 (DD)

Over 200 disks, most formats \$12 per disk.
Send \$2 for PD catalog. Sample disk \$8.

Sheepshead Software™
P.O. Box 486
Boonville, CA 95415

CIRCLE NO. 113 ON FREE INFORMATION CARD

FANTASTIC LOW PRICES ON BASF QUALIMETRIC DISKETTES

- * LIFETIME WARRANTY *
- * PLASTIC STORAGE CASES *

 **\$139^{ea.}** ^{5 1/4" SSDD} **\$189^{ea.}** ^{5 1/4" DSDD}

All BASF Diskettes include a PLASTIC DISK CADDY, Tyvek sleeves, reinforced hubs, user identification labels and write-protect tabs.

Shipping: 5 1/4" DISKETTES—Add \$3.00 per 100 or fewer diskettes
Payment: VISA or MASTERCARD accepted. COD orders only, add \$3.00 handling charge. Taxes: Ill. residents only, add 8% sales tax

WE WILL BEAT ANY NATIONALLY ADVERTISED PRICE ON THE SAME PRODUCT AND QUANTITIES!

For orders only: 1-800-621-6827
(In Illinois: 1-312-944-2788)
(All other calls: 1-312-944-2788)
Hours: 9AM-5PM Central, Mon.-Fri.

DISK WORLD!, Inc.

Suite 4806 • 30 East Huron Street • Chicago, Illinois 60611

DISK WORLD! Authorized Reseller
Information Processing • **BASF**
Media

CIRCLE NO. 114 ON FREE INFORMATION CARD

Now available for the computer experimenter!

COMPUTER CONNOISSEUR'S DELIGHT!

NOW BE IN CONTROL WITH YOUR COMPUTER — THE ONLY PUBLICATION OF ITS KIND WRITTEN FOR THE USER. DISCOVER THE SECRETS AND LEARN THE VERSATILITY OF MODERN COMPUTER COMMAND CONTROL CONCEPTS. EXPERIMENT WITH COMPUTER AND TELEPHONE SYSTEMS, INTERFACE THEM, LEARN HOW THEY WORK, WHAT THEY DO, AND HOW TO GET THEM TO WORK FOR YOU! A COMPLETE TELEPHONE ENGINEERING COURSE IS INCLUDED IN MONTHLY CHAPTERS. BRINGING YOU THROUGH STEP, CROSSBAR, ESS, BUBBLE, AND ATOMIC SWITCHING SYSTEMS! EXCLUSIVE COVERAGE IN BIOLOGICAL COMPUTING SYSTEMS, TOLL COMPUTERS AND TELEPHONES ARE THE FUTURE. THIS PUBLICATION IS AN ABSOLUTE MUST FOR EVERYONE INTERESTED.

UNPUBLISHED MATERIAL

WIT

COMICS

DIRECTORY LISTING

NET-WORKS

AC-CESSE CODES

The one you've all been waiting for!

NOW AVAILABLE — Learn how to repair telephones and telephone systems. Now they work in monthly installments with the magazine for you.

Computel

PUBLISHED MONTHLY

ONE YEAR SUBSCRIPTION \$14.00

(SAMPLE COPY \$2.00)

SUBSCRIPTION & 2 PROGRAMS \$20.00

Order Labels On: 480 • COMPUTEL, Inc. (New York, NY) • 800 • COMPUTEL, Inc. (Los Angeles, CA) • 300 • COMPUTEL, Inc. (San Francisco, CA)

COMPUTEL—the complete SOURCE for everyone. You can now do the things you've only heard about, right in the privacy of your own home. Indispensable reference to phreaks and hackers. Learn how to get all kinds of computer programs FREE. Get the inside story of big business systems—their quirks and flaws—and remain up to date with vital occurrences within the computer industry. Computel is a publication designed for everyone who has an intense curiosity of computer systems, containing a wealth of hard to find information, codes, and numbers. Published monthly.

USA

Computel Publishing Society

6354 VAN NUYS BL., #161-E, VAN NUS, CA 91401

CIRCLE NO. 97 ON FREE INFORMATION CARD

TimeEPROMmer

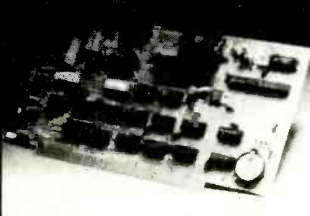

\$100

EPROM PROGRAMMER REAL TIME CLOCK
All the best features for EPROM Programming and a Real Time Calendar-Clock for \$100!

- All Eprom types from 2708 to 2764
- ZIF Socket, Port Addressable
- Comprehensive Menu driven software including Source
- Socketted Lithium Battery backup

Call or send for literature package
VISA, MASTERCARD, COD Accepted
Assembled and Tested \$295, Kit \$195

OPTRONICS TECHNOLOGY 716-377-0369
2990 Atlantic Ave.
Penfield, NY 14526

DISCOUNT COMPUTER EQUIPMENT

LOWEST PRICES on Printers,
Disk Drives, Software, and
Other Computer Equipment!
EPSON, Star Micronics, Okidata,
Tandon, TEAC, & Many Others.

For a free catalog call

918/825-4844

918-825-4844 Small Business COMPUTERS

Votrax® SC-01A SPEECH SYNTHESIZER



\$32 each
(\$24 in
hundreds)

Order in Ones or Thousands

The SC-01A Speech Synthesizer is a completely self-contained solid state device. This single chip phonetically synthesizes continuous speech of unlimited vocabulary.

Computer interlaces and text-to-speech algorithms also available for product development.

Micromint is the largest U.S. distributor of the SC-01A. Call us for a price quote

Call 1-800-645-3479, in N.Y. 1-516-374-6793

MICROMINT INC.
561 Willow Avenue
Cedarhurst, NY 11516



Add \$2.00 for shipping & handling

CIRCLE NO. 115 ON FREE INFORMATION CARD

Computers & Electronics Marketplace

CLASSIFIED RATES: Per Word, 15 Word Minimum. **COMMERCIAL:** \$5.00, **PERSONAL:** \$3.00, **EXPAND-AD:** \$7.50. Ads set in all bold type @ 20% premium. Ads set with background screen @ 25% premium. **DISPLAY:** 1" x 2 1/4", \$605.00. 2" x 2 1/4", \$1,165.00. 3" x 2 1/4", \$1,675.00. **GENERAL INFORMATION:** Frequency rates and prepayment discounts available. Payment must accompany order except credit card—Am. Ex., Diners, MC, VISA (include exp. date)—or accredited ad agency insertions. Copy subject to publisher's approval; must be typewritten or printed. First word set in caps. Advertisers using P.O. Boxes MUST supply permanent address and telephone number. Orders not acknowledged. They will appear in next available issue after receipt. Closing date: 1st of the 2nd month preceding cover date (e.g., Mar. issue closes Jan. 1). Send order & remittance to: Classified Advertising, **COMPUTERS & ELECTRONICS** Magazine, 1 Park Avenue, New York, NY 10016. To Charge your ad to a major credit card, call Lois Price at (212) 503-5115. For Customer Service, call (212) 503-4506.

FOR SALE

GOVERNMENT and industrial surplus receivers, transmitters, sniperscopes, electronic parts, Picture Catalog 25 cents. Meshna, Nahant, Mass. 01908.

RECONDITIONED TEST EQUIPMENT \$1.00 for catalog. WALTER'S TEST EQUIPMENT, 2697 Nickel, San Pablo, CA 94806. (415) 724-0587.

ELECTRONIC CATALOG. Over 4,500 items. Parts, & components. Everything needed by the hobbyist or technician. \$2.00 postage & handling (United States Only), refundable with first \$15.00 order. T & M Electronics, 472 East Main St., Patchogue, NY 11772. (516) 289-2520.

PRINTED CIRCUIT BOARDS, your artwork. Quick delivery. Reasonable. Atlas Circuits, Box 892, Lincoln, NC 28092. (704) 735-3943.

POLICE CODE UNSCRAMBLERS, lets you hear the coded messages of Police, Fire and Medical channels, plus other scanner accessories, satisfaction guaranteed. DNE Inc., Rt. 7, Box 257-A, Hot Springs, AR 71901. (501) 623-6027.

CABLE TV CONVERTERS & EQUIPMENT. Plans and parts. Build or buy. For more information send \$2.00: C & D ELECTRONICS INC., P.O. Box 21, Jenison, MI 49428.

FREE Catalog of special function IC's and quality components. Goldsmith Scientific, Box 318M, Commack, New York 11725.

FREE! 1984 CATALOGUE. 1001 bargains. Speakers-parts-tubes-video cassettes—record changers—tape recorders—kits. EVERYTHING IN ELECTRONICS. Write: MCGEE RADIO & ELECTRONICS, 1901 McGee Street, Kansas City, MO 64108-1891.

TV & RADIO TUBES, 59¢ each. Send for free catalog. Cornell, 4213 University, San Diego CA 92105.

12 SATELLITE DISH AND POLAR MOUNT. Total weight 125-lbs. For \$189.00. For information send \$4.95 (Refundable u.p.) to: Satellite Operational Systems, P.O. Box 2002, Titusville, FL 32781.

CABLE TV products. Jerrold, Hamlin and Oak, send \$3.00 to ADDITIONAL OUTLET CORP., 111 E. Commercial Blvd., Ft. Lauderdale, FL 33334.

CABLE TV EQUIPMENT, Notch filters for "Beeping" Channels. Information \$1.00. Goldcoast, Box 63/6025 CE, Margate, Florida 33063 (305) 752-9202.

LOWEST POSSIBLE PRICES ANYWHERE! Computers Hardware—Software—Printers. Audio, Video. Car Stereo. ELECTRIFIED DISCOUNTERS, 996 Orange Ave., West Haven, CT 06516. MC/VISA. (203) 937-0106.

NEW! MULTI-CHANNEL MICROWAVE

Complete Antenna Systems from \$69⁹⁵

Full 800 Mhz Range
Tune 1.9-2.7 Ghz
Includes all
ITFS Channels

DEALERS WANTED

COD's and Credit Card
Orders call TOLL FREE

1-800-247-1151

GALAXY
ELECTRONICS
5644 N. 53rd Ave.
Glendale, AZ 85301
1-602-247-1151



CABLE TV. EQUIPMENT, JERROLD HAMLIN, OAK, all types. We also have Jerrold SB-3 in kit form. All parts and instructions included. Dealer inquiries invited. S.A.P. 3531 W. Glendale Ave., Phoenix, Arizona 85021 (602) 973-9117.

PAY-TV RECEPTION. HBO, Showtime, Cinemax 'High-To-Book \$4.95 Diptronic. Box 80(B8), Lake Hiawatha, NJ 07034

CABLE TELEVISION FACTS AND SECRETS. Now you can get the informative publication that CATV companies have been unsuccessfully trying to get banned for 15 years. Movie Channel, HBO and Showtime converters, etc. Send \$8.75 to: CABFAX, P.O. Box 091196, Bexley, Ohio 43209.

FREE BROCHURE! Largest selection of computer oriented T-shirts and caps. Must see! Computer Graphics, Box 4055, Lutherville, Maryland 21093.

SATELLITE TV RECEIVER BREAKTHROUGH! Build your own system and save! Instruction manuals, schematics, circuit boards! Send stamped envelope: XANDI, Box 25647, Dept. 22B Tempe AZ 85282

Telephone Audio Coupler connects between your recorder auxiliary input and phone line modular jack. (T adapter included). Play back or record messages. Uses improved broadcast engineering techniques. \$14.95 plus \$2.00 p&h. Info \$1.00. Columbus Music Company, 2514 13 Street, Columbus, NE 68601.

MINIATURE LONG-RANGE TELEPHONE TRANSMITTER. Monitor calls. Complete plans \$4.00 US. Stargift, 41 Pine, Kapuskasing, Ontario Canada P5N 1X6. U.S. Inquiries.

FREE catalog of special function IC's and quality components. Goldsmith Scientific, 720 E. Industrial Park Dr., Manchester, NH 03103

COMPUTER EQUIPMENT/PARTS

SAVE 90% Build Your Own Minicomputer. Free Details. Digatek, 2723 West Butler Dr., Suite 20C, Phoenix, AZ 85021.

FREE 64 PAGE COMPUTER CATALOG crammed full of thousands of the best buys and lowest prices around! A.P. COMPUTER PRODUCTS, Dept. CE, 214A East Main, Patchogue, NY 11772. (516) 698-8636.

USED COMPUTER terminals, printers, modems, cables, surplus electronic parts. Specials: CRT's \$20.00, Hardware Modems \$50.00. Catalog \$1.00. Roudure Company, 'The Computer Room' CE, 2522 Butler Street, Dallas, TX 75235, (214) 630-4621.

REPLACEMENT RIBBONS for computer printers and word processors. Fantastic saving! Thousands in stock. Quick delivery Call/write 1 (800) 292-6272. National Computer Ribbons, 114 Elbank Ave. Baltimore, MD 21239.

SELF CONTAINED eprom programmer/emulator kit, from U.S. \$79.00 Z-80 based microcomputer kit, from U.S. \$129.00 FREE CATALOG Protec, 725 Decarie #202, St-Laurent, QC, Canada H4L 3L4. Tel. (514) 744-3363. U.S. Inquiries.

CLEARANCE Sale. Keychain cards, photographic film, transparent tape, line printer paper, ditto masters. All used only once. RPM, Box 4, Elm, KY

COMPUTER SOFTWARE

FREE VIC-20 and COMMODORE 64 USERS GROUP MEMBERSHIP with software purchase. Why pay to belong to a users group when you don't have to? Benefits: Newsletter, extensive club library, discounts, contests, questions hot-line and more! Free details—(803) 797-1533. Lords of Basic, P.O. Box 459, Dept. 102 Ladson, SC 29456.

DISKETTE FORMAT CONVERSIONS/DOWNLOADING, from \$5.00. Port-A-Soft, 423 #800N, Orem, UT 84057. 801/226-6704

HORSE & DOG HANDICAPPING PROGRAMS FOR MOST PERSONAL COMPUTERS. Free Catalog: Gambler's Edge Computing, Dept. B6, 250 Richards Rd., Suite 254, Kansas City, MO 64116.

TI-99/4A CASSETTE CABLES \$16.71 (Extended Basic, Logo, Mini-memory \$88.11 each!), PHP1250 Drive \$210.94. CSC, Box 1361, Bloomington, IL 61702-1361. (309) 828-3251.

RENT PUBLIC DOMAIN SOFTWARE. It's not copyrighted, no fees to pay. Copy hundreds of useful business, utility and game programs from our rental libraries onto your own computer at home! SASE NATIONAL PUBLIC DOMAIN LIBRARY, 1062 Taylor Vista, CA 92083. (619) 941-9295.

DISCOUNT Computer—Software, Wargames, Video cassettes. FREE catalog. Wizard Entertainment, Box 509, Saugus, CA 91355.

TS 1000, TI99/4A, VIC-20 Software. Turns Programs into Profits; Catalog: Midwest Software, 9922 Harwich, Crestwood, MO 63126.

FREE TI99-4A/TRS80-COCO/TRS80-MC10/VIC-20/TI-MEX program! Send stamps! eZRA E.Z.R.A. Company, Box 5222-CSE, San Diego, California 921005.

COMMODORE 64 Educational package. Eng. Math, Science. 104 programs on 8 discs. \$39.95. Millsons, Box 180, Kennesaw, GA 30144.

COMMODORE 64/VIC 20 Games/educational software. Over 400 titles! Write for FREE catalog! American Peripherals, 12 Bangor St., Lindenhurst, NY 11757.

HARNESS AND THOROUGHbred RACING HANDICAPPING PACKAGE. \$31.95. Specify: Cassette, Diskette—Apple II+e. IBM PC, COMMODORE 64, VIC-20, Atari, TI-99/4A, TRS-80, FREE INFORMATION! SOFTWARE EXCHANGE. Box 5382CE West Bloomfield, Michigan 48033

SOFTWARE CLEARANCE: TS1000 programs from Timex for \$1.99. Atari programs like Jawbreaker \$8.95. VIC20 and Apple programs at below cost prices. FREE catalog. Megatrack Computers, PO Box 940, Jackson Heights, NY 11372. (212) 927-1104.

TI-99/4A, C-64 TImEX 16K-48K, VIC, IBM, OWNERS. 5 fun programs for \$2.00! Get Baseball, Etching-Sketch, Blackjack, Dungeon, Galactic Patrol. Specify your computer. CHIPMUNK SOFTWARE. 634 Littlecroft, Upper-Darby, PA 19082.

TI-99/4A Software for personal, home entertainment, and business applications. Write for free catalog to: Micro-Biz Hawaii, Dept. P 98-1409D. Kaahumanu St., Alea, Hawaii 96701.

CHECK your disks! Cygnax disks in boxes with the code ADB3 had aluminum oxide mixed with the iron oxide by mistake. This will grind 1/8" from a read/write head in 12 revolutions. Please return disks for replacement. C.D.I.

FOOTBALL FORECASTER, NFL or college \$19.95 each, \$29.95 both + \$2.00 p/h. 16K. TS 1000, TRS-80C EBC, VIC-20, C-64. HAUG WILD SOFTWARE, P.O. Box 7668, Little Rock, AR 72217.

FREE SOFTWARE. Earn "BONUS BUCKS" for FREE Software, Books and Supplies. Catalog \$1.00 (refundable with order). Specify model. Computer Discount Center Inc., Dept. CE, PO Box 1548, Springfield, VA 22151

FOR SUPER SAVINGS ON DISKS (Verbatim or 3M S/D-\$21. D/D-\$26), Modems (Hayes 1200-\$479, 1200B-\$399), Printers, Paper & Cables call (513) 861-SOFT. Will beat any published price! Visa/MC/COD.

MAXELL MD-1 DISKETTES \$25.00/10 plus \$1.00 S&H. VISA/MC. Cottage Resources, Suite 243, 1032 Stevenson Drive, Springfield, IL 62703.

RENT SWAP your SOFTWARE. FREE catalog. SUPER LIBRARY, Box 27125, Orlando, FL 32867

THE MATHEMATICIAN is a complete math package for the TS1000 with nearly the power of PROTRAN, a program available for mainframes, but very easy to use. Do your homework. Comes with documentation, hardcopy for easy conversion to any other computer, and program. Requires 32K. Cassette \$19.95. Arco disk \$24.95. Russell Reeve, 835N 750E, Bountiful, UT 84010.

COMPUTER TRAINING through disks/tutorials, IBM, Apple, Sanyo, etc. Hardware, Software. Work Stations. Ryle Data, Box 210E, Mountain St, Halliburton, Ont. K0M 1S0 Canada. (705) 457-2774.

THE BEST TI-99/4A SOFTWARE BARGAIN! 104 TRFIC CASSETTE PROGRAMS ONLY 50¢ EACH! Hours of enjoyment. Exceptional value! THE EXCHANGE, C.E. -10, PO Box 46, STERLING, VA 22170 (703) 435-2789

WE WILL BEAT ANY PRICE. SSDD Maxwell! MD-1, \$18.95/10, Dysan, 104/1D, \$21.95/10. DSSD Maxwell! MD-2, \$29.95/10, Dysan 104/2D, \$30.95/10. 1-(800) 245-6000. Tape World, 220 Spring St., Box 361, Butler, PA 16003. (412) 283-8621.

ELECTRONICS made easy for Apple II users with Mentor, the proven theoretical circuit package. Excellent learning aid too. \$174.95. Korsmeyer Electronic Design, Inc., 5701 Prescott, Lincoln, NE 68506. (402) 483-2238.

BIGGEST TI-99/4A SELECTION. Newest exciting software and hardware bargains. Hard to get items. Send for free catalog. Fast Service. D.E. Box 690, Hicksville, NY 11801.

BBS PROGRAM, for C64, 1541 Drive, Automodem \$79.95. Atlasware, 4120 Lakeland, Robbinsdale, MN 55422. Dealers wanted!

USED SOFTWARE free catalog, buy, sell, all computers, Software Exchange Incorporated, Box 485, Hales Corners, Wisconsin 53130.

COMPUTER HARDWARE

COMPLETE COMPUTER schematic. Z80 or 8080 system 24"x36" sheet notes. \$10.50. Schematic, 1443S 680 E. Orem, UT 84058.

PHONE LISTENING DEVICE

Record telephone conversations in your office or home. Connects between any cassette or tape recorder and your telephone line. Starts automatically when phone is answered. Records both sides of conversation. Stops recorder when phone is hung up.

19⁹⁵ ea. Qty discounts available

WIRELESS MIC

10 times more powerful than other mics. Transmits up to 1/2 mile to any FM radio. Easy to assemble kit. 15V battery (not incl.) Call (305) 725-1000 or send \$19.95 + \$1 shipping per item to USI Corp., P.O. Box CE-2052, Melbourne, FL 32901. COD's accepted. For catalog of transmitters, voice scramblers and other specialty items, enclose \$2 to USI.

HARD TO FIND lightbulbs thousands types buy, sell. Jetco, P.O. Box 8755, Newport Beach, CA 92658.

ALARM EQUIPMENT WHOLESALE! Burglar, Holdup, Fire Medical. We can prewire. Easy installation! Fast police notification service. Nationwide! Catalog \$1.00 U.S. Detection, 109 21st., Dept. CE South, Birmingham, Alabama 35233

Computer/Satellite modulators, CCTM cameras, monitors, MATV, Kits. Free video catalog. Phone (402) 987-3771. Dealership available. ATV Research, 13-CE Broadway, Dakota City, NE 68731.

MICROWAVE ANTENNAS COMPLETE WITH WARRANTY from the original manufacturer. Three styles Daisey, Parabolic, and Yaggi. We also repair all down converters and power supplies. S.A.P. 3531 W. Glendale Ave., Phoenix, Arizona 85021. (602) 973-9117

FOR SALE BY OWNER. Listing of microcomputers and peripherals for sale by owner. IBM-PC, IBM-XT Portable, Apple, many others for complete listing send \$26.00 to: JEGAL CORP., Box 244, Wyckoff, New Jersey 07481.

USED TI810 PRINTER. Less than one million characters. Must sell due to incompatibility. Extra ribbon provided. \$800 or best offer. FX Duffy Inc. (215) 438-8400. Attention: DATA Processing Department.

A SINGER'S DREAM!



REMOVES VOCALS FROM RECORDS!

Now you can sing with the world's best bands! The Thompson Vocal Eliminator can remove most or virtually all of a lead vocal from a standard stereo record and leave the background!

Write or call for a free brochure and demo record.
LT Sound, Dept. CE, P.O. Box 338,
Stone Mountain, GA 30086 (404) 493-1258

SUPER SAVERS Apple Compatible Floppy \$165, 1/2 ht. \$175, Hard Disk 10mb \$1395, Monitor 12" Amber or Green \$115. Internal 10mb Hard Disk for IBM \$1095, Floppy JA551-2 \$174. Oztech, (800) 222-6697, California (408) 980-9987.

TIMEX/SINCLAIR

AERCO will continue to provide high performance disk, printer, and other interfaces for ALL MODELS of Timex/Sinclair computers. Box 18093, Austin, TX 78760, (512) 451-5874.

Timex 2068 programs. Wall street: Biorhythms: Disassemblers: Star Trek and many more. \$10 each. SAE plus \$1 for comprehensive list. C. Dos-Santas, P.O. Box 9521, Fountain Valley, CA 92728.

TS-1000 2K Software. Loan breakdown, Checkbook balancer, Savings balancer, Bargraph, Addition quizard, Multiplication quizard, Robot drive train design; each on computer grade cassette. Complete instructions. \$9.99 each. Post paid VISA/MASTERCARD give name, card number, expiration date, signature. Sturdyvant Laboratories, Box 116CE, Bedford, MI 49020.

FASTFILE, professional data base management system—Add, Edit, Sort, Delete, Query, Analyze, LPrint-Best filing program for ZX81/TS1000 or money back. Write for more information or send \$19.95 for cassette and manual: Tom Cole, 1314 Speight # 15, Waco, TX 76706. Texans add 5% tax.

COMMODORE 64

TEXAS HOLDLEM FOR COMMODORE 64. THE BEST POKER PROGRAM TO DATE. Send \$29.95 for tape or disk. GOLDRUSH, 5646 N. Pershing, Stockton, CA 95207.

600 + COMMODORE 64 SOFTWARE TITLES! Bonanza Catalog \$2.00 (refundable). SKELGRAF, 4415 Basswood, Bellaire, Texas 77401.

CABLE T.V.

CHANNEL 3—60db notch filter, 66 5MHz \$32. Crosley, Dept. 607, Box 840, Champlain, NY 12919.

CABLE TV SECRETS, the Informative Publication the Cable Companies Tried to Ban. HBO, Movie Channel, Showtime converters, etc.—\$8.95. CABLE FACTS, Box 711-PE, Pataskala, Ohio 43062.

CABLE TV CONVERTERS and modulators. Commercial types. BEST PRICES. Catalog \$2.00. Professional Video Inc., 4670 Hollywood Blvd., Hollywood, CA 90027.

PLANS AND KITS

Communicate for miles with other computers with no license radio link. Study package with full details, sources. \$8.00 refundable. Broadcast Technical Services, 11 Walnut St., Marshfield, MA 02050.

PROJECTION TV ... CONVERT your TV to project 7 foot picture ... Results comparable to \$2,500 projectors ... Total Cost less than \$30.00 ... PLANS AND 8" LENS \$19.95 ... Illustrated information FREE. Macrocoma-CAX Washington Crossing, Pennsylvania 18977. Creditcard orders 24 Hours, (215) 736-3979.

200 ELECTRONICS KITS, Projects, plans, send stamps for list. MATCO ELECTRONICS, Box 316CE, Cadillac, MI 49601.

MAILING LISTS

FREE MAILING LIST analysis. Details. GOC-8N, Box 1107, Stuart, FL 33494. (305) 334-5205.

COMPUTER REPAIRS

DISK DRIVES ALIGNED AND REPAIRED. 5 1/4"-SS-\$50, 5 1/4"-DS & 8"-SS-\$60, 8"-DS-\$80; includes \$20 in parts. Most home and personal computers repaired. Dealers/users Invited, MICROAIDE INC. (201) 283-1910.

WANTED

GOLD, electronic, circuit board scrap, silver, platinum, tantalum, mercury, Ores, metals assayed. Samples evaluated. Wholesale Terminal, toll free 1-800-932-1010, (617) 326-3442 in Mass.

GOVERNMENT SURPLUS

IS IT TRUE YOU CAN BUY JEEPS FOR \$44 THROUGH THE U.S. GOVERNMENT? Get the facts today! Call (312) 742-1142 Ext. 4649.

TUBES

TUBES: "Oldies", Latest. Supplies, components, schematics. Catalog Free (stamp appreciated). Steinmetz, 7519-PE Maplewood, Hammond, Ind. 46324.

HUGE INVENTORY! Thousands of types. Wholesale prices. FREE CATALOG! ETCO Electronics, DEPT. 290, Plattsburgh, NY 12901.

TUBES—RECEIVING, Industrial and Semiconductors Factory Boxed. Free price sheet including TV, radio and audio parts list. TRANSLERONIC, INC., 1365 39th St., Brooklyn, NY 11218. Telephone: (212) 633-2800. Toll free: (800) 221-5802. Ask for Abe.

7,000,000 TUBES. World's largest inventory. Free catalog. UNIT ELECTRONICS, Dept. CE, P.O. Box 213, Elizabeth, NJ 07206.

TV & RADIO TUBES, 59¢ each. Send for FREE CATALOG. Cornell, 4213 University, San Diego, CA 92105.

PERSONALS

MAKE FRIENDS WORLDWIDE through international correspondence, illustrated brochure free. Hermes-Verlag, Box 110660/Z, D-1000 Berlin 11, W. Germany.

ORIENTAL SINGLES seeking cultural exchange, friendship, sharing, marriage. WRITE: CHERRY BLOSSOMS, Box 1021P, Honolulu, Hawaii 96727.

CORRESPONDENCE TO ASIA FOR LASTING RELATIONSHIP. Free information. AAWS-CE, Box 2777, Orcutt, CA 93455-0777.

MATHEMATICA! INSIGHTS: Easily understood illustrated booklet (also for computers) discovers new formulas from traditional concepts. ORDER TODAY! MONEY BACK GUARANTEED. \$1.00. Michael Gilbert, Box 2376, El Paso, TX 79952.

INSTRUCTION

UNIVERSITY DEGREES BY SPECIAL EVALUATION of existing credits and Job Experience. Fast, inexpensive. Call (614) 863-1791. Or write: EVALUATION, Box 13151-A10, Columbus, Ohio 43213.

REPAIR ELECTRONIC ORGANS—Revised home study course covers all current makes and models. Free booklet. Niles Bryant School, P.O. Box 20153, Sacramento, CA 95820.

LEARN WHILE ASLEEP! HYPNOTIZE! Astonishing details, strange catalog free! Autosuggestion, Box 24-ZD, Olympia, Washington 98507.

MEDICAL ELECTRONICS TECHNOLOGY, home study. Troubleshoot medical instruments. WTI, P.O. Box 3124, Fresno, CA 93650-3124.

HANDLE YOUR OWN LEGAL AFFAIRS—Be a Paralegal. Accredited Attorney Instruction. Home Study. FREE CATALOG. Southern Career Institute, Drawer 104CE-2158, Boca Raton, FL 33427. (305) 368-2522.

EARN \$800+WEEK! Get your "F.C.C. Commercial Radiotelephone License" at home. "Free" details. COMMAND, D-100, Box 2223, San Francisco 94126.

UNIVERSITY DEGREES without classes. Bachelor's, Master's, Doctorates. Accredited, inexpensive, fast. Dr. John Bear, P.O. Box 11447-C9, Marina Del Ray, CA 90295.

Get your 2-Year COLLEGE DEGREE in Electronics Technology

Train at Home in Spare Time...

Choose from exciting opportunities in the fast-growing space-age industries... Automation, Aerospace, Cable-TV, Missile Design, Electronic Circuitry, Computers, Telemetry and much, much more. No previous experience necessary. No need to quit your job. Your Associate Degree gives you everything you need to qualify for an Electronics Technician Position. Instructors are as close as your telephone. Use our 24-hour home-study hot line—we pay the bill. Send for free facts. No obligation. No salesman will call. Mail coupon today!

ICS Center for Degree Studies, Dept. PD094

ICS Electronics Center, Scranton, PA 18515

Rush free facts telling how I can train to be an Electronics Technician and get my 2-year Associate Degree at home in spare time.

NAME _____ AGE _____

ADDRESS _____

CITY / STATE / ZIP _____

LEARN TOUCH TYPING IN ONE EVENING—Computer or typewriter—complete home study kit \$6.50. Check or MO to TOUCHTYPE, 1043 Hearshstone, Cincinnati, OH 45231.

FOR INVENTORS

INVENTIONS, IDEAS, NEW PRODUCTS WANTED! Industry presentation/national exposition. Call free 1-800-528-6050—Arizona, 1-800-352-0458. X831.

PATENT AND DEVELOP your invention. FREE PATENT INFORMATION. Richard L. Miller, P.E., 3612-E, Woolworth Building, New York, NY 10007, (212) 267-5252.

INVENTORS! IDEAS HAVE VALUE!

Ever think of an idea, forget it and see it later on the market? Many people don't forget, act quickly and are rewarded by American Industry. Write down your idea! We offer free disclosure registration and initial consultation regarding your idea's potential value. Call or write without delay for your free information package.

AMERICAN INVENTORS CORPORATION
82 Broad St., Dept. CE
Westfield, MA 01086
413-568-3753

A Fee Based Marketing Company
Offices Coast to Coast

BUSINESS OPPORTUNITIES

MECHANICALLY INCLINED individuals desiring ownership of Small Electronics Manufacturing Business—without investment. Write: BUSINESSSES, 92-K10 Brighton 11th, Brooklyn, New York 11235.

ERASE DEBTS with little-known law—create wealth! Details FREE—Wealth Kit, No. EE10, Billings, NY 12510.

ONE MAN CRT FACTORY. T.V.'s, Business machines, Monitors, Scopes, VDT's. \$3.00 rebuilding nets \$100-\$500 each tube. Higher profits overseas. New/used. FACTORY, 1909 Louise, Crystal Lake, IL 60014. (815) 459-0666.

BORROW \$300-\$30,000 INTEREST FREE! Keep indefinitely! Free Details. Write: American, 1601 Main, Plainfield, Indiana 46168.

BUMPER STICKER PRINTING DEVICE. Cheap, simple, portable. Free details. Bumper, POB 22791 (PE), Tampa, FL 33622.

FREE CATALOGS. Repair air conditioning, refrigeration. Tools, supplies, full instructions, Doocolo, 2016 Canton, Dallas, Texas 75201.

BORROW \$30,000 without interest! All eligible. Repay anytime. Free details! Infohouse-CE, 808 Post, San Francisco, CA 94109.

EARN EXTRA INCOME with your microcomputer. Super opportunities! Free details. Scitec, Box 02038, Columbus, OH 43202.

\$360 WEEKLY/UP, MAILING CIRCULARS! No quotas. Sincerely interested, rush stamped envelope: Marketing International, Box 15967-E9, San Diego, CA 92115.

BE A COMPUTER PIONEER! Time-based/A.I./consumer software & development, now with Timex, Commodore & Sinclair Q.L. applications. For business and personal software. PROGRAMMERS INQUIRE. TIMESTAR, PO Box 3521, Greenville, DE 19807.

PROJECTION TV ... MAKE \$\$\$'s assembling Projectors ... Easy ... Results comparable to \$2,500 projectors. Your total cost less than \$20.00. PLANS, 8" LENS & Dealers information \$17.50 ... Illustrated information FREE ... Macrocoma-CB, Washington Crossing, Pennsylvania 18977. Creditcard orders 24 Hours (215) 736-2880.

HOW TO START AND OPERATE your own profitable business at home. 100% guaranteed. Send for free brochure to Billy King, Box 1378, Borger, Texas 79008.

MULTI-CHANNEL microwave antennas. Highest quality, low prices, dealers welcome. D.T. compact \$38.00; P.T.-1 \$48.00; SR-1 \$65.00; D.T. Grid \$69.00; PTS-33 \$75.00. All units complete! Daisy Tenna, Box 42010, Phoenix 85080. (800) 874-9033.

COMPUTER ILLITERATE TO \$33,000 + PROGRAMMER IN ONE YEAR. How I did it—complete details. Send \$8.95 to: R.B.P., 3063 Sugar Lane, Vienna, VA 22180.

MAIL ORDER OPPORTUNITY! Start profitable home business without experience or capital. Information free. Mail Order Associates, Inc., Dept. 70, Montvale, NJ 07645.

INTERMEDIATE AND ADVANCED ELECTRONICS tutor by mail needed. Write D. DiMino, 3102 E. Highland # 35, Paton, CA 92369.

LEARN HOW TO earn extra money with your Microcomputer. FREE details. Box 25545 B, Honolulu, Hawaii 96825.

REVEALING, 40 page, info pack, on how to start your own COMPUTER hardware/software MAIL ORDER/RETAIL business. Send \$10 to: JPI, PO Box 7033, Huntington Beach, CA 92615.

REAL ESTATE

500 OFFICES ... 45 STATES! 30,000 listing on computer, 16,000 under \$50,000! Free printouts and regional catalogs! UNITED FARM AGENCY, 612-EP West 47th, Kansas City, MO 64112. Ph: 1-800-821-2599, in MO 1-800-892-5785.

EMPLOYMENT OPPORTUNITIES

CALIFORNIA'S SILICON VALLEY. Current job listings. Engineers, technicians, programmers, assemblers, many more. Complete information and listings \$3.00. Calwest, Dept. 10A, PO Box 3516, Santa Clara, CA 95055.

ELECTRONICS/AVIONICS EMPLOYMENT OPPORTUNITIES. Details FREE. Aviation Employment Information Service, Box 240E, Northport, New York 11768.

INSURANCE

SAFEWARE. If your computer is important to you, insure it! SAFEWARE provides full replacement of hardware, media and purchased software. As little as \$35.00 a year for comprehensive coverage including fire, theft, power surges, earthquake, water damage, auto accident. Call 8 to 8 Mon. through Sat. SAFEWARE, The Insurance Agency, Inc., 2929 North High Street, Columbus, OH 43202. (800) 848-3469 (nat), (614) 262-0559. (OH).

BOOKS & MAGAZINES

FAMILY TREE CLIMBERS COMPUTER APPLICATION GUIDE \$24.95; Quarterly magazine \$20/year. Posey International, PO Box 338, Oren, Utah 84057.

SATELLITE TV VIEWERS

Get the most complete weekly listings
Send \$1 for sample copy.

Satellite TV Week

"P.O. Box 308Z, Fortuna, CA 95540"
800-358-9997 (U.S.) • 800-556-8787 (Calif.)
707-725-2476 (all others)

Interested in home satellite TV?

Learn how it works, what services are available, how to buy a system and more through the new booklet *Tuning In To Satellite TV*. Clip out this coupon and send it with your name and address, and \$1.00 for postage and handling to:

Tuning In To Satellite TV
CommTek Publishing Company
P.O. Box 2228, Dept. J
Hailey, ID 83333

PUBLISHERS' OVERSTOCKS, BARGAIN BOOKS 2,000 titles, all subjects! Free catalog: Hamilton, Box 15-D, Falls Village, CT 06031.

ELECTRONIC SYSTEMS NEWSLETTER is a monthly publication written especially for the electronics hobbyist/experimenter. Fascinating projects, new ideas, sources. Free details. AF Publishing, Dept. CE, PO Box 524, So. Hadley, MA 01075.

MISCELLANEOUS

COMPUTER LOVERS GIFT CATALOG. Chocolate computers, diskette ties, computer clocks, jewelry and wallets. Write: SweetWare, 516 Shelburne Road, Dept. A South Burlington, VT 05401. (802) 862-6939.

"ASK ME ABOUT MY NEW COMPUTER" Bumper Stickers. \$2. HI-CUT, POB 420007, DEPT. C1, Houston, TX 77242-0007.

SHOP AT HOME! Use your modem to call Fantasy Plaza. FREE Electronic Shopping at (818) 840-8066.

FREE CATALOG!

Just let us know and we'll mail you a FREE *Creative Computing* Catalog—16 pages filled with books, buyer's guides, magazines, and more!

To get your FREE catalog, write to: *Creative Computing* Catalog, Dept NA1X 39 East Hanover Ave., Morris Plains, NJ 07950.

NEC APC III (Continued from page 41)

soundboard card for enhanced sound capabilities and easier use of games, and a TV adapter.

Compatibility and Software

The APC III is an IBM PC "work-alike" rather than a compatible. (You will have to buy software optimized for the machine.) However, it will read some IBM MS-DOS data files.

NEC has obviously made a strong effort to provide a large software base before releasing the machine. It claims that 90 percent of the most popular packages are currently available and it plans to release compatible versions of virtually all best-selling software.

The programs provided for this review (Wordstar, BPS:Graphics, Multiplan and MS-DOS) ran beautifully on the machine. There is even a complement of games available, including the popular Infocom adventure series and a number of arcade style games.

In addition to the packages already mentioned, software available directly from NEC includes Supercalc 3, Friday!, the BPI accounting series, the Dow Jones series (Analyzer, Investment Analyzer and Dow Jones Link), the Final Word, the Real World accounting series, the Accounting Plus series and a number of communications and language packages (RM-Cobol, C, BASIC, Logo, and Fortran). Some vertical market packages are also currently supported.

Performance

While I performed no specific benchmarks, I did run all of the applications software provided and used my IBM PC Portable to compare the performance of Wordstar and Multiplan.

Mini Jini (Continued from page 54)

printer will automatically print the overrun as a second line.

Several math functions are available for printing reports. Fields can be added to, subtracted from, and multiplied or divided by any other field, with the result stored in an "answer" field. The same functions can be applied as constants to any field, modifying the data within the field.

While Mini Jini crunches data with exceptional speed, getting the data into the computer is unusually slow, even for in-memory data files. To start with, the Commodore 64's serially interfaced disk drive is relatively slow compared to bus-driven drives such as are found on most other computers. While the program scrolls the incoming data on the screen and the input buffer loads from the disk,

With its 8-MHz, true 16-bit CPU, it is no surprise that the NEC outperforms the PC by a wide margin. Scrolling is smooth and fast, and spreadsheets recalculate very quickly. If you are used to the IBM performance level, you will be suitably impressed with the speed and power of the APC III.

In addition, the superior screen display and keyboard make the machine a real joy to work at, whether for minutes or hours.

Summary

The NEC APC III is an excellent computer. It is intelligently designed and packed with advanced features. The performance and quality are high.

While it is not directly compatible with the IBM PC, NEC seems to be well on its way to providing all the software necessary for small businesses and for professionals. The one noticeable exception is Lotus 1-2-3, although negotiations to put Lotus up on the APC III were underway at the time this article was written.

If the newer software packages are supported on the APC III, its value will be enhanced immeasurably. Priced competitively, the APC III is fast and well designed. Its high-resolution color display and graphics capabilities make it extremely versatile. Although it is too early to write about the product's reliability, other systems by NEC are tops in this category.

The APC III is definitely worth examining and is certainly a lot more than a PC look-alike. With its tremendous price/performance ratio and Unix options, I feel the APC III offers superior value. ♦

after a full read the computer "waits" while the files are organized internally. For example, the program took 5 minutes and 10 seconds to load and present the main menu of a sample disk file provided with it (consisting of 81 records averaging 65 characters in 8 fields)—and that's slow. Also, alphabetizing the same file for just the name field took exactly 1 minute. That too is relatively slow for a small file.

But notwithstanding the time required for loading a file and ordering a field, Mini Jini works well; as in-memory systems go, it's unusually easy to use, requiring almost nothing in the way of a tutorial or documentation. The 39-page manual is sparse, but very adequate. Also, unusually noteworthy error-trapping makes the program almost goof-proof. ♦

BIG SAVINGS ON GROUP SUBSCRIPTIONS

If you're part of a group that uses microcomputers in school, the office or a user group, you may be eligible for substantial discounts to the world's leading computer magazines!

For more information, have a representative contact: Dan Rosensweig—212-503-5354
Ziff-Davis Publishing Company
One Park Avenue—4th Floor
New York, NY 10016

A+, The Independent Guide For Apple Computing

COMPUTERS & ELECTRONICS

MICROSYSTEMS

PC TECH JOURNAL

PCjr., The Independent Guide To The IBM PCjr In Education, Home and Business

A+ DISK, New Programs on Diskette For Apple II Series Computers

CREATIVE COMPUTING

PC, The Independent Guide To IBM Personal Computers

PC DISK, New Programs on Diskette for the IBM PC, PCXT, PCjr and Most Compatibles MD3C

Electronic Univ. (Continued from page 82)

As of now, TeleLearning has no major competitors. "We have a certain technical lead, but that won't last very long," admitted Gordon.

"However, we do provide the two most important things: low-cost and ease of use. I took the engineers that I worked with at Atari and Friends Amis and married their experience with that of others in the field who know about time sharing, error correction software, and automating the telecommunications process.

"What I've done is to take big, very sophisticated technologies and put them into very little and very simple boxes."

Gordon is aware that providing quality is a key to the success of his service. To this end, all new course authors/instructors must provide a course outline and introduction to TeleLearning for evaluation.

Once in progress, courses are monitored for academic standards, and the TeleLearning system keeps an eye on its own technical communications quality.

"If a student has requested some help and the instructor has not responded within a set time, say 48 hours, then we get on the phone to that instructor," said Gordon. "If there is some overriding reason why that instructor can't contact the student we will then put in a substitute instructor to handle the problem."

TeleLearning also has a "dean." Every lesson requires that the students send in information to the instructor for evaluation. Periodically these evaluations are reviewed at random through the dean's office.

TeleLearning's Analysis System software monitors every function of the Electronic University network: the quality of the phone lines being used; the performance of the selected timesharing network; and whether or not data is being sent and received correctly.

If problems are encountered at any level, the Analysis System can take action to overcome them.

Among those who will undoubtedly benefit from the network are the handicapped (the first person to register at the initial press conference was a double amputee). But other people will benefit from this significant breakdown of barriers to education.

"We have a woman who is in a home for the elderly in Brooklyn teaching a prisoner in California," said Gordon.

Politicians are applauding Gordon for helping another section of the population as well. He is providing new jobs for teachers at a time when the traditional sources of employment are being cut back. ♦

WORLD'S LARGEST COMPUTER MAGAZINE Computers & ELECTRONICS

ADVERTISERS INDEX

RS no.	ADVERTISER	PAGE no.
32	ACTS, Inc.	115
50	Active Electronics	119
15	Air National Guard	33
13	Anadex, Inc.	5
	AT&T	Cover 2, 1
33	BASF	29
	Classified Advertising	122-127
	Cleveland Institute of Electronics, Inc.	34-37
56	CompuServe	47
60	CompuServe	101
67	CompuTel Publishing Society	117
39	The Computer Book Club	21
7	Craftsman Corp.	116
14	Digi-Key Corp.	121
6	Discount Computers	110
25	Dust-Off II/ Falcon Safety Products	22
51	Electronic Specialists	114
	Epson America, Inc.	13-15
44	Fujitsu	Cover 4
	General Electric Grantham College of Engineering	6-7 117
8	Hayes Microcomputer	55
24	Heath Co.	77-78
26	Heath Co.	93
10	Heath Co.	107
	Hewlett-Packard	45
	Hewlett-Packard	53
	Hume Publishing	19
49	IBM Corporation	10-11
41	IBM Corporation ICS	42-43 114
21	Jameco Electronics	118
22	JDR Microdevices	120
23	J & R Music World	115
20	Leading Edge	2
	Micro Exchange	17
2	Microstuf, Inc.	51
	NRI Schools	95-97
	NRI Schools	24-27
5	Nibble Notch Computer Products	116
36	Panasonic	39
40	Protecto	23
	Radio Shack	31
	Scottsdale Systems	117
38	Star Micronics	Cover 3
42	Tam's Inc. Tektronix	114 49

In the flash of one second, Delta-10 can print the alphabet six times.

At 160 cps, 100% duty cycle. Delta-10 is built for speed. It's the dot matrix printer that quickly strikes up an intense working relationship with your computer.

There's no nonsense. Delta-10 performs with serial and parallel interfaces as standard. The 8K buffer gives Delta-10 the power to instantaneously store and print data as it frees your computer to continue its job. Turn Delta on

and it can print three crisp copies simultaneously at the continuous speed of 160 cps.

And Delta-10's performance isn't only measured in swiftness. There's the diversity of its character fonts, its true descender matrix, and its underlining ability.

Star's new Delta-10. Designed for red-hot efficiency. And isn't that what you need?

star
MICRONICS · INC

THE POWER BEHIND THE PRINTED WORD.

200 Park Avenue, New York, NY 10166

Dallas, TX (214) 456-0052 • Boston, MA (617) 326-8560

Chicago, IL (312) 773-3717 • Irvine, CA (714) 586-8850

Circle No. 38 on Free Information Card

Star now has a new Delta-10 "PC Printer" model that's fully compatible with the IBM* PC and all PC-compatibles!

*IBM is a registered trademark of International Business Machines Corp.



Fujitsu's Micro 16sx.TM For business professionals in search of excellence.

Fujitsu's new Micro 16sx personal business computer is truly world class. A superb synthesis of speed, power, precision, quality and reliability from Japan's largest computer company.

A high clock rate makes it nearly twice as fast as other popular 16-bit micros. It also has a great memory. With 384,000 characters of RAM expandable to over one million.

More power to you. The Micro 16sx has a built-in 10 or 20 million character hard disk drive. A storehouse of information that can hold up to 5,600 or 13,200 pages of text. Other features include a real time clock with battery backup, serial and parallel ports, and a 360K 5 1/4" floppy disk drive.

For business graphics, it has a high resolution tilt/swivel color monitor supported by its own RAM and microprocessor. A flexible architecture with an interchangeable 8085 16-bit microprocessor

gives you built-in protection against obsolescence. With three expansion slots for future additions like main-frame or minicomputer communications. For software freedom of choice, there is no better choice. The Micro 16sx has the versatility to run MSTM-DOS, CP/M-86[®] or multi-tasking Concurrent CP/M-86TM software. Take your pick.

Discover excellence. See Fujitsu's new Micro 16sx. It's the best in the business. For the name of your nearest authorized Fujitsu dealer call toll free (1)800-MICRO 16.

