

# WORLD'S LARGEST COMPUTER MAGAZINE

# Computers

## & ELECTRONICS

JULY 1984

\$1.95

### The Tandy 2000 Means Business

**Build A Computer Drafting System**

**Tips To Avoid Video Eye Strain**

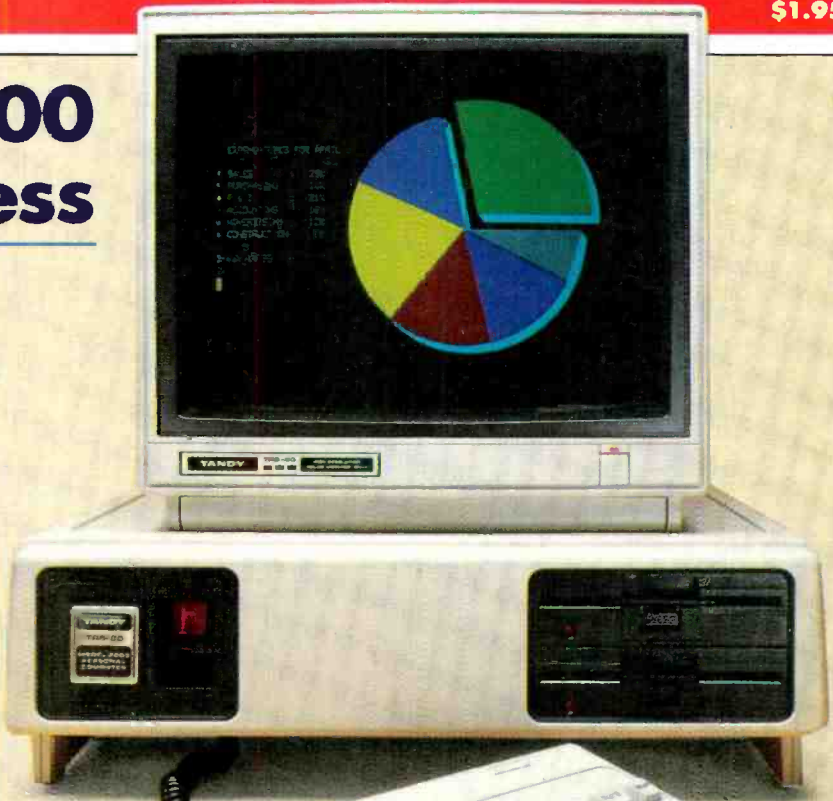

### Price Breakthrough On HP LaserJet



### IBM Portable PC



L DARKNELL JR  
 6450 MYRTLEWOOD DR  
 PERTINO CA 95014  
 07\*4F  
 \*\*\*\*\*S-DIGIT 95014  
 303092 DRK 6450M091 141D DECB4



**To Help Managers Manage**  
**Exciting Voice Typewriter In Works!**

# Epson. For those who need it, simplicity.

One computer.

Two points of view.

The Epson QX-10 personal computer.

To many, the Epson represents the ultimate in simplicity.

Just press a single key for the function you require: word processing, scheduling, business graphics, address book or file management. One key-stroke produces your program. There are no rigamaroles to remember. No disks to change.

The result: you start to work immediately. And you start being productive, immediately. With step-by-step prompts. In plain English, not computerese.

Simplicity itself.

Or is it?

The plain fact is that the ease of operation the Epson offers today is accomplished with a degree of technological sophistication most other computers can only promise for tomorrow — specifically, fully integrated software, operating in an interactive environment.

The few other computers offering such "simplicity" cost \$5,000 to \$15,000 more. And most other computers can't offer it at any price. Which makes one wonder exactly what they do offer, in terms of either simplicity, or performance.

---

## HOW MUCH CAN YOU DO ON THE EPSON? HOW MUCH ARE YOU READY TO DO?

---

The Epson's ease of operation may spoil you, but it certainly won't limit you.

Case in point: every Epson comes complete with an integrated software system — *Valdocs*® — to effortlessly provide the basic functions for which most people buy computers. The Epson also comes with *CP/M*®-80 2.2, so you can choose from the hundreds of programs in the CP/M library. And only Epson offers an exciting new collection of seven best-selling programs now specially enhanced to give you every powerful feature, plus Epson one-button simplicity. Included are

*dBase II*®, *Friday!*™, *Microplan*®, *Graphplan*™, *WordStar*®, *SpellStar*®, and *MailMerge*®. And the Epson also allows you to add *MS*™-DOS compatibility, so you have access to best-sellers like *Lotus*® 1-2-3®.

Best of all, you will run the software of your choice on the computer of choice. The high-performance Epson. With 256K RAM. 128K dedicated video memory. The breathtakingly sensible *HASCI*™ keyboard. Dual 380K double density disk drives.

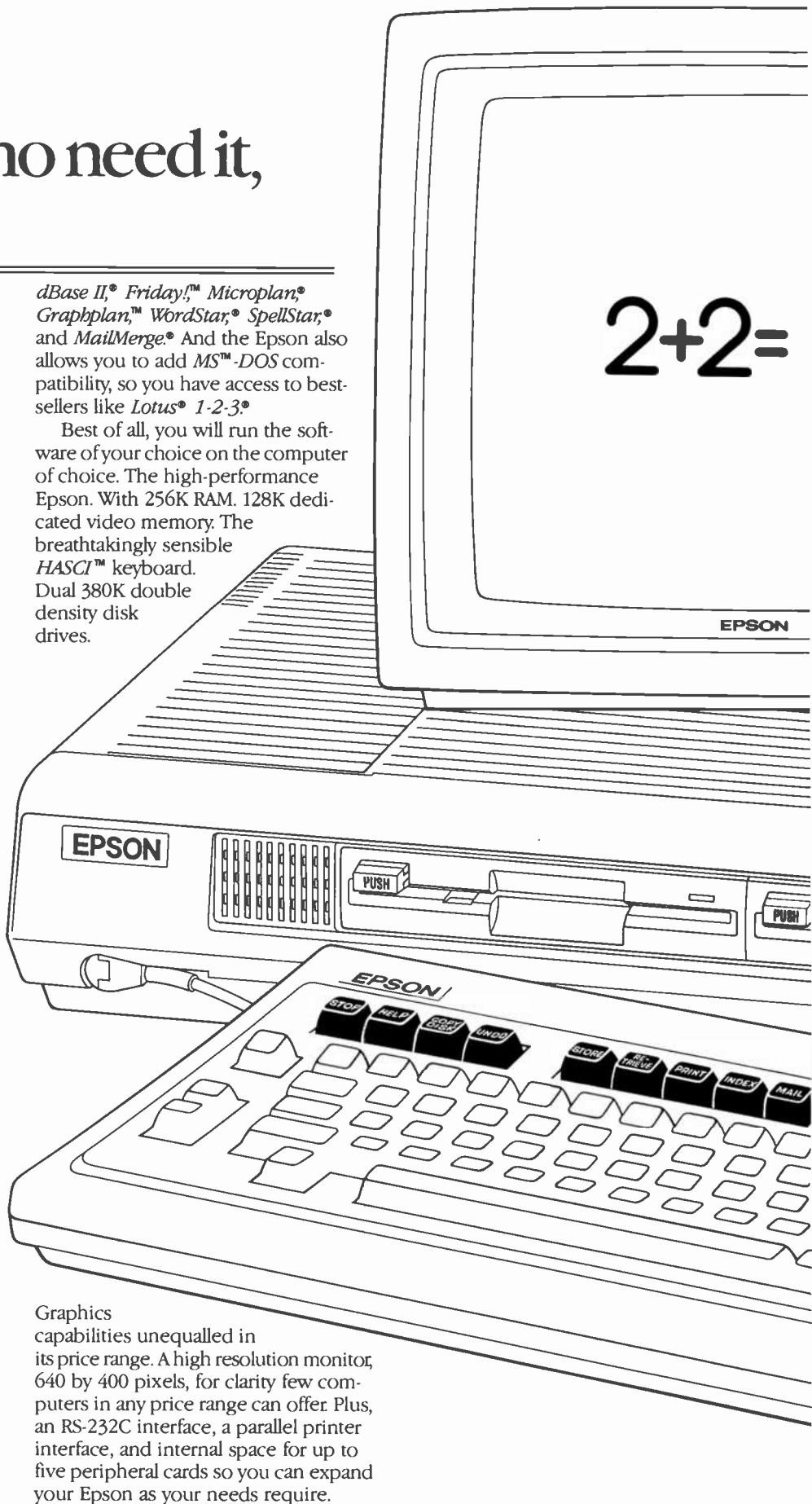

Graphics capabilities unequalled in its price range. A high resolution monitor, 640 by 400 pixels, for clarity few computers in any price range can offer. Plus, an RS-232C interface, a parallel printer interface, and internal space for up to five peripheral cards so you can expand your Epson as your needs require.

One further point: all these features, and quite a few more, are included in the Epson's \$2,995 price. Some com-

# Epson. For those who can handle it, performance.

puter companies ask you to pay extra for features like these. Most can not offer them at any price.

That, too, is performance. The kind of performance that can make choosing a personal computer very simple, indeed.

**EPSON QUALITY. OR, WHY  
WONDER WHAT TERRIBLE  
KLUDGES LURK IN WHICH  
SLEEK BOXES.**

If you know computers, you know Epson. Epson printers set the industry standard for quality, reliability and value. Rest assured, the same can be said for the Epson personal computer.

The satisfying silence of the slim, Epson-designed disk drives is one way for you to judge or, for an inside-out perspective, here is an excerpt from a review by Jim Hanson in the April, 1983 issue of *Microcomputing*\*

"The Epson QX-10 is soundly designed and executed. I looked hard and found no evidence of kludging or shorting out anything in the name of economy. All the connectors have gold on them and are of quality manufacture. The printed circuit boards are heavy, with soldermarks on both sides of double-sided boards. The circuit boards are completely silk-screened with component labels, and the layout is as professional and clean as you will find anywhere."

Isn't this what you expect? After all, it's an Epson.

**A WORD TO THE WISE:  
GET YOUR HANDS ON  
THE EPSON.**

Is the Epson a simple, easy-to-use computer for beginners? Or a sophisticated high-performance computer for the experienced? The answer is "yes." And when you think about it, aren't those two computers the one you need now?

**For technical specifications, and the complete, 3-part *Microcomputing* review, along with the name of your nearby Epson dealer, call toll-free (800) 421-5426. California residents, call (213) 539-9140.**

\*Excerpt reprinted by permission of *Microcomputing Magazine*. All rights reserved.  
CP/M, dBase II, Microplan, WordStar, SpellStar, MailMerge, Lotus, J23 are registered trademarks of Digital Research, Ashton-Tate, Chang Labs, MicroPro (3), and Lotus Development (2). Valdocs, Graphplan, MS, and HASCI are trademarks of Rising Star, Chang Labs, Microsoft, and Rising Star, respectively.

# EPSON

STATE-OF-THE-ART...SIMPLICITY.

Circle No. 26 on Free Information Card



*Richard Lach*

## DISCOVER COMPUTERS WITH ATARI.



Atari® presents the five greatest advances in the creative arts since someone put 72 crayons in one box.

What would Cezanne say to an electronic orange? Surely Van Gogh would go for some flowers painted in phosphors (those glowing things in your TV screen). And you bet Beethoven would be blown away by a computer synthesized symphony.

Too bad. They were all born too early. But luckily you weren't. Because Atari makes several home computer products to help you create all these things and more.

First, there's ATARI Paint,\* the program that turns the joystick you already own into a computerized paintbrush that helps you explore the fascinating world of computer art.

### Get the magic touch with Atari Touch Tablet.

The ATARI Touch Tablet with Atari-Artist™ software cartridge turns your TV into a magic palette of 128 dazzling colors.

The Touch Tablet works a little like an electronic slate. Hook it into any ATARI Computer and what you draw on the tablet will instantly appear on your TV screen. You can draw on the Touch Tablet with the unique electronic stylus that comes with it—or even with your finger.

And all the on-screen commands that control your Touch Tablet are labelled with simple sym-

bols as well as words. So everyone from preschoolers to grandparents can create without going near the keyboard.



### Atari Light Pen lets you write right on the screen.

ATARI Light Pen with Atari-Graphics™ software cartridge is among the best tools available for teaching hands-on computer creativity. To draw circles, rectangles, or simply fool around with freehand sketching, just press the pen to your TV screen and VOILA... A trail of sparkling color follows it.

You can fill in your sketches with one or more of 128 colors. Or choose from over 2,800 patterns.

### Roll over Beethoven, AtariMusic is here.

Sure, Beethoven took music lessons. But even he didn't get the head start you'll get with AtariMusic™ I or AtariMusic™ II. And once you understand the

basics you'll be ready to move up to ATARI Music Composer® and create original compositions in four part harmony!

All of these programs were designed to get the best from your ATARI Computer, including the ATARI 800XL™ or the less expensive ATARI 600XL™. Both machines give you unsurpassed Atari graphics and four sound channels. And whether you're painting with light or composing at the computer keyboard, you can store your creation on the ATARI 1010™ Program Recorder or the more sophisticated 1050™ Disk Drive.

And if all that doesn't convince you that our new programs are a giant step beyond crayons, consider this: the kids will never write on the wall with a computer.

\*SuperBools™ Software developed by Capital Children's Museum, Washington, D.C., licensed by Reston Publishing Company, Inc. © 1982 Reston Publishing Company, Inc. All Rights Reserved.



**DISCOVER  
WHAT YOU AND  
ATARI  
CAN DO.**

© 1984 Atari Inc. All Rights Reserved. A Warner Communications Company.

Circle No. 9 on Free Information Card

# Computers & ELECTRONICS

## Features

### 36 HP's New LaserJet Printer

By Josef Bernard

Sooner than anyone expected—an affordable laser printer.

### 40 Mister Impossible: Ray Kurzweil

By Louis Melton

The man who says he will be marketing a voice activated typewriter by 1985.

### 46 Continuous Speech Recognition

By Maryann Walsh and Josef Bernard

The state of the art in computer recognition of natural speech.

### 52 Helping Managers Manage

By John Light

Decision support systems aid in collecting and analyzing data.

### 56 Video Display Terminals and Vision

By Bob Margolin

What you should know about visual stress and VDT use.

### 60 Store It with Light

By Jeff Hecht



Optical storage systems promise dramatically lower cost per bit.



### 66 Beyond the Basics at Microsoft

By Greg Gianas

An inside look at the largest independent software developer.

## Reviews

### 18 The Tandy 2000

By Barbara and John McMullen

### 24 IBM's Transportable

By William Barden, Jr.

The Portable PC is luggable—and oh so compatible.

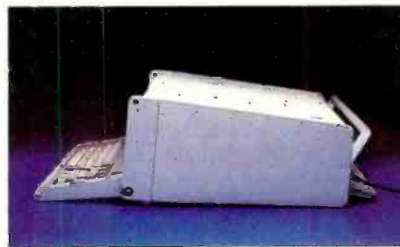

### 26 Mitsubishi Video Printer

By Fred Blechman

An inexpensive way to get hard copy from your screen.

### 29 Cut & Paste

By Mark Andrews

An easy-to-use word processor for the Apple II family.

### 71 Budget Daisywheel Printing—Smith-Corona L1000

By Joe Desposito

Smith-Corona's L1000 offers letter quality at a low price.

## Columns

### 8 Les Solomon on Computer Hardware

Memory You Can Bank on.

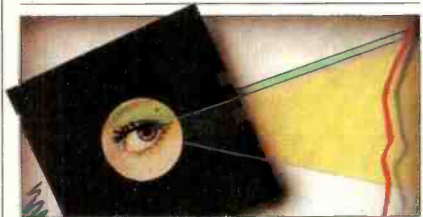

### 13 Bits & Bytes

By Sol Libes

### 74 The Computer Scientist

By Forrest M. Mims, III

More on Computer Aided Drafting.

## Departments

### 4 Editorial

By Seth R. Alpert

### 6 Letters

### 78 New Products

### 106 Computer Mart/ Electronics Classified

### 112 Advertisers' Index

COVER PHOTOS BY BOB LORENZ

COPYRIGHT © 1984 BY ZIFF-DAVIS PUBLISHING COMPANY. All rights reserved. Computers & Electronics (ISSN 0032-4485) July 1984, Volume 22, Number 7. Published monthly by Ziff-Davis Publishing Co., at 3460 Wilshire Blvd., Los Angeles, CA 90010. Richard P. Fries, President; Selwyn Taubman, Treasurer; Bertram A. Abrams, Secretary. One year subscription rate for U.S. and Possessions, \$15.97; Canada, \$20.97; all other countries, \$23.97 (cash orders only, payable in U.S. currency). Second Class Postage Paid at Los Angeles, CA 90052 and at additional mailing offices. Authorized as second class mail by the Post Office Dept., Ottawa, Canada, and for payment of postage in cash. POPULAR ELECTRONICS including ELECTRONICS WORLD trademark registered. Indexed in the Reader's Guide to Periodical Literature. Ziff-Davis also publishes Boating, Car and Driver, Cycle, Flying, Popular Photography, Skiing, Stereo Review, Electronic Experimenter's Handbook, and Tape Recording & Buying Guide. POSTMASTER: Send address changes to COMPUTERS & ELECTRONICS, Circulation Dept. P.O. Box 2774, Boulder, CO 80302. Please allow at least eight weeks for change of address, enclosing, if possible, an address label from a recent issue. Permissions. Material in this publication may not be reproduced in any form without permission. Send requests for permission to Elizabeth Amado, Rights and Permissions, Ziff-Davis Publishing Co., One Park Ave., New York, NY 10016.

# SETH R. ALPERT EDITORIAL

## EDITORIAL: COMPUTER LITERACY REVISITED

I RECENTLY attended a meeting of my local school board at which a committee of teachers presented recommendations regarding computer expenditures for the coming academic year. The group wanted additional hardware and software. But there was something else they wanted even more.

The issue of computers in education is very much on the public's mind and yet people who are not actively involved with schools have probably not given it much thought. A few editorials ago I addressed the computer literacy craze with words of reassurance: Computers will



eventually be so easy and natural to use that gaining literacy will be about as difficult as learning to drive a car.

However, I think kids are missing out if they are not exposed to computers in their school years. No, I am not thinking of computer literacy. Nor am I thinking of keyboard familiarity—read this month's feature about Ray Kurzweil and you will see that keyboards may soon be considerably less important. Nor am I thinking about the benefits of computer assisted instruction, for there is no conclusive proof that today's CAI technology is any more effective than traditional teaching methods.

Instead, what is on my mind is the thinking skills that computers can help develop. For young children, problem solving skills can be learned through languages like LOGO. Older children who learn to program will also approach

problems in an organized way and be able to take them apart while still retaining a global view of the whole. I believe that such skills have tremendous importance and carry-over into other disciplines.

There is another good reason for having computers in the schools. They provide something that I am afraid is all too frequently lacking in classrooms: fun.

Okay, computers belong in the schools, so each district ought to run out and buy a pile, right? At the board meeting I went to, the committee of teachers advocated adding enough equipment to the district's inventory to allow for a machine in each elementary school classroom and a well equipped computer lab at the high school. So what's the catch?

You see, there *is* a serious computer literacy problem after all. But the problem is with the teachers, not the students! In my district, there are teachers who are literally afraid to plug a computer in. Just buying more hardware won't solve that sort of problem. What is more needed is a full-time "computer person" in each school to provide training and hand holding for the existing staff.

The small group of faculty members presently involved is swamped. They haven't got the time to teach as well as train and support their colleagues. Evaluating new software and hardware is even harder. One committee member claimed that it takes 10 hours just to evaluate a single software product. Although that seems long to me, it is indicative of the problem. The National Education Association's endorsements might have been of some help, but their commercial involvement with products throws their role into question.

Right now, it truly seems to be a case of the blind leading the blind. We have computer illiterate school boards directing computer illiterate staffs. I hope my district and others like it will find the money to bring some real expertise in-house. Until they do, it might be advisable to turn to community residents who are computer specialists for their advice and counsel. It might be one way to avoid some costly mistakes. ◇

# WORLD'S LARGEST COMPUTER MAGAZINE Computers & ELECTRONICS

WILLIAM S. DAVID *Publisher*

SETH R. ALPERT *Editor*

PETER COSTA *Executive Editor*

LESLIE SOLOMON *Technical Director*

JOHN R. RIGGS *Managing Editor*

ROBERT LASCARO *Associate Art Director*

A. W. BURAWA *Senior Editor*

JOSEPH DESPOSITO *Technical Editor*

JOSEF BERNARD *Technical Editor*

ANDRE DUZANT *Technical Illustrator*

JEFF NEWMAN *Editorial Assistant*

AMY MADWED *Art Assistant*

**Contributing Editors:** Sol Libes, Forrest M. Mims, III, Barbara E. McMullen, John F. McMullen

**Editorial and Executive Offices**  
One Park Avenue, New York, N.Y. 10016.  
212-503-3500

### Advertising Sales Offices

#### New York

Ken Lipka 212-503-5029

#### Midwestern

Robert Vanek, Suite 1400, 180 N. Michigan Ave., Chicago, IL 60601. 312-346-2600

#### Western

Janet Bish, 11 Davis Dr., Belmont, CA 94002. 415-594-2290

Anne Abeln, 3460 Wilshire Blvd., Los Angeles, CA 90010. 213-387-2100

#### Southeastern

Mark Browning, PO Box 81306, 2511 Carroll Ave., Atlanta, GA 30366. 404-455-3430.

### Consumer Computers & Electronics Magazine Division

Larry Sporn	President
Jeff Hammond	Vice President, Marketing
Carole Mandel	Vice President, Circulation
Eileen G. Markowitz	Vice President, General Manager
Jerry Schneider	Vice President, Licensing & Special Projects
Herbert Stern	Vice President, Creative Services
Jonathan D. Lazarus	Editorial Director
Peter J. Blank	Creative Director

### Ziff-Davis Publishing

President Richard P. Friese; President Consumer Magazine Division Albert S. Traina; Executive Vice President, Marketing and Circulation Paul H. Chook; Senior Vice President Phillip T. Heffernan; Senior Vice President Sidney Holtz; Senior Vice President Edward D. Muhlfeld; Senior Vice President Philip Sine; Vice President Baird Davis; Vice President George Morrissey; Vice President Rory Parisi; Vice President William L. Phillips; Treasurer Selwyn Taubman; Secretary Bertram A. Abrams

**Editorial correspondence:** COMPUTERS & ELECTRONICS, 1 Park Ave., New York, NY 10016. Editorial contributions must be accompanied by return postage and will be handled with reasonable care; however, publisher assumes no responsibility for return or safety of manuscripts, art work, or models submitted.

The publisher has no knowledge of any proprietary rights which will be violated by the making or using of any items disclosed in this issue.



Member Audit Bureau of Circulations

# THE TANDY TRS-80® MODEL 2000

The ultra-high performance MS-DOS personal computer that operates at twice the speed of the IBM PC.

## Radio Shack Heralds the Dawn of a New Era in Microcomputer Technology

Our Tandy 2000 delivers much more than other 16-bit MS-DOS based computers. More speed. More disk storage. More expansion. Higher resolution graphics. And a modular design that advances the science of ergonomics.

## Use the Hottest Names In Software

Like dBase II data base management. Microsoft-Multiplan spreadsheet analysis. PFS:File electronic filing. MultiMate word processing. And many more already acclaimed by the entire microcomputer industry.

## Increased Speed, Storage and Expansion

A "next-generation" 16-bit microprocessor makes the Tandy 2000 much faster than other MS-DOS computers, so you get the job done quicker. With 1.4 megabytes of storage, you can set up massive data bases. If you need even more storage, choose our Tandy 2000 HD with a built-in hard disk drive. You can add more memory, high-resolution color and monochrome graphics, our new Digi™-Mouse and more. And you can do most installations yourself.

## Complete Service and Support

The Tandy 2000 is backed with the quality and support that have kept Tandy Corporation in the forefront of the microcomputer industry from the beginning. Come in for a demonstration today.

Tandy 2000 With  
Two Disk Drives

**2750<sup>00</sup>**  
26-5103

Commercial Lease Available  
For Only \$95 Per Month  
(Plus Applicable Use/Sales Tax)

Tandy 2000 HD With  
Built-in 10-Megabyte Hard Disk

**4250<sup>00</sup>**  
26-5104

Commercial Lease Available  
For Only \$150 Per Month  
(Plus Applicable Use/Sales Tax)

Non-interlaced monitor, graphics and Digi-Mouse not included

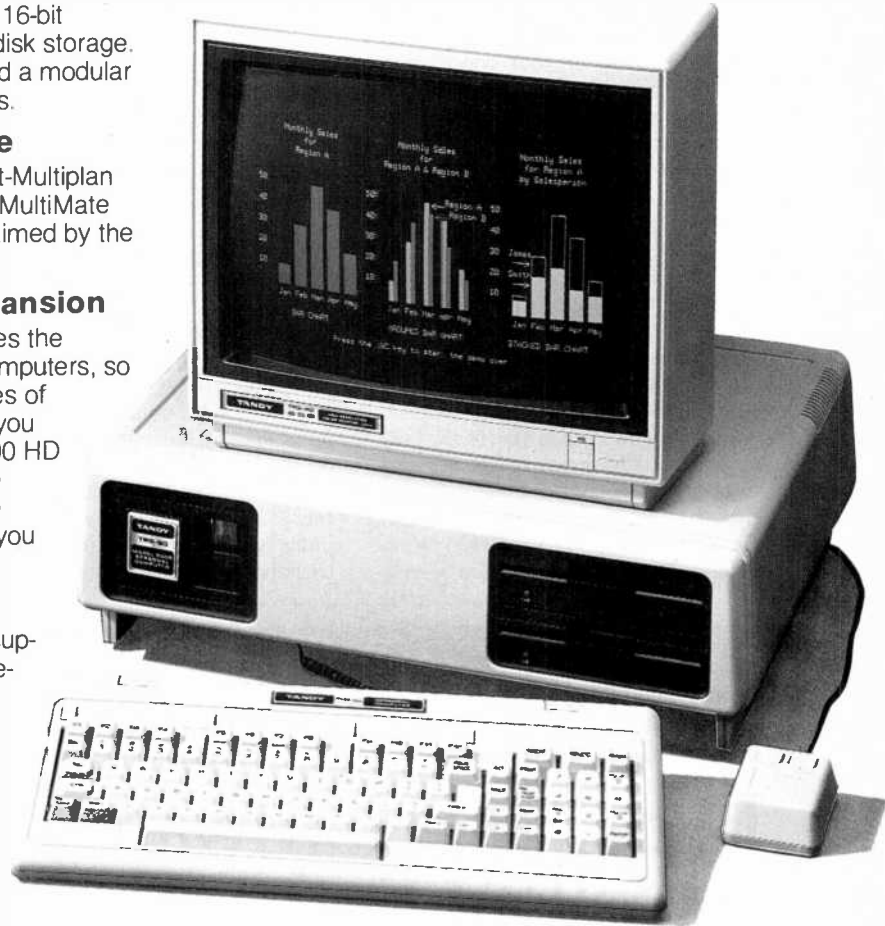

## Compare the Tandy 2000 to the IBM PC

Price Comparison <sup>1</sup>	Tandy 2000	IBM Personal Computer
Base Unit	\$2750	\$2104
2nd Drive	Included (720K)	\$529 (320K)
Monochrome Monitor	\$249	\$345
Display/Printer Adapter	Included	\$335
128K RAM	Included	\$165
RS-232	Included	\$120
MS-DOS 2.0	Included	\$60
Total Cost*	\$2999	\$3658
Feature Description	Tandy 2000	IBM Personal Computer
Internal Memory	128K Standard	64K Standard
Disk Capacity Per Drive	720K	160K or 320K (optional)
Microprocessor Clock Speed	8 MHz	4.7 MHz
True 16-Bit Microprocessor	Yes (80186) 16-bit/16-bit data path	No (8088) 16-bit/8-bit data path
User-Available Expansion Slots*	4	2
Graphics Options		
Color Resolution	640 x 400	320 x 200
Number of Colors	8	4
Monochrome Resolution	640 x 400	640 x 200

\*Comparable IBM configuration with monochrome adapter and display, communications adapter, two 320K disk drives and 128K RAM  
<sup>1</sup>Manufacturer's pricing as of 9/1/83

Available at over 1100  
Radio Shack Computer Centers and at  
participating Radio Shack stores and dealers

# Radio Shack® COMPUTER CENTERS

A DIVISION OF TANDY CORPORATION

Send me a free Tandy 2000 brochure.

Mail To: Radio Shack, Dept. 84-A-683  
300 One Tandy Center, Fort Worth, Texas 76102

NAME \_\_\_\_\_  
COMPANY \_\_\_\_\_  
ADDRESS \_\_\_\_\_  
CITY \_\_\_\_\_ STATE \_\_\_\_\_ ZIP \_\_\_\_\_  
TELEPHONE \_\_\_\_\_

Prices apply at Radio Shack Computer Centers and participating stores and dealers. IBM is a registered trademark of International Business Machines Corp. PFS is a registered trademark of Software Publishing. MS and Multiplan are trademarks of Microsoft Corp. MultiMate is a trademark of Softword Systems Inc. dBase II is a trademark of Ashton-Tate.

# LETTERS

## Technical Truth Squad

Based on a reading of the April issue of C&E, I feel that your editors need the aid of a "technical truth squad" to do battle with those of your contributors who are either caught up by their own marketing exaggerations or are baffled by their own terminology, I'll volunteer for the first shift.

Since he works for Motorola, Dev Chakravarty's extra enthusiasm can be excused when he writes about the M68010 (page 66), but he should still understand that, even with virtual memory, we won't have CPUs that can address "limitless amounts of memory" until we have computer architectures with infinite-width addresses.

If, as William Barden says (page 118), the Apricot "Manager . . . is a binary tree of menus . . ." then I can only conclude that each menu allows the user only a two-way (binary) choice. While the term "binary" adds an aura of mys-

tique to the phrase, it is clearly inappropriate here.

—WILLIAM H. BOYD, JR.  
Diamond Bar, CA

## The Great Carrot Experiment

In reference to R. N. Muffly's comments in your May Letters column concerning his "CACG" (Carrot Activated Computer Glitch), I once noticed a similar phenomenon while eating salted peanuts as I gazed at the flat trace on an oscilloscope screen. Subsequent investigation proved the source of the strange glitch to be vibrations from the masticated nuts traveling into the eyeball and distorting something or other. Verification of this can be obtained by balling up one's fist and forcefully striking oneself on the head and face while viewing an oscilloscope or CRT display. A sweep rate of 20 ms/cm works well. Since computer hackers and electronics engineers by nature are masochists, this is a rea-

sonable experiment. The February 1984 issue of *Scientific American* has a rather complete explanation of this and similar self-induced visual effects.

A word of caution about the carrot experiment, however! Our special products development department recently field-tested a self-heating frozen pizza. It used a stainless steel foil bonded to a cover of aluminum foil. To activate, one simply pressed the foil cover into contact with the tomato-paste pizza surface. The dissimilar metals and acidic contents formed a galvanic cell so that current flowed and heating resulted. The problem came when careless supermarket clerks placed our product on the bottom of the bag, thus activating the self-heating feature while in transit. The cost of removing a lava-like flow of mozzarella cheese from the interior of a Mercedes is astronomical.

—RICHARD L. PEARSON  
Gastonia, NC

## One good thing deserves another:

# Excellent Hardware, Excellent Software, X'Int™ Diskettes.

Why settle for a diskette that doesn't measure up to the quality you're looking for in a total computer system?

Choose the diskette manufactured with added features and quality standards that make it the very best available. Choose the X'Int diskette that's backed by a lifetime warranty.

Find out for yourself. Demand the 5¼" diskette that will give you nothing less than excellent results.

Only at an X'Int dealer near you.

**X'Int** FLEXIBLE DISKETTES

We live up to our name.

X'Int Diskette Products, inc.  
630 International Parkway  
Richardson, Texas 75081



Our 10 pack features a unique Program Shelf™  
X'Int's complete 5¼" product line of diskettes  
are Perma Sealed and carry a lifetime warranty.

Circle No. 63 on Free Information Card



# Build your own IBM PC compatible and save hundreds of dollars.



## Heath proudly announces the NEW HS-151 Desktop and HS-161 Portable computers.

One of the world's largest software libraries has IBM's name on it. Now you can run that software on Heath's new IBM PC compatible computers, available in easy-to-build kits.

Can you build one of these computers? 85% of our first-time customers ask the same question. And the answer is 100% yes. You can.

In fact, you *should* build one. You'll save a lot of money while learning about computers in general and the Heath PC's in particular.

**Build confidence...** and your new computer... one step at a time. Two main circuit boards come to you pre-assembled and factory-tested. So that you can build the three other boards, we include a test soldering board plus helpful soldering instructions to make sure you get it right.

Our instruction manuals are easy to understand, thorough and packed with cogent illustrations. And once it's built, the computer guides you

through a full range of included disk-based diagnostics.

**Expert advice** is only a phone call away, should you need it. You'll reach a trained consultant whose specialty is talking sense, not jargon.

We'll do whatever's necessary to make our pledge come true: "We Won't Let You Fail." Our entire business depends on that simple promise.

**Experience a little wonder and a lot of pride.** Save money, too, by building the highest quality personal computer. The Heath PC's have 128K RAM standard (expandable to 640K) a professional keyboard, dual 360K disk drives and optional Winchester. These machines are truly complete. Both are color capable and MS-DOS is included.

Check out the Heath PC computers today. IBM compatibility means they'll run the most popular software. And, with the money saved by building a kit, think of all the peripherals and software you can buy!

**HS-151 Desktop PC with standard floppy disk drive or optional hard disk.**

**CIRCLE READER SERVICE CARD.** Get more information on the most rewarding personal computers. The HS-151 Desktop PC and HS-161 Portable PC.

\*MS is a registered trademark of Microsoft Corporation.

**For computing on the go... the HS-161 Portable.**



The HS-161 has the same features as the HS-151. Amber Monitor included. Convenient keyboard folds up, two disk drives fold down.



## Heathkit®

Heath  
Company

A subsidiary of Zenith Radio Corporation

Circle No. 24 on Free Information Card

CP-230

# LES SOLOMON ON COMPUTER HARDWARE

## MEMORY YOU CAN BANK ON

Last month I discussed the differences between 8-, 16-, and 32-bit processors. This subject came about from some discussions we had here on the editorial staff. During these talks, I happened to say that last month's column was not quite true since only "names" were used.

Now, I would like to explain what I meant and also introduce the computer newcomer to a subject called "memory bank switching".

It seems that, once we identify something and give it a "name", that name sticks for all time. For example, in microcomputers we have an address bus, a data bus, and a control bus.

Because "that is what it is," some people claim the address bus should be used only for addresses, the data bus only for data, and the control bus only for control signals. However, that is not quite true. As the Queen of Hearts says in *Alice in Wonderland*, "a thing is what I say it is." Or, as Gertrude Stein said, "Rose is a rose is a rose is a rose."

When you read the specs on a processor, you will find one that says since the particular processor has 16 address lines, it can directly communicate with up to 65,536 bytes of memory (usually called "64K" or a full house). \*

Then you read an advertisement about a computer using the same processor and note that this particular system's claim to fame is that it can address a few hundred thousand bytes of memory.

What is even more interesting is that an 8-bit processor like the Z80 although having only 16 address lines can address up to 16 megabytes (yes, 16 megabytes) of memory.

This is where the questions start to fly. "How can this be? Who is right, and what the heck is going on around here?"

Well, the spec sheet, advertisement, and claim are all telling the truth despite the apparent conflict. The spec sheet uses "direct" memory addressing, while the machine discussed in the ad and the claim uses what is called "bank switching" of memory.

In direct memory addressing, the processor uses all its address lines, which in

the case of 16 lines means directly addressing one "bank" of 65,536 bytes.

Bank switching means that more than one 64K "bank" of memory can be connected to the computer, with only one bank accessed at any one time. The computer never "sees" more than 64K bytes.

This is possible because microprocessors based on grandfather 8080 (Z80, 8085, 8088, etc.) also use their 8 data lines to communicate with up to 256 I/O ports none of which occupy any memory space. This is not the same as "memory mapped I/O" as used in other processors where memory addresses them-



selves are used for I/O ports.

This brings up the "names" thing. Is a data line only a data line when it is carrying data and an address line an address line only when it is carrying an address? What do you call data lines and/or address lines when they are carrying I/O instructions?

Some processors use some of the address lines to carry data signals during certain times. Now what do you call these lines?

Some processors have only 8 address lines (the 1802 for example). To address the specified 64K of memory, the 1802 first loads the high order address bits into a latch, then when the low order address bits come out of the processor (on the same pins), the latch fires; and, *voilà*, there are 16 address lines as if by magic. This is called "multiplexing".

By using just the lines coming from the chip, the 8080 types of processors can utilize the 16 address lines—capable of addressing 65,536 bytes of memory, and the 256 I/O ports (carried on the 8 data lines), with each port "calling" one 64K page of memory, to address up to 16,777,216 bytes of memory ( $65,536 \times 256$ ).

Now, instead of the 16 address lines usually specified, a simple 8080 (and family) processor can have up to 24 "address" lines, without bothering its 8 data lines. This flipping back and forth between "pages" of memory is called "bank switching."

To perform such bank switching, the software must be arranged so that, when the program needs more memory, a signal is sent to the particular bank switch output port to select the desired 64K "page."

Obviously, you can use bank switching and as much RAM as your power supply can cope with. Although each major bank of memory will fall at 64K boundaries, internal switching can be used to select memory blocks within any selected 64K page.

### Cassette Storage

While on the subject of memory, if you want to find out how much data you can put on a cassette, all you have to do is use the equation  $(B \times S)/8 =$  kilobytes where  $B$  is the baud rate of the cassette output port (available from the computer manual) and  $S$  is the length of the tape in seconds (e.g., a 10 minute tape is 600 seconds, etc.).

There are two things to keep in mind. One is that the length of actual usable tape is less than the total length of the tape to account for gaps between programs, computer lead-tone requirements, and other formatting needs. The other is that some cassettes are not as long (per side) as they are labelled.

As another example, assume 250 baud and a 20-minute tape. This comes out to  $(250 \times 1200)/8$  or 37.5 kilobytes. For an Apple II having a 1200-baud cassette port, a 20-minute tape produces 180 kilobytes, a 30-minute is 270 kilobytes, etc. ◇

ART BY YVONNE BUCHANAN

# READ ONLY



*A review of the IBM Personal Computer family: Summer 1984*

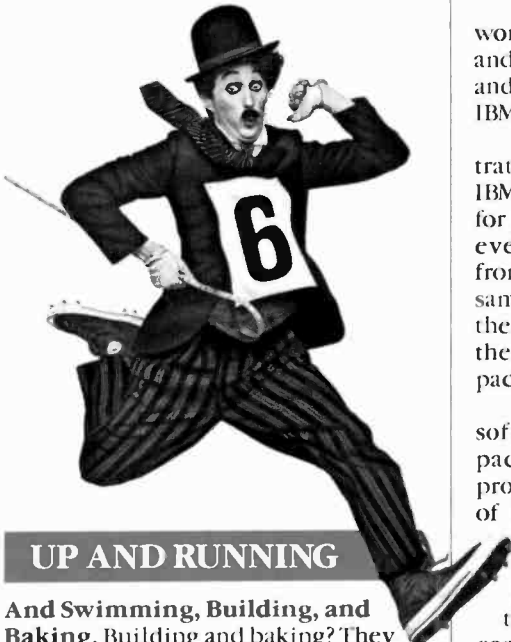

## UP AND RUNNING

**And Swimming, Building, and Baking.** Building and baking? They don't produce gold medal winners, but they do figure in staging the Olympic games. So do 200 IBM Personal Computers (including software) that are part of IBM's sponsorship of the 1984 Olympics in Los Angeles. In fact, IBM PCs are hard at work in both sports and administration.

PCs are involved in a wide range of planning and analytical activities, though they don't provide official results of the various athletic events. Some events, for example, use the IBM PC to determine how competitors are seeded—who competes against whom. In other events, such as archery, the PC simplifies the complex task of recording scores and compiling statistics for each athlete as the competition progresses.

In events like gymnastics that depend on points awarded by judges, statistics can be kept on the PCs to analyze scoring consistency. Also, a whole range of information about individual athletes, past Olympics, and

world and national records, both past and present, can be quickly recalled and compared with the help of the IBM PC.

Last but not least, administration. Spreadsheet programs, such as IBM's Multiplan™, were used on the PC for planning and forecasting by nearly every administrative department, from Construction to Ticketing. The same departments speed up some of their day-to-day accounting tasks with the help of the PC and IBM accounting packages.

Departments with specific software needs developed special packages with the assistance of a programmer whose services are part of IBM's Olympic sponsorship. Specially designed programs include database management applications to help handle transportation requirements and inventory control programs to keep track of sports equipment and personnel records.

In short, there's hardly an area of planning and staging the 1984 Summer Olympics that the IBM Personal Computer doesn't play a part in. Maybe there *should* be medals for administration.

Multiplan is a U.S. trademark of Microsoft Corporation.



## ON THE STOREFRONT

**A Shorter Distance between PC Points.** We're all familiar with the feeling of being lost in the growing maze of new computer products. IBM has opened a path through that maze, straight to the information and answers you need about IBM Personal

Computer Products—information about a specific software package or hardware configuration and answers to technical questions.

The key to entering this new information path is the IBM Customer Support System (CSS) at your authorized IBM Personal Computer retail dealer or IBM Product Center. Dealers in over 300 cities throughout all 50 states use the Customer Support Sys-

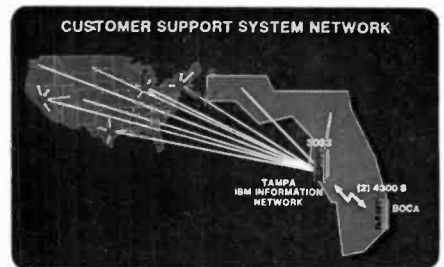

tem, which includes a nationwide communications network, to help give you instantaneous computer-age service support that's unmatched by any other computer manufacturer.

**Colorful Stops along the Way.** More than 1,700 authorized IBM dealers have access to a permanent and continually updated directory of IBM Personal Computer product information in IBM's Customer Support System. For a sharp color display of the type and level of information you want, visit your dealer or IBM Product Center and choose from lists of options displayed on an IBM PC color monitor. There are choices that guide you quickly and easily from product directories to in-depth product demonstrations and configuration information.

Since knowing how to take the first step is often a problem, CSS gives you a variety of possible starting points. By selecting the appropriate category—such as printers or business software—you can move to a list of specific products and then to the



*Information from CSS with simple one-key commands*

product demonstration you want. If you know a product name to begin with—Word Proof, for example—CSS will make an alphabetic search for it. To keep you up-to-date, there's also a special listing for new product announcements.

You can browse through the CSS displays at your own pace, pausing at a given spot or moving quickly backward or forward by using simple one-key commands that are always displayed at the bottom of the screen. One of these commands enables you to make print-outs of any information you wish to save for future reference.

The IBM PC family's color graphics capabilities make the CSS software demonstrations especially impressive. The Multiplan demonstration, for example, consists of several consecutive screens of information. Each screen is split vertically, with representative sections of the actual program on the left and explanatory text on the right. By the time you've seen the entire demonstration, you'll have a good idea of both *what* the program can do for you and *how* it does it.

**Answers at the End of the Line.** Over 1,000 authorized IBM retail dealers and IBM Product Centers are linked through their Customer Sup-

port System to the IBM Information Network. This nationwide communications capability helps your dealer give you fast, efficient service. Warranty claims, for instance, can be handled through CSS with a minimum of paperwork and delay. Dealers also use the network to communicate with other dealers and with IBM to keep abreast of the latest product and service information.

In addition, the CSS network is your gateway to technical information about the IBM Personal Computer family of products. IBM maintains a database on a 3033 mainframe in Tampa, Florida, that your dealer can use to answer—within minutes—a wide range of questions. If the solution isn't on hand in the database, your question can be submitted through CSS to a technical support staff in Boca Raton. There, it will be analyzed and an answer returned through CSS to your dealer.

The information used to answer your inquiry is added to the CSS database, where it will be immediately available for anyone else with a similar question. Your technical inquiries therefore contribute to the growth of the Customer Support System. Its on-line product information, color graphics displays, and advanced communications all have a single purpose—to help you get the most out of your investment in IBM Personal Computer hardware and software products.



## HARDWARE NEWS

**Color.** There's color news for the IBM PC, IBM PC XT, and IBM *Portable* PC in the form of the IBM Personal Computer Color Printer. It's a high-performance, dot matrix printer that can print charts, graphics, artwork, and text in up to eight colors. The Color Printer produces color graphics that can enhance the appearance of your reports and presentations and make the information they contain even easier to understand. It can also type directly onto overhead transparencies.

The IBM PC Color Printer's range of performance features make it especially well suited for heavy-use/high-productivity applications. A near letter quality printing mode is standard. Printing speeds of up to 200

characters per second can help save time. So can programmable automatic control of print requirements such as print mode, line spacing, and margin and tab setting. These programmable features act as an extension of many software products—word processing programs, for instance—and can be initiated with just a few keystrokes.

A final feature for those who like a personal touch. You can use the Color Printer to personalize your documents by varying the printing modes, character spacing, and boldness. This allows you to differentiate

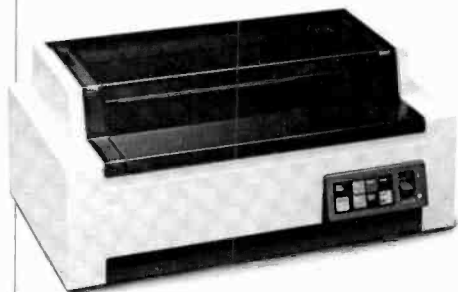

*The IBM PC Color Printer*

among headlines, subheads, and quotations and even to print math and science equations.

**The Big Crunch.** Not long ago, computing and number crunching were nearly synonymous. Personal computers and software for everything from office management to agriculture changed that, but the need for heavy number crunching has hardly disappeared. If it's still a part of your computer workload, the IBM Personal Computer 8087 Math Co-processor can help speed up your calculations.

The 8087 is a floating point co-processor that multiplies, divides, adds, subtracts, exponentiates, and performs trigonometric and logarithmic functions. It works together with the PC's 8088 processor to improve the execution speed of floating point operations by as much as 10:1. The Math Co-processor increases calculation speeds so greatly because it makes floating point operations a hardware rather than a software function.

In addition to increasing the speed—and often the level of precision—of statistical and analytical math packages, the Math Co-processor can improve the display speed of graphics and video games. It also significantly improves high-level language execution time, and is designed to work with the APL Interpreter and the version 2.0 Pascal and FORTRAN Compilers discussed next in this issue.



## WHAT'S THE PROGRAM

**We Speak Your Language.** IBM Personal Computers are shameless polyglots. They can handle most of the popular programming languages you want to work with. Much of the credit for their versatility goes to the IBM Disk Operating System (DOS) 2.10. This updated version of DOS 2.00 was developed to provide support for the IBM PCjr as well as for the IBM PC, PC XT, and IBM *Portable* PC. So all members of the IBM Personal Computer family are united by a single master program that provides the required support between their hardware and a wide range of application programs.

More to our present linguistic point, the DOS 2.10 diskette contains two programs, Disk BASIC and Advanced BASIC, to help you write your own programs on an IBM PC. (IBM PCjr BASIC—a separate, optional cartridge—provides this support for the PCjr.) Disk BASIC adds DOS file support, date, time of day, and communications capabilities to the BASIC language that comes with every personal computer from IBM. Advanced BASIC adds advanced key trapping and advanced graphics—including viewports, windows, and paint tiling—plus music and other capabilities.

DOS has other features that help simplify advanced program development and design, including a line editor, a linker, background printing, and chaining of commands. For help with writing and editing particularly sophisticated BASIC programs, there's the BASIC Programming Development System, a software package that consists of two programs and four utilities. The first program includes a Text File Editor and a Structured BASIC Pre-processor; the second includes a BASIC Formatter and a BASIC Cross-Reference.

**Native Translators Available.** The IBM BASIC Compiler compiles or translates the BASIC programs you've written, down to native object code so they'll run on your IBM PC. And BASIC is just the beginning. DOS also provides the support you need to develop and run programs using the IBM Personal Computer Macro Assembler or the FORTRAN, COBOL, and Pascal Compilers.\*

Two of these, the FORTRAN and

Pascal Compilers, are available in recently updated versions. IBM PC Pascal 2.0 is based on the ISO standard, and IBM PC FORTRAN 2.0 conforms to the ANSI-77 standard subset level. Both new versions feature improved arithmetic capabilities, and both support the IBM 8087 Math Co-processor for greatly increased speed in processing floating point calculations. (For more about the Math Co-processor, see "Hardware News" in this issue of *Read Only*.)

In addition, versions 2.0 of the FORTRAN and Pascal Compilers feature a Library Manager for creating user-defined libraries and provide easy access to all files in any subdirectory through DOS path support. FORTRAN 2.0 supports linking of object modules with subroutines written in Pascal 2.0 and vice versa. Both new versions support linking of object modules with subroutines written in IBM PC Macro Assembler.

There's a bargain in store for those who already own the 1.0 versions of these compilers: you have the option of buying an upgrade to the 2.0 version at a substantial savings from the full 2.0 price.

To ensure that your programming reach doesn't exceed your grasp, the IBM PC APL Interpreter enables you to write and edit your own programs in APL. It can also be used to exchange data files and workspace between your IBM PC and many mainframe computers.\*

Finally, if you're inclined to make serious use of the IBM PC's array of programming aids, we suggest that you also take a look at the recently announced IBM PC Sort program. It provides support for data types and file organizations used by the IBM DOS-supported languages mentioned

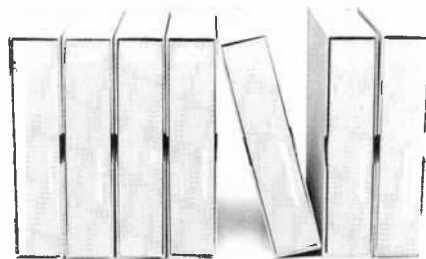

*Application development tools from IBM*

above and can significantly speed and streamline your programming efforts.

IBM PC Sort can be used as a stand-alone utility, integrated into a batch job stream, or invoked directly from a COBOL program via the Sort verb. It can sort records from a data file

or files, merge multiple input files, selectively include or exclude records, and create an output file containing the records, pointers, or keys from the input files. There are no arbitrary limits in IBM PC Sort for file size, record length, number of keys, or number of input files.

\*BASIC Compiler and Macro Assembler will run on the IBM PCjr. API Interpreter will not. Although the IBM PCjr does not support FORTRAN, COBOL, and Pascal Compilers, most of their output will run on the PCjr if there is sufficient storage.

**Now Get Organized.** The IBM PC's ability to run a wide variety of commercially available programs and to help you develop your own applications may result in a good news/bad news situation. The good news is that you'll be able to satisfy your application requirements. The bad news is that you'll probably be the one responsible for keeping track of your growing library of programs. If, as we've often found, enthusiasm outstrips organization, you may find yourself falling behind—especially if you're working in an area, such as

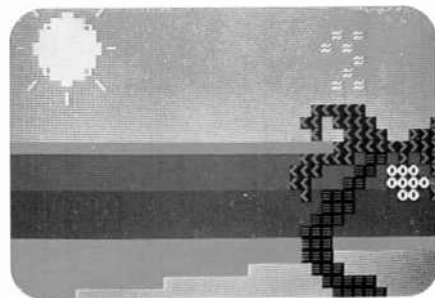

*Animation Creation software from IBM*

small business finance or education, where programs multiply rapidly.

Fortunately, help is in sight, in the form of Fixed Disk Organizer, an IBM software package that does just what its name suggests.

Fixed Disk Organizer has a master menu that lets you sort out your various application programs by category—word processing, spreadsheet, communications, and so on. You can tailor the menu to your specific application needs by adding new menu categories, revising or deleting existing categories, or changing titles. The master menu allows you to review all the programs stored on your fixed disk at a glance and to call them up quickly with just a couple of keystrokes.

Fixed Disk Organizer also helps protect sensitive data by allowing you to create passwords and restrict access. It also enables you to write a

string of complex DOS commands into a batch file and execute them whenever you want simply by selecting that file from the menu. And in case part of your organizational problems stem from not always remembering just how things are organized, you can use Fixed Disk Organizer to establish Help files as a reminder.

So we're all in trouble—no more excuses for not being organized.

**Moving Pictures and Mathematical Castles.** Let's not forget that there's more to life than programming, compiling, and getting organized. There's also software from IBM for pure enjoyment and for enjoyable education. Two such packages are Animation Creation and Adventures in Math.

Adventures in Math incorporates math drills into an adventure game with vivid color graphics of a castle and its passageways and treasures. To find the way out—and to uncover as many treasures as possible along the way—children (or particularly skillful adults) have to solve basic math problems. The program's difficulty level increases as you solve the problems you're confronted with.

Using Animation Creation, you or your children can draw your own pictures and watch them come to life. To draw pictures, you select from 254 computer characters and position them on your screen. Add color by choosing any of 16 foreground and 8 background colors. Then, by slightly repositioning the images on successive screens, you can create animation.

Next stop, Hollywood.



## HARDCOPY

**You Can't Enjoy the Game without a Program.** Earlier in this issue (see "On the Storefront"), we discussed the Customer Support System for online information about IBM Personal Computer products. Much of that information is also available in two publications: *The Guide*, a directory of Personal Computer offerings from IBM, and *The Library*, a directory of IBM Personal Computer software offerings. If you want to enjoy the personal computer game, these are the "programs" you need to do it.

*The Guide*, published twice a year, is a catalog that contains clear, concise descriptions of IBM PC, IBM PC XT, IBM PCjr, and IBM *Portable* PC systems. It also reviews printers, video displays, expansion units, and all other IBM PC hardware products. A separate section of *The Guide* contains articles on IBM PC software packages.

Both hardware and software articles are illustrated

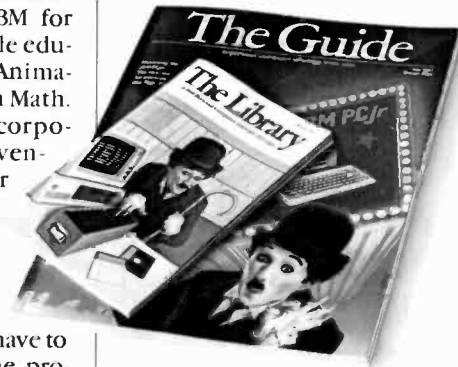

with annotated color photographs—of key screens for the software packages—and start with charts that provide quick product overviews. Other noteworthy features include sample configuration tables for all three systems and a closing section on Sales and Service Support.

*The Library*, updated quarterly, presents an overview in booklet form of the entire IBM PC software product line. It presents the software by category, with sections on Operating Systems and Languages, Personal Productivity, Communications, Business, Education, and Entertainment. Program descriptions are brief and to the point. Each includes a short overview, program highlights, and system requirements. There's also a chart at



**IBM®**



the end of the booklet that shows at a glance which programs are compatible with the IBM PCjr.

**Or the Hardware without a Manual.** If *The Guide* and *The Library* are the general road maps to IBM PC products, the *Technical Reference* and *Hardware Maintenance and Service manuals*—now available in newly updated versions—are the detailed maps of downtown. It's not a trip everyone wants to take, but if you do, these are the right directions.

There's a three-volume *Technical Reference* set for the PC and another for the PC XT and *Portable* PC. These manuals include the functional specifications for the system units and for the options and adaptors in the IBM PC product line. The *Hardware Maintenance and Service* manual details many aspects of troubleshooting a personal computer from IBM. It includes a parts catalog, a section on preventive maintenance, and instructions for identifying the failure of a replacement unit.

\*These manuals are intended for use by technically qualified service personnel.



## TIPS AND TECHNIQUES

If you use Personal Editor—IBM's full-screen editor for writing programs and brief documents—but find yourself displaying the Help file whenever you forget a function key assignment, here's a little help from the fellow forgetful.

Function key assignments can easily be displayed on the command line of your Personal Editor screen by assigning F1 to display the unmodified keys and alt+F1 to display the alt+Fx keys. You can then assign the Help function to alt+H, although you probably won't need it nearly as often as before.

The macro for the F1 assignment can be written as follows: def f1 = [cursor command] [begin line] 'F: 2=Save 3=File 4=Quit 5=Erase 6=EraseEOL 7=Print 8=Switch 9=InsL 10=Ins&Indt' [cursor data].

For more information about IBM Personal Computer products, see your authorized IBM Personal Computer dealer or IBM Product Center. To learn where, call 800-447-4700. In Alaska and Hawaii, 800-447-0890.

©1984 International Business Machines Corporation

Little Tramp character licensed by Bubbies Inc., s.a.

# SOL LIBES BITS & BYTES



## Rumors & Gossip

► Tandy Corp. is rumored very close to introducing the Model 200 portable, the successor to the popular Model 100, using a 16-line, 80-character electroluminescent display. . . . While Epson is expected to introduce a new portable with a 25-line by 80-character LCD display. . . . Hitachi and Mitsui of Japan are reportedly planning to release portables with 16 80-character line flat displays, at least 256 K of RAM and a single disk drive. Since Timex has exited the home computer business, the price of the Timex 2068 Color Computer (list \$199.95) is expected to tumble to the \$50-100 range. As many as 60,000 of these units are reported in dealers' stocks. The 2068 is the U.S. version of the Sinclair Spectrum which is very popular in Europe. In the meantime Sinclair is having trouble producing its new QL 68008-based computer and it not expected to start shipping in England until this month with U.S. deliveries anticipated by late fall. . . . Osborne Computer, now that it is reorganized, may shortly begin shipping its PC compatible portable.

## Commodore Rumors

► Commodore may release a \$99, 16K RAM machine, called the C-16, to replace the popular VIC-20, which has only 5K of RAM. The machine will be upgradable to 64K of RAM. Commodore is expected to continue selling the VIC-20 in Europe, where it is much more popular than in the U.S.

Commodore may also introduce its 264 and 364 bigger brother this fall. These machines were shown at the Con-

sumer Electronics Show in January and described earlier in this column. They may replace the C-64 and provide upgraded performance.

Lastly, Commodore showed, at a recent European trade show, a prototype of its long-rumored Z8000-based office-oriented machine. Commodore has refused to say when, or if, this machine will go into production. However, they have promised that, if it goes into production, it will have 256K of RAM and use the Unix operating system. In the meantime, Commodore is expected to shortly introduce an office-oriented IBM-compatible machine which is essentially a copy of the Hyperion.

## Laser Printer Prices Dropping

► One of the shortcomings of the Apple Macintosh computer is that its printer is not capable of faithfully reproducing the Mac's super graphics. This is also true for other high-density graphics systems. But this situation is expected to change soon as printer manufacturers begin shipping new lower-cost laser printers at prices competitive with current dot-matrix type printers. Laser printers can space their dots much more closely thus producing high-quality characters, curves and diagonal lines.

Currently available laser printers sell for \$20,000 and up. However, Canon USA Inc. reportedly will introduce a laser printer selling for around \$3,000. And next year similar products are expected from Ricoh of America Inc. and Xerox. Apple Computer is expected to sell the Canon printer for use with the Macintosh system. This will print with

almost twice the detail of the current Mac printer.

In other printer news, Epson is expected to introduce an ink-jet printer capable of 80 and 200 cps with resolution of 240 x 240 dots per inch to later be upgraded to 300 x 300 dots per inch; expected list price is \$2,000. And look for Diablo Systems to have a daisywheel printer operating at up to 80 cps.

## Computer Stores Growing

► Future Computing Inc. reports that at the end of 1983 there were 3,152 computer specialty stores and that with the current rate of growth this is expected to increase to 5,000 by the end of 1985 and to 7,000 by January 1989. They further report that at the end of 1983 there were 462 Computerlands and 418 Radio Shack Computer Centers in the U.S. California is the state with the most stores—455 and Vermont the least—2.

## Optical Disks Expected Shortly

► It is predicted that we will soon see the introduction of optical disk options for personal computers. Expected to sell for less than \$1,000 they should be less than 5 1/4" in size and store upwards of half a gigabyte. Currently systems are available from about a half dozen manufacturers using 12" and 14" media and costing between \$5,000 and \$120,000.

These disks—which are not erasable—are expected to sell for under \$100. The drives, when production increases sufficiently, are expected to sell for less than \$300.

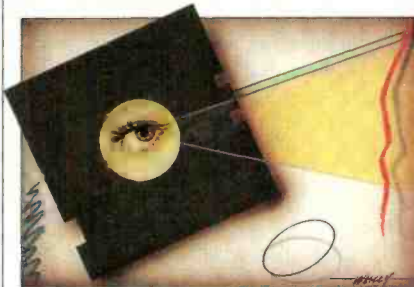

Basically, the same technology currently being used in digital audio laser disks is expected to be applied to computer data storage. Sony already offers a consumer CD player with an RS-442 serial data port.

Both the IBM Entry Systems division, which makes the IBM PC, and Digital Research Inc., creator of CP/M, are known to be evaluating the use of laser

## Bits & Bytes

disks with personal computers. 3M is developing the media for these optical drives.

### Disk Drive Prices Falling

► Last year Taiwan exported almost 90,000 disk drives, mainly 5¼" drives, to the U.S., pushing down prices. This year's export to the U.S. will be between 400,000 and 800,000 units. Further, Taiwan will soon start exporting 5¼" Winchester drives to the U.S. Thus, there is no doubt that prices for both hard disk and floppy drives will be dropping significantly in the near future.

### Flat Panel Displays Increasing in Popularity

► Large flat panel display technology is finally moving from the laboratory to the marketplace. For example, Hewlett-Packard will introduce portable and desktop computers using flat electroluminescent panels built by Sharp of Japan. And later this year, Commodore will introduce three new computers with a liquid crystal display which Commodore will make in-house.

Coming out of R & D labs, mainly in Japan, are LCDs with thin-film transistors which provide significantly better brightness, resolution and viewing angle than the current multiplexed displays. These new active-matrix displays that put a transistor behind every pixel are expected to also make possible color LCDs and reduce the weight and power consumption. The problem is insuring uniformity and high yield when one has an 80-character by 25-line display consisting of 6 x 8 pixels in each character and a total of 96,000 transistors in a 9-inch diagonal area. Seiko and Sanyo have already demonstrated small active-matrix displays and Sharp, Canon, Matsushita, Mitsubishi, NEC, and Hitachi are also known to be developing such displays. Sanyo has already demonstrated a full-color LCD display using color filters. In the U.S., Commodore is known to be using this technology in its panels. And AT&T Bell Labs, Crystal-Vision Inc., IBM, PanelVision Corp., and UCE Inc. are also known to have LCD R&D efforts, although none are believed as far along as the Japanese. These panels initially will display 80 characters by 16 lines with 25-line displays and should be expected on the market by late 1985.

Meanwhile, IBM has already introduced a gas-discharge plasma panel that is 17.2 inches diagonally containing close to 750,000 individually addressable pixels. The 3-inch-thick panel can display 80 characters by 24 lines.

### Apple IBM Battle

► Now that Apple Computer finally released its low-cost version of the IIe, the Apple-IBM war moves to a new battle scene. Apple appears to have lost the battle for the office of the future. Few businesses are buying the Apple IIe, Lisa or Macintosh systems for their desktops. Apple has not conceded the battle, however, and we may see more action on this scene.

On the home front Apple appears to be winning. The lowering of the price for the Apple IIe and the introduction of the PCjr have served as a stimulus for Apple

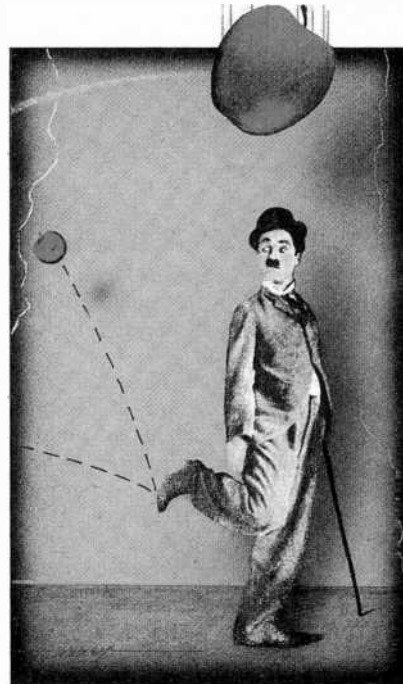

sales. A complete Apple IIe suitable for word processing costs less than PCjr.

In fact, sales of the PCjr are proving quite disappointing to IBM dealers, many of whom are already offering significant discounts. The machine may just be priced too high for a home system, especially when one can put together home systems for half the price based on machines from Commodore and Atari. The new Apple IIc is in effect an "Applejr" and it appears that Apple may have learned from some of IBM's mistakes with the PCjr. It has a very high compatibility with the IIe and thus will run most of the II software while the PCjr has a much lower level of compatibility with its bigger brother. It has a more standard keyboard and desirable features such as optional battery pack and flat panel displays (expected out this fall). Most important, it sells for a heck of a lot less than the PCjr. I expect it to be very successful.

I expect that the Apple-IBM battle

will intensify even more. IBM is a very aggressive competitor and therefore I think they will soon announce changes to the PCjr to make it more attractive. First, I expect the PCjr price to drop and a new keyboard to be announced. And then there is that \$40-million advertising campaign IBM has launched to sell jrs. Further, I expect IBM will soon introduce a fully portable version of the PC with integrated display, battery and disk drive. Apple will probably respond by releasing a new version of the IIe with 16-bit processing capability.

### Software's Top Ten

► Future Computing Inc., a Richardson, TX, marketing research firm, lists the following companies as the top ten microcomputer software producers and their estimated sales for last year. It is interesting to note that the top three are hardware manufacturers who also publish software. The dollar volumes shown are in millions of dollars.

1. IBM	\$110
2. Radio Shack	110
3. Apple Computer	68
4. Microsoft	68
5. VisiCorp	52
6. MicroPro	50
7. Digital Research	44
8. Lotus Development	38
9. Ashton-Tate	33
10. Peachtree	20

### Random News

► The Sinclair ZX81 may not yet be dead. Sinclair has signed an agreement with Samsung Electronics, South Korea, to manufacture both ZX81 and Spectrum home computers. . . . KayPro has reduced the price of the KayPro II transportable to \$1295 making it the lowest cost complete CP/M computer on the market. . . . Microsoft has announced that it will offer its "Windows" package for the Xenix multiuser operating system as well as for MS-DOS. . . . NASA's Ames Research Center, Moffitt Field, CA, recently ran benchmark tests on the new Fujitsu VP-200 and Hitachi S-810 supercomputers and concluded that the machines are equal, and in some cases surpass, U.S. supercomputers from Cray Research and Control Data. . . . The U.S. customs service reports that 1983 saw the long-standing U.S. computer trade surplus with Japan turn into a deficit as shipments of computer peripherals subassemblies and computers from Japan to the U.S. tripled from the previous year. . . . *The Wall Street Journal* reports that there are now 9.1 million personal computers installed in the U.S. ◊



# INTRODUCING HAVAC. THE NEXT BEST PERSONAL COMPUTER

If you're buying a personal computer for the first time, you don't need the biggest and brightest to begin with.

Think simple.  
Sensibly priced.  
Less than **\$850.**

Of course, you'll want some initial training to get you started. The Havac comes with its own disk operating system and "Training" software like Typewriter, Calculator and Havacom for communications. And once you've mastered the basics, you can use software from the largest selection in the world.

Apple® Software.

Game-like computers that are comparably priced can't offer software like Havac can. But if games are your bag, Havac has a Joystick/Paddle port. And a port for RS-232C, Parallel/Serial printer or an additional disk drive. Which we also make. Havac already has one disk drive built in.

So, if the biggest and brightest are beyond your budget, take a look at The Next Best Personal Computer.



The Havac from  
MICROSCI.

Ask your

dealer for a simple demonstration or write: MICROSCI, 2158 Hathaway, Santa Ana, CA 92705 (714) 241-5600.

Circle No. 5 on Free Information Card



A Standun Company



Apple® is a registered trademark of Apple Computer Inc.

\*Built-in. 164K disc drive. 64K RAM, 8K ROM. 40 column/24 line screen. 280 x 192 dot color graphics. 4 cursor keys and 2 special function keys. Compact and transportable. Made In America.



# Announcing a small im

It's 12" x 11¼" x 2¼"  
 It weighs less than 8 pounds.\*  
 And costs less than \$1,300.\*\*  
 Yet with 128K, the new Apple® IIc Personal Computer is a lot bigger than it looks.

*The IIc has a full-size keyboard.*



Because it's inherited all the talents of the eminently talented Apple IIe:

The versatility to run over 10,000 different software programs.

The ironclad reliability of the first true VLSI motherboard.

And the artistic ability of 16 high-resolution colors.

The IIc also has some talents of its very own.

For instance, a switchable 80/40-character display.

Switchable QWERTY/Dvorak keyboard.

A built-in half-high 143K single-sided disk drive.

Built-in serial ports for modems, printers and an extra half-high drive.

Even built-in mousetronics so it's ready to use a mouse and all the new Apple II mouseware.

And our newest brainchild is certainly not an orphan.

You can grow it with a whole family of Apple II accessories and peripherals.

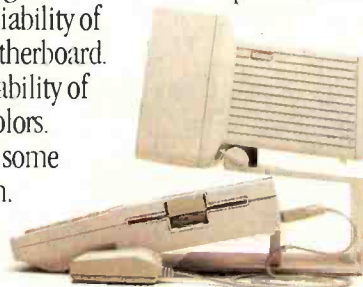

*Thin, isn't it? Even with its built-in disk drive.*



# Improvement on the Apple IIe.

Including the new Apple Scribe—Apple's first full-color print-on-anything printer for under \$300, it can handle anything from business graphics to term papers.

The IIc's father, of course, is the granddaddy of the whole personal computer industry, the Apple IIe. Which, lest we forget, has quite a few improvements of its own this year.

The IIe can now use our ProFile™ hard disk — so it can store about 2400

pages of anything you'd like to remember.

And the Apple IIe is still the most expandable personal computer there is.

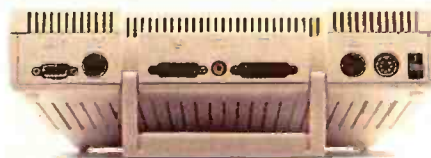

*Built-in ports for making all the right connections.*

You can increase its RAM to an elephantine 512K. Add a Z-80 card to run CP/M.\*\*

In fact, you can grow it with enough cards and peripherals to run just about any family business. Like Saudi Arabia.

So you see, the only question is whether you need an expandable Apple II. As in IIe.

Or a compact Apple II. As in IIc.

Just visit your friendly authorized Apple dealer.

And tell them what size improvement you'd like.



\* Don't asterisks make you suspicious as all get-out? Well, all this one means is that the IIc CPU alone weighs 7.5 pounds. The power pack, monitor, an extra disk drive, a printer and several bricks will make the IIc weigh more. Our lawyers were concerned that you might not be able to figure this one out for yourself. \*\* The FTC is concerned about price fixing. So this is only a Suggested Retail Price. You can pay more if you really want to. Or less. © 1984 Apple Computer, Inc. Apple, the Apple logo and ProFile are trademarks of Apple Computer, Inc. CP/M is a trademark of Digital Research Inc. For an authorized Apple dealer nearest you, call (800) 538-9696. In Canada, call (800) 268-7796 or (800) 268-7637.

# HARDWARE REVIEWS



## THE TANDY 2000

*Speed and elegance mark Radio Shack's MS-DOS debut*

**BY B. & J. McMULLEN**

ONE of the major players in the microcomputer game from the beginning has been Radio Shack. Now it is attempting to strengthen its hand with the Tandy TRS-80 Model 2000 personal computer. For \$2750, Radio Shack/Tandy offers a 128K MS-DOS computer with two disk drives, detached keyboard, and serial and parallel ports.

Tandy has chosen the rather safe road of adhering to the MS-DOS operating system standard instead of either completely relying on its own unique system (as it did for years with TRS-DOS) or choosing a system like Apple's Macintosh to emulate. This choice may not place the 2000 at the very leading edge of technology but it certainly makes it fit comfortably within the universe of "current state of the art" systems.

What does make the 2000 approach the leading edge is Tandy's choice to forsake pure IBM PC compatibility by using faster and newer components in the system. This decision significantly differentiates the machine technically from the IBM PC. However, it also presents some peril. The Model 2000 cannot utilize software designed for the IBM PC as the pure compatibles do (Compaq, Columbia, etc.). Therefore Tandy is dependent on companies such as Lotus and Microsoft to develop versions of their software for the Model 2000. Tandy has both courted developers like these and, through its advertising, stressed its technical superiority over the IBM PC.

### The Basic Machine

The Model 2000 utilizes Intel's 80186 microprocessor, an enhanced 8086 that includes additional support ICs right on the chip. In addition to the CPU, the 80186 includes an 8-MHz clock generator, two 16-bit programmable timer/counters, and two high-speed independently programmable DMA channels, as well as other ICs. This processor allows the 2000 to run at over twice the internal speed of the IBM PC. The speed improvement is due both to the clock speed difference (8 MHz vs. the PC's 4.7 MHz) and the fact that the 2000 is a full 16-bit machine while the 8088-based PC

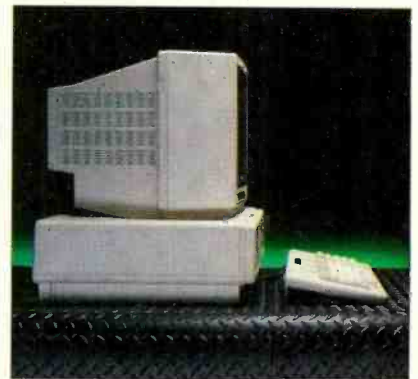

is a 16-bit processor with an 8-bit bus. There is also a socket for the 80187 floating-point numeric processor.

The system comes with a minimum of 128K RAM and is expandable to a maximum of 768K (vs. 640K for the PC). The system contains two 720K half-height floppy disk drives (compared to the 360K floppy capacity of the PC) in its standard configuration. (Optionally, the second floppy can be replaced by a 10M-byte hard disk.)

The system is housed in an attractive cream-colored case—a welcome departure from the traditional Radio Shack battleship grey. The main unit has the power switch conveniently placed at the front left-hand side along with a reset switch. The half-height drives are stacked on top of one another at the right, with the boot drive below the secondary one. The main unit can sit on the desk or stand vertically on the floor. If the latter tack is chosen, there is a pedestal available (\$90) for the monochrome monitor and a stand for the main unit (\$145). At the rear of the unit are horizontal slots for hardware expansion, and RS-232 (DB25 connector) serial port and Centronics (male 36-pin connector) parallel port.

The color change, coupled with the decision to use the "Tandy" rather than the "Radio Shack" name for the ma-

chine, indicates an attempt to slightly change the previous TRS-80 image. The Model 2000 and the portable Model 100 are systems that are aimed at the business professional and the executive rather than the hobbyist or small businessperson that have been Radio Shack's traditional marketplace. The subtle changes in packaging and titling reflect this shift in emphasis.

### Display and Graphics

Tandy offers two display monitors for the 2000: the VM-1 high-resolution monochrome monitor (\$249) and the CM-1 high-resolution color monitor (\$799). The standard configuration offers a text display of 80 (or 40) characters by 25 lines. An optional graphics board is available for \$449.

The monitor clarity of the 2000 is one of its most appealing features. With the optional graphics board, the resolution is 640 × 400 for both monochrome and color monitors. The 2000 will display graphics on its monochrome monitor (the PC will not). It supports up to 8 colors in the color mode (compared to the 4 supported by the PC), but needs a \$199 upgrade to do it. The colors presented by the 2000 are vivid (the yellow is the best we have seen on a micro) and the graphics demonstration program provided on the MS-DOS diskette will impress even the computer sophisticate.

### The Keyboard

The keyboard on the 2000 appears flimsier than the one on the IBM PC but is far superior in almost every other way. For example, the ENTER (shift) key is in the right place for typists (unlike the PC); the directional arrow keys do not interfere with the numeric keypad as they do on the PC; and there are LEDs that indicate when the numeric lock and caps lock modes have been activated.

Additionally, the programmable function keys are located in a straight horizontal row across the top of the keyboard (there are 12 function keys on the Tandy compared to 10 on the PC), and PRINT (for screen printing) and BREAK are single keys and do not require the use of the SHIFT, CTRL, or ALT keys. However, we do prefer the availability on the IBM keyboard of the additional "\*" (asterisk) key. We feel that any machine that runs MS-DOS as a standard should have the colon (:), and asterisk keys available in lower-case.

While none of the keyboard improvements are revolutionary, they do answer all of the criticisms of the PC keyboard.

### Hardware Expansion

With the 2000, Tandy has attempted to produce an "open" machine that will interest third party hardware and software developers. It has published a *Hardware Reference Manual* and a *Software Reference Manual*, which include schematics and assembly language modules to encourage such development. If this "openness" provides the stimulus to develop the same type of system expansion devices that such firms as AST, Quadram and Tecmar have developed for the IBM PC, Tandy will benefit greatly.

Another indication of "openness" is the fact that all hardware options, with the exception of the internal hard disk and the first memory upgrade, are user-installable. The method of installing options is extremely straightforward and is explained well in the manual (option installation does not require opening the computer). Hardware options are installed in a card cage accessible from the back of the unit. Users will find this procedure far more "friendly" than installing cards into slots in an Apple II or an IBM PC.

### Compatibility

Although programs that run on the IBM PC and compatibles may not be utilized on the Model 2000, the use of standard MS-DOS format provides data compatibility between the PC and Model 2000. (As part of this review we converted IBM PC-DOS "BAT" files and dBase II command and data files to the Model 2000 and utilized the files and commands with the Model 2000 version of dBase II). This level of compatibility enables current PC users to consider a transfer to a Model 2000 with little impact on their activities.

### Software Base

To succeed in the professional marketplace obviously requires more than subtle enhancements. It also requires more than technical excellence (witness the comparative lack of success of the Corvus Concept and the Apple Lisa). The most important factor in success in this marketplace is the availability of software that runs on the particular machine and performs the activity that the prospective purchaser perceives as needed (witness the success of the Apple II computer, much of which is attributed to the availability of VisiCalc solely on the Apple for over one year).

(Continued on page 96)

### Specifications

**Product:** Tandy TRS-80 Model 2000

**Mfr:** Radio Shack  
Tandy Corporation  
1600 One Tandy Center  
Fort Worth, TX 76102

**Dimensions:** 18<sup>3</sup>/<sub>8</sub>"W × 15<sup>1</sup>/<sub>2</sub>"D × 6"H

**Weight:** 25 lb

**Price:** \$2750

**Operating System:** MS-DOS 2.0

**Features:** 80186 CPU, dual half-height  
720K disk drives, 128K RAM,  
RS-232 Centronics, display  
adapter.

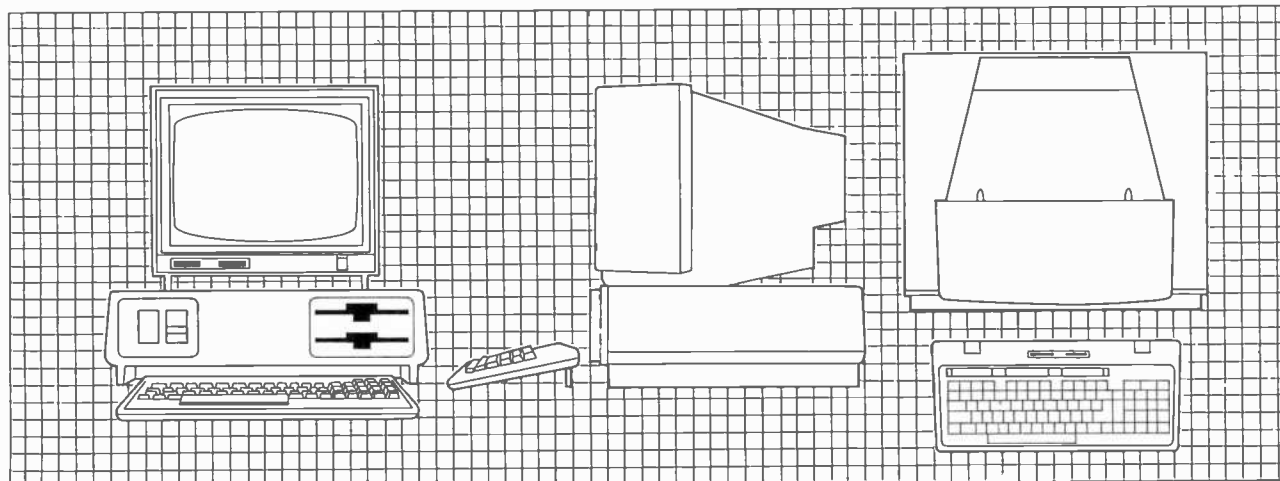

Go on line in the world's fastest growing technology.

# NEW! DATA COMMUNICATIONS TRAINING FROM NRI

**Practical training includes computer, modem, test instruments, and access to exclusive NRI communications network**

Satellites . . . microwave . . . fiber optics . . . dedicated land lines. Suddenly the world is communicating in a new and different way, via digital data systems. People talking to computers . . . computers to computers . . . information is stored, retrieved, and relayed in nanoseconds. And an entirely new kind of communications is born.

## **Industry, opportunities to triple**

Data and telecommunications is already a \$150 billion industry and is expected to triple over the next five years. One typical company has grown from \$85 million to \$650 million . . . a 765% growth since 1978 alone. The need for qualified technicians to install, maintain, and service this enormous investment in high-tech equipment is tremendous even now. Opportunities and salaries can go nowhere but up and up.

Training includes the following equipment you keep . . . 16K computer, modem, breakout box, digital multimeter and the exclusive NRI Discovery Lab.

## **NRI will train you at home**

You can learn at home in your spare time to become a data communications technician with NRI at-home training. NRI will start you with the basics, build upon your knowledge with easy-to-follow, bite size lessons to take you into the world of digital data communications. You'll learn what it takes to work on satellite, microwave, fiber optic, and telephone data links.

And you'll learn at your own comfortable pace, without classroom pressures or evenings away from your family.

Over the past 70 years, NRI has taught the latest high-tech skills to almost 2 million

students to become the world's largest and most successful school of its kind.

**Hands-on training includes computer, modem, breakout box and much more**

NRI takes you beyond 'book learning.' As part of your course, you receive plenty of practical





Tie into the NRI network using computer, software, and modem you get as part of your training.

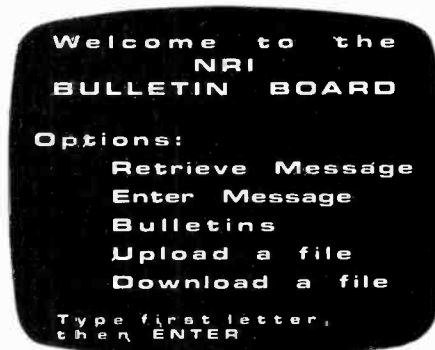

### Move into the future, send for Free Catalog

You can't find training like this anywhere else. . . only NRI trains you at home for an exciting and rewarding career in the brilliant new world of Data Communications. Mail the postage-paid card right now for our big catalog of high-tech electronic careers showing all the equipment you get, detailed lesson descriptions, and career opportunities. Look it over and decide where you want your future to grow. Act now. There's a real need for trained data communications technicians.

## **NRI** SCHOOLS

### McGraw-Hill Continuing Education Center

3939 Wisconsin Avenue, N.W.  
Washington, D.C. 20016

We'll give you tomorrow.



TRS-80 is a trademark of the Radio Shack division of Tandy Corp. SM a service mark of Source Telecomputing Corp., a subsidiary of the Reader's Digest Association, Inc.



You receive a professional digital multimeter and the NRI Discovery Lab, where you construct solid-state circuits and demonstrate practical applications of the theory you've learned.

### Learn on-line with the exclusive NRI data network

You'll learn what data communications is all about by actually becoming part of an operating network. Using your computer, modem, and terminal software, you'll go on line to "talk" to your instructor, take your final exam by computer link, communicate with other NRI students and leave messages on the NRI "bulletin board."

You'll also receive a valuable offer for membership in THE SOURCE<sup>SM</sup> telecommunications network. A phone call ties you in for reviews of computer equipment, lets you interact with others via electronic mail, tap computer-oriented employment services and much more.

hands-on training that gives you real-world skills. You get the Radio Shack Color Computer, with 16K memory to teach you the systems and language of data communications. And you get an operating modem to let you tie in with world-wide communications networks.

You build your own RS-232C interface breakout box, an indispensable installation and troubleshooting instrument you'll use throughout your career.

# IBM'S TRANSPORTABLE

*The Portable PC  
is luggable—and oh  
so compatible*

**BY WILLIAM BARDEN JR.**

**T**he new IBM PC Portable is a well-designed, reliable piece of hardware that will do a good job of running existing PC software. However, even in Southern California, the earth didn't move for me as I put it through its paces and pulled it apart.

In this review we'll concentrate on two questions: How does the PC Portable compare with the standard PC and would it be wise to buy one in lieu of the full-size PC? How does the PC portable stack up against competitive portables, presumably the very same products that spawned the development of the PC Portable to begin with?

## **The Basic Machine**

Take an IBM XT motherboard with a larger capacity power supply, throw in one or two half-height disk drives, add an amber monitor, package it in a case about the same size and weight as a Compaq portable, and you've got the new IBM PC Portable. It runs PC-DOS 2.1 and in essence is a shrunken down PC. (Or a new design of a Compaq, whichever you prefer.)

The PC Portable is packaged as a single unit. Buttoned up, the unit measures 20" × 17" × 8" and weighs about 30 lb. The weight may not seem like much, but it's considerable. I thought carrying the unit over to a friend's house two blocks away would be a good test—a distance comparable to the walk in many airports from parking lot to loading gate. Although I'm in pretty good shape, I stopped twice to switch hands. The unit comes with a canvas carrying bag which would make the transportable task a little easier, unless you've got a bad back. The point here is that although the unit is *transportable*, you certainly wouldn't want to spend more than about 10 minutes per day carrying it around.

When you arrive at your destination and are ready to run, the front of the cabinet swings down from the top, revealing the keyboard, which stays attached to the main unit. However, you can easily disengage the spring-loaded knobs that

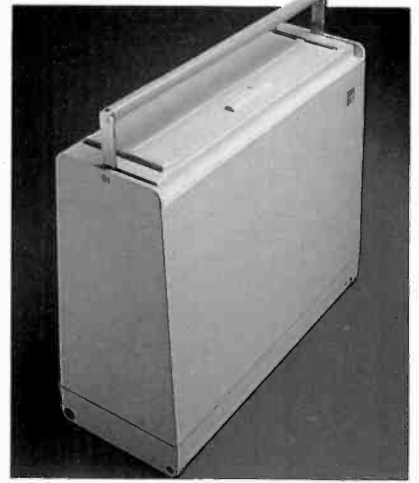

**Three views showing the compactness of the PC Portable.**

hold the keyboard to the main unit. The keyboard then can be moved a maximum distance of about 4' away from the main unit.

The keyboard is attached to the main unit by a modular 4-conductor telephone jack. (I was tempted to try plugging the keyboard into my PCjr, which also uses a telephone jack, but caution and thoughts of blown chips prevailed.) The cable connecting the keyboard is a coiled cable similar to the one on the Compaq portable. Unlike the Compaq cable, however, the cable on the PC Portable is stowed in a 6" × 3/4" cutout on the upper left of the keyboard case. Workable, but not elegant.

The rear of the case has an accordian-like plastic panel that exposes the expansion card slots, power switch, and connectors. Another non-elegant point is that the power cord does not have a dedicated space for storage, unless you carefully fold it up and fold down the plastic accordian cover over it, or put it in the fabric carrying case.

## **The PC Portable Vs. the PC**

When I went to my friendly neighborhood authorized IBM dealer I found that he had several PC Portables in stock. "People had them on order and then decided to buy the full-sized PC," he said. After researching the Portable I believe him, and I'll tell you why.

*The Amber Screen.* The first thing you notice about the PC Portable is the amber screen. It's a 9-inch monochrome monitor that has a crisp appearance and appears to be easy on the eyes. But why amber? Rumor has it (and I'll bet even middle-level IBM managers wouldn't give you a definitive answer on this) is that IBM evaluated several different CRT tubes for ruggedness and the one that came out the best was only available in amber! Is amber easier on the eyes than the traditional green-screen monochrome monitor? Amber is used a great deal in Europe and some claim that its use does result in less eyestrain. There have been no objective tests made on this subject to my knowledge, and I'd have to



believe that this is more personal preference than anything else. Neither I nor any of the four or five other people that used this system seemed to feel that the amber screen was a detriment. However, no one felt that it was an improvement over the green screen, either.

A more significant point is that the 9" monitor is almost one-half the size (in area) of even a 12" monitor. There's no question in my mind that the smaller size will contribute to eyestrain over long periods of time. Another negative aspect is that the screen is much lower than eye level and somewhat difficult to see when the keyboard is attached to the main unit. I'd think that you'd want to disengage the keyboard and mount the main unit about 10" higher than normal for comfortable viewing.

**The Keyboard.** The PC Portable's active keyboard area is the same width and height as the IBM PC— $15 \frac{3}{4}'' \times 3 \frac{3}{4}''$ . The key layout is identical to the PC; the key feel is very similar to the feel of the PC; the keys "click" the same way as the PC; the key travel appears to be the same; and the pressure required to actuate the key is about the same. And like the PC keyboard unit, it has rear supports that allow you to adjust the slope of the keyboard for comfortable use. In short, the Portable keyboard is apparently the same one used for the PC.

**The Disk Drives.** The PC Portable has one or two half-height disk drives. Many people have used these in the PC without any reliability problems and at this point it's safe to say that the half-height drives don't degrade the system in the slightest. One nit-picking comment (and I must preface it by saying that computer users are really getting jaded to complain about such things) is that IBM could have chosen drives that were quieter than the ones in the PC Portable. But then again, maybe you like the audio

feedback signalling disk activity. With the requirement of PC-DOS 2.1, the drives are formatted for 360K bytes.

**Graphics.** Unlike the bare bones PC, the PC Portable comes with a Color Graphics card. This means that graphics are possible on the Portable, although they will be in amber and black. The Color Graphics card has an output that can be connected to an external RGB monitor to provide full color. By making the Color Graphics card a standard fea-



Side view of the PC Portable.

ture in the system, IBM has dulled the competitive edge from claims of other portable PC compatibles that they can utilize both text and graphics on the same screen, but more on that later.

**Inside the Portable.** The Portable uses an 8088 microprocessor, the same one, of course, used by the PC and many PC compatibles. Internal RAM storage is 256K bytes, four times as much as the minimum (but not very usable) memory storage of the PC. The Portable, like the PC, will support additional RAM up to 512K with the addition of an expansion unit. An 8087 Math Co-Processor can be added directly to the board, as in the PC.

Because the motherboard is an XT version, one or two hard disk drives can be added to the basic system for 10 or 20 megabytes of additional storage. Howev-

er, the hard disk drives are not available from IBM at the time of this writing, although they presumably are available from other manufacturers. (Rumors persist about a half-height, 20-megabyte hard disk drive being developed by IBM, which would be a powerful addition to the PC Portable.)

**Expansion Capability.** Probably the most severe shortcoming of the PC Portable is the number and types of expansion slots available. The PC XT comes with 8 full-sized expansion slots. One of these slots is not available in the Portable. One of the remaining seven slots is dedicated to the disk drive controller, and another is used for the standard Color Graphics card. That leaves 5 slots. In order to fit in the CRT and disk drives, however, it was necessary to limit the remaining slots to one full size and four "short" slots. Two of the short slots fit 5" long cards and two fit  $4 \frac{3}{4}''$  long cards. This means that you will have to be somewhat selective about the types of cards you're installing. You cannot, for example, install both an internal modem card and a hard drive controller card (from an alternate supplier), as they

(Continued on page 99)

#### Specifications

**Product:** IBM PC Portable

**Mfr:** IBM Corp.

Systems Products Div.

Entry Systems

PO Box 1328

Boca Raton

FL 33432

**Dimensions:** 20"L × 17"W × 8"H

**Weight:** 30 lb

**Price:** \$2795

**Operating System:** PC-DOS 2.1

**Features:** 8088 CPU, one 360K half-height disk drive, 9" amber monitor, 256K RAM.

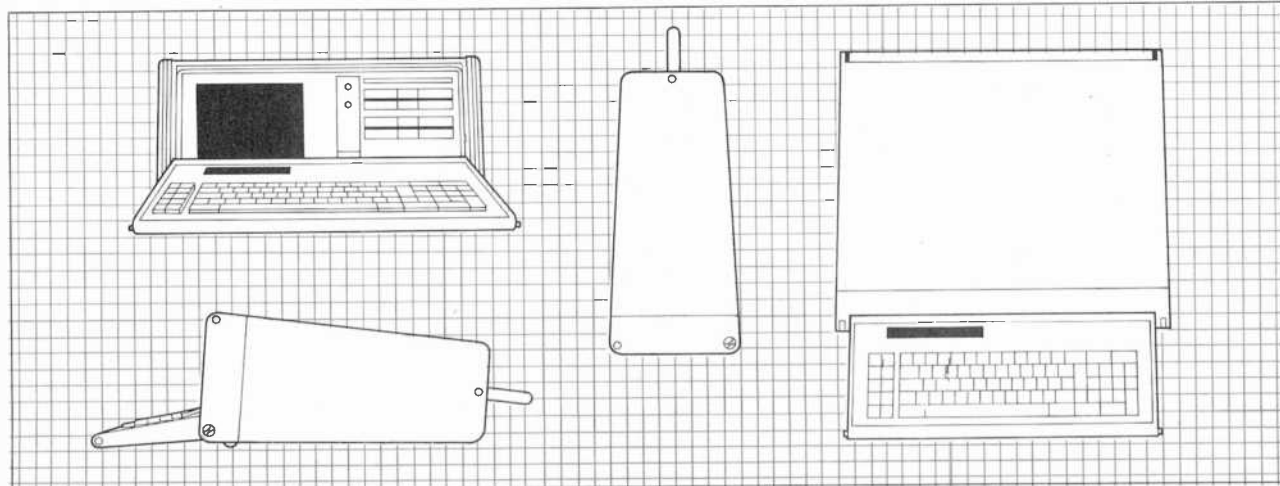

# MITSUBISHI VIDEO PRINTER

*An inexpensive way to get hard copy from your screen*

BY FRED BLECHMAN

**H**OW many times have you wished you had a hard copy of the graphics of the game on your computer screen? Generally, unless you take a photograph of the display, you're out of luck! Most printers do not have the capability to reproduce screen graphics or require special programming to do so. And while special equipment can be obtained to "dump the screen" to some printers in color, this usually involves considerable time and expense.

But there is a possible solution. The Mitsubishi P50U Video Printer provides a 16-level monochrome high-resolution screen dump from any standard video source—television, video camera or computer—in 15 seconds, with as many additional copies as you want.

Actually, this product was not intended specifically for the computer market. Originally it was designed to allow people to capture images of their favorite TV shows, sporting events, TV-offer addresses and phone numbers, foreign language and cooking lessons, stock market quotations, weather maps, teletext and so forth. They could also get prints directly from their video recorders and cameras. Connecting to a personal computer is only mentioned incidentally by Mitsubishi.

When the product was launched in Japan it did poorly at first. However, component video has become very popular in Japan and video outputs are available on many Japanese television sets. It also became apparent that people enjoyed taking video prints of their favorite TV shows or characters, increasing the popularity of the video printer.

Other uses, such as capturing real-time video in security and industrial applications, have also been found. The unit is now being offered in the United States through Mitsubishi Electric Sales America to the industrial and OEM (original equipment manufacturers) market, as well as through local Mitsubishi dealers to regular consumers.

## Specifications

The P50U Video Printer is 8 $\frac{3}{8}$ " wide,

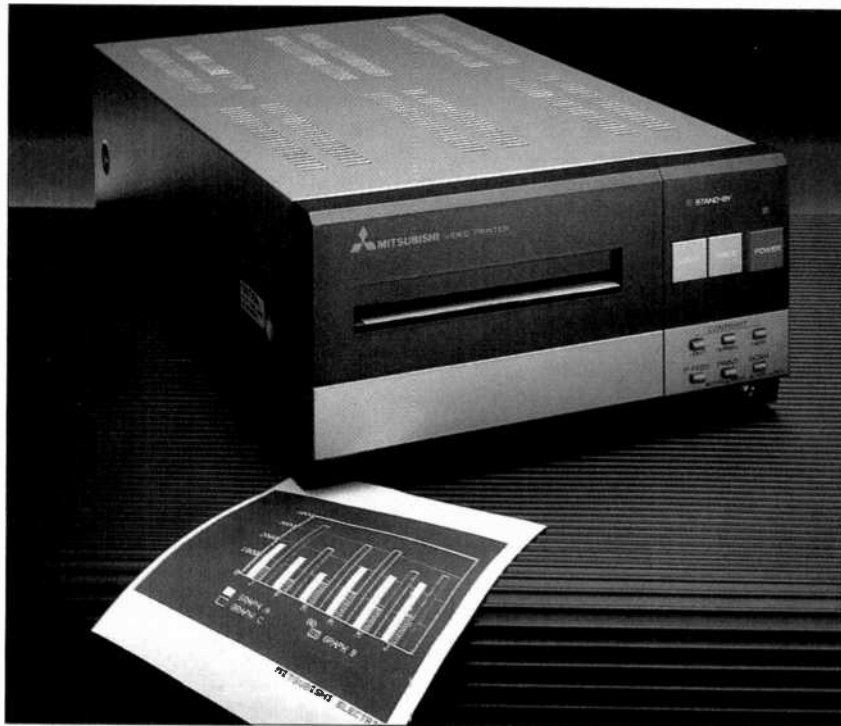

14 $\frac{3}{16}$ " deep, 4 $\frac{7}{16}$ " high and weighs almost 12 pounds. It uses standard 117-volt, 60-Hz power and consumes about 65 watts. The printer uses special white thermal paper on 4 $\frac{5}{16}$ " wide by 82 $\frac{1}{2}$ " long rolls yielding 220 prints per roll with normal print spacing. Since the paper sells for \$18 for 4 rolls, that turns out to be about 2 cents a print. Each screen print is 4" wide and 3 $\frac{3}{16}$ " high with a resolution of 280 × 234 dots, with 16 tones ranging from black to white.

While the nine pushbuttons and two indicators make this unit appear complicated, it is actually extremely easy to operate.

## The Computer Connection

The Video Printer can only be used with a video signal—monochrome or NTSC composite video. Technically, this must be negative sync, 1 volt peak-to-peak, with a 75-ohm impedance. Since these are the common standards, this should pose no problem. However, if

## Specifications

**Product:** P50U Video Printer

**Mfr:** Mitsubishi Electric Sales

America, Inc.

110 New England Ave.

West Piscataway

NJ 08854

**Dimensions:** 8 $\frac{3}{8}$ "W × 14 $\frac{3}{16}$ "D × 4 $\frac{7}{16}$ "H

**Weight:** 12 lb

**Price:** \$390

**Features:** 16-level monochrome high-resolution screen dump; 15-second print.

you don't have a "monitor" or "video out" connection (usually using an RCA phonojack) on your computer, you will need to add one to use the printer. Most of the newer home computers, such as the Timex 2068, Coleco Adam, Sanyo MBC 550, IBM PCjr, and TI-99/4A have a video/monitor output jack. Among the exceptions are the Radio Shack computers, which either have built-in monitors or use "TV" outputs that connect to a TV antenna. Some Radio Shack computers, such as the TRS-80 Color Computers, have video adapters available from independent vendors.

A 6 shielded cable, with RCA phono plugs on each end, is supplied with the video printer. You merely run this cable from your computer video jack to the printer video input jack, and then use your regular video cable from the printer video output jack to the monitor video input. While this may appear to be a series connection, the printer and the monitor are operating in parallel. The monitor picture is not affected; nor is a regular printer attached to your computer.

## Using the Printer

Using the video printer is simple and straightforward. You simply plug the printer into an ac power outlet and connect the video cables to the computer and monitor. Loading the paper roll is quick and easy, although the otherwise-excellent documentation fails to caution you that the paper must be emulsion-side down. (If it's upside down, you'll find out when you try to print because it

# COMMODORE 64

(more power than Apple II at half the price)

## \$99.50\*

- 170K DISK DRIVE \$159.00 \*
- TRACTION FRICTION PRINTER \$79.00 \*

# COMPUTER AND SOFTWARE SALE

WE  
HAVE  
THE  
BEST  
SERVICE

WE  
HAVE  
THE  
LOWEST  
PRICES

# VIC-20

(a real computer at the price of a toy)

## \$79.50

- COM-64 POWER FOR VIC-20 \$79.00
- NEW VOICE SYNTHESIZER \$59.00 (Com-64 or VIC-20)

### \* COMMODORE 64 COMPUTER \$99.50

You pay only \$199.50 when you order the powerful 84K COMMODORE 64 COMPUTER! LESS the value of the SPECIAL SOFTWARE COUPON we pack with your computer that allows you to SAVE OVER \$100 off software sale prices!! With only \$100 of savings applied, your net computer cost is \$99.50!!

### \* 170K DISK DRIVE \$159.00

You pay only \$259.00 when you order the 170K Disk Drive! LESS the value of the SPECIAL SOFTWARE COUPON we pack with your disk drive that allows you to SAVE OVER \$100 off software sale prices!! With only \$100 of savings applied, your net disk drive cost is \$159.00.

### \* TRACTION FRICTION PRINTER \$79.00

You pay only \$179.00 when you order the Starstar T/F deluxe line printer that prints 8 1/2 x 11 full size, single sheet, roll or fan fold paper, labels etc. 40, 66, 80, 132 columns. Impact dot matrix, bi-directional, 80 CPS. LESS the value of the SPECIAL SOFTWARE COUPON we pack with your printer that allows you to SAVE OVER \$100 off software sale prices!! With only \$100 of savings applied your net printer cost is only \$79.00.

### 4 COLOR PRINTER/PLOTTER \$99.00

Lowest cost, 4 color, 80 column, letter quality PRINTER/PLOTTER for Com-64 or VIC-20 computers!! List programs, High resolution graphics for charts and geometric figures. INCLUDES INTERFACE AND SPECIAL SOFTWARE SAVINGS COUPON!!

### 80 COLUMN BOARD \$99.00

Now you program 80 COLUMNS on the screen at one time! Converts your Commodore 64 to 80 COLUMNS when you plug in the 80 COLUMN EXPANSION BOARD!! PLUS—you can get an 80 COLUMN BOARD WORD PROCESSOR with mail merge, terminal emulator, ELECTRONIC SPREAD SHEET. List \$59.00 SALE \$24.95 If purchased with 80 COLUMN BOARD!! (Tape or Disk)

### 80 COLUMNS IN COLOR EXECUTIVE WORD PROCESSOR \$69.00

This EXECUTIVE WORD PROCESSOR is the finest available for the COMMODORE 64 computer! The ULTIMATE for PROFESSIONAL Word-processing application! DISPLAYS 40 OR 80 COLUMNS IN COLOR or Black and White! Simple to operate, powerful text editing with a 250 WORD DICTIONARY, complete cursor and insert/delete key controls line and paragraph insertion, automatic deletion, centering, margin settings and output to all printers! Includes a powerful mail merge. 20,000 WORD DICTIONARY - List \$24.95 SALE \$19.95. EXECUTIVE DATA BASE - List \$69.00 SALE \$49.00. (Disk)

### SPECIAL SOFTWARE COUPON

We pack a SPECIAL SOFTWARE COUPON with every COMMODORE 64 COMPUTER-DISK DRIVE-PRINTER-MONITOR we sell! This coupon allows you to SAVE OVER \$100 OFF SALE PRICES! Up to \$500 savings are possible!!

### PROFESSIONAL SOFTWARE COMMODORE 64

Name	List	Sale	Coupon
Executive Word Processor	\$99.00	\$69.30	\$59.00
Executive Data Base	\$69.00	\$59.30	\$39.00
20,000 Word Dictionary	\$24.95	\$19.35	\$14.95
Electronic Spreadsheet	\$59.95	\$49.30	\$39.00
Accounting Pack	\$49.00	\$39.30	\$29.00
Total 5.2			
Word Processor			
Tape	\$69.00	\$49.30	\$34.00
Disk	\$79.95	\$59.30	\$39.00
Total Text 2.6			
Word Processor			
Tape	\$44.95	\$34.35	\$22.00
Disk	\$49.00	\$39.30	\$27.00
Total Label 2.6			
Tape	\$24.95	\$18.30	\$12.00
Disk	\$29.95	\$23.30	\$15.00
Programmers Helper (Disk)	\$59.00	\$39.35	\$29.95
80 Column Screen (Disk)	\$59.95	\$39.35	\$29.95
Crush-Crumble-Chomp (Tape/Disk)	\$29.95	\$24.35	\$19.95
Pitstop (Cartridge)	\$39.95	\$29.35	\$24.95
Typing Teache (Tape/Disk)	\$29.95	\$24.35	\$15.00
Sprite Designer (Disk)	\$16.95	\$14.35	\$10.00
Fireball Joy Stick	\$24.95	\$15.35	\$10.00
Light Pen	\$39.95	\$16.35	\$14.95
Dust Cover	\$ 8.95	\$ 6.35	\$ 4.60

(See 100 coupon items in our catalog!)

Write or call for

Sample SPECIAL SOFTWARE COUPON!

### EXECUTIVE QUALITY PROFESSIONAL BUSINESS SOFTWARE

The Cadillac of business programs for Commodore 64 Computers

Item	List	*SALE	Coupon
Inventory Management	\$99.00	\$59.00	\$49.00
Accounts Receivable	\$99.00	\$59.00	\$49.00
Accounts Payable	\$99.00	\$59.00	\$49.00
Payroll	\$99.00	\$59.00	\$49.00
General Ledger	\$99.00	\$59.00	\$49.00

### VIC-20 COMPUTER \$79.50

This 25K VIC-20 computer includes a full size 66 key typewriter keyboard color and graphics keys, upper/lower case, full screen editor, 16K level II microsoft basic, sound and music, real time floating point decimal, self teaching book, connects to any T.V. or monitor!

### COM-64 POWER FOR VIC-20 \$79.00

Just plug in our 32K RAM MEMORY EXPANDER and you get as much usable programming power as the Commodore-64 computer!! Master control switches on cover, Gold Edge connectors, five year warranty (FREE \$29.95; CARTRIDGE GAME)

### NEW VOICE SYNTHESIZER \$59.00

For Com-64 or VIC-20 computers. Just plug it in and you can program words and sentences, adjust volume and pitch, make talking adventure games, sound action games and customized talkies!! FOR ONLY \$19.95 you can add TEXT TO SPEECH, just type a word and hear your computer talk—ADD SOUND TO "ZORK," SCOTT ADAMS AND AARDVARK ADVENTURE GAMES!! (Disk or tape).

### 16K RAM CARTRIDGE \$49.00

Increases VIC-20 programming power 4 times. Expands total memory to 41K (41,000 bytes). Memory block switches are an outside cover! CARDCO Includes FREE \$29.95 game!!

### 8K RAM CARTRIDGE \$34.95

Increases VIC-20 programming power 2 1/2 times. Expands total memory to 33K (33,000 bytes). Includes FREE \$16.95 game.

### 3 SLOT SWITCHABLE EXPANDER \$24.95

Allows you to add 3 cartridges at one time—switch select to turn slots on or off—PLUS reset button. A must for your VIC-20 computer!!

### 60K MEMORY EXPANDER \$49.00

Six Slot Board — Switch selectable — Reset button — Ribbon cable — CARDCO. A must to get the most out of your VIC-20 Computer!

### 9" GREEN SCREEN MONITOR \$69.00

Excellent quality SANYO, easy to read, 80 columns x 24 lines, Green Phosphorous screen with anti-glare, metal cabinet! Saves your T.V. PLUS \$9.95 for connecting cable. Com-64 or VIC-20.

### 12" GREEN OR AMBER MONITOR \$99.00

Your choice of green or amber screen monitor, top quality, SANYO, 80 columns x 24 lines, easy to read, anti-glare, faster scanning! A must for word processing PLUS \$9.95 for connecting cable. Com-64 or VIC-20.

- LOWEST PRICES • 15 DAY FREE TRIAL • 90 DAY FREE REPLACEMENT WARRANTY
- BEST SERVICE IN U.S.A. • ONE DAY EXPRESS MAIL • OVER 500 PROGRAMS • FREE CATALOGS

Add \$10.00 for shipping, handling and insurance. Illinois residents please add 6% tax. Add \$20.00 for CANADA, PUERTO RICO, HAWAII orders. WE DO NOT EXPORT TO OTHER COUNTRIES.

Enclose Cashiers Check, Money Order or Personal Check. Allow 14 days for delivery, 2 to 7 days for phone orders, 1 day express mail! Canada orders must be in U.S. dollars. VISA — MASTER CARD — C.O.D.

Circle No. 40 on Free Information Card

# PROTECTO ENTERPRISES

(WE LOVE OUR CUSTOMERS)

BOX 550, BARRINGTON, ILLINOIS 60010  
Phone 312/382-5244 to order

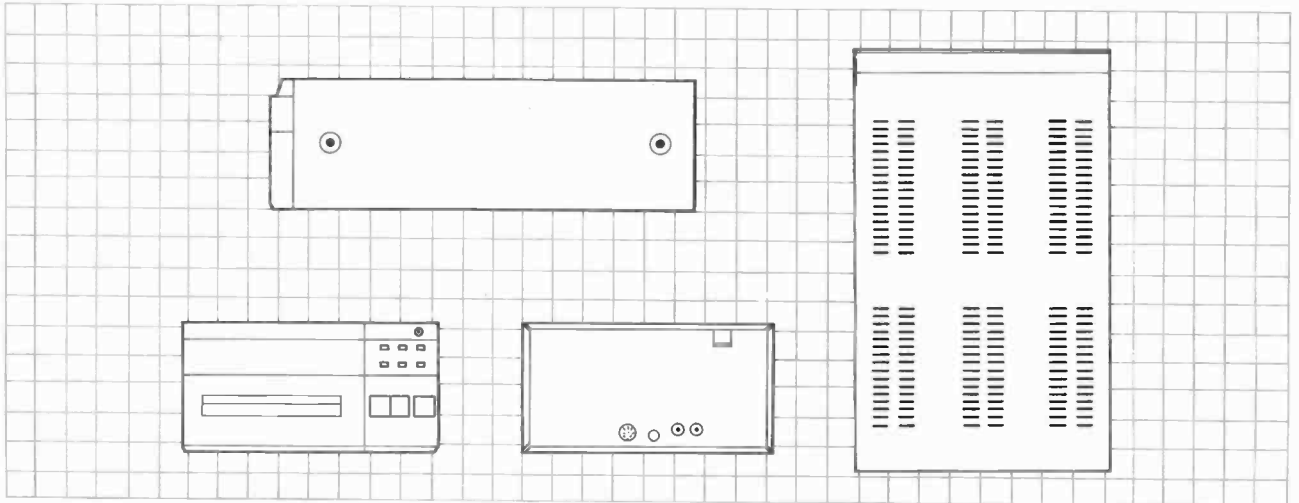

will turn out to be blank.)

When you press the printer's **POWER** button a red LED above it lights as a power-on indicator. With paper properly loaded, a **STANDBY** LED also lights. With the computer on and operating, you just watch the monitor screen until you see something you want printed. Press the large **PRINT** button and the video frame on the monitor at that instant is frozen in the video printer memory, is digitized, and prints as it feeds out the front slot. If you want another copy, just press the large **COPY** button. That's all there is to it.

There are other options that increase the flexibility of the unit. For example, included with the video printer is a remote controller with a 16' cable so that you can command a print from a convenient location. The six small buttons on the lower front panel offer other options. The three **CONTRAST** buttons allow you to have a light, normal or dark print. The **P-FEED** button allows you to advance the paper. The small **PRINT** button has two positions. When it is in the out position, you get a video print that looks like the screen in terms of light and dark. For example, white letters on a black background is the typical display for many terminals. When this button is pushed in, however, the printer reverses the image, giving you, in the example, black letters on a white background. This can increase legibility.

The small **SCAN** button is used to invert the image top to bottom. As the print normally emerges from the printer, the image is printed bottom to top, and is "right-side up." However, if you are printing several frames in sequence, just press in the **SCAN** button and the print comes out inverted, printing from top to bottom, for a continuous sequence of frames.

The back of the unit has two RCA

phono jacks for the video input and output connections, and a rotary control to adjust for different video input levels. I found the video input level control made little difference in the result, but might be important if your input video level is beyond the normal range.

There's also a **TELETEXT INPUT TERMINAL** connector on the back of the unit. Unfortunately, the documentation does not define the pinout or purpose, except that it may be used for a "teletext decoder." It looks like Mitsubishi has plans for this unit to replace a display in teletext operation.

#### Hands-On

I've used the video printer with a Coleco Adam, a Timex 2068 and a Sanyo MBC 550. I've also used it with a video recorder. The results in all cases were excellent for graphics, good for pic-

tures, but limited for text exceeding 32 characters per line. The 80-character line of the Sanyo was not usable. The black areas are solid (not individual lines, as you might expect) and the overall print quality is satisfactory for print reproduction, though not as good as a clear black-and-white photo. Of course, a color photo or slide is much superior, but it costs more and is inconvenient.

If you are doing any programming, documentation, articles or books, the video printer could be extremely useful, as I've found it to be, especially for reproducing high-resolution graphics. It is not intended to replace your regular letter-quality or dot-matrix computer printer. You might find additional use with your TV (if it has a video output), VCR or video camera for entertainment or industrial use. It's a very versatile, easy-to-use, effective tool. ♦



# SOFTWARE REVIEWS

## CUT AND PASTE

*An easy-to-use word processor for the Apple II family*

BY MARK ANDREWS

EVER since computers began moving from the office into the home, software publishers have been seeking the perfect word processing program for personal computer owners. The ideal program would emulate most of the important functions of an office word processor, but it would not be much more difficult to master than an ordinary portable typewriter.

No one has succeeded yet, and it is not likely that anyone will. No matter how cleverly a word processing program may be designed, there will always be a tradeoff between how much it can do and how easy it is to use. It's a simple law of program design. The more features a program has, the more difficult it is to master.

The people who designed "Cut and Paste," a new word processing program published by Electronic Arts, understand this law very well. They admit that C&P is not a word processor for secretaries, office managers, or people who process words for a living. It lacks many features that experienced computer users have come to take for granted in word processing programs. But what it does, it does very well. It claims to be "the first sensible word processor for the home." And it succeeds admirably in fulfilling that aim.

Cut and Paste may well be the easiest-to-learn, easiest-to-use word processing program on the market. The software firm claims "an elderly lady" once mastered a prototype version of C&P in half an hour. And that is not difficult to believe. This reviewer had Cut & Paste up and running in less than 10 minutes, without even bothering to look at the program's instruction manual. And configuring C&P to work with a specific computer-printer combination—in this case, an Apple IIe and an Epson MX-80 printer—was extremely easy. It usually takes several hours to get a word processing program to operate properly on these two pieces of equipment. With Cut

& Paste, all it took was one trial printing run—using just one sheet of paper—and minor adjustments of a couple of margins. And that was that. In *less than one minute*, the C&P program was printing perfect copy. It can also be used, of course, with many other kinds of printers.

Cut & Paste is a disk-based program with a suggested retail price of \$50. It is available in versions that can be run on Atari computers, the Commodore 64, and the Apple IIe.

The Apple version is designed specifically for the Apple IIe. If the IIe has an 80-column card installed, C&P will automatically generate an 80-column video display.

Cut & Paste comes in a flat foldout package that resembles a miniature record album. Inside the package there are two disks (a program disk and a user disk), an excellent 14-page instruction manual, and a quick-reference keystroke card. The package also includes a comprehensive and easy-to-understand set of onscreen prompts and "help" instructions, but you won't encounter those until you get the C&P program running on your computer screen.

To use Cut & Paste with one disk drive, you boot the program's master disk, then exchange it for a user disk. If

you have two disk drives, you can put your user disk in Drive 2. The user disk can be the one that comes with the program or one that you've created.

Before you can create a user disk, you must format it using the C&P master disk since the program uses nonstandard disk-formatting procedures. And that could be considered a shortcoming of the Cut & Paste program. Because it uses a nonstandard disk format, the user disks that it produces are not compatible with other word processors, or with most database or telecommunication programs.

When you boot the Cut & Paste program, using both the master disk and your user disk, C&P presents a display showing the file names of all the documents stored on your user disk. Below this list of documents, at the bottom of the screen, there is a list of program functions. You can use this command line to load, save, print, delete, or copy a file, configure a printer, or carry out a number of other kinds of operations.

While this all-purpose menu is on your screen, you can use your computer's cursor-movement (arrow) keys to decide what you want to do next. If you want to load a document into your computer's memory so you can edit or print

*(Continued on page 34)*

**Cut & Paste comes in a flat foldout package like a record album.**



PHOTO BY STEVE BORNIS

# If you have put off learning more electronics for any of these reasons, act now!

- I don't have the time.*
- High school was hard for me and electronics sounds like it may be hard to learn.*
- I can't afford any more education.*
- I have a family now.*
- I'm here. You're there. I've never learned that way before. I'm not sure it will work for me.*

**Read the opposite page and see how you can get started today!**

**Be honest with yourself. Are the reasons really excuses? You already know enough about electronics to be interested in reading this magazine. So why not learn more? If you need encouragement, read on and see how excuses can be turned into results.**

**You don't have the time.**

Be realistic. All you have in life is a period of time. Use it. Try to know more tomorrow than you do today. That's the proven way to success.

**Electronics sounds like it may be hard to learn.**

You already know something about electronics or you wouldn't be reading this. Now, build on that. CIE Auto-Programmed® Lessons help you learn. Topics are presented in simple, logical sequence. All text is clear and concise for quick, easy understanding. You learn step by step, at your own pace. No classes to attend. Nobody pressures you. You *can* learn.

**You can't afford any more education.**

Actually, you can't afford NOT to gain the skills that can put you ahead of the others. It makes sense to invest in yourself through education — learning a skill. If you are not able to pay full tuition now, convenient monthly payments can be arranged.

**You have a family now.**

All the more reason why you have the responsibility to advance yourself. For the sake of your family. Do you want them to have what you had or have *more* than you had? The choice is yours. Electronics is a rewarding career choice. CIE can help you to get started on that career.

**You're there. We're here. How does CIE help you learn?**

First, we *want* you to succeed. You may study at home, but you are not alone. When you have a question about a lesson, a postage stamp gets you your answer fast. You may find this even better than having a classroom teacher. CIE understands people need to learn at their own pace. When CIE receives your completed lesson before noon, it will be graded and mailed back to you the same day with appropriate instructional help. Your satisfaction with your progress comes by return mail. That's how CIE helps you learn.

**NOW, IF YOU AGREE CIE TRAINING CAN WORK FOR YOU, HOW ELSE CAN CIE HELP YOU?**

CIE is one of the largest independent home study schools in the world that specializes in electronics. Although "big" does not always mean "best," it is evidence that CIE is a strong, successful institution with the people and resources to help you succeed.

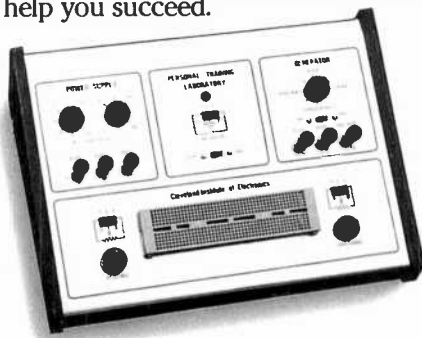

**Step-by-step learning includes "hands-on" training.**

The kind of professional you want to be needs more than theory. That's why some of our courses include the Personal Training Laboratory, which helps you put lesson theory into actual practice. Other courses train you to use tools of the trade such as a 10MHz, solid-state, triggered-sweep oscilloscope. Or a Digital Learning Laboratory to let you apply the digital theory that's essential today for anyone who



wants to keep pace with electronics in the eighties. Or a Microprocessor Training Laboratory you learn to program and interface with displays, memories, switches, and more.

**Your credentials can impress employers.**

One of the best credentials you can have in electronics — or any other career field — is a college degree. That's why CIE gives you the opportunity to earn an Associate in Applied Science in Electronics Engineering Technology. Any CIE career course can offer you credit toward the degree...more than half the number needed in some cases.

You can also prepare for the government-administered FCC (Federal Communications Commission) Radiotelephone License, General Class. It can be a real mark in your favor...government-certified proof of your specific knowledge and skills.

**Find out more! Today. Now.**

There's a card with this ad. Fill it in and return. If some other ambitious person has already removed it, use the coupon.

You'll get a copy of CIE's free school catalog, along with a complete package of personal home study information.

For your convenience, we'll try to arrange for a CIE representative to contact you to answer any questions you may have.

If you are serious about a rewarding career, about learning electronics or building on your present skills, your best bet is to go with the electronics specialists — CIE. Mail the card or coupon today or write CIE (please mention the name and date of this magazine), 1776 East 17th Street, Cleveland, Ohio 44114.

This could be the best decision you've made all year.

PE-15

**CIE** Cleveland Institute of Electronics, Inc.  
1776 East 17th Street, Cleveland, Ohio 44114

Accredited Member National Home Study Council

YES...I want to learn from the specialists in electronics — CIE. Send me my FREE CIE school catalog...including details about the Associate Degree program... plus my FREE package of home study information.

Print Name \_\_\_\_\_

Address \_\_\_\_\_ Apt. \_\_\_\_\_

City \_\_\_\_\_ State \_\_\_\_\_ Zip \_\_\_\_\_

Age \_\_\_\_\_ Area Code/Phone No. \_\_\_\_\_ / \_\_\_\_\_

Check box for G.I. Bill bulletin on Educational Benefits:  Veteran  Active Duty

**MAIL TODAY!**

## Cut and Paste

(Continued from page 29)

it, you can move the cursor over the name of the document and hit the ESCAPE key. The cursor will then move to the command line at the bottom of the screen, and you can use the command line to choose the type of operation you'd like to perform on the selected document.

When you've loaded a document into RAM, the text of the document replaces the lists of file names on your video tube. The command line remains in place at the bottom of the screen, but contains some new commands—including the CUT and PASTE commands that give the program its name.

You can edit the document on the screen by using the arrow keys—along with a few control-key functions—to move the cursor around. The left, right, up, and down arrow keys operate just as you'd expect. Pressing the CONTROL key and the letter B simultaneously will

### It claims to be the first sensible word processor for the home

move you backward through the text by one full screen. In the same fashion, CONTROL-F moves you forward one full screen. CONTROL-S brings you to the start of a document, and CONTROL-E will move you to the end.

To erase a single character using Cut & Paste, you must use the backspace key. There are no commands for deleting words, lines or paragraphs, or for moving the cursor backward or forward a word at a time. But, using the program's Cut & Paste function, blocks of text can be deleted, inserted or moved around with ease.

To delete a block of text from a document—or to cut it—to use the terminology preferred by the program's designers—you position the cursor at the beginning of the block you want to delete, and type CONTROL-A (for anchor). Then, using any of the program's cursor movement keys, position the cursor at the end of the block you want to "cut." As the cursor moves, it will appear to spread out, highlighting the text that you want to delete by displaying it in reverse video. When the block of text to be deleted is highlighted, you cut it out of the document you're working on by typing CONTROL-C. As soon as you do that, the block that you're deleting is lifted from the text display.

The lifted block is not gone perma-

nently, however, but stored in a temporary buffer. You can also put deleted text back into a document by positioning the cursor at the point where you want it inserted and typing CONTROL-P (for "paste"). Then the deleted text is put in its new location.

The new location does not have to be within the same document. Since the special buffer stores the text in such a way that the text remains intact when a new document is loaded into the computer's memory, text can be moved into the buffer, saved there while a new document is loaded, and then loaded into the new document using CONTROL-P. So, the cut-and-paste function can also be used to move text from one document to another.

When you've written or edited a document using Cut & Paste, you can save it using the SAVE command on the command line. And you can print it using the command line's PRINT instruction.

Although Cut & Paste provides a terrific, easy-to-use method for manipulating blocks of text, it has sacrificed flexibility for simplicity. Some formatting functions are unavailable.

For example, you cannot underline text in a Cut & Paste document, nor use subscripts or superscripts, nor print boldface type. There are no variable tab stops; the tab key moves the cursor across the page in fixed five-space increments. The program can be set to print headers (a header is a line of type that is repeated at the top of every page)—but, except for page numbers, no foot-lines are allowed. There are no means for automatically justifying the right-hand margin of a document, nor is it possible to center lines on a page automatically. And, although the program does number pages, it uses a single format—with the page number centered at the bottom.

The Cut & Paste program is not compatible with any spelling checker currently available, nor can it be used with a mail-list program to generate form letters or run off envelopes automatically. And, as mentioned earlier, it cannot currently be used with telecommunications software.

In conclusion, Cut & Paste is easy to learn and a delight to use, and it is certainly inexpensive. But be wary of its limitations. C&P is a great little word processor for writing an occasional letter, memo or term paper. But if your needs are more demanding, it may not be the best word processing program for you.

Cut & Paste is published by Electronic Arts, 2755 Campus Drive, San Mateo, CA 94403. Telephone: 415-571-7171. ◇

## Enter CompuServe's Electronic Mall™ and shop at your convenience in these exciting departments.

The Micro Mart  
The General Store  
The Travel Agent  
The Book Bazaar  
The Record Emporium  
The Photo Booth  
The Software Shop  
The Financial Market  
The Magazine Kiosk  
The Gardening Shed  
The Newsstand

### A sample of the companies participating in CompuServe's Electronic Mall™ includes:

Amdex  
American Airlines  
American Express  
AST Research  
Bank of America  
Bantam  
Big T Automotive  
Buick  
CBS Publishing  
CDEX  
Colonial Penn  
Commodore  
Computer World  
Digital Equipment  
dillithium Press  
800 Software  
47th Street photo  
Grolier  
Harvard Business Review  
Heath  
Heinold Commodities  
Hertz  
E.F. Hutton  
Inmac  
Innovative Software  
Knapp Press  
Magazine Entree  
Magazine Supply House  
Manufacturer's Hanover Trust  
Max Ule  
McGraw-Hill  
Metropolitan Life  
Microsoft  
Miracle Computing  
Misco  
Newsnet  
Novation  
Official Airline Guide  
Pan American Electronics  
Peachtree Software  
Practical Peripherals  
Program Store  
Professional Color Labs  
RCA Record Clubs  
Record World  
Sears  
Select Information Exchange  
Sim Computer Products  
Simon and Schuster  
Small Computer Book Club  
Software Advisor  
Stark Brothers  
Supersoft  
Vanguard  
VisiCorp  
Waldenbooks  
Woman's Day Books  
Ziff-Davis

Merchants and manufacturers who want to participate in the Electronic Mall™ may contact: Stephen A. Swanson, L.M. Berry & Co., P.O. Box 6000, Dayton, OH 45401, (513) 296-2015.



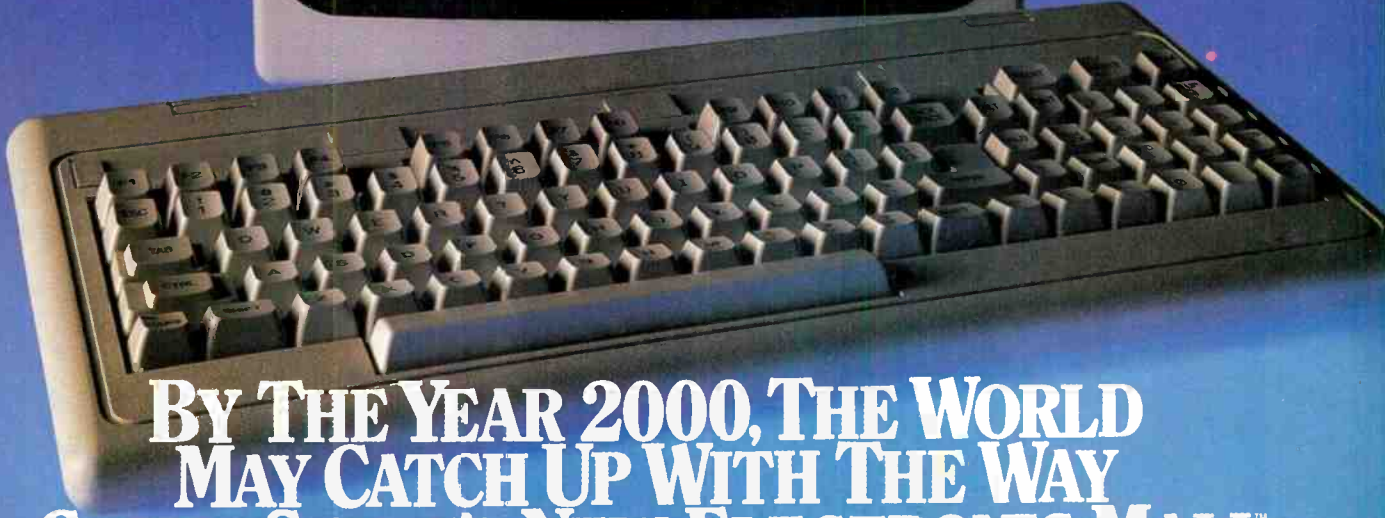

# BY THE YEAR 2000, THE WORLD MAY CATCH UP WITH THE WAY COMPU SERVE'S NEW ELECTRONIC MALL™ LETS YOU SHOP TODAY.

**Introducing the first computer shopping service that brings you convenience, savings and enjoyment.**

Here's your chance to expand the practical uses of your personal computer. Sign up for CompuServe and shop in our new Electronic Mall. It's easy to use. It tells you more about the products you're buying. It lets you order faster. And it's totally unique.

**CompuServe's new Electronic Mall™ offers you all these shopping innovations.**

– It's enormous! So it gives you in-depth information on thousands of goods and services, and lets you buy even hard-to-find merchandise. – Its unique "Feedback" service lets you ask the merchants themselves specific questions. – It's incredibly efficient in ordering the products and services you want.

– Its special discount opportunities make it economical, purchase after purchase. – And its name-brand merchants assure you of top-quality merchandise.

**Make the CompuServe Electronic Mall 15-Minute Comparison Test.**

*What you can do in 15 minutes shopping the Electronic Mall way.*

- Call up on your computer screen full descriptions of the latest in computer printers, for instance.
- Pick one and enter the order command.
- Check complete descriptions of places to stay on your next vacation.
- Pick several and request travel brochures.
- Access a department store catalog and pick out a wine rack, tools, toys... any thing!
- Place your order.

*What you can do in 15 minutes shopping the old way.*

- Round up the family and get in the car.

**The Electronic Mall, a valuable addition to the vast world of CompuServe.**

CompuServe's Consumer Information Service brings you shopping information, entertainment, personal communications and more.

You can access CompuServe with almost any computer and modem, terminal or communicating word processor.

To receive your illustrated guide to CompuServe and learn how to subscribe, call or contact...

## CompuServe

Consumer Information Service  
F.O. Box 20212  
5000 Arlington Centre Blvd.  
Columbus, OH 43220

**800-848-8199**

In Ohio call 614-457-0802

Circle No. 60 on Free Information Card

An H & R Block Company

The Electronic Mall™ is a cooperative venture between CompuServe Inc., and L.M. Berry & Company.

# HP'S New

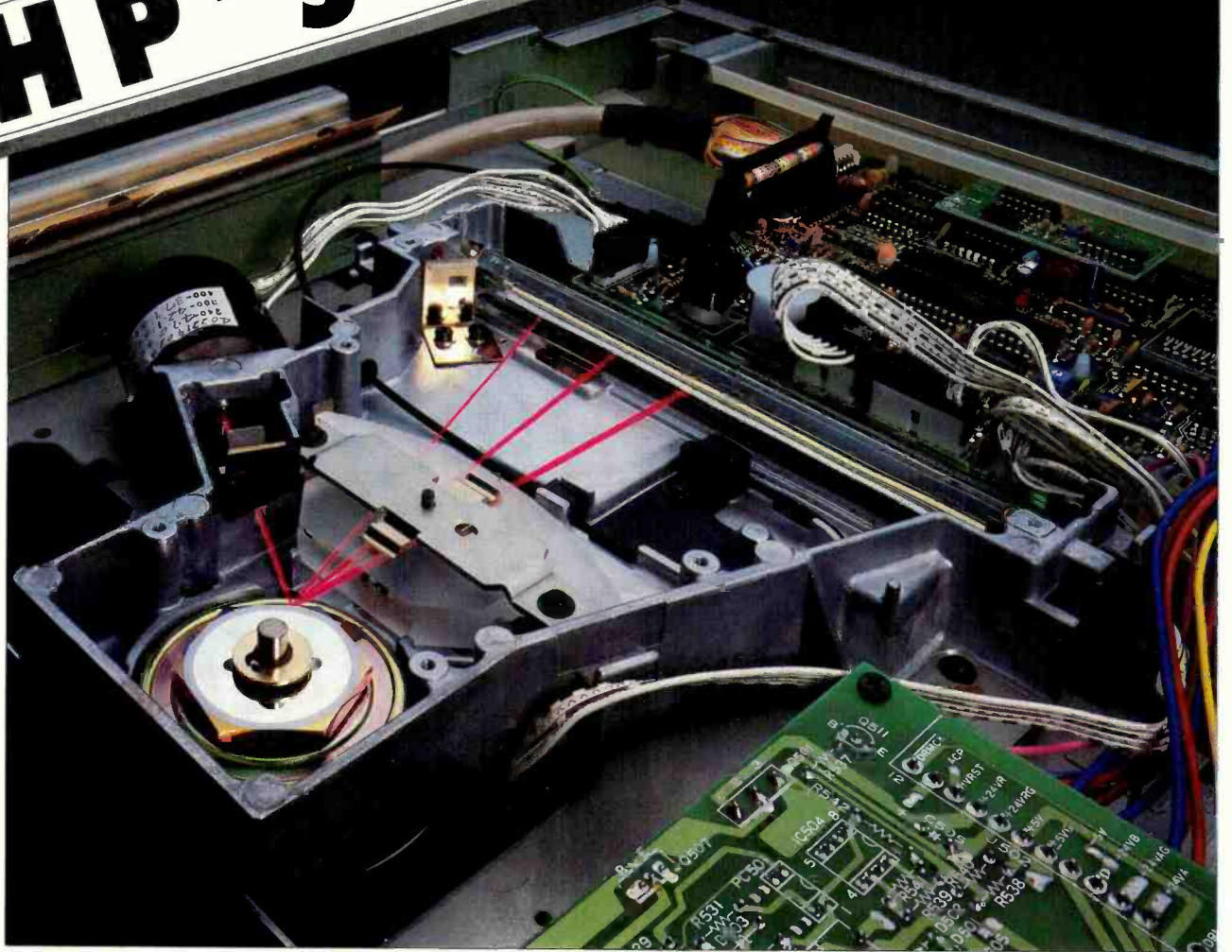

# LaserJet Printer

*Sooner than anyone expected—an affordable laser printer*

**O**NLY a few months ago, COMPUTERS & ELECTRONICS published an article describing how laser printers work. At that time they were affordable only by corporations (or a few rare individuals) with tens of thousands of dollars in their budgets for such an item.

Today you can buy one.

Hewlett-Packard's LaserJet printer costs less than \$3,500, can print an impressive eight pages a minute, and can be connected to any computer with an RS-232 serial port. Before the LaserJet appeared, the least expensive laser printer

## BY JOSEF BERNARD

cost about \$13,000, and prices went up—steeply—from there. How did HP do it?

The answer lies in recent developments in photocopier technology. Last year Canon, a Japanese company noted originally for its fine photographic equipment, and more lately for high quality photocopy machines, introduced a low-priced (\$995) desktop copier, the

*Josef Bernard is a Technical Editor on COMPUTERS & ELECTRONICS.*

PC-10 Plain Paper Copier.

What makes this copier interesting (and affordable) is that what is normally the most delicate and expensive-to-replace component—the drum that receives and applies the image-forming toner to the paper—is a throwaway item. Instead of being coated with the traditional photosensitive selenium, it uses a plastic compound. The drum does not have to be resurfaced or replaced when it is damaged or wears out (which is relatively frequently in the case of traditional designs). Instead it is just discarded and replaced with a new one.

This EP (for ElectroPhotographic) drum-assembly cartridge, shown in Fig. 1, also contains a supply of toner sufficient to last the approximate life of the drum—about 3000 pages. When a new cartridge is inserted, so is a new supply of toner. Cartridge replacement is inexpensive, fast, and clean.

This revolutionary technology is also



**Fig. 1. EP drum-assembly cartridge.**

the basis for the LaserJet printer.

**How It Works**

The LaserJet (also designated HP 2686A) printer is designed around Canon's LBP-CX laser "print engine." The print engine is essentially a photocopier with the latent image on the drum being formed directly by a laser rather than by light reflected from a document.

In its bare-bones form, the LBP-CX print engine is designed to reproduce raster-scanned video images. What Hewlett-Packard has done is to add interfacing electronics to permit serial connection to a computer, and character-generation circuitry much like that



**The LaserJet is the size of a standard desktop copier.**

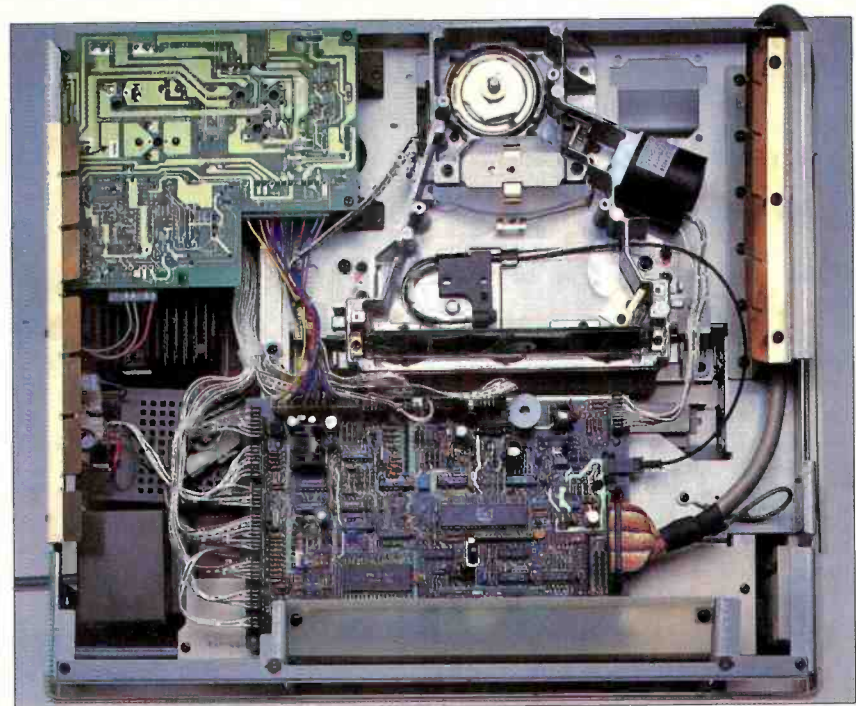

**Internal view shows the scanning mirror and laser at top.**

**Fig. 2. Principal sections of the LaserJet system.**

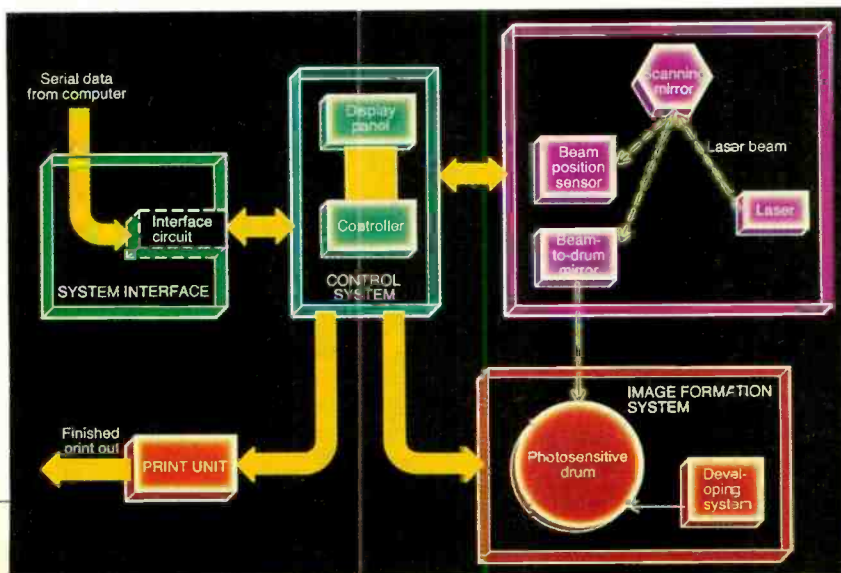

which produces the display on the screen of a computer's CRT or terminal.

As illustrated in Fig. 2, data is transmitted from the computer's serial port at rates up to 9600 baud to the input of the LaserJet. There it is fed to a character-generator ROM that contains dot-patterns for 182 characters, including the USASCII character set and letters used in various European alphabets. Plug-in ROM cartridges are available for other type fonts, and can provide proportional spacing, italics, and boldface printing.

The dot patterns are converted into electrical pulses that modulate a semiconductor infrared laser. (This is another reason the LaserJet carries such a low price tag. Traditional laser printers have used expensive helium laser tubes.)

Because of the speed and precision re-

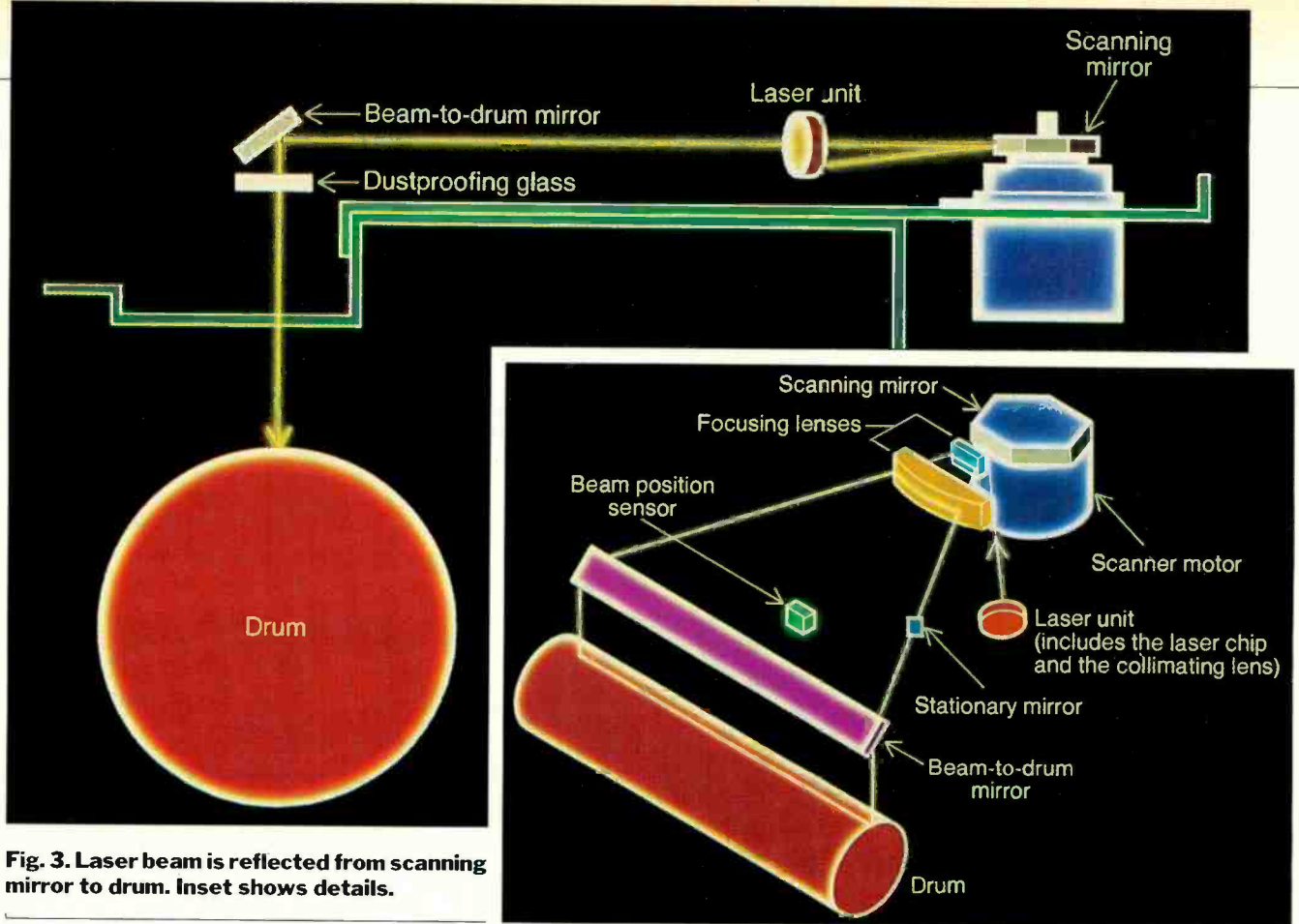

**Fig. 3. Laser beam is reflected from scanning mirror to drum. Inset shows details.**

quired, it is not feasible to have the laser scan the image-forming drum mechanically. Instead, as shown in Fig. 3, the laser light is beamed onto a six-faceted precision mirror spinning at the rate of 5600 revolutions per minute ( $93\frac{1}{3}$  revolutions per second) and reflected across the surface of the drum. As the drum turns, the image is formed top to bottom. Optical elements focus the light from

the laser into a spot measuring just 90 by 100 microns (a micron is a millionth of a meter, or 0.00003937 inches). This is obviously much smaller than required for the LaserJet's claimed 300 dots-per-inch resolution. The discrepancy lies in the fact that the laser "dots" are overlapped to create the impression of continuous lines (see the sidebar on the opposite page).

The plastic surface of the drum has a high positive electrical charge. Where it is struck by the light from the laser, that charge is dissipated, making those areas negative with respect to the rest of the drum. The toner material is also positively charged. It adheres to the negatively charged areas produced by the laser, but not to the positively charged ones. Thus the toner reproduces the image written by the laser beam. When the toner is fused to a sheet of paper or other material, hard copy results.

**Fig. 4. Screen dump produced by LaserJet from HP-150 computer.**

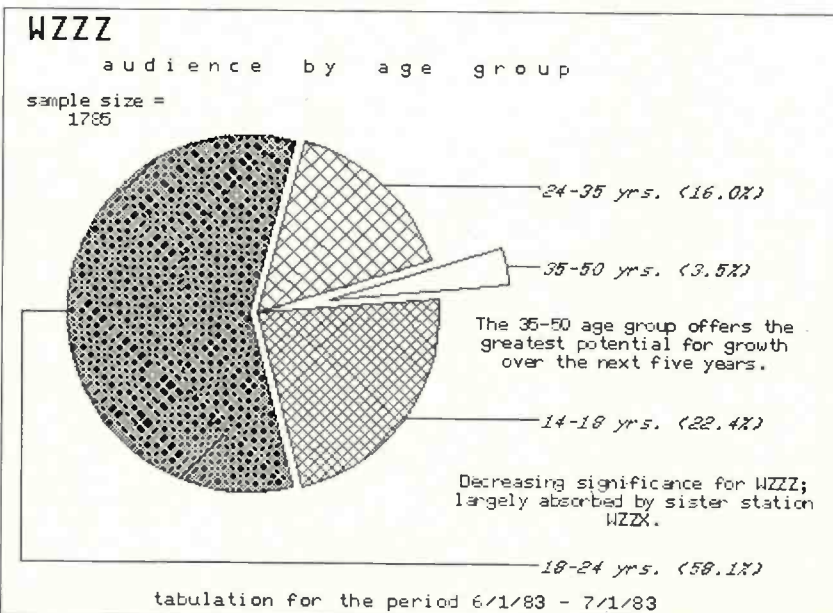

#### Features and Performance

The LaserJet, which weighs 71 pounds, measures 18.5 x 11.4" and is about the size of a desktop copier. It is extremely quiet in operation—so quiet that it's almost impossible to tell when it's actually printing.

There are very few adjustments that have to be made by the user. Probably the most complex is the print-density dial, which allows control of the lightness or heaviness of the characters printed.

An interesting feature is an indicator in the EP cartridge (visible through a window of the right side of the printer) that indicates approximately how many prints have been made. As it changes color from green to yellow to red, it signifies a decrease in toner level. When it is fully red, the cartridge should be replaced.

(Continued on page 87)

# PRINT SPEED AND APPEARANCE

BY JOSEF BERNARD

**T**HE quality of the output you get from a printer depends not only on its price, but also on the technology it uses.

The photographs on this page show enlargements (about 8X magnification) of the output of several types of printers. Figures A and B are both from a Texas Instruments TI 855 dot-matrix impact (as opposed to a thermal or electrosensitive type) printer. Fig. A shows the output in "draft" mode, Fig. B in "correspondence" mode.

Figure C is the output of a high-quality daisywheel printer of the type that might be found in an office environment, in this case a Diablo 1650 using a metal printwheel. Finally, Fig. D is a specimen from Hewlett-Packard's LaserJet printer.

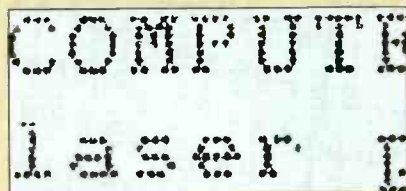

Fig. A

The draft-quality dot-matrix print in Fig. A is obviously crude. You wouldn't put much trust in a lawyer who sent out letters looking like this (although he'd probably be pretty inexpensive to put on retainer). This mode is best suited for drafts of letters or manuscripts, mailing labels, or for program listings where appearance is not an important factor.

One advantage of dot-matrix printers that have a draft mode is speed—they can crank out as many as 160 or more characters per second. Furthermore, printers that can operate *only* in this mode are generally available at quite reasonable prices. If you *have* to have a printer, but are operating on a limited budget, this may be the way for you to go.

Although beauty is in the eye of the beholder, draft-quality output is strictly utilitarian. Some dot-matrix fonts do not even have descenders (the portion of the letter that is printed "below the line," like the letters "j" and "g"). This makes it difficult to distinguish between a "g" and an "s," and prolonged reading of documents printed using such a font can be a strain on both eyes and the brain.

Correspondence-quality dot-matrix output (sometimes called "near-letter-quality" or "NLQ") is a considerable improvement over draft quality. It is



Fig. B

achieved by having the print head make several passes over the same line, with the head position offset by a small fraction of an inch on each pass. This, of course, slows down the throughput of the printer significantly, but the loss in speed is compensated for by the improvement in quality.

The output of some printers using this mode can be difficult to distinguish from that of formed-character printers (like typewriters and daisywheel devices).

The dot-matrix origin of this type of output becomes even less obvious in photocopies. Still, there is a discernable difference between near-letter-quality printing and full formed character printing. While the former may be suitable for personal and some business correspondence, for situations where appearance is important, even the best dot-matrix impact printer may not suffice.

Dot-matrix printers, while they are relatively fast and inexpensive, are also noisy. They screech, buzz, or whine like a mosquito, and can be annoying to have running while you are trying to work nearby. Still, they offer a lot of value for the money, and are the largest selling.

Formed-character printers—those using a daisywheel or thimble, or a Selectric-type "golf ball" print



Fig. C

element—are the elite of computer printers. Their output is indistinguishable from that of a good typewriter.

Although originally quite expensive (\$3000 dollars and up), over the past two years, reasonably priced daisywheel printers have appeared. Several typewriter manufacturers have entered the daisywheel market with under-\$600 units. Although slower in performance

than their more expensive brethren, and lacking some of their versatility, these low-priced daisywheel printers are making a significant impact.

Even Coleco's Adam comes with a daisywheel printer (although its output looks more like it came from a manual portable than from an office typewriter).

There have recently appeared on the market reasonably priced ink-jet printers that work by squirting fine drops of ink onto the surface of a piece of paper. (A printer of this type, the Radio Shack CGP-220, was reviewed in the February 1984 COMPUTERS & ELECTRONICS.)

Low cost ink-jet printers operate at a moderate rate of speed (35-40 characters per second) and are exceptionally quiet. While the quality of their output leaves a lot to be desired, they can produce fairly impressive color graphics.

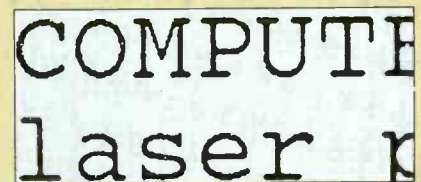

Fig. D

Finally, we come to laser printers. Until now the least expensive one cost in the neighborhood of \$13,000 and you could easily pay three or more times that.

Laser-printer characters are also formed by a matrix of dots—but a very fine matrix. Typically they print at 300 dots per inch. If you examine Fig. D closely, you can just make out the irregularities caused by the overlapping dots.

To the naked eye, laser-printer characters are indistinguishable from those produced by formed-character impact printers. The only significant difference is that, since laser printing technology is largely based on that used for xerography, *nobody* gets an original. Or, to put it another way, everybody gets a copy. Since no print element such as a daisywheel or "golf ball" strikes the paper, there are no "bumps" behind the periods and commas.

Laser printers are fast. HP's LaserJet can print eight pages—single-, or double-spaced, or solid black—a minute, provided the computer can keep up with it. Assuming that a single-spaced page contains 54 lines of 65 characters, that's 3510 characters per page. Since 8 pages/minute works out to one page every 7.5 seconds, that's 468 characters per second. Letter quality! ◇



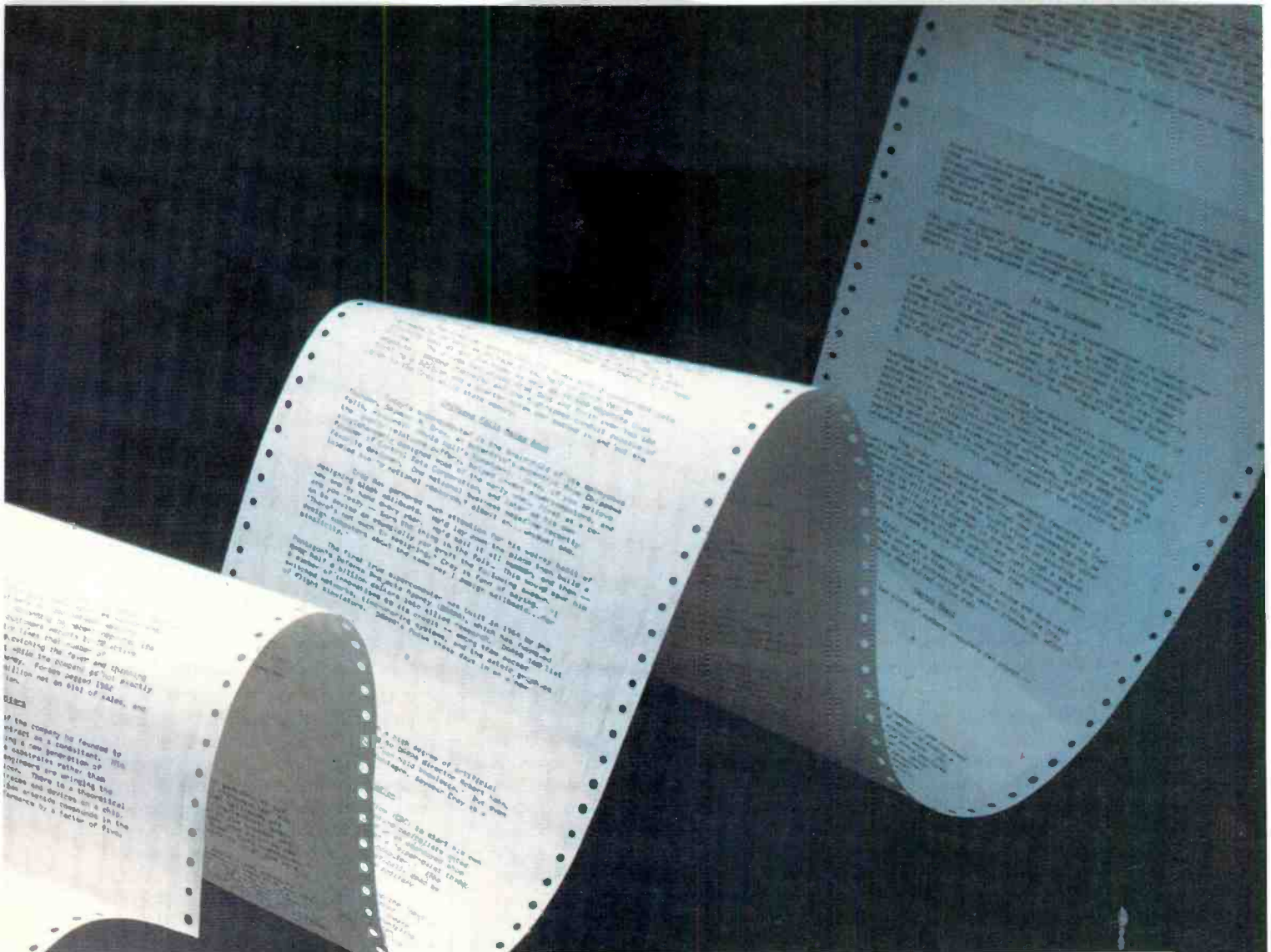

# MISTER IMPOSSIBLE: RAY KURZWEIL

*The man who developed the first reading machine for the blind says he will have a working voice-activated typewriter by 1985*

**BY LOUISE MELTON**

**I**MAGINE speaking into a device that could translate your verbal pearls of wisdom, memos, and letters into neatly typed text.

The voice-activated typewriter has been sought after since the mid-1940s. More properly termed a voice-activated word processor, the VAT is an integration of acoustic, electronic, mathematical and advanced linguistic technologies into the ultimate man-machine computer interface. Such a powerful machine would rival even Mr. Spock's Vulcan mind link.



The science fiction analogy isn't too far off the mark. The attempts of universities and well-funded corporate research and development groups have so far failed to produce a commercially viable VAT system. In fact, as recently as 1981, *Scientific American* published an article (Levinson, Stephen E. and Mark Y. Liberman, "Speech Recognition by Computer." *Scientific American*, April 1981) citing a convincing list of reasons why such a system would be a technical impossibility before 2020. Human language is infinite-

## Mr. Impossible

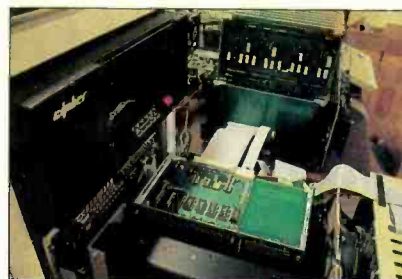

VAT is being developed on a homemade parallel processor 200 times as fast as a Motorola 68000.

ly rich and complex both in syntax and vocabulary. Speakers add to the complexity with their own regionally slurred vowel sounds, idiosyncratic glottal stops, and vulnerability to the common cold. Just writing software discerning enough to pick consistent meaning from all the possible combinations of human sounds within a given language is an enormous challenge. And the processor power required to support such software would be so great as to preclude any practical application.

Ray Kurzweil says he'll be manufacturing and selling a practical VAT system by 1985. He says it'll be in a box about 18 inches square and cost between

\$5000 and \$10,000.

Robin Kinkead, Director of Product Development at Kurzweil Speech Systems, says the *Scientific American* article "was just catnip to Ray. The impossible—that's the kind of challenge he loves."

### The Boy Genius Who Attracts Talent and Capital

Kurzweil, the principal inventor of the Kurzweil Reading Machine for the blind, is used to doing the impossible. A 36-year-old boy genius who wonders if people will stop applying the term to him when he's forty, Kurzweil still includes references to teenage triumphs in his companies' press releases. He began de-

veloping and selling nationally distributed software at 13. As a talented young pianist and computer freak in high school, he won the prestigious International Science Fair with a computer program that analyzed musical patterns and used them to generate what Kurzweil now calls "second-rate Mozart." Today he plays first-rate Mozart, Gershwin and Beethoven on a Kurzweil 250, a revolutionary electronic piano he and his staff developed that faithfully reproduces the natural acoustic sounds of a concert grand piano as well as other instruments and choral voice. He is the chief executive officer of two companies, Kurzweil Music Systems and Kurzweil

## THE IMPACT OF THE KURZWEIL 250

BY MARTIN PORTER

**R**AYMOND Kurzweil is more than an authority on artificial intelligence. He is a pioneer who brings AI technology from the lab to the marketplace.

As president of Kurzweil Music Systems, 35-year-old Kurzweil is known for inventing the Kurzweil 250, a revolutionary digital music synthesizer. Given limited introduction at the National Association of Music Merchants (NAMM) summer expo in Chicago last year, the Kurzweil 250 is said to be the first electronic keyboard with a sound and feel in-

distinguishable from an acoustic grand piano.

It was in 1976, however, that Kurzweil first made his mark, spearheading the development of the Kurzweil Reading Machine, a computer that scans any typeface and reads it aloud to



the visually impaired. Its key feature is a microprocessor which generalizes about the specific shapes before it—regardless of their size and typeface—identifies them as particular letters and synthe-

sizes them into speech.

That achievement alone might be enough for some inventors but Kurzweil has long shared a computing career with a family musical tradition.

The son of conductor/pianist Fredric Kurzweil, he began studying the piano at age six. Soon after, he discovered computer electronics, and published his first nationally distributed program for an IBM mainframe when he was 13 years old. He combined his two interests at 16 to win the International Science Fair with a computer analysis of music and went on to win seven national awards in that area by the time he graduated from MIT with a degree in computer science.

The Kurzweil 250 is the logical extension of that early work. Carrying a retail price tag of \$10,700, the 250 uses artificial intelligence principles and a Motorola 68000 microprocessor to create a complex model of an acoustic piano





**Kurzweil's intellectual leadership attracts top scientific and academic talent.**

Speech Systems, and is the chairman of a third, Kurzweil Computer Products. The latter produces primarily the Reading Machine for the Blind and its offspring the Kurzweil Data Entry Machine—products whose basic technology has never been duplicated by any other company in spite of intense and expensive R & D efforts.

Unlike the flakey genius of American mythology who sells out his patents for a pittance, Kurzweil has managed both to guard the design secrets of his impossible devices and to develop them commercially. First-round investors made a profit of seventeen times their original investment when Xerox bought Kurz-

weil Computer Systems in January 1980. Kurzweil retained management control of the company which is today one of Xerox' more profitable divisions. Xerox is also one of the major investors in Kurzweil Speech Systems and its ambitious VAT development project. International Research Development predicts a \$3.5 billion market for VAT systems by the end of the decade and says he'll pick off half of it. Xerox, an important vendor of office automation systems, has done some VAT research of its own at its Palo Alto facility and is betting that Ray Kurzweil gets to the finish line before Bell Labs, IBM or even the highly publicized Japanese.

Top researchers in artificial intelligence, speech recognition, linguistics and acoustics are making the same bet. According to Robin Kinkead, a human factors expert who left a secure job at Xerox to join Kurzweil's VAT research team, Kurzweil's intellectual leadership exerts a powerful attractive force on scientists and academics who compete for the privilege of working with him. "A few years ago I stood in the back of a room and listened to a speech Ray was making on the VAT idea. And I thought, 'He's going to do it.' It was going to be the most important thing in human factors engineering in years and I wanted to be a part of it."



**The Kurzweil 250 uses pattern recognition techniques to simulate the sound and feel of a top-quality grand piano.**

sound—as well as that of other instruments (including a choir of *human* voices). The design gives the 250 a velocity sensitive keyboard, so that the note responds with a timbre equal to the force on the key.

The 12-note polyphonic instrument is capable of accurately reproducing the

sounds of several instruments at once, while the 88-note keyboard can be divided up to 87 times with keys assigned to different voices and effects. An on-board digital sequencer allows cross-voicing and the addition of more voices from a preset selection of 60 choices, including a synthesized violin said to have a realistic attack, several different organ and guitar sounds, brass and strings. Additional voices can be added with ROM cartridges and new sounds can be digitally recorded and modeled directly into the unit's memory.

Using the unit's Musical Instrument Digital Interface MIDI and a personal computer, the instrument can simultaneously play and write musical notation on the computer monitor. Projects can be stored on a 3-1/2 inch floppy disk or edited in musical terms. Using software (now under development) it also will be able to instruct the user to play and oper-

ate the instrument in simple English.

The 250 is being shipped from Kurzweil Music System's (KMS) factory in Waltham, Massachusetts. The unit has been used experimentally by the Pat Metheny Group though, and judging by the music industry reaction at the fall Audio Engineering Society convention in New York, it won't be long before the man who gave computer eyes to the blind will give professional musicians and audio connoisseurs a computer instrument to match their ears. ◇



## Mr. Impossible

Why so much confidence in one man? While Kurzweil is very much the team player whose analytical abilities and open-mindedness are a major contributor to the the design team's success, some of the work could only be done by Kurzweil himself. He personally wrote some of the code for the reading machine artificial intelligence software and for the electronic piano. He is also writing some of the unique software for the VAT system. Ray Kurzweil is probably the world's leading authority on artificial intelligence and pattern recognition—bases on which not only VAT but the entire next generation of computer systems may be built.

### What's So Difficult About Voice Input?

In traditional numerical computing, the computer deals indiscriminately

with discrete bits of information. Artificial intelligence allows the computer to deal with information as symbols that have relationships, inherent behaviors and meaning in terms of the context in which they are presented. Because they emulate, albeit in a crude and very limited way, the human mind's ability to extract meaning from context, artificial intelligence systems are several orders of magnitude more efficient in pattern recognition applications than traditional computers.

Human speech is the toughest pattern recognition application because of the enormous number of variables the software has to handle. In a commencement address delivered at Hofstra University on December 19, 1982, Kurzweil no doubt boggled the minds of graduates, faculty, and honored guests alike with a classic example of why computers have

so much trouble with natural language. Kurzweil cited work done on computerized translation in the early 1960s by world-renowned Harvard linguist Susumu Kuno who is now an important member of Kurzweil Speech Systems' development team. With characteristic understatement, Kurzweil told his Hofstra audience that the work "... was interesting in its revelation of an unexpected ambiguity in the English language. Kuno asked his computerized 'parser,' as it was called, what the sentence 'Time flies like an arrow' means. In what has become a famous response, the computer replied that it was not quite sure. It either meant that time passes as quickly as an arrow passes. Or perhaps it is a command telling it to time the flier the same way that an arrow times flies—that is, time flies like an arrow would, or perhaps it is a command tell-

# DESIGNING AN ELECTRONIC GRAND PIANO

BY RAY KURZWEIL

**W**E set out to build a device that replicated the full, rich sound of a top of the line acoustic grand piano. But more than that, we wanted to simulate sounds of virtually every instrument in the orchestra: oboes, drums, violins—even the human voice. The goal was to produce sounds so faithful to the original that one would not be able to tell (without looking) whether the sound came from a real oboe or from the computerized keyboard. Because sounds that are considered "synthetic" are inherently simpler than acoustic sounds, success in recreating acoustic instruments would enable us to capture any synthesizer sound as well.

Before attempting a solution, it would be a good idea to try to gain a deeper understanding of what the problem is. Let us consider the question: "What is a piano?" One answer would be a collection of some several hundred strings, a sounding board and the other ten thousand odd parts that make up a "modern" acoustic grand piano. We are more interested, however, in a *functional* description.

From this perspective, a piano is a collection of keys of a certain shape that have a very distinctive "snappy" feel when pressed, which in turn initiate "pi-

ano" sounds. Each sound depends on only three factors—which key is being struck, the force or velocity of the strike, and the state of the foot pedals. We all know that the pitch or fundamental frequency of each note is determined by which key is pressed. The effect of the force applied to the key is more complex,

evolution of different parts of the sound spectrum during the attack and decay portions of each tone.

If we strike a particular key with a particular velocity, a single piano tone will result, which generally lasts for somewhere between 10 and 30 seconds. Because this single tone is the result of

the interaction of hundreds of strings, a complex sounding board and many other physical components, this "single" tone is in fact a composite of many constituent sounds, each of which has a complex and rapidly varying sound spectrum. The sum of these constituent changing sounds is called the "time varying timbre" of a single piano note. As noted above, this time varying timbre is quite different for different levels of force applied to the key, and of course for different keys. The state of the "sustain" pedal also has an impact.

Let us try a brute force approach to capturing the piano and other instrument sounds electronically. We will record (using very high quality recordings) each of the 88 keys at each of many (256, for example) loudness levels. We now have 22,528 recordings of piano notes, each about 30 seconds long. For each of these recordings, there are, as



**We wanted to recreate about 100 instruments.**

however. It is generally associated with loudness in that a harder strike results in a louder sound. But the sound from a hard strike is not the same as amplifying the sound from a soft strike. Also affected is the character of the sound; loud tones are dramatic whereas soft tones are mellow. In terms of the physics of the sounds, this is reflected in a different

ing it to time those flies that are similar to arrows—that is time flies that are like an arrow. Or perhaps it means that the subspecies of flies known as time flies

## Will Kurzweil have a VAT before AT&T, IBM and the Japanese?

have a fondness for arrows—time flies like arrows.”

There are very limited commercial speech input systems in operation today, primarily in industrial applications, and a few are available for use with personal computers, office, and telephone sys-

mentioned above, constituent sounds (that make up each piano tone) which now gives us many more sounds. If we now analyze each of these constituent time-varying sounds, we end up with many billions of pieces of information. Since the piano is only one of about 100 instruments that we would like to capture, we end up with trillions of pieces of information.

Even with today's relatively inexpensive computer memories, such an approach would not be feasible, at least not at reasonable cost. Our approach, then, has been to note that we can greatly reduce or compress this mass of information by finding distinctive patterns. The information can then be stored in a kind of computer shorthand, which can be reexpanded only when it is actually needed (when the notes are actually played).

The next step, then, is to actually find these patterns. Doing it by hand would not be feasible because, again, of the sheer magnitude of the job. We have used instead what are called “pattern recognition” techniques (which is part of the field of Artificial Intelligence) to automatically find these patterns. Now, the task of recreating the piano goes as follows. We record the actual instrument at many different pitches and loudness levels. Our automatic analysis program, using pattern recognition techniques, analyzes these recordings and finds the salient patterns to create what

tems. One industrial system, for example, recognizes 340 words spoken discretely, that is with a pause between words, at rates up to 180 words per minute. The TI Speech Command Center offers eight vocabularies of 50 words each for spreadsheet manipulation and voice dialing applications. Bell Labs has developed voice input/output systems that enable computers to function as information and credit card operators. But these are not true VAT—voice-to-text—systems. Japan's NEC has sold a VAT product capable of handling a 150-word vocabulary of connected speech—up to four seconds in duration before a pause is required—and converting it to text output.

None of these systems is capable of timing flies like arrows or of analyzing the syntax of such a phrase and extracting logical information from it. As in the

we call a “contoured sound model.” This computer model of the piano is then stored in the computer memory of our instrument. When the keyboardist plays the keyboard, the built-in computer and other specialized hardware and software actually recreates in real-time the original sounds. There should be no audible difference between the original sounds analyzed and the recreated sounds.

We can now in a similar manner create “contoured sound models” for any acoustic instrument (or for electronic

NEC system, syntactical confusions are avoided by severely limiting the vocabulary. Words like *where*, *ware* and *wear* cannot be differentiated from the context in which they are used. Most of today's speech input systems are based on conventional computing software and hardware architectures and depend on template matching for pattern recognition. Certain carefully chosen words—usually between 50 and 250 depending on the system and the narrowly defined application—are stored in the computer's memory. When the words are spoken, information from the sound waves becomes input, usually in the form of frequencies rather than as digitized in-

*(Continued on page 84)*

*Louise Melton is a free-lance writer based in New England, who specializes in advanced technologies.*



**The days of the lone inventor are gone.**

sounds or even sound effects), even for choruses of sounds like an orchestral string section or a choir of human voices. By building the analysis program into the instrument, users can sample their own sounds (a favorite instrument, their own voice, a creaking door) and create their own contoured sound models to play on the keyboard. Other capabilities

such as a 12-track sequencer to allow the playing of multiple parts of a multi-instrumental composition (such as a Beethoven symphony or a rock band) now becomes relatively straightforward.

One last complication remains the keyboard itself. Even in terms of the functional description of a piano, the unique feel of the keys is an important distinguishing characteristic of a good quality piano. In an acoustic piano, this is achieved by the piano key being attached to the piano “action,” which on a grand piano has some 90 individual parts (for each key). We approached this problem by building some specialized analysis equipment to plot the mechanical displacement of a number of real acoustic piano actions to see exactly what happens during each millisecond of a typical strike. We then designed a special action of our own to duplicate the dynamic displacements we had observed. In some ways our job here was easier than that faced by an acoustic piano manufacturer. We do not need to actually strike and dampen piano strings, we only have to duplicate the unique feel of the piano key.

It should be pointed out that accomplishing these various tasks involved a carefully coordinated effort of many very talented individuals. Like many significant efforts today, it has been a highly interdisciplinary project involving experts in many fields. ◇

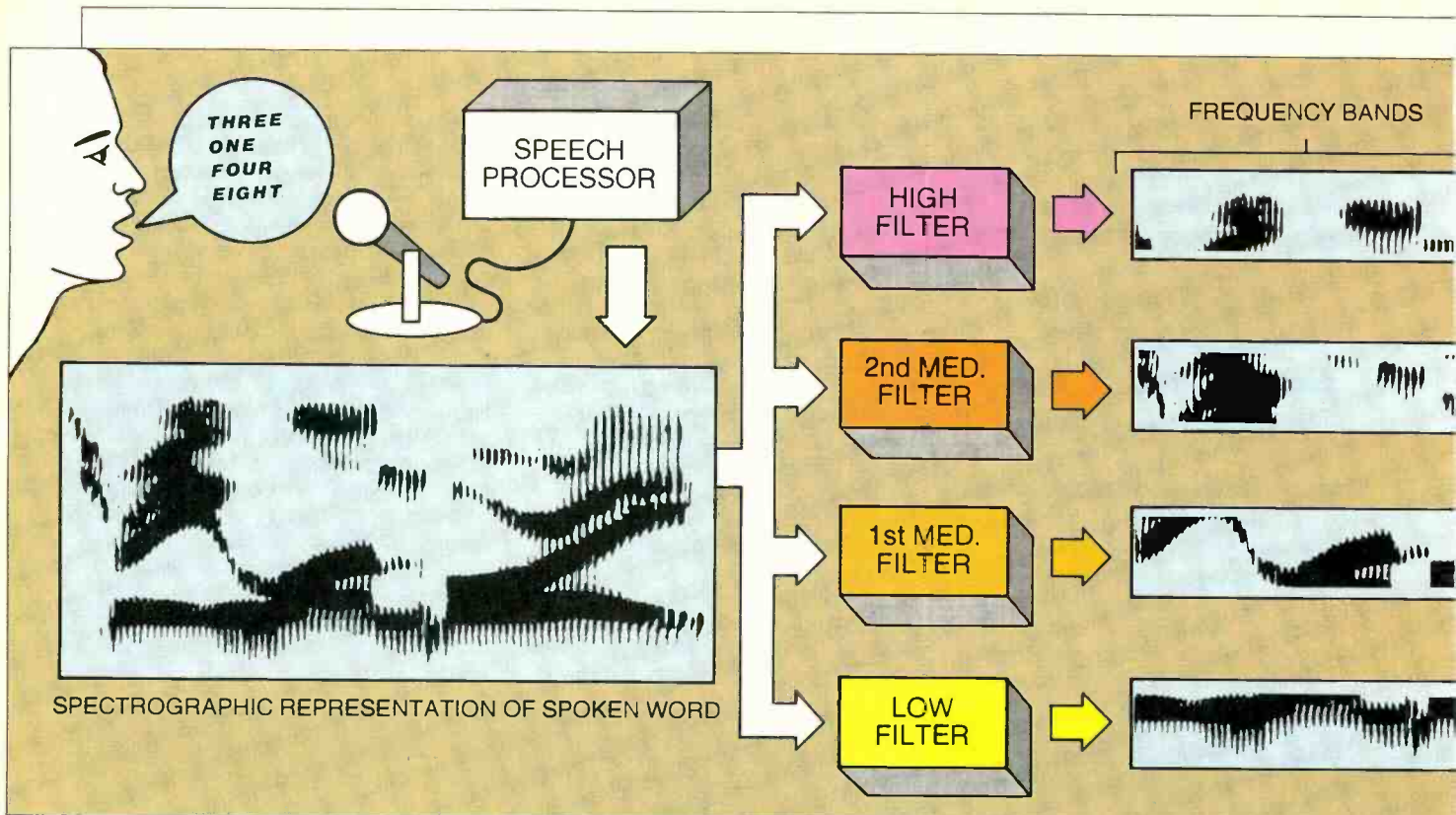

# THE NEXT GENERATION OF SPEECH RECOGNITION

*Computer recognition of words in natural speech is particularly difficult. Here's how the latest commercial products work.*

**BY MARYANN P. WALSH AND JOSEF BERNARD**

**S**PEECH recognition devices for computers have been available for over a decade, but recent advances in speech research and in VLSI technology have made them practical and affordable for use with microcomputers.

Until very recently, the recognition of colloquial speech by computers has been impossible. While a computer might have been programmed to respond to the phrase "What's the matter with you?", asking "Wassamatta'tchoo?" would have elicited either no response or a totally erroneous one. Each word would have had to have been spoken separately and distinctly.

Continuous speech recognition—the ability of a computer to understand colloquial speech, with all its running to-

gether of words and the resulting peculiarities of pronunciation—is at last becoming a reality. Within the next decade or so, we may be conversing with computers just as we would with human beings.

## How Computers Listen

How does the spoken word get into the computer where it is to be recognized? The first step is to convert the sound waves generated by the human vocal tract into electrical impulses. That's done by a microphone, usually worn as part of a headset so that the operator's hands are free for such things as keyboard entry of data. Sometimes special noise-cancelling microphones are used to keep out as much ambient noise

as possible, since it can only confuse the computer.

All the information required to understand human speech is contained within a relatively narrow bandwidth—about 300-3000 Hz. The range of frequencies generated by the vocal tract is, of course, much greater, but all the intelligence of speech can be conveyed using this small portion of the audio spectrum. (Voice-grade telephone systems are not noted for high fidelity. They don't have to be. Just a few kilohertz suffice to convey a message.)

Therefore, the output of the microphone is filtered to remove the extraneous frequencies, leaving only what is essential. The resulting analog electrical signal is converted into digital form by

ART BY NINA WALLACE

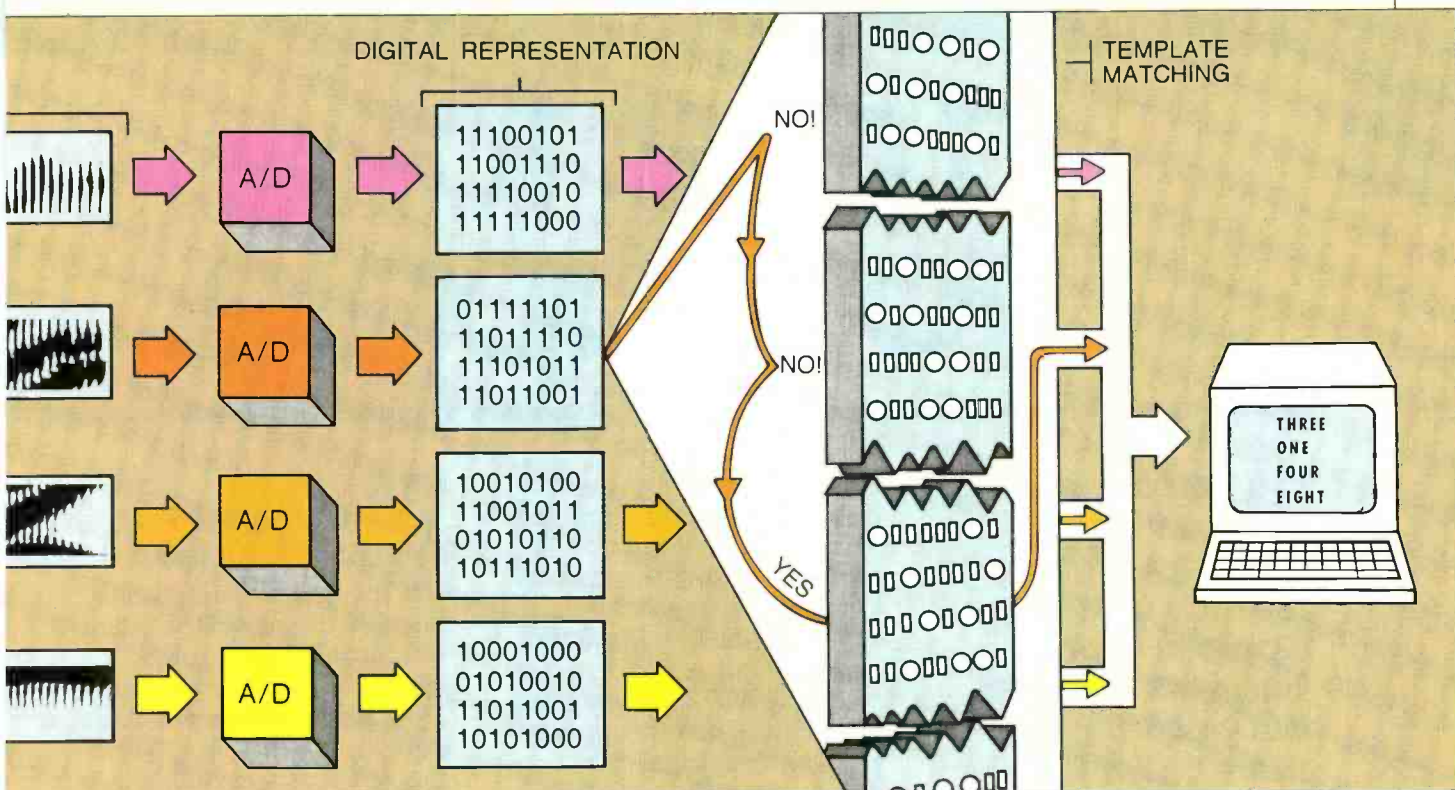

**Spectrograph of the words "three, one, four, eight" is used to illustrate how computers recognize speech.**

an A/D (analog-to-digital) converter. The bit groups are then ready to be processed by the speech recognition circuitry and software. The computer has heard what you have said; now it has to understand it.

### Speech Recognition

How does a computer understand speech? In very simple terms, it does so by comparing the digital representation of what it "hears" with a "template" representing the idealization of that digital representation.

The figure above includes a spectrograph of the spoken words "three, one, four, eight." It is extremely rich and complex in information content. Speech recognition systems do not rely on simple analysis of amplitude vs. time. There is just not enough information there. Instead, the speech spectrum is usually divided into several frequency bands, and the content of each band is analyzed and compared with that of the others to reach a determination.

Speech recognition systems can be classified as speaker dependent and speaker independent. A *speaker-dependent* system is "trained" to recognize the speech patterns of a specific individual. The computer "learns" the frequency patterns of a particular word as spoken by a particular person. Such a system can have a recognition accuracy ap-

proaching 99%, but can also have serious limitations.

For instance, like a trained animal, it will generally respond only to the voice of the person who has trained it. If we were to examine spectrographs of the same word as spoken by several different individuals, we would see that the distribution of energy across the speech spectrum differs for each. Since the computer and speech recognition software depend on recognizing a particular distribution of energy for a given word, any change in that pattern will cause a serious misunderstanding, or worse, a total lack of comprehension.

Compounding the problem is the fact that the same word may be spoken by the same individual in any number of ways. If the inflection is changed, the frequency distribution of energy changes, and the word may not be recognized. Even something as simple as a sore throat or a cold can affect a speaker's voice to the degree where he will not be understood by the system he trained.

A *speaker-independent* system is much more complex. It can, to a degree, generalize. It requires a much larger overhead in software and processing power, but overcomes many of the shortcomings of a speaker-dependent system.

Because speaker-independent systems currently support only small vocabularies, continuous speech recognition sys-

tems, to be useful, must—for the time being, at least—remain speaker dependent.

### Continuous Speech Recognition

There are two different systems used for speech recognition. The first, *isolated word recognition*, works one word at a time. That is, the computer is not capable of making sense out of two or more words (even if they are in its vocabulary) if they are spoken right after the other.

Take, for example, the number 123. It is highly unlikely that the phrase "one-hundred-twenty-three" would be part of a computer's vocabulary. Even the phrases "one hundred" and "twenty three" would probably not be understood.

Therefore, the number would have to be presented as "one-two-three." But a computer equipped only for isolated word recognition would bog down in trying to assimilate that. Each word would have to be spoken individually, with a pause between each one. "One (pause), two (pause), three (pause)." That would be the only way it could understand "123," with silences being used to separate one word from the next.

(Continued on page 50)

Maryann Walsh is a research engineer at Votan, specializing in the processing of digital signals. Josef Bernard is a Technical Editor on C&E.

# a .plus for your apple...

**Are you depending more on your Apple? Are you already using an Apple in your business or home, but want to get more out of it? When upgrading your system, do you rely entirely on the retailer's claims? Do you find that other magazines don't go beyond simplistic programming ideas?**

**LOOK NO FURTHER!  
A+ IS HERE!**

A+ will teach you how to maximize the functions of your Apple. It brings to life new and innovative program applications for the Apple II series and the *new* Macintosh microcomputers . . . features you won't find anywhere else! You'll find reviews of new software packages and in-depth evaluations of new hardware and peripherals for the Apple.

A+ is a useful tool to help you get the most out of your Apple in both the office and the home!

A+ is not written for computer technicians, nor is it a simple magazine written for new users...A+ is written for *you*, covering...the programs *you* can adapt for your office and home...the products *you* can purchase to expand your Apple II series or Macintosh microcomputer...the applications you can implement to increase your productivity...the topics *you* want *and* need, month after month!

**SUBSCRIBE TODAY  
AND SAVE UP TO 33%!**

## **A+ IS THE BUSINESS GUIDE FOR APPLE COMPUTING!**

Get the reviews and evaluations of the newest releases for business and finance... which of the three leading Dow Jones Market analyzers is right for you...how to use the Apple as a crystal ball to predict the future of your company...financial forecasting and analysis programs to meet your needs...inventory control programs that aren't losers...patient- and client-profile packages that tell a story...and ways to increase the efficiency of your word processor, in the office or at home!



Tablets for IIs—new relief for the creative professional and student.

## **A+ IS THE CONSUMER'S GUIDE TO NEW SOFTWARE!**

Each issue of A+ gives you unbiased evaluations of the



THE INDEPENDENT GUIDE FOR **apple** COMPUTING



latest software releases for home and office...programs that teach you how to use video games to help children learn...which modems will make your Apple a great communicator...the software solution to combine graphics, animation and text...problem solving with artificial intuition...software that gives you *all* of your money's worth ...and games that challenge your mental faculties and *not* your good nature!

**A+ IS YOUR MONTHLY "FACT SHEET" ON NEW HARDWARE AND PERIPHERALS!**

A+ covers what you need to expand your Macintosh or Apple II series...current advances in telecommunications and networking...new ways to augment memory...how to



**Modem Magic—Reach out and access an information service.**

access a wider variety of peripherals with greater ease ...what debugging aids *really* work...how to expand your RAM...ink-jet printers or dot-matrix printers...and the

hardware you'll need to accomplish the jobs in your business and home!

You'll get this and so much more in each monthly issue of A+! Regular columns and features covering Graphics, Programming, Education, Games and Entertainment make A+ the source for new applications and ideas...and Rescue Squad, Thoughtware and Product News round out all the facts you need for your Apple!

A+ is the complete guide for Apple computing, *the* magazine you can't do without!



**Dictionary Disk—It's new, it's hot and makes word processing a snap.**

**A+** THE INDEPENDENT GUIDE FOR **apple** COMPUTING  
P.O. Box 2964 • Boulder, Colorado 80322

**YES!** I don't have to look any further, A+ is here! Please enter my subscription to A+ for:

- One year (12 issues) for only \$19.97—SAVE 20%!     Two years for only \$36.97—SAVE 26%!     Three years for only \$49.97—SAVE 33%!

Savings based on full one-year subscription price of \$24.97.

Mr./Mrs./Ms. \_\_\_\_\_ please print name in full

Company \_\_\_\_\_

Address \_\_\_\_\_

City \_\_\_\_\_ State \_\_\_\_\_ Zip \_\_\_\_\_

**Check one:**  Payment enclosed     Bill me later

Charge my:  American Express     Visa     MasterCard

Card No. \_\_\_\_\_ Exp. Date \_\_\_\_\_

Add \$12 a year in Canada and all other foreign countries. Please allow 30 to 60 days for delivery of first issue.

AM8H310

# Speech Recognition

Those silences are important, for they are the delimiters that indicate to the computer the beginning and end of each word. *Continuous speech recognition*, on the other hand, takes into account the fact that such artificial silences do not normally occur in the course of speech. A system capable of continuous speech recognition is capable of picking out the words it has been taught to recognize out of a stream of words that it may not know.

As an example, assume that the computer has been programmed to sound a beep every time it hears the word

"beep." If just that one word were spoken, a beep would be produced, regardless of whether an isolated-word or continuous-speech system were in use.

Using a continuous speech recognition system, a response would also be obtained when the phrases "beep now," "please beep," or "a little beep would be appreciated" were uttered. The key word "beep" would be picked out from among the others.

A continuous speech recognition system still has to be trained one word at a time, but it is able to detect and respond to the words it knows from among all

those directed at it.

There is a trick that can give the illusion of continuous speech recognition in an isolated word recognition system. That is to train the computer to think that an entire phrase is just a single word.

With this method, the computer can be made to equate something such as the simple DOS command DIR with the phrase "What files are on the current disk?" The word DIR (or "directory") is never even spoken. The catch here, though, is that the same phrase must be used every time. The computer may

# HOW COMPUTERS RECOGNIZE SPEECH

VOICE recognition systems can be either *speaker dependent* or *speaker independent*. The former requires the user to "train" the system by speaking each word to be recognized several times (the more times each word is spoken during the training session the higher the recognition rate will be) so that the system can store the information that characterizes the word in a *reference template*. The word to be recognized is known as a *trial utterance*.

Speaker-independent recognition requires no training. The vocabulary is predefined and templates representative of the speech characteristics of the general population are stored in the system. Since continuous speech recognition—the ability to pick out known vocabulary words from a stream of speech—has so

far been implemented only on speaker-dependent systems, that is the area we shall concentrate on.

In isolated-word speech recognition (where words have to be spoken individually rather than imbedded in a phrase or sentence) a *feature extraction* algorithm samples data over short time segments (analogous to the frames on a strip of movie film) and computes a set of parameters (called *features*) that characterize the data for each segment.

Typical features include frequency band amplitudes, pole-model filter coefficients, time-domain power peaks, and statistical model parameters. To describe each of these would require an inordinate amount of space; suffice it to say that these parameters can be used to derive a unique description for the com-

puter of the sound produced during the sampling period.

The time-segment feature blocks derived are called *frames*. To perform speech recognition, a pattern-matching scheme is used that determines how close a trial utterance is to a template by comparing features frame by frame. The closest match determines the recognition response.

To put it another way, when a trial utterance is spoken, features can be extracted and a trial utterance series of frames computed. To perform a pattern match, some measure, or rule, is needed to define the difference between two frames of data. This measure of difference is called a *distance*, and can be as simple as subtracting two amplitudes, or as complicated as a nonlinear, time-

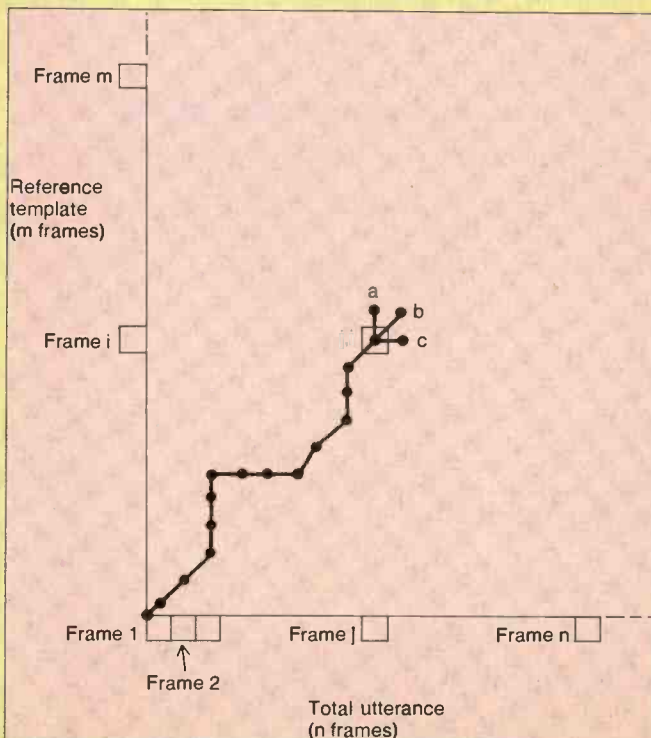

**Fig. A (left).** Dynamic path in isolated-word recognition. Typical decision point is at *j, i*.  
**Fig. B (below).** Dynamic path in continuous-speech recognition. Point *B* follows *A*, *D* follows *C*, etc.

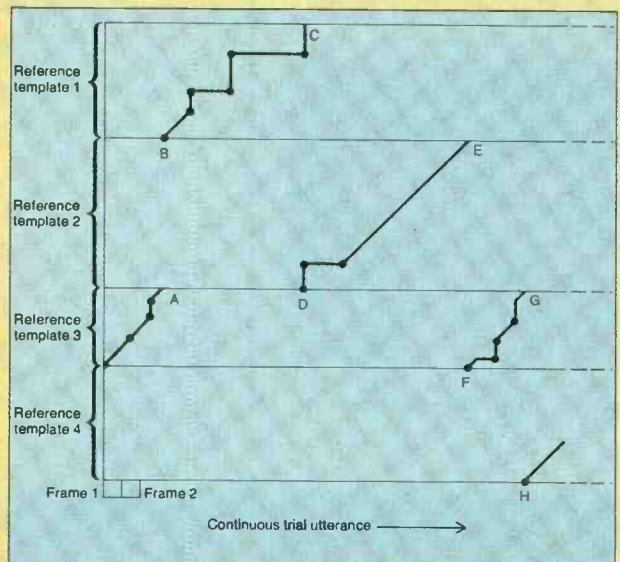



sometimes pick up on slight variations from what it has been taught, but it's a risky proposition. This trick is best limited to "show-off" demonstrations.

### Problems in Speech Recognition

Computers are stupid and, unless you play strictly by the rules with which they have been programmed, they can be extremely uncooperative. Speech recognition is a game with very strict rules.

To begin with, the English language is full of words that sound the same. Homonyms such as "where," "ware," and

*(Continued on page 88)*

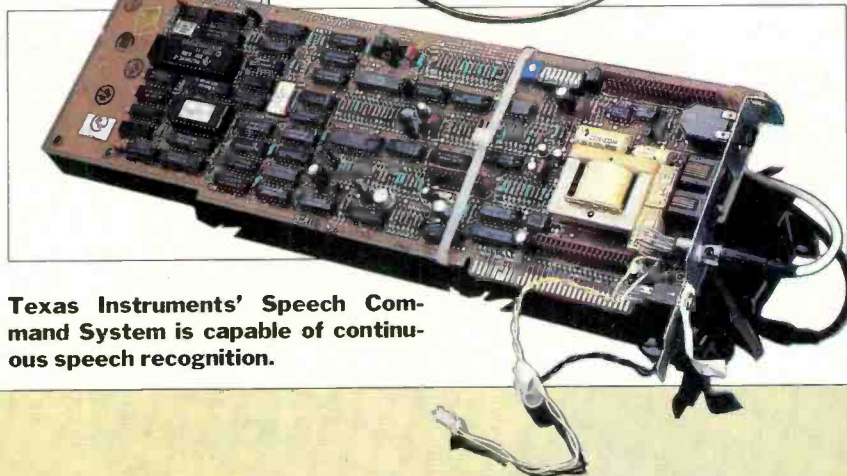

Texas Instruments' Speech Command System is capable of continuous speech recognition.

varying function of several parameters.

Another rule is required to determine the cumulative distance over several frames. One method used for this is called "dynamic programming," or DP. It allows a "time warping" of two series of frames to compute their cumulative distance.

Consider the same word spoken at different times. It can be spoken in many different ways. Some of the factors that can change are the volume, the pitch, the speed with which the word is spoken and, in particular, the speeds at which individual parts of the word are pronounced.

The feature extraction algorithm must take into account these variances while at the same time preserving the identifying characteristics that distinguish one word from another. Dynamic programming compensates for the time-variance aspect of utterances.

Figure A is a graphic representation of a trial utterance. The x-axis represents the series of frames of that utterance, and the y-axis a reference template to which the utterance is compared. The origin of the graph (at the lower left-hand corner) is the starting point for a DP path that will be generated through a simple geometric rule and that will terminate at point "T."

The path will describe an optimum series of frame-to-frame comparisons, yielding a cumulative distance between the trial utterance and the template. This distance can then be compared to the distances from the trial utterance to *all* the reference templates in the system's vocabulary. The comparison resulting in the minimum distance will define the best guess as to the identity of the trial utterance.

In the case of very high (or great) distances, the system could invoke a *thresholding* constraint that would reject

the guess as being outside the recognition vocabulary. This is referred to as a "no match."

In the case of isolated word recognition, the dynamic programming rule, i.e., how the path is constrained, is relatively simple. At each point in the path, a decision is made as to which will be the next point  $j, i$  in Fig. A, this decision is based on three possible choices, denoted by  $a, b$ , and  $c$ .

These represent, respectively: a repeat of the trial utterance frame for matching against the next reference template frame; a repeat of the reference template frame for matching against the next trial utterance frame; or a match of the next trial utterance frame against the next reference template frame. The choice is made according to the smallest frame-to-frame distance that would be accumulated for each of the three options. This forces the DP path through each reference and trial utterance frame, but allows considerable flexibility with regard to the time-warping aspect of the utterance.

In isolated word recognition, each trial utterance is captured separately, i.e., there is an algorithm in the system that detects the beginning and the end of a word and saves only the information pertaining to the word, and not to the silence at either end of it.

In continuous speech recognition, however, while word capture can be performed during training to collect reference templates, word capture is not possible during the trial utterance because there is no certainty as to where one word ends and another begins. Therefore, no origin or endpoint can be defined for the DP pattern match.

The objective for pattern matching in continuous speaker-dependent recognition can be summarized as follows: minimize the distance for any series of any

number of templates without knowing where words start or end.

To incorporate the appropriate boundary conditions into the DP process, the algorithm must be modified so that *at every step* in the DP path one template can end and another begin. This can be thought of as sliding an elastic window over the data to try to find the best match.

For a four-word vocabulary, the DP path takes the form illustrated in Fig B, where each section of the y-axis represents a different reference template, entered from the bottom and exited later in the trial utterance at the top.

Essentially, a fourth option is added to the DP rule: the next point in the path can be the beginning of a new template, and this point will follow a template that ended during a prior trial utterance frame and that had the lowest distance of all possible reference templates ending at the particular trial utterance frame.

It is not possible to know if it is best to start a template at a given utterance frame until the final distance associated with that template matched against the utterance is known. Therefore, the information regarding all possible starting points for templates must be preserved until a recognition is made and a "best path" of templates is traced back to the beginning of an utterance.

The bottom line is that there is a memory storage requirement for word-linking information as well as for cumulative distances for each reference template for each trial utterance frame.

The additional memory and computational requirements for continuous speaker dependent recognition increase exponentially with the number of reference templates. Only in the last few years has hardware been available that can provide the necessary match calculations in real time. ◇

# HELPING MANAGERS MANAGE

*Decision support systems aid managers in the data collection and analysis tasks that are fundamental to getting their jobs done*

**BY JOHN LIGHT**

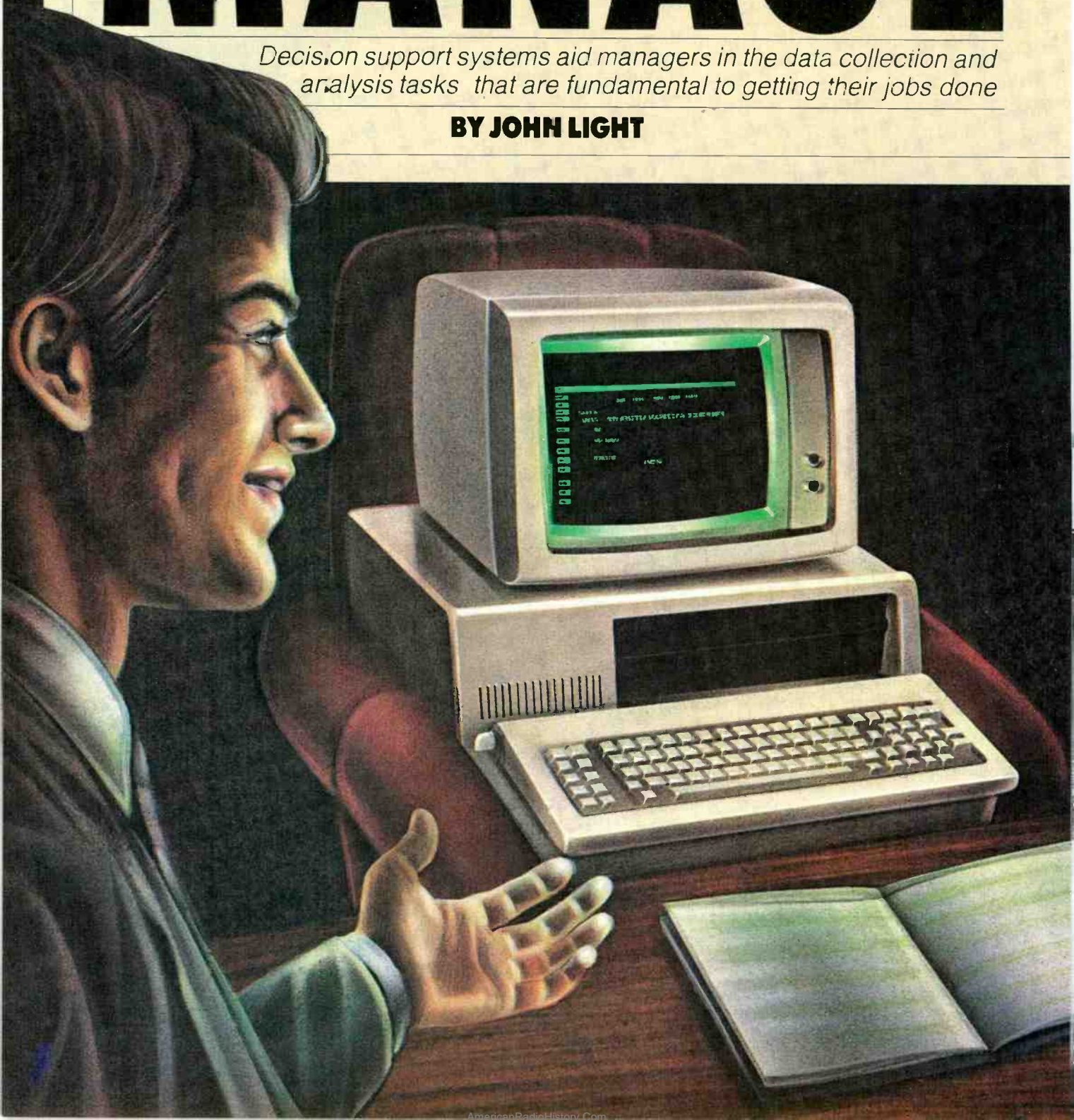

**F**OR years managers in forward-thinking large companies have used advanced mainframe software packages to help them make day-to-day and long-term decisions. Software packages of this type are generically known as Decision Support Systems (DSS). Any true mainframe DSS offers fully integrated database, display (reports and graphics), model development, and 4th-generation language capabilities. But DSS systems that run on mainframe (or large mini) computers cost a lot of money—typically more than half a million dollars, if you include both the software and hardware to run it.

And then came microcomputers—small, powerful, and several orders of magnitude cheaper than their mainframe counterparts. Managers who could not afford half-million dollar

mainframe DSSs embraced these small wonders, even though the larger systems had demonstrably more capabilities. Today, the two worlds—micro and mainframe—are coalescing. This is happening primarily because microcomputer hardware is becoming more powerful. In response, spreadsheet software (which was originally used for micro applications) has become more sophisticated, almost rivaling mainframe DSSs. Simultaneously, software vendors are exploring ways to make the mainframe packages friendlier, more accessible, and cheaper.

In this article, we will examine representatives of the current generation of micro-DSS software and compare them to those on mainframes. We'll also discuss the concept of software integration—what it is, how important it is, and

how, in particular, it applies to DSSs. We will also peer into the future and try to guess what the next generation of this software might look like.

Table I shows four micro products that typify the range of power currently available. Each of these systems includes facilities for using data to build models—the *sine qua non* of any DSS. All have display capabilities and a type of modeling language. And as we shall soon see, their features compare well to existing mainframe DSSs.

#### Data Management

Since DSSs involve the use of data in model building, data management is ob-

---

*John M. Light is president of Xpert Edge Inc., a Claremont CA business software retailing and consulting firm.*

---

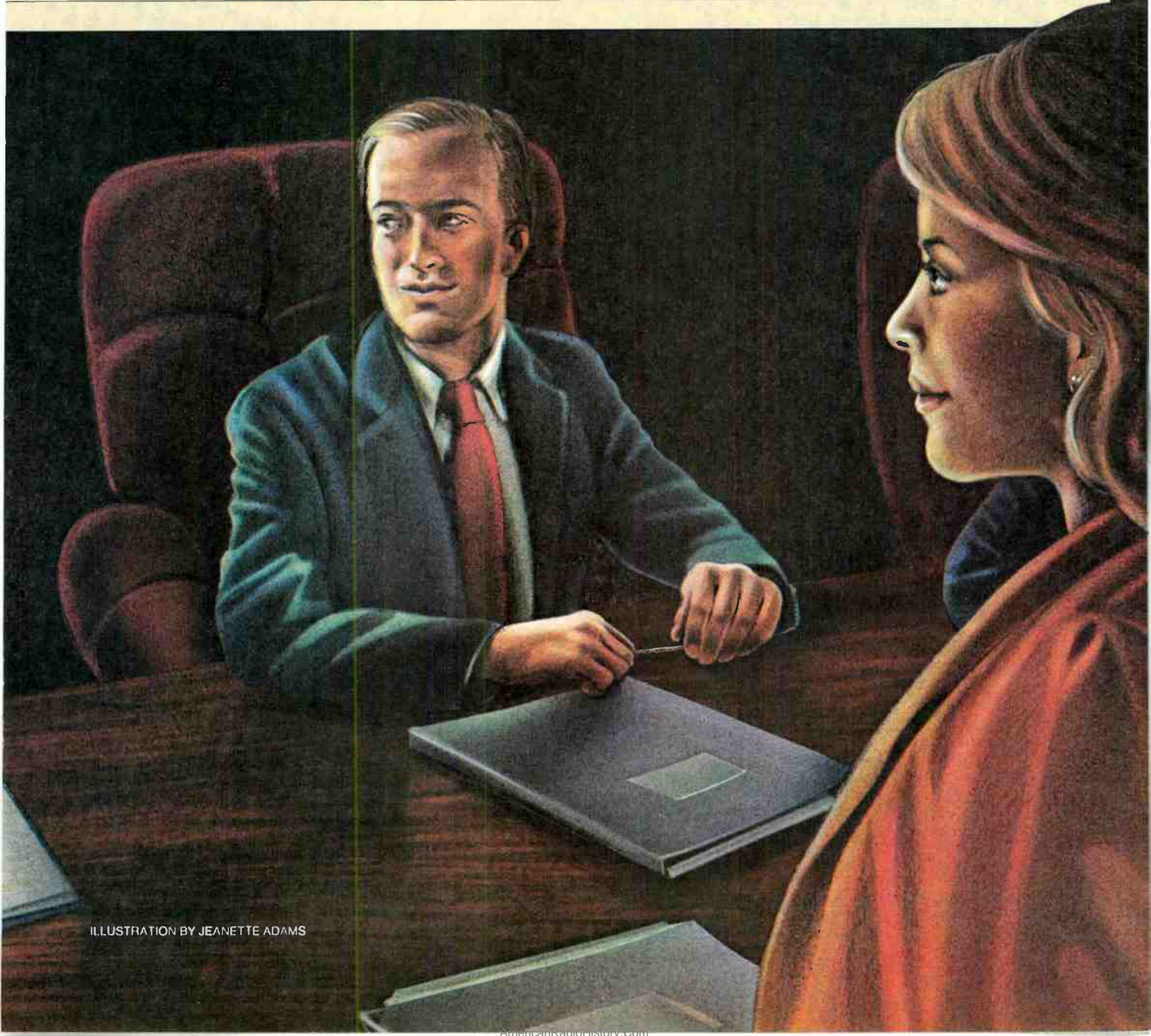

ILLUSTRATION BY JEANETTE ADAMS

## Managers Manage

viously critical. This is one area where the mainframe packages still enjoy a significant advantage. The chief reason is that many mainframe DSSs offer *multi-dimensional* databases (the usual micro database is two dimensional).

A mainframe multidimensional database has three, four, or even more dimensions. For instance, you could maintain budget data by time period, line item, and company division. And there are commands for extracting arbitrary subsets of this information, for example, for selected times, line items, and/or divisions. You can even build in automatic aggregation: If your database uses months as its basic time unit, you can assign months to years (fiscal or calendar), and at your discretion, peruse yearly rather than monthly figures.

More generally, data management on micros is hampered by problems with processing power, storage capacity, and "centrality." The processing power problem stems from the clock speeds and word sizes employed by the most popular microprocessors, particularly the Intel 8088 used in the IBM PC and compatibles. Database management

software is extremely complex—it must do a lot of nasty maintenance duties to rapidly present data to users in an intuitively comfortable way. Nevertheless, remarkably powerful database software is available for micros, though lack of processing speed imposes limits.

A diskette, further, is a rather small repository for any significant amount of information. Hard disks are becoming more popular, of course, and are growing in size. But they are far from ubiquitous.

Finally, "centrality" refers to the undeniable need for managers to be able to access the same data. This is important to ensure that analyses are based on the same information, and also to help ensure data integrity. Garbage in, garbage out. Clearly any large company will think twice about the value of models developed from a thousand different personal databases!

With these caveats in mind, the data management capabilities of the systems shown in Table I are impressive, and sufficient for many management support activities. These systems offer two types of data management: flat file handlers

and relational databases.

A flat file is a two-dimensional array—a "spreadsheet image," if you will. The columns of this array might be time units—months or years—while the rows are budget-line items, sales for different products, or the like. Until the advent of database technology on large computers, all computer-readable data were stored in flat files.

Lotus 1-2-3 implements flat files by literally storing a spreadsheet. Each cell entry is represented by a number, label, or formula. Encore! and IFPS/P allow you to store data separately from a spreadsheet. For instance, perhaps you have used some other system to project sales for each of the next 24 months by product line. Encore! would allow you to store these numbers alone, and then define a variety of models—that is, spreadsheets—which use the data (for example, projected income statement and balance sheet). In 1-2-3, you would have to make these two essentially different models part of the same spreadsheet to allow you to refer to the cells containing the data, or "import" the sales data from a master spreadsheet, or reenter the sales data by hand for each spreadsheet—all of which are less convenient alternatives.

Flat files are usually fine for storing management-level data, since such data are most often two-dimensional. One dimension is typically time (months, quarters, etc.), and the other may be product sales, general ledger account balance (or budgets or projections), and so forth.

But if you need to store three (or higher) dimensional data on your micro, and no multidimensional data management is available, a relational database is the next-best choice. Relational databases have two important properties: a number of flat files can be related; and data can be extracted from a set of related files to form what looks to the user like a flat file—in essence, a spreadsheet.

You can avoid continually re-storing the same information by relating files. For instance, suppose you want to create a database of product sales by product line for each of the last 24 months. This is no problem for a stored spreadsheet—the rows are the products, the columns are months, and cell entries are sales figures. But suppose you also need to break out sales by salesperson? In 1-2-3 you can do this by defining a different row for each salesperson/product combination (columns are still time periods). Unfortunately any product information other than identifier (name or number, say) will have to be duplicated on each such record. This is a big waste of space.

**TABLE I—MICRO DSS SOFTWARE**

	1-2-3	Encore!	IFPS/P	K-Man
Flat file handler	x	x	x	x
Relational DBMS	o	o	o	x
Spreadsheet	x	x	x	x
General-purpose math functions	x	x	x	x
Financial functions	x	x	x	o
Goalseeking Programming	o	x	x	o
language	x	x	x	x
Regression	o	x	o	o
Review cell def's onscreen	o	x	x	o
High quality reports	o	x	x	x
Graphics	x	x	x	o

x=yes, o=no

### Micro DSS Manufacturers

**1-2-3**  
Lotus Development Corp.  
161 First St.  
Cambridge, MA 02142  
617-492-7171  
List Price: \$495  
Requirements: IBM PC/XT or compatible  
192K, two disk drives

**Encore!**  
Ferox Microsystems Inc.  
6th Floor  
1701 N. Fort Meyer Drive  
Arlington, VA 22209  
800-336-5496  
703-841-0800  
List Price: \$695  
Requirements: IBM PC/XT or compatible  
256K, two disk drives

**IFPS/P**  
Execucom Systems Corp.  
PO Box 9758  
Austin, TX 78766  
512-346-4980  
List Price: \$7  
Requirements: IBM PC/XT or compatible  
384K, two disk drives

**Knowledgeman**  
Micro Data Base Systems Inc.  
PO Box 248  
Lafayette, IN 47902  
317-463-2581  
List Price: \$500  
Requirements: IBM PC/XT or compatible  
192K, two disk drives

The same problem arises if you want to store transaction-level data—let's say, individual purchases by customer. A flat-file database requires you to duplicate all "customer master" data in each record—in other words, to repeat customer name, address, etc. in each sales transaction. The more repeat business you have, the more space you waste.

A relational database solves these problems by requiring only that two files have some identifier (or identifiers) in common; for example, the same customer number. Then any transaction involving that customer can be stored in a record containing information unique to the transaction (what was purchased, number of units, etc.), while information about the customer can be obtained by using the customer number to search the customer master file.

Further, as noted above, this multidimensional information can be pulled out in a spreadsheet format. For example, if you only care about sales over all products and months for a single sales person, one command will create this two-dimensional subset of the database.

Flat files are sufficient in two cases:

- You run a small business, which does not require three or more dimensions worth of data very often; for instance, you do not operate in a number of distinct geographical areas, you do not have a divisional or departmental structure, etc.

- You have a larger business, but can access two-dimensional subsets of management data (or appropriately aggregated transactional data) from a database on a larger computer.

If you need to store more complex or detailed data on your micro, then a relational database manager is at present the best available alternative.

If one of the systems in Table I is your introduction to DSSs, you will probably find their data management at least adequate. If, on the other hand, you are used to mainframe DSS data management, you will probably be disappointed by the lack of flexibility, and the relatively small amounts of data you can handle before things bog down. If you fall in the latter category, there may be some good news for you in the following section.

### Modeling Support

Data management is only half the story in a DSS; the other half is modeling. By "model" we mean any abstract representation of a real-world process. Typical business-relevant models include:

- A projected income statement (variable expense accounts may be assumed to depend on projected sales levels, and are

thus defined to be some mathematical function of sales);

- A cash-flow projection (inflows and outflows of cash can be related to each other over time);

- A marketing effect model (assumptions are made which relate expenditures on different marketing vehicles—advertising, direct sales, mailouts, etc.—to resulting sales).

There are two aspects of modeling

## Data management is one area where the mainframe DSSs still enjoy a significant advantage

support to consider. Firstly, what mathematical relationships can be represented by the DSS; and, secondly, once the model is built, how easily can it be used for asking hypothetical questions?

The ease and flexibility of representing mathematical relationships depends on several related DSS features: built-in mathematical functions and capabilities; capabilities for defining your own functions; and debugging aids (to validity-check the different relationships).

The spreadsheet has become a standard model-definition device for micro-computer software, and all the systems in Table I allow the usual interdependent cell definitions—for example, you might define one cell as the sum of the three cells just above it. This innovation was developed in the micro world, and has proven to be an excellent way for not only creating but also manipulating and displaying many models.

All four systems in Table I contain a variety of built-in functions, like sums, averages, etc. Encore! has more financially-oriented functions (internal rate of return, net present value, ACRS capital cost recovery, etc.); Lotus 1-2-3 and Knowledgeman, while also offering some financial functions, contain more general-purpose functions.

All four systems include a fully-integrated programming language which can be used (among other things) to create "custom" functions and relationships. Lotus 1-2-3's is relatively rudimentary—it's really a way of capturing keystrokes and executing them later.

Testing and branching are possible, but it is a very awkward way to program.

Knowledgeman, IFPS/P, and Encore!, on the other hand, contain reasonably powerful programming languages, and can be used for program development much more straightforwardly. Thus, if you want to calculate a solution to a set of simultaneous equations, Knowledgeman or Encore! would be best. (IFPS/P will actually handle simultaneous equations automatically.)

None of these systems contains much in the way of debugging aids. Knowledgeman's language lends itself to easily readable listings (even though you have to use an ASCII word processor or line editor to create them, since Knowledgeman has no built-in editor). Encore! does have a built-in editor, and also (like Knowledgeman) a reasonably English-like programming language that makes systems development and debugging possible. Lotus 1-2-3 allows you to list the definitions for each cell in a spreadsheet—a minimal way to review what you've programmed. Also 1-2-3's error messages are not as comprehensive as the other two systems.

You also need to consider how easily you can answer hypothetical questions with a model, once it is built. To begin with, the spreadsheet capability of all the systems in Table I allows you to change a value in any given cell, and have the values in other cells that depend on that value change also.

Encore! and IFPS/P, since they store data separately from the model, allow you to prepare different "scenarios" using different data (Knowledgeman permits this too, but not as easily). In addition IFPS/P gives you the ability to temporarily change model assumptions (logic) and see what would happen.

Like their mainframe cousins, Encore! and IFPS/P support "goalseeking"—an ability to solve a model in reverse (for example determining the level of sales required to produce a gross margin of 25%).

This is an impressive litany of modeling features. But micro DSS's do fall short in some areas. None of the systems shown in Table I include either Monte Carlo simulation or sensitivity analysis support, as such. Monte Carlo methods allow you to vary inputs "randomly" according to some known probability distribution (hopefully similar to what the real world might produce) and see the model results. Sensitivity analysis can be performed manually by the analyst using different scenarios, but automatic support (for example, plus or minus 10% on

*(Continued on page 92)*

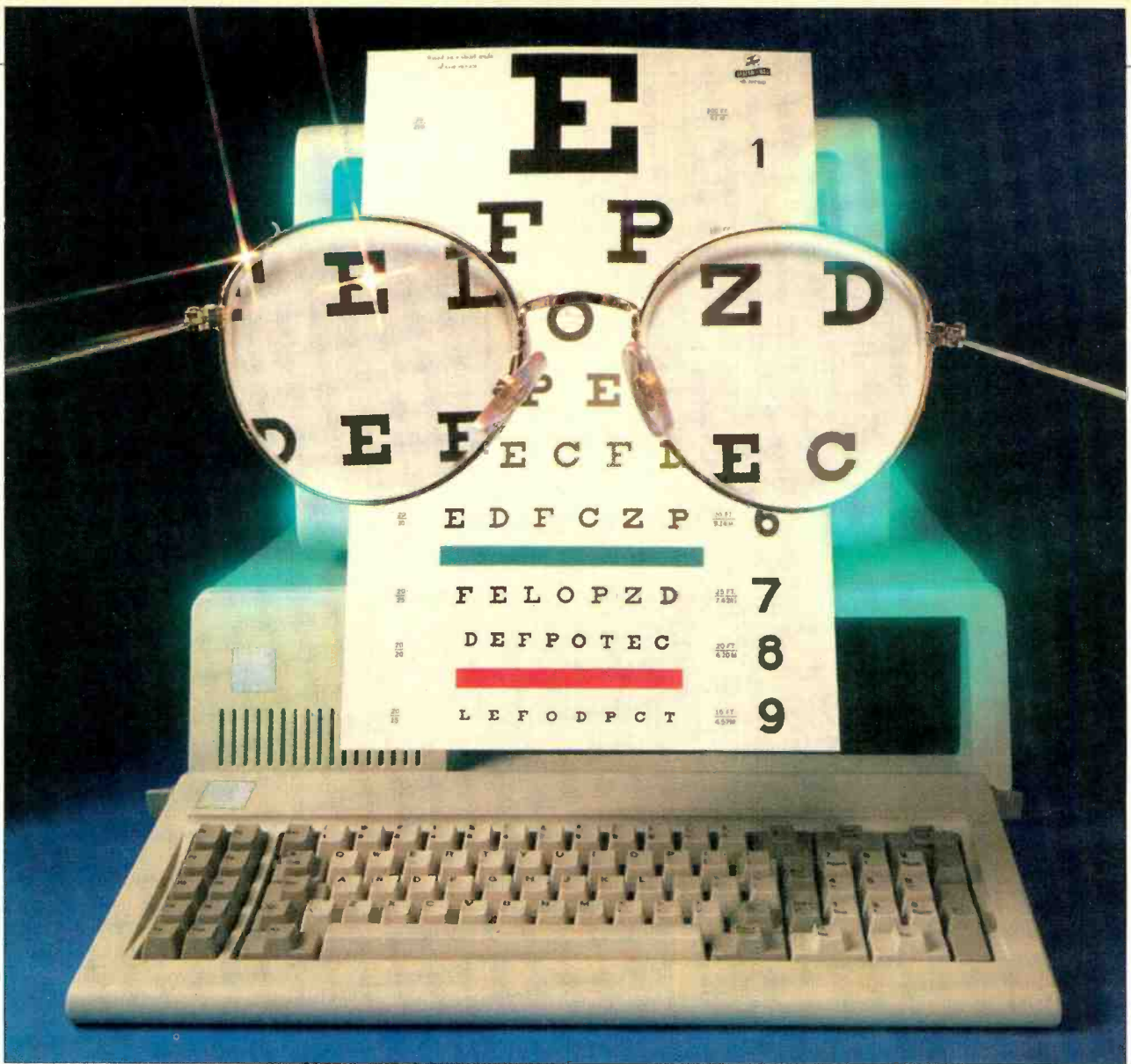

# VIDEO DISPLAY TERMINALS AND VISION

*Behavioral optometry offers new insight into and solutions for stress experienced by VDT operators*

If you work with or are around video display terminals (VDTs), you have probably experienced or heard others complaining about headaches, backaches, and/or sore, tired, red, or burning eyes. If so, you are not alone. Hardly a week goes by in which there is not a story in the news about problems arising from

## BY BOB MARGOLIN

the use of VDTs. Yet in spite of the growing number of such reports, there are still those who believe the problems reported by VDT operators are strictly psychosomatic.

Some VDT proponents, particularly

those involved in office automation, often cite the conclusions of a widely quoted study conducted by the National Academy of Science. The study, "Video Displays, Work, and Vision", concluded that the use of VDTs has no effect on the pathology of eyesight and that there is no clear evidence that the use of VDTs

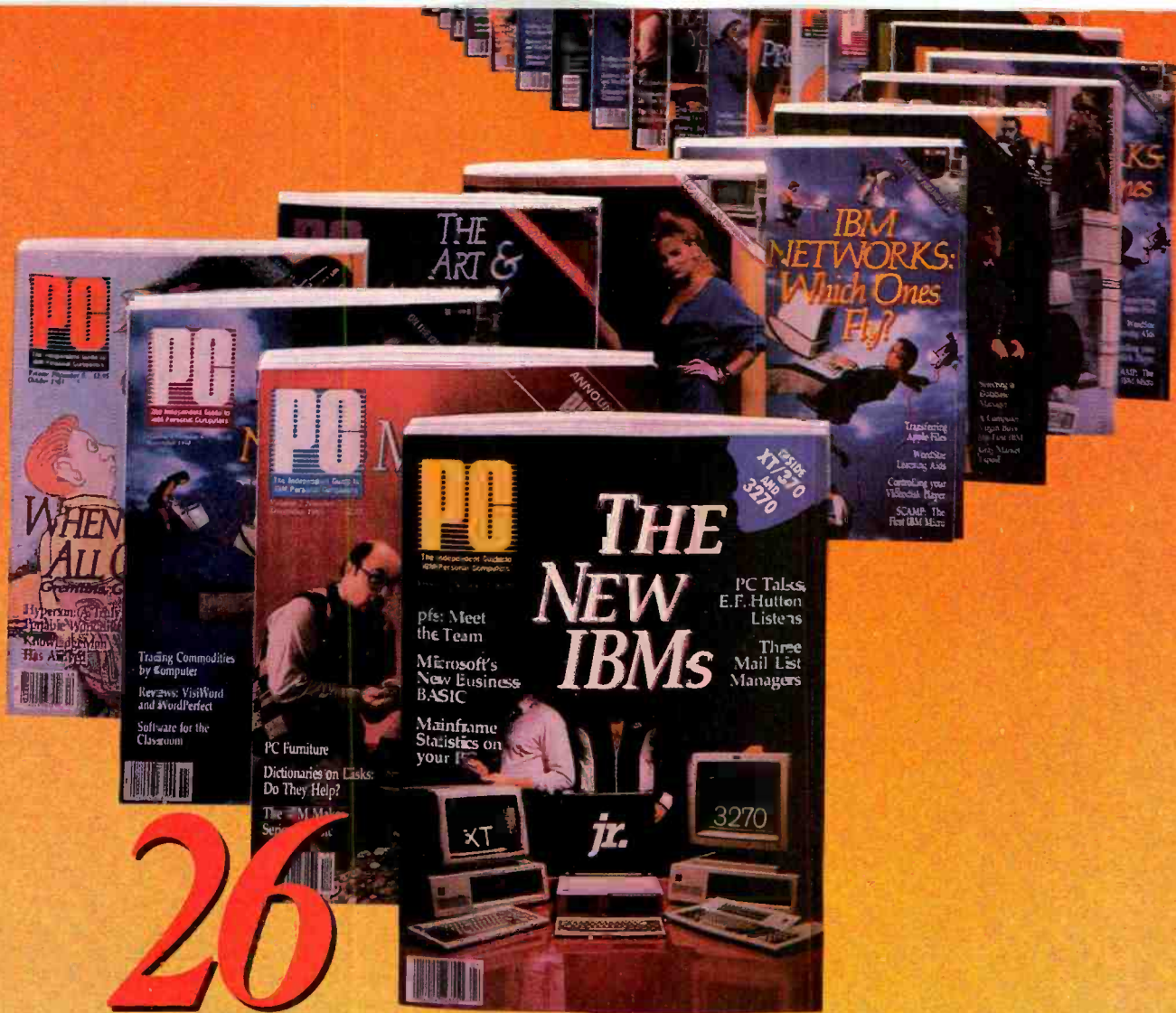

26

# REASONS TO SUBSCRIBE TO

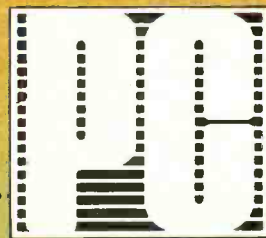

Your subscription will bring you 26 big issues every year of the most up-to-date facts and technological breakthroughs that affect you and your IBM or compatible personal computer. 26 big issues of PC delivered to your door AT UNBELIEVABLE SAVINGS!

Every other week you'll get a library of professional insights including latest coverage of newly-released hardware and peripherals. You'll find timely information on innovations in programming, applications and networking. You'll communicate with professionals and users like yourself and get reviews of new software packages, some before they even hit the shelves.

You can subscribe to PC, The Independent Guide To IBM Personal Computers for as little as \$1.02 an issue! Use the attached card or the coupon at right TO SUBSCRIBE TODAY!

**GET THE MOST UP-TO-DATE INFORMATION FOR YOU AND YOUR PC WITH PC, 26 TIMES A YEAR!**

**26** SUBSCRIBE TO

P.O. BOX 2443 • BOULDER, CO 80322

**26**

**YES**, Please enter my subscription to PC for:

- 26 issues (one year) for only \$29.97...**LESS THAN \$1.16 A COPY!**
  - 52 issues for only \$52.97...**LESS THAN \$1.02 A COPY!**
- Full one-year subscription price \$34.97. Single copy price \$2.50.

Mr./Mrs./Ms. \_\_\_\_\_ please print name in full PC8H013

Company \_\_\_\_\_

Address \_\_\_\_\_

City \_\_\_\_\_ State \_\_\_\_\_ Zip \_\_\_\_\_

Check one:  Payment enclosed  Bill me later

Charge my:  American Express  Visa  MasterCard

Card No. \_\_\_\_\_ Exp. Date \_\_\_\_\_

Add \$52 a year for postage to Canada and all other foreign countries. Please allow 30 to 60 days for delivery of first issue.

at a point a few inches in front of or behind the point of focus. Because of lag,

plus lenses. Unlike the hands-worn by myopics, which optically bring

computer field.

# STORE IT WITH LIGHT

*Optical storage systems will soon provide more storage for less money*

**BY JEFF HECHT**

**I**magine mass-produced plastic cards, the size of ordinary credit cards, that carry up to two megabytes of software in a virtually indestructible format. Or imagine a plastic disk 12 centimeters (4¾ inches) in diameter—smaller than most of today's floppy disks—that can store 100 to 360 megabytes of data for 10 years or more. You won't have to imagine long. Those breakthroughs are almost here, thanks to the use of laser light to read and write data.

*Jeff Hecht is a free-lance author who writes frequently on the subject of lasers and their applications.*

Optical data storage made its first big splash last fall, when several major companies announced systems for use with mainframe computers. Systems able to hold over one gigabyte (1000 megabytes) were reported by Storage Technology Corp. (Louisville, Colorado), Hitachi Ltd. (Japan), Thomson-CSF (France), and Xerox (through the Optimem division of its Shugart subsidiary in Sunnyvale, California). Other firms are

following  
with







PHOTO BY BARRY BLACKMAN

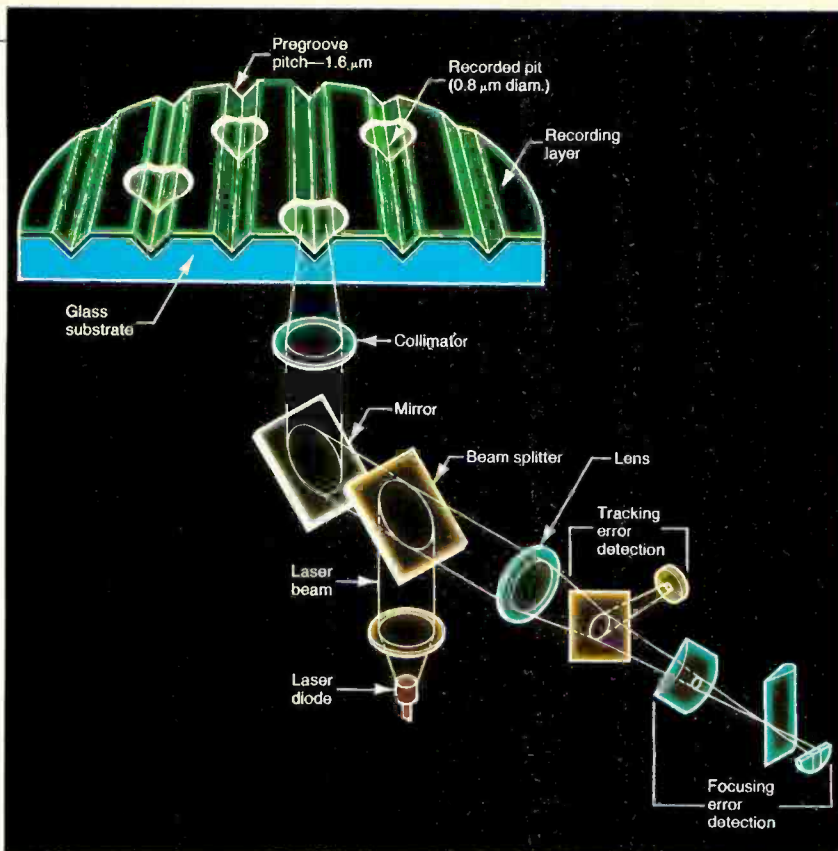

**The complex system required for writing and reading optical disks.**

their own versions.

Smaller-scale systems for desktop computers are not far behind. More than a dozen companies have licensed the optical storage card technology developed by Drexler Technology Corp. of Mountain View, California, and one licensee has already demonstrated how the cards can be used to reprogram arcade video games. More than a dozen companies in Japan, the United States, and Europe are working on 12-centimeter optical disk drives that may be ready for the market next year. From all indications, optical storage is coming on fast.

### Optical Storage Technology

In the new systems, data is stored optically, by writing on light-sensitive material with pulses from a tightly focused laser beam. The laser pulse produces a visible change in the tiny area it strikes, typically a pit, blister, or darkened spot that reflects more or less light than the surrounding area. The recorded data can be read by scanning the surface with a continuous laser beam that is weak enough to have no effect on the storage medium.

The major attraction of the optical disk is its very high data storage density. A tightly focused laser beam can write spots less than one micrometer (1/25,000 inch) in diameter, and cram over one gigabyte (1000 megabytes) of data onto a 30-centimeter (12-inch) disk. The data spots can be increased to 5 or 10

micrometers in diameter to permit inexpensive replication of the data on plastic cards, which can be read by low-cost laserless readers. Even those large data spots are much smaller than the area needed to magnetically record a data bit.

Increasing the data-storage density both decreases the volume needed for archives and speeds data retrieval. That is why government agencies with massive archives, ranging from the Library of

Congress to the National Security Agency, are among the first customers for optical storage systems. Such huge storage needs are met by "jukeboxes" containing many optical disks, each 12 or 14 inches in diameter, which can be placed automatically on the read/write drive. Many other mainframe computer users need more storage than they now have but not as much as government agencies. Their needs can be met with optical drives that hold a single 12- or 14-inch disk. Systems that use smaller optical disks, or even cards, are in the works for the more modest needs of personal computers.

Data density is by no means the only difference between optical and magnetic media. While magnetic media permit numerous write/erase/write operations, a single optical recording is permanent. Once a region on an optical disk has been written on, it cannot be erased and used again. Many systems allow users to insert codes on a disk to bypass unwanted or obsolete data, or to obliterate old data by writing holes everywhere in the region, but the media cannot be reused. The industry is still unsure if this is good or bad news.

Permanent optical recordings able to last 10 years or more should be good news for people who want to store information and retrieve it unchanged. But it is neither necessary nor desirable for records that require frequent updating or that are only temporary. A key uncertainty is media cost. If cost drops low enough, optical recording may become attractive even for many short-lived data files.

**Lower graph is expanded 500X to show capability of 12-inch optical disk compared to other storage media.**

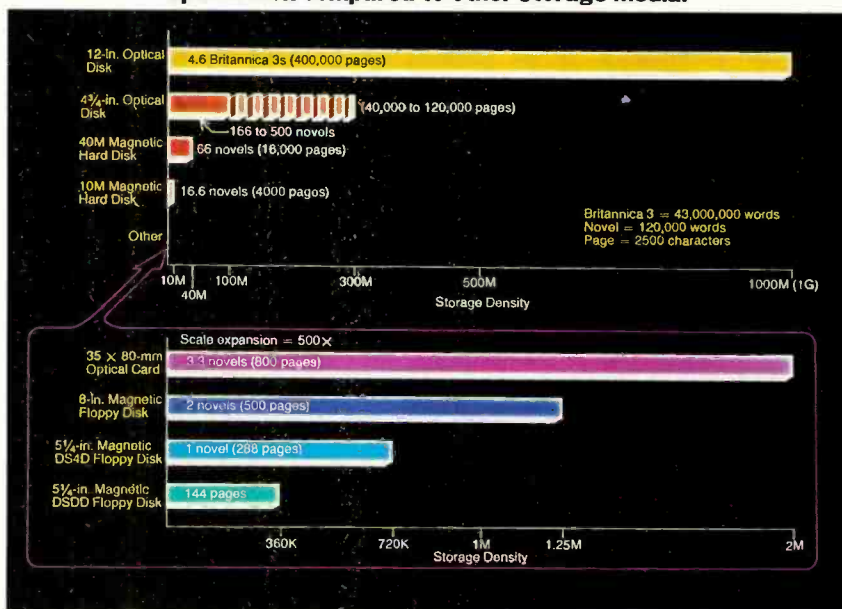

### From Failure to Success

The technology used in optical disk data storage originated with another concept that has never gotten far off the ground—the Laservision videodisk player. In the early 1970s, both the Dutch giant N.V. Philips and the American entertainment conglomerate MCA Inc. turned to lasers to play back video programs prerecorded on disks. Master disks are recorded with a laser and then replicated by a sophisticated pressing technique. The laser technique squeezes up to an hour of programming on one side of a 12-inch disk. Video playback quality is generally excellent. However, for home entertainment, consumers prefer the recording capabilities of videocassette recorders to being limited to the prerecorded programs on videodisk. Instead, laser videodisk players are being used for instruction and to provide realistic imagery for video games.

A digital variation on the analog videodisk technology was developed by Philips and Sony for digital audio playback. The "Compact Disk" (abbreviated CD) or "Digital Audio Disk" players are becoming popular with affluent audiophiles because of their noise-free sound, and tens of thousands of players a month are rolling off production lines in Japan. The 12-centimeter size of the audiodisk seems to be the universal choice among developers of optical disk drives for personal computers because lasers, optics, and mechanical components are already in mass production.

Development of digital data storage

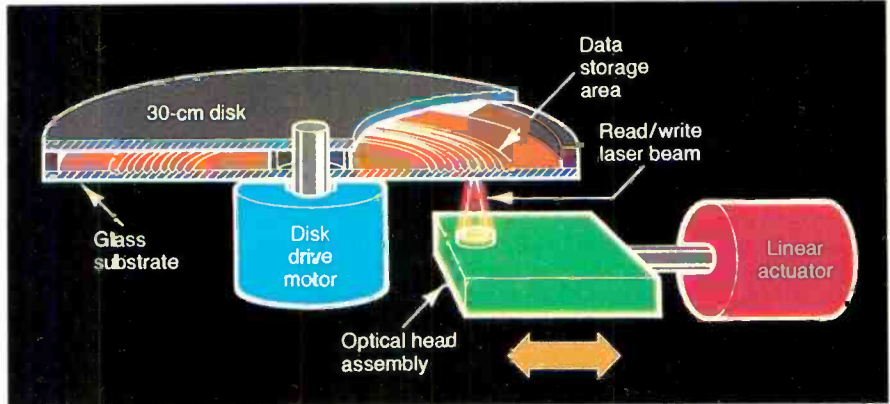

Details of three main elements of the optical disk system.

systems started once the large capacity of optical media was realized. The designs have some important differences. Videodisks and audiodisks—like software distribution cards—must be prerecorded, then distributed to customers. Optical data storage requires a medium onto which the user can write and then from which you can read without changing the recorded data. It also requires a much lower error rate than videodisks or audiodisks now offer. These problems helped to delay the debut of optical data storage. In a sense, the media problems have never been solved; they have just been circumvented. About one bit in a million is recorded incorrectly on optical media, but most optical storage systems use sophisticated error-detection and correction schemes that reduce the error level the user sees to

around one bit in a trillion.

### Small Systems

Early emphasis in optical disk technology was aimed toward providing mainframe computers with tremendous storage capability. This effort continues, but the recent explosive growth in the use of personal computers has also spurred designers to develop smaller, less-expensive versions to suit the more modest needs of these users. To attain this goal, designers are using 12-cm disks and are borrowing other components from digital audio disk players that currently retail for \$400 to \$600 in the U.S. Target retail price for the data drives is expected to be in the \$1000 to \$2000 range.

Information Storage Inc. of Colorado

### DEC optical storage disks.



## Store It with Light

Springs is working on a 12-centimeter optical disk drive that will fit into the same space as a 5¼-inch floppy disk drive. The optical disk would store 100 to 360 megabytes, hundreds of times the capacity of most floppies and larger than that of most hard disks for desktop computers. Steve Popovich, president of the startup company, hopes to sell the optical disk drives to system makers for \$600 each. That would probably put the single-unit retail price in the \$1500 to \$1800 range.

Other companies are also working on such systems. Philips, for example, showed a developmental version last fall

at the Comdex show in Las Vegas. Interest is most intense in Japan where at least a dozen companies are working on their own new systems.

One major U.S. advocate of the small disk systems is Jerry Drexler, president of the Drexler Technology Corp. and a pioneer in optical storage, who largely abandoned work on 12-inch disks a couple of years ago. Drexler, whose company develops media but not disk drives, estimates that products are 10 to 16 months away and will probably retail for \$1000 to \$2000, with the upper limit set by the price of magnetic-storage Winchester drives.

### Optical Cards for Software Distribution

Some people are looking at 12-centimeter disks for software distribution, but their 100-megabyte capacity is far beyond what is needed. Drexler believes that smaller-capacity optical storage cards would be a better choice.

The optical-storage card is Drexler's brainchild. Two or three years ago, he was talking about replacing the magnetic stripe on the back of credit cards with optical storage media to record financial transactions. He has also proposed using the cards as portable medical histories,

*(Continued on page 94)*

# OVSHINSKY: OPTICAL STORAGE PIONEER

BY MARTIN PORTER

**I**F as promised, the optical laser disk replaces the magnetic disk as the computer industry's choice of storage, there will be a lot of celebrating in Troy, Michigan.

And even though electronic titans like Matsushita and IBM will likely get credit for the innovation, it was in Troy nearly 15 years ago that the idea of storing information on erasable glass particles was invented by a local, self-trained physicist named Stanford Ovshinsky.

From his small-town vantage point, Ovshinsky and his wife have built a \$20 million company by conceiving new ideas and waiting for the giants to pick up the logic. His company, Energy Conversion Devices (ECD), developed the science of Ovonic (named after Ovshinsky, also a bonafide term in *Webster's New World Dictionary*), which involves the storage of energy with amorphous crystal materials.

So-called "ovonic materials" can be coated on plastic and used to store either digital or analog information. A laser beam can erase the data and start over again. The process could ultimately transform the optical disk from a strictly playback status—like the videodisk and Compact Disk—to a truly interactive, recordable and reusable commodity.

This sounds similar to the standard magnetic tape, floppy and hard-disk technologies that currently dominate consumer audio, video and computer products. There is a difference, however. Optical disks carry substantially more storage capacity, as much as  $10^{12}$  bits of information.

Ovshinsky said, "We began working in amorphous materials as early as 1960. We discovered you could get a very high

signal-to-noise ratio. Since it was non-magnetic, you could place spots of information very close together and obtain tremendous resolution. Furthermore, you could do it reversibly."

To picture Ovshinsky, the inventor, as a rube who stumbled upon a revolutionary idea the way the Beverly Hillbillies happened upon black gold would be far from accurate. Stanford Ovshinsky did

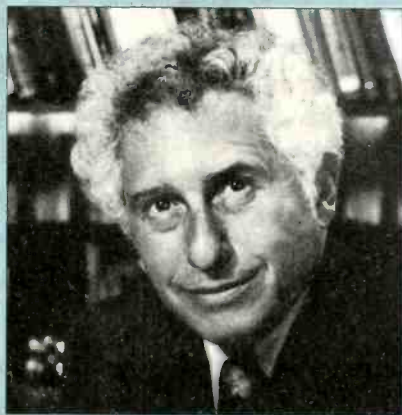

Stanford Ovshinsky

not happen upon any of his inventions by accident nor is he unsophisticated about their market potential.

The 62-year-old inventor, who worked his way up from trade school, through the Michigan automotive industry, to doing brain research at Wayne State Medical School in Detroit, talked about his unorthodox and nonacademic training.

"Being self-taught was the reason I looked at things differently than others," he said. "I wasn't tied down with the baggage of old technology and old concepts and old technical wisdom."

It was while working in biochemistry that Ovshinsky saw a relationship that would stimulate all subsequent studies with amorphous materials. He recognized that the brain was no more than a biological semiconductor. Moreover, he saw a similarity between brain cells and amorphous glasses. Unlike crystalline substances which are stable as a result of an orderly atomic structuring, amorphous glasses, such as chalcogenide, have atoms that are randomly assorted—a method of information transfer that looked similar to the biological maneuverings of the brain.

Ovshinsky would ultimately apply for nearly 200 patents and write 85 scientific papers from this early idea. He has had his share of detractors but, then again, there were also those who listened and took out licenses: most notably, Sharp Corporation of Japan and IBM. No commercial applications were forthcoming, though. In 1974, he took the idea to the Japanese electronics giant Matsushita Electric Industrial but returned to America without a deal. Even his supporters agreed that it was an idea ahead of the times.

"I felt very lonely out there for many years," he said.

Then in 1983, nearly ten years after he presented them with the idea, Matsushita made a big media splash with an information storage medium of the future: a readable and erasable optical disk process. In what many considered "a major coup," the Japanese company, known for its brand names of Panasonic and Quasar in the U.S., introduced an Optical Document File System that stores 10,000 documents on eight-

*(Continued on page 94)*

# IS YOUR COLOR FADING AWAY?

## ADD MORE COLOR TO YOUR COLOR COMPUTER WITH

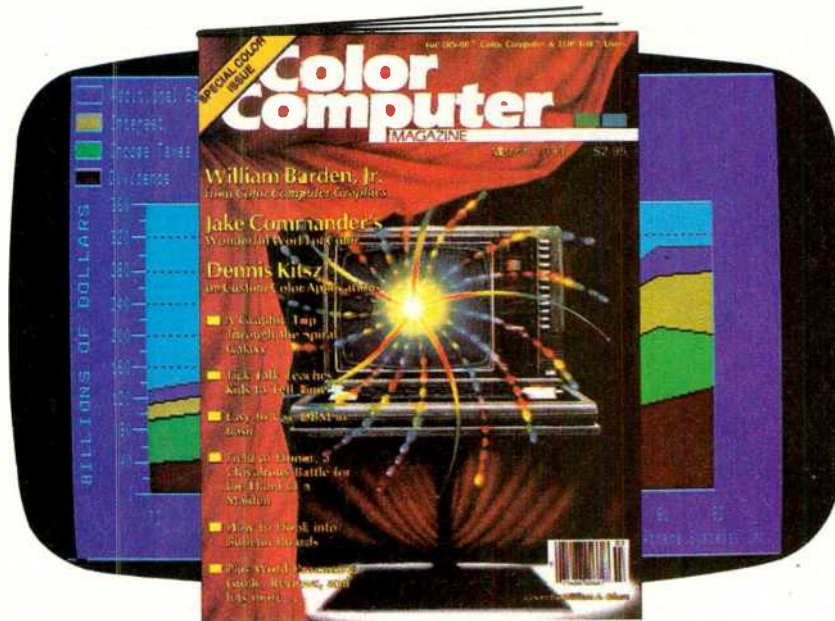

**H**ave you been looking for the magazine to make your Color Computer more colorful... versatile and fun?! It's here... in full color... with bright new ideas, programs and games—The COLOR COMPUTER Magazine, the magazine for TRS-80 Color Computer users and owners! Every issue of The COLOR COMPUTER Magazine brings you a new "users manual" and program guide each month! You'll get:

- Programs for home and business... adults and kids!
- Software and Hardware reviews on the best (and least expensive) ways to upgrade your system!
- Games of skill, chance and luck!
- Sound and music synthesizing tips!

- How-to articles for the "Do-It-Yourselfer"!

You'll also find current listings of new products, directories and compatible peripherals for your Color Computer!

ADD "LIVING COLOR" TO YOUR HOME COMPUTER AND SAVE UP TO 41% WITH The COLOR COMPUTER Magazine!

### YES!



I want to make my Color Computer more versatile! Please enter my subscription to **The COLOR COMPUTER Magazine** for:

- One year for \$17.97. I SAVE 28%!
- Two years for \$31.97. I SAVE 36%!
- Three years for \$43.97. I SAVE 41%!

Savings based on full one-year (12-issue) subscription price of \$24.97.

Mr/Mrs/Ms \_\_\_\_\_ please print name in full TR8H153

Company \_\_\_\_\_

Address \_\_\_\_\_

City \_\_\_\_\_ State \_\_\_\_\_ Zip \_\_\_\_\_

**Check one:**  Payment enclosed  Bill me later

Charge my:  American Express  Visa  MasterCard

Card No. \_\_\_\_\_ Exp. Date \_\_\_\_\_

Please allow 30 to 60 days for delivery of first issue.  
Add \$8 per year for Canada and all other foreign countries.

THE COLOR COMPUTER MAGAZINE—P.O. Box 2597—Boulder, CO 80322

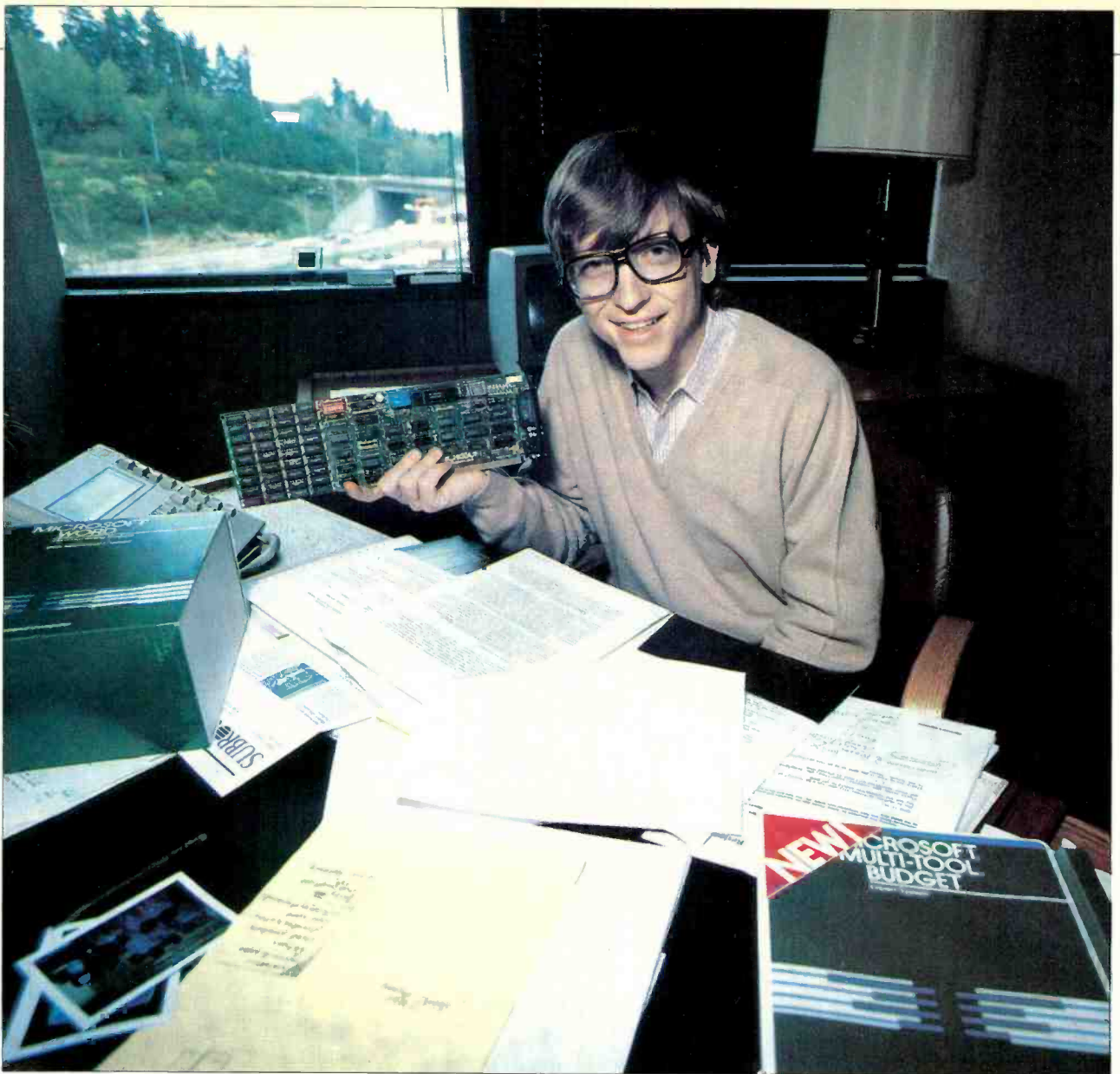

# BEYOND THE BASICS AT MICROSOFT

*An inside look at the largest independent software developer*

## **Who Are Those Guys?**

Of the approximately 5,000 companies developing software solely for microcomputers, Microsoft is the oldest, largest and most profitable. Bill Gates, 28, co-founder and CEO, wrote the first BASIC for Micros with his high school friend, Paul Allen. That was back in 1975. Two years later, Microsoft did \$5

## **BY GREG GIANAS**

million in sales with five employees. Last year the company sold \$68 million worth of languages, operating systems, RAM cards, OEM contracts, and applications tools.

Today, the burgeoning company em-

loys more than 500 people and plans to occupy a fourth, 62,000-square-foot, building before the end of the year. Who are those guys? What makes this company tick, who are the innovators at Microsoft, what are they doing, and where do these exuberant people believe they are taking the microcomputer industry?

### Dormitory Atmosphere

If you were to walk through the narrow halls of any of Microsoft's three buildings in Bellevue, Washington, you would see that nearly everyone, from self-proclaimed "go-fer" to product manager, has his own office with windows. The halls are virtually quiet with the only noise coming from people typing on their Zenith terminals inside their glass-and-plaster "bubbles." Except for the modern windows, the atmosphere resembles a college dormitory for math majors. Everyone is dressed informally and there is an air of intense concentration.

Despite the quiet facade, many of those who are recruited by Microsoft feel a strong undercurrent of pressure.

... It's like an honors class in college: it's not easy to excel here."

### A Terminal in Every Room

As in most prestigious schools, there is almost an invisible bond linking everyone together. Having a terminal in nearly every room helps establish this bond at Microsoft.

Perhaps foreshadowing the future, the workers are tied together via MILAN (Microsoft Local Area Network). The Xenix-based network enables people to work together and to respond to the requests or comments of others instantly. The gray-and-green, utilitarian terminals aren't just for show; they are used extensively, almost passionately, for both product development and sending



**CEO Bill Gates studies a new software proposal.**

guage. It's efficient because it can be mapped from its source to its object effectively; and it's being adopted by the universities as their standard language. If we picked MESA, for instance, we might have all of the above, but we'd have to get programmers in here and then train them." Microsoft's Xenix is the multi-user OS which links their Zeniths to each other and to their DEC 2060, the PDP-11/70s, and the Vax 11/750. Everyone praised the effects of using the terminals to send electronic mail. "We have an extremely high bandwidth here," said Nahum Stiskin, General Manager of Microsoft Press, "when you get talented and hard-working people within E-mail of each other, you get an extremely exciting environment."

### Center of the World

At Microsoft there are no ergonomically designed work stations to hold the computer terminals which clutter the individualized offices. The terminals sit on simple desks. Expensive paintings don't decorate the walls either. Instead, posters curl around plastic tacks. Some show a map of the world with the word "Microsoft" placed in the center. It is the only location which is marked and identified on the maps.

"It's the center of the Universe here," said Nikora. Nikora was recruited from



**Microsoft President John Shirley at the keyboard.**

Pete Higgins, recently recruited from the Stanford Business School to manage the marketing of Multiplan, described the atmosphere at Microsoft. "You can come here any time of day or night, any day in the year, and find someone here. . . . It's not considered unusual here to be an extremely hard worker.

and receiving electronic mail.

Microsoft's products are constructed on the terminals using "C" language. Leo Nikora, Manager of Systems Products tells why C is used. "We write in C because it's a high level language," says Nikora. "Therefore you get high productivity from it, and it's a portable lan-

### The growing Microsoft campus housing 500 employees.



PHOTOGRAPHS BY CLYDE KELLER

## Microsoft

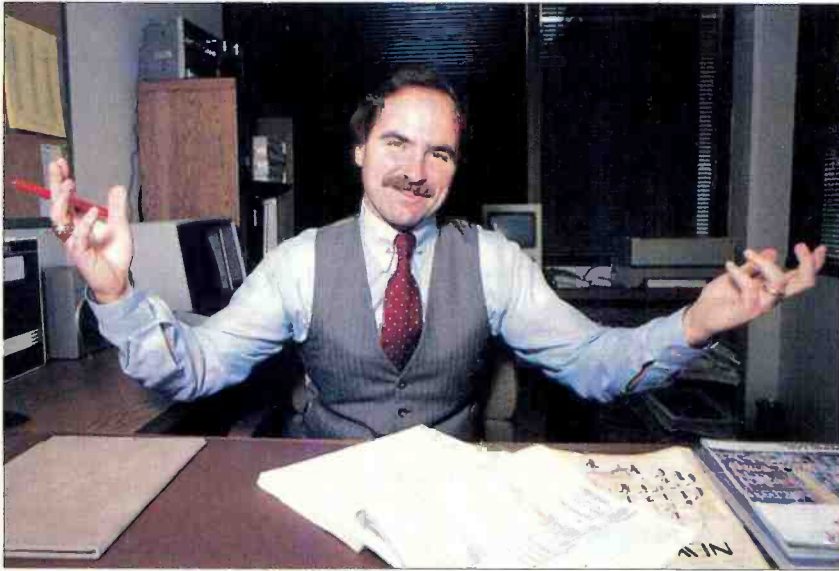

Rowland Hanson is in charge of Corporate Communications.

Xerox's office systems division, where he supervised the development of Ethernet services.

### Making Computers Like Hammers, Windows, and Colt 45s

"Where's Microsoft going? We're making it so that computers will be like hammers you buy in a hardware store: you just grab it and use it. That's how PCs will be after Windows," he said.

Revealing a universal feeling at Microsoft, Nikora explained that Microsoft Windows would democratize soft-



Leo Nikora manages systems products.

ware and make computers more readily available to more people. Windows will make it so "you will no longer have the wizards, the guys in the white capes who know all the control sequences," said Nikora. Windows will enable users to feel that "I'm as good as the next guy; I can make it (the software and computer) perform just like the next guy. Windows is like the Colt 45 of the west; it's the great equalizer: we have the same fire power as the next guy. Most applications in the future will be written in the Windows environment. Forty-two major

OEMs have joined in our effort. This is a monument to the way Microsoft works."

### Developers and Marketers

Nikora was surprised to discover how Microsoft works. Sitting crosslegged on the top of his desk, he recounted his reaction to the position he was offered. "I told Bill (Gates) I wanted to help Microsoft get into the network business, that I knew it cold. I was asked, 'how would you like to be in marketing?' I thought that marketing was for parasites—the people who make it difficult for developers—but marketing is different here." At Microsoft marketing people are transferred from the ranks of developers, within the languages and system sections, so they know what can and cannot be done. Thus, when a marketing manager requests that a certain product be made, he knows what it will take to accomplish the mission.

Much care is taken at Microsoft to enable everyone to standardize the microcomputer industry and make Microsoft the "IBM of microcomputer software."

### Microsoft's New Face

Microsoft's managers and product developers seem committed to serving the needs of the novice user. This differs from the past. Gates has taken purposeful steps to create a new perception of Microsoft by hiring a former image maker of a leading cosmetics firm to help "make Microsoft a quality name," like Estee Lauder or Mercedes.

According to Rowland Hanson VP of Corporate Communications at Microsoft, Gates went to an employment re-

cruiting firm in New York and said "he wanted him to get the best cosmetics marketer he could find—someone with the cosmetic point of view." Hanson was called, while he was VP of marketing for Neutrogena and asked to visit Gates in Bellevue on a Sunday afternoon. Hanson's reaction was: "Bellevue, where's that?—some place in outer Siberia—and, Microsoft? What's this Microsoft—never heard of it!" Nevertheless, Hanson was impressed with Gates's understanding of marketing concepts.

### Moisterizers and Microsoft's Makeup

Hanson began his meeting with Gates by questioning why Gates wanted someone with cosmetic marketing experience to create the corporate image of a software company. Pointing to cosmetics ads in magazines, Gates asked Hanson the difference between one moisturizer and another, besides the fact that one was sold for \$40 an ounce and the other for \$1 an ounce. "There is no difference, essentially," replied Hanson. To this Gates said, "In a nutshell, that's why I'm talking to you. There is a major difference between reality and perception. It's nice to be the technical leader, but we also need to be perceived as the technical leader, because the reality without the perception isn't going to get us anywhere."

Creating the proper perception of Microsoft in the mind of John or Jane Doe is Hanson's mission, and he has a precise plan for doing it. "We are mak-



Microsoft Press Director, Nahum Stiskin.

ing high-performance software," said Hanson, admitting the intent of wanting people to associate Microsoft software with the performance and quality of Mercedes. "People have a product ladder in their mind," Hanson explained, "when they think of quality frozen food, for instance, they think of Stouffers and Sara Lee... But people can't tangibly tell you why they're the best—they just have that perception."

### Women Won't Be Left Out

When asked if he plans to ignore



women as a valid market, as most software developers have, Hanson smiled and took another ad off the wall which showed a woman's hand holding a Multiplan disk. Then he showed another ad with a man's hand holding the "Word." The art work is intended to attract both sexes by subliminally suggesting that, yes, men can benefit from word processing software, just as women can enjoy the time-saving features of spreadsheet software.

Caring about addressing women as an important market segment is not the consideration of just Rowland Hanson. Other developers are also keenly aware of this growing segment of the software marketplace.

Dr. Charles Simonyi, manager of the End-User Applications Group, gave a surprising commentary to the fact that most data processing managers view with disdain the cute little icons on Apple's new Mac. "Their opinion (data processing managers') is not significant," said Simonyi, "I want to know what secretaries and housewives think!"

Simonyi was recruited from Xerox PARC where he was instrumental in writing the "Bravo" software for the Xerox Alto. In 1972 this software em-



**Multi-Tools Group Mgr. Charles Simonyi stands in microforest.**

ployed a "mouse" to move the cursor to a menu of icons—like Apple's "Lisa" and "Mac"—and showed "what you see is what you get" on the screen. Yet, Simonyi had intensive experience with computers long before he wrote software for Xerox. Simonyi's first job was writ-

ing a compiler for a first generation Russian computer (with vacuum tubes) while living in Hungary in 1966. His second job was working his way through college, using a second generation computer, a CDC 6400, at the University of California at Berkeley. Simonyi helped

## C&E TALKS WITH BILL GATES

**B**ill Gates, 28, has built Microsoft from a small 5-person operation to a \$68-million enterprise which employs 500 people. Gates's beliefs in open management and developmental freedom, analysts say, are largely responsible for Microsoft's impressive growth as a leading independent software company in the United States. To get some understanding of how Microsoft's chief executive officer sees the future, *C&E* interviewed Gates at Microsoft.

**Q.** What do you think computers are really for? What will they do for humanity? Will they bring us closer together?

**A.** It's kind of corny to say that computers are meant to bring us closer together. But we actually believe stuff like that. Computers spark creativity. One day everyone will have one.

**Q.** What are you doing at Microsoft to make this possible?

**A.** We were the first microcomputer company. We are the leading microcomputer software company. Our primary mission is to develop state-of-the-art software. We are staying away from vertical markets. That limits our leverage.

**Q.** Do you intend to bring software companies closer together?



**A.** It used to be that hardware was moving ahead of software development without them interfacing with each other. Now we have more of a balance because there is a software layer in between. Microsoft "Windows" is an example of this new technology.

**Q.** Are you conscious of leading the technology?

**A.** The industry has a natural direction of its own. We are trying to keep in touch with what the user needs.

**Q.** How are you trying to do that?

**A.** We get feedback from our technical support department. People call in and say they wish they had this and that. And we take these inputs and collect them. But we still use our own intuition.

**Q.** How do you make it all work so well at Microsoft? Was electronic mail at Microsoft one of your ideas?

**A.** Electronic mail will be a part of the office of the future where networking is totally central.

**Q.** Are there any new products you want to talk about?

**A.** Windows is important. Networking is on its way and so are enhancements to Word such as an upcoming mailmerge, tutorial disk, and new documentation.

**Q.** Will word processing bring more people to computers or will spreadsheets?

**A.** I've always been surprised at how well spreadsheets sell. But I think in the long run, word processing will outsell spreadsheets. Word processing can construct ideas not realized in graphics . . . I've always thought it was important to have a notepad for thinking. ◇

## Microsoft

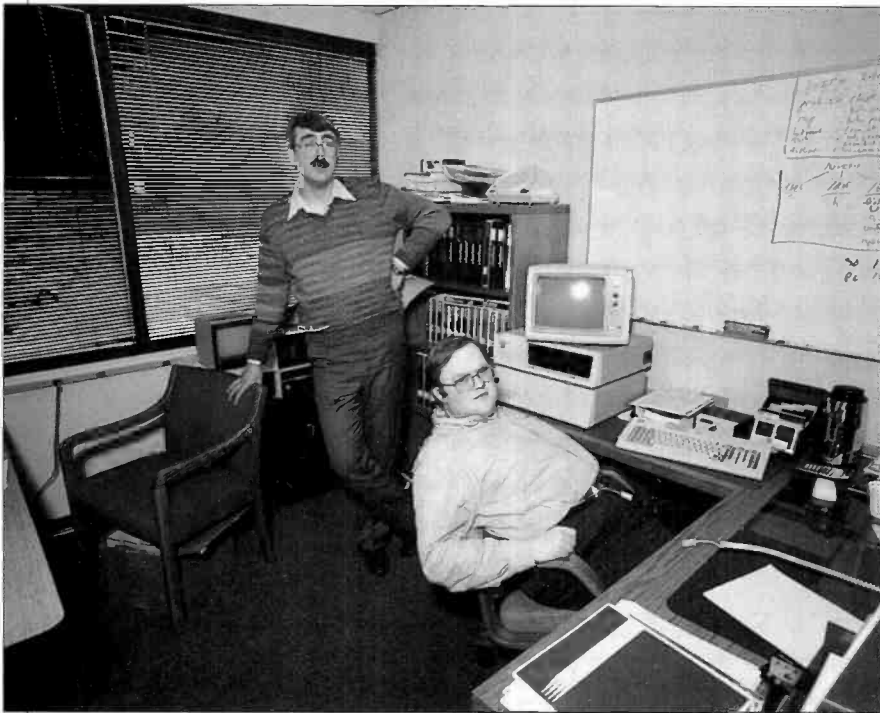

**Rick Farmer, Product Support Manager, talks to Clay Jackson, seated.**

create what he calls the "first real personal computer," (the Xerox Alto), at Xerox. Now, at Microsoft, he's working on the next generation of computer software. "This gives me a unique perspective: I have the same perspective (of computer technology) as a 55-year-old, American computer scientist," he said. Simonyi is 35 and one of the oldest manager/developers at Microsoft.

When asked what attracted him to computers at such an early age, he said, "Why is a fly attracted to fly paper? Flies land on all kinds of objects. They just stick to fly paper. Really, the question should be, 'What makes computers so sticky?' For a young person, computers give the only opportunity to express himself in a serious way. I can count on the finger of one hand the professions a 17 year old can have where he is doing something serious. When I was young, computers gave me a way I could do something serious . . ."

It's no wonder that Simonyi viewed science with seriousness. His father is an electrical engineering professor who is currently writing a book on the history of physics for the University of Chicago Press. What did he learn from his father that may have helped him at Microsoft? Simonyi confessed he had trouble with word problems in his mathematics as a boy. His father taught him an approach to problems he has used ever since: "He (Simonyi's father) said, 'If I told you the result is five, how would you know it is correct? Assume you know the answer,

then checking the answer will give you the equation.' "Simonyi uses this problem solving method when he programs, in addition to dimensional analysis, which he also learned from his father. Essentially, Simonyi said, "dimensional analysis means that you must not add apples and oranges: you can't add temperature and pressure. Einstein said  $E=MC^2$  (Energy is equal to mass times velocity squared). We see that this was dimensionally correct. However, if we heard that  $E=MC^3$ , then we would see that this is not dimensionally correct, because energy is measured in  $Kg M^2/sec^2$  units. In programming, it's the same thing: we wouldn't want to be comparing a month with the number 31; you

would know that something is suspicious . . . Just by looking at the dimension, you can find a lot of errors . . . You won't find all the bugs—it (dimensional analysis) won't tell you what's right—but it will tell you what's wrong."

### Softer Software

Simonyi sees stability and standards as goals that software developers need to achieve. "In the software business at this point," said Simonyi, "we desire stability. Now we have standards: MS-DOS, the Mac environment, Windows, Xenix. These things will develop a more stable environment so better and better software can be developed." What will make software better? "We want 'softer' software." Such software will "acquire knowledge while the user is in the process and then modify its behavior . . . (for example) noticing that the user is proficient in a certain area and then allowing the user to escape unneeded sequences." Just as we must train our pets to have good manners in the house, so too we must train our computers to "behave" the way we wish, said Simonyi. Simonyi does not believe people should be taught to adapt to computers, but that computers should be adapted to people. "Before mice, you had to execute commands which you had to memorize. Now you won't need as much knowledge to operate the machine. With Multiplan, for instance you will use the mouse and just point to the column boundary, push down on a button and the boundary becomes gray. Then you will point where you want the the column to be and press a button and you'll have it. Now, that's

*(Continued on page 98)*

*Greg Gianas is a former newspaper reporter currently working for a large computer retailer in the Seattle area.*

### Willie Tilse and his mouse testing device.

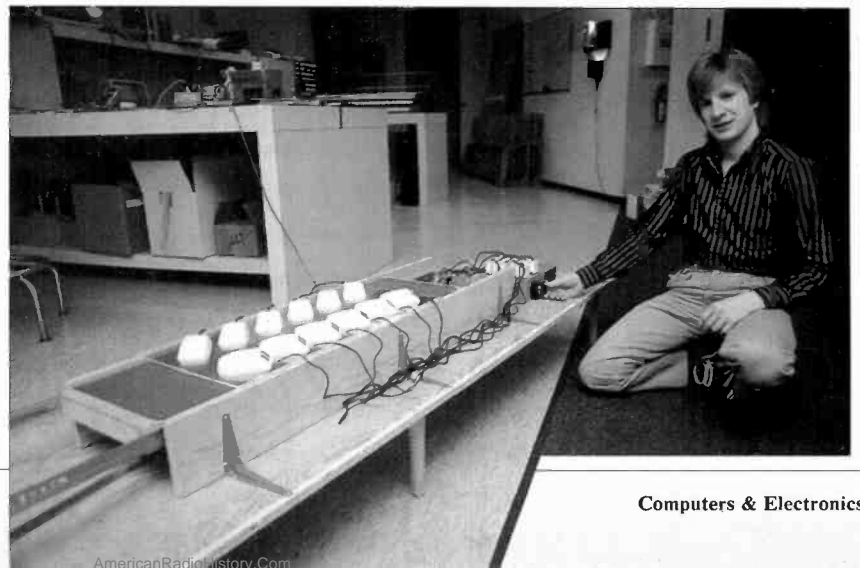

# BUDGET DAISYWHEEL PRINTING

*Smith-Corona's L-1000  
offers letter quality  
at a low price*

**BY JOE DESPOSITO**

**A** FEW years back daisywheel printers were known for two things: letter-quality output and high cost. Letter quality is still a trademark of these printers, but now there are models available at very attractive prices. One of the leading manufacturers of low cost daisywheel printers is Smith-Corona, a company that gained fame producing low cost home/office electric typewriters. Their latest product is the L-1000, a descendant of the TP II line of daisywheel printers.

The L-1000 is a versatile printer that can easily be interfaced with most microcomputers—it has both RS-232 serial and Centronics parallel ports. Print speed is 12 cps, which is faster than most typists, but slow for electronic printing. Thus, the L-1000 is not suited for heavy business use. Suggested retail price of the L-1000 is \$545; an optional tractor feed attachment costs \$149.

## General Features

The L-1000 is about the same size as a portable typewriter (19.5" × 13.5" × 6.4"), but at 20.7 lb it weighs considerably less. A panel on the lower front right of the machine contains a power-on light and three switches. The leftmost switch is a three-position rocker switch used to select 10, 12 or 15 characters per inch. The center switch is the top-of-form switch. This is used to set the top margin on fanfold paper; it also causes the printer to respond to the ASCII form-feed character. The rightmost switch is a form-feed/self-test momentary-action rocker switch. For self-test, you hold down the switch while powering up. At any other time, a press of the switch will cause a form feed of paper to the top of the next page. This switch is also used to index paper one line at a time (the top-of-form switch must be in the clear position).

At the rear are the power switch, ac power cord connector and serial and

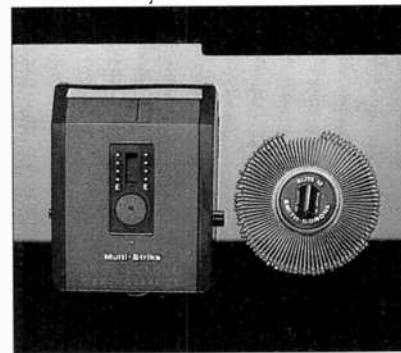
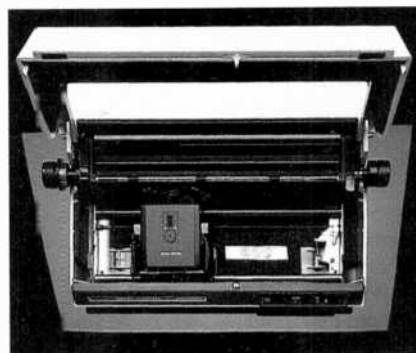

**Under the hood: lower left photo, interior of print mechanism; right photo, ribbon cartridge and print wheel.**

parallel connectors. The top cover of the L-1000 lifts up to provide access to the printwheel and ribbon. As would be expected from Smith-Corona, the ribbon is housed in a cartridge that you can pop in

**Print quality  
is excellent;  
though it may take  
a couple of minutes  
for a typical letter**

and out with ease. The printwheel, however, is not as easy to replace. You first have to locate a hammer-retract dial at the left side of the cartridge holder, turn it and then pull the printwheel off. A variety of printwheels with different fonts

is available.

The L-1000 prints bidirectionally (something secretaries find hard to do) at 12 cps, which is about 125-150 words per minute. It can underline if you send it the appropriate control codes. The pitch, which can be set with the front panel switch, can also be set by sending control codes.

## Interfacing the L-1000 to Your Microcomputer

Any microcomputer that has a standard Centronics parallel or RS-232 serial interface can be hooked up to the L-1000. Generally, parallel interfacing is just a matter of plugging a standard 36-pin male connector into the printer. We used the L-1000 with an Apple IIe and IBM PC without any difficulties or unusual setup techniques.

When using the RS-232 port, however, you must set switches on the L-1000

## Smith-Corona's L-1000

that correspond to your computer's serial protocol. There are two 7-position DIP switches hidden behind a vent at the rear of the printer. One DIP switch selects baud rates from 50 to 19,200, while the other selects various serial conventions such as word length, parity, and busy. With the L-1000, you can use

the paper. If you lay the paper against the paper guide and just roll it through, it sometimes becomes misaligned and gets chewed up slightly on the left side. The paper release lever is not much help. When you pull it up, it allows you to move the paper; but when you push it down, the force moves the paper enough

letters, manuscripts, and term reports. The printer does make a racket while it does its job, and it vibrates somewhat, too. If you place the printer on a movable stand, it seems to vibrate more.

The L-1000 appears to be a reliable machine. We used it for about three months, sometimes all-day long, without any problems.

### Conclusions

The L-1000 printer offers good value for those who need letter-quality output. Once you get used to some of its paper loading eccentricities you shouldn't have any trouble. Interfacing with a variety of computers is simple, and changing ribbons is a snap.

The print quality is excellent, though a typical letter might take a couple of minutes to print out. A variety of typestyles is available just by popping in different printwheels.

I recommend the L-1000 to anyone who needs a reliable letter-quality printer for small to moderate workloads. ◇

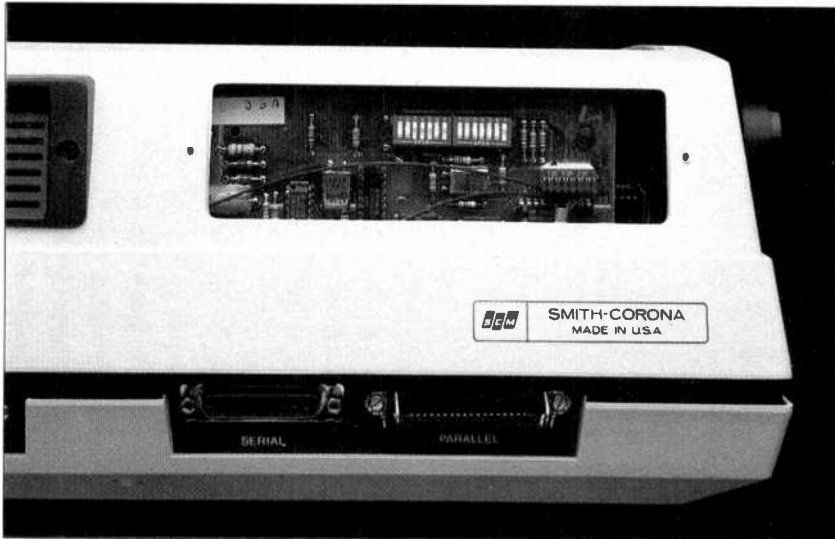

Rear view of printer showing DIP switches.

hardware or software (XON/XOFF) handshaking protocols. We used the L-1000 with the Epson Notebook Computer. Other than removing two screws to get at the switches, and setting them to comply with the protocols described in the Epson manual, we had no problem printing.

### Using the L-1000

The L-1000 can be used with single sheet or fanfold paper. When using it with single sheets, loading paper is similar to loading a standard typewriter. However, it's not easy to correctly align

to misalign it again. The solution we found was to insert the paper a fraction of an inch away from the paper guide, pull the paper release lever up, align the paper, and hold it tightly against the platen when pushing the paper release lever back down. A problem for sure.

If you want to use fanfold paper, you must purchase an optional tractor-feed mechanism, which is fairly simple to install. If you try to use form-feed paper without the tractor feed, your paper eventually becomes misaligned.

The print quality of the L-1000 is excellent and is ideally suited for business

### Specifications

**Product:** L-1000 Daisywheel Printer

**Mfr:** Smith-Corona

65 Locust Ave.

New Canaan, CT 06840

**Dimensions:** 19.5" × 13.5" × 6.4"

**Weight:** 20.7 lb

**Price:** \$545

**Features:** 12 cps print speed; RS-232 and Centronics ports; 10, 12, or 15 cpi manual or programmable select; accepts a variety of printwheels; cartridge ribbon loading; manual/programmable form feeds and line feeds; optional tractor feed, \$149; baud rates from 50 to 19,200; bidirectional printing; DIP-switch selectable transmission characteristics including word length, parity, stop bits, etc.

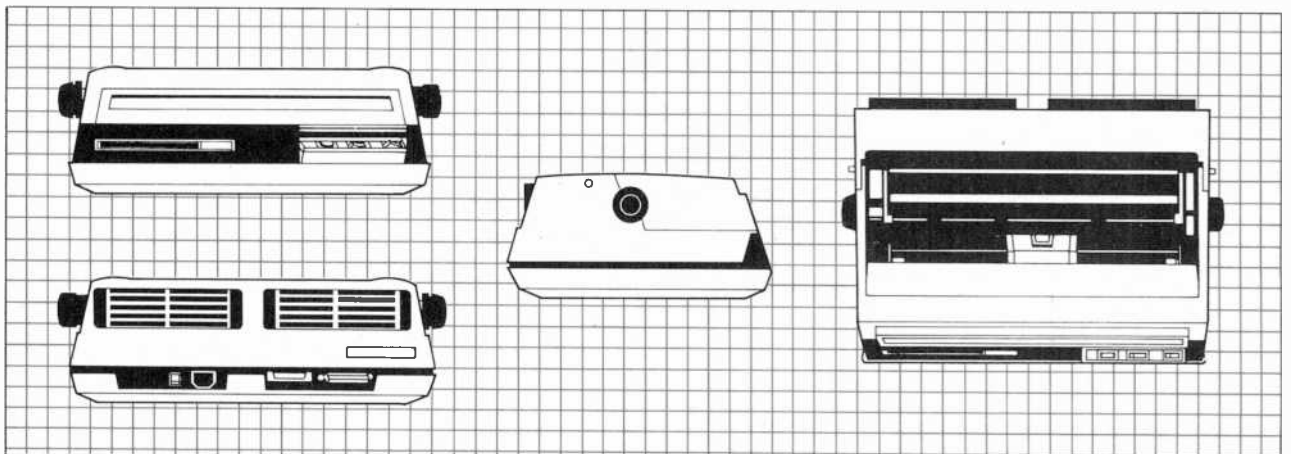

# TO KEEP UP WITH TODAY'S TECHNOLOGY

# ...YOU HAVE TO KNOW WHERE TO TURN.



When you turn to *Computers & Electronics*, you're reading the world's foremost publication covering the microcomputer industry — where last night's discovery is today's technology. *Computers & Electronics* is your direct link to state-of-the-art information in:

### Microcomputer Developments

Whether you're investing \$300 or \$3000, turn to *Computers & Electronics* first. You'll find candid test reports of all major new microcomputers... from the Commodore 64 to the Apple™ IIe to the IBM-PCXT. And you'll discover which unit has the power, software and expansion capability to meet your specific needs. At your specific budget.

### New Peripherals and Software

Micro programs and add-ons are increasing almost geometrically. Let *Computers & Electronics* sort it all out for you.

You'll get features like a buyer's guide to printers. A preview of the first workable economical thesaurus program that runs on virtually any CP/M-based system. Advance looks at new products like a joystick for Visicalc®... disk drive assemblies... a color monitor for the IBM-PC.

### Increase Your Computer Science I.Q.

*Computers & Electronics* will enlighten you with easy-to-understand discussions of computer fundamentals. Such as the series on learning 16-bit microcomputer technology and an in-depth look at the structure of CP/M.

You'll also delve into the future with articles like Super Chip: next-generation personal computers with double the performance at a lower price.

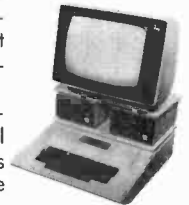

### Plenty of Hands-On Action, Too

With expert input from *Computers & Electronics*, and your own electronics savvy, you'll find dozens of ways to experiment with... upgrade... and increase the versatility and performance of your system.

For example, with less than \$3 and very little time, you can add a feature to your keyboard that lets you automatically repeat a character by holding down a key. Or you might want to build a circuit that lets you match a 600-baud CoCo to a 300-baud printer.

Heard about the important new electrically-erasable PROMs? *Computers & Electronics* will keep you filled in on the improved memory chips as they're produced — how they work, how to wire them, what applications to use them for.

### Get Every Issue... PLUS Savings up to 37%!

If you're not getting every informative issue of *Computers & Electronics*, there's a gap in your knowledge — and enjoyment — of today's high-speed, high-tech revolution. And now's the best time to subscribe, while this introductory offer is in effect: One year (12 big issues) for just \$12.97, with long-term savings available up to 37%!

So keep up with what's happening. Turn to the special postpaid order card or the coupon below...now!



**DON'T MISS ONE INFORMATIVE ISSUE. SUBSCRIBE NOW AND SAVE UP TO 37%!**

WORLD'S LARGEST COMPUTER MAGAZINE  
**Computers & ELECTRONICS**

P.O. Box 2774  
Boulder, CO 80322

**YES!** Keep me tuned in with *Computers & Electronics* for the term I've checked below:

- One year (12 issues) just \$12.97 — **I save 24%!**
- Two years just \$22.97 — **I save 32%!**
- Three years just \$31.97 — **I save 37%!**

(Savings based on full one-year subscription price of \$16.97)

Mr. /Mrs. /Ms.

(please print full name)

CE45168

Address

Apt.

City

State

Zip

CHECK ONE:  Payment enclosed.  Bill me later.

Please charge my credit card:  American Express  MasterCard  Visa

Card No.

Exp. Date

Add \$5 a year in Canada; all other foreign add \$8 a year. Please allow 30-60 days for delivery of first issue.

FORREST M. MIMS III

# THE COMPUTER SCIENTIST

## MORE ON COMPUTER AIDED DRAFTING

**S**YSTEMS and software for computer-aided drafting (CAD) have traditionally been much more expensive than those for word processing. Fortunately, as I described in last month's column, the development of CAD systems designed around personal computers like the Apple II/IIe and the IBM PC family is bringing prices down to much more reasonable levels.

Probably the best buy thus far in commercially available personal CAD software is Robographics' CAD-1 (Chessell Robocom Corporation, 111 Pheasant Run, Newtown, PA 18940). For \$1095, this Apple II/IIe based package includes a precision joystick controller and highly interactive software that can tackle virtually any drafting task.

CAD-1 will provide a powerful CAD system for a total hardware and software investment of around \$3500. If this is too high for your budget and you don't require all the features of CAD-1, you might want to consider designing your own customized computerized drafting system.

I've explored the world of do-it-yourself CAD for several months and have found a way to assemble a custom CAD system using hardware that costs about \$2300. You can assemble a CAD system for even less if you're willing and able to modify the software to accommodate a low-cost x/y plotter. And if you can suffer through the process of storing your programs on cassette tape, you can save an additional \$580. That's the combined price of a disk drive and a switch interface you'll need to operate the graphics tablet and drive at the same time.

If you want to assemble your own CAD system but don't happen to own the particular hardware I've used, you'll still want to carefully review the procedures (and pitfalls) that follow. With appropriate attention to software design, any of the procedures can be directly applied to other hardware systems. For instance, the plotter routines for drawing various symbols and pictorials can be included in *any* driver software.

Don't be distracted by the accompanying samples of art drawn by my CAD

system if you're not interested in producing professional looking electronic circuit diagrams. Though the system I've assembled is specifically tailored for drawing electronic circuits, it can be modified, as you'll soon see, to draw anything from plumbing fixtures to house plans.

### Do-it-yourself CAD

As the diagram in Fig. 1 clearly reveals, even a simple do-it-yourself CAD system requires a fair number of peripherals. My low-cost CAD system is designed around a Radio Shack TRS-80

drawing of the selected symbol previously drawn on the graph paper, the plotter immediately responds by drawing a perfect version of the symbol. The final drawing is assembled piece-by-piece by selecting additional symbols from the menu and touching the pen to the appropriate locations on the tablet. When all the symbols are in place, they can be connected by selecting a *line* option from the menu. Finally, with some extra programming, labels and titles can be added by means of the computer's keyboard.

The monitor (a TV set) is used only to indicate which symbol has been selected

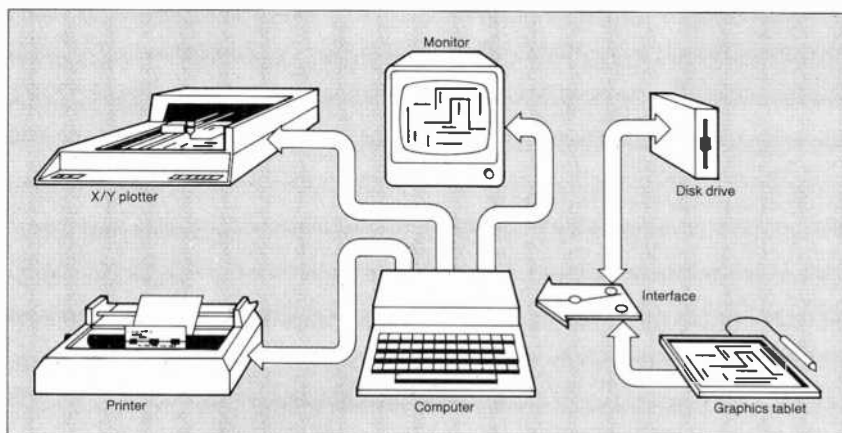

Fig. 1. Do-it-yourself Computer Aided Drafting (CAD) system.

Color Computer equipped with a single disk drive, a TRS-80 X-Pad graphics input tablet, and a Hewlett-Packard HP7470A pen plotter.

A Radio Shack Multi-Pak Interface is necessary to simultaneously operate the disk drive and the graphics tablet. Though not absolutely necessary, a printer is helpful for making software listings, particularly the plotter codes for drawing figures.

As presently configured, my system is designed to be operated only in a *digitizing* (or *trace*) mode. A rough drawing of a circuit diagram is made on a sheet of graph paper and placed over the graphics tablet. The tablet's pen is then used to select symbols from a menu along the borders of the tablet.

When the pen is touched to the rough

drawing of the selected symbol previously drawn on the graph paper, the plotter immediately responds by drawing a perfect version of the symbol. This greatly speeds up the input process since you can concentrate on operating the pen without having to keep watching the monitor.

With the help of the excellent graphics features of CoCo Extended BASIC, which are very similar to those of IBM's PCjr, you can expand the system so that the monitor displays the drawing as the trace is made. If you're ambitious, provisions for rotation, zoom, enlarge, edit, text, and labels can be included in the program. To provide the ultimate verification to menu selections, speech synthesis can be added. I'll have more to say about these ideas later.

### The Graphics Tablet

Though there are many kinds of pointing devices for personal computers, I'm satisfied that for CAD applications in which rough drawings are transformed into publication-quality art, only expensive video camera digitizing methods exceed the operating ease and simplicity of the graphics tablet. Joysticks, trackballs, mice, and lightpens are better for on-screen menu selection and symbol placement.

The TRS-80 X-pad, which is supplied with a friendly, entry-level manual, is simple to use and program. But, as we'll soon see, it's not perfect.

The pad itself includes under its active area a double-sided, etched circuit board. On one surface is a vertical array of 58 parallel, copper traces. On the other is a horizontal array of 45 parallel traces. All the traces are separated by 0.2 inch.

Apparently the X-pad circuitry sends sequential signals through each of the traces so at any instant the traces of only one of the 2,610 overlapping vertical-horizontal pairs are simultaneously energized. A small coil in the tip of the pen detects the electromagnetic field emitted by the traces. Since the timing of the signals through the traces is known, the circuitry can determine to a reasonable degree of accuracy the location of the pen.

It's important to note that the pen does *not* have to contact the surface of the pad to provide location coordinates. However, the pen contains a pressure-sensitive switch to indicate when its point is pressed on the tablet.

As shown in Fig. 2, the X-Pad's coordinate system generally matches that of the Color Computer. The exception is the margin around the entire active area of the pad. As we'll see later, the margin can be used to create a symbol menu.

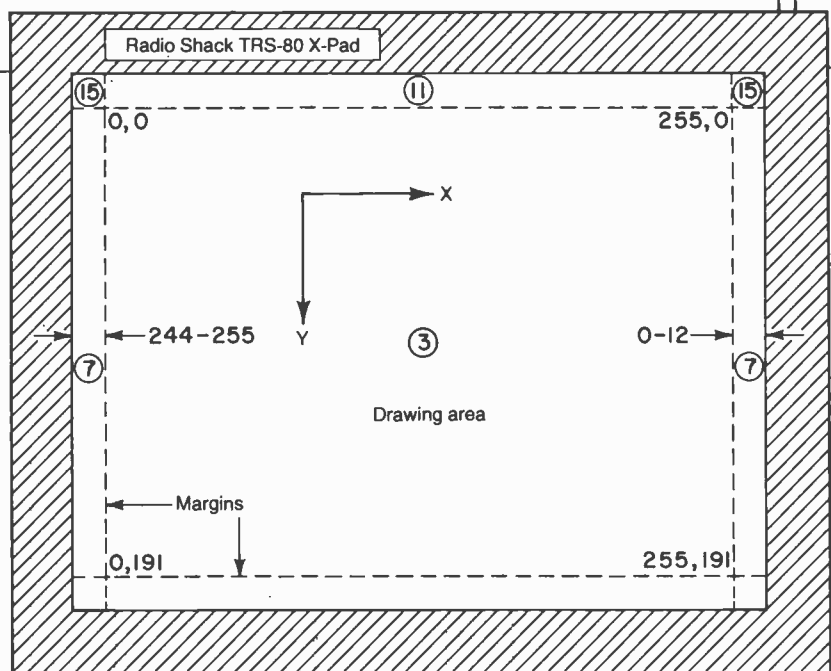

Fig. 2. Coordinate system of Radio Shack's X-Pad graphics Tablet.

In operation, the X-Pad pokes the current pen coordinates (*x* is the horizontal axis and *y* is the vertical axis) and the status of the pen's pressure switch into three RAM locations. This routine will display on the screen all three parameters:

```
10 CLS
20 PRINT @ 7, "X-PAD
COORDINATES"
30 X=PEEK (65376) : Y=PEEK
(65377) : S=PEEK (65378)
40 PRINT @ 135, "X=" ; X ;
"Y=" ; Y
50 PRINT @ 199, "PEN
STATUS: " ; S
60 GOTO 30
```

This routine is very useful, for with it the operation of the X-Pad can quickly be verified. It's particularly useful if your X-Pad is like the one I purchased and doesn't always work properly the first time the computer is switched on.

This problem probably occurs when the X-Pad's connector isn't properly

Signal	Status
0	Pen up and away from pad
1	Pen down and away from pad
2	Pen within 1" of pad surface
3	Pen down of drawing region or bottom margin
4	Pen not within 1" of X-margin (left or right margin)
5	Pen down on X-margin
6	Pen not down but touching paper on X-margin
7	Pen down on X-margin
8	Pen not within 1" of Y-margin (top margin)
9	Pen down on Y-margin
10	Pen within 1" of Y-margin
11	Pen down on Y-margin
12	Pen up but near X- and Y-margin
13	Pen down on X- and Y-margin
14	Pen touching paper in upper left or upper right X-Y corner but not down
15	Pen down in upper right or

Fig. 3. Pen status numbers.

Fig. 4. RS-232 interfacing between a CoCo and HP7470A plotter.

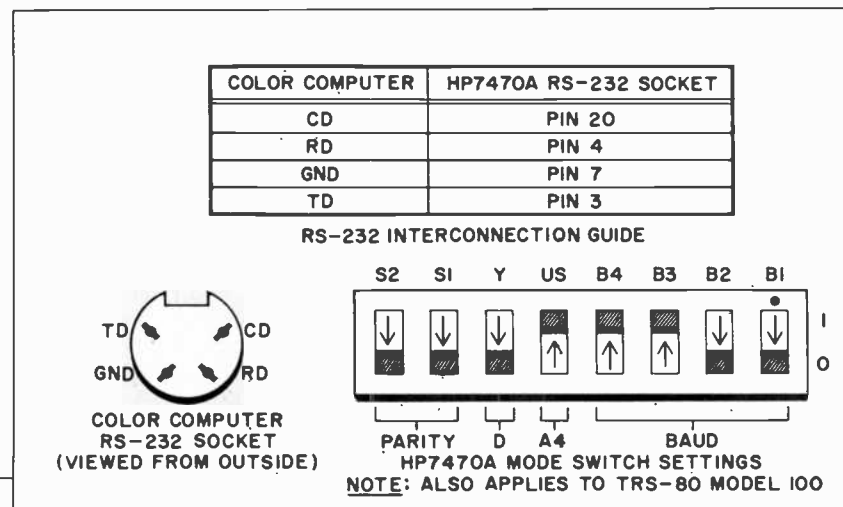

aligned with the socket in the CoCo. When the pad fails to work, the computer must be switched off and the X-Pad's connector removed and reinserted. The status program should then be run again to verify the pad's operation.

The Pen Status numbers are particularly interesting. For instance, a 0 means the pen is not touching the pad and is out of the pad's range. A 1 means the pen is pressed down but not on the pad. A 2 means the pen is within an inch of the pad's surface but is not touching it. A 3 means the pen is pressed down on the pad's surface.

Figure 2 shows the x-y coordinate system of the X-Pad and the pen status that results when the pen is placed down on various regions of the pad. Figure 3 is a

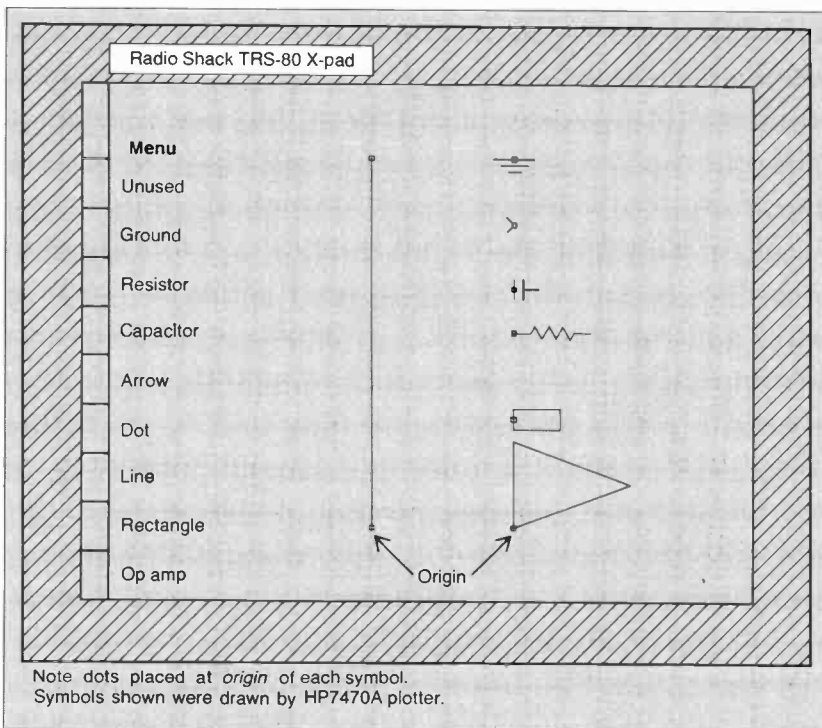

Fig. 5. "Circuit Plot" menu and symbols.

summary of all the pen status numbers. The Color Computer accesses both the X-Pad and a disk drive through the same socket. Therefore, an appropriate expansion interface is required to connect both the pad and a drive to the computer. Though several such devices are made by companies that make CoCo peripherals, I do not know if any of them allow the pad and the drive to operate *simultaneously* as does Radio Shack's Multi-Pak Interface.

The Radio Shack interface requires that the drive be plugged into No. 4 of its four sockets for best results. When this is done, both the drive *and* the X-Pad have simultaneous access to the CoCo, even when the interface's selector switch is at position four.

When the computer and interface are first switched on, move the interface selector switch to position four and press the CoCo's reset switch. If the Disk Extended Color BASIC message doesn't appear on the display after a second or so, try moving the interface switch away from and back to position four and then reset the CoCo again.

Incidentally, *never* remove or insert the X-Pad or disk drive connectors (or ROM cartridges) when the CoCo and its expansion interface are switched on. Instead, shut down *both* systems *before* making any changes.

**Experimenting with the X-Pad.**

Here's a simple routine that allows you to use the X-Pad to make freehand drawings on the computer display:

```

10 'X-PAD TO SCREEN
20 CLS:PCLS
30 PMODE 4, 1: SCREEN 1, 1
40 X=PEEK(65376):Y=
(65377):S=PEEK(65378)
50 IF S=3 THEN PSET(X,Y,1)
60 GOTO 40

```

When this program is run, line 50 checks to see if the pen is pressed down on the X-Pad. If it is (S=3) then a point of color is set at the intersection of the

x/y coordinates at the pen's location. To clear the screen, press BREAK, type RUN and hit ENTER.

The program doesn't cycle as fast as you can draw, so rapidly sweeping the pen across the tablet will leave behind a trail of widely spaced dots. Nevertheless, the program is fast enough to track routine drawings.

This program provides a convenient way to check the accuracy of your X-Pad. Move the pad away from metal objects, hold the pen in a vertical position and trace geometric patterns (circles, polygons, etc.) with a drafting template placed over the pad. The resulting image on the screen will closely resemble the template only when the image is drawn in the center portion of the tablet. Tracing made near the border of the tablet (but not in the menu regions) will be recognizable but distorted.

The final link in a good CAD system is a pen plotter. You can easily add a plotter and expand the previous routine so it draws the same image on both the screen *and* a sheet of paper. This routine is for the HP7470A and other plotters that understand HPGL (Hewlett-Packard Graphics Language):

```

10 'X-PAD TO SCREEN AND
PLOTTER
20 CLS:PCLS
30 PMODE 4, 1: SCREEN 1, 1
40 PRINT #2, "IN:SC0,
255, 191, 0;SP1;"
50 X=PEEK(65376):Y=PEEK
(65377):S=PEEK(65378)

```

Fig. 6. Publication-quality diagram drawn by "Circuit Plot."

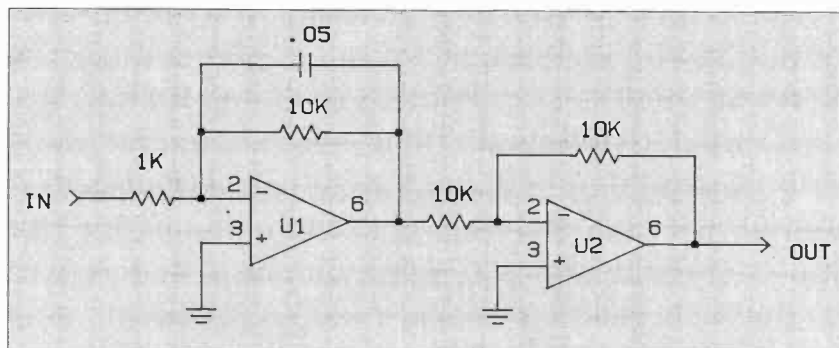
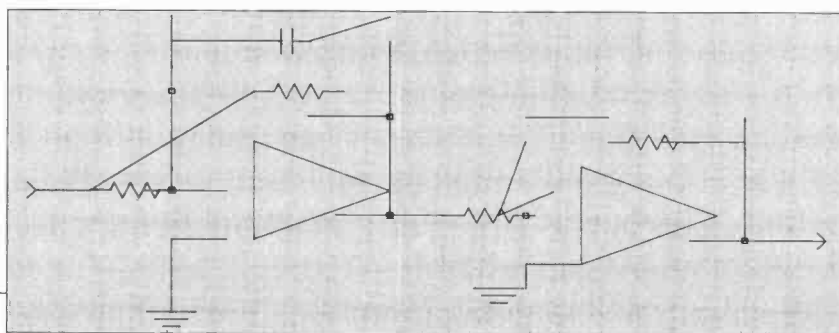
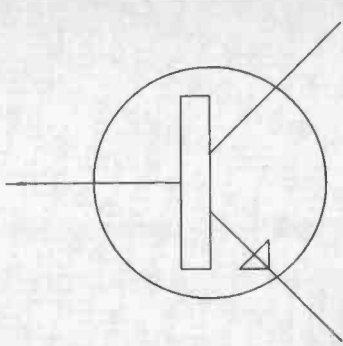

Fig. 7. Circuit in Fig. 6 after a slight grid misalignment.







```

900 PRINT "NPN TRANSISTOR:
SELECT LOCATION."
910 GOSUB 6000
920 IF S < > 3 THEN GOTO 910
930 SOUND 175,3
932 PRINT # -2, "PA"H,V";"
935 PRINT # -2, "SC0,225,160,0;"
940 PRINT # -2, "PD;PR12,0,0,
-6,2,0,0,12,-2,0,0,-6,PU,2,
-2,PD,9,-9,PU;"
945 PRINT # -2, "PR0,22,PD,-9,
-9,PU,4,4,PD,0,-2,-2,2,0,
PU,-4,-6;CI8;PU;"
950 GOTO 10

```

**Fig. 8A. NPN transistor routine.**

```

60 IF S < > 3 THEN PRINT
#-2, "PU;"
70 IF S=3 THEN PSET (X, Y, 1)
80 IF S=3 THEN PRINT # -2,
"PA"X, Y"; PD;"
90 GOTO 50

```

For this program to work, follow the plotter switch settings and RS-232 connections shown in Fig. 4. Because of the time consuming plotter instructions, this program is *very* slow. Therefore, you'll have to move the pen very slowly. Nevertheless, with a little patience, you can make the plotter draw simple maps and pictures by using the X-Pad to trace the originals.

The aspect ratio of the plotter drawings will favor the x-axis, thereby causing them to appear flattened. This occurs because I selected a plotter scale identical to that of the X-Pad. You can revise the plotter SC (scale) instruction in line 40 to improve the aspect ratio.

Now that you know how to interface the CoCo with an X-Pad, plotter and disk drive, you're ready to try a CAD program. One program I've developed, "Circuit Plot", is shown in Listing 1.

Circuit Plot is much simpler than it might first appear. Line 10 establishes a scale for the plotter equivalent to approximately one-fifth the scale of the X-Pad. Line 30 retrieves the pen status (x/y coordinates and pen switch). Lines 40-80 form a menu by dividing the left margin of the X-Pad into ten boxes. The remainder of the program consists of the symbol-drawing routines.

When initially run, the program enters a loop that repeatedly checks the pen status. If the pen is touched anywhere in the left margin, the program

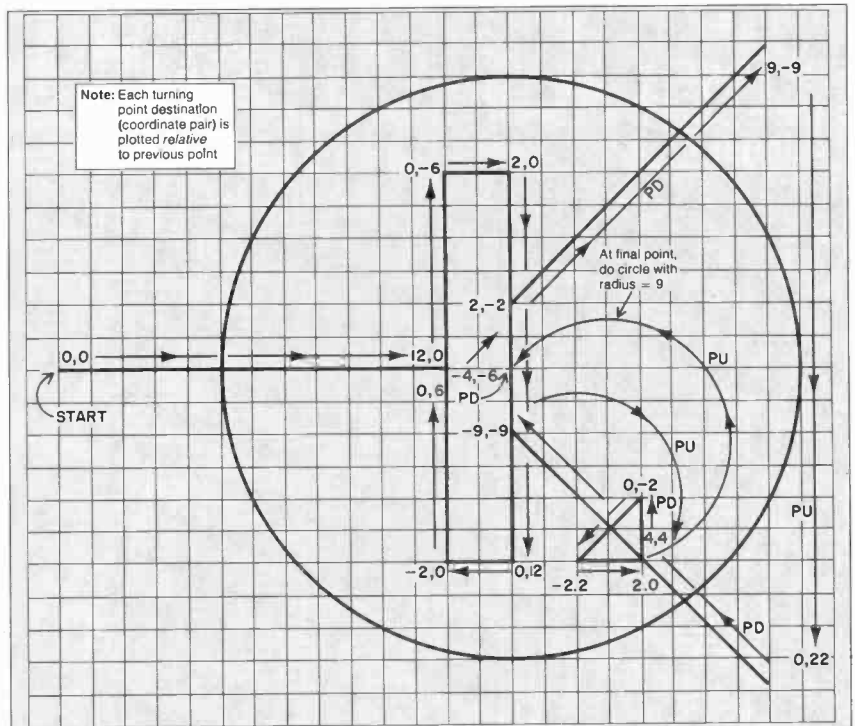

**Fig. 8B. Worksheet showing how npn transistor in 8A was planned.**

sounds a tone and jumps to the symbol-drawing routine at the address given by the menu instructions (lines 70-80).

After printing on the screen the name of the selected symbol, the symbol-drawing routine waits for the pen to be pressed down anywhere on the tablet (see the subroutine at line 6000). When the pen touches the pad, the program sounds a tone and instructs the plotter to move (PA or plot absolute) to the x and y coordinates (divided by five) given in lines 6000 and 6010. The plotter then draws the symbol in accordance with a string of code following a PR (Plot Relative) instruction. After the symbol is drawn, the symbol-drawing routine returns program control to line 30. The program then waits for a new menu selection.

#### Using Circuit Plot

The most difficult aspect of Circuit Plot is making a calibrated graph to be used as an overlay for the X-Pad. Since the tablet is not perfectly linear, the only way to make an accurate graph is to run a program that displays the x-y coordinates divided by five. You can then use the pen to mark on a paper sheet taped over the pad's active area an array of reference dots separated at intervals of one unit.

The X-Pad is much more accurate in its central region. For best results, therefore, ignore the regions near the margins and mark a rectangle of dots surrounding the center of the pad. Next, mark a small colored dot between each of the

previous dots. Complete the graph by connecting the colored dots with a grid of parallel lines. Don't be surprised if the distance between lines varies slightly.

You can draw your rough circuit diagrams on copies of the grid or on tracing paper taped over the original grid. In any event, it is essential that the grid, copy or otherwise, be attached with masking tape in the *exact* position on the pad where it was when the calibration dots were made.

Figure 5 shows the menu of symbols provided in Listing 1. To make a drawing, first sketch a rough version of a circuit on a sheet of tracing paper (or a copy of the grid) taped over the X-Pad's grid. Be sure to use only the symbol available in the menu. The symbols and lines can be crude, but their origins (or reference points) shown in Fig. 5 must be placed directly over a grid.

Next, load a sheet of paper into the plotter and select a symbol from the menu with the pen. After the message on the screen verifies the selection, touch the pen to the origin of the rough drawing of the symbol (see Fig. 5) on the pad. The plotter will immediately draw a perfect version of the symbol.

You can then select another symbol and plotting location. See Fig. 5 to determine where to select origin and destination points for the lines that interconnect various symbols.

When the drawing is complete, you can exit Circuit Plot by pressing the pen down on a surface other than the X-Pad.

(Continued on page 97)

# NEW PRODUCTS



## DUAL-PROCESSOR DESKTOPPER

Computer Technology's Z80/6502-based desktop computer runs both CP/M and Apple software. It comes with 64K (optionally expandable to 256K) of RAM, a 16-color palette in its high-resolution mode, an orange video monitor, an 80-column friction/

tractor-feed dot-matrix printer, a 163K floppy disk drive, and four software packages. Built in are printer, disk drive, language, and 40/80-column interface devices, plus a real-time digital clock. The computer's keyboard offers eight programmable function keys, a numeric keypad, and separate cursor-control keys.

Pressing an EVE key self-tests all I/O ports. Sams Software provided include: Pen-Pal word processor, Instant Recall electronic filer, and Financial Facts and Money Tool financial budgeting aids. \$2195. Address: Computer Technology Int'l., Inc., 200 Murray Hill Pkwy., East Rutherford, NJ 07073.

## LETTER-QUALITY PRINTER

The Model LQ/2 letter-quality printer from Cardco is "Commodore ready" and is input-compatible with computers that have Centronics-standard parallel output ports. Standard features include 12-cps printing speed; compact, lightweight design; friction feed for handling roll and cut-sheet paper; 8½-in. carriage; drum-head design; and bold and underlining printing capabilities. Power for the printer can be obtained from the ac line or, optionally, from a battery pack. \$349.95. Address: Cardco, Inc., 300 S. Topeka, Wichita, KS 67202.



## VOICE SYNTHESIZER

The Voice Pak from Spectrum Projects is a phoneme-based voice synthesizer add-on for the Radio Shack TRS-80 Color Computer. It uses the Votrax SC01 synthesizer chip, in cartridge format, to provide an unlimited vocabulary with automatic or user-supplied inflection, variable voice level adjustment, and four programmable levels of pitch. A single line of code allows The Voice Pak to add speech to any BASIC program. The system comes with demo software on cassette, text-to-speech scanner, and a Word Manager that constructs custom user dictionaries. \$69.95 + \$3.00 S/H. Address: Spectrum Projects, 9315 86 Dr., Woodhaven, NY 11421.

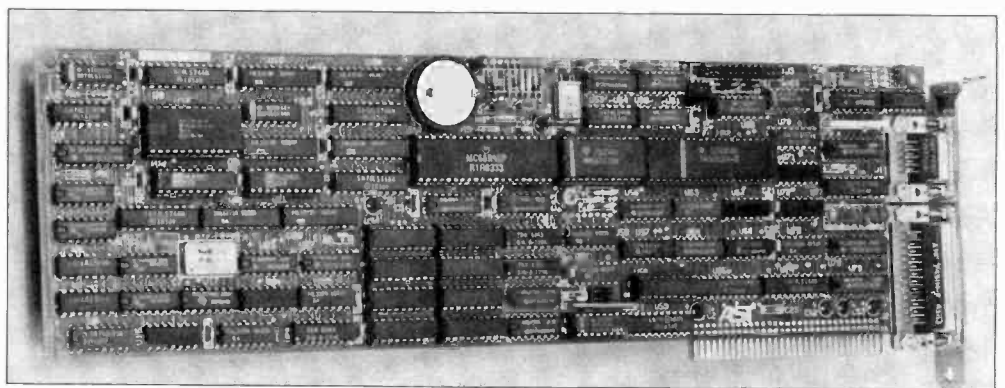

## MULTIFUNCTION GRAPHICS CARD

The MonoGraphPlus from AST Research adds high-resolution and bit-mapped graphics capabilities to the IBM monochrome video monitor. Compatible with Lotus 1-2-3 and other popular programs, it lets IBM PC-XT

users take full advantages of the graphics attributes of the software and provides a flicker-free display. The card features an IBM-compatible parallel printer port and PC-DOS-compatible clock/calendar with battery backup and comes with AST's SuperPak software, which includes

AstClock, SuperDrive, and SuperSpool. An optional IBM-compatible serial port is available. Requires: IBM PC or PC-XT with floppy disk drive, 64K of RAM, and IBM monochrome video monitor. Address: AST Research Inc., 2121 Alton Ave., Irvine, CA 92714.

## VIDEO MONITOR STAND

A new stand for computer video monitors is now available from Coin Controls. Made of ABS plastic, the pedestal-style stand features horizontal swivel and vertical tilt so that the user can position his monitor for most comfortable viewing. The stand is designed to accommodate most popular video monitors. \$29.95. Address: Coin Controls, Inc., Competition Pro Div., 2609 Greenleaf Ave., Elk Grove Village, IL 60007.



## VOICE/DATA WORKSTATION

Ambi's AmbiSet executive workstation places a two-line voice/data PBX on a desktop to automate business communications and provide processing capability that can be upgraded to include full compatibility with IBM and MS-DOS computers. Standard features include: typewriter keyboard; 8 × 80-character

LCD screen; 8088 CPU; 128K user RAM; 64K battery-backed CMOS RAM for fast-dial directory; 45K EPROM personality modules; RS-232C serial port; proprietary 50-pin Telephone Access Bus (TAB); 300/1200-baud operation; "smart modem" features; software architecture compatible with the IBM PC. Mass-storage and a full-size video display

monitor can be optionally added. The system is fully compatible with existing pulse and rotary telephone lines. The personality modules allow the system's 10 function keys to be custom programmed to exactly meet specific communications needs. Address: Ambi Corp., Marketing Services Group, 1033 Washington Blvd., Stamford, CT 06901.

## MULTIFUNCTION PC CARD

Synetix's new PC Handler for the IBM PC, PCjr, and PC Portable, PC-compatibles, and the Apple II is a multi-function board that allows multiple PCs to share a common printer, modem, hard disk, or other peripheral. An on-board CPU and firmware handle all housekeeping chores independent of the

host computer. Among the features included with the PC Handler are two serial ports, four IBM-compatible parallel ports, a clock/calendar, spooling capability, and RAM disk emulation. The board comes with 64K of RAM and is expandable to 512K with 64K RAM chips. \$795. Address: Synetix Inc., 10635 NE 38 Pl., Kirkland, WA 98033.

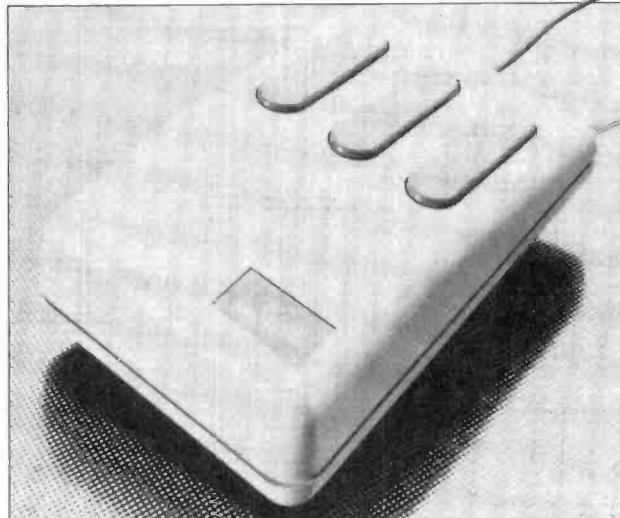
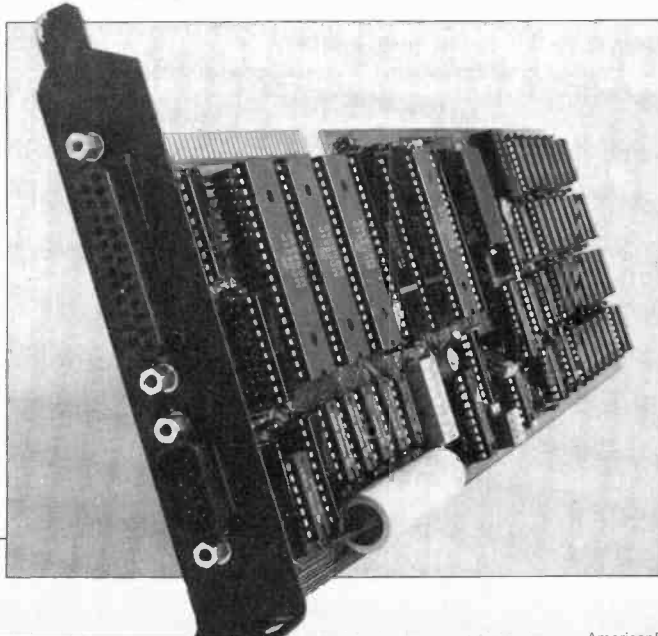

## OPTICAL MOUSE FOR IBM PCs

PC Mouse from Mouse Systems is an optical mouse for the IBM PC, PC-XT, PCjr, and workalike computers. It comes with Designer Pop-up menu software that enables the user to design and personalize his own pop-up menus. The pop-up menu software eliminates the need to memorize any complex commands.

The user simply selects a command from the pop-up menu by pointing at it with the PC Mouse and pressing one of its three buttons. Connection to the computer is through a standard RS-232C serial interface. Software is a one-time, one-line procedure that requires no modifications to existing applications software. \$295.

Circle No. 83 on Free Information Card

# NEW PRODUCTS

## STREAMING TAPE DRIVES

Two new 500M-capacity streaming tape drives available from MegaTape Corp. permit use of standard off-the-shelf controllers for incorporation into personal computers. Both models use 1/2-in.-wide magnetic tape cartridges. The full-wide Model MT-2210 and half-wide Model MT-2220 drives operate in a 200- or 50-ips streaming mode and a 50-ips start/stop mode. Data transfer rate at 200 ips is 240K per second. Backup of 500M of data can be accomplished in 36 minutes at 200 ips. All encoding and decoding of data is accomplished in the unit's in-

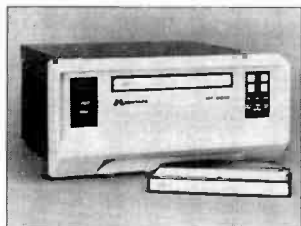

tegral formatter and is transparent to the controller. A unique head-stepping feature permits accessing any record stored in a cartridge within an average of 30 seconds. Diagnostic routines are built into firmware. \$5500 for MT-2210; \$5750 for MT-2220; \$140 per 500M cartridge. Address: MegaTape Corp., 1041 Hamilton Rd., PO Box 317, Duarte, CA 91010.

## DAISYWHEEL PRINTER

Blue Chip Electronics has announced availability of its Model D40/15 CBM Commodore-compatible daisy-wheel printer. Printing speed of the new printer is a relatively fast 35 characters per second. Manufactured in West Germany, the printer comes with a bidirectional tractor paper feeder and automatic cut-sheet insertion/ejection capability. \$1595. Address: Blue Chip Electronics, Inc., Two West Alameda, Tempe, AZ 85282.

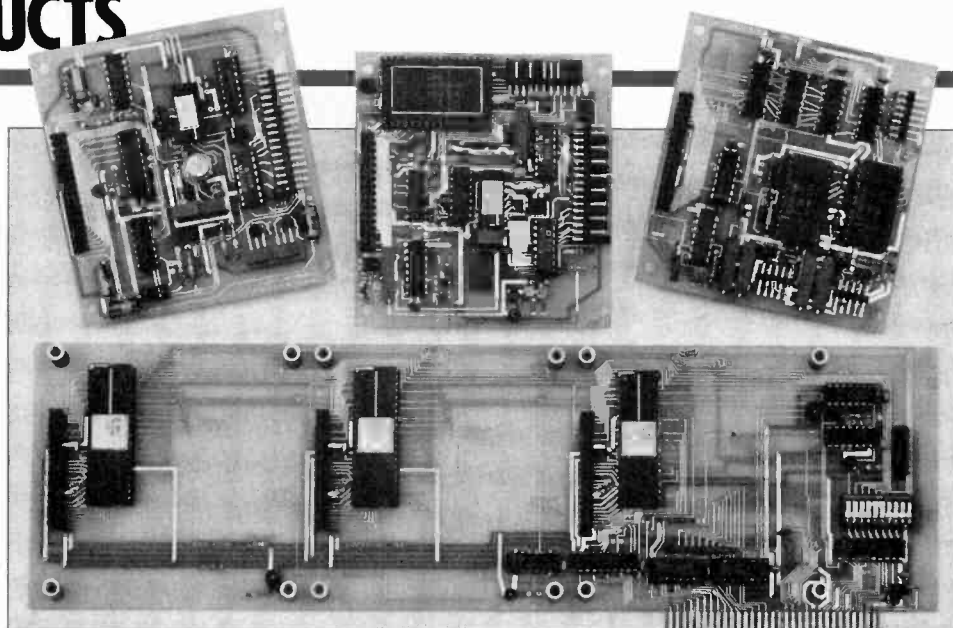

## DATA-ACQUISITION SYSTEM

A family of data-acquisition and control products for the IBM PC has been announced by Qua Tech, Inc. The new offerings include 8- and 12-bit A/D and D/A converter modules and a Parallel Expansion Board. The 72-line I/O Parallel Expansion Board can accept up to three

converter modules, so that the user can specify the configuration that exactly meets his needs. The 8-bit D/A module has a 16-microsecond conversion time and an up to 32-kHz sampling frequency, while the 12-bit A/D module's conversion time is 25 microseconds and sampling rate is up to 25 kHz. Both have either 16 single-ended or 8 differential in-

put channels and provision for an external clock. A Labstar software package containing drivers is supplied with all modules. \$390 for 8-bit A/D converter with Parallel Expansion Board; \$690 for 12-bit A/D module with Parallel Expansion Board. Address: Qua Tech, Inc., 478 E. Exchange St., Akron, OH 44304.



## PRINTER INTERFACE

The Card/? from Cardco is a Centronics parallel printer interface, with graphics capability, that permits Commodore C-64 and VIC-20 computers to be used with any standard parallel-input printer. The card plugs directly into the same slot that normally accommodates the Commodore printer. Card/? has switch or software control of Commodore ASCII to standard ASCII conversion. No modifications are required to either computer or printer, nor is additional hardware or software required, to use the interface device. \$89.95. Address: Cardco, Inc., 313 Mathewson, Wichita, KS 67214.

## HARD DISK PORTABLE COMPUTER

Corona has added the Model PPCXT portable hard disk-based computer with bundled software to its family of 16-bit IBM PC-compatible computers. Features include an 8088 CPU, 256K of RAM (expandable to 512K on a single board), 10M hard disk system, 360K 5 1/4" floppy drive, 80-character by 25-line (640 × 325-pixel graphics resolu-

tion) video display with 9" amber CRT, RS-232C serial port, Centronics-compatible parallel port, 110-watt switching power supply, detached PC-compatible keyboard, and four PC-compatible expansion slots. Bundled software includes MS-DOS 2.0, GW BASIC, MultiMate word processor, and PC Tutor self-teaching program. \$4895.

Circle No. 86 on Free Information Card



# NEW PRODUCTS

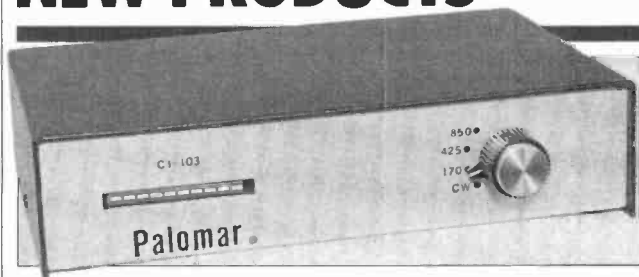

## RADIO COMPUTER INTERFACE

Palomar Engineers' new Model CI-103 is a deluxe computer interface for radio operators. It contains crystal-controlled digital filters to assure selectivity and stability, plus crystal control of transmit tones. Separate 12-pole mark and space filters are provided for all shifts. Other features include: front-panel switches; exclusive relay control of push-to-talk; transmission and reception of RTTY and ASCII signals at 170-,

425-, and 850-Hz shifts; digital tuning meter; plus and minus keying outputs that will handle up to 300 volts; mark and space outputs for oscilloscope tuning. Kantronics software mates the Palomar interface with Atari, Apple, Texas Instruments TI-99/4, Commodore VIC-20 and C-64, TRS-80 Color Computers. \$139.95; \$119.95 for Model CI-103A receive-only interface; \$9.95 for ac adapter. Address: Palomar Engineers, 1924-F W. Mission Rd., Escondido, CA 92025.

## BRIEFCASE COMPUTER

The Sidekick from INCOM Systems is a complete computer system in a briefcase. It consists of a lap-size portable computer, data-type cassette recorder, thermal printer, direct-connect modem, and ac adapter—all nested for protection in an antistatic foam-lined attache case. Computer features include: 8 × 40-character LCD display; BASIC, TEXT, and TELECOM programs in ROM; 32K each of RAM and ROM (can accommodate internally another

32K of RAM and/or 32K of ROM); an external slot for plugging in 32K RAM cartridges; and RS-232C serial, Centronics parallel, floppy disk, CRT, cassette, bar-code reader, and serial I/O interfaces. Additional software provided at no extra cost with the computer consists of six business, six utility, and three entertainment programs. Also included is WRITE+, a text formatter, plus one Traveling Software program. \$1995. Address: INCOM Systems, Inc., 4801 24 Ave. NE, Seattle, WA 98105.



# SOFTWARE SOURCES

**Business Language.** A new version of the Data Business Language (DBL) that provides a minicomputer-like programming environment for microcomputers has been introduced by Digital Information Systems. Written in the C language, the new version of DBL currently runs under MS-DOS on the Hewlett-Packard 160, IBM PC, Data General Model 10, Wang PC, and DEC Rainbow, with support for other major micros expected soon. DBL 4.0 includes several extensions that increase programmer productivity while reducing development and maintenance costs. Language enhancements include software virtual memory, multi-key ISAM files, full-screen programming functions, and a powerful symbolic debugger that reduces the number of compilations and speeds development time. From \$449. Address: Digital Information Systems Corp., 3336 Bradshaw Rd., Suite 340, Sacramento, CA 95827.

**Pascal Compiler.** The Pascal Compiler from Limbic Systems simplifies development of software for customized applications on the Commodore C-64 computer. The compiler generates efficient native code for the Commodore microprocessor. It includes a linker (which permits combining assembler code into a program), debugging facilities, and an editor. The documentation provides a tutorial on Pascal program development through the compilation process. About \$50. Address: Limbic Systems, 560 San Antonio Rd., Suite 202, Palo Alto, CA 94306.

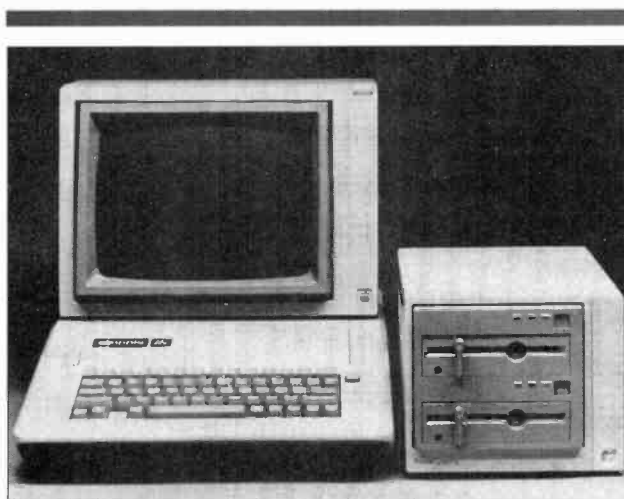

## MS-DOS DISK DRIVE SYSTEM

A disk drive system that enables Apple II computers to run MS-DOS, as well as Apple operating system, software has been announced by Rana Systems. The 8086/2 is a plug-compatible coprocessor and dual disk drive system that uses an 8086 CPU, double-sided 360K drives, and 256K of RAM (expandable to 512K). A separate socket for a numeric coprocessor is pro-

vided. The system contains 16K of ROM, plus 32K of ported video RAM organized into two pages of graphics or eight pages of 80-column by 25-line text. Display modes include a choice of 80 or 40 × 25 characters in either monochrome or color in two software selectable fonts in the text mode and 320 × 200- to 640 × 400-pixel graphics resolution in monochrome and up to four colors. \$1795.

Circle No. 84 on Free Information Card

# NEW PRODUCTS

## PERSONAL INKJET PRINTER

ThinkJet is a personal inkjet printer from Hewlett-Packard. The portable printer can be used with H-P's own computers and computers from a variety of other manufacturers. ThinkJet combines the printhead with the ink reservoir in a convenient disposable unit that can be replaced for less than \$10. Key specifications include: 150-cps throughput; 11 × 12 charac-

ter matrix; multiple print sizes; bold and underline printing with no loss in printing speed; full graphics capability with 192 × 96- or 96 × 96-dpi resolution; 500-page average ink-cartridge life; and tractor and friction paper feed. Centronics, HP-IB, and HP-IL (battery-powered) interfaces are available, average battery life is rated at 200 pages, and noise level is said to be under 50 dB. \$495.

Circle No. 85 on Free Information Card



## MULTIPLE-WINDOW LAP PORTABLE

The IS-11, dubbed the Consultant, briefcase-size computer from Sord offers multiple-windowing capability and integrated business software. The computer features a low-power CMOS processor, 32K of nonvolatile RAM (expandable to 64K), 64K of ROM, 8-line × 40-character LCD window, typewriter-style keyboard with separate cursor-control and six function keys,

rechargeable Ni-Cd battery pack, and ac adapter/recharger. Software in ROM gives the user access to data handling, calculation, word processing, communications, and help functions. The computer measures 11<sup>13</sup>/<sub>16</sub>" W × 8<sup>7</sup>/<sub>16</sub>" D × 1<sup>7</sup>/<sub>16</sub>" H and weighs 4 lb 6 oz. \$995; \$1095 with built-in modem (available in September). Address: Sord Computer of America, Inc., 645 Fifth Ave., New York, NY 10022.

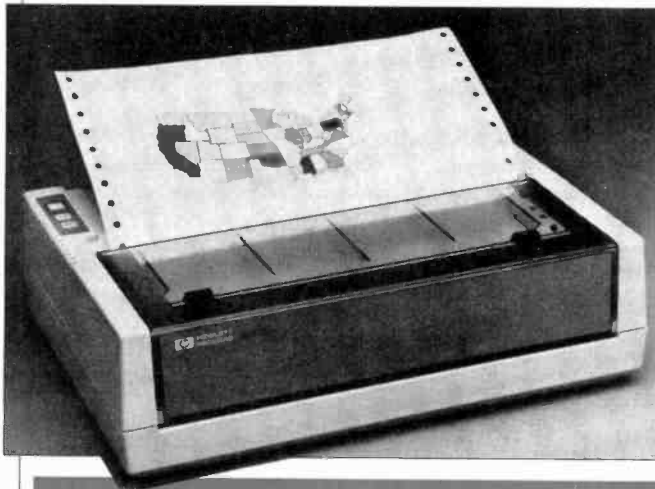

## CLUSTERED SYSTEM BOARD

The XTender printed circuit board from PC Technologies upgrades an IBM PC (with hard disk) or PC-XT to serve as a host for up to five terminals. Each terminal can operate independently, with full use of the host, to create a clustered processing capability. The board slips into the computer's chassis slot, where its 80186 CPU works with the computer's 8088 processor to manage all I/O functions. An 80286 on the XTender board executes all applications programs and a multitasking, multiuser operating system. The XTender is offered with 512K or 1024K of RAM. It requires no hardware or software changes to the host computer and can be operated with a wide variety of ASCII terminals. Address: PC Technologies Inc., 738 Airport Blvd., Box 2090, Ann Arbor, MI 48106.

## DETACHED EXTENSION KEYBOARD

The Data Spec from Alliance Research is a new detached extension keyboard for the Apple II and II+. The full upper/lower-case keyboard offers 97 preprogrammed functions and commands, 20

of which are located on a separate keypad for easy access. All four mathematical functions are located next to a 10-key numeric pad. Also, such key words as FOR, NEXT, PRINT, DIR, PIP, TYPE, and others are available with two-key operations. Data Spec

comes with a 10-ft coiled cable. The keyboard can replace or supplement the existing Apple keyboard. It measures 17<sup>3</sup>/<sub>4</sub>" × 7<sup>1</sup>/<sub>2</sub>" × 1<sup>1</sup>/<sub>2</sub>". \$299.95. Address: Alliance Research Corp., 18215 Parthenia St., Northridge, CA 91325.



# FOCUS ON YOUR KAYPRO

You own a Kaypro 2, 4 or 10, and you use it all the time. Yet you know you can do more with it and get the software to work harder for you. The users manual has helped you, but a guide directing you to the functions you bought the Kaypro for is what you really need. **Look no further, THE KAYPRO: AN APPLICATIONS GUIDE is here!**

This book is not a programming guide, nor is it a technical reference manual. It is a definitive guide on how you can maximize your unit's productivity. Among the topics discussed are:

- Using CP/M to its best advantage
- How MS/DOS can enhance your machine
- How to utilize Perfect Writer™ to its fullest and how to cut editing time in half
- Using Perfect Speller™ with a word processor
- How Perfect Filer™ can be used in a variety of list management and database applications
- Writing with WordStar™ and a comparison of WordStar and Perfect Writer
- Hooking up the Kaypro to a printer, and a configuration table for twenty of the most popular printers.

And specific case studies and uses for writers, academicians, teachers, physicians, lawyers, small businessmen and organizations.

If you own a Kaypro 2, 4 or 10, you need THE KAYPRO: AN APPLICATIONS GUIDE. Order your copy today! ONLY \$12.95!

Available in your local bookstore and computer store.

**For faster delivery, PHONE TOLL-FREE  
9 am-5 pm E.S.T.: 1-800-631-8112  
(In NJ only: 201-540-0445)**

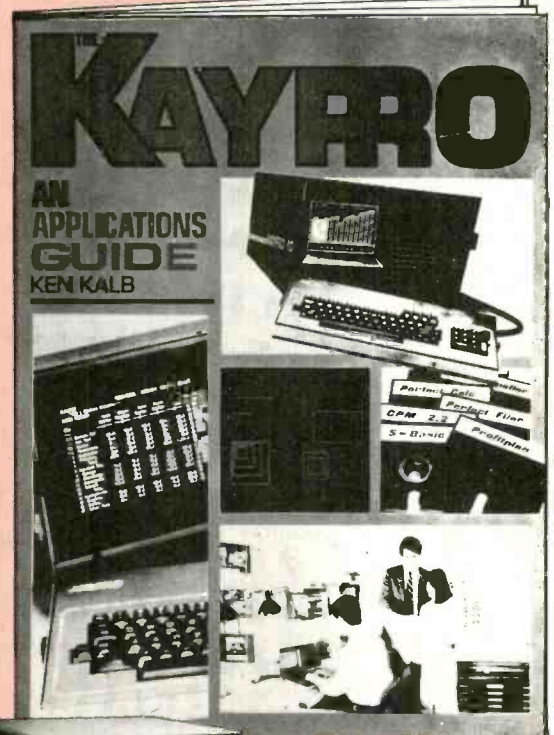

## CREATIVE COMPUTING PRESS

Dept. MV4F, 39 East Hanover Avenue  
Morris Plains, NJ 07950

Please send me \_\_\_\_\_ copies of THE KAYPRO: AN APPLICATIONS GUIDE at \$12.95\* plus \$2.00 postage and handling (\$5.00 outside USA) each. #70-4

**Payment Enclosed \$ \_\_\_\_\_** \*Residents of CA, NJ and NY State add applicable sales tax.

**Charge My:**  American Express  
 MasterCard  Visa

Card No. \_\_\_\_\_ Exp. Date \_\_\_\_\_

Mr./Mrs./Ms. \_\_\_\_\_  
(print full name)

Address \_\_\_\_\_

City \_\_\_\_\_

State/Zip \_\_\_\_\_

Please send free catalog.

Circle No. 4 on Free Information Card

## Mr. Impossible (Continued from page 45)

formation. The frequency patterns are then matched against templates. Storing templates for all the words in a language and for all the variations on pronunciation of those words is literally impossible. And even if it were possible, searching the template memory base for each word as it is spoken by a given person would require an inordinate amount of time even on the fastest supercomputers.

The critical performance features of VAT systems are therefore: (1) the number of words in the recognition vocabulary; (2) how long it takes the computer to recognize and process speech input; and (3) the number of speakers the system can respond to.

Systems that can respond only to a specified voice or voices are called *speaker-dependent*. Systems that can respond to virtually any number of voices are called *speaker-independent*. The number of variables the computer has to handle contributes to processing speed. Speaker-dependent systems can accommodate a larger vocabulary because they do not have to deal with as many vocal variables. Conversely, *speaker-independent* systems have to sacrifice vocabulary to accommodate a larger number of users as is the case with the Bell speech systems.

Research on VAT systems with the fairly large vocabularies necessary for general-purpose text production has been going on for over a decade beginning with \$15 million worth of defense department-sponsored programs at Carnegie Mellon, the Stanford Research Institute, MIT's Lincoln Labs, and the Cambridge-based research firm Bolt, Beranek and Newman among others. Among commercial research and development programs, IBM's ten-year effort under the leadership of information theorist Fred Jelinek is the closest to fruition. Jelinek's project is expected to result in a speaker-dependent office dictation system with a 5000-word vocabulary. Processing time for recognition will be approximately 200-times real time. A user will be required to provide fifteen minutes of speech input in order to "train" the system to respond to his unique speech pattern.

Kurzweil says his speaker-dependent system will offer a 10,000-word vocabulary and processing speeds of 150 words per minute. It will require very brief pauses between spoken words and an hour's training by individual users. Its vocabulary will be somewhat flexible in that words not in the speakers' vocabularies will be dropped from memory and other words that do occur will be added as the system is used.

### Common Hardware— Uncommon Software

According to linguist Glenn Akers, a principal Kurzweil consultant, the difference between the IBM and Kurzweil systems lies in the basic approach. Akers says the IBM effort is "the most advanced VAT next to Kurzweil." He points out, however, that "IBM's is not an artificial intelligence system. They're very strong from the standpoint of information theory. Ray's teams advantage is their strength in AI, linguistics and psychoacoustics."

Kurzweil agrees. All of his pioneering products have largely made use of existing hardware technology. "The Reading Machine for the Blind, for example," he says, "used the standard minicomputer technology of the 1970s. It supplied us with sophisticated, low-cost hardware capable of supporting the extensive memory and compute requirements of AI software. Speech is a more complex pattern recognition problem. It requires more computational power. Technologies like parallel processing and custom VLSI chips to provide that power at a reasonable cost have become readily available in the 1980s."

## Parallel processing, VLSI chips will help recognition problems

Robin Kinkead agrees that adequate and affordable hardware is universally available. Kurzweil Speech Systems has designed and built its own computer—a parallel processor operating under Unix and programmed in C which is 200 times faster than a conventional 32-bit microprocessor-based development system like the Motorola 68000 and about 50 times faster than a VAX supermini, the system most often used in AI application development. The homegrown parallel processor allows software developers to write, prototype, and test software subsystems for the VAT. And the company has custom-designed the chips that will go into the VAT system itself. "Our chips aren't that complex, though," Kinkead says. "We aren't pushing the state of the art in hardware."

Kurzweil is pushing the state of the art in software. It is his track record of

success in achieving significant breakthroughs in pattern recognition software that has investors, co-workers and industry analysts convinced that he'll produce the promised VAT system on schedule.

In July 1983, at the end of the first year of development, Kurzweil Speech Systems integrated its major software subsystems in the lab and ran a voice input test. It took ten hours of computer processing time for the infant system to recognize a word accurately—but it was the recognition that was important, not the processing speed. The test proved it was possible to build a workable system.

### The Breakpoint that Precedes Success

In each technological development project, there is a breakpoint that, once reached, demonstrates that the ultimate goal will be achieved. It's a lot like cracking a cipher. Once the basic coding scheme is figured out, there is no doubt that you'll be able to translate messages written in that cipher.

In 1974, when Kurzweil and others began working on the Reading Machine for the Blind, OCR—optical character recognition—was already a familiar technology. Black numerals on the bottoms of checks and pricing and inventory control stripes on packages in the grocery store had been around since the 1960s. Those numerals and stripes have to be very precisely and consistently formed, however, in order to be legible to the computer. Kurzweil wanted to develop an optical character recognition system that could read virtually any typeface and translate that data into speech. To do that, he had to concentrate not on the specifics of the image to be read but on its general and universal characteristics—its pattern. That pattern, once discovered, had to be documented in the memory of a computer system intelligent enough to infer the presence of matching patterns in input material that might represent many variations on the basic pattern.

People don't have any trouble figuring out that a Times Roman Bold A with heavy horizontal serifs is the same as a crisp *sans serif* Helvetica A. *Serifs*, broken type and any number of printing oddities and accidents are irrelevant to the information the character is meant to convey. People see an A as a consistent relationship of angles, lines, closed and open spaces. Unlike literal-minded numerical computers, people reduce letters, words, punctuation marks and the use of space, as in paragraph indentations, to their common visual features. If



the top of an A is missing, we can deduce the letter A from the angle of the two incomplete vertical lines, or we can fill in series of missing letters from their context.

The breakpoint in the development of the Kurzweil Reading Machine for the Blind came a year after the problem was first tackled. Such is Kurzweil's unique genius in the mathematics of pattern recognition that, by 1975, he had an artificial intelligence software system running in simulation that could achieve an acceptable level of accuracy in reading large numbers of diverse print input images that conventional OCR couldn't handle—different typefaces, broken or degraded type, letters touching, and others. The system did not work in real time. Crude, by today's standards, scanning hardware had been used to collect thousands of characters and introduce them into memory. Processing was slow and laborious but the accuracy and versatility were there. Once the basic logic processing software and pattern recognition algorithms were in place, it was, as Kurzweil says, "just a matter of adding the computer and optical hardware to

make a real time system consistent with the cost goals we had in mind for a practical, useful product."

By the end of 1976, the first Reading Machine for the Blind was delivered to the Perkins School for the Blind in Wampanoag, Massachusetts. Its speech synthesizer was perhaps unlovely, but it opened the libraries of the world to blind people at reading speeds that were comparable to a human reader's.

The KDEM, Kurzweil Data Entry Machine, which is used to scan printed text and convert it into machine-readable code, took until 1978 to reach the market. Because the ultimate recipient of the input data is a machine, and not an intelligent listener, the KDEM required greater accuracy and higher recognition speeds in order to make it practical in high-volume data input environments. But the code had been cracked and there was never any doubt that Kurzweil would indeed produce the KDEM.

Development of the Kurzweil 250 computerized piano went even more quickly. Kurzweil Music Systems, Inc. was formed in mid-1982. Less than a year later, the company had achieved its

technical breakpoint with a laboratory prototype that could, as Dick Dalessio says, "freeze dry a note with all its modulations and demodulations and play it back to you as if there were a Steinway in the room." By January 1984, the company was demonstrating a production model to eager crowds of musicians and dealers at trade shows. The system, which can be interfaced with a personal computer, makes extensive use of acoustic and pattern recognition software that is, as is the case with the reading machines, an inimitable and very well guarded trade secret.

### The VAT System Has Been Demonstrated

According to Kurzweil, the VAT project is already well past its essential software development breakpoint. "Speech Systems is ahead of schedule in development," he says. "The expert software modules have been demonstrated to Xerox and others in the lab. The custom VLSI chips have been designed. And we are currently working on the key hardware architecture."

The major software subsystems in-

## discwasher® SpikeMaster™ Surge Suppressor

### Superior protection for your electronics

All electronic equipment needs protection. Computers, televisions and audio systems are all damaged by periodic electrical surges in standard wall current.

The Discwasher SpikeMaster is THE superior suppressor to protect your investment in equipment.

**SpikeMaster incorporates these desirable features.**

- Multimode suppression systems protect against fast rise time surges, absorbing high power surges quickly.
- Multistage suppression systems guarantee protection whether the "hot" wire, ground wire or both deliver destructive surges.
- RFI filtering isolates your equipment from interfering radio signals on the power line.

The heavy duty Discwasher SpikeMaster is attractively designed for home or office. SpikeMaster incorporates four widely spaced outlets, an on/off switch with indicator light and a 6 1/2 foot power cord.

Independent laboratory tests (to stringent I.E.E.E. standards) confirm that SpikeMaster outperforms and out protects suppression devices costing twice as much.

**discwasher** 1407 North Providence Road, P.O. Box 6021, Dept. CE, Columbia, MO 65205 USA  
A DIVISION OF JENSEN AN ESMARK Company

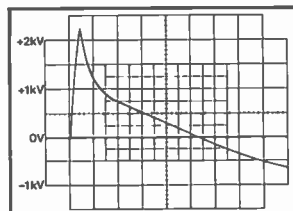

**Surge**  
The 1000 volt unsuppressed surge reaches a peak of 2,200 volts.

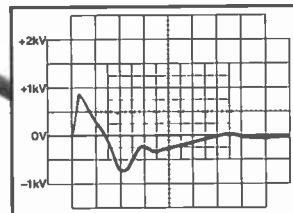

**\$150 suppressor**  
Protection from a unit costing over \$150 allows an 870 volt surge through the line with a 750 volt residual surge close behind.

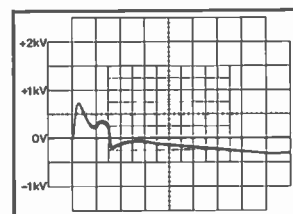

**SpikeMaster**  
SpikeMaster clamps the surge in 30 microseconds. WITH SPIKEMASTER, A LOWER PEAK VOLTAGE AND QUICKER RESPONSE TIME MEANS BETTER PROTECTION FOR ALL YOUR DELICATE ELECTRONIC EQUIPMENT.

## Mr. Impossible

clude a language processor that applies grammatical and syntactical rules and the characteristic patterns of a speaker's voice to the task of inferring what a spoken word will be. Using that process, humans can narrow the possibilities down to around fifty words. The VAT can reduce the number of possibilities to around 500 out of a vocabulary of 10,000. Once the choice of possibilities has been narrowed down, the second major subsystem applies acoustical patterns to the 500 to determine precisely which one is being spoken.

The acoustical subsystem has been the most difficult to create. English—a rich mongrel language bred of Teutons, Celts, Romans, Norman French and a dozen other peoples—has 10,000 syllables compared to a tidier spoken language like Japanese with only 120. (The Japanese, however, may have a more compelling need for a VAT system because their typists have to contend with some 3,200 characters.) Digitized waveforms of speech signals, changes in pitch, phonetic information, syllables and words—information at all these levels has to go into the recognition algorithms.

Kurzweil cites one simple example of the difficulties encountered in developing the acoustical subsystem, "The vocal tract goes through certain transformations to pronounce a vowel. Perhaps the speaker doesn't pronounce the vowel but goes directly into pronouncing the following plosive. The VAT system has to be able to deduce the presence of the vowel from the context of the voice preparation to pronounce it and the following plosive. Syntactical and grammatical constraints also have to be programmed into the system to resolve ambiguities."

Therefore, among the 25-member team of computer scientists, electrical engineers, and human factors experts, speech scientists and linguists are especially important. In addition to Susumo Kuno, Kurzweil works with: Glen Akers, an associate of Kuno's at Harvard in computational linguistics; MIT acoustics scientist Dennis Klatt who developed the recently introduced DECTalk and Speech Plus speech synthesis systems; Francis Ganong, an acoustic speech scientist with special expertise in cognitive computer science from the University of Pennsylvania; and others.

Kurzweil and his research team at Kurzweil Speech Systems are exceptionally reticent to discuss the technical details of their work—one of the reasons, no doubt, that Kurzweil has managed to protect the exclusivity of his inventions.

One may infer, however, that lessons in AI, pattern recognition and, notably, acoustics have been learned during the development of the reading machines and the Kurzweil 250 and have been carried over into the VAT project.

Kurzweil points out, "There are striking analogies between OCR and VAT. Both require template matching or the mathematical equivalent thereof and minimal property extraction. The key is to write algorithms accurate and intelligent enough to recognize universal features reliably and to be able to make decisions about ambiguous features like broken type or an idiosyncratic pronunciation of certain vowel sounds. Property detection routines depend on the context of other properties and conditions. That makes for very complex math and software that has to be able to 'learn.'"

It is virtually impossible to avoid anthropomorphic words like *learn* and *training* in the context of Kurzweil's intelligent devices. Learning and training are an integral part of their operation. KDEM operators, for example, place a

### There are striking analogies between OCR and VAT

book on the scanning plate and introduce its text to the system. When the computer cannot recognize a character, it notifies the operator by putting up a message on his terminal display screen. The operator checks the character and inputs its correct identity. The computer then continues to scan until it is stumped again, at which point it will ask for human help. Because it is an AI system capable of drawing inferences and applying new information to new problems, the KDEM is capable of learning from this training. The more training it receives, the more rapidly it learns, until scanning only a page or two of a new typeface becomes sufficient for it to read everything printed in that typeface indefinitely.

#### A VAT in the Office by 1985?

There is little doubt from a technical standpoint that Ray Kurzweil's promise to produce a working VAT system by 1985 will be, indeed, has already been,

fulfilled. *Scientific American*—the magazine that had two years before unwittingly challenged Ray Kurzweil to develop a VAT before 2020—carried a feature on "Talkwriters" in its August 1983 issue which prominently featured Kurzweil's VAT as a *fait accompli*.

Whether or not the work of configuring a system within a practical cost range will be done by 1985 is not as clear.

By computer industry standards, the KDEM hasn't really enjoyed dramatic price/performance improvements. Although in the interest of fairness, one must point out that the Reading Machine and KDEM utilize labor-intensive and therefore increasingly expensive optical and mechanical components as well as electrical subsystems. The KDEM sold originally for \$120,000. Today a KDEM system ten times faster and with a higher recognition and accuracy rate sells for around \$30,000. Today's Reading Machine, which does not have volume sales to contribute to reductions in per-unit production costs, is around 50% cheaper than the first model and offers greater memory, an expanded recognition capability and a very much improved voice output quality.

Kurzweil says the VAT system makes use of "large standard hardware subsystems that will help bring down the price." And Kurzweil, the mathematical genius who sold his semester project at MIT's Sloan School of Management for \$100,000 plus royalties, has brought production, quality control and marketing experts into his company to supply manufacturing and sales strength.

According to Kurzweil some 85% of all today's business text is created either by hand or by hunt-and-peck typing. The market for a workable VAT system is therefore enormous in terms of text production and editing alone. Database retrieval is a second, potentially much larger applications area. "That's the whole thrust of the fifth generation computer project sponsored by Japan's MITI," Kurzweil says, "providing ease of access to computer-based information and computer tools to non-technical personnel. Natural language processing and VAT are two of the four pillars of the project along with supercomputers and artificial intelligence."

Kurzweil is already working on follow-on products to the first VAT that will be announced in 1985. One of them, he hopes, will be a VAT-based system to enable deaf people to use the telephone with complete freedom and flexibility. No one who knows anything about Ray Kurzweil and his impossible machines doubts for a moment that he'll do it. ◊

# HP LaserJet

(Continued from page 38)

The LaserJet's control panel is a bit bewildering. (There had to be a catch somewhere, didn't there?)

Two seven-segment LEDs provide error (and some status) information as numeric codes that are explained in the user's manual. They are easy to interpret. When the printer is first turned on it undergoes a self-test, indicated by an "05" (a printing self-test can also be invoked manually from the control panel with the SELF TEST key). The message "02" tells you to wait (the machine takes about two minutes to warm up), and "00" means it's ready. A green READY light also illuminates when the printer is set to go.

A MANUAL FEED key allows you to select manual feed of paper a sheet at a time, or to use automatic feed from the paper tray.

There are five membrane switches in all, some with indicator lights that are somewhat perplexing.

There is no RESET button, for example. Should an error condition occur, it will take a little searching through the manual or experimentation to discover that the CONT(inue) button is the one to push to get things started again after the condition has been corrected.

Also, there is no DATA light to indicate that information is flowing from the computer into the printer. Instead, the LED in the ON LINE key illuminates when data starts to flow into the printer's 50K buffer. The light goes off when the buffer is empty.

The LaserJet is not only an inexpensive laser printer. It is an inexpensive laser printer with a number of features.

It offers three modes of operation. The first is the "print" mode, used for document printing. The other two are "portrait" (vertical) and "landscape" (horizontal) graphics modes. An example of the printer's graphics mode output is shown in Fig. 4.

As mentioned earlier, the resolution in the print mode is 300 dots per inch. The default resolution in the other two modes is 75 dots per inch. This is not a limitation of the printer. Rather, it is set to correspond approximately to the display resolution of a computer such as the IBM PC. Under software control, graphics resolutions of 100, 150 and 300 dots per inch can be selected, although the image size will be inversely proportional to the resolution factor.

The printer can accept any one of four paper trays that can hold up to 100 sheets each. Sizes accommodated are: 8½" x 11" (letter size), 8½" x 14" (legal size), and the European A4 (198 mm x 287mm) and B5 (170mm x 247mm)

sizes. In addition, a manual-feed mode can be selected and paper of almost any size (envelopes, for example) fed one piece at a time.

The LaserJet is not limited to printing on ordinary copier paper, though. It will accept any material—letterhead, colored stock, acetate for transparencies, vellum, etc.—that can be run through an ordinary copier. The LaserJet has even been known to print on business cards, although Hewlett-Packard does not recommend this practice.

In its basic configuration, the LaserJet can produce only one character font (Courier 10) and perform only a few special functions such as underlining. The addition of a ROM module called a font cartridge expands its capabilities dramatically. The cartridges are priced at about \$200.

## Specifications

<b>Product:</b> LaserJet 2686A Laser Printer
<b>Mfr:</b> Hewlett-Packard
PO Box 15
Boise, ID 83707
<b>Dimensions:</b> 18.5" x 16.2" x 11.4"
<b>Weight:</b> 71 lb
<b>Price:</b> Under \$3500
<b>Features:</b> Process: dry type electrophotography (toner supplied in disposable EP cartridge with image forming drum). Resolution: 300 dots/in. (text); 75, 100, 150, 300 dots/in. (graphics).

Cartridges are available for a number of type styles and, when in place in their slot at the front of the printer, allow such enhancements as italics, boldface, and sub- and superscripting.

Furthermore, with the font cartridge in place, type sizes can be changed, pitches (characters per inch) varied, and several typefaces selected at will.

Many of the LaserJet's functions and parameters are selectable or modifiable under software control using escape sequences (the ESC key followed by a string of numbers). Some of these sequences are four or five characters long, and would be tedious to use under normal conditions.

There is some good news (and some bad) about this, though. The bad news is that H-P's escape sequences are non-standard. They do not resemble those of any other printer except those in H-P's line. That means that existing word-processing packages will not allow you to make use of features like underlining and boldface without imbedding the complex escape sequences in the body of your text. H-P is working on this problem though, and should shortly have available code-translation packages for a number of software packages.

The good news is that, for most word

processors, there's a sneaky way to alleviate the escape sequence problem. With a keyboard-redefiner program like Talisman or Smartkey II, you can "teach" a little-used key ("#", for instance) to output a string of characters . . . i.e., an escape sequence.

In conjunction with a command such as PeachText's "OUT," you can thus send a complex escape sequence to the LaserJet with just one keystroke.

## Is It Worth It?

What is it that makes the LaserJet different from "similar" printers costing ten times more? And, do you need a laser printer, even if it is relatively inexpensive?

While it is solidly built, the LaserJet is not intended for heavy-duty use. If you need something that can grind out eight or more pages a minute, eight hours a day, five days a week, you need something more durable.

The LaserJet is duty-rated for 3000 pages per month, or about 130 pages a day. That should satisfy the needs of most small businesses or private individuals (such as writers), but may not be enough for larger operations. Heavier duty laser printers can run practically continuously, and have a throughput about 50% greater.

As far as operating costs go, the cost of the EP cartridge (\$99 in single unit quantities) works out to about 3.3 cents per page. This is a little cheaper than using a plastic multistrike cartridge in an impact printer, but a bit more expensive than using a fabric ribbon. Paper, as always, is extra.

With its (maximum) power draw of 850 watts, electricity may also become a slight factor in cost operating this printer.

However, the LaserJet is fast, clean, extremely quiet, and can generate a number of typefaces and styles. It can, unlike other letter-quality printers, produce detailed graphics, as well.

The quality of its output is equal to or better than an ordinary paper copier. In appearance, the characters produced by the LaserJet are very nearly equivalent to those produced by daisy-wheel and other formed-character printers. (In fact, a new term—possibly Very Near Letter Quality, or VNLQ—will probably have to be coined for printers of this sort.)

If you're in the market for a high-quality printer, you should give serious consideration to the LaserJet. With its speed and impressive array of features, it may be just what you've been looking for. ◊

## Speech Recognition (Continued from page 51)

"wear" abound. This actually simplifies the problem of speech *synthesis*, but it makes recognition more difficult. While it is possible to create algorithms that examine the context in which a word is used to determine its meaning, such programming is difficult and memory and processing time requirements involved make their use impractical, especially in real time.

Another significant problem is noise. How does a computer differentiate between noise and words?

Fortunately, much ambient noise can be attenuated to a level where it is insignificant, or filtered out before it is processed by the speech recognition program. Some noise, though, may occur during intervals between words, or when nothing is being spoken at all.

In an isolated recognition system this can cause serious difficulties. Because the noise is preceded and followed by (relative) silence, it is taken to be speech, and much time can be wasted in the computer's trying to determine the meaning of the input "word."

### **A speaker-dependent system can have an accuracy approaching 99%**

By its nature, though, continuous speech recognition is relatively immune to this sort of interference. Since it is continuously searching for matches for words it knows and rejecting those it doesn't, a continuous speech recognition system automatically rejects noise as simply another word it doesn't understand.

There is another type of noise as well, for that's what unintelligible (or unknown) words can be considered to be. Again, continuous speech recognition, because of its constant processing, can just ignore such noise as something that is not in its vocabulary.

#### **What the Future Holds**

For a limited vocabulary in a stable (although possibly noisy) environment, current technologies perform fairly well. Word-, syllable-, and phoneme-based al-

# APPLICATIONS FOR SPEECH RECOGNITION

**W**ITH computers able to understand human speech—at the moment imperfectly, but in the not-too-far-distant future with a fairly high degree of comprehension—the question of how we will use this facility arises.

The most obvious use is to have computers respond to the spoken word rather than to have to input information from a keyboard. Since one of the most keyboard-intensive computing applications is word processing, an intelligent typewriter (or word processor) comes to mind. Such a device (according to the article elsewhere in this issue on research now being undertaken by Ray Kurzweil) should be with us soon.

Taking this one step further, it should be possible to obtain rough-draft hard copy translation from words spoken in one language to words in another. Such literal translation could then be refined by human translators. And if work in artificial intelligence and speech synthesis continues at the present rate, it may not be too long before it is possible to convert sentences spoken in one tongue directly into speech in another!

What other uses are there for a computer that can understand and react to speech? The disabled who, for one reason or another are unable to type, or find it a laborious task, could certainly benefit from this technology.

Speech-controlled appliances would be a boon to such people. Motorized intelligent wheelchairs are one possibility. Perhaps even robots to fetch and carry.

A speech-recognizing computer has no preconceived notions of how a word is supposed to be pronounced. Those whose speech was impeded by such diseases as cerebral palsy could train a computer to respond to their commands almost as easily as those blessed with normal speech faculties.

Hands-off applications for the general populace should also appear. How about a telephone that responds to the command, "Call John Smith" by dialing his

number for you? Or (and this capability has already been available for several years) consider the ability to turn appliances on or off just by "saying the word". Because the range of audio frequencies required by speech-recognition devices is rather narrow, such commands could even be given from a remote location by telephone.

In business applications, workers performing such tasks as taking orders or inventories could use hard-wired or radio (or optical) links to speech recognition equipment to record the information they gathered directly into a computer equipped to use it.

On a more serious note, a speaker-dependent computer could be used for voiceprinting—validation of a person's identity for access to restricted information or areas.

Perhaps at some time in the future we'll all be voiceprinted at the age of 18, and the record put into a database for use by the police or other agencies.

The more you think about it, the more possibilities occur. And the advent of practical continuous-speech recognition that permits anyone to speak to a computer and be understood brings these possibilities closer to being probabilities.

Will all human-computer communication eventually be through the spoken word? Probably not.

There will still be traditionalists who feel that a keyboard (or pen, for that matter) is the only way to transcribe their thoughts. Further, for a number of purposes it will still be easier to push a button than to tell the computer to push it. Operations requiring precise manual control will still use joysticks, waldos (mechanical devices that respond to the movements of the fingers, hands, or other limbs), and similar means of input.

Most of the applications arising from speech-recognition technology have not yet even been devised. Speech recognition by electronic devices will undoubtedly change the ways in which we work and live. ◇

gorithms have relative advantages and disadvantages, but no one has truly found the "atom" of signals that can be used as the ultimate building block for speech recognition (or synthesis) and enable consistent recognition of a large and varied vocabulary.

In parallel with speech signal processing endeavors, artificial intelligence techniques are being explored to enhance large vocabulary accuracy through complicated syntactical structures that can

## How does a computer differentiate between noise and words?

be used to limit active reference candidates. Further, systems can be trained to expect sentence-like input, and to infer meaning from context. In that way, a recognition system will become a speech "understander" rather than just a listener.

### CONTINUOUS SPEECH RECOGNITION PRODUCTS

HERE are two continuous speech recognition systems for micro-computers. Write or call the manufacturers for further information.

**Continuous Speech Recognition Recognizer.** Supports a 150-entry vocabulary consisting of words or short phrases. Will pick out target words located anywhere within a stream of normal conversation. Has capability to translate speech into keyboard commands. Speech recognition software in ROM. VOTAN, 4487 Technology Drive, Fremont, CA 94538. (415-490-7600). \$2450 (IBM PC board), \$3950 (RS-232 stand-alone voice terminal).

**Speech Command System.** Plug-in board assembly for TI Professional computer. Recognizes 50 words per vocabulary; vocabularies can be switched "on-the-fly." Includes speech digitizer with direct connection to telephone (to deliver or record messages, etc.), "transparent keyboard" (voice control of DOS and programs). Texas Instruments Inc., PO Box 402450, Dallas, TX 75240. (800-527-3500). \$2600.



## Sanyo 550

How would you like your Sanyo System? We're selling Sanyo 550 systems with dual 160K disk drives, MS-DOS, Sanyo Basic, Wordstar, Calstar, Easywriter 1, a high resolution Sanyo CRT-36 monitor, and cables for \$1,099.

And now we have the same configuration only with dual 320/360K drives and "double-sided" DOS for \$1399.

If you're interested in buying the hottest micro of 1984, give us a call. Find out why our prices, inventory and product knowledge have made us Sanyo's largest authorized dealer.

ALTOS 586-40... \$7395



## Columbia

Don't buy a clone alone when you can get one with MS-DOS, CP/M-86, Basica, Perfect Writer TM, Perfect Speller TM, Perfect Calc TM, Perfect Filter TM, Fast Graphs TM, Home Acct Plus, Space Commanders, a Tutorial and nationwide Bell and Howell service. (Prices for 1600 series include video card and keyboard).

V.P. \$2249  
Xtra 128K RAM \$279  
1600-1 \$2499  
1600-4 \$3695

### PRINTERS, ETC.

Okidata 92 ..... \$174 off  
Gemini 10X ..... \$115 off  
MT-Spirit 80 ..... \$298  
Silver Reed 550 ..... \$529  
Toshiba 1351 ..... \$1515  
Juki 6100 ..... \$449  
Epsons ..... call for price  
ETC.  
ADD5 Viewpoint ..... \$449  
Password Modems ..... \$319  
160K Drives ..... \$89

# Scottsdale Systems Ltd.

617 N. Scottsdale Road, Suite B, Scottsdale, Arizona 85257

(602) 941-5856

Call 8-5 Mon.-Fri. Closed week of July 4th

We participate in arbitration for business and customers through the Better Business Bureau.

### SERVICE/ORDERING

ORDERING: MAIL ORDER ONLY: If you plan to visit us call for an appointment. Prices listed are for cash and include 3% cash discount. P.O.'s add 2% Visa/Mastercard add 3%. AZ. residents add 8%. Prices subject to change, product subject to availability. Personal/Company checks take 3 weeks to clear. 0-20% restocking fee for returned merchandise. Shipping extra - products are f.o.b. point of shipment. Software is sold only with systems and is not warranted for suitability. Registered trademarks: Wordstar-Microware International; CP/M and MP/M - Digital Research.

### RATED #1 FOR SERVICE & RELIABILITY

CALL TOLL FREE  
800-221-8180  
IN NEW YORK STATE  
CALL (212) 732-8600

# MUSIC WORLD

23 PARK ROW  
NEW YORK CITY,  
NEW YORK  
10038

## THIS MONTH'S SUPER SPECIALS

### ATARI 800XL

\$249.95

- Home Computer
- 64k RAM 256 Colors
- Built-in High Level BASIC

### ATARI 600XL HOME COMPUTER

\$149.95

- 16k RAM Built-in Basic
- Expandable to 64k

### ATARI HARDWARE

- ATARI 1010 Program Recorder \$74.95
- ATARI 1050 Disk Drive \$149.95
- ATARI 850 Interface Module \$169.95
- MICRO PERIF. 64k Exp for 600XL \$119.95

### ATARI SOFTWARE

- ATARI C6000 Demo \$34.95
- ATARI CX4191 Invitation to Prog \$21.95
- ATARI CX4018 Micro Program Package \$45.95
- DATA-SOFT ZAXXON Cassette \$76.95

### ATARI J600 GAMEWARE

- ATARI CX2699 Star \$27.95
- ATARI CX2690 Bengo \$27.95
- ATARI CX2675 Ms. Pac Man \$28.95
- ATARI CX2676 Centipede \$27.95
- ATARI CX2691 Joust \$27.95
- ATARI CX2694 Pole Position \$28.95
- PARKER 5300 Frogger \$22.95
- PARKER 5370 Snakey \$22.95

### ATARI 5200 GAMEWARE

- ATARI CX5209 Baseball \$27.95
- ATARI CX5240 Joust \$27.95
- ATARI CX5206 Galaxian \$27.95
- ATARI CX5217 Pole Position \$27.95

### MODEMS

- ATARI 1050 Direct Connect \$119.95
- ATARI CX5240 Joust \$129.95
- VC 1600 Modem for Vic 20 \$39.95
- VC 1650 Autodial for C64 \$89.95

### ANCHOR AUTOMATION Workstation

- Universal cabling \$54.95
- Specify Cable for Apple, Texas Inst, Atari 2118M \$12.95

### ANCHOR AUTOMATION MK-III

- RS232 Comp. Interf. Compatible \$349.95

### SANYO MBC555

- 128k Color Computer
- Double Disk Drives
- Software Pak

\$1249.95

### MONITORS

- VIC C1707 12" Color \$238.95
- VIC C1720A 12" Color \$259.95
- TAXAN 420 13" Super Hi-Res. Includes 8M Cable \$479.95
- TAXAN 100 17" Green Screen \$109.95
- TAXAN 100 Amber Screen \$119.95
- TAXAN 210 12" RGB Composite \$279.95
- AMDEK 300A 12" Amber Screen \$159.95
- AMDEK 500C 12" Amber Screen \$139.95
- AMDEK COLDE 13" Monitor \$299.95
- ZENITH 281 12" Color Screen \$139.95
- PANASONIC CT160 10" Color \$169.95
- PANASONIC DT1500 13" Color \$349.95
- PANASONIC DT1000 10" Color \$119.95

### APPLE IIe

\$1279.95

- Starter System Includes Monitor, 80 Col. Card, Drive & Controller

### APPLE SOFTWARE

- BARRON'S BU. SALT. DISK \$69.95
- CONTINENTAL HOME ACCT. DISK \$48.95
- SYSTEM COMPILER DISK \$79.95
- SUBLOGIC FLIGHT SIMULATOR DISK \$29.95
- ATARI DISK II User Man. Disc \$29.95
- BROOKBUND BANK STREET WRITER Word Process. Disk \$39.95

### EAGLE PC2 PERSONAL COMPUTER

- 128k RAM
- 2 Drives
- 12" Screen
- IBM Compatible
- MS DOS 3.31 686

\$2449.95

### FLOPPY DISKS

- ELEPHANT BRAND 5 1/4" (80x of 10) \$4.95
- MAXELL MDX 5500 (80x of 10) \$4.90
- BASE FD-10 (80x of 10) \$2.90
- VERBATIM RD-225 (80x of 10) \$2.90
- DYSAN 104 10 5500 (80x of 10) \$2.90
- WABASH 55:00 5 1/4" (80x of 10) \$2.90

### VIDEO GAMES

- COLECOVISION Game Console \$99.95
- COLECO WOD 4 For Atari Cards \$59.95
- ATARI CX7600 Game Console \$84.95
- GOVSEY 4 Master Components \$49.95

### COLECO ADAM

\$499.95

- 64k Computer
- V-1541 170k Disk Drive
- Top-Rated Sierra On-Line
- Homeowner's Word Process

### COMMODORE 64 HARDWARE

CARDCO 7 + C Printer Interface w/ Graphics \$69.95  
V64 CPM Card Version 2.2 \$59.95

### COMMODORE 64 SOFTWARE

- V64 EZ Calc Disk \$59.95
- V64 EZ SCRIPT Desk \$17.95
- V64 EZ SPELL Disk \$17.95
- V64 Nevada Cobol \$39.95
- V64 Nevada Fortran \$39.95
- ATARI 850 to Calstar \$34.95
- SPINNAKER Fraction Review \$24.95

### VIC V1111 16k RAM Expander \$64.95

### VIC V1211 3k more graphics \$69.95

### ATARI-SOFT RKB520 Robotron \$54.95

### ATARI-SOFT RKB507 Defender \$29.95

### ATARI-SOFT RKB544 Ms. Pac Man \$34.95

### DISK DRIVES

- INDUS SYSTEMS Atari CT 180k with DOS \$389.95
- INDUS SYSTEMS Apple CT 180k \$249.95
- RANA 1000 DOS \$349.95
- RANA 1000 For Atari 180k \$299.95
- ATARI-SOFT RKB507 Defender \$29.95
- With Controller Card \$319.95
- RANA ELITE 1 For Apple II \$249.95

### FOR FREE GIANT CATALOGS:

CALL TOLL FREE 800-426-6027

- 288 PAGE AUDIO/VIDEO/COMPUTER CATALOG
- 64 PAGE RECORD AND CASSETTE CATALOG
- 80 PAGE VIDEO MOVIE CATALOG

23 PARK ROW, DEPT. CE7, NYC, NY 10038

HOW TO ORDER BY MAIL: For PROMPT AND COURTEOUS SHIPMENT, SEND MONEY ORDER, CERTIFIED CHECK, CASHIER'S CHECK, MASTERCARD/VISA (include card number, expiration date and signature). DO NOT SEND CASH. PER. SOCIAL AND BUSINESS CHECKS MUST CLEAR OUR BANK BEFORE PROCESSING. \$25 MINIMUM ORDER. Shipping, handling & insurance charge is 5% of Total Order with \$3.95 minimum. WE SHIP TO CONTINENTAL U.S., ALASKA, HAWAII, PUERTO RICO AND CANADA ONLY (Canadian Orders Add 5% Shipping with a \$9.95 minimum charge). For shipments by air, please include these charges. SORRY NO C.O.D.'s, NEW YORK RESIDENTS PLEASE ADD SALES TAX. ALL MERCHANDISE SHIPPED BRAND NEW, FACTORY FRESH, AND 100% GUARANTEED. WE ARE NOT RESPONSIBLE FOR ANY TYPOGRAPHICAL ERRORS.

NO PREVIOUS EXPERIENCE NECESSARY

# BECOME YOUR OWN COMPUTER EXPERT

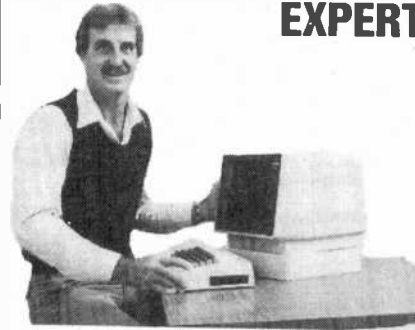

- \* LEARN HOW TO USE A COMPUTER
- \* UNDERSTAND HOW TO CHOOSE AND USE SOFTWARE
- \* WRITE USEFUL, PROFESSIONAL PROGRAMS
- \* LEARN HOW TO MAKE THEM RUN ON ANY COMPUTER

### UNDERSTAND PROGRAMS LIKE:

WORD-PROCESSING  
SPREADSHEETS  
DATA BASE MANAGEMENT  
BUSINESS GRAPHICS  
COMPUTER-AIDED LEARNING  
GAMES AND MUCH MORE!

### UNDERSTAND PERSONAL COMPUTERS

LEARN EVERYTHING about microcomputers, applications, operations, and programming. UNDERSTAND COMPUTER TALK and computer systems. WRITE USEFUL, PROFESSIONAL PROGRAMS. Use and modify any of thousands of readily available home or business programs for your own special needs. Learn about applications software.

Now you can write your own programs and get a computer to do just what you want. Get the most out of any computer by designing your own professional programs. Do-it-yourself and beat the high price of pre-packaged software. Or learn to use computers and applications software, to make your life and your work easier and more productive.

### LEARN AT YOUR OWN PACE IN YOUR SPARE TIME

Our guided independent study program allows you to learn at your own pace, in your spare time, in the privacy of your own home. No classes to attend. Learn on your own with full assurance that our expert instructors will provide you with personalized, one-on-one counseling.

### LEARN EVEN BEFORE YOU DECIDE ON A COMPUTER

Everything is explained in clear, easy-to-understand language. You will enjoy learning to use a computer—EVEN IF YOU DON'T OWN ONE. Learn to program from the first lesson, programs that will run on any personal computer you choose: IBM, APPLE, COMMODORE, TRS, TI and more.

### LEARN AT HOME, TAKE IT TO WORK

Programming is the best way to learn to use computers, and we can show you the best—and most economical—way to learn programming!

Send today for your free information package. No salesman will call.

**halix**  
INSTITUTE

CENTER FOR COMPUTER EDUCATION  
DEPT. 44-7  
1743 So. Vermont Ave., Los Angeles, CA 90006

HALIX CENTER FOR COMPUTER EDUCATION  
DEPT. 44-7  
1743 SO. VERMONT AVE.  
LOS ANGELES, CA 90006

YES! Send me information on how I can learn about computers and programming at home!

Name \_\_\_\_\_ Age \_\_\_\_\_

Address \_\_\_\_\_

City \_\_\_\_\_ State/Zip \_\_\_\_\_

I already have a computer available

Make \_\_\_\_\_ Model \_\_\_\_\_

## Video Display Terminals (Continued from page 59)

the eye's lens geometry in an attempt to bring the display into sharp focus. This process of continuously seeking sharp edges in fuzzy displays may significantly contribute to the symptoms reported by VDT operators.

Since the problem results from shortcomings in VDT display technology, there is little that can be done beyond adjusting the monitor to provide as sharp an image as possible. However, VDT operators can minimize the resulting symptoms by frequently looking away from the display screen and focusing on some well-defined distant object.

There is another, more subtle vision problem arising from the VDT display. If you carefully examine the type on this page, you will notice that it is rather complex in design. The lines that make up the letters vary in thickness. Some lines, like the arm in a lower-case r, have enlarged, rounded ends, and most letters have little "feet" called serifs. These and other stylistic variations in the design of each letter contribute to the quality of the type we read daily.

While there are those who believe complex typography is used for text because it is inherently easier to read, there are others who believe it has become easier to read only because we have become so accustomed to seeing it. Whatever the case, complex typography is demonstrably easier to read and understand than the simple, no-frills characters displayed on a VDT screen. The greater difficulty experienced by the brain in comprehending the meaning of the simple characters displayed on a VDT often result in slower comprehension rates. This, in turn, may frustrate some operators, leading to the headaches and other symptoms reported.

Another factor that affects comprehension is the way in which the characters in a VDT display are produced. Unlike printed characters, which consist of solid lines, VDT characters are produced using dot-matrix technology. Just as it is more difficult to read something printed on an inexpensive dot-matrix printer than on a formed-character daisywheel printer, so too is it more difficult to read a VDT screen than a printed page.

### Introducing Saccades

Still another factor affecting comprehension is the way in which information is taken in by the eye. For most people, the eye increments along a line of type in small steps, called saccades. Researchers have concluded that, on average, type of the size and style usually found in newspapers and magazines is read in five-let-

ter saccades. The characters displayed on a VDT screen, however, are larger than conventional type. Also, whereas the characters in type take only as much horizontal room as they need (proportional spacing), characters displayed on a VDT are generated in dot matrices of uniform width (for example, an "i" requires as much horizontal space as an "m"). As a result, the eye, on average, takes in only three VDT characters at a time, increasing the number of saccades required to read the same information.

Increasing the number of saccades reduces the ease with which information is comprehended in two important ways. First, the brain is presented with shorter fragments that are more difficult to identify. For example, a series of five letters are much easier to comprehend than a series of just three letters each. The result is a reduction in reading speed from a typical 300 words per minute to just 180 or so.

Equally important, increasing the number of saccades also increases the number of eye movements required to read a given amount of text. Over the course of a day, it is reasonable to expect the extra eye movement to increase the likelihood of headaches and other related symptoms.

Behavioral optometrists differ with their orthodox brethren in their approach to improving VDT comprehension. They believe that in many cases the use of low-power "plus" lenses may eliminate the problem. By optically pushing back the VDT screen, the character size becomes small enough to be read in saccades of five letters. Also, since the characters are smaller, their dot-like construction becomes less noticeable. Furthermore, as already mentioned, by pushing back the image, plus lenses can reduce convergence lag.

A relatively large percentage of the general population suffers from reading disabilities of one kind or another. According to the OEP, many studies have revealed that poor readers often have irregular eye movement patterns and prolonged fixations.

Many poor readers are unaware that they suffer from these symptoms; they know only that reading is a problem. As a result, they try to avoid jobs that require a great deal of reading and writing. But as office automation spreads, these people are finding themselves being forced to work with VDTs and, hence, may experience the kind of symptoms being reported. However, behavioral optometrists believe that these reading disabilities can be overcome through visual training.

### Ergonomic Factors

The OEP believes that as much as two-thirds of the symptoms reported by VDT operators are vision related. The remainder result from the ergonomic conditions existing in the workplace.

One of the most important of these is glare. Bright lights, for example, located where they are seen when the operator looks squarely at the VDT can directly affect overall vision. The changes in posture an operator assumes to avoid the glare can, in itself, lead to such problems as astigmatism.

Another important ergonomic factor is reflection. Images reflected off the VDT's screen appear to be "behind" it. Because of this, the operator's point of focus can constantly shift between the screen and the point behind it where the image appears to be located. As a result, the operator finds it more difficult to concentrate on the display and comprehend what is on the screen.

### Flicker

Flicker is another ergonomic hazard faced by VDT operators. Flicker results from a decay in the intensity of light emitted by the CRT's phosphor between scans by the electron beam. It is a function of both the CRT's sweep or refresh rate and the persistence of the phosphors being used. Color monitors, which typically have relatively low refresh rates, are more likely to produce visible flicker than monochrome displays. However, some VDT operators are sufficiently sensitive to flicker that even monochrome displays can cause them visual distress.

Another possible consequence of flicker is its relationship to the small movements the eyes make—the saccades—stepping from one group of characters to the next. The brain normally gathers and analyzes the information contained in one saccade before moving to the next. In susceptible people, however, flicker may induce the eyes to saccade to the next group of letters before the brain has fully comprehended the contents of the previous one. As a result, the susceptible individual will have difficulty following the flow of information presented in the display. Not only will this create frustration and reduce the overall reading rate, the extra eye movements made over the course of a day can contribute to eye fatigue.

Although little can be done to reduce the flicker of existing equipment, VDTs purchased for new installations should be as flicker-free as possible. Since peripheral vision appears more susceptible to the effects of flicker than central vi-

sion, operators should view their VDTs as squarely as possible. This will at least minimize the effects of what flicker their VDTs produce.

Contrast is still another ergonomic factor contributing to VDT operator discomfort. Studies show that increased contrast often improves nearpoint performance. With this in mind, the OEP recommends that the VDT be adjusted so that the characters are 10 times brighter than the screen background, and that room lighting be three times brighter than the characters.

### The Workstation

Last, but certainly not least, there is the matter of the workstation itself. According to the OEP, many VDT-related vision problems can be minimized through proper design and workstation layout (Fig. 3). Ideally, the keyboard, screen, and any printed copy should be equally distant from the operator's eyes. The copy and screen should also be on the same level—about 20 degrees below eye level. A shaded, adjustable copy lamp that can be moved to a position where it does not cause reflections in the VDT screen is also recommended. Finally, the keyboard should be located so that the wrist and lower arm are parallel to the floor.

The OEP also recommends that the workstation should be oriented so that the operator faces an open space beyond the VDT screen. The VDT itself should be adjustable so that the operator can move or tilt it to eliminate reflections and glare. To minimize the potential for operator discomfort, the screen should be cleaned and the focus and image be adjusted regularly.

Even under the best ergonomic conditions, visual distress can occur if operators are required to stare at their VDTs continuously. Because of this, the OEP recommends that operators take a break of 15 minutes or so at least once every two hours. Furthermore, if the VDT workload is especially demanding, the operator should switch for a few minutes to another non-VDT task at least once each hour. ♦

*For more information about vision and VDTs, telephone the Optometric Extension Program Foundation: 800-423-4111 (714-641-3883 in California), or send a stamped legal-size, self-addressed envelope to the Optometric Extension Program Foundation, Inc., 2912 S. Daimler St., Santa Ana, CA 92705 for a free copy of its guide to relieving VDT-related vision complaints.*

## WHY PAY MORE?

BUY AT DEALER PRICES

**30 DAY SATISFACTION GUARANTEE**

(ALL ITEMS 100% APPLE & FRANKLIN COMPATIBLE)



**ZEUS 2001 — \$999.00 NOW \$549.00**

**ZEUS 3005 (Detachable Keyboard) \$599.00**

**APPLE + CP/M + 64K**

- \* 8 Expansion Slots
- \* Auto Repeat Keys
- \* 69 Function Keys
- \* Built-in Cooling Fan
- \* Numeric Key Pad
- \* Expandable To 128K
- \* Color Graphics
- \* Break + Pause Keys
- \* Runs Apple and CP/M Software



**DISK DRIVE\* — \$275.00 NOW \$169.00**

- \* 35 Track SS-DD
- \* Quiet + Reliable
- \* Shuggart Mechanism
- \* 90 Day Warranty



**YANJEN MONITOR — \$179.00 NOW \$119.00**

- \* 20 MHZ
- \* 1,000 Lines At Center
- \* Amber or Green
- \* Super High Resolution

### ACCESSORIES

(100% COMPATIBLE TO APPLE AND FRANKLIN)

	WAS	NOW
1. Disk Drive Interface Card	\$159.00	\$ 59.00
2. TEAC Slimline Disk Drive	\$285.00	\$218.00
3. Z-80 CP/M Softcard	\$199.00	\$ 79.00
4. 80 Column Card	\$299.00	\$ 99.00
5. 16K RAM Card	\$159.00	\$ 59.00
6. 128K RAM Card	\$499.00	\$199.00
7. RS-232 Serial Interface	\$169.00	\$ 79.00
8. Integer Card	\$149.00	\$ 49.00
9. Communication Card	\$149.00	\$ 79.00
10. Parallel Printer Interface	\$159.00	\$ 49.00
11. 16K To 64K Buffer Printerface	\$289.00	\$139.00
12. Epson Printer Card	\$149.00	\$ 34.00
13. Prowriter Printer	\$595.00	\$389.00
14. Super 5 Printer	\$499.00	\$299.00
15. T.V. Interface	\$ 35.00	\$ 15.00
16. Modern Apple Cat II (with S.W.)	\$389.00	\$249.00

works or runs on ours

**DISCOUNT COMPUTERS**

3500 S. Orange Ave., Suite #102  
Orlando, Fla. 32806

**(305) 425-7770**

Ask About Our \$3.00 Phone Credit

Circle No. 2 on Free Information Card

## Helping Managers Manage (Continued from page 55)

sales forecasts, etc.) would be better.

A more serious drawback for some DSS applications is the relative lack of statistical analysis capabilities in the micro systems. This weakness means that such basic model inputs as sales forecasts must be developed elsewhere, or simply assumed.

Again, much of this problem stems from the processing limitations of microcomputers. Multivariate statistical analysis is extremely processing-intensive, and even small analyses can grind on for some time on a micro.

### Display Capabilities

Three display features of interest are onscreen facilities, report generation, and graphics. The micro DSS's of Table I stack up very nicely against mainframe systems here. We've already noted that, besides being a modeling device, a spreadsheet is an effective on-screen display device that reflects changes in any aspect of the model immediately.

One problem with a spreadsheet, though, is that (as with 1-2-3) you cannot see the cell definitions on the display, except for the one where the cursor is located. It is therefore more difficult to see what's going on, particularly for a complex model. This problem is solved in IFPS/P by displaying the model definition in a separate window. Since IFPS/P permits cells to be defined in English, you see a neat set of statements such as:

Profit = Sales - Expenses.

KnowledgeMan has a forms generation capability that can be used for screen input or output (and can be printed as well). Thus you can view model results—on screen or printed—in a completely custom form. Encore!'s report generator offers similar power, as does IFPS/P's. In fact, with any of these systems, one can create presentation-quality reports from models. By contrast, 1-2-3 only permits you to view or print a spreadsheet as it is, with one-line headers and footers, imperfect control over the location of dollar signs, etc. It is quite sufficient, however, if senior management or a client will not be looking at the information, or the report is simple.

Finally graphics are well-supported by Encore! and IFPS/P. To get really nice-looking hard copy, a plotter is important; and even then, these systems lack some features found in full-scale presentation-quality graphics systems. Yet graphics support is impressive. For instance in Encore! you are allowed control of labels, scaling, graph type (bar, stacked bar, floating bar, horizontal bar, scatter plot, line graph, pie chart), legend, etc. IFPS/P and 1-2-3 support col-

or, although without complete user control over which colors are used for what.

To sum up, the micro-DSS's in Table I offer incredible power for the money. Their features compare favorably with mainframe systems costing *several hundred* times more. The two biggest areas of weakness in the micro area are data management and statistics. Both of these functions lend themselves to mainframe processing power.

### Integration

Integration is simply the ease with which different software features are able to work together. And ease resolves itself into two further components, namely, what is possible to do, and what does the user have to worry about?

Another problem with standalone

## Multifunctional microcomputer software has almost outmoded DSS

products is that they all had their own command environment, which obviously made learning them a problem. Along with integrated software has come integrated command structures.

But how integrated is integrated? For instance, suppose you have a series of programs with a similar command environment, but which are sold separately, and which require some data-swapping to be able to work together. This kind of arrangement is superior to completely standalone applications, but requires users to be aware of what the software is doing, what form the data are in, etc.

Integration is particularly salient in any discussion of micro-mainframe systems. It is clearly possible to move data between a micro and mainframe. You don't necessarily have to be a programmer—there are a number of off-the-shelf programs that will work for some situations. But this approach involves users in data management very heavily. You need to be sure that the mainframe data are in an accessible form, that your downloading program knows that form, and whatever micro software you will use can read the data once downloaded. Possible? Sure. Convenient? Not really. In fact, this kind of nonintegrated solution is contrary to the spirit of DSS. Since time is of the essence for managers, a DSS ought to provide resource access

(e.g. to a mainframe) as transparently as possible. You should not, ideally, have to worry about the details of data transfer—you should just be able to say, in effect, "Go get the data."

### IFPS and IFPS/P

IFPS has been perhaps the most widely-used mainframe financial DSS. IFPS/P is built to work with mainframe IFPS, to some extent. In particular, you can share both data and models between the two systems.

Data sharing is accomplished by uploading and downloading data files. IFPS/P has a telecommunications package built-in, so you use it to log onto mainframe IFPS. Once there, you open a "models and reports" file. You return to local micro mode and execute a command to copy the datafile of interest to the micro, or to move it to the mainframe.

A similar procedure is used to transfer a model, except a file containing model specifications is moved. Also, there are some relatively minor discrepancies between the mainframe and micro version of the IFPS modeling language, so you need to "translate" them on the micro after receiving (or before sending). A command is provided for this purpose. It is not possible to select particular variables to be moved—you get an entire file. Moreover, this process will not work except with an IFPS model and reports file. This is an integrated micro-mainframe link, but still is a relatively loose link. You talk to the micro and mainframe separately, physically transfer data (or models), and even have to consider the form of the model commands (being sure they are appropriately translated). On the other hand, the process is pretty well automated, and there aren't a lot of details to consider.

### The Future—Distributed DSS?

We have seen that considerable decision support capability is now available on IBM-compatible microcomputers. Some of the weaknesses of these micro-DSS's are being dealt with in the form of micro-mainframe links. Where will all this lead?

One clear trend is towards what once was considered mainframe processing power in a low-priced micro system. Very-large-scale-integrated (VLSI) processors can be cheap but powerful. Thus it will soon be possible to run mainframe database management and statistical software on a micro that costs no more than a present-day IBM PC.

This is probably desirable for statisti-



cal software. There is no inherent reason to centralize statistical processing, and a micro-based DSS would provide the usual advantages of modularity and predictable execution speed. For some specialized applications—management science or operations research—systems may be designed to hand really big processing jobs to a mainframe via a communications link. But there is not enough demand for such applications in the business community right now to warrant such an elaborate design.

Data management is another matter. Even if every manager in a particular corporation could have mainframe-level data management in his desktop micro, there would still be important questions concerning data sharing and data integrity. Who would input and maintain all that data? How can a company ensure that all managers use the same data for analyses? These are obviously corporate-level concerns that cannot be solved by individual managers.

There are two main avenues for future development. First, a company may keep all corporate data in a central "database machine." Individual users will be able to access this information, select aggregates or subsets, and download to local storage where necessary. The emphasis will be on data sharing.

This kind of design requires a central staff to maintain the "corporate data," however. Some companies may have many departments, each of which generates and maintains its own data. Under these circumstances a "distributed database" approach looks more attractive. Micro users connected by a high-speed local area network (LAN) could have corporate data available as a "virtual" local database—but actually, everyone would be sharing data with everyone else. The data management software would handle all the technical details to find data available on someone else's storage device. Aside from data management, integrated DSS software could reside entirely on the micro.

Obviously, in-between designs are possible as well, with departments having modest-sized database machines sharing data with other departmental machines and/or a central corporate database, and users with micros accessing the data through links to the departmental machines.

#### Conclusions

The widespread availability of flexible, multifunctional microcomputer software has almost outmoded the term "DSS." After all, is 1-2-3 a DSS if you use it (as some small businesses do) for

developing accounting systems? On the other hand, it is still important to recognize that managers have distinct information needs, and that these needs are met to a greater or lesser extent by different types of software.

Does the advent of cheap, powerful micro-based DSS's mean that all managers will soon be using data and models?

In larger corporations, the biggest barriers seem to be data availability. In smaller companies, the biggest barrier may be knowledge—the fanciest DSS in the world is of little use to a manager who isn't comfortable with data and models. Maybe we will see the day when DSS software includes an online "expert advisor" too! ◇

## We'll back you up!



### ATTENTION COMMODORE 64 OWNERS

If you own a disk drive then you'll need "The Clone Machine". Take control of your 1541 drive.

NEW IMPROVED WITH UNGUARD.\*  
Package includes:

- 1.) Complete and thorough users manual
- 2.) Copy with one or two drives
- 3.) Investigate and back-up many "PROTECTED" disks
- 4.) Copy all file types including relative types
- 5.) Edit and view track/block in Hex or ASCII
- 6.) Display full contents of directory and print
- 7.) Change program names, add, delete files with single keystroke
- 8.) Easy disk initialization
- 9.) Supports up to four drives

**\$49.95**

\*UNGUARD Now allows you to read, write and verify bad sectors and errors on your disk making it easy to back-up most protected software.

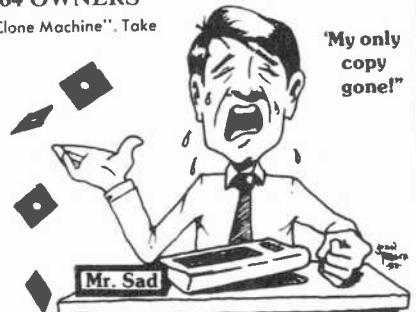

Dealers & Distributors  
Inquiries Invited

CALL (201) 838-9027

**MICRO WARE**

P.O. Box 113  
Pompton Plains, N.J.  
07444

Circle No. 34 on Free Information Card

## Put Professional Knowledge and a COLLEGE DEGREE in your Electronics Career through

### HOME STUDY



#### Earn Your DEGREE

No commuting to class. Study at your own pace, while you continue your present job. Learn from Grantham easy-to-understand lessons, with help from your home-study instructors.

You can earn your B. S. Degree in the Grantham electronics degree program, offered by independent home study and accredited by the NHSC Accrediting Commission.

Our free bulletin gives details. Write for *Bulletin E-84*.

**Grantham College of Engineering**  
2500 So. LaCienega Blvd.

P. O. Box 35499

Los Angeles, California 90035

## REDUCES DISKETTE COST 50%!

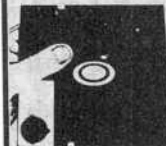

Make use of the back of your 5 1/4" Diskettes and SAVE.

- **NIBBLE NOTCH** tools make it easy
- Adds the precise notch where you need it.
- Doubles diskette space or MONEY BACK.

#### NIBBLE NOTCH I

Cuts square notch for Apple, II, II+, IIe, III, Franklin and Commodore.

only **\$14.95** each  
add \$1.50 each P&H / (\$4.50 each foreign P&H)

#### NIBBLE NOTCH II

Cuts square notch and 1/4" inch round "index hole." For use with computers other than those shown above.

only **\$21.90** each  
add \$2.50 each P&H / (\$6.50 each foreign P&H)

SATISFACTION GUARANTEED OR YOUR MONEY BACK

\*Florida Residents Add 5% Sales Tax\*

**ORDER TODAY!**

SEND CHECK OR MONEY ORDER TO:

**NIBBLE NOTCH**  
**COMPUTER PRODUCTS**

DIVISION OF CORTRAN INTERNATIONAL

4211 NW 75th TERRACE, DEPT. 83  
LAUDERHILL, FL 33319

PAT. PEND.

ALL TRADEMARKS ARE ACKNOWLEDGED

Circle No. 1 on Free Information Card

## Store It with Light

(Continued from page 64)

which could be read and added to by physicians equipped with suitable read/write units. His latest enthusiasm is software distribution.

Drexler envisions mass-produced cards, each carrying standard computer software that could be read, but not altered, by personal computers. He points out that the two-megabyte capacity of present cards could comfortably hold large integrated software packages such as Lotus 1-2-3. As card capacity increases, versions of the same program written for several different computers could be put on the same card, a concept Drexler calls the "Rosetta Stone Card" after the stone whose parallel inscriptions in four languages make it possible to decipher Egyptian hieroglyphics. Another possibility is "The Complete Software Card," which would carry the instruction manual as well as the program, so the user could get help on-line. Drexler adds that purely instructional material could also be "published" on optical cards, to be read on-line.

Both software users and writers might welcome optical-card distribution. The cards should be much more durable than floppy disks, reducing user concerns about loss of expensive software. If the cards are used purely as a distribution medium, it should be possible to keep software pirates from copying them, which is good news for software writers.

Both optical cards and readers for them should be inexpensive. Drexler says that blank cards would sell for about \$1.50 each in lots of 100,000, adding that his company is set up to produce 40,000 cards a day. In the same quantity,

prerecorded cards would run from \$1.50 each for 125-kilobyte cards to \$5.25 each for two-megabyte cards. Drexler estimates that laserless readers that use CCD (charge-coupled device) arrays to read cards would cost about \$70 each in large OEM quantity, or about \$200 when sold separately or integrated into desktop computers. Read/write units with semiconductor diode lasers would run about three to seven times the price of read-only modules.

Thirteen companies around the world have licensed Drexler's optical card technology for \$250,000 to \$300,000 each. The list includes such big names as Canon Inc. (Japan), Fujitsu Ltd. (Japan), Honeywell Information Systems, NCR Corp., Toshiba, and Wang Laboratories Inc. Another Japanese licensee, Logitech, demonstrated optical-card reprogramming of arcade video games at the Amusement Showcase International trade show in Chicago this past February. The reprogramming card lets a single console be used for many different games, saving arcades the high cost of replacing single-game units that quickly go out of fashion. The customer might rent his favorite game card from the operator and plug it into a multi-game console. Other applications are likely to follow soon.

Capacity of optical storage is expected to rise. A 35 × 80-millimeter (1.38 × 3.15-inch) strip of optical material can hold two megabytes of data recorded as 10-micrometer spots. These spots are more than 10 times larger than those on high-density optical disks, making possible low-cost replication and use of inex-

pensive readers, and leaving room for future improvement as well. Drexler expects gradually to bring the spot size down to three micrometers by 1990, raising the capacity of an optical stripe to 20 megabytes while maintaining larger tolerances than on high-density disks.

### Systems for Massive Archives

Government agencies have been a major force in pushing the development of huge-capacity optical storage. RCA's Advanced Technology Laboratories has been working on jukebox systems for a few years, and this summer will deliver engineering development models to NASA and the Air Force. NASA's interest is in storing data collected by satellites and spacecraft; the military has its own archives. Each RCA system stores 1.25 trillion bytes on 128 14-inch (35-centimeter) disks. Data on any disk in the system can be located within five seconds, report developers George J. Ammon and Bohdan W. Siryj. Three government ministries in the Netherlands will evaluate an optical jukebox system called "Megadoc" developed by Philips to store digitized images of documents for rapid retrieval.

Demonstrations of two separate optical storage systems are planned by the Library of Congress in its Optical Disk Pilot Program. The test is seeking solutions for three problems with the library's 80-million item collection: deterioration, limited storage space, and retrieval of individual items. A 100-disk jukebox system will store digitized images of about a million pages from magazines, manuscripts, and collections of

## Ovshinsky

(Continued from page 64)

inch optical disks (700 megabytes each). Though clearly the product was aimed at the office automation marketplace, there was no doubt that those involved in home video, audio and computers were watching closely, already figuring out their market application, as well.

Stanford Ovshinsky also watched, but wasn't pleased with what he saw. The technology was credited to Matsushita's \$600 million a year research program. Their technicians described the breakthrough as a trick of adding a pinch of germanium, indium and lead to the normal tellurium oxide optical disk coating. This allowed the recording material to be switched between its crystalline and amorphous states that Ovshinsky had devised ten years earlier and even introduced to the company without compensation.

A lawsuit last spring was the result. ECD enjoined Matsushita from marketing its erasable optical memory disk system, claiming patent infringement and misappropriation. The timing was apparently right since the move followed IBM's FBI sting operation of Hitachi for theft of corporate secrets. In Michigan, —with the idle automotive factories not far away—the idea of a "small" American inventor fighting off Japanese big business was a publicly appealing crusade. Before a Senate subcommittee, Ovshinsky likened Matsushita's move to "technological piracy."

However, the expected legal give-and-take was quickly settled six months later—a surprisingly short time for any patent dispute. The end result was that Matsushita gave Ovshinsky credit *de facto* for his work by becoming an ECD

licensee for the technology.

"I think what happened is a model of sorts of Japanese/American tension. We worked things out so we both could benefit. Matsushita showed good will and not a piratical response to the situation," he explained, adding that he expects substantial royalties once Matsushita begins production of its erasable optical disk product.

Ovshinsky does not consider himself a maverick. He admits, though, that thinking differently and remaining independent are main ingredients in his overall business scheme. "My aim in life is not to fight," he said. "Like any inventor, my aim is to have my ideas recognized."

Then, remembering the already sizable scope of his success, he quickly said, "And marketed." ◇

maps and sheet music. The stored information can be displayed on video screens or printed on paper. A second system will use videodisk technology to store "nonprint" material including film segments, still pictures, sound recordings, and 30 antique paper "motion picture" sets. The library will develop indexing software to go with both systems, which will have terminals in public areas to see how well they serve library users.

Commercial versions of optical storage systems do not aim for such high capacity yet. The first models had only limited capacity or were designed for special applications such as automated filing—the storage of digitized image of documents. Toshiba has sold about 300 of its "Tosfile" document storage systems in Japan since late 1981, but the error rate of its optical disk is much too high for computer storage. Matsushita's Panasonic subsidiary sells an optical disk system that records 15,000 video images on an eight-inch (20-centimeter) disk. True data-storage disks did not come on the market until last fall.

The highest-performance system is offered by Storage Technology, which re-

portedly invested more than \$40 million in development costs. Designed for use with large mainframes, the system stores four gigabytes (4000 megabytes) on one side of a 14-inch disk with an error rate of one bit in 10 trillion. It takes about 0.085 second to find data on the disk.

Most other systems use 12-inch disks, have an-average access time of about 0.25 second and an error rate around one in a trillion, and carry smaller price tags. The Optimem 1000 drive from Xerox's Shugart subsidiary, for example, is sold for \$6000 to \$10,000 in OEM quantity, and would probably retail at twice these prices. The Optimem drive, along with similar models from NEC Corp. and Thomson-CSF, stores up to 1.3 Gb on one side of a 12" disk. Hitachi doubles the capacity using both sides.

### Towards the Future

Developers are already looking toward a new generation of optical storage systems. A main goal is to develop erasable materials that would avoid the need for permanent recording. Many computer files are not archival but are rather, periodically updated data bases, such as

lists of customers. Updating permanent optical media is possible but clumsy; it requires inserting a cross-reference to another part of the disk, perhaps obliterating the old data, and writing the new data in the new place. This approach is reasonable if there are few updates, but not if revisions are extensive.

Erasable optical materials have proved to be more difficult to develop than permanent ones. But some progress has been made in this area. Matsushita announced last year that it plans to market an erasable optical disk in which data is recorded by causing changes in the physical properties of a thin-film coating. However, that statement was early even by the standards of the computer industry, and no product is expected to appear on the market before next year. Sony, Philips, and Sharp Corp. (Japan) have each demonstrated optical disk drives in which data is recorded by changing magnetic properties of a storage medium in ways that can be detected optically. The drive demonstrated last year by Philips crammed 10 megabytes onto a disk just five centimeters (two inches) in diameter, for use with person-

## AMAZING DEVICES

**PERSONAL DEFENSE AND PROPERTY PROTECTION UTILIZE SPACE AGE TECHNOLOGY.**  
CAUTION THESE DEVICES CAN BE HAZARDOUS AND MAY SOON BE ILLEGAL.

**POCKET PAIN FIELD GENERATOR — IPG50**  
Assembled..... \$59.50  
IPG5 Plans..... \$7.00 IPG5K Kit/Plans..... \$39.50

**PHASOR PAINFIELD CROWD CONTROLLER — PPF10**  
Assembled..... \$250.00  
PPF1 Plans..... \$15.00 PPF1K Kit/Plans..... \$175.00

**BLASTER**— Provides a plasma discharge capable of puncturing a can.  
Assembled..... \$79.50  
BLS10 Plans..... \$10.00 BLS1K Kit/Plans..... \$59.50

**SHOCKER/PARALYZING DEVICE** — Very intimidating and effective.  
SHG60 Assembled..... \$99.50  
SHG6 Plans..... \$10.00 SHG6 Kit/Plans..... \$79.50

**RUBY LASER RAY GUN** — Intense visible red beam burns and welds hardest of metals. **MAY BE HAZARDOUS.**

**RUB3 All Parts Available for Completing Device** \$15.00  
**CARBON DIOXIDE BURNING, CUTTING LASER** — Produces a continuous beam of high energy. **MAY BE HAZARDOUS.**

**LCS. All Parts Available for Completing Device** \$15.00  
**VISIBLE LASER LIGHT GUN** — produces intense red beam for sighting, spotting, etc. Hand held complete.  
LGU3, Plans. \$10.00 (Kit & Assembled Units Available)  
**IR PULSED LASER RIFLE** — Produces 15-30 watt infra-red pulses at 200-2000 per sec.  
LRG3. All Parts & Diodes Available..... \$10.00

**BEGINNERS LOW POWER VISIBLE LASER** — Choice of red, yellow, green — provides an excellent source of monochromatic light.  
LHC2 Plans..... \$5.00 LHC2K Kit..... \$29.50

**SNOOPER PHONE** — Allows user to call his premises and listen in without phone ever ringing.  
SNP20 Assembled..... \$89.50  
SNP2 Plans..... \$9.00 SNP2K Plans/Kit..... \$59.50

**LONG RANGE WIRELESS MIKE** — Miniature device clearly transmits well over one mile. Super sensitive, powerful.  
MFT1 Plans..... \$7.00 MFT1K Plans/Kit..... \$39.50

**WIRELESS TELEPHONE TRANSMITTER** — Transmits both sides of phone conversation over one mile, shuts off automatically.  
VWPM5 Plans..... \$8.00 VWPM5K Plans/Kit..... \$34.50

**TALK & TELL AUTOMATIC TELEPHONE RECORDING DEVICE** — Great for monitoring telephone use.  
TAT20 Assembled..... \$24.50  
TAT2 Plans..... \$5.00 TAT2K Plans/Kit..... \$14.50

Our phone is open for orders anytime. Technicians are available 9-11 a.m., Mon-Thurs for those needing assistance or information. Send for free catalog of hundreds more similar devices. Send check, cash, MO, Visa, MC, COD to: **INFORMATION UNLIMITED**  
DEPT Q1, P.O. Box 716, Amherst, N. H. 03031 Tel: 603-673-4730

# CABLE TV CONVERTERS

## Largest Selection of Equipment Available

*\$ Buy Warehouse Direct & Save \$*



36 channel converter  
**\$4595**



36 channel wired remote converter only  
**\$8895**

*Send \$2 for complete catalog of converters and equipment*

Quantity Discounts • Visa • Master Charge  
Add 5% shipping — Mich. residents add 4% sales tax

**C&D Electronics, Inc.**  
P.O. Box 21, Jenison, MI 49428  
(616) 669-2440

## CALCULATOR SAVINGS

<b>hp</b> HEWLETT PACKARD	HP-11C Programmable..... \$74.99	82160A HP-IL Module..... \$99.99
	HP-12C Financial..... 99.99	82161A Cassette Drive..... 359.99
	HP-15C Programmable..... 99.99	82162A HP-IL Printer..... 359.99
	HP-16C Hexadecimal..... 99.99	82164A RS-232 Interf. .... 249.99
	HP-41C Alpha Progrmb. .... 149.99	82198A 80 col Video Int 269.99
	HP-41CV Full Memory..... 189.99	7470A HP-IL Plotter..... 899.99
	HP-41CX Extnd Functn..... 259.99	82180A Extnd Functns..... 59.99
	82104A Card Reader..... 149.99	82181A Extnd Memory..... 59.99
	82143A Printer..... 289.99	82182A Time Module..... 59.99
	82153A Wand..... 99.99	HP-75C Computer..... 699.99
	HP-71B Computer..... 419.99	HP-75D Computer..... 929.99
	82400A Card Reader..... Call	HP-41 System Case..... 49.99
	824C1A HP-IL Interface..... 107.99	Port-X-Tender to 10 pts 129.99
	82420A 4K Mem for 71B..... 59.99	
	HP-75C Computer..... 699.99	
	HP-75D Computer..... 929.99	
	82740A 8K Mem for 75..... 149.99	

Call for Low Prices on all Accessories and Software

Ti	CC-40 Compact 6K Expandable Computer..... \$199.99
	CC-40 Solid State Software..... from 49.99
	Ti-55-II Scientific Calculator w/ Statistics..... 34.99
	LCD Programmer Hexadecimal Converter..... 59.99
	BA-55 Advanced Handheld Financial..... 49.99
	Ti-5310 Desk Printing Financial..... 109.99

Sharp	EL-7050 4-Color Graphwriter..... \$79.99
	EL-7001 Memowriter..... 39.99
	EL-7100 Deluxe Memowriter..... 69.99
	EL-550 Printing Handheld Scientific..... 29.99
	EL-5500T Handheld Computer/Calculator..... 79.99
	CE-126P Cassette Interface/Printer for 5500..... 84.99
	EL-7050R Factory refurbished..... 39.99
	EL-7001R Factory refurbished..... 29.99
	EL-7100R Factory refurbished..... 39.99
	EL-550R Factory refurbished..... 19.99
	PC-1500/A ROM Software Modules..... 49.99

Casio	FX-700P Handheld Computer, 1568 steps..... \$69.99
	FA-3 Cassette Adapter for FX-700P..... 34.99
	FP-12 20-column printer for FX-700P..... 59.99
	FX-92 Credit card Solar Scientific Calculator..... 24.99
	FX-450 Scientific Calculator with Hexadecimal..... 29.99
	FX-191 Scientific Scaler..... 44.99
	PF-800 Data Bank..... 64.99
	SL-800 Film Card..... 22.99

Use cashier's check, postal money order, VISA, or M/C. Personal checks take five weeks to clear. Add shipping; 1% of your order (\$3.50 minimum). East of Missp/R extra 1% SO. C&D res 6% Subject to availability, USA prices.

**ORDER 800-421-5188** Outside  
TOLL-FREE Information line (213) 633-3262 CA, AK, HI

## tam's

INCORPORATED

Tam's Inc, Dept CE-7  
14932 Garfield Ave.  
Paramount, CA 90723  
(213) 633-3262

Circle No. 42 on Free Information Card

## Store It with Light

al computers. However, neither Philips nor the two Japanese companies have said anything about marketing plans.

Despite the progress with erasable materials, some observers remain skeptical about their products. One concern is stability of the recorded data, particularly if exposed to light or heat.

Other concepts are in the works as well. Jerry Drexler talks about optical storage materials in tape form, for re-

coding large quantities of data, such as collected by satellites, which should be saved but need not be used frequently. A small group at IBM's San Jose Research Laboratory led by Gary C. Bjorklund is working on a way to increase optical storage density a thousandfold by recording data at the same point using different wavelengths of light. That idea seems far from practical, but so did optical data storage a few years ago.

The first generation of optical storage systems should start having an impact on the computer world within a couple of years. They promise data storage that is more compact, longer-lived, and more reliable than floppy disks. They promise a better way to distribute software and to store data you cannot afford to lose. Optical storage will not make floppy disks or hard disks instantly obsolete, but it should do many jobs better. ◇

## Tandy 2000

(Continued from page 19)

Tandy recognized this ingredient and set out to woo the developers of the key software in the management analysis area so that they would tailor their software for the Model 2000. Tandy was relatively successful in this pursuit and was able to announce when the Model 2000 was introduced that well-known, already successful software such as Multiplan, dBase II, Multi-Mate, Microsoft Word and the PFS series (PFS:File, PFS:Report, PFS:Write and PFS:Graph) either were already available for the Model 2000 or would be within 6 months and would be marketed under the Tandy name and supported by the Tandy organization.

In this announcement, Tandy also set sight on the small business market and announced the availability (for the first time on microcomputers) of the MAI/Basic Four Small Business Accounting Programs (General Ledger, Accounts Receivable, Accounts Payable, Inventory, Purchase Order, Order Entry and Payroll). Finally, Tandy announced VideoTex Plus which allows, with appropriate modem interface, communications with remote data bases such as CompuServe and Dow Jones. The announcement of these products with the Model 2000 was of major importance and the product universe announced was certainly more comprehensive and exciting than the universe initially announced with the IBM PC.

Tandy did not rest on its laurels after the initial announcement but continued to attempt to expand the software base. It soon announced agreement to market Ovation Technologies' "Ovation," an integrated multi-function system and then, in possibly the most significant development in the software area to date, announced an agreement with Lotus Development Corporation for the marketing of the far and away biggest selling MS-DOS program, "1-2-3," under the Tandy name. The Lotus announcement gave final credence to the Tandy marketing comparisons with the PC. (Prior to

the announcement it seemed a bit ludicrous to take seriously a direct comparison with the PC when the 2000 could not run the most important software for the PC. The judgment for many people would be rather: "Is it better to have a PC or compatible that runs '1-2-3' or a technically superior machine that cannot."). Christopher Morgan, Vice President of Communications for Lotus Development says "We are very excited about the installation of '1-2-3' on the 2000 as we feel that the high quality of the system makes it obvious that Tandy intends to be a major player in the professional marketplace."

In addition to these agreements with software producers that put products in Radio Shack stores under the Tandy name, Tandy arranged with still other vendors a type of catalog sales arrangement in which a customer can decide on a program in a Radio Shack store and order it. The store will place the order into the new "Express Order" system and the order will be routed directly to the producer of the software who will ship it within 24 hours directly to the client. In this case, software maintenance and support will be provided by the software vendor. Agreements of this type are already in place with such firms as MicroPro and Information Unlimited and programs such as Wordstar, Easywriter and Word Perfect are available through this procedure.

When one views the total universe of software encompassed by the products marketed under Tandy's own name and through Express Software, one realizes the great success Tandy has had in convincing developers to "port" their software to the 2000.

### Software Performance

We spent considerable time utilizing both packaged software such as dBase II, PFS:File and Multiplan and programming languages such as Microsoft's BASIC and FORTRAN. In every case, the software ran faster and, once we

were acclimated to the more standard keyboard, was slightly more pleasant to use than the comparable version on the IBM PC or true compatible. The speed difference was quite apparent in the processing intensive software products such as Multiplan but far less dramatic in those systems that are highly disk I/O intensive. (A dBase II procedure that sets up files and indexes for processing and then counts the number of records in the data file took 01:56:60 minutes on the 2000 and 02:06:78 on the PC when the data file contained 354 records—a 10 second or an approximate 08.5% increase in "thru-put.") We found the text mode of the Tandy color monitor to be at least as sharp and restful to the eye as text displayed on an IBM Monochrome monitor. We also found that, in addition to all its other pluses enumerated above, the touch of the 2000 keyboard had, in our opinion, a nicer feeling than either the IBM or Compaq keyboards.

### Summary

We find the Tandy TRS-80 Model 2000 to be a superior system in both packaging and performance. We feel that Tandy has properly analyzed the marketplace and has responded to it. The MAI/Basic Four Accounting Series makes the system very attractive for small businesses, and the professional market is well served by the 1-2-3, Multiplan, Word, dBase II, etc. products. We do not expect the Model 2000 to be as successful as the IBM PC, which has been available for over two years, or Apple's Macintosh, which represents a new approach to the user-interface and has received tremendous press, but we feel that the machine is of sufficient quality to warrant the attention of new computer purchasers. It is a cost-efficient system and is supported by a proven organization. We further feel that Tandy is to be commended for choosing to produce a technically superior machine rather than developing just another IBM PC look-alike. ◇

# Computer Scientist

(Continued from page 77)

Do the same to change a menu selection. Then type RUN and hit ENTER.

Figure 6 shows a publication-quality circuit diagram made with Circuit Plot. A very crude draft version of this circuit was sketched on the calibrated grid in a few seconds.

Unfortunately, even a slight misalignment of the grid on the X-Pad can cause serious errors. Figure 7, for example, is what resulted when the rough version of the circuit in Fig. 6 was moved slightly out of alignment.

## Expanding the Menu.

You can add ten additional menu boxes along the X-Pad's right margin by inserting the following lines into Listing 1:

```
55 IF X<200 THEN 85
85 SOUND 200,3
90 B=11-(1+INT(Y/20))
95 ON B GOTO 1100,1200,
1300,1400,1500,1600,
1700,1800,1900,2000
```

You'll have to develop plotter instructions for producing symbols for these new locations and the two unused locations in the left menu. To get you started, Fig. 8 shows how an npn transistor, a fairly tough symbol, is programmed. Its listing can be inserted directly in the master Listing 1.

Incidentally, line 945 in Fig. 8 can be appended to line 940. Just omit PRINT # -2, in line 945 and the final quote marks in line 940. I used two lines since the original line 940 was too long to be printed across a sheet of paper.

For best results when encoding symbols to be plotted, first draw a rough symbol on a sheet of graph paper having an appropriate scale. Select an origin and mark plot-relative coordinates at each turning point. When you assemble the coordinates into a string of code, be sure to include pen-up and pen-down commands when necessary.

There's no need to worry if your symbol has the wrong size or aspect ratio. I used the wrong graph paper to establish the plot-relative coordinates for the transistor in Fig. 8. The resulting transistor was egg shaped and much too big. Rather than repeat the laborious task of developing new coordinates for a smaller, rounder transistor, I simply inserted a revised scale instruction in the transistor symbol-drawing routine given in Fig. 8.

Incidentally, even a single error will wreak havoc with a plotted symbol! Careful planning and a dose of patience will pay off in faster symbol programming.

## Going Further.

Though I use Circuit Plot to produce

publication quality circuit diagrams, the same programs can be easily adapted to draw mechanical parts, lumber, floor plans, plumbing diagrams, and anything else the plotter can be programmed to draw. For a basic CAD system that simply transforms rough sketches into finished drawings, your major programming hurdle will be developing plotter codes for the symbol you want to use.

Though my system does the job for which it was designed, it's quite primitive by commercial CAD standards. If you enjoy programming, you might want to expand Listing 1 to include functions like zoom, enlarge, scale, rotate, and label. All these functions can be achieved by means of straightforward HPGL plotter instructions.

You might also want to include features for drawing diagrams on the computer's monitor and storing both individual symbols and completed drawings on a diskette. The ability to store drawings on diskette is particularly important, for you can then develop routines for revising completed drawings long after they were made.

Speech synthesis is another area you might want to explore. Several companies make reasonably priced, easily programmed speech synthesizers for the CoCo. I plan to acquire such a module and modify Listing 1 to include a spoken verification of symbols when they are selected from the menu. This will eliminate menu errors and the need to refer to the monitor.

Finally, you might want to devise an entirely new CAD system of your own just as I've done. If so, be sure to consider some of the new graphics tablets that are now available.

In particular, the PowerPad by ChalkBoard, Inc. (3772 Pleasantdale Road, Atlanta, Georgia 30340) appears to be ideally suited for do-it-yourself CAD. Unlike the X-Pad I've used, the PowerPad doesn't suffer from nonlinearity problems because its sensitive surface is an array of 120 x 120 switches. ◇

## LISTING 1

```
1 'CIRCUIT PLOT
2 '
5 'COPYRIGHT 1984 BY FORREST M.
MIMS, III
10 PRINT # -2, "IN;SC0,51,40,0;SP1;"
20 CLS
30 GOSUB 5000
40 IF S < > 7 THEN 30
50 IF S = 1 THEN 7000
60 SOUND 175,3
70 A = 11 - (1 + INT(Y/20))
80 ON A GOTO 100,200,300,400,500,600,700,
800,900,1000
99 '
100 PRINT "OP-AMP: SELECT LOCATION."
110 GOSUB 6000
120 IF S < > 3 THEN 110
130 SOUND 150,3
140 PRINT # -2, "PA"H,V";PR0,0,PD,0,-4,
-5,2,-5,2,PU;"
150 GOTO 20
199 '
200 PRINT "OPEN RECTANGLE: SELECT
LOCATION."
210 GOSUB 6000
220 IF S < > 3 THEN 210
230 SOUND 160,3
240 PRINT # -2, "PA"H,V";PR0,0,PD,0,.5,2,
0,0,-1,-2,0,0,5,PU;"
250 GOTO 20
299 '
300 PRINT "LINE: SELECT ORIGIN."
310 GOSUB 6000
320 IF S < > 3 THEN 310
330 SOUND 170,3
340 PRINT # -2, "PA"H,V";PD;"
350 PRINT "SELECT DESTINATION."
360 GOSUB 6000
370 IF S < > 3 THEN 360
380 SOUND 180,3
390 PRINT # -2, "PA"H,V";PU;"
395 GOTO 20
399 '
400 PRINT "DOT: SELECT LOCATION."
410 GOSUB 6000
420 IF S < > 3 THEN 410
430 SOUND 200,3
440 PRINT # -2, "PA"H,V";PR,1,1,PD,0,-.2,
-.2,0,0,2,0,PU;"
450 GOTO 20
499 '
500 PRINT "ARROWHEAD: SELECT
LOCATION."
510 GOSUB 6000
520 IF S < > 3 THEN 510
530 SOUND 150,3
540 PRINT # -2, "PA"H,V";PR,0,0,PD,-.3,
-.3,PU,.3,3,PD,-.3,3,PU;"
550 GOTO 20
599 '
600 PRINT "CAPACITOR: SELECT
LOCATION."
610 GOSUB 6000
620 IF S < > 3 THEN 610
630 SOUND 160,3
640 PRINT # -2, "PA"H,V";PR,0,0,-.5,PD,
0,1,PU,4,0,PD,0,-1,PU,0,5,PD,7,0,PU;"
650 GOTO 20
699 '
700 PRINT "RESISTOR: SELECT
LOCATION."
710 GOSUB 6000
720 IF S < > 3 THEN 710
730 SOUND 250,3
740 PRINT # -2, "PA"H,V";PD;PR,75,0,.15,
-.3,3,6,3,-.6,3,6;"
745 PRINT # -2, "PR,3,-.6,3,6,.15,-.3,
.75,0,PU;"
750 GOTO 20
799 '
800 PRINT "GROUND SYMBOL: SELECT
LOCATION."
810 GOSUB 6000
820 IF S < > 3 THEN 810
825 SOUND 200,3
830 SOUND 200,3
840 PRINT # -2, "PA"H,V";PR,-.9,0,PD,1.8,
0,PU,-1.5,3,PD,1.2,0,PU,-.9,3,PD,6,
0,PU;"
850 GOTO 20
899 '
5000 X = PEEK(65376):Y = PEEK(65377):
S = PEEK(65378):RETURN
6000 X = PEEK(65376):H = INT(X/5)
6010 Y = PEEK(65377):V = INT(Y/5)
6020 S = PEEK(65378):RETURN
7000 PRINT # -2, "SP1;"
7010 PRINT "QUIT CIRCUIT PLOT":END
```

## Microsoft (Continued from page 70)

direct. The difference is like telling a robot to move so many spaces left and so many spaces right . . . versus grabbing the darn thing and moving it."

What is the secret to making a software company "move"?

### King Arthur on a High Bandwidth

Leo Nikora offered this picture of what Gates is accomplishing at Microsoft: It used to be, before Bill Gates came along, that companies thought they had to produce proprietary products, otherwise you couldn't make lots of money, he said.

"Now Bill Gates has shown that the person who gets everyone to work together will share in the wealth. It's like what happened in the Middle Ages with King Arthur, when all the lords were fighting for dominance and each one of them living in their own crummy little castle. Now, thanks to Bill Gates, we're all getting together to do this symbiotic stuff and everyone's got a nice castle," he said. Simonyi explained why he likes working for Microsoft.

"Two things make a company good to work for," said Simonyi, and Microsoft offers both. "First is faith in management. You want to avoid, as you get older, wasting precious time. It's easy to contribute to something which is going nowhere (in this industry). Simonyi explained that because Gates has a technical background, there is no time wasted trying to "educate management" at Microsoft. "We're on a high bandwidth communication here," Simonyi said. He said the people at Microsoft communicate much like infantry soldiers who know their jobs and each other very well: "We exchange information in grunts and get on with it, like the way two infantry soldiers who understand each other communicate. One doesn't say, 'you go around that building over there and start firing,' he grunts and the other knows what he means. That's the way it is here."

### 17-hour Days

Larry Levitsky, national marketing manager of Microsoft Press, has a simple reason as to why people work so hard at Microsoft. "I can answer that question in two words," he said. "Bill Gates. Bill sets the pace. Everyone's running trying to keep up with Bill. Fifteen- to seventeen-hour days are not unusual here, six to seven days a week. I've worked eight years in corporate offices in New York, and I've never seen a chairman of the board work this hard. It's good to see him work so hard. He inspires you." A former graduate student of Russian lit-

erature and translator of Russian computer manuals for the United Nations, Levitsky marketed books for Harcourt Brace, EP Dutton, New American Library, and Grove Press, and he was hand-picked to market Microsoft's books.

Microsoft's new Press is managed by Nahum Stiskin, former founder and owner of Tokyo's "Autumn Press," a counterculture press in the 1970s. Stiskin was educated in the 1960s "when technology was evil. . . . We had the conception that we were better off without technology—technology to us then was the B-52, Vietnam, and nuclear weapons—technology was dangerous." So what's Stiskin (an author of books on Physics and Zen, Philosophy and Cooking, Politics and Medicine) doing managing a press which publishes books about computers? As a writer, Stiskin used a computer to "liberate the creative process." He knows the value and frustration of using a computer as a person who has never liked machines. With his background in publishing, his knowledge of computers and of the neophyte user, Stiskin is perhaps just what a computer book company needs: a manager with a deep love for the humanities, em-

## MICROSOFT SOFTWARE PRODUCTS

### Operating Systems

- MS-DOS
- Xenix
- MSX
- MSX-DOS
- Windows

### Languages

- BASIC Interpreter
- BASIC Compiler
- Business BASIC Compiler
- Applesoft BASIC Compiler
- FORTRAN Compiler
- FORTRAN-80 Compiler
- COBOL Compiler
- Pascal Compiler
- C Compiler
- Assembly Language Development System (for Apple II)
- Macro Assembler
- mLISP
- Sort
- Edit

### Applications Software

- Word
- Multiplan
- Typing Tutor II
- muMath
- Decathlon
- Flight Simulator
- Project
- Chart (for Macintosh)

pathy for the largest, untapped, market segment, and a desire to help others use a potentially intimidating machine to promote communication between people.

Contrary to what you might expect, Microsoft Press is not a company whose purpose is to explain and clarify Microsoft's manuals. The Press will publish books which not only address Microsoft software, but also "the culture as a whole," as shown by *The New Papyrus*, a collection of 21 essays about computers and culture which, according to Stiskin, will be the "classic compendium, showing the evolution of the industry." In short, Microsoft Press "is not a vanity press only related to Microsoft products." Stiskin's Press is going after a particular market of book buyers with the intention of creating the standard in computer book publishing.

### Book Buyers Have Changed

Stiskin explained how the market for computer books has changed recently. It used to be that the buyers of computer books didn't care how the books were packaged or written. They were hobbyists, for the most part.

"Now the market is more mainstreamed; business executives are using the machines far more, and there's a penetration into the home market. There's an upward tick in the marketplace. We are appealing to a quality audience: young, 18-35, upwardly mobile as a result of their education, life style, taste, and what they read. The rest of the publishers are moving down stream; they're moving 'down market,' using low-cost paper with swiftly written copy, swiftly packaged." That's not where Microsoft Press is going, with Simon & Shuster distributing their books by such authors as Peter Norton, Cary Lu, Mitchell Waite, and a dozen other well-known writers.

Why will Microsoft Press do well? ". . . We can achieve the highest levels of accuracy in the industry (because) we (Microsoft) are the people who drive the industry. We know what's happening in 1985; for God's sake, we're doing it!" Stiskin said.

Product support is an acknowledged area of concern. Some dealers who have called Microsoft describe how they have to wait on the line for an average of 35 minutes before someone has an opportunity to answer their questions. Rick Farmer, manager of product support, is aware of this problem. In fact he knows precisely how many people get tired and hang up—more than 50%—and he doesn't see the problem being solved by hiring more support technicians. "I fore-

see this as an never-ending problem," said Farmer, "the more people we put on, the more people are encouraged to call. If more people would read the manual, then fewer people would call."

### Microsoft Licensed Training Centers

To help the thousands of frustrated users out there, Allen Stewart, National Training Manager, is going around the country, building relationships with software training centers so that Microsoft's users will get the maximum support possible in the most professional environment available. By this summer, Stewart estimates Microsoft will have established more than 100 authorized Microsoft Learning Centers throughout North America. He believes that these training centers will take much of the load off the software support lines in Rick Farmer's section and give Microsoft's customers what they want and need—professional, person-to-person training.

Why are there so many calls asking for help with "user-friendly" software and what is being done to help the growing, silent majority of confused consumers?

### Telepathic Computers

According to Farmer, a former programmer in the oceanography department at the University of Washington, "The people who use computers now are a product of the TV generation. Their attitude is, turn it (the computer) on and it's done; turn on the TV tube and it will do all for you; you don't have to do much . . . therefore, you don't have to read the manual. Most people are into the thing of 'sit back and watch the ele-

phant dance.' They can't understand why this thinking machine will require them to think. The goal of development (at Microsoft) is to make it easier to tell the machine what to do—closer to a telepathic computer." Until this time arrives, Farmer plans to develop a data

## Why are there so many calls asking for help with user-friendly software?

base of answers to the 300 most common problems. People will call in, describe their problem, and a computer will search, using key words, and eventually offer an answer.

### More 'Human' Computers

One of the developers of Microsoft Windows is John Butler, a former cardiologist turned programmer. As a cardiologist, Butler was angered by the quantity of facts which doctors must memorize, especially regarding testing procedures. The use of computers would help doctors spend more constructive time with patients, he thought, thus encouraging them to view people as something more than "bags of pathology." Yet, Butler noticed that computers appeared to be "serviced by priests;" and, (because of the perceived nature of their complexity), computers have been kept from people who could most benefit

from them.

When trying to determine how he could best "improve the world" with his talents for understanding people and discrete mathematics, Butler decided that he wanted to be intimately involved in "making computers available to real people." Microsoft Windows is Butler's first step toward making computers more "telepathic" for the average citizen who doesn't have the time or inclination to program a computer.

An almost childlike joy of *playing at your work* seems to characterize Microsoft. This attitude is seen from top management down to an assistant to an engineering tech like Willie Tilse, who built the "Mouse Mileage Life Test Machine" from "bits and pieces, whatever I found lying around."

Tilse was given the job of "exercising the mice to extinction" to make sure that the life span claims of the mouse packages were accurate. To do this, Tilse collected furniture legs, a desk top pad, kitchen drawer slides, scrap copper tubing, Boeing surplus parts, shelf brackets, and a used kidney dialysis motor. He made the tester with a switch box that had a fail safe circuit and counting circuitry. He then cut the plexiglas with a router and drill press he brought from home. Why such devotion?

Tilse expressed his view of why the people at Microsoft work so hard and accomplish so much. "Here you're allowed to be whomever you are . . . just being able to function without anyone looking over your shoulder . . . helps me want to work hard; it doesn't seem like work to me (even though he described more than a few 17-hour days) . . . These are my toys. I'm out there playing with my toys. It's fun to me." ◇

## IBM Portable (Continued from page 25)

would each require full-sized slots. Many of the cards from other manufacturers are full-sized cards, too. The Portable's limitations on card size will undoubtedly spur development in this area. Another problem is that the XT motherboard, with more slots, doesn't permit card widths that can be used in the PC.

**Benchmarks.** I have a series of benchmark programs which I've used to compare the speeds of various computers. They range from a simple FOR . . . TO loop to measure rudimentary BASIC speeds, through computation and disk operations. I expected no difference between the speeds of my PC and the

speeds of the PC portable and, in fact, the speeds were identical for all tests.

**Overall Comparison of the Portable and PC.** As I mentioned earlier, I could well imagine that a discerning buyer might take a full-sized PC in preference to the Portable. Pricing, however, doesn't seem to be the factor. Current prices for the PC with Color Graphics card, one disk drive, and a "foreign" monochrome monitor are about \$2200 at a discount dealer and \$2500 from an authorized IBM dealer. With the IBM monochrome monitor you're up to \$2400 to \$2700 or more. This compares to \$2795 for the Portable. A two-drive version of the PC ranges from \$2700 to

\$3200, compared to \$3220 for the Portable configuration.

It appears that buyers are probably influenced more by the unconventional amber screen and the expansion limitations of the Portable in choosing the standard PC over the Portable. For a user who is solely intrigued by the newness of the Portable and doesn't really travel frequently, it probably makes more sense to stick with the PC, unless he's pining for the amber screens and amber brews of Munich.

### The PC Portable Vs. Compaq

The second portion of this review must, of necessity, compare the PC Por-

# IBM Portable

table with other PC-compatible portables. Let's just stick with the most successful and compatible portable manufacturer, Compaq. Compaq was successful for two reasons: extreme compatibility (by design) and true transportability. The Compaq unit will run virtually all software that runs on the PC, even the veritable Lotus 1-2-3 and MicroSoft Flight Simulator, the de facto benchmark tests for compatibility. Although actual unit sales figures haven't been released (one hears the figures \$111,000,000 in sales in the first year), 60,000 systems seems to be in the right ballpark.

How does Compaq compare to the PC Portable? There are several points of interest. The basic Compaq system is, first of all, very similar to the PC Portable (or is it the reverse?). It has about the same dimensions, about the same weight, and the same general physical arrangement in the way the keyboard swings down. The keyboard has the same key arrangement as the PC and a similar, but not identical feel. (It is a quieter keyboard without the "key click" that establishes user feedback, a subjective quality that

## How does Compaq compare with the PC Portable—very similarly

you may like or dislike.) Like the PC Portable, the Compaq can have 256K of RAM on the motherboard, a Color Graphics card (it will take standard IBM cards, by the way, and is "bus compatible"), and one or two half-height disk drives. The price for a 128K RAM single-drive system is \$2495 and for a dual-drive system is \$2995.

Here are some differences, however. First of all, of course, the Compaq has a green monochrome monitor. In addition, the system supports two types of displays. One mode emulates an IBM PC with Monochrome Adapter card. The second emulates IBM PC with Color Graphics card. Much ado is made about the fact that the monochrome emulation produces an extremely crisp text

on the screen, and in comparison tests, I'll have to agree that the Compaq *does* have a sharper, crisper text image than the PC Portable, which uses the Color Graphics interface. The higher quality text image partially compensates for the small screen size of the monitor.

Secondly, the Compaq has a parallel printer port "bundled" in the basic system. This makes the comparison price for a similarly equipped PC Portable almost equal when you consider the \$150 price tag on a Printer Adapter card for the PC portable.

The major difference, however, is the number of "long" expansion slots available. The Compaq has three long slots available. This means that you can be less selective about adding cards to the Compaq and, since the Compaq is bus compatible with the PC bus, you can add a variety of manufacturer's cards whether they're long or not.

Another plus for the Compaq is that there's a hard-disk version of the Compaq available called the Compaq Plus. This advantage probably won't be around for much longer, however, and may be gone when you read this.

### QUALITY COMPONENTS - NOT MAIL ORDER "SECONDS"

Send \$1.00 postage and handling for FREE COMPLETE CATALOG which includes coupon for \$1.00 OFF purchase.

#### ARIES ZERO INSERTION FORCE SOCKETS -



can actuated, true zero insertion - tin plated solder tail pins - capable of being plugged into dip sockets, including wire wrap.

Stock No.	No. of Pins	1-9	10-49	50
11055	24	4.98	4.35	\$3.90
11056	28	5.15	4.50	4.05
11057	40	6.31	5.95	5.35
11058	64	12.02	10.50	9.45

**IC-KOOLERS** from UNITRACK\* dissipate over 2 watts of heat from IC's producing longer life and better performance. Just push IC-Kooler on heat is collected from top and bottom of IC and dissipated. Won't shake loose!



#### WILD ROVER

Touch switch capsule. Operating motion is .005" without the use of a levered arm. Extremely fast on and off with low noise. Normally operated 1.5 VAC. 1.5 amp-30 milliohm resistance - 615 radius by .160 thick.

Stock No.	1-9	10 & Up
12098	\$1.42	\$1.28

**SCREW MACHINED SOCKET PINS**, loose, packaged in bags of 100. Stock No. 11310 is solder tail with gold collet in shell. Stock No. 11311 is wire wrap with gold collet gold shell.

Stock No.	Description	1 Bag	5 Bags	10 Bags
11310	Bag of 100 solder tail pins	4.95	4.45	\$3.95
11311	Bag of 100 wire wrap pins	11.95	10.75	9.50

#### TIN WIRE WRAP SOCKETS

Tin plated phosphor bronze contact - 3 wrap

Stock No.	No. of Pins	1-99	499	500
11301	8	\$4.40	\$3.30	\$3.00
11302	14	.59	.54	.45
11303	16	.64	.58	.48
11304	18	.73	.66	.55
11305	20	.99	.90	.75
11306	22	1.12	1.02	.85
11307	24	1.25	1.14	.95
11308	28	1.52	1.38	1.15
11309	40	2.05	1.86	1.55

#### TIN LOW PROFILE SOCKETS

Tin plated copper alloy 688 contact pins with gas tight seal.

Stock No.	No. of Pins	1-24	25-99	999
11201	8	\$1.0	\$0.9	\$0.8
11202	14	.14	.13	.12
11203	16	.16	.15	.14
11204	18	.18	.17	.15
11205	20	.20	.18	.16
11206	22	.22	.20	.18
11207	24	.22	.22	.20
11208	28	.28	.26	.25
11209	40	.40	.37	.35

#### 60/40 ROSIN CORE SOLDER

Stock No.	Dia. (feet)	10 L	Price
50075	.062	1	\$1.16
50076	.062	25	4
50077	.062	50	8
50078	.032	3	1.5
50079	.032	86.5	4
50080	.032	175	8

#### EKI KITS

come with all parts necessary to assemble!  
 • Stock No. 88844 TV Jammer Kit "wipes out" your TV screen... \$ 7.71  
 • Stock No. 88850 Whooper Alarm Kit makes a great alarm or siren... \$11.33  
 MANY, MANY MORE KITS AVAILABLE IN FULL LINE CATALOG

**Low profile .050 inch centers - can be bent or folded or "zipped" to separate individual connectors. Inter-faces with all insulation displacement connectors!**

**3M ScotchFlex® INSULATION DISPLACEMENT CABLES**

STOCK NO.	NO. OF CONDUCTORS	ROLL LENGTH	ROLLS	PRICE
30302	14	28.20	34.48	\$17.64
30303	18	28.80	34.48	20.16
30304	24	43.30	38.72	30.04
30306	40	71.98	61.18	50.34
30308	60	69.98	76.48	62.99
30310	14	28.88	24.38	20.08
30311	18	32.78	27.98	22.95
30312	24	49.16	41.79	34.41
30313	30	81.94	89.65	97.38
30314	40	102.42	87.06	71.69
30315	60	129.42	111.22	94.61
30316	14	43.94	37.35	30.76
30317	18	50.12	42.42	35.16
30318	24	75.32	64.02	52.72
30319	30	125.52	108.59	89.83
30320	40	156.90	137.17	108.83

#### Special of the Month!

**NOW - Desolder with one hand!**  
 • Eliminates need for separate soldering iron and desolder pump!  
 Revolutionary new Electric Desoldering Iron. Easy, portable, hand held... performs like an industrial desolder station. No air required. Easy cleaning.  
 Stock No. Electrical Price  
 13349 115VAC 50/60 Hz \$28.95 \$17.50

#### OPCOA

Single Digit Displays - Common Cathode  
 Stock No. Color Price 1 100  
 12082 Red \$1.12 \$ .99  
 12085 Green 1.84 1.63  
 12087 Yellow 1.92 1.70  
 12089 Orange 2.08 1.84

Right Angle Socket for Above Displays  
 Stock No. Price  
 11010 \$1.24 \$ .99

**OPTEL LCD's with pins**  
 Stock No. 47005 Stock Description 1 10  
 47005 3 1/2 dig. 5 \$ 5.95 \$ 5.50  
 47006 4 dig. 5 " 5.95 5.50  
 47007 4 dig. 7 " 11.90 11.00

Stock No. 47006  
 Stock No. 47007

#### The Battery Just Wrap™ Tool

New battery powered tool wraps insulated wire around .025" square posts without need for pre-cutting and strip stripping. Complete with bit and 100 ft. 30 AWG wire.  
 Stock No. Description Price  
 13340 Battery just-wrap tool with bit and 100 ft. 30 AWG wire \$50.95  
 13341 Replacement bit 10.35  
 13342 100 ft. blue replacement wire 7.54  
 13343 100 ft. white replacement wire 7.54  
 13344 100 ft. yellow replacement wire 7.54  
 13345 100 ft. red replacement wire 7.54

#### MICRO Charts - colorful 8 1/2" x 11" charts eliminate the need to stumble through manuals and summaries. Fully decoded - instant access - totally comprehensive - gives pin outs, cycle times, buy notes, etc., etc.

Stock No.	Reference	Price
23010	Z80 CPU	5.95
23011	8080A/8085A	5.95
23012	8502 (85XX)	5.95
23013	8048 and relatives	5.95
23014	547400 TTL Pinouts	5.95
23015	Basic Algorithms	5.95

#### PIN FORMING TOOL

puts IC's on their true row to row spacing. One side for .300 centers. Flip tool over for devices .600 centers. Put device in tool and squeeze.  
 Stock No. Price  
 11059 \$12.95  
 NEW! ANTI-STATIC MODEL 10200 \$14.95

#### Scotchflex® Breadboard Systems Basic kit

comes with 24 various Dual Sockets, 40 various Plug Strips, wire and tools. Kit can be used with any of the six boards.

Stock No.	Description	Price
03500	Basic Kit	\$79.95
03511	Basic Board, 4.5 x 5.5	19.50
03506	Intel SBC-8010 Board, 12 x 6.75	64.95
03507	Motorola M-6800 Board, 9.75 x 6	42.95
03508	S-100 Board, 10 x 5.3	38.95
03509	Z-80 Board, 7.7 x 7.5	38.95
03510	Eurocard Board, 6.3 x 3.9	21.95

#### OK MACHINE AND TOOL

**IC INSERTION/EXTRACTION KIT**  
 Includes DIP IC extractors and inserters to accommodate IC's from 14 to 40 pins. Tools that engage conductive surfaces and CMOS safe and include ground leads.  
 Stock No. Price  
 13309 \$41.34

#### SOCKET WRAP ID

DIP socket-sized plastic panels with numbered holes in openings. Slip onto socket before wire wrapping to identify pins. Also write on them for application, IC part number, function, etc. Simplifies initial wire wrapping, trouble shooting and repair.  
 \$1.95 per pack

#### LOW PROFILE DIP SWITCHES

Stock No.	NO.	POS.	Price
10351	2	1-24 25	1.35
10352	2	1-35 35	1.35
10353	2	1-45 45	1.35
10354	2	1-60 60	1.35
10355	7	1-90 90	1.35
10356	7	1-10 10	1.35
10357	7	1-15 15	1.35
10358	7	1-20 20	1.35
10359	7	1-25 25	1.35

# SINTEC

28 8th St., Box 410  
 Co. Frenchtown, NJ 08825



TOLL 800-526-5960  
 FREE in NJ (201) 996-4093

Circle No. 36 on Free Information Card



### Other PC-Compatible Portables

There are a number of other PC-compatible portables that offer embellishments over the PC, but are less compatible than the Compaq. The Corona Portable offers a higher-resolution text display than the PC Portable, together with such features as underlining and reverse video. Like the Compaq, the Corona system offers dual-screen display and also provides higher-resolution graphics than the PC Portable. A parallel and serial printer port are built into the system and four expansion slots are provided. The price is about the same as the Compaq—\$2595 for a single drive system and \$2995 for a dual drive system, however, some software is "bundled" in the basic system price.

### It might be better to go with the company that establishes the standards

Another portable that has been moderately successful is the Columbia Portable VP. It comes in about the same configuration as the Corona, with built-in parallel and serial ports. The system has only one expansion slot, however. On the positive side, it comes with a number of different software packages bundled in its price, again slightly less than \$3000 in the 128K RAM, dual-drive version. There are a number of other PC compatible portables, with varying degrees of embellishments and compatibility. And it appears that more are yet to come; for example, Kaypro plans to introduce a PC-compatible portable later this year.

### Overall Comparison of the PC Portable and Compatible Portables

The IBM PC Portable and Compaq are virtually identical in performance and options, so it's really a choice between green and amber screens and types of expansion slots, for the most part. With the other systems, the matter seems to boil down to whatever features you'd most like to have in a portable, with the IBM PC forming a base.

However, there's another factor involved. Even Compaq is *not* IBM. Even though Compaq will run virtually all PC software, it is still not setting up standards for IBM systems—IBM is. Obviously IBM thought that there was enough money being made in the PC-

compatible portable area to introduce its own system. Will this decision (call it free enterprise or greed, depending upon your personal business philosophy) also predominate in the software area and in future products? There's some evidence that IBM is already clamping down on their PC-compatible competition with lawsuits over BIOS firmware. If this trend continues and IBM moves away

from its "open machine" policy, owners of PC-compatible machines may find that they've lost some of their compatibility with new products. It's the American way to root for the underdog, but where \$3000 of money is involved it might be more prudent to go with the company that establishes the standards. And who exemplifies the American business ideal more than Big Blue? ◇



# Active



**The One Stop Electronic Shop!**

**Call Toll FREE 1-800-343-0874**

**In the United States:**

#### Mail Orders

P.O. Box 8000  
Westborough, Mass.  
01581  
(Mass) (617) 366-0500

#### Boston

133 Flanders Road  
Westborough, Mass.  
01581  
(617) 366-9684

#### Seattle

13107 Northup Way  
Bellevue, Wash.  
98004  
(206) 881-8191

**In Canada:**

#### Montréal

5651 Rue Ferrier  
Montréal, Québec  
H4P 1N1  
(514) 731-7441

#### Toronto

14 Carlton Street  
Toronto, Ontario  
M5B 1K5  
(416) 977-7692

#### Downsview

86 St. Regis Cr. N.  
Downsview, Ontario  
M3J 1Y8  
(416) 630-0400

#### Ottawa

1023 Merivale Road  
Ottawa, Ontario  
K1Z 6A6  
(613) 728-7900

#### Calgary

3220-5th Ave. N.E.  
Bay 2  
Calgary, Alberta  
T2A 5N1  
(403) 235-5300

#### Vancouver

3070 Kingsway  
Vancouver, B.C.  
V5R 5J7  
(604) 438-3321

**Visit your nearest Active store, call, write or circle the Reader Service Card for your copy of Active's new catalog.**

CIRCLE NO. 50 ON FREE INFORMATION CARD

# 4164

64K DYNAMIC  
200 ns

# \$595

# 4116

16K DYNAMIC  
250 ns

# 8/\$795

### STATIC RAMS

2101	356 x 4	(450ns)	1.95
5101	256 x 4	(450ns) (cmos)	3.95
2101-1	1024 x 1	(450ns)	.89
2102L-4	1024 x 1	(450ns) (LP)	.99
2102L-2	1024 x 1	(250ns) (LP)	1.49
2125	1024 x 1	(45ns)	2.95
2111	256 x 4	(450ns)	2.49
2111L	256 x 4	(250ns) (LP)	2.95
2112	256 x 4	(450ns)	2.99
2114	1024 x 4	(450ns)	8/9.95
2114-25	1024 x 4	(250ns)	8/10.95
2114L-4	1024 x 4	(450ns) (LP)	8/12.95
2114L-3	1024 x 4	(300ns) (LP)	8/13.45
2114L-2	1024 x 4	(200ns) (LP)	8/13.95
TC5514	1024 x 4	(650ns) (cmos)	2.49
TC5518	2048 x 4	(250ns) (cmos)	9.95
2147	4096 x 1	(55ns)	4.95
TMS4044-4	4096 x 1	(450ns)	3.49
TMS4044-3	4096 x 1	(300ns)	3.99
TMS4044-2	4096 x 1	(200ns)	4.49
UPD410	4096 x 1	(100ns)	3.95
MK4118	1024 x 8	(100ns)	9.95
TMM2016-200	2048 x 8	(200ns)	4.15
TMM2016-150	2048 x 8	(150ns)	4.95
TMM2016-100	2048 x 8	(100ns)	6.15
HM6118-4	2048 x 8	(200ns) (cmos)	4.75
HM6118-3	2048 x 8	(150ns) (cmos)	4.95
HM6118-2	2048 x 8	(120ns) (cmos)	8.85
HM6118LP-4	2048 x 8	(200ns) (cmos) (LP)	5.95
HM6118LP-3	2048 x 8	(150ns) (cmos) (LP)	6.95
HM6118LP-2	2048 x 8	(120ns) (cmos) (LP)	10.95
TMS4016	2048 x 8	(200ns) (cmos)	8.95
Z6132	4096 x 8	(300ns) (Cstat)	34.95
HM6284LP-15	8192 x 8	(150ns) (cmos)	38.95
HM6284LP-15	8192 x 8	(150ns) (cmos)	49.95

LP = Low Power      Cstat = Quasi-Static

### DYNAMIC RAMS

TMS4027	4096 x 1	(250ns)	1.99
2107	4096 x 1	(200ns)	1.95
MM5280	4096 x 1	(300ns)	1.95
TMS4080	4096 x 1	(300ns)	1.95
UPD411	4096 x 1	(300ns)	1.85
TMS4050	4096 x 1	(300ns)	1.95
MK4108	8192 x 1	(200ns)	1.85
MM5298	8192 x 1	(250ns)	1.85
4116-300	16384 x 1	(300ns)	8/11.75
4116-250	16384 x 1	(250ns)	8/7.95
4116-200	16384 x 1	(200ns)	8/12.95
4116-150	16384 x 1	(150ns)	8/14.95
4116-120	16384 x 1	(120ns)	8/28.95
2118	16384 x 1	(150ns) (5v)	4.95
MK4332	32768 x 1	(200ns)	9.95
4184-200	85536 x 1	(200ns) (5v)	5.95
4184-150	85536 x 1	(150ns) (5v)	6.95
4184-120	85536 x 1	(120ns) (5v)	8.95
MCM6885	85536 x 1	(200ns) (5v)	8.95
TMS164-15	85536 x 1	(150ns) (5v)	8.95
TMS4416	16384 x 4	(150ns) (5v)	9.95
41258	262144 x 1	(200ns) (5v)	CALL

5v = Single 5 volt supply

### EPROMS

1702	256 x 8	(1us)	4.50
2708	1024 x 8	(450ns)	3.95
2758	1024 x 8	(450ns) (5v)	5.95
2716-6	2048 x 8	(650ns)	2.95
2716	2048 x 8	(450ns) (5v)	3.95
2716-1	2048 x 8	(350ns) (5v)	5.95
TMS2518	2048 x 8	(450ns) (5v)	5.50
TMS2718	2048 x 8	(450ns)	7.95
TMS2532	4096 x 8	(450ns) (5v)	5.95
2732	4096 x 8	(450ns) (5v)	4.95
2732-250	4096 x 8	(250ns) (5v)	8.95
2732-200	4096 x 8	(200ns) (5v)	11.95
2732A-4	4096 x 8	(450ns) (5v) (21VPGM)	6.95
2732A	4096 x 8	(250ns) (5v) (21VPGM)	9.95
2732A-2	4096 x 8	(200ns) (5v) (21VPGM)	13.95
2764	8192 x 8	(450ns) (5v)	6.95
2764-250	8192 x 8	(250ns) (5v)	7.95
2764-200	8192 x 8	(200ns) (5v)	19.95
TMS2564	8192 x 8	(450ns) (5v)	14.95
MCM68764	8192 x 8	(450ns) (5v) (24pin)	39.95
MCM68764	8192 x 8	(350ns) (5v) (24pin)	42.95
27128-30	16384 x 8	(300ns) (5v)	29.95
27128	16384 x 8	(250ns) (5v)	34.95

5v = Single 5 Volt Supply      21VPGM = Program at 21 Volts

### ★ ★ ★ ★ HIGH-TECH ★ ★ ★ ★

## SSI 263 SPEECH SYNTHESIZER

- ★ MICROPROCESSOR COMPATIBLE
- ★ 5 8-BIT CONTROL REGISTERS
- ★ ENHANCE YOUR MOCKINGBOARD OR BUILD STEVE CIARCIA'S SWEET TALKER II (BYTE MARCH '84)

# 39.95

### ★ ★ ★ ★ SPOTLIGHT ★ ★ ★ ★

- ★ Computer managed inventory — virtually no back orders!
- ★ Very competitive prices!
- ★ Friendly staff!
- ★ Fast service — most orders shipped within 24 hours!

### CRYSTALS

32.768 khz	1.95
1.0 mhz	3.95
1.8432	3.95
2.0	2.95
2.097152	2.95
2.4576	2.95
3.2768	2.95
3.579545	2.95
5.0	2.95
5.0	2.95
5.0688	2.95
5.185	2.95
5.7143	2.95
6.0	2.95
6.144	2.95
6.5536	2.95
8.0	2.95
8.0	2.95
10.738635	2.95
14.31818	2.95
15.0	2.95
15.0	2.95
17.430	2.95
18.0	2.95
18.432	2.95
20.0	2.95
22.1184	2.95
32.0	2.95

### CMOS

4000	.29	4528	1.19
4001	.25	4531	.95
4002	.25	4532	1.95
4006	.89	4538	1.95
4007	.29	4539	1.95
4008	.95	4541	2.64
4009	.39	4543	1.19
4010	.45	4553	5.79
4011	.25	4555	.95
4012	.25	4556	.95
4013	.38	4581	1.95
4014	.79	4582	1.95
4015	.39	4584	.75
4016	.39	4585	.75
4017	.69	4702	12.95
4018	.79	74C00	.35
4019	.39	74C02	.35
4020	.75	74C04	.35
4021	.79	74C08	.35
4022	.79	74C10	.35
4023	.29	74C14	.59
4024	.65	74C20	.35
4025	.29	74C30	.35
4026	1.65	74C32	.39
4027	.45	74C42	1.29
4028	.69	74C48	1.99
4029	.79	74C73	.65
4030	.39	74C74	.65
4034	1.95	74C76	.80
4035	.85	74C83	1.95
4040	.75	74C85	1.95
4041	.75	74C86	.39
4042	.69	74C89	4.50
4043	.85	74C90	1.19
4044	.79	74C93	1.75
4046	.85	74C95	.99
4047	.95	74C107	.89
4049	.35	74C150	5.75
4050	.35	74C151	2.25
4051	.79	74C154	3.25
4053	.79	74C157	1.75
4060	.89	74C160	1.19
4066	.39	74C161	1.19
4068	.39	74C162	1.19
4069	.29	74C163	1.19
4070	.35	74C164	1.39
4071	.29	74C165	2.00
4072	.29	74C173	.79
4073	.29	74C174	1.19
4075	.29	74C175	1.19
4076	.79	74C192	1.49
4078	.29	74C193	1.49
4081	.29	74C195	1.39
4082	.29	74C200	5.75
4085	.95	74C221	1.75
4086	.95	74C244	2.25
4093	.49	74C373	2.45
4098	2.49	74C374	2.45
4099	1.95	74C901	.39
14409	12.95	74C902	.85
14410	12.95	74C903	.85
14411	11.95	74C905	10.95
14412	12.95	74C906	.95
14419	7.95	74C907	1.00
14433	14.95	74C908	2.00
4502	.95	74C909	2.75
4503	.65	74C910	9.95
4508	1.95	74C911	8.95
4510	.85	74C912	8.95
4511	.85	74C914	1.95
4512	.85	74C915	1.19
4514	1.25	74C918	2.75
4515	1.79	74C920	17.95
4516	1.55	74C921	15.95
4518	.89	74C922	4.49
4519	.39	74C923	4.95
4520	.79	74C925	5.95
4522	1.25	74C926	7.95
4526	1.25	74C928	7.95
4527	1.95	74C929	19.95

### UARTS

AY5-1013	3.95
AY3-1015	6.95
PT1472	9.95
TR1602	3.95
2851	9.95
IM6402	7.95
IM6403	8.95
INS8250	10.95

### GENERATORS BIT-RATE

MC14411	11.95
BR1941	11.95
4702	12.95
COM5016	16.95
COM8116	10.95
MM5307	10.95

### FUNCTION

MC4024	3.95
LM566	1.49
XR2206	3.75
8038	3.95

### MISC.

UPD7201	29.95
TMS99532	29.95
ULN2003	2.49
3242	7.95
3341	4.95
MC3470	4.95
MC3480	9.00
11C90	13.95
95H90	7.95
2513-001 UP	9.95
2513-002 LOW	9.95

### CLOCK CIRCUITS

MM5314	4.95
MM5369	3.95
MM5369-EST	4.25
MM5375	4.95
MM58167	12.95
MM58174	11.95
MSM5832	3.95

### KEYBOARD CHIPS

AY5-2376	11.95
AY5-3600	11.95
AY5-3600 PRO	11.95

### 6800

68000	49.95
6800	2.95
6802	7.95
6803	19.95
6808	13.90
6809E	14.95
6809	11.95
6810	2.95
6820	4.35
6821	2.95
6828	14.95
6840	12.95
6843	34.95
6844	25.95
6845	14.95
6847	11.95
6850	3.25
6852	5.75
6860	7.95
6875	6.95
6880	2.25
6883	22.95
68047	24.95
68488	19.95

6800 = 1MHZ	1795
68B00	10.95
68B02	22.25
68B09E	29.95
68B09	29.95
68B10	6.95
68B21	6.95
68B40	19.95
68B45	19.95
68B50	5.95
68B00 = 2 MHZ	1795

### 6500

6502	4.95
6504	6.95
6505	8.95
6507	9.95
6520	4.35
6522	6.95
6532	9.95
6545	22.50
6551	11.85
6502A	6.95
6522A	9.95
6532A	11.95
6545A	27.95
6551A	11.95
6502B	9.95

DISC CONTROLLERS	1771	16.95
	1791	24.95
	1793	26.95
	1795	29.95
	1797	49.95
	2791	54.95
	2793	54.95
	2795	59.95
	2797	59.95
	6843	34.95
	8272	39.95
	UPD765	39.95
	MB8876	29.95
	MB8877	34.95
	1691	17.95
	2143	

# TMM2016

2K x 8 STATIC  
200 ns

# \$4.15

# HM6264

3K x 8 STATIC  
150 ns

# \$39.95

### 74LS00

74LS00	.24	74LS173	.69
74LS01	.25	74LS174	.55
74LS02	.25	74LS175	.55
74LS03	.25	74LS181	2.15
74LS04	.24	74LS189	8.95
74LS05	.25	74LS190	.89
74LS08	.28	74LS191	.89
74LS09	.29	74LS192	.79
74LS10	.25	74LS193	.79
74LS11	.35	74LS194	.69
74LS12	.35	74LS195	.69
74LS13	.45	74LS196	.79
74LS14	.59	74LS197	.79
74LS15	.35	74LS221	.89
74LS20	.25	74LS240	.95
74LS21	.29	74LS241	.99
74LS22	.25	74LS242	.99
74LS26	.29	74LS243	.99
74LS27	.29	74LS244	1.29
74LS28	.35	74LS245	1.49
74LS30	.25	74LS247	.75
74LS32	.29	74LS248	.99
74LS33	.55	74LS249	.99
74LS37	.35	74LS251	.59
74LS38	.35	74LS253	.59
74LS40	.25	74LS257	.59
74LS42	.49	74LS258	.59
74LS47	.75	74LS259	2.75
74LS48	.75	74LS260	.59
74LS49	.75	74LS266	.55
74LS51	.25	74LS273	1.49
74LS54	.29	74LS275	3.35
74LS55	.29	74LS279	.49
74LS56	1.25	74LS280	1.98
74LS73	.39	74LS283	.69
74LS74	.35	74LS290	.89
74LS75	.39	74LS293	.89
74LS76	.39	74LS295	.99
74LS78	.49	74LS298	.89
74LS83	.60	74LS299	1.75
74LS85	.69	74LS323	3.50
74LS86	.39	74LS324	1.75
74LS90	.55	74LS352	1.29
74LS91	.89	74LS353	1.29
74LS92	.55	74LS363	1.35
74LS93	.55	74LS364	1.95
74LS95	.75	74LS365	.49
74LS96	.89	74LS366	.49
74LS107	.39	74LS367	.45
74LS109	.39	74LS368	.45
74LS112	.39	74LS373	1.39
74LS113	.39	74LS374	1.39
74LS114	.39	74LS375	.95
74LS122	.45	74LS377	1.39
74LS123	.79	74LS378	1.18
74LS124	2.90	74LS379	1.35
74LS125	.49	74LS385	3.90
74LS126	.49	74LS386	.45
74LS132	.59	74LS390	1.19
74LS133	.59	74LS393	1.19
74LS136	.39	74LS395	1.19
74LS137	.99	74LS399	1.49
74LS138	.55	74LS424	2.95
74LS139	.55	74LS447	.95
74LS145	1.20	74LS490	1.95
74LS147	2.49	74LS624	3.99
74LS148	1.35	74LS640	2.20
74LS151	.55	74LS645	2.20
74LS153	.55	74LS668	1.69
74LS154	1.90	74LS669	1.89
74LS155	.69	74LS670	1.49
74LS156	.89	74LS674	14.95
74LS157	.65	74LS682	3.20
74LS158	.59	74LS683	3.20
74LS160	.69	74LS684	3.20
74LS161	.65	74LS685	3.20
74LS162	.69	74LS688	2.40
74LS163	.65	74LS689	3.20
74LS164	.69	81LS95	1.49
74LS165	.95	81LS96	1.49
74LS166	1.95	81LS97	1.49
74LS168	1.75	81LS98	1.49
74LS169	1.75	25LS2521	2.80
74LS170	1.49	25LS2569	4.25

### 74S00

74S00	.32	74S124	2.75	74S197	1.49
74S02	.35	74S132	1.24	74S201	6.95
74S03	.35	74S133	.45	74S225	7.95
74S04	.35	74S134	.50	74S240	2.20
74S05	.35	74S135	.89	74S241	2.20
74S08	.35	74S138	.89	74S244	2.20
74S09	.40	74S139	.89	74S251	.95
74S10	.35	74S140	.89	74S253	.95
74S11	.35	74S151	.95	74S257	.95
74S15	.35	74S157	.95	74S258	.95
74S20	.35	74S158	.95	74S260	.79
74S22	.35	74S158	.95	74S273	2.45
74S30	.35	74S161	1.55	74S280	1.95
74S32	.40	74S162	1.55	74S287	1.90
74S37	.88	74S163	1.55	74S288	1.90
74S38	.85	74S168	3.55	74S289	6.89
74S40	.35	74S169	3.55	74S301	6.95
74S51	.35	74S174	.55	74S373	2.45
74S64	.40	74S175	.55	74S374	2.45
74S65	.40	74S181	3.55	74S387	1.95
74S74	.50	74S182	2.55	74S412	2.98
74S85	1.99	74S188	1.55	74S471	4.95
74S86	.50	74S189	6.65	74S472	4.95
74S112	.50	74S194	1.49	74S474	4.95
74S113	.50	74S195	1.49	74S570	2.95
74S114	.55	74S196	1.49	74S571	2.95

### VOLTAGE REGULATORS

7805T	.75	7805T	.85
78M05C	.35	7808T	.85
7808T	.75	7812T	.85
7812T	.75	7815T	.85
7815T	.75	7824T	.85
7824T	.75	7305K	1.49
7805K	1.39	7312K	1.49
7812K	1.39	7315K	1.49
7815K	1.39	7324K	1.49
7824K	1.39	73L05	.79
78L05	.69	73L12	.79
78L12	.69	73L15	.79
78L15	.69	LM323K	4.95
78H05K	9.95	LA78540	1.95
78H12K	9.95		

C, T = TO-220 K = TO-3  
L = TO-9

### SOUND CHIPS

76477	3.95	AY3-8910	12.95
76488	5.95	AY3-8912	12.95
76489	8.95	MCC340	1.49
SSI-263			39.95

### 7400

7400	.19	74123	.49
7401	.19	74125	.45
7402	.19	74126	.45
7403	.19	74132	.45
7404	.19	74136	.50
7405	.25	74143	4.95
7406	.29	74145	.60
7407	.29	74147	1.75
7408	.24	74148	1.20
7409	.19	74150	1.35
7410	.19	74151	.55
7411	.25	74153	.55
7413	.35	74154	1.25
7414	.49	74155	.75
7416	.25	74157	.55
7417	.25	74159	1.65
7420	.19	74160	.89
7421	.35	74161	.69
7425	.29	74163	.69
7427	.29	74164	.85
7430	.19	74165	.85
7432	.29	74166	1.00
7437	.29	74167	2.95
7438	.29	74170	1.65
7442	.49	74173	.75
7445	.69	74174	.89
7446	.69	74175	.89
7447	.69	74177	.75
7448	.69	74181	2.25
7451	.23	74184	2.00
7473	.34	74185	2.00
7474	.33	74191	1.15
7475	.45	74192	.79
7476	.35	74193	.79
7482	.95	74194	.85
7483	.50	74195	.85
7485	.59	74197	.75
7486	.35	74198	1.35
7489	2.15	74221	1.35
7490	.35	74246	1.35
7492	.50	74247	1.25
7493	.35	74259	2.25
7495	.55	74273	1.95
7497	2.75	74276	1.25
74100	1.75	74279	.75
74107	.30	74366	.65
74109	.45	74367	.65
74116	1.55	74368	.65
74121	.29	74393	1.35
74122	.45		

### BYPASS CAPS

.01 UF DISC	100/6.00
.01 UF MONOLITHIC	100/12.00
1 UF DISC	100/8.00
1 UF MONOLITHIC	100/15.00

### EPROM ERASERS SPECTRONICS CORPORATION

	Capacity	Intensity	
	Chip	(uW/Cm <sup>2</sup> )	
PE-14	9	8,000	83.00
PE-14T	X	9,000	119.00
PE-24T	X	12,960	175.00
PL-265T	X	30,960	255.00
PR-125T	X	25,17,000	349.00
PR-320T	X	42,17,000	595.00

### INTERFACE

8T26	1.59
8T28	1.89
8T95	.89
8T96	.89
8T97	.89
8T98	.89
DM8131	2.95
DP8304	2.29
DS8833	2.25
DS8835	1.99
DS8836	.99
DS8837	1.65
DS8838	1.30

### CENTRONICS

<b>IDCEN36</b>	
Ribbon Cable	
36 Pin Male	8.95
<b>IDCEN36/F</b>	
Ribbon Cable	
36 Pin Female	8.95
<b>CEN36</b>	
Solder Cup	
36 Pin Male	7.95

### DATA ACQUISITION

ADC0800	15.55	DAC0800C	4.95
ADC0804	3.49	DAC080E	2.95
DAC0806	1.95	DAC102C	8.25
ADC0809	4.49	DAC102Z	5.95
ADC0816	14.95	MC1408L6	1.95
ADC0817	9.95	MC1408L8	2.95

### CONNECTORS

RS232 Male	2.50
RS232 Female	3.25
RS232 Hood	1.25
S-100 ST	3.95

### EXAR

XR 2206	3.75
XR 2207	3.75
XR 2208	3.75
XR 2211	5.25
XR 2240	3.25

### INTERSIL

ICL7106	9.95
ICL7107	12.95
ICL7660	2.95
ICL8038	3.95
ICM7207A	5.59
ICM7208	15.95

### 9000

9316	1.00
9334	2.50
9368	3.95
9401	9.95
9601	.75
9602	1.50
96S02	1.95

### LINEAR

LM301	.34	LM348	.99	LM567	.89	LM187-2	8.25
LM301H	.79	LM350K	4.95	NE570	3.95	LM187C	3.50
LM307	.45	LM350T	4.60	NE571	2.95	LM187L	5.49
LM308	.69	LM359	.69	NE590	2.50	LM187T	5.49
LM308H	1.15	LM359	1.79	NE592	2.75	LM187Z	3.25
LM309H	1.95	LM376	3.75	LM709	.59	LM188A	1.95
LM309K	1.25	LM377	1.95	LM710	.75	LM188F	1.75
LM310	1.75	LM378	2.50	LM711	.79	ULN2M03	2.49
LM311	.64	LM379	4.50	LM723	.49	LM287	2.05
LM311H	.89	LM380	.89	LM723H	.55	LM287-8	2.25
LM312H	1.75	LM380B	1.15	LM733	.98	LM290	.85
LM317K	3.95	LM381	1.60	LM741	.35	LM291	1.00
LM317T	1.19	LM382	1.60	LM741N-14	.35	LM297	2.95
LM318	1.49	LM383	1.95	LM741H	.40	LM390	.59
LM318H	1.59	LM384	1.95	LM747	.69	LM395	1.25
LM319H	1.90	LM386	.85	LM748	.59	LM399	.98
LM319	1.25	LM387	1.40	LM1014	1.19	LM397	1.25
LM320 (see 7900)		LM389					

**NATIONAL SEMICONDUCTOR • PANASONIC • QUALITY** - Name brand products from nationally recognized manufacturers.  
**AVOID CHEMVIC • ATLANTIC DIODES • N. MOLEX • A.A. MOLEX • A.A. MOLEX • J. MOX MACHINE • UNGAR • GC CHEMICALS • J. NATIONAL SEMICONDUCTOR • PANASONIC • SAVINGS** - Volume Discounts • OEM Quantity Pricing • Toll Free 800 Number  
**Service** - Computerized order processing and inventory control. **Volume Discounts • OEM Quantity Pricing • Toll Free 800 Number**  
 The Big (HUGE) Discount makes Big Price Differences (S&P) Buy More!  
**CHEMICALS • ARIES • PLESSEY • MOLEX • E. MACHINE • DIAMOND TOOL • UNGAR • GC CH. AS INSTRUMENTS • A.A. P PRODUCTS • DI. MID TOOL • UNGAR • GC CHEMICALS • ARIES • PLESSEY • MOLEX • E.** master charge

### INTEGRATED CIRCUITS

Part No.	Price	Part No.	Price	Part No.	Price
7400 TL	41	7410 TL	41	7420 TL	41
7401 TL	41	7411 TL	41	7421 TL	41
7402 TL	41	7412 TL	41	7422 TL	41
7403 TL	41	7413 TL	41	7423 TL	41
7404 TL	41	7414 TL	41	7424 TL	41
7405 TL	41	7415 TL	41	7425 TL	41
7406 TL	41	7416 TL	41	7426 TL	41
7407 TL	41	7417 TL	41	7427 TL	41
7408 TL	41	7418 TL	41	7428 TL	41
7409 TL	41	7419 TL	41	7429 TL	41
7410 TL	41	7420 TL	41		

### INTEGRATED CIRCUITS

Part No.	Price	Part No.	Price	Part No.	Price
4000 CMOS	1.00	4001 CMOS	1.00	4002 CMOS	1.00
4003 CMOS	1.00	4004 CMOS	1.00	4005 CMOS	1.00
4006 CMOS	1.00	4007 CMOS	1.00	4008 CMOS	1.00
4009 CMOS	1.00	4010 CMOS	1.00	4011 CMOS	1.00
4012 CMOS	1.00	4013 CMOS	1.00	4014 CMOS	1.00
4015 CMOS	1.00	4016 CMOS	1.00	4017 CMOS	1.00
4018 CMOS	1.00	4019 CMOS	1.00	4020 CMOS	1.00
4021 CMOS	1.00	4022 CMOS	1.00	4023 CMOS	1.00
4024 CMOS	1.00	4025 CMOS	1.00	4026 CMOS	1.00
4027 CMOS	1.00	4028 CMOS	1.00	4029 CMOS	1.00
4030 CMOS	1.00	4031 CMOS	1.00	4032 CMOS	1.00

### TEST INSTRUMENTS

Part No.	Price	Part No.	Price	Part No.	Price
IC SOCKET	1.00	IC SOCKET	1.00	IC SOCKET	1.00
IC SOCKET	1.00	IC SOCKET	1.00	IC SOCKET	1.00
IC SOCKET	1.00	IC SOCKET	1.00	IC SOCKET	1.00
IC SOCKET	1.00	IC SOCKET	1.00	IC SOCKET	1.00
IC SOCKET	1.00	IC SOCKET	1.00	IC SOCKET	1.00
IC SOCKET	1.00	IC SOCKET	1.00	IC SOCKET	1.00
IC SOCKET	1.00	IC SOCKET	1.00	IC SOCKET	1.00
IC SOCKET	1.00	IC SOCKET	1.00	IC SOCKET	1.00
IC SOCKET	1.00	IC SOCKET	1.00	IC SOCKET	1.00
IC SOCKET	1.00	IC SOCKET	1.00	IC SOCKET	1.00

### 150 CAPACITORS

Part No.	Price	Part No.	Price	Part No.	Price
150 CAP	1.00	150 CAP	1.00	150 CAP	1.00
150 CAP	1.00	150 CAP	1.00	150 CAP	1.00
150 CAP	1.00	150 CAP	1.00	150 CAP	1.00
150 CAP	1.00	150 CAP	1.00	150 CAP	1.00
150 CAP	1.00	150 CAP	1.00	150 CAP	1.00
150 CAP	1.00	150 CAP	1.00	150 CAP	1.00
150 CAP	1.00	150 CAP	1.00	150 CAP	1.00
150 CAP	1.00	150 CAP	1.00	150 CAP	1.00
150 CAP	1.00	150 CAP	1.00	150 CAP	1.00
150 CAP	1.00	150 CAP	1.00	150 CAP	1.00

### DISC CAPACITORS

Part No.	Price	Part No.	Price	Part No.	Price
DISC CAP	1.00	DISC CAP	1.00	DISC CAP	1.00
DISC CAP	1.00	DISC CAP	1.00	DISC CAP	1.00
DISC CAP	1.00	DISC CAP	1.00	DISC CAP	1.00
DISC CAP	1.00	DISC CAP	1.00	DISC CAP	1.00
DISC CAP	1.00	DISC CAP	1.00	DISC CAP	1.00
DISC CAP	1.00	DISC CAP	1.00	DISC CAP	1.00
DISC CAP	1.00	DISC CAP	1.00	DISC CAP	1.00
DISC CAP	1.00	DISC CAP	1.00	DISC CAP	1.00
DISC CAP	1.00	DISC CAP	1.00	DISC CAP	1.00
DISC CAP	1.00	DISC CAP	1.00	DISC CAP	1.00

### NEW! KIT

Part No.	Price	Part No.	Price	Part No.	Price
NEW KIT	1.00	NEW KIT	1.00	NEW KIT	1.00
NEW KIT	1.00	NEW KIT	1.00	NEW KIT	1.00
NEW KIT	1.00	NEW KIT	1.00	NEW KIT	1.00
NEW KIT	1.00	NEW KIT	1.00	NEW KIT	1.00
NEW KIT	1.00	NEW KIT	1.00	NEW KIT	1.00
NEW KIT	1.00	NEW KIT	1.00	NEW KIT	1.00
NEW KIT	1.00	NEW KIT	1.00	NEW KIT	1.00
NEW KIT	1.00	NEW KIT	1.00	NEW KIT	1.00
NEW KIT	1.00	NEW KIT	1.00	NEW KIT	1.00
NEW KIT	1.00	NEW KIT	1.00	NEW KIT	1.00

**DIGI-KEY** Compare the Discount When  
 Discount comparing Prices  
 The Digi-Key volume discount and Service charges are simple to apply. Most items sold by Digi-Key may be combined for a volume discount. Items that are not discountable are identified by the suffix "ND" following the part number. When placing your order, total all of the discountable items and apply the appropriate discount. To this subtotal, add the non-discountable items. Then add the shipping charge. The total amount is the amount you will be billed. In the U.S.A., Canada and Mexico when payment accompanies order.  
**WHEN ORDERING BY PHONE CALL 1-800-348-5144 (In Minn., Ak., Hi. call 218-681-6674)**  
 You may pay by check, money order, Master Charge, VISA or C.O.D. **DIGI-KEY GUARANTEE:** Any order or products purchased from Digi-Key that prove to be defective will be replaced or refunded if returned within 90 days from purchase with a copy of your invoice.

Circle No. 14 on Free Information Card

American RadioHistory.com

7400

Number of Pins or Price for New Stock Purchase

MICROPROCESSOR COMPONENTS

Digitalker™

Table with 4 columns: Part No., Pns, Price, Part No., Pns, Price. Lists various 7400 series components like SN7400N, SN7401N, etc.

Table with 4 columns: Part No., Pns, Price, Part No., Pns, Price. Lists MICROPROCESSOR CHIPS like CPU1, CPU2, CPU3, etc.

Table with 4 columns: Part No., Pns, Price, Part No., Pns, Price. Lists Z80, Z80A, Z80B, Z80C SERIES components like Z80, Z80C, Z80C-01, etc.

Table with 4 columns: Part No., Pns, Price, Part No., Pns, Price. Lists 6500/6800/6800 SERIES components like MC6502A, MC6502B, etc.

Table with 4 columns: Part No., Pns, Price, Part No., Pns, Price. Lists 74LS series components like 74LS00, 74LS01, 74LS02, etc.

Table with 4 columns: Part No., Pns, Price, Part No., Pns, Price. Lists 74LS series components like 74LS100, 74LS101, 74LS102, etc.

Table with 4 columns: Part No., Pns, Price, Part No., Pns, Price. Lists 74S/PROMS series components like 74S100, 74S101, 74S102, etc.

Table with 4 columns: Part No., Pns, Price, Part No., Pns, Price. Lists DISK CONTROLLERS like MS1771-1, FD1191, etc.

Table with 4 columns: Part No., Pns, Price, Part No., Pns, Price. Lists CA-LINEAR components like CA3010N, CA3039N, etc.

Table with 4 columns: Part No., Pns, Price, Part No., Pns, Price. Lists CD-CMOS components like CD4001, CD4002, CD4003, etc.

DT1050 Applications: Teaching aids, appliances, clocks, automotive, telecommunications, language translations, etc.

DT1050 Digitalker™ \$34.95 ea. MM54104 Processor Chip \$14.95 ea.

DT1057 - Includes the DT1050 vocabulary from 137 to over 260 words. Expands 2 ROMs and specs.

Part No. DT1057 \$24.95 ea.

Table with 4 columns: Part No., Pns, Price, Part No., Pns, Price. Lists INTERSIL components like 7045PI, 7045V/K, etc.

30009 1983 InterSIL Data Book (1356p.) \$9.95

Table with 4 columns: Part No., Pns, Price, Part No., Pns, Price. Lists NEW PRODUCT: 74HC High Speed CMOS components like 74HC00, 74HC01, etc.

Table with 4 columns: Part No., Pns, Price, Part No., Pns, Price. Lists 74C-C/MOS components like 74C00, 74C01, etc.

Table with 4 columns: Part No., Pns, Price, Part No., Pns, Price. Lists LINEAR components like LM139N, LM147N, etc.

Table with 4 columns: Part No., Pns, Price, Part No., Pns, Price. Lists WIRE WRAP SOCKETS (GOLD) LEVEL #3 components like 8 pin WW, 16 pin WW, etc.

Table with 4 columns: Part No., Pns, Price, Part No., Pns, Price. Lists SOLDERTAIL STANDARD (TIN) components like 8 pin ST, 16 pin ST, etc.

## COMMODORE 64 INTERFACING BLUE BOOK

Written by a college professor in a friendly and informative style, this book is a gold mine of practical information on how to build a variety of useful interfaces for your computer. Over 30 projects including cassette interface, printer interface, expansion bus, light pen, RS-232 interface, more user ports, thermometer, speech synthesizer and two other voice projects, A/D and D/A converters. 5 telephone interfaces including a sophisticated voice mail project, motor controllers, AC power control, logic analyzer, capacitance meter, spectrum analyzer, home security system and many more. \$16.95 postpaid. Foreign orders add \$3 for AIR MAIL shipping.

## VIC 20 INTERFACING BLUE BOOK

30 hardware interfacing projects for the VIC 20. Similar to the 64 book above. See what your VIC can do with a little interfacing. \$14.95 postpaid.

**microsignal**  
Dept. B, P.O. BOX 22  
MILLWOOD, NY 10546

## EPROM Eraser \$44.90 EPROM Programmer \$159



### ERASER

- contains same features as competitors' but cost less than one half their price
- erases up to 9 chips
- 6.4 mA/cm<sup>2</sup> on chips
- chip drawer prevents UV exposure to users
- long life UV tube
- erase time from 15 min

### PROGRAMMER

- ★ PROGRAMS & COPIES: 2516, 2532, 2716, 2732, 2732A.
- ★ 4K INTERNAL RAM BUFFER STORAGE CAPACITY.
- ★ NO PERSONALITY MODULE REQUIRED.
- ★ POWER CAN BE REMOVED FROM ZIF SOCKET WHEN LOADING EPROMs.
- ★ BINARY ADDRESS AND DATA DISPLAY.
- ★ INDEPENDENT UNIT -- VERIFIES, PROGRAMS, INPUTS DATA FROM BINARY KEYBOARD, LOADS DATA FROM EPROM TO RAM, AND CHANGES ANY BIT OF DATA.
- ★ FULL 90-DAY GUARANTEE ON ALL PRODUCTS FOR ANY DEFECTS IN MATERIALS AND WORKMANSHIP.

**ANGO ELECTRONICS CORP.** 212-685-6336  
P.O. BOX 112 HARRISON, NJ 07029 TLX: 421531 ARTIST

Mail orders: Please add \$3 handling charge  
N.J. residents: Please add 6% sales tax

CIRCLE NO. 96 ON FREE INFORMATION CARD

## PRINTER STAND or DESK

- \* Size: 27h x 24d x 27" w.
- \* Black Painted Steel
- \* Sh. Wt. 75 Lbs.
- \* Shipped Freight Collect
- \* Use Order No. 2A70585



**\$39.95**



### FAN CONTROL

Controls Speed Of AC MOTORS!

ONLY **\$3.88** 3 for \$10.00

Muffin Fans, Caravel Fans, Blowers, ETC... Good for 115/220 VAC up to 6 amps stall current. Control rated at 1.6 amps. Size: 1 1/4 x 2 x 1 1/2" Shaft mounting. Use Order No. 3BS0269.

## BNF Enterprises

119r FOSTER St.  
Peabody MA 01960  
(617) 531-5774

Customer Pays All Shipping Charges.

CIRCLE NO. 116 ON FREE INFORMATION CARD

## MODULES FOR TIMEX-Sinclair

**\$149.95**  
MD-2B



## MODEM

- 2 FREE HOURS COMPUSERVE NOW BOTH ORIGINATE AND ANSWER
- Send & Receive Programs by Phone
- Copy Information into Memory. Print It. Review It. Save It On Tape. Send Text From Memory.
- Use Timex 2040 Printer or Any RS-232 Printer.
- RS-232 Printer Port Provided.
- No extra Memory Required. But with 64K Memory You Can Store Up To 60 Full Screens.
- ADAPTABLE TO THE NEW 2068

BYTE-BACK CO. Rt. 3 Box 147 Brodie Rd., Leesville, S.C. 29070 Ck. COD VISA M/C AM EXP Ph. 803-532-5812 Add \$4.95 shipping to all orders 10 day money back guarantee plus 90-day warranty

CIRCLE NO. 97 ON FREE INFORMATION CARD

## SAVE 90%

IBM Machine with a 40% plus in performance-8086 based system with 128KB memory two RS232 Ports plus a Centronics Port for ~\$235 Upgradable!

CPMachine-4MHz Z80A based 64KB memory, two RS232 Ports for ~\$120.00

16/32 bit commercial workhorse a 68000 based, 128KB memory three RS232 Ports for ~\$265 - Expandable!

Floppy Interface \$60, 25 x 80 CRTs \$200, Software, Boards ROMs, Parts and MORE!

### FREE CATALOG

**DIGATEK CORPORATION SUITE 7**  
2723 West Butler Drive  
Phoenix AZ 85021

Why waste money on a Commodore, Atari, TI, etc. when a system with a future costs less?

CIRCLE NO. 98 ON FREE INFORMATION CARD

## Fast ANALOG I/O BOARD

For Commodore 64, TRS80 Color, Apple, Timex, & most any computer with a memory port. 8 channels A/D & 8 channels D/A. 1.8 µs A/D convert time. 8 bit res. Easy to program. Box & cable available. \$220.

### Software for Commodore 64 & Board

**SCOPE**  
Dual trace. 256 samples taken at rates from 3 to 72000 Hz. Trigger & cursor. Disk & printer utilities. Averaging. Usable subroutines.

**F.F.T.**  
128 spectrum lines. Displays 0 Hz to 1/2 sample freq. Mag & phase done in 1 sec! Needs CPM card.

Scope & FFT on disk w/manual... \$85.  
Similar software for TIMEX on EPROM... \$85.  
Please call or write for FREE CATALOG.

## Computer Continuum

301 Sixteenth Avenue  
San Francisco, CA 94118 (415) 752-6294

CIRCLE NO. 99 ON FREE INFORMATION CARD

got a

## COMMODORE 64 OR TIMEX SINCLAIR COMPUTER ?

GET STARTED WITH BOSS DISCOUNT SOFTWARE

GAMES, BUSINESS, EDUCATION, TUTORIAL

WRITE FOR FREE CATALOG

EULYN ENTERPRISES  
4N 650 RIDGEWOOD  
BENSenville, IL., 60106

(312) 543-4225

CIRCLE NO. 99 ON FREE INFORMATION CARD

## Radio Shack TRS-80™ Computers

At Guaranteed Savings



from **Pan American Electronics**

1117 Conway Ave.  
Dept. CE  
Mission, Texas 78572  
Ph. 512/581-2766  
Telex 767339

CALL TOLL FREE  
800-531-7466

CIRCLE NO. 100 ON FREE INFORMATION CARD

## It's simple. . . .

## CALL & SAVE MONEY

**1-800-841-0860**

## UP TO 20% DISCOUNT COMPUTERS

MONITORS • PRINTERS  
CALL FOR BEST PRICES



## MICRO MANAGEMENT SYSTEMS

TELEMARKET DEPT. # 12  
2803 THOMASVILLE RD. EAST  
CAIRO, GEORGIA 31728  
GA. & INFO 912-377-7120

CIRCLE NO. 101 ON FREE INFORMATION CARD

# ICs PROMPT DELIVERY!!!

SAME DAY SHIPPING (USUALLY)

DYNAMIC RAM			
256K	150 ns	\$49.90	
64K	200 ns	5.67	
64K	150 ns	5.87	
64K	120 ns	7.50	
16K	200 ns	1.21	
EPROM			
27128	300 ns	\$22.50	
2764	250 ns	9.25	
2732	450 ns	5.40	
2716	450 ns	3.60	
2532	450 ns	4.80	
STATIC RAM			
5565P-15	150 ns	\$43.00	
6264LP-15	150 ns	45.50	
6116P-3	150 ns	6.56	

MasterCard VISA or UPS CASH COD  
**Factory New, Prime Parts**  
**MICROPROCESSORS UNLIMITED**  
 24,000 South Peoria Ave.  
 BEGGS, OK 74421 (918) 267-4961

\* Prices shown above are for April 13, 1984.  
 Please call for current & volume prices. Prices subject to change. Please expect higher prices on some parts due to world wide shortages. Shipping and insurance extra. Cash discount prices shown. Small orders received by 6 PM CST can usually be delivered to you by the next morning, via Federal Express Standard Air - \$3.95

CIRCLE NO. 102 ON FREE INFORMATION CARD

# MICROSETTE

## 5-1/4-inch DISKETTES

- Single or double sided, all double density (SSDD, DSDD).
- Soft sector, reinforced hub.

ITEM	10 PACK	50 PACK
SSDD	\$25.00	\$100.00
DSDD	35.00	150.00

## CASSETTES

- Error-free computer grade.
- |      |       |       |
|------|-------|-------|
| C-10 | 7.50  | 32.50 |
| C-20 | 9.00  | 39.00 |
| C-60 | 11.00 | 50.00 |
| C-90 | 15.00 | 70.00 |

UPS SHIPPING INCLUDED  
 In Continental USA  
 CA Customers add taxes

**MICROSETTE CO.**  
 475 Ellis St., Mtn. View,  
 CA 94043 (415) 968-1604

CIRCLE NO. 103 ON FREE INFORMATION CARD

# 20 PROGRAMS on 2 cassette tapes

for 16K  
 TS1000,  
 TS1500,  
 & ZX81  
 only  
 \$19.95



\*for TS2068 C-64, VIC 20, ATARI, TRS COLOR & MC-10 only \$29.95

Save money, learn about the exciting world of home computing and have fun doing it with the new HOME-PAC.<sup>™</sup>  
 The HOME-PAC with 21 page user manual covers educational, graphics, recreational, home-finance & utility applications.

**10 DAY MONEY BACK GUARANTEE**  
 Please add \$2.00 shipping and handling to order.

**SIMPLEX SOFTWARE**

220 N. Centre St., Dept. CEI  
 Merchantville, NJ 08109  
 MC, VISA & Checks Accepted  
 Orders & inquiries state computer type

CIRCLE NO. 104 ON FREE INFORMATION CARD

# TOTAL CONTROL

For the  
**Timex-Sinclair Computer**

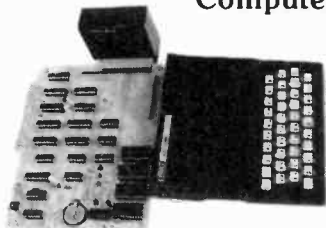

Built & Tested \$174.95  
 Bare Board \$49.95

I/O  
 16 lines IN 16 lines OUT  
**Real Time Clock / Calendar**  
 with Battery Back up  
**Analog to Digital Converter**  
 8 channel  
**8K Non-Volatile RAM**  
 RAM or EPROM  
 Compatible with  
 ZX-80, ZX-81, TS-1000 & TS-1500

TERMS: Check or Money Order  
 Calif. Res. Add 8%  
 SHIPPING: Inside U.S. \$5.00  
 Outside U.S. \$10.00

**JK AUDIO**  
 P.O. Box 3295  
 Escondido, CA 92025-0580  
 (619) 741-5132

CIRCLE NO. 105 ON FREE INFORMATION CARD

# TRS-80 COMPUTER DISCOUNTS

- Factory Direct
- Best Prices Anywhere
- No Out-of-State Taxes
- 100% Radio Shack Warranty
- Free Price List
- Authorized TRS-80

## SCOTT TASSO ASSOCIATES

175 North Delsea Drive  
 Vineland, N.J. 08360

800-257-0426

NJ 609-691-7100

CIRCLE NO. 106 ON FREE INFORMATION CARD

# COMPUTER FURNITURE



## Genuine Oak

Veneer \$89.95 Each

Completely Finished — Ready for Use  
 Excellent for Student, Home or Office

Send name and address with check or money order for \$89.95 per unit. Specify model no. Add \$15.00 for castors. Include \$10.95 for prompt shipping. Mail to: C.F.M.

P.O. Box 520652 • Salt Lake City, UT 84152

**MONEY BACK GUARANTEE**  
 A Division of  
 Timeless Computer Furniture Manufacturers

CIRCLE NO. 107 ON FREE INFORMATION CARD

# POWER LINE PROBLEMS?



## SPIKE-SPIKERS™...The Solution!

Minimize equipment damaging spikes and conducted RF noise to or from sensitive equipment. Transient surge protection plus low pass RFI hash filtering. All units 120V 15A.



**MINI II \$44.95**

Wall Mount  
 3-stage filter  
 2 sockets

**QUAD II \$59.95**

Wall mount, Dual 3-stage filter  
 4 sockets & light



**DELUXE \$79.95**

Dual 5-stage filtered  
 ckt. 8 switch sockets  
 main switch, fuse, light

**Kalglo Electronics Co., Inc.** Order Factory Direct  
 65 84 Ruch Rd., Dept. C E 215-837-0700  
 Bethlehem, PA 18017

Out of State  
**1800-524-0400**

DEALERS INVITED  
 PA Res. Add 6% • COD add \$3.00 + Shipping

CIRCLE NO. 107 ON FREE INFORMATION CARD

# BUILD YOUR OWN COMPUTER!!

68000 BASED MULTI-BUS COMPATIBLE KIT

4 BOARD SET INCLUDES:

- 1 6 SLOT MOTHER BOARD
- 1 CPU CARD
- 1 I/O with UPD 765 FLOPPY CONTROLLER
- 1 128K RAM CARD

SCHEMATICS PARTS LIST & ASSEMBLY DRAWINGS

KT 1001 COMPUTER KIT (FLATBOARDS ONLY)	\$189.99
KT 1004 COMPUTER KIT (UNTESTED BOARDS - POPULATED)	\$399.99
KT 1002 COMPUTER KIT (DOCUMENTATION ONLY)	\$35.00
KT 1003 PAL FOR RAM BOARD	\$6.99
KT 1005 CP/M FOR KIT (INCLUDES BIOS)	\$350.00

WE CARRY A COMPLETE LINE  
 OF ELECTRONIC COMPONENTS  
 SEND FOR A FREE CATALOG !!!



NICORN ELECTRONICS  
 10010 CANOGA AVE. UNIT B-8  
 CHATSWORTH, CALIF. 91311  
 (818) 341-8833

CIRCLE NO. 108 ON FREE INFORMATION CARD

# SAVE ON MEMOREX DISKETTES

**\$180** ea. 5 1/4" SSDD Qty. 20  
**\$235** ea. 5 1/4" DSDD Qty. 20

5 1/4" SSDD-96TPI \$2.49 ea. 5 1/4" DSDD-96TPI \$3.25 ea.  
 Boxed in 10's with Tyvek sleeves, reinforced hubs and labels.

DISKETTES FOR MACINTOSH & HP-150 AT TERRIFIC SAVINGS!

3 1/2" Memorex \$3.99 ea.

See our big ad in this issue for other great values!  
 Shipping: 5 1/4" or 3 1/2" DISKETTES—Add \$3.00 per 100 or fewer diskettes. Payment: VISA and Mastercard accepted. COD orders only, add \$3.00 handling charge. Taxes: Illinois residents, please add 8% sales tax.

WE WILL BEAT ANY NATIONALLY ADVERTISED PRICE ON THE SAME PRODUCTS AND QUANTITIES!

Nationwide: 1-800-621-6827

Illinois: 1-312-944-2788

Hours: 9AM - 5PM Central Time

Minimum Order: \$35.00

**DISK WORLD, Inc.**

Suite 4806 • 30 East Huron Street • Chicago, Illinois 60611

**MEMOREX**

**GENERAL INSTRUMENT** SP0256-AL2

# Speech Synthesizer

UNLIMITED VOCABULARY **GI** EASY INTERFACE TO ANY COMPUTER

**\$25.00** each plus \$2.00 shipping

The General Instrument ALLOPHONE speech processor is a single chip LSI device that synthesizes continuous speech of unlimited vocabulary. Not to be confused with limited (stored) vocabulary speech chips like the JP0256-017. Documentation includes program listings, interfacing, etc., for use with Apple, VIC-20, Commodore 64 and TRS-80. Also general info for use with other systems!

**\*PARTIAL KIT\* ALSO AVAILABLE\***  
Includes CHIP, PC board, hard to find components, documentation, etc.  
Apple \$42. Commodore 64 \$40.  
VIC-20 \$40. TRS-80 (1-111) \$40.  
plus \$3.00 shipping

SEND CHECK or M.O. to:  
SILICON SOLUTIONS, INC.  
4710 Wellington Blvd.  
Alexandria, La. 71303

Call (318) 442-7733 for VISA or MC orders.

CIRCLE NO. 109 ON FREE INFORMATION CARD

# ★MICROCOMPUTER★ BUSINESS SOFTWARE

## MEDICAL MGMT... DENTAL MGMT... INSURANCE AGENT LEGAL BILLING..... PROPERTY MGMT.. AND MUCH MORE !

UNIVAIR INTERNATIONAL  
9024 St. Charles Rock Road  
ST. LOUIS, MISSOURI 63114

(314) 426-1099

CIRCLE NO. 110 ON FREE INFORMATION CARD

# ELECTRONIC COMPONENTS

**MOUSER ELECTRONICS**  
NEW PRODUCTS  
FREE 160 PAGE CATALOG

MANUFACTURERS OF QUALITY ELECTRONIC COMPONENTS  
OVER 15,000 DIFFERENT ITEMS IN STOCK!

**MOUSER ELECTRONICS**  
11433 WOODSIDE AVE. SANTEE, CA 92071  
PHONE: (619) 449-2222 TWX: 910-331-1175

CIRCLE NO. 111 ON FREE INFORMATION CARD

**LEO ELECTRONICS, INC.**  
2730 Monterey Street, Suite 111  
Torrance, California 90503  
(213) 212-6133 • (800) 421-9565  
Telex: 291 986 LEO UR

## PRICE! QUALITY! SERVICE!

RAMS			
4116 (150ns)	1.35	16K UPGRADE	
4116 (200ns)	1.25		
4164 (150ns)	4.95	64K UPGRADE	
4164 (200ns)	4.75		
6116P-3	4.40		
EPROMS			
2708	3.00	2532	4.50
2716	3.20	2732	3.95
TMS2716	4.75	2764	7.00

TERMS: Check, Visa, Mastercard. Call for C.O.D. U.S. Funds only. California residents add 6 1/4% sales tax. SHIPPING: Add \$2.00 for Ground and \$5.00 for Air. ALL MAJOR MANUFACTURERS ALL PARTS 100% GUARANTEED. Pricing subject to change without notice.

# SAVE MORE THAN EVER ON 3M Scotch® DISKETTES

LIFETIME WARRANTY!

**\$185** ea 5 1/4" SSDD (744) Qty. 20  
**\$235** ea 5 1/4" DSDD (745) Qty. 20

5 1/4" SSDD—96TPI (746)	\$2.60 ea.
5 1/4" DSDD—96TPI (747)	\$3.25 ea.
8" SSDD (740)	\$2.05 ea.
8" SSDD (741)	\$2.50 ea.
8" DSDD (743)	\$3.10 ea.

Shipping: 5 1/4" DISKETTES—Add \$3.00 per 100 or fraction thereof. 8" DISKETTES—Add \$4.00 per 100 or fraction thereof. OTHER ITEMS: Shipping charges as shown in addition to diskette shipping charges. Payment: VISA or MasterCard. COD orders only, add \$3.00. Taxes: Illinois customers, please add 8%.

Hours: 9 AM-5 PM Central Time  
For fast service call  
Nationwide: 1-800-621-6827  
In Illinois: 312-944-2788

**DISK WORLD!**  
Suite 4806 • 30 East Huron Street • Chicago, Illinois 60611

Authorized Distributor  
Information Processing Products **3M**

Now we can make any computer sing as well as talk, for only \$219.

As featured in Garcia's Circuit Cellar, "BYTE" Magazine, September, October 1982.

**Microvox.**

MICROVOX is a completely self contained professional voice quality text-to-speech synthesizer MICROVOX may be easily interfaced to any computer, modem, RS-232C serial or parallel output device.

- 6502 Microprocessor based text-to-speech algorithm.
- SC-01A phoneme based speech synthesizer
- 64 crystal controlled inflection levels
- 3000 character buffer
- RS-232C and parallel port interfaces.
- On board power supply
- Music and sound effects capability

MV01 Microvox Assembled & Tested ..... \$299.00  
MV02 Microvox, complete kit ..... \$219.00

To Order: Call Toll Free 1-800-645-3479  
In N.Y. 1-516-374-6793

**MICROMINT, INC.**  
561 Willow Avenue  
Cedarhurst, NY 11516

CIRCLE NO. 112 ON FREE INFORMATION CARD

# CONVERT YOUR TV TO A HIGH QUALITY MONITOR

USE WITH COMPUTERS, VCR's & CAMERAS

Kit permits Dual Mode operation on B&W or Color sets

- Hi-resolution • Up to 80 characters per line • Wide bandwidth • Direct Video • Safe-Easy installation

**34.95** ACVM

DVM-1 Hot Chassis kit with Audio available.

**VAMP Inc.**  
Box 411, Los Angeles, CA 90028  
(213) 466-5533

# Now available for the computer experimenter!

COMPUTER CONNOISSEUR'S DELIGHT!  
NOW BE IN CONTROL WITH YOUR COMPUTER — THE ONLY PUBLICATION OF ITS KIND WRITTEN FOR THE USER. DISCOVER THE SECRETS AND LEARN THE VERSATILITY OF MODERN COMPUTER COMMAND CONTROL CONCEPTS. EXPERIMENT WITH COMPUTER AND TELEPHONE SYSTEMS. INTERFACE THEM. LEARN HOW THEY WORK. WHAT THEY DO... AND HOW TO GET THEM TO WORK FOR YOU! A COMPLETE TELEPHONE ENGINEERING COURSE IS INCLUDED IN MONTHLY CHAPTERS, BRINGING YOU THROUGH STEP, CROSSBAR, ESS, BUBBLE, AND ATOMIC SWITCHING SYSTEMS! EXCLUSIVE COVERAGE IN BIOLOGICAL COMPUTING SYSTEMS, TOOL COMPUTERS AND TELEPHONE ARE THE FUTURE. THIS PUBLICATION IS AN ABSOLUTE MUST FOR EVERYONE INTERESTED.

UNPUBLISHED MATERIAL  
WIT  
COMICS  
DIRECTORY LISTING NET. WORKS  
ACCESS CODES

The one you've all been waiting for

**Computel**  
PUBLISHED MONTHLY

ONE YEAR SUBSCRIPTION \$14.00 (SAMPLE COPY \$2.00)  
SUBSCRIPTION & 2 PROGRAMS \$20.00

COMPUTEL—the complete SOURCE for everyone. You can now do the things you've only heard about, right in the privacy of your own home. Indispensable reference to phreaks and hackers. Learn how to get all kinds of computer programs FREE. Get the inside story of big business systems—their quirks and flaws—and remain up to date with vital occurrences within the computer industry. Computel is a publication designed for everyone who has an intense curiosity of computer systems, containing a wealth of hard to find information, codes, and numbers. Published monthly.

**Computel Publishing Society**  
6354 VAN NUYS BL., #161-A / VAN NUYS, CA 91401

CIRCLE NO. 113 ON FREE INFORMATION CARD

# DRIVE CONTROL UNIT

Turns off 8 inch Drives when not being accessed

Save Drive. Save Media. Quiet Operation. Easily installed. Thousands are in use. For Shugart 800/850, Siemens 100/200, CDC Qume DT8, Remex 4000 Kit \$29.95 Assembled and Tested \$49.95

Call or send for literature package  
VISA, MASTERCARD, COD Accepted

**OPTRONICS** 716-377-0369  
TECHNOLIG 2990 Atlantic Ave.  
Penfield, NY 14526



## Votrax<sup>®</sup> SC-01A SPEECH SYNTHESIZER

**\$42 Each**  
**(\$32 in hundreds)**

**Order in Ones or Thousands**

The SC-01A Speech Synthesizer is a completely self-contained solid state device. This single chip phonetically synthesizes continuous speech of unlimited vocabulary.

Computer interfaces and text-to-speech algorithms also available for product development.

*Micromint is the largest U.S. distributor of the SC-01A. Call us for a price quote.*

Call 1-800-645-3479, in N.Y. 1-516-374-6793

**MICROMINT INC.**  
561 Willow Avenue  
Cedarhurst, NY 11516



Add \$2.00 for shipping & handling.

CIRCLE NO. 114 ON FREE INFORMATION CARD

## GREAT DISKETTES

Super low prices  
**SYNCOM**

The low priced, high quality diskette with a LIFETIME WARRANTY. Packed in polybags of 10 with Tyvek envelopes, labels and reinforced hubs. One of the best buys we've seen.

**\$139** ea. 5 1/4" SSDD  
QTY. 20

**\$185** ea. 5 1/4" DSDD  
QTY. 20

**OTHER GREAT VALUES:**

DISKETTE 70—Holds 70 5 1/4" diskettes in dust free safety \$14.95 ea. + \$3.00 Shpg.

DISK CADDIES—Flip up style holds 10 5 1/4" diskettes \$1.85 ea. + .20 Shpg.

**\$15.00 Bonus Offer!**

For the lowest priced, highest quality diskettes, storage cases, printer ribbons and paper products, send for our catalog FREE with your order. \$1.00 otherwise. **BONUS!** Every catalog includes \$15.00 worth of bonus coupons.

Shipping: 5 1/4" DISKETTES—Add \$3.00 per 100 or fraction thereof. OTHER ITEMS: Shipping charges as shown in addition to diskette shipping charges. Payment: VISA or MC. COD orders, add \$3.00 Taxes: Illinois customers, please add 8%.

Nationwide: 1-800-621-6827  
In Illinois: 1-312-944-2788  
Minimum Order: \$35.00  
WE WILL BEAT ANY NATIONALLY ADVERTISED PRICE!

**DISK WORLD!**  
Suite 4806 • 30 East Huron Street • Chicago, Illinois 60611

**SYNCOM**

# SALES POWER

Computers & Electronics not only sells itself at a nice profit, it helps sell the hardware and software in your store too. Because it goes home with customers and continues to influence buying decisions long after you're closed for the day. Let's talk now.

**CALL COLLECT:**  
**(212) 725-7679**

Or write:  
**Ziff-Davis Publishing**  
One Park Avenue  
New York, NY 10016

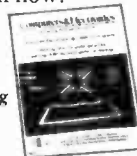

Minimum order: 10 copies. We pay all shipping costs.

## TS1000 ZX81



### 3-Color Keyboard Symbols with Conversion Instructions

- Plastic TS1000-ZX81 keyboard symbols in Black, Red and Blue. Opaque background. Will fit all standard-size keys. Adhesive backing for easy application.
- Simple illustrated instructions will show you how to convert a cheap (about \$20) surplus keyboard to a full-size TS1000/ZX81 console. "...as easy as stringing wire on a fence."
- Do's and Don'ts for selecting a surplus keyboard.
- Bonus for the "pro" - Schematic Diagram of Computer.

**MULE Electronics \$12\***  
Dept. 310  
444 Lincoln Blvd.  
Venice, California 90291

\*Add \$1.50 P&H. California residents add 6.5% tax. Money-back guarantee, of course.

CIRCLE NO. 115 ON FREE INFORMATION CARD



### Best Prices On TRS-80 Computers

Our 6th year of discounts  
Ed or Joe McManus  
Fgt. Prepaid. Save Tax.  
Toll Free 800-231-3680

**Marymac Industries, Inc.**  
22511 Katy Fwy., Katy  
(Houston) Tx 77450  
1-713-392-0747  
Telex 774132

See us in the Wall Street  
Journal every Tues. Wed. Thurs.

## DISCOUNT COMPUTER EQUIPMENT

*LOWEST PRICES on Printers, Disk Drives, Software, and Other Computer Equipment!*  
*EPSON, Star Micronics, Okidata, Tandon, TEAC, & Many Others.*

Call toll-free for a FREE catalog:  
**800-331-3896**  
In Oklahoma Call 918/825-4844

**AMERICAN** 918/825-4844 **SMALL BUSINESS COMPUTERS**

# Computers & Electronics Marketplace

**CLASSIFIED RATES:** Per Word, 15 Word Minimum. **COMMERCIAL:** \$5.00. **PERSONAL:** \$3.00. **EXPAND-AD<sup>®</sup>:** \$7.50. Ads set in all bold type @ 20% premium. Ads set with background screen @ 25% premium. **DISPLAY:** 1" x 2 1/4", \$605.00. 2" x 2 1/4", \$1,165.00 3" x 2 1/4", \$1,675.00. **GENERAL INFORMATION:** Frequency rates and prepayment discounts available. Payment must accompany order except credit card—Am. Ex., Diners, MC, VISA (include exp. date)—or accredited ad agency insertions. Copy subject to publisher's approval; must be typewritten or printed. First word set in caps. Advertisers using P.O. Boxes MUST supply permanent address and telephone number. Orders not acknowledged. They will appear in next available issue after receipt. Closing date: 1st of the 2nd month preceding cover date (e.g., Mar. issue closes Jan. 1). Send order & remittance to: Classified Advertising, **COMPUTERS & ELECTRONICS Magazine**, 1 Park Avenue, New York, NY 10016. To Charge your ad to a major credit card, call Lois Price at (212) 725-4312.

## FOR SALE

**GOVERNMENT** and industrial surplus receivers, transmitters, snooper scopes, electronic parts. Picture Catalog 25 cents. Meshna, Nahant, Mass. 01908.

**RECONDITIONED TEST EQUIPMENT** \$1.00 for catalog. **WALTER'S TEST EQUIPMENT**, 2697 Nickel, San Pablo, CA 94806. (415) 724-0587.

**ELECTRONIC CATALOG.** Over 4,500 items. Parts, & components. Everything needed by the hobbyist or technician. \$2.00 postage & handling (United States Only), refundable with first \$15.00 order. T & M Electronics, 472 East Main St., Patchogue, NY 11772. (516) 289-2520.

**PRINTED CIRCUIT BOARDS**, your artwork. Quick delivery. Reasonable. Atlas Circuits, Box 892, Lincolnton, NC 28092. (704) 735-3943.

**POLICE CODE UNSCRAMBLERS**, lets you hear the coded messages of Police, Fire and Medical channels; plus other scanner accessories, satisfaction guaranteed. **DNE Inc.**, Rt. 7, Box 257-A, Hot Springs, AR 71901. (501) 623-6027.

**CABLE TV CONVERTERS & EQUIPMENT.** Plans and parts. Build or buy. For more information send \$2.00: **C & D ELECTRONICS INC.**, P.O. Box 21, Jenison, MI 49428.

**FREE Catalog** of special function IC's and quality components. Goldsmith Scientific, Box 318M, Commack, New York 11725.

**FREE FLYER!** IC's, resistors, capacitors, jacks, etc., plus SSM music synthesizer/audio IC's, power amp modules, analog delay IC's, computer books, and more. Also plans for analog delay/chorus unit! **PGS Electronics**, Route 25, Box 304 Terre Haute, IN 47802.

**TV & RADIO TUBES**, 59¢ each. Send for free catalog. Cornell, 4213 University, San Diego CA 92105.

**PRINTED CIRCUIT BOARDS.** QUICK PROTOTYPES production, design, reflow solder. Send print or description for quote to: **KIT CIRCUITS**, Box 235, Clawson, MI 48017.

**SATELLITE TELEVISION COMPLETE SYSTEMS.** Free catalog. Write: Sunspur Sales, P.O. Box 32245 A-6, Fridley, MN 55432.

## CABLE TV

**Buy Direct & Save**

### SUPER SPECIALS



**40 CHANNEL CONVERTER**  
\$29<sup>95</sup>



**36 CHANNEL REMOTE CONTROL CABLE CONVERTER**  
\$69<sup>95</sup>

Advanced Solid State design and circuitry allows you to receive mid & super band channels. Restores programming to Video Recorders.



**JERROLD 400 THE ULTIMATE CABLE TV CONVERTER**



**60 CHANNEL INFRARED REMOTE CONTROL**  
\$129<sup>95</sup>

Send \$5 for Complete Catalog

**DIRECT VIDEO SALES**  
P.O. BOX 1339  
JEFFERSONVILLE, INDIANA 47130  
CALL 1-812-282-4786

## NEW! MULTI-CHANNEL MICROWAVE

\*\*\*\*\*  
Complete Antenna Systems from \$69<sup>95</sup>  
\*\*\*\*\*

Full 800 Mhz Range  
Tune 1.9-2.7 Ghz  
Includes all ITFS Channels

**DEALERS WANTED**

COD's and Credit Card Orders call TOLL FREE  
**1-800-247-1151**



**GOLD STAR**



**SILVER STAR**



**TELE STAR**



**STAR II**



**GALAXY ELECTRONICS**  
6009 N. 61 Avenue  
Glendale, AZ 85301  
1-602-247-1151

## WERSI electronics

### ORGAN & PIANO KITS

#### ALPHA DX 300



**fully DIGITAL RS 232 Interface**

For Free Sound Info  
Call 1-800-233-3865  
or write WERSI USA  
Dept. M3 P.O. Box 5318  
Lancaster, PA 17601

**THE WORLD LEADER**

### Worlds Most Remarkable Radar Jammer!



Causes speed radar guns and devices to read out your choice of either a percentage of your true speed when in automatic mode (example: Your speed; 76 mph, auto mode set for 75%, speed displayed—57 mph), or the speed that you dial in when in manual mode. Transmits only in the presence of speed radar, or by manual override. Operates on both X and K bands. **WARNING:** The device described in this literature is not legal for use against police radar, and is not FCC approved.

For complete literature and plan package, send \$14.95 to:  
Phillips Instrument Design Co., Inc.  
9560 S.W. Barbour Blvd., Suite # 109 CE  
Portland, Oregon 97219  
VISA OR M/C ORDERS ONLY (503) 626-6764

**CABLE TV SECRETS**, the informative publication the cable companies are trying to ban. HBO, Movie Channel, Showtime converters, etc. Send \$8.95 to: **CABLE FACTS**, Box 711-PE, Pataskala, Ohio 43062.

**GEARMOTORS** \$35.00. 12VDC(6-36) 60 RPM. 1/6 HP. Instructions. Also speed controls. Drives robots, antenna doors, gates, carts. Sepac, 625 NW 41 Street, Seattle, WA 98107.

**RF MODULATORS for SATELLITE TELEVISION, MICRO-COMPUTERS CCTV.** Also monitors, cameras, kits. **FREE VIDEO CATALOG.** Phone (402) 987-3771. Dealers Welcomed. **ATV RESEARCH**, 13-P Broadway, Dakota City, NE 68731.

**12 SATELLITE DISH AND POLAR MOUNT.** Total weight 125-lbs. For \$189.00. For information send \$4.95 (Refundable u.p.) to: **Satellite Operational Systems**, P.O. Box 2002, Titusville, FL 32781.

**CABLE TV products.** Jerrold, Hamlin and Oak, send \$3.00 to **ADDITIONAL OUTLET CORP.**, 111 E. Commercial Blvd., Ft. Lauderdale, FL 33334.

**FREE 1984 COMPUTER FURNITURE CATALOG.** Over 20 manufacturers. Never a shipping charge. Visa/MC. Interior Design Systems, 3641-CE St. Mary's Place NW, Washington, D.C. 20007.

**ALARM EQUIPMENT—Burglar, Holdup, Fire, Medical.** We prewire. Easy installation! Wholesale prices. Fast police notification service—Nationwide; Catalog \$1.00 U.S. **DETECTION**, 109 21st. South, Birmingham, Alabama 35233.

**HARD TO FIND lightbulbs** thousands types buy, sell. **Jetco**, P.O. Box 8755, Newport Beach, CA 92658.

**RECONDITIONED FAX, G-2, hand-operation**, with paper. \$385.00 C&F USA per unit. For more information write: **Musashino Machine Co., Ltd.**, Minami-Hanahata 3-7-13, Adachi-ku, Tokyo 121, Japan.

**LOWEST POSSIBLE PRICES ANYWHERE!** Computers Hardware—Software—Printers, Audio, Video, Car Stereo. **ELECTRIFIED DISCOUNTERS**, 996 Orange Ave., West Haven, CT 06516. MC/VISA. (203) 937-0106.

**CABLE TV EQUIPMENT**, Notch filters for "Beeping" Channels. Information \$1.00. **Goldcoast**, Box 63/6025 CE, Margate, Florida 33063 (305) 752-9202.

**FREE CATALOG!** UTILITIES, games, amateur radio software for VIC-20, Commodore 64, TI/99/4A. **RAK Electronics**, Box 1585, Orange Park, FL 32067.

**KILLING BACK PAIN?** FREE 16 page, color catalog, specializing in back-relief products. We market only medically tested equipment recommended by doctors. Write **The Backache Store**, PO Box 111, Wabasha, MN 55981.

**CCTV PACKAGE:** B/W camera, 16mm lens, 9" monitor, camera mount, 50 ft. coaxial cable—\$325. **A. Lipton, Inc.**, 29W 47th St., New York, NY 10036. (212) 944-1373. Your CCTV headquarters.

**SATELLITE TV RECEIVER BREAKTHROUGH!** Build your system and save!! Instruction manuals, schematics, circuits boards! Send stamped envelope: **XANDI**, Box 25647, Dept. 22X, Tempe, AZ 85282.

**CABLE TELEVISION FACTS AND SECRETS.** Now you can get the informative publication that CATV companies have been unsuccessfully trying to get banned for 15 years. **Movie Channel, HBO and Showtime converters**, etc. Send \$8.75 to: **CABFAX**, P.O. Box 091196, Bexley, Ohio 43209.

**ELECTRONIC PARTS** \$1.00 deposit list 1972 prices. **Checkmate Avionics**, 624 Rosewood, Grand Rapids, MI 49506.

### COMPUTER EQUIPMENT/PARTS

**SAVE 90% Build Your Own Minicomputer.** Free Details. **Digatek**, 2723 West Butler Dr., Suite 20C, Phoenix, AZ 85021.

**FREE 64 PAGE COMPUTER CATALOG** crammed full of thousands of the best buys and lowest prices around! **A.P. COMPUTER PRODUCTS**, Dept. CC, 214A East Main, Patchogue, NY 11772. (516) 698-8636.

**48K APPLE COMPATIBLE COMPUTER:** US \$380.00 and hundreds of programs. Details US \$1.00. **Reliant**, P.O. Box 33610, Shungwan, Hong Kong.

**WANT A PLEASANT SURPRISE?** Call or write for quotes: Atari, Commodore, Timex, T.I., Corona (IBM work-alike), Amdek, Gemini, Apple & IBM accessories, Hayes, More. **GET SURPRISED!** **HARDWARE SOFTWARE ANYWARE CO.**, 10 Coles Street, Brooklyn, NY 11231, (212) 596-3592.

**CASSETTES—COMPUTER QUALITY.** C-20 length with plastic case and blank labels. 10 for \$7.50, 25 for \$18.00, 50 for \$34.00 or 100 for \$63.00. We pay postage. NY residents add tax. Check or MO to: **WMJ DATA SYSTEMS**, 4 Butterfly Drive, Hauppauge, NY 11788.

**REPLACEMENT RIBBONS** for computer printers and word processors. Fantastic saving! Thousands in stock. Quick delivery. Call or write: 1 (800) 292-6272. **National Computer Ribbons**, 114 Elbank Ave., Baltimore, MD 21239.

**USED COMPUTER terminals, printers, modems, cables, surplus electronic parts.** **Specials: CRT's \$20.00, Modems \$20.00, Modems \$35.00, Catalog \$1.00.** **Rondure Company**, "The Computer Room" CE, 2522 Butler Street, Dallas, TX 75235, (214) 630-4621.

### COMPUTER SOFTWARE

**FREE VIC-20 and COMMODORE 64 USERS GROUP MEMBERSHIP** with software purchase. Why pay to belong to a users group when you don't have to? Benefits: Newsletter, extensive club library, discounts, contests, questions hot-line and more! Free details—(803) 797-1533. **Lords of Basic**, P.O. Box 459, Dept. 102 Ladson, SC 29456.

**DISKETTE FORMAT CONVERSIONS/DOWNLOADING**, from \$5.00. **Port-A-Soft**, 423 #800 N, Orem, UT 84057. 801/226-6704.

**TI-99/4A PROGRAMMERS:** Affordable Software! Catalog, only \$1. **PROGRAMS SOFTWARE**, 1435 Burnley Square North, Columbus, Ohio 43229.

**TS 1000, ZX81, TI 99/4A, VIC-20 SOFTWARE.** Send for **FREE Catalog:** **Midwest Software**, 9922 Harwich, Crestwood, MO 63126.

### MICROWAVE ANTENNA SYSTEMS

Freq. 2.1 to 2.6 GHz • 34 db Gain • COMPLETE SYSTEMS (as pictured)

Commercial 40" Rod Style \$89.95  
Parabolic 20" Dish Style \$79.95

**TWO YEAR WARRANTY PARTS AND LABOR**

CALL OR WRITE FOR KITS • PARTS • INDIVIDUAL COMPONENTS

We Repair All Types Down Converters & Power Supplies



**Phillips-Tech Electronics**  
P.O. Box 34772  
Phoenix, AZ 85067  
(602) 967-6972

Special Quantity Pricing • Dealers Wanted

### Telephone Listening Device

Record telephone conversations in your office or home. Connects between any cassette or tape recorder and your telephone or telephone LINE. Starts automatically when phone is answered. Records both sides of phone conversation. Stops recorder when phone is hung up. This device is not an answering service.



Each \$19.95  
Qty. Disc Avail



size 2'x 3'x 1/4"

**Super Powerful Wireless Mic**

10 times more powerful than other mics. Transmits up to 1/4 mile to any FM radio. Easy to assemble kit. 15V battery (not incl.). Call (305) 725-1000 or send \$19.95+\$1.00 shipping per item to **USI Corp.**, P.O. Box CE-2082, Melbourne, FL 32901. **COD's accept.** For catalog of transmitters, voice scramblers and other specialty items, enclose \$2.00 to **USI Corp.**

TI-99/4A CASSETTE CABLES \$16.71 (Extended Basic, Logo, Mini-memory \$88.11 each!), PHP1250 Drive \$210.94. CSC, Box 1361, Bloomington, IL 61702-1361. (309) 828-3251.

RENT PUBLIC DOMAIN SOFTWARE. It's not copy-righted, no fees to pay. Copy hundreds of useful business, utility and game programs from our rental libraries onto your own computer at home! SASE NATIONAL PUBLIC DOMAIN LIBRARY, 1062 Taylor, Vista, CA 92083. (619) 941-0925.

TI-99/4A "99-CALC" Electronic Spreadsheet Program in Extended Basic, 16K. Cassette and Instructions \$20.00 p.p. P.C. Barnes, 24631 Via San Fernando, Mission Viejo, CA 92692.

MULTI-LINGUAL, educational and other software, FREE CATALOGUE. The Professor, 959 N.W. 53rd St., Ft. Lauderdale, FL 800-222-1399.

DISCOUNT Computer—Software, Wargames, Video cassettes. FREE catalog. Wizard Entertainment, Box 509, Saugus, CA 91355.

DISCOUNT SOFTWARE/HARDWARE-30% minimum below retail. Apple II/II+, Atari 400/800/XL, TI-99/4A, Vic-20, Commodore 64, IBM/PC. Gemini-10X \$275.00, Okidata 92P \$445, Epson RX-80 F/T \$380.00. Flight simulator II \$37.50, Zork I/II/III \$26.50 each. TI extended basic \$77.50. Direct connect printer interface; TI \$85.00, Atari \$69.50. Send \$1 (stamps okay) for extensive software/hardware catalog. Specify computer system. Multi-Video Services, Box 246, East Amherst, NY 14051. (716) 688-0469 (5-9 P.M.).

FREE Commodore—64/1199-4A/TRS80-COCO/TRS80-MC10/VIC-20/TIMEX program! Send stamps! EZRA EZRA Company, Box 5222-CJU, San Diego, California 921005.

COMMODORE 64 Educational package. Eng, Math, Science. 104 programs on 8 discs. \$39.95. Millsons, Box 180, Kennesaw, GA 30144.

COMMODORE 64/20 air speed and direction \$29.50, kit \$59.50. Temperature, security, remote control systems and more. Details \$2.50. Goodin Simple Kits, 316 California, Suite 3F, Reno, NV 89509.

HARNESS AND THOROUGHbred RACING HANDICAPPING PACKAGE... \$31.95. Specify: Cassette, Diskette—Apple II+, IBM PC, COMMODORE 64, VIC-20, Atari, TI-99/4A, TRS-80, FREE INFORMATION! SOFTWARE EXCHANGE. Box 5382 West Bloomfield, Michigan 48033.

COMMODORE VIC20 OWNERS! Send \$3.00 for Cassette with Five New Games: Snerf Software, Box 25938, Chicago, IL 60625.

COMMODORE 64/VIC 20 Games/educational software. Over 400 titles! Write for FREE catalog! American Peripherals, 122 Bangor St., Lindenhurst, NY 11757.

TI-99/4A, C-64 TIMEX 64K, VIC OWNERS. 5 fun programs for \$2.00! Get Baseball, Etching-Sketch, Blackjack, Dungeon, Galactic Patrol. Specify your computer. CHIPMUNK SOFTWARE, 634 Littlecroft, Upper-Darby, PA 19082.

VIC 20 LEARN MORSE CODE THE EASY WAY. Softwear \$10.00 +\$1.00 handling. RSCO, PO Box 11192, Cleveland, OH 44111.

VIC-20 COMPLETE SERIES OF QUALITY educational programs, all under \$15.00. For free brochure write: School-master Programming Company, Box 194, Pomona, CA 91769.

HORSE & DOG HANDICAPPING PROGRAMS FOR MOST PERSONAL COMPUTERS. Free catalog: Gambler's Edge Computing, Dept. B6, 250 Richards Road, Ste. 254, Kansas City, MO 64116.

TI-99/4A Owners. Get your free catalog of new, exciting low cost software. D.E., Box 690, Hicksville, NY 11801.

SOFTWARE DISCOUNTED 35%. BRAND NAME SOFTWARE—IBM, APPLE, COMMODORE-64/20, Atari, TRS, TI. FREE CATALOG! Provide make. SOFTWARE SUPERMARKET, 21 Nashua Drive, Dep/cei, Marlboro, NJ 07746. (201) 780-8419.

COMMODORE 1540/1541 single disk copy-backup page and more HUMBOLDT ELECTRONIC, 2205 Driscoll Drive, Reno, NV 89509.

DISCOUNT FOR UNIQUE accessories and software for all micros, also many electronic components. FREE CATALOG. TOOLS FOR COMPUTERS, P.O. Box 727, New Rochelle, NY 10802. (914) 235-5131.

## COMPUTER HARDWARE

ATARI EPROM BOARDS FROM \$7.95. Call or write VDC, Box 539, Glencoe, MD 21152. (301) 428-0605.

July 1984

FREE! 1984 CATALOGUE. 1001 bargains. Speakers-parts-tubes-video cassettes—record changers—tape recorders—kits. EVERYTHING IN ELECTRONICS. Write: McGEE RADIO & ELECTRONICS, 1901 McGee Street, Kansas City, MO 64108-1891.

5 MEGABYTE HARD DISK DRIVES, new shugart SA1002 \$269. CONTROLLERS \$331. Digital Search, Greer, SC (803) 877-9444.

## COMPUTER PUBLICATIONS

"DISK DRIVE MANUAL."—Drive Alignment, Speed Adjustment, Maintenance, Repair-Without Special Software, Equipment. Comprehensive, 15,000+ words. \$15. Brochure \$1. CONSUMERTRONICS, 2011 Crescent, Alamogordo, NM 88310.

MICRO MOONLIGHTER NEWSLETTER—our third year of home computer business resources! Sample \$3.00. Dept. CC, 4121 Buckthorn Court, Lewisville, TX 75028.

COMMODORE 64 Software source; over 400 entries, \$10.00 plus \$2.00 shipping/handling to MSC, P.O. Box 1039, Mt. Vernon, NY 10550.

APPLE DMP USERS... HERE IT IS! How to program your Dot Matrix Printer. \$7.95 ppd. Money—back guarantee. FREE DETAILS. Timberline Press, 7207 Lipan St., Denver, CO 80221.

## COMPUTER GRAPHICS

AVL computer graphics & programming systems. Slide, Motion, Overhead, Video, & Audio equipment & supplies. Rentals & Staging. Custom Graphics. Slides & Presentations. NEW ORIENT MEDIA-IL. 1-(800) 223-9473, 1-(312) 428-6000.

## COMPUTER FURNITURE

CUSTOM BUILD computer workstation. Fast, easy, inexpensive. Simple tools. Write: Workstation, Box 31636, Seattle, WA 98103.

## TIMEX/SINCLAIR

TREE FORTH for the 2K+ Sinclair User—\$49.95. Multitasking forth for ZX81 and TS1000. Free information. Contact: Softmagic Corp., 1213 West High Street, Bryan, Ohio, 43506. (419) 636-4531.

AERCO will continue to provide high performance disk, printer, and other interfaces for ALL MODELS of Timex/Sinclair computers. Box 18093, Austin, TX 78760, (512) 331-0719.

\*\*ZX81 TEXT PROCESSOR\*\* 16-64K RAM, 1100-7700 words. Write, read, edit, print, save, clear text. Full or window-screen editing. \$12.50 tape/instructions. Check/m.o.: A. Rodriguez. 1605 Pennsylvania Ave 204, Miami Beach, FL 33139.

STOCK ANALYSIS/PORTFOLIO. Fundamental Stock Analysis \$17.00, Portfolio Database & Performance \$15.00. Tape & Tutorial. P.A. residence add 6%. Specify model (1000/1500, 2068), ORIONS BELT ENTERPRISES, 807 N. Fairway Road, Glenside, PA 19038.

TS1000 SOFTWARE—Space games, tax programs, business programs, and personal programs. Send for price list. SASE to: WMJ DATA SYSTEMS, 4 Butterfly Drive, Hauppauge NY 11788.

Timex 2068 programs. Wall street: Biorhythms: Disassemblers: Star Trek and many more. \$10 each. SAE plus \$1 for comprehensive list. C. Dos-Santas, P.O. Box 9521, Fountain Valley, CA 92728.

QUICKLOAD CARTRIDGE-TS1000/1500 accessory-saves/loads programs FIFTEEN TIMES FASTER! Stores MEGABYTE on one cassette! \$34.95. SASE catalog. ROMPAK, 8206 Blackburn, L.A. CA 90048.

T5-1000 2K software. Loan Breakdown, Checkbook Balancer, Savings Balancer, Bargraph, Addition quizard. Multiplication quizard. Each on computer grade cassette. Complete instructions. \$12.99 each. Post paid Visa/Mastercard give card number, expiration date, signature. Sturdivant Laboratories, Box 116CE, Bedford, MI 49020.

BYTE THE BIT. Money/loans. 22 fantastic 2K programs. Price list and description send SASE: Nelco Pacific, P.O. Box 202, Edmonds, WA 98020.

## COMMODORE 64

VIC 20/C64 DATASETTE SCHEMATICS, PARTS LISTS, layouts. All versions \$7.95 COMPUCLINIC 766 Tower Ave., Cedarburg, WI 53012.

## C.B. EQUIPMENT

CB MODIFICATIONS, conversions, books, plans, kits, repairs. Catalog \$2. CBCI, Box 31500PE, Phoenix, AZ 85046. (602) 996-8700.

## CABLE T.V.

CHANNEL 3—60db notch filter, 66 5MHz \$32. Crosley, Dept. 607, Box 840, Champlain, NY 12919.

## PLANS AND KITS

MICROPROCESSOR CONTROLLED. Six voice polyphonic synthesizer plans. \$15.00. Syntron 1075 1/2 Mill Rd., Helena, Mt 59601.

HBO CONVERTER. Complete instructions and schematic. Send \$4.00 and SASE. Electrographics, 630 Sullivan, Deltona, Florida 32725.

Communicate for miles with other computers with no license radio link. Study package with full details, sources. \$8.00 refundable. Broadcast Technical Services, 11 Walnut St., Marshfield, MA 02050.

SPIKE SUPPRESSOR. Build it yourself for less than \$10.00. Complete plans and parts sources \$3.00. ProComp, 618 Olivewood Dr. #5, Merced, CA 95340.

## MAILING LISTS

COMPUTER SHOW ATTENDEES N.Y., N.J.: 15,000 NAMES. \$30/M. P/S labels. For info, (201) 297-2526.

FREE MAILING LIST analysis. Details. GOC-4N, Box 1107, Stuart, FL 33494. (305) 334-5205.

## WANTED

GOLD, electronic, circuit board scrap, silver, platinum, tantalum, mercury. Ores, metals assayed. Samples evaluated. Wholesale Terminal, toll free 1-800-932-1010. (617) 326-3442 in Mass.

## GOVERNMENT SURPLUS

IS IT TRUE YOU CAN BUY JEEPS FOR \$44 THROUGH THE U.S. GOVERNMENT? Get the facts today! Call (312) 742-1142 Ext. 4649.

## TUBES

TUBES: "Oldies". Latest. Supplies, components, schematics. Catalog Free (stamp appreciated). Steinmetz, 7519-PE Maplewood, Hammond, Ind. 46324.

HUGE INVENTORY! Thousands of types. Wholesale prices. FREE CATALOG! ETCO Electronics, DEPT. 290, Plattsburgh, NY 12901.

## PERSONALS

UNIVERSITY DEGREES BY MAIL! Bachelors, Masters, Ph.Ds. Free revealing details. Counseling, Box 317-EP7, Tustin, California 92680.

MAKE FRIENDS WORLDWIDE through international correspondence, illustrated brochure free. Hermes-Verlag, Box 110660/Z, D-1000 Berlin 11, W. Germany.

FREE: WORLD'S LARGEST PARTNER PHOTO CATALOG for friendship and marriage. Personalized introductions. INTERCONTACT, Box 12, Toronto, Canada M4A 2M8.

CORRESPONDENCE TO ASIA FOR LASTING RELATIONSHIP. Free information. AAWS-CE, Box 2777, Orcutt, CA 93455-0777.

ORIENTAL SINGLES seeking cultural exchange, friendship, sharing, marriage. WRITE: CHERRY BLOSSOMS, Box 1021P, Honokaa, Hawaii 96727.

## INSTRUCTION

UNIVERSITY DEGREES BY SPECIAL EVALUATION of existing credits and Job Experience. Fast, inexpensive. Call (614) 863-1791. Or write: EVALUATION, Box 13151-A7, Columbus, Ohio 43213.

REPAIR ELECTRONIC ORGANS—Revised home study course covers all current makes and models. Free booklet. Niles Bryant School, P.O. Box 20153, Sacramento, CA 95820.

**ADVERTISERS INDEX**

**F.C.C. COMMERCIAL RADIOTELEPHONE LICENSE. Home Study. Fast, Inexpensive! Free details. COMMAND, D-100 Box 2223, San Francisco 94126.**

**LEARN WHILE ASLEEP! HYPNOTIZE!** Astonishing details, strange catalog free! Autosuggestion, Box 24-ZD, Olympia, Washington 98507.

**MEDICAL ELECTRONICS TECHNOLOGY,** home study. Troubleshoot medical instruments. WTI, P.O. Box 3124, Fresno, CA 93650-3124.

**BASIC GATE RELATIONSHIP!** Building blocks of Computers and electronic control circuits. 2 hour VHF video tape \$47.98 plus \$3.75 shipping and handling. Send check or money order to: INTREPID TEC INC, PO Box 175, Fountain Green, Utah 84632.

**FOR INVENTORS**

**INVENTIONS, IDEAS, NEW PRODUCTS WANTED!** Industry presentation/national exposition. Call free 1-800-528-6050—Arizona, 1-800-352-0458, X831.

**PATENT AND DEVELOP** your invention. **FREE PATENT INFORMATION.** Richard L. Miller, P.E., 3612-E, Woolworth Building, New York, NY 10007, (212) 267-5252.

**BUSINESS OPPORTUNITIES**

**MECHANICALLY INCLINED** individuals desiring ownership of Small Electronics Manufacturing Business—without investment. Write: **BUSINESSES.** 92-K7 Brighton 11th, Brooklyn, New York 11235.

**ERASE DEBTS** with little-known law—create wealth!! Details **FREE**—Wealth Kit, No. EE7, Billings, NY 12510.

**ONE MAN CRT FACTORY.** T.V.'s, Business machines, Monitors, Scopes, VDT's. \$3.00 rebuilding nets \$100-\$500 each tube. Higher profits overseas. New/used. **FACTORY.** 1909 Louise, Crystal Lake, IL 60014. (815) 459-0666.

**BORROW \$300-\$30,000 INTEREST FREE!** Keep indefinitely! Free Details. Write: American, 1601 Main, Plainfield, Indiana 46168.

**BUMPER STICKER PRINTING DEVICE.** Cheap, simple, portable. Free details. Bumper, POB 22791 (PE), Tampa, FL 33622.

**FREE CATALOGS.** Repair air conditioning, refrigeration. Tools, supplies, full instructions. Doolco, 2016 Canton, Dallas, Texas 75201.

**BORROW \$30,000** without interest! All eligible. Repay anytime. Free details! Infohouse-CE, 808 Post, San Francisco, CA 94109.

**EARN EXTRA INCOME** with your microcomputer. Super opportunities! Free details. Scitec, Box 02038, Columbus, OH 43202.

**START YOUR OWN** Microcomputer based mail order business. Free info. Bark Research, 21 Foxanna Dr, CE Hershey, PA 17033.

**BE A COMPUTER BROKER/CONSULTANT** if you are good with micros, then your advice is needed. Book tells all to get you started as a broker/consultant in your own home. Where to buy. How to get clients. Cash in on fast growing area of micros. \$5.00. ETC Marketing, P.O. Box 5205, Hacienda, CA 91745.

**\$360 WEEKLY/UP.** Mailing Circulars! No quotas. Sincerely Interested, rush stamped envelope: Commission Mailing, Box 15967-E6, San Diego, CA 92115.

**PROFIT, Save.** Enjoy shopping the exciting International Marketplace from the comforts of home or office. Information catalog \$3.00, Albrew, 2530 Cypress Ave., Norman, OK 73069.

**MAIL ORDER OPPORTUNITY!** Start profitable home business without experience or capital. Information free. Mail Order Associates, Inc., Dept. 712, Montvale, NJ 07645.

**SERVICES**

**SHOP AT HOME!** Use your modem to call Fantasy Plaza. **FREE** Electric Shopping at (818) 840-8066.

**REAL ESTATE**

**500 OFFICES ... 45 STATES!** 30,000 listing on computer, 16,000 under \$50,000! Free printouts and regional catalogs! **UNITED FARM AGENCY,** 612-EP West 47th, Kansas City, MO 64112. Ph: 1-800-821-2599, in MO 1-800-892-5785.

**EMPLOYMENT OPPORTUNITIES**

**GOVERNMENT JOBS**—Thousands of vacancies must be filled immediately. \$17,634 to \$50,112. Call 716-842-6000, Ext 3900.

**ELECTRONICS/AVIONICS EMPLOYMENT OPPORTUNITIES.** Details **FREE.** Aviation Employment Information Service, Box 240E, Northport, New York 11768.

**BOOKS & MAGAZINES**

**MICROWAVE TECHNOLOGY BOOK;** learn to build local microwave receivers, satellite TV, police radar and much more. Send \$5.00 plus 75¢ for postage and handling to: Tom Howell Productions, POB 32357, Washington, DC 20007.

**COMMODORE—64 SOFTWARE DIRECTORY** Descriptions, requirements, and prices of over 450 packages categorized by Business, Educational, Games, Etc. Also includes programming hints and listings of useful programs. \$3.95. H.S. ENTERPRISES, P.O. BOX 367, HANCOCK, MD 21750.

**MISCELLANEOUS**

**BASIC DATE SUBROUTINE**—input: mmddyy, output: month dd, 19yy + weekday month dd, 19yy + more. For complete, compilable, source code, documented, send check. \$19.95. Ice System Inc, 345 Queens St. #980, Honolulu, Hawaii 96813.

**THIS MAGAZINE IS  
 AVAILABLE IN MICROFORM  
 DIRECT INQUIRIES TO:  
 MICRO PHOTO DIVISION  
 BELL & HOWELL  
 OLD MANSFIELD ROAD  
 WOOSTER OH 44691  
 Contact Christine Ellis  
 Call toll-free (800) 321-9881  
 in Ohio, call (216) 264-6666 collect**

RS no.	ADVERTISER	PAGE no.
50	Active Electronics .....	101
	Apple Computer .....	16-17
9	Atari .....	2
	C & D Electronics .....	95
	Classified Advertising ....	106-112
	Cleveland Institute of Electronics, Inc .....	30-32
60	CompuServe .....	34-35
61	CompuServe .....	Cover 4
14	Digi-Key Corp. ....	104
2	Discount Computers .....	91
66	Discwasher .....	85
	Epson America, Inc. ...	Cover 2, 1
	Grantham College of Engineering .....	93
	Halix Institute .....	90
24	Heath Co. ....	7
	IBM Corporation .....	9-12
	Information Unlimited/ Scientific Systems .....	95
6	IQ Technologies, Inc. ....	Cover 3
21	Jameco Electronics .....	105
22	JDR Microdevices .....	102-103
23	J & R Music World .....	89
5	Microsci .....	15
34	Micro-Ware .....	93
	NRI Schools .....	20-23
1	Nibble Notch Computer Products	93
40	Protecto .....	27
	Radio Shack .....	5
	Scottsdale Systems .....	89
36	Sintec Co. ....	100
42	Tam's Inc. ....	95
63	X'llnt Diskette Products, inc. ....	6

.....CLASSIFIED ADVERTISING ORDER FORM.....

1 _____	2 _____	3 _____	4 _____	5 _____
6 _____	7 _____	8 _____	9 _____	10 _____
11 _____	12 _____	13 _____	14 _____	15 (MINIMUM)
16 _____	17 _____	18 _____	19 _____	20 _____
21 _____	22 _____	23 _____	24 _____	25 _____
26 _____	27 _____	28 _____	29 _____	30 _____

Please refer to heading on first page of this section for ad placement information.

**REGULAR: \$5.00 EXPAND-AD®: \$7.50 (per word).**

# OF WORDS \_\_\_\_\_ # OF INSERTIONS \_\_\_\_\_

PAYMENT ENCLOSED \$ \_\_\_\_\_

CHARGE: You will be billed monthly.  American Express  Diners  Visa  MasterCharge-Interbank # \_\_\_\_\_

Account # \_\_\_\_\_ Exp. Date \_\_\_\_\_

SIGNATURE \_\_\_\_\_

PRINT NAME \_\_\_\_\_

ADDRESS \_\_\_\_\_

CITY \_\_\_\_\_ STATE \_\_\_\_\_ ZIP \_\_\_\_\_ CE-784

# THE SMART WAY TO CONNECT COMPUTER EQUIPMENT.

There's only one cable on the market that allows you to hook your computer to virtually any peripheral. It's the Smart Cable. Its on-board logic matches any RS-232 port to another. Instantly. And automatically. No other cable can do it. So don't face the problem of needing a new cable for every new connection. Buy the only cable you'll ever need to buy. The Smart Cable. Suggested retail \$89.95.



**IQ TECHNOLOGIES, INC.**

11311 N.E. First Street

Bellevue, WA 98005

(206) 451-0232

TELEX 701 472 IQTECH UD

1-800-232-8324

Circle No. 6 on Free Information Card



*Smart Cable*



CompuServe

# If you could get your investment information where Wall Street gets its investment information, you'd get it from us.

Now CompuServe's Executive Information Service puts the most accurate, comprehensive investment information available at your fingertips.

*For the first time ever*, individual investors can join the ranks of the most prestigious Wall Street firms who depend on CompuServe to provide them with a broad spectrum of comprehensive financial information for research, portfolio management and merger/acquisition strategies.

*Instant retrieval* of continuously updated quotes on over 9,000 issues and 10 years of daily historical pricing on over 50,000 securities...

*Standard and Poor's* descriptive information on more than 3,000 companies...

*Value Line Data Base-II* extensive fundamental data to analyze the performance of more than 1,700 major corporations...

*Disclosure II* descriptive and financial information derived from SEC filings for over 8,500 companies...

*Institutional Brokers' Estimate System (IBES)* earnings projections on over 2,800 widely followed companies...

*Evans Economics* daily updated economic forecasts, historical statistics and analysis of more than 20 major economic indicators plus continuous public opinion polls on economic and financial issues...

*Reports* on technical market trends, personal portfolio evaluation and the most comprehensive analysis capabilities currently available...

You get all this plus demographic information on every zip code in the U.S., access to consultants through the Geneva Series, state of the art electronic communications, the full scope of the prestigious AP Wire Services, travel information and reservations and more of the high quality financial information that has made CompuServe

the premier supplier of investment information to the greatest names on Wall Street.

For a free illustrated guide to CompuServe's Executive Information Service, write or call:

Name \_\_\_\_\_

Address \_\_\_\_\_

City \_\_\_\_\_

State \_\_\_\_\_ Zip \_\_\_\_\_

## CompuServe

Executive Information Service  
P.O. Box 20212  
5000 Arlington Centre Blvd.  
Columbus, Ohio 43220

**800-848-8199**  
In Ohio, call 614-457-0802

An H&R Block Company

Circle No. 61 on Free Information Card