

Popular Electronics®

WORLD'S LARGEST-SELLING ELECTRONICS MAGAZINE

MAY 1981/95¢

"Smart" Controller for Greenhouse Lights

Electronic Telephone Ringer

Wireless Tachometer for Auto Tune-ups

Direct Broadcast Satellites -

Studio to home TV
via outer space!

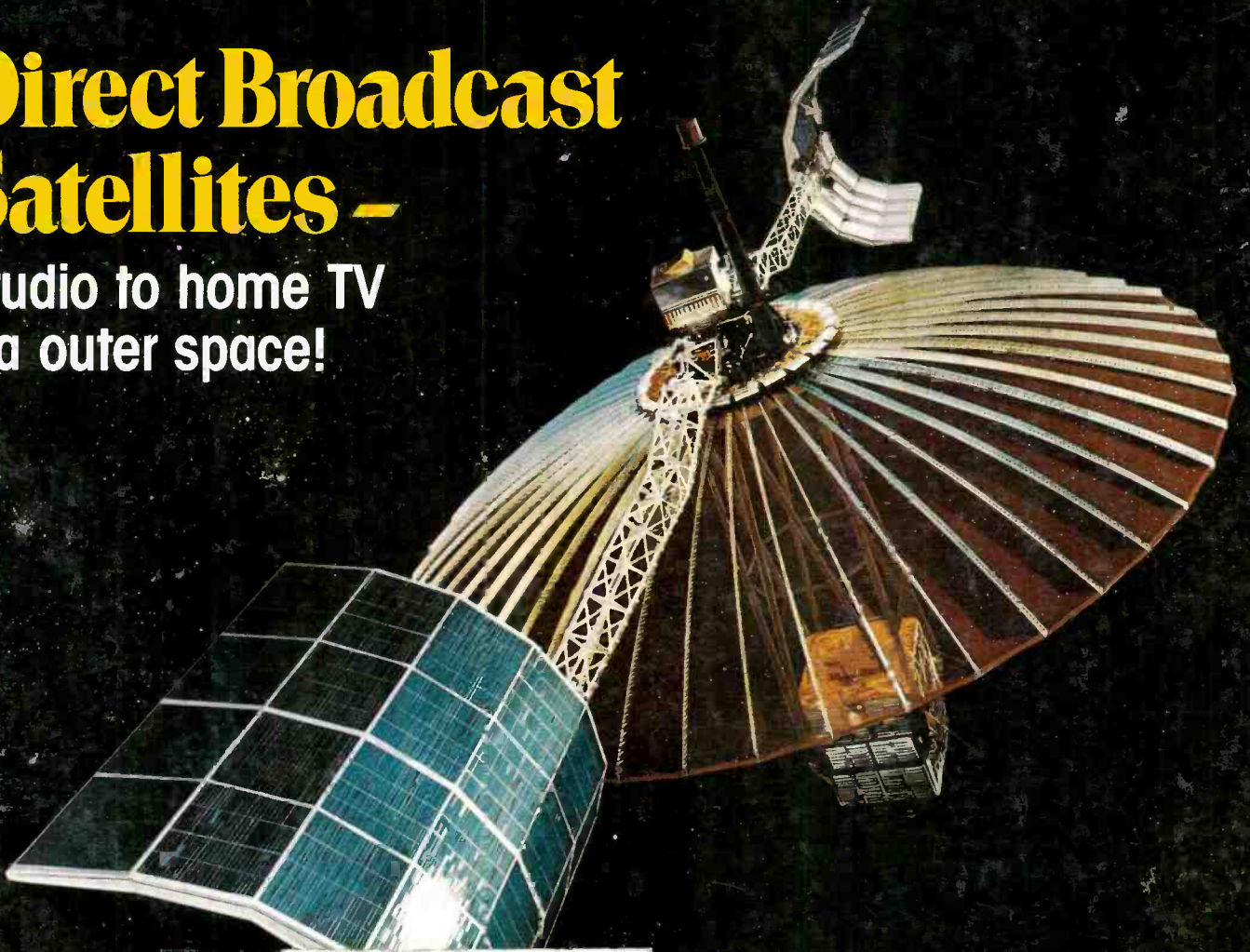

6450 MYRLEWOOD DR
L. DARRKELL JR
CUPERTINO, CA 95014
503092 DRK 6450M091 141D DECE2

ed in this issue:

Hewlett-Packard HP-85 Computer
L112 Speaker
Fluke D811 Multimeter

WHY JUST WATCH TV WHEN YOU CAN WATCH THE WORLD?

Downlink™ home satellite TV system gives you access to more than 60 TV channels — many of these you've never seen before. Channels that even the most sophisticated cable-TV system operators don't carry.

Downlink lets you pick up everything that's transmitted via satellite throughout the entire North American continent. The result is an enormous increase in the scope and quality of your TV reception.

Watch foreign and domestic sports. View movies and uncut news. See foreign language and religious programs. Enjoy adult entertainment shows. Be there for live coverage from the House of Representatives ... the entertainment and educational possibilities are endless.

And since you get your picture directly from the satellite, with Downlink the quality of your TV reception is better than what you're getting now. All at a price significantly below previous systems.



The Downlink home TV satellite system consists of an antenna with an amplifier and a receiver. It's easy to hook up and simple to use. The antenna can go on your porch, in your backyard, or on any flat roof. You put the receiver near your TV (on a coffee table, for instance) and use it to switch from one channel to another, just as you normally switch TV channels. Downlink consists of the highest quality components. It's rugged, durable and backed by a one-year warranty. Go to your nearest video dealer and see for yourself.

For more information, contact:
Black and White Enterprises, Ltd.
P.O. Box 33
Putnam, Connecticut 06260
203-928-7955

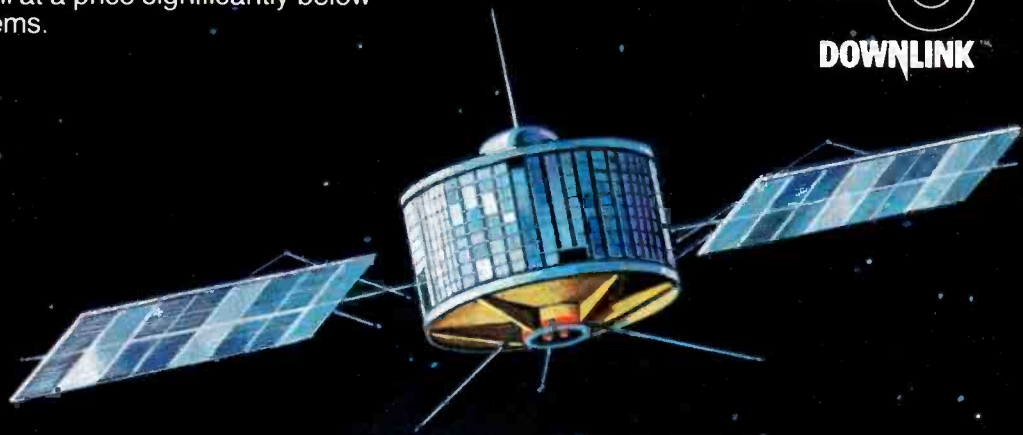

You won't believe the sound of the Sonora Sportsmate. More than a portable radio, it's a portable AM/FM stereo receiver! Just flip the switch, put on the featherlite earphones, and wherever you are, the beautiful music is yours. The sound is so rich and pure, you'll swear you're listening to one of the world's most expensive stereos.

**TURN IT ON AND LET IT
TURN YOU ON!**

The Sportsmate is designed to go where you go. Its computer circuitry and space-age design make it super lite! A special built-in clip lets you attach it to your belt or pocket. You can take it anywhere—skating, skiing, or jogging. Take it to the beach or the ballgame, the office or the opera. The Sportsmate is perfect everywhere.

**IT'S YOUR OWN, PRIVATE,
STEREO RECEIVER.**

*4½" x 3" x 1" radio unit.
Weighs 12 ounces.
Carrying case.
Stereo balance control; stereo indicator light.
Operates on 3 AA batteries.*



**\$49.95
NEVER
SOUNDED
THIS
GOOD!**

**AN AM/FM STEREO RECEIVER
FOR \$49.95?**

Other comparable units retail for up to 3 times the price of the Sportsmate! Now, for the price of theirs, you can get his AND hers Sportsmates.

**CALL TOLL-FREE AND ORDER
YOUR SPORTSMATE TODAY.**

The Sportsmate is FCC approved

Call or write
to order Markline's
Free Catalog.

and guaranteed by Markline. To order your Sportsmate by mail, send \$49.95 plus \$3.50 for shipping, handling and insurance (Massachusetts residents add \$2.50 state tax). You can also order by calling Markline, toll-free, at 800-225-8493 or 800-225-8390.

**OUT-OF-THIS-WORLD
ELECTRONICS.**

The Sportsmate is one of the many unusual and exciting electronic products we carry. Our new, 32-page, full-color catalog features the newest and the best in unusual electronics, from talking clocks to hand-held computers. Give us a call and we'll send you our free catalog.

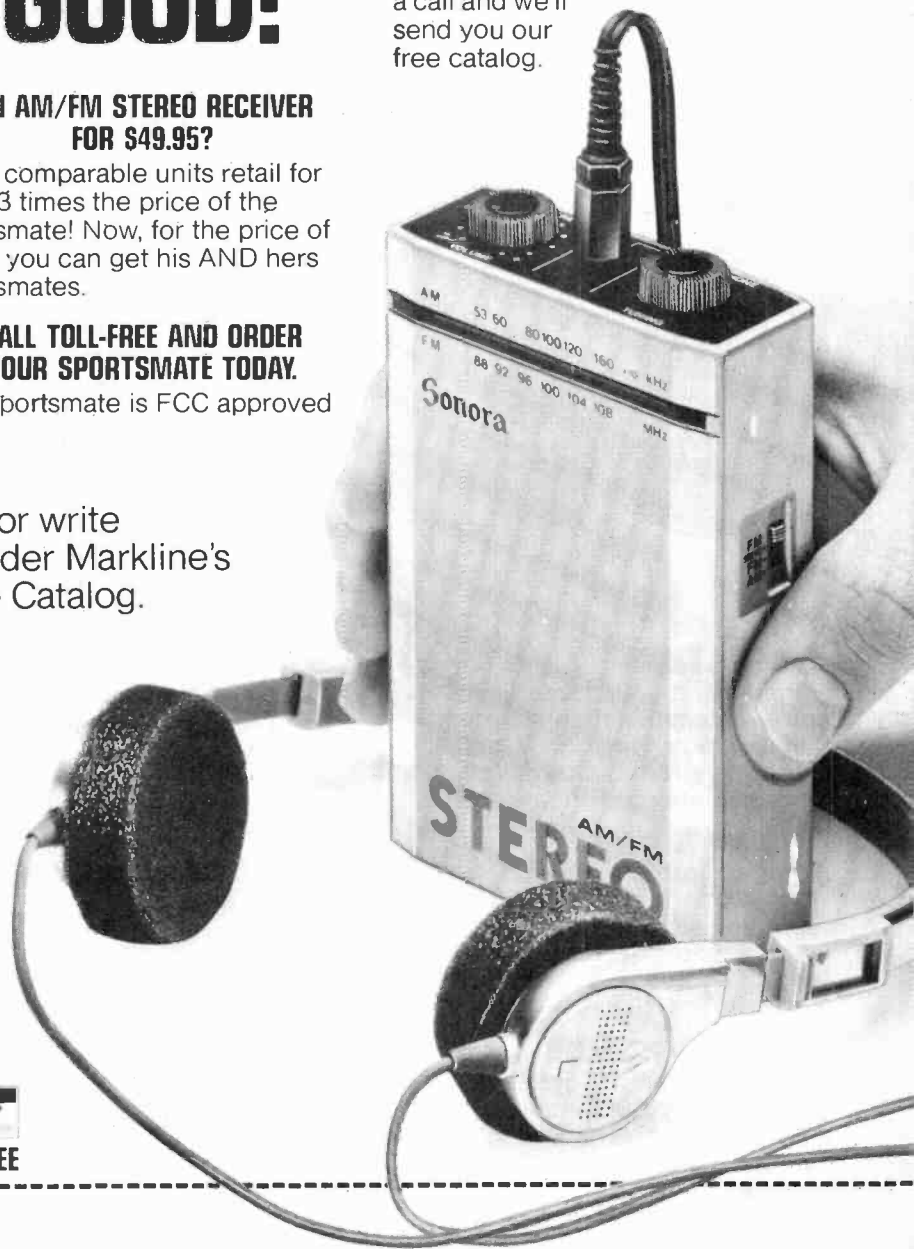

ORDER TOLL-FREE

**800-225-8493
800-225-8390
(IN MASS.
1-617-891-6495)**

MARKLINE

P.O. Box 171 Dept. 5696
Belmont, MA 02178

CIRCLE NO. 36 ON FREE INFORMATION CARD

A NEW STANDARD OF RECORD CARE

DISCWASHER D4 SYSTEM



NEW D4 FLUID

Inherently more active against record contamination. Inherently safe for record vinyl. Preferentially absorptive formula carries all contamination off the record.

NEW D4 FABRIC

Unique directic ral fibers preferentially remove fluid and contamination. D4 fabric results in clearly better cleaning, better drying and ultimately residue-free surfaces.

UNMATCHED VALUE

The Discwasher D4 System is enhanced by the durability and aesthetics of the hand-finished walnut handle. Included in the D4 System are the DC-1 Pad Cleaner and new instructions.

discwasher[®]
PRODUCTS TO CARE FOR YOUR MUSIC

1407 N. Providence Rd.
Columbia, Missouri 65201

CIRCLE NO. 15 ON FREE INFORMATION CARD

Popular Electronics[®]

WORLD'S LARGEST-SELLING ELECTRONICS MAGAZINE

Feature Articles

TV FROM OUTER SPACE: THE COMING OF DIRECT BROADCAST SATELLITES / John J. McVeigh	53
<i>A new force in the development of the home video system.</i>	
RTTY MEETS THE COMPUTER / Karl Thurber	61
<i>How new, sophisticated gear is bringing radioteletype up-to-date.</i>	
PROGRAM MERGING ON A TRS-80 / James Friddle	82
<i>Machine language utility permits combining of two programs.</i>	

Construction Articles

A "SMART" GREENHOUSE LIGHT CONTROLLER / Mark L. McWilliams	67
<i>Provides artificial illumination when sunlight is not available.</i>	
A LOW-COST ELECTRONIC RINGER FOR TELEPHONE LINES / Bradley Albing	70
<i>Circuit replaces electromechanical ringer in a telephone.</i>	
A WIRELESS IDLE TACHOMETER FOR AUTO TUNE-UPS / John E. Davis	75
VOCAL ZAPPER MAKES YOU A "SUPERSTAR" / Craig Anderton and David Karr	78
<i>Substitute your voice for the center channel of a stereo record.</i>	

Equipment Reviews

JBL MODEL L112 THREE-WAY SPEAKER SYSTEM	22
TOSHIBA MODEL CA944 19" COLOR TV RECEIVER	25
FLUKE MODEL D811 TRUE RMS MULTIMETER	34
HEWLETT-PACKARD MODEL HP-85 COMPUTER	48

Columns

ENTERTAINMENT ELECTRONICS / Ivan Berger	14
<i>The TV Connection.</i>	
COMPUTER BITS / Carl Warren	37
<i>New Systems for 1981.</i>	
COMPUTER SOURCES / Leslie Solomon	40
HOBBY SCENE / John McVeigh	84
SOLID-STATE DEVELOPMENTS / Forrest M. Mims	85
<i>Optoisolators—The Photon Connection.</i>	
EXPERIMENTER'S CORNER / Forrest M. Mims	88
<i>The Polapulse Water Battery.</i>	
DX LISTENING / Glenn Hauser	92
<i>Revolution By Radio Revisited.</i>	
PROJECT OF THE MONTH / Forrest M. Mims	96
<i>Model-Railroad Crossing Light.</i>	

Departments

EDITORIAL / Harold A. Rodgers	4
<i>The Video Guerrilla Army.</i>	
LETTERS	6
NEW PRODUCTS	8
AUDIOPHILE RECORDINGS	20
OPERATION ASSIST	107
ADVERTISERS INDEX	111
PERSONAL ELECTRONICS NEWS	112

COVER ART COURTESY NASA

COPYRIGHT © 1981 BY ZIFF-DAVIS PUBLISHING COMPANY. All rights reserved. Popular Electronics (ISSN 0032-4485) May 1981, Volume 19, Number 5. Published monthly by Ziff-Davis Publishing Co., at One Park Ave., New York, NY 10016. Philip B. Korant, President; Selwyn Taubman, Treasurer; Bertram A. Abrams, Secretary. One year subscription rate for U.S. and Possessions, \$14.00; Canada, \$17.00; all other countries, \$19.00 (cash orders only, payable in U.S. currency). Second Class Postage Paid at New York, N.Y. 10016 and at additional mailing offices. Authorized as second class mail by the Post Office Dept., Ottawa, Canada, and for payment of postage in cash. POPULAR ELECTRONICS including ELECTRONICS WORLD, Trade Mark Registered. Indexed in the Reader's Guide to Periodical Literature. Ziff-Davis also publishes Boating, Car and Driver, Cycle, Flying, Popular Photography, Skiing, Stereo Review, Electronic Experimenter's Handbook, and Tape Recording & Buying Guide. Forms 3579 and all Subscription Correspondence: POPULAR ELECTRONICS, Circulation Dept. P.O. Box 2774, Boulder, CO 80302. Please allow at least eight weeks for change of address, enclosing, if possible, an address label from a recent issue. Permissions. Material in this publication may not be reproduced in any form without permission. Requests for permission should be directed to John Babcock, Rights and Permissions, Ziff-Davis Publishing Co., One Park Ave., New York, NY 10016.

Three good reasons why professionals pick Apples.

1 In research

Apple personal computer systems help you collect, store and analyze data as fast as you can load a disk and execute a program. Because more than 100 companies offer software for Apple, you have the largest program library for manipulating your data in the personal computing world. Need special programs? Use any of Apple's development languages — BASIC, FORTRAN, Pascal.

2 In engineering

Apple personal computer systems let you define models, make trade-offs and refine prototypes. Want to study cause and effect of several variables? Apple computes new results instantly and displays them in colorful, easy-to-read graphs, charts or plots on a video monitor.

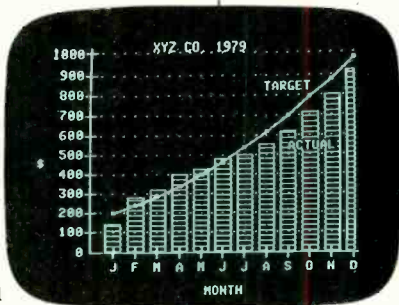

3 In production management

Apple personal computer systems make it easy to gather data, analyze productivity, measure yields and facilitate all phases of production control. Want to speed up repetitive tasks?

Rely on Apple's word processing capabilities to write, edit and print your reports.

Apples grow with you.

Whichever system you pick, Apple never locks you into a single configuration. You can use up to four or eight I/O accessory expansion slots to add an IEEE bus, Apple's Silentype™ printer, a modem or a graphics tablet. Add memory up to 64K bytes or 128K bytes. Add up to four or six 5 1/4" disk drives without adding any overhead.

For support, service and the best extended warranty in the industry — Apple is the answer.

If you have any other questions about why Apple is the pick for professionals in engineering, see your nearest Apple computer dealer or

	Apple II	Apple III
Maximum Memory Size	64K bytes	128K bytes
Screen Display	40 column (80 column with peripheral card) 24 Lines Upper Case	80 column 24 Lines Upper Case/Lower Case
Screen Resolution (B & W)	280 x 192	560 x 192
Screen Resolution (Color)	140 x 192 (6 colors)	280 x 192 (16 colors)
Keyboard	Fixed	Programmable
Numeric Key Pad	Accessory	Built-in
Input/Output	8 expansion slots	4 expansion slots plus built-in: disk interface RS-232 interface Silentype™ printer interface clock/calendar
Disk Drives	Add-on one to six drives	One drive built-in, plus interface to support three more drives
Languages	BASIC Fortran 77 Pascal Assembly Pilot	Enhanced BASIC Fortran 77 Pascal Assembly
Typical Configuration Pricing	CPU, 48K RAM, single disk drive, B & W Monitor (9"). Silentype™ printer, and BASIC. \$2875.00*	CPU, 96K RAM, Integrated disk drive, B & W Monitor (12"). Silentype™ printer, SOS, Enhanced BASIC. \$4865.00*

*Suggested retail price.

call 800-538-9696. In California, 800-662-9238. Or write: Apple Computer, 10260 Bandle Drive, Cupertino, CA 95014.



apple computer inc.

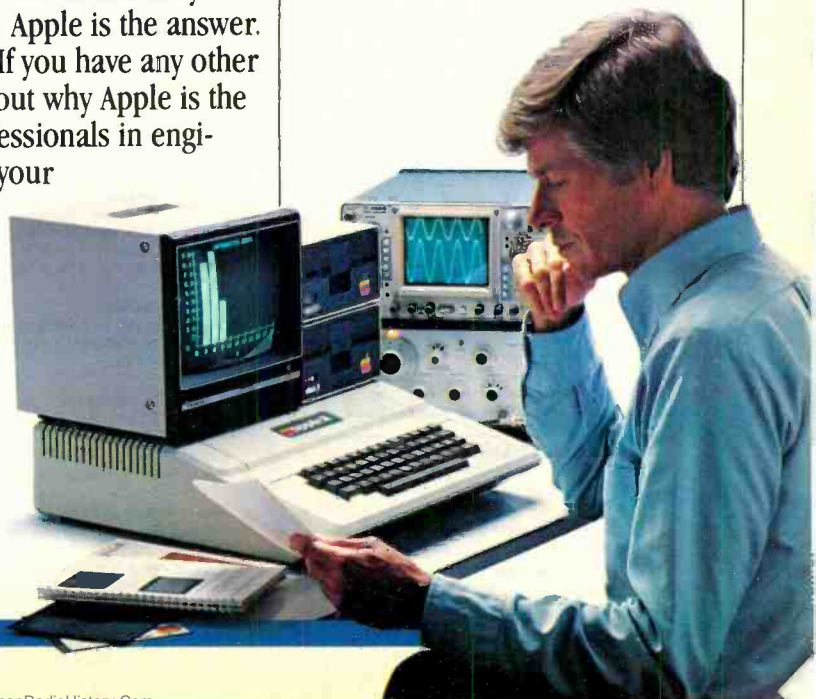

EDITORIAL

The Video Guerilla Army

Early one morning several months ago, I, as one of a large group of other journalists, was invited to a demonstration/opening in the electronics department of Macy's department store in New York. What we saw and heard that day was essentially Sony's concept of futuristic video/audio/electronic games systems. These ranged from a projection TV of dimensions sufficient to virtually surround the viewer, to elaborate combinations of video and audio, to setups that let one play life-size (more or less) electronic games.

While I was duly impressed by the technological tour de force inherent in the demonstration, it was hard to repress a lingering skepticism. (Perhaps this is an occupational disease of journalists.) Would people really want to immerse themselves in video to this extent? Could a TV, however futuristic, glorified, and graced by ancillary hardware, serve as the principal focus of an environment, or perhaps of a new life-style? Quite frankly, I had my doubts.

My skepticism suffered an initial, though

hardly disabling, blow when I visited a model solar house built under the sponsorship of the Copper Development Association at a location in southwestern Connecticut. The building ("dwelling system" might be a better term) used electronic controls for its heat collection and management and even included an array of photovoltaic cells that produced enough electricity to run the circulating pumps for a limited time. All of this was supervised by an Apple computer that also amassed statistics on the overall system operation.

But there was a second microcomputer, too. This one, much as in the demonstration at Macy's, was hooked up to a large, rear-projection TV (a General Electric model, in this case), with an audio system included as well. What was most interesting was that the architects had made it all fit right in. The system belonged where it was and was comfortable to be around. While, granted, the house was a "hang-the-cost" venture, an important point had been made.

What finally turned me from skepticism

and convinced me that the phrase "video revolution," however hackneyed, refers to a real phenomenon was information from you, who read POPULAR ELECTRONICS. Fully 15% of you now own a video cassette recorder, as compared with 1.8% of the households in the U.S. Equally impressive in terms of the limited availability of product, 1% of you already own video disc systems. Furthermore, almost a third of the readers who have VCRs use them with cameras, most of them color cameras.

All of this amounts to quite a showing of video activism. Clearly, whatever thrusts are being made in this suddenly ebullient area must have a phalanx of PE readers in the lead. We've always thought you were a special bunch of people—but you keep surprising us anyway.

Hal Rodgers

JOE MESICS
Publisher

ARTHUR P. SALSBERG
Editorial Director

HAROLD A. RODGERS
Executive Editor

LESLIE SOLOMON
Senior Technical Editor

JOHN R. RIGGS
Managing Editor

EDWARD I. BUXBAUM
Art Director

ALEXANDER W. BURAWA
Features Editor

JOHN J. McVEIGH
Technical Editor

ANDRE DUZANT
Technical Illustrator

CARMEN ROBLES
Production Editor

JEFF NEWMAN
Editorial Assistant

Contributing Editors

Carl Warren, Stan Prentiss
Glenn Hauser, Julian Hirsch, Forrest Mims

MARIE MAESTRI
Executive Assistant

OLIVIA WILSON
Promotion Coordinator

PEARL HARRINGTON
Assistant to the Publishing Director

SIDNEY HOLTZ
Publishing Director

Popular Electronics

Editorial and Executive Offices
One Park Avenue
New York, New York 10016
212 725-3500

Publisher
Joe Mesics
212 725-3568

New York Office
Advertising Manager:
Richard Govatski (725-7460)

Eastern Advertising Manager
Bonnie B. Kaiser (725-3580)
Richard B. Eicher (725-3578)

Midwestern Office
Suite 1400, 180 N. Michigan Ave.,
Chicago, IL 60601 (312 346-2600)
Sales: Ted Welch

Western Representative
Norman S. Schindler & Associates, Inc.
7050 Owensmouth Ave., #209
Canoga Park, CA 91303 (213 999-1414)
Sales: Norm Schindler, Jon Marshall

Representation in Japan
James Yagi
Oji Palace Aoyama
6-25, Minami Aoyama, 6 Chome, Minato-Ku
Tokyo, Japan (407-1930/6821, 582-2851)

Ziff-Davis Publishing Company

Philip B. Korsant
Richard Friese
Phillip T. Heffernan
Sidney Holtz
Edward D. Muhlfeld
Philip Sine
Albert S. Traina
Robert Baviet
Paul Chook (Research)
Baird Davis (Production)
Edgar W. Hopper (Marketing)
George Morrissey
Selwyn Taubman
Bertram A. Abrams

President
Senior Vice President
Senior Vice President
Senior Vice President
Senior Vice President
Senior Vice President
Senior Vice President
Vice President
Vice President
Vice President
Vice President
Treasurer
Secretary

W. Bradford Briggs

Vice Chairman

Ziff Corporation

William Ziff
I. Martin Pompadur
Hershel B. Sarbin
Furman Hebb
Bruce Maggin
Lawrence Sporn

Chairman
President
Executive Vice President
Vice President
Vice President
Vice President

Editorial correspondence: POPULAR ELECTRONICS, 1 Park Ave., New York, NY 10016. Editorial contributions must be accompanied by return postage and will be handled with reasonable care; however, publisher assumes no responsibility for return or safety of manuscripts, art work, or models submitted.

The publisher has no knowledge of any proprietary rights which will be violated by the making or using of any items disclosed in this issue.



Member Audit Bureau
of Circulations

POPULAR ELECTRONICS

Video Review® knows a bright idea when it sees one.



Simulated TV picture. Simulated wood cabinet

Video Review magazine tests a lot of sophisticated video products.

They get to see virtually every make and type of color TV receiver.

Which makes their selection of Magnavox as their standard TV receiver pretty impressive.

"We thought the Magnavox picture quality and resolution were superb."

"Ever since Video Review began testing products," says the magazine, "we've been looking for a top quality, 19-inch TV set that might serve as a standard of reference for all of the other products we test... video cameras, video cassette recorders, video cassettes.

"We thought the Magnavox picture quality and resolution were superb, and that off-the-air sensitivity was also extremely good.

"Major VHF channels were received with uniformly accurate color fidelity. This receiver produced superior color pictures

even when using its own indoor VHF and UHF antennas."

"The special tuning features and remote control capabilities of the Magnavox receiver are awesome."

"The tuning system is purely electronic and totally digital," they continue. "There is a fine tune switch and a memory lock button. If any channel is received mistuned, the user simply fine tunes up or down in frequency by holding the button, and when perfect tuning has been achieved, the button is released and the memory lock button is depressed once.

"Nearby is Magnavox's Video-matic feature. Depressing this button activates the electronic eye for automatic brightness adjustment, color adjustment circuits and automatic fine tune."

"...unusually good for any receiver."

Overall, Video Review rated the Magnavox 9.5 or better (out of a

possible 10.0) on Video Quality, Reception Sensitivity, Color Fidelity, and Video Resolution and Fidelity. As they put it, "...unusually good for any receiver."

We can only add that once you see a Magnavox color TV at your Magnavox dealer, we think you'll agree.

For Magnavox color TV specifications, write Magnavox Consumer Electronics Company, Dept. 700, P.O. Box 6950, Knoxville, Tennessee 37914.

© 1980 MAGNAVOX CONSUMER ELECTRONICS CO.

MAGNAVOX
MAGNAVOX
MAGNAVOX
MAGNAVOX

The brightest ideas in the world are here to play.

CIRCLE NO. 34 ON FREE INFORMATION CARD

ARE YOU READY FOR REAL?

 **CROWN** announces five new audio instruments, built exclusively for your home audio system, and designed for the most accurate reproduction – the real sound – of your favorite music.

- a new FM tuner that solves RF intermodulation problems
- a new pre-amp that packs unbelievable sonic accuracy and total control into a 1¾" chassis
- three powerful, clean new amps featuring the Crown MULTI-MODE™ circuit that stops distortion at all listening levels.

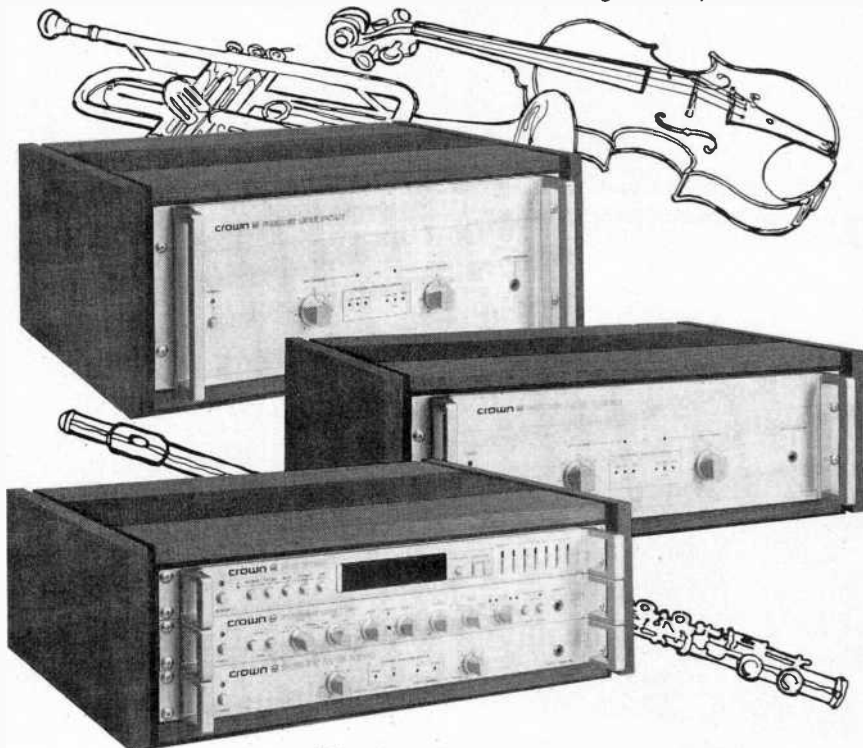

They're on their way to your Crown dealer now, so you can look, touch and listen. Or you can read all about them in your own home by sending the coupon below and \$5 for the latest edition of the CROWN INFORMATION PACKAGE. Over 100 pages, including a "tour" of the Crown factory in Indiana; brochures that explain the operation of all these new instruments plus information on Distinction products; technical articles by Crown engineers on the MULTI-MODE™ circuit and other audio topics; complete reprints of publication reviews; price lists and dealer addresses. Satisfaction guaranteed or we'll refund your \$5. Your Crown dealer will give you this PACKAGE free if you visit his store. If you don't know his address, use the Reader Service Card for a free dealer list. Or call 219/294-5571.



...WHEN YOU'RE READY FOR REAL!

For your CROWN INFORMATION PACKAGE, send this coupon and five dollars to Crown International, 1718 W. Mishawaka Road, Elkhart, IN 46517. PE5

Name _____

Address _____ City _____

State _____ Zip _____ Phone _____ / _____

LETTERS

Reading AC Ripple on DVMs

In our use of the Beckman Series 300 Digital Multimeters ("PE Tests Beckman Tech 310 DMM," March, p 44) we found that they are indeed handy to use but they do not have the ability to read ac ripple on a dc power supply. There is no dc blocking capacitor in the ac voltage measuring circuits so that a dc voltage will be displayed equally well on dc and ac voltage scales. Beckman suggests adding an external capacitor, which works fine but is unhandy. We cured the problem by building a switched probe with a 0.1- μ F capacitor in series.—Lawrence Page, Bradenton, FL.

The solution used here is the conventional approach. When selecting the series capacitor, keep reactance in mind since low-frequency response is determined by this value. Also make sure the voltage of the capacitor is suitable for measured dc plus ac peak.—Ed.

The Toy Gun

The Ad*Zap wireless TV commercial killer (February, p 44) is a great idea. I get angry with commercials too. But pulling a toy gun and shooting the TV with infrared light is not a good way to kill commercials. An individual who pulls the toy gun and shoots at the TV when angry with the commercials may also find it easy to pull a real gun and shoot when angry with something or someone. Let's keep the transmitter in the box, not in the toy gun.—Oral T. Sezer, Milwaukee.

Video Information

Having read several of your reviews of new TV sets, I ask that you include information as to the following: (1) the set works (or does not work) well with a microcomputer or video games in both (or either) color and black and white; and (2) the set has (or does not have) easy-to-plug-in features which allow connection to a microcomputer. I don't expect that any color TV will ever be on a par with a really fine monitor. However, there should be some measuring stick by which we can compare.—W.N. Coxe, Jr., Baton Rouge, LA.

The information you want is there. The minimum bandpass for video monitors is at least 6 MHz, so using a TV set as a substitute is marginal at best. The bandwidth of an NTSC video signal (~ 4.5 MHz) permits a display of about 16 lines of 40 characters each. Since you would normally connect to the TV antenna terminals, the bandwidth given in the report applies. If this is 3 MHz or less, the set is not good for a computer display. Horizontal and vertical overscan of more than 15% would also cause problems.—Ed.

We've got it all together.



Weller



Weller



Xcelite



Wiss



Nicholson



Boker

**Boker
Crescent
Lufkin
Nicholson
Plumb
Weller, Wiss
Xcelite**



Lufkin



Crescent



Plumb

Take a good look round this ad and you'll agree that "All together" is no exaggeration. Whether you're making or mending, cutting or joining, striking, measuring or stripping, there's a Cooper tool that's just right for the job. Don't take chances on tools. Specify Cooper and get 'em right the first time!

from Cooper The Toolmaker. ^{T.M.}



The Cooper Group

BOKER® CRESCENT® LUFKIN® NICHOLSON® PLUMB® WELLER® WISS® XCELITE®

P.O. Box 728, Apex, North Carolina 27502. Tel: (919) 362-7510. Telex: 579497

CIRCLE NO. 12 ON FREE INFORMATION CARD

NEW PRODUCTS

Additional information on new products covered in this section is available from the manufacturers. Either circle the item's code number on the Free Information Card or write to the manufacturer at the address given.

TI LCD Slide-Rule Calculator

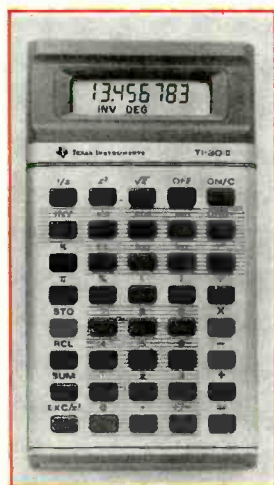

Texas Instruments' new Model TI-30-II slide-rule calculator offers all the basic functions of the TI-30 student calculator plus x-factorial, degree/radian/grad conversions, and a constant memory. It has a liquid-crystal display with an eight-digit mantissa and two-digit exponent (internal accuracy is 11 digits). In addition to the standard arithmetic operations, the calculator can handle powers and roots, trig functions, and percentages. A four-key

Optonica Dual-Cassette Deck

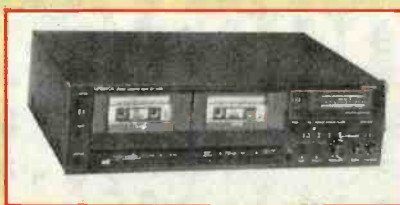

Separate cassette wells, one containing a record head, the other a play head, are used in Optonica's Model RT-6605 cassette deck. Each head, thus, can be optimized for its task. The triple-layer sendust recording head has a 3-micron gap for

high recording sensitivity, while the triple-layer sendust playback head's 0.8-micron gap is said to provide extended frequency response. Dubbing and editing capabilities are built in, and a dubbing level control facilitates copying from one tape formulation to another. Other features include: metal-tape capability, output level control, peak level display with peak hold, bias-adjustment control, timer standby mechanism, and double Dolby noise reduction. Specifications: wow and flutter, 0.045% wrms; frequency range, 20 to 21,000 Hz (metal tape); and S/N 70 dB. \$550.

CIRCLE NO. 88 ON FREE INFORMATION CARD

memory and 15 levels of parentheses round out the TI-30-II's features. User-replaceable miniature batteries provide up to 1000 hours of operation. \$20.

CIRCLE NO. 87 ON FREE INFORMATION CARD

Ungar Portable Desoldering System

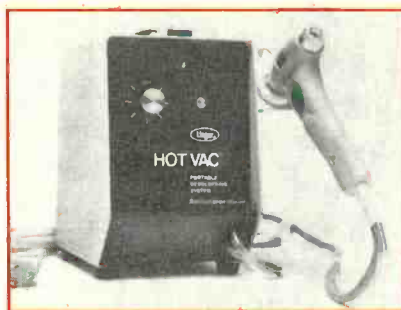

The new Hot Vac 4000 desoldering system from Ungar contains a built-in vacuum pump and can be used anywhere ac power is available. Solder melted by the long-life tip is removed by vacuum action and retained in a built-in solder reservoir, which can be easily emptied even when the heater is at operating temperature.

Tip temperature is adjustable over an approximate 500° to 1000° F range, allowing the tool to be used for a variety of tasks. The temperature-sensing heater is said to provide instantaneous temperature recovery and transient spike suppression, making the tool safe for use with MOS and other sensitive components. Tips of various sizes are included.

CIRCLE NO. 86 ON FREE INFORMATION CARD

Mitsubishi Stereo Preamp

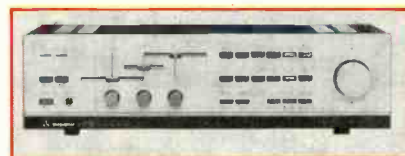

Mitsubishi Audio's Model DA-P30 dual-monaural preamplifier offers wide dynamic range, high slew rate, selectable capacitance loading, and a built-in moving-coil head amplifier in the phono section. LEDs in its SPEAKERS, PROGRAM, and RECORD selector buttons identify operating conditions. Docked with the DA-A30 power amp, the DA-P30 performs speaker switching via built-in relays. The equalization section has bass, midrange, and treble controls, featuring continuously variable turnover frequencies in overlapping ranges from 33 Hz to 20 kHz. Each channel has its own power supply. Specifications: phono overload, 380 mV for MM, 16 mV for MC cartridges; S/N 81 dB for MM cartridges; channel separation, 75 dB; slew rate, 200 V/μs. Size is 18½"W x 9½"D x 5¾"H, and weight is 15.7 lb. \$450.

CIRCLE NO. 89 ON FREE INFORMATION CARD

MFJ Police/Fire Converter



Connected in the antenna line of any 2-meter (synthesized or vfo) transceiver, the Model MFJ-311 Police/Fire Explorer from MFJ Enterprises extends coverage to the high-band police and fire frequencies. Rigs that cover 144 to 148 MHz can

be made to receive 154 to 158 MHz, the band to which virtually all vhf high-band police and fire activities are assigned. A pushbutton switch turns the converter on and off. In its OFF position, the converter is bypassed, allowing transmissions with very low insertion SWR. Even if the switch is left in its ON position during transmit, the converter will withstand up to 25 watts without damage. Size is 4"W x 3"D x 1"H. The unit comes with a mounting bracket for mobile installation. \$49.95 plus \$4 shipping and handling. Address: MFJ Enterprises, Box 494, Mississippi State, MS 39762.

Acoustic Test Signal Generator

Hall Engineering's Model ATG-301 acoustic test signal generator is said to eliminate guesswork when adjusting equalizers, optimizing speaker placement,

STOP BURGLARS BEFORE they enter your home

Protect your family with this new micro-computer burglar alarm "FREE" for 30 days.

Burglars seek easy targets. Few have the daring or the knowledge to challenge the new Perim-A-Tron™ Home Security System. No other burglar alarm under \$2,000 can give you more protection...or match it for features that will give you and your family safety and peace of mind. For starters, it is wireless, installs in minutes, and is portable should you ever move.

THE BRAIN VS. THE BURGLAR

Perim-A-Tron's™ central console, or "BRAIN", employs a microprocessor, making it the most advanced security system available for consumer use. With Perim-A-Tron™ on duty, small sensors monitor doors and windows ready to signal the "Brain" from as far as 250 feet, in the event of a break-in attempt. The "Brain" processes each signal instantaneously and sounds not only a self-contained 85db internal alarm, but also a second 95db remote siren to augment the inside alarm or for placement outside to alert neighbors and police.

The Perim-A-Tron™ is so easy to live with that pets can come and go through partly-open windows or sliding glass doors without triggering it, yet so vigilant that an intruder will set it off before he can enter.

THOUSANDS OF OPTIONS

Perim-A-Tron's™ micro-computer lets you choose from thousands of three digit disarm codes. Only you know your code. But if your son's friend receives a "demonstration", you can easily change the code again...and again. You need no specially coded key which can be lost, misplaced, or stolen. The system even has two separate channels, each with its own distinct alarm sound. This feature allows you to zone your system. For example: Channel 1—house, Channel 2—garage, or Channel 1—doors, Channel 2—windows.

HOW IT WORKS

Operating the system is simplicity itself. When leaving, a light on the console tells you that you've armed the system properly, and have from 5 to 45 seconds to leave the house. This variable delay feature, not found on some expensive commercial systems, is selective so that it can apply only to frequently used doors. All other openings would be set for instant alarm. Upon returning home, you have ample time to turn the system off, thereby avoiding a false alarm.

If a break-in attempt occurs while you're away, an alarm memory light on the console tells you so. What's more, after sounding for

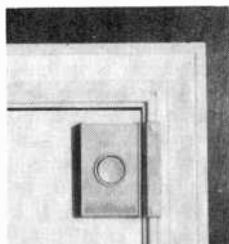

This photo shows a transmitter & magnet installed. If a break-in attempt occurs, separating the two, the transmitter sends a signal to the console which sounds an alarm to scare away the burglar. Installation takes only a few moments & doesn't even require a screwdriver.



Perim-A-Tron's™ 20 button keyboard gives you protection a \$2,000 commercially installed system can't beat. Includes powerful remote horn.

10 minutes and scaring away the intruder, the system shuts off automatically and re-sets itself.

A CONSTANT GUARDIAN

Leave Perim-A-Tron™ in Test Mode during the day and it will signal when anyone leaves or enters. This thoughtful signal will not operate the remote horn but gives a 2½ second warning on the internal speaker only.

If power fails (or is cut-off), the console has a battery back-up. And each battery powered transmitter/sensor will signal at the console if the battery runs low.

The Perim-A-Tron™ system is highly resistant to false alarms because it is not sensitive to motion or sound. Pets can roam at will, curtains can blow in a breeze, you or your children can visit the kitchen for a midnight snack—all without setting off an alarm.

COMING HOME SAFELY

There is nothing more frightening than finding a prowler lurking near your house when you arrive home at night. Our system's EXTRA PROTECTION DESIGN lets you carry a transmitter in your pocket, purse or glove compartment (it's about the size of a cigarette pack). With simple modification, it serves as a PANIC device and will set off the alarm at the press of a button.

COMPARE IT

Hard-wired "commercial" burglar alarms can cost \$2,000 PLUS a monthly fee (and you still never own it). Motion and sound detectors cost up to \$200 per unit and cover only limited areas. Your home may require two or three of these units and, in most cases, no alarm will sound until AFTER a prowler is inside for 30 seconds or more. Perim-A-Tron™ combines pre-entry protection with micro-electronic circuitry to provide the most protection at the lowest cost.

U.L. APPROVED

The Perim-A-Tron™ Home Security System is listed by Underwriters Laboratories as a burglary protection device, a rating which goes beyond electrical safety. To earn this listing our alarm was thoroughly tested for critical burglary protection functions such as transmitter range, sound volume, battery back-up, keyboard component life, battery failure warning, and test function. This tough-to-get U.L. listing resulted from the exacting standards engineered into the Perim-A-Tron™.

YOU BE THE JUDGE

We urge you to order just the basic Perim-A-Tron™ system (pictured above) for a 30-day trial period. Use it to protect your family while you sleep and to protect your home while you're away. Then if you're not convinced that the Perim-A-Tron™ is the most advanced, efficient security system available today, return it undamaged for a complete, no-quibble refund—including return postage. You are protected by a 90 day manufacturer's warranty as well as Shelburne's 25 year reputation for satisfied customers.

HERE'S HOW TO ORDER

To order simply send your check for \$229.95 plus \$5.65 for shipping and handling to the address below. Credit card holders can speed delivery of their system by using our toll-free number listed below. We will then promptly ship your Perim-A-Tron™ unit complete with easy-to-understand instructions and decals warning that the premises are protected. Additional transmitters are available for \$29.95 each, but one is not required for every door and window. Instead, magnetic contacts can be purchased and easily connected to the transmitter, allowing you to cover additional openings for as little as \$5 each. The instruction booklet is quite useful in helping you determine the correct combinations to protect your home or office at the lowest possible cost.

Give yourself some peace of mind—order a Perim-A-Tron™ today at no obligation.

Maryland Residents add 5% Sales Tax.

CREDIT CARD HOLDERS
CALL TOLL-FREE:
800-638-6170
from 9am-5pm EST Mon.-Fri.
Maryland Residents Call 363-4304

©1981 The Shelburne Company

The
Shelburne
Company

110 Painters Mill Road Dept. V-68
Owings Mills, Md 21117 (301) 363-4304

and making other acoustic tests and measurements. The ATG-301 provides a source of white noise, pink noise, and finite-octave bandwidth pink noise that can be used with a sound-level meter or microphone to provide accuracy of frequency-response measurement said to be equivalent to a 1/3- or 1/9-octave spectrum analyzer. In the bandwidth mode, the center frequency is variable from 20 Hz to 20 kHz, and bandwidths of 1, 1/2, 1/3, 1/5, 1/10, 1/20 octave are available. A unique feature is that correction for sound-level meter or microphone frequency response can be read off the front dial. \$299. Address: Hall Engineering, Dept. P-1, Box 506, Martinsville, NJ 08836.

Gusdorf Video Equipment Cabinet



Gusdorf Corp. has added the Model 1915 video-equipment and software cabinet to its Status Pro Collection. The upper compartment is designed to house up to a 19" TV receiver. Behind the lower compartment's doors are a retractable shelf that allows a video cassette recorder or video disc player to slide out for easy access and

WEB Printer Controller



WEB International's TLEC intelligent printer controller allows an IBM Model 50, 60, or 75 electronic typewriter to be used with a TRS-80, Apple, or Commodore computer for word processing. A Z80

Technidyne Wireless Phone

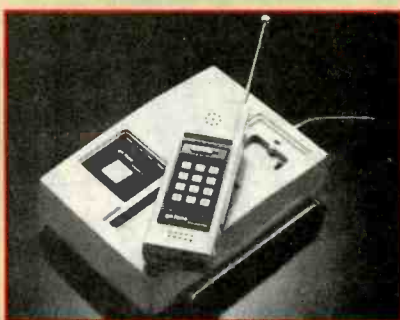

The "Go Fone" is a new wireless FM telephone system from Technidyne Corp. Its base station plugs into any existing tele-

phone jack and the ac power line and has such items as in-use, power, and lock indicators, a call switch, and telescoping antenna. Base-station receive sensitivity is rated at 1 mV, and transmit and receive frequencies are 1.6 to 1.8 MHz and 49.8 to 49.9 MHz, respectively. Size is 9 1/4"W x 7"D x 2 5/8"H, and weight is 2 lb 14 oz. The carry-along handset measures 7 1/4"L x 2 1/2"W x 1 1/4"D, weighs 11 oz, and is powered by four rechargeable NiCd cells. It has an off/standby/talk switch, automatic redial function, low-battery LED indicator, charge jack, belt clip, and telescoping antenna. Communicating range is said to be 300 feet. \$249.95.

CIRCLE NO. 93 ON FREE INFORMATION CARD

a shelf for storage of tapes and discs. The 45 1/4"H x 30"W x 20"D cabinet is available in pecan finish with Rendura coating protection or walnut. Wide casters are fitted to the bottom for easy mobility. Approximate retail price is \$235.

CIRCLE NO. 92 ON FREE INFORMATION CARD

Eico Portable DMM



A new handheld 3 1/2-digit multimeter with liquid-crystal display (LCD) has

been introduced by Eico Electronic Instrument Co., Inc. The Model 274 DMM measures ac and dc voltages to 700 and 1000 V, respectively; ac and dc current to 1000 mA; and resistance to 20 megohms. Accuracy is rated at ±0.8% of reading on dcV, ±1% on acV; ±1.5% on both acI and dcI, and 1% on ohms, all ±1 digit. Input resistance is rated at 10 megohms. Other features include: automatic polarity, overrange, and battery-test indicators; automatic zeroing; full overload protection; and separate RANGE and FUNCTION switches. A single 9-volt battery powers the DMM for up to 200 hours. Supplied with 9-volt battery, test probes, spare fuse, and carrying case, the Model 274 retails for \$89.95.

CIRCLE NO. 94 ON FREE INFORMATION CARD

Audio Electronics Speaker System

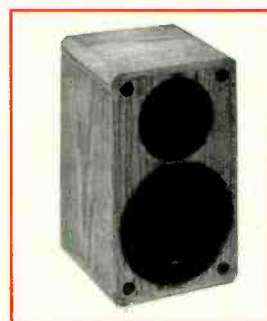

The Model AES-60 is the smallest model in a new line of PC (Phase Coherent) speaker systems from Audio Electronics Systems, Inc. The woofer in this two-way system has a solid, flat diaphragm that is said to eliminate the cone breakup encountered with paper-cone woofers. Due to its construction, the woofer is claimed to act like a true piston whose phasing and coherence precisely match the waveforms of the soft-dome tweeter used in the system. The 6" woofer/1" tweeter system has a rated frequency range of 40 to 20,000 Hz and a nominal impedance of 8 ohms. Sensitivity is rated at 86 dB SPL.

"No one else gives you as many functions in a handheld DMM.

Now you can move up to Fluke."

We've got great news for people who've been holding out for a high quality, high performance DMM at a moderate price: Fluke's new nine-function model D 804 is now available at select electronics supply stores.

With a suggested U.S. price of only \$249 and features you won't find in any other handheld DMM, the D 804 is an exceptional value. Here's why.

Logic level and continuity testing: A real time-saver for troubleshooting passive circuits in pcb's, cables, relay panels and the like. The D 804 has a switch-selectable audible tone and visual symbols to indicate continuity or logic levels.

Direct temperature readings in °C: Used with any K-type

thermocouple, the D 804 delivers fully-compensated readings in °C from -20°C to +1265°C, for checking heating and refrigeration systems.

Peak hold feature captures transients: A short-term memory in the D 804 captures and holds the peak reading of a motor starting current.

And more: 0.1% basic dc accuracy, conductance, 26 measurement ranges, battery, safety-designed test leads and a one year parts and labor warranty. A full line of accessories is also available to extend the measurement capabilities of your DMM.

Ask your dealer about the powerful, versatile D 804 and the rest of Fluke's new Series D line of low-cost digital multimeters.



From the world leader in DMM's. Now we've designed one for you.

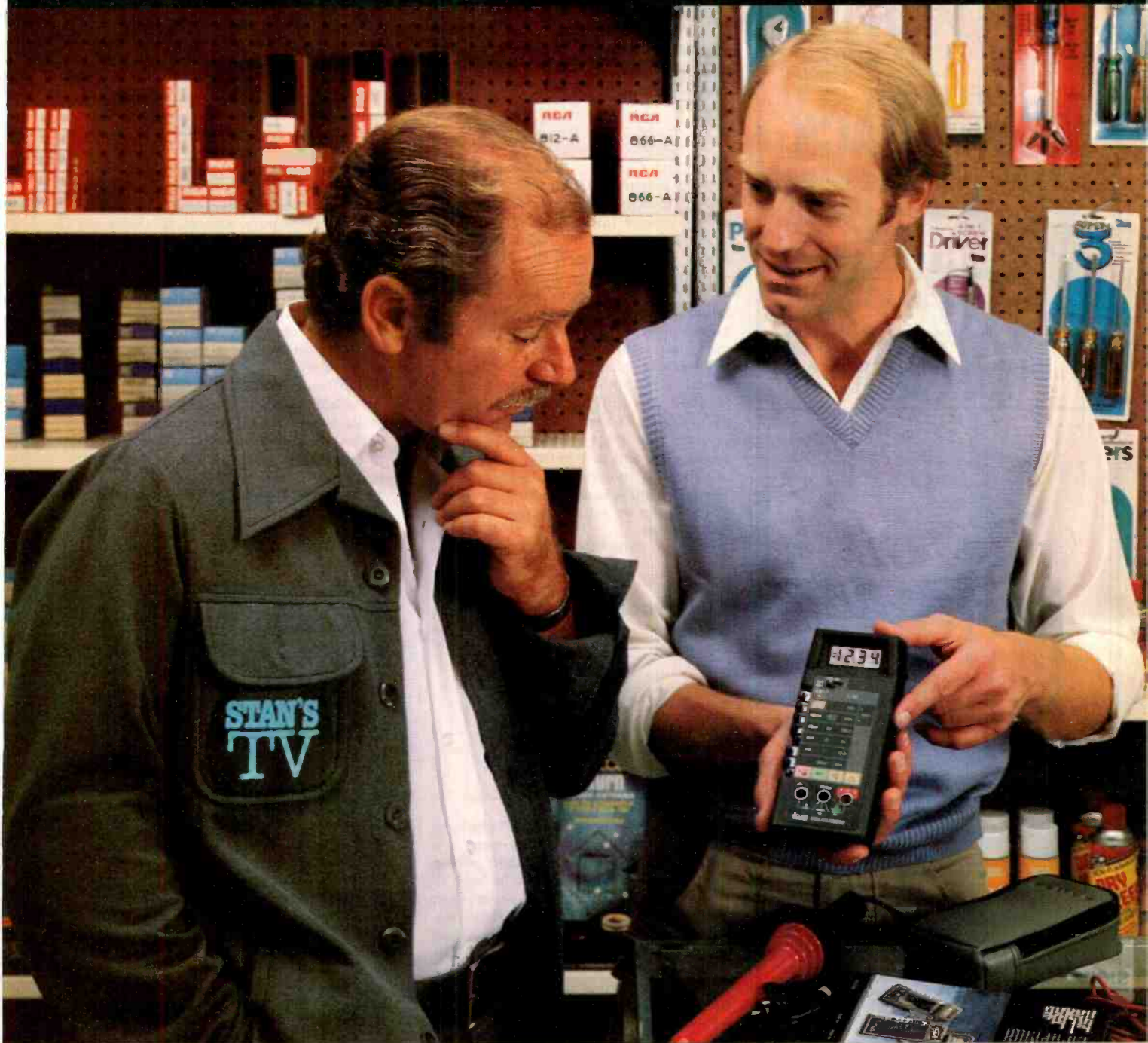

*Suggested U.S. list price
For technical data circle no.
22 ON FREE INFORMATION CARD

If your dealer doesn't carry Series D
Multimeters yet, call this number. We'll be
happy to tell you who does. 1-800-426-9182

FLUKE[®]

WHY K40 BECAME THE LARGEST SELLING CB ANTENNA IN JUST ONE YEAR!

Because

K40™ OFFERS A MONEY BACK

DOUBLE GUARANTEE

- TRANSMITS FARTHER
- RECEIVES CLEARER

...THAN ANY ANTENNA
IT REPLACES!

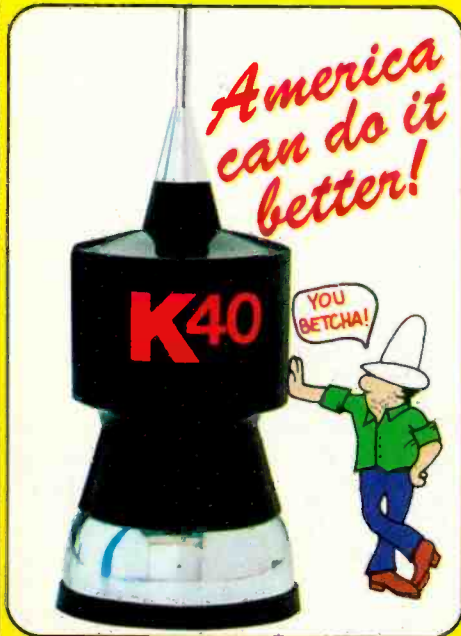

**AN AMERICAN MADE PRODUCT
FROM AN AMERICAN COMPANY.**
Call your local CB Dealer



For a **FREE** demo!

AMERICAN ANTENNA

© Copyright 1979 American Antenna Elgin, Illinois

CIRCLE NO. 5 ON FREE INFORMATION CARD

new products

for a 1-watt input at 1 meter distance. Recommended input power is 25 to 125 watts. The oak enclosure measures 13 1/4" H x 8" W x 8" D. Sold only in pairs, the AES-60 is priced at \$150 per unit.

CIRCLE NO. 95 ON FREE INFORMATION CARD

Heath Security System Kits



The Heath Company has added two new security systems to its kit line. The Model GD-3510 security light control (\$139.95) uses a passive infrared sensor to detect changes in temperature, accompanied by motion, in a 25-ft-square area. It can turn on lights and/or other electrical devices, to a 500-watt maximum, and can be adjusted to prevent false triggering. Safeguards prevent the system from triggering false alarms during daylight or because of temperature changes without motion. The Model GD-1800 Delta Minuteman II (\$189.95) uses ultrasonic sound to protect up to 300-sq-ft areas. The control unit/detector runs the system, powers several accessories, and can initiate a telephone call through an optional GD-1156 dialer. The GD-1800 is hard wired to its accessories and can be set up to handle closed-loop systems.

CIRCLE NO. 90 ON FREE INFORMATION CARD

ADC Phono Cartridge



The Astrion is a new hand-crafted phono cartridge from ADC. Its cantilever is a laser-etched solid sapphire shaft whose high "stiffness-to-mass" ratio is said to provide better transient response than that of conventional types. The stylus is a hand-polished, extended elliptical (0.0015" x 0.00025") nude diamond. The moving assembly is mounted in a unique Orbital Pivot system that is said to have no restrictive armature wires, adhesives or governors. Specifications: frequency response, 20 to 20,000 Hz \pm 1 dB; stylus force, 1.2 \pm 0.2 grams; channel separation, 30 dB at 1 kHz, 20 dB at 10 kHz, with tracking capability of 30 cm/s from

3 to 10 kHz and 21 cm/s from 400 Hz to 3 kHz. \$185.

CIRCLE NO. 96 ON FREE INFORMATION CARD

MuSYS Offers S-100 Multiprocessing

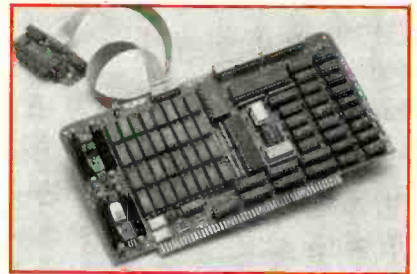

MuSYS Corp.'s Net/80 single-board microcomputer operates as a slave processor for networks loosely coupled to an S-100 bus. It comes with 64K bytes of RAM, single-level interrupt, console serial port, and parallel port for communicating with the S-100 master CPU. Each slave operates independently, except for resource queuing in the master CPU. The master controls the slaves completely and can reset or interrupt each at any time. Transfer can be performed with Z80 block I/O instructions at near-DMA speeds, while retaining protection and validation capability for the master. A bootstrap ROM, supplied with each slave downloads system software into RAM and then switches out of address space to make available the entire 64K of RAM. An expansion bus on each slave allows access to additional peripherals. The system is CP/M compatible. \$1395.

CIRCLE NO. 97 ON FREE INFORMATION CARD

Platt Zipper Tool Case



Platt Luggage, Inc., has recently introduced a handy item of interest to electronics engineers, technicians, and hobbyists—a compact zipper tool case. The 13" x 10" case is available as Model 650-Z-T in 1 1/2" thickness and Model 655-Z-T in 2 1/2" thickness. Either case contains 29 pockets for storage of such small tools as pliers, wire strippers, screwdrivers, socket wrenches, alignment and burnishing tools, etc. Address: Platt Luggage, Inc., 2301 S. Prairie Ave., Chicago, IL 60616.

Akai Mini Video Monitor

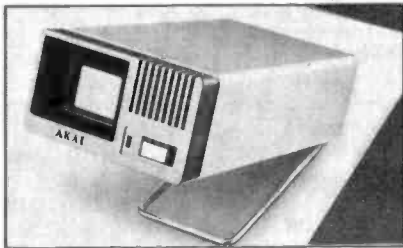

Akai's Model RC-V10U "Peek-A-View" is a miniature remote video monitor designed for use with the company's ActiVideo video cassette recorder. Equipped with a 1 1/2" TV screen and pause control, it allows you to hear and see whatever is taped when something else is being viewed, and to remove unwanted material from a recording at the push of a button. The device can be used both indoors and outdoors for instant playback of home movies wherever you happen to be. Power for the Peek-A-View is supplied by the ActiVideo VCR. \$169.95.

CIRCLE NO. 98 ON FREE INFORMATION CARD

Enhanced-Legibility Dot-Matrix Printer

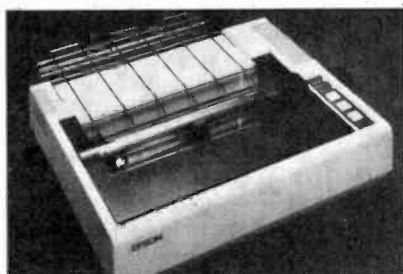

Epson's new dot-matrix printer, MX-80, features a full character set in up to 12 print modes, some of which approach correspondence-quality printing through multi-strike and/or multi-pass techniques. There's a choice of four print densities and 40, 66, 80, or 132 printing columns. A snap-out disposable print head simplifies replacement when it reaches its life expectancy of 50-to-100-million characters. The MX-80 prints bidirectionally at 80 cps and is driven from an eight-bit parallel input, with RS-232 and IEEE488 options. Paper width range is 4" to 10" with an adjustable tractor-type pin feed. Dimensions are 4.2"H x 14.7"W x 12"D. \$650.

CIRCLE NO. 99 ON FREE INFORMATION CARD

Harada CB Antenna

Harada has announced availability of a new manual antenna for CB radio. Model CM-51 has a center-loaded, single-mirror mount, as well as a completely shielded weatherproof loading coil and heavy-duty flexible spring. The two-section stainless-steel mast extends to 28". An 8' cable is supplied with the antenna. \$26.

CIRCLE NO. 100 ON FREE INFORMATION CARD

**Our ADC Integra
phono-cartridge's
overhang
adjustment
VS
their nuts,
bolts and
hassles.**

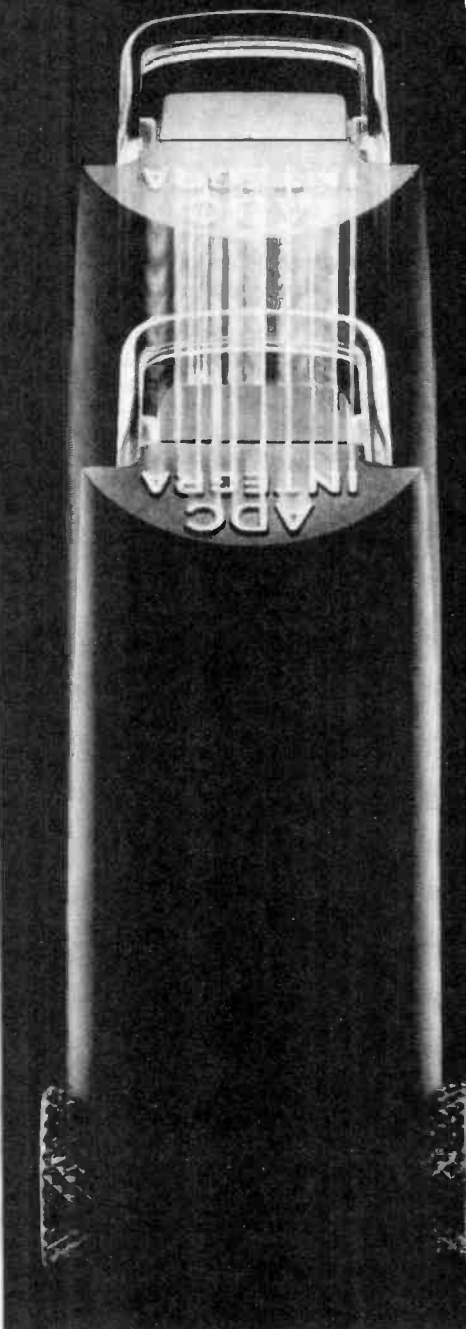

As your tonearm sweeps a record, the angle the stylus makes with the record groove constantly changes. The result? Offset angle distortion. It's an old problem. That's why it took a new kind of cartridge to solve it... our ADC Integra. Unlike conventional cartridges, the ADC Integra is a carbon fibre integrated headshell/cartridge with overhang dimension adjustment. There are no more nuts, no more bolts and that means no more hassles. To minimize offset angle distortion all you do is release the adjustment locks. Adjust. Then re-lock. It's incredibly simple. We've even included a tracking angle gauge. So it's also incredibly accurate. Because we know even an error as small as 2° can more than double cartridge distortion! Impressed? We thought so. But the most impressive feature of our new overhang dimension adjustment is that it is available in three different ADC Integra models. One for every kind of budget. All for one kind of sound... devastating. If you'd like to hear more call Audio Dynamics Corp. toll-free (800) 243-9544 or your ADC dealer.



CIRCLE NO. 2 ON FREE INFORMATION CARD

ENTERTAINMENT ELECTRONICS

The TV Connection

By Ivan Berger

JUDGING by the number of jacks and connections, the backs of some TV sets are beginning to resemble those of hi-fi systems. Once limited to two screw terminals for the antenna lead and, sometimes, an audio jack (so you could turn your TV set into a phonograph), most of today's sets have two pairs of screw terminals (for uhf and vhf), plus a connection for 75-ohm coaxial cable for vhf input. As viewers have begun to demand better sound, while refusing to pay more for it, some sets have

buy an accessory switcher. Less obvious is the fact that you get a better picture. Going directly from your VCR's or disc's video output to a video input jack gives you a picture that is about 3 to 6 dB less noisy than if you first fed that signal through your VCR r-f modulator then to your TV tuner. Even broadcast pictures will be improved a bit if you're far from the station. Fed through a VCR (the usual connection), off-the-air signals become 3 to 4 dB weaker. In a fringe reception area, that can make a big difference.

That explains the input jacks, all right; but what about the output and "bridging" jacks? The tuner audio output jacks can be used to feed a hi-fi system. The video output jack can be used with a VCR that has no tuner of its own (home VCRs all have tuners, but professional ones rarely do) or to supplant a VCR's tuner with a better one (assuming that the tuner in your set is better). The video output jack can also be used to feed a monitor that lacks a tuner, to feed a video digitizer so you can store or modify the image in your computer . . . and so on. It's not so much an obviously useful feature as it is one that's cheap to provide and potentially useful.

And the bridging jacks? They're in parallel with the input 1 jacks, so you can "loop through" to feed the video 1 signal to another VCR for dubbing, to another set, or wherever else you choose. When you're not looping through, you have to switch in a 75-ohm terminating resistance. To loop through, you switch out the resistances on all but the last piece of equipment in the string.

The RCA model is the most elaborate home monitor, but it's not the only one. JVC has a 5-inch model, the 610-US, with one set of inputs and only tuner outputs—no loop-through. Panasonic just introduced a similar 5-inch model, the CT-5511, at the Winter Consumer Electronic Show. V.A.M.P. offers 13- and 19-inch monitor receivers, too. You'll also find direct video and audio inputs in some projection television systems like the Heathkit and Hitachi.

Actually, home-set manufacturers like Sony, Panasonic, Toshiba, Sharp and Zenith have long had monitor receivers in their lines—but you'd never see or hear of them at ordinary TV dealerships. They're sold, instead, through audio-visual and professional video dealers, who also handle brands unknown in our home market, such as N.E.C. and Ikegami.

Professional monitor receivers differ in one obvious respect from those sold for home use: in addition to the jacks so far described, you'll often find an eight-pin plug for video and audio inputs and the tuner outputs. Professional VCRs (including industrial VHS and Beta models and U-Matics) will either have a matching jack or come with a cable for it, so you can hitch and unhitch them with a single plug instead of several. Often, such monitors will also use BNC, uhf or other heavy-duty jacks for video

(Continued on page 20)



Panasonic's Model CT-5511
5-inch home monitor.

sprouted audio output jacks to feed hi-fi systems. (That's actually a revival—premium sets like Conrac and Fleetwood had such outputs in the fifties, and Heathkit color sets have had them since the beginning.)

The back of RCA's new VEM575 19-inch monitor receiver, though, looks like the apotheosis of connectors. In addition to the r-f jacks, there are four each for audio and video: audio and video output jacks carrying the signal from the tuner, a second pair of jacks for video input 2 and its accompanying audio, and two pairs, bridged together, for the video and audio of input 1. A switch on the front of the set lets you select broadcast or cable signals or the output of your VCR, video disc, game or computer.

The obvious advantage of this arrangement is its flexibility: you need only flip a switch to decide what to watch—no need to mess with cables or

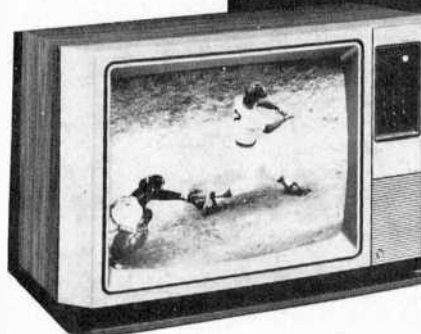
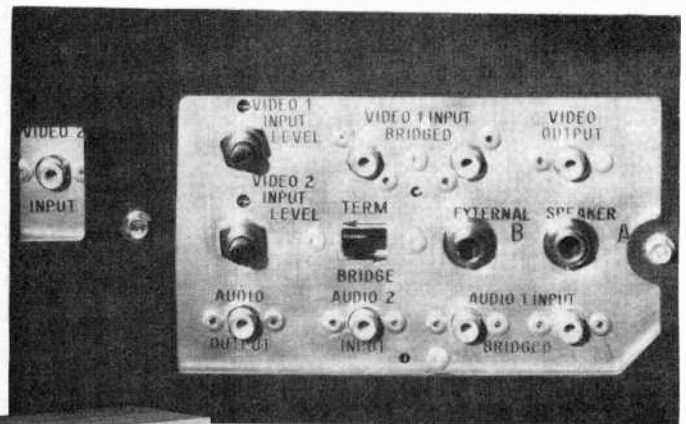

At left is RCA's ColorTrak
Video Monitor Model VEM575.
Above is a view of the
input and output jacks
located on the rear panel.

Low-Cost Computing Starts at Radio Shack With TRS-80TM Model III.



16K Model III

\$999

26-1062

32K Model III as shown complete with two disk drives

Only \$2495

26-1063

(And Never Stops!)

Radio Shack's new TRS-80 Model III gives you all the features you want to start out with at prices you can afford. What's more, you get the flexibility you need for low-cost expansion. If you're serious about micro-computing, Model III is the best computer to start with—and to grow with!

The "Extras" Are Built In. Why pay extra for features that are standard on Model III? You get a 65-key keyboard complete with a 12-key datapad, a 12" high-resolution monitor, and even a parallel printer interface. All at no extra cost!

Includes Powerful BASIC. Model III BASIC language in 14K ROM provides a full 64-character by 16-line screen format, as well as a 32-character mode. You also get upper

and lower case characters, special graphics characters, a program line editor, 500/1500 baud cassette operation, real time clock, and firmware for an optional RS-232 interface.

And since Model III BASIC is software compatible with our popular Model I Level II BASIC, you can choose from a wide variety of ready-to-run programs.

Room to Expand, Too. Model III is tough to outgrow. Expand with up to 48K of RAM, and four 175K double-density disk drives (two internally). For office use, start with our 32K two-disk Model III desktop business computer and expand with printers, software and much more.

Why Pay More? Dollar for dollar, the TRS-80 Model III is your best buy in personal computers. And it's available at 6100

Radio Shack stores and dealers and 130 Computer Centers—with 135 service centers nationwide. Get a demonstration today!

Radio Shack[®]

The biggest name in little computers[™]

A DIVISION OF TANDY CORPORATION

Send for More Information on TRS-80 Computers

Radio Shack Dept. 81-A-294
1300 One Tandy Center
Fort Worth, Texas 76102

NAME _____
STREET _____
CITY _____ STATE _____
ZIP _____ PHONE _____

Retail prices may vary at individual stores and dealers. Special order may be required.

At CIE, you get electronics career training from specialists.

If you're interested in learning how to fix air conditioning, service cars or install heating systems – talk to some other school. But if you're serious about electronics...even earning an Associate Degree... come to CIE – The Electronics Specialists.

John E. Cunningham

**Special Projects Director
Cleveland Institute of Electronics**



My father always told me that there were certain advantages to putting all your eggs in one basket. "John," he said, "learn to do one important thing better than anyone else, and you'll always be in demand."

I believe he was right. Today is the age of specialization. And I think that's a very good thing.

Consider doctors. You wouldn't expect your family doctor to perform open heart surgery or your dentist to set a broken bone, either. Would you?

For these things, you'd want a specialist. And you'd trust him. Because you'd know if he weren't any good, he'd be out of business.

Why trust your education and career future to anything less than a specialist?

You shouldn't. And you certainly don't have to.

FACT: CIE is the largest independent home study school in the world that specializes exclusively in electronics.

We have to be good at it because we put all our eggs in one basket: electronics. If we hadn't done a good job, we'd have closed our doors long ago.

Specialists aren't for everyone.

I'll tell it to you straight. If you think electronics would make a nice hobby, check with other schools.

But if you think you have the cool — and want the training it takes — to make sure that a sound blackout during a prime time TV show will be corrected in seconds — then answer this ad. You'll probably find CIE has a course that's just right for you!

At CIE, we combine theory and practice. You learn the best of both.

Learning electronics is a lot more than memorizing a laundry list of facts about circuits and transistors. Electronics is interesting because it's based on some fairly recent scientific discoveries. It's built on ideas. So, look for a program that starts with ideas — and builds on them.

That's what happens with CIE's Auto-Programmed® Lessons. Each lesson uses world-famous "programmed learning" methods to teach you important principles. You explore them, master them completely . . . before you start to apply them!

But beyond theory, some of our courses come fully equipped with the electronics gear to actually let you perform hundreds of checking, testing and analyzing projects.

In fact, depending on the course you take, you'll do most of the basic things professionals do every day — even use a Digital Learning Laboratory to apply the digital theory essential today to keep pace with electronics in the eighties.

Plus there's a professional quality oscilloscope you build and use to "see" and "read" the characteristic waveform patterns of electronic equipment.

You work with experienced specialists.

When you send us a completed lesson, you can be sure it will be reviewed and graded by a trained electronics instructor, backed by a team of technical specialists. If you need specialized help, you get it fast . . . in writing from the faculty specialists best qualified to handle your question.

People who have known us a long time, think of us as the "FCC License School."

We don't mind. We have a fine record of preparing people to take . . . and pass . . . the government-administered FCC License exams. In fact, in continuing surveys nearly 4 out of 5 of our graduates who take

the exams get their Licenses. You may already know that an FCC License is needed for some careers in electronics — and it can be a valuable credential anytime.

Associate Degree

Now, CIE offers an Associate in Applied Science Degree in Electronics Engineering Technology. In fact, all or most of every CIE Career Course is directly creditable towards the Associate Degree.

Find out more! Mail this card for your FREE CATALOG today!

If the card is gone, cut out and mail the coupon.

I'll send you a copy of CIE's FREE school catalog, along with a complete package of independent home study information.

For your convenience, I'll try to arrange for a CIE representative to contact you to answer any questions you may have.

Remember, if you are serious about learning electronics . . . or building upon your present skills, your best bet is to go with the electronics specialists — CIE. Mail the card or coupon today or write CIE (and mention the name and date of this magazine), 1776 East 17th Street, Cleveland, Ohio 44114.



Pattern shown on oscilloscope screen is simulated.

CIE

Cleveland Institute of Electronics, Inc.
1776 East 17th Street, Cleveland, Ohio 44114

PE-38

YES . . . John, I want to learn from the specialists in electronics — CIE. Send me my FREE CIE school catalog — including details about the Associate Degree program — plus my FREE package of home study information.

Print Name _____

Address _____ Apt. _____

City _____

State _____ Zip _____

Age _____ Phone (area code) _____

Check box for G. I. Bill information: Veteran Active Duty

Mail today!

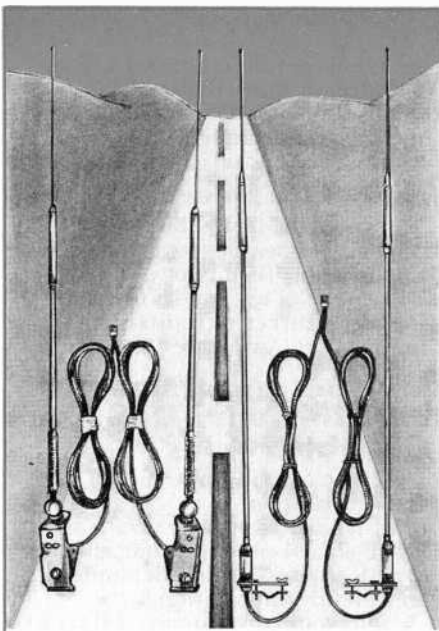

HUSTLER — STILL THE LEADER IN DUAL CB ANTENNA SYSTEMS

Since introducing the industry's first dual CB antenna systems, Hustler has continually led the way in the development of these advanced designs.

Today, Hustler offers you the widest selection of quality dual CB systems available. Whether you're behind the wheel of the family car, RV, or a long-haul semi, a Hustler dual antenna system will give you a signal pattern unmatched in uniformity. Total electrical and mechanical reliability. Freedom from fading and blind spots when you change direction, and twice the signal capture area.

Hustler dual antenna systems feature professional-quality components: heavy chrome plated mounts, oversized "Hi-Q" resonators, superflex stainless steel radiators, dual phasing harnesses with balanced power feed, and much more...

For a consistently clear channel any way you turn, you can't surpass dual CB antenna systems by the original: Hustler — still the standard of performance.



3275 North "B" Avenue
Kissimmee, Florida 32741

An AMERTRON Company

(Continued from page 14)

connections, rather than the RCA jacks most used in home gear. When you're working professionally, it's vital that plugs stay put.

Not all monitors are monitor receivers, either. That phrase is used only for monitors with built-in tuners. Many professional monitors (and some sold for home computer use) have video (and, in some cases, audio) inputs, but nothing else. Without external video sources, their screens will remain blank.

They may also remain blank if you use the wrong kind of video source. All VCRs and video disc players, all home games, and most computer video output devices put out "composite" signals—an NTSC color signal, plus sync—and most monitors have composite inputs for them. But some color devices and professional monitors have RGB connections—separate jacks for each of TV's three primary colors (red, green, blue). And I've heard of monitors with separate picture and sync inputs. You're unlikely to encounter such systems, but it never hurts to check.

Cable-ready is another term you'll see on some new TV-set spec sheets. It designates a set that connects to multi-channel cable systems with no converter. Such systems need converters because they use channels outside the regular vhf (54-88 and 174-216 MHz) and uhf (470-890 MHz, though frequencies above 800 are now used for other services) bands. Cable channels A through I use "mid-band" frequencies (120-174 MHz) and channels J through W use

"super-band" frequencies (216-300 megahertz).

Since these TV channels aren't broadcast (their frequencies are used by other radio services), sets usually can't receive them. But with 23% of U.S. households on the cable now (according to the National Cable Television Association), there's a market for sets that can pick those channels up. Most of these are frequency-synthesis sets which either substitute cable channels for uhf (most cable systems convert uhf channels to other frequencies) or add them on as channels 84-99.

Again, there are advantages to using the new connections in preference to traditional ones. Many cable systems charge less to users who require no converter boxes. With channel selection made at the set, not at the cable box, you can use remote control. And eliminating the box removes one more piece of clutter in your room.

Just buying a cable-ready set doesn't necessarily ensure that you won't need a converter, though. Some cable-ready sets get only the midband channels—not enough, if your local system uses the super-band ones, too. And there are no firm frequency standards for these special channels—a set that tunes them in on one cable system may not on another. Some sets (certain Zenith models come to mind) have an adjustment for this, but with most, check for compatibility before you buy. Pay-movie and similar services such as Home Box Office, Cinemax and Showtime, still need a box to decode their scrambled signals. ◇

AUDIOPHILE RECORDINGS

Klemmer's music is cool, "laid-back," and full of delicate shadings. Where other saxophonists occasionally roughen the tone for emphasis or give the inherently "honky" low tones free rein, Klemmer's sound is pristine, limpid, and well controlled at all times. Rather than demanding attention, this album captivates it—and with elegance. —*Harold A. Rodgers.*

JOHN KLEMMER: *Touch.* Mobile Fidelity Sound Labs MFSL C-006. This is the first Mobile Fidelity music cassette to come into our possession, and to call its quality astonishing might be just a little bit of an understatement. Each cassette is a real-time dub from the original master, recorded onto BASF chromium dioxide. Dolby B noise reduction is used as well.

The sound we experienced from this tape was extremely clear and clean, with saturation and the other ills common in the medium notably absent. At the end of the music, it is possible to hear reduction of residual hiss in two stages: first, presumably, when the faders on the mixing board are shut down and again when the feed to the duplicator is turned off. This suggests that the hiss level on these cassettes is lower than that of either the master tape or the original mixing board. Most impressive!

BEE GEES: *Spirits Having Flown.* Nautilus NR17. Nautilus calls this a "Super Disc." It is neither a digital recording nor a direct-cut disc, but rather a remastering of a high-quality analog tape of recent vintage. The remastering, however, is performed at half-speed (16 $\frac{2}{3}$ rpm) and with lavish engineering care. Production, using the highest quality vinyl and stamping methods, is on a par with the remastering, and the result justifies the "Super Disc" appellation. There is not a hint of audible surface hiss or any distracting "pops" or "ticks."

The sound is wide-range with good, solid, yet musical bass—no one-note juke box thump here. Try *Stop (Think Again)* on the second side for some crystalline cymbals in the rhythm section. One more point: if you hear any flutter, it's just the Bee Gees doing their thing.—*Ed Buxbaum.*

THE LOWER YOUR RECORDING SPEED, THE MORE YOU NEED MAXELL HIGH GRADE.

Whenever you use your video cassette recorder for slow motion, freeze frame or in the six-hour mode, it must operate at a lower speed. Even though most recorders are designed to handle this, most videocassettes aren't.

Lower recording speeds place a lot more pressure on the video tape, which can cause the magnetic oxide particles on the tape's surface to loosen and eventually fall off. And once a tape starts to lose its oxide particles, you start to lose your picture quality.

Unlike ordinary video tape, Maxell High Grade is designed to give you a clear, sharp picture at any recording speed. Our oxide particles are smaller

and more densely packed on the tape surface.

Which is why we have better color resolution, frequency response and signal-to-noise ratio, especially at the lower speeds.

And, because of our unique binding process and calendaring system, the oxide particles on Maxell High Grade stay put. This drastically reduces friction and video recorder head wear. So not only will you get better picture quality, but you'll also be able to enjoy it a lot longer.

And you thought all video tape was pretty much the same. **maxell**
IT'S WORTH IT.



CIRCLE NO. 37 ON FREE INFORMATION CARD

Maxell Corporation of America, 60 Oxford Drive, Mahanoch, N.J. 07074

Audio Product of the Month

CHOSEN BY THE EDITORS OF POPULAR ELECTRONICS

JBL Model L112 Three-Way Speaker System

THE Model L112, a three-way design based on all-new drivers and crossover components, is JBL's finest bookshelf speaker. Its 12" woofer operates in a ported enclosure, crossing over at 1.1 kHz to a 5" cone-type midrange driver and at 3.7 kHz to a 1" dome tweeter. The particle board enclosure is veneered in genuine American black walnut, whose grain is enhanced by an oil/wax finish. Dark brown grille cloth stretched on a welded metal frame and held in place by plastic snaps is designed for minimum interference with the acoustic characteristics of the drivers. Under the grille is a control panel with continuously variable level adjustments

for the midrange and high-frequency drivers.

The input connectors resemble insulated binding posts with holes into which the stripped ends of the connecting wires are inserted to be locked in place by a 90-degree clockwise rotation of the connector end.

Model L112 measures 24½" H x 14¼" W x 13" D, and weighs about 50 pounds. The speakers are manufactured in mirror-image pairs, with their middle- and high-frequency drivers slightly off the vertical center line of the front panel. Either one can be used at the left or right position. Suggested retail price is \$450 each. *(Continued on page 24)*





The first television
that lets you take control.

Literally.

What's the unique attraction on this Toshiba color television receiver?

A magnetized, micro-thin control panel (shown actual size) that you can remove and use as a remote-control unit.

Random-access channel selection, variable volume, muting, channel scan and the on/off switch function either on or off the set.

This 19" diagonally measured television also boasts advancements in color worth spelling out in black and white.

Like its automatic dark picture intensifier, white-detail purifier and our new comb-filter high-resolution processor. For crisper color separation, increased clarity and superb image reproduction. All in a striking, multifaceted design.

Why decide between remote control or manual when you can buy one TV that's both?



TOSHIBA
Again, the first.

Toshiba America, Inc., 82 Totowa Road, Wayne, NJ 07470 Toshiba Hawaii, Inc., 327 Kamakee Street, Honolulu HI 96814
CIRCLE NO. 69 ON FREE INFORMATION CARD

(Continued from page 22)

General Description. Nominal impedance of the L112 is 8 ohms, and it is recommended for use with amplifiers rated from 10 to 300 watts per channel. The unit is said to deliver 89-dB sound pressure level at 1 meter with a 1-watt input.

An unusual design feature, the Symmetrical Field Geometry (SFG) woofer magnetic system, has been incorporated into all current JBL speakers. The development was spurred by the increasing difficulty of procurement (and the high cost) of the Alnico magnets JBL had used exclusively. JBL studies had shown that ceramic (ferrite) magnets caused more second-harmonic distortion in the acoustic output than did Alnico. This was caused in part by an asymmetrical distribution of magnetic flux on the two sides of the magnetic gap through which the voice coil moved. The SFG magnetic system employs specially shaped pole pieces, plus an aluminum flux stabilizing ring (acting as a shorted turn). Current induced in the ring creates a flux opposing the flux changes caused by interactions between the voice coil and the magnetic structure and reduces second-

harmonic distortion. Third-harmonic distortion is not affected.

The L112 woofer cone is coated with a material that gives it the optimum mass and damps its response at higher frequencies. The cone is driven by a 3"-diameter edge-wound copper voice coil, working in conjunction with a 10½-lb magnetic system. Enclosed in a sealed subchamber to isolate it from the woofer, the midrange driver has a stiff 5" paper cone driven by a 7/8"-diameter voice coil. The tweeter has a lightweight phenolic dome coated with aluminum by a vapor deposition process.

Midrange and tweeter level controls are calibrated in terms of the decibel change each provides in its operating frequency range. The "0 dB" mark corresponds to a flat acoustic output in an anechoic chamber, and the adjustment range for each driver is from +3 to -12 dB, plus a fully off position.

Laboratory Measurement. The frequency response curve for the JBL L112 was generated by combining measurements made in the reverberant field of a normally furnished room (from 100 to 20,000 Hz) with close-miked woofer response measurements from 20 to 1,000 Hz. Middle- and high-frequency response was measured with a sweeping warble-tone sine-wave signal and heavy recorder pen damping to smooth out the effects of room resonances and standing waves.

Low-frequency response was measured separately at the woofer cone and at its port opening. After adjustment for the relative areas of the two sources, the curves were combined to simulate the anechoic response of the speaker woofer system.

Reverberant field measurements were made with the microphone on the axis of the left speaker (at a 12-foot distance) and about 30 degrees off the axis of the right speaker. The difference between the raw response curves at high frequencies is an indication of tweeter directivity, principally in the horizontal plane. We average the two curves and correct them for the known room response (which was obtained with the aid of calibrated speakers whose acoustic power output response was accurately known) before combining the low- and high-frequency curves.

Combined frequency response of the JBL L112 was uniform and smooth, varying only about ±3 dB from 45 to 20,000 Hz. Maximum woofer output occurred at 70 Hz; effective acoustic crossover between the cone and port radiation was at 45 Hz. The 12" woofer does not maintain flat response in the upper part of its range (about 1000 Hz) but our combined measurements suggest that the midrange driver continues to work well below its crossover frequency. Overall system output is quite uniform from 100 to 1,000 Hz.

Horizontal dispersion of the tweeters was very good. There was typically a difference of 2 to 4 dB between the left and right speaker curves throughout the entire tweeter operating range, but this was fairly constant with frequency.

Midrange level could be varied between +2 dB and about -12 dB with respect to a 0-dB reference level. The control affected system response to some degree between 300 and 8,000 Hz. The tweeter control started to work at about 2,000 Hz, with a range from +2.5 dB of boost to virtually infinite attenuation above about 5,000 Hz.

Low-frequency distortion was measured with the same technique as was frequency response, at nominal power inputs of 1 and 10 watts. Although we did not plot the second and third harmonic components separately, their combined value measured less than 0.5% from 100 to 60 Hz and only 3.6% at 35 Hz at 1 watt input. Increasing the drive to 10 watts made only a moderate change in distortion, which was 1% or less down to 60 Hz and reached 6.3% at 35 Hz.

Sensitivity of the L112 was almost exactly as rated, and we measured an acoustic sound pressure level of 90 dB at 1 meter when we drove the speaker with 2.83 volts (1 watt into 8 ohms) of random noise in an octave centered at 1,000 Hz. System impedance minima were 6 to 7 ohms between 30 and 40 Hz, 100 and 150 Hz, and at about 2,000 Hz. The lowest impedance in the audio range was 5 ohms in the band from 7 to 10 kHz. Bass resonance was at 62 Hz, with an impedance peak of 25 ohms; there were also impedance peaks of 19 ohms at 600 Hz and 9 ohms at 3,800 Hz.

User Comment. We preferred the JBL L112 with its level controls set to 0, which gave the best subjective balance in our room as well as the flattest measured frequency response. The sound was as smooth and uncolored as the very flat measured frequency response suggested it would be. This speaker seemed to be equally "at home" with classical orchestral and vocal music as with popular music. We installed the speakers against the wall, with the tweeters at the ear level of a seated listener, and found it to be an effective arrangement.

Summarizing, the JBL L112 is a fine-sounding wide-range speaker system with low distortion. It is sensitive enough to be driven by a 10-watt amplifier yet rugged enough to absorb the full music program output of a 200-to-300-watt amplifier. It is solidly constructed and is as handsome as a simple rectangular box is likely to be. Though somewhat larger, heavier, and more expensive than a typical bookshelf system, the L112 surely merits its place at the top of JBL's offerings in that category.

—Julian D. Hirsch

CIRCLE NO. 101 ON FREE INFORMATION CARD



FREE!
1981
DISCOUNT
ELECTRONICS
CATALOG

JOIN THE PAK!
Send for our Free catalog and become a member of our exclusive Pak. Our members receive Poly Paks' exciting catalog several times a year. We offer:
Penny Sales, Free Premiums and Low, Low Prices on a wide variety of Electronic Products such as Computer Peripherals, Integrated Circuits, Speakers, Audio Equipment, Rechargeable Batteries, Solar Products, Semiconductors, and much, much more!
Take advantage of our 25 years as America's foremost Supplier of discount electronics.

Over 4.5 Million Satisfied Customers

RUSH ME YOUR FREEDISCOUNT CATALOG!

NAME: _____
ADDRESS: _____
CITY: _____
STATE: _____ ZIP: _____

CLIP AND MAIL COUPON TODAY TO:
POLY PAKS, INC.
P.O. BOX 942, P05
S. LYNNFIELD, MA, 01940 (617) 245-3828

CIRCLE NO. 50 ON FREE INFORMATION CARD

Popular Electronics Tests



Screen picture by Discovision.

the Toshiba CA-944 19" Color TV Receiver

TOSHIBA's Model CA-944 19" color-TV receiver is handsomely packaged in a wood-grain cabinet with contrasting silver trim. It features a deluxe "Comput-R-Tune" control panel for one-button access to any of 12 user-programmed vhf and uhf channels. Picture adjustment is performed by automatic fine tuning (aft), automatic color balance (abc), and "Color Pilot" systems. Picture quality can also be adjusted to taste with an auxiliary picture sharpness control. Finally, a "Tomatic Eye" senses ambient light and adjusts picture brightness accordingly. A CATV jack is provided, but there are no facilities for tuning CATV channels.

The CA-944 measures 24 $\frac{7}{8}$ " W x 16 $\frac{3}{4}$ " H x 15 $\frac{3}{4}$ " D and weighs 47 lb. Suggested retail price is \$549.95.

General Information. This set is built around a "Blackstripe"™ picture

tube, four large integrated circuits, and 18 transistors. It also has an analog tuning system that uses discrete voltages for selecting the various vhf and uhf channels. This system is one of the more unusual tuning arrangements we've come across. Dc voltages and amplifiers are used throughout, and there are some interesting automatic fine tuning (aft) applications. Touch switches are used to transfer voltage functions for both channel tuning and U/V switching. At the same time, dynamic aft from the receiver maintains the local tuner oscillators precisely 45.75 MHz above the incoming video carrier.

As each of the 12 channel-selector switches is engaged, voltages are generated to tell the tuning system which channel and its corresponding tuner have been selected. As each channel is selected, a positive pulse passes through diode DB01 (Fig. 1). This excites QB61

and QB62 emitter-follower and inverter stages and n-channel FET QB01. Transistors QB61 and QB62 invert this positive pulse and momentarily turn off the audio, while the FET is positively biased, turning on source/drain current and defeating aft.

Normal aft voltages are received through board terminals 15 and 16. They are then heavily filtered and routed to the bases of QB04 and QB02. Transistor QB03 serves as a constant-current generator for QB61 and QB62 and is biased from the +180-volt supply that is further dropped across RB21 and zener-regulated by DB02 at approximately 32 volts.

Inputs to buffer amplifier QB05 come from DC01 through DC12. As input voltages change, QB05 supplies an active load for the collector of QB06 and base of QB07. Changing aft inputs to the base of QB06 are inverted and dc

The future belongs to the creative electronics technician.

NEW FROM NRI. DESIGN TECHNO

Be prepared to grow with the world's biggest growth industry. Enroll now in this exciting career program from the leader in electronics training.

There are a lot of good jobs out there in electronics. But the best jobs go to the people who can think and work creatively. Those who can conceive and design circuits and equipment... those who can initiate ideas and carry them through... those who can turn theoretical concepts into reality. These are the people commanding up to \$18,000 as starting salaries, earning \$30,000 or more with experience and ability. And NRI can help you join their company.

The First Complete Program of Its Kind

Now, for the first time in the history of home study, NRI offers you a new and exciting course in Electronic Design Technology. A course that starts with the fundamentals and builds from there to prepare you for an electronic career where the growth is. You're trained for exciting jobs in the creation of communications equipment, computers, consumer products, anything that needs electronic circuits.

Only NRI gives you such complete and concentrated training in the design of electronic circuits. And you learn at home in your spare time, without quitting your job or wasting time, travel, and gas going to night school. You learn with NRI-developed training methods that combine knowledge with practical experience.



NRI Circuit Designer Gives Hands-On Experience

You learn by doing. No ivory-tower, strictly theoretical course here. You actually design and build modern electronic circuits, run tests, and verify specs. You learn how various systems interact, design your own circuits to perform specific tasks, learn to look for better ways and new ideas.

The NRI Circuit Designer is a totally unique instrument with full breadboarding capability, built-in multiple power supplies and a multi-function signal generator for circuit testing. Fast, simple connections let you build up prototype

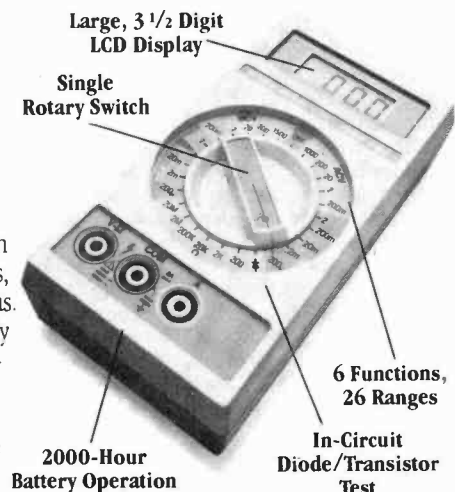

POPULAR ELECTRONICS

ELECTRONIC LOGY TRAINING

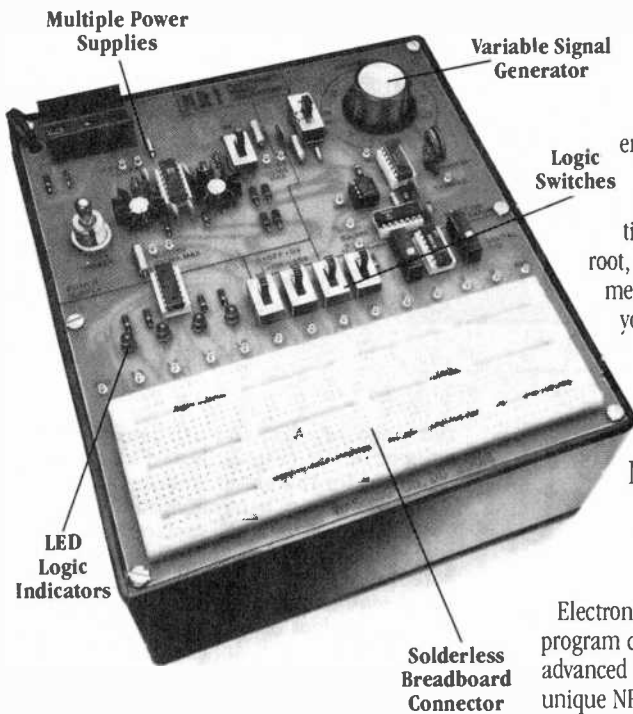

engineering instrument that includes trigonometric functions as well as square root, logarithms, and memory. Together with your Circuit Designer, they work to give you a sound basis of practical experience.

NRI Fast-Track Training

Although the NRI Electronic Design Technology program carries you through advanced electronics, the unique NRI lesson concept simplifies and speeds learning.

Especially written for individual instruction, each lesson covers its subject fully and thoroughly. But extraneous material is eliminated, language is clear and to the point, organization is logical and effective.

You'll start with subjects like Fundamentals of Electronic Circuits, progress rapidly through Circuit Theory to Solid-State Electronics and on to Digital Electronics, Computers, and Microprocessors. Hand in hand with your theory will be practical Design Lab experiments, circuit demonstrations, and test/measurement procedures that make it all come to life.

No Experience Necessary

You need absolutely no electronic experience to be successful with this modern course. If you're a high school graduate with some algebra, you should handle it without any trouble. We even include, at no extra charge, the NRI Math Refresher Module, designed to help you

brush up on your math and teach you any new concepts you may need from basic algebra through phasors and circuit analysis.

Free Catalog, No Salesman Will Call

There's so much to tell you about

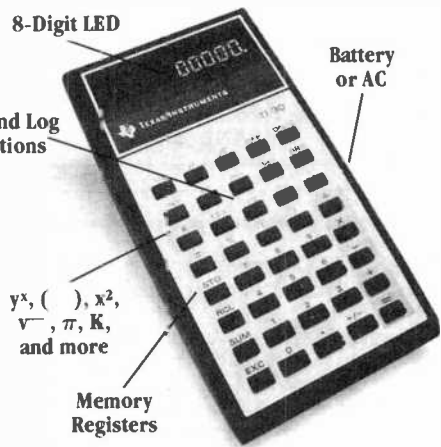

circuits, immediately check them out for function or faults. It handles both linear and digital integrated circuits as well as discrete components such as transistors and diodes. Six practical lab units carry you through both the theoretical and practical world of electronic circuit design.

Professional Working Instruments

Your course also includes the choice of the professionals... the 6-function, 26-range Beckman digital multimeter for fast, accurate voltage, current, and resistance measurements. It features accurate LCD readout and full portability. You also get the famous Texas Instruments TI-30 scientific calculator to speed and simplify circuit analysis and design. It's a true

this exciting new course for the electronic 80's, we can't do it all here. Send the postage-paid card for our free, 100-page catalog with all the facts about this and other NRI electronics courses. We'll rush it right to you without obligation. Look it over and discover for yourself why only NRI can prepare you so well for your future. If card has been removed, please write to us.



NRI SCHOOLS
McGraw-Hill Continuing
Education Center
3939 Wisconsin Ave.
Washington, D.C. 20016

We'll train you for the good jobs.

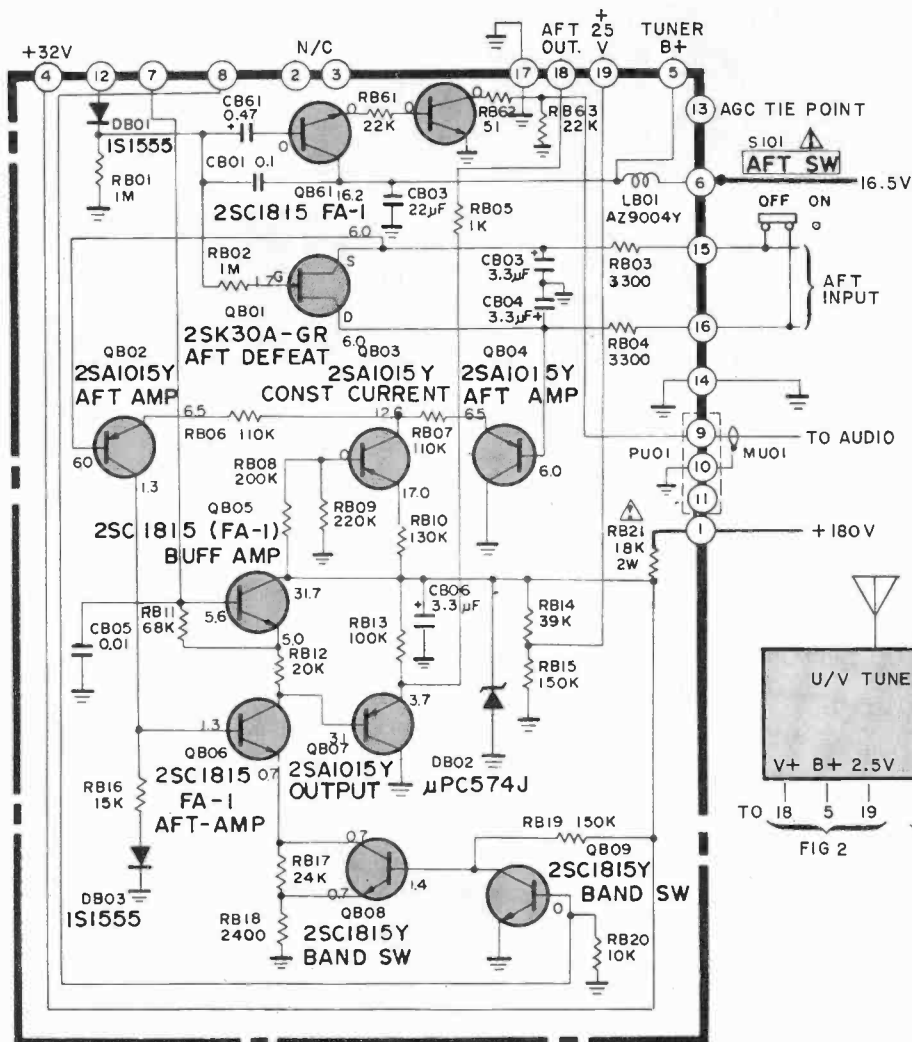

heats up and stops current flow. The ac is half-wave rectified, and operating voltage reaches the collectors of a Darlington regulator, which is biased by a current-limiter transistor stage.

Should an overcurrent condition exist, the current-limiting stage conducts harder and reduces the voltage at the input to the Darlington regulator. This lowers the output of the regulator until the overcurrent condition is cleared or the limiter shuts down the regulator altogether. When voltage changes occur, an error amplifier, whose emitter is supplied with a reference current, is biased more or less heavily, depending on the direction of the change. The changing collector potential from the error amplifier reaches the Darlington regulator, which controls current flow and, hence, output voltage for the +123-volt bus.

Although three of the four ICs in the set are hardly unusual, the chroma/luminance processor is. It is supplied with composite video and color burst by

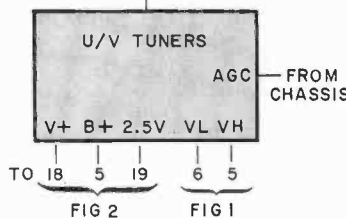

Fig. 1. Schematic of the Tuner Control Board, including dynamic aft, band switching and dc operating voltages.

coupled through QB07, whose output is then delivered to aft voltage terminal VT on the U/V tuner.

The only change in the above routine is when the uhf is engaged. At this point, band switch QB09 conducts, reducing bias at the base of second bandswitch QB08 to zero. This removes emitter/collector bypass current and restores RB17 to the emitter circuit of QB06. As its emitter impedance rises, QB06's collector voltage rises, QB07 conducts less, and positive voltage from the 32-volt source increases across RB13. This places additional dc potential on the VT tuner port but maintains aft control.

The regulated supply delivers a stable

123 volts, principally for the deflection circuits and audio outputs. Other dc operating voltages are obtained from taps on the flyback transformer (FBT).

Ac from the power line passes through a fuse and the r-f line filter and is ground returned to the chassis. When the POWER switch is closed, full current passes through the degaussing network until a temperature-dependent resistor

the video i-f, agc, and aft detector circuits in IC101 (Fig.2). No i-f alignment is needed for this setup, and there is only a single shunt bandpass coil (L102) across the output of surface acoustic wave filter Z101. Otherwise, only aft detector coil L103 and 4.5-MHz trap Z201 require alignment. Traps and other usual devices never need tuning.

While it might appear that limiter coil L171 implies a synchronous video detector, a basic 3.5-MHz output on the other side of the 4.5-MHz sound trap indicates otherwise. This coil is just part of the aft detector to which it is connected and must be adjusted for best overall

Fig. 2. Effective SAW and video i-f integrated filter circuits improve S/N.

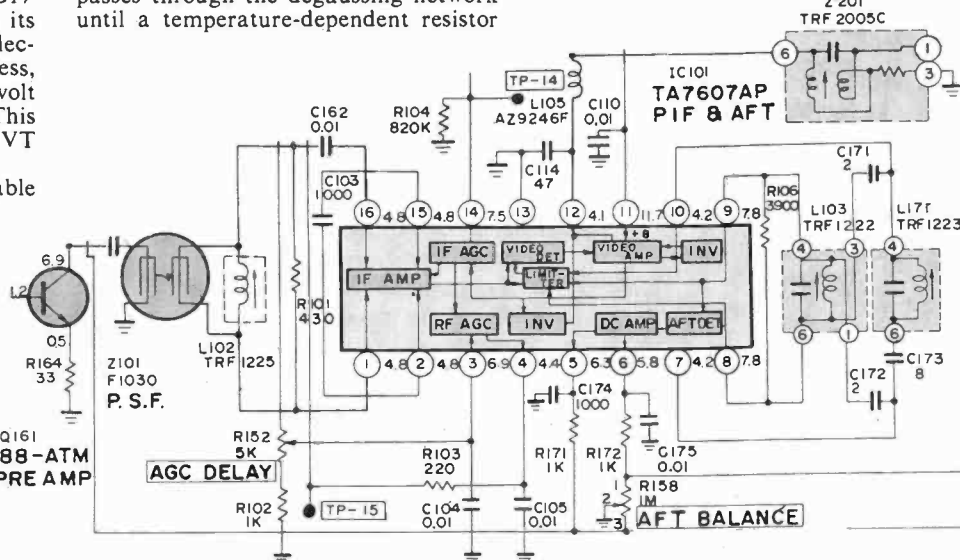

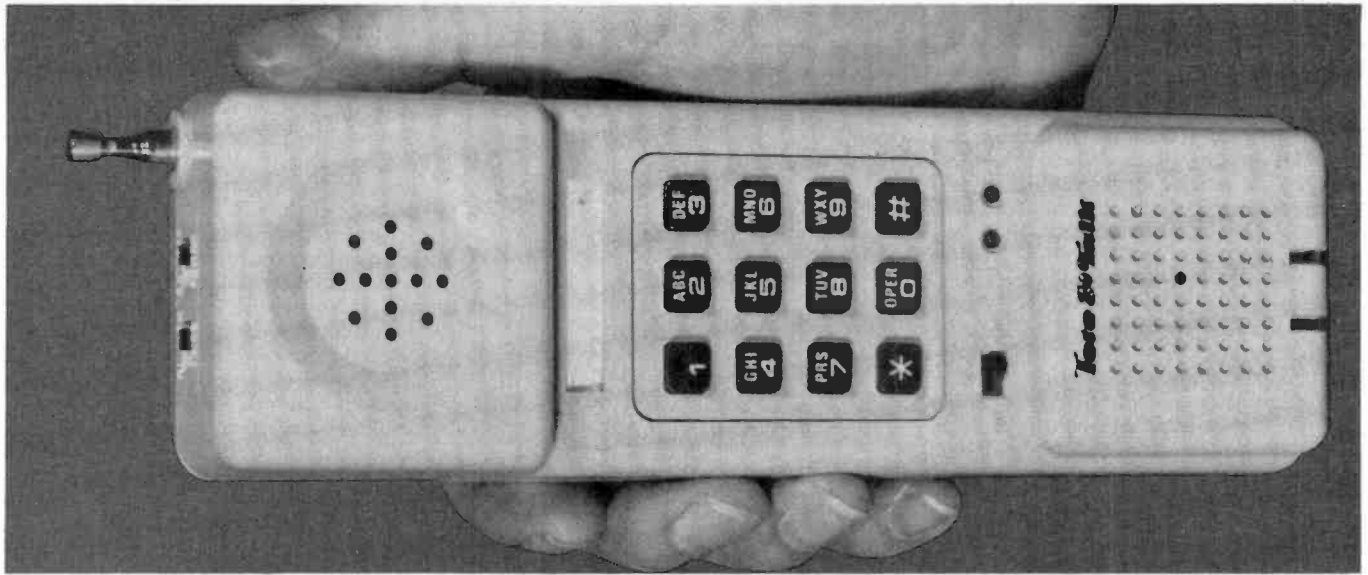

Unshackled

You're free at last from phone cords and extra monthly service charges.

Here's a phone that uses your own phone number and requires no installation.

You're out for a walk. About halfway around the block, you hear a pleasant beeping sound. To the amazement of those nearby, you reach in your pocket, extract a small 12 ounce object, and answer your telephone.

The sound quality is so good that except for the occasional sound of a passing car, nobody would suspect that you weren't sitting at home in your living room as you talk to them.

The new 700ft extended range cordless telephone by Universal Security, works perfectly on all push button or rotary dial phone systems, both at home and at the office.

You don't need a special phone number. There is no operator involved as there is in mobile phones. You plug this phone in just like any regular extension phone and there are no phone company monthly charges.

DO YOU HATE YOUR PHONE?

If you're inundated with phone calls all day, consider the new found freedom you'll experience with this cordless phone. It's so comfortable to use, you will reach for it first, even before you reach for your own desk phone.

Imagine for a moment that you are seated at your desk talking on the phone. As you talk, get up and stretch or go sit in a more comfortable chair.

Step out of your office and hand your secretary a note, or even walk right out of the building to the lunch truck or a nearby restaurant. The person you are talking to will never know.

You can place or receive calls within an area about equal to 12 football fields depending on environmental conditions. While you're talking, you can walk to a colleague's office to confer, or make a trip to the shipping department to check on a client's order in person.

The sound is crisp and clear. It is both static and drift free. There are no push to talk buttons. It's just like a normal phone. Plus, you can even control the

volume. If you dial a busy number, the phone will remember the number and redial it for you automatically with the touch of a single button.

HOME AND OFFICE

Use your cordless phone at the office during the week, then just 'throw' it in your briefcase before you leave work. You can use it all weekend at home.

Simply plug in the AC plug and the modular phone plug at the office or at home. The cordless phone goes where you go and is operational in 30 seconds.

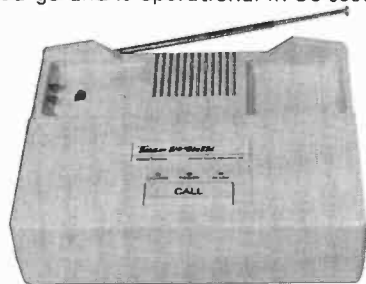

Just plug in the base unit. The handset goes where you go.

YOU'LL LOVE IT AT HOME

Imagine walking the dog while talking on the phone. If you're needed at home, you can even be paged.

Think of the convenience for your wife, of being able to talk on the phone while keeping track of the children. She can check on them in the yard or down the street.

Consider the security of being only seconds away from the police or fire department. You can instantly call a doctor or anyone, anywhere. It's a superb personal security device.

Just walking from room to room, or up and down stairs cord-free is a real thrill. You can take a bath, mow the lawn or order a pizza from anywhere.

When your phone arrives, why not make a call from the living room or garden. It's a great combination of posh luxury and life saving utility.

NO INSTALLATION

If you can plug in a lamp, you can install your new cordless phone.

At the office, with multiline phones, we offer the phone octopus for \$9.98. (It's a \$24 value) You simply insert it at the cable junction by your phone and you can select between 3 different lines.

You can of course call the phone company and they'll put a jack in for a one time charge of about \$15.

A SECURE INVESTMENT

Universal Security Instrument Co. is an electronic security company. The new Tote and Talk 3200 is U.S. Government approved. It is both FCC and UL listed and is backed by Universal's limited 90 day warranty. DAK is America's largest direct selling manufacturer of magnetic products.

TRY THE TOTE AND TALK RISK FREE

Experience the thrill of total phone freedom as you roam throughout your home, yard or even a neighbor's house. You'll save time at the office with this cordless phone at your side.

Try the Tote and Talk for 30 days. If you aren't 100% satisfied for any reason simply return it in its original box for a courteous refund.

To order your cordless Tote and Talk risk free with your credit card, call our toll free hotline, or send your check for the special sale price of only \$189 plus \$3 for postage and handling-Item 9112 Add \$9.98 for the Multiline octopus. Item 9113 (CA res add 6% sales tax.)

It's a risk free investment that will pay for itself many times in convenience, security, and savings in time.



Call TOLL-FREE (800) 423-2636
In California Call (213) 984-1559
10845 Vanowen St., North Hollywood, CA 91605

CIRCLE NO. 13 ON FREE INFORMATION CARD

aft response. When video is neither synchronously nor full-wave detected, demodulation is by a single diode or a transistor. This usually means additional filtering is required to remove envelope "tweets" that inevitably result. Surface-wave filter Z101 and its input preamplifier feed the i-f and thereby enhance the receiver's signal/noise ratio.

Toshiba handles the TA7608CP chroma/luminance IC a little differently from its immediate competition. A variable sharpness control is added to the emitter of the discrete transistor picture corrector, which serves as both an inverting amplifier and part of the manual and automatic-brightness limiter circuit. This RLC control traditionally rounds off some of the high frequencies, smoothing out picture response in the process, sacrificing some detail.

Composite video from i-f IC101 enters the TA7608CP analog chip, which is simultaneously gain-enabled by a contrast amplifier and inverted for the usual chroma 3.08-to-4.08-MHz band-pass filter before entering the first chroma amplifier. Chroma and burst then go to the second chroma and burst amplifiers. Both amplifiers are pulse-gated from the flyback transformer so that the chroma amplifier operates during the 52- μ s line scan time and the burst during the 11-to-12- μ s horizontal blanking interval. Burst amplitude controls gain of the second chroma amplifier, while its phase determines the frequency output of the vco's 3.58-MHz subcarrier regenerator and subsequent visual effects of tint (hue).

Gate inputs into the killer amplifier, along with connections to R - Y and B - Y demodulators, cut off the chroma amplifier when only a monochrome sig-

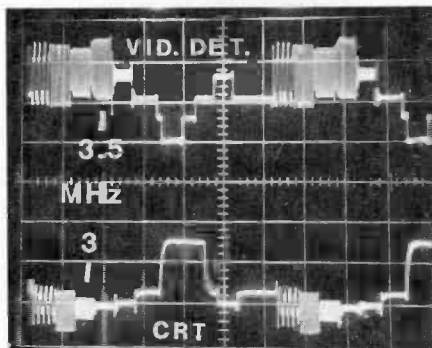

Fig. 3. Multiburst test patterns at video detector and CRT cathodes.

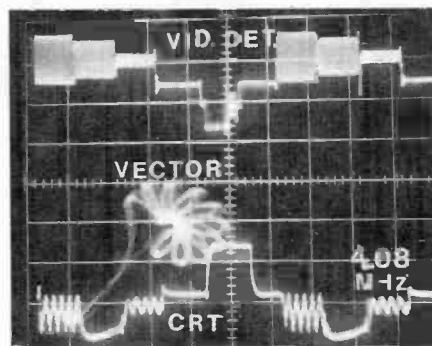

Fig. 4. Swept chroma and vector patterns at video detector and CRT.

nal is incoming. When chroma reaches them, the two demodulators are gated by approximately 80° phase-shifted CW sine waves from the 3.58-MHz vco oscillator via the lower matrix. Fully demodulated color information from the R

- Y and B - Y outputs is resistively combined by the upper matrix and delivered via direct coupling to the luminance/chroma output amplifiers to the cathodes of the CRT.

Meanwhile, video information from the contrast amplifier passes through the luminance delay line. It is then pedestal (black-level) clamped and routed to the IC video amplifier. It then goes to the final discrete video amplifier and the RGB mixing stages. In the mixing stages, luminance and chroma are combined and routed to transistors that directly drive the CRT.

About the only other unusual thing this Toshiba receiver does is tie certain inputs into a "Fail Safe" board that prevents excessive high-voltage from causing ionizing radiation to be emitted. Inputs to this board are rectified voltages from windings on the flyback transformer. The filtered output goes directly to the X-ray circuit in the sync IC, which kills the horizontal oscillator when an overvoltage exists.

Test Results. We noted that 4.08-MHz swept information (Fig. 4) at the video detector and CRT is at a lower amplitude than is usually the case. Also, even though the vector pattern is relatively symmetrical and free of cross-overs, there was some high-frequency jitter present, which affects color rendition to a degree. Otherwise, we see no evidence of peaking transients in either the i-f or luminance amplifiers.

On the plus side, we noted comfortable 3-MHz bandpass at the CRT (Fig. 3). Low-frequency response was excellent on both sides of the squared-off tip of the sync pulse during the horizontal blanking interval, and burst is well-defined on the back porch of the blanking pulse. Finally, we measured a large 67-dB swing before age clipping.

Comments. Channels are easily and accurately accessed. Any channel selector button can be preprogrammed for whatever U/V station you desire in your area, except CATV frequencies. (Channel numerals are supplied for user insertion in the blank spaces near each button, and an LED comes on when a given channel is selected.)

Horizontal overscan of only 10% is great, allowing you to see almost all of the transmitted picture. Furthermore, convergence is virtually perfect. While there is a slight amount of pincushioning on the right side of the screen, you aren't likely to notice it. Picture resolution and definition were generally very good, and color reproduction was about average. We especially like both sharpness and brightness actions, the manual controls for which are located on the top-rear of the set's cabinet.

In terms of our test results, actual viewing performance, and serviceability, the CA-944 is a first-rate product. It certainly merits serious consideration if you're in the market for a color-TV receiver.—Stan Prentiss

CIRCLE NO. 102 ON FREE INFORMATION CARD

TOSHIBA MODEL CA944 RECEIVER LABORATORY DATA

Parameter	Measurement
Tuner/receiver sensitivity (min. signal for snow-free picture):	vhf (Ch. 6): -9 dBmV uhf (Ch. 30): -7 dBmV
Voltage regulation (line varied from 105 to 130 V):	Low voltage: 123-V supply—95% 16.5-V supply—96%
Luminance bandpass at CRT:	3 MHz
Luminance bandpass at video detector:	3.5 MHz
S/N at CRT:	40.1 dB
Convergence:	99.9%
Horizontal overscan:	10%
Agc response (before sync clipping or black level shift):	67 dB
Audio bandpass (3 dB down):	110 Hz to 2.8 kHz
Dc restoration:	≥89%
Auxiliary earphone audio output Z at 1 kHz:	12 ohms
Pincushion/barreling:	1%
Power requirement (signal applied):	75 W

Note: Instruments used in these measurements are: Tektronix/Telsquipment D66, D67A oscilloscopes; Sadelco FS-30-VU 1/s meter; Data Precision 245, 1350, 1750 multimeters; B&K-Precision 1248, 1250 color-bar generator; Seacore VA48 (modified), CG169, color bar and signal generators and PRI57 power supply; and Winegard DX-300 amplifier.

AN INCREDIBLE BREAKTHROUGH.

Introducing the Bearcat® 350, the first scanner that shows you broadcasting frequencies in plain and simple English.

The new Bearcat 350 easily qualifies as the most advanced scanner in the history of scanner radios.

Besides being the most sophisticated Bearcat Scanning monitor, it is also the world's first alpha-numeric scanner. Simply put, for the first time you have the option of scanning frequencies by numbers or names.

Quantum leap.

The Bearcat 350 will revolutionize scanners just as plain English computers revolutionized the computer industry a few years ago. All because of this simple fact: We find it easier to deal with words than with numbers.

How it works.

Programming the Bearcat 350 for numeric and alphabetic capabilities is deceptively uncomplicated. First to program the frequencies numerically you stop the scanning action.

Then you press the alpha-numeric key. Next you program in the frequency number in the usual manner. Touching the "enter" button locks the frequency in the Bearcat 350's memory bank.

© 1981 Masco Corp of Indiana

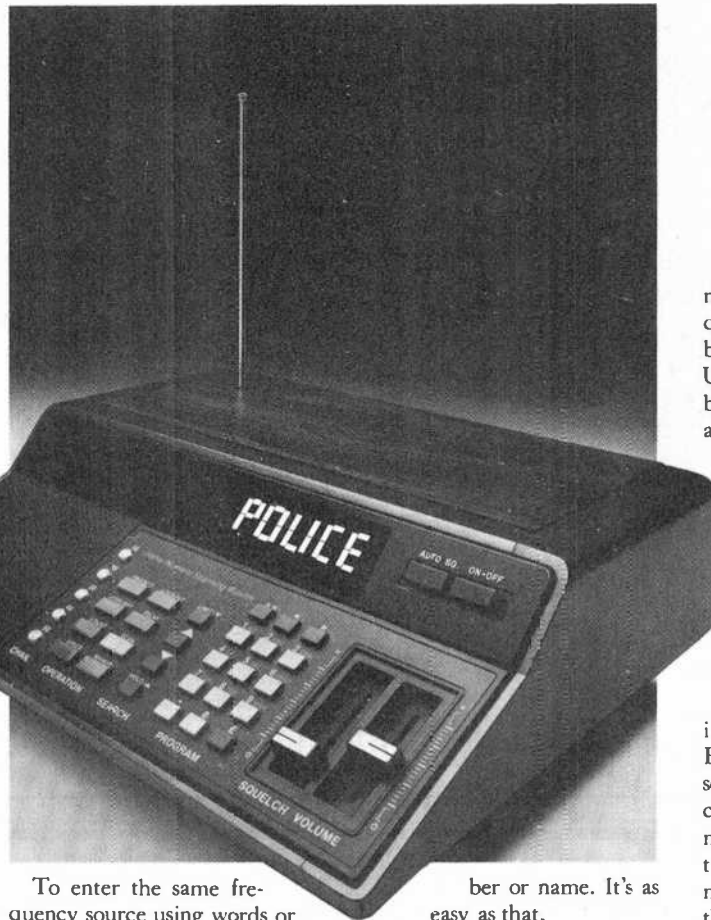

To enter the same frequency source using words or abbreviations simply press the alpha-numeric key again. Your unit is ready to be programmed by frequency name.

"Type" in the word or abbreviation for the frequency source. Press the "enter" button again. Your Bearcat 350 is ready to receive frequencies by num-

ber or name. It's as easy as that.

More than words.

Even without the alpha-numeric capabilities, the Bearcat 350 would be an unbelievable advancement in no-crystal scanning.

Its complex synthesized technology gives it the capability of

receiving every local public frequency automatically. You will be able to receive low, high, UHF, UHF-T public service bands, the 2-meter and 70 CM amateur (Ham) bands, plus the AM aircraft band.

The Bearcat 350 scans up to 50 channels in five banks—10 channels per bank.

Impressive extras.

It took Bearcat Scanners, the leader in scanner radios, to give you these impressive features in the Bearcat 350: patented selective scan delay, direct channel access, scan speed control, automatic squelch, patented track tuning circuitry and front mounted speaker. And look at these extras: two digital display panels, AC/DC operation, counter on each channel to determine which are most active, priority, and attractive die cast metal cabinet. See your Bearcat Scanner dealer today. Ask about the incredible Bearcat 350. Your perception of scanner radios will never be the same again.



Electra Company
Division of Masco Corp of Indiana
300 East County Line Road
Cumberland, Indiana 46229
International Business Office
Suite 102, 1828 Swift
North Kansas City, Missouri 64116

BEARCAT® SCANNERS

CIRCLE NO. 18 ON FREE INFORMATION CARD

Popular Electronics Tests

The Fluke D811

True RMS Multimeter



FLUKE's Model D811 True RMS Multimeter is a general-purpose, battery- or line-powered instrument designed for both bench and field use. Its companion, the Model D810, is similar in all respects, except that it is line-powered only. Features of the Model D811 include ability to measure rms values of ac voltage and current, even on nonsinusoidal waveforms; 3 1/2-digit large (0.5") LCD display; autozero and autopolarity; basic dc accuracy of 0.1%; transient protection to 6 kV; seven functions and 31 ranges; conductance function to make measurements equivalent to resistances as high as 10,000 megohms (200 nS or nanoSiemens); three ranges for diode/transistor tests; and three ranges for low-power ohms. Accuracy of the basic instrument is guaranteed for one year.

Model D811 measures 8 1/2" W x 2 1/2" H x 10" D and weighs 3 lb 6 oz with batteries installed. The suggested retail price is \$299.

General Description. The entire front panel, containing the LCD display, 10 function/range pushbuttons, and power on/off pushbutton, is recessed under an extending "lip" to protect these elements from damage in the case of an inadvertent fall to a hard surface. The probe connection is also unique in that the Y8008 Touch-Hold Probe is terminated in a 4-pin connector that can be plugged into the three (mA, COMMON, V/ Ω /S) front-panel connectors and a polarizing hole. If desired, conventional banana-jack terminated test leads can be used in these input connectors. With

ALL THE PROGRAMS YOU'LL EVER NEED. FOR \$600.

Say goodbye to the costs and frustrations associated with writing software: The Last One® will be available very soon.

More comprehensive and advanced than anything else in existence, The Last One® is a computer program that writes computer programs. Programs that work first time, every time.

By asking you questions in *genuinely* plain English about what you want your program to do, The Last One® uses those answers to generate a totally bug-free program in BASIC, ready to put to immediate use.

What's more, with The Last One®, you can change or modify your programs as often as you wish. Without effort, fuss or any additional cost. So as your requirements change, your programs can too.

In fact, it's the end of programming as you know it.

And if, because of the difficulties and costs of buying, writing and customising software, you've put off purchasing a computer system up to now, you need delay no longer.

The Last One® will be available very soon from better computer outlets. To place your order, take this ad into your local dealer and ask him for further details. Or in case of difficulty, please write to us direct.

THE LAST ONE®

YOU'LL NEVER NEED BUY ANOTHER PROGRAM.

D. J. 'AI' Systems Ltd., Ilminster, Somerset, England TA19 9BQ. Telephone: 011-44-4605-4117. Telex: 46338. ANYTYRG.

**ΩMEGA
Sales Co.**

12 Meeting St.
Cumberland, RI 02864
(401) 722-1027

**WHOLESALE
COMPUTER PRICES
DIRECT TO
THE PUBLIC!**

**PRODUCT SPECIAL
of the MONTH!!**

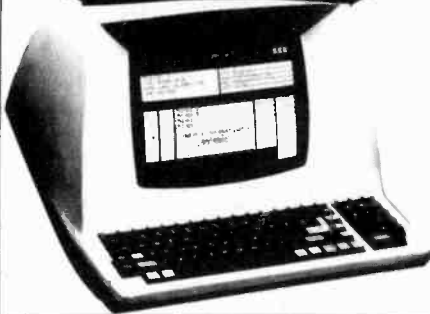

**Televideo - 912C - \$679
920C - \$739**

INTERTEC
SUPERBRAIN



Atari 800
16K \$759



EPSON MX-80

APPLE II



\$479



DIABLO 630

NEC
Spinwriter



\$2195 (with
tractor feed)

**CALL TOLL FREE
EAST COAST 1-800-556-7586
WEST COAST 1-800-235-3581**

ΩMEGA ships via UPS, truck, or air. COD's.
Visa, Mastercharge accepted, with no service charge.

**WE ALSO OFFER
ANADIX • RADIO SHACK
QUME • NEC MONITORS
NORTHSTAR**



the Y8008 connector inserted, the probe tip function is dependent on the setting of the various pushbuttons. The probe comes with a variety of tip attachments, and a pair of conventional test leads is provided. The 10-ampere input has its own banana-plug connector.

The *dc voltage* function provides five ranges from 200 mV to 1 kV with an accuracy of $\pm 0.1\%$ of reading plus one digit on all ranges. Overload protection to 1 kV dc or peak ac is provided on all ranges, the input resistance is 10 megohms on all ranges, normal-mode rejection is greater than 60 dB at power-line frequency, and common-mode rejection is greater than 90 dB at dc and power-line frequency.

The *ac voltage* function provides five ranges from 200 mV to 750 volts. Rated accuracy from 200 mV to 200 volts is $0.5\% + 2$ digits from 45 Hz to 10 kHz; $1\% + 2$ digits from 10 kHz to 20 kHz; and $5\% + 3$ digits between 20 kHz and 50 kHz. On the 750-volt ac range, accuracy is $0.5\% + 2$ digits from 45 Hz to 1 kHz. Overload protection extends to 750 volts rms, 1 kV peak, not to exceed 107 volt-Hz, except for 10 seconds maximum on the 200-mV and 2-volt ranges. The input impedance is 10 megohms with less than 100 pF shunt capacitance. Common-mode rejection is greater than 60 dB at 60 Hz.

The *resistance* function provides six ranges from 200 ohms to 20 megohms. Accuracy is rated at $\pm 0.2\%$ reading + 1 digit on the four lower ranges and $\pm 0.5\%$ reading plus 1 digit on the upper two ranges. Overload on all ranges is 500 volts dc or rms, while the open-circuit voltage is less than 3.5 volts on all ranges. Three diode test ranges are provided to forward-bias diode junctions.

Three *conductance* ranges are provided. These are useful for measuring conductances too low (resistances too high) to be resolved by normal measurement techniques. The unit of conductance is the Siemen (S). The 2-mS (1/500 Ω) range measures down to 1 MS (1/1 M Ω), $\pm 0.4\%$ reading + 1 digit; the 20- μ S (1/50 k Ω) range measures to 10 nS (1/100 M Ω) with the same accuracy as the 2-mS range, while the 200-nS (1/5 M Ω) range goes to 0.1 nS (1/10¹⁰ Ω) with an accuracy of $\pm 1\%$ reading + 10 digits. Overload protection to 500 volts dc or rms is provided on all ranges.

Dc currents are measured in six ranges from 200 μ A to 10 amperes. Accuracy is $\pm 0.3\%$ reading + 1 digit except on the 10-ampere range where it is $\pm 0.5\%$ reading + 1 digit. Overload protection is by fuses except for the 10-ampere range. The voltage burden is 0.3 volt maximum on all ranges except 2 amperes which is 0.9 volt, and 10 amperes where it is 0.5 volt.

Ac currents can be measured via six ranges from 200 μ A to 10 amperes. Accuracy on the 200- μ A through 200-mA ranges, between 45 Hz and 10 kHz, is $1\% + 2$ digits; and between 10 kHz and 20 kHz, it is $2\% + 2$ digits. On the 2- and 10-ampere ranges, accuracy between 45 Hz and 2 kHz is $1\% + 2$

digits. The overload and voltage burden is the same as for dc current.

Operating temperature is between 0°C and 50°C, with the temperature coefficient less than 0.1/°C times the applicable accuracy specifications from 0°C to 18°C and 28°C to 50°C. Acceptable relative humidity for the instrument extends to 80% at 35°C or 70% at 50°C. Rechargeable NiCd batteries provide from 15 to 40 hours of operation, with a 14-hour recharge time. Low battery voltage is indicated by the sign BT on the LCD display.

Comments. The Fluke D811 was checked by Lockheed Electronics Instrumentation Measurements Lab., against standards traceable to the National Bureau of Standards. The IML found that the D811 met its advertised specifications in all respects.

In using the instrument, we had no problems. We really liked the Touch-Hold Probe and its method of connection to the DMM. Because of its connector, the probe can be left permanently attached to the meter, and there is no need to shuffle test leads to change function. The "hold" pushbutton on the probe—which "freezes" the LCD display—has been very helpful, as we can now store a voltage or resistance measurement and check the value given on a schematic.

The instruction manual (which is as important as any peripheral) is very well written, profusely illustrated, and covers the D811 completely. It even provides the names, addresses and telephone numbers of worldwide Fluke technical service centers.

The D811 is hardly a pocket-size instrument, but it is not large and bulky. Its convenient carrying handle also acts as a variable tilt stand for bench operation. And, a detailed summary of device specifications is printed on the underside of the case.

Other optional accessories include the 801-600 High Current Probe that allows current measurement from 2 to 600 amperes, the 80K-40 High Voltage Probe that allows voltage measurement from 1 to 40 kV dc or peak ac, and 28 kV rms ac, the 81RF High Frequency Probe that allows measurement of signals from 0.25 to 30 volts rms between 100 kHz to 100 MHz, the 80T-150 Temperature Probe for measurements between -50°C to +150°C, or -58°F to +302°F, and the Y8205 Carrying Case made of soft vinyl plastic. The last also has provisions for test leads, the power cord, and compact accessories.

In our view, the D811 RMS Multimeter is an excellent instrument, whose specifications are somewhat better than one would expect of such a reasonably priced instrument. Furthermore, it incorporates several unique features that in practice prove very much worthwhile. We can recommend it, without reservation, to anyone in need of a first-class bench/portable digital multimeter. — Les Solomon.

CIRCLE NO. 104 ON FREE INFORMATION CARD

COMPUTER BITS

By Carl Warren

New Systems for 1981

JANUARY is when manufacturers attend the annual Winter Consumer Electronics Show in Las Vegas to display their new products for the consumer market. This year, there were few really "new" product introductions. Most of the products turned out to be already familiar items in new packages, but there were a number of items worthy of note.

What many of us thought would be a significant entry to the personal-computer market by Commodore Consumer Products Group turned out to be little more than a repackaging concept, with color- and sound-generation capabilities thrown in. The product, the Video Interface Computer (VIC) 20, is a less-than-



Mattel Electronics Computer Backgammon

\$300, keyboard-sized unit with 5K bytes of RAM; circuitry that supports eight character colors, eight border colors, and 16 screen colors; and sound generators for development of computer music. It's designed to use the same PETBASIC and graphics functions used in the company's Pet microcomputer. Memory can be expanded to 32K of RAM, and the system can handle disk drives, printer, cassette deck, and game controls.

Mattel Electronics again showed up with its "Intellivision" video-games player/computer system and numerous games. The system consists of a master unit whose primary function is to provide video-game playing capability and a keyboard unit into which the master component plugs. The master unit offers a reasonable display, and the games are better than most. The keyboard component, which has been announced several times before and never reached market, includes a cassette deck and a very weak

keyboard. On the plus side, Mattel deserves high marks for its hand-held computer games, particularly computer

Backgammon and Baseball. A lot of effort was put into developing these, and it shows.

One machine that is especially interesting is the Bally Arcade from Astrovision. This unique microcomputer uses Bally BASIC and the so-called ZGRASS-32 keyboard, which is designed specifically for developing graphics. Arcade provides a palette of 256 colors by allowing you to define degrees of gray scale and shading. The bandwidth of the typical home TV receiver will be the limiting factor in this system, but I was surprised at the clarity of display in terms of resolution and dynamics of the graphics at the demonstration I

DON LANCASTER MAKES IT SIMPLE.

SAMS BOOKS MAKE IT ECONOMICAL.

If you're an electronic buff, here's your chance to learn from one of the most popular authors in electronics. For a limited time, Sams is offering a special discount on some of our best-selling Lancaster books.

LEARN ABOUT TTLs, CMOS, ACTIVE-FILTERS, VIDEO GRAPHICS. SAVE 15%!

TTL COOKBOOK (#21035)
A complete guide to transistor-transistor logic. Learn what TTL is, how it works, and how to use it. Includes many practical applications including many digital counters and instruments. \$9.50

CMOS COOKBOOK (#21398)
Everything you need to understand CMOS, how to power it, and how to use it. Even has a minicatalog of over 100 devices, including pinouts and use descriptions. \$10.50

ACTIVE-FILTER COOKBOOK (#21168)
A practical, user-oriented approach to active-filters. Includes uses for active-filters in brainwave research, electronic music, quadrature art, and psychedelic lighting. \$14.95

THE CHEAP VIDEO COOKBOOK (#21524)
A complete guide to super low cost alphanumeric and graphic microprocessor-based video displays. Includes do-it-yourself construction details and documented and debugged support software. \$5.95

SON OF CHEAP VIDEO (#21723)
The latest circuits to get alphanumeric and graphics video out of a microcomputer onto a video screen. Includes details on a \$7 complete video display system and a \$1 super-simple full transparency concept and other hands-on hardware projects. \$8.95

Sams Books

Mail to: Howard W. Sams & Co., Inc. 4300 West 62nd St.
P.O. Box 7092, Indianapolis, IN 46206.

	Quantity	
TTL COOKBOOK #21035	\$ 9.50	_____
CMOS COOKBOOK #21398	\$10.50	_____
ACTIVE-FILTER COOKBOOK #21168	\$14.95	_____
THE CHEAP VIDEO COOKBOOK #21524	\$ 5.95	_____
SON OF CHEAP VIDEO #21723	\$ 8.95	_____

ORDER ALL 5 BOOKS AND SAVE AN ADDITIONAL 15%!

<input type="checkbox"/> PAYMENT ENCLOSED	<input type="checkbox"/> CHECK	Amount of order	\$ _____
<input type="checkbox"/> MONEY ORDER	<input type="checkbox"/> VISA	Deduct 15% if ordering all 5 books	\$ _____
<input type="checkbox"/> MASTERCARD Interbank No. _____		Add local sales tax where applicable	\$ _____
(Minimum credit card purchase \$10)		Shipping & handling costs	\$ 2.00
		Total Amount of Order	\$ _____

Account No. _____ Expiration Date _____
 Name (print) _____ Signature _____
 Address _____
 City _____ State _____ Zip _____

Prices subject to change without notice. Offer expires 8/31/81 AD085
 For the name of your nearest Sams Book outlet, or to order by phone, call toll-free 1-800-428-3696.

WANT AUTO- RANGING?



AWS EZ 6100

AND...

- An unprecedented five-year warranty
- Pricing as low as \$105
- 3 1/2 digit display
- Autoranging on Volts and Ohms
- Continuity buzzer (Model EZ 6100)
- Range hold (Model EZ 6100)
- Autopolarity
- Automatic indication, unit and signs
- Feather touch button to select AC/DC - Lo Ω/Ω function
- Low battery warning sign
- Safety fused

EZ 6100	
DCV 0-1000	5-Autoranges
ACV 0-600	4-Autoranges
DCMA 0-200	2-Ranges
ACMA 0-200	2-Ranges
Ω 0-2000K Ω	5-Autoranges
Low Power Ω	0-2000K Ω
4-Autoranges Plus Continuity Buzzer	
EZ 6200	
DCV 0-1000	5-Autoranges
ACV 0-600	4-Autoranges
DCMA 0-200	1-Range
ACMA 0-200	1-Range
Ω 0-2000K Ω	5-Autoranges
Low Power Ω	0-2000K Ω
4-Autoranges	

- Order AWS EZ 6200... \$105
- Order AWS EZ 6100 with continuity buzzer and range hold \$142
- Order AWS C-30 Ever-Ready carrying case \$20
- For ordering information call toll-free: 800-645-5398 (N.Y., Hawaii, Alaska call collect 516-231-7050).

**A.W. SPERRY
INSTRUMENTS INC.**
The Measurable Advantage.
245 Marcus Blvd., Hauppauge, N.Y. 11787

witnessed at CES. I'll pass on pricing and technical details when I get them.

Speak Up. Since 1978, there has been a growing interest in computer-generated speech and speech recognition. Texas Instruments leads in this field with its "Speak and Spell" unit. This year, TI has added the "Speak and Read" learning aids, designed to assist teachers. Speak and Read cartridges available now include "Who's Who at the Zoo," "Sea Sights," and "Dog on a Log." The solid-state plug-in modules retail for \$25 each.

TI has also put forth major efforts in communication-mode modules and is aiding outside sources in developing software for its 99/4 microcomputer. Now software developers can use Pascal and a special development system. If you're in the software business and want to develop software for the 99/4, contact TI for details.

Anyone who wants to develop his own speech laboratory would do well to contact Telesensory Speech Systems, which has an advanced speech synthesizer for small computers. The company's Series III speech module can accommodate standard and custom vocabularies of up to 256 words. The module contains the company's own speech synthesizer, vocabulary data memory, on-board speech filter, and audio amplifier. The TTL-compatible board requires a +5-volt supply. Consult Telesensory directly for pricing and technical details and ask for a catalog of all its speech products.

On the subject of speech synthesis, *Giving a Voice to Computers*, by Ed Teja, an expert in voice technology, should be available from Tab Books or through your local computer or electronics retailer for about \$10. It will acquaint you with the fundamentals of speech-synthesis and provide basic experiments you can perform. Perhaps the

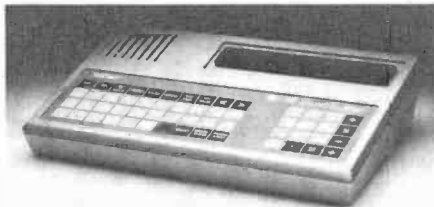

Tiger Electronics Talking Computer

book's most important feature is its list of speech-module manufacturers.

Tiger Electronic Toys Inc. had an interesting item at the CES—a 1500-word vocabulary computer dubbed the K-2-8. The manufacturer characterizes this system as a gap jumper, since it's not limited to 250 words. The system has 15 different learning modes with specific goals for the student to reach.

Other Systems to Consider. If you're in the bulk-mailing business and maintain large mailing lists, you should keep an eye out for the WHIZ from AM

International. This specialized mailing-list system consists of an 80 × 24 character video display, Z80-based computer with 64K bytes of RAM, dual 5.25" single-sided double-density floppy-disk drives, and a Dataproducts dot-matrix bidirectional printer.

Mailing-list software for the WHIZ is written in Microfocus CIS COBOL and offers the same facilities found on large minicomputer systems. Price of the basic system is only \$8990. Adding an automatic labeler boosts system price to \$14,990, which is still \$6000 less than what you'd pay for a similar system from another manufacturer.

A new system that hasn't received much attention is the IF800 Model from OKI. It resembles Hewlett-Packard's high-end color-graphics systems and even emulates H-P's clear graphics. Resolution is 640 × 200 dots, each individually addressable. The Model 20 system is currently supported by an extremely powerful version of Microsoft BASIC, COBOL, FORTRAN, and a BASIC compiler. A color display, light pen, and time-of-day clock are all part of the package. I couldn't find out what the system costs or where to buy it, but you can expect it to compete with Apple in price. Look for it in the second half of this year. Additional information is obtainable from BMC International. ♦

MORE INFORMATION

For additional information about the products or services discussed in this column, contact the companies directly.

AM International

1900 Ave of the Stars
Los Angeles, CA 90067
213-556-9639

Astrovision

6460 Bosch Blvd, Suite 215
Columbus, OH 43229
614-885-0130

BMC International (USA) Inc

Union Bank Building, Suite 600
11222 LA Cienega Blvd
Inglewood, CA 90304
213-641-4588

Commodore

Consumer Products Group
761 Fifth Ave.
King of Prussia, PA 19406
215-666-6800

Telesensory Speech Systems

3408 Hillview Ave, Box 10099
Palo Alto, CA 94304
415-493-2626

Texas Instruments Inc.

Inquiry Answering Service
Box 225012 M/S 308
Dallas, TX 75265

Tiger Electronic Toys Inc.

500 North Michigan Ave.
Chicago, IL 60611
312-836-7100

Vitek

1160 Barbara Drive
Vista, CA 92083
714-724-0210

Start learning and computing for only **\$129.95** with a **Netronics 8085-based computer kit**. Then expand it in low-cost steps to a business/development system with 64k or more RAM, 8" floppy disk drives, hard disks and multi-terminal I/O.

THE NEW EXPLORER/85 SYSTEM

Special! Full 8" floppy, 64k system for less than the price of a mini! Only **\$1499.95!**

(Also available wired & tested, \$1799.95)

Imagine — for only \$129.95 you can own the starting level of Explorer/85, a computer that's expandable into full business/development capabilities — a computer that can be your beginner system, an OEM controller, or an IBM-formatted 8" disk small business system. From the first day you own Explorer/85, you begin computing on a significant level, and applying principles discussed in leading computer magazines. Explorer/85 features the advanced Intel 8085 cpu, which is 100% compatible with the older 8080A. It offers on-board S-100 bus expansion, Microsoft BASIC in ROM, plus instant conversion to mass storage disk memory with standard IBM-formatted 8" disks. All for only \$129.95, plus the cost of power supply, keyboard/terminal and RF modulator if you don't have them (see our remarkable prices below for these and other accessories). With a Hex Keypad/display front panel, Level "A" can be programmed with no need for a terminal, ideal for a controller, OEM, or a real low-cost start.

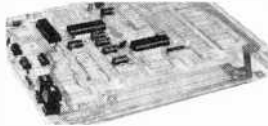

Level "A" is a complete operating system, perfect for beginners, hobbyists, industrial controller use. \$129.95



Full 8" disk system for less than the price of a mini (shown with Netronics Explorer/85 computer and new terminal). System features floppy drive from Control Data Corp., world's largest maker of memory storage systems (not a hobby brand!)

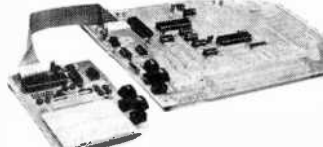

Level "A" With Hex Keypad/Display.

LEVEL "A" SPECIFICATIONS

Explorer/85's Level "A" system features the advanced Intel 8085 cpu, an 8355 ROM with 2k deluxe monitor/operating system, and an advanced 8155 RAM I/O ... all on a single motherboard with room for RAM/ROM/PROM/EPROM and S-100 expansion, plus generous prototyping space.

PC Board: Glass epoxy, plated through holes with solder mask. • I/O: Provisions for 25-pin (DB25) connector for terminal serial I/O, which can also support a paper tape reader ... cassette tape recorder input and output ... cassette tape control output ... LED output indicator on SOD (serial output) line ... printer interface (less drivers) ... total of four 8-bit plus one 6-bit I/O ports. • Crystal Frequency: 6.144 MHz. • Control Switches: Reset and user (RST 7.5) interrupt ... additional provisions for RST 5.5, 6.5 and TRAP interrupts on-board. • Counter/Timer: Programmable, 14-bit binary. • System RAM: 256 bytes located at F800, ideal for smaller systems and for use as an isolated stack area in expanded systems ... RAM expandable to 64K via S-100 bus or 4k on motherboard.

System Monitor (Terminal Version): 2k bytes of deluxe system monitor ROM located at F900, leaving 6600 free for user RAM/ROM. Features include tape load with labeling ... examine/change contents of memory ... insert data ... warm start ... examine and change all registers ... single step with register display at each break point, a debugging/training feature ... go to execution address ... move blocks of memory from one location to another ... fill blocks of memory with a constant ... display blocks of memory ... automatic baud rate selection to 9600 baud ... variable display line length control (1-255 characters/line) ... channeled I/O monitor routine with 8-bit parallel output for high-speed printer ... serial console in and console out channel so that monitor can communicate with I/O ports.

System Monitor (Hex Keypad/Display Version): Tape load with labeling ... tape dump with labeling ... examine/change contents of memory ... insert data ... warm start ... examine and change all registers ...

single step with register display at each break point ... go to execution address. Level "A" in this version makes a perfect controller for industrial applications, and is programmed using the Netronics Hex Keypad/Display. It is low cost, perfect for beginners.

HEX KEYPAD/DISPLAY SPECIFICATIONS
Calculator type keypad with 24 system-defined and 16 user-defined keys. Six digit calculator-type display, that displays full address plus data as well as register and status information.

LEVEL "B" SPECIFICATIONS

Level "B" provides the S-100 signals plus buffers/drivers to support up to six S-100 bus boards, and includes: address decoding for on-board 4K RAM expansion selectable in 4k blocks ... address decoding for on-board 8k EPROM expansion selectable in 8k blocks ... address and data bus drivers for on-board expansion ... wait state generator (jumper selectable), to allow the use of slower memories ... two separate 5 volt regulators.

LEVEL "C" SPECIFICATIONS

Level "C" expands Explorer/85's motherboard with a card cage, allowing you to plug up to six S-100 cards directly into the motherboard. Both cage and card are neatly contained inside Explorer's deluxe steel cabinet. Level "C" includes a sheet metal superstructure, a 5-card, gold plated S-100 extension PC board that plugs into the motherboard. Just add required number of S-100 connectors.



Explorer/85 With Level "C" Card Cage.

LEVEL "D" SPECIFICATIONS

Level "D" provides 4k of RAM, power supply regulation, filtering decoupling components and sockets to expand your Explorer/85 memory to 4k (plus the origi-

nal 256 bytes located in the 8155A). The static RAM can be located anywhere from 0000 to EFFF in 4k blocks.

LEVEL "E" SPECIFICATIONS

Level "E" adds sockets for 8k of EPROM to use the popular Intel 2716 or the TI 2516. It includes all sockets, power supply regulator, heat sink, filtering and decoupling components. Sockets may also be used for 2k x 8 RAM IC's (allowing for up to 12k of on-board RAM).

DISK DRIVE SPECIFICATIONS

- 8" CONTROL DATA CORP. professional drive.
- LSI controller.
- Write protect.
- Single or double density.
- Data capacity: 401,016 bytes (SD), 802,032 bytes (DD), unformatted.
- Access time: 25ms (one track).

DISK CONTROLLER / I/O BOARD SPECIFICATIONS

- Cont. ups to four 6" drives.
- 1771A LSI (SD) floppy disk controller.
- Onboard data separator (IBM compatible).
- 2 Serial I/O ports.
- AutoBoot to disk system when system reset.
- 2716 PROM socket included for use in custom applications.
- Onboard crystal controlled. (IBM compatible).
- Onboard I/O baud rate generators to 9600 baud.
- Double-sided PC board (glass epoxy).

DISK DRIVE CABINET/POWER SUPPLY

- Deluxe steel cabinet with individual power supply for maximum reliability and stability.

ORDER A COORDINATED EXPLORER/85 APPLICATIONS PAK!

Beginner's Pak (Save \$26.00!) — Buy Level "A" (Terminal Version) with Monitor Source Listing and AP-1 5-amp Power Supply: (regular price \$199.95), now at SPECIAL PRICE: \$169.95 plus post. & insur.

Experimenter's Pak II (Save \$53.40!) — Buy Level "A" (Hex Keypad/Display Version) with Hex Keypad/Display, Intel 8085 User Manual, Level "A" Hex Monitor Source Listing, and AP-1 5-amp Power Supply: (regular price \$279.35), all at SPECIAL PRICE: \$219.95 plus post. & insur.

Special Microsoft BASIC Pak (Save \$103.00!) — Includes Level "A" (Terminal Version), Level "B", Level "D" (4k RAM), Level "E", 8k Microsoft in ROM, Intel 8085 User Manual, Level "A" Monitor Source Listing, and AP-1 5-amp Power Supply: (regular price \$439.70), now yours at SPECIAL PRICE: \$329.95 plus post. & insur.

ADD A TERMINAL WITH CABINET,

GET A FREE RF MODULATOR: Save

over \$114 at this SPECIAL PRICE: \$499.95 plus post. & insur.

Special 8" Disk Edition Explorer/85 (Save over \$104!) — Includes disk-version Level "A", Level "B", two S-100 connectors and brackets, disk controller, 64k RAM, AP-1 5-amp power supply, Explorer/85 deluxe steel cabinet, cabinet fan, 8" SD/DD disk drive from famous CONTROL DATA CORP. (not a hobby brand!), drive cabinet with power supply, and drive cable set-up for two drives. This package includes everything but terminal and printers (see coupon for them). Regular price \$1630.30, all yours in kit at SPECIAL PRICE: \$1499.95 plus post. & insur. Wired and tested, only \$1799.95.

Special! Complete Business Software Pak (Save \$625.00!) — Includes CPM 2.0, Microsoft BASIC, General Ledger, Accounts Receivable, Accounts Payable, Payroll Package: (regular price \$1325), yours now at SPECIAL PRICE: \$699.95.

Please send the items checked below:

- Explorer/85 Level "A" kit (Terminal Version) ... \$129.95 plus \$3 post. & insur.
- Explorer/85 Level "A" kit (Hex Keypad/Display Version) ... \$129.95 plus \$3 post. & insur.
- 8k Microsoft BASIC on cassette tape. \$64.95 postpaid.
- 8k Microsoft BASIC in ROM kit (requires Levels "B", "D" and "E") ... \$90.95 plus \$2 post. & insur.
- Level "B" (S-100) kit ... \$49.95 plus \$2 post. & insur.
- Level "C" (S-100 6-card expander) kit ... \$39.95 plus \$2 post. & insur.
- Level "D" (4k RAM) kit ... \$60.95 plus \$2 post. & insur.
- Level "E" (EPROM/ROM) kit ... \$5.95 plus 50¢ p&h.
- Deluxe Steel Cabinet for Explorer/85 ... \$49.95 plus \$3 post. & insur.
- Fan For Cabinet ... \$15.00 plus \$1.50 post. & insur.
- ASCII Keyboard/Computer Terminal kit: features a full 128 character set, w/41 case; full cursor control; 75 ohm video output; convertible to baudot output; selectable baud rate, RS232-C or 20 ma. I/O, 32 or 64 character by 16 line formats, and can be used with either a CRT monitor or a TV set (if you have an RF modulator) ... \$149.95 plus \$3.00 post. & insur.
- Deluxe Steel Cabinet for ASCII keyboard/terminal ... \$19.95 plus \$2.50 post. & insur.
- New! Terminal/Monitor: (See photo) Same features as above, except 12" monitor with keyboard and terminal is in deluxe single cabinet; kit ... \$390.95 plus \$7 post. & insur.
- Hazeltine terminals: Our prices too low to quote — CALL US
- Lear-Sigler terminals/printers: Our prices too low to quote — CALL US
- Hex Keypad/Display kit ... \$60.95 plus \$2 post. & insur

- AP-1 Power Supply Kit ±8V @ 5 amps) in deluxe steel cabinet ... \$39.95 plus \$2 post. & insur.
- Gold Plated S-100 Bus Connectors ... \$4.85 each, postpaid
- RF Modulator kit (allows you to use your TV set as a monitor) ... \$8.95 postpaid.
- 16k RAM kit (S-100 board expands to 64k) ... \$190.95 plus \$2 post. & insur.
- 32k RAM kit ... \$299.95 plus \$2 post. & insur.
- 48k RAM kit ... \$390.95 plus \$2 post. & insur.
- 64k RAM kit ... \$499.95 plus \$2 post. & insur.
- 16k RAM Expansion kit (to expand any of the above in 16k blocks up to 64k) ... \$99.95 plus \$2 post. & insur. each
- Intel 8085 cpu Users' Manual ... \$7.50 postpaid.
- 12" Video Monitor (10MHz bandwidth) ... \$139.95 plus \$5 post. & insur.
- Beginner's Pak (see above) \$169.95 plus \$4 post. & insur.
- Experimenter's Pak (see above) ... \$219.95 plus \$6 post. & insur.
- Special Microsoft BASIC Pak Without Terminal (see above) ... \$329.95 plus \$7 post. & insur.
- Same as above, plus ASCII Keyboard Terminal With Cabinet, Get Free RF Modulator (see above) ... \$499.95 plus \$10 post. & insur.
- Special 8" Disk Edition Explorer/85 (see above) ... \$1499.95 plus \$26 post. & insur.
- Wired & Tested ... \$1799.95 plus \$26 post. & insur.
- Extra 8" CDC Floppy Drives ... \$499.95 plus \$12 post. & insur.
- Cabinet & Power Supply For Drive ... \$69.95 plus \$3 post. & insur.
- Drive Cable Set-up For Two Drives ... \$25 plus \$1.50 post. & insur.

- Disk Controller Board With I/O Ports ... \$199.95 plus \$2 post. & insur.
- Special: Complete Business Software Pak (see above) ... \$699.95 postpaid.

SOLD SEPARATELY:

- CPM 1.4 ... \$100 postpaid.
- CPM 2.0 ... \$150 postpaid.
- Microsoft BASIC ... \$325 postpaid.
- Intel 8085 cpu User Manual ... \$7.50 postpaid.
- Level "A" Monitor Source Listing ... \$25 postpaid.

Continental U.S.A. Credit Card Buyers Outside Connecticut

CALL TOLL FREE: 800-243-7428

To Order From Connecticut Or For Technical Assistance, call (203) 354-9375

Total Enclosed (Conn res. add sales tax) \$ _____

Paid By: Personal Check Cashier's Check/Money Order

VISA MasterCard (Bank No. _____)

Acct. No. _____ Exp. Date _____

Signature _____

Print Name _____

Address _____

City _____

State _____ Zip _____

NETRONICS Research & Development Ltd.
333 Litchfield Road, New Milford, CT 06776

COMPUTER SOURCES

By Leslie Solomon
Senior Technical Editor

Hardware

S-100 D/A Converter. The S-100 compatible SB-64 features 64 output channels, each driving a 1K load, with $\pm 0.4\%$ absolute accuracy from 0 to 10.625 volts. Address decoding allows memory-mapped I/O to any 256-byte sector and IEEE S-100 specs are met. Options include 10 digital outputs, fast 12-bit DAC with 3-microsecond settling time, ± 15 -volt tracking regulator with 600-mA output, and 24-bit address decoding. \$514. Address: Digital Multimedia Control, 2338 Patterson #12, Eugene, OR 97405.

DDDS Floppy for Apple. The LCA-22 is a controller board for the Apple II. It is software compatible with Apple DOS and contains 256 bytes of boot ROM. It can control up to four 8-inch, single- or double-sided, single- or double-density disk drives to produce a stor-



age capacity of 4.4 megabytes. Average access time is 200 ms, and DMA is 62.5K bytes/second transfer rate. The board comes with cable, diskette, and documentation. \$699. Address: Lobo Drives International, 354 S. Fairview Ave., Goleta, CA 93117 (Tel: 805-683-1576).

Handprint Data Terminal. The Micropad enables hand-written alphanumeric data to be entered in a computer at the time of writing. It consists of a pressure-sensitive writing surface, a mi-

croprocessor, and a built-in 40-character display. A conventional ballpoint pen or pencil may be used. Data is converted to ASCII and transmitted via RS-232 or current loop to the computer. Writing area is 168 \times 102 mm and is 11 rows by 28 columns. The display is formed on a 7 \times 5 dot-matrix, 5-mm high, green display. A DB-25 connector is provided and baud rate is to 1200. Self diagnosis software is provided. It requires an external 21-volt power supply. Address: Micropad Inc., Suite 1510, 35 E. Wacker Dr., Chicago, IL 60601 (Tel: 312-346-4667).

Apple Interface The D109 Universal Digital Interface for the Apple II occupies one slot, and features 32 digital input or output lines, 4 programmable timers, 2 shift registers, full interrupt capability, and optional current drive and isolation. It can take control of the 32 data lines, which can be used as inputs or outputs as dictated by software. The timers can be set from one microsecond to 17 years, and there are 14 different interrupts. Address: Interactive Structures Inc., Box 404, Bala Cynwyd, PA 19004 (Tel: 215-667-1713).

KIM A/D. KIMSET1 gives a KIM the capability of measuring up to 16 channels of analog input with a resolution of eight bits. Consisting of a KIMMOD, AIM16 16-channel A/D converter, MANMOD1 manifold module, POW1 power supply, software, and operating instructions, the system plugs into the applications port. It converts the 16 0-to-5.12-volt analog inputs to their equivalent 0 to 255 digital values. \$285. Address: Connecticut microComputer Inc., 150 Pocono Rd., Brookfield, CT 06804 (Tel: 203-775-9659).

Z80 Monitor ROM. Housed in a single 2716 EPROM, and designed to support the SSM CB2-Z80 Microcomputer Board, a new EPROM monitor allows operator to display, substitute, or fill memory; perform hex arithmetic; establish two program breakpoints; set and examine registers; assign I/O devices; input and output from an I/O port; plus other board-level programming. Built-in scanning enables the monitor to review remaining memory and set the stack. Extensive documentation and listings are provided. \$89. Address: SSM Microcomputer Products, 2190 Paragon Drive, San Jose, CA 95131 (Tel: 408-946-7400).

SS-50 Bus RAM. The M24SS RAM plug-in is available in 8-, 16-, and 24-K-byte configurations. There is also an 8K-byte kit for expanding the 8K and 16K-byte versions. The boards work with the SS-50 or extended addressing SS-50C bus. The boards may be strapped to reside in any of the sixteen 64K-byte zones of an extended 1M-byte memory space, is organized in 8K segments that may be located at any 8K boundary, and includes a 6800/6809 memory diagnos-

tic. The 8K is \$199.95, 16K is \$349.95, and a 24K is \$499.95. The memory expansion kit is \$139.95. Address: Percom Data Co., 211 N. Kirby, Garland, TX 75042 (Tel: 214-272-3421).

Robots. A complete catalog of mechanical and electronic parts for construction of a robot is now available. It includes parts from a number of manufacturers, plus a wide array of other mechanical elements. There is also a robot newsletter. Address: The Robot Mart, 19 West 34th St., New York, NY 10001 (Tel: 212-695-5108).

TRS-80 to GPIB. The Model 488-80C Interface Adaptor enables any Radio Shack Model 3 with a minimum of 16K RAM and Level II BASIC to be used as a GPIB-488 controller with GPIB I/O in BASIC. The machine language program interacts with either

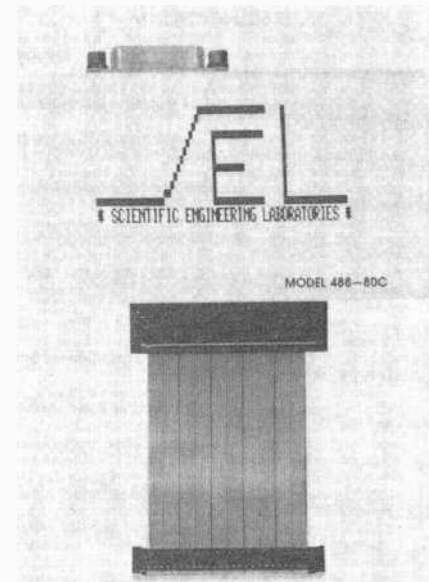

Level 2 or Disk BASIC. An optional relocatable driver program (ML3) is available for assembler level GPIB I/O programming. \$225. ML3 is \$35. Address: Scientific Engineering Lab., 11 Neil Dr., Old Bethpage, NY 11805 (Tel: 516-694-3205).

Apple Calendar/Clock. The Model 7424 Calendar/Clock Module provides accurate real-time counting for the Apple II. The battery powered crystal-controlled clock counts seconds, minutes, hours, days of the week and month, months and years. It includes three separate jumper-selectable driver programs, space for user-written drivers, and an on-board 1K of EPROM. In addition, 256 bytes of RAM or ROM may be added for custom software. Both 12- and 24-hour formats are available and an interrupt may be generated every millisecond, second, minute or hour. It also allows both interrupt and daisy-chain passthrough. \$125. Address: Cali-

SOUND UNLEASHED

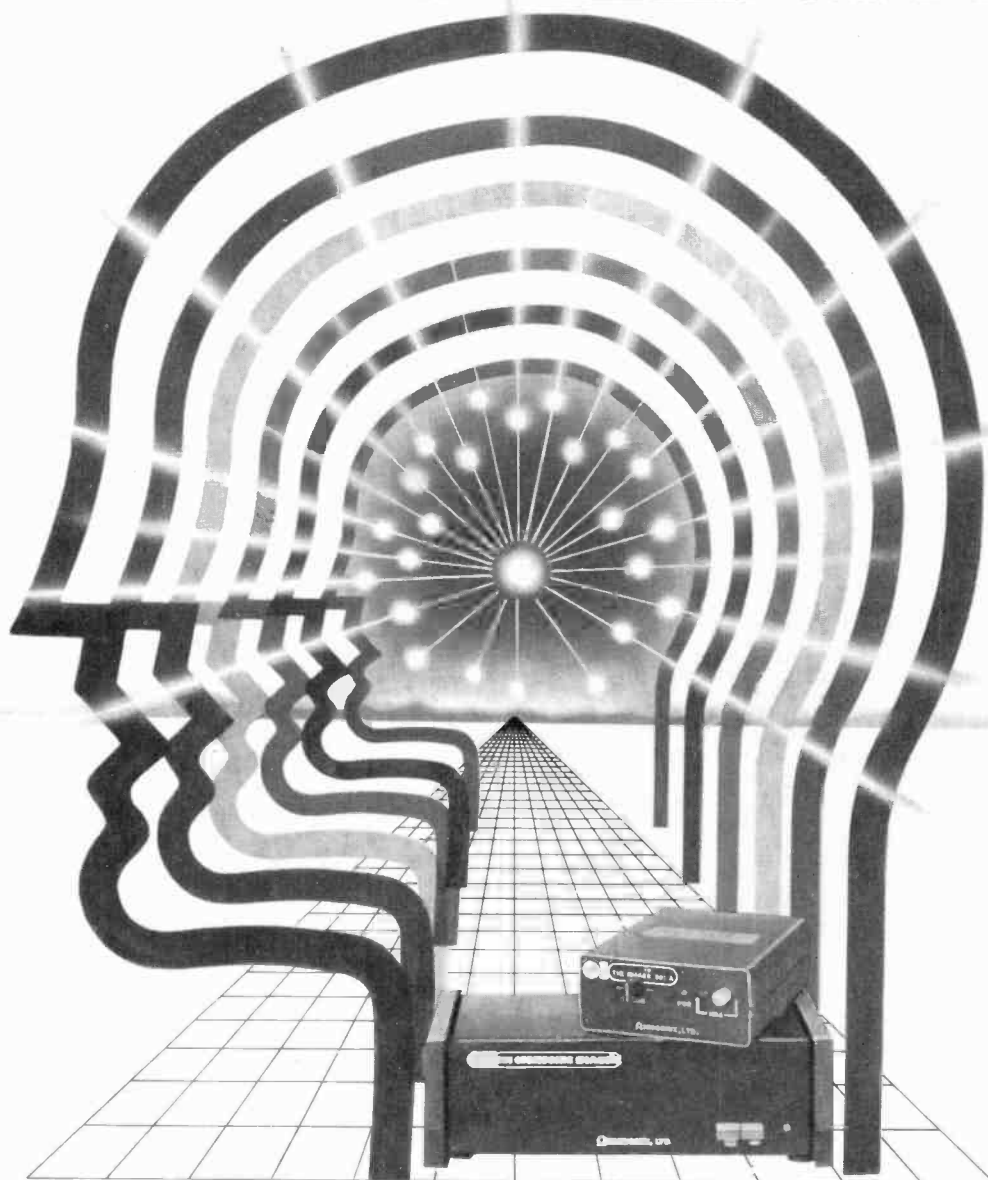

You may not realize it, but you've only been listening to music in two dimensions. In fact, owners of the most sophisticated systems utilizing the latest enhancement techniques are also only hearing two-dimensional sound, totally lacking the missing third dimension, Omnisonic Imagery™. Even owners of the most modest stereo systems will recognize the 801 Omnisonic Imager™ as one of the most significant improvements in music reproduction in years. This advance, available after extensive research by Omnisonix in the field of psychoacoustics, is intended to provide the enjoyment and feeling of live musical performance. To vastly upgrade the performance of your stereo system, simply connect the 801 to the tape or preamp input/output jacks and listen to clear, distinct sound images that seem to surround you, even while moving about. In fact, the impact is so great that the sound seems to come from outside the

speaker plane, often overhead and to the rear. Your home virtually becomes a concert hall.

Hearing is convincing

To experience the dramatic presence and detail that have been missing from your records, digitally recorded discs, and pre-recorded tapes, take a few of your favorites to an Omnisonix dealer for a demonstration; you are in for a musical delight. And amazingly enough, any tape you record through an Omnisonic Imager will retain the Omnisonic quality when it is played back on a conventional stereo system. The 801 Omnisonic Imager also adds a dimension to FM, monophonic AM and TV sound, with a simple adjustment.

Highway imagery

The new Imager 801-A™ does for your car stereo what the 801 does for your home music system. It raises the sound from the floor level to the ear level. The variable

imager control allows you to vary the image to any auto environment.

Hear what you've been missing

Join the growing thousands of music listeners who have found it completely affordable to enjoy the delight of Omnisonic Imagery and discover what they had been missing with conventional stereo.

Since all Omnisonic Imagers are designed and built for lasting performance under strict quality control conditions, Omnisonix offers a lifetime warranty on the active proprietary circuitry.

**Call today, toll free
1-800-243-0688**

For additional information and the name of your nearest Omnisonix dealer. Write: P.O. Box 430, Northford, Ct. 06472 or call 203-239-6213 in Connecticut.

OMNISONIX, LTD.
Setting Sound Free

CIRCLE NO. 64 ON FREE INFORMATION CARD

fornia Computer Systems, 250 Caribbean Dr., Sunnyvale, CA 94086 (Tel: 408-734-5811).

Software

Apple FORTRAN/COBOL. Written for an Apple II using a Softcard, both languages run under CP/M. FORTRAN-80 is a fast and compact compiler that can handle several hundred statements per minute in a single pass and needs less than 25K bytes of memo-

ry. It compiles true Z80 machine code which is 2 to 3 times faster than Apple FORTRAN. It supports a double precision, integer X4 and X1 data types and is supplied with an extensive library of floating point, math and I/O routines, and a linking loader. \$195. COBOL-80 is ANSI Standard 1974 and includes sequential, line sequential, relative and indexed sequential data files. Full screen I/O and editing and program chaining with parameter passing is provided. Program segmentation allows programs larger than memory size. It includes a linking loader, macro assembler, library manager, cross reference-assembler, and all documentation. \$750. Address: Mi-

crosoft Consumer Products, 400 108th Ave., NE, Suite 200, Bellevue, WA 98004 (Tel: 206-454-1315)

TRS-80 Screen Editor. The Full Screen Editor 1010-20 is compatible with Level II and Disk BASIC for the TRS-80 Model I. The full-screen display can be positioned to see any portion of the program and the cursor can be positioned to any point in the screen. Features include character change/insert/delete, extend line, insert lines, delete line or blocks of lines, copy line or blocks of lines, move lines or blocks of lines, renumber entire program, search program for specified string, global change, and macro key facility. The latter allows redefining the 26 alphabetic keys to represent BASIC keywords or any other character string. \$24.95. The EDTASM version (1010-30) for assembly language programming with the same features is also \$24.95. Address: Computer Applications Unlimited, Box 214, Dept. 48C, Rye, NY 10580.

16-Bit CP/M. CP/M-86 is an operating system designed for 8086/8088-based microcomputers. This 16-bit product is designed to take advantage of the 8086 address space and speed, while expanding upon the facilities of standard CP/M. It can also function as a slave node in a CP/NET network. MP/M-86 and PL/I-86 will soon be introduced. Address: Digital Research, Box 579, 801 Lighthouse Ave., Pacific Grove, CA 93950 (Tel: 408-649-3896).

Atari 800 Programs. IRIDIS #1 contains four programs for the Atari 800 computer. Clock is an old-fashioned wall clock with chimes; Cap uses the joystick to knock down targets; Logo is a flashy demo of the Atari color registers; and Polygons allows the machine to construct a variety of geometric patterns. \$9.95 for cassette, \$12.95 for diskette. Address: The Code Works, Box 550, Goleta, CA 93017 (Tel: 805-967-0905).

Apple Utilities. Designed for the Apple II with Romplus board, Renumber/Merge requires 48K, Applesoft in ROM, and will operate with or without Disk II. When activated, it will not interfere with any program in memory. \$49.95. Disk Copy/Disk Space consists of two disk utility programs in one ROM. Disk Copy will duplicate a disk with one drive, two drives with one controller, or two drives and two controllers. Disk Space will read track bit map and display number of free sectors and bytes. \$49.95. Will operate with DOS 3.2, 3.3, 32K or 48K, Int, FP, LS, II, or II Plus. Address: Soft CTRL Systems, Box 599, West Milford, NJ 07480.

TRS-80 Games. "Space Colony" for the Programma High Resolution Graphic Board is a shoot-em-up game for a 4K, Level II system with sound. \$9.95 for Programma Board or standard

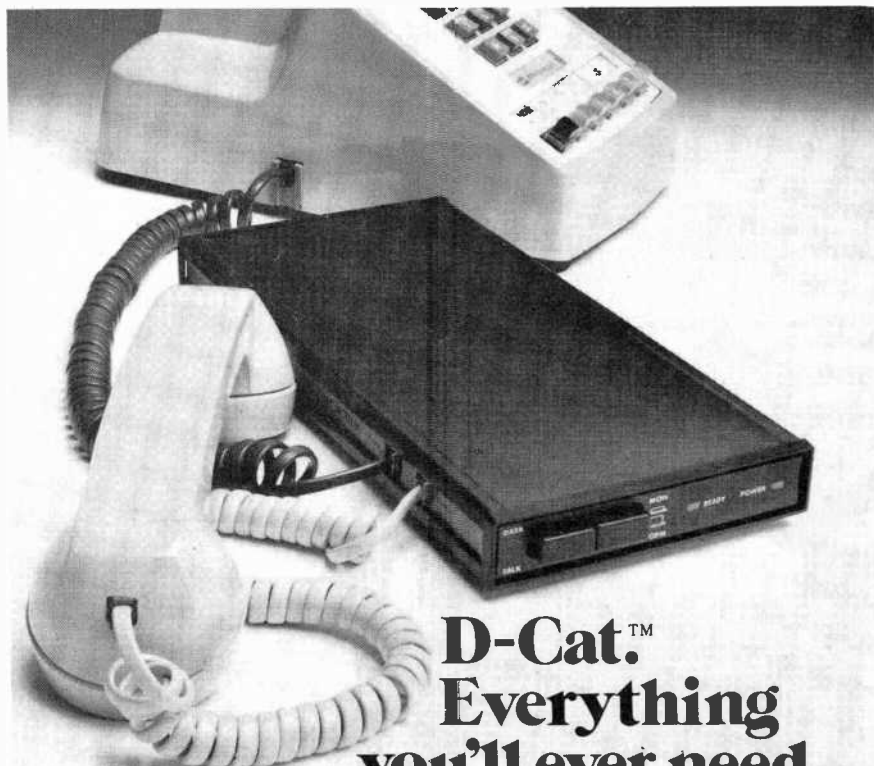

**D-Cat™
Everything
you'll ever need
in a basic, direct modem.**

There's only one originate/answer modem that gives you the performance and reliability of a direct connect modem with the portability and price of an acoustic. Novation's new D-Cat.

D-Cat is the only direct modem that's FCC approved for handset jack connection with any modular phone. Use it at home or at work on a 50-pin, six line business phone. Talk to D-Cats, Cats, or any other Bell 103 compatible modem.

D-Cat also has all the features you want: full duplex capability, voice/data

monitor, up to 20 dB performance improvement over acoustic, hold function, privacy button, self-test, and a remarkable price. Only \$199.

But best of all, it's from Novation. The recognized world leader in personal communications.

**D-Cat by
Novation**

Call for details:
(800) 423-5410
In California (213) 996-5060

Available at Avnet Electronics, Hamilton Electro, Hamilton Avnet, Kierulff Electronics, Byte Shops, Computerland, and your local computer store.

Novation, Inc., 18664 Oxnard Street, Tarzana, California 91356

CIRCLE NO. 44 ON FREE INFORMATION CARD

ELECTRONICS BOOK CLUB

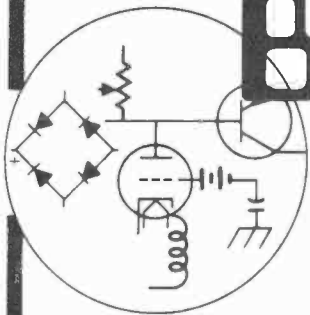

Take 4
exceptional \$1⁰⁰
books for
(values to \$70.80)

1209
List \$11.95

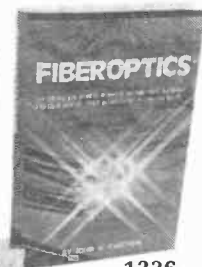

1236
List \$14.95
1339
List \$13.95



1250
List \$16.95
1225
List \$15.95

Start saving now for discounts up to 75% on hundreds of interesting, info-packed volumes . . . PLUS special Members' Bonus Benefits!

1245
List \$16.95



1062
List \$12.95

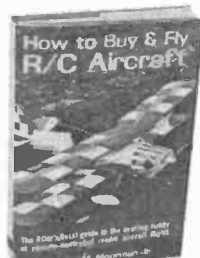

1221
List \$14.95



1186
List \$12.95

OSCAR:
The Ham Radio
Satellites

1120
List \$8.95

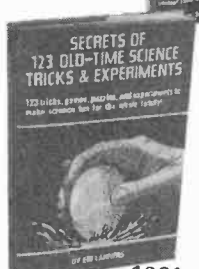

1261
List \$12.95

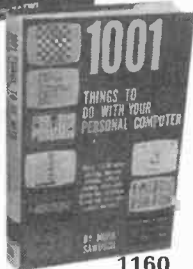

1160
List \$12.95

More books to pick from . . .

- How to Make Home Electricity From Wind, Water and Sunshine. List \$10.95. No. 1128
- 99 Test Equipment Projects You Can Build. List \$12.95. No. 805
- Radio Astronomy for the Amateur. List \$8.95. No. 714
- Tower's International Op Amp Linear-IC Selector. List \$12.95. No. 1216
- 303 Dynamic Electronic Circuits. List \$9.95. No. 1060
- The Master IC Cookbook. List \$16.95. No. 1199
- How to Design & Build Your Own Custom TV Games. List \$14.95. No. 1101
- Modern Digital Communications. List \$10.95. No. 955



1203
List \$14.95

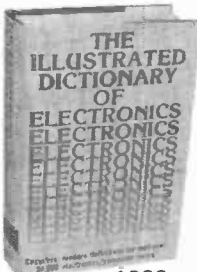

1066
List \$19.95

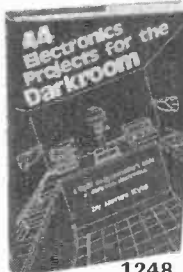

1248
List \$14.95

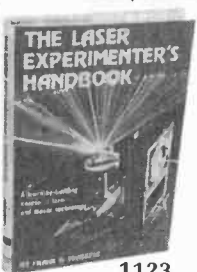

1123
List \$9.95

7 very good reasons to try Electronics Book Club . . .

- **Reduced Member Prices.** Save up to 75% on books sure to increase your know-how
- **Satisfaction Guaranteed.** All books returnable within 10 days without obligation
- **Club News Bulletins.** All about current selections—mains, alternates, extras—plus bonus offers. Comes 14 times a year with dozens of up-to-the-minute titles you can pick from
- **"Automatic Order".** Do nothing and the Main selection will be shipped to you automatically! But . . . if you want an Alternate selection—or no books at all—we'll follow the instructions you give on the reply from provided with every News Bulletin
- **Continuing Benefits.** Get a Dividend Certificate with every book purchased after fulfilling Membership obligation, and qualify for discounts on many other volumes
- **Bonus Specials.** Take advantage of sales, events, and added-value promotions
- **Exceptional Quality.** All books are first-rate publisher's editions, filled with useful, up-to-the-minutes info

ELECTRONICS BOOK CLUB Blue Ridge Summit, PA 17214

Please accept my Membership in Electronics Book Club and send the 4 volumes circled below. I understand the cost of the books selected is \$1.00 (plus shipping/handling). If not satisfied, I may return the books within ten days without obligation and have my Membership cancelled. I agree to purchase 4 or more books at reduced Club prices during the next 12 months, and may resign any time thereafter.

714 805 955 1060 1062 1066 1101 1120
1123 1128 1160 1186 1199 1203 1209 1216
1221 1225 1236 1245 1248 1250 1261 1339

Name _____ Phone _____

Address _____

City _____

State _____ Zip _____

(Valid for new members only Foreign and Canada add 20%.)

PE-581

SATELLITE HOME EARTH STATIONS

Complete — \$3495.00,
IMMEDIATE SUPPLY

Satelco
5540 W. Pico Blvd.
Los Angeles, CA 90019
(213) 931-6274

CIRCLE NO. 53 ON FREE INFORMATION CARD

THE HUSTLER SATELLITE VIDEO SYSTEM

Designed for the Discriminating

The Hustler Satellite Video System receiver is tailored for the quality-conscious Earth Station owner. It is...

- Simple — no complicated meters or adjustments
- Enjoyable — 24 channels of television programming
- Convenient — easy, plug-in connections
- Reliable — professional-calibre performance
- Attractive — wood cabinet with brushed aluminum panel

Clearly the choice of those who know quality

HUSTLER

3275 North "B" Avenue Kissimmee, Florida 32741

An ARMAVIA Company

TRS-80 graphics. "Symon/Capture" is a blockage-type game with graphics and sound, the Symon portion being a variation of Simon. \$12.95 for cassette, \$17.95 diskette. "Super Invaders" is the famous arcade alien invader game sweeping the country. It has sound and requires 32K. \$24.95 diskette only. Address: Soft Sector Marketing Inc., Box 2471, Livonia, MI 48150 (Tel: 313-425-4020).

TI/Source. TEXNET for the TI-99/4 home computer offers all the services of the Source information utility plus new data bases that take advantage of the color, graphics, sound, music, and speech capabilities of the TI-99/4. In addition, it allows users to hear any messages typed on the computer keyboard, or transmitted over the TEXNET system. Address: Texas Instruments Inc., Consumer Relations, Box 53, Lubbock, TX 79408 (Tel: 800-858-4565; in Texas, 800-692-4279).

Apple Communications Package. The Datacom is a data communications package for use with a Hayes Micromodem II for Pascal-equipped Apple systems. The package consists of a diskette and Pascal manual containing two levels of program commands; Datacom Terminal Program for Pascal; and Pascal Micromodem II routines. Software uses English words, simultaneous print while connected, 110 or 300 baud transmission, and auto-dial/auto-answer capabilities. \$50. Address: Hayes Microcomputer Products Inc., 5835 Peachtree Corners East, Norcross, GA 30092 (Tel: 404-449-8791).

Visicalc Utility. The VU #3 is a modular disk-based utility that accepts data produced by Visicalc through the PRINT-DISK command, and to reorganize and restructure it so that the data can be read by other Visicalc programs. It will also accept Integer and Applesoft data, relocate individual pieces, rows,

columns, and blocks of data, or the entire input file. It also allows many input files to be written as one output file, or one input file to be written as many output files. It can write output data for Visicalc, Integer, or Applesoft programs, view input or output files, and correct individual records of the output file. It also allows new data into the output file, which can be overlaid on a Visicalc program as data. \$69.95 plus \$4.95 p/h. Address: Progressive Software, Box 273, Plymouth Meeting, PA 19462 (Tel: 215-279-4438).

TRS-80 Word Processing. WP-730.4 Word Processor is for use with a TRS-80 Level II with 16K and Line Printer II (Centronics 730 or similar). Features include typing limited by user's ability, same editing capability as TRS-80 Level II, upper/lower-case printout, change line length from 1 to 80 characters, adjustable margins and right justification, expanded printout, centered lines, indented lines, and cassette save. No disk system is required. \$35. Address: GB Associates, Box 3322, Granada Hills, CA 91344.

COBOL Course. The Heathkit/Zenith EC-1105 COBOL Programming Course covers both the ANS 74 and ANS 68 versions of COBOL. It teaches the fundamentals of encoding, input characteristics, program hierarchy, identification, environment, data, and procedure divisions. Six practice programs are included. It employs audio-tutorial learning, using text and nine audio cassettes. \$149.95. Address: Heathkit/Zenith Educational Systems, Dept. 350-490, Benton Harbor, MI 49022, or any Heathkit Electronic Center.

ET-3400 Users Group. Users of the Heath ET-3400 microprocessor training system now have a user's group and newsletter. Contact ET-3400 Users Group, c/o Charles Van Dyke, 11231 Oak St., El Monte, CA 91731 (Tel: 213-443-2237, CompuServe 70250,463).

Monopoly Program. "Monty Plays Monopoly" turns Apple II and TRS-80 computer into skilled players of the classic Parker Brothers board game. This is not a monopoly game, but a computerized opponent programmed to act as another player, with graphics. As many as seven players (plus Monty) can play at

one time. The computer generates the dice throws, and keeps track of each player's position with prompts. Sound effects have been added. \$34.95 diskette, \$29.95 cassette. Address: Personal Software Inc., 1330 Bordeaux Drive, Sunnyvale, CA 94086 (Tel: 408-745-7841).

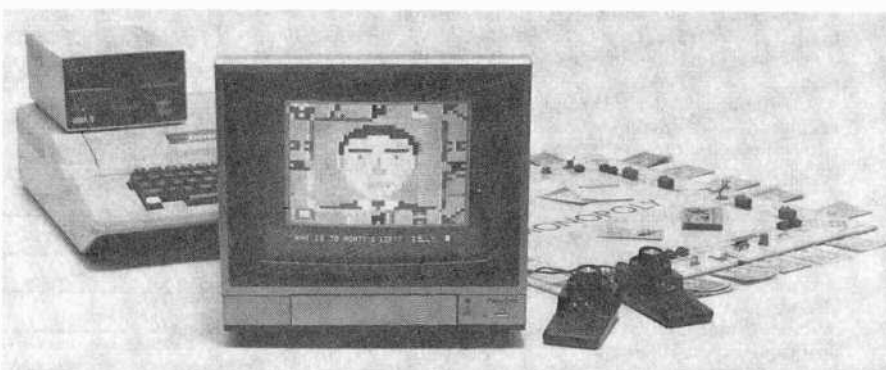

You'll be a little richer after building one of these.

H-19 Professional Video Terminal



H-8 Personal Computer with Dual Floppy Disk Storage



H-11A 16-Bit Computer with Dual Floppy Disk Storage



H-89 All-In-One Computer with Floppy Disk Storage



H-14 Serial Printer



Self-Instruction for Assembly and BASIC Programming



Richer in knowledge

Once you build your own computer, you'll know it inside out. You'll know how to make it work for you, how to make it grow as your skills grow.

Richer in savings

Build-it-yourself kits cost less — about 30% less than comparable assembled computers. And you'll probably never need to pay someone for service because no one will know your computer better than you.

Is it hard?

Not at all. Heath makes it simple with easy-to-assemble designs and with step-by-step manuals that guide you from unpacking to final plug-in. And a Heathkit helping hand is always just a phone call away.

Innovative software

Heath offers you innovative programs for running your home or business, and exciting games for your family. You can have Microsoft™ BASIC™, one of the most powerful and widely used languages.

Heath User's Group (HUG) will share with you a library of over 500 programs to make your computer serve you in ways you never imagined.

Complete hardware

Choose from three computer systems:

The H89 All-In-One Computer gives you everything in one compact, convenient unit.

The flexible H8 gives you the freedom to combine memory and interfacing for exactly the system you require.

And the powerful H11A gives you 16-bit

power for your most complex programs.

The Heathkit line includes video terminals, matrix and letter-quality printers and a complete selection of accessories. You'll even find award-winning self-instruction packages to teach yourself programming in BASIC or Assembly.

FREE CATALOG

It's all in the new 104-page Heathkit Catalog, along with nearly 400 electronic kits for your home, work or pleasure. Send for your free catalog today, or pick one up at your Heathkit Electronic Center.*



Heathkit®

*Visit your Heathkit Electronic Center in the U.S. or Canada where Heathkit Products are displayed, sold and serviced. See your white pages for the location nearest you. Heathkit Electronic Centers are units of Veritechnology Electronics Corporation in the U.S.

Write to Heath Company, Dept. 010-774, Benton Harbor, MI 49022
(In Canada write Heath Company, 1480 Dundas St. E., Mississauga, Ont. L4X 2R7)

CIRCLE NO. 26 ON FREE INFORMATION CARD

CP-156

Popular Electronics Tests



Hewlett-Packard HP-85 Computer

HEWLETT-PACKARD calls the HP-85 the "personal computer for the professional." Judging by its base price (\$3,250), the cost of peripherals, and the titles of the available software, the HP-85 is intended for accountants, engineers, and scientists—and fairly well-heeled ones at that.

Inside the HP-85's 17.8"D x 16.5"W x 6.3"H, 20-lb package is a fully integrated computing system consisting of: a 5-in. CRT that can display 32 x 16 alphanumeric or 256-by-192-dot graphics; 32-column thermal printer; tape-cartridge storage system; HP's own CPU; 16K bytes of RAM (expandable to 32K bytes maximum); and BASIC in ROM. Additionally, the computer has rear-panel slots for plugging in a comprehensive range of optional items via an HP-IB interface module (\$395), which handles up to 14 peripherals.

Among the options available from HP are: a 16K byte memory module (\$395); 7225A graphics plotter (\$2,050 plus \$750 for required personality module); 2631B dot-matrix impact printer

(\$3,650 plus \$150 for high-density print option); and an assortment of 5 1/4" and 8" double-sided, double-density flexible-disk drives (\$1,500 to \$6,500). Software is available in cartridge-tape Application Pacs for \$95 each and includes such titles as BASIC Training, Circuit Analysis, Financial Decisions, and Waveform Analysis.

For those who wish to configure their own systems, HP has the HP-83, which is identical to the HP-85 but lacks the on-board printer and cartridge-tape system. Price is \$2,250. Hewlett-Packard also has, in the works, a less expensive printer that will interface serially with the HP-83 and HP-85; cost of the printer will be about \$1,000.

System Hardware. The HP-85 is built around a custom-designed proprietary microprocessor and a powerful BASIC language that integrate the various elements into a unitary computing system. All additions to the system (RAM expansion, ROMs, and peripherals) are accomplished externally,

through four plug-in "module ports." Even the roll paper for the printer is loaded into an isolated well in the top of the cabinet.

There's not much to tell about the NMOS microprocessor, except that it is designed to access up to 112K bytes of mixed ROM and RAM. Resident in the HP-85 are 16K bytes of RAM and 32K bytes of ROM. To these can be added an optional 16K byte RAM module and up to six 8K byte ROM modules.

On power-up, the HP-85 goes directly into BASIC, and since there's no way of exiting BASIC, there's no means for entering machine-language routines. However, in the BASIC mode, you have access to all of the system's elements, including peripherals.

The cartridge-tape system is used to load programs and data from the Application Pacs and for storing user written data and programs on blank tapes. This system is completely under program control, using such keys as REW (rewind) and LOAD, which can also be invoked by calls in a BASIC program.

Save on Scanners! NEW Rebates!

Communications Electronics™, the world's largest distributor of radio scanners, celebrates Father's Day early with big savings on Bearcat scanners. Electra Company, the manufacturers of Bearcat scanners is offering consumer rebates on their great line of scanners, when purchased between April 1 and May 15, 1981.

With a scanner, you can monitor the exciting two-way radio conversations of police and fire departments, intelligence agencies, mobile telephones, energy/oil exploration crews, and more. Some scanners can even monitor aircraft transmissions! You can actually hear the news before it's news. If you do not own a scanner yourself, now's the time to buy your scanner from Communications Electronics. Choose the scanner that's right for you, then call our toll-free number to place your order with your Visa or Master Charge.

We give you excellent service because CE distributes more scanners worldwide than anyone else. Our warehouse facilities are equipped to process thousands of scanner orders every week. We also export scanners to over 300 countries and military installations. Almost all items are in stock for quick shipment, so if you're a person who prefers fact to fantasy and who needs to know what's really happening around you, order your scanner today from CE!

NEW! Bearcat® 350

The Ultimate Synthesized Scanner!

Allow 120-240 days for delivery after receipt of order due to the high demand for this product. List price \$599.95/CE price \$419.00

4-Band, 50 Channel • Alpha-Numeric • No-crystal scanner • AM Aircraft and Public Service bands. • Priority Channel • AC/DC Bands: 30-50, 118-136 AM, 144-174, 421-512 MHz. The new Bearcat 350 introduces an incredible breakthrough in synthesized scanning: Alpha-Numeric Display. Push a button—and the Vacuum Fluorescent Display switches from "numeric" to word descriptions of what's being monitored. 50 channels in 5 banks. Plus, Auto & Manual Search, Search Direction, Limit & Count, Direct Channel Access, Selective Scan Delay, Dual Scan Speeds, Automatic Lockout, Automatic Squelch, Non-Volatile Memory. Reserve your Bearcat 350 today!

Bearcat® 300

List price \$549.95/CE price \$349.00/\$25.00 rebate Your final cost is a low \$324.00

4-Band, 50 Channel • Service Search • No-crystal scanner • AM Aircraft and Public Service bands. • Priority Channel • AC/DC Bands: 32-50, 118-136 AM, 144-174, 421-512 MHz. The Bearcat 300 is the most advanced automatic scanning radio that has ever been offered to the public. The Bearcat 300 uses a bright green fluorescent digital display, so it's ideal for mobile applications. The Bearcat 300 now has these added features: Service Search, Display Intensity Control, Hold Search and Resume Search keys, Separate Band keys to permit lock-in/lock-out of any band for more efficient service search.



NEW! Bearcat® 350

FREE Bearcat® Rebate Offer

Get a coupon good for a \$25 rebate when you purchase a Bearcat 300, 250, 220 or 210XL; \$20 rebate on model 160; \$10 rebate on model Four-Six Thin Scan and \$5 rebate on the Bearcat 5. To get your rebate, mail this coupon with your original dated sales receipt and the Bearcat model number from the carton to Electra. You'll receive your rebate in four to six weeks. Offer valid only on purchases made between April 1, 1981 and May 15, 1981. All requests must be postmarked by May 30, 1981. Limit of one rebate per household. Coupon must accompany all rebate requests and may not be reproduced. Offer good only in the U.S.A. Void where taxed or prohibited by law. Resellers, companies, clubs and organizations—both profit and non-profit—are not eligible for rebates. Employees of Electra Company, their advertising agencies, distributors and retailers of Bearcat Scanners are also not eligible for rebates. Please be sure to send in the correct amount for your scanner. Pay the listed CE price in this ad. Do not deduct the rebate amount since your rebate will be sent directly to you from Electra. Orders received with insufficient payments will not be processed and will be returned.

Bearcat® 250

List price \$429.95/CE price \$279.00/\$25.00 rebate Your final cost is a low \$254.00

50 Channels • Crystalline • Searches Stores • Recalls • Digital clock • AC/DC Priority Channel • 3-Band • Count Feature. Frequency range 32-50, 146-174, 420-512 MHz. The Bearcat 250 performs any scanning function you could possibly want. With push button ease you can program up to 50 channels for automatic monitoring. Push another button and search for new frequencies. There are no crystals to limit what you want to hear. A special search feature of the Bearcat 250 actually stores 64 frequencies and recalls them, one at a time, at your convenience.

Bearcat® 220

List price \$449.95/CE price \$289.00/\$25.00 rebate Your final cost is a low \$264.00

Aircraft and public service monitor. Frequency range 32-50, 118-136 AM, 144-174, 420-512 MHz. The Bearcat 220 is one scanner which can monitor all public service bands plus the exciting AM aircraft band channels. Up to twenty frequencies may be scanned at the same time.

Not only does this new scanner feature normal search operation, where frequency limits are set and the scanner searches between your programmed parameters, it also searches marine or aircraft frequencies by pressing a single button.

Bearcat® 210XL

List price \$349.95/CE price \$229.00/\$25.00 rebate Your final cost is a low \$204.00

18 Channels • 3 Bands • Crystalline • AC/DC Frequency range: 32-50, 144-174, 421-512 MHz. The Bearcat 210XL scanning radio is the second generation scanner that replaces the popular Bearcat 210 and 211. It has almost twice the scanning capacity of the Bearcat 210 with 18 channels plus dual scanning speeds and a bright green fluorescent display. Automatic search finds new frequencies. Features scan delay, single antenna, patented track tuning and more!

NEW! Bearcat® 160

List price \$299.95/CE price \$189.00/\$20.00 rebate Your final cost is a low \$169.00

16 Channels • 3 Bands • AC only • Priority Dual Scan Speeds • Direct Channel Access Frequency range: 32-50, 144-174, 440-512 MHz. Would you believe...the Bearcat 160 is the least expensive Bearcat crystalline scanner.

This scanner presents a new dimension in scanning form and function. Look at the smooth keyboard. No buttons to punch. No knobs to turn. Instead, finger-tip pads provide control of all scanning operations, including On/Off, Volume and Squelch. Of course the Bearcat 160 incorporates other advanced Bearcat features such as Priority, Direct Channel Access, Dual Scan Speeds, Automatic Channel Lockout, Scan Delay and Auxiliary. All this performance in sleek, contemporary styling. And at a price so low, it astounds even us!

Bearcat® 5

List price \$134.95/CE price \$94.00/\$5.00 rebate Your final cost is a low \$89.00

8 Crystal Channels • 3 Bands • AC only Frequency range: 33-50, 146-174, 450-508 MHz. The Bearcat 5 is a value-packed crystal scanner built for the scanning professional — at a price the first-time buyer can afford. Individual lockout switches.

Bearcat® Four-Six ThinScan™

List price \$189.95/CE price \$124.00/\$10.00 rebate Your final cost is a low \$114.00

Frequency range: 33-47, 152-164, 450-508 MHz. The incredible, Bearcat Four-Six Thin Scan™ is like having an information center in your pocket. This three band, 6 channel crystal controlled scanner has patented Track Tuning on UHF. Scan Delay and Channel Lockout. Measures 2 1/4 x 6 1/4 x 1 1/4". Includes rubber ducky antenna. Order crystals for each channel. Made in Japan.

TEST ANY SCANNER

Test any scanner purchased from Communications Electronics™ for 31 days before you decide to keep it. If for any reason you are not completely satisfied, return it in original condition with all parts in 31 days, for a prompt refund (less shipping/handling charges and rebate credits).

Fanon Slimline 6-HLU

List price \$169.95/CE price \$109.00

Low cost 6-channel, 3-band scanner!

The Fanon Slimline 6-HLU gives you six channels of crystal controlled excitement. Unique Automatic Peak Tuning Circuit adjusts the receiver front end for maximum sensitivity across the entire UHF band. Individual channel lockout switches. Frequency range 30-50, 146-175 and 450-512 MHz. Size 2 1/4 x 6 1/4 x 1 1/4". Includes rubber ducky antenna. Order crystal certificates for each channel. Made in Japan.

Fanon Slimline 6-HL

List price \$149.95/CE price \$99.00

6-Channel performance at 4-channel cost!

Frequency range: 30-50, 146-175 MHz.

If you don't need the UHF band, get this model and save money. Same high performance and features as the model HLU without the UHF band. Order crystal certificates for each channel. Made in Japan.

FANON SCANNER ACCESSORIES

SCMA-6 Mobile Adapter/Battery Charger..... \$49.00
CHB-6 AC Adapter/Battery Charger..... \$15.00
CAT-6 Carrying case for Fanon w/Belt Clip..... \$15.00
AUC-3 Auto lighter adapter/Battery Charger..... \$15.00

OTHER SCANNERS & ACCESSORIES

Regency® M400 Scanner..... \$259.00
Regency® M100 Scanner..... \$199.00
Regency® R1040 Scanner..... \$169.00
SP50 AC Adapter..... \$9.00
SP51 Battery Charger..... \$9.00
SP58 Carrying Case for Bearcat 4-6 ThinScan™..... \$12.00
FB-E Frequency Directory for Eastern U.S.A..... \$12.00
FB-W Frequency Directory for Western U.S.A..... \$12.00
FFD Federal Frequency Directory for U.S.A..... \$12.00
MK350 Mobile mounting kit for Bearcat 350..... \$12.00
B-4 1.2 V AAA Ni-Cad's for ThinScan™ and Fanon..... \$9.00
A-135cc Crystal certificate..... \$3.00
Add \$3.00 shipping for all accessories ordered at the same time.

INCREASED PERFORMANCE ANTENNAS

If you want the utmost in performance from your scanner, it's essential that you use an external antenna. We have six base and mobile antennas specifically designed for receiving all bands. Order #A60 is a magnet mount mobile antenna. Order #A61 is a gutter clip mobile antenna. Order #A62 is a trunk-lip mobile antenna. Order #A63 is a 3/4 inch hole mount. Order #A64 is a 1/2 inch snap-in mount, and #A70 is an all band base station antenna. All antennas are \$35.00 and \$3.00 for UPS shipping in the continental United States.

BUY WITH CONFIDENCE

To get the fastest delivery from CE of any scanner, send or phone your order directly to our Scanner Distribution Center. Be sure to calculate your price using the CE prices in this ad. Michigan residents please add 4% sales tax. Written purchase orders are accepted from approved government agencies and most well rated firms at a 10% surcharge for net 10 billing. All sales are subject to availability. All sales on accessories are final. Prices, terms and specifications are subject to change without notice. Out of stock items will be placed on backorder automatically unless CE is instructed differently. Most products that we sell have a manufacturer's warranty. Free copies of warranties on these products are available prior to purchase by writing to CE. International orders are invited with a \$20.00 surcharge for special handling in addition to shipping charges. All shipments are F.O.B. Ann Arbor, Michigan. No COD's please. Non-certified and foreign checks require bank clearance.

Mail orders to: Communications Electronics™, Box 1002, Ann Arbor, Michigan 48106 U.S.A. Add \$7.00 per scanner or phone product for U.P.S. ground shipping and handling, or \$14.00 for faster U.P.S. air shipping to some locations. If you have a Master Charge or Visa card, you may call anytime and place a credit card order. Order toll free in the U.S.A. Dial 800-521-4414. If you are outside the U.S. or in Michigan, dial 313-994-4444. Dealer inquiries invited. All order lines at Communications Electronics™ are staffed 24 hours.

Scanner Distribution Center™ and CE logos are trademarks of Communications Electronics™

† Bearcat is a federally registered trademark of Electra Company, a Division of Masco Corporation of Indiana.
‡ Regency is a federally registered trademark of Regency Electronics Inc.

Copyright © 1981 Communications Electronics™



COMMUNICATIONS ELECTRONICS™

854 Phoenix □ Box 1002 □ Ann Arbor, Michigan 48106 U.S.A.
Call TOLL-FREE (800) 521-4414 or outside U.S.A. (313) 994-4444

We're first with the best.™

CIRCLE NO. 1 ON FREE INFORMATION CARD

TEST ROUTINE

```

10 REM *FILL SIN (X) / X
20 GCLEAR
30 RAD
40 SCALE -4*PI, 4*PI, -.5, 1.5
50 YAXIS 0, .5
60 XAXIS 0, PI/6
70 FOR X = -4*PI to 4*PI STEP PI/20
80 IF X = -4*PI THEN MOVE X, SIN(X) / X
90 IF X = 0 THEN 130
100 DRAW X, SIN(X) / X
110 MOVE X, 0
120 DRAW X, SIN(X) / X
130 NEXT X
140 END

```

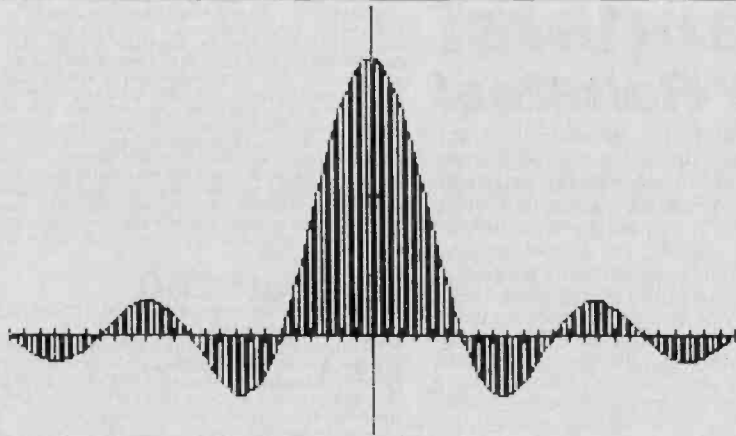

The tape system can store up to 210K bytes of data or 195K bytes of program on a standard 140-foot tape, with up to 42 named files per tape cartridge. This file-naming feature allows you to load either specific programs or to access various types of data in a simple, straightforward manner. Transfer rate is 650 bytes per second, average access time is 9.3 seconds, search speed is 7.8K bytes (60 in.) per second, and read/write speed is 10 in. per second. The system is equipped with a mechanical security system and has provisions for extra security via program control.

The HP-85's keyboard is an impressive, attention-getting feature. This is one of the few microcomputers with a typewriter-style keyboard on which each key is designed to perform a specific function. Virtually every function you can think of is implemented with a specific key. For example, pressing the LIST key causes a program in memory to be listed on the CRT screen. Tap LIST and SHIFT simultaneously, and the listing goes to the printer for hard-copy read-out. Touch the COPY key, and all on-screen graphics go to the printer, point by point. All of these functions are called by separate keys, without the need for user-written drivers.

The 92-key board is divided into four major parts: standard alphanumeric/punctuation typewriter board; numeric keypad with arithmetic functions (+, -, *, /, etc.); user-definable special-function keys; and display/system-control keys. Using the keyboard, you can directly access 128 of the HP-85's 256-character set. The remaining 128 characters, which are the same as the first 128 but underscored, are accessed via the CHR\$ function.

Hewlett-Packard has reversed standard keyboard convention with the CAPS LOCK key on the HP-85. Normally, pressing down CAPS LOCK locks in the upper-case print mode. On the HP-85, it locks in the lower-case mode. The company reasons that the computer will be used more for entry of specialized data and programs than for text editing, in which case, the upper-case mode would be used more often. (Remember, too, that BASIC converts all lower-case

characters, except those in strings enclosed in quotes, to upper case. Since upper-case is the "normal" mode for BASIC, this implementation of the CAPS LOCK key is logical, even though it takes some getting used to.)

The HP-85's built-in thermal printer is designed to print 32 alphanumeric (and graphics) characters per second. Much of this speed comes from the fact that printing is bidirectional. While text is printed exactly as shown on the CRT screen, graphics are rotated by 90° to permit creation of long graphs that wouldn't otherwise fit across the 4" width of the roll paper. Since this is a thermal printer, it requires special paper, which sells for about \$15 per roll.

The Software. HP-85 extended BASIC is often called an enhanced version of the original Dartmouth BASIC. "Enhanced" here simply means that the language has been designed to take advantage of the power of the integrated HP-85 computing system. Containing more than 150 commands and statements, HP-85 BASIC gives you full control over the CRT screen, on-board printer and cartridge-tape system, and all optional HP peripherals.

HP-85 BASIC enhancements allow you to perform a number of things other BASICs usually don't. For example, a unique software security system that operates on four levels, allows you to protect specified data and program files from being listed, edited, duplicated, written over, and even appearing in the catalog. With the CHAIN and COMMON commands, you can write a very long program and break it into small parts that can be called and executed automatically. The only limitation on program length would be the amount of data that can be stored on tape cartridge or optional disk.

Two levels of data precision are available with HP-85 BASIC. With "full" precision, you get a 12-digit mantissa and three-digit (± 499) exponent. Using "short" precision, five digits of mantissa and a two-digit (± 99) exponent are available. Integer range is ± 99999 .

HP-85 BASIC also allows user definition of the eight special-function keys to

interrupt program execution and direct program flow. Also, you can program a built-in beeper to sound, defining when and how long it will sound and its frequency. This useful feature can be used to signal completion of a desired subroutine, prompt for input, or highlight output. Frequency range of the beeper is approximately 0 to 4,575 Hz.

Another feature of this BASIC is its clock and timer functions. Time is maintained as seconds since midnight, referenced to the year and day of the year. Three timers can be independently programmed to generate periodic interrupts at intervals ranging from 0.5 to 99,999,999 ms (up to 1.16 days).

This isn't just another BASIC interpreter. It's actually an incremental compiler BASIC that checks each line on input for proper syntax. A syntactically correct line of data is interpreted directly to a run-time module and becomes a part of the program being written. If syntax is incorrect, however, an error message is generated on-screen and no entry is made to the program until the error is corrected.

Perhaps more important than input error checking is the method HP-85 BASIC uses for handling data structures, such as arrays. In this BASIC, data is initialized in much the same manner as it is in Pascal and ADA. This means that you can point to any given byte in an array or data set, regardless of where it may reside, even if it's on tape.

Lacking PEEK and POKE statements (they are absent from HP-85 BASIC), the user is barred from access to the processor and, hence, from entry of machine-language routines during programming. Access to the processor really wouldn't help—Hewlett-Packard doesn't provide the instruction set. While omission of PEEK and POKE may represent a major obstacle for the hobbyist, it is consistent with the business applications foreseen by the machine's designers. Professionals who use the HP-85 for business and design applications will rarely if ever need access to the processor. Moreover, just about any task you wish to perform on the HP-85 can be accomplished through BASIC.

For those determined to work in ma-

chine language, Hewlett-Packard has a Series 80 assembler ROM (\$295) that provides limited access to the processor. Plugged into a slot on the rear of the computer, the ROM provides access to many of the entry points used in HP-85 BASIC, including all math routines, high- and low-level CRT control, general I/O routines, etc. Also contained in the Series 80 ROM is an editor that checks for syntax. A comprehensive 400-page manual supplied with the ROM gives full documentation.

Evaluation. It would be unfair—and foolish—to evaluate the HP-85 in direct comparison with such general-purpose computers as the Heath H89, Apple II, or Radio Shack TRS-80. The HP-85 wasn't designed to facilitate machine-language programming, word processing, games playing, etc. In essence, it is dedicated to professional applications where BASIC will suffice. Viewed in this light, the HP-85 is nicely appointed, well integrated, and easy to operate.

We were impressed by the HP-85 BASIC for its power and its relatively high speed. One test of a BASIC is to write the statement 10 GOSUB 10 and observe what happens when it's executed. Most BASICs search through memory for the subroutine and then return an error message like OUT OF MEMORY AT 10 or GOSUB WITHOUT RETURN. HP-85 BASIC, however, returns an immediate error message. The manual gives a good method of checking out HP-85 BASIC. The test routine, shown with its output in the accompanying box, computes and plots a graph. It took 129 seconds to execute, which is acceptable but not particularly fast, since each plot is calculated as it's being drawn.

The system is capable of sharp high-resolution graphics, allowing you to put up to almost 50,000 (256 x 192) dots on-screen, each individually plotted. This being the case, you can design and display any graphics you might need—even create your own character sets. To simplify graphics operations, HP provides special commands that allow you to draw, erase, position labels on axes of graphs, define the limits of the axes, etc. Time, in HP-85 is kept and displayed in an unconventional way. According to the manual, you set time by typing SET-TIME 28800,81076, which represents 8 a.m., March 17, 1981. When displayed, the 28800 refers to the number of seconds since midnight, while 8107 is interpreted in two parts, the first two digits representing the year and the remaining digits the number of days into the year. It would be much better if the date and time could be presented in the format 03/17/81 and 08:00, instead of requiring extra interpretation.

At the present time, the only vendor of software for the HP-85 is Hewlett-Packard itself, which means that the range of available programs is seriously restricted.

However, now that the Series 80 as-

sembly ROM and manual are available to prospective software markets, this situation can be expected to get better.

While Hewlett-Packard offers a Text Editing Pac for the HP-85, it is suitable for occasional or light-duty use. If text editing is something that you need often or for very long, you'll probably be happier with a different computer.

The Bottom Line. With all of its attributes, the HP-85 is a limited computer. If you're in the market for a personal computer for the home, the HP-85 prob-

ably won't be your best choice. To begin with, it's considerably more expensive than typical home computers, and every option added boosts the system price even more. But price aside, the HP-85 would be a poor choice for software development or learning advanced programming skills. On the other hand, for the professional who wants basic number crunching, and doesn't much care how the computer goes about providing it, the HP-85 could be excellent.

—Carl Warren

CIRCLE NO. 103 ON FREE INFORMATION CARD

If you're looking for trouble, you came to the right place.

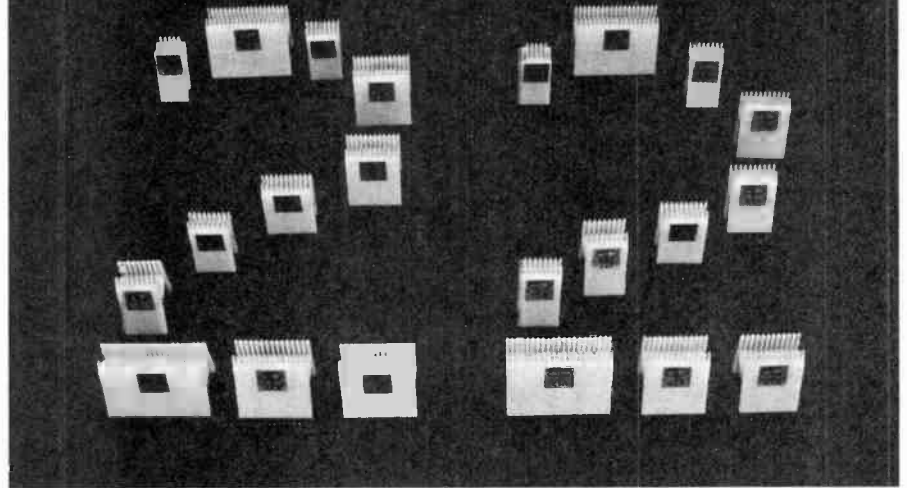

When you're testing circuitry, you need the best troubleshooter around: The AP Test Clip.

It's made with a narrow nose shape that allows for easy attachment on high density boards. Nailhead pins that keep probe hooks from sliding off ends. Open nose design that permits probe tip access to DIP leads. And a contact comb that fits between DIP leads, eliminating any possibility of shorts. All these little design differences add up to the ultra-reliable, safe, quick DIP troubleshooting you need.

You can buy AP Test Clips in 22 standard or connector-

compatible models in 11 sizes. (They're also available with long, headless test lead pins for attachment to AP jumper cable assemblies.) And every one is made with highest quality engineering-and industrial-grade materials for long life and reliability.

So don't go looking for trouble until you've contacted your AP PRODUCTS distributor and ordered AP Test Clips—the best little troubleshooters around.

Call TOLL FREE, 800-321-9668, for the name of the distributor nearest you. (In Ohio, call collect: (216) 354-2101.)



**A P PRODUCTS
INCORPORATED**

1359 West Jackson Street
Painesville, Ohio 44077
(216) 354-2101

In Europe, contact A P PRODUCTS GmbH • Bäumlesweg 21 • D-7031 Weil 1 • W. Germany

CIRCLE NO. 7 ON FREE INFORMATION CARD

**Now that POPULAR ELECTRONICS has you
looking to the heavens,
we'd like to show you the best
satellite system on earth.**



The THIRD WAVE SATELLITE COMMUNICATIONS SYSTEM®, Model TVRO-1, is the world's first completely integrated satellite reception system designed specifically for the home. It is the most technologically advanced direct-from-satellite-to-home television reception terminal, yet is as simple to operate as your present television or stereo system. Professional quality reception of most 3.7 to 4.2 GHz satellite transmissions is available with this frequency synthesized 24 channel remote controlled earth station. It is like having your own private cable network with your choice of all the best programming this hemisphere has to offer, including direct satellite relayed programs from all over the world. The TVRO-1 is designed to be your primary building block for telecommunications and data innovations of the coming decades.

Direct-to-home satellite reception...not only the ultimate in home entertainment, but also a tool to promote a new era in world communication and understanding.



**Third Wave
COMMUNICATIONS
CORPORATION**

2600 Gladstone
Ann Arbor, Michigan 48104
Phone (313) 996-1483

Your investment; \$10,000 plus shipping & installation.

AUTHORITATIVE ENGINEERS SATELLITE SURVIVAL KIT
 T.W.C.C. 2600 Gladstone Ave. Ann Arbor, MI 48104
 • Technical Data • System Design Considerations & Calculations
 • Sight Selection Techniques • Satellite Glossary & Footprints
 PLUS • SATELLITE CO-ORDINATES FOR YOUR HOME
 Send \$10 check or money order

Name _____
 Address _____
 City _____
 Latitude _____ State _____ Longitude _____ Zip _____

or call TOLL-FREE
 1-800-228-2606
 24 Hrs., 7 days a wk
 Credit cards
 Accepted

TV FROM OUTER SPACE: THE COMING OF DIRECT BROADCAST SATELLITES

BY JOHN J. McVEIGH
Technical Editor

Artist's conception of a Direct Broadcast Satellite.
Courtesy Satellite Television Corporation.

By the turn of the century, a typical American home is expected to contain a highly developed and flexible video installation. This will include a 90-channel, interactive cable link, direct reception from six local broadcasters, a well-stocked video

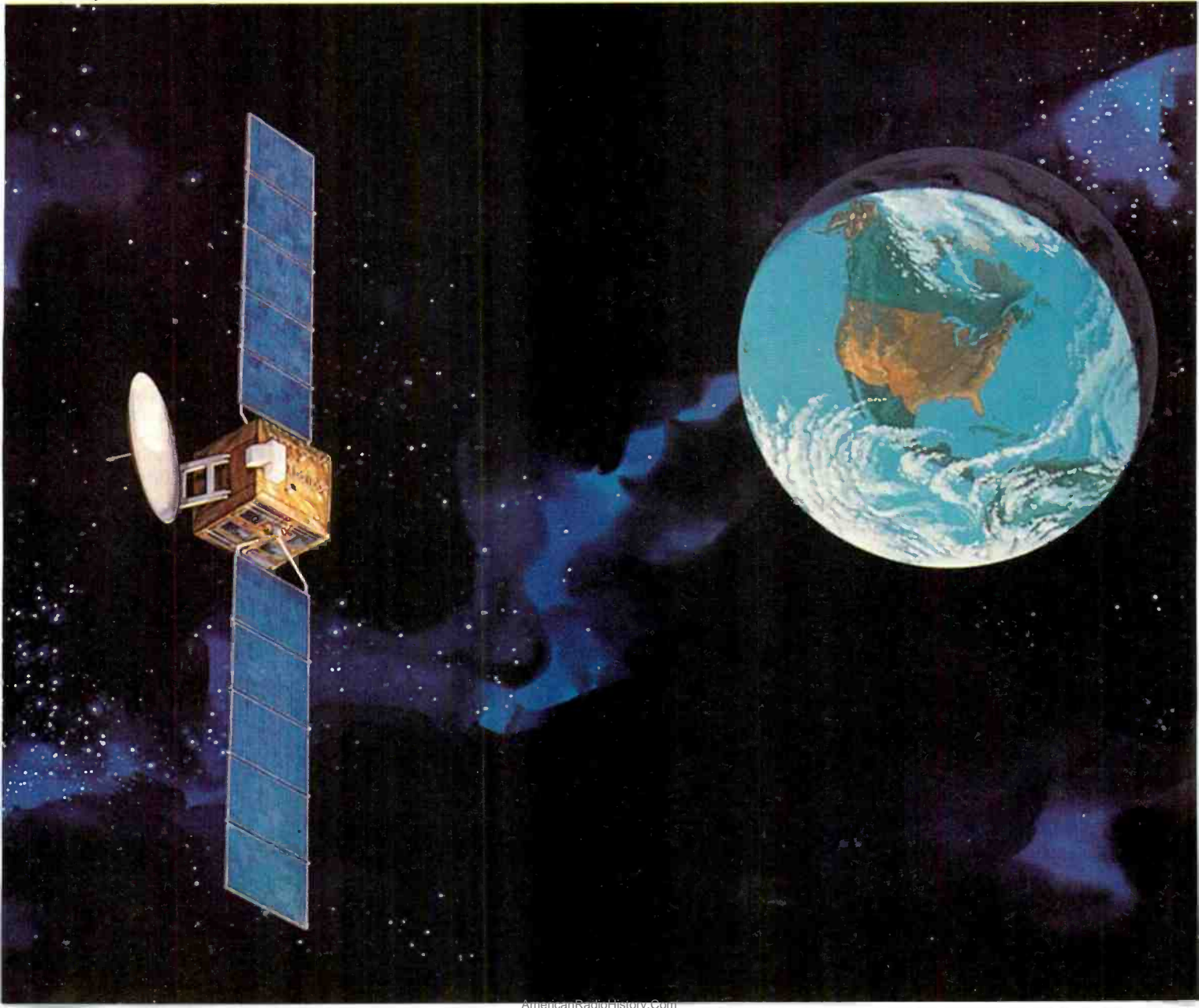

cassette and disc library with associated hardware, and a compact, rooftop dish antenna and electronics package for Direct Broadcast Satellite (DBS) reception.

That's the prediction of Dr. Elizabeth Young, President of the Public Service Satellite Consortium. She and other experts forecast increased use of video for existing services—notably in entertainment and education—as well as the development of completely new applications such as electronic newspapers, shopping catalogs, and mail deliveries. Direct Broadcast Satellites are expected to play a key role in this video revolution that will profoundly change our way of life. The beginnings of DBS service is not far off—COMSAT is planning to start such a service for the Eastern United States as soon as 1984.

Television From Satellites is, in one sense, nothing really new. As long ago as 1945, Arthur C. Clarke described

a global satellite communications system in a paper entitled "Extraterrestrial Relays" that was published in the British magazine *Wireless World*. The basis of this system was the *geosynchronous* satellite. Mr. Clarke had calculated that a satellite placed in a precisely circular orbit approximately 22,300 miles above the equator would have an orbital velocity matching the rotational velocity of the earth. The satellite would thus appear to hang motionless in the sky above a particular position and have a line-of-sight view of approximately one-half of the earth's surface. A system of only three such satellites would offer coverage of the entire planet.

Such satellites, now a reality, receive signals from one earth station and re-broadcast them to (usually) many other earth stations. Because the satellites appear motionless, the earth-station antennas can be aimed at one of them and left in fixed positions. The satellites carry banks of *transponders*—complex electronic circuits that receive signals transmitted from earth stations, shift them in frequency, and amplify them for re-broadcast to other earth stations. In most cases, communications are conducted on microwave frequencies above 3 GHz.

Presently, there are scores of geosynchronous communications satellites in orbit and operation. Most of them (about three-quarters of the total) han-

dle domestic, international, and military traffic. The rest perform scientific, meteorological, or experimental functions. Of those that handle domestic video traffic, only a few can be considered Direct Broadcast Satellites.

Most current video activity consists of the feeding of programs to network affiliates, independent subscriber stations, and cable-television installations. The major networks, the Public Broadcasting System, religious organizations, and distributors of pay-television fare employ transponders on such satellites as the *Comstars*, *Westars*, and *Satcoms* to distribute their programming across the nation. The transponders carried by these satellites have relatively low levels of output power—four or five watts.

Of course, it is possible for an individual to receive signals from the satellites directly. To do this, a relatively elaborate and costly receiving system must be installed. The low signal levels involved necessitate the use of large, high-gain receiving antenna and a quiet, high-gain *low-noise amplifier* (LNA). Also, the received signal must be shifted in frequency and its audio and video components reassembled into a form compatible with standard TV receivers.

A number of companies, including Downlink, Inc., in Putnam, CT; Satelco Division of Thunder-Compute, in Los Angeles, CA; and Third Wave Communications, Inc., in Ann Arbor, MI offer complete satellite television receive-only (TVRO) systems at the retail level. These systems, such as the Third Wave Communications Model TVRO-1 that is shown in Fig. 1, are physically large and expensive—typical costs range from \$4000 to \$15,000. Accordingly, for the present, DBS television reception is limited to those who can accommodate imposing physical structures and afford relatively substantial expenditures.

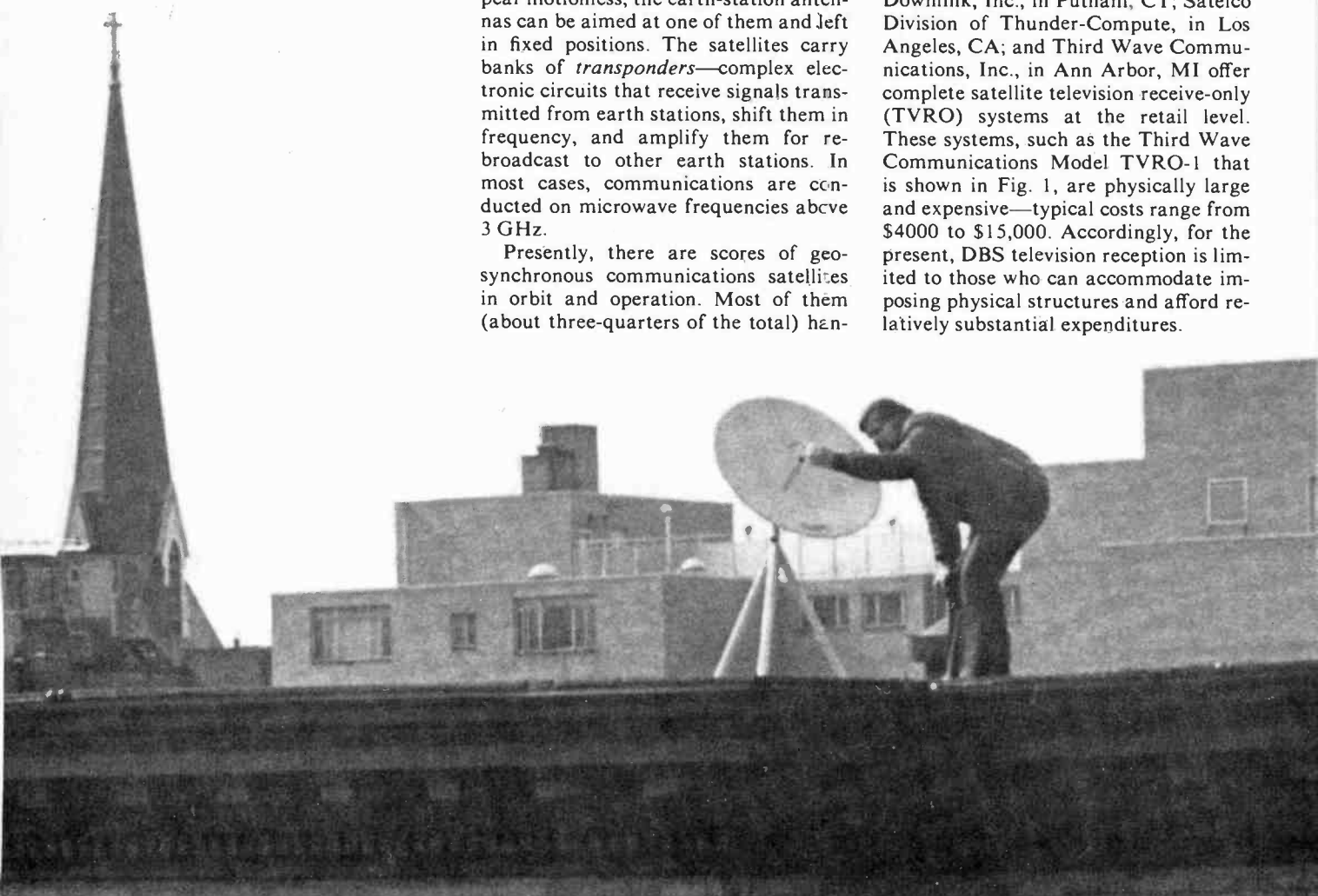

This will change as satellites designed specifically to beam television signals to viewer-owned or -leased receiving systems are lofted into orbit and program originators develop organized distribution channels. Efforts along these lines are already underway, both in the United States and Canada.

How DBS Began. The first domestic geosynchronous-satellite communications system in the free world came into being in late 1972. A U.S. Thor-Delta launch vehicle placed Canada's Anik I satellite into orbit. This satellite was followed by Anik II, Anik III, and Anik B. (Anik is the Eskimo word for *brother*.)

Canada is a country well suited for DBS systems. Almost 90% of its population lives in a belt that is 100 miles wide and bounded on the east and west by the Atlantic and Pacific Oceans and on the south by the U.S. The remaining 10% lives in scattered settlements in the northern region of the country. These settlements are too remote to receive television signals from stations in the more densely populated part of the country, and most are too small to make conventional broadcast installations economically practical. Hence, the Canadian national government was intensely interested in devising new, alternative methods of providing television programming and essential communications to the northern part of the country. The ANIK system is the route that it decided to take.

ANIK I, ANIK II, and ANIK III were built by Hughes Aircraft. They are cylindrical in shape, measure six feet in diameter and 12 feet in height, weigh 1265 pounds, and are spin stabilized. Their transponders generate 5 watts of

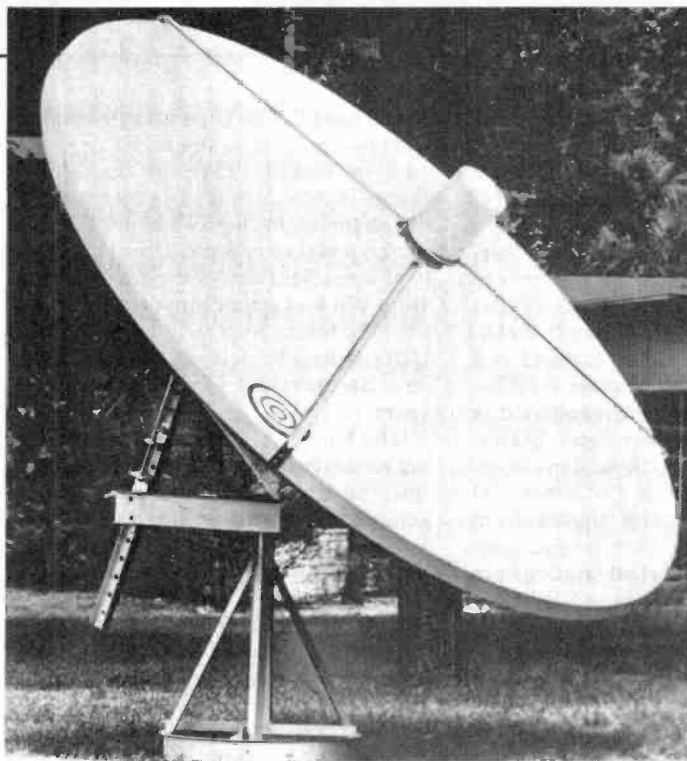

Fig. 1. The TVRO-1 satellite receiver system made by Third Wave Communications has a 12-ft dish and all the electronics needed for consumer use.

output power, and their transmitting antennas have gains of 27 dB. ANIK III is in regular service relaying television programs in French and English to earth stations scattered across Canada. It uses an uplink passband of 5.927 to 6.403 GHz and a downlink passband of 3.702 to 4.178 GHz. When ANIK III went on station, ANIK I and ANIK II were relegated to handling telephone, data, and message traffic, and to serving as backups for the ANIK III video relay.

The HERMES satellite, a joint endeavor of the Canadian Department of Communications and NASA, was

launched in January 1976. It was a higher-powered satellite than the earlier ANIKs and carried transponders that functioned in the 12/14-GHz passband (12-GHz downlink, 14-GHz uplink) that future DBS systems will employ. During its 3½-year operating lifetime, it

A master dish antenna such as this from S-C (opposite) could be used for apartments to receive satellite programming.

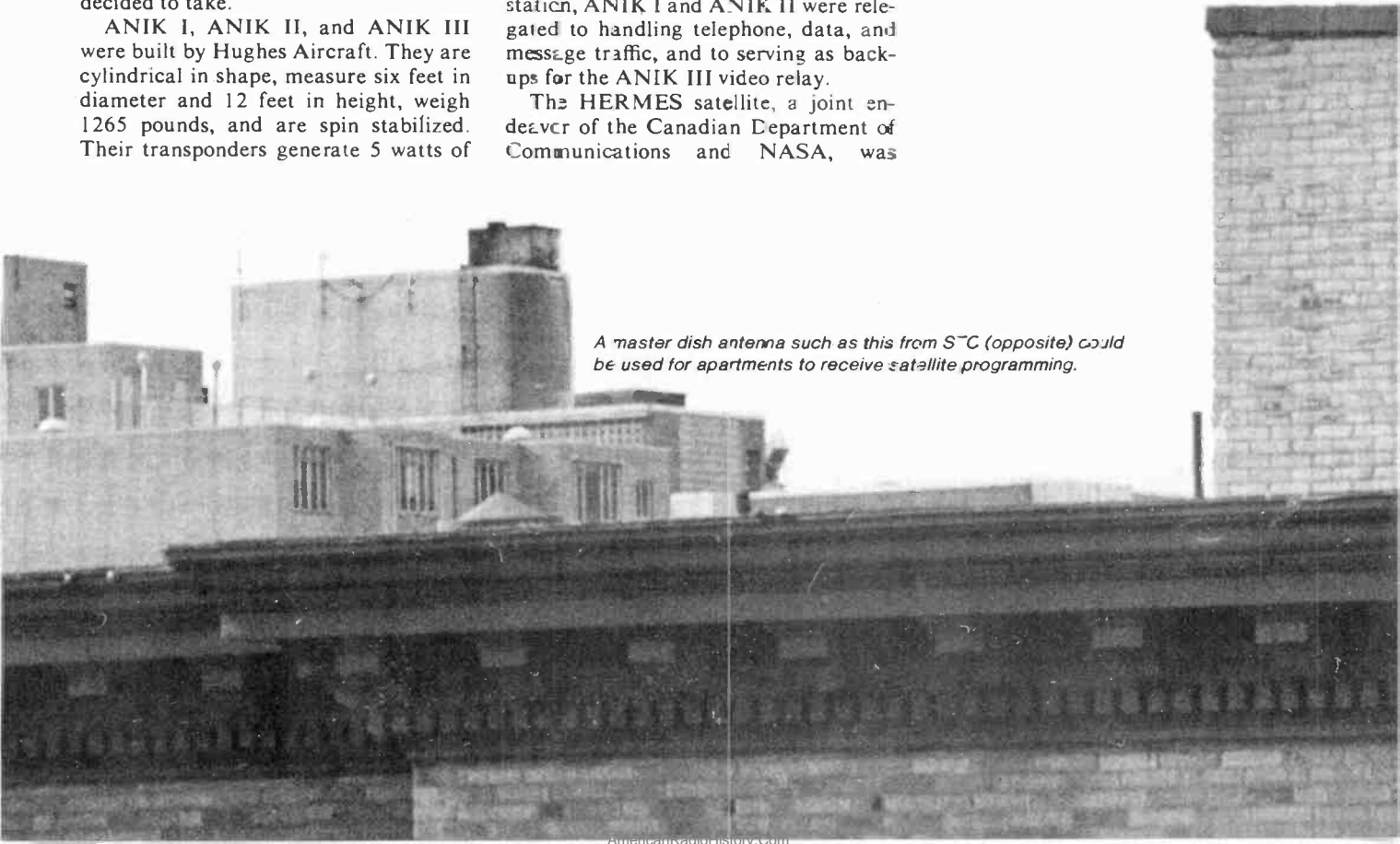

relayed signals to Lima, Peru, and the Australian outback, and performed communications experiments for the United States and Canada in the 12/14-GHz band.

ANIK-B was launched in December, 1978. It carries 12 transponders that operate in the 4/6-GHz band and six that operate in the 12/14-GHz band. Downlink power in the 4-GHz passband is 3 dB greater than that of earlier ANIKs, and the 12-GHz downlink is radiated in the form of four 20-watt spot beams. Approximately 110 earth stations in remote sections of British Columbia and northern Ontario receive signals from ANIK-B and provide them to the communities in which the earth stations are installed. Earth stations for ANIK-B reception cost \$3600 each on a small-quantity basis.

Two future ANIK satellites are being readied for launch. ANIK-C, shown in the artist's conception of Fig. 2, is expected to go into orbit this year. It will carry 16 transponders, each with an output power of 15 watts. Most of the earth stations that receive signals from ANIK-C are expected to feed CATV

"head ends." This is so because cable is used to a proportionally much larger extent in Canada than in the United States. ANIK-D will carry 24 transponder channels, each of which will be able to carry 960 voice signals simultaneously or one color television signal. The satellite will be carried into orbit by either the U.S. Space Shuttle or an augmented Delta launch vehicle and is expected to have an operating life of at least eight years.

The United States has been conducting an ambitious communications-satellite program of its own. Perhaps the progenitor of the future Direct Broadcast Satellites was the experimental communications satellite ATS-6, shown in Fig. 3. Launched into orbit from Cape Canaveral on May 30, 1974, this sixth in the series of Applied Technology Satellites was the first communications satellite to use a large (30-foot) parabolic transmitting antenna and high-power,



Fig. 2. Artist's conception of ANIK-C satellite in geosynchronous orbit. Primary coverage area is outlined on earth.

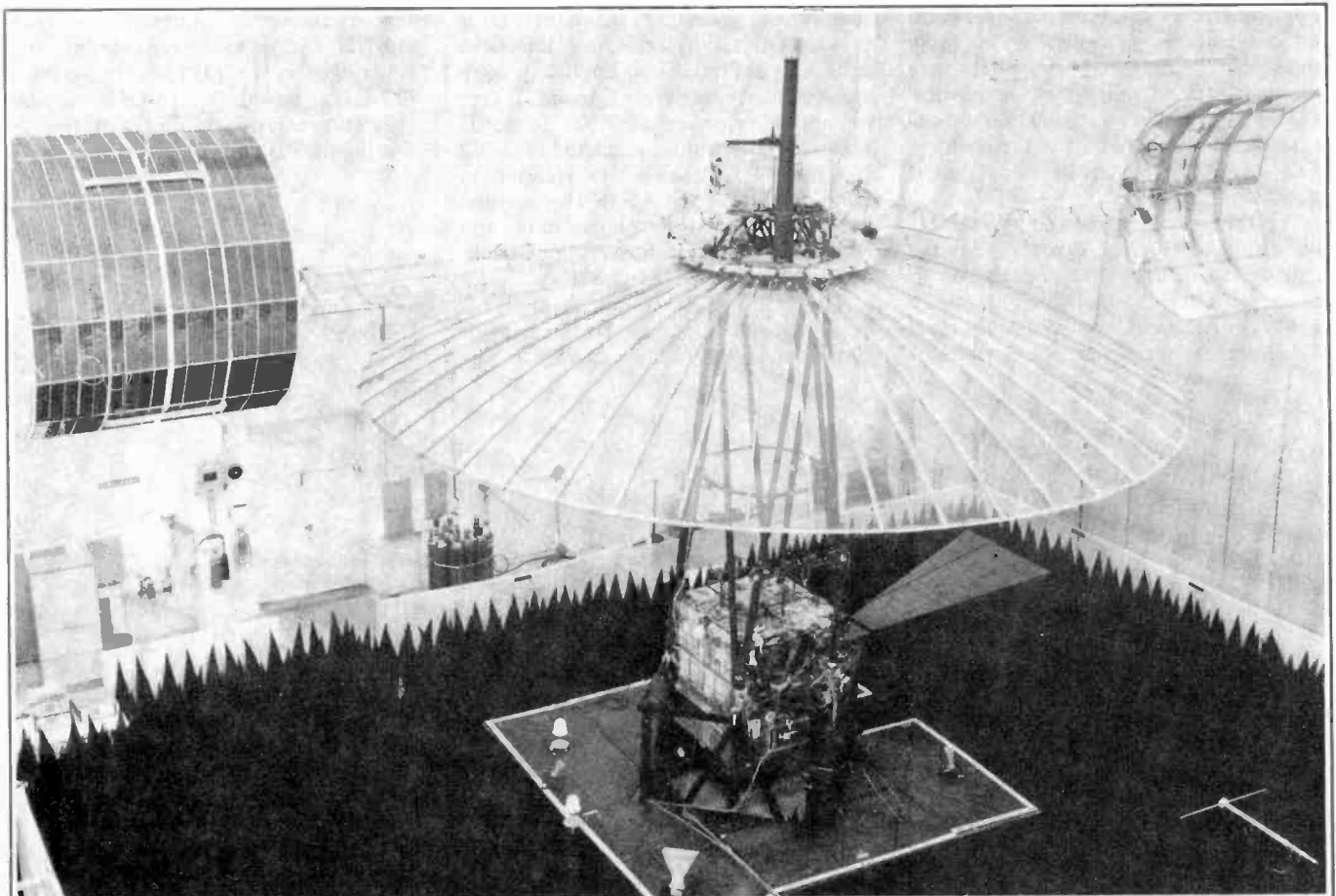

Fig. 3. The ATS-6 experimental communications satellite, the sixth in a series of Applied Technology Satellites, was launched from Cape Canaveral in 1974.

solid-state transmitters. It was also the first to provide direct television broadcast and duplex video communications to low-cost ground stations.

Transponders onboard ATS-6 transmitted signals in the S and C microwave bands at 2.6 and 4 GHz, respectively, and in the uhf television band at 860 MHz. Among its many accomplishments was to transmit educational television programs to thousands of low-cost earth stations installed in remote villages scattered across the Indian subcontinent. It also provided a multiple-access duplex telecommunications relay link for merchant ships and commercial aircraft. It tracked the manned spacecraft of the Apollo/Soyuz orbital-rendezvous mission, relayed live television programs to earth stations for conventional rebroadcast, and measured C-band radio interference as well as the propagation and signal-handling characteristics of space-communications links in the region between 20 and 30 gigahertz.

The satellite also provided tracking and data-relay information, performed L-band experiments for air-traffic control and marine navigation applications, and assisted in the measurement of sig-

nal attenuation of paths between the satellite and various locations in the U.S. These measurements have been used to determine the minimum acceptable power levels for transponders that will be carried by future satellites, including those that will perform DBS functions. ATS-6 was powered down on August 2, 1979 because of attitude- and orbital-control thruster failures, but it was briefly reactivated on November 24 of the same year for particle measurements that were performed in conjunction with other satellites.

The Future. DBS systems are expected to come into their own before too long. One harbinger of this anticipated development is an application submitted to the Federal Communications Commission on December 17, 1980 by the Satellite Television Corporation (STC). This corporation, a subsidiary of the Communications Satellite Corporation (COMSAT), asked for FCC authorization to offer the public a multiple-channel, commercial-free, subscription television service beamed directly from Direct Broadcast Satellites to individual homes.

If its petition is approved, STC will

initiate service within three or four years. It will loft two high-power (185 watts/transponder) satellites into geosynchronous orbit and will offer subscription television to an area roughly equal to the Eastern Time Zone of the United States. The satellites will have 17-GHz uplinks and 12-GHz downlinks, and, because of the high power used, their transponders will employ traveling-wave tubes as output devices. An artist's conception of an STC Direct Broadcast Satellite is the lead illustration of this article.

One of the satellites will function as an active relay, with the second held in reserve as a backup. The costs of development and launch for the two satellites and of the ground equipment are estimated by STC to be \$252 million. Eventually, a total of six STC satellites will be placed into geostationary orbit, spaced 20 degrees apart in an arc from 115° West to 175° West Longitude. Four will relay signals from an earth station near Las Vegas to receiving installations in the Eastern, Central, Mountain, and Pacific Service Areas (Fig. 4). Backup and control facilities will be in Santa Paula, California.

Each of the four relay satellites will

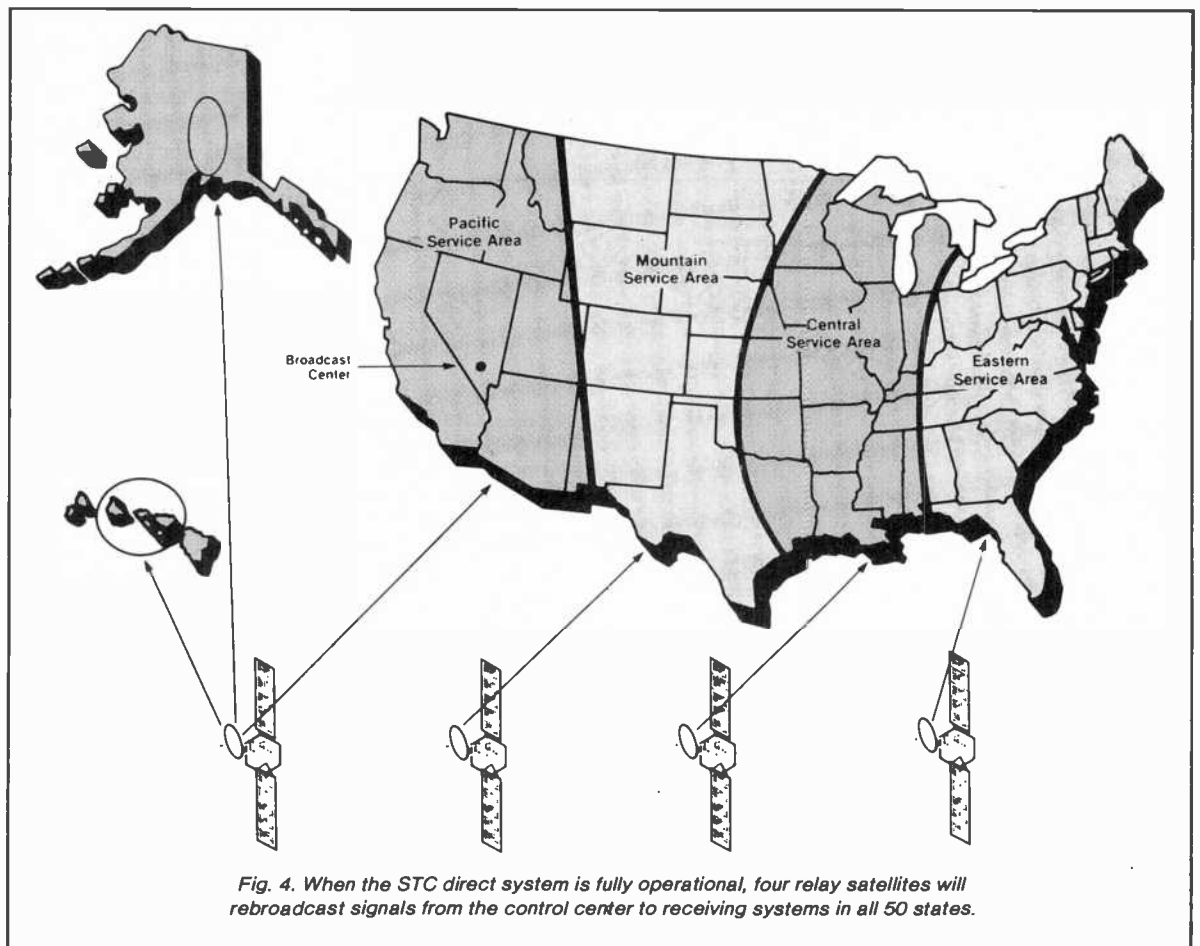

Fig. 4. When the STC direct system is fully operational, four relay satellites will rebroadcast signals from the control center to receiving systems in all 50 states.

beam signals to a particular service area. The satellite charged with transmitting signals to the Pacific Service Area will provide coverage to the most populated portions of Alaska and Hawaii by means of spot beams. Two satellites will be held in reserve as backups.

A DBS receiving system will employ a small dish antenna approximately 2½ feet in diameter and a compact electronics package, both mounted on the subscriber's rooftop (Fig. 5) or at some other convenient location with an unobstructed line of sight to the appropriate relay satellite. Signals will be fed via coaxial cable from the output of the outdoor electronics package to a small unit placed on top of the subscriber's television receiver. This unit would descramble the signals and shift them to a vacant television channel. Picture quality is expected to be comparable to that of ca-

ble-television reception except during periods of torrential rain, when atmospheric attenuation would increase and receiver S/N would be degraded.

The programming to be offered by STC will consist of three commercial-free channels of entertainment, public-affairs, and educational productions. The general programming plans for the three channels appear in the Table. Special programs may be offered on pay-per-program and pay-per-series bases. Optional services would include stereo sound, simultaneous transmission of the program's audio component in a second language, closed captioning for viewers with impaired hearing, and teletext data transmission.

In addition to such general-interest fare as movies and concerts, STC plans to place major emphasis on "narrow-casting," that is, special-interest pro-

gramming. The corporation will be able to do this because of the DBS service's inherent ability to gather relatively small, scattered groups of viewers with common but special interests into larger audiences. STC plans to take advantage of existing programming sources and, where possible, to simulate the development of new sources or to develop its own programming. These sources might include such institutions as experimental theatres, museums, universities, and scientific and professional organizations. A major feature of the multichannel STC service will be the ability to "counterprogram." That is, different types of programming would appear simultaneously on each of the three channels. This will allow STC to meet the majority of audience interests at the most opportune times.

Subscriber cost would be approximately \$25.00 per month for the basic DBS service and the rental of equipment. Installation of the receiving equipment would cost approximately \$100, which would include the purchase price of the dish antenna. The remaining equipment could be purchased from STC or from competing sources if the subscriber prefers to own the entire installation. In that case, the basic programming service alone would cost \$14 to \$18 per month. (All figures are expressed in 1980 dollars.)

STC's Goals. The obvious goal of the STC program is to satisfy consumer demand for diversified home-video services. Others are to promote competition in the subscription-television market; to stimulate the economy by creating thousands of new jobs in the fields of spacecraft and equipment manufacturing, program production, installation and maintenance of receiving systems, and marketing and promotional activities; to provide minority and dual-language programming; and to bring subscription-television programming to rural and other underserved areas. The STC also hopes its efforts will help to preserve the traditional United States leadership in space-communications technology.

Several other nations are engaged in the planning and development of DBS services for their citizens. Japan's BSE satellite has been providing direct broadcasts to home receivers in Japan and Okinawa for several years. The European Space Agency is also involved in DBS research and development.

It is clear that Direct Broadcast Satellites will play a key role in the coming video revolution. Their influence will soon be felt—odds are that within a few years you will be given the opportunity of receiving DBS programming in your home on a subscription basis. ◇

GENERAL PROGRAMMING PLANS FOR THE STC DBS CHANNELS

Channel A "Superstar"	Channel B "Spectrum"	Channel C "Viewer's Choice"
Major motion pictures	Children's programs	Sports
Popular concerts	Film classics	Adult education
Theatre specials	Public affairs	Experimental theatre
Family entertainment	Performing arts and cultural attractions	Lecture hall

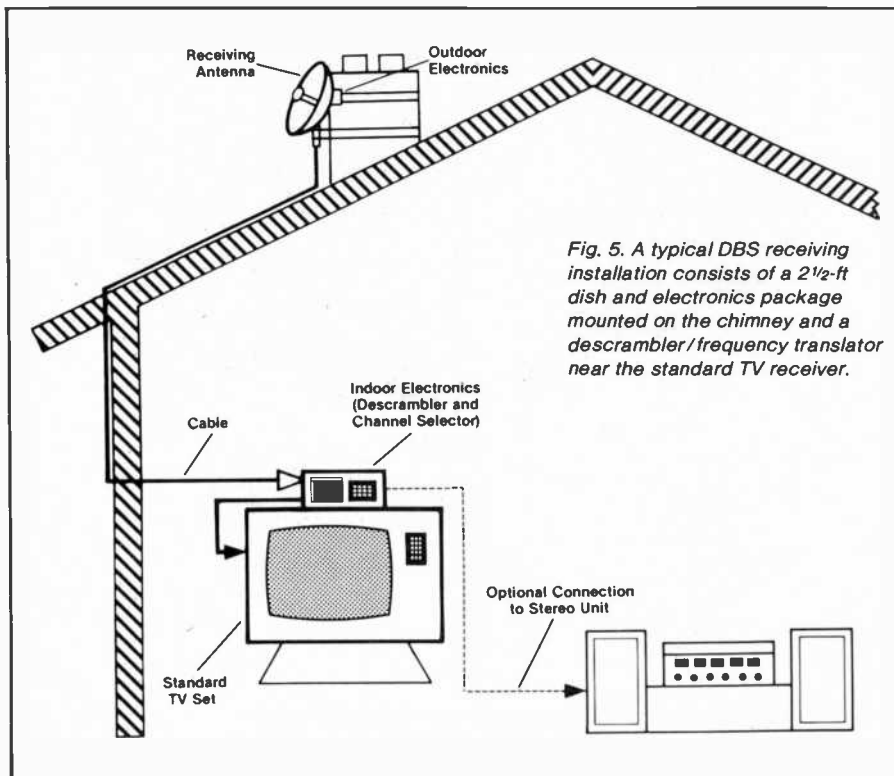

Fig. 5. A typical DBS receiving installation consists of a 2½-ft dish and electronics package mounted on the chimney and a descrambler/frequency translator near the standard TV receiver.

DOWN-TO-EARTH PRICES ON OUT-OF-THIS-WORLD PERSONAL COMPUTERS AND COMPONENTS.

Look at this!



Ohio Scientific Superboard II \$299

- It's the first complete computer system on a board.
- Superboard II uses the ultra powerful 6502 Microprocessor
- 8K Microsoft BASIC-in-ROM
- 4K static RAM on board, expandable to 8K
- Full 53-key keyboard, with upper and lower case. Plus user expandability.
- Video interface and audio cassette interface.

The Ohio Scientific Superboard II at \$299 — in today's economy — has got to be the best buy by far. It will entertain you with spectacular graphics made possible by its ultra high resolution graphics and super fast BASIC. It will help you in school or industry, as an ultra powerful scientific calculator. Advanced scientific functions and a built-in "immediate" mode allow you to solve complex problems without programming.

The Superboard II can be expanded economically, for business uses, or to remotely control your home appliances and security. Even communicate with other computers.

Read what's been written about Superboard II:

"We heartily recommend Superboard II for the beginner who wants to get into microcomputers with a minimum cost. A real computer with full expandability."

—POPULAR ELECTRONICS, MARCH 1979

"The Superboard II is an excellent choice for the personal computer enthusiast on a budget."

—BYTE, MAY 1979

Look at these easy hardware prices:

610 Board For use with Superboard II and Challenger 1P. 8K static RAM. Expandable to 24K or 32K system total. Accepts up to two mini-floppy disk drives. Requires +5V @ 4.5 amps.	\$ 298
Mini-Floppy Disk Drive Includes Ohio Scientific's PICO DOS software and connector cable. Compatible with 610 expander board. Requires +12V @ 1.5 amps and +5V @ 0.7 amps. [Power supply & cabinet not included.]	299
630 Board Contact us for important details.	229
AC-3P 12" combination black and white TV/video monitor.	159
4KP 4K RAM chip set.	79
PS-005 5V 4.5 amp power supply for Superboard II.	45
PS-003 12V power supply for mini-floppies.	45
RF Modulator Battery powered UHF Unit.	35
CS-900B Metal case for single floppy disk drive and power supply. [While stock lasts.]	49
AC-12P Wireless remote control system. Includes control console, two lamp modules and two appliance modules, for use with 630 board.	175
AC-17P Home security system. Includes console, fire detector, window protection devices and door unit for use with 630 board.	249
C1P Sams C1P Service manual	8
C4P Sams C4P Service manual	16
C3 Sams Challenger III manual	40

Ohio Scientific and independent suppliers offer hundreds of programs for the Superboard II, in cassette and mini-floppy form.

Freight Policies All orders of \$100 or more are shipped freight prepaid. Orders of less than \$100 please add \$4.00 to cover shipping costs. Ohio residents add 5.5% Sales Tax.



Hours: Call Monday thru Friday.
8:00 AM to 5:00 PM E.D.T.
TOLL FREE: 1-800-321-5805

Guaranteed Shipment
Cleveland Consumer Computers & Components guarantees shipment of computer systems within 48 hours upon receipt of your order. **Our failure to ship within 48 hours entitles you to \$35 of software, FREE.**

To Order: Or to get our free catalog **CALL 1-800-321-5805 TOLL FREE.** Charge your order to your **VISA** or **MASTER CHARGE** account. Ohio residents call: (216) 464-8047. Or write, including your check or money order, to the address listed below.



CLEVELAND CONSUMER COMPUTERS & COMPONENTS

P.O. Box 46627
Cleveland, Ohio 44146

Order Form: **CLEVELAND CONSUMER COMPUTERS & COMPONENTS** P.O. Box 46627 Cleveland, Ohio 44146

- | | |
|--|---|
| <input type="checkbox"/> Superboard II \$299. | <input type="checkbox"/> RF Modulator \$35. |
| <input type="checkbox"/> 610 Board \$298. | <input type="checkbox"/> AC-3P 12" B/W Monitor \$159. |
| <input type="checkbox"/> Mini-Floppy Disk Drive \$299. | <input type="checkbox"/> C1P Sams Manual \$8. |
- [Attach separate sheet for other items.]

NAME _____

ADDRESS: _____

CITY: _____ STATE: _____ ZIP: _____

PHONE: _____

Payment by: VISA _____ MASTER CHARGE _____ MONEY ORDER _____

Credit Card Account # _____

Expires _____ Interbank # [Master Charge] _____

TOTAL CHARGED OR ENCLOSED \$ _____ [Ohio Residents add 6.5% Sales Tax]

Orders of less than \$100, please add \$4.00 to cover shipping costs. Orders will be accepted from U.S. and Canada only. All prices quoted are U.S., date of publication, standard UPS shipping FOB the factory.

IMMORTAL MUSIC SHOULDN'T BE KEPT ON MORTAL TAPE.



Good music never dies. Unfortunately, a lot of cassette tapes do.

At Maxell, we've designed our cassettes to be as enduring as your music. Unlike ordinary cassettes, they're made with special anti-jamming ribs that help prevent tape from sticking, stretching and tearing.

And our cassette shells are built to standards that are as much as 60% higher than the industry calls for.

So if you'd like to preserve your old favorites for the years to come, keep them in a safe place. On one of our cassettes.



IT'S WORTH IT.

Microprocessors, video terminals and other sophisticated gear are bringing radioteletype up-to-date

RTTY MEETS THE COMPUTER



RADIOTELETYPE transmissions, which have a “deedle-deedle” sound to the human ear, constitute one of the more exotic modes of shortwave communication. Traffic sent via RTTY includes news dispatches, weather bulletins, commercial messages, and amateur radio chit-chat. Whereas in the “old days,” RTTY was based on temperamental electromechanical equipment, one can now use compact, quiet, and totally electronic gear such as video terminals, keyboard units, and the latest microcomputers.

RTTY. There are two common types of RTTY teleprinter in use, the *page printer* and the *tape printer*. The former is more popular, and prints on a paper roll almost as wide as business letter paper. The latter prints on paper tape (usually gummed) to be cut to letter-size widths and pasted in a series of lines on sheets of paper. Teleprinters usually operate at standard speeds of 60, 67, 75 or 100 words per minute (wpm). RTTY communications at any of these speeds can be found on the amateur bands.

Page printers such as the Models 15, 26, 28 and 32 are favorites for ham use, especially the Model 15 and the Model 28. Usually too expensive to be purchased new, used commercial printers can frequently be obtained for as little as \$30 to \$35 at hamfests and swap meets or through the classified ads of the ham magazines.

Other common devices are *reperforators* and *typing-reperforators*, such as the Model 14RO that allows recording of received messages or locally typed messages on punched paper tape. Having tape capability allows one to peck out a message slowly but transmit it at regular speed on the air. Most fancy “RTTY pictures” are generated thus.

Tape readers (or TDs for Transmitter Distributors) will also be found in a well-equipped RTTY installation. These electromechanical devices read or scan the punched paper tape made on the reperforator and convert the patterns of holes into electrical impulses. The Model 14TD is a popular tape reader for ham use.

In addition to these devices, *composite machines* that can perform page-printer, tape-reader and reperforator functions are also used. These include such surplus units as the Model 19, 28ASR, and 32ASR.

Codes. To transmit information expeditiously over wire and radio links, special codes have been developed. The familiar Morse, a binary (on/off) code

originally developed in the early 1830s, is the basis for manual telegraphy and radiotelegraphy or "CW" transmission. Teleprinter is similar, but uses "marks" and "spaces," (two different signals) rather than the "dots" and "dashes" (merely different signal durations) used in Morse. The teleprinter code, known as *Baudot*, is such that each code character contains the *same number* of information elements (bits) and each element is of *fixed length*.

Baudot is a binary, 5-level code with 32 characters available. Adding a "lower case" register to the keyboard results in additional combinations, just as on a typewriter. Each set of five elements is sent in serial fashion, and each element has two possible conditions—mark or space. On punched tape, holes represent the marks and unpunched areas the spaces. Normally, a start pulse is sent ahead of the five information elements and a stop pulse is added at the tail end, for a *total* of 7 pulses. These start and stop signals make possible the synchron-

ization of the transmitting and receiving teleprinters. The standard Baudot code is shown in the Table.

The relatively simple 5-level Baudot code, with its 32 available characters, is somewhat limited. Stock tickers and teletypesetter machines use 6-level codes, and an 8-level code is common in computer applications. The American Standard Code for Information Interchange, or ASCII, is a more flexible code and is making many inroads into Teletype® and related work. Like Baudot, the ASCII code employs start and stop pulses, but it has eight rather than five information pulses. This allows a much larger variety of characters.

Transmission Methods. For radio communications, the dc pulses generated by the teleprinter ("on" corresponding to "mark" and "off" to "space") must be applied in some way to the transmitter. It's possible to transmit RTTY signals by CW-like on/off or make-and-break (MAB) keying. The

common practice, however, is to employ two discrete signals, slightly separated in frequency, in a system known as *frequency-shift keying* (FSK). This method of transmitting teleprinter information has real advantages in that there is little sensitivity to interference from signals on nearby frequencies. There is a high degree of discrimination against noise pulses and signal fading, too.

In FSK, the transmitter is generating an r-f output from the start of the transmit interval to its conclusion, whether or not encoded information is being sent. When no information is being transmitted, the carrier frequency remains constant. When encoded text is sent, the carrier rapidly switches back and forth between the mark and space frequencies. Many different "standard" and "nonstandard" shifts have been used over the years. On the amateur bands, 850-Hz shift (the difference between the mark and space frequencies) was once popular. However, as narrower-bandwidth receivers, with their in-

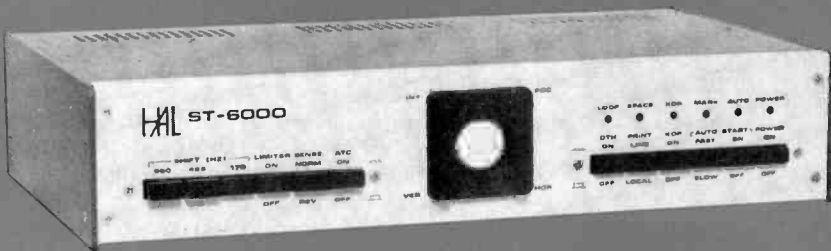

The HAL ST-6000 demodulator features three shift ranges, an audio tone keyer, keyboard-operated switch, and oscilloscope tuning indicator.

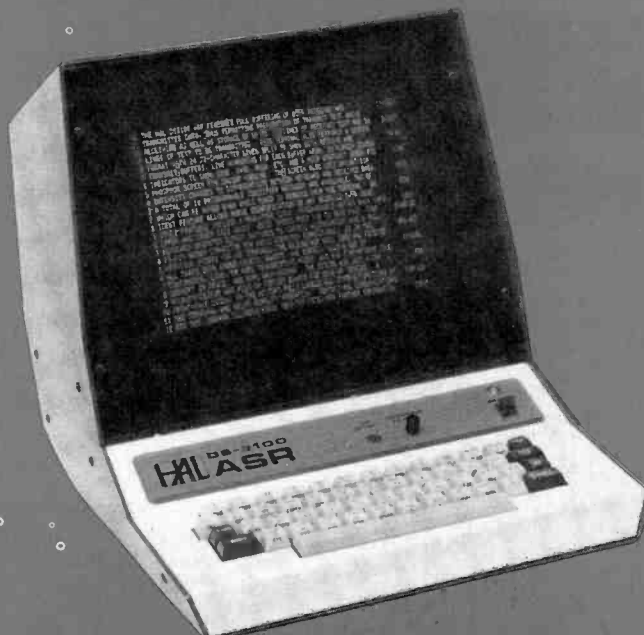

Microcraft's RTTY Reader uses a microprocessor to handle Baudot at four speeds or ASCII and display it on an eight-moving-character readout.

This automatic send-receive terminal (HAL OS-3100) has full buffering for Baudot or ASCII teleprinter codes or Continental Morse.

creased signal-to-noise ratios and enhanced selectivity characteristics, came into vogue, 170-Hz shift took the lead on the crowded ham bands.

Radioteletype Today. There are essentially two main types of new RTTY systems. One is the *dedicated* RTTY system, which usually consists of an electronic keyboard and a video display monitor. This system has its own special-purpose microprocessor built-in and is intended strictly for RTTY encode and decode functions. HAL Communications, Microlog, Info-Tech and Xitex have introduced highly sophisticated systems that directly replace mechanical teleprinters.

The second type teams up a computer interface unit with the character-generating, display and computational capabilities of a home computer system. For such computers as the Radio Shack TRS-80, Apple, Sorcerer, and Pet, interface units are available that make it possible to use them as automated RTTY systems. Macrotronics, Inc., of Keyes, California, offers interfaces, software and accessories. Some of the more useful features provided by such interface units include narrow or wide shift selection, keyboard-selectable

speeds, programmable message memories, automatic shift, line feed and unshift-on-space, and automatic CW ID.

For those who want to explore RTTY cheaply, at least one company has marketed a low-cost RTTY decoding unit. Microcraft Corp. produces the RTTY Reader, a device that accepts the audio output of the receiver and automatically decodes and displays RTTY characters on a large LED display. The RTTY Reader can handle Baudot at 60, 67, 75, and 100 wpm, as well as 110-baud ASCII, at shifts of 170, 425, or 850 Hz. It is easily read when characters are sent "hunt-and-peck" from a keyboard and the effective speed is as little as 20 to 25 wpm, but is not as useful with commercial stations transmitting at steady speeds of 60 or more wpm. At \$250, the device will be of interest to DXers, ragchewers, and SWLs who want to "get their feet wet" in RTTY without a deep, expensive plunge.

Equipment. To do RTTY work, you'll need a transmitter and receiver or transceiver and an antenna. The transmitter must be stable in frequency and rugged enough to be capable of extended "key-down" operation. This is an especially severe requirement for many contempo-

rary hf rigs, which were designed primarily for use in SSB applications and use low-duty-cycle, TV-sweep tubes as final amplifiers. Running them with a 100% duty cycle during the transmitting interval stresses their power supplies and r-f output stages. A good hf transmitter or transceiver with transmitting-type tubes in the final amplifier stage should work well on RTTY, but additional forced-air cooling might be necessary. Similarly, the transmitting antenna must withstand continuous application of power.

The receiver should be stable in frequency (especially for narrow shift work), and high in selectivity. The typical 2.4-to-2.7-kHz, -6-dB selectivity of most receivers in the SSB mode is acceptable in many cases, but better selectivity will reduce QRM. If your receiver needs more selectivity, you can add an accessory i-f filter or an external active audio filter, or use an RTTY demodulator that has adequate audio filtering.

The demodulator—sometimes called the converter, terminal unit, or "TU"—converts the receiver's audio output into dc keying pulses. Demodulators vary in complexity and price, depending mainly on the systems used to achieve selectivity, tuning, noise discrimination, and suppression of fading and multipath. Most include a high-voltage dc "loop" output that can be used to drive a mechanical teleprinter. Some recent models have digital I/O interfaces for use with electronic terminals.

A terminal—sometimes known as an ASR, or "automatic send-receive" unit—will have two main elements: a keyboard assembly and a printer or display unit. As in the case of the demodulator, the more flexible, newer gear has both a dc loop and an I/O interface so that it can be used with either classic mechanical systems or the newer solid-state equipment. Desirable terminal features include ability to process ASCII and Morse codes in addition to Baudot; programmable messages; text editing; keyboard-operated transmit ("KOX"); transmit and receive buffer memories; split-screen operation (for the simultaneous display of received and transmitted information); a real-time clock; and other RTTY amenities.

For FSK transmission, a modulator is required. (One is often incorporated in the terminal.) Its function is either to produce the desired frequency shift or generate audio tones that can be used to modulate the transmitter. "Direct" keying of a transmitter's vfo circuit, the classic way to generate FSK, requires modification of the transmitter and some potentially tricky adjustments.

Very popular today, especially for use

BAUDOT-CODE CHARACTER SET AND BIT SEQUENCES

Lower Case	Upper Case	Start Bit	Bit 1	Bit 2	Bit 3	Bit 4	Bit 5	Stop Bit
A	-	0	1	1	0	0	0	1
B	?	0	1	0	0	1	1	1
C	:	0	0	1	1	1	0	1
D	\$	0	1	0	0	1	0	1
E	3	0	1	0	0	0	0	1
F	1	0	1	0	1	1	0	1
G	&	0	0	1	0	1	1	1
H	#	0	0	0	1	0	1	1
I	8	0	0	1	1	0	0	1
J	1	0	1	1	0	1	0	1
K	(0	1	1	1	1	0	1
L)	0	0	1	0	0	1	1
M	.	0	0	0	1	1	1	1
N	.	0	0	0	1	1	0	1
O	9	0	0	0	0	1	1	1
P	0	0	0	1	1	0	1	1
Q	1	0	1	1	1	0	1	1
R	4	0	0	1	0	1	0	1
S	Bell	0	1	0	1	0	0	1
T	5	0	0	0	0	0	1	1
U	7	0	1	1	1	0	0	1
V	:	0	0	1	1	1	1	1
W	2	0	1	1	0	0	1	1
X	/	0	1	0	1	1	1	1
Y	6	0	1	0	1	0	1	1
Z	"	0	1	0	0	0	1	1
Blank	N-P**	0	0	0	0	0	0	1
Carr ret.	N-P	0	0	0	0	1	0	1
Line feed	N-P	0	0	1	0	0	0	1
Space	N-P	0	0	0	1	0	0	1
Letters	N-P	0	1	1	1	1	1	1
Figures	N-P	0	1	1	0	1	1	1

*1 = mark; 0 = space

**N-P means "nonprinting"

with hf SSB transmitters, is *indirect* FSK or audio-frequency shift keying (AFSK). In this system, application of audio tones to the transmitter's microphone input results in an equivalent FSK output signal. For example, if a SSB transmitter is placed in its lower-sideband mode and driven with a 2125-Hz audio tone, the transmitter's r-f output will be 2125 Hz *below* the suppressed-carrier frequency. If the input tone is then changed to 2295 Hz (corresponding to a 170-Hz shift), the r-f output frequency will be 2295 Hz below the suppressed-carrier frequency. If carrier and unwanted-sideband suppression are good, the transmitter output will be indistinguishable from a signal generated by direct keying of the vfo.

At one time, RTTY tones were 2125 Hz (mark) and 2975 Hz (space) for an 850-Hz shift. As transmitter stability and receiver selectivity and stability improved, 170-Hz shift became practicable. The space frequency was accordingly changed to 2295 Hz (the mark remained at 2125 Hz). These three tones are still considered standard in the US. However, filter-type SSB equipment (with its -6-dB bandwidth as narrow as 2.1 or 2.4 kHz) will not pass the 850-Hz shift, 2975-Hz space tone with sufficient amplitude. Either the SSB equipment has to be modified, or the tones must be lowered to fit the filter bandpass. Both approaches have been used. There is a low-tone standard, popular in Europe, that places the mark at 1275 Hz and space at 1475 Hz (170-Hz shift). The space is at 2125 Hz for an 850-Hz shift.

The two sets of tones can work interchangeably in hf SSB work because the receiver's bfo detection scheme makes it possible to place the tones at any appropriate pair of frequencies. However, in vhf AFSK applications, the two sets are not compatible because the *actual* audio tones are transmitted as AM or FM and cannot be frequency-translated by simply retuning the receiver. In the United States, the standard high tones are used on vhf so that the same demodulator and modulator can be used in both vhf and hf. However, on vhf, the mark tone is customarily changed or inverted from 2125 to 2295 Hz. A shift of 170 Hz is used almost exclusively, as on hf.

Unique Aspects of RTTY. There are many unique communications modes that can be used on RTTY. These include the *Answer-Back* (W-R-U, or "Who are you"); *Autostart* or "all-call"; and *Selcal* or "selective calling." Answer-Back is triggered by a specific access code. In response, a preprogrammed message will be sent by the teleprinter so configured. Autostart

turns on the teleprinter circuits whenever an RTTY signal is received and requires no specific access code. Selective calling allows a teleprinter so equipped to be interrogated and controlled remotely by means of a special access code. It's also possible to design, receive and transmit RTTY pictures and "art-work." Even music can be sent using the bells of mechanical printers.

Being in the audio range, demodulated RTTY signals can be recorded on magnetic tape. A cassette recorder is usually employed, and it's considerably cheaper, quieter and more convenient than a mechanical paper tape unit. However, recordings become very sensitive to wow and flutter at the low (170-Hz) shift usually used in ham work, so a recorder with less than 0.25% weighted rms wow and flutter should be used. Also, cassette recordings might not be exactly compatible *between* machines due to the small differences in drive-motor speed between them. Of course,

when using home computers with RTTY interfaces, the cassette recorder that is part of the computer system can be used not only to store the enable RTTY program, but also to record QSOs (contacts), "brag tapes," and other material.

Where the Action Is. RTTY operation is very popular on the 80- and 20-meter CW bands, with spotty activity on the other bands. Eighty-meter stations congregate between 3600 and 3650 kHz, and 20-meter stations are active between 14.075 and 14.100 MHz. Other nominal frequencies popular among RTTY enthusiasts are 7090 kHz, 21090 kHz and 28090 kHz. As we noted, 170-Hz shift is used almost universally. Sixty wpm (45 baud) is the most popular speed, but 100 wpm (74 baud) is also used. On vhf, operation is concentrated on the 2-meter band around 146.700 MHz. There are many RTTY FM repeaters in use which typically use the standard 146.10-MHz input/146.70-MHz output channelization.

Bear in mind that a RTTY QSO is different from a SSB QSO if for no other reason than it all has to be typed out. Results depend on the typing skills and characteristics of the two operators. However, the same general conversations take place and include such staples as name, QTH (location), equipment used, weather, and technical talk. It takes a bit longer to type things out, so attention must be paid to transmission length to avoid exceeding the FCC's 10-minute identification rule and to keep the rig's PA from overheating.

For "just listening," weather, point-to-point, ship-to-shore, and news service transmissions are of interest. However, unusual speeds and shifts other than the standard 170 or 850 Hz will make it impossible to copy much of what you hear. Remember—it is unlawful to divulge the contents of any nonbroadcast traffic that you monitor.

Much useful information can be found in the daily RTTY bulletins broadcast by the ARRL headquarters station, W1AW, in Newington, CT. This includes propagation forecasts, OSCAR satellite technical data, as well as regulatory and general-interest newsworthy information. The ARRL's monthly magazine, *QST*, regularly contains W1AW's operating schedule.

Hopefully, the wealth of fascinating RTTY activity will whet your appetite to explore this mode further. An old means of communications has successfully merged with the newest computer technology to produce an exciting challenge for the operator who's willing to give it a try. ◇

DIRECTORY OF MANUFACTURERS

A-Tronix

Suite C6, 23151 Alcalde Dr.
Laguna Hills, CA 92653

DGM Electronics

787 Briar Lane
Beloit, WI 53511

Dynamic Electronics

P.O. Box 896
Hartselle, AL 35640

ECM Corp.

412 N. Weinbach Ave.
Evansville, IN 47711

Flesher Corp.

P.O. Box 976Q
Topeka, KS 66601

HAL Communications Corp.

P.O. Box 365
Urbana, IL 61801

Info-Tech, Inc.

2349 Weldon Parkway
St. Louis, MO 63141

Macrotronics, Inc.

P.O. Box 518
Keyes, CA 95328

Microcraft, Inc.

P.O. Box 513
Thiensville, WI 53092

Xitex Corp.

9861 Chartwell Dr.
Dallas, TX 72543

A Microcomputer for everyone at a Micro Price

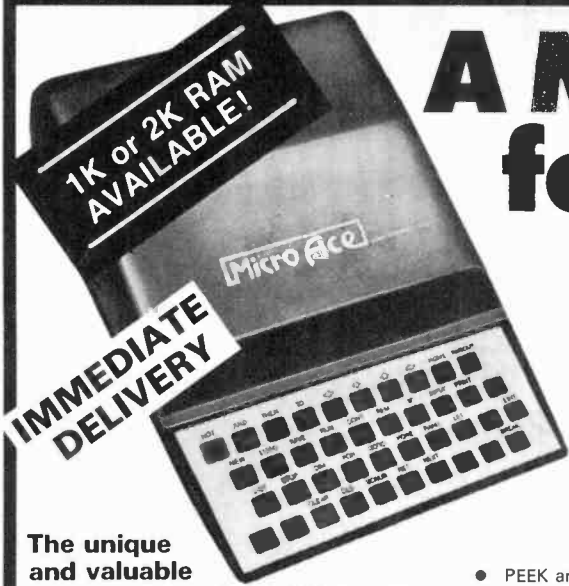

The **MicroAce** - a new generation of miniature computers
A COMPLETE COMPUTER for \$149.00 for 1K Kit



Post and Packing FREE
 (Add 6% Tax for Shipments inside California)

The unique and valuable components of the MicroAce

The MicroAce is not just another personal computer. Quite apart from its exceptionally low price, the MicroAce has two uniquely advanced components: the powerful BASIC interpreter, and the simple teach yourself BASIC manual.

The unique versatile BASIC interpreter offers remarkable programming advantages:

- Unique 'one-touch' key word entry: the MicroAce eliminates a great deal of tiresome typing. Key words (RUN, PRINT, LIST, etc.) have their own single-key entry.
- Unique syntax check. Only lines with correct syntax are accepted into programs. A cursor identifies errors immediately. This prevents entry of long and complicated programs with faults only discovered when you try to run them.
- Excellent string-handling capability - takes up to 26 string variables of any length. All strings can undergo all relational tests (e.g. comparison). The MicroAce also has string input - to request a line of text when necessary. Strings do not need to be dimensioned.
- Up to 26 single dimension arrays.
- FOR/NEXT loops nested up to 26.
- Variable names of any length.
- BASIC language also handles full Boolean arithmetic, conditional expressions, etc.
- Exceptionally powerful edit facilities, allows modification of existing program lines.
- Randomise function, useful for games and secret codes, as well as more serious applications
- Timer under program control.

- PEEK and POKE enable entry of machine code instructions, USR causes jump to a user's machine language sub-routine.
- High-resolution graphics with 22 standard graphic symbols.
- All characters printable in reverse under program control.
- Lines of unlimited length.

'Excellent value' indeed!

For just \$149.00 (excluding handling charge) you get everything you need to build a personal computer at home... PCB, with IC sockets for all ICs; case; leads for direct connection to a cassette recorder and television (black and white or color); everything!

Yet the MicroAce really is a complete, powerful, full-facility computer, matching or surpassing other personal computers at several times the price.

The MicroAce is programmed in BASIC, and you can use it to do quite literally anything, from playing chess to managing a business.

The MicroAce is pleasantly straightforward to assemble, using a fine-tipped soldering iron. It immediately proves what a good job you've done: connect it to your TV ... link it to the mains adaptor ... and you're ready to go.

Fewer chips, compact design, volume production-more power per Dollar!

The MicroAce owes its remarkable low price to its remarkable design: the whole system is packed on to fewer, newer, more powerful and advanced LSI chips. A single SUPER ROM, for instance, contains the BASIC interpreter, the character set, operating system, and monitor. And the MicroAce 1K byte

RAM (expandable to 2K on board) is roughly equivalent to 4K bytes in a conventional computer - typically storing 100 lines of BASIC. (Key words occupy only a single byte.)

The display shows 32 characters by 24 lines. And Benchmark tests show that the MicroAce is faster than all other personal computers.

No other personal computer offers this unique combination of high capability and low price.

The MicroAce teach-yourself BASIC manual.

If the features of the BASIC interpreter mean little to you - don't worry. They're all explained in the specially-written book *free* with every kit! The book makes learning easy, exciting and enjoyable, and represents a complete course in BASIC programming - from first principles to complex programs. (Available separately - purchase price refunded if you buy a MicroAce later.) A hardware manual is also included with every kit.

The MicroAce Kit:
\$149.00 with 1K COMPLETE
\$169.00 with 2K

Demand for the MicroAce is very high: use the coupon to order today for the earliest possible delivery. All orders will be despatched in strict rotation. If you are unsuccessful in constructing your kit, we will repair it for a fee of \$20.00, post and packing FREE. Of course, you may return your MicroAce as received within 14 days for a full refund. We want you to be satisfied beyond all doubt - and we have no doubt that you will be.

280 A microprocessor chip, widely recognised as the best ever made.

Sockets for TV, cassette recorder, power supply.

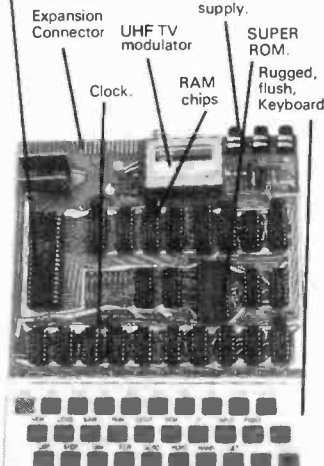

Your MicroAce kit contains...

- Printed circuit board, with IC sockets for all ICs.
- Complete components set, including all ICs - all manufactured by selected world-leading suppliers.
- New rugged keyboard, touch-sensitive, wipe-clean.
- Ready-moulded case.
- Leads and plugs for connection to domestic TV and cassette recorder. (Programs can be **SAVEd** and **LOADed** on to a portable cassette recorder.)
- Mains adaptor of 600 mA at 9VDC nominal unregulated.
- FREE course in BASIC programming and user manual.

JOIN THE REVOLUTION - DON'T GET LEFT BEHIND - ORDER YOUR MICRO ACE NOW!!

Send Check, Money Order or quote your Credit Card No. to:
MicroAce 1348 East Edinger, Santa Ana, California, Zip Code 92705.
 or phone (714) 547 2526 quoting your Credit Card Number.

Quantity	Description	Unit Price	TOTAL
	MicroAce Kit 1K	\$149.00	
	MicroAce Kit 2K	\$169.00	
	Manual	\$10.00	
	1K Upgrade Kit	\$29.00	
Shipments inside California add 6% TAX		TOTAL	

- Amex.
- Diners
- Check
- Money Order
- Master Charge
- Visa

Card No. _____

Exp. Date _____

Name _____

Address _____

City _____ State _____ Zip _____

Albia Electronics

ALL NEW!

DM-10 LOW OHM METER MODULE

Measures resistance from 10 milliOhms to 20 Ohms. Now you can measure resistance down to 10 milliOhms with this low cost, easy to use DVM module. Check coil resistance, transformers, relays, chokes, printed circuit board copper paths and ground cables. Special zero balance control nulls out input cable resistance to insure accurate readings. Your DVM has to be set to 2V range during operation.



- Resistance range 10 milliOhms to 20 Ohms
- Zero Calibration control
- Battery powered (push to read battery saver circuit). Requires 1.9 Volt Battery (not included).
- Size 6.25" x 3.75" x 2" (Input cables not included or available)

FREQUENCY METER MODULE LOW COST DM-11, "5Hz to 100MHz"

Measure frequencies from 5Hz to 100MHz on your digital voltmeter with a resolution of 3 1/2 digits — easy to use — perfect for field service — lab testing — home hobbyist! Connect the DM-11 to your DVM, set the DVM to the 2VDC range, connect a signal to the DM-11 via a BNC cable (not included) and measure the frequency of any source. Hi Lo Range LED's insure fast accurate readings.

- Input Sensitivity: < 100Hz < 80mV
- 100Hz — 60MHz < 30mV
- > 60MHz < 70mV
- Size 6.25" x 3.75" x 2"
- External 9V DC power supply included. (Model MMAC-2)
- BNC Input Cable Accessory (Model PSA-2 add \$14.95)

Completely assembled and tested! Ready to use!



YOUR CHOICE

Any 2 For \$124.99
\$69⁹⁵
 EACH
 All 4 For \$239.99

Completely assembled and tested! Ready to use!

8 CHANNEL SCOPE MULTIPLEXER, DM-12

Convert your single channel scope into a 4 or 8 channel instrument; just connect the DM-12, 8 channel scope multiplexer to your scope, clip the 8 input probes to the signals you want to view. Simple, easy, fast — can handle logic level TTL signals from DC to 3MHz. Features separate spacing and trace amplitude controls and selectable sampling rate — all to insure easy clear scope display.

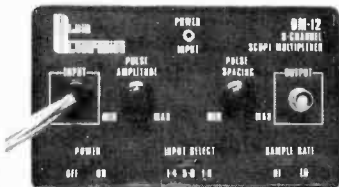

- 8 TTL compatible Input channels (1 TTL load per channel) can drive 50 Ohm scope cable.
- Maximum full screen amplitude 1.6 Volts adjustable.
- Trace amplitude and spacing controls.
- 4 or 8 channel selector switch.
- 8 color coded input cable, 24" long with insulated alligator clips.
- External 9 VDC power supply included (Model MMAC-2)
- Size 6.25" x 3.75" x 2"
- BNC Output Cable Accessory (Model PSA-2 add \$14.95).

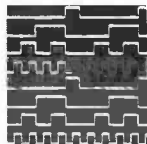

Completely assembled and tested! Ready to use!

LOW COST DM-8 CAPACITANCE METER MODULE

Connect this high quality low cost Capacitance Meter Module, DM-8 to your digital Volt Meter and turn it into a Digital Capacitance Meter — the Low Cost Way!

(When placing order specify the make and model DVM you're using so that factory modifications, if required, may be made before shipment is made.)

Completely assembled and tested! Ready to use!
INSTANT ORDER INFORMATION BELOW!

- Push to read range (button) from 1pF to 20,000µF
- Zero calibration control
- In one easy to use, self-contained package.
- Battery powered, with "push to read" battery saver circuit (9V batteries not included).
- Size 6.25" x 3.75" x 2"



LOW COST HIGH FREQUENCY COUNTER — NOW IN STOCK!!



The Albia Model DM-7, 8 Digit High Frequency Counter is easy to use, switch selectable time base input by a single BNC, nothing to build — nothing more to buy!

- 5 Hz to 550 MHz
- 8 big easy-to-read .43" high intensity LED display
- Crystal (±3 ppm @ 25 C) controlled 0.1 or 1.0 sec. gate times
- Convenient benchtop size (7"x10"x3") durable attractive case

NEVER BEFORE AT THIS LOW PRICE **\$149⁹⁵** Includes Warranty

COMPLETELY ASSEMBLED • PRE-CALIBRATED • PRE-TESTED

REGULATED TRIPLE POWER SUPPLY BARGAIN PRICED ALBIA MODEL DM-6

A fully assembled and tested power supply that provides a solid, fully wired triple power supply including fixed 5V @ 1 Amp, 5V to 15V @ 0.5 Amp, and -5V to -15V @ 0.5 Amp — all supplies regulated, short proof. Each supply has short indicator LED. Complete and ready for use in a durable (8"x6"x3 1/2") metal case.

\$99⁹⁵ Includes Warranty



FREE!!
 NEW 1981
 MID-YEAR
 CATALOG



Exciting new products! Send today!!

ALBIA SATISFACTION WARRANTY:

If for any reason, whatsoever, you are not completely satisfied with your purchase, return it within 30 days of purchase date for a full refund — it's as simple as that!

FOR FAST AND DEPENDABLE DELIVERY SERVICE

CALL TOLL FREE: 1-800-243-6953 9 A.M. to 5 P.M. E.S.T.

WE ACCEPT MASTER CHARGE, VISA AND AMEX CREDIT CARDS

Connecticut Residents add 7 1/2% Sales Tax • Prices shown in U.S. currency only. Foreign orders add 15%.

ALBIA ELECTRONICS INC

24 Albia St. • New Haven, CT 06512



FREE ALBIA "TEMPLATE" WITH EVERY ORDER RECEIVED by May 25, 1981

POSTAGE & HANDLING	
ORDERS	ADD
UP TO \$10.00	\$1.95
\$10.01 - \$25.00	3.75
\$25.01 - \$50.00	4.65
\$50.01 - \$100.00	6.45
ORDERS OVER \$100.00 WITHIN UNITED STATES	7.55

A "SMART" GREENHOUSE LIGHT CONTROLLER

Grow temperamental plants with artificial light when the sunlight goes away

BY MARK L. McWILLIAMS

WITH their controllable growing conditions, greenhouses and hot frames can make possible the cultivation of plants too delicate to survive the rigors of the natural environment in many parts of the north Temperate Zone. Well-established technologies for the control of temperature and humidity exist, but photoperiod (the time for which the plant is exposed to light) and the intensity of light in its duration are also important, if not critical, to plant growth. Lamps whose spectral output is consistent with plant needs exist; the problem is how to control them.

To allow the lamps to run for a fixed period of time regardless of whether the sun is hidden or not is unacceptable. For one thing, some plants would be subject to excessive illumination, and, for another, heat build-up could stress the temperature-control system. Turning the lamps on when the sun is hidden and off when it reappears would be an improvement, but this too is subject to difficulties. One is that temporary occultations of the sun, as by passing clouds, birds, or aircraft, would cause an excessive number of on-off cycles and adversely affect lamp life.

An acceptable controller would give positive control of the duration of the photoperiod, turn on the lamps if

the sun were to disappear for any significant length of time, and ignore short-term solar "dropouts." The system described in this article has these attributes.

Overall operation of the controller is shown in Fig. 1. The photoresistor monitors the sun's light and produces a voltage drop across its associated series resistor that is compared against a value set by the sensitivity control. If the light intensity, hence the voltage applied to the comparator noninverting input, is too low, the comparator will trigger timer 1. This timer will delay for a preset interval (up to 10 minutes or so) to determine if the light intensity remains low. Thus, momentary blockages of the sun won't cause the lamps to turn on. If allowed to time out, timer 1 will trigger timer 2, which will turn on the lamps for some minimum time (for example, 30 minutes), but will also keep the lights on as long as the sun remains hidden.

If it has finished timing-out, when the sunlight returns, timer 2 will trigger timer 3. This timer will keep the lamps on for some period (15-20 minutes) to make sure that the sun is back to stay. If it is, the lamps will turn off when timer 3 times out. If not, the comparator will trigger timer 1, and the whole cycle starts again. (If timer 1's delay is sufficiently less than that

of timer 3, the lamps will stay on after the timer 3 period times out if the sun is hidden again.)

Circuit Operation. The complete circuit is shown in Fig. 2. Photoresistor *PC1*'s resistance can range from a few hundred to 100,000 ohms or more depending on how much light falls on it. However, only 20 to 50 ohms difference was found when a bright sunny day was compared to an overcast day. To detect such a very small difference, comparator *IC1* is used. With *S3* in its normal position, the voltage drop across *R3* is compared against that set by sensitivity control *R1*. When the light is relatively dim, the *IC1* output at pin 2 goes low, thus triggering timer 1 (*IC4A*) via *C1*. The *IC1* output is inverted by *IC2A* and applied to one input of AND gate *IC3*. Resistor *R2* acts as feedback to improve the *IC1* switching action.

Timer 1 (*IC4A*) is one-half of a 556 operating in its one-shot mode. When it times out, its output at pin 5 is inverted by *IC2B* and fed to the other input of AND gate *IC3*. When both inputs to *IC3* are high, the gate triggers timer 2 (*IC5A*), via inverter *IC2D*. Thus, two conditions are necessary to trigger timer 2—low ambient light and the timing-out of timer 1.

Timer 2 (*IC5A*) will turn on for a

minimum period determined by $R15-C11$. However, this timer will stay on indefinitely as long as the light impinging on $PC1$ is low, since the $IC1$ output will remain low, and as long as

it is low, timer 1 ($IC4A$) will not be released from its timing cycle. Capacitor $C14$ will keep timer 2 on even after it has timed out for as long as timer 2 is in its "on" state, it will ener-

gize relay $K1$ via $D1$ which, in turn, supplies ac power to lamp socket $S01$. After timer 2 turns off, it triggers $IC5B$ timer 3 via $C13$. This timer remains on for a period determined by

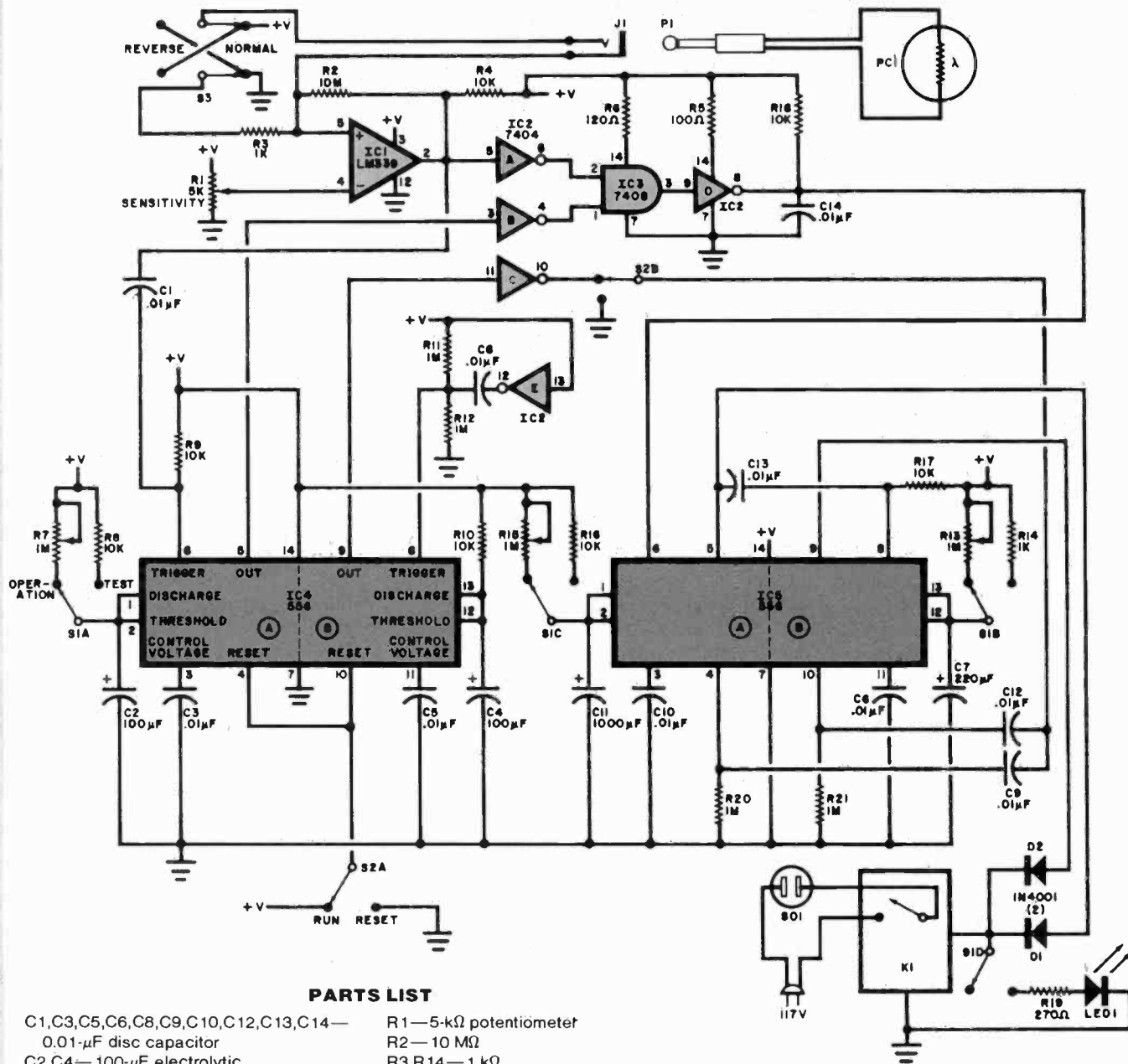

PARTS LIST

- C1, C3, C5, C6, C8, C9, C10, C12, C13, C14 — 0.01- μ F disc capacitor
- C2, C4 — 100- μ F electrolytic
- C7 — 220- μ F electrolytic
- C11 — 1000- μ F electrolytic
- D1, D2 — 1N4001 diode
- IC1 — LM339 quad comparator
- IC2 — 7404 hex inverter
- IC3 — 7408 AND gate
- IC4, IC5 — 556 dual timer
- J1 — 2-conductor jack
- K1 — Solid-state relay (Radio Shack 275-236)
- LED1 — 20-mA light-emitting diode
- PC1 — CdS photoresistor (Radio Shack 276-116)
- Following are 1/2-W, 10% resistors unless otherwise specified
- R1 — 5-k Ω potentiometer
- R2 — 10 M Ω
- R3, R14 — 1 k Ω
- R4, R8, R9, R10, R16, R17, R18 — 10 k Ω
- R5 — 100 Ω
- R6 — 120 Ω
- R7, R13, R15 — 1-M Ω mini-potentiometer (Radio Shack 271-229)
- R11, R12, R20, R21 — 1 M Ω
- R19 — 270 Ω
- S1 — 4-pole, 2-position rotary switch (Radio Shack 275-1384)
- S2, S3 — Dpdt miniature toggle switch (Radio Shack 275-620)
- Misc. — Sockets for ac, IC mounting sockets, case (Radio Shack 270-627), pc board, wire, solder, 6-volt battery eliminator, etc.

Fig. 2. Schematic diagram of the complete timer circuit. Points marked +V can be connected to a 6-volt battery eliminator or a separate 6-volt supply can be built and mounted in the enclosure.

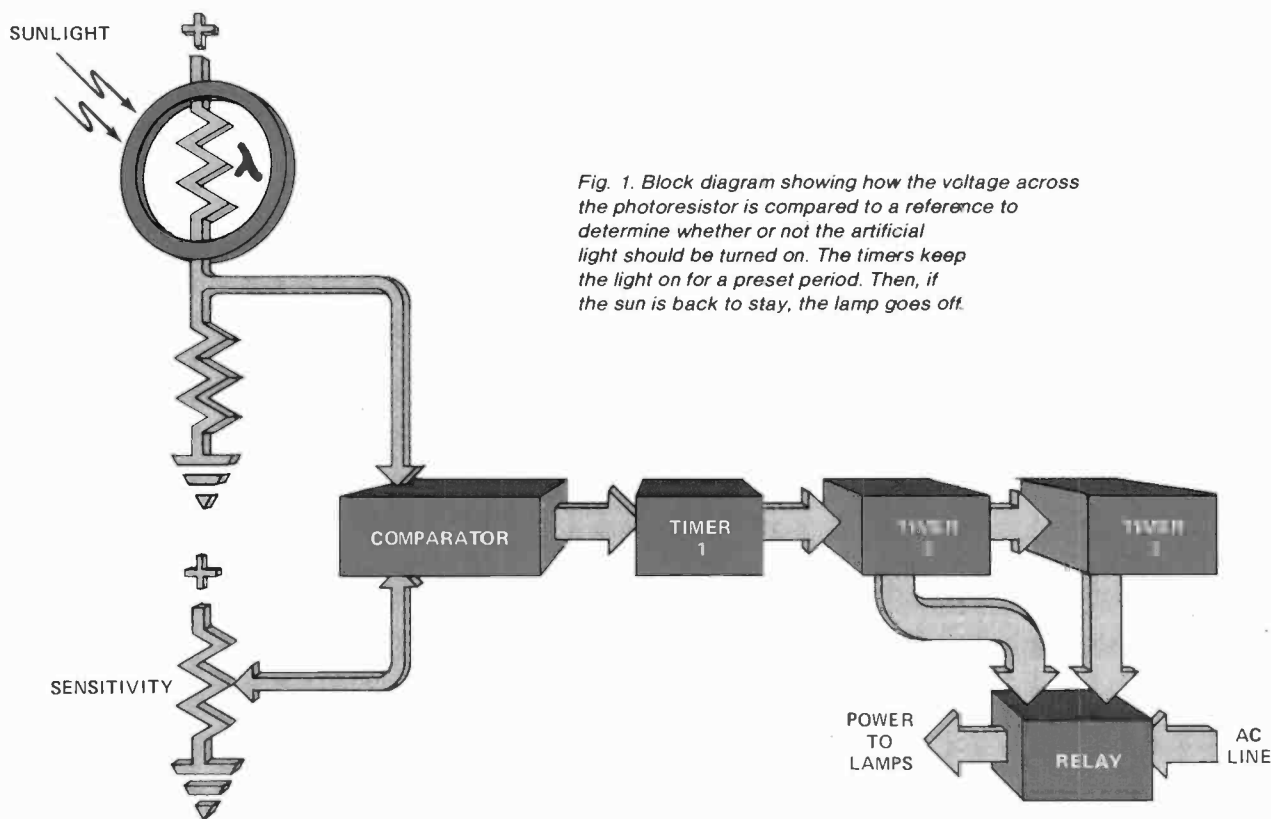

Fig. 1. Block diagram showing how the voltage across the photoresistor is compared to a reference to determine whether or not the artificial light should be turned on. The timers keep the light on for a preset period. Then, if the sun is back to stay, the lamp goes off.

R13-C7. Timer 3 also energizes the relay via D2.

When timer 3 times out, relay K1 is de-energized if the IC1 output went high since timer 3 started. However, if the low light condition returned and IC1 went low again, timer 1 will turn on again, and the cycle starts over. If timer 1's delay is sufficiently less than timer 3's, timer 2 will turn on before timer 3 can time out and the relay will remain energized.

IC4B is used as a switch debouncer, and prevents timers 2 and 3 from being triggered when the power is first applied. This timer is used to momentarily reset both halves of IC5 (via C9 and C12) during the one second or so period just after the power is applied to the circuit.

A conventional 6-volt battery eliminator can be used to supply the 45 or 70 mA needed by the circuit. A 24-hour clock timer can then be used to power the battery eliminator so that the light controller operates only during daylight hours.

Switch S1 places the controller into either TEST or OPERATION status. The only difference between these two conditions is that the timer delays are only a few seconds in the TEST mode. This latter mode is used mainly to adjust sensitivity control R1. LED1 will glow in TEST so the lamps do not have

to be connected to S01. When the unit is not in the test mode, the LED will not operate.

Switch S3 permits the unit to be used for much more than just a light controller. For initial testing as a light controller, S3 should be positioned as shown with R3 grounded.

Construction. The controller can be built on perf board, or a pc board can be fabricated. Sockets can be used for the ICs if desired. Once built, the circuit can be mounted within a selected enclosure with only the three switches, R1, J1, LED1, and lamp power socket S01, mounted on an outside surface. A 6-volt power supply can also be mounted within the enclosure. The ac power line can exit via a grommetted hole at the rear.

Adjustment. Plug the photoresistor into J1, and place it so that its light-sensitive surface is receiving direct sunlight. Place S1 in the TEST position, then S2 to RESET, then RUN. Adjust R1 in small steps until a small amount of shade caused by your hand (12 or more inches away from PC1) causes LED1 to turn on. Allow sufficient time between each R1 adjustment for timer 1 to time out. If it does not time out, place S2 in RESET, back R1 off, and try again.

When you have adjusted R1 to your satisfaction, place S1 in the OPERATION position and connect the lamps to S01. Control R1 may have to be re-adjusted under actual overcast conditions. Note that a little hysteresis is present in IC1 and if R1 is adjusted "too tight", the controller will not turn the lamps off even when full sunlight appears.

While it was designed primarily as a light controller, the unit can be used to control other ac loads depending on the type of sensor plugged into J1. For example, replacing PC1 with a temperature sensor, the controller could be used to turn on heating elements after ignoring momentary high temperatures. Using the same probe but placing S3 in the REVERSE position, which switches the relative positions of R3 and the external probe in their voltage divider configuration—the controller can be used to turn on exhaust fans while ignoring sudden low temperatures.

It is possible that some user modification of potentiometer R1 and R3 might be necessary if probes having different resistance characteristics from those of PC1 are used. Also, if even the small amount of hysteresis present in IC1 cannot be tolerated, experiment with different valued resistors for feedback resistor R2. ◇

A LOW-COST ELECTRONIC RINGER FOR TELEPHONE LINES

*Solid-state circuit can replace
the electromechanical ringer in a telephone*

BY BRADLEY ALBING

RECENT FCC rules changes allow users to connect electronic devices of non-Bell manufacture to telephone-company lines. One such device is the low-cost Electronic Ringer. Like a standard electromechanical ringer, it generates bursts of sound when triggered by ring pulses. However, it is not physically bulky and doesn't load down the telephone line. The sound it generates can be modified in several respects to suit the user's taste and to help him differen-

tiate activity on one telephone line from that on another. The Electronic Ringer can also be used to actuate external devices in response to an incoming call. Several optional circuits for this application will be described.

About the Circuit. The schematic diagram of the Electronic Ringer appears in Fig. 1. At the onset of an incoming telephone call, an ac signal is applied between the green (*tip* or *T*) and red (*ring* or *R*) wires of the tele-

phone line. This signal, which has an amplitude of approximately 90 volts root mean square and a frequency of between 20 and 40 Hz, is capacitively coupled to optoisolator *IC1*. The input network comprising *R1*, *R2*, *C1*, *D1*, *D2* and *IC1* minimizes the line loading and imbalance that simpler ring-detection circuits can cause. Diodes *D1* and *D2* are included to suppress "dial tapping"—the tendency of rotary-dial pulses to actuate the ringer circuit.

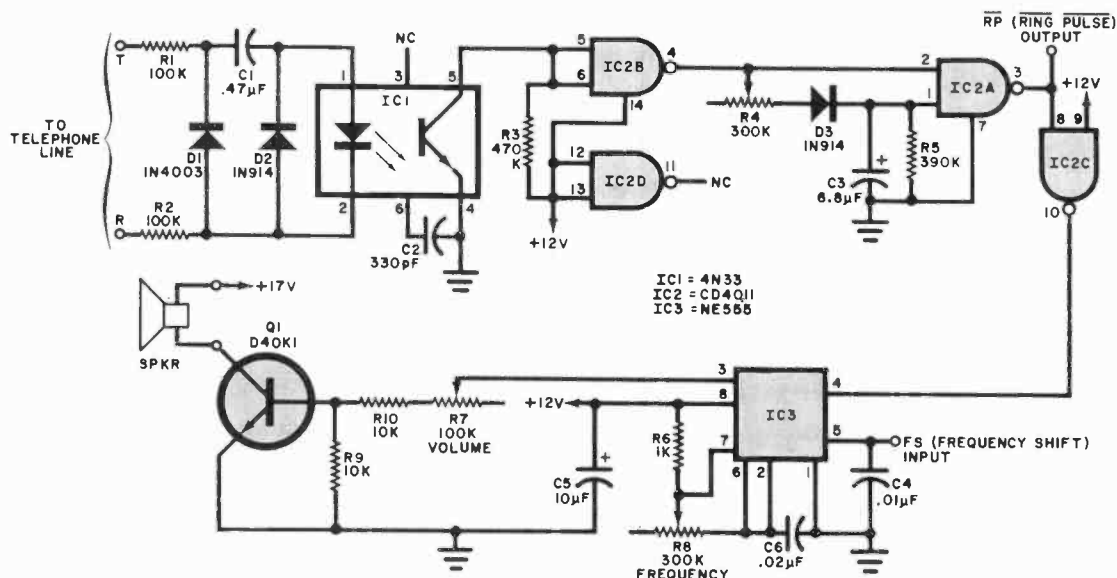

Fig. 1. Schematic diagram of the Electronic Ringer. Optoisolator *IC1* couples ring pulses from the telephone line to the detector circuit.

telephone ringer

Components denoted by an asterisk comprise the optional circuits shown in Figs. 3, 4 and 5.

- C1—0.47- μ F, 200-V Mylar capacitor
- C2—330-pF, 25-V disc ceramic capacitor
- C4, C9*, C11*, C14*—0.01- μ F, 25-V disc ceramic capacitor
- C3—6.8- μ F, 16-V tantalum capacitor
- C5—10- μ F, 16-V tantalum capacitor
- C6—0.02- μ F, 25-V disc ceramic capacitor
- C7—1000- μ F, 35-V aluminum electrolytic
- C8—100- μ F, 35-V aluminum electrolytic
- C10*, C12*, C13*—1- μ F, 16-V tantalum
- D1—1N4003 rectifier
- D2, D3, D8*, D9*, D10*, D11*, D12*, D13*—1N914 silicon switching diode
- D4, D5, D6—1N4001 rectifier
- D7—1N5738 12-V, 1/2-W zener diode
- F1—1/4-A, fast-blow, type 3AG fuse
- IC1—4N33 optoisolator
- IC2—CD4011 quad two-input NAND gate
- IC3—NE555 timer
- IC4*, IC6*—CD4516 four-stage, up/down programmable binary counter

PARTS LIST

- IC5*—74C04 hex inverting buffer
 - IC7*—74C154 4-line-to-16-line decoder/demultiplexer
 - K1*—12-V dc spdt relay
 - Q1—D40K1 or equivalent npn silicon power transistor
 - Q2—2N3904 or equivalent npn silicon switching transistor
- The following, unless otherwise specified, are 1/4-watt, 10% tolerance, carbon-composition fixed resistors.
- R1, R2—100 k Ω
 - R3—470 k Ω
 - R4, R8—300-k Ω , linear-taper, pc-mount trimmer potentiometer
 - R5—390 k Ω
 - R6, R12*, R15*, R18*, R20*, R22*—1 k Ω
 - R7—100-k Ω , linear-taper, pc-mount trimmer potentiometer
 - R9, R10, R14*—10 k Ω
 - R11—270 Ω
 - R13*, R19*—220 k Ω

- R16*, R17*—50-k Ω , linear-taper, pc-mount trimmer potentiometer
 - R21—4.7 M Ω
 - SPKR—8- Ω dynamic speaker
 - T1—22-V, 500-mA, center-tapped step-down transformer
- Misc.—Printed circuit or perforated board, IC sockets or Molex Soldercons, fuseholder, line cord, strain relief, suitable enclosure, standoffs, terminal strips, suitable connectors, two-conductor cable, hookup wire, solder, etc.

Note—The following is available from BFA Electronics, Box 212, Northfield, OH 44067: Kit of parts for the basic Electronic Ringer project (Figs. 1 and 2) excluding the dynamic speaker, No. ER-Kit, priced at \$25.00 plus \$2.00 postage and handling for U.S.A. Also available separately is an etched and drilled printed-circuit board (Fig. 6), for \$6.00 plus \$1.00 postage and handling for U.S.A. orders. Ohio residents, add state sales tax.

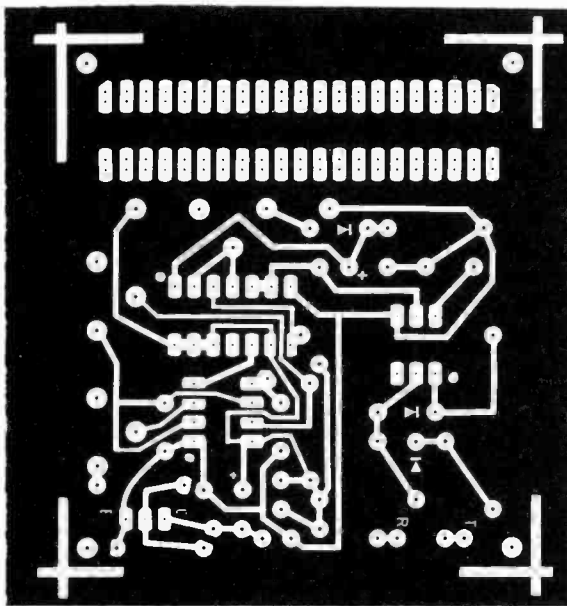

Fig. 6. Etching and drilling guide for pc board.

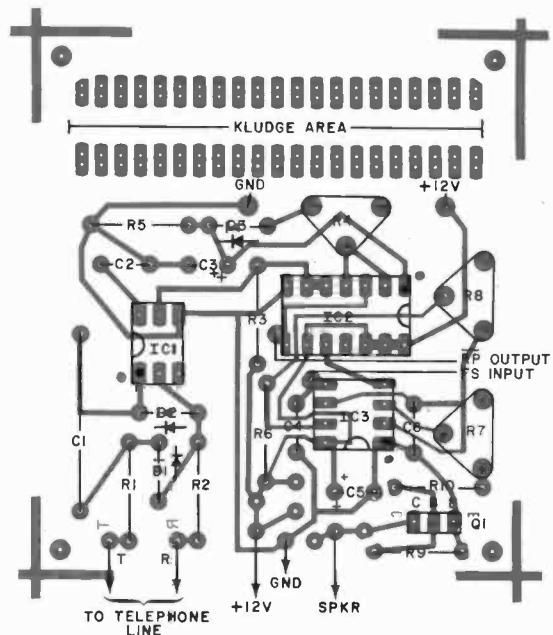

Fig. 7. Component-placement guide for pc board.

pulses are received, the RESET input is switched between logic 0 and logic 1 by IC2C, and the multivibrator produces bursts of oscillation at a rate determined by the frequency of the pulse train. The output of the timer is a square wave whose frequency (nominally 500 Hz to 2 kHz) is determined by potentiometer R8. The square wave appears at pin 3 and is coupled to driver transistor Q1 via VOLUME control R7 and resistor R10. The transistor alternately saturates and cuts off at an audio rate and causes a square-wave current to flow through the voice coil of the dynamic speaker.

Power for the Electronic Ringer is provided by the supply shown in Fig.

2. Line-voltage ac is stepped down by T1 and full-wave rectified by D4 and D5. Capacitor C7 filters the output of the rectifier into an unregulated +17 volts dc. This voltage is applied to one side of the voice coil of SPKR and to the voltage-regulating network D6, C8, R11 and D7. This network provides +12 volts dc, regulated, to the rest of the circuit. Note that the supply lacks a switch; in use, the project should be powered continuously.

Circuit Options. The pitch of the Electronic Ringer's tone signal can be varied by means of potentiometer R8, and its volume by means of R7. Further modification of the tone is possi-

ble by use of the circuit shown in Fig. 3. The RP OUTPUT from IC2A clocks four-bit binary counter IC4, which generates output pulse trains at one-half, one-fourth, one-eighth and one-sixteenth of the input signal frequency. One of these outputs can be fed back to the FS INPUT of timer IC3 by means of the network R16, R17, D9, D10 and R15 to shift the frequency of the timer's square-wave output. The high- and low-frequency tones can be adjusted independently by means of R16 and R17. At the end of each burst of ring pulses, counter IC4 is reset by the network D8, R12, R13 and C10.

The RP OUTPUT can be used to drive

telephone ringer

other circuits, such as those shown in Figs. 4 and 5. External devices can be actuated by means of the circuit shown in Fig. 4. The network *D11*, *R18*, *R19* and *C12* integrates the \overline{RP} OUTPUT into a dc level that is inverted by *IC5A*. This inverting buffer provides base drive to *Q2* when its output is at logic 1. When the transistor receives base drive, it conducts and sinks current for the coil of relay *K1*. The contacts of this relay can control an external electronic circuit or electromechanical device.

In the more complex circuit of Fig. 5, the \overline{RP} OUTPUT is processed by an input network similar to that of Fig. 4. The output of inverting buffer *IC5A*, however, drives four-bit binary counter *IC6*, whose four output lines are connected to the address inputs of demultiplexer *IC7*. Fifteen of the demultiplexer's output lines are employed in this project. Each in turn changes states when the appropriate number of pulses clocks counter *IC6*. A selected demultiplexer output can be connected to a driver/relay circuit or similar interface. If this is done, an external circuit or device will be actuated after the appropriate number of rings.

Construction. The Electronic Ringer can be assembled on either a printed-circuit or perforated board. Full-size etching-and drilling, and component-placement guides for a suitable pc board appear in Figs. 6 and 7, respectively. The board contains a kludge area at one end within which circuit options can be installed. If the existing ringer of a standard 500-series desk telephone is removed, this pc board can be installed inside the telephone enclosure. Alternatively, a custom enclosure can be used.

The project's power supply should be isolated from the telephone to prevent stray pickup of 60-Hz ac radiated by the power line and the step-down transformer. A two-conductor cable can be used to connect the *T* and *R* input terminals of the project to the green and red wires, respectively, of the telephone line. If desired, telephone-type connectors can be used to facilitate interconnection of the project and the line.

If the project won't respond to incoming calls or if dial tapping occurs, reverse the *T* and *R* connections. Also, reverse the polarity of the connections between power transformer *T1* and the ac line cord. ♦

computique computique computique

TEXAS INSTRUMENTS
INCORPORATED
electronic calculators



TI-35 STU MATH	22.50
BUS ANAL	21.95
BA II EXEC	44.95
BUS CARD	39.95
INVEST ANAL	48.95
TI-55 SCI	34.95
TI-57 SCI PROG	49.95
TI-5100 PRINTER	39.95
TI-5015 PRINTER	54.95
TI-5040 PRINTER	NEW 69.95
TI-5135 PRINTER	69.95
TI-5142 PRINTER	NEW 99.95
TI-58C	99.95
TI-59	209.95
PC-100C	169.95
SPEAK & SPELL	59.95
SPEAK & READ	74.95
SPEAK & MATH	67.95
99/4 HOME COMPUTER CALL	



THE HP-85!

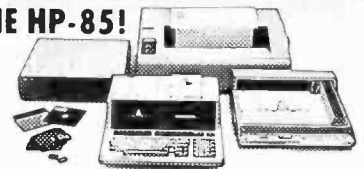

Complete Enhancements, Peripherals and Accessories

Your HEWLETT PACKARD Headquarters

HP-67	299.95	HP-32E SCI	49.95
HP-97	599.95	HP-37E BUS	59.95
HP-33C SCI	79.95	HP-41, 41CV, SYS I, II	CALL
HP-34C SCI	119.95	HP-85	CALL
HP-38C BUS/RE	119.95	HP-83	CALL

(714) 549-7373
INFORMATION LINE

(800) 432-7066
TOLL FREE (Within CA)

(800) 854-0523
TOLL FREE (Outside CA)

apple computer MEANS BUSINESS



- Personal Computers Designed for Analysis and Business Word Processing
- Immediate Delivery

apple // NOW!!
AUTHORIZED DEALER
AND LEVEL 1 SERVICE CENTER

- Ask about Peripherals and Software
- All at Great Prices!!



CHESS CHALLENGER "7" 99.95
SENSORY CHESS CHALLENGER "8" NEW 129.95



TOUCH THE FUTURE
800 (16K) STARTER SYSTEM 899.95
ATARI VISICALC AVAILABLE CALL

CODE-A-PHONE 1000 99.95
1750 NEW 269.95

ALSO: CANON, TOSHIBA, NSC, SEIKO, MATTEL, PEARLCORDER, IIT, GTE, CASIO, SHARP, AND MANY OTHERS. ALL AT GREAT PRICES!!

WE WILL MEET OR BEAT ANY COMPETITOR'S ADVERTISED PRICE ON MOST ITEMS IF HE HAS THE MDSE. ON HAND. VISA, MASTERCARD, MONEY ORDER, PERS. CK. (14 WRKG DAYS TO CLR.). COD ACCEPTED; MIN. \$4.95 SHIPPING U.S.A. AIR ON REQST. CAL. RES. ADD 6% SALES TX. ALL MDSE S'BJ. TO AVAIL. PRICES S'BJ. TO CHANGE.

MAIL & PHONE
ORDERS ONLY

Send orders to:

3211 SO. HARBOR BLVD.
SANTA ANA, CA 92704
NEWPORT
(714) 549-7373

computique

WEST LOS ANGELES
(213) 820-4223
TARZANA
(213) 705-7507

MID-WILSHIRE
(213) 385-7777
LAWDALE
(213) 370-5795

PASADENA
(213) 795-3007
BREA
(714) 990-6600

WRITE OR CALL FOR
FREE CATALOG
POPEL-May 81

PROFESSIONAL DISCOUNTS

CIRCLE NO. 11 ON FREE INFORMATION CARD

Enjoy SATELLITE TV Now

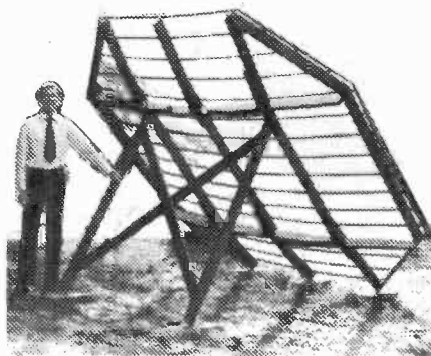

It's easy. A backyard dish antenna like the one above lets you enjoy **everything** cable subscribers get—and more. Watch movies, sports, news, family and adult entertainment. Over 100 TV and radio services.

Only 3 parts are needed, a dish antenna, LNA pream-

plifier and receiver. Let Global TV Electronics show you how to build a video system the family can enjoy. Our big (8x11 in.) book is loaded with installation details, plan descriptions, antenna aiming routines and signal strength maps. It **tells everything** and your satisfaction is **guaranteed**. Even if you want to build it all from scratch, we show complete kit and part sources and much more. Order today.

GLOBAL TV ELECTRONICS

P. O. Box 219-K, Maitland, Florida 32751
Send \$7.95 Today! Add \$2.00 for 1st class (airmail)
or call our 24 hour C.O.D. Rush order line (305) 862-5068

Name _____

Full Address _____

SUPER DISCOUNTS ON ALL COMPUTER EQUIPMENT

16K MEMORY ONLY \$25.95!

For TRS-80 Keyboard or Expansion interface. KEYBOARD requires jumpers: \$2.00 Extra. These are 200 ns tested RAM for the TRS-80, APPLE or EXIDY.

DISK DRIVES for the TRS-80 OR PMC-80:

All of our drives come complete with power supply and chassis. They may be used with existing Radio Shack drives on the same cable! 40 track drives store 102K bytes single density, and 175K double density. 80 track drives have 175K single density and 345K double density! All drives guaranteed 90 days, one year on power supply.

40 track MPI drives	\$319.95
40 track TEAC drives	\$315.95
40 track TANDON drives	\$319.95
80 track MPI drives	\$449.95
80 track TEAC drives	\$429.95
2 drive cable	\$ 25.95
4 drive cable	\$ 39.95
NEWDOS 80 OPERATING SYSTEM	\$139.95
NEWDOS 80 PATCH Patches NEWDOS 80 to work with single or double density and the doubler.	\$ 59.95
PERCOM'S DOUBLER for double density operation!	\$219.95

The DOUBLER works with the TRS or PMC expansion interfaces to allow you to use your drives in double density! You may still operate your drives as single density also! Comes with DBLDOS operating system which allows you to transfer single density files to double and vice versa! **GREAT BUY!**

DISKETTES: VERBATIM DATALIFE! BOX OF TEN SOFT OR HARD SECTORED 5 1/4" \$32.50

WE HAVE DRIVES AND CONTROLLERS FOR THE MODEL III. CALL FOR PRICES!!!

MODEMS AND TELE-COMMUNICATIONS

LYNX Telecommunication system for the TRS-80 and PMC-80	\$279.95
---	----------

Includes terminal software and connections for instant hookup! Can be connected to the TRS-80 or PMC-80 with or without an expansion interface!

LEXICOM MODEM 300 BAUD Requires RS-232	\$169.95
THE SOURCE: Hook-up to the "SOURCE"	\$ 99.95
ATARICONNECTION: Modem for 400/800, complete with software!	\$249.00
APPLECONNECTION: Modem for APPLE II	\$279.95

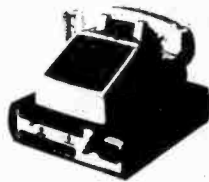

COMPLETE SYSTEMS:



PMC-80, 16K LEVEL II COMPUTER \$739.00

The PMC-80 is a work alike to the TRS-80 mod I computer! Comes with Microsoft's BASIC in ROM. Built in cassette. 12" green screen video monitor. Expandable to 48K.

Compatible to All TRS-80 MOD I Programs.

PMC 80 without monitor	\$595.00
RF-MOD for PMC to TV hookup	\$39.95
PMC-80 EXPANDER 100 SYSTEM	\$644.00

INCLUDES: 32K memory, S-100 bus, RS-232 interface, Parallel printer driver, Disk controller. Fully compatible with TRSDOS, NEWDOS, VTOS, and all other TRS-80 Mod I disk software!

APPLE II COMPUTERS 16K	\$1195.00
APPLE II COMPUTERS 48K	\$1299.00
ATARI 400	\$ 495.95
ATARI 800 COMPUTER	\$ 795.00
ZENITH Z-89 48K, 1 DISK ALL IN ONE COMPUTER	\$2495.00

VIDEO MONITORS

LEEDEX 100 12" B/W MONITOR	\$139.95
SANYO 9" B/W MONITOR	\$199.95

PRINTERS

OKIDATA MICROLINE 80 All OKI'S have TRS-80 Graphics!!!	\$ 499.00
--	-----------

Comes with friction and pin feed, upper/lower case, Graphics.

EPSON MX-80 PRINTER: Word Processing Quality Printout with Graphics!	Call
NEC SPINWRITER with Tractor Feed	\$2995.00
DIABLO MODEL 1630 with Tractor	\$2695.00
UNIVERSAL PRINTER STANDS	\$ 94.50

Other Accessories:

SUP-R-MOD RF Modulator for APPLE	\$29.95
ARCHBOLD SPEED-UP MOD FOR TRS MOD I. Allows up to 300% increase!	\$45.00
MICROSOFT BASIC Decoded and other mysteries	\$29.95
TRS-80 DISK and other mysteries	\$18.95
ZBASIC BASIC COMPILER for MOD I and MOD III TRS-80 and PMC-80 Increase basic program speeds by up to 200 times!!!!	
Tape	\$79.95
Disk	\$89.95

Both For Only \$99.95 Specify MOD I or MOD III

WE HAVE HUNDREDS OF PROGRAMS FOR ALL THE POPULAR COMPUTERS!
CALL FOR OUR FREE CATALOG

Personal and Business Checks take 3 weeks to clear. For fastest delivery use Certified Checks, Money Orders, Credit Card, or C.O.D.

We will try and beat any published price on any system! Call!

SIMUTEK COMPUTER PRODUCTS™

4877 E. Speedway Blvd
Tucson, Arizona 85712
(602) 323-9391 Technical Questions

CALL TOLL FREE TO ORDER

(800) 528-1149

Please mention this magazine when ordering
ARIZONA RESIDENTS ADD 6% SALES TAX.
WE TAKE VISA, MASTER CARD.

TRS-80 IS A TRADEMARK OF RADIO SHACK A TANDY CORP APPLE IS A TRADEMARK OF APPLE INC

A WIRELESS IDLE TACHOMETER FOR AUTO TUNE-UPS

*Eliminate risk of damage to
electronic ignition systems*

BY JOHN E. DAVIS

PERFORMING your own automobile tune-ups can be a source of personal satisfaction as well as a way to save money, but if you own a late-model car with electronic ignition, you'll find that the process is not what it used to be. Many modern ignition systems are magnetically triggered and have no points to adjust, thus relegating dwell meters to museums. However, the anti-pollution devices on modern engines have made idle speed considerably more critical than it once was, so an idle tachometer is still required. Since some of these systems can be severely damaged by momentarily grounding the tachometer tie-in point, the problem is where and how to connect the tach without damaging the ignition module.

The best way would be to avoid electrical interconnection with the ignition system entirely, and you can achieve this by building the Wireless Idle Tachometer described here. The tachometer is designed to operate with any four-, six- or eight-cylinder, four-cycle engine having spark ignition. It can be used with two-cycle engines, but the meter indications will be twice the actual engine speed.

Idle tachometers generally indicate from 0 to 1000 rpm. However, partly

for ease of calibration it was decided to extend the range of the tachometer described here to 2000 rpm.

Circuit Operation. The tachometer circuit (Fig. 1) uses a two-transistor monostable as a frequency-to-current converter. The input signal is radiated from the ignition system and picked up on a small telescoping (portable radio-type) antenna nearby; the output is displayed on a meter.

Under quiescent conditions, $Q1$ is off and $Q2$ is on. Since the collector of $Q2$ is low, there is not enough voltage to forward-bias series-connected diodes $D3$ and $D4$ and produce a current flow through $R10$, $R11$, and $M1$.

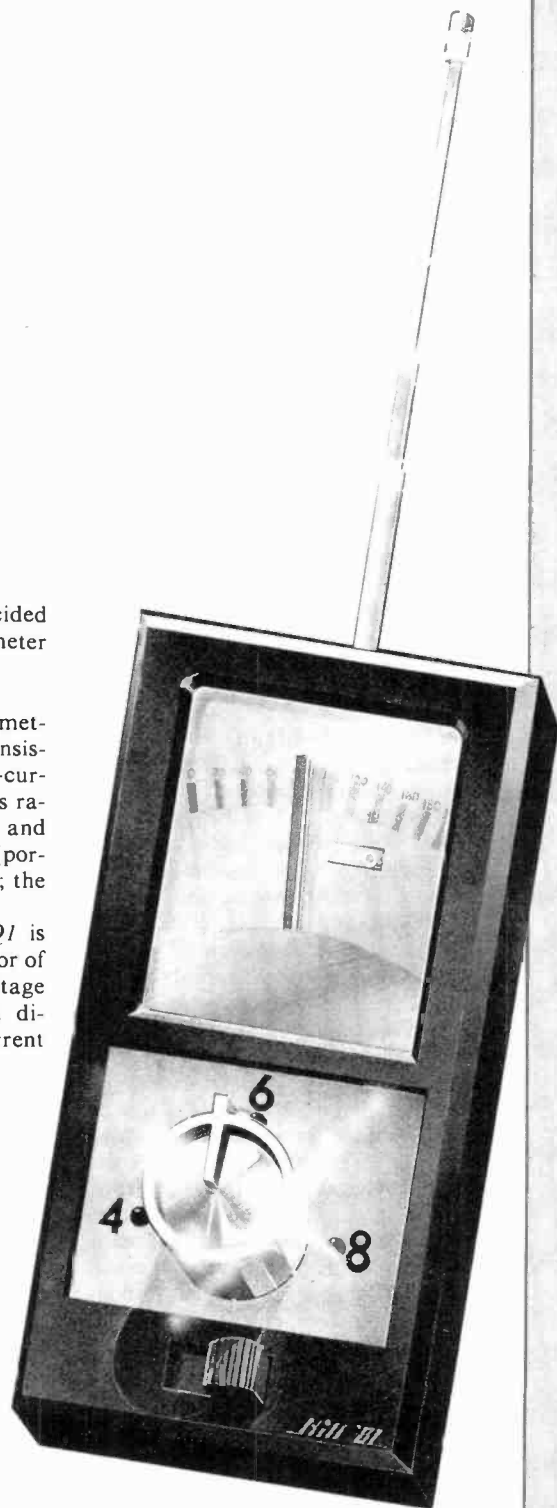

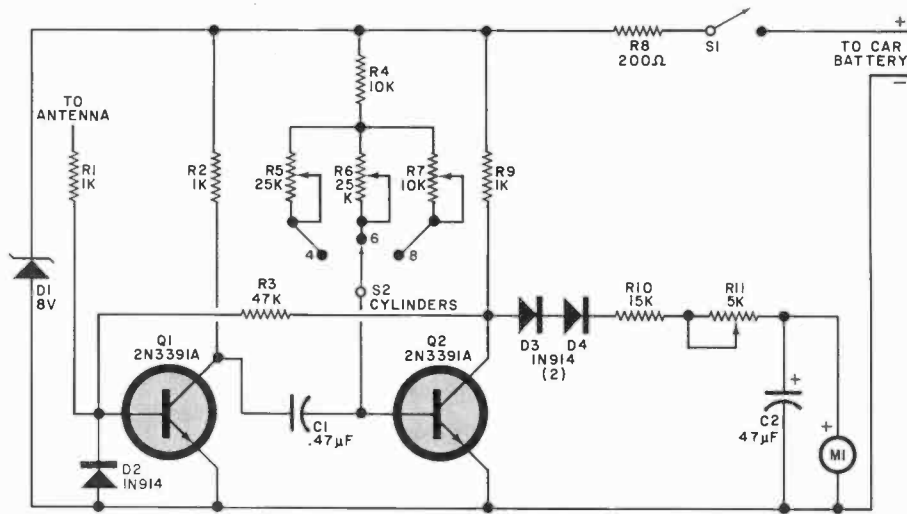

Fig. 1. The tachometer uses a two-transistor monostable circuit as a frequency-to-current converter.

PARTS LIST

- C1—0.47- μ F capacitor
- C2—47- μ F electrolytic
- D1—8-V, 1-W zener diode
- D2,D3,D4—Silicon diode (1N914 or similar)
- M1—200- μ A meter
- Q1,Q2—2N3391A transistor
- R1,R2,R9—1-k Ω , 1/2-W resistor
- R3—47-k Ω , 1/2-W resistor
- R4—10-k Ω , 1/2-W resistor
- R5,R6—25-k Ω , mini-pc potentiometer (Radio Shack #271-336 or similar)
- R7—10-k Ω mini-pc potentiometer (Radio Shack #271-335 or similar)
- R8—200- Ω , 2-W resistor
- R10—15-k Ω , 1/2-W resistor
- R11—5-k Ω linear-taper potentiometer
- S1—Spst toggle switch
- S2—Three-position rotary switch
- Misc.—Telescoping portable radio antenna, suitable plastic enclosure, two-conductor power cable, battery connector, etc.

When the antenna picks up a positive-going ignition signal, Q1 turns on and forces Q2 to turn off for an interval determined by the time-constant of C1 and the resistance selected by switch S2. The choice of time constant sets the tach for 4-, 6-, or 8-cylinder engines.

When turned off, the collector of Q2 rises to deliver a constant-voltage, constant-duration pulse to the meter network. Meter M1 will indicate the current flow. When each positive-going ignition pulse finishes, Q1 returns to its cutoff state, and Q2 reverts to its conducting state. This stops generation of the meter pulses. As the ignition system rapidly cycles on and off, the two-transistor circuit will follow, and the meter needle will flutter. This is prevented by C2 which smooths the current pulses.

Potentiometer R11 provides means to compensate for errors due to ambient temperature variations. For example, if the ambient temperature is 20° F different from the temperature at which the tachometer was calibrated, an error of about 25 rpm will be found. If you are not overly concerned about temperature variations, use a fixed 2,200 ohms for R11.

Resistor R8, in conjunction with zener diode D1, maintains a constant 8 volts for the circuit. Switch S1 is the on/off switch. Diode D2 protects Q1

from negative spikes, while R3 provides the necessary feedback.

Construction and Calibration. Circuit layout is not critical and the builder may use point-to-point wiring on perf board or the

printed circuit board shown in Fig. 2.

Meter M1, switches S1 and S2, and control R11 are mounted on the top panel of the case. Capacitor C2 is mounted directly on the meter terminals. The two-conductor power cable exits the case where convenient.

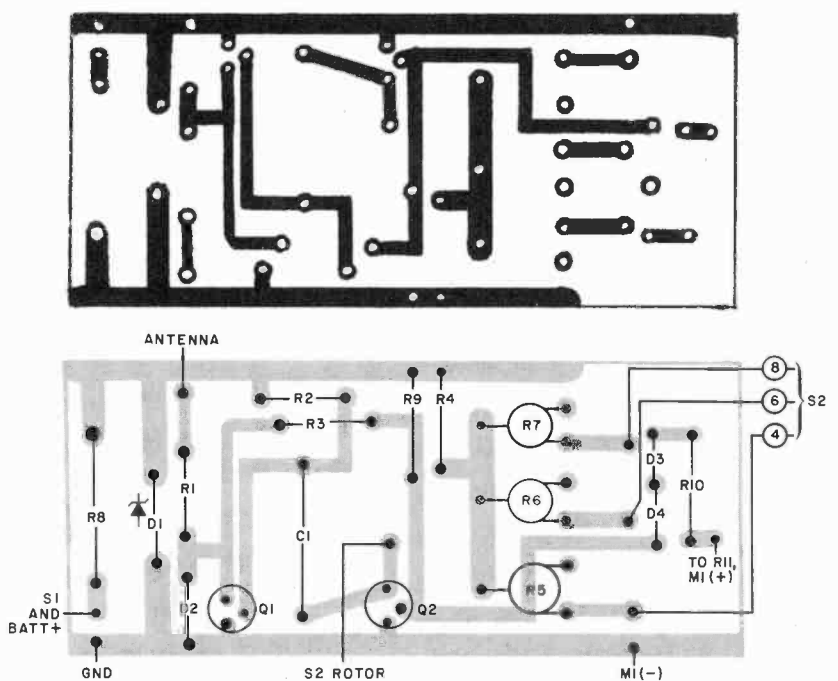
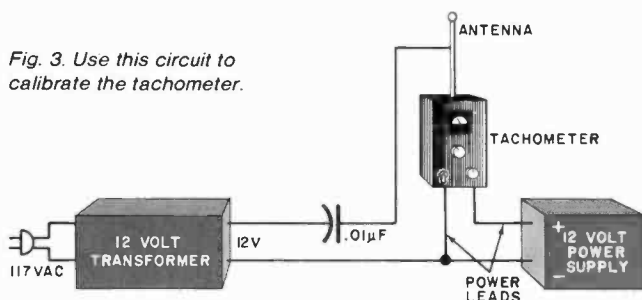

Fig. 2. Etching and drilling guide (top) and component layout diagram for a printed-circuit board for the tachometer.

Fig. 3. Use this circuit to calibrate the tachometer.



tion system and the antenna. This is most likely to occur when the car's ignition wires are concealed by the air cleaner or some other metallic element. If this is the case, move the antenna closer to the ignition coil or distributor. If you get no meter display, the power leads of the tachometer may be reversed. This will keep the unit from operating, but won't damage it. Once you get stable readings, you can tune your car accurately and be confident that you won't "blow" costly ignition parts. ♦

The antenna can be mounted in any part of the case where space allows, with a hole drilled so that the antenna can be extended. If you use a plastic case, it isn't necessary to insulate the antenna. If a metal case is used, insulation will be required whenever the antenna connects to, or passes through, the cabinet.

Calibration requires a 12-volt dc power supply (or a car battery), a 12-volt transformer, and a capacitor (approximately 0.01 µF). These components are arranged as illustrated in Fig. 3.

Turn the tachometer on and allow a few minutes for temperature stabilization. Position *R11* to the center of its rotation. This point should be marked on the case for future reference. Set cylinder-select switch *S2* to "4" and adjust *R5* for a meter indication of 180 (1800 rpm). Place the switch to "6" and adjust *R6* for an *M1* indication of 120 (1200 rpm), then set the switch to "8" and adjust *R7* for 90 (900 rpm).

If *R11* is left in the circuit and the user wishes to recalibrate the unit for accurate readings at an elevated or reduced ambient temperature, the procedure is as follows. At that ambient temperature chosen, hook up the circuit shown in Fig. 3, and adjust *R11* for the correct reading on any of the three settings of *S2*. The other two scales will also be correct, since *R11* adjusts all three scales simultaneously. Potentiometers *R5*, *R6*, and *R7* should not be readjusted for temperature compensation.

Use. With the vehicle engine running, hook the tachometer power leads to the car battery, turn it on, wait approximately one minute, then extend the telescoping antenna. Set cylinder-selector switch *S2* to the proper setting and hold the antenna about one or two feet over the engine. You should get a stable indication of engine rpm. If the display is erratic and the needle jumps around, there is insufficient coupling between the igni-

ATTENTION VCR OWNERS

NOW ONE STOP SHOPPING FOR EVERYTHING YOU NEED FOR TOTAL VIDEO ENJOYMENT. SEND FOR ALL THREE OF OUR CATALOGS AND YOU CAN SHOP ALL YOUR VIDEO NEEDS FROM THE COMFORT OF YOUR OWN HOME. WE ACCEPT MASTER CHARGE AND VISA CARDS AND MOST ORDERS ARE SHIPPED WITHIN 48 HOURS OF RECEIPT. HERE ARE THE CATALOGS YOU WILL RECEIVE WHEN YOU RETURN THE COUPON BELOW.



VIDEO YESTERYEAR CATALOG 72 page fully illustrated catalog listing 417 cassettes on TV shows, slapstick, horror, experimental movies, color cartoons, great classics, science fiction, music, comedy, mysteries and westerns. Included are Charlie Chaplin, Danny Kaye, Lenny Bruce, Laurel & Hardy, Amos N Andy, W.C. Fields, Buster Keaton, The Beatles, Bing Crosby, James Cagney, Duke Ellington, James Bond, Bela Lugosi, Alfred Hitchcock, Roy Rogers, Gene Autry, Bob Steele, Ken Maynard, Tex Ritter, Tarzan, Flash Gordon, Buck Rogers, Dick Tracy, Peter Pan, Colgate Comedy Hour, Burns & Allen, Ozzie & Harriet, Howdy Doody, Sherlock Holmes, Ernie Kovacs, Ed Wynn, Your Show of Shows, Ed Sullivan, Star Trek, Elvis Presley, Jack Benny and many many more.



VCR DIGEST 20 page illustrated catalog listing Akai, Hitachi, JVC, MGA, Panasonic, Quasar, RCA, Sanyo, Sharp, Sony, Toshiba, Zenith video recorders and cameras. Easy to read chart lists all features including recording speeds, maximum recording times, power consumption, weight and special features for each recorder and camera. Also included are the latest in video accessories. Dust covers, storage racks, cleaning kits, tables, stands, cabinets, title lettering sets, attache cases for tapes, lens care kits, tripods, caddys, and more. As an added feature there is a special section on the fantastic serials from Republic Studios. The Masked Marvel, Captain America, Spy Smasher, Red Ryder, Zorro, King of the Rocket Men, and many more all available on video cassettes.



ADULT VIDEO CATALOG 36 page illustrated catalog in full color listing almost 1,000 different titles and almost 100 all male titles. The most comprehensive lineup of adult video tapes available anywhere, all at discount prices. All tapes are the highest quality, made available from producers and distributors around the world in the original uncut versions. A must for any serious adult collector. (PLEASE NOTE: THIS CATALOG IS AVAILABLE ONLY TO ADULTS OVER THE AGE OF 18 YEARS OLD. SIGNATURE STATING YOU ARE OF LEGAL AGE MUST BE FILLED OUT ON THE BOTTOM OF THE ORDER FORM TO RECEIVE THIS CATALOG). For those people who find this type of material offensive, please indicate and we will omit this catalog from your order.



NATIONWIDE VIDEO INC.

66-72 Long Island Expressway, Maspeth, New York 11378

ENCLOSED PLEASE FIND \$3.00 (REFUNDABLE WITH ANY ORDER OF \$50.00 OR MORE) TO COVER POSTAGE AND HANDLING. PLEASE SEND ME ALL THREE CATALOGS OFFERED.

NAME _____

ADDRESS _____

CITY _____ STATE _____ ZIP _____

I CERTIFY THAT I AM 18 YEARS OLD AND WISH TO RECEIVE YOUR ADULT VIDEO CATALOG: _____

(Signature)

I DO NOT WISH TO RECEIVE YOUR ADULT VIDEO CATALOG

PE

VOCAL ZAPPER MAKES YOU A "SUPERSTAR"

Cancels the "phantomed" center channel of a stereo record and lets you substitute your own voice

BY CRAIG ANDERTON AND DAVID KARR

WHETHER to practice singing, have fun at parties, or just feel like a rock star, the Vocal Zapper may be just what you want. This inexpensive device lets you remove a lead singer's voice during playback of most stereo records and substitute your own voice. The Zapper is effective only with stereo records and most effective with those in which the lead vocalist (and bass instruments, if used) occupy center-stage, with vocal and nonbass-instrumental accompaniment mixed more toward the left or right of the stereo spread. (This type of mix is common in popular music.)

To create the center-channel effect, the sound engineer generally mixes equal amounts of in-phase lead-vocal (and bass) signal with the directional left- and right-channel signals. When a stereo record mastered in this manner is played back, the mix psychoacoustically places the lead vocalist stage-center, with accompanying voices and instruments to the left and right of the stereo spread.

In the ZAP mode, the Zapper subtracts the left and right stereo signals fed to its inputs in a differential amplifier. The result is that all common-mode (equal-amplitude, in-phase) signals in both channels—in this case, the lead vocalist—are cancelled out. What emerges from the amplifier and is fed back into the stereo system is a single mono signal with all the original left- and right-of-center information, including any reverb that may have been added to the lead vocal, but no lead vocal. The residual reverb will generally be of a low enough level to be unobjectionable if you replace the lead vocal with your own voice. In fact, you may even find it desirable, since it adds depth to the sound.

To prevent complete cancellation of common-mode bass information, one channel has been modified to permit only those frequencies above about 160 Hz to be cancelled by the Zapper. Since unequal amounts of common-mode bass signal appear in the differential amplifier, little of it is eliminated from the mono signal at the output. Mono signals fed to the Zapper will be cancelled almost entirely.

About the Circuit. The heart of the Vocal Zapper, shown schematically in Fig. 1, is differential amplifier *IC1*. This IC and microphone preamplifier *IC2* can be an LM301, LM748, or any equivalent uncompensated operational-amplifier integrated circuit.

With *S1* set to NORM, both the left input at *J1* and the right input at *J2* are mixed together and fed to the negative, inverting input of *IC1*. Since in this mode only one input of *IC1* has a signal applied to it, no differential amplification occurs. In this event, *IC1* simply passes on *all* the signal information, including common-mode

vocal in mono form, to both *J3* and *J4*, the left and right outputs, respectively. If a microphone is plugged into *J5* in the NORM mode, its signal would be amplified by microphone preamplifier *IC2* and mixed with the left and right input signals to provide a "duet" signal capability. (Microphone gain is set as desired with potentiometer *R11*.)

Setting *S1* to ZAP (common-mode cancel) causes the left-channel input signal to feed the positive, noninverting input of *IC1*, while the right-channel signal continues to feed the negative input. Once the two signals enter *IC1*, one of them is inverted (phase shifted by 180°) so that common-mode information cancels. The music at this point would be lower in volume than in the NORMAL mode.

The value of *C3* has been selected to prevent complete cancellation of bass information in the common-mode signals. Frequencies below about 160 Hz pass through the differential amplifier from *J1* with considerably lower amplitude than those



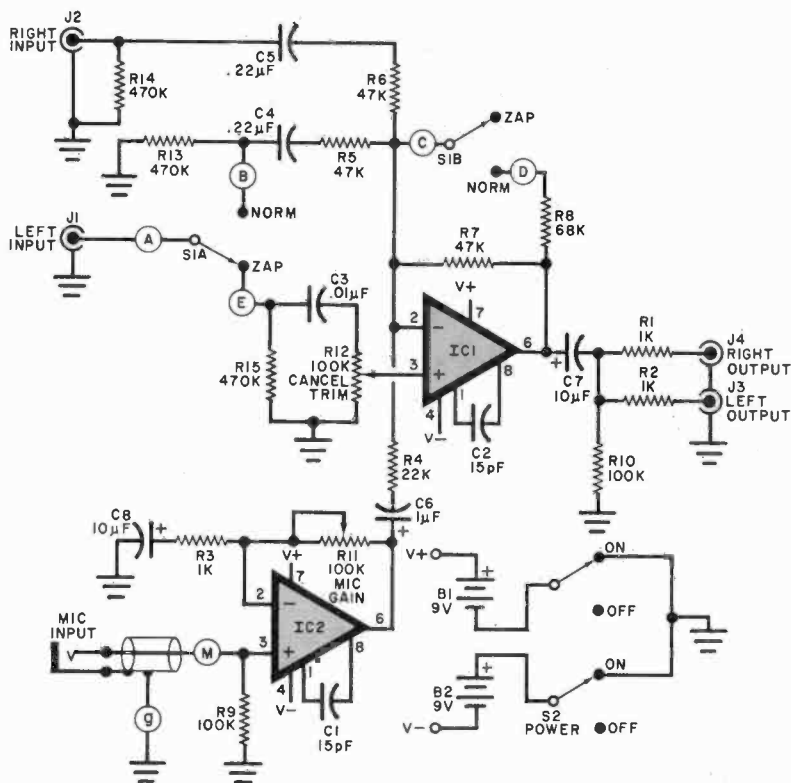

PARTS LIST

- B1, B2—9-volt transistor battery
- C1, C2—15-pF disc capacitor
- C3—0.01- μ F, 15-V disc or Mylar capacitor
- C4, C5—0.22- μ F, 15-V disc or Mylar capacitor
- C6—1- μ F, 15-volt electrolytic or tantalum
- C7, C8—10- μ F, 15-volt electrolytic or tantalum
- IC1, IC2—LM301, LM748 or equivalent op amp (see text)
- J1 through J4—Phono jack (see text)
- J5—Microphone jack (see text)
- Unless otherwise specified the following are $\frac{1}{4}$ -watt, 10% tolerance fixed resistors
- R1, R2, R3—1 k Ω
- R4—22 k Ω
- R5, R6, R7—47 k Ω
- R8—68 k Ω
- R9, R10—100 k Ω
- R11, R12—100-k Ω upright pc-type trimmer potentiometer
- R13, R14, R15—470 k Ω
- S1, S2—Dpdt switch
- Misc.—Printed-circuit or perforated board; IC sockets (optional); sheet aluminum for front and rear panels; L brackets; No. 6 machine hardware; dry-transfer lettering kit; hookup wire; solder, etc.

Fig. 1. Schematic diagram of the Zapper. IC1 and IC2 can be any uncompensated op amp ICs similar to the LM301.

from J2. Although these two bass signals are common-mode, they are of unequal amplitudes and, therefore, don't cancel completely. During zap-

ping, you can add your own voice in place of the vocal being cancelled simply by singing into a microphone plugged into MIC input J5.

Power for the circuit is supplied by a pair of 9-volt transistor batteries, B1 and B2. Since the circuit requires a bipolar source, B1 and B2 are ar-

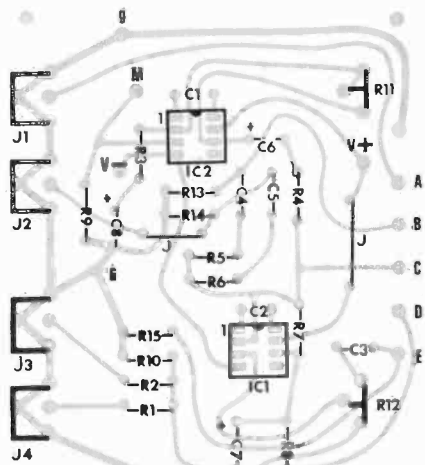
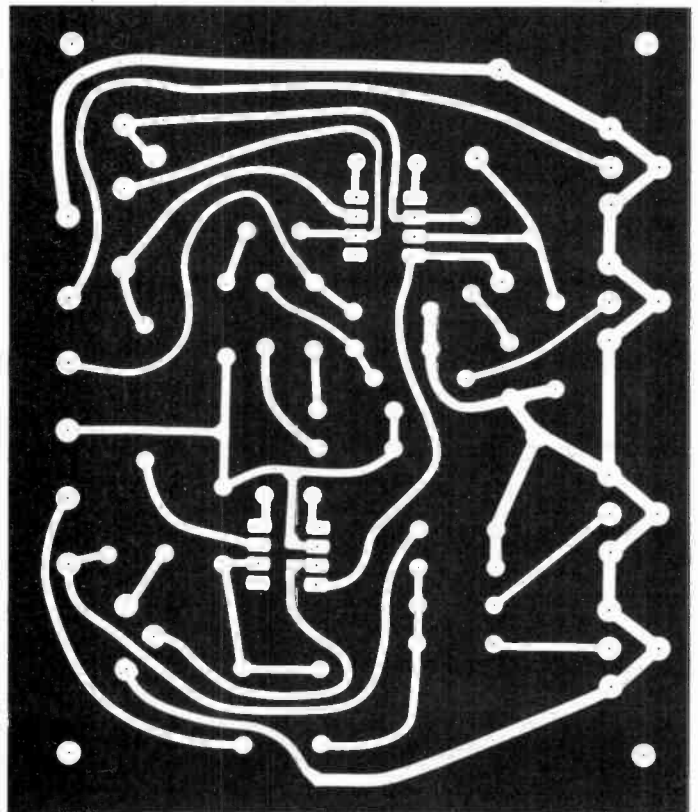

Fig. 2. Actual-size foil pattern for a pc board is at right; component layout above.



KIT ORDERING INFORMATION

The following is available from PAIA Electronics, Inc., P.O. Box 14359, Oklahoma City, OK 73116: complete kit of parts No. 6730K, including front panel for \$24.95 plus \$3 postage. Also available separately: pc board No. 6730pc for \$9.95. Add \$5 handling charge for foreign orders.

THIS MONTH'S SUPER SPECIALS!

Audio & Video

VIDEO		AUDIO	
SONY SL 5400 Betamax	\$799	TECHNICS RS-M45 Cass Deck	\$225
JVC HR-6700 Video Rec.	\$799	B.I.C. T-2 Cassette Deck	\$159
ZENITH VR-9000 Beta Vid. Rec.	\$699	DUAL 606-55 T-1 A/Cass.	\$219
RCA VET-250 Video Rec.	\$775	TECHNICS SA-202 Receiver	\$145
RCA VEP-150 Port. Vid. Rec.	\$729	PIONEER SX-3700 Receiver	\$259
SONY KV-1914 19" Color TV	\$439	TECHNICS SL-D2 Turntable	\$109
PANASONIC CT 8010 19" Col. TV	\$359	AKAI UCU-2 Micro Int. Amp.	\$159
PANASONIC CT 288 17" Col. TV	\$279	TECHNICS S121 Tuner	\$145

CAR STEREO

PIONEER		JENSEN	
CASSETTE IN-DASH W/RADIO		CASSETTE IN-DASH W/RADIO	
KP-1500	\$490	R-402 receiver	174.90
KP-2500	599.00	R-406 receiver	199.90
KP-4500	714.90	R-410 receiver	219.90
KP-5500	124.90	R-420 receiver	259.90
KP-8500	141.90	SPEAKERS	
KE-2100	174.90	J-1001 6x9 separates	94.90
KE-3000	209.90	J-1065 6x9 inas II	62.50
KE-20	214.90	J-1033 6x9 inas II	79.50
KP-3500 (foreign cars)	129.90	J-1201 6x9 coax II thin	59.90
KP-4502 (foreign cars)	144.90	J-1101 4x10 inas II	62.50
KP-8000	154.90	J-1150 4x10 inas II	70.90
KPX9000 (req amp)	154.90	J-1174 5 1/4 inas II	62.50
KPX9500 (req amp)	170.90	J-1124 5 1/4 inas II	79.95
		J-1188 5 1/4 inas II thin	42.95
		J-1069 6x9 coax II	40.50
		J-1037 6x9 coax II	59.50
		J-1041 5 1/4 coax II	49.50
CASSETTE UNDER DASH		SANYO	
KP-373	84.90	IN-DASH CASSETTE	
KP-575	94.90	FI-1405	179.95
KP-500	99.90	FI-1408	219.90
KP-666 (req amp)	129.90	FI-1405	119.95
KP-77G (req amp)	104.90	FI-2400	224.90
KP-88G (req amp)	99.90	FI-C2	54.90
KPX60C	118.90	FI-C4	64.90
KP707G	144.90	FI-C5	71.90
		FI-C8	99.90
		FI-210	109.90
		FI-C16	147.90
POWER AMPS/EQUALIZERS		BLAUPUNKT	
BP-320	49.90	CR 3001	238.90
AD-30	89.90	CR 3001	432.90
AD-50	141.90	CR 4000	259.90
GM-40	49.90	CR 5001	314.90
GM-120	104.90	BEA-100	107.90
CD-5	89.90	BEA-200	174.90
		BEA-50	74.95
CAR SPEAKERS		CLARION	
TS-M2	32.90/PAIR	PE-0500 pagumamba	569.90
TS-13	32.90/PAIR	PE-0508	319.90
TS-07	37.90/PAIR	PE-175B	172.90
TS-167	44.90/PAIR	PE-550A	94.90
TS-168	82.90/PAIR	3001QB1	177.90
TS-05	62.90/PAIR	3001QB2	137.90
TS-6	69.90/PAIR		
TX-X9	129.90/PAIR		

WE ALSO CARRY THE FULL LINE OF CAR STEREOS BY PANASONIC, SONY, SAMSUNG, METSUN, SONY, AUDIOVEX AND CRAIG.

BLANK CASSETTES

AUDIO		VIDEO	
AMPEX GRAND MASTER I OR C90	2.99	WE CARRY VIDEO TAPES BY AMPEX	
FUJIFILM I OR III C90	2.99	BASF, TDK, JVC, MAXELL, PANASONIC,	
SCOTCH HIGHLANDER C 90 3-PK	4.99	MEMOREX, TDK, SCOTCH, SONY, RCA	
MEMOREX HI BIAS C90	141.99	AND QUASAR	
SCOTCH MASTER II OR III C90	3.25	ALL BETA I 500	10.95
SONY FC9 C90	3.25	ALL BETA I 750	13.95
TDK D-C90	1.49	ALL VHS 1/20 (EXCEPT HG)	14.95
TDK D-C60	1.19	MATTEL INTELLIVISION	219.90
TDK D-C30	1.08	AIARDI VIDEO GAME CX 2600	148.95
TDK ADC90	2.45	SPACE INVADERS CARTRIDGE	23.00
TDK SA-C60	2.15	PANA. DV-1400 Video Rec.	899.00
TDK SA-C90	2.99	ZENITH V-975Q	1020.00
TDK MA-C90 METALL	6.29		
TDK MA-C90 METALL	7.99		
MAXELL UD, UD6LL, UD6LLR	100 LOW TO		
CALL OR WRITE FOR PRICES	ADVERTISE		
SANSUI AUD-58 Int. Amp.	274.00		
TECHNICS SA-303 Receiver	199.00		

WE STOCK B&W AND COLOR TV'S, VHS AND BETA VIDEO RECORDERS, AND HOME MOVIES FROM ALL MAJOR HOLLWOOD STUDIOS SEND FOR CATALOGUE.

MINIMUM ORDER 12 TAPES
100% GUARANTEED

ACCESSORIES

CAR ACCESSORIES		HEADPHONES	
FUZZBUSTER ELITE	134.95	KOSS PRO 4AAA	46.50
FOX XR RADAR DETECTOR	99.50	KOSS TECH VFR	46.50
FOX XKRW (remote)	109.50	KOSS HVXILC	46.00
SUPERFOX	224.90	SENNEISER HD-20	52.50
PAGE ALERT 4000	114.95	SENNEISER HD-430	72.50
BELL 810 (superhell)	154.95	AUDIO TECHNICA ATM-7	94.90
HAR FA 80 (Ant)	33.95	PIONEER SE-205	22.95
MISCELLANEOUS		SONY MDR-3	34.50
BIC FM-8 BEAM BOX	24.00	SONY MDR-7	54.95
BIC FM-8 BEAM BOX	34.90	CARTRIDGES	
BIC FM-10 BEAM BOX	64.00	SHURE M91ED	19.95
CASIO C-80 Calc/Watch	44.90	SHURE M95ED	29.95
CASIO ML-81 CALCULATOR	31.95	SHURE V151V	96.99
CHESS CHALLENGER X7	87.00	PICKERING XSV 3000	53.95
BRIGGAMOR CHALLENGER 7	85.90		
BSR X101K1	68.95		
BSR X10211 (Timer)	50.95		
BIC B-1	19.95		
BONE FONE RADIO	63.95		
SONY TPSL2 PORT. STEREO	179.95		

RECORDS

ALL ROCK, JAZZ & CLASSICAL

At 7.99 list At 8.99 list At 9.99 list Cass & 8-Track
499 599 699 Same Price as LP:
Minimum Order:
5 Records or Tapes

PRICES MAY VARY ON IMPORTED RECORDS. We Stock all Major Labels

HOW TO ORDER BY MAIL: For prompt shipment send money order, certified check, cashier's check, Master Charge or Visa (include card number, expiration date and signature). Shipping insurance charge is 5% of total (or \$3.95 minimum (\$5 additional for orders outside of Continental U.S.)). N.Y.S. residents add tax. No C.O.D. All merchandise 100% guaranteed brand new and factory fresh. 3 weeks delay on personal checks.

ORDER TOLL FREE (800) 221-8180 Customer Service Hot Line
For more information call: 732-8500 (212) 233-0657



23 PARK ROW, NEW YORK, N.Y. 10038 DEPT. PE
SEND FOR OUR 200 PAGE FREE CATALOG

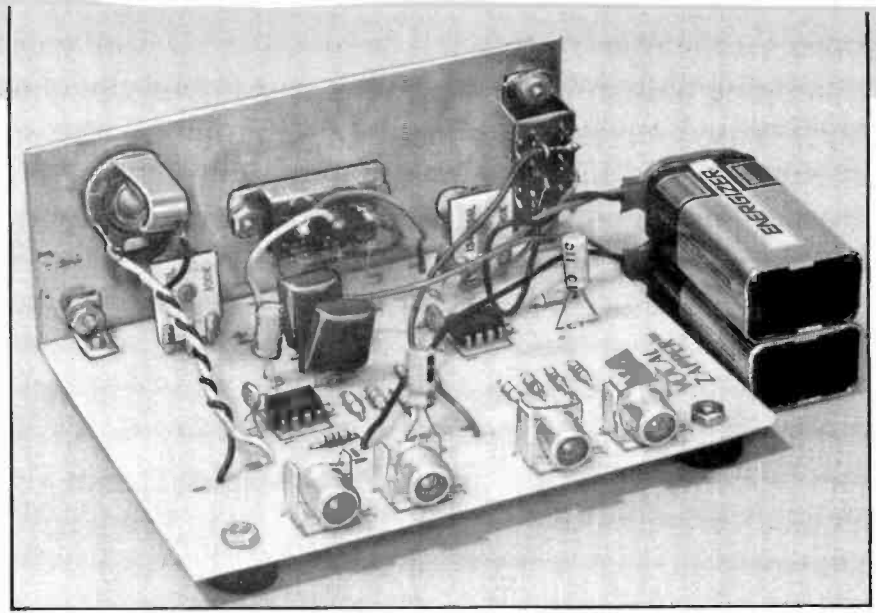

Fig. 3. Photo of the interior of the author's prototype. Right-angle pc-mount jacks were used for J1 through J4.

ranged to supply ± 9 volts, referenced to signal ground.

Construction. The Zapper is best assembled on a printed-circuit board (see Fig. 2) or perforated board with solder clips. In either case, sockets are optional, but recommended, for IC1 and IC2.

Mount the resistors, capacitors, trimmer potentiometers, and ICs (or their sockets) as shown in the compo-

nent-placement guide. Don't forget to install the two jumpers at the locations labelled J. You have the option with J1 through J4 of using either right-angle pc-mount jacks (see Fig. 3) or standard panel-mount jacks.

Referring to the lead photo, prepare a front panel to accommodate POWER and NORM/ZAP switches S1 and S2 and MIC jack J5 and to provide access to CANCEL TRIM and MIC GAIN controls R12 and R11. (Note: Select a

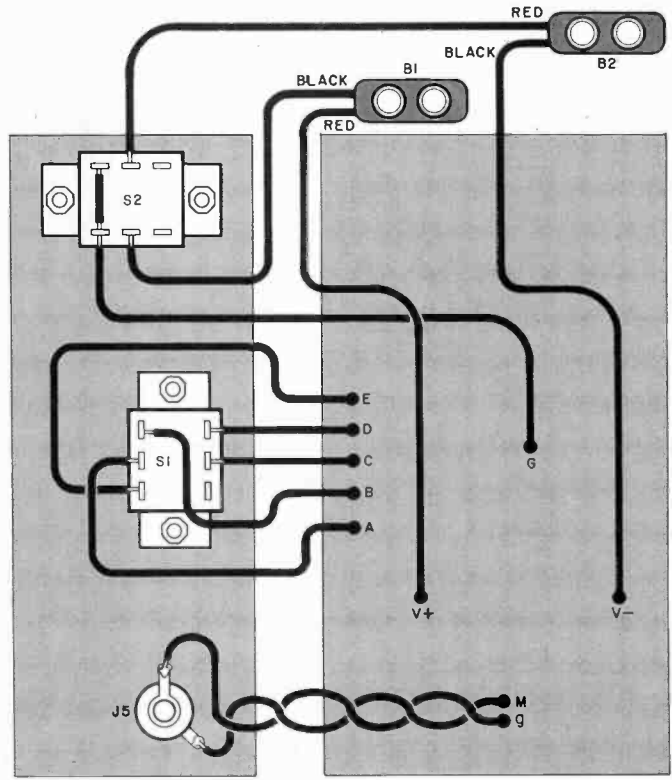

Fig. 4. Follow this wiring diagram to connect the front panel to the components on the pc board.

jack that mates with the connector on the microphone you plan to use with the Zapper and drill a hole just large enough to accommodate it.) Then mount the panel to the pc assembly edge with the letters A through E on it with a pair of small L brackets.

Loosely twist together two lengths of different colored insulation hookup wire or substitute a length of shielded cable and solder one end to the lugs on the MIC jack. Being careful to maintain proper polarization, connect and solder the other end of the twisted pair or shielded cable to points M (hot) and g (signal ground) on the pc board. This step and the remainder of off-board wiring are shown in Fig. 4.

Installation and Use. Snap a pair of batteries into their connectors, but leave the POWER switch off. Then connect the Zapper into your stereo system's TAPE OUT/TAPE MONITOR loop. From now on, when you wish to use the Zapper, all you do is activate the receiver or amplifier tape-monitoring function.

After installation, turn on power first to the Zapper and then to the stereo system. Set your stereo system's input selector to PHONO but leave the TAPE MONITOR switch in the out position. When you play a stereo record, you should now hear normal stereo sound. Set the Zapper to NORM and switch in the stereo system's tape-monitor function. The stereo spread should now disappear and be replaced by mono sound. You might also note a slight drop in overall volume.

Now switch to the ZAP mode and listen to the sound. The lead vocal should be absent, but the stereo spread should remain. If you can hear the lead vocal (don't confuse this with any reverb that may have been added), adjust the CANCEL TRIM control for maximum cancellation, which should occur somewhere near the center of the pot. The CANCEL TRIM control need not be touched again.

Once the Zapper is operating properly, plug headphones into the amplifier and then a microphone into the Zapper. (Don't attempt to listen through speakers with a live microphone. If you do, acoustic feedback can damage your system.) As you sing into the microphone, adjust the MIC GAIN control for the proper blend between microphone and program material. At first, you might tend to set mike gain too high, which could result in distortion. With a little practice, you'll soon be using the MIC GAIN control with the proper "touch." ♦

FREE McIntosh STEREO CATALOG and FM DIRECTORY

Get all the newest and latest information on the new McIntosh catalog. In addition you will receive an FM station directory that covers all of North America.

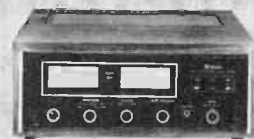
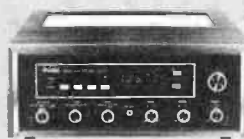
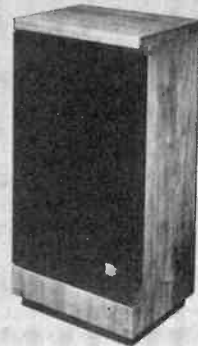

**SEND
TODAY!**

McIntosh Laboratory, Inc.
East Side Station P.O. Box 96
Binghamton, N.Y. 13904

PE

NAME _____
ADDRESS _____
CITY _____ STATE _____ ZIP _____

If you are in a hurry for your catalog please send the coupon to McIntosh.
For non rush service send the Reader Service Card to the magazine.

CIRCLE NO. 42 ON FREE INFORMATION CARD



▲ APPLE II+ (48K) \$1199.00



▲ ATARI 800
◀ (48K) \$1019.00

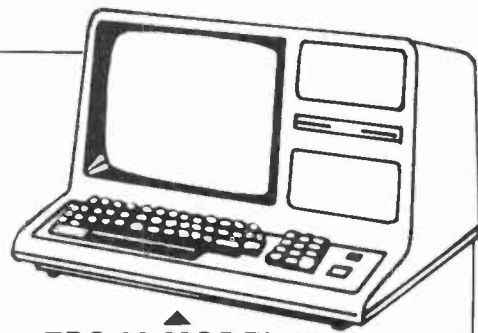

▲ TRS-80 MODEL III (48K)
\$1019.00

PRINTERS

MICROLINE-80.....\$499.00
MICROLINE-82.....\$699.00
MICROLINE-83.....\$999.00
EPSON MX-70.....\$449.00
EPSON MX-80.....\$519.00
EPSON MX-80FT.....\$699.00
CENTRONICS 737....\$769.00

TERMS: Prices and specifications are subject to change. HARDSIDE accepts VISA & MASTERCARD. Certified checks and Money Orders. Personal checks accepted (takes 3 weeks to clear). HARDSIDE pays all shipping charges (within 48 states) on all PREPAID Orders OVER \$100.00. On all orders over \$100 a \$2.50 handling charge must be added. COD orders accepted (orders over \$250 require 25% deposit) there is a \$5.00 handling charge. UPS Blue Label. Air Freight available at extra cost.

TSE-HARDSIDE
6 South St. Milford, NH 03055 (603) 673-5144
TOLL FREE OUT-OF-STATE 1-800-258-1790



3 BITS FROM BYTE

NEW

BUILD YOUR OWN Z80 COMPUTER

This practical guide shows how to build a working computer based on the Zilog Z80 microprocessor. Each computer subsystem is fully explained and supported by proven design and testing information. The description focuses on a basic single-board microcomputer containing:

- easy expansion to include a video terminal
- a 1K-byte operating system
- serial and parallel ports
- hexadecimal display
- audio cassette mass storage

330 pp., softcover
Available June 1981
\$15.95

BUILD YOUR OWN Z80 COMPUTER

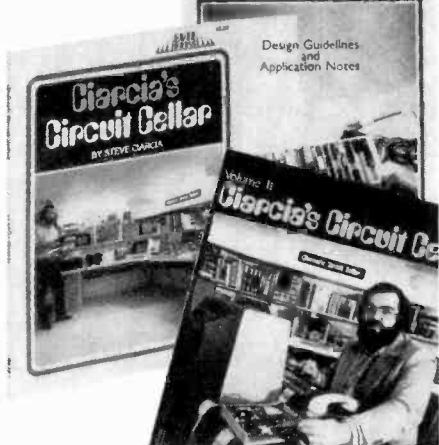

CIARCIA'S CIRCUIT CELLAR

VOL. I details a variety of microcomputer projects. A collection of the best articles from the popular series in BYTE magazine, it includes:

- D/A conversion
- programming EPROMS
- AC remote-controlled appliances
- digitized speech
- touch input video display

Complete instructions. 125 pp., softcover \$8.00

VOL. II tells how microcomputers can be interfaced to our environment, including:

- building a computer controlled home-security system
- computerizing appliances
- transmitting digital information over a beam of light
- building the Intel 8086 microprocessor system design kit
- I/O expansion for the TRS-80

Every step spelled out. 330 pp., softcover \$12.95

STEVE CIARCIA is a Computer Consultant, Electrical Engineer, and author of "Ask Byte" and "Circuits Cellar" columns in BYTE magazine.

Order by phone. Call toll free
800-258-5420



Please send:

- BUILD YOUR OWN Z80 COMPUTER \$15.95
- CIARCIA'S CIRCUIT CELLAR, VOL. I \$8.00
- CIARCIA'S CIRCUIT CELLAR, VOL. II \$12.95

Add 75¢ to cover postage and handling.

- Check enclosed in the amount of \$ _____
- VISA Master Charge Expires _____

Card # _____
Name _____
Title _____
Company _____
Street _____
City _____ State _____ Zip _____

BYTE BOOKS 70 Main Street
Peterborough, NH 03458 B351

CIRCLE NO. 9 ON FREE INFORMATION CARD

PROGRAM MERG

Machine-language utility permits combining two programs

BY JAMES L. FRIDDLE

UNLESS you have an expansion interface and disk system, adding a subroutine to one or more BASIC programs in a TRS-80 means typing. And if the subroutine is long or often used, it means lots of typing, which can generate errors in your work as well as fatigue.

The machine-language program in Listing 1 allows you to load a BASIC program from cassette tape into memory and combine it with a BASIC program already in memory, using the Level-3 MERGE command. (This assumes that the second program has line numbers higher than the program already in memory.) If you are unfamiliar with machine-language programming, Listing 2 comprises a BASIC program that will POKE the MERGE routine into protected memory, and then erase itself. Since the MERGE routine contains only relative addressing, it can be located at any block of memory the user desires. If

the addresses given in the listing are retained, the KBFIX routine can be used as well. When using the MERGE routine, enter 32594 for MEMORY SIZE? when the TRS-80 is turned on. Address 418CH must be loaded with MERGE program address, in this case 7F53H. Once this has been accomplished, then activating the MERGE command, starts the program.

To use the MERGE command, enter your main program after making sure that its highest line number does not encroach on the lowest line number of the subroutine. Place the cassette containing the previously recorded subroutine in the recorder, press the play button, and enter the command MERGE. The recorder will start; and when the program is found, the usual asterisks will appear. When the cassette stops, enter LIST and verify that there is a single program containing the original main program with the appended subroutine. ♦

LISTING 1

Add.	Code	Line#	Mnemonics	Remarks
7F53		010	ORG 7F53H	
		020		;L2MERGE VERSION 2.0
7F53	DD 2A F9 40	030	LD IX, (40F9H)	;GET LINE # POINTER
7F57	DD 2B	040	DEC IX	
7F59	DD 2B	050	DEC IX	;LINE POINTER ADDR
7F5B	DD 2B	060	DEC IX	
7F5D	DD 2B	070	DEC IX	
7F5F	AF	080	XOR A	
7F60	CD 12 02	090	CALL 0212H	;DEFINE DRIVE
7F63	CD 96 02	100	CALL 0296H	;FIND SYNC BYTE
7F66	06 04	110	LD B,4	;READ FIRST 4 BYTES
7F68	CD 35 02	120 LP1	CALL 0235H	;READ BYTE
7F6B	10 FB	130	DJNZ LP1	;DONE?
7F6D	CD 35 02	140 LP2	CALL 0235H	;LOAD BASIC TAPE
7F70	DD 77 02	150	LD (IX+2),A	;PUT BYTE IN MEM
7F73	B7	160	OR A	
7F74	20 08	170	JR NZ, SKP	
7F76	3A 3F 3C	180	LD A, (3C3FH)	;CHANGE *
7F79	EE OA	190	XOR OAH	
7F7B	32 3F 3C	200	LD(3C3FH),A	* CHANGED
7F7E	AF	210 SKP	XOR A	;O A & RESET FLAGS

ING ON A TRS-80

NEW!!! THE ELECTRIC MOUTH*



for \$100, Elf II, Apple, TRS-80 Level II*

From \$99.95 kit

Now — teach your computer to talk, dramatically increasing the interaction between you and your machine.

That's right: the ELECTRIC MOUTH actually lets your computer talk! Installed and on-line in just minutes, it's ready for spoken-language use in office, business, industrial and commercial applications, in games, special projects, R&D, education, security devices — there's no end to the ELECTRIC MOUTH's usefulness. Look at these features:

- * Supplied with 143 words/letters/phonemes/numbers, capable of producing hundreds of words and phrases.
- * Expandable on-board up to thousands of words and phrases (just add additional speech ROMs as they become available).
- * Four models, which plug directly into S100, Apple, Elf II and TRS-80 Level II computers.
- * Get it to talk by using either Basic or machine language (very easy to use, complete instructions with examples included).
- * Uses National Semiconductor's "Digitalker" system.
- * Includes on-board audio amplifier and speaker, with provisions for external speakers and amplifier.
- * Adds a new dimension and excitement to programming: lets you modify existing programs and games to add spoken announcements of results, warnings, etc.
- * Installs in just minutes.

Principle of Operation: The ELECTRIC MOUTH stores words in their digital equivalents in ROMs. When words, phrases, and phonemes are desired, they are simply called for by your program and then synthesized into speech. The ELECTRIC MOUTH system requires none of your valuable memory space except for a few addresses if used in memory mapped mode. In most cases, output ports (user selectable) are used.

Spoken Material Included											
one	eighteen	at	dollar	inches	number	ss	c	i			
two	nineteen	cancel	down	is	of	second	d	u			
three	twenty	case	equal	it	off	set	e	v			
four	twenty	cent	error	kilo	on	space	f	w			
five	thirty	400hertz	feet	left	out	speed	k	x			
six	fifty	80hertz	tone	flow	less	over	star	h	y		
seven	sixty	20ms	silence	(ue)	lesser	parenthesis	start	l	z		
eight	seventy	40ms	silence	gallon	limb	percent	stop	l	k		
nine	eighty	60ms	silence	go	low	please	than	k			
ten	ninety	160ms	silence	gram	lower	plus	the	l			
eleven	hundred	320ms	silence	great	mark	point	time	m			
twelve	thousand	control	greater	meter	pound	try	n				
thirteen	million	check	have	mile	pulses	up	a				
fourteen	zero	comma	high	milli	rate	volt	p				
fifteen	again	control	higher	minus	re	weight	q				
sixteen	ampere	danger	hour	minute	nearly	a	r				
seventeen	and	degree	in	near	right	b	s				

**"Elf II" and "The Electric Mouth" are reg. trademarks of Netronics R&D Ltd. "Apple" is a reg. trademark of Apple Computer Inc. "TRS-80 Level II" is a reg. trademark of Tandy Corp.

Continental U.S.A. Credit Card Buyers Outside Connecticut

CALL TOLL FREE 800-243-7428

To Order From Connecticut Or For Technical Assistance, Etc.,

Call (203) 354-9375

NETRONICS R&D LTD. Dept PE

333 Litchfield Road, New Milford, CT 06776

Please send the items checked below:

- \$100 "Electric Mouth" kit \$99.95
- Elf II "Electric Mouth" kit \$99.95
- Apple "Electric Mouth" kit \$119.95
- TRS-80 Level II "Electric Mouth" kit \$119.95

Add \$20.00 for wired & tested units. All plus \$3.00 postage & insurance. Conn res. add sales tax.

Total Enclosed \$

Personal Check Cashier's Check/Money Order

Visa Master Charge (Bank No. _____)

Acct. No. _____ Exp. Date _____

Signature _____ Print _____

Name _____

Address _____

City _____

State _____ Zip _____

LISTING 2

```

1  REM MERGE 2.0 BASIC LOAD JLF 6/29/80
2  REM ENTER 32594 FOR MEMORY SIZE ON POWERUP
10  FOR X=32595 TO 32712
20  READ Y:POKE X,Y
30  NEXT
40  DATA 221,42,249,64,221,43,221,43,221,43,221,43,175,205,
18,2,205,150,2,6,4,205,53,2,16,251,205,53,2,221,119,2,183,32
50  DATA 8,58,63,60,238,10,50,63,60,175,221,182,0,221,182,
1,221,182,2,221,35,32,225,205,248,1,42,249,64,229,221,225,
17,235,66
60  DATA 237,82,229,209,221,43,221,43,221,110,0,221,102,1,
175,124,181,40,13,175,25,229,221,117,0,221,116,1,221,225,
24,232,221
70  DATA 229,225,35,35,34,249,64,34,251,64,34,253,64,195,25,
26
80  POKE 16780,83:POKE 16781,127
90  NEW
    
```

reprint series

Many important articles covering a variety of interests in the broad field of electronics are published in POPULAR ELECTRONICS. Reprints of selected articles and test reports are now available in the event that you missed some you would like to have for reference or study purposes—or for projects you wish to build. Reprints are only \$2 each; \$1 for those marked with an asterisk. Minimum order \$6.

Test reports

AUDIO

- 40871 ADC Accutrac 4000 Record Player
- 40874 MXR Stereo Graphic Equalizer
- 40875 Nakamichi Model 500 Stereo Cassette Deck
- 40878 Pickering Model XV-15/625E Stereo Phono Cartridge
- 40879 Pioneer Model CT-F8282 Stereo Cassette Deck
- 40886 Stanton Model 681EEE Stereo Phono Cartridge
- 40887 Teac Model PC-10 Portable Stereo Cassette Deck
- 40970 Speakerlab Model S7 Speaker System Kit
- 40973 Burwen Model DNF 1201A Noise Reducer System
- 41113 Dahlquist Model DQ-1W Low-Brass Module
- 41315 Sony "Class D" Amplifier
- 41316 Electrovoice "Series II" Speakers
- 41317 AR 9 Speakers
- 41318 JVC JI-V77 FM Tuner
- 41319 Pioneer CT-F900 Cassette Deck
- 41320 Luxman R-1120 Receiver
- 41321 Dual C-819 Cassette Deck
- 41322 B.I.C. 2-speed Cassette Deck
- 41323 SAE Two Amplifier and Tuner
- 41324 Hitachi Mosfet Power Amp
- 41325 Akai PO-1000 Open-Reel Tape
- 50137 RG Dynamics Signal Processor
- 50140 Pioneer Reverb Amp
- 50150 Pioneer TV Sound Tuner

COMMUNICATIONS

- 40891* Drake Model SSR-1 AM/SSB Communications Receiver
- 40892* Kenwood Model TS-820 Amateur Radio Transceiver
- 41114 Ten-Tec Century/21 Ham Transceiver
- 41326* Panasonic 5-Band SW Portable
- 41327* Electra Microprocessor Scanner
- 50145 McKay Dymek Receiver
- 50129* Realistic Receiver
- 50136* Grundig Communications

TEST INSTRUMENTS

- 40928* B&K-Precision Model 280 Digital Multimeter
- 40930* Ballantine Model 1010A Dual-Trace Scope
- 40931* Fluke Model 8020A Digital Multimeter
- 40932* Hewlett-Packard Model 280 Digital Multimeter
- 40934* Sencore Model TF-70 Portable Transistor Tester
- 40935* Triplet Model 60 Analog Multimeter
- 41115 B&K Precision Model 1820 Universal Frequency Counter
- 50122 Spectrum Analyzer
- 50133* Phillips Oscilloscope

*Reprints are \$2 each, \$1 for those marked with asterisk. Minimum order \$6.

HERE'S HOW TO ORDER

CASH: Mail your order with your name, address and remittance to POPULAR ELECTRONICS REPRINTS, P.O. Box 278, Pratt Station, Brooklyn, NY 11205. U.S. orders shipped first class. Add 50¢ per order for postage and handling. Outside USA—shipped AIR MAIL ONLY. Add \$2 per order. Residents of CA, CO, DC, FL, IL, MA, MI, MO, NY STATE, UT, AND VT add applicable sales tax.

CHARGE: Your American Express, Visa, MasterCard, or Diners Club account. Include your name, address, card #, expiration date, and signature.

PHONE ORDERS ACCEPTED (minimum \$10). PHONE 24 HRS. TOLL FREE 800-431-2731. New York State only 800-942-1940.

HOBBY SCENE

By John McVeigh,
Technical Editor

Add-On Audio Muting

Q. I have a stereo receiver that offers excellent performance but lacks audio muting—that is, a network activated by a pushbutton switch that introduces a specific amount of attenuation to reduce the audio level during telephone interruptions, etc. Could you describe an external circuit that can be used for this purpose?—S. Jordan, Chattanooga, TN

A. The circuit shown in the figure can attenuate an audio signal by a fixed

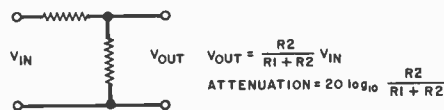

amount. Resistor values should be selected to provide the desired attenuation according to the formula given. The value of R_2 should be at least ten times less than the input impedance of the stage which it drives. This will prevent that stage from loading the voltage divider and changing the amount of actual signal attenuation. The circuit can be installed at a line-level point in the audio chain. A spare tape-monitor loop controlled by a pushbutton switch is an ideal candidate. If one is not available, the attenuator can be mounted in a small, external enclosure. It can be inserted into and removed from the signal chain (say, at the preamplifier output/power-amplifier input) by means of a double-throw switch at the attenuator input to bypass the voltage divider. Note that one resistive network is required for each audio channel.

Another Wireless Microphone

Q. In the Hobby Scene for July 1980, you showed a three-transistor vhf wireless microphone. May I suggest a simple, single-transistor vhf wireless microphone?—R. Perrigo, Merseyside, Liverpool, U.K.

A. Thank you very much for your suggestion, which is shown schematically in the accompanying figure. I'm sure many readers will want to experiment with the circuit. Although you have not stated so explicitly, seemingly a short length of solid copper wire should be used for the antenna and the values of C_2 and C_3

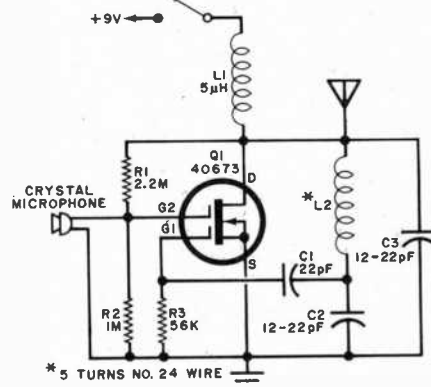

chosen for the desired transmitting frequency. Some adjustment of the operating frequency is possible by increasing or decreasing the pitch of the winding comprising L_2 . The circuit can be powered by a 9-volt transistor battery.

Motor Speed Control

Q. I have a few questions about the "Drill Speed Control" presented in the Tips and Techniques column of the November 1980 issue. What is an RC network? What is an SCR? Is the modular bridge rectifier RECT1 one unit, or is it made up of four separate diodes?—James L. Keyser, Toledo, OH

A. An RC network is a group of electrically interconnected resistors (R) and capacitors (C). In the circuit under discussion, it comprises the two 100-ohm resistors and 50- μ F electrolytic capacitors. An SCR is a silicon controlled rectifier. It is a three-terminal, four-layer

(pnpn) semiconductor that functions as a switch. When a small amount of current is injected into its gate, it can allow a much larger current to flow from its anode to its cathode. Such devices are often used as power switches that can be controlled by low-level gate signals. The modular bridge rectifier as specified is one unit that contains four silicon diodes. However, you can use four individual diodes, each having its own case. Using four separate diodes in place of one modular bridge rectifier will have no effect on the electrical operation of the Drill Speed Control or, for that matter, any other circuit.

the 1981 formula-1™

the antenna specialists co. presents the latest advance in high-performance antennas for professional CB communications ...and major support for REACT ❄

Formula cars and our new Model M-710 *Formula-1* share an identical engineering strategy: continually refine a proven basic design with one objective: MAXIMUM POSSIBLE PERFORMANCE.

That's *Formula-1*—direct descendant of A/S's classic base-loaded mobile police antennas. Born for performance, built to last, *Formula-1* is the result of over 25 years of continuous development. Today's new state-of-the-art in mobile CB antennas.



- Precision-wound, water-proof coil. Lifetime burnout guarantee.
- Factory tuned; set-screw ultra-fine tuning.
- Longer whip for more "reach."
- Tapered stainless steel whip minimizes range-robbing wind deflection.
- Anti-static whip ball-tip.
- New quarter-turn quick-disconnect life tested over 2,500 times.
- Easy to install. 17' pre-assembled cable, miniature in-line connector, contour-forming protective mounting gasket, hardware for both roof-top or trunk-lip mounting.
- 5-year limited warranty.

the antenna specialists co.

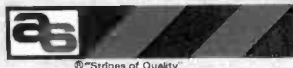

a member of The Allen Group
12435 Euclid Avenue, Cleveland, Ohio 44106
Export: 2200 Shames Drive
Westbury, L.I., New York 11590
Canada: A.C. Simmonds & Sons, Ltd.

❄ *Formula-1* contributes more than just performance:

To encourage CB for serious highway communications, we're donating \$1.00 to REACT International for every *Formula-1* purchased in 1981. Join REACT. Get involved. Ask your dealer.



solid-state developments

ment can provide excellent high-voltage isolation, but the physical distance between the elements is such that the LED will require more current for the same degree of coupling as that of an optoisolator in which the LED and phototransistor are separated only by a thin glass window.

This brings us to the optoisolator parameter known as the *current transfer ratio* (CTR). Simply stated, CTR is the ratio of the input current applied to the isolator's light emitter to the output current generated by the isolator's photodetector. Commercial optoisolators have CTRs ranging from less than 20 percent to more than 500 percent.

Higher isolation voltages are achieved by moving the LED away from the phototransistor, so the CTR is usually inversely proportional to electrical isolation. Note the values given for the illustrated units.

Incidentally, a CTR greater than 100 percent doesn't violate conservation of energy. High CTR results from the inherent gain of a phototransistor or photodarlington detector. Optoisolators using these types of detectors can be considered optoelectronic amplifiers or gain blocks with applications beyond electrical isolation and signal coupling.

Applications. One of the most important applications for optoisolators is high-voltage electrical isolation. There have been instances of accidental electrocution of hospital patients by the very electronic monitoring equipment intended to help them. Fig. 2 shows how a low-cost photodarlington optoisolator can provide electrical isolation between a battery-powered metabolic sensor and a bedside, line-powered monitoring system. This not only reduces shock hazards, but also protects the low-voltage circuits.

Fig. 3 shows how an optoisolator can monitor a high-voltage ac signal and emit a dc output when the high ac voltage is present. This idea can be adapted to monitor a telephone line to detect the ac ring signal.

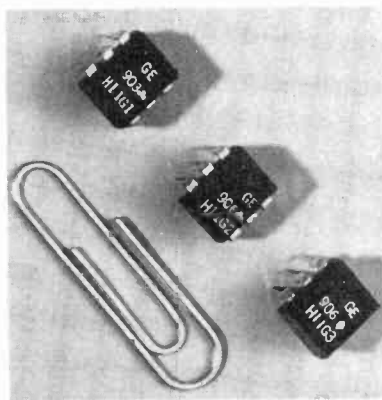

Three types of optocouplers Made by General Electric in 6-pin mini-DIPs.

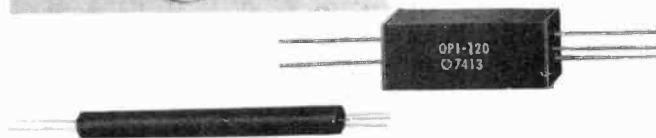

Three TRW Optron isolators: above right, 15-kV rating with CTR of 20%; above left, 50-kV, 10% CTR; at right, 6-kV, 400% CTR.

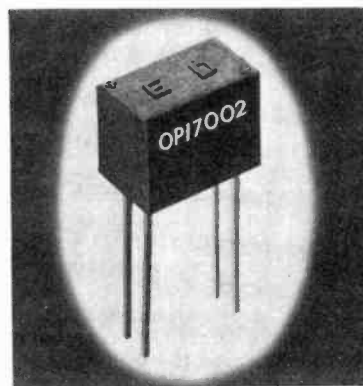

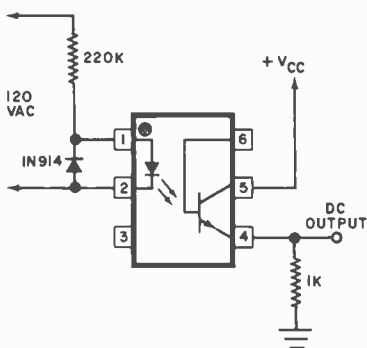

Fig. 3. Use of an optoisolator as a line-voltage monitor.

Fig. 4 shows a telephone-ring detector that was published in Hewlett-Packard Application Note No. 951-1. The circuit provides 2500 volts of isolation between the telephone line and an external circuit. Although it extracts power from ring voltage to forward-bias the LED in the optoisolator, loading of the telephone is minimal. The circuit consumes only about 100 microamperes from a ring signal.

It's important to realize that the voltage-isolating capability of the optoisolator in these and other applications is no greater than the isolation provided by the circuit board upon which the unit is mounted. Solder bridges, bits of wire, nearby metal objects or wire leads can greatly reduce effective isolation. The isolation can also be reduced by surrounding contaminants such as solder flux and moisture.

Special-Purpose Optoisolators. Thanks to optical fibers, it's possible to make optoisolators that can provide complete isolation of potential differences of many millions of volts! These are handy for monitoring high-voltage transmission lines and controlling high-voltage switching circuits.

Another use for optical-fiber isolation is coupling signals between avionic equipment that may be subjected to massive electromagnetic pulses (EMP). The Air Force exposes various of its aircraft to such pulses at several special test facilities near Albuquerque. The pulses simulate the EMP that accompanies a nuclear blast. Conventional shielded cables are

not sufficient to prevent the induction of noise spikes by the EMP. Optical fibers, on the other hand, intercept absolutely none of the EMP.

Optical Integrated Circuits. Laboratories in the United States and abroad are doing research and development work on what can be termed "optical integrated circuits." In such circuits, photons play the role that electrons do in conventional circuits, thus making possible faster switching speeds and direct interfacing with optical fibers.

The news releases issued by some of these laboratories would have us believe that the optical IC is a radically new development. Actually, ordinary optoisolators can be considered types of hybridized optical ICs. They have been available for more than 15 years. Nevertheless, optical integrated circuits represent a fascinating new technology, and future installments of this column will keep you posted on new developments.

Reader Mail. Alvin O. Kriegel, Jr. of Beaumont, TX has written to express interest in solid-state gas detectors, particularly those capable of detecting methane. Alvin is a drilling "mud logger" on the Texas gulf coast and is interested in finding natural gas.

In 1968, Figaro Engineering, Inc. introduced a semiconductor gas detector made from sintered tin dioxide (SnO_2). The electrical resistance of SnO_2 decreases when combustible or reducing gases are absorbed by the material. The detector can detect concentrations of a few hundred parts per million of many gases, including methane, ammonia, carbon monoxide and dozens of others.

Figaro manufactures several SnO_2 sensors, all of which require relatively simple drive and sensing electronics. The company's address is 3-7-3, Higashitoyonaka, Toyonaka City, Osaka 560 Japan. I've seen these sensors (they're designated with a TGS prefix) advertised in various technical magazines published in this country, but I cannot find them in electronics buyers' guides.

Alvin and other interested readers might also want to contact Economy Gauge and Instrument Supply (4560 West 34th Street, Houston, TX 77092), which sells many different types of gas detectors. ◇

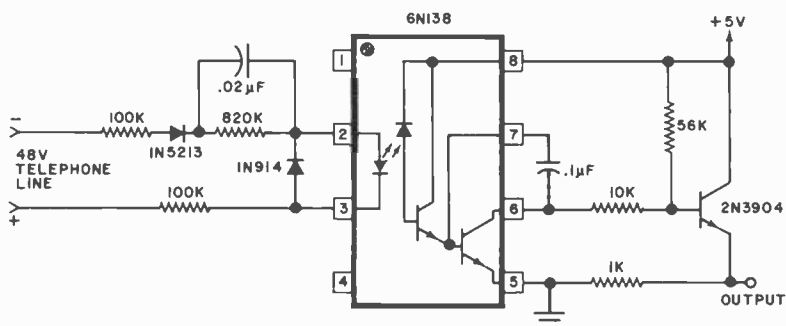

Fig. 4. This telephone-ring detector from Hewlett-Packard provides 2.5 kV of isolation.

Wanna make some money?

Then get in on the ground floor of outer space by becoming a dealer in satellite earth stations from Advanced Electronics. The Earth Station People

You'll be able to offer your customers a 'turn-key' system from a complete installation to the most comprehensive advertising and marketing program ever devised for the satellite earth station industry.

We like to think the wave of the future is here. So, give us a call and let us tell you what is happening in San Francisco, Houston, Los Angeles and Las Vegas. It's Amazing.

FROM OUTSIDE NEVADA CALL
800-634-6047

ADVANCED ELECTRONICS, INC.

AE 5081 Arville Street
Las Vegas, Nev. 89118

(702) 871-8766

THE EARTH STATION PEOPLE

CIRCLE NO. 3 ON FREE INFORMATION CARD

Challenging electronics projects!

1981 ELECTRONIC EXPERIMENTER'S HANDBOOK



1981 Electronic Experimenter's Handbook

from the Editors of Popular Electronics.

If you love to build experimental electronics projects, you'll love all the great plans and ideas in the new 1981 Electronic Experimenter's Handbook!

Every plan is for a useful (or just plain fun) device, and contains circuit information, schematics, parts lists, pc board diagrams, construction tips and usage information. You'll find plans for everything from a wide range audio signal meter (with an LED readout) to an electronic racing game!

Order your copy today. It's packed with projects, experiments—even small computer information! And it's a bargain at just \$2.95* plus 55¢ postage and handling! (Outside U.S.A., \$5.00.) *Residents of CA, CO, DC, FL, IL, MA, MI, MO, NY State, UT and VT add applicable sales tax.

Send payment with your name and address to:

ELECTRONIC EXPERIMENTER'S HANDBOOK

Dept. 01454 • P.O. Box 278
Pratt Station • Brooklyn, New York 11205

EXPERIMENTER'S CORNER

By Forrest M. Mims

The Polapulse® Wafer Battery

SOME of my relatives own Polaroid SX-70 Land cameras. One reason I look forward to family gatherings is the frequent use these cameras receive on such occasions. It's always nice to see the excellent photos the cameras provide, but perhaps my primary interest lies in the empty film packs, each of which contains a used Polapulse® 6-volt wafer battery. The battery powers the camera's electronics and drive motor.

The Polapulse battery has been deliberately overdesigned by Ray-O-Vac and Polaroid engineers to ensure that it will reliably power the SX-70 camera even under the most demanding circumstances. Probably the worst possible scenario is when all the available emulsions in the SX-70 film pack are exposed in rapid sequence under low-temperature conditions. Overdesigning the Polapulse battery provides plenty of reserve power for rapid-fire photo sessions. This also means that the battery still has plenty of life left in it even after its film-pack carrier has been tossed in the trash.

Recently, Polaroid began selling Polapulse batteries as products in their own right. For \$15, one can buy five Polapulse P100 batteries and a plastic holder that has connection wires.

This month, we will take a detailed look at the new Polapulse P100 battery. We will examine the battery's specifications as given in Polaroid's literature, and then look at the characteristics of Polapulse batteries that have been salvaged from discarded SX-70 film packs.

Polapulse Construction. The Polapulse battery utilizes the traditional LeClanche carbon-zinc chemistry in a physical configuration which differs radically from the cylindrical LeClanche cells with which we are all familiar.

The basic building block of the Polapulse has about the same physical dimensions as a playing card and is called a *duplex sheet*. As its name implies, the duplex sheet is a thin conductive card coated on one side with manganese dioxide and on the other with zinc. A single duplex sheet forms one-half of each of two adjacent 1.5-volt cells.

In the Polapulse, four duplex sheets are interspersed with separator layers made from synthetic fibers which have been impregnated with a gelled electrolyte. The conductive layer of the duplex sheet interconnects adjacent cells without the need for solder tabs, welded connections or wires. This provides a very simple, highly reliable, multicell battery.

The top side of the sandwich of cells is covered with an alu-

minum foil sheet coated on its lower side with zinc. This functions as the battery's negative terminal. The bottom side of the battery is covered with a second aluminum foil sheet coated on its upper surface with manganese dioxide. This becomes the positive terminal.

A paper insulating sheet, which has a square hole for electrical access, is bonded to the positive electrode. A protruding portion of the upper negative electrode is folded over the paper backing so that both electrodes are on the same side of

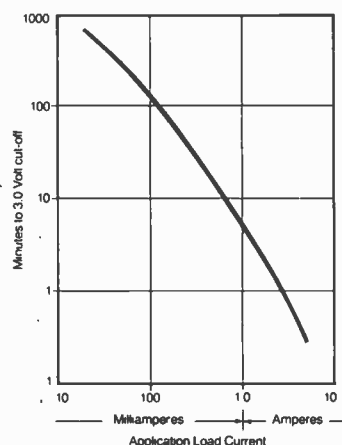

Fig. 2. Capacity (in minutes of time in use) of a Polapulse vs. load current.

the battery. The multilayer battery is then laminated into a sturdy package by adhesive borders around the perimeter of each separator sheet. A vent prevents excessive gas buildup.

Figure 1 shows the construction of the duplex sheet and its orientation with respect to one adjacent separator. The overall dimensions of the Polapulse at this point are 3.73" x 3.04". The battery is a wafer-thin 0.18", and it weighs just under an ounce.

Polapulse batteries intended for use in SX-70 film packs are mounted on a card measuring 3.45" x 4.2" and are secured in place with laminated plastic film. Electrical access to the electrodes is provided by two circular apertures punched in the card.

The paper, plastic and foil construction of the Polapulse probably sounds very flimsy if you have not held one of these batteries in your hand. Actually, however, the battery is surprisingly sturdy. The adhesive bond around its perimeter provides a very rigid frame around the relatively fragile layers which form the battery.

More than 300,000,000 Polapulse batteries have been manufactured for SX-70 film packs. Thanks to the battery's adhesive bond and its protective outer layers, no instances of damage caused by leakage have been reported.

Electrical Specifications. The Polapulse delivers up to 6.8 volts, open circuit. Its useful temperature range is 20° F to 130° F (-7° C to 54° C). The most important feature of the battery is its surprisingly high capacity. For example, a fresh Polapulse can deliver a hefty 26 amperes on an instantaneous basis. After 30 seconds, the current decreases to a still-

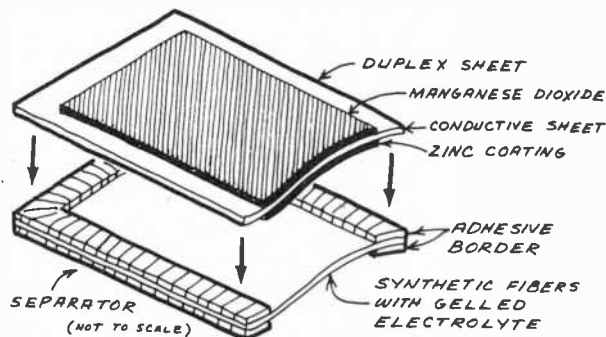

Fig. 1. Two layers in a Polapulse battery.

experimenter's corner

impressive 5 amperes. The current decreases to 2.5 amperes after 60 seconds.

Polaroid has published the following continuous discharge ratings for the Polapulse (3-volt cutoff).

Discharge Current (A)	Discharge Interval (Minutes)	mAh
0.02	690.0	230
0.05	234.0	195
0.10	102.0	170
0.50	14.7	123
1.00	5.7	95
5.00	0.4	33

These data are summarized in the graph of capacity versus load current in Fig. 2. A Polaroid brochure on the Polapulse P100 battery includes the family of constant-current drain curves in Fig. 3. How do these data compare with the performance of other types of batteries? Figure 4 shows plots of

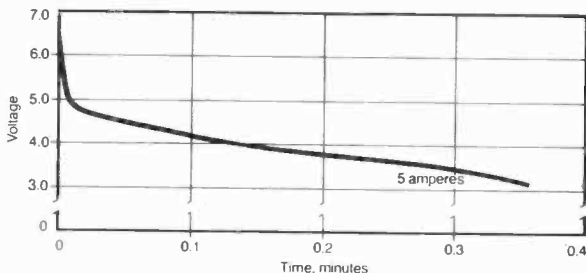
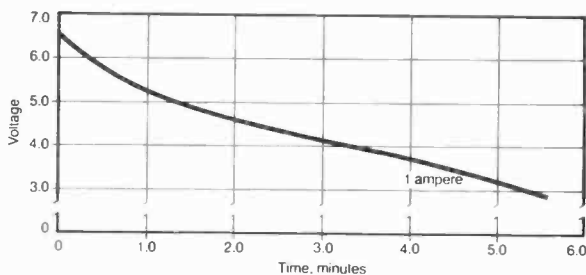
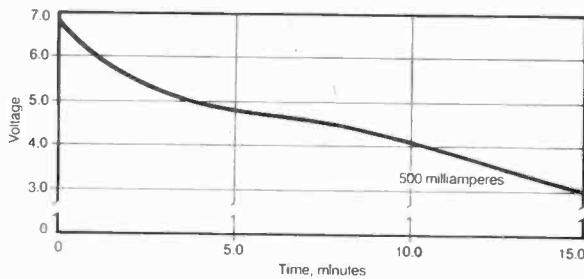
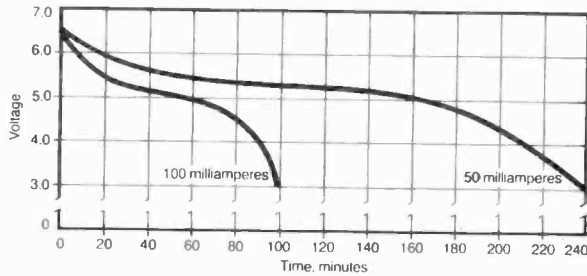
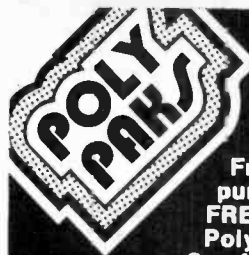

Fig. 3. Constant-current discharge curves for the Polapulse battery showing how the voltage drops off with time for various current drains. Top to bottom, currents are: 50 mA, 100 mA, 500 mA, 1A, and 5 A.



Free!

Look at this fantastic offer from Poly Paks!!

Free Premium offer with every \$20 purchase. Your order today will give FREE tools for tomorrow! Here's how Poly Paks Free Premium offer works: One free premium with your \$20 order. Two free premiums with your \$40 order. Three free premiums with your \$60 order.

VEEDER-ROOT 6 DIGIT COUNTER

ONLY \$4.98
2 for \$9.00

Non-resettable. 6-Digit counters run from 0 to 999999. Electro mechanical assembly requires 115 VAC, 60 Hz, 8 watts. Speed: 1000 counts/minute. 3/8" x 2" window reveals black digits on white background. Gray, wrinkle-finish metal case measures 3-1/4 x 2-1/2 x 1-5/8". 10" insulated wire leads have quick-connect type spade terminals.

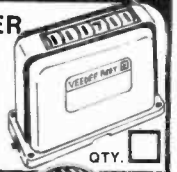

Cat No. 5113

QTY.

12.5 VOLT 600 mA NICKEL CAD BATTERY PAK

\$12.49 2/\$24

- 10 "AA" Size Cells Connected in Series
- Comes in 2-7/8" x 1-1/8" x 2" Insulated Plastic Case. (Picture Shown Less Top Half of Case)
- Easily Accessible Top Mounted Solder Tab Leads

Cat No. 6676

QTY.

GIANT SOLAR DISCS

- | Cat. No. | Size | Rating | VDC | Price |
|----------|--------|--------|-----|---------|
| 3788 | 3 1/2" | 1 amp | .5 | \$ 8.95 |
| 5075 | 4" | 1 amp | .5 | \$10.95 |



"BLOCK" FANS

- 115 VAC • 15 WATTS
- ONLY 4-11/16" SQ.
- 1-1/2" DEEP!
- 75 CFM OR BETTER

Cat. No. 3108



\$11.88 2/\$23

QTY.

60 WATT 3-WAY CROSSOVER NETWORK

Crossover Iraq: 700 Hz. + 4000 Hz. Attenuation char. 12 db/oct. Power: 60 watts (max.) 8 ohms impedance. Four heavy copper coils are mounted on a 5-1/16" x 3-7/16" board, with mounting holes on 3-1/2 x 4" ctrs. Terminals have slide lug connectors, 1-1/2" high.

Cat No. 6339



\$10.88 QTY.

PIEZO ELECTRIC TWEETER HORN SOLID STATE 3-1/2"

- No Voice Coil!
- No Crossover Network!
- Frequency Range: 4000 - 40,000 Hz.
- High Impedance, Exceeds 8 Ohms @ 100K Hz.
- Handles 55 Watts Peak, 35 Watts RMS

Cat No. 5656

ONLY \$8.88 2/\$17

Plug in three floodlites, or colored lites and watch them dance to the rhythm, pitch and volume. Low, mid-range and highs are separated and displayed on individual channels. Variable intensity control for each channel. Easy to assemble with step-by-step instructions.



\$28.50

QTY.

"SPACE SHOT" AUDIO GAME BOARD

- Provides Authentic "Outer Space" Sound Effects
- Sound Effects Include: Rocket Blast, Phaser Fire, Space Man Breathing, "Clear the Launch Pad" Alarm Gong, Even 21st Century Music!
 - Requires 8 Ohm Speaker and 9V Transistor Radio Type Battery.
 - Size 4-1/2" x 1-3/4" x 1"

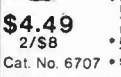

\$4.49 2/\$8

Cat No. 6707

QTY.

"CHROMA STROBE" 3 CHANNEL COLOR ORGAN KIT

Plug in three floodlites, or colored lites and watch them dance to the rhythm, pitch and volume. Low, mid-range and highs are separated and displayed on individual channels. Variable intensity control for each channel. Easy to assemble with step-by-step instructions.



\$28.50

QTY.

12 VDC 10 AMP POWER SUPPLY

Converts 115VAC to 12VDC to 10 Amps fully regulated! Supplies up to 15 Amp surge. Dual transistor regulation with Motorola 2N3055 and 2N3773 for maximum dependability. Less than 100 mv ripple, regulation better than 5%. Extra large heat sink for ULTRA COOL operation. Front panel colour switch, fuse, and indicator lamp for fingertip control. 8 1/2" x 6 1/2" x 4 high.



\$59.95

QTY.

CUTTING PLIERS

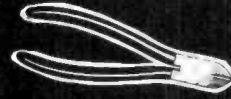

LONG NOSE PLIERS



7-PC. NUTDRIVER SET



FREE!! Premiums

POLY PAKS

P.O. BOX 942, PE-5
S. LYNNFIELD, MA. 01940

Total Amount of Order \$ _____

SHIPPING AND HANDLING: U.S. ADD \$3; FOREIGN, ADD \$7.
MASS. RES. ADD 5% SALES TAX.

NAME _____

ADDRESS _____

CITY _____

STATE _____ ZIP _____

Enclosed is CHECK, MONEY ORDER
Charge my MASTERCARD VISA

ACCT. # _____ EXP. DATE _____

Order By Phone 1-617-245-3828

ORDERING INSTRUCTIONS • Indicate Quantity in Box Near Item Desired
• Complete Coupon Section • Cut Out Ad and Send to Poly Paks, Inc.

Send me your FREE catalog

experimenter's corner

load current versus voltage for the Polapulse and several conventional batteries. The Polapulse provides superior performance under the conditions specified.

Experimenting with Polapulse. In preparing this column, I evaluated several Polapulse batteries salvaged from

discarded film packs about a year ago. The results were fairly impressive, considering the batteries' age and prior use.

Figure 5, for example, is a graph of one battery's discharge voltage over a period of 30 minutes. The data from which the plot was derived were obtained by connecting a 100-ohm precision resistor across the terminals of the Polapulse. The voltage across the battery was then measured with a DVM at 30-second intervals for the first five minutes, and at 5-minute intervals for the remaining 25 minutes.

The discharge current during this test, discounting that which flowed during the initial 10-second surge, ranged from 47 mA when the battery developed 4.72 volts to 39 mA when battery voltage decreased to 3.9 volts. These discharge currents and output voltages mean that the Polapulse is more than adequate for powering many CMOS circuits. Intermittent operation will result in longer battery life and permit higher discharge rates.

I am particularly interested in emergency lighting. So I was curious to know if a used Polapulse battery would power a

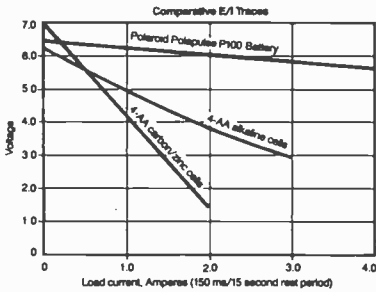

Fig. 4. Comparing the output of the Polapulse with other batteries.

COMPARE - SAVE WORK WEAR TUFFSHIRTS

RUGGED-TOUGH-DURABLE . . . You'll get years more of wear for the money.
100% WASH n WEAR PERMANENT PRESS
65% POLYESTER / 35% COTTON
 Great for shop, yard work, garage, odd jobs. Neat looking, yet take a lot of punishment and hard wear. 2 big breast pockets, 5 button front with horizontal buttonholes for better grip, long tails for comfort. All seams double stitched and reinforced for extra strength.

Not available in any store - Mail order purchase only
YOU MUST BE SATISFIED OR YOUR MONEY BACK.

After 10 days, if not completely satisfied, return shirts for full credit refund.



Navy, Lt. Blue, Med. Green, Lt. Gray, Tan, White S. M. L. XL. XXL. Long or Short Sleeves.

Short Sleeves **3 FOR \$20.95**

Long Sleeves **3 FOR \$22.95**

(includes shipping)
THE TOUGHEST WORK SHIRT EVER MADE

NOT AVAILABLE IN ANY STORE — MAIL ORDER PURCHASE ONLY

Long Sleeve - 3 for \$22.95 Short Sleeve - 3 for \$20.95
 Qty. Color Size Sleeve

Total Amt \$ _____
 Card No. _____
 Check Enclosed VISA MASTER CARD Exp. Date _____
 (signature required for charge card purchase)

Name _____ Send Me Your Free Mailings
 Address _____
 City _____ State _____ Zip _____



WORK WEAR CORP., INC. Dept. PE
 1768 East 25th St. • Cleveland, Ohio 44114
 Mrs. of quality clothing since 1915
 CIRCLE NO. 61 ON FREE INFORMATION CARD

BACK ISSUES AVAILABLE...

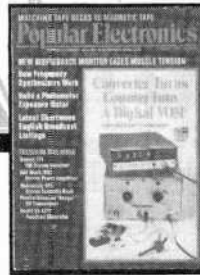

If you've missed any of the previously published issues of Popular Electronics Magazine a wide selection is still available. Copies may be ordered for issues published during the past 12 months. In the event a particular issue ordered is out of print your payment will be returned promptly.

Order by mailing \$3.00 per copy (postage & handling included) to Popular Electronics, P.O. Box 278, Pratt Station, Brooklyn, N.Y.

(Outside U.S.A. copies are \$4.00 each.)

Please be sure to enclose payment and identify the specific issues you wish to receive.

For more information on advertised products, equipment tested, etc., circle appropriate number on postpaid Free Information Card.

MODEL II



\$459⁰⁰ DISCOUNT Off List

64K 1 DRIVE \$3440.00

No Taxes on Out of State Shipments

Immediate Shipment On Most Items

\$DISCOUNTS

TRS-80[®] DEALER A301

26-3001 4K Color.....	\$353.00
26-1145 RS-232 Board.....	84.00
26-1140 "O" K Interface.....	249.00
26-1160 Mini Disk.....	419.00
26-1172 Modem.....	135.00
Fast 100 CPS Centronics 730 Printer.....	577.00
Text Quality Centronics 737 Printer.....	737.00

1-800-841-0860 Toll Free Order Entry
MICRO MANAGEMENT SYSTEMS, INC.

DOWNTOWN PLAZA SHOPPING CENTER
 115 C SECOND AVE. S.W.
 CAIRO, GEORGIA 31728
 GA. & EXPORT PHONE NO. (912) 377-7120

CIRCLE NO. 41 ON FREE INFORMATION CARD

FREE COMPUTER CATALOG UPON REQUEST



26-1061 4K I.....	\$629.00
26-1062 16K III.....	865.00
26-1063 32K III	
2 Drives, RS232.....	2225.00

Largest Inventory in S.E. U.S.A.

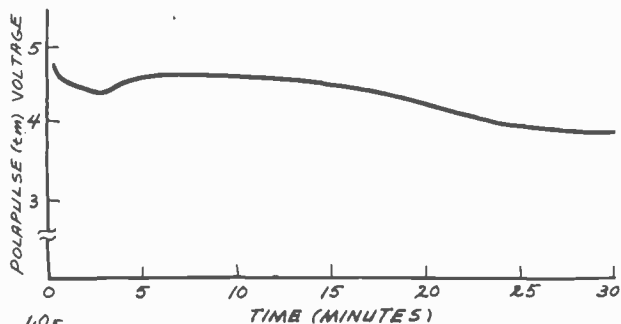

Fig. 5. Discharge curve of a salvaged Polapulse over 30 min.

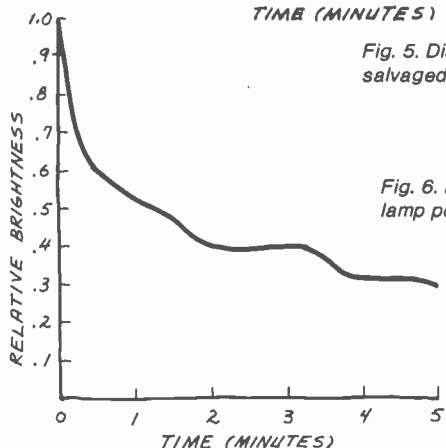

Fig. 6. Light output of a PR-13 lamp powered by a Polapulse.

PR-13 incandescent lamp. This lamp is often used in hand-held lights powered by 6-volt batteries. At 5.5 volts, they drain about 470 mA from the battery.

A quick check with clip leads showed that the Polapulse

can easily power a PR-13 lamp at a high level of brightness. To monitor the lamp's output over a period of time, I placed the lamp adjacent to a solar cell whose output was monitored with a milliammeter. Figure 6 shows the results. When the light from the lamp became too dim for practical use, the meter gave a reading of 0.3 mA.

The salvaged Polapulse provided excellent light levels for approximately two minutes and usable light for the next two minutes. Four minutes isn't very long, but intermittent operation would result in even greater overall duration. Considering the compact size of the Polapulse, it makes an ideal power source for a miniature, short-term emergency light for camping trips and bike tours.

Making Connections to the Polapulse. The easiest way to solve the connection problem is to buy a Polapulse holder from a Polaroid dealer. This holder, however, will not accept Polapulse batteries salvaged from film packs. For these, you can use alligator clips to make temporary connections. Make sure the clips don't touch one another and don't penetrate the battery's protective covering. For best results, wrap a layer of vinyl electrical tape around one-half of each clip. The exposed half of each clip should be placed over the aluminum contact terminals of the battery.

Incidentally, you can reduce the size of salvaged Polapulse batteries by removing the outer protective envelope. Place the battery on a work surface with its printed side down. Then use a hobby knife to slit the clear plastic covering along the edge of the battery. This procedure will not harm the battery, but it will reduce its size.

For More Information. You can obtain more information about the Polapulse P100 wafer battery from the Polaroid Corporation's Commercial Battery Division (784 Memorial Dr., Cambridge, MA 02139). Ask for a specification sheet. ◇

Put Professional Knowledge and a COLLEGE DEGREE in your Electronics Career through HOME STUDY

Earn Your DEGREE

No commuting to class. Study at your own pace, while continuing your present job. Learn from easy-to-understand lessons, with help from your home-study instructors whenever you need it.

In the Grantham electronics program, you first earn your A.S.E.T. degree, and then your B.S.E.T. These degrees are accredited by the Accrediting Commission of the National Home Study Council.

Our free bulletin gives full details of the home-study program, the degrees awarded, and the requirements for each degree. Write for *Bulletin ET-81*.

Grantham College of Engineering
2500 So. LaCienega Blvd.
Los Angeles, California 90034



apple computer

Complete Microprocessors line, peripherals & Terminals.

APPLE II PLUS, 48K	\$1215.00	Disk 130K controller	\$575.00
LANG SYS W/PASCAL	395.00	SOROC 1014G	1195.00
Z-80 SOFT CARD	299.00	TI-99/4	499.00
TI-745	1440.00	TI-810	1695.00

Texas Instruments

Invest Anal	\$ 44.95	Speak & Spell	\$49.95
TI-55	29.95	Spelling Bee	29.95
Accessories	call us	TI Programmer	47.95
TI-58C	84.50	MBA	49.95
PC130C	149.95	TI-5100	37.50
TI-59	199.00	TI-5015	59.00
Bus Anal II	35.50	TI-5025	59.95
TI-55-II	39.95	TI-5040	63.00

HEWLETT-PACKARD

System I	394.95	HP 41C Prog	189.00
System II	669.95	HP 41C Printer	289.00
HP 33C	75.00	HP 41C CRD RDR	169.00
HP 34C	119.00	HP 41C Mem Module	26.00
HP-38C	114.99	HP-41CV	239.95

HP-83 HP-85 and accessory - call us for prices
HP-41CV Sys I and II and Quad Ram - call us for prices

SCM TYPEWRITER SPECIALS

SCM 2200	\$269.00	INTREPID	\$274.00
SCM 2500	285.00	CLASSIC 12	144.00

All units shipped in original cartons with accessories according to manufacturer's specification. Send money orders, personal check (2 weeks to clear). In Illinois add 8% sales tax. Add \$5.95 minimum shipping & handling charges per unit. We ship UPS. Subject to availability. Written warranty for special products can be obtained free upon request. Above prices are for mail order and prepaid only. Prices and specifications subject to change without notice. Send mail orders.

Nabik's, Inc.

519 DAVIS EVANSTON ILL. 60201 TEL 312-869-6144

The world of electronics gee-wizardry

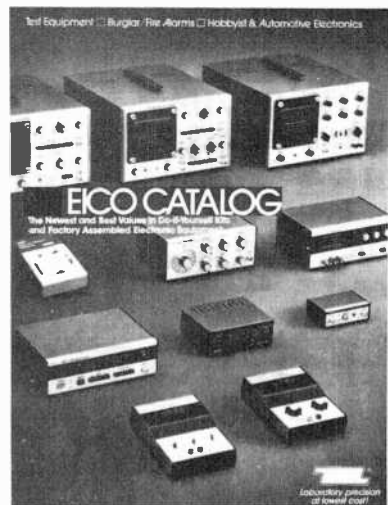

-YOURS FREE.

32-pages of test instruments — from the latest digital multimeters to the famous EICO scopes. Security systems. Automotive and hobbyist products. Kits and assembled. EICO quality. EICO value. For FREE catalog, check reader service card or send 50¢ for first class mail.

EICO® 108 New South Road
Hicksville, N.Y. 11801

CIRCLE NO. 17 ON FREE INFORMATION CARD

NEW INDOOR ACTIVE ANTENNA

Covers 300 KHz - 30 MHz.
For SWL, BCL, VLF DXers.

Rivals long
wires

\$79⁹⁵
(+ \$4.00
shipping)

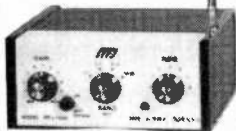

MFJ-1020 NEW INDOOR ACTIVE ANTENNA sits on your desk ready to listen to the world. Rivals can often exceed reception of outside long wire. Unique Tuned Active Antenna minimizes intermod, provides RF selectivity, reduces noise outside tuned band. Also use as preselector for external antenna. Covers 300 KHz to 30 MHz in five bands. Adjustable telescoping antenna. Controls: Tune, Band Selector, Gain, On-Off/Bypass. LED. FET, bipolar circuitry. Phono jack for external ant. 6x2x6 inches. 9-12 VDC or 9 V battery for portable use. 110 VAC with optional AC adapter. \$7.95.

Order from MFJ and try it. If not delighted, return within 30 days for refund (less shipping). One year unconditional guarantee.

Order yours today. Call toll free 800-647-1800. Charge VISA, MC. Or mail check, money order.

CALL TOLL FREE ... 800-647-1800

MFJ Enterprises, Inc.
BOX 494, MISS. STATE, MS 39762

CIRCLE NO. 39 ON FREE INFORMATION CARD

Talking Clocks
Video Recorders

Thinking
Thermostats

Hit Movie
Cassettes

Sleep Machines

FREE Catalogue

Please send me my FREE copy of THE HIGH TECHNOLOGY CATALOGUESM. And reward my quick response by including my FREE \$5 Gift Certificate!

Name _____

Address _____

City _____

State _____ Zip _____

I now own: Home Video Recorder
 Personal Computer

INOVISION
AN EDS CORPORATION

Mail to: Inovision Dept PE581
P O Box 400040 Dallas, TX 75240

CIRCLE NO. 29 ON FREE INFORMATION CARD

DX LISTENING

By Glenn Hauser

Revolution by Radio Revisited

SCARCELY a sesquiyear after *Radio Sandino* played such an important role in the Nicaraguan revolution, El Salvador gained a shortwave clandestine station of its own. Previously reported on mediumwave only, then occasionally on 7500 and 7900 kHz, *Radio Liberación*, "the official voice of the Farabundo Martí National Liberation Front" (FMLN), began regular broadcasts on 8243.1 kHz, January 10. This coincided with the rebels' "final offensive," which was a bit too optimistic.

Radio Liberación could be heard clearly in North America, as early as 2245 GMT, and as late as 1400. The announced schedule changed from day to day, but the most reliable times to hear the station were around 1200 and 0100 GMT. On at least one occasion, *Radio Liberación* stayed on the air all night. Coinciding with setbacks the rebels suffered at the hands of government forces ten days later, the station disappeared for a week. There were also frequent breaks in transmission.

As is customary with clandestine outlets, it claimed to broadcast from "somewhere in El Salvador", though it seems far more likely to have operated from secure territory across the Gulf of Fonseca in Nicaragua, which openly supported the FMLN movement. In any event, the sound of *Radio Liberación* was very reminiscent of *Radio Sandino* when it was clandestine—fever-pitch exhortations to rise up and overthrow the government, Cuban revolutionary music, speeches by *comandantes*, explicit "revolutionary orientation" on how to make Molotov cocktails and contact bombs, calls for general strikes, and bursts of machine-gun fire. During its first few days on the air, *Radio Liberación* suffered only incidental interference from maritime traffic, which is authorized to use the 8-MHz band; but then there appeared deliberate interference including CW transmissions and a continuous carrier 1 kHz away. The only frequency announced was "8.2 MHz between the 31 and 41 meter bands," leaving the station wide latitude for variation. Should the fate of El Salvador still be undecided as you read this,

you might still hear *Radio Liberación* somewhere in this range. However, in late January, another pro-FMLN station, *Radio Venceremos* was being heard with one-hour broadcasts around 1200 and 2300 GMT on weaker frequencies varying widely between 7025 and 7075 kHz; and by Feb. 8, *Radio Liberación* was no longer on 8243.

The government station, YSS, had been irregularly active on shortwave as well, but after two weeks of silence decided it had better get back on the air Jan. 12 to counter the "final offensive." Unfortunately, the only frequency of YSS, 9553½ kHz, has always been subject to heavy interference from other "legal" stations within a crowded band. During this period, all Salvadorian stations (AM and FM) not under rebel control were required to relay YSS, which identified only as the "Gran Cadena Nacional de Radiodifusión". In contrast to the revolutionary uproar on *Radio Liberación*, YSS tried to keep the populace calm with elevator music and much calmer patriotic exhortations to repel all foreign invaders. On Jan. 14, we learned from YSS that the country had gone on "summer time" (though it's a tropical country, it's still officially winter in the Northern Hemisphere) of EST instead of CST. This also brought about some changes in the transmission schedule of *Radio Liberación*. YSS could be heard best around 0100-0230 GMT, when *HCJB* opened on 9555 until a late closing at 0700, and from 1100 GMT. Also penetrating well into North America is the split-frequency medium-wave outlet of YSS, on 655 kHz (halfway between *WSM* and *WNBC* or Mexico City).

It's also possible to see El Salvador television, best along the U.S. Gulf Coast and 300 km inland, if you have a clear channel 2, 4 or 6, during a sporadic-E opening from that direction. Look for test patterns or call slides of YSR-TV, YSU-TV and YSLA-TV, respectively, on those channels.

Several other shortwave stations carried lots of news about the fighting in El Salvador—*Radio Habana Cuba*, the Costa Ricans *Radio Reloj* on 6006 kHz,

POPULAR ELECTRONICS

CALCULATOR SAVINGS



HP-32E Scientific	42.95
HP-33C Programmable	68.95
HP-34C Adv. Programmable	114.95
HP-37E Financial	58.95
HP-38C Adv. Financial	114.95
HP-41C Alpha Programmable	187.95
HP-41CV (Full Memory)	237.95
HP-41CV System I (+ Crd. Rdr.)	379.95
HP-41CV System II (C.R. Printer)	639.95
Card Reader 41	164.95
Printer 41	289.95
Optical Wand 41	92.95
Memory Module 41C	23.95
Quad Memory 41C	76.95
HP-67 Programmable	287.95
HP-67 Desk Programmable	579.95
HP-85 Desk Computer	2495.00



CALL FOR LOW PRICES ON ALL CALCULATOR AND COMPUTER ACCESSORIES

Texas Instruments

TI-35	19.95	TI-59	209.95	TI-99 4 Console	449.95
TI-55	32.95	PC-100C	159.95	Language Tutor	129.95
TI-57	39.95	Programmer	49.95	Speak & Spell	59.95
TI-58C	99.95	TI-2040	67.95	Business Analyst II	39.95

CALL FOR LOW PRICES ON ALL TI CALCULATORS AND WATCHES

Sharp	PC-1211 Handheld Computer	CALL
	EL-5100 Alphanumeric scientific programmable	69.95
	EL-5101 Alphanumeric scientific programmable	39.95
	EL-5200 Compact message center, 37 alarms	84.95
	EL-7000 Miniature typewriter and calculator	99.95
	CT-660E Talking digital alarm clock	59.95
Casio	FX-502P Slim programmable, 256 steps	79.95
	FX-5100P Slim programmable, 38 steps	34.95
	ML-75 12 melody credit card calculator with alarm	34.95
	M-10 Compact musical keyboard	124.95
	W-100 Water sports alarm chron. 325 feet	34.95
	M-12 12 melody alarm chrono	39.95
	CA-90 Calculator alarm chrono watch	44.95
Pearlorder	S202 Microcassette tape recorder	79.95
	S802 Two-speed, two-hour recorder	99.95
	S901 Olympus smallest two-hour	139.95
Craig	M100 Language translator	69.95
Canon	P5-D Smallest rechargeable print and display	49.95
	P10-D World's most popular mini printer	69.95

For faster delivery use cashiers check or money order. Add shipping: 1% of your order (\$2.75 min.). East of Mississippi River add \$1.50. California residents add 6% tax. Subject to availability. VISA and MC accepted.

ORDER TOLL-FREE **800-421-5188** OUTSIDE CA, AK, HI
Information line (213) 633-3262



Tam's Dept. PE 5
14932 Garfield Ave.
Paramount, CA 90723
(213) 633-3262

CIRCLE NO. 59 ON FREE INFORMATION CARD



DON'T BLAME THE SOFTWARE!



Power Line Spikes and Hash often cause memory loss or erratic operation. Often floppies, printer & processor interact!

OUR unique ISOLATORS eliminate equipment interaction AND curb damaging Power Line Spikes, Surges and Hash.

3 filtered 3-prong sockets and integral Spike Suppression. 125 VAC, 15 Amp, 1875 W Total — 1 KW per socket.

ISO-1 ISOLATOR. 3 Filtered Sockets; 1000 Amp 8/20 usec Spike Suppressor \$62.95

ISO-4 ISOLATOR. 6 Filtered Sockets; 1000 Amp 8/20 usec Spike Suppressor \$106.95

ISO-3 SUPER-ISOLATOR. 3 DUAL filtered Sockets; 2000 Amp 8/20 usec Spike Suppressor \$95.95

ISO-7 SUPER-ISOLATOR. 5 DUAL filtered Sockets; 2000 Amp 8/20 usec Spike Suppressor \$154.95

Master-Charge, Visa, American Express
TOLL FREE ORDER DESK 1-800-225-4876
(except AK, HI, MA, PR & Canada)

Electronic Specialists, Inc.

171 South Main Street, Natick, MA 01760

Technical & Non-800: 1-617-655-1532

CIRCLE NO. 19 ON FREE INFORMATION CARD

dx listening

and *Radio Noticias del Continente* on 9615 (the latter suffering severe jamming at times); and *La Voz de Nicaragua* on 5950. Its mediumwave counterpart, *Radio Sandino*, can often be heard by those in a position to null out *WSB* on the same frequency, 750 kHz. Those limited to English language news could tune *Radio Free Grenada* at 2300 and 15045; or *Radio Habana Cuba* at 0100 and 0230 on 11930, 0330 and 0500 on 11760; 0630 on 9525.

Meanwhile, conflict in neighboring Guatemala had an impact on shortwave broadcasting and shortwave listening. The *Toronto Globe & Mail* reported that a station operated by a 400-year-old church from the shores of beautiful Lake Atitlán, was destroyed by the Guatemalan army Nov. 3, shortly after the director of *La Voz de Atitlán*, Gáspar Culán Yataz, had been kidnapped and badly wounded. The station had served the predominantly Indian audience of the area, advocating human rights. It was often heard in North America on 2390 kHz, and many DX listeners have verifications signed by Sr. Culán. (This is not to be confused with a Mexican on the same frequency, *Radio Huayacocotla*, which benefits from this tragedy by a reduction in interference.) Our thanks to Syd Osterman for this report.

Country by Country. Austria. One of the better DX programs is "Austrian Shortwave Panorama," Sundays from *ORF*, at 0900 GMT on 9770, 1235 on 21655, 1805 on 15560. Reception is best in eastern North America. Included are frequent contributions from yours truly, such as unhurried DX news, and background features (for example, tapes of *Radio Liberación*.)

Cook Islands may be among the first countries to appear on the new 22-meter shortwave broadcast band (13.6-13.8 MHz) agreed to at the 1979 World Administrative Radio Conference. Richard Wood reports that Radio Cook Islands is planning to register a frequency on this band to boost daytime coverage.

Gabon. Africa Number One returned to the air Feb. 4, but to everyone's surprise, on the 60-meter band where it had never operated before. Its 500-kW transmitter put powerful signals into North America until sign-off at 2305 GMT and from sign-on at 0500—all in French but with slick European production. *ANO* tried various frequencies between 4808 and 4812 kHz.

Iran & Afghanistan (to rather than from). While anyone's first guess as to the location of clandestine stations opposing the Khomeini regime in Iran would be Iraq, this has been confirmed by the careful monitoring of Ernest Behr in Kenora, Ont., and the not-so-



CABLE TV CONVERTERS AND OTHER GOOD STUFF!

SMASHING ALL SALES RECORDS - OUR NEW 30 CHANNEL CABLE TV CONVERTER!

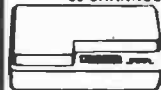

Converts mid & super band cable channels for viewing on your TV set!
No. 335VA047 **39.95** \$34.95 ea./5

HOT NEW IMPORT! REMOTE CONTROL 30 CHANNEL CABLE TV CONVERTER!



Includes remote TV on/off switch and fine tuning control!
No. 335VA275 **89.95** \$79.95 ea./5 \$74.95 ea./10

ETCO MKII WIRELESS - THE ULTIMATE CABLE TV CONVERTER!



Set TV to channel 3, and the hand held remote control does it all!
No. 335ZA008 **189.00**

VIDCOR 2000 CONVERTER ELIMINATES PROBLEMS WHEN TAPING FROM CABLE TV



Restores your VCR's capability for programming. Restores remote channel control. Enables videotaping of one cable program while watching another.
No. 335VA950 **89.95** \$79.95 ea./5 \$74.95 ea./10

UNUSUAL FACTORY SURPLUS MID-BAND - SUPER-BAND CABLE TV TUNER



Converts cable channels to a common IF frequency. Experimenters - build cable converters, decoders, etc. With schematic. No. 335VA342 **19.95** \$17.50 ea./10

335VA309 Detailed schematic & spec sheet \$1.50

FACTORY SURPLUS UHF TUNERS



Brand new production surplus. All solid state. Ideal for experimental work building cable TV converters, etc. No. 335SU099 **4.95** \$3.95 ea./10

MINIATURE FM WIRELESS MICROPHONE



Hides in the palm of your hand. Reception on any standard FM radio or receiver. No. 335VA482 **29.95** \$27.50 ea./5 \$26.95 ea./10

QUARTER-MILE WIRELESS MICROPHONE & RECEIVER SYSTEM



FCC approved crystal controlled wireless mike & receiver. All battery operated. Electrical wide range response. VU meter. No. 335VA093 **69.95** \$49.95 ea./5

ETCO GENERAL PURPOSE TUBE TESTER



IN KIT FORM. Checks for leakage, shorts, emission, 7, 9 pin, octal, loctal, compactron, novistor. In portable case. No. 335KT146 **49.95** \$49.95 ea./5 \$49.95 ea./5

DUMPING! NORELCO ENDLESS LOOP CASSETTES!

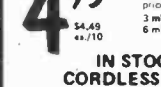

Impossible to find at any price!
3 minutes - No. 335VA605 \$4.95 ea./10
6 minutes - No. 335VA606 \$4.95 ea./10

IN STOCK - THE MURA CORDLESS TELEPHONE SYSTEM!



Answer & originate calls with this unique cordless telephone. 400 ft. range! No charge! Low number! No call! Imported from West Germany. No. 335VA561 **144.88** \$129.95 ea./5

SALE OF QUARTZ BATTERY OPERATED CLOCK MOVEMENTS!

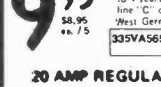

Accuracy of 1 min./year up to 4 years operation! 1.5 like line 'C' call imported from West Germany. No. 335VA561 **9.95** \$8.95 ea./5 \$1.95/ea./5

20 AMP REGULATED 12VDC POWER SUPPLY!

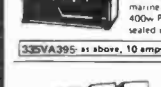

13.8 vdc no load, 12.5 vdc full load. Easily handles ham station, marine radio, SSB linear up to 400w P.E.P. Brand new, factory sealed cartons. No. 335VA394 **59.88** \$48.95 ea./5

335VA395: as above, 10 amp - \$49.95 - 39.95 ea./5

FREE OUR LATEST 98 PAGE FASCINATING CATALOG - jam packed with unique items, electronic bargains and unusual offers. Write or circle the information card number below.

ETCO ELECTRONICS 100 COUNTRY SHOPPING CENTER PLATTSBURGH, N.Y. 12601
Check with order, please. Visa & Mastercard OK. (Sorry, no C.O.D.). Add 15% for UPS & Handling (E-taxes refunded). N.Y. State residents add 7% sales tax. Dealer & Export inquiries invited. Our telephone order desk never closes. Call 1-518-561-8700.

CIRCLE NO. 20 ON FREE INFORMATION CARD

SAVE!

MONEY • TIME • FREIGHT

QUALITY STEREO EQUIPMENT AT LOWEST PRICES.

YOUR REQUEST FOR QUOTATION RETURNED SAME DAY.

FACTORY SEALED CARTONS—GUARANTEED AND INSURED.

SAVE ON NAME BRANDS LIKE:

PIONEER	SANSUI
KENWOOD	DYNACO
SHURE	SONY
MARANTZ	KOSS

AND MORE THAN 50 OTHERS BUY THE MODERN WAY BY MAIL—FROM

illinois audio

BANK CARDS ACCEPTED

12 East Delaware
Chicago, Illinois 60611

312-664-0020
800-621-8042

CIRCLE NO. 28 ON FREE INFORMATION CARD

dx listening

careful operation of the transmitters involved. Ernie found that Farsi programs of *Free Voice of Iran*, another clandestine called *Radio Iran*, and of *Radio Baghdad's* Persian service all used the same frequency (with pauses in between). This wouldn't necessarily be positive proof, except the frequency varied from day to day between 9560 and 9580 kHz; and there were no detectable breaks in transmission. Two other clandestines, *Radio Vatan* (Homeland), for Iran, and *Radio Mujahidin*, for Afghanistan, use different frequencies but their schedules are coordinated in such a way that it seems likely they share another site, more distant (since higher frequencies are used), and for political reasons, Egypt is the most likely source.

Korea, North. Listening to *Radio P'yongyang* may be rather tedious, but just reading through their program schedule can be rather entertaining. Thanks to Bill Bergadano for forwarding it to us. Monday, "20 Year Long Anti-Japanese Revolt Under Red Sunrises" (repeated Thursday); Tuesday, "Travelogues on a Beautiful Place" (repeated Sunday); Wednesday, "Bio: Kim Il Sung" and "Korea in the Eyes of Foreigners"; Thursday, "The Juche Idea is the Beacon of Revolution"; Friday, "Cholema Korea Accelerates the Juche" and "Modernization & Scientification of the National Economy"; Saturday, "A Great Man" and "Mailbag"; Sunday, Music. So far, I have not determined just when the shows occur within 110-minute-long transmissions, and may never do so. It should be noted, however, that since the last schedule we received, there has been a marked decline in the number of program titles involving Our Great Leader Kim Il Sung (known familiarly among aficionados as "OGLKIS").

USSR. Radio Moscow isn't the only station emanating from the Soviet capital. Entirely distinct to the Soviet mind is *Radio Station Peace & Progress*, "the voice of Soviet public opinion", which has some half-hour English broadcasts not directed to North America, but which you might encounter by tuning around the bands at 1300, 1330, 1430, 1530 and 1630 GMT. It generally takes a line even harder than *Radio Moscow*, but has been known to include some readings from great Russian literature for general interest.

But there is still another Moscow shortwave station, which does not appear in such references as the *World Radio-TV Handbook*. It may be debatable whether it's a broadcast station, but other stations doing the same thing are listed. To the CIA it is, since it appeared in *Broadcasting Stations of the World* (last published in 1974). It is the Soviet

AMAZING DEVICES

(((PHASERS)))

PPF-1 PHASER PAIN FIELD — This device recently developed and patented in our labs is being evaluated by law enforcement agencies for riot and crowd control. It is now available but soon will come under the jurisdiction of weapons and internal machine control making it unavailable to the public. The device is hand-held and looks like a BUCK ROGERS ray gun. It is hazardous if not used with discretion.

PPF-1 PLANS \$15.00
 IPG-1 INVISIBLE PAIN FIELD GENERATOR — This amazing, simple hand-held device is about the size of a pack of cigarettes and generates a directional field of moderate to intensive pain in the lower part of the head up to a range of 50'. Device is simple and economical to make.
 IPG-1 PLANS \$6.00 IPG-1K ALL PARTS \$39.50
 IPG-10 ASSEMBLED & TESTED FOR ANIMAL CONTROL \$49.50

LASERS

RUBY LASER RAY PISTOL — Produces highly intense red beam, capable of burning. A hazardous device. PLANS, PARTS, SOURCES \$15.00
 HIGH POWERED CARBON DIOXIDE BURNING AND CUTTING. Complete plans and all parts sources \$15.00
 SOLID STATE IR 12 WATTS with built in power supply plans \$8.00 Complete kit with collimator \$74.00
 POCKET LASER pulsed, visible red plans \$7.00
 Complete kit \$59.50 Also complete plans and parts sources for RUBY, YAG, NEDDYNIUM, HeNe ARGON, DYE, NITROGEN and many more lasers.

SECURITY

SNP-2 SNOOPER PHONE — Dial home or office phone while on vacation activating sensitive mike without phone ringing. Excellent property protection and intrusion device.
 SNP2 PLANS \$7.00
 SNP2Z ALL PARTS \$49.50
 SNP20 ASSEMBLED AND TESTED \$89.50
 LONG RANGE XMTR PLANS \$6.00
 SEE-IN-THE-DARK PLANS \$8.00
 DIRECTIONAL SHOTGUN MIKE PLANS \$7.00
 SUPER SENSITIVE PARABOLIC MIKE PLANS \$7.00
 SOUND & TELEPHONE OPERATED TAPE RECORDER \$8.00
 CATALOG ON PLANS, KITS & FINISHED UNITS \$1.00

Send check or money order to:
SCIENTIFIC SYSTEMS, Dept. Q1, Box 118
AMHERST, N.H. 03031

CIRCLE NO. 54 ON FREE INFORMATION CARD

SEE YOUR DEALER TODAY

DEMAND THE ORIGINAL

'Firestik'

The #1 Helically Wire-Wound and Most Copied Antenna in the World!

CITIZEN BAND

2 METER • MARINE TELEPHONE
LAND MOBILE TELEPHONE

FIBERGLASS ANTENNAS
AND ACCESSORIES.

CORDLESS TELEPHONE ANTENNA
INCREASES DISTANCE
5 TO 10 TIMES!
NEW MODEL 49 V.I.P.

SPECIAL QUOTES!
ON 27 TO 1000 MHZ
FIBERGLASS ANTENNAS
ANYWHERE IN THE WORLD!

Dealer & Distributor Inquiries Invited
SEND FOR FREE CATALOG

'Firestik' Antenna Company
2614 East Adams/Phoenix, AZ 85034

Name _____
 Street _____
 City _____
 State _____ Zip _____

Serving the CB and
Communications Market Since 1962.

5-YEAR REPLACEMENT WARRANTY

CIRCLE NO. 21 ON FREE INFORMATION CARD

30 TUNE MELODY MICROPROCESSOR

FEATURES

- * 30 Melodies
- * Variable Tone
- * Variable Tune Speed
- * Variable Volume
- * Direct Output To Speaker
- * Auto or Manual Tune Change
- * Low Power
- * Operated By Two 9V Batteries

APPLICATIONS

- * Electronic Door-chimes
- * Musical Car-horn
- * Entrance Warning
- * Music Box..... etc.

Spec. Sheet & Typical Circuit Schematic Included

- | | | |
|---|--------------------------------|-------------------------------------|
| 1 Pomp & Circumstances (Land of Hope and Glory) | 12 Happy Birthday | 27 Wedding March (Mendelssohn) |
| 2 Auld Lang Syne | 13 Jingle Bells | 23 Sailor's Hornpipe |
| 3 Charge! | 14 Soldiers Chorus (Faust) | 24 Slave and a Haricot |
| 4 Rule Britannia | 15 Close Encounters Theme | 25 Colonel Bogey March |
| 5 Westminster Chimes | 16 O Canada | 26 Twinkle, Twinkle, Little Star |
| 6 Deutschlandlied | 17 Mexican Hat Dance | 27 William Tell Overture |
| 7 Greensleeves | 18 God Save The Queen | 28 Eyes of Texas |
| 8 Star Spangled Banner | 19 My Country 'Tis Of Thee | (I've been working on the Railroad) |
| 9 Mozart Sonata | 20 Oranges & Lemons | 29 Bach Toccata in D Minor |
| 10 Beethoven's 5th Symphony | 21 Blue Danube Waltz (Strauss) | 30 Lorelei |
| 11 La Marseillaise | 21 Wilhelmus | |

Special Offer \$5.95

Two for \$11.00

Cal. Res. Add 6% Tax
Check, M/O, with order
Postage & Handling Add \$2.00
C.O.D.'s Add \$1.00

SRJ INTERNATIONAL CORP.

1936 Hillman Avenue
Belmont, Calif. 94002
(415) 593-8508

OEM INQUIRIES INVITED
QUANTITY DISCOUNTS

CIRCLE NO. 35 ON FREE INFORMATION CARD

dx listening

News Agency TASS, which broadcasts "news" in Russian at dictation speed (presumably for remote areas of the USSR or embassies abroad still not tied in by more sophisticated methods) on an unknown schedule. DX listener Paul Kowalski in Milwaukee ran across this last winter on 9850 kHz around 0630-0800 GMT. During the lengthy pauses there would be the sound of a clock ticking, once per second. This and four other channels are listed by the CIA—7420, 9160, 9490 and 9880 kHz, each with the relatively low power of 15 or 50 kW.

Updating items in our January and March columns: The Cuban clandestine serving Africa may be in Angola instead of Ethiopia. *Radio Patagonia Chilena* has been reported on 6105 instead of 6080. "Malta Calling" should have been mentioned in the item on Malta—it's Saturday 0700-0800 on 9670. *Rádio Renascença* has been operating on 11745 at 1830-2030. The *VOA* relay on Antigua is to be mediumwave only; *Radio Free Grenada* refers to it as "Free Caribbean."

English-Language Listings: The following changes and additions should be made to the listings that appeared in the April issue. To make the corrections

as concise as possible, only the GMT, station name, and frequency correction are given.

1200-1230, R. Japan, 9505, ex-1000-1030, now 1000-1015
 1200-1230, R. Tashkent, 6025, 9540 (until late April)
 1200-1255, R. Peking, 9820 (until late April)
 1230-1415, TWR, Bonaire, 11815, not 15255
 1400-1500, V. of Indonesia, 11790, ex-11715; 15150, ex-15200
 1400-1500, R. Malaysia Sarawak, 4950
 1535-1545, V. of Greece, 21455 not 21555
 1600-1630, R. Portugal, 21475, ex-21530 (exc. Sun.)
 1600-1800, AFRTS, add 17765
 1800-1900, V. of Vietnam, 15010
 1800-2200, AFRTS, add 17765, 21570
 1900-1930, R. Japan, 15270 (ex-1400-1530, now 1400-1415)
 2000-2030, Kol Israel, 17645, 15582, 12025, 11637; not 15105, 9815, 9425
 2100-2130, R. Algiers, 15365, ex-15307
 2100-2155, R. RSA, 17780, ex-17775
 2130-2200, R. Sophia, 11860, 11920
 2200-2215, R. Japan, 11955, ex-11790 (via Portugal)
 2200-2300, CBC Radio, 11925, not 11780
 2230-2300, R. Nacional, Angola, 11955 (Mon.-Fri.)
 2230-2300, Kol Israel, add 12025
 2300-2330, R. Vilnius, 17870, 15240,

15100, 11790, 11770
 2300-2400, AFRTS, 11790, not 15430
 2300-2400, WYFR, 9535
 2345-2445, R. Japan, 15430, ex-15270
 0000-0100, R. Sofia, 15330, 11830
 0000-0500, FEBC, Philippines, delete 17810
 0035-0230, HCJB, Ecuador, 15360, ex-15355
 0100-0200 AFRTS, 15345, 15330, not 6030
 0200-0255, R. RSA, 5980
 0200-0430, AFRTS, add 9755
 0300-0330, R. Portugal, 6025, ex-6185
 0300-0730, VOA, 15240 not 15245; 15330 from 0600 only
 0430-0500, R. Sofia, 11860
 0430-0600, AFRTS, add 17765, 15330, 9755
 0500-0515, Kol Israel, 17710, 15582, not 11960, 9009
 0500-0515, R. Japan, 15430, ex-15270
 0500-0600, TWR, Bonaire, 9755, 800
 0500-0800, R. Nigeria, Kaduna, 4770 (not all English)
 0530-0545, R. Niamey, Niger, 5020
 0600-0615, R. Japan, 15430, ex-15270
 0600-0700, AFRTS, add 9755
 0600-0730, HCJB, Ecuador, 15225, ex-9760, ex-0700-0830
 0700-0715, R. Japan, 15430 ex-15270; 11770 ex-15130 via Portugal
 0700-0720, R. Netherlands, 25650, 21480, 11720
 0945-1215, R. New Zealand, delete 6105. ◇

4PDT RELAY

POTTER BRUMFIELD
 • 4 pin strip
 • 3 amp contacts
 • 24 volt d.c. or
 • 120 volt a.c. coil
 • Used but fully tested

\$1.50 each
 specify coil voltage
 LARGE QUANTITIES AVAILABLE
 SPECIALTY ELECTRONICS

FLASHER LED

Litronix FRL-4403
 diffused red led with built
 in flashing unit T-1 package
 pulse rate 3Hz by 20 ma

2 for \$1.70

SUB MINI L.E.D.

0.079" x .098" 20mA @ 1.75V
 10 for \$1.00
 200 for \$18.00
 400 for \$32.00
 1000 for \$70.00

COMPUTER GRADE CAP.

1,700mfd NEW
 150 VDC \$2.00
 2 1/2" DIA X 4 3/4" HIGH
 6,400mfd \$2.50
 60 VDC
 1 3/8" DIA X 4 1/4" HIGH
 11,500mfd 18 VDC \$1.50
 1 3/8" DIA X 3 1/4" HIGH
 22,000mfd 15 VDC \$2.50
 2" DIA X 2 1/2" HIGH
 CLAMPS TO FIT CAPACITORS 50a ea

7-17vdc S.S. BUZZER

STAR #CMB-12
 • Fits dip socket
 • CMOS compatible
 • Max current 14mA
 • Sound output

\$1.25 each 70dB @ 20 cm

FLAT LEVER HANDLE MINI TOGGLE

SPDT RATED 6 AMPS @ 125 V
 1 4 0 BUSHING

\$1.00 each
 10 for \$8.50
 100 for \$75.00

TRANSFORMERS

120 volt primaries

3 VOLTS at 200 mA \$1.25
 6 VOLTS at 150 mA \$1.25
 12 V.C.T. at 500 mA \$2.50
 16.5 V. at 3 AMPS \$6.50
 30 V.C.T. at 3 AMPS \$5.50

1N5762 DIAC

SWITCH VOLT 36V
 min 34 V • max 38 V
 4 for \$1.00

DPDT 12VDC ENCLOSED RELAY

10 AMP CONTACTS
 AVAILABLE WITH NO FLANGE, CAN BE SOCKETTED

\$3.00 EACH
 10 for \$27.50
 SOCKETS \$1.00

22/44 EDGE CONNECTOR

TIN SOLDER TAIL .156" x .200"

\$1.35 each 10 for \$12.50

50K SLIDE POT

Knobs for Slide Pots 20c each
 75c each audio taper

• 3.12 inch long • 2.34 inch slide

LEARN MICROPROCESSING on your own computer!

You Learn How To:

- Design & code micro-processor software
- Use logic & Bit Manipulation Techniques
- Enter & execute programs on your own computer
- Understand Microprocessor Architecture & Support Chips
- Control Programmable Input/Output Ports
- Implement Real-Time Interrupt Handling & Data Transfer
- Design your own microcomputer

You Will Receive:

- A fully tested and assembled 8085A Microcomputer with 1K RAM, 1K EPROM and 1K PROM Memory, Programmable I/O, Keyboard Unit, CPU Card, Display and Operating System. 44 pin edge connector can be configured to any bus structure, area on CPU Card for custom wire-wrap design or user defined interface circuitry, completely expandable
- Complete Step-by-Step Instruction Manual
- Complete User's Manual with programs included
- 352 page 8085A Cookbook takes you from basic microprocessor concepts to actual design of an 8085A microcomputer
- 344 page 8080/8085 Software Design Book 1 with over 150 executable program examples plus detailed examination of all 244 instructions and typical assembly language program for the 8080/8085 Microprocessor

Satisfaction Guaranteed. If not completely satisfied you may return the product within 30 days for a full refund.

RATED BEST VALUE BY INSTRUCTORS

PACCOM
 14905 NE 40th, Dept PES
 REDMOND, WA 98052

CREDIT CARD ORDERS
 CALL TOLL-FREE
1-800-426-6254 EXT 25

YES! I want to start learning Microprocessors. Please rush me
 8085AAT Microprocessor Training Unit at \$299.95 plus \$3.00 P & H
 8085 Cookbook 21697 \$12.95 8080/8085 Software Book 21541 \$9.50

NAME _____
 ADDRESS _____
 CITY _____ ST. _____ ZIP _____
 CARD NO. _____ EXP. DATE _____
 SIGNATURE _____

Waiting for a lead synthesizer that has it all?

PROTEUS I™ PROGRAMMABLE PRESET LEAD SYNTHESIZER

Your wait is over!

You've always had a lot of options. You could have the convenience and easy operation of a normalized synthesizer if you were willing to give up the versatility of modular equipment. Or the unlimited spectrum of tone colors and timbres of modules if you didn't mind the cumbersome patch cords and time required to set up or change a patch. You could have programmable presets if you could raise the bucks, or low-cost equipment if you could stand the snap-crackle-pop.

You could even have such technically innovative features as computer control of voice and sequence if you had the technical savvy to design it all and make it work.

Now you have another option. YOU CAN HAVE IT ALL. Wide range, precise, low-noise, presets, meaningful patch bay and an easy-to-use computer interface.

All at a price that's nothing but unbelievable.

Want to know more? Proteus I's Using/Assembly manual which includes a demo tape will answer all of your questions. The price, \$10.00 is refundable upon purchase of either the kit or assembled model.

PART OF THE NEW GENERATION FROM PAIA Electronics, Inc.

1020 W. Wilshire, Oklahoma City, OK 73116 • (405)843-9626
 CHARGE ORDER? Call our 24 hour Demo/Order line 405-843-7396

I'm convinced, send Proteus I, \$699.00 enclosed. (shipped Freight Collect)

Send the easy-to-assemble Proteus I Kit, \$499.00 enclosed. (Freight Collect)

Tell me more. Rush the Assembly/Using manual & demo tape for Proteus I. (\$10.00 enclosed, refundable)

Send free catalog

Name: _____
 Address: _____
 City: _____ State: _____ Zip: _____

Visa _____ MC _____ Card No.: _____

PAIA Electronics, Dept. 4 P, 1020 W. Wilshire, Okla. City, OK 73116

CIRCLE NO. 48 ON FREE INFORMATION CARD

MAY 1981 95

Radio Shack is America's Parts Place™

No Minimum Order! No Waiting! Low Prices!

100% Prime CMOS ICs

Low As **89¢**

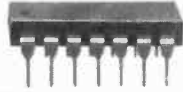

- Static-Protected "B" Series
- Pin-Out Diagram & Specs Included

Type	Cat. No.	Each
4001	276-2401	.99
4011	276-2411	.89
4013	276-2413	1.19
4017	276-2417	1.99
4027	276-2427	1.19
4511	276-2447	1.99
4059	276-2449	.99
4050	276-2450	.99
4066	276-2466	1.59
4070	276-2470	.99

LS-Series ICs Low As **79¢**

Pin-Out Diagram & Specs Included

Type	Cat. No.	Each
74LS00	276-1900	.79
74LS02	276-1902	.79
74LS04	276-1904	.79
74LS08	276-1908	.79
74LS32	276-1915	.89
74LS73	276-1918	.99
74LS74	276-1919	.79
74LS75	276-1920	.99
74LS90	276-1923	1.19
74LS123	276-1926	1.49
74LS151	276-1929	1.09
74LS157	276-1930	1.19
74LS161	276-1931	1.59
74LS164	276-1932	1.59
74LS175	276-1934	1.39
74LS193	276-1936	1.69
74LS367	276-1835	1.59

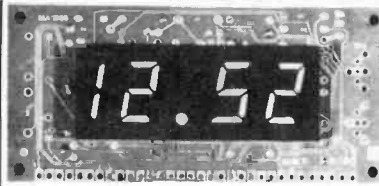

Time/Temp Module

Reg. 24.95
20% Off! 19.88

Pre-Wired and Feature-Packed

Variable-brightness LED display reads 12/24-hour time, temperature in C or F, 24-hour alarm drives a speaker directly. Has 10-minute snooze and 59-minute sleep functions—get ambitious and add "clock radio" features to a stereo or TV! 1 1/4x3 3/4x1 1/4". Includes instructions which specify parts for DC operation. Requires three resistors, temp. sensor and power transformer. 277-1006

LM334 Sensor. 276-1734 2.29 Power Transformer. 273-1530 5.99

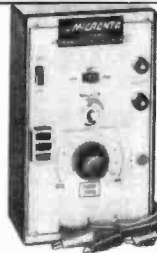

Transistor Checker

16.95

A "Must" for Your Test Bench

Tests all types, in or out of circuit. Indicates relative current gain, "opens," "shorts" and permits matching. Has output for external meter or scope. With instructions. Requires one "C" battery. 22-024 16.95

Pocket Signal Injector

5.49

It's a Real Timesaver

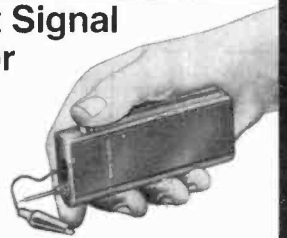

Produces a signal rich in harmonics for testing all stages from antenna to speaker. Has On/Battery condition indicator. With leads and instructions. Requires two "AA" batteries. 22-4033 5.49



Dual-Gate MOSFET

1.59

3N211. For RF mixer, amplifier and oscillator use to 450 MHz. 360 mW max; TO-72 case. 276-2045 1.59

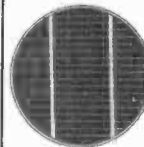

Solar Cell

9.99

High-efficiency 3" diameter cell delivers 0.42V at 1 amp (0.42-ohm load) in full sunlight. 276-123 9.99

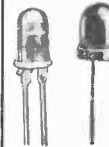

Unique LEDs

Low As **1.29**

A TriColor. Red on DC, green on reverse DC, yellow on AC! 276-035 1.39
B Red Flasher. CMOS IC and LED in one package. 3-5VDC. 276-036 1.29

Phototransistor



89¢

TTL compatible, similar to FPT-100. Sensitive, with fast response time. 276-130 89¢

50 Type 1N914 Silicon Diodes



Long Leads **1.98**

Switching time low as 4 ns. Ideal for logic circuits. PRV: 90V. 276-1620 Pkg. of 50/1.98



VMOS Power FETs

Low As **1.59**

Diode-Protected Gate
A VN10KM. 1W diss. TO-92 + case. 276-2070 1.59
B VN67AF. 15W diss. TO-202 case. 276-2071 2.49

"Noise" IC

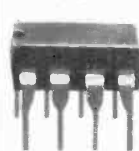

2.69

With Data

MM5837. 17-bit shift register with built-in clock. White or pink noise from an 8-pin DIP. 276-1768 2.69

16K Hobby RAM



29% Off!

16-Pin Reg. DIP **9.95**

4116 Dynamic. 100% prime. 16,384x1 bits. 1 ms refresh. 276-2505 Sale 9.95

Submini SPDT DIP Relay



2.99

5VDC Coil

For PC board and DIP sockets. Contacts: 1A at 125VAC. 56-ohm coil. 3/8x9/16". 275-216 2.99

Mercury Bulb Switch



NEW!

1.19

Gravity actuated—tilt to close circuit. 5A at 125VAC. Style may vary. 275-027 1.19

DPST 12VDC Reed Relay

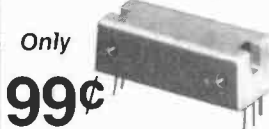

Only **99¢**

Encapsulated. For low-power circuits. Contacts: 0.5A at 125VAC. Coil: 375 to 800 ohms. 1 1/8x9/16x7/16". 275-229 99¢

Top-Octave IC



44% Off!

Reg. 6.99

3.88

Build a keyboard instrument or musical doorbell using this 16-pin DIP. With data. 276-1780 3.88

Rhythm IC



33% Off!

Reg. 6.59

4.44

Build an "electronic drum set" using this 16-pin DIP. Six combinable patterns. With data. 276-1785 Sale 4.44

Start Your Next Project at The Shack®



Prices may vary at individual stores and dealers

Radio Shack®

A DIVISION OF TANDY CORPORATION • FORT WORTH, TEXAS 76102
OVER 7500 LOCATIONS IN 40 COUNTRIES

DIGI-KEY CORPORATION

In Minn., Ak., HI. Call 216-681-6674

Capacitors • Real-Time Clock/Calendar • E.P. Johnson • Terminal Strips • T.I. Connectors • Wire Wrapping Supplies • CMOS Rectifiers • Power Sources • Sams Books • Diamond Tools • Panavice
 A.P. Products • Elextronics • Zenier Diodes • Breadboarding • Wire Buzzers • Vices • Templates • Diodes • Switches • Drafting Aids • Soldering Supplies • Edge Connectors • IC Sockets
 Enclosures • Resistors • Resistor Networks • Hardware • Power Supplies • Hobby Boxes • Phono Plugs & Jacks • Integrated Circuits • Clocks/A/D & D/A • Nickel-Cadmium Batteries
 Microprocessors & Support • Luxo Lamps • Clocks • Bezel • PC Layout Supplies • Lithium Batteries • Tantalum Capacitors • Time Temperature Clocks/A/D & D/A • Nickel-Cadmium Batteries
 Electrolytic Capacitors • Potentiometers • Car Clocks • Fans • Clocks • Home Clock Kits • Tools • Fuse Holder Boards • Linear Products • Heat Sinks & Accessories • Solder Wick • AND MORE

Multi-Digit LED Numeric Series

18-Digit LED

Device	Supply	Format	Price
NS4374	Red	CA-DIRECT	\$2.00
NS4375	Red	CA-DIRECT	\$3.00
NS4376	Red	CA-DIRECT	\$4.00
NS4377	Red	CA-DIRECT	\$5.00
NS4378	Red	CA-DIRECT	\$6.00
NS4379	Red	CA-DIRECT	\$7.00
NS4380	Red	CA-DIRECT	\$8.00
NS4381	Red	CA-DIRECT	\$9.00
NS4382	Red	CA-DIRECT	\$10.00
NS4383	Red	CA-DIRECT	\$11.00
NS4384	Red	CA-DIRECT	\$12.00
NS4385	Red	CA-DIRECT	\$13.00
NS4386	Red	CA-DIRECT	\$14.00
NS4387	Red	CA-DIRECT	\$15.00
NS4388	Red	CA-DIRECT	\$16.00
NS4389	Red	CA-DIRECT	\$17.00
NS4390	Red	CA-DIRECT	\$18.00
NS4391	Red	CA-DIRECT	\$19.00
NS4392	Red	CA-DIRECT	\$20.00
NS4393	Red	CA-DIRECT	\$21.00
NS4394	Red	CA-DIRECT	\$22.00
NS4395	Red	CA-DIRECT	\$23.00
NS4396	Red	CA-DIRECT	\$24.00
NS4397	Red	CA-DIRECT	\$25.00
NS4398	Red	CA-DIRECT	\$26.00
NS4399	Red	CA-DIRECT	\$27.00
NS4400	Red	CA-DIRECT	\$28.00
NS4401	Red	CA-DIRECT	\$29.00
NS4402	Red	CA-DIRECT	\$30.00
NS4403	Red	CA-DIRECT	\$31.00
NS4404	Red	CA-DIRECT	\$32.00
NS4405	Red	CA-DIRECT	\$33.00
NS4406	Red	CA-DIRECT	\$34.00
NS4407	Red	CA-DIRECT	\$35.00
NS4408	Red	CA-DIRECT	\$36.00
NS4409	Red	CA-DIRECT	\$37.00
NS4410	Red	CA-DIRECT	\$38.00
NS4411	Red	CA-DIRECT	\$39.00
NS4412	Red	CA-DIRECT	\$40.00
NS4413	Red	CA-DIRECT	\$41.00
NS4414	Red	CA-DIRECT	\$42.00
NS4415	Red	CA-DIRECT	\$43.00
NS4416	Red	CA-DIRECT	\$44.00
NS4417	Red	CA-DIRECT	\$45.00
NS4418	Red	CA-DIRECT	\$46.00
NS4419	Red	CA-DIRECT	\$47.00
NS4420	Red	CA-DIRECT	\$48.00
NS4421	Red	CA-DIRECT	\$49.00
NS4422	Red	CA-DIRECT	\$50.00

Panasonic

MEETS REQUIREMENT MIL-R-3540

SWITCHING POWER SUPPLIES

100W, 200W, 300W, 400W, 500W, 600W, 700W, 800W, 900W, 1000W

Model	Power	Price
PS-100	100W	\$10.00
PS-200	200W	\$15.00
PS-300	300W	\$20.00
PS-400	400W	\$25.00
PS-500	500W	\$30.00
PS-600	600W	\$35.00
PS-700	700W	\$40.00
PS-800	800W	\$45.00
PS-900	900W	\$50.00
PS-1000	1000W	\$55.00

DAP PRODUCTS INCORPORATED

ACE 218, ACE 227, ACE 236, ACE 200-K, ACE 212

ACE 218: 1.500 200/250/300/350/400/450/500/550/600/650/700/750/800/850/900/950/1000/1050/1100/1150/1200/1250/1300/1350/1400/1450/1500/1550/1600/1650/1700/1750/1800/1850/1900/1950/2000/2050/2100/2150/2200/2250/2300/2350/2400/2450/2500/2550/2600/2650/2700/2750/2800/2850/2900/2950/3000/3050/3100/3150/3200/3250/3300/3350/3400/3450/3500/3550/3600/3650/3700/3750/3800/3850/3900/3950/4000/4050/4100/4150/4200/4250/4300/4350/4400/4450/4500/4550/4600/4650/4700/4750/4800/4850/4900/4950/5000/5050/5100/5150/5200/5250/5300/5350/5400/5450/5500/5550/5600/5650/5700/5750/5800/5850/5900/5950/6000/6050/6100/6150/6200/6250/6300/6350/6400/6450/6500/6550/6600/6650/6700/6750/6800/6850/6900/6950/7000/7050/7100/7150/7200/7250/7300/7350/7400/7450/7500/7550/7600/7650/7700/7750/7800/7850/7900/7950/8000/8050/8100/8150/8200/8250/8300/8350/8400/8450/8500/8550/8600/8650/8700/8750/8800/8850/8900/8950/9000/9050/9100/9150/9200/9250/9300/9350/9400/9450/9500/9550/9600/9650/9700/9750/9800/9850/9900/9950/10000/10050/10100/10150/10200/10250/10300/10350/10400/10450/10500/10550/10600/10650/10700/10750/10800/10850/10900/10950/11000/11050/11100/11150/11200/11250/11300/11350/11400/11450/11500/11550/11600/11650/11700/11750/11800/11850/11900/11950/12000/12050/12100/12150/12200/12250/12300/12350/12400/12450/12500/12550/12600/12650/12700/12750/12800/12850/12900/12950/13000/13050/13100/13150/13200/13250/13300/13350/13400/13450/13500/13550/13600/13650/13700/13750/13800/13850/13900/13950/14000/14050/14100/14150/14200/14250/14300/14350/14400/14450/14500/14550/14600/14650/14700/14750/14800/14850/14900/14950/15000/15050/15100/15150/15200/15250/15300/15350/15400/15450/15500/15550/15600/15650/15700/15750/15800/15850/15900/15950/16000/16050/16100/16150/16200/16250/16300/16350/16400/16450/16500/16550/16600/16650/16700/16750/16800/16850/16900/16950/17000/17050/17100/17150/17200/17250/17300/17350/17400/17450/17500/17550/17600/17650/17700/17750/17800/17850/17900/17950/18000/18050/18100/18150/18200/18250/18300/18350/18400/18450/18500/18550/18600/18650/18700/18750/18800/18850/18900/18950/19000/19050/19100/19150/19200/19250/19300/19350/19400/19450/19500/19550/19600/19650/19700/19750/19800/19850/19900/19950/20000/20050/20100/20150/20200/20250/20300/20350/20400/20450/20500/20550/20600/20650/20700/20750/20800/20850/20900/20950/21000/21050/21100/21150/21200/21250/21300/21350/21400/21450/21500/21550/21600/21650/21700/21750/21800/21850/21900/21950/22000/22050/22100/22150/22200/22250/22300/22350/22400/22450/22500/22550/22600/22650/22700/22750/22800/22850/22900/22950/23000/23050/23100/23150/23200/23250/23300/23350/23400/23450/23500/23550/23600/23650/23700/23750/23800/23850/23900/23950/24000/24050/24100/24150/24200/24250/24300/24350/24400/24450/24500/24550/24600/24650/24700/24750/24800/24850/24900/24950/25000/25050/25100/25150/25200/25250/25300/25350/25400/25450/25500/25550/25600/25650/25700/25750/25800/25850/25900/25950/26000/26050/26100/26150/26200/26250/26300/26350/26400/26450/26500/26550/26600/26650/26700/26750/26800/26850/26900/26950/27000/27050/27100/27150/27200/27250/27300/27350/27400/27450/27500/27550/27600/27650/27700/27750/27800/27850/27900/27950/28000/28050/28100/28150/28200/28250/28300/28350/28400/28450/28500/28550/28600/28650/28700/28750/28800/28850/28900/28950/29000/29050/29100/29150/29200/29250/29300/29350/29400/29450/29500/29550/29600/29650/29700/29750/29800/29850/29900/29950/30000/30050/30100/30150/30200/30250/30300/30350/30400/30450/30500/30550/30600/30650/30700/30750/30800/30850/30900/30950/31000/31050/31100/31150/31200/31250/31300/31350/31400/31450/31500/31550/31600/31650/31700/31750/31800/31850/31900/31950/32000/32050/32100/32150/32200/32250/32300/32350/32400/32450/32500/32550/32600/32650/32700/32750/32800/32850/32900/32950/33000/33050/33100/33150/33200/33250/33300/33350/33400/33450/33500/33550/33600/33650/33700/33750/33800/33850/33900/33950/34000/34050/34100/34150/34200/34250/34300/34350/34400/34450/34500/34550/34600/34650/34700/34750/34800/34850/34900/34950/35000/35050/35100/35150/35200/35250/35300/35350/35400/35450/35500/35550/35600/35650/35700/35750/35800/35850/35900/35950/36000/36050/36100/36150/36200/36250/36300/36350/36400/36450/36500/36550/36600/36650/36700/36750/36800/36850/36900/36950/37000/37050/37100/37150/37200/37250/37300/37350/37400/37450/37500/37550/37600/37650/37700/37750/37800/37850/37900/37950/38000/38050/38100/38150/38200/38250/38300/38350/38400/38450/38500/38550/38600/38650/38700/38750/38800/38850/38900/38950/39000/39050/39100/39150/39200/39250/39300/39350/39400/39450/39500/39550/39600/39650/39700/39750/39800/39850/39900/39950/40000/40050/40100/40150/40200/40250/40300/40350/40400/40450/40500/40550/40600/40650/40700/40750/40800/40850/40900/40950/41000/41050/41100/41150/41200/41250/41300/41350/41400/41450/41500/41550/41600/41650/41700/41750/41800/41850/41900/41950/42000/42050/42100/42150/42200/42250/42300/42350/42400/42450/42500/42550/42600/42650/42700/42750/42800/42850/42900/42950/43000/43050/43100/43150/43200/43250/43300/43350/43400/43450/43500/43550/43600/43650/43700/43750/43800/43850/43900/43950/44000/44050/44100/44150/44200/44250/44300/44350/44400/44450/44500/44550/44600/44650/44700/44750/44800/44850/44900/44950/45000/45050/45100/45150/45200/45250/45300/45350/45400/45450/45500/45550/45600/45650/45700/45750/45800/45850/45900/45950/46000/46050/46100/46150/46200/46250/46300/46350/46400/46450/46500/46550/46600/46650/46700/46750/46800/46850/46900/46950/47000/47050/47100/47150/47200/47250/47300/47350/47400/47450/47500/47550/47600/47650/47700/47750/47800/47850/47900/47950/48000/48050/48100/48150/48200/48250/48300/48350/48400/48450/48500/48550/48600/48650/48700/48750/48800/48850/48900/48950/49000/49050/49100/49150/49200/49250/49300/49350/49400/49450/49500/49550/49600/49650/49700/49750/49800/49850/49900/49950/50000/50050/50100/50150/50200/50250/50300/50350/50400/50450/50500/50550/50600/50650/50700/50750/50800/50850/50900/50950/51000/51050/51100/51150/51200/51250/51300/51350/51400/51450/51500/51550/51600/51650/51700/51750/51800/51850/51900/51950/52000/52050/52100/52150/52200/52250/52300/52350/52400/52450/52500/52550/52600/52650/52700/52750/52800/52850/52900/52950/53000/53050/53100/53150/53200/53250/53300/53350/53400/53450/53500/53550/53600/53650/53700/53750/53800/53850/53900/53950/54000/54050/54100/54150/54200/54250/54300/54350/54400/54450/54500/54550/54600/54650/54700/54750/54800/54850/54900/54950/55000/55050/55100/55150/55200/55250/55300/55350/55400/55450/55500/55550/55600/55650/55700/55750/55800/55850/55900/55950/56000/56050/56100/56150/56200/56250/56300/56350/56400/56450/56500/56550/56600/56650/56700/56750/56800/56850/56900/56950/57000/57050/57100/57150/57200/57250/57300/57350/57400/57450/57500/57550/57600/57650/57700/57750/57800/57850/57900/57950/58000/58050/58100/58150/58200/58250/58300/58350/58400/58450/58500/58550/58600/58650/58700/58750/58800/58850/58900/58950/59000/59050/59100/59150/59200/59250/59300/59350/59400/59450/59500/59550/59600/59650/59700/59750/59800/59850/59900/59950/60000/60050/60100/60150/60200/60250/60300/60350/60400/60450/60500/60550/60600/60650/60700/60750/60800/60850/60900/60950/61000/61050/61100/61150/61200/61250/61300/61350/61400/61450/61500/61550/61600/61650/61700/61750/61800/61850/61900/61950/62000/62050/62100/62150/62200/62250/62300/62350/62400/62450/62500/62550/62600/62650/62700/62750/62800/62850/62900/62950/63000/63050/63100/63150/63200/63250/63300/63350/63400/63450/63500/63550/63600/63650/63700/63750/63800/63850/63900/63950/64000/64050/64100/64150/64200/64250/64300/64350/64400/64450/64500/64550/64600/64650/64700/64750/64800/64850/64900/64950/65000/65050/65100/65150/65200/65250/65300/65350/65400/65450/65500/65550/65600/65650/65700/65750/65800/65850/65900/65950/66000/66050/66100/66150/66200/66250/66300/66350/66400/66450/66500/66550/66600/66650/66700/66750/66800/66850/66900/66950/67000/67050/67100/67150/67200/67250/67300/67350/67400/67450/67500/67550/67600/67650/67700/67750/67800/67850/67900/67950/68000/68050/68100/68150/68200/68250/68300/68350/68400/68450/68500/68550/68600/68650/68700/68750/68800/68850/68900/68950/69000/69050/69100/69150/69200/69250/69300/69350/69400/69450/69500/69550/69600/69650/69700/69750/69800/69850/69900/69950/70000/70050/70100/70150/70200/70250/70300/70350/70400/70450/70500/70550/70600/70650/70700/70750/70800/70850/70900/70950/71000/71050/71100/71150/71200/71250/71300/71350/71400/71450/71500/71550/71600/71650/71700/71750/71800/71850/71900/71950/72000/72050/72100/72150/72200/72250/72300/72350/72400/72450/72500/72550/72600/72650/72700/72750/72800/72850/72900/72950/73000/73050/73100/73150/73200/73250/73300/73350/73400/73450/73500/73550/73600/73650/73700/73750/73800/73850/73900/73950/74000/74050/74100/74150/74200/74250/74300/74350/74400/74450/74500/74550/74600/74650/74700/74750/74800/74850/74900/74950/75000/75050/75100/75150/75200/75250/75300/75350/75400/75450/75500/75550/75600/75650/75700/75750/75800/75850/75900/75950/76000/76050/76100/76150/76200/76250/76300/76350/76400/76450/76500/76550/76600/76650/76700/76750/76800/76850/76900/76950/77000/77050/77100/77150/77200/77250/77300/77350/77400/77450/77500/77550/77600/77650/77700/77750/77800/77850/77900/77950/78000/78050/78100/78150/78200/78250/78300/78350/78400/78450/78500/78550/78600/78650/78700/78750/78800/78850/78900/78950/79000/79050/79100/79150/79200/79250/79300/79350/79400/79450/79500/79550/79600/79650/79700/79750/79800/79850/79900/79950/80000/80050/8010

16K

Memory

8/\$19.95

4116 200ns

NEC

Mostek

ALL MERCHANDISE 100% GUARANTEED!

CALL US FOR VOLUME QUOTES

LS SERIES

74LS00	32	74LS155	1.19
74LS01	28	74LS156	.95
74LS02	38	74LS157	.79
74LS03	32	74LS158	.82
74LS04	35	74LS160	.94
74LS05	28	74LS161	.99
74LS08	38	74LS162	.99
74LS09	38	74LS163	.99
74LS10	32	74LS164	.99
74LS11	29	74LS165	.99
74LS12	39	74LS166	2.40
74LS13	38	74LS168	1.79
74LS14	99	74LS169	1.79
74LS15	35	74LS170	1.89
74LS20	26	74LS173	.82
74LS21	30	74LS174	1.19
74LS22	34	74LS175	1.09
74LS26	40	74LS181	2.19
74LS27	35	74LS190	1.15
74LS28	39	74LS191	1.31
74LS30	35	74LS192	.88
74LS32	39	74LS193	.98
74LS33	54	74LS194	1.80
74LS37	78	74LS195	2.40
74LS38	39	74LS196	.82
74LS40	25	74LS197	.82
74LS42	79	74LS221	1.28
74LS47	78	74LS240	1.89
74LS48	78	74LS241	1.89
74LS51	35	74LS242	1.89
74LS54	35	74LS243	1.89
74LS55	32	74LS244	1.79
74LS73	44	74LS245	2.89
74LS74	48	74LS251	1.32
74LS75	58	74LS253	.89
74LS76	50	74LS257	.89
74LS78	59	74LS258	.89
74LS83	90	74LS259	2.89
74LS85	1.23	74LS260	.68
74LS86	45	74LS266	.68
74LS90	70	74LS273	1.69
74LS92	82	74LS275	3.39
74LS93	.71	74LS279	.59
74LS95	1.11	74LS283	1.03
74LS96	.86	74LS290	1.25
74LS107	.43	74LS293	1.89
74LS109	.49	74LS295	1.09
74LS112	.48	74LS298	1.24
74LS113	.48	74LS352	1.59
74LS114	.59	74LS353	1.59
74LS122	.55	74LS363	1.39
74LS123	.99	74LS365	.99
74LS134	2.99	74LS366	.99
74LS125	.99	74LS367	.99
74LS126	.88	74LS368	.99
74LS132	.69	74LS373	1.85
74LS136	.58	74LS374	1.81
74LS138	.79	74LS377	1.48
74LS139	.79	74LS385	1.90
74LS145	1.18	74LS386	.65
74LS148	1.39	74LS390	1.90
74LS151	.79	74LS393	1.90
74LS153	.79	74LS395	1.69
74LS154	2.39	74LS670	2.20

SPRING MEMORY SALE

RAMS		100pcs	EPROMS		100pcs		
2101	(450ns)	2.49	2.29	1702	(1 us)	4.95	4.75
2102-1	(450ns)	.99	.95	2708	(450ns)	4.95	4.75
21L02-1	(450ns)	1.29	1.15	2758(5v)	(450ns)	9.95	Call
2111	(450ns)	2.99	2.49	2716(5v)	(450ns)	7.95	6.95
2112	(450ns)	2.99	2.79	2716-1(5v)	(350ns)	12.95	10.95
2114	(450ns)	2.95	2.85	TMS2516	(450ns)	9.95	9.50
2114L-2	(200ns)	8/29.95	3.10	TMS2716	(450ns)	9.95	8.95
2114L-3	(300ns)	8/24.95	2.95	2732	(450ns)	29.95	Call
4027	(250ns)	4.95	3.95	TMS2532	(450ns)	21.95	Call
4116-15	(150ns)	8/21.95	2.65	TMS25L32	(450ns)	29.95	Call
4116-20	(200ns)	8/19.95	2.35	TMS2564	(500ns)	179.95	Call
4116-30	(300ns)	8/18.99	2.29				

NEED YOUR ORDER SHIPPED TODAY?

THEN CALL TOLL FREE

800-538-5000

IN CALIF.

800-662-6233

BEFORE YOU BUY, CALL US. WE WILL BEAT ANYONE'S PRICES

6800

6800	11.75
6810	4.60
6820	5.75
6821	6.40
6828	9.95
6834	19.95
6850	5.75
6852	5.75
6875	6.95

8080

8080A	3.95
8085A	12.95
8212	2.75
8214	5.25
8216	2.75
8224	2.95
8226	3.49
8228	4.95
8238	5.50
8251	6.95
8253	12.95
8255	6.50
8257	16.95
8259	14.95
8275	49.95
8279	15.95

Z80

Z80	9.95
Z80A	12.95
Z80-CTC	7.65
Z80-DMA	18.00
Z80-PIO	7.60
Z80-SIO/2	27.50
Z80-SIO/9	20.50

MISC.

1771-B01	24.95
3242	9.95
AY5-1013	4.99
8T26	2.49
8T28	2.49
8T97	1.69
8T98	1.69

T.V.

CIRCUITS

MC1330	1.89
MC1350	1.29
MC1358	1.79
LM380	1.29
LM565	.99
LM741	.29
LM1310	1.90
LM1800	1.99
LM1889	2.49

7400 SERIES

7400	.19	7450	.19	74123	.59
7402	.19	7472	.29	74151	.69
7404	.24	7473	.34	74153	.59
7406	.29	7474	.35	74154	1.49
7407	.29	7475	.49	74156	.69
7408	.24	7476	.35	74157	.69
7410	.19	7483	.65	74161	.79
7420	.19	7486	.35	74163	.89
7430	.19	7490	.49	74164	.89
7432	.29	7491	.69	74173	1.39
7440	.19	7492	.59	74174	.89
7442	.49	7493	.49	74175	.89
7445	.69	7496	.74	74176	.89
7446	.69	74100	1.19	74192	.79
7447	.59	74107	.34	74193	.79
7448	.69	74121	.34	74196	.79

IC SOCKETS

8 pin ST	10/1.29	8 pin WW	.59
14 pin ST	10/1.29	14 pin WW	.69
16 pin ST	10/1.29	16 pin WW	.89
18 pin ST	10/1.29	18 pin WW	.99
20 pin ST	10/1.29	20 pin WW	1.09
22 pin ST	10/1.29	22 pin WW	1.39
24 pin ST	10/1.29	24 pin WW	1.49
28 pin ST	10/1.29	28 pin WW	1.69
40 pin ST	10/1.29	40 pin WW	1.99

ST = SOLDDERTAIL WW = WIREWRAP

VOLTAGE REG's

7805T	.89	7905T	.99
7812T	.89	7912T	.99
7815T	.99	7915T	1.19
7824T	.99	7924T	1.19
7805K	1.39	7905K	1.49
7812K	1.39	7912K	1.49
78L05	.69	79L05	.79
78L12	.69	79L12	.79
78L15	.69	79L15	.79

TRANSISTORS

2N2222	10/1.00	100/8.99
2N3904	10/1.00	100/8.99
2N3906	10/1.00	100/8.99
2N3055	.79	10/6.99

LEDS

Jumbo Red	10/1.00
Jumbo Green	6/1.00
Jumbo Yellow	6/1.00
5082-7760 .43°C	.79
MAN74 .3CC	.79
MAN72 .3CA	.99

74S00 SERIES

74S00	.50	74S124	3.95	74S283	4.75
74S02	.50	74S174	1.49	74S387	5.75
74S04	.50	74S188	4.75	74S471	18.75
74S08	.50	74S195	1.95	74S472	18.75
74S37	.55	74S240	2.95	74S474	19.95
74S74	.80	74S260	1.80	74S570	7.80
74S113	.79	74S287	4.75	74S571	7.80

CMOS

4001	.35	4024	.99	4070	.49
4002	.39	4025	.29	4071	.49
4007	.25	4027	.65	4072	.49
4009	.49	4040	1.29	4081	.39
4010	.45	4042	.79	4093	.99
4011	.35	4046	.79	4098	2.49
4012	.29	4047	2.49	4503	.69
4013	.49	4049	.49	4508	3.95
4016	.59	4050	.69	74C04	.39
4017	1.19	4060	1.39	74C141.49	
4020	1.19	4066	.79		
4023	.29	4069	.39		

LINEAR

LM301v	.34	LM556	.69	LM1488	1.39
LM308v	.98	LM565	.99	LM1489	1.39
LM309K	1.49	LM566v	1.49	LM1800	1.99
LM311v	.64	LM567v	1.29	LM1889	2.49
LM317t	2.29	LM723	.49	LM3900	.59
LM318v	1.49	LM733	.98	75451v	.39
LM323k	4.95	LM741v	.29	MC1330v	1.89
LM324	.59	LM747	.59	MC1350v	1.29
LM339	.99	LM748v	.59	MC1358	1.79
LM377	2.29	LM1310	1.90		
LM380	1.29	LM1414	1.59		
LM555v	.39	LM1458v	.69		

T = TO-220

V = 8 pin

K = TO-3

DIP SWITCHES

4 position	.99
5 position	1.02
6 position	1.06
7 position	1.09
8 position	1.14

JDR MICRODEVICES, INC.

1101 South Winchester Blvd.

San Jose, California 95128

800-538-5000 408-247-4852

TERMS: Include \$2.00 for shipping. \$10.00 minimum order. Send SASE for complete catalog. Bay Area Residents add 6 1/2% sales tax. Calif. Residents add 6% sales tax. We reserve the right to limit quantities and substitute manufacturer. Prices subject to change without notice. Foreign orders add suff. postage.



7400

SN7400N	.25	SN74155N	.75
SN7401N	.25	SN74157N	.69
SN7402N	.25	SN74160N	.89
SN7403N	.25	SN74161N	.89
SN7404N	.25	SN74162N	.89
SN7405N	.25	SN74163N	.89
SN7406N	.35	SN74164N	.89
SN7407N	.35	SN74165N	.89
SN7408N	.25	SN74166N	1.25
SN7409N	.25	SN74167N	2.75
SN7410N	.25	SN74170N	1.95
SN7411N	.25	SN74172N	4.95
SN7412N	.35	SN74173N	1.39
SN7413N	.40	SN74174N	.99
SN7414N	.69	SN74175N	.89
SN7416N	.25	SN74176N	.79
SN7417N	.25	SN74177N	.79
SN7420N	.25	SN74179N	1.49
SN7421N	.25	SN74180N	.79
SN7422N	.25	SN74181N	2.25
SN7423N	.25	SN74182N	.79
SN7424N	.25	SN74182N	2.49
SN7426N	.25	SN74185N	2.49
SN7427N	.25	SN74187N	1.25
SN7428N	.49	SN74189N	1.95
SN7429N	.25	SN74191N	1.95
SN7430N	.25	SN74192N	.89
SN7432N	.25	SN74193N	.89
SN7437N	.25	SN74194N	.89
SN7438N	.25	SN74195N	.69
SN7439N	.25	SN74196N	.69
SN7440N	.25	SN74197N	.89
SN7441N	.89	SN74198N	1.49
SN7442N	.59	SN74199N	.49
SN7443N	1.10	SN74201N	1.25
SN7444N	1.10	SN74202N	.99
SN7445N	.25	SN74203N	1.49
SN7446N	.25	SN74204N	1.55
SN7447N	.79	SN74205N	.79
SN7448N	.79	SN74206N	1.49
SN7449N	.25	SN74207N	1.95
SN7450N	.25	SN74208N	1.95
SN7451N	.25	SN74209N	1.25
SN7452N	.25	SN74210N	.69
SN7453N	.25	SN74211N	.69
SN7454N	.25	SN74212N	.69
SN7455N	.25	SN74213N	.69
SN7456N	.25	SN74214N	.69
SN7457N	.25	SN74215N	.69
SN7458N	.25	SN74216N	.69
SN7459N	.25	SN74217N	.69
SN7460N	.25	SN74218N	.69
SN7470N	.25	SN74219N	.69

LITRONIX DISPLAY SALE

LIMITED OFFER! WHILE THEY LAST!

DL-4500	DL-4507	DL-2300	DL-4509	DL-6500	DL-3130
DL-4520A	DL-4520B	DLG-2535			
DL-4120A					

MULTI-DIGIT REFLECTOR ARRAYS FOR CLOCKS

PART NUMBER	CHAR. INT.	POLARITY	DESCRIPTION	LIGHT OUTPUT			FORWARD VOLTAGE			CONTROLED FORWARD CURRENT PER CHARACTER	PRICE
				TYPE	MIN.	MAX.	TYPE	MAX.	MAX.		
DL-4800 (H) (H)	50	CC MPX	8 Seg 7 Segment	8	1.0	1.0	1.7	2.0	30	2.49	
DL-4801 (H) (H)	50	CC MPX	8 Seg 7 Segment with Common Anode	8	1.0	1.0	1.7	2.0	30	4.99	
DL-4120A (H) (H)	1.0	CC MPX	1 Seg 3 Digit	1.0	1.0	1.0	1.4	1.0	30	3.99	

DISCRETE LEADS

XC556E .200" green	5/51	MV50 .085" red	6/51	XC111R .190" red	5/51
XC556G .200" green	4/51	XC209R .125" red	5/51	XC111G .190" green	4/51
XC556Y .200" yellow	4/51	XC209G .125" green	4/51	XC111Y .190" yellow	4/51
XC556C .200" clear	4/51	XC209Y .125" yellow	4/51	XC111C .190" clear	4/51
XC22R .200" red	4/51	XC26R .185" red	4/51		
XC22G .200" green	4/51	XC26G .185" green	4/51		
XC22Y .200" yellow	4/51	XC26Y .185" yellow	4/51		
MV10B .170" red	4/51	XC26C .185" clear	4/51		

C.C. - Common Anode C.C. - Common Cathode

DISPLAY LEADS

Type	Polarity	Ht	Price	Type	Polarity	Ht	Price
MAN 1	C.A.-red	270	2.95	DLG507	C.A.-green	500	1.25
MAN 2	5x7 D.O.M.-red	300	4.95	DL704	C.C.-red	300	1.25
MAN 3	C.C.-red	125	2.25	DL707	C.A.-red	300	1.25
MAN 52	C.A.-green	300	1.25	DL728	C.C.-red	500	1.49
MAN 54	C.C.-yellow	300	1.25	DL741	C.C.-red	600	1.25
MAN 71	C.A.-red	300	7.75	DL746	C.A.-red ± 1	630	1.49
MAN 72	C.C.-red	300	7.75	DL747	C.A.-red	600	1.49
MAN 74	C.C.-yellow	300	4.49	DL759	C.C.-red	600	1.49
MAN 80	C.C.-orange	300	9.99	DLG847	C.C.-orange	800	1.49
MAN 3630	C.A.-orange ± 1	300	9.99	OL030	C.C.-orange	800	1.49
MAN 3640	C.C.-orange	300	9.99	OL039	C.C.-red	110	3.5
MAN 6410	C.A.-orange	400	9.99	FND358	C.C. ± 1	357	9.99
MAN 6410	C.A.-orange-DO	560	9.99	FND501	C.C. (FND500)	500	9.99
MAN 6630	C.A.-orange ± 1	560	9.99	FND507	C.C. (FND510)	500	9.99
MAN 6640	C.C.-orange-DO	560	9.99	HDSF3401	C.A.-red	800	1.50
MAN 6650	C.C.-orange ± 1	560	9.99	HDSF3403	C.C.-red	800	1.50
MAN 6550	C.A.-orange	560	9.99	5082-7751	C.A., R.H.D.-red	430	1.25
MAN 6710	C.A.-red-DO	560	9.99	5082-7760	C.A., R.H.D.-red	430	1.75
MAN 6750	C.C.-red ± 1	560	9.99	5082-7302	4x7 961. elg. RHD	600	22.00
MAN 6780	C.C.-red	560	9.99	5082-7304	Overrange char. (± 1)	600	19.95
DLG304	C.C.-orange	300	1.25	41828	Photo Isolator Opto-Isol.	600	9.99
DLG307	C.C.-orange	300	1.25	LIT-1	Photo Isolator Opto-Isol.	600	9.99
DLG500	C.C.-green	500	1.25	MC3010	Optically Isol. Triac Driver	1.25	

74LS

74LS00	.29	74LS132	1.15
74LS01	.29	74LS133	1.15
74LS02	.29	74LS134	1.15
74LS03	.29	74LS135	1.15
74LS04	.29	74LS136	1.15
74LS05	.35	74LS137	1.15
74LS06	.29	74LS138	1.15
74LS07	.29	74LS139	1.15
74LS08	.29	74LS140	1.15
74LS09	.29	74LS141	1.15
74LS10	.29	74LS142	1.15
74LS11	.29	74LS143	1.15
74LS12	.29	74LS144	1.15
74LS13	.29	74LS145	1.15
74LS14	.29	74LS146	1.15
74LS15	.29	74LS147	1.15
74LS16	.29	74LS148	1.15
74LS17	.29	74LS149	1.15
74LS18	.29	74LS150	1.15
74LS19	.29	74LS151	1.15
74LS20	.29	74LS152	1.15
74LS21	.29	74LS153	1.15
74LS22	.29	74LS154	1.15
74LS23	.29	74LS155	1.15
74LS24	.29	74LS156	1.15
74LS25	.29	74LS157	1.15
74LS26	.29	74LS158	1.15
74LS27	.29	74LS159	1.15
74LS28	.29	74LS160	1.15
74LS29	.29	74LS161	1.15
74LS30	.29	74LS162	1.15
74LS31	.29	74LS163	1.15
74LS32	.29	74LS164	1.15
74LS33	.29	74LS165	1.15
74LS34	.29	74LS166	1.15
74LS35	.29	74LS167	1.15
74LS36	.29	74LS168	1.15
74LS37	.29	74LS169	1.15
74LS38	.29	74LS170	1.15
74LS39	.29	74LS171	1.15
74LS40	.29	74LS172	1.15
74LS41	.29	74LS173	1.15
74LS42	.29	74LS174	1.15
74LS43	.29	74LS175	1.15
74LS44	.29	74LS176	1.15
74LS45	.29	74LS177	1.15
74LS46	.29	74LS178	1.15
74LS47	.29	74LS179	1.15
74LS48	.29	74LS180	1.15
74LS49	.29	74LS181	1.15
74LS50	.29	74LS182	1.15

SOCKETS

ZERO INSERTION FORCE

* Nickel Boron Plating
* G.F. PSF Plastic Body
* For Testing IC's

Part No.	Pins	Price	Part No.	Pins	Price	Part No.	Pins	Price	Part No.	Pins	Price
214-3339	14 pin	6.95	222-3343	22 pin	9.95	214-3692	14 pin	9.75	222-3696	22 pin	12.95
214-3340	16 pin	6.49	224-3344	24 pin	9.95	214-3693	16 pin	9.95	224-3697	24 pin	12.75
214-3341	18 pin	6.95	228-3345	28 pin	11.95	214-3694	18 pin	11.95	228-3698	28 pin	13.95
220-3342	20 pin	8.95	240-3346	40 pin	12.95	220-3695	20 pin	11.95	240-3699	40 pin	15.95

SOCKETS RECEPTACLES

Part No.	Pins	Price	Part No.	Pins	Price	Part No.	Pins	Price	Part No.	Pins	Price
LM100CLH	4.50		LM3407-5	1.25		LM309H	1.95		LM3915N	3.95	
LM100C	4.75		LM3407-12	1.25		LM309K	1.25		LM3915P	3.95	
LM100T	4.75		LM3407-15	1.25		LM309L	1.95		LM3915S	3.95	
LM100V	4.75		LM3407-18	1.25		LM309M	1.25		LM3915T	3.95	
LM100W	4.75		LM3407-20	1.25		LM309N	1.95		LM3915U	3.95	
LM100X	4.75		LM3407-25	1.25		LM309P	1.25		LM3915V	3.95	
LM100Y	4.75		LM3407-30	1.25		LM309Q	1.25		LM3915W	3.95	
LM100Z	4.75		LM3407-35	1.25		LM309R	1.25		LM3915X	3.95	
LM100A	4.75		LM3407-40	1.25		LM309S	1.25		LM3915Y	3.95	
LM100B	4.75		LM3407-45	1.25		LM309T	1.25		LM3915Z	3.95	
LM100C	4.75		LM3407-50	1.25		LM309U	1.25		LM3915AA	3.95	
LM100D	4.75		LM3407-55	1.25		LM309V	1.25		LM3915AB	3.95	
LM100E	4.75		LM3407-60	1.25		LM309W	1.25		LM3915AC	3.95	
LM100F	4.75		LM3407-65	1.25		LM309X	1.25		LM3915AD	3.95	
LM100G	4.75		LM3407-70	1.25		LM309Y	1.25		LM3915AE	3.95	
LM100H	4.75		LM3407-75	1.25		LM309Z	1.25		LM3915AF	3.95	
LM100I	4.75		LM3407-80	1.25		LM309AA	1.25		LM3915AG	3.95	
LM100J	4.75		LM3407-85	1.25		LM309AB	1.25		LM3915AH	3.95	
LM100K	4.75		LM3407-90	1.25		LM309AC	1.25		LM3915AI	3.95	
LM100L	4.75		LM3407-95	1.25		LM309AD	1.25		LM3915AJ	3.95	
LM100M	4.75		LM3407-100	1.25		LM309AE	1.25		LM3915AK	3.95	
LM100N	4.75		LM3407-105	1.25		LM309AF	1.25		LM3915AL	3.95	
LM100O	4.75		LM3407-110	1.25		LM309AG	1.25		LM3915AM	3.95	
LM100P	4.75		LM3407-115	1.25		LM309AH	1.25		LM3915AN	3.95	
LM100Q	4.75		LM3407-120	1.25		LM309AJ	1.25		LM3915AO	3.95	
LM100R	4.75		LM3407-125	1.25		LM309AK	1.25		LM3915AP	3.95	
LM100S	4.75		LM3407-130	1.25		LM309AL	1.25		LM3915AQ	3.95	
LM100T	4.75		LM3407-135	1.25							

the SPECIALS continue

Why pay more... we stock the right parts at the right price.

PRICE CRASH:

EIGHT 16K DYNAMIC RAMS FOR \$24.50!!

Volume buying does it again! These are top quality, high speed, low power RAMs suitable for expanding memory in TRS-80[®] I/II/III and Color Computers, Heath H89, Apple, newer PETS, etc. Backed by one year limited warranty. Add \$3 for two dip shunts and conversion instructions for TRS-80[®] I.

TR-80 is a trademark of the Tandy Corporation

SOLDERTAIL SOCKETS

... get 'em while you can!
 8 pin 100/\$5.95
 14, 16 & 18 pin 50/\$4.95
 20 pin 40/\$4.95
 24, 28 pin 30/\$4.95
 40 pin 20/\$4.95

LINEARS

(package type: H = TO99, M = minidip, D = dip, TK = TO66)
 201H-S Improved 301 op amp 10/\$2
 308H-S Micropower op amp 6/\$2
 703H-S RF/IF amp 6/\$2
 723D-S Voltage regulator 6/\$2
 741M-S Compensated op amp 15/\$2
 1458M-S Dual 741 10/\$2
 4195TK-S Dual track 15V reg w/ data 2/\$2

1000 uF 35V axial capacitor 10/\$2.00
 10,000 uF 10V axial capacitor 5/\$2.00
 S-100 card edge connectors 10/\$29.50
 Resistor asst. (cut & bent leads) 1000/\$5
 10/\$9.90
 50/\$2

MISCELLANEOUS SPECIALS

2102 low power 1K static RAM
 General purpose silicon signal diodes
 GT5306 NPN darlington, min gain 17000, 25V 200 mA, TO92 package 100/\$8.95
 NPN transistor similar 2N3904 100/\$7.95
 PNP transistor similar 2N3906 100/\$8.95
 4N28 opto-coupler 6 pin minidip, MCT-2/IL-1 pinout 5/\$2
 SN76477 complex sound generator 1/\$2.50
 New low price! MA1003 12V DC clock module: \$10.95, matching case \$3.95
 RCA phono jacks - these are super quality, closed circuit jacks that are the best we've seen in years. American made. 20/\$1.95
 Opto-isolator Grab Bag - 50 mixed opto-isolators from a major manufacturer. Unmarked 6 and 8 lead minidips include single and dual types with diode, transistor, and darlington outputs. Test them yourself and save! Not recommended for beginners. 50/\$4

CMOS

4012-S Dual 4 input NAND 12/\$2
 4020-S 14 stage counter 4/\$2
 4023-S Triple 3 Input NAND 12/\$2
 4044-S Quad R-S latch 4/\$2
 4046-S Phase locked loop 2/\$2
 4071-S Quad 2 input OR 12/\$2
 4093-S Quad 2 in NAND Schmitt trig 4/\$2
 4507-S Quad EX-OR 4/\$2
 4510-S BCD up/down counter 2/\$2
 4511-S BCD to 7 seg decode/drvr 3/\$2
 4512-S 8 channel data selector 4/\$2
 5101-S CMOS 1K low power memory 10/\$17.50

DC ROBOT MOTOR

DC fractional HP motor runs on 1 to 5V. Good for experimenting with robots, toys, games, etc. 10/\$2.95

TO-220 NEGATIVE VOLTAGE REGULATORS

7906 -6V regulator 2/\$2
 7908 -8V regulator 2/\$2
 7912 -12V regulator 2/\$2
 79M15 -15V regulator 2/\$2
 7918 -18V regulator 2/\$2
 7924 -24V regulator 2/\$2

TERMS: Cat res add tax. Allow 5% shipping excess refunded. Orders under \$15 add \$2 handling. VISA and Mastercard orders for 16K RAMs only call (415) 562-0638, 24 hrs. Include street address for UPS. Prices subject to change without notice; limited quantity on most items.

FREE CATALOGUE: Find out more about our exceptional product line. For 1st class delivery, add 41 cents in stamps; foreign orders add \$2 (refundable with order).

GODBOUN

ELECTRONICS

BOX 2355, OAKLAND AIRPORT, CA 94614

CIRCLE NO. 23 ON FREE INFORMATION CARD

HAND HELD GAME BOARD SPECIALS

These are the complete functional circuit boards from popular hand held games — no case or batteries supplied.

Computer Perfect

Has 10 LEDs and tone signals. You try to guess correct button sequence to light LEDs in order. Requires two 9V batteries. With instructions. C24404 \$4.50



Computer Mind

You guess the secret number stored in computer chip memory. Has 10 LEDs and keyboard. Requires one 9V battery. With instructions. C24405 \$3.75



Starsound Board

Unique board uses IC circuitry and gravity switch to produce space engine sounds. Point the board downwards and it produces "idle" sounds. Point upwards and the sound increases in pulsating frequency to produce "Blastoff" sounds. Originally had LED circuitry but this has been removed. Sound portion is 100% perfect. Requires 9V battery and speaker. C24406 \$2.50
 2" Speaker for above. C24311 99¢



120 VAC Xenon Strobe Kit

Complete variable rate strobe light kit. Contains all parts, PC board, line cord and instructions. C23071 \$7.50



Super LED Flasher Kit

Great for Robot projects this simple to build kit uses IC circuitry to randomly flash 4 LEDs: 2 red, 1 yellow, 1 green. Complete with all parts, PC board and instructions. Size: 2" x 2". Operates on 9VDC. C24407 \$4.98

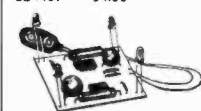

CHANEY electronics inc.

P.O. BOX 27038 DENVER, COLORADO 80227

Phone Orders 303-781-5750

• Minimum AD Order \$6.00
 • Please include \$1.50 for postage
 • VISA MC accepted
 • Phone orders are welcome

Send for our free catalog of unique items

CIRCLE NO. 10 ON FREE INFORMATION CARD

Quest

ELECTRONICS

P.O. Box 4430C Santa Clara, CA 95054

Will calls: 2322 Walsh Ave. (408) 988-1640 TWX 910-338-2139

Same day shipment. First line parts only. Factory tested. Guaranteed money back. Quality IC's and other components at factory prices.

INTEGRATED CIRCUITS

74LS00 TTL	MOS MEMORY RAM	PRGM	MICROPROCESSOR	IC SOCKETS	DISPLAY LEADS
74LS00 29 2101-1 3.85 1702A 4.95 6502 10.95	29 2102-1 3.95 2708 5.10 6504 9.95	29 2102A-4 1.45 2745F 18.00 6502 9.95	8 75 22 30 6.95 14 12 24 35 11.95	12 28 32 18 27 36 58 5.95 20 29 40 57 5.95	CA 270 2.90 CC 129 3.90 CA 300 1.98 CA 300 1.25 CA 300 1.50 CA 300 1.50 CA 300 1.95 CA 300 1.95 CA 300 1.35 CA 300 3.90 CA 300 2.20 CA 300 6.0 CA 300 9.50 CA 300 2.20
74LS02 35 2102A-4 1.45 2745F 18.00 6502 9.95	35 2102A-4 1.45 2745F 18.00 6502 9.95	35 2102A-4 1.45 2745F 18.00 6502 9.95	18 27 36 58 5.95 20 29 40 57 5.95	18 27 36 58 5.95 20 29 40 57 5.95	CA 270 2.90 CC 129 3.90 CA 300 1.98 CA 300 1.25 CA 300 1.50 CA 300 1.50 CA 300 1.95 CA 300 1.95 CA 300 1.35 CA 300 3.90 CA 300 2.20 CA 300 6.0 CA 300 9.50 CA 300 2.20
74LS04 14 2102A-4 1.45 2745F 18.00 6502 9.95	14 2102A-4 1.45 2745F 18.00 6502 9.95	14 2102A-4 1.45 2745F 18.00 6502 9.95	18 27 36 58 5.95 20 29 40 57 5.95	18 27 36 58 5.95 20 29 40 57 5.95	CA 270 2.90 CC 129 3.90 CA 300 1.98 CA 300 1.25 CA 300 1.50 CA 300 1.50 CA 300 1.95 CA 300 1.95 CA 300 1.35 CA 300 3.90 CA 300 2.20 CA 300 6.0 CA 300 9.50 CA 300 2.20
74LS08 35 2102A-4 1.45 2745F 18.00 6502 9.95	35 2102A-4 1.45 2745F 18.00 6502 9.95	35 2102A-4 1.45 2745F 18.00 6502 9.95	18 27 36 58 5.95 20 29 40 57 5.95	18 27 36 58 5.95 20 29 40 57 5.95	CA 270 2.90 CC 129 3.90 CA 300 1.98 CA 300 1.25 CA 300 1.50 CA 300 1.50 CA 300 1.95 CA 300 1.95 CA 300 1.35 CA 300 3.90 CA 300 2.20 CA 300 6.0 CA 300 9.50 CA 300 2.20
74LS10 35 2102A-4 1.45 2745F 18.00 6502 9.95	35 2102A-4 1.45 2745F 18.00 6502 9.95	35 2102A-4 1.45 2745F 18.00 6502 9.95	18 27 36 58 5.95 20 29 40 57 5.95	18 27 36 58 5.95 20 29 40 57 5.95	CA 270 2.90 CC 129 3.90 CA 300 1.98 CA 300 1.25 CA 300 1.50 CA 300 1.50 CA 300 1.95 CA 300 1.95 CA 300 1.35 CA 300 3.90 CA 300 2.20 CA 300 6.0 CA 300 9.50 CA 300 2.20
74LS13 55 2111-1 3.75 2758 19.50 6850 3.95	55 2111-1 3.75 2758 19.50 6850 3.95	55 2111-1 3.75 2758 19.50 6850 3.95	18 27 36 58 5.95 20 29 40 57 5.95	18 27 36 58 5.95 20 29 40 57 5.95	CA 270 2.90 CC 129 3.90 CA 300 1.98 CA 300 1.25 CA 300 1.50 CA 300 1.50 CA 300 1.95 CA 300 1.95 CA 300 1.35 CA 300 3.90 CA 300 2.20 CA 300 6.0 CA 300 9.50 CA 300 2.20
74LS14 14 2112-1 3.95 2741A 3.95 2741A 3.95	14 2112-1 3.95 2741A 3.95 2741A 3.95	14 2112-1 3.95 2741A 3.95 2741A 3.95	18 27 36 58 5.95 20 29 40 57 5.95	18 27 36 58 5.95 20 29 40 57 5.95	CA 270 2.90 CC 129 3.90 CA 300 1.98 CA 300 1.25 CA 300 1.50 CA 300 1.50 CA 300 1.95 CA 300 1.95 CA 300 1.35 CA 300 3.90 CA 300 2.20 CA 300 6.0 CA 300 9.50 CA 300 2.20
74LS20 35 2114 3.75 2748 55.00 8085 12.95	35 2114 3.75 2748 55.00 8085 12.95	35 2114 3.75 2748 55.00 8085 12.95	18 27 36 58 5.95 20 29 40 57 5.95	18 27 36 58 5.95 20 29 40 57 5.95	CA 270 2.90 CC 129 3.90 CA 300 1.98 CA 300 1.25 CA 300 1.50 CA 300 1.50 CA 300 1.95 CA 300 1.95 CA 300 1.35 CA 300 3.90 CA 300 2.20 CA 300 6.0 CA 300 9.50 CA 300 2.20
74LS22 35 2114 300ns 4.25 2748-B 55.00 8086 9.95	35 2114 300ns 4.25 2748-B 55.00 8086 9.95	35 2114 300ns 4.25 2748-B 55.00 8086 9.95	18 27 36 58 5.95 20 29 40 57 5.95	18 27 36 58 5.95 20 29 40 57 5.95	CA 270 2.90 CC 129 3.90 CA 300 1.98 CA 300 1.25 CA 300 1.50 CA 300 1.50 CA 300 1.95 CA 300 1.95 CA 300 1.35 CA 300 3.90 CA 300 2.20 CA 300 6.0 CA 300 9.50 CA 300 2.20
74LS24 50 2116 3.95 2750A 35.00 280 9.95	50 2116 3.95 2750A 35.00 280 9.95	50 2116 3.95 2750A 35.00 280 9.95	18 27 36 58 5.95 20 29 40 57 5.95	18 27 36 58 5.95 20 29 40 57 5.95	CA 270 2.90 CC 129 3.90 CA 300 1.98 CA 300 1.25 CA 300 1.50 CA 300 1.50 CA 300 1.95 CA 300 1.95 CA 300 1.35 CA 300 3.90 CA 300 2.20 CA 300 6.0 CA 300 9.50 CA 300 2.20
74LS28 60 2116 200ns 26.95 2825 4.75 8212 2.90	60 2116 200ns 26.95 2825 4.75 8212 2.90	60 2116 200ns 26.95 2825 4.75 8212 2.90	18 27 36 58 5.95 20 29 40 57 5.95	18 27 36 58 5.95 20 29 40 57 5.95	CA 270 2.90 CC 129 3.90 CA 300 1.98 CA 300 1.25 CA 300 1.50 CA 300 1.50 CA 300 1.95 CA 300 1.95 CA 300 1.35 CA 300 3.90 CA 300 2.20 CA 300 6.0 CA 300 9.50 CA 300 2.20
74LS30 60 2116 200ns 26.95 2825 4.75 8212 2.90	60 2116 200ns 26.95 2825 4.75 8212 2.90	60 2116 200ns 26.95 2825 4.75 8212 2.90	18 27 36 58 5.95 20 29 40 57 5.95	18 27 36 58 5.95 20 29 40 57 5.95	CA 270 2.90 CC 129 3.90 CA 300 1.98 CA 300 1.25 CA 300 1.50 CA 300 1.50 CA 300 1.95 CA 300 1.95 CA 300 1.35 CA 300 3.90 CA 300 2.20 CA 300 6.0 CA 300 9.50 CA 300 2.20
74LS32 60 2116 200ns 26.95 2825 4.75 8212 2.90	60 2116 200ns 26.95 2825 4.75 8212 2.90	60 2116 200ns 26.95 2825 4.75 8212 2.90	18 27 36 58 5.95 20 29 40 57 5.95	18 27 36 58 5.95 20 29 40 57 5.95	CA 270 2.90 CC 129 3.90 CA 300 1.98 CA 300 1.25 CA 300 1.50 CA 300 1.50 CA 300 1.95 CA 300 1.95 CA 300 1.35 CA 300 3.90 CA 300 2.20 CA 300 6.0 CA 300 9.50 CA 300 2.20
74LS33 60 2116 200ns 26.95 2825 4.75 8212 2.90	60 2116 200ns 26.95 2825 4.75 8212 2.90	60 2116 200ns 26.95 2825 4.75 8212 2.90	18 27 36 58 5.95 20 29 40 57 5.95	18 27 36 58 5.95 20 29 40 57 5.95	CA 270 2.90 CC 129 3.90 CA 300 1.98 CA 300 1.25 CA 300 1.50 CA 300 1.50 CA 300 1.95 CA 300 1.95 CA 300 1.35 CA 300 3.90 CA 300 2.20 CA 300 6.0 CA 300 9.50 CA 300 2.20
74LS34 45 2116 200ns 26.95 2825 4.75 8212 2.90	45 2116 200ns 26.95 2825 4.75 8212 2.90	45 2116 200ns 26.95 2825 4.75 8212 2.90	18 27 36 58 5.95 20 29 40 57 5.95	18 27 36 58 5.95 20 29 40 57 5.95	CA 270 2.90 CC 129 3.90 CA 300 1.98 CA 300 1.25 CA 300 1.50 CA 300 1.50 CA 300 1.95 CA 300 1.95 CA 300 1.35 CA 300 3.90 CA 300 2.20 CA 300 6.0 CA 300 9.50 CA 300 2.20
74LS37 60 2116 200ns 26.95 2825 4.75 8212 2.90	60 2116 200ns 26.95 2825 4.75 8212 2.90	60 2116 200ns 26.95 2825 4.75 8212 2.90	18 27 36 58 5.95 20 29 40 57 5.95	18 27 36 58 5.95 20 29 40 57 5.95	CA 270 2.90 CC 129 3.90 CA 300 1.98 CA 300 1.25 CA 300 1.50 CA 300 1.50 CA 300 1.95 CA 300 1.95 CA 300 1.35 CA 300 3.90 CA 300 2.20 CA 300 6.0 CA 300 9.50 CA 300 2.20
74LS38 75 2116 200ns 26.95 2825 4.75 8212 2.90	75 2116 200ns 26.95 2825 4.75 8212 2.90	75 2116 200ns 26.95 2825 4.75 8212 2.90	18 27 36 58 5.95 20 29 40 57 5.95	18 27 36 58 5.95 20 29 40 57 5.95	CA 270 2.90 CC 129 3.90 CA 300 1.98 CA 300 1.25 CA 300 1.50 CA 300 1.50 CA 300 1.95 CA 300 1.95 CA 300 1.35 CA 300 3.90 CA 300 2.20 CA 300 6.0 CA 300 9.50 CA 300 2.20
74LS42 14 2116 200ns 26.95 2825 4.75 8212 2.90	14 2116 200ns 26.95 2825 4.75 8212 2.90	14 2116 200ns 26.95 2825 4.75 8212 2.90	18 27 36 58 5.95 20 29 40 57 5.95	18 27 36 58 5.95 20 29 40 57 5.95	CA 270 2.90 CC 129 3.90 CA 300 1.98 CA 300 1.25 CA 300 1.50 CA 300 1.50 CA 300 1.95 CA 300 1.95 CA 300 1.35 CA 300 3.90 CA 300 2.20 CA 300 6.0 CA 300 9.50 CA 300 2.20
74LS47 14 2116 200ns 26.95 2825 4.75 8212 2.90	14 2116 200ns 26.95 2825 4.75 8212 2.90	14 2116 200ns 26.95 2825 4.75 8212 2.90	18 27 36 58 5.95 20 29 40 57 5.95	18 27 36 58 5.95 20 29 40 57 5.95	CA 270 2.90 CC 129 3.90 CA 300 1.98 CA 300 1.25 CA 300 1.50 CA 300 1.50 CA 300 1.95 CA 300 1.95 CA 300 1.35 CA 300 3.90 CA 300 2.20 CA 300 6.0 CA 300 9.50 CA 300 2.20
74LS48 14 2116 200ns 26.95 2825 4.75 8212 2.90	14 2116 200ns 26.95 2825 4.75 8212 2.90	14 2116 200ns 26.95 2825 4.75 8212 2.90	18 27 36 58 5.95 20 29 40 57 5.95	18 27 36 58 5.95 20 29 40 57 5.95	CA 270 2.90 CC 129 3.90 CA 300 1.98 CA 300 1.25 CA 300 1.50 CA 300 1.50 CA 300 1.95 CA 300 1.95 CA 300 1.35 CA 300 3.90 CA 300 2.20 CA 300 6.0 CA 300 9.50 CA 300 2.20
74LS49 14 2116 200ns 26.95 2825 4.75 8212 2.90	14 2116 200ns 26.95 2825 4.75 8212 2.90	14 2116 200ns 26.95 2825 4.75 8212 2.90	18 27 36 58 5.95 20 29 40 57 5.95	18 27 36 58 5.95 20 29 40 57 5.95	CA 270 2.90 CC 129 3.90 CA 300 1.98 CA 300 1.25 CA 300 1.50 CA 300 1.50 CA 300 1.95 CA 300 1.95 CA 300 1.35 CA 300 3.90 CA 300 2.20 CA 300 6.0 CA 300 9.50 CA 300 2.20
74LS50 14 2116 200ns 26.95 2825 4.75 8212					

THE MICROCOMPUTER MART

COMPUTER RETAIL STORES

MICROCOMPUTER MART RATE: 1" x 1 Column (1-5/8") \$150. 1-1/2" x 1 Column (1-5/8") \$225.00. 2" x 1 Column (1-5/8") \$300.00. **GENERAL INFORMATION:** Frequency rates available. Payment must accompany copy except credit card—Am. Ex., Diners, MC, VISA (supply Expiration date)—or accredited ad agency insertions. Orders are not acknowledged. They will appear in next available issue after receipt. Closing date: 1st of the 2nd month preceding cover date (for example, April issue closes February 1st). Send order and remittance to MicroComputerMart, POPULAR ELECTRONICS, One Park Avenue, New York, NY 10016. Direct inquiries to (212) 725-3485.

CALIFORNIA

OHIO SCIENTIFIC MICRO-COMPUTERS

A.A. Office
Equipment Company
2140 American Avenue
Hayward, CA 94545
(415) 782-6110

The Original
ByteShop
1415 W. El Camino Real
Mountain View, CA 94040
(415) 969-5464

OVER 4000
Microcomputer parts, boards,
peripherals, systems,
and software
IN STOCK
Send for your free 1981 catalog
JADE
Computer Products
4901 West Rosecrans Ave.
Hawthorne, California 90250
(213) 973-7707
(800) 421-5500

ILLINOIS

FARNSWORTH COMPUTER
Apple, Hewlett-Packard
I.D.S. Printers
Monthly Specials
1891 N. Farnsworth Ave.
Aurora, IL 60505. (312) 851-3888

TEXAS

TEXAS COMPUTER SYSTEMS
Radio Shack
Authorized Sales Center, OFFERS
LOWEST PRICES on
TRS-80
COMPUTERS
Call TOLL FREE for the BEST PRICES on all
Radio Shack® Computers and accessories
* FREE SHIPPING on most items
* No out of state sales tax charged
NEW—Percom **DOUBLE DENSITY** for Model I. Twice the disk
space. Easy to install, no modifications. Copies single density to
DOUBLE DENSITY to convert existing software. Less than \$200.
TOLL FREE 800-351-1473
Texas Residents 915-557-0673
TEXAS COMPUTER SYSTEMS
106 E. 10th, Brady, Tx. 76825
Radio Shack® Author and Sales Center (751)
195 SP-1, a registered trademark of Radio Shack

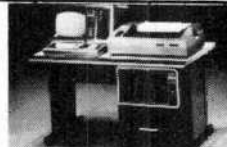

As a Radio Shack® Authorized
Sales Center owned & operated
by Pan American Electronics, Inc.,
we can sell them for less. *No taxes*
collected on out-of-state ship-
ments. *We pay shipping & insur-*
ance
TOLL FREE 800/531-7466
Texas & Main No.
512/581-2765
1117 Conway
Mission, Texas 78572

NEW HAMPSHIRE

As advertised in 73 Amateur Radio,
80 Microcomputing &
Kilobaud Microcomputing magazines
TRS-80 Model II 64K
FREE CATALOG \$3400⁰⁰ plus frt.
ADAMS MAIL ORDER MICROS
Dept. PB, 603-924-3041
P.O. Box 427, Marlboro, N.H. 03455

WISCONSIN

OHIO SCIENTIFIC SYSTEMS
We'll Beat Any Price!
We also carry Apple Computers
Write or call for prices
TOLL FREE 1-(800) 558-4237
COMPUTERS PLUS INC.,
2749 South 108th St.
Milwaukee, WI 53227
(414) 321-1770

COMPUTER RETAILERS
Increase Your Sales Responses!!!
Your computer store ad in
THE MICROCOMPUTER MART
will enable you to reach
POPULAR ELECTRONICS'
Electronics Activist audience
. . . an audience that utilizes
microcomputer equipment
for business AND personal
purposes.
For further details, call
(212) 725-3485.

DON'T MISS
MICROCOMPUTING
— the encyclopedia of microcomputing
and **80 microcomputing**
— for the users of the TRS-80®
For subscription information write to:
Microcomputing, 88 Pine Street, Portsmouth, N.H. 03801
Attn: Dore
*This is a member of the Radio Shack Division of TSC Corporation

MASSACHUSETTS



THIS is only one of hundreds of unusual values . . .
Get your **FREE CATALOG** today!
245A Great Road Littleton, MA 01460
Model 111 16 K • \$859
TOLL FREE 1-800-343-8124
computer plus

RHODE ISLAND

WHOLESALE COMPUTER PRICES DIRECT TO THE PUBLIC!
Apple • Atari • HP-85 • Intertec • Soroc • TRS-80II • NEC Spinwriter
CALL TOLL FREE 1-800-556-7586
OMEGA Sales Co. 12 Meeting St. Cumberland, RI (401) 722-1027

Globe Scout 680A transmitter. Need manual and schematic. Dr. Alvin J. Bernard, Box 14576, Orlando, FL 32807.

Measurements model 188 and 210A FM signal generators. Need service manuals and schematics. John E. Anderson, 2356 Fowler St., Bellmore, NY 11710.

Baldwin model C3 amplifier. Need schematic. Bryan Berkebile, 8 River Road, Amherst, NH 03031.

Hallcrafters model S-108 shortwave receiver. Need schematic and inspection manual. G. Foy, 413 N. Argonne Ave., Sterling, VA 22170.

Eapey R-366/TRR-5 receiver. Need operations manual. Dave Day, 27 11 Beech, Bakersfield, CA 93301.

Radio Engineering Laboratory model REL R-104 receiver. Need schematic. A. Harquell, 1915 Lead S.E., Albuquerque, NM 87106.

Melnsner model 8C FM tuner. Need schematic. Bill Meehan, 38 Leland Road, Rochester, NY 14617.

Heathkit model IM-38 VTVM. Need operating manual and schematic. Carl P. Caemmerer, 2309 Holland Ave., #1J, Bronx, NY 10467.

Mercury 1000 tube tester. Need most recent tube data charts. Steve Borsner, 141 Dover Road, Millis, MA 02054.

Roberts tape recorder model 90. Need owner's and service manual. R. Stanich, 173 Columbia Heights, Brooklyn, NY 11201.

Precision E200 signal generator, Zenith 8G005 transoceanic clipper, and RCA AR88 receiver. Need owner's manuals. W. O'Connell, 802 15th Avenue So., St. Petersburg, FL 33701.

Commercial Trades Institute model VT20, serial MCB 231769001 voltmeter. Need schematic. Mary V. Saunders, 304 4th Ave., Jerome, ID 83338.

Xetex model OS-15A oscilloscope. Need schematic, parts list or manual. Walter S. Jackson, 281 Irish Road, Berwyn, PA 19312.

OPERATION ASSIST

Jackson Electrical Instruments Co., model 800 bar generator. Need operation manual and schematic. Albert J. Pryor, 1007 Camellia Dr., Alameda, CA 94501.

Hammarlund HQ-129-X shortwave receiver. Need schematic, parts list and instruction and service manuals. John G. Megna, 7825 S.W. 148th St., Miami, FL 33158.

Philco model 7100 color bar and dot generator. Need schematic and operating manual. W.H. Whittier, 1251 Hillcrest Avenue So., Clearwater, FL 33518.

Electronics Classified

CLASSIFIED RATES: Per Word, 15 Word Minimum. **COMMERCIAL:** \$3.00. **EXPAND-AD*:** \$4.50. **DISPLAY:** 1" x 2 1/4", \$370.00. 2" x 2 1/4", \$740.00. 3" x 2 1/4", \$1,110.00. **GENERAL INFORMATION:** Frequency rates and prepayment discounts available. Payment must accompany order except credit card—Am. Ex., Diners, MC, VISA (include exp. date)—or accredited ad agency insertions. Copy subject to publisher's approval; must be typewritten or printed. First word set in caps. Advertisers using P.O. Boxes MUST supply permanent address and telephone number. Orders not acknowledged. They will appear in next available issue after receipt. Closing date: 1st of the 2nd month preceding cover date (e.g., Mar. issue closes Jan. 1). Send order & remittance to: Classified Advertising, Popular Electronics Magazine, 1 Park Avenue, New York, NY 10016. Direct inquiries to Rose Lynch (212) 725-7686.

FOR SALE

FREE! Bargain Catalog—I.C.'s, LED's, readouts, fiber optics, calculators parts & kits, semiconductors, parts. Poly Paks, Box 942PE, Lynnfield, Mass. 01940.

GOVERNMENT and industrial surplus receivers, transmitters, snooperscopes, electronic parts. Picture Catalog 25 cents. Meshna, Nahant, Mass. 01908.

ELECTRONIC PARTS, semiconductors, kits. **FREE FLYER.** Large catalog \$1.00 deposit. **BIGELOW ELECTRONICS,** Bluffton, Ohio 45817.

RADIO—T.V. Tubes— 49 cents each. Send for free catalog. Cornell, 4213 University, San Diego, Calif. 92105.

SOUND SYNTHESIZER KITS — Surf \$16.95, Wind \$16.95, Wind Chimes \$22.95, Musical Accessories, many more. Catalog free. PAIA Electronics, Box J14359, Oklahoma City, OK 73114.

TELETYPE EQUIPMENT: Copy Military, Press. Weather, Amateur, Commercial Transmissions. Catalog \$1.00. **WEATHER MAP RECORDERS:** Copy Satellite Photographs, National-Local Weather Maps. Learn How! \$1.00. Atlantic Sales, 3730 Nautilus Ave., Brooklyn, NY 11224. Phone: (212) 372-0349.

BUILD AND SAVE TELEPHONES, TELEVISION, DETECTIVE, BROADCAST Electronics. We sell construction plans with an Engineering Service. Speakerphones, Answering Machines, Carphones, Phonevision, Dialers, Color TV Converters, VTR, Games, \$25 TV Camera, Electron Microscope, Special Effects Generator, Time Base Corrector, Chroma Key, Engineering Courses in Telephone, Integrated Circuits, Detective Electronics. **PLUS MUCH MORE.** NEW Super Hobby Catalog PLUS year's subscription to Electronic News Letter, \$1.00. Don Britton Enterprises, 6200 Wilshire Blvd., Los Angeles, Calif. 90048.

UNSCRAMBLERS FOR any scanner. Several models available. Free literature. Capri Electronics, 8753T Windom, St. Louis, MO 63114.

UNSCRAMBLERS, seven models available to decode police, ambulance, and fire coded transmissions. Other scanner devices, Tone encoders/decoders, Telephone accessories, etc. Free Catalog. **KRYSTAL KITS,** Box 445, Bentonville, AR 72712. (501) 273-5340.

POLICE/FIRE SCANNERS, crystals, antennas, CBs, Radar Detectors. HPR, Box 19224, Denver, CO 80219.

PRINTED CIRCUIT supplies, chemicals, tools, artwork, plating solutions. Major credit cards. Catalog \$2.00, refundable. **CIRCOCLEX,** Box 198, Marcy, NY 13403.

RECONDITIONED TEST EQUIPMENT \$1.00 for catalog. **WALTER'S TEST EQUIPMENT,** 2697 Nickel, San Pablo, CA 94806, (415) 758-1050.

Buy Gov't Surplus SAVE To 85% SURPLUS CENTER Box 82209-PE Lincoln, Nebraska Zip Code 68501

Send 60c For Big Bargain Catalog

1000's Of Bargains; Surplus, Excess Inventory, Brand Name New Equipment

COMPRESSORS • WINCHES • GEAR MOTORS
TELEPHONES • WELDERS • POWER PLANTS
SURVEYING INSTRUMENTS • ELECTRONICS
FIRE/BURGALAR ALARMS • PARIQ GUNS
TARPS • BINOCULARS • TOOL BOXES
HYDRAULICS • AIR TOOLS • PUMPS



CABLE TV DESCRAMBLERS AND CONVERTERS, MICROWAVE ANTENNAS AND DOWN CONVERTERS. Plans and parts. Build or buy. For information send \$2.00. C&D Company, P.O. Box 21, Jenison, MI 49428.

FIBER OPTIC SPECIALS — 100 foot spool of fiber \$3.00—Experimenter's kit \$6.00—High Power LED with matched Detector \$10.00—Data Link construction plans (detailed) \$5.00. Catalog with samples \$1.00. **FIBERTRONICS,** Box 322-A, Primos, PA 19018.

NEW ELECTRONIC PARTS. Continuously stocked. Stamp brings catalog. Daytapro Electronics, 3029 N. Wilshire Ln., Arlington Hts., IL 60004.

ELECTRONIC CATALOG. Over 4,500 items. Parts, & components. Everything needed by the hobbyist or technician. \$2.00 (U.S. funds) \$4.00 Foreign Postage & handling, refundable with first \$15.00 order. T & M Electronics, 472 East Main St., Patchogue, NY 11772. (516) 289-2520.

SPEAKERS SAVE 50%. Build your own speaker system. Write: McGee Radio Electronics, 1901 McGee Street, Kansas City, Missouri 64108.

PRINTED CIRCUIT BOARDS, your artwork. Quick delivery. Reasonable. Atlas Circuits, Box 974, Waynesville, NC 28786. (704) 456-3739.

HAMS, CBERS, SWLS, ELECTRONICS BUFFS! Parts, kits and plans now available for Popular Electronics projects. **MORSE-A-WORD:** Circuit boards \$24.00; Essential parts kit \$99.95; Complete four character kit \$149.95; Eight character kit \$169.95; Wired \$249.95. **RTTY READER:** Boards \$24.00; Complete kit \$189.95; Wired \$269.95, S&H \$5.00 kits; \$1.50 boards. Use VISA/Mastercard. (414) 241-8144. Write for catalog. **MICROCRAFT,** POB 513PE, Thiensville, WI 53092.

SCRAMBLED TELEVISION— Encoding/Decoding. New publication. Complete theory, circuits. \$9.95. Workshop, Box 393PEG, Bethpage, NY 11714.

RARE OUT-OF-PRINT ALBUMS. 25,000 in stock (FS). List \$2.00 refundable. Record Warehouse, Box 4617, Dept. PE, Rochester, NY 14613.

Telephone Listening Device

Record telephone conversations in your office or home. Connects between any cassette or tape recorder and your telephone or telephone LINE. Starts automatically when phone is answered. Records both sides of phone conversation. Stops recorder when phone is hung up. This device is not an answering service.



Size 1 1/2" x 1 1/2"

Each \$18.95

Qty Disc Avail



Size 2 1/2" x 1 1/2"

Super Powerful Wireless Mic

10 times more powerful than other mics. Transmits up to 1/4 mile to any FM radio. Easy to assemble kit. 15V battery (not incl.)

Call (305) 725-1000 or send \$18.95 + \$1.00 shipping per item to USI Corp., P.O. Box PE-2052, Melbourne, FL 32901. COD's accept. For catalog of transmitters, voice scramblers and other specialty items, enclose \$2.00 to USI Corp.

CHEMICALS, Apparatus, Project Books, Wide Selection. Catalog send \$1.00 to Pioneer Corp., 14a Hughey Street, Nashua, NH 03060.

TEST EQUIPMENT, new and used. Catalog \$1.00. PTI, Box 8756; White Bear Lake, MN 55110.

QUALITY AUDIO COMPONENTS, Multi-Track Equipment, Programmable Calculators, Accessories. Competitive Pricing! Prompt Delivery! Knowledgeable staff! Service Facility! Credit Cards accepted. **FREE catalog, SOUND IDEAS,** Dept. SR, PO Box 340, Cary, N.C. 27511. 1-800-334-2483 (N.C. 919-467-8462).

SATELLITE TELEVISION INFORMATION — Build or buy your own Earth Station. U.S.: \$4.00 Satellite Television, RD 3, Oxford, NY 13830.

\$9.95



Digits 6.1mm
Dia. 30mm

LCD DIGITAL CLOCK CALENDAR

Alternating date and time. Great for cars, boats, airplanes. Long life battery. 4 year calendar. One year guarantee. Magnetic pieces for mounting. Other modules and products available.

Suite E-428, Fifth Avenue
LCD, Scottsdale, AZ 85253

BUILDING A ROBOT? Using stepper motors? **SASE:** Sparky Electronics, 64-62 Dry Harbor Rd., Middle Village, NY 11379.

ELECTRO-VOICE Hi Fi component loudspeakers. Building your own Speaker System? Use the best Free discount catalog. **SONIX,** Dept. PE, Box 58, Indian Head, MD 20640. (301) 753-6432.

UNSCRAMBLE CODED MESSAGES from police, fire and medical channels. Also telephone recording adaptor. Same day service. Satisfaction guaranteed. **Don Nobles Electronics, Inc.** Rt. 7, Box 610-A, Hot Springs, AR 71901. (501) 623-6027.

SATELLITE TELEVISION . . . HOWARD/COLEMAN boards to build your own receiver. For more information write . . . **ROBERT COLEMAN,** Rt. 3, Box 58-APE, Travelers Rest, S.C. 29690.

REMULATOR (LM 1889)-audio & video inputs - output R.F. switched for T.V. channel 3 or 4 \$29.00. UHF and MICROWAVE units connect to T.V. antenna for commercial free movies at home \$300.00. These are not kits. **VIDEO GALLERY INC.,** 2270 Wyandotte W., Windsor, Ontario, Canada N9B 1K2 (519) 254-2001. Visa & M.C.

RESISTORS 1/4W, 1/2W 5% C.F. 3c ea. NO MINIMUMS. Send for details. Bulk pricing available. **JR Industries,** 5834-C Swancreek, Toledo, Ohio 43614. U.S. Inquiries.

HIGH FIDELITY COMPONENTS AND CAR TAPE PLAYERS. Buy top name brand equipment at the same price many dealers pay. 130,000 customers nationally, **IN BUSINESS 29 YEARS.** TOLL FREE 1-800-638-8806 or 1-301-488-9600.

DECODER KIT, TV UHF CHANNELS. Sine Wave Encoder System. Model 7 + 11 Mark I, complete kit \$139.00, plus 5% for shipping and handling. Also parts etc. Catalog \$1.00. Visa, Master Charge acceptable. Simple Simon Electronic Kits, 1185 S. Hawthorne Blvd., Hawthorne, California 90250. TEL: (213) 675-2335.

PCB as low as 15c sq-in. FREE DRILLING. International Enterprise, 6452 Hazel Circle, Simi Valley, CA 93065.

SUBSCRIPTION TELEVISION EDUCATION MANUAL! Two scrambling decoding systems, theory, circuits. Decoder dealers listed. \$14.95. Kits available. Satisfaction guaranteed. **ABEX,** P.O. Box 26601-P4, San Francisco, CA 94126.

TELEVISION DOWNCONVERTERS and decoders \$99.95 up. Details for SASE. **GW Electronics,** POB 688, Greenwood, IN 46142.

SAVE UP TO 50% on name brand test equipment. Free catalog and price list. **Salen Electronics,** Box 82, Skokie, IL 60077.

POLICE SCANNERS AT WHOLESALE PRICES. VISA/MC Phone orders accepted. (415) 573-1624. Free catalog write: **Scanners Unlimited,** 1199A Laurel Street, San Carlos, CA 94070.

SATELLITE TELEVISION receivers \$300, dishes \$100, LNAs, downconverters. Catalog \$5.00. **Satellite Systems Development,** 1271 Traugher St., Milpitas, CA 95035.

PICTURE TUBE REBUILDING equipment new and used. **ATOLL TELEVISION,** 6425 Irving Park, Chicago, Illinois 60634.

SUBSCRIPTION TV. 2300MHz Microwave Antenna Plans. Fully Guaranteed. \$9.95. **DynaComp Electronics,** Dept. GF-1, P.O.B. 4181, Scottsdale, AZ 85258.

TUBES, IC'S, ni-cads, FiresTck antennas, multimeters, amateur-short wave receivers, scanners, radar, and metal detectors. A + E. C.O.D.'s 1-800-531-5405.

HARD to find components for the audio or music experimenter. **Electronic Music Consultants,** 533-P San Blas Pl., Santa Barbara, CA 93111.

TOP QUALITY SPEAKERS AND KITS. Send \$2.00. **Speaker Warehouse,** 809 North Route 441, Hollywood, FL 33021.

G.I. SURPLUS test equipment. Top quality, low prices. Free list. **Discount Photo,** 435 Bath St., Santa Barbara, California 93101.

FACTORY OUTLET Stereo Cassette \$30.00. 70 watt power booster \$40.00. Thirty day warranty. **MSC,** P.O. Box 706, Mancos, CO 81328.

ROBOT DESIGN BREAKTHROUGH. Easily Built, Untrappable, Controlled with 4 Bit Input, Microprocessor Adaptable, Complete Plans with 24x36 Blueprint \$6.95. Zarnis Engineering, 251 First Street PE, Perrysburg, Ohio 43051.

PRINTED CIRCUIT BOARDS—quick turn around for small quantities—also artwork and assembly—call or write: Merrimac Eng., 10 South Island Ave., Batavia, IL 60510. (312) 879-6412.

RF POWER TRANSISTORS - TUBES SPECIAL PARTS for "HAM" linears. MRF454 \$17.00, MRF455A \$14.00, 8950 \$9.00, 6LF6 \$5.50, Catalog and cross-reference help available. C.O.D., VISA/MC Accepted. WESTCOM, 1320 Grand, San Marcos, CA 92069. (714) 744-0728.

RADIOTELETYPE WORLD PRESS stations list. Over 50 news services transmitting 24 hours in English worldwide. Much news confidential. Hundreds of frequencies and times. Simple Equipment. How to set up, sources. Book including three lists, \$5.00 postpaid. UNIVERSAL ELECTRONICS, 1280 Aida Drive, Reynoldsburg, Ohio 43068.

SCRAMBLED TELEVISION TUNERS: Wideband UHF tuner, covers most of UHF to VHF channels. \$24.95 plus \$1.50 postage. Money order only. Quest Electronics, Box 1722, Costa Mesa, CA 92627.

AMATEUR SCIENTISTS, Electronics Experimenters... Construction plans - drawings, schematics, parts lists. Over 60 items. Catalog - \$1.00. Technical Writers Group, Box 5994, University Station, Raleigh, NC 27650.

COMPLETE SOLID STATE Color television recorder-reproducer electronic assembly with power supply. \$24.95. Visa, Master Card. Madison Electronics, Box 217, Madison, Alabama 35758. Telephone 205-837-6658.

BEARCAT SCANNERS. The new BC150, 10 channel, 5 band, digital display, lockout. \$187.00 plus \$5.00 shipping. UPS. KMR Distributors, Box 5262, Norman, OK 73070.

ATARI SPACE INVADERS IS MORE FUN with the RAPID FIRE Variation. Doesn't LIMIT YOU to FIRING ONLY LASER each time. APPLIES INSTANTLY!! NO MODIFICATION TO YOUR COMPONENTS! NOW SPECIALLY PRICED! \$5.98 COMPLETE. BALIS, Box 522, Brooklyn, NY 11215.

SINEWAVE TV DECODER - Negative and plans. Uses Formula International tuner. \$15. Jomar, 2028 Knightsbridge, Dr., Cinti., Ohio 45244.

AIM your SATELLITE TELEVISION ANTENNA ACCURATELY using azimuth & elevation data computed for your location ANYWHERE WORLDWIDE. Chart shows which of 44 satellites are within your reception area. You will also receive our 7 page booklet showing future launches, frequencies, formats, antenna/feedline data, list of satellite TV suppliers. \$10.00. COMPUSAT, 643 South Route 83, Elmhurst, IL 60126.

UNIQUE PLANS: SUBSCRIPTION TELEVISION DECODER, \$10.00. Telephone Memory Dialer, Negative Ion Generator, \$4.00 each. PC Patterns included, Parts and kits available. For more information, send SASE. COLLINS ELECTRONICS, Box 6424, San Bernardino, CA 92412.



ELECTRONIC ORGAN KITS
3-4 Manuals
THEATER and CLASSICAL

Wurlitzer reproductions Refundable Parts
Brochure \$2.00 Catalog \$1.50

DEVTRONIX ORGANS, INC., Dept 20
6101 WAREHOUSE WAY, SACRAMENTO, CA 95826

FREE TV DECODER PLNSNS—Send self addressed stamped envelope for free plans, parts list and price list to SCR Electronics, Inc., 9533 Valley View, Cypress, CA 90630.

SUBSCRIPTION TV. Complete 2300MHz Micro-Wave Antenna System, fully guaranteed—\$279.95. Plans—\$9.95, refundable toward purchase of antenna. DYNACOMP ELECTRONICS, Dept. GF-1, POB 4181, Scottsdale, AZ 85258.

ANTI-GRAVITY Solid State Electronic Levitation. No moving parts, magnets, gases, exotic fuels. Data, Schematics, Diagrams. 78 pages 8x10 mimeo, \$15 ppd. Guaranteed! Visa/MC; Foreign add 20%. A.E.S., Box 132-M, Eureka Springs, Arkansas 72032.

MICROWAVE ANTENNAS—Down Converts microwave signals to VHF television band. Parabolic dish and commercial 'yague' (long rod) types. Up to 65 miles range. Fully assembled (not a kit) and useable indoors. Satisfaction guaranteed—use on 10 day trial. Factory direct from \$169.50. Call toll-free 1 (800) 634-6062.

MEASURE LARGE CURRENTS WITH YOUR DMM

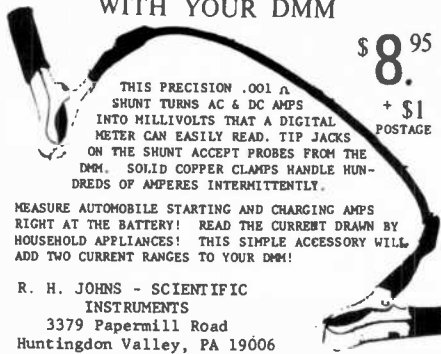

\$8.95
+ \$1 POSTAGE

THIS PRECISION .001 Ω SHUNT TURNS AC & DC AMPS INTO MILLIVOLTS THAT A DIGITAL METER CAN EASILY READ. TIP JACKS ON THE SHUNT ACCEPT PROBES FROM THE DMM. SOLID COPPER CLAMPS HANDLE HUNDREDS OF AMPERES INTERMITTENTLY.

MEASURE AUTOMOBILE STARTING AND CHARGING AMPS RIGHT AT THE BATTERY! READ THE CURRENT DRAWN BY HOUSEHOLD APPLIANCES! THIS SIMPLE ACCESSORY WILL ADD TWO CURRENT RANGES TO YOUR DMM!

R. H. JOHNS - SCIENTIFIC INSTRUMENTS
3379 Papermill Road
Huntingdon Valley, PA 19006

AMATEUR RADIO

MADISON DEEP HAM DISCOUNTS. Kenwood, Yaesu, Icom, Drake, Accessories—Stock. FREE flyer, Madison Electronics, 1508-P McKinney, Houston, TX 77010. (713) 658-0268.

RADIO AMATEUR CALLBOOKS 1981 Directories of Radio Amateurs around the world. U.S. Callbook \$20.50; Foreign Callbook \$19.50, shipping included. See your dealer or write for FREE catalog. Radio Amateurs Callbook, Dept. PE, 925 Sherwood Dr., Lake Bluff, IL 60044.

PLAY YOUR TAPES, records, T.V. on any F.M. radio in your house - wireless - simple hook-up. Satisfaction guaranteed, \$24.95. Port-o-Sound Co., Box 279A, Howard Beach, NY 11414.

"OWNER REPAIR OF RADIO EQUIPMENT" Book, \$8.70 (Club Discount). K6RQ, 14910 LG Blvd., Los Gatos, CA 95030.

COMPUTER EQUIPMENT

SURPLUS COMPUTER PERIPHERALS: "Selectric" I/O typewriter bargains. World's largest selection. Send 25c for bargain-packed flyer. CFR, Box 144, Newton, NH 03858.

LEARN MICROCOMPUTERS on your own computer. Send \$5.00 for 2 complete instruction manuals. Paccom, 14905 NE 40th, Dept. MPE021, Redmond, WA 98052.

WANTED — Sell your unwanted computer through us. Big savings for buyers in pre-owned equipment. Buyers/sellers — Send SASE or 25c for details, Autocom, Box 246, Glenham, NY 12527.

RF MODULATORS! Special versions for SATELLITE TELEVISION, COMPUTERS, CCTV. Also Monitors, Cameras, Kits. FREE catalog. Phone (402) 987-3771. Dealers welcomed. ATV RESEARCH, 13-P Broadway, Dakota City, NE 68731.

TRS-80 COLOR COMPUTER Complete 16K. Memory Conversion Kit for the 4K. System \$59.95. Instructions only \$12.00. Culpeper Computer, 502-B South East St., Culpeper, VA 22701.

INTERACT COMPUTERS — Software, service. Best prices. Send for catalog: MICRO VIDEO, Box 7357, Ann Arbor, Michigan 48107.

COMPUTERISTS AND COMPUTER CLUBS! Why pay full price for software? We have it all for most any system and will not be undersold! Guaranteed! Write for free listings. Pacific Discount Software, 3205 Production Circle, Oceanside, Cal. 92054. 714-439-6201.

FREE COMPUTER SUPPLIES CATALOG - 1600 field-proven products compatible with any mini or microcomputer. Tapes, disks, floppies, cartridges, cables, furniture, ribbons, more. Order by mail, phone, 24 hour shipment. Inmac, 2465 Augustine Drive, Dept. 200, Santa Clara, Cal. 95051. Call Sandy (408) 727-1970.

8 SOCKET AC POWER STRIP. Eliminate interaction between microcomputers, floppies, printers, memory caused by power line coupling. Varistors eliminate power line spikes that may cause memory loss, errors. Hash filters on each of 3 pairs. Lighted switch, fuse, 3 wire cord, 1875 watts total. Model MFJ-1107. Call or write for more information. To order call toll-free 800-647-1800. Charge VISA, MC or mail check, money order for \$69.95 plus \$4.00 shipping. MFJ Enterprises Inc., Drawer AJ, Mississippi State, MS 39762.

HOME CHESS COMPUTERS - Free illustrated Buyer's Guide. PMK Associates, P.O. Box 598-E, East Brunswick, NJ 08816. (201) 246-7680, 24 hours.

SOFTWARE FOR SMALL SYSTEMS. TRS-80, CPM, Northstar. This month's special: ALL OSBORNE CBASIC BUSINESS PROGRAMS on CPM disk... \$100. Send system info for catalog. SOFTWARE REVIEW, 704 Solano Ave., Albany, California 94706. (415) 527-7730.

PROGRAMMERS! CASH IN on Micro Explosion in Education. Market your software to public schools nationwide. New service, low rates. Details, P.O. Box 105, Toms River, NJ 08753.

TRS-80 color 16K upgrade with instructions \$39.95; Machine language monitor in basic on tape \$14.95. G/M Electronics, 13017 41st S., Seattle, WA 98168.

SAVE 90% Build Your own Minicomputer. Free Details. Diga-tek, 2723 West Butler Dr., Suite 20C, Phoenix, AZ 85021.

ATARI 800 (16K)—\$735; Free Catalog; GENERAL COMPUTER, P.O. Box 345, Melbourne, FL 32901; (305) 777-5400.

ATARI® You already own a powerful hobby computer!

Realize its capabilities by plugging our MagiCard module into your unaltered Video Computer System™ console. Using our instruction manual, obtain direct control of your ATARI game's features through 6502 machine language programs and your keyboard controls. Send check or money order for \$49.95 (in Illinois, add 8% tax) to Computer Magic, Inc., Box 3383, Fox Valley Center, Aurora, Illinois 60505.

ATARI and Video Computer System are trademarks of ATARI Inc.

C.B. EQUIPMENT

GET MORE CB CHANNELS AND RANGE! Frequency Expanders, boosters, speech processors, how-to-books, plans, modifications. Catalog \$1. CB CITY, Box 31500PE, Phoenix, AZ 85046.

PALOMAR - PRIDE - ATLAS: Exclusive Repair Facility. Factory trained technicians, all work guaranteed. Palomar Electronics Repair Service, 1320 Grand, San Marcos, Cal 92069. (714) 744-0720.

CABLE TV

500 PHILIPS 32 CHANNEL CABLE TV converters and VCR programmers. \$17,800 prepaid to your door. Sample \$48. Birnbom, 3655 Ridgewood, Suite 103, Montreal, Canada H3V 1B4. (phone 514-739-0614). (U.S. inquiries)



39.95
ADD \$2.50 FOR POSTAGE

ORDER No. 198AE047

BICO ROUTE 9N,
PLATTSBURGH, N.Y. 12901
Tel.: (518) 561-8700.

FREE!
UNUSUAL 96 PAGE
ELECTRONIC PARTS
& IDEAS CATALOG!

PLANS AND KITS

PRINTED CIRCUIT Boards from sketch or artwork. Kit projects. Free details. DANOCINTHS Inc., Dept. PE, Box 261, Westland, MI 48185.

LASERS HANDBOOK with burning, cutting, Ruby Reds, CO's complete plans, books, and parts. Send \$4.00 to: Famco, Dept. PE, Box 1902, Rochester, NH 03867.

GIANT SCREEN TV projection system converts any television into 7-foot picture. Lens & instructions \$14.95. (Dealers welcome). Bell Video, 4616 Belair Rd., Baltimore, MD 21206.

BUILD AN ORCHESTRA THE EASY WAY

Preview the world's most advanced Do-It-Yourself Organs, Planos, Synthesizers, Amps, etc. Send \$6.00 for our famous "Sight & Sound" pack. WE RSI Electronics, Inc., Dept. M2, P.O. Box 5318, 1720 Hempstead Rd., Lancaster, PA 17601.



STEPPER MOTOR EVALUATION KIT contains Stepper Motor, Driver Board, Instructions. Ideal for hobbyists, Robot builders. \$74.69, SES, Inc., 64-62 Dry Harbor Rd., Middle Village, NY 11379.

IN-GROUND SWIMMING POOL KIT — Blue-prints — Vinyl Liner — Side-Walls — Skimmer — Filter — Pump — All materials Necessary for Construction — Except Local Materials — 16'x32' \$1,995.00-FOB. Cheswick Pool Sales Inc., Rte. 28, Cheswick, PA 15024. (412) 274-6400. Call Collect.

BUILD SCOPEBOX* - eight trace shortage oscilloscope for fraction of a month's rent, **DISPLAY ON ANY TV.** For the information and A.N. send \$5.00, refundable toward purchase of parts. **CONCORD INSTRUMENTS, P.O.B. 1044, Melville, NY 11747.**

PAY-TV UNSCRAMBLER, Build your own. Fits all TV sets. Complete plans, \$6.95. PCEP Enterprises, Box 837-S, New York, NY 10274.

UNIQUE TV DECODER plugs between UHF and VHF tuners on tube or solid-state sets. Plans \$3.95; **DECODER ANTENNA** receives multi-polarized signals. Plans \$3.95; Antenna Kit \$19.95. Helico, P.O. Box 304, Bridgewater, MA 02324.

TESLA COIL — 40" SPARKS! Plans \$7.50. Information 75 cents. Huntington Electronics, Box 2009-P, Huntington, Conn. 06484.

DIGITAL AND SOUND EFFECTS PROJECTS. Send stamp for information. Waveform, 7 Bradford Ave., Pittsburgh, PA 15205.

SINCLAIR ZX80 KEYBOARD BEEPER \$12.00. Video Inverter Kit \$5.00. **BURNETT ELECTRONICS,** 908 Morris Street, Cincinnati, Ohio 45206.

UNDERWATER FISH DETECTOR: Listen to and record the amazing sounds of marine life. You might even be able to improve your catch. Easy to assemble and use. Complete Kit, \$29.95. **AUTOMOTIVE ECONOMETER KIT:** Featured in Feb. 1980 P.E. Electronic Vacuum gauge monitors your driving habits and can save you gasoline. Current price, \$26.95. **P.C. BOARDS, PARTS AND PLANS:** Computer Chess, Pocket Stopwatch, and 100MHZ Frequency Counter. Send S.A.S.E. for information. **ALPHA Electronics,** PO Box 1005, Merritt Is., FL 32952. 305 453-3534.

SUBSCRIPTION TV DECODER KIT. Includes parts, manual, and Etched Board. \$39.00. Manual only \$4.60. Catalog \$2.00. **JOE, P.O. Box 61, Cumberland, RI 02864.**

PROTECT your home with a simple, inexpensive security system. Complete plans only \$2.95. D. Keeler, PO Box 81264, Mobile, AL 36608.

ELECTRONICS WORKBENCH. 34 x 48 worktop, equipment risers, easily built. Hobbyist's must: Complete plans \$2.00. Masterplans set 31-01. P.O. Box 24295. Columbus, Ohio 43224.

ALARMS

Burglar-Fire Protection

Protect Your Life, Home, Business, Auto, etc.

- Our catalog shows how. Install your own alarm systems and devices and save \$\$\$\$.
- We offer FREE write-in engineering service.

Lowest Prices on Reliable, High-Quality Alarm Systems and Devices

FREE CATALOG

Burdex Security Co. Box 82802-PE Lincoln, Ne. 68501

BURGLAR, FIRE, CAR! Finest equipment! Save! Free Catalog. Refundable! AAS, 186A Oxmoor Road, B'ham, AL 35209.

SECURITY ALARMS: Complete kits reasonably priced. For literature send \$2.00 refundable first order. Blue Gator Enterprises, Box 551E, Earleton, Florida 32631.

HIGH FIDELITY

A SINGER'S DREAM!

REMOVES VOCAL FROM MOST STEREO DISCS

The Thompson Vocal Eliminator can actually remove most or virtually all of a solo vocalist from a standard stereo record and yet leave most of the background music untouched! Not an equalizer! We can prove it works over the phone. Write for a brochure and demo record below. **COST: \$249.00**

YOU SHOULD SEE US

For:

- Time Delay/Ambience
- Studio Echo/Reverb
- Tape Noise Reduction
- Parametric Equalization
- Electronic Crossovers
- Compressor/Expanders
- Mic Preamp/Mixers

We manufacture a full line of high quality audio and recording equipment. You will probably have to pay twice as much elsewhere to obtain comparable quality. Only Direct Sales make our prices and quality possible. Send \$1 for a 2 page brochure and 20 minute demonstration record.

Write to: **LT Sound, Dept. PE, P.O. Box 338, Stone Mountain, GA 30086, Phone (404) 493-1258**

193 **MARANTZ SQA-2** and 156 Marantz CD400B quad adapters. Original sealed factory cartons. \$5950 the lot. **Ridgewood, BOX 777, Champlain, NY 12919.**

DIAMOND NEEDLES and Stereo Cartridges at Discount prices for Shure, Pickering, Stanton, Empire, Grado, Audio Technica, Osawa, Satin and ADC. Send for free catalog. **LYLE CARTRIDGES, Dept. P, Box 69, Kensington Station, Brooklyn, New York 11218. Toll Free 800-221-0906 9AM - 8PM except Sunday.**

WANTED

GOLD, Silver, Platinum, Mercury, Tantalum wanted. Highest prices paid by refinery. Ores assorted. Free circular. **Mercury Terminal, Norwood, MA 02062.**

TUBES

RADIO & T.V. Tubes — 49 cents each. Send for free Catalog. **Cornell, 4213 University, San Diego, Calif. 92105.**

TUBES: "Oldies", Latest. Supplies, components, schematics. Catalog Free (stamp appreciated). **Steinmetz, 7519-PE Maplewood, Hammond, Ind. 46324.**

TUBES-RECEIVING, Industrial and Semiconductors Factory Boxed. Free price sheet including TV, Radio and audio parts list. **Transleteronic, Inc., 1365 39th St., Brooklyn, New York 11218. Telephone: (212) 633-2800. Toll free: 800-221-5802.**

HUGE INVENTORY! Thousands of types. Wholesale prices. **FREE CATALOG!** **ETCO Electronics, DEPT. 290, Plattsburgh, NY 12901.**

GOVERNMENT SURPLUS

MANUALS for Govt Surplus radios, test sets, scopes. List \$1.00 (cash). **Books, 7218 Roanne Drive, Washington, D.C. 20021.**

JEEPS — \$19.30!! — **CARS** — \$13.50!! — **650,000 ITEMS!!** — **GOVERNMENT SURPLUS!!** — **Most COMPREHENSIVE DIRECTORY AVAILABLE** tells how, where to buy!! — **YOUR AREA** — \$2. — **MONEYBACK GUARANTEE!!** — "Government Information Services". **Department GE-81, Box 99249, San Francisco, California 94109.**

PERSONALS

MAKE FRIENDS WORLDWIDE through international correspondence, illustrated brochure free. **Hermes-Verlag, Box 110660/Z, D-1000 Berlin 11, W. Germany.**

PENFRIENDS — **ENGLAND** — **USA**, through correspondence. Send age, interests. Free reply. **Harmony, Box 89PE, Brooklyn, New York, 11235.**

CORRESPONDENCE FOR FRIENDSHIP IN PHILIPPINES, MALAYSIA. Free information. **AACC-(PE), Box 1542, Canoga Park, Calif. 91304.**

INSTRUCTION

UNIVERSITY DEGREES BY MAIL! Bachelors, Masters, Ph.D.'s. Free revealing details. **Counseling, Box 317-PE05, Tustin, California 92680.**

LEARN WHILE ASLEEP! HYPNOTIZE! Astonishing details, strange catalog free! **Autosuggestion, Box 24-ZD, Olympia, Washington 98507.**

LEARN ELECTRONIC ORGAN SERVICING at home. Completely revised course covers latest models including digital, LSI's, synthesizers, etc. **NILES BRYANT SCHOOL, PO Box 20153, Sacramento, CA 95820.**

PASS FCC EXAMS

The Original FCC Tests-Answers exam manual that prepares you at home for FCC First and Second Class Radiotelephone licenses. Newly revised multiple choice exams cover all areas tested on the actual FCC exam. Plus "Self-Study Ability Test" Proven! \$12.95 postpaid. (Add \$2.00 for first class Air Mail.) Moneyback Guarantee

TESTS-ANSWERS FOR FCC FIRST AND SECOND CLASS COMMERCIAL LICENSE

COMMAND PRODUCTIONS Radio Engineering Division P.O. Box 26348-P San Francisco, CA 94126

Be an ELECTRICIAN

Skilled Electricians Average Over \$11 an Hour

Learn at home in spare time with no previous experience. We encourage you to check on the job market in your area and send for employment success figures of our graduates. Learn installation, maintenance, construction, lighting, heating, air conditioning applications. Send for FREE FACTS.

Electrician's School, Dept. P.D041, ICS Center, Scranton, PA 18515

COLLEGE DEGREES BY SPECIAL EVALUATION of EXISTING Credentials & Job Experience. Fast, Inexpensive. (614) 863-1791. **Guidance, Box 13151-A5, Columbus, Ohio 43213. Be Specific.**

YOU CAN NOW EARN A Bachelor, Master, or Doctoral Degree without leaving home. Courses are under faculty guidance. **Kensington University, (P.O. Box 2036-M), 512 E. Wilson, Glendale, CA 91209.**

LEARN TELEVISION—Complete theory in really simple language. Many illustrations and complete transmitter & receiver circuits. \$6.50 post paid in USA. **Apron Laboratories, P.O. Box 323, Bloomington, IN 47402.**

MEDICAL ELECTRONICS TECHNOLOGY, home study. Troubleshoot medical instruments. **MDC, P.O. Box 124, Pine-dale, CA 93650.**

ATTENTION ELECTRONIC TECHNICIANS

Highly Effective Home Study BSEE Degree Program for Experienced Electronic Technicians

Our New Advanced Placement Program grants Credit for previous Schooling & Professional Experience. Advance Rapidly! Our 36th Year!

FREE DESCRIPTIVE LITERATURE!

Cook's Institute of Electronics Engineering DESK 15 P.O. BOX 20345, JACKSON, MS 39209

FOR INVENTORS

PATENT AND DEVELOP your invention. Registered Patent Agent and Licensed Professional Engineer, Send for **FREE PATENT INFORMATION** every inventor should have. **Richard L. Miller, P.E., 3612 Woolworth Building, New York, NY 10007. (212) 267-5252.**

MANUFACTURER SEEKING Patented, Unpatented Inventions. Generous royalties. **Advantek International, 1100 17th NW, Washington, DC 20036.**

INVENTIONS WANTED

FREE CONSULTATION • **NO IDEA TOO SMALL**

Disclosure registration Potential cash or royalties from manufacturers seeking new ideas. For free information on how to register your ideas Call or write.

AMERICAN INVENTORS CORP.

59 Interstate Dr. Dept PE
West Springfield, MA 01089 (413) 737-5376
A Fee Based Service Company

BUSINESS OPPORTUNITIES

FREE CATALOGS. Repair air conditioning, refrigeration. Tools, supplies, full instructions. **Doolin, 2016 Canton, Dallas, Texas 75201.**

MECHANICALLY INCLINED individuals desiring ownership of Small Electronics Manufacturing Business — without investment. Write: **BUSINESSES, 92-K5 Brighton 11th, Brooklyn, New York 11235.**

MECHANICALLY INCLINED INDIVIDUALS

Assemble electronic devices in your home. Knowledge, or experience not necessary. Get started in spare time. Above average profits. \$300 - \$600/Wk possible. Sales handled by others. No investment — Write for free details.

ELECTRONIC DEVELOPMENT LAB

Box 1560PE, Pinellas Park, FL 33565

ERASE DEBTS with little-known law — create wealth!! **Details FREE** — Blueprints. **NO. EE4, LaGrangeville, NY 12540.**

BORROW \$25,000 "OVERNIGHT." Any purpose. Keep indefinitely! **Free Report!** **Success Research, Box 29070-GE, Indianapolis, IN 46229.**

FREE BOOK "2042 Unique Proven Enterprises." Fabulous "unknowns," second inflation income. **Haylings-M, Carlsbad, CA 92008.**

NEW TAX LOOPHOLES DISCOVERED. Everyone Eligible. Free sample newsletter. Write **ULC, Box 179-BA, Clarkston, GA 30021.**

BORROW \$30,000 without interest! All eligible. Repay any time. Free details. **Infohouse, Box 1004, PE5, New York, NY 10003.**

WANT YOUR OWN RADIO STATION? Investment/experience unnecessary. Free information. "Broadcasting", **Box 130-A4, Paradise, CA 95969.**

FREE ISSUE OF NEWSLETTER about opportunities in microelectronics. Write: **MEDIATRONICS, 7 Autumn Lane, Amherst, MA 01002.**

BIG MONEY IN BUSINESS PRINTING! 25% COMMISSION PLUS BIGGEST CASH BONUS! Build your own profitable year around business. Show tremendous line of salesbooks, register forms, unit sets, letterheads, envelopes, invoices, statements, business cards and dozens of other printed products. Lowest prices in industry. Something for every business and professional person. Free sales kit includes ad specialties, calendars, signs and ad matches. No experience needed. Our catalogs are easy to understand. We're over 50 but still young and aggressive, so we can show you the road to a very profitable full or part time career. Free sales kit. National Press, Dept. 147, North Chicago, IL 60064.

MAILORDER OPPORTUNITY! Start profitable home business without experience or capital. Write for free book, case histories, plus complete details. No obligation. Mail Order Associates, Dept 747, Montvale, NJ 07645.

PROJECTION TV . . . Make \$200.00 + per evening assembling Projectors . . . Easy . . . Results equal to \$2,500 projectors . . . Your total cost less than \$15.00 . . . **PLANS, LENS & Dealer's information \$14.00 . . .** Illustrated information FREE . . . Macrocomchx, Washington Crossing, PA 18977.

FREE BOOK "2042 Unique Proven Enterprises," Fabulous "unknowns," second inflation income. Haylings-M. Carlsbad, CA 92008.

START YOUR OWN TV STATION, inexpensively—New FCC rules! Details free. TRA Inc., 2900 N. Dixie Hwy—102, Ft. Lauderdale, FL 33334.

ATTENTION—T.V. MEN/related fields! HI-PROFIT/LUCRATIVE. YOU can rebuild CRT's for \$3 to \$10 when you own our patented equipment. Lakeside, 4071 Elston, Chicago, IL 60618. (312) 583-6565.

EMPLOYMENT OPPORTUNITIES

ELECTRONICS/AVIONICS EMPLOYMENT OPPORTUNITIES. Report on jobs now open. Details FREE. Aviation Employment Information Service, Box 240E, Northport, New York 11768.

JOBS OVERSEAS - Big money fast. \$20,000 to \$50,000 plus per year. Call 716-842-6000, ext. 111B.

HYPNOTISM

FREE Hypnotism. Self-Hypnosis. Sleep Learning Catalog! Drawer H400, Ruidoso, New Mexico 88345.

FOR SALE

Satellite TV

FOR THE HOME

Sick of Network TV?

Our receiver lets you get over 75 channels of television directly from earth-orbiting cable TV satellites: HBO, Showtime, super stations, sports and movies worldwide.



We don't just sell information! We Manufacture Hardware!

technical information book and catalog gives you all the facts. Inexpensive dishes, feeds, telemetry software, kits and more. Recommended reading by NASA, The Office of Consumer Affairs and quality companies like Rockwell/Collins. Send \$7.95 today!

CALL
24-hr. C.O.D. Hotline
(305) 339-7800

SPACECOAST
RESEARCH CORPORATION

P.O. Box 442-A, Altamonte Spgs, FL 32701

SATELLITE VISION SATELLITE VISION

We manufacture the highest spec 3-meter dish & video dish in the world 41db gain! We also sell direct. Immediate delivery or you pick up. Complete details including satellite TV information, aiming service and discount schedule. Send \$1.25 for postage & handling.

TIGER TENNAS
P.O. Box 561
Casselberry, Florida 32707

BUY DIRECT



REPAIRS & SERVICES

TV TUNERS REBUILT, VHF or UHF only \$11.90. Send for free mailing kit. JW Electronics, Box 51A, Bloomington, IN 47402.

ALL T.V. TUNERS repaired \$11.95. Also repair Modules. Fast, quality work. MIKE'S T.V. TUNER SERVICE, Box 187, Bean Station, TN 37708. (615) 581-6393.

REAL ESTATE

BIG . . . NEW . . . FREE SUMMER CATALOG! Over 2,800 top values coast to coast! UNITED FARM AGENCY, 612-EP West 47th, Kansas City, MO 64112.

RUBBER STAMPS

RUBBER STAMPS, BUSINESS CARDS. Many new products. Catalog. Jackson's, E-100, Brownsville Rd., Mt. Vernon, Ill. 62864.

BOOKS AND MAGAZINES

ELECTRONICS BOOKS AVAILABLE. World publishers. Lowest prices. Ask catalogue. Business promotion, Lajpatrai Market, Delhi, India.

ELECTRONIC MUSIC and home recording in Polyphony magazine. Advanced applications, interviews, projects, computer music. Sample \$1.50. Subscription (6 issues), \$8.00 US/\$10.00 foreign. POLYPHONY, Box P20305, Okla. City, OK 73156.

PUBLISHERS' OVERSTOCK, BARGAIN BOOKS 2,000 titles, all subjects! Free catalog: Hamilton, 98-86 Clapboard, Danbury, CT 06810.

LOTTERIES make some people millionaires, so can micro-computers. New publication shows how. \$5.00. NEO PUBLISHING, P.O. Box 1368, L.I.C., NY 11101.

LEARN CHORDS and how to USE them. Add FULL SOUND to your playing. A proven approach. GET LASTING RESULTS from your practice. Beginners or advanced. Two illustrated volumes (385p) on LEARNING and USING CHORDS. No risk - FREE INFORMATION. MLS PUBLISHING, Dept. 11PE, RD3 Box 142, Olean, NY 14760.

TECHNICIANS & ENGINEERS - Want to be top notch? Learn "The Principles And Psychology To Trouble-shoot And Problem-solve Anything." Order: "The Mastermind" \$15, info \$1.00. 1 year satisfaction guarantee. Alex Bottai, 4020 Brandongate #10, Malton, Ontario L4T 3W8.

THE SUPERMARKET OF ELECTRONICS—thousands of items for sale or trade each month. Free classified ad with subscription. Only \$5.00 to Nuts & Volts, POB 1111-P, Placentia, CA 92670

RECORDS & TAPES

RECORDS — TAPES! Discounts to 73% All labels; no purchase obligations; newsletter; discount dividend certificates. 100% guarantees. Free details. Discount Music Club, 650 Main St., Dept. 5-0581, New Rochelle, NY 10801.

DO-IT-YOURSELF

PROJECTION TV . . . Convert your TV to project 7 Foot picture. Results equal to \$2,500 projector. Total cost less than \$20.00. **PLANS & LENS \$16.00.** Illustrated info. FREE: Macrocomci, Washington Crossing, PA 18977. MC/VISA 215-736-3979.

AVAILABLE SERVICING DATA for Hi-Fi units. Tape Recorders, Auto Radios, CB's, Scanners, TV's, and VCR's. PHOTO-FACT* 1981 Index lists data available and source on over 110,000 consumer electronic units. Send \$2.50 plus 50 cents shipping to Howard W. Sams Co., Dept. X0113, 4300 W. 62nd St., Indpls., IN 46268.

MISCELLANEOUS

MPG INCREASED! Bypass Pollution Devices easily. REVERSIBLY!! Free details — Posco GEE4, LaGrangeville, NY 12540.

AUTOMOBILE RE-TUNING FOR MAXIMIZED ECONOMY. Details FREE! Techneering, Box 12191DD, Norfolk, VA 23502.

CORVAIR PARTS - 4500 parts, 300 page illustrated catalog: \$3.50: Clark's Corvair Parts, Inc., Shelburne, MA 01370.

Popular Electronics

ADVERTISERS INDEX

RS no.	ADVERTISER	PAGE no.
3	Advanced Electronics	87
	Albia Electronics	66
4	All Electronics Corp.	95
65	Altec Lansing	Cover 3
5	American Antenna	12
6	Antenna Specialists	86
7	AP Products	51
8	Apple Computer	3
2	Audio Dynamics Corp.	13
	Bullet Electronics	98
9	Byte	82
10	Chaney Electronics	106
	Classified Advertising	108, 109, 110, 111
45	Cleveland Consumer Computers	59
	Cleveland Institute of Electronics, Inc.	16, 17, 18, 19
1	Communications Electronics	49
12	Cooper Group	7
	Crown International	6
11	Computique	73
13	DAK	31
14	Digi-Key Corp.	100, 101
15	Discwasher	2
63	D.J. Systems	35
16	Downlink	Cover 2
17	EICO	91
18	Electra Corp.	33
19	Electronic Specialists	93
58	Electronics Book Club	43
20	ETCO	93
21	Firestik	94
22	Fluke	11
	Global	73
23	Godbout Electronics, Bill Grantham College of Engineering	106
24	Hanley Engineering	97
25	Hardside	81
26	Heath Co.	45, 46, 47
27	Hustler	20, 44
28	Illinois Audio	94
29	Inovision	92
30	Jameco Electronics	105
31	JDR Microdevices	102
32	J&R Music World	80
34	Magnavox	5
36	Markline	1
37, 38	Maxell Corp. of America	21, 60
42	McIntosh Laboratory, Inc.	81
39	M.F.J. Enterprises	92
	MICROCOMPUTER MART	107
40	Micro Ace	65
41	Micro Management Systems	90
	Nabih's	91
	Nationwide Video Inc.	77
	Netronics, R & D Ltd.	39, 83, 85
44	Novation, Inc.	42
	NR1 Schools	26, 27, 28, 29
46	Olympic Sales	96
	Omega Sales Corp.	36
64	Omnisonix Ltd.	41
47	Paccm	95
48	PAIA Electronics, Inc.	95
49	Peripherals Plus	96
50, 51	Poly Paks	24, 89
52	Quest Electronics	106
	Radio Shack	15, 99
62	RCA	Cover 4
	Sams Books	37
53	Satelco	44
54	Scientific Systems	94
68	Shelburne Co.	9
56	Simutec	74
57	Sperry, A.W.	38
35	SRJ International	94
59	Tams, Inc.	93
	Third Wave Communications	52
	Toshiba	23
61	Work Wear Corp.	90

AGRICULTURE WILL USE ELECTRONIC DATA TRANSMISSION when the Professional Farmers of America starts its new marketing information service, called "Instant Update." Using telephone lines and standard television sets for display, the service will transmit prices, government and market information, weather, and other "agribusiness" data to in-home or in-office Radio Shack Videotex terminals. With a TRS-80 Model II computer as the connecting link to the central data base, information will be available 24 hours a day and will cost \$95 per month, plus telephone charges.

ANNUAL 15% GROWTH FOR US COMPUTERS is forecast by Venture Development Corp. (Wellesley, MA) with a total sales in computers, peripherals, and data storage systems by 1982 of \$49.2 billion. Computer industry growth is expected to be 50% greater than that of the consumer electronics industry during the same period. In special areas, the largest growth rate will be 39.1% in small business computers. Floppy disk drives will be the fastest growing product in the data-storage area.



SPEED LISTENING FOR VCR, combined with speed viewing, will be possible without the common "Donald Duck" distortion, with the use of a new IC developed by Variable Speech Control Co. (San Francisco, CA). The new linear, bipolar LSI chip has been used with a Matsushita bucket brigade device to provide continuously variable-speed viewing in a number of videocassette recorders. The touch of a button on a remote control unit is claimed to provide as much as double-speed playback with intelligible audio.

DEMAND FOR CIRCUIT DESIGN ENGINEERS IS HOT according to a survey conducted by National Personnel Associates (Grand Rapids, MI) a network of 237 agencies. Electronic designers ranked third behind programmers and systems analysts in scarcity in the job market. Design of circuits for computers and new military contracts are areas in which the demand is particularly high and which have created the shortage.

SMOKEY BEAR'S RADAR GUN may have to measure up. Standards for speed-measuring radar devices have been drafted by the National Bureau of Standards and proposed by the Department of Transportation's National Highway Traffic Safety Administration. The proposed performance requirements and test methods for evaluating radar devices were requested by NHTSA in 1977 after the national 55 mph speed limit was set. If the standard is adopted, only those devices that meet it will be eligible for purchase by state and local governments with federal highway funds.

GENERAL ACCESS TO AN ASTRONOMICAL SATELLITE is the purpose of a project sponsored by the Independent Space Research Group in coordination with 20 students and faculty members of Rensselaer Polytechnic Institute (Troy, NY). The satellite being built by the group will weigh 175 lb, measure six feet in length and feature an 18-inch diameter space telescope. It will probably be launched as a piggyback payload on an Ariane rocket. Initial plans are for the satellite to photograph planets and measure the brightness of stars. Its transmissions back to earth could be picked up by amateur radio equipment with photographic printers or slow-scan TV sets.

STAR OF AN OTHELLO TOURNAMENT in Santa Cruz, CA, was Instant Software's Pro-Thello III microcomputer program. It defeated all comers on mini and microcomputers and was in the process of downing Digital Equipment's macrocomputer program when a 400,000-to-1 bug in the program surfaced and caused it to default. As of now, Pro-Thello III should be available in both cassette and disk for the TRS-80 from Instant Software (Peterborough, NH).

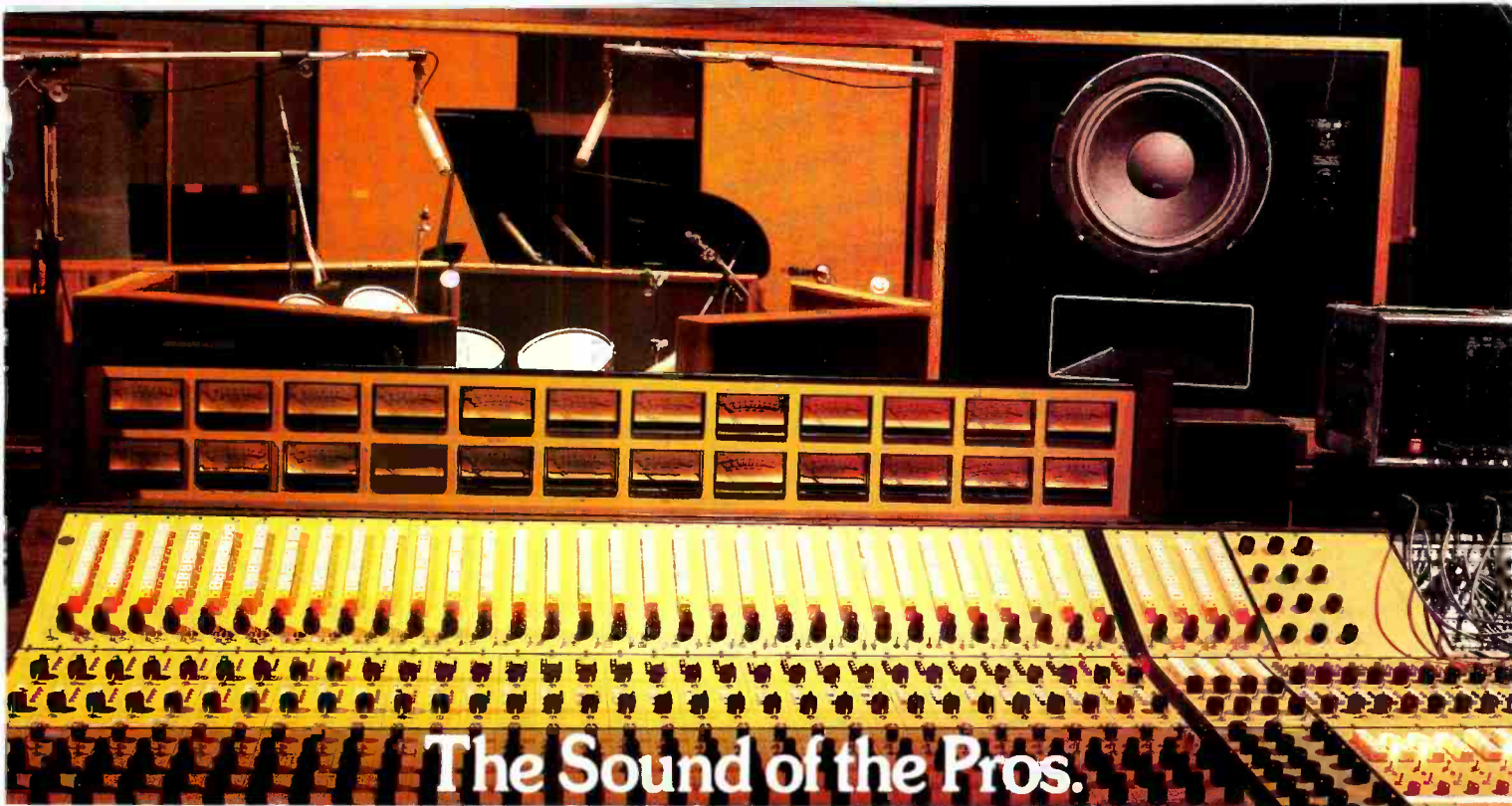

The Sound of the Pros. For the Pro at Home.

Ocean Way Recording, Hollywood, CA

We've been perfecting professional sound reproduction for almost half a century. From the famous Voice-of-the-Theater™ to our studio monitors and large floor-standing models, Altec Lansing is continuing a tradition of creating significant advancements in speaker technology. And now we've taken the most recent professional sound innovations and put them into our new speakers for the house, our models 4, 6 and 8. As a result, you can hear what has made Altec Lansing a long time favorite in studios, theaters and on sound stages from coast to coast: Crisp, clear sound realism.

Professional features made for the home.

Here are some of the acoustic innovations featured by our new speakers: The Altec Tangerine®, a revolutionary radial phase plug that brings out all the high frequencies blocked by standard circumferential phase plugs. It works with our new LZT (Lead Zirconate Titanate) ultra high-frequency compression driver that replaces magnets and voice coils with a state-of-the-art semiconductor for super clean sound.

Another important professional feature is our Mantaray® constant directivity horn that expands your

listening "sweet spot" well off to the sides of the speakers.

We've also developed a different approach to a cross-over network design that minimizes distortion and improves high-frequency response. In addition, each of our new models is equipped with an Automatic Power Control to protect the speaker from power overloads without shutting off the sound.

There's also a new look to our new home speaker line. We use rare Endriana wood from the South Pacific for our speaker cabinetry which highlights an unusually rich woodgrain and exhibits extraordinary acoustic properties.

Of course, there's a lot more to our speaker designs than these new enhancements. The sum total of

many years spent in speaker research and development is incorporated in our home models.

Sound experience in a Free brochure.

If you'd like to learn more about all the professional features we've built into our new line, write for our free brochure "A New Generation of Speaker Systems for the Home." Better yet, visit your nearest Altec Lansing listening room and find out how we adapted our professional sound quality to the environment of your home. For the name of your local dealer, call toll-free (800) 528-6050, Ext. 730; in Arizona (800) 352-0458. Or write: Altec Lansing International,



1515 S. Manchester Ave., Anaheim, CA 92803.



CIRCLE NO. 65 ON FREE INFORMATION CARD

INTRODUCING THE TWO-IN-ONE VIDEO RECORDER FROM RCA: **CONVERTIBLE SELECTAVISION**

RECORD THE BEST TELEVISION SHOWS.

This is the videotape recorder you've been waiting for. Convertible SelectaVision VCR. New from RCA.

Our new model VFP-170 lets you record up to six full hours of your favorite television shows on a single videotape cassette. It lets you record one show while you watch another. And it gives you the option of playing back those programs at your convenience.

You can even record while you're away from home. Convertible SelectaVision has a 14-day programmable memory that automatically turns itself on and off—and even changes channels—when you've got places to go and people to see.

And that's just for starters. Because Convertible SelectaVision doesn't just make it easy to record your favorite shows on videotape. It makes it fun to watch them, too.

There's a twelve-function remote control unit that lets you play back your tapes with special effects like slow motion, frame-by-frame advance and stop action.

Want to locate your favorite scenes? Press the picture search button, and you can review cassettes in high-speed forward or reverse motion without having the screen go dark. And you can edit out unwanted programming with the remote pause while you're recording—all from the convenience of your chair.

Now, this might seem like a lot for any video recorder to do. But Convertible SelectaVision is really two video recorders in one. And this is only half the story.

For the complete line of SelectaVision VCR models and color video cameras, write to: RCA Consumer Electronics, Department 32-312, 600 North Sherman Drive, Indianapolis, IN 46201.



CONVERT IT TO A HOME MOVIE OUTFIT.

Chances are, some of the best shows you watch on Convertible SelectaVision will be family entertainment programs—starring your own family.

That's because Convertible SelectaVision gives you the option of adding a videotape camera (RCA's new CC010 would be an excellent choice). And converting the recorder to a home movie outfit that you can use indoors or out.

Birthdays, weddings, bar mitzvahs, reunions. The best family times all become Prime Time material when you've got Convertible SelectaVision.

It's lightweight, compact and has a built-in, rechargeable battery. So you can carry it most anywhere. And videotape your family and friends for over an hour on a single charge.

There are practical uses, too. Convertible SelectaVision can videotape your backhand, your sales presentations and record your possessions for insurance purposes.

Best of all, Convertible SelectaVision gives you an instant television playback of whatever you record. No waiting for expensive film processing. No additional screens or projectors. And, because videotape can be used again and again, no money wasted on bad film.

Convertible SelectaVision. It's the two-in-one video recorder you've been waiting for. And it's waiting for you at your RCA Dealer's now.

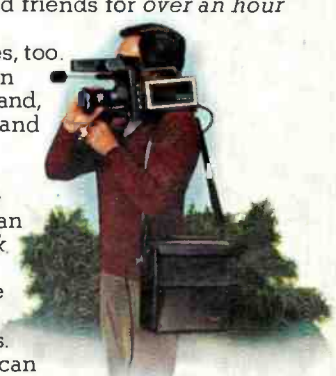

Let RCA turn your television into
SelectaVision®



CIRCLE NO. 62 ON FREE INFORMATION CARD