

1978 STEREO FM TUNER BUYING DIRECTORY

Popular Electronics®

WORLD'S LARGEST-SELLING ELECTRONICS MAGAZINE

JANUARY 1978/\$1

Build "CHARGE!" — a 12-V DC Electronic Bugler

How a Spectrum Analyzer Works

Plus:

The Direct-Disc Revolution + Exploring Computer Bus Lines + Read/Write Memory Experiments + Audio Loudness Controls + Lou Garner's Annual Electronics Predictions



New 1978 Electronic Games

A roundup of latest micro-processor-based video and nonvideo electronic games sweeping the nation.



TESTED THIS ISSUE:

- Yamaha Model 2020 AM/Stereo FM Receiver
- Optonica Model RT-3535 Stereo Cassette Deck
- dbx Model 128 Dynamic Range Enhancer
- E.F. Johnson Viking 4360 CB AM Mobile Transceiver

303196 DRK 6450H090 141D NOV79
 01
 L DARKNELL JR
 6450 MYRTLEWOOD DR
 SAN JOSE CA 95129

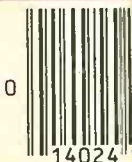

Popular Electronics

Retailers: Notice of display-allowance plan is within last three pages.

The Cobra 50XLR CB has it all. AM/FM Stereo. Cassette. And CB. All in one compact unit. All engineered to bring you the same loud and clear sound Cobra is famous for.

The remote mike houses the channel selector, squelch control, and channel indicator. So all you need for talking CB is right there in your hand. The cassette player features through the dial loading and four-way fader control.

Because they're only five inches deep, there's a Cobra in-dash radio to fit almost any car with little or no modification to the dash. This feature, plus the step-by-step Installation Manual and Universal

Installation Kit makes them the easiest in-dash radios to install. And our Nationwide network of Authorized Service Centers makes them the easiest to service.

There are four Cobra in-dash models to choose from including AM/FM/Stereo/8-track/CB. But no matter which you choose you can be sure of getting the best sounding radio going. The ultimate car radio.

The Cobra.



Punches through loud and clear.

Cobra Communications Products
DYNASCAN CORPORATION
6460 W. Cortland St., Chicago, Illinois 60635

Write for color brochure
EXPORTERS: Empire • Plainview, N.Y. • CANADA: Atlas Electronics • Toronto
Subject to FCC type acceptance.

CIRCLE NO. 50 ON FREE INFORMATION CARD

THE ULTIMATE CAR RADIO.



Just read your blood pressure
on the large easy-to-read meter
of the Astropulse 10.



Home Blood Pressure Computer

*A new space-age measuring system
lets you easily check your blood pressure
quickly and accurately without a stethoscope.*

The new Astropulse 10 lets you quickly read your blood pressure without a stethoscope and without even rolling up your sleeve.

The system is based on three micro-electronic circuits and a microphone transducer. The microphone picks up pulses in your artery, and the integrated circuits measure the pulses and relay this information to a meter which visually displays your two blood pressure readings. There is no expensive stethoscope required, no guesswork or complicated steps to follow.

EASY TO USE

Taking your own blood pressure is quite simple. Just stick your hand through a self-tightening velcro cuff, slide the cuff up your arm, pull the tab and attach the tab to the velcro material. The tab will stick automatically without loosening. Then squeeze the rubber bulb to inflate the cuff, and take your blood pressure readings.

When a doctor reads your blood pressure, he uses his skill and a stethoscope to recognize your systolic and diastolic readings. Now a computer can do this in the convenience of your home and on a regular basis.

The Astropulse 10 also flashes an LED signal and an audible tone at the two blood pressure readings to assist the hard-of-hearing or those with poor eyesight.

DOCTORS ENCOURAGE USE

Knowing your correct blood pressure is very important. Statistics show that as many as 25 million Americans suffer from hypertension, yet only half know about it. Hypertension results in high blood pressure, and high blood pressure usually goes unnoticed until other symptoms of hypertension occur—often too late to correct.

The Astropulse 10 is so easy to use that it encourages regular blood pressure monitoring—exactly what doctors recommend. Even if your health has been perfect, hypertension and blood pressure can occur at anytime.

SOLIDLY BACKED

The Astropulse is powered by a readily-available 9-volt battery supplied with each unit. The Astropulse uses solid-state electronics so service should never be required. But if service is ever required, JS&A's prompt



The Astropulse 10 was designed to take your own blood pressure in the privacy of your home. The cuff is easily tightened with the self-tightening bar and the velcro material. Just pull the flap and attach it to the cuff.



The entire blood pressure kit fits nicely in the carrying case supplied free with each unit. The carrying case measures 3½" x 4" x 7" and the entire system weighs only 20 ounces.

service-by-mail center is as close as your mailbox. JS&A is a substantial company selling advanced space-age products directly to consumers for over a decade—further assurance that your modest investment is well protected.

To order your Astropulse 10, simply send your check for \$69.95 plus \$2.50 for postage and handling (Illinois residents add 5% sales tax) to the address shown below, or credit card buyers may call our toll-free number below. By return mail, you'll receive your Astropulse 10 complete with a 90-day limited warranty, carrying case and blood pressure record book.

TEST IT YOURSELF

When you receive your monitor, see how easy it is to slip the cuff on your arm, tighten and inflate. See how easy it is to read. If for any reason you are not absolutely pleased with your unit, return it within 30 days for a full refund, including your \$2.50 postage and handling. There is no risk.

Space-age technology has made it easy to know your own blood pressure. Order an Astropulse 10 at no obligation today.

JS&A NATIONAL
SALES
GROUP

Dept. PE One JS&A Plaza
Northbrook, Ill. 60062 (312) 564-9000
CALL TOLL-FREE... 800 323-6400
In Illinois call ... (312) 498-6900
©JS&A Group, Inc., 1977

SWT

ANALOG DELAY



INTRODUCING... TWO-CHANNEL ANALOG DELAY UNIT FOR AMBIENCE SYNTHESIS AND DELAY EFFECTS

FEATURES

- * TWO INDEPENDENT CHANNELS
- * 3072 STAGES OF DELAY PER CHANNEL
- * ADJUSTABLE INPUT AND OUTPUT LEVELS WITH INPUT OVERLOAD INDICATION
- * INTERNAL OR EXTERNAL VOLTAGE CONTROLLED DELAY TIME
- * COMPANDOR IN EACH CHANNEL
- * 3 MODES/CHANNEL WITH ADJUSTABLE MIX
- * CONVENTIONAL REVERB OUTPUT FOR MUSIC EFFECTS

If you haven't heard what analog delay can do for home music reproduction, you're missing something. Let's face it, stereo in your living room is flat and

2 dimensional. Without the mixture of direct and delayed sounds that a large hall provides, almost all music reproduced in the home is lifeless. Quadraphonics has not proved to be the solution to this problem. The recent development of bucket-brigade semiconductor technology has made it possible to offer a reasonably priced delay unit that can transform your listening room into a concert hall. Using your present stereo system, the 2AS-A, and whatever you have in the way of 2 additional speakers and 2 channels of power amplification—you have all the parts to put together an ambience system that is capable of creating the kind of 'space' you enjoy music in. You don't need state-of-the-art componentry to enjoy an ambience system. The secondary power amplifiers and speakers can be of very modest perfor-

mance and yet still serve to create strikingly realistic spaciousness in your listening room. If you don't have 2 extra power amp channels on hand, we offer several low cost, low power amps in kit form that would be ideal for this purpose.

Although the 2AS-A has been designed for use in music reproduction systems as an ambience synthesizer, its voltage controlled clock and mixing capabilities allow it to be configured in a number of ways for delay effects such as phasing, flanging, chorus, and vibrato. External voltage control for special effects must be user supplied.

The 2AS-A is sold in kit form only and includes the circuit boards, components, chassis (11½" x 10" x 4"), cover 120VAC power supply, assembly instructions and application notes.

2AS-A Analog Delay Unit
\$250.00 ppd. Cont. U.S.

SWT

Southwest Technical
Products Corp.

219 W. Rhapsody, San Antonio, Texas 78216

London: Southwest Technical Products Co., Ltd.
Tokyo: Southwest Technical Products Corp./Japan

MAIL THIS COUPON TODAY

Enclosed is \$ _____ or BAC # _____

or Master Charge # _____ Bank # _____ Expire Date _____

NAME _____

ADDRESS _____

CITY _____ STATE _____ ZIP _____

SOUTHWEST TECHNICAL PRODUCTS CORPORATION
Box 32040, San Antonio, Texas 78284

Coming Next Month

BUILD A LOW-COST EPROM PROGRAMMER

NO CAMERA / NO CHEMICAL PRINTED-CIRCUIT BOARDS

MODERN TURNTABLE DESIGN

TEST REPORTS

Garrard GT-25 Turntable
Sherwood Micro CPU / 100 Stereo FM Tuner
Ten-Tec Century / 21 CW Transceiver

Electronic games on the cover include: Fairchild's Video Entertainment System (upper left); Mattel Electronics™ Football (upper right); and Parker Bros. Code Name: Sector™.

POPULAR ELECTRONICS, January 1978, Volume 13, Number 1, Published monthly at One Park Avenue, New York, NY 10016. One year subscription rate for U.S. and Possessions, \$12.00; Canada, \$15.00, all other countries, \$17.00 (cash orders only, payable in U.S. currency). Second Class postage paid at New York, NY and at additional mailing offices. Authorized as second class mail by the Post Office Department, Ottawa, Canada, and for payment of postage in cash.

POPULAR ELECTRONICS including ELECTRONICS WORLD, Trade Mark Registered. Indexed in the Reader's Guide to Periodical Literature.

COPYRIGHT © 1977 BY ZIFF-DAVIS PUBLISHING COMPANY. ALL RIGHTS RESERVED.

Ziff-Davis also publishes Boating, Car and Driver, Cycle, Flying, Modern Bride, Popular Photography, Skiing and Stereo Review.

Material in this publication may not be reproduced in any form without permission. Requests for permission should be directed to Jerry Schneider, Rights and Permissions, Ziff-Davis Publishing Co., One Park Ave., New York, NY 10016.

Editorial correspondence: POPULAR ELECTRONICS, 1 Park Ave., New York, NY 10016. Editorial contributions must be accompanied by return postage and will be handled with reasonable care; however, publisher assumes no responsibility for return or safety of manuscripts, art work, or models.

Forms 3579 and all subscription correspondence: POPULAR ELECTRONICS, Circulation Dept., P.O. Box 2774, Boulder, CO 80302. Please allow at least eight weeks for change of address. Include your old address, enclosing, if possible, an address label from a recent issue.

The publisher has no knowledge of any proprietary rights which will be violated by the making or using of any items disclosed in this issue.

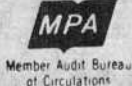

Feature Articles

- 24 **LOUDNESS CONTROL—BOON OR BANE?** / Julian Hirsch
- 33 **NEW 1978 ELECTRONIC GAMES** / Kris Jensen
Video and nonvideo games for the public's recreation.
- 49 **THE SPECTRUM ANALYZER IN HI-FI MEASUREMENTS** / Julian Hirsch
- 54 **1978 STEREO FM TUNER BUYING DIRECTORY** / Ivan Berger
Specifications and features of today's FM tuners.
- 58 **HOW FM TUNERS WORK! PART 2** / Julian Hirsch
The detector and modulation / demodulation circuits.

Construction Articles

- 45 **BUILD "CHARGE"** / Ronald W. Reese
A digital electronic bugle with amplifier for auto or home use.
- 60 **USING EXISTING HOUSE WIRING FOR COMPUTER REMOTE CONTROL, PART 2** / Dan Sokol, Gary Muhonen, and Joel Miller
Details on the remote circuits.

Columns

- 16 **STEREO SCENE** / Ralph Hodges
The Direct-to-Disc Revolution (?)
- 64 **SOLID STATE** / Lou Garner
"For I Dript into the Future. . . ."
- 67 **EXPERIMENTER'S CORNER** / Forrest M. Mims
Read / Write Memories (RAM's), Part 2.
- 69 **HOBBY SCENE Q & A** / John McVeigh
- 77 **COMPUTER BITS** / Hal Chamberlain
Bus Systems.
- 80 **CB SCENE** / Gary Garcia, KQI4178
Automatic Transmitter Identification.

Julian Hirsch Audio Reports

- 26 **YAMAHA MODEL CR-2020 AM / STEREO FM RECEIVER**
- 29 **OPTONICA MODEL RT-3535 STEREO CASSETTE DECK**
- 31 **dbx MODEL 128 DYNAMIC RANGE ENHANCER**

Electronic Product Test Reports

- 74 **E. F. JOHNSON VIKING 4360 REMOTE-CONTROL MOBILE AM CB TRANSCEIVER**
- 75 **SENCORE MODEL DVM37 DIGITAL MULTIMETER**

Departments

- 4 **EDITORIAL** / Art Salsberg
Electronics and the Handicapped.
- 6 **LETTERS**
- 12 **NEW PRODUCTS**
- 15 **NEW LITERATURE**
- 100 **OPERATION ASSIST**

JOSEPH E. MESICS
Publisher

ARTHUR P. SALSBERG
Editorial Director

LESLIE SOLOMON
Technical Editor

JOHN R. RIGGS
Managing Editor

IVAN BERGER
Senior Editor

ALEXANDER W. BURAWA
Features Editor

EDWARD I. BUXBAUM
Art Director

JOHN McVEIGH
Associate Editor

ANDRE DUZANT
Technical Illustrator

CLAUDIA TAFARO
Production Editor

DORIS A. MATTHEWS
Editorial Assistant

Contributing Editors
Hal Chamberlin, Lou Garner, Glenn Hauser
Julian Hirsch, Ralph Hodges, Forrest Mims
Ray Newhall, Wilfred Scherer

JOSEPH E. HALLOLAN
Advertising Director

JOHN J. CORTON
Advertising Sales

LINDA BLUM
Advertising Service Manager

FRANCES YERKES
Executive Assistant

EDGAR W. HOPPER
Publishing Director

ZIFF-DAVIS PUBLISHING COMPANY
Editorial and Executive Offices
One Park Avenue New York, New York 10016
212-725-3500

Hershel B. Sarbin, President
Philip Korsant, Executive Vice President
Furman Hebb, Executive Vice President
John R. Emery, Sr. Vice President, Finance and Treasurer
Phillip T. Heffernan, Sr. Vice President
Edward D. Muhlfeld, Sr. Vice President, Sports Division
Philip Sine, Sr. Vice President
Frank Pomerantz, Vice President, Creative Services
Arthur W. Butzow, Vice President, Production
Lawrence Sporn, Vice President, Circulation
George Morrissey, Vice President
Sydney H. Rogers, Vice President
Sidney Holtz, Vice President
Albert S. Traina, Vice President
Paul H. Chook, Vice President
Edgar W. Hopper, Vice President
Robert N. Bavier, Jr., Vice President
Charles B. Seton, Secretary

William Ziff, Chairman
W. Bradford Briggs, Vice Chairman

Midwestern Office
The Patis Group, 4761 West Touhy Ave.,
Lincolnwood, Illinois 60646, 312 679-1100
Thomas Hockney, Michael Neri, Gerald E. Wolte
Western Office
9025 Wilshire Boulevard, Beverly Hills, CA 90211
213-273-8050; BRadshaw 2-1161
Western Advertising Manager: Bud Dean
Japan: James Yagi
Oji Palace Aoyama; 6-25, Minami Aoyama
6 Chome, Minato-Ku, Tokyo 407-1930/6821,
582-2851



Editorial

ELECTRONICS AND THE HANDICAPPED

I was startled to learn at a recent AT&T press conference that there are about 50-million people in this country who are considered to be handicapped to some extent. (For example, 1 out of 4 elderly people suffer hearing-loss problems.) And I was impressed by the ongoing efforts of a voluntary organization of telephone-industry workers—the Telephone Pioneers of America—who create and make available various electrical and electronic aids for the blind, deaf, retarded, and motion- and speech-handicapped after working hours.

Many of these devices require some handiness with a soldering iron; a few demand kit-building experience. For instance, one "Pioneers" chapter supplies an "Audio Aid" device to enable needy persons who are hard-of-hearing to boost the sound level of a TV receiver, motion-picture, etc., so that it can be heard better. (A converted portable radio's speaker acts as a microphone in this case, and the amplified sound is heard through an earphone.) Complete plans are available for converting a G.E. Model P2790 or Model 7-2705 portable radio for this purpose from Telephone Pioneers of America, Bell Telephone Laboratories, Room 6H-416, Murray Hill, NJ 07974. Any radio with an earphone jack can be similarly modified, though some parts substitutions may be required. A pc foil pattern (1" x 7/16") is included in the plans, as well as a point-to-point wiring diagram.

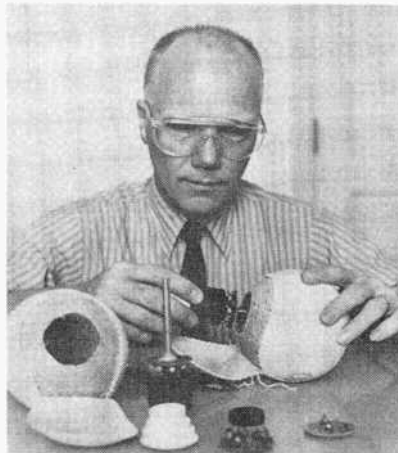

Putting the "beep" in the baseball.

Another illustration of how Pioneers' ingenuity and dedication have made life more pleasurable for handicapped people is the development of a "beeping" softball. Here, a telephone engineer buried an amplifier and electronic beeper inside a ball so that blind children can play baseball. In 1973, the Audio Ball was placed in the National Baseball Hall of Fame in Cooperstown. Today, local Pioneer chapters have devised other "beeping" sports aids for the blind: an audio basketball laced with bells that's played against a backboard wired for sound; an audible hockey puck; a beeping horseshoe game; a beeping golf putting device; an audio ring-toss game, and so on.

For retarded and autistic children who can't relate to adults, Telephone Pioneers developed, make and donate talking dolls and toy animals. The toys are equipped with two-way radios so that a therapist can remain out of sight and talk through the toy to young patients, who frequently respond to this "person."

There are a host of other ways in which persons with electronics know-how can aid the handicapped. For example, people confined to wheelchairs could be shown how their everyday living can be enhanced through listening to shortwave radio broadcasts, learning Morse code, building electronic kits, etc. There are other areas of assistance, too. For instance, one may record book and magazine articles on tape for distribution to the blind. A vocal interface for a computer would enable some handicapped people to control a variety of electric appliances, even opening and closing a door, by emitting a specific sound. The list of ways in which you can provide help through your knowledge of electronics is virtually endless. So why not set aside some time for this very worthwhile effort?

Any PE readers interested in contributing ideas or assistance to the Pioneers, or wish to receive free plans for any devices that help the handicapped, contact the Telephone Pioneers of America at AT&T, 195 Broadway, New York, NY 10007.

Art Salsberg

Send today for the
NEW WINTER '78
HEATHKIT CATALOG

FREE



The world's largest selection of fun-to-build electronic kits plus value-packed Heath-recommended assembled products. Heathkit products are world-famous for their easy step-by-step instructions, top performance and professional specifications.

MAIL COUPON BELOW FOR YOUR FREE COPY!

Select from nearly 400 unique electronic kits for the student, hobbyist and experimenter including:

- TEST & SERVICE INSTRUMENTS ■ PERSONAL COMPUTERS
- ELECTRONICS COURSES ■ AMATEUR RADIO
- COLOR TV ■ HI-FI COMPONENTS ■ HOME PRODUCTS
- MARINE, AUTO & AIRCRAFT ACCESSORIES

FREE

Send for your Heathkit Mail Order Catalog today! It's filled with large, clear illustrations and complete descriptions of unique products you can build and service yourself!



You can get a FREE retail catalog by redeeming this coupon in person at any of the 50 Heathkit Electronic Centers (Units of Schlumberger Products Corporation) in major markets coast-to-coast, where Heathkit products are sold, displayed, and serviced. (Retail prices on some products may be slightly higher.) Check the white pages of your telephone books for the Heathkit Electronic Center nearest you.

HEATH Schlumberger	Heath Company, Dept. 010-370 Benton Harbor, Michigan 49022
Please send me my FREE Heathkit mail order Catalog. I am not on your mailing list.	
Name _____	
Address _____	
City _____	State _____
CL-649	Zip _____



Letters

ALGEBRAIC NOTATION TRANSLATION

To your many readers who have requested an "algebraic" translation of my June 1977

article "How to Program Calculators for Fun and Games," all of the game programs have been translated from Hewlett-Packard "Reverse Polish Notation" into Texas Instruments "algebraic" notation for the SR-56. They are available for the nominal fee of \$2.00 to cover printing, postage, and handling—Dale G. Platteter, Suite 201, 1315 Q St., Bedford, IN 47421.

RADAR DETECTORS

This is in rebuttal to your November Editorial's comments about whether it was morally correct to use radar detectors. My corporation uses them in all our vehicles; not to "outfox" the law, but as a reminder that "radar" is

being used on our vehicles. We do this because we know that some highway patrolmen running speed traps will lie to make "brownie points."—Clarence Jones, Saint George, SC.

GREMLINS AT WORK

About the article in the November issue, "How to Dress up Your Projects." The first page was terrible. I could hardly read it.—Damon Hill, Atlanta, GA.

The circuits in Figs. 2 and 3 of "Experimenter's Corner," October 1977, should be interchanged.—G. Levelius, Mansfield, OH.

COMPLIMENTS ON QUALITY

Permit me to compliment POPULAR ELECTRONICS' quality and content. Some 25 years ago, I was reading the Amateur Radio magazines and remember PE as a pulp magazine that appeared to be written for the average sixth grader. I guess those sixth graders have grown up, and PE has kept pace with the growth, providing us with sophisticated and fascinating articles and magnificent ads. My only wish is that you would have more ads from some of the computer stores because I am so ignorant about computers that I do not know where or how to start digging out the information, equipment sources, etc.—Jay M. Burns, Luling, LA.

WANTS MORE "GUIDES"

I very much enjoyed and benefitted from "Guide to Oscilloscopes" (June 1977). I am a third-year electrical engineering student, and the article on scopes answered many questions my college instructors never bothered to address. I would like to see POPULAR ELECTRONICS publish similar features on power supplies, r-f generators, and VOM's. I am particularly interested in these items.—Charles B. Howard, Minneapolis, MN.

INTERFACING

While considering the construction of a giant digital scoreboard ("A Digital Timer-Scoreboard for Athletic Events," August 1975), I found a simple and very effective means of directly interfacing digital IC's to large ac displays. I used a light-activated SCR optoisolator (GE's H11C1). The Ga-As LED in this device can be driven directly by the current that normally drives one segment of a small LED display. I used the Intersil 7205 stopwatch IC, which has a 5-volt, 20-mA multiplexed output. Each segment of my giant display consists of four clear "nite lites" wired in parallel. The display consumes about 150 mA at 117 volts ac per segment, which is well within the 300-mA rating of the LASCR.—Doug Henry, Corvallis, OR.

LOG CONVERTER PART NUMBER CHANGE

In the "1/2-octave Real Time Audio Analyzer, Part 2," in the October 1977 issue, Texas Instruments has changed the number of IC36 from SN76502 to TL441 — Gil Gamesh, Babylon, N.Y.



NEW LSI TECHNOLOGY

FREQUENCY COUNTER

TAKE ADVANTAGE OF THIS NEW STATE-OF-THE-ART COUNTER FEATURING THE MANY BENEFITS OF CUSTOM LSI CIRCUITRY. THIS NEW TECHNOLOGY APPROACH TO INSTRUMENTATION YIELDS ENHANCED PERFORMANCE, SMALLER PHYSICAL SIZE, DRASTICALLY REDUCED POWER CONSUMPTION [PORTABLE BATTERY OPERATION IS NOW PRACTICAL], DEPENDABILITY, EASY ASSEMBLY AND REVOLUTIONARY LOWER PRICING!



1 1/4 LBS.
COLOR:
BLACK

SIZE:
3" High
6" Wide
5 1/2" Deep

FEATURES AND SPECIFICATIONS:

DISPLAY: 8 RED LED DIGITS .4" CHARACTER HEIGHT
GATE TIMES: 1 SECOND AND 1/10 SECOND
[AUTO DEC. PT. PLACEMENT]
RESOLUTION: 1 HZ AT 1 SECOND, 10 HZ AT 1/10 SECOND.
FREQUENCY RANGE: 10 HZ TO 60 MHZ. [65 MHZ TYPICAL].
SENSITIVITY: 10 MV RMS TO 50 MHZ, 20 MV RMS TO 60 MHZ TYP.
INPUT IMPEDANCE: 1 MEGOHM AND 20 PF.
[DIODE PROTECTED INPUT FOR OVER VOLTAGE PROTECTION.]
ACCURACY: ± 1 PPM [± .0001%] AFTER CALIBRATION TYPICAL.
STABILITY: WITHIN 1 PPM PER HOUR AFTER WARM UP [0.001% XTAL]
IC PACKAGE COUNT: 8 [ALL SOCKETED]
INTERNAL POWER SUPPLY: 5.2 V DC AT 800 MA. REGULATED.
INPUT POWER REQUIRED: 8-12 VDC OR 115 VAC AT 50/60 HZ.
POWER CONSUMPTION: 4 WATTS
INPUT CONNECTOR: BNC TYPE

**ORDER BY PHONE OR MAIL
COD ORDERS WELCOME**

KIT #FC-50C	60 MHZ COUNTER WITH CABINET & P.S.	\$119.95
KIT #PSL-650	650 MHZ PRESCALER [NOT SHOWN]	29.95
MODEL #FC-50WT	60 MHZ COUNTER WIRED, TESTED & CAL.	165.95
MODEL #FC-50/600 WT.	600 MHZ COUNTER WIRED, TESTED & CAL.	199.95

KIT #FC-50C IS COMPLETE WITH PREDRILLED CHASSIS ALL HARDWARE AND STEP-BY-STEP INSTRUCTIONS. WIRED & TESTED UNITS ARE CALIBRATED AND GUARANTEED. PRESCALERS WILL FIT INSIDE COUNTER CABINET.

TERMS: FOR SHIPPING, HANDLING & INSURANCE TO US & CANADA ADD 5% ALL OTHERS 10%. FLORIDA RES. ADD 4% SALES TAX. COD CHARGE \$1.00.



OPTOELECTRONICS, INC.

BOX 219 • HOLLYWOOD, FLA. 33022 • (305) 921-2056

101-416 p.—Electronic Circuit Design Handbook—4th Edition (\$17.95)

ELECTRONIC CIRCUIT DESIGN HANDBOOK

913-478 p.—The Complete Handbook of Electrical & House Wiring (\$10.95)

The Complete Handbook of Electrical & House Wiring

950-396 p.—Illustrated Dictionary of Broadcast-CATV-Telecommunications (\$14.95)

The Illustrated Dictionary of Broadcast-CATV-Telecommunications

Practical CB Radio Troubleshooting & Repair

754-238 p.—Practical CB Radio Troubleshooting & Repair (\$8.95)

Master Handbook of 1001 Practical Electronic Circuits

800-602 p.—Master Handbook of 1001 Practical Electronic Circuits (\$12.95)

BUILD YOUR OWN WORKING ROBOT

841-236 p.—Build Your Own Working Robot (\$8.95)

Modern Communications Switching Systems

678-278 p.—Modern Communications Switching Systems (\$17.95)

554-480 p.—Computer Technician's Handbook (\$14.95)

COMPUTER TECHNICIAN'S HANDBOOK

BY BRICE WARD

Photo Guide to AM/FM Stereo

934-288 p.—Photo Guide to AM/FM Stereo Repair (\$9.95)

709-296 p.—Modern Guide to Digital Logic: Processors, Memories & Interfaces (\$9.95)

The ABC Book of Hi-Fi/Audio Projects

921-170 p.—The ABC Book of Hi-Fi/Audio Projects (\$7.95)

Modern Digital Communications

955-308 p.—Modern Digital Communications (\$10.95)

"THE COMPULATOR" BOOK

975-322 p.—The "Compulator" Book—Build Super Calculators & Minicomputer Hardware With Calculator Chips (\$10.95)

How to Repair Home Kitchen Appliances

835-294 p.—How to Repair Home Kitchen Appliances (\$8.95)

CBer's Handybook of Simple Hobby Projects

868-168 p.—CBer's Handybook of Simple Hobby Projects (\$6.95)

How to Use AF & RF Signal Generators

927-238 p.—How to Use AF & RF Signal Generators (\$8.95)

Microprocessor Programming for Computer Hobbyists

952-382 p.—Microprocessor Programming for Computer Hobbyists (\$12.95)

3RD CLASS FCC LICENSE STUDY GUIDE

893-322 p.—Third Class FCC License Study Guide (\$9.95)

Handbook Of IC Circuit Projects

629-224 p.—Handbook of IC Circuit Projects (\$8.95)

Facts About Club Membership

- The 4 introductory books of your choice carry publishers' retail prices of up to \$65.80. They are yours for only 99¢ each (plus postage and handling) with your Trial Membership.
- You will receive the Club News, describing the current Selection, Alternates and other offerings, every 4 weeks (13 times a year).
- If you want the Selection, do nothing; it will be sent to you automatically. If you do not wish to receive the Selection, or if you want to order one of the many Alternates offered, you simply give instructions on the reply form (and in the envelope provided), and return it to us by the date specified. This date allows you at least 10 days in which to return the form. If, because of late mail delivery, you do not have 10 days to make a decision and so receive an unwanted Selection, you may return it at Club expense.
- To complete your Trial Membership, you need buy only four additional monthly selections or alternates during the next 12 months. You may cancel your Membership any time after you purchase these four books.
- All books—including the Introductory Offer—are fully returnable after 10 days if you're not completely satisfied.
- All books are offered at low Member prices, plus a small postage and handling charge.
- Continuing Bonus: If you continue after this Trial Membership, you will earn a Dividend Certificate for every book you purchase. Three Certificates, plus payment of the nominal sum of \$1.99, will entitle you to a valuable Book Dividend of your choice which you may choose from a list provided Members.

ELECTRONICS BOOK CLUB

Blue Ridge Summit, Pa. 17214

Please open my Trial Membership in ELECTRONICS BOOK CLUB and send me the 4 books circled below. I understand the cost of the books I have selected is only 99¢ each, plus a small shipping charge. If not delighted, I may return the books within 10 days and owe nothing, and have my Trial Membership cancelled. I agree to purchase at least four additional books during the next 12 months, after which I may cancel my membership at any time.

101	554	629	678	709	754	800
	841	868	885	893	913	
921	927	934	950	952	955	975

Name _____ Phone _____
 Address _____
 City _____
 State _____ Zip _____

(This offer valid for new Members only. Foreign and Canada add 10%) PE-18

May we send you your choice of 4 of these practical, time-and-money-saving books as part of an unusual offer of a Trial Membership in Electronics Book Club?

Here are quality hardbound volumes, each especially designed to help you increase your know-how, earning power, and enjoyment of electronics. Whatever your interest in electronics, you'll find Electronics Book Club offers practical, quality books that you can put to immediate use and benefit.

This extraordinary offer is intended to prove to you, through your own experience, that these very real advantages can be yours...that it is possible to keep up with the literature published in your areas of interest, and to save substantially while so doing. As part of your Trial Membership, you need purchase as few as four books during the coming 12 months. You would probably buy at least this many anyway...without the substantial savings offered through Club Membership.

To start your Membership on these attractive terms, simply fill out and mail the coupon today. You will receive the 4 books of your choice for 10-day inspection. YOU NEED SEND NO MONEY! If you are not delighted, return the books within 10 days and your Trial Membership will be cancelled without cost or obligation.

ELECTRONICS BOOK CLUB, Blue Ridge Summit, Pa. 17214

Learn to service Communications/CB equipment at home...with NRI'S COMPLETE COMMUNICATIONS COURSE

Learn design, installation and maintenance of commercial, amateur, or CB communications equipment.

The field of communications is bursting out all over. In Citizens Band alone, class D licenses grew from 1 to over 2.6 million in 1975, and the FCC projects about 15 million CB'ers in the U.S. by 1979. That means a lot of service and maintenance jobs . . . and NRI can train you at home to fill one of those openings. NRI's Complete Communications Course covers all types of two-way radio equipment (including CB), AM and FM

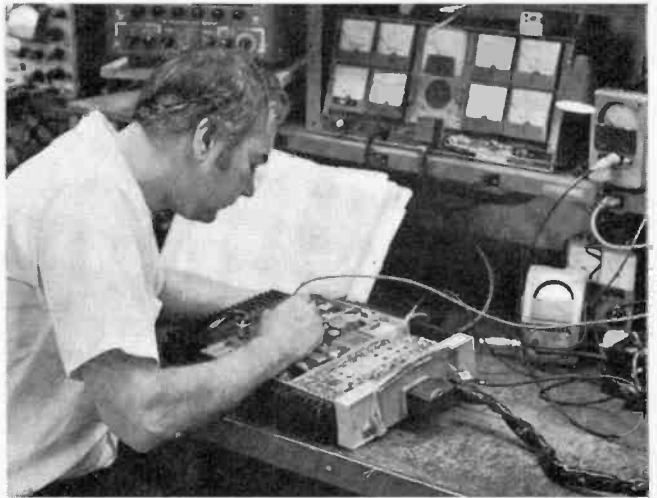

special instruction so you can go on the air.

The complete course includes 48 lessons, 9 special reference texts, and 10 training kits. Included are: your own electronics Discovery Lab, Antenna Applications Lab, CMOS Frequency Counter, and an Optical Transmission System. You'll learn at home, progressing at your own speed, to your FCC license and into the communications field of your choice.



Transmission and Reception, Television Broadcasting, Microwave Systems, Radar Principles, Marine Electronics, Mobile Communications, and Aircraft Electronics.

The course will also qualify you for a First Class Radio Telephone Commercial FCC License or you get your tuition back.

Learn on your own 400-channel digitally-synthesized VHF transceiver.

You will learn to service all types of communication equipment, with the one unit that is designed mechanically and electronically to train you for CB, Commercial and Amateur communications: a digitally-synthesized 400-channel VHF transceiver and AC power supply. This 2-meter unit gives you "Power-On" training. Then we help you get your FCC Amateur License with

NEW CB SPECIALIST COURSE NOW OFFERED



NRI now offers a special course in CB Servicing. You get 37 lessons, 8 reference texts, your own CB Transceiver, AC power supply and multi-meter . . . for hands-on training. Also included are 14 coaching units to make it easy to get your commercial radio telephone FCC license—enabling you to test, install, and service communications equipment.

NRI offers you five TV/Audio Servicing Courses

NRI can train you at home to service TV equipment and audio systems. You can choose from 5 courses, starting with a 48-lesson basic course, up to a Master Color TV/Audio Course, complete with designed-for-learning 25" diagonal solid state color TV and a 4-speaker SQ™ Quadraphonic Audio System. NRI gives you both TV and Audio servicing for hundreds of dollars less than the two courses as offered by another home study school.



All courses are available with low down payment and convenient monthly payments. All courses provide professional tools and "Power-On" equipment along with NRI kits engineered for training. With the Master Course, for instance, you build your own 5" wide-band triggered sweep solid state oscilloscope, digital color TV pattern generator, CMOS digital frequency counter, and NRI electronics Discovery Lab.



™Trademark of CBS Inc.

NRI's complete computer electronics course gives you real digital training.

Digital electronics is the career area of the future . . . and the best way to learn is with NRI's Complete Computer Electronics Course. NRI's programmable digital computer goes far beyond any "logic trainer" in preparing you to become a computer or digital technician. With the IC's in its new Memory Kit, you get the only home training in machine language programming . . . experience essential to trouble shooting digital computers. And the NRI programmable computer is just one of ten kits you receive, including a TVOM and NRI's exclusive electronics lab. It's the quickest and best way to learn digital logic and computer operation.

You pay less for NRI training and you get more for your money.

NRI employs no salesmen, pays no commissions. We pass the savings on to you in reduced tuitions and extras in the way of professional equipment, testing instruments, etc. You can pay more, but you can't get better training.

More than one million students have enrolled with NRI in 62 years.

Mail the insert card and discover for yourself why NRI is the recognized leader in home training. No



salesman will call. Do it today and get started on that new career.

APPROVED UNDER GI BILL
if taken for career purposes Check box on card for details.



NRI SCHOOLS
McGraw-Hill Continuing Education Center
3939 Wisconsin Avenue,
Washington, D.C. 20016

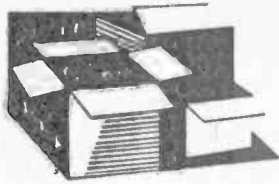

New Products

Additional information on new products covered in this section is available from the manufacturers. Either circle the item's code number on the Reader Service Card inside the back cover or write to the manufacturer at the address given.

SETTON TURNTABLE

The TS-11, a turntable with several convenience features, has been announced by Setton International. Controls are arranged on the front panel for easy access, and the dust-cover telescopes, rather than lifting, both to prevent jarring of the arm and to allow the

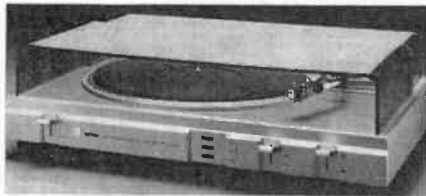

turntable's use on shelves with limited headroom. The two-speed turntable has an automatic return and shutoff. A light illuminates the stylus path as it moves across the disc, for easier manual cueing.

CIRCLE NO. 91 ON FREE INFORMATION CARD

COBRA CB/RADIO COMBINATIONS

Cobra Communications has announced two 40-channel CB/stereo FM-AM combination units for in-dash mobile use. Both are only 5 inches deep, with adjustable tuning shafts for easier adaptation to most cars, and are supplied with 24-page installation manuals. A built-in monitor circuit automatically cuts off sound from the AM/FM radio section when calls are received on any pre-selected CB channel. CB sections feature DynaMike gain control and an r-f/S meter. The Cobra 47XLR, with remote-control digital-readout microphone, pushbutton AM-FM tuning and PA output provision is \$299.95. The 46XLR, without those three features, is \$259.95. It includes front-panel LED channel readout.

CIRCLE NO. 92 ON FREE INFORMATION CARD

SHARP CASSETTE DECK

Microprocessor control is used to add several unique functions to Sharp's new RT-3388 cassette deck. The Auto Program Locate Device (APLD), which searches ahead to the next blank space between selections on existing Sharp decks, can be programmed on this one to jump ahead to the 2nd, 3rd, or even 19th such blank space, and either stop



or begin playing at that point. The memory rewind will not only rewind to zero (or any other point) and stop or begin playing, but can also be programmed to stop at any given point on the tape thereafter. The tape counter is an LCD digital display which can also be set to show the time a tape has been running. A built-in quartz digital clock allows timer-operated automatic recording or playback. Other features include Dolby noise reduction, dual VU meters with peak indicators, mike and line mixing, and separate bias and equalization selector switches. \$300.

CIRCLE NO. 93 ON FREE INFORMATION CARD

RAM STEREO PREAMPLIFIER

The RAM200 stereo preamplifier from RAM Audio Systems, Inc. features FET inputs, class-A output circuits, and some unusual control features. Balance is controlled by an array of 5 pushbuttons, which gives a range up to 30 dB of attenuation, in 2-dB steps, in either channel. Preamplifier output level is indicated in dBm by dual LED arrays. Input and output connections, including two phono circuits, tuner, aux, two tape monitor circuits and one external processor loop, are accessible beneath a removable panel at the top-rear of the cabinet. There is an additional front-panel input and tape output. Other features include direct input for moving-coil cartridges, automatic muting for amplifier and speaker protection, and a tape-output interlock that prevents feedback howl. THD and IM are reportedly each less than 0.02%, and S/N is greater than 80 dB on phono inputs. \$1000.

CIRCLE NO. 94 ON FREE INFORMATION CARD

MODULAR ELECTRONIC PROJECTS

A modular system of snap-in components that can be used to assemble a variety of educational electronic projects has been an-



nounced by Takahashi and Associates. Six kits are available, each consisting of a number of interchangeable module blocks carrying the symbols of the components they contain, plus a plastic frame with battery case, tuning capacitor meter and antenna. The number of module blocks supplied ranges from 12 in the smallest kit to 46 in the largest, whose frame also includes a light-sensitive CdS cell, a speaker and several built-in controls. Among the projects that can be assembled from the kits are a radio, a wireless microphone, a light control circuit, touch buzzer, morse code tone circuit, and others. No soldering is required. Address: Takahashi & Associates, 3183-G Airway Ave, Costa Mesa, CA 92626.

COMMANDER CB ANTENNA

"Magnum Ears", a twin-loaded CB mobile or apartment antenna only 13 inches high, has been announced by Commander. VSWR is adjustable to 1.2:1 or better, according to the



manufacturer. The twin-loaded radiating elements form a centered dipole with a claim of high efficiency. The antenna comes with a 6-pole magnetic base mount that measures 4" in diameter. \$21.95.

CIRCLE NO. 95 ON FREE INFORMATION CARD

OHIO SCIENTIFIC COMPUTER

Ohio Scientific has added the Challenger II to its Challenger microcomputer series. The new model is a complete computer, equipped with CPU, optional 8k BASIC in ROM, a 256k



Memory Management ROM, a 4k RAM and a serial port. The system can be operated at clock rates of 1 MHz or 2 MHz. It's available in two video-based models, the IIV and IIP.

CIRCLE NO. 96 ON FREE INFORMATION CARD

B.I.C. INDOOR FM ANTENNA

The "Beam Box," an electronically directable FM antenna styled to resemble other stereo components, has been announced by B.I.C.

POPULAR ELECTRONICS

Where superior technology makes the musical difference: Sansui's new DC integrated amplifier and matching tuner.

Sansui is proud to introduce the new AU-717 DC integrated amplifier and matching TU-717 tuner, designed for your greatest listening pleasure. We are proud of the superlative specifications that our sophisticated research has achieved. The finest available at any price.

But the best specs alone don't always mean the finest music reproduction. And so we are proud that our precision engineering and superior circuitry design create pure and brilliantly clean tonal quality that's distinctly superior.

Listen to what we offer: Frequency response of the AU-717 from main in, 0Hz to 200kHz (+0dB, -3dB), (the widest of any DC integrated amplifier available), gives you sharp, clear transients and greatly reduced phase shift problems. Total harmonic distortion is astoundingly low, less than 0.025%, from 10-20,000Hz. 85 watts/channel min. RMS, both channels driven into 8 ohms.

Dual independent power supplies provide truest stereo separation and a large power reservoir. For uncolored phono reproduction equalization is within ± 0.2 dB (20-20,000Hz, extended RAA curve). And the calibrated-

attenuator level control guarantees volume precision.

The matching TU-717 tuner features dual IF bandwidth to let you select for lowest distortion (0.07% mono, 0.07% stereo) or maximum selectivity (80dB). S/N is excellent: 80dB mono, 77dB stereo.

In addition, the AU/TU 717's are elegantly styled, offer rack mounting adaptors and are most attractively priced. Less than \$450* for the AU-717 and less than \$320* for the TU-717.

Listen to these brilliant new components at your franchised Sansui dealer today. When you hear the new Sansui AU/TU-717's, you will never again want to settle for less than the best.

Sansui. A whole new world of musical pleasure.

*Approximate nationally advertised value. The actual retail price will be set by the individual dealer at his option.



Sansui

SANSUI ELECTRONICS CORP.

Woodside, New York 11377 • Gardena, California 90247

SANSUI ELECTRIC CO., LTD., Tokyo, Japan

SANSUI AUDIO EUROPE S.A., Antwerp, Belgium • In Canada Electronic Distributors:

CIRCLE NO. 42 ON FREE INFORMATION CARD

FREE

McIntosh CATALOG and FM DIRECTORY

Get all the newest and latest information on the new McIntosh Solid State equipment in the McIntosh catalog. In addition you will receive an FM station directory that covers all of North America.



MX 113

FM/FM STEREO - AM TUNER AND PREAMPLIFIER

SEND TODAY!

McIntosh Laboratory, Inc.
East Side Station P.O. Box 96
Binghamton, N.Y. 13904
Dept. PE

NAME _____
ADDRESS _____
CITY _____ STATE _____ ZIP _____

If you are in a hurry for your catalog please send the coupon to McIntosh.

For non rush service send the Reader Service Card to the magazine.

CIRCLE NO. 27 ON FREE INFORMATION CARD

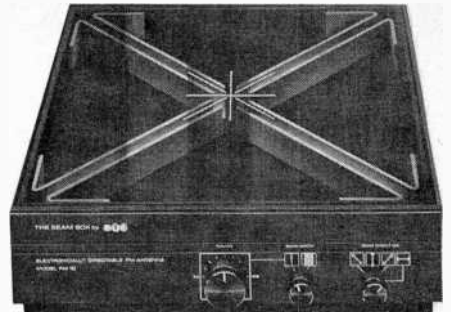

The antenna, which requires no batteries or power, has a bi-directional pickup pattern which can be oriented into any of four pairs of quadrants at 45° intervals, to reduce multipath interference. Switch-selected, broad and narrow bandwidth settings are available and the antenna may be tuned, in the narrowband position, to be less selective to unwanted signals. Bandwidth at the narrow setting is 3 MHz at -3dB points. At approximately 4 MHz from the tuned frequency, response is claimed down 10 to 12 dB. Gain is said to be -5 dB in narrowband position, -12 dB in wideband, referenced to a standard dipole. \$89.95.

CIRCLE NO. 97 ON FREE INFORMATION CARD

AP PRODUCTS BREADBOARDS

The Unicard series of reusable, solderless breadboard module cards from AP products has been revised. Like the previous Unicards, the new models include matrix breadboarding sockets on bus-wired circuit boards designed to plug into standard 5/4" card racks. They also have extractor handles for easy withdrawal and rubber feet for protection during bench work. The new Unicards' matrix sockets now have rows of 5 tie-points (vs. the previous models' 4), giving the new Unicard I a total of 960 tie-points (192 rows of 5) and 1620 (324x5) for the new version of the Unicard II. Prices start at \$31.50 for the Unicard I.

CIRCLE NO. 98 ON FREE INFORMATION CARD

HOBBYISTS! ENGINEERS! TECHNICIANS! STUDENTS!

Write and run machine language programs at home, display video graphics on your TV set and design microprocessor circuits — the very first night — even if you've never used a computer before!

SPECIFICATIONS

ELF II features an RCA COSMAC COS/MOS 8-bit microprocessor addressable to 64k bytes with DMA, interrupt, 16 registers, ALU, 256 byte RAM, full hex keyboard, two digit hex output display, 5 slot plug-in expansion bus, stable crystal clock for timing purposes and a double-sided plated-through PC board plus RCA 1861 video IC to display any segment of memory on a video monitor or TV screen.

RCA COSMAC microprocessor/mini-computer

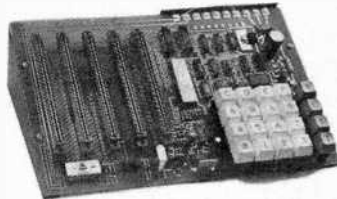

A THOUGHTFUL GIFT FOR ANYONE WHO MUST STAY UP TO DATE IN COMPUTERS AND ELECTRONICS!

ELF II \$99⁹⁵

USE ELF II FOR...

GAMES

Play interactive keyboard games, games with analog inputs, games utilizing your TV set for a video display!

GRAPHICS

Create pictures, designs, alpha-numerics and fabulous animated effects on your TV screen for hour after hour of family fun!

CIRCUIT DESIGN

Design circuits using a microprocessor. Use ELF II as a counter, alarm system, lock, controller, thermostat, timer, telephone dialer, etc. The possibilities are infinite!

Coming Soon!

Exclusive Netronics Plug-In Program Debugger and monitor allows visual display of any program on a clock pulse by clock pulse basis to help you learn programming 1-a-s-t! • 4k memory • Cassette I/O • D to A, A to D • Controller plug-ins.

Available now

SEND TODAY

NETRONICS R&D LTD., Dept. PE-1
333 Litchfield Road, New Milford, CT 06776 Phone (203) 354-9375
Yes! I want to run programs at home and have enclosed:
 \$99.95 plus \$3 p&h for RCA COSMAC ELF II kit. Featured in POPULAR ELECTRONICS. Includes all components plus everything you need to write and run machine language programs plus the new Pixie chip that lets you display video graphics on your TV screen. Designed to give engineers practice in computer programming and microprocessor circuit design, ELF II is also perfect for college and college-bound students (who must understand computers for any engineering, scientific or business career). Easy instructions get you started right away, even if you've never used a computer before!

As your need for computing power grows, five card expansion bus (less connectors) allows memory expansion, program debugger/monitor, cassette I/O, A to D and D to A converters, PROM, ASCII keyboard inputs, controllers, etc. (soon to be available as kits). Manual includes instructions for assembly, testing, programming, video graphics and games plus how you can get ELF II User's Club bulletins. Kit can be assembled in a single evening and you'll still have time to run programs, including games, video graphics, controllers, etc., before going to bed! \$4.95 for 1.5 amp 6.3 VAC power supply, required for ELF II kit. \$5.00 for RCA 1802 User's Manual.
 I want mine wired and tested with the power transformer and RCA 1802 User's Manual for \$149.95 plus \$3 p&h. Conn. res. add sales tax.

NAME _____
ADDRESS _____
CITY _____
STATE _____ ZIP _____
 Send info on other kits!
Dealer Inquiries Invited

BOSE SPEAKER SYSTEM

A new Bose Direct/Reflecting speaker system, Model 601, features four 3" tweeters and two 8" woofers, all radiating in different directions through the top and front of the ported enclosure. System impedance is 8 ohms;



POPULAR ELECTRONICS

crossover frequency, 2 kHz. Minimum amplifier power required is 15 watts rms per channel or more. A major portion of the sound energy is directed upward, both directly to the listener and indirectly via the wall above and behind the speaker, to position the sound above the level of sound-absorbing furniture and simplify speaker placement. A 2-position "symmetry control," which alters the speaker's directional characteristics by varying the signal level to the various drivers, is also provided as an aid to easier placement. The 601 is supplied in mirror-image pairs. Dimensions are 25.5"H x 15"W x 13"D (66 x 39 x 33 cm).

CIRCLE NO. 99 ON FREE INFORMATION CARD

PANASONIC CAR CASSETTE PLAYER

The Model CX-7100 cassette player is one of a new line of car audio components introduced by Panasonic. The CX-7100 has an auto reverse mechanism for continuous play, a two-stage preamp and dual-channel amplifier. Output power is 4.5 watts per channel at 400 Hz with 10% THD into a 4-ohm load. Other features include one-lever operation for fast forward/rewind/eject, lockable fast forward and rewind, and automatic and manual program selector, and a direction indicator lamp. Dimensions are 7 4/5"W x 2 12/25"H x 5 3/10"D (190 x 64 x 135 mm) and weight is 3.3 lb (1.5 kg). Price \$99.95.

CIRCLE NO. 100 ON FREE INFORMATION CARD

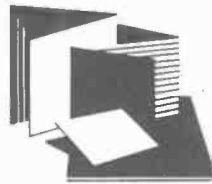

New Literature

CB ANTENNA TUNER BROCHURE

"The Ultimate in Antenna Tuning Systems," a new four-page brochure that describes new "isolated circuit" antenna tuners for mobile and base stations for CB operation is available from Norcom Electronics Inc. The brochure illustrates and describes the company's "Iso-Tune," "Back Talk," and "Ultra-Tune" antenna tuners, all of which are said to tune antenna systems to optimum SWR across all 40 channels. Address: Norcom Electronics Inc., 23611 Chagrin Blvd., Beachwood, OH 44122.

NBS HOME SECURITY ALARM PAMPHLET

Descriptions of the different home security alarm systems and their operation are highlighted in "Home Security Alarms: What They Are and How They Work" from the National Bureau of Standards. The pamphlet suggests where each type of system should be in-

stalled for best protection, explains how the sensors and "panic buttons" are connected to the control unit, tells how the alarm reports intrusions, and offers tips on cost, quality, and performance. Address: Home Security Alarms, Dept. 676E, Consumer Information Center, Pueblo, CO 81009.

ORA REPLACEMENT CATALOG

Eight-page catalog contains original Japanese replacement parts for the service of CB radio, TV, hi-fi equipment, etc. It features integrated circuits, transistors, ceramic filters, tape and cassette heads, plus more. Address: Ora Electronics, Box 7548, Van Nuys, CA 91409.

HEATH INSTRUMENTS CATALOG

A 32-page Heath/Schlumberger catalog lists their complete line of test instruments and new products. These include three new frequency counters with ranges up to 1 GHz, a FET multimeter, a lin/log swept-function generator, and a low-cost voltage-controlled function generator. Other instruments included are oscilloscopes, chart recorders, VOM's and VTM's, power supplies, distortion analyzers, color TV service equipment, learn-at-home electronics courses, and more. Address: Heath/Schlumberger Instruments, Dept. 570-010, Benton Harbor, MI 49022.

ok® wire wrapping center ok®

NEW HOBBY WRAP MODEL BW 630



Battery
wire
wrapping
tool

\$34.95
ONLY \$29.95
COMPLETE WITH BIT
AND SLEEVE

STRIP/WRAP/UNWRAP TOOL MODEL WSU-30



\$5.95*

RIBBON CABLE ASSEMBLY

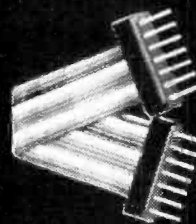

DIP SOCKETS

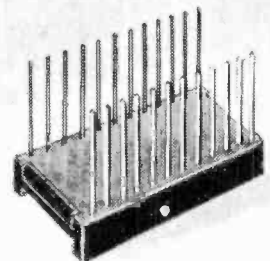

DIP IC INSERTION TOOL WITH PIN STRAIGHTENER

MODEL
INS-1416



\$3.49*

WIRE DISPENSER MODEL WD-30-B

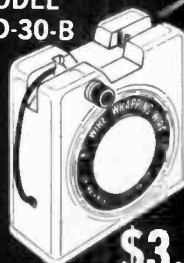

\$3.45*

PRE-CUT PRE-STRIPPED WIRE

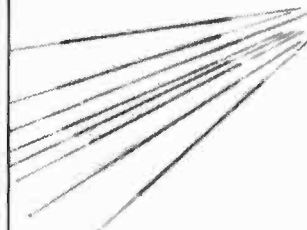

WIRE WRAPPING KIT

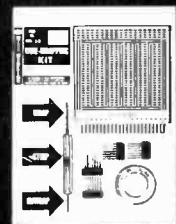

\$15.45*

*MINIMUM ORDER \$25.00, SHIPPING CHARGE \$1.00. N.Y. CITY AND STATE RESIDENTS ADD TAX

OK MACHINE AND TOOL CORPORATION

3455 CONNER STREET, BRONX, NEW YORK, N.Y. 10475 U.S.A.
PHONE (212) 994-6600 TELEX NO. 125091

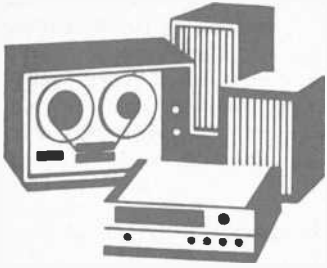

Stereo Scene

By Ralph Hodges

THE DIRECT-TO-DISC REVOLUTION(?)

NOT LONG AGO, I got my first chance to participate in a direct-to-disc recording session. It was not what you'd call a major production. Only one performer, a function generator, was involved, and the object was to put about a minute or so of a 1-kHz square wave on lacquer (i.e., the lacquer-coated aluminum disc on which a master disc recording is cut).

You probably have noticed oscilloscope photos of 1-kHz square waves in phono-cartridge test reports, usually

made with a square-wave test record from CBS. If the cartridge is reasonably good, the photos can look pretty decent in terms of waveform and visible resonances; and if a cartridge can make the waveform look good, we can generally assume that the recording itself is good, right? A fair assumption. However, CBS has cut that square wave without RIAA equalization, so that, with a magnetic phono cartridge, the recording must be played back with a "flat" phono preamplifier. Most consumers don't have a

suitable high-sensitivity preamplifier that lacks RIAA equalization. Therefore, our intention was to cut a square wave with the full RIAA recording preemphasis, so that it would play back flat on the average audiophile's phono system. This makes a world of difference and of difficulty in the cutting studio.

The Agony of Defeat. The sorry fact is that the best of modern disc-recording equipment cannot cut a clean 1-kHz RIAA square wave. At least it couldn't the way we were going about it, with a modified Wavetek function generator having a rise time almost faster than light. We used in succession the current Ortofon and Neumann cutters, generally considered to represent the state of the art, with about an equal lack of success. Even some of the cutters' electronics were found not up to the task, so that we had to bypass them and run straight into the lathes' power amplifiers. Still not good enough! A cutting-stylus assembly is a comparatively massy, inertia-plagued structure which, when stimulated in this brutal way, is just bound to ring. We could see the ringing under the microscope and we could see it when we played the test cuts, indicating that—in this respect at least—the playback phono cartridge was actually better than the cutting instrument.

Finally we fudged and cut a 500-Hz square wave instead (which, because we were doing half-speed cutting, was actually 250 Hz as far as the cutting head was concerned). This turned out to be much easier.

Direct-Cutting Philosophy. I began this column by saying that this was a direct-to-disc recording session, and it certainly was for a minute or two. However, almost all the rest of the many cuts we were putting onto our test record were derived from a master tape, and you may be justified in wondering why the square-wave test couldn't come from the master tape as well. The reason is that, as bad as a cutter head seems to be at handling a square wave, the typical tape machine is about a hundred times worse. Although tape recording involves no mechanical inertia (according to Barkhausen, there is definitely a sort of magnetic "inertia" involved, however), it does involve oodles of phase shift. Sony offers a phase-corrected machine (Model TC-880-2) that can reproduce a nicely recognizable



FREQ. OUT.

CSC's done it again.

Broken the price and performance barriers with the new MAX-100. The multimode, professional portable frequency counter that gives you more range, visibility, accuracy and versatility than any comparable unit at anywhere near its low, low price.

MAXimum performance.

MAX-100 is a cinch to use. It gives you *continuous readings* from 20Hz to a *guaranteed 100MHz*, with 8-digit accuracy. Fast readings with 1/6-sec. update and 1-sec. sampling rate. Precise readings, derived from a crystal-controlled time base with 3ppm accuracy. High-sensitivity readings from signals as low as 30 mV, with diode-circuit overload protection up to 200V peaks.

Input signals over 100MHz automatically flash the most significant digit. And to indicate low-battery condition and extend remaining battery life, the *entire display* flashes at 1Hz.

MAXimum versatility. Wherever and whenever you need accurate frequency readings, MAX can do the job. Use it with clip-lead cable supplied. Mini-whip antenna. Or low-loss in-line tap with UHF connectors. For AM or FM; CB, ham, business radio and R/C transmitter or receiver alignment. Monitoring audio and RF gen-

erators. Checking computer clocks and other digital circuits. Repair of depth sounders and fish spotters. Troubleshooting ultrasonic remote controls. For these, and hundreds of other applications, you'll find it indispensable.

MAXimum visibility. MAX-100 features a big, bright 0.6" multiplexed 8-digit LED display, with leading-zero blanking. So you don't have to squint, or work too close. And, MAX's flip-up stand is *built-in*.

MAXimum flexibility. MAX-100 operates from *four* power sources, for use in labor or field. Internal alkaline or NiCad batteries. 110 or 220V with charger/eliminator. 12V with automobile cigarette-lighter adapter/charger. And external 7.2-10V supply.

MAXimum value. With all its impressive specs, you'd expect MAX to cost a lot more than a low \$134.95, complete with clip-lead cable and applications/instruction manual. But that's another nice thing about MAX: though it's accurate enough for lab use, it's well within the reach of hobbyists' and CB-ers' budgets.

Try MAX for yourself at your CSC dealer — or contact us for full specs and your local dealer's name. Once you see how hardy MAX is, you'll want to "freq out" too. With CSC.

Specifications.

Range: 20 Hz to 100 MHz, guaranteed.
Gate time: 1 sec. **Resolution:** 1 Hz. **Accuracy:** ± 1 count + time base error. **Input Impedance:** 1 M Ω /56 pF. **Coupling:** AC. **Sine Wave Sensitivity:** 30 mV RMS @ 50 MHz. **Internal Time Base Frequency:** 3.579545 MHz crystal osc. **Sensitivity:** ± 3 ppm @ 25°C, 0-50°C. **Temp-Stability:** Better than 0.2 ppm/°C. **Max. Aging:** 10 ppm/year. **Display:** Eight .6" LED digits; anti-glare window. **Leading-zero blanking:** decimal point appears between 6th and 7th digit when input exceeds 1 MHz. **Overflow:** with signals over 99,999,999 Hz, most significant (left hand) digit flashes, allowing readings in excess of 100 MHz. **Display update:** 1/6-second plus 1 sec. gate time. **Low Battery Indicator:** When power supply falls below 6.6 VDC, all digits flash @ 1 Hz rate. Flashing display extends battery life. **Power:** 6 AA Alkaline or NiCad cells (internal); **External:** 110 or 220 VAC Eliminator, charger; Auto cigarette lighter adapter; 7.2-10 VDC ext. supply; **Bat. Charging:** 12-14 hr. **Size (HWD):** 1.75" x 5.53" x 7.75" (4.43 x 14.30 x 19.69 cm.) **Weight:** Less than 1.5 lb. (0.68 kg) w/batteries. **Accessories Included:** Clip-lead input cable; manual.

CONTINENTAL SPECIALTIES CORPORATION

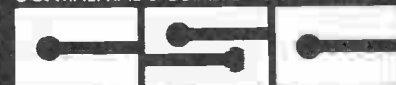

70 Fulton Terrace, Box 1942, New Haven, CT 06509
 203-624-3103 TWX 710-465-7257
 WEST COAST: 351 California St., San Francisco, CA 94104,
 415-421-8872 TWX 310-372-7952
 GREAT BRITAIN: CSC, LK LTD,
 Spu Road, North Feltham Trading Estate,
 Feltham, Middlesex, England.
 DR-290-8782 Int'l Telex 851-881-3669
 MEXICO: ELPRO, S.A., Mexico City 5-23-30-04
 CANADA: Len Finlier Ltd., Ontario

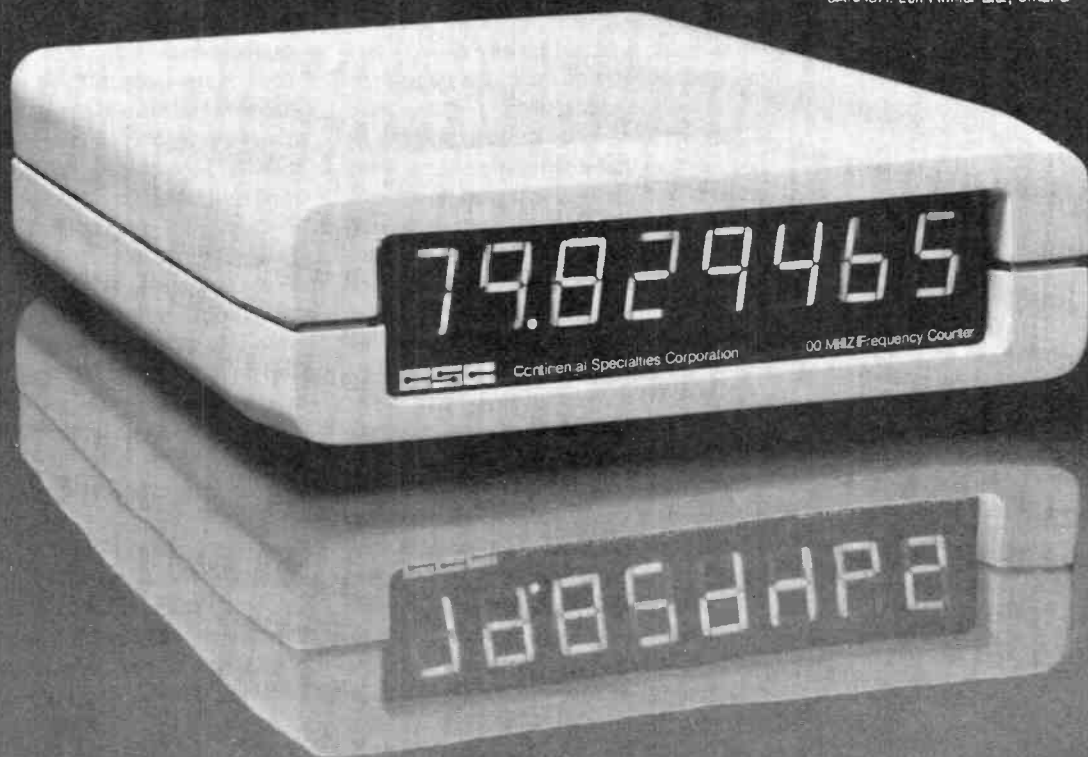

CIRCLE NO. 8 ON FREE INFORMATION CARD

Good soldering begins with the right solder selection

Different soldering applications require different alloys and different fluxes. Even different combinations of the two. You can't solder stainless steel, a pc board or aluminum with the same material. It just won't work. And that's a fact.

Now Multicore makes soldering easy. Not only to select the right solder. But to use it also. The flux is included in the solder as multiple cores. And in just the right ratios. There's no mess. Nothing to add. Think of it. Multiple cores for better distribution of the flux. You solder faster. Use less solder. Get better results. And that's a fact too.

Prove it to yourself.



Send For Your Solder Sampler Kit

Consists of 5 special solders each in a feed-out metal dispenser. Totals over 60 ft. for every solder requirement.

ELECTRICAL: Best general purpose solder with non-corrosive rosin flux for all types of wiring. Savbit® formula protects soldering iron tip from wearing out.

ELECTRONIC: A 60/40 tin/lead alloy, but extra thin (22 gauge) for electronic applications. Non-corrosive rosin flux cores.

STAINLESS STEEL AND SILVER JEWELRY: A tin/silver alloy with special flux; contains no lead. Blends in so well, you can hardly tell where it's been used.

ALUMINUM: Special flux and silver alloy combination for soldering aluminum. There's nothing like it on the market.

PLUMBING AND SHEET METAL: For most metal joining applications except aluminum. Uses acid type flux.

ALL 5 FOR \$8⁹⁵ Shipping and handling included

Plus Bonus Pak of Emergency Solder

A flat, tape-like solder that melts with a match, ideal for most on-the-spot emergency repairs

MULTICORE SOLDERS
DEPT. PE 178, WESTBURY, N.Y. 11590

Send me a "Solder Sampler Kit" at the special \$8.95 price (limit of one per person) and include my bonus Emergency Solder.

NAME _____

ADDRESS _____

CITY/STATE/ZIP _____

Check or money order must accompany order
N.Y. State residents add approx. Sales Tax

FREE Solder User's Guide

No purchase required. Just circle reader service card.

Multicore
SOLDERS

square wave for an oscilloscope display. But even so, in comparison with a cutting lathe, most tape machines come off a distinct second best, all possible things being considered.

At present, phase shift is a controversial subject in audio circles. It's easy to demonstrate that you can put a square wave through huge amounts of it and never hear the difference. But on the other hand, process it in another way and you might hear a very distinct difference. And, of course, keeping track of phase phenomena in a modern recording facility handling music signals by means of multiple microphones, several tape machines, numerous signal processors, and finally a cutting lathe is staggeringly complex. In fact, in practice no one really attempts to do it; everyone down the line just tries to trust his ears.

This is one of the cases frequently made for direct-to-disc recordings, the recent proliferation of which has come as a great surprise to many both within and outside the music/recording industry. To take the points made by the direct-cut recordists and their disciples in some sort of order:

(1) Simplify. Eliminate all those generations of tape, which can only degrade rather than exalt the final result, and take the music right to its final recorded form as directly as possible.

(2) Again, simplify. A direct-cut recording must take place in real time, and it is absolutely final. The mixing engineer will therefore have to decide on his basic balances right at the start, and forget about any possibility of "fixing" them somehow in a later mixdown session. He will also realize that any wrong move he makes at the mixing console will ruin an entire LP side, every single note of which will have to be rerecorded. On the assumption that an engineer/producer's second and third guesses are frequently worse than his first (made when the performers were actually present and playing), the direct-to-disc approach imposes a harsh discipline that will (theoretically) make for a better final recording. It will also serve to make the engineer/producer much more conservative, which is the way audio purists generally think he ought to be.

(3) And yet again, simplify. Many audiophiles and many audio professionals suspect that the Dolby system and other noise-reduction processors, which have largely contributed to making the whole multitrack recording technique possible, are responsible for considerable audible degradation of the final result. (This is

not by any means proven, I hasten to point out.) Properly executed direct-disc recording is inherently quiet, so you can get rid of all the black boxes.

(4) Improve. The tape medium in its present form is seriously limited by noise on the one hand and magnetic-saturation effects on the other. The disc medium is temperature, excursion, and velocity limited. Temperature is always a consideration; it is readily possible to burn out the coils of a cutter head. But temperature considerations are largely irrelevant to noise and distortion. As for excursion and velocity, a modern cutter can create a groove that undulates widely and rapidly enough to throw any available playback stylus into fits of mis-tracking. Hence a tape recordist constantly flirts with distortion to maintain dynamic range. A disc recordist need worry only about seeing smoke—and about the possibility of cutting a groove that no consumer record player will be able to follow. Thus, disc recording is superior (theoretically) in performance potential and overall flexibility.

(5) Rationalize. The disc medium does of course have some serious ultimate limitations, most of them concerned with the fact that an LP record is only 12 inches wide. Grooves take up space, and the more vigorous their excursions the more space they take up. It occasionally happens that a recording studio sends a 60-minute tape, full of electric bass and kick drum, to a disc-mastering house with instructions to turn it into a single LP that is louder and bassier than anything in the "Top Ten." Well, it simply can't be done. So the disc engineer curses the tape engineer, and finally some compromise is worked out whereby the tape is either "conditioned" to suit the disc's limitations and/or some material is dropped. Now had the disc engineer been involved from the moment the first microphone was set up, making available his intimate knowledge of the potential and limitations of his equipment (with which the tape engineer often has only a passing familiarity), the final recording would be (theoretically) much more rationally and carefully produced. I need hardly point out that, in a direct-to-disc situation, the disc engineer is present right from the beginning.

The Consumer View. Everyone I know who has heard any of the better direct-to-disc productions has recognized their sonic merits to at least some degree (the musical merits of some of them are debatable, though). I will never

Magazines At Discount



Reg. Rate: 2 Issues/\$12

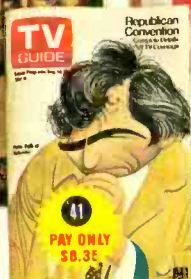

Lowest Avail. Sub. Rate/32 Issues



Newsstand Rate: 25 Issues/\$25

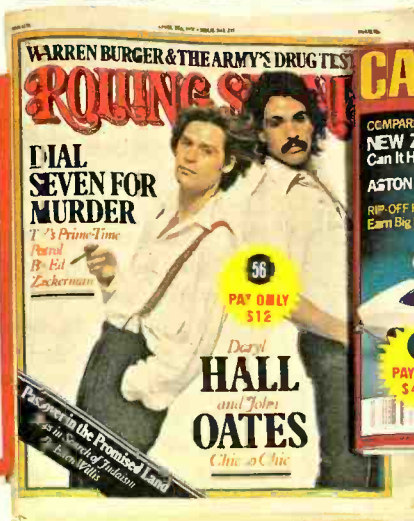

Reg. Rate: 26 Issues/\$18



Reg. Rate: 12 Issues \$9.98

You SAVE up to 50%

Here's your chance for a real bargain bonanza on your favorite magazines. You may select as many as five of these titles at the special introductory rates shown — up to 50% off! To order, indicate the magazines you want by inserting their code numbers in the boxes on the attached order card. Or write to: MAGAZINES AT DISCOUNT, A Division of Ziff-Davis Publishing Co., P.O. Box 2703, Boulder, Colorado 80322.

CHOOSE YOUR FAVORITES AT DISCOUNT PRICES!

24 ISSUES APARTMENT LIFE YOU PAY ONLY \$7.97 Reg. Rate: 24 issues \$14.97 21	12 ISSUES GOLF YOU PAY ONLY \$3.97 Reg. Rate: 12 issues \$7.94 63	12 ISSUES Outside YOU PAY ONLY \$7.99 Reg. Rate: 12 issues \$12 82	6 ISSUES skeptic YOU PAY ONLY \$6 Reg. Rate: 6 issues \$9 83
4 ISSUES BACKPACK YOU PAY ONLY \$6 Reg. Rate: 4 issues \$9 67	12 ISSUES HOUSE BEAUTIFUL YOU PAY ONLY \$6.97 Reg. Rate: 12 issues \$10 74	12 ISSUES Popular Electronics YOU PAY ONLY \$7.97 Reg. Rate: 12 issues \$12 06	7 ISSUES SKIING YOU PAY ONLY \$4.99 Reg. Rate: 7 issues \$7.98 09
51 ISSUES Business Week YOU PAY ONLY \$26 Newsst. Rate: 51 issues \$63.75 48	17 ISSUES McCall's YOU PAY ONLY \$9.97 Newsst. Rate: 17 issues \$16.15 27	12 ISSUES POPULAR PHOTOGRAPHY YOU PAY ONLY \$5.99 Reg. Rate: 12 issues \$11.98 07	12 ISSUES SPORTS AFIELD YOU PAY ONLY \$7.50 Reg. Rate: 12 issues \$15 75
12 ISSUES CAR DRIVER YOU PAY ONLY \$4.99 Reg. Rate: 12 issues \$9.98 02	18 ISSUES Mechanix ILLUSTRATED YOU PAY ONLY \$5.96 Reg. Rate: 18 issues \$9.97 28	18 ISSUES Popular science YOU PAY ONLY \$5.97 Reg. Rate: 18 issues \$18.91 35	26 ISSUES Sports Illustrated YOU PAY ONLY \$9.97 Reg. Rate: 26 issues \$26 38
12 ISSUES COUNTRY MUSIC YOU PAY ONLY \$7.95 Newsst. Rate: 12 issues \$12 76	10 ISSUES MOTHER JONES YOU PAY ONLY \$8.88 Reg. Rate: 10 issues \$12 69	12 ISSUES Prevention YOU PAY ONLY \$6.99 Reg. Rate: 12 issues \$7.85 36	12 ISSUES Stereo Review YOU PAY ONLY \$4.99 Reg. Rate: 12 issues \$9.98 11
12 ISSUES Cycle YOU PAY ONLY \$4.99 Reg. Rate: 12 issues \$9.98 03	12 ISSUES Ms. YOU PAY ONLY \$5 Reg. Rate: 12 issues \$10 47	12 ISSUES psychology today YOU PAY ONLY \$6.97 Reg. Rate: 12 issues \$12 08	25 ISSUES TIME YOU PAY ONLY \$12.50 Newsst. Rate: 25 issues \$25 40
9 ISSUES Handyman YOU PAY ONLY \$5.95 Reg. Rate: 9 issues \$7.95 51	25 ISSUES Newsweek YOU PAY ONLY \$12.50 Newsst. Rate: 25 issues \$25 44	14 ISSUES REDBOOK YOU PAY ONLY \$7.97 Newsst. Rate: 14 issues \$13.30 37	32 ISSUES TV GUIDE YOU PAY ONLY \$8.35 Lowest Avail. Sub. Rate: 32 issues 41
18 ISSUES Field & Stream YOU PAY ONLY \$5.97 Reg. Rate: 18 issues \$11.93 43	26 ISSUES NewTimes YOU PAY ONLY \$7.50 Reg. Rate: 26 issues \$15 31	26 ISSUES ROLLING STONE YOU PAY ONLY \$12 Reg. Rate: 26 issues \$18 56	52 ISSUES TV GUIDE YOU PAY ONLY \$13.56 Lowest Avail. Sub. Rate: 52 issues 99

EARN MONEY

as a

Wilson Dealer

You can make large profits as a lucrative Wilson Dealer of Citizens Band and Amateur products: Base Station and Mobile Antennas, Crank-up Towers, Rotors, Amateur Radios . . . and more!

The Dealer Program provides for prepaid freight, fast delivery of in-stock products, sales assistance — with extensive national advertising and free descriptive literature. Get the details of how easily you can qualify in your marketing area, no inventory investment required.



Fill out and mail the coupon below and we will send all the details.

Consumer Products Division
Wilson Electronics Corp.

"The fastest growing name in Communications"
P. O. Box 19000, 4288 So. Polaris
Las Vegas, NV 89119, (702) 739-1931

I am interested in a Wilson Dealership. Please send details.

Name _____

Address _____

City _____ State _____ Zip _____

Phone _____

CB Products Amateur Products

forget the expression on the face of a widely known and respected tape authority when he heard the concluding finger-cymbal "ping" on the "Peace Train" cut (Sheffield release number 2) come through his speakers. And that points up one of direct-to-disc's distinct advantages: the disc medium is capable of considerably more dynamic range at high frequencies than is the current tape medium. As Craig Stark clearly pointed out in an article in the November issue of this magazine, tape will actually lose high-frequency energy the further it is driven into saturation. The disc medium, particularly if a CD-4 cutting stylus is used, will not lose "recoverable" energy in this way; it may actually gain energy from distortion products (which may come from overload of the cutter-head amplifiers, the cutter head itself, or your playback stylus or electronics).

Otherwise, reaction to the direct-to-disc phenomenon seems to be mixed. In what I think is the majority view, serious listeners believe that a disc recording originating from a tape source can be just as technically satisfying, although it may not be capable of quite so many sonic pyrotechnics. I won't comment except to say that most recordings I hear are far from equalling the better direct-to-disc productions. Of course, this is readily attributable to the typical record's being a mass-produced product—a carefully mass-produced product, yes, but one that does not generally receive more care than what is considered necessary for mass-marketability. When someone goes to the trouble of producing a direct-to-disc recording, he is not likely to neglect the subsequent metalwork, pressing, and packaging that will bring it to the consumer in the most attractive form possible. Some, like the Umbrella albums distributed by Audio Technica, bear a prominent individual serial number, and are treated in every way like a limited-edition fine arts print. (Incidentally, direct-to-disc recordings are true limited editions. When all the parts involved in pressing the record, from lacquer to metal master to mother to stamper are worn out, the recording ceases to be available unless the performers go back into the recording studio and do it all over again. Some direct-to-disc producers even skip the mother-stamper stages and press from the metal masters, which makes the edition even more limited, although of potentially higher quality.)

Aesthetics may also deserve a part in the direct-to-disc picture. My reaction on

first hearing the Lincoln Mayorga Brahms-Handel piano coupling (Sheffield Lab 4) was that the performance, although not likely to devastate the musical world, had a very satisfying vitality, flow and continuity. Continuity is forced upon a performer by the direct-cut process; a cutting lathe cannot be stopped at mid-LP side and then restarted. Many music appreciators seem to feel that the patched-together performance made possible by tape editing has become a wretched excess—another instance in which direct-to-disc imposes a possibly beneficial discipline on all the parties that are involved.

Most people believe that economics will determine the final fate of direct-to-disc recording. As far as I know, you cannot buy a direct-cut disc for less than about \$12, which may be a bargain because these recordings are not cheap to produce. The one truly large-scale production to emerge so far is Telarc's recording, distributed by Discwasher, of the Cleveland Orchestra playing selections of Berlioz and others. (However, look for at least one big orchestral release from Sheffield at any moment.) I have nothing but admiration for the dedicated people who embarked on this project, but it must have been frighteningly expensive to finance. And it is, alas, flawed (flawed in my opinion by an improper application of multi-miking techniques—a practice that the "simplicity" philosophy of direct-to-disc seemed destined to resist). As has been pointed out, the recording does not offer an overwhelming amount of music per side, both because the sides were intended to be of the highest quality and because the recording engineer had to space the grooves by intuition. (When you cut a record from a tape, a "preview" head some distance in front of the actual playback head scans the tape and directs a computer to allow as much groove spacing—but no more—as is necessary to accommodate the musical violence that is to follow.)

Still, the Telarc/Cleveland production has some exciting things to be heard, if your sound system and your aural expectations are as demanding as my own. As listeners to recorded music, we may never encounter its like again. And there is one thing everyone is hopeful about: that the conspicuous success of the direct-to-disc revolution will force the standards of all recorded music to become that much higher. At present, the great body of recorded music has a long way to go. ◇

The most important piece of audio equipment you'll ever own.

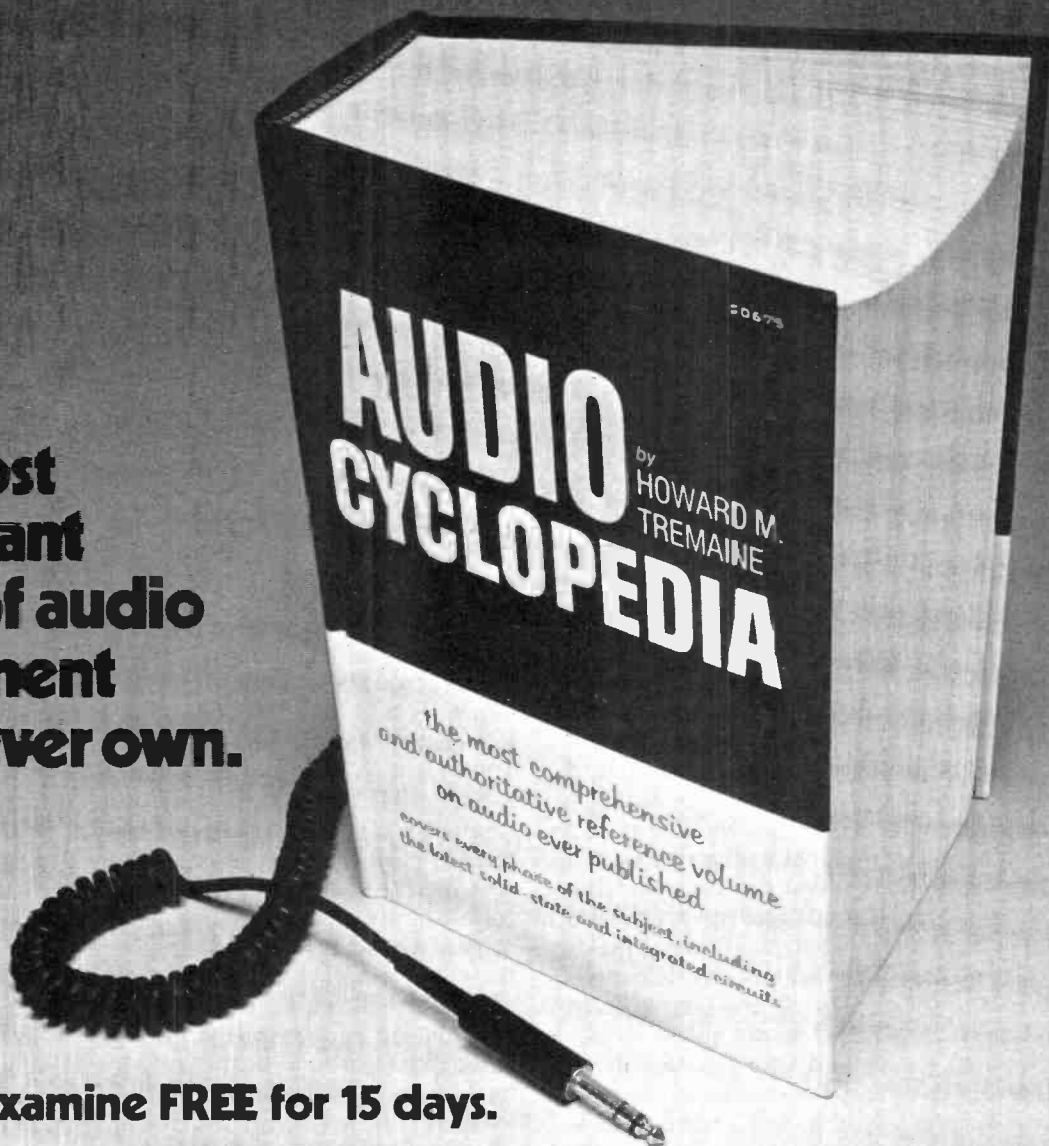

Yours to examine FREE for 15 days.

25 FACT-FILLED CHAPTERS ARRANGED IN "EASY-TO-FIND" QUESTION AND ANSWER FORM

- Basic Principles of Sound
- Acoustics, Studio techniques, and Equipment
- Constant-Speed Devices, Motors, and Generators
- Microphones
- Attenuators
- Equalizers
- Wave Filters
- Transformers and Coils
- Sound Mixers
- VU and Volume Indicator Meters
- Vacuum Tubes, Transistors, and Diodes
- Audio Amplifiers
- Disc Recording
- Cutting Heads
- Recording and Reproducing Stylus
- Pickups
- Magnetic Recording
- Optical Film Recording
- Motion Picture Projection Equipment
- Loudspeakers, Enclosures, Headphones, and Hearing Aids
- Power Supplies
- Test Equipment
- Audio-Frequency Measurements
- Installation Techniques
- General Information, Charts and Tables

Be our guest. Examine the AUDIO CYCLOPEDIA free for 15 days. You'll find out why it is considered the most comprehensive and authoritative book ever written on the subject. And you'll get a FREE \$3.50 bonus book to keep no matter what!

The AUDIO CYCLOPEDIA is literally a one-book audio library. It has long been considered "the bible" by amateur stereo buffs as well as professional technicians. That's why you'll find it in constant use not only in home workshops and at stereo centers, but also in recording studios, broadcast booths and concert halls.

This giant reference book is over 3" thick,

and packed with 1,757 illustrated pages. It features 3,645 questions and answers and a 50 page "instant-find" index for subject identification. It is truly the big one in audio electronics and it puts all the information you'll ever need right at your fingertips, chapter by chapter.

Send for the AUDIO CYCLOPEDIA today. If you don't agree that it's the most important piece of audio equipment you own, just return it within 15 days. You won't owe a cent. And no matter what you decide, you'll get a free \$3.50 copy of *The ABC's of Tape Recording* to keep just for mailing the coupon.

FREE-BOOK FREE-TRIAL COUPON



Save postage & handling costs. Full payment enclosed (plus tax where applicable). 15-day return privilege still applies.

Yes, please rush me the AUDIO CYCLOPEDIA (#21455) for my free trial. I understand if not completely satisfied, I may return it within 15 days, and owe nothing. Otherwise, I'll keep it for only \$39.95 plus postage and handling and local taxes (where applicable).

And, whatever I decide, a copy of "The ABC's of Tape Recording" (valued at \$3.50) is mine free!

Name _____
 Address _____
 City _____
 State _____ Zip _____



Mail to Audel
 4300 W. 62nd Street
 Indianapolis, Indiana 46206
 A Division of Howard W. Sams & Co., Inc. EB37A



Audio Reports

LOUDNESS CONTROL—BOON OR BANE?

MOST PEOPLE, when they first see a knob labelled "loudness" on a high-fidelity amplifier or receiver, probably assume that it is just a volume control under a different name. To be sure, it does control volume, but the distinction between a *volume* control and a *loudness* control is much more than a matter of semantics or word choice.

In the earliest days of hi-fi, people became aware that, when the volume of a musical or vocal program was reduced, the balance between the low, middle, and high frequencies was altered. The apparent bass volume decreased much more than the mid-range, or overall volume level, and to a lesser extent there was an exaggerated loss of highs as well. The effect was to give a program a thin, constricted sound at low listening levels, even when the system was capable of delivering a full-frequency-range response at normal listening levels.

The explanation of this effect lies not in the equipment, but in a property of the human ear. We do not hear all frequencies with equal loudness, even though they may impinge on the ear with equal intensity. The ear is most sensitive at about 3500 Hz and slightly less so at lower and higher frequencies, even at high volume levels. In addition, the change in hearing sensitivity (the human frequency response, if you will) is also level dependent. At sound levels of 90 dB or more (a rather loud level for home music reproduction) there is relatively little difference in hearing sensitivity over much of the audio range, except for the broad peak in response at about 3500 Hz. As the absolute sound level is decreased, low frequencies must be emphasized proportionally in order to sound as loud as a 1000-Hz reference tone. The same sort of emphasis is required at high frequencies for equal apparent loudness, except that the shape of the curve at high frequencies changes very little with changes in loudness.

A number of acousticians have made experimental studies of this effect. Perhaps best-known were Fletcher and Munson, of Bell Telephone Laboratories, whose findings were published in the early 1930's. Subsequently, other investigators derived somewhat different families of curves that relate subjective loudness to frequency and level. The Fletcher-Munson Equal Loudness Contours are reproduced in

Fig. 1. As we shall see, their validity, or lack of it, as compared to the results obtained in later experiments, has little bearing on the subject at hand. The contours represent the sound pressure level (SPL) required at various frequencies to sound as loud as a 1000-Hz tone does at the indicated level.

Early hi-fi enthusiasts were quick to relate the phenomenon of apparent loss of bass at low volumes to the Fletcher-Munson effect. If their findings were correct, it would be reasonable to assume that, if a truly high-fidelity recording of a musical performance which would be heard at levels of 90 dB or more in the concert hall were to be played in the home at a 60-dB average level, there would be a considerable loss of apparent bass response. In fact, the Fletcher-Munson contours show that a 30-Hz tone would have to be boosted in level by about 25 dB to sound as loud as a 1000-Hz tone at 60 dB but would require a correction of only about 3 dB at 90-dB levels.

An apparently simple and logical solution to this dilemma would be to build a frequency compensating circuit into the volume control of the amplifier so that reducing the midrange level boosts the bass (and possibly the treble, although there are differing views on this) in the correct amounts to conform to the shape of the equal-loudness contour for each listening level. This is essentially what has been done (or at least attempted) in the vast majority of amplifiers and receivers manufactured for the high-fidelity market in the past 25 years or more.

Unfortunately, although all of these *loudness compensators* do pretty much what they were designed to do (electrically), most of them fail dismally to make a recording or broadcast sound as natural at low levels as it does at higher listening levels. Worse, most of them make the sound so tubby and heavy that few serious music lovers would even consider using the compensation. Fortunately, in almost every amplifier, it can be switched off, leaving the "loudness control" to act as a normal volume control.

To see why these schemes fail, take another look at the Fletcher-Munson curves. Each is related to a specific sound pressure level at the listener's ear. Now look at the family of loudness compensation frequency-response curves in Fig. 2, which are typical of the performance of most modern amplifiers and re-

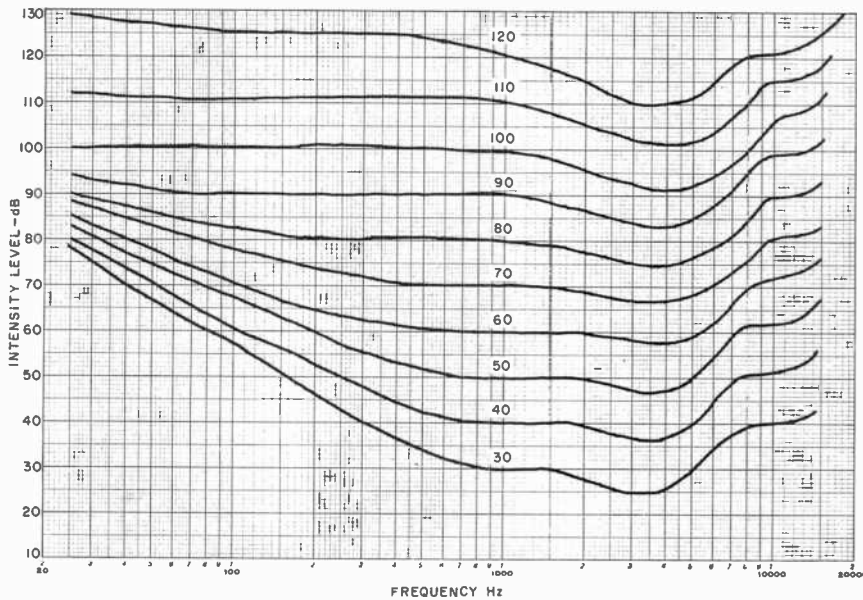

Fig. 1. Fletcher-Munson curves show how perceived loudness varies with frequency even though test signal amplitude remains constant over range.

ceivers. Each is related to a specific amplifier volume control setting, with 0 dB corresponding to a maximum volume setting. Unfortunately, there is no relationship between the two sets of curves. Even their shapes are different, but if they were alike, the situation would be no better. Depending on the gain of the amplifier, efficiency and frequency response of the speaker systems, size of the listening room and its furnishings, listening level preferences, particular recording, sensitivity of the phono cartridge, acoustic conditions under which the recording was made, and other factors equally beyond the listener's control or knowledge, the amount of boost provided by the loudness control may be nearly correct. However, it is more likely to give too much or too little compensation at any given frequency. There is literally almost no chance for such a system to perform properly.

It would appear to be self-evident that *any* type of loudness compensation must have a means for independently setting the absolute listening level and the amount of compensation applied. In effect, this means two volume controls are required. Inexplicably,

this point seems to have escaped the attention of the vast majority of receiver and amplifier designers. (They know better, of course, but marketing considerations tend to dominate the situation.) The end result is the almost universal use of a simple tapped volume control with a capacitor or a simple RC network that comes into play at a certain control setting, regardless of program level.

All of the equal-loudness contour curves were derived from measurements made on numbers of human subjects and statistically processed so that the result is a sort of composite or "average" hearing response. Statistics being what they are, there is always a good chance that you or I will hear things differently from the predictions of the curves. Even if the compensation worked perfectly, it would not be correct for us. In this author's opinion, the exact compensation curve used at any given control setting is relatively unimportant, since the whole process is at best a crude approximation. Any of the proposed compensation curves, when applied correctly, is probably better than nothing. However, when they are applied

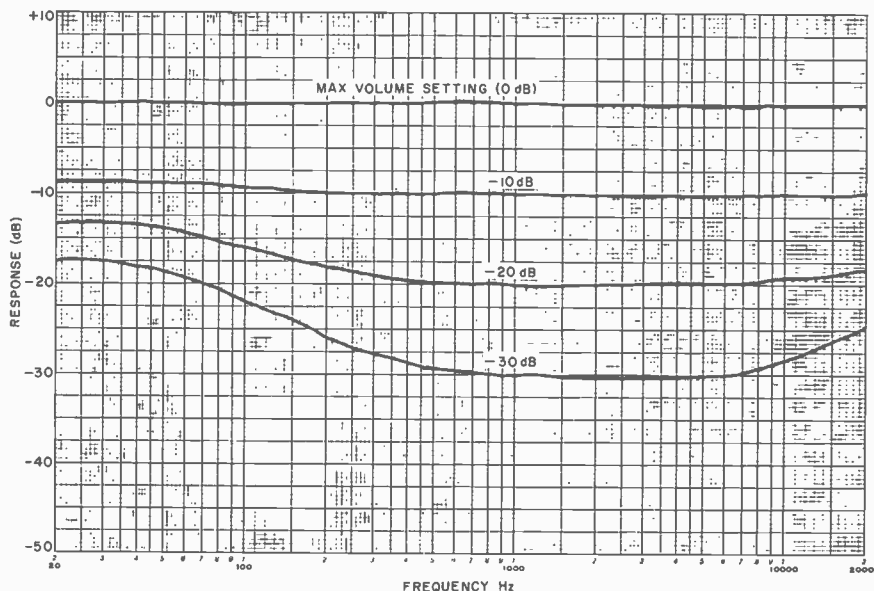

Fig. 2. Loudness compensation curves typical of performance of most modern amplifiers and receivers. Each is related to a specific volume setting.

incorrectly, it is certain that any of them is worse than nothing at all.

The situation is not completely hopeless, however. The handful of receivers and amplifiers that do have separate volume and loudness controls can usually be made to sound at least acceptable when loudness compensation is used for low-level listening. Some are better than others, and individual preferences certainly play a part in such quality judgments. One of the best indications of a good loudness compensation system is that the loudness of the program hardly seems to change as the control setting is changed.

This may seem paradoxical (after all, we do want to change the volume), but the key word is "seems."

A case in point is the Yamaha Model CR-2020 receiver reviewed in this issue. It is astonishing how little the quality of the program changes as the loudness control is operated through its full range, yet the mid-range level has changed by 20 dB, or a power ratio of 100 times. The program becomes less loud, but almost imperceptibly so because the frequency balance is maintained at a subjectively constant value. This is the entire justification for the loudness control in the first place.



YAMAHA MODEL CR-2020 AM/STEREO FM RECEIVER

Medium-high-power receiver has exceptionally versatile operating flexibility.

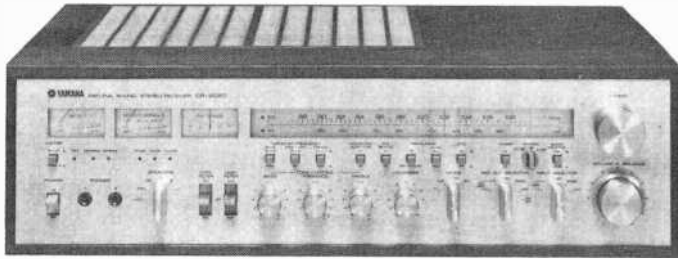

All Yamaha hi-fi receivers share a basic family resemblance. The Model CR-2020

AM/stereo FM receiver represents no exception. It is rated to give 100 watts/channel into 8 ohms from 20 to 20,000 Hz with less than 0.05% total harmonic distortion (THD). The receiver's front panel has a simple rectangular dial cut-out with no bezel or decorative trim across the top of its silver-colored panel.

The receiver is supplied in an attractively finished walnut-grain wooden cabinet. It measures 21¼"W × 16¼"D × 6½"H (54 × 41.5 × 16.7 cm) and weighs 42.5 lb (19.3 kg). National advertised value is \$700.

General Description. The FM scale has linearly spaced calibrations at 0.5-MHz intervals and red LED's that indicate which tuner section (FM or AM) is in use. The dial "pointer" is a piece of plastic that resembles the cursor on a slide rule, with a fine red line that facilitates precise frequency readings. The smooth flywheel mechanism that drives the tuning system is operated by a large aluminum knob to the right of the dial window.

To the left of the dial are three meters. The FM TUNING meter is a conventional center-of-channel indicator. The other two meters are labelled SP OUT; they indicate the voltages across the speaker terminals and are calibrated logarithmically in watts delivered to 8-ohm loads over a range of from less than 0.01 watt to 200 watts. The center meter, moreover, serves a dual function. In addition to being an SP OUT meter, it also serves as a SIGNAL Q meter to indicate the signal quality and is, hence, a combination signal-strength and multipath-distortion meter. When a signal has been tuned for a maximum pointer deflection and the antenna is oriented for minimum fluctuation of the meter's pointer, the signal is heard with the least amount of noise and distortion.

A button under one of the meters converts the center meter to a full-time SIGNAL Q meter when it is depressed, simultaneously disengaging the other SP OUT meter. In normal use, with the button in its out position, the function change occurs automatically. As soon as the tuning knob is touched, the center meter indicates signal quality. Releasing the knob automatically switches the meter back to indicating output power. The

switch is provided for situations where one cannot hold the tuning knob, as when changing antenna orientation.

At the lower right of the front panel is a large VOLUME control knob, behind which is a center-detented BALANCE ring. The other controls are arranged in functional groups, with the tone controls at the lower center of the panel. The BASS, TREBLE, and PRESENCE controls each have 11 detented positions. Buttons above them can be used to change the bass and treble turnover frequencies, with a choice of 125 or 500 Hz for the bass and 2.5 or 8 kHz for the treble. The action of the PRESENCE control is centered at 3000 Hz, unlike the usual midrange tone control that operates at 1000 or 1500 Hz. A button located between the turnover selectors is used to switch in and out the tone controls.

The LOUDNESS compensation control, located to the right of the tone controls, is a Yamaha exclusive. This 11-position detented control allows a user to vary the midrange gain over a 20-dB range while simultaneously boosting the low and high frequencies relative to the mid-range. With the LOUDNESS control fully clockwise, the response is flat and the VOLUME control is set to give the loudest listening level one expects to use. Then when the volume is adjusted with the LOUDNESS control, a proper balance is maintained between the different frequencies without the unnatural heaviness that mars the sound of most loudness-compensation systems.

The MODE selector can be used to connect either channel or their sum to both audio channels as well as to provide normal and reversed channel stereo operation. The INPUT SELECTOR

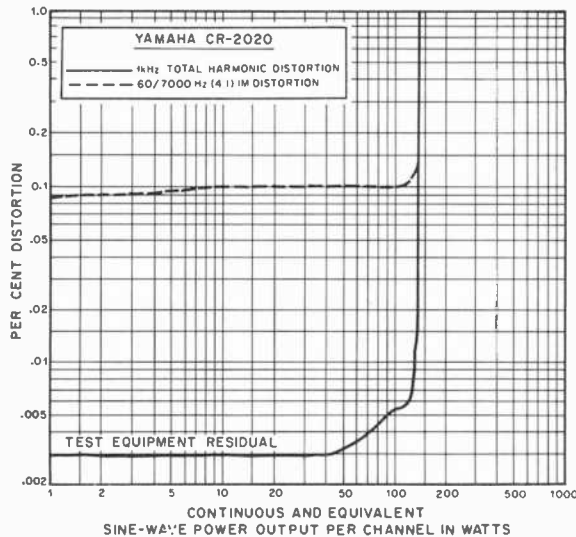

1000-Hz total harmonic distortion and 60/7000-Hz IM distortion.

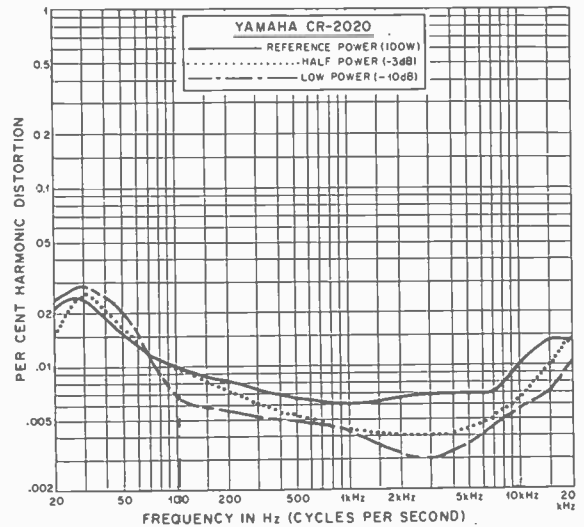

Total harmonic distortion at rated (100 W), half, and low power.

and REC OUT SELECTOR, unique to the entire Yamaha receiver line, are entirely independent. This setup allows one to tape from any source while listening to any other source.

The INPUT SELECTOR has positions for TAPE 1, TAPE 2, TUNER, PHONO, and AUX. The REC OUT SELECTOR can supply either one or two tape decks with signals from TUNER, AUX, or PHONO sources or from the preamplifier output (PRE OUT). The last permits the full tone-control and filter capability of the receiver to be used ahead of the tape recording process. There are two cross-connected dubbing positions for copying tapes from either machine to the other and providing the capability of monitoring the playback from either deck with the appropriate setting of the INPUT SELECTOR.

Above the tape switches are a TUNER button that allows selection of either AM or FM reception and a small PHONO selection switch with positions for a magnetic and a moving-coil cartridge input. (The receiver has a built-in "preamp" for the very low output of moving-coil cartridges.) The AUDIO MUTE button, located near these controls, permits the audio level to be reduced by 20 dB for temporary interruptions.

Other buttons under the dial scales include switching for an external DOLBY FM ADAPTER, which simultaneously changes the deemphasis from 75 to 25 μ s; FM BLEND for noise reduction on weak stereo signals; FM MUTING, which in its OFF position switches the tuner to mono operation; and MUTING LEVEL for selection of either a 3- or a 30- μ V muting threshold. The final button, labelled OTS (Optimum Tuning System), actually

controls an afc system that is automatically deactivated when the tuning knob is touched. When a station is tuned in and the tuning knob is released, the afc system comes on slowly. With the OTS button engaged, the OTS is disabled at all times.

Completing the front-panel control lineup are lever switches for POWER and LOW and HIGH FILTERS and a rotary switch that connects any or none of three pairs of speaker systems or two combinations of two pairs at a time to the amplifier's outputs. The FILTER switches each have three positions with center OFF. The LOW turnover frequencies are nominally at 15 and 70 Hz, the HIGH at 8000 and 12,000 Hz. All filter slopes are at a rate of 12 dB/octave. Above these switches is a row of LED's that indicate the status of the POWER, TONE CONTROL, AUDIO MUTING, FM BLEND, and OTS switches and when a stereo FM station is being received.

There are also two PHONES jacks on the panel.

On the rear apron of the receiver are a full complement of phono-jack connectors for the signal sources, three sets of insulated spring clips for the amplifier outputs, and antenna terminals for 75- and 300-ohm FM antennas and a wire-type AM antenna. The ferrite-rod AM antenna is hinged. Separate PRE OUT and MAIN IN amplifier connectors that are normally joined together by a slide switch make it possible to insert signal-processing devices between the two parts of the circuit. There are also three accessory ac outlets on the rear apron, one of which is switched.

Laboratory Measurements. Yamaha does not use the "standard" method for rating the distortion and noise performance of its receivers. The company's Noise-Distortion Clearance Range method is an expression of the

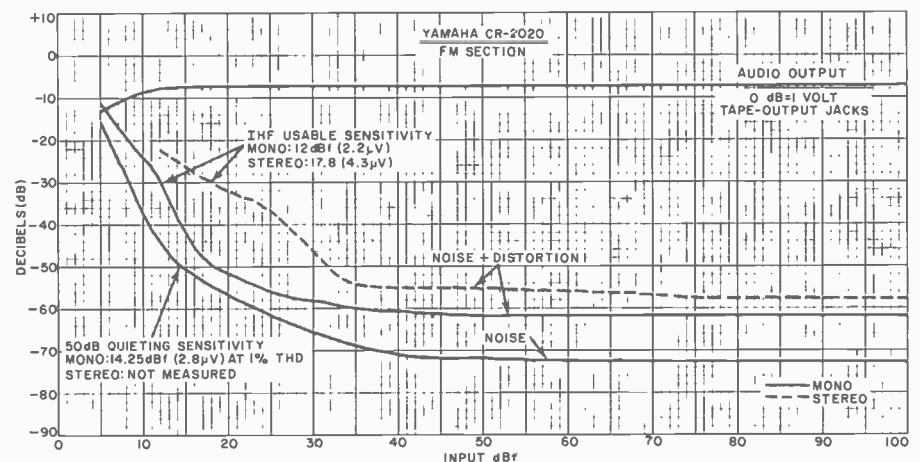

Noise and sensitivity curves for FM section of receiver.

total noise and distortion in the output of the amplifier as a function of output power when measured with a conventional null-type distortion meter. This part is quite standard; where the departure from the standard arises is in making the measurement through the preamplifier at 1000 Hz with the VOLUME control set 20 db below its maximum.

In the case of the Model CR-2020, Yamaha's NDCR rating is less than 0.1% noise and distortion between 100 mW and 100 watts output into 8 ohms. This represents very good performance, especially at the low-power end where the distortion of most amplifiers is masked by noise. To a great extent, this is due to the use of a dual volume control, with one section before the tone control amplifier and the other following it. This causes the noise to drop steadily as the volume setting is reduced, yet minimizes the possibility of overload from a high-level input signal.

We did not measure the NDCR as such, but much of the same information can be inferred from our normal measurements. The one-hour pre-conditioning period at one-third power made the receiver quite hot, especially on the grille above the output transistors, but with no ill effects. The outputs clipped at 130 watts/channel, with both channels driving 8-ohm loads at 1000 Hz. The 4- and 16-ohm clipping levels were 172 and 82 watts, respectively.

The 1000-Hz THD was below the 0.003% residual of our test equipment from 0.1 watt to more than 50 watts output and was only 0.007% at 120 watts, just short of the clipping point. The IM distortion was 0.057% at 0.1 watt and about 0.1% in the 10-to-130-watt output range. Even at a very low output of 10 mW, the IM was under 0.1%, which was an indication of the relative absence of crossover distortion.

At rated power and below, the THD was 0.02% to 0.03% at 20 to 50 Hz (approximately the residual of the test equipment at those frequencies). It reduced to 0.003% to 0.006% at middle frequencies and increased to 0.01% to 0.015% at 20,000 Hz. The risetime, through the AUX inputs, was 5 μ s, and the slew rate of the amplifier was 21 volts per microsecond.

As might be expected, the tone controls could provide almost any desired response characteristic. With the 125- and 8,000-Hz turnover frequencies, a considerable variation was possible in the output at the frequency extremes, with no effect between 300 and 3000

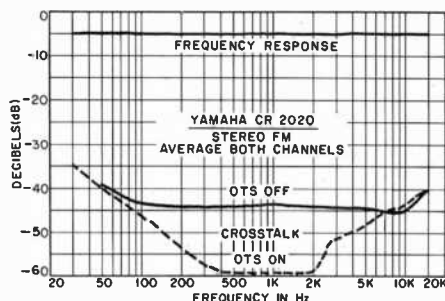

Frequency response and crosstalk with optimum tuning in and out.

Hz. The action of the PRESENCE control peaked at 3500 Hz and had no effect below 1000 Hz or beyond 10,000 Hz. Since the maximum range of this control was ± 6 dB, extreme effects were not possible. It was much more subtle in its action than some earlier so-called "presence" controls we had seen.

The filters are among the best to be found on a contemporary receiver. The measured cutoff frequencies of the HIGH filter (where the response was down 3 dB) were 7 and 10 kHz, and with its 12-dB/octave slope, it was possible to reduce hiss significantly without a serious effect on program quality. The LOW filter had its -3-dB frequency at 75 Hz (in its 70-Hz position) and was an effective rumble filter. In the 15-Hz position, the response was down 2 dB at our lower measurement limit of 20 Hz.

Yamaha's loudness compensation is, in our opinion, one of the best (if not the best) currently available. It is probably the only one we are able to use without unacceptable deterioration of listening quality. As the control is turned counterclockwise, the loudness drops almost imperceptibly, because the apparent frequency balance remains constant over the full 20-dB range of the control. (That range is somewhat limited and might require the main VOLUME control to be reset from time to time, but this is a small price to pay for the listening benefits of the system.)

The RIAA equalization error of the phono preamplifier was too small to measure, being less than the inherent ± 0.25 dB resolution of the General Radio frequency-response plotter. The equalization changed by less than 0.5 dB at any frequency when measured through the inductance of a typical phono cartridge.

The receiver has an unusually high audio gain. It required only 35 mV at the AUX inputs, 0.58 mV at the PHONO input, for a reference output of 10 watts. The respective unweighted noise levels were

-82 and -72 dB, which in addition to the very low distortion readings tend to confirm Yamaha's NDCR rating. In spite of its high sensitivity, the phono input overloaded at a very high 280-mV input. No measurements were made on the moving coil "preamplifier."

The FM tuner section was in many ways as impressive as the receiver's audio amplifier. In mono, the IHF sensitivity was 12 dBf (2.2 μ V) with 1% distortion. In stereo, the IHF sensitivity was 17.8 dBf (4.3 μ V), but the 50-dB quieting sensitivity could not be measured accurately because of a considerable level of 19-kHz pilot carrier signal that masked the noise level in the audio outputs. The pilot carrier level was -48 dB, making this one of the very few specifications in which the receiver fell short of its published ratings. (The rated suppression is 60 dB, which is not a particularly low figure, either.)

The distortion at a 65-dBf (1000 μ V) input was 0.085% in mono and 0.16% in stereo, and the mono S/N at that input was 72.5 dB. These measurements were made, as the IHF standard specifies, with the AFC (OTS) turned off. Turning it on resulted in a substantial increase in distortion, to 0.58%. Carefully centering the tuning meter actually made the distortion greater, yielding a 0.75% reading. The stereo distortion, with L - R modulation and OTS off, was 0.4% at 100 Hz, 0.089% at 1000 Hz, and 0.12% at 6000 Hz.

The FM frequency response was ruler-flat, varying no more than about ± 0.1 dB from 30 to 15,000 Hz with the OTS on. With the OTS off, the response was much the same, except that the tuner section switched into mono below 50 Hz for some inexplicable reason. This was one of several strange effects we observed, mostly relating to the automatic functions of the receiver, such as the OTS and the meter function switching. For example, the stereo channel separation was virtually uniform at 44 to 45 dB from 100 to 12,000 Hz and still a superb 40 dB at 30 and 15,000 Hz with the OTS off. Turning on the OTS improved the separation dramatically to an almost unbelievable 59 to 60 dB between 500 and 2000 Hz.

The other tuner performance characteristics ranged from good to excellent. The capture ratio was 1 dB at a 45-dBf (100 μ V) input and 0.8 dB at 65 dBf. The AM rejection was a very good 70 dB. Image rejection was about 88 dB. Alternate channel selectivity was 74 dB, and adjacent channel selectivity was 4 dB. The

stereo threshold was 12 and 33 dBf (2.2 and 25 μ V) in the alternate positions of the MUTE switch. The corresponding muting thresholds were 14 and 35 dBf (2.7 and 30 μ V). The muting had no hysteresis allowing it to drop in and out with almost no change in signal level. This is undesirable, since a fading signal can rapidly jump in and out of stereo, with more audible side effects than if the mute and unmute levels were slightly different. However, the muting action was very smooth and noise-free.

The AM tuner section had a frequency response (and overall listening quality) far above the average. It had a notable lack of background noise and a frequency response that was down 6 dB at 35 and 7200 Hz.

User Comment. The Yamaha Model CR-2020 receiver was so outstanding in its performance that the few instances where it fell short of expectations are obvious only because of the contrast. Even so, the "plusses" so far outweighed the "minuses" that we were left with a strongly positive net impression of the receiver.

In actual use, the receiver was a pleasure to hear and to operate. Not only does it have just about the best loud-

ness compensator in the business, but its operating flexibility is extraordinary. The receiver competes with a host of very fine receivers, but it can match any of them in sound quality and has few, if any, peers with respect to versatility.

Yamaha does not use a low-pass filter in its FM audio outputs to remove the 19-kHz pilot carrier. Instead, a proprietary carrier cancellation circuit is used. This gives a truly flat frequency response, but in our test unit, it allowed an undesirable amount of the 19-kHz carrier to leak into the program outputs. It is probable that the adjustment of the cancellation circuit had shifted on our test sample. There were, of course, no audible effects from the -48-dB level of the carrier, although it did make some of our measurements difficult to perform. It could easily cause problems with an inadequately filtered tape recorder and almost certainly with an external Dolby unit. There would be no problem if the rated -60-dB suppression were obtained.

In addition to the strange behavior of the OTS system and its effect on distortion and channel separation, the accuracy of the SP OUT meter could not be checked because at power levels exceeding about 10 watts, the meters cut

off and returned to zero. On program material, the meters could be driven to about 50 watts before the same thing occurred. Obviously, this is not normal behavior, and we would not be surprised to find that a single fault was responsible for all of these mysterious effects. These are likely unique to our test sample, not the typical production run.

The SIGNAL Q meter was an outstandingly effective tuning aid. It accurately indicated relative signal strength and multipath distortion over a wide range of receiving conditions. Only an oscilloscope might tell the user more, but it would be much more expensive and certainly not as easy to interpret as the meter. Those listeners who depend on AM for any significant part of their listening will find the AM tuner in this receiver to be one of the handful that have acceptably good AM quality—in this case, much more than acceptably good.

In sum, the Yamaha Model CR-2020 is an elegant receiver, tastefully styled and distinctively different from any of its competitors in appearance, operating features, and performance. It is powerful enough for the majority of home installations; yet it is not burdened by excessive size, weight, or price.

CIRCLE NO. 101 ON FREE INFORMATION CARD

OPTONICA MODEL RT-3535 STEREO CASSETTE DECK

Features automatic program locating feature for cueing tape selections.



Optonica's Model RT-3535 tape deck features a novel Auto Program Locator Device (APLD) that can be used to cue rapidly to any of several selections recorded on a single cassette. To some extent,

the APLD system overcomes a fundamental limitation of the tape medium, which usually cannot be readily accessed in a random manner as can be done with disc recordings.

The front-loading deck, which is the company's top-of-line model, features two tape heads and two motors. The

capstan is driven by a dc servomotor/voltage-generator setup, while a high-torque dc motor drives the tape hubs.

The deck measures 18 $\frac{3}{8}$ "W x 14"D x 5 $\frac{3}{4}$ "H (466 x 356 x 146 mm) and weighs 22.4 lb (10.2 kg). Its nationally advertised value is \$429.95.

General Description. At the left of the front panel is the tape compartment, below which is the usual row of control levers. Pressing the EJECT lever causes the cassette compartment door to swing upward into the machine. To load a cassette, it must be pushed into the loading ramp at a slight upward angle for a dis-

tance of about 2" (5.1 cm), which allows the cassette to drop easily into playing position.

The cassette compartment door must be closed manually. (It can also be left open during play.) If a cassette is already in the compartment, a firm pressure on the EJECT lever pops it out of the compartment for easy removal. Although the cassette compartment door has a window, the angle of the cassette and the lack of internal illumination make it difficult to determine visually the playing status of the tape.

The other levers in the grouping are for controlling tape motion stop/start, turning on and off the record circuits, switching to fast forward or reverse wind, and activating the pause function. It is possible to go from any operating mode to any other operating mode without stopping the tape. The one exception to this is that the tape must come to a stop before the EJECT lever is operated. There is an automatic mechanical disengagement of the capstan at the end of the tape.

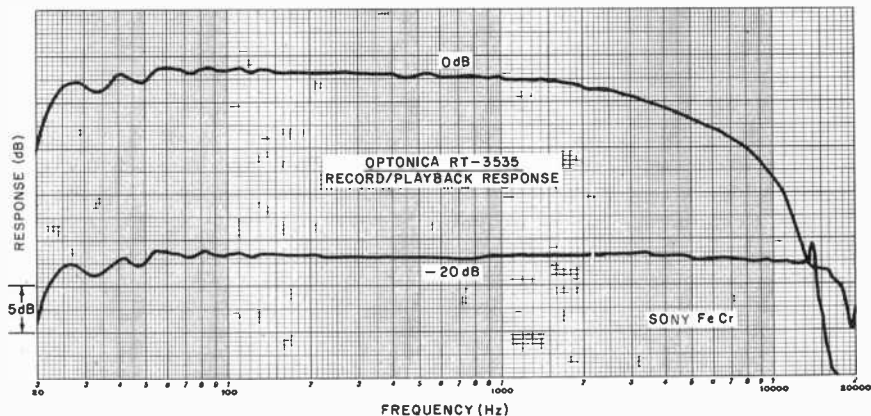

Record/playback response of Optonica RT-3535 with Sony FeCr tape.

To the left of the control levers are two microphone jacks, a stereo headphone jack and a pushbutton POWER switch. To the right of the cassette compartment are three pushbuttons labelled SPACE, INPUT and LIMITER, respectively. The SPACE button is used in connection with the APLD system to insert non-signal segments on the tape; the INPUT switch connects the recording preamplifier to either the LINE or the MICROPHONE sources (the two cannot be mixed); and pressing the LIMITER switch automatically prevents distortion from excessive signal levels when the recording level exceeds 0 dB. The index counter and its reset button are located immediately below these pushbuttons.

Three lever switches at the lower center of the panel permit adjustment of the deck's operating parameters for different tape formulations. The BIAS switch has positions labelled LOW, MED, and HIGH. The EQ (equalization) switch has two positions labelled 70 μ s and a third labelled 120 μ s. Between the BIAS and EQ switches are legends for NORM, FeCr, and CrO₂ that indicate the recommended settings for the three basic tape formulations. (A fourth formulation, low noise/high output, can also be obtained by changing switch positions.) The third switch controls the Dolby noise-reduction system that is built into the deck. It has an OFF and two ON positions, the uppermost connecting the MPX FILTER to remove any 19-kHz pilot carrier from FM signals in addition to providing noise reduction.

At the upper right of the panel are two large illuminated dB meters, between which are a red RECORDING indicator and a green DOLBY indicator. At the bottom of the panel are the OUTPUT control (for adjusting the level of the playback signal simultaneously for both channels) and separate RECORD level controls for

the two channels. Between the controls and meters is a row of 10 small black buttons numbered 1 through 9 and C, plus a button with no identification. These are the APLD system controls.

The APLD system functions in both the fast-forward and the rewind modes. It senses the absence of a recorded program between the selections recorded on the tape. As an example of how it works, assume you wish to hear the fifth selection on the tape, omitting the first four selections. A light touch on button number 4 will cause the deck to skip the first four selections and stop at the beginning of the fifth selection. Then, all you need do is operate the PLAY lever to hear the desired selection.

When the number 4 button is touched, the unidentified button proves to be a seven-segment numeric LED indicator that displays the number of the button activated (in this case, a numeral 4). Each time the fast-moving tape passes an interval between selections, the displayed number decrements by one digit.

The C button clears the APLD system's memory. This permits the user to resume normal operation of the deck. If C is pressed during a fast-speed search, the tape stops at that point.

The proper operation of the APLD system depends on the absence of program material for a duration of at least 4 seconds between selections. When the user makes his own recordings, the deck is equipped to insert the necessary silent interval automatically. To accomplish this, the SPACE button is first depressed and at the end of each selection the PAUSE lever is operated. This immediately cuts off the recording signal but allows the tape to run for a few seconds to provide the silent interval.

The level meters are fast-responding, peak-indicating types to minimize the chances of overloading the tape on

high-level transients. The tape heads are not accessible from the front. However, a small door on top of the deck can be removed to permit cleaning.

Laboratory Measurements. We checked the playback equalization of the deck with TDK and Nortronics tapes for the "normal" (120- μ s) EQ setting and Teac tape for the 70- μ s settings. In both cases, the response was within ± 1 dB from 40 to 10,000 Hz. The overall record/playback response was then measured with Maxell UD-XL (normal), TDK SA (CrO₂), and Sony Ferrichrome (FeCr), as recommended by Optonica. The "normal" response had a slightly depressed upper midrange output, but was within ± 2 dB from 21 to 15,000 Hz. The CrO₂ response was flatter, with a ± 2.5 -dB variation from 22 to just beyond 15,000 Hz. The best overall frequency response was with FeCr tape, which varied only ± 2 dB from 23 to 17,000 Hz, bettering the company's own specification of 30 to 17,000 Hz.

The Dolby circuits changed the high-frequency response by no more than 2 dB at a -20-dB level, and caused no measurable change at a -40-dB level. The MPX FILTER had less than a 1-dB effect on the response at 14,000 Hz, but it attenuated the incoming signals by more than 20 dB at 16,500 Hz and higher frequencies.

For a 0-dB recording level, the input was 72 mV through the LINE inputs and 0.185 mV through the MIC inputs. The playback output from a 0-dB recording depended on the tape used. It ranged from a maximum of 0.77 volt with TDK SA to a minimum of 0.53 volt with Sony FeCr tape. The limiter had no effect until the input level reached +1 dB, but an input of as much as +20 dB was held to an effective 2.7-dB increase in recording level, with only 3% playback distortion. The meters had a 10% to 15% overshoot on 0.3-second tone bursts and indicated +0.5 dB on a standard Dolby level tape of 200 nWb/m. (The calibrated Dolby level is at 0 dB.)

At a 0-dB recording level, the playback distortion was 0.71% with Maxell UD-XL, 2.5% with TDK SA, and 1.8% with Sony FeCr tapes. The reference 3% distortion level was reached at recording inputs of +6 dB, +1 dB, and +3 dB, respectively.

The IEC "A" weighted S/N reading (without Dolby) for the tapes, referred to the 3% distortion signal level, was 60.7 dB with UD-XL, 57.4 dB with SA, and 58.3 dB with FeCr tapes. With the Dolby

system switched in and using CCIR weighting, these figures improved to 68.5, 66.4, and 67 dB. At maximum gain, the noise through the microphone inputs increased by 10 dB. But at usable gain settings, the noise increase was both inaudible and unmeasurable.

Although the headphone output was designed for 8-ohm phones, the volume level was adequate with 200-ohm phones as well.

The flutter was 0.13% on playback only in an unweighted rms measurement and 0.14% in a combined record/playback measurement. The transport operated smoothly and quietly. In its fast speeds, it moved a C60 cassette from end to end in about 82 seconds.

User Comment. As our lab measure-

ments reveal, this is a very good recorder, whose performance is generally of the caliber one would expect from a machine in its price class.

One difficult test for many cassette recorders to pass is to record FM tuner interstation hiss at a -10-dB level and to compare the playback with the incoming signal. Most machines reveal varying degrees of dulling of the highs and sometimes low-frequency colorations. The Model RT-3535, however, passed this test with a virtually perfect reproduction of the hiss, using TDK SA tape.

We found that the APLD system performed well on most commercially recorded tapes, but it could be "fooled" by an insufficiently long silent interval between selections or by unexpected silences within a selection. With our own

recordings, made with the aid of the SPACE button on the deck, the APLD worked perfectly every time.

This deck marks an auspicious entry for Optonica into the American audio scene. There are a host of cassette decks with generally similar features and performance, but this one offers something different. Perhaps not everyone will find the APLD equally useful, but if random rapid access to one of a series of recordings on the same cassette is of any importance to you, this machine offers an ideal answer to the problem. Best of all, none of the fundamental performance qualities of a first-rate cassette deck seem to have been sacrificed in any way as a result of the inclusion of the APLD system.

CIRCLE NO. 102 ON FREE INFORMATION CARD

dbx MODEL 128 DYNAMIC RANGE ENHANCER

Remarkably effective, versatile unit's operation is formidable to master.



The expanders and compressors from dbx have been a part of professional and

home audio scenes for several years. During this time, they have undergone considerable modification and improvement to make them better, more unobtrusive performers. The latest, and perhaps most effective, of the dbx devices is the Model 128 dynamic range enhancer. It is a remarkably versatile accessory that can provide noise reduction and dynamic range enhancement either separately or simultaneously.

The Model 128 is normally connected into the tape recording and monitoring path of an amplifier or receiver. The tape recorder then connects to the system via jacks located on the rear apron of the Model 128. In operation, the Model 128

consumes only 10 watts of power from the ac line.

The Model 128 is compact, measuring only 11"W x 10¾"D x 3¾"H (28 x 27.3 x 9.5 cm) and weighing 8 lb (3.6 kg). Its nationally advertised value is \$450.

General Description. As a tape recording noise-reduction system, the Model 128 compresses the signal going into the recorder by a factor of 2:1. (A 20-dB input change emerges as a 10-dB change in output.) The dynamic range of the system is approximately 110 dB, making it theoretically possible to compress a "live" program with a 100-dB dynamic range into 50 dB, which can be accommodated by any good open-reel tape recorder and some of the better cassette decks.

During playback, the Model 128 acts as an expander whose slope comple-

ments the recording compression slope. Hence a 10-dB playback level change coming out of the recorder is converted to the original 20-dB change by the dbx circuits. The program dynamics are not modified in the recording and playback process through the Model 128, but any noise added in the recorder is reduced by the amount of the playback expansion (values up to 30 dB are possible in practice). Unlike the Dolby and ANRS systems, whose operation depend on precisely controlled levels within the system, the dbx system is virtually independent of level. (A 60-dB program range can be located anywhere within the unit's 110-dB range without affecting the final results).

The successful operation of a compressor requires close matching of the recording and playback slopes and operating time constants. Since the same circuits are used for both functions, dbx manages to achieve this quite successfully. The detailed operation of the dbx Model 128 (employing what dbx calls the "dbx II" system) is quite complex. It is explained in considerable detail in the instruction manual for the Model 128. It is worth noting that "encode" and "decode" frequency response characteris-

tics of the Model 128, in its noise reduction mode, are far from "flat." About 10 dB of high-frequency preemphasis is used during recording and a corresponding deemphasis during playback to further reduce the modulation noise that accompanies the action of the dbx processor.

The second function of the dbx 128 is as a dynamic range enhancer, or volume expander. This is done with a separate expansion channel, usable simultaneously with the noise reducer or by itself when playing ordinary disc or FM radio programs. Actually, the enhancer channel can be continuously varied from full ("infinite") compression to an expansion slope of 2.0, although compression is not likely to be used except for such purposes as background music or accommodating the wide range of signal levels that usually exist during a conference or meeting. As the control knob is advanced through a slope of 1.0 (linear), the most prominent effect is usually the change in background noise, which drops markedly during expansion. With an expansion slope of 1.2 or 1.3, it is possible to realize a worthwhile noise reduction on most programs, without objectionable side effects, and with a corresponding enhancement of the program dynamics.

The basic operation of the dbx 128 is controlled by six pushbutton switches, three of which are for the noise-reduction functions during tape recording. The BYP (bypass) button routes the tape recorder signals around the dbx circuits; REC switches in the compressor (with a 2.0 slope) between the program and the recorder's input, with the high-frequency preemphasis added; and PLAY places the dbx circuits in the recorder's playback path with high-frequency deemphasis and in a 2.0 expander mode.

The two enhancement buttons are labelled PRE and POST and refer to the position of the variable compander circuit relative to the tape noise reduction circuit. PRE allows the program to be expanded or compressed before it is recorded, while POST makes these operations possible on the playback signal (in both cases, independent of the action of the noise reducer). With proper use of this feature, the Model 128 actually makes it possible to improve the quality of a tape recording, relative to the original signal, instead of merely not adding any more noise to it.

A control knob to the left of the enhancement buttons permits the compander slope to be varied. A LEVEL con-

trol near it operates in conjunction with amber and red LED's on the panel to set the level at which the device goes from expansion to compression. The enhancement circuit can also be set to go into operation above a certain signal level (as set by the LEVEL control) instead of operating over the full dynamic range of the instrument. Pressing the button changes the mode from linear to "above threshold" so that the dbx system becomes a peak limiter or a peak compressor, according to one's needs. Program levels are unaffected when the amber LED is on.

The remaining controls include a power switch, a tape playback level matching control, and an input selector button labelled TAPE and DISC. The latter position bypasses all the tape recorder circuits to permit the enhancement circuits to operate on the program coming from the associated amplifier or receiver. The DISC nomenclature applies to the playing of dbx-encoded phonograph records, of which there are a few, through the decoding circuits of the Model 128.

Laboratory Measurements. The dynamic nature of the dbx Model 128 range enhancer makes it impractical to make quantitative performance measurements. Except for verifying the deemphasis and preemphasis curves and the complementary nature of the recording and playback slopes, we evaluated the system's performance entirely by actual use.

User Comment. In spite of its small size and accessory nature, the Model 128 is a formidable unit to master. The user's manual is very complete (almost too complete, in some respects), but it is not easy reading. Our recommendation is that it be studied like a textbook on dynamic signal processing, which it very nearly is, and that the Model 128 be set up in a system and the controls experimented with until one has a fairly clear idea of what is happening when any particular control configuration is used.

The SLOPE control must be set to 1.0 when noise reduction is in use. Otherwise, the input and output signal relationships will be altered. The control has no detent or definite center position but appears to be accurately calibrated.

With a slope of about 1.2, the expander was very effective in reducing background hiss from phonograph records and FM tuners, with a light enhancement of dynamic range and almost never any signs of noise "pumping" (a com-

mon weakness of expanders). The entire operation was so noncritical that, in most cases, one would not be concerned unduly about the actual signal levels, or when the threshold lights were flashing. (Although out of habit, we tried to keep them flashing on normal program variations.)

As a noise reducer, the Model 128 was at its best. The magnitude of the compression during recording can be appreciated by listening to the program off the tape while recording. It is incredibly noisy and shrill. When the same program is played back through the PLAY mode, however, one would never guess that it ever had been in compressed form. It sounded exactly like the original program, in every respect, without an audible hint of processing.

With a cassette recorder, the Model 128 makes it possible to record at a low level (as low as -20 dB, hardly moving the recorder meter pointers), thus avoiding the usual problems with high-frequency tape saturation. Yet, during playback, the S/N ratio is at least as good as with normal operation of the machine. Although Dolby noise reduction can be used with the Model 128, dbx points out that it offers no advantage, and should be switched off when one is making a dbx recording.

A drawback of the dbx system is its incompatibility with other noise-reduction systems, such as the omnipresent Dolby and ANRS, or with no system at all. A dbx recording *must* be played back through a dbx decoder since it is unlistenable in its encoded form. The same applies to dbx phonograph discs; they have an unbelievable dynamic range when properly played, but cannot be listened to without a dbx decoder. Moreover, the Model 128 does not provide the ability to monitor a program off the tape while recording. (It has only one set of circuits. The reasons for making the Model 128 in this way are obvious when one considers its price, even without the duplication of facilities required.)

Aside from the foregoing, and likely more important to serious recordists, the Model 128 is perhaps the most effective and versatile tape recording noise reducer and dynamic range enhancer available to the amateur recordist or hi-fi enthusiast. Aside from the considerable practice needed to become familiar with its operating modes, it is a virtually fool-proof product and is outstandingly free of the undesirable side effects that often accompany such signal processing.

CIRCLE NO. 103 ON FREE INFORMATION CARD

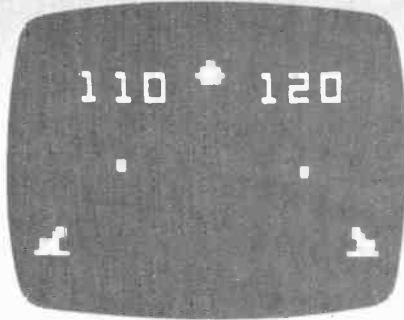

SPACE WAR



T.V. SCHOOL HOUSE I



T.V. CASINO I
BLACKJACK

“Only after you’ve experienced the sheer joy of slaughtering your best friend will you know the true meaning of fun.”

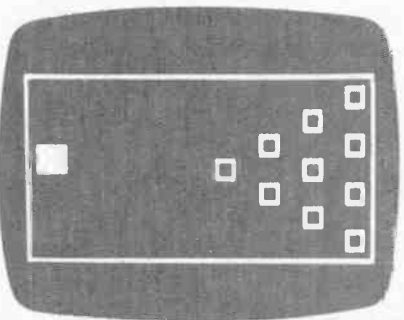

BOWLING

Courtesy RCA

New 1978 Electronic Games

A host of video and nonvideo electronic games, many using micro-processors, promises the public more stimulating fun for leisure time.

BY KRIS JENSEN

A COUPLE of years ago, an electronic video game consisted of a simple “black box” that, when connected to a TV receiver, produced little more than some version of video table tennis. In some cases today, that black box is virtually a personal computer. Now there are games whose color images try your gambling instincts at blackjack, your “destroy” capability against an enemy tank, your patience and fortitude through a maze while a “cat” attempts to devour you, your artistic talent with computer-drawn pictures, or your knowledge of math and history. And that is just the beginning in video games!

Furthermore, there are nonvideo games—a new breed of electronic battlegrounds emerging from game manufacturers who were never in the electronics business. Traditional game manufacturers like Parker Brothers (of Monopoly™ fame), Milton Bradley, Mattel Toys, and others now offer nonvideo hand-held or table-top electronic games. Consequently, these manufacturers blithely sidestepped the FCC and the production delays caused by Class I interference tests.

The Electronic Industries Association estimates that some 3.5-million video games were sold last year. The figure for this year is expected to reach 10 million—and that is for video games alone,

non-TV games are coming on strong, too. With figures like these, integrated-circuit chip suppliers such as General Instruments, Texas Instruments, National Semiconductor, and Rockwell are hard pressed just to keep up with anticipated demands.

Then and Now. Atari got the video-game ball rolling across TV screens in a big way in 1975 with its “Pong” game, a hit-the-ball with a paddle game that featured automatic on-screen digital scoring. “Super Pong” followed, offering four resident games—two forms of tennis, Catch, and Robot, all in full color with automatic scoring and sound effects. A host of other companies shared the success in this market, including Coleco and Magnavox, among leaders of “dedicated” games.

Now these games are commonplace. Prices have dropped considerably—to as low as \$19.95. Moreover, there are many more game variations available in a number of 1977–1978 models. Atari, as an example, has dropped its former line and introduced “Ultra Pong,” with 16 color-game variations selling for 40% less than last year’s more limited “Super Pong.” National Semiconductor’s “Adversary 370”—introduced last year as a tennis-hockey-handball game—has been joined by the company’s new “Ad-

versary 600," which has 12 action fields and 23 games that include "Pinball" and "Wipeout" (with 240 stationary targets) games as well as some of the traditional paddle-ball games. It uses NS's MM57106 game chip, combined with an LM1889 Modulator IC to produce full color, audio and r-f signals. Magnavox's "Odyssey 4000" has eight full-color games with remote, hand-held joysticks. Unlike most other paddle-ball games, users can move on-screen players in horizontal as well as vertical directions. In addition, an "Odyssey 5000," with many more built-in games, is expected to be marketed.

There are also video games that do not feature paddle-ball formats. For example, Atari has debuted a \$79.95 "Video Pinball" game, a tank battle game, and a "Stunt Cycle" game.

Most games provide a host of devices to make them more interesting, such as different paddle sizes, choice of ball speeds, etc. An interesting innovation this year on a few games is indenting the hockey-goal areas so that the puck can rebound behind the goal, as in the real-life sport. The major consideration here is to minimize eventual boredom. But a new generation of video games will surely overcome this possibility: programmable video games.

Programmable Video Games.

Fairchild Camera and Instrument broke the ice on programmable video games at the end of 1976 with its "Video Entertainment System." Based on a reprogrammable microcomputer chip set, it spearheaded the format used by other manufacturers of programmable games. Here, one inserts what appears to be a tape cartridge (actually it's a solid-state circuit that contains game programs on ROM) into a slot on the game machine to select a particular game or games in full color if played on a color TV receiver. Hockey and tennis are resident games

stored in the machine's F8 microprocessor. These games are disabled when a Videocart™ is inserted. There are 15 different cartridges available at this writing, including "Baseball," "Desert Fox" (a tank battle game), "Shooting Gallery," "Math Quiz," and an introduction to "Backgammon." The machine is priced at \$169.95, while each game cartridge is listed at \$19.95.

The baseball game may be cited as an example of the degree of sophistication that microprocessor games can achieve. Here, a "green" team plays nine innings against a "blue" team. The player whose team is in the field can control the positioning of outfielders in order to "catch" the ball hit by the batter. Furthermore, he can pitch a fast ball, let-up ball, slow ball, and curve ball in any direction. Balls, strikes, outs and runs register on screen. Hit the batter and a figure on the screen goes to first base. The score is automatically maintained on screen, of course. Clearly, the challenge of outfoxing one's opponent makes the enjoyment of a game last that much longer.

Following on the heels of Fairchild's programmable video game was RCA with its "Studio II Home TV Programmer." Whereas Fairchild's game has remote controls, RCA's features two calculator-type keyboards on the console, which measures 15" long x 7" wide x 2" deep. There are five resident games: Bowling, Freeway, Addition, Doodle, and Patterns. Plug-in cartridges, of which there are currently six, also consist of ROM's that plug into a socket. Built-in games are then disabled; players continue to control new games via the front-panel keyboards. Among the plug-in cartridge games available are baseball, space war, and "TV School House" (social studies and mathematics quizzes). The latter has a Yellow Series for elementary students and an Orange Series for advanced students. Both are

accompanied by manuals to answer questions randomly selected by the Studio II computer. The faster the correct answer is selected and entered on the keyboard, the higher the score registered on the TV screen. The console is priced at \$149.95, and cartridge prices range from \$14.95 to \$19.95 each, depending on contents.

The RCA Studio II game is based on the CDP1802, the same 8-bit chip used in the POPULAR ELECTRONICS "Elf" microcomputer, as well as the black-and-white graphics chip. In addition, inside the machine are two 512 x 8-bit ROM's. They act as an "interpreter" to provide common game-display patterns such as scorekeeping, alphanumeric and sub-routines. A second ROM contains programming to execute any of five resident games. TV refresh (direct-memory access or DMA is used), and stack and variable storage are provided by 512 bytes of RAM.

Atari's new \$189.95 "Video Computer System" comes with one plug-in cartridge that provides 27 game variations with full-color capability, including a combat package of "Tank" and "Jet Fighter." The latter game provides steerable and nonsteerable missiles, cloud formations and multiple fighter versus bomber combinations. The system includes two joystick controls, four detachable paddle controls and a player difficulty option switch. Five additional cartridges are currently available, offering 10 to 50 game variations each. They include "Space Mission," "Air-Sea Battle," "Street Racer," "Indy 500" and "Video Olympics."

Bally, well known for its arcade games, has entered the consumer electronics market with a programmable video game called, "Professional Arcade." The model has two on-board games called "Gunfight" and "Checkmate," with controls for up to four players. In addition, it incorporates a 4-func-

a Electronics (assembled by Rockwell International) for Mattel, Inc.'s "Auto Race" include PPS-4/1 micro-computer and segmented LED matrix.

b Milton Bradley's nonvideo "Comp IV" selects one of 32,000 random-number combinations when turned on. The players then try to guess number.

c In Fidelity Electronics' "Chess Challenger," moves are entered via keyboard. Display indicates player/machine moves and game outcome.

d Microphotograph of Texas Instruments' TMS-1000 microprocessor. It can be tailored to fit any number of games and has direct drive for displays.

e Studio II, RCA's TV programmer, has five built-in games and also uses optional plug-in cartridges for other types of programs.

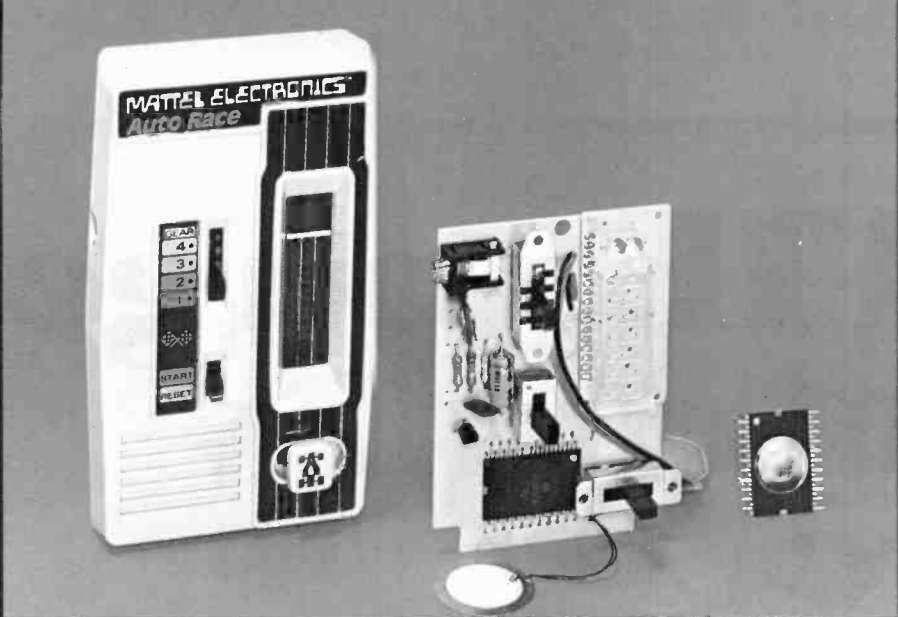

a



b



c

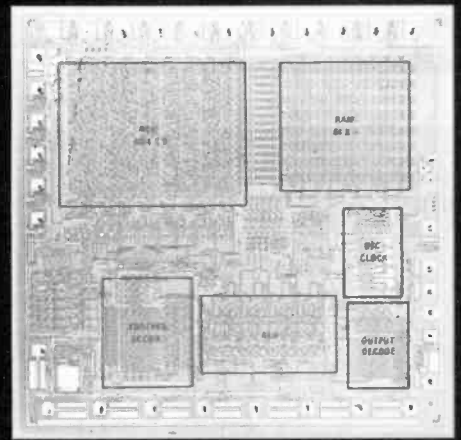

d



e

At CIE, you get electronics career training from specialists.

If you're interested in learning how to fix air conditioners, service cars or install heating systems – talk to some other school. But if you're serious about electronics, come to CIE – The Electronics Specialists.

John E. Cunningham

**Special Projects Director
Cleveland Institute of Electronics**



My father always told me that there were certain advantages to putting all your eggs in one basket. "John," he said, "learn to do one important thing better than anyone else, and you'll always be in demand."

I believe he was right. Today is the age of specialization. And I think that's a very good thing.

Consider doctors. You wouldn't expect your family doctor to perform open heart surgery or your dentist to set a broken bone, either. Would you?

For these things, you'd want a specialist. And you'd trust him. Because you'd know if he weren't any good, he'd be out of business.

Why trust your education and career future to anything less than a specialist?

You shouldn't. And you certainly don't have to.

FACT: CIE is the largest independent home study school in the world that specializes exclusively in electronics.

We have to be good at it because we put all our eggs in one basket: electronics. If we hadn't done a good job, we'd have closed our doors long ago.

Specialists aren't for everyone.

I'll tell it to you straight. If you think electronics would make a nice hobby, check with other schools.

But if you think you have the cool — and want the training it takes — to make sure that a sound blackout during a prime time TV show will be corrected in seconds — then answer this ad. You'll probably find CIE has a course that's just right for you!

At CIE, we combine theory and practice. You learn the best of both.

Learning electronics is a lot more than memorizing a laundry list of facts about circuits and transistors. Electronics is interesting because it's based on some fairly recent scientific discoveries. It's built on ideas. So, look for a program that starts with ideas — and builds on them.

That's what happens with CIE's Auto-Programmed® Lessons. Each lesson uses world-famous "programmed learning" methods to teach you important principles. You explore them, master them completely... before you start to apply them!

But beyond theory, some of our courses come fully equipped with the electronics gear to actually let you perform hundreds of checking, testing and analyzing projects.

In fact, depending on the course you take, you'll do most of the basic things professionals do every day — things like servicing a beauty of a Zenith color TV set... or studying a variety of screen display patterns with the help of a color bar generator.

Plus there's a professional quality oscilloscope you build and use to "see" and "read" the characteristic waveform patterns of electronic equipment.

You work with experienced specialists.

When you send us a completed lesson, you can be sure it will be reviewed and graded by a trained electronics instructor, backed by a team of technical specialists. If you need specialized help, you get it fast... in writing from the faculty specialists best qualified to handle your question.

People who have known us a long time, think of us as the "FCC License School."

We don't mind. We have a fine record of preparing people to take... and pass... the government-administered FCC License exams. In fact, in continuing surveys nearly 4 out of 5 of our graduates who take

the exams get their Licenses. You may already know that an FCC License is needed for some careers in electronics — and it can be a valuable credential anytime.

Find out more! Mail this card for your FREE CATALOG today!

If the card is gone, cut out and mail the coupon.

I'll send you a copy of CIE's FREE school catalog, along with a complete package of independent home study information.

For your convenience, I'll try to arrange for a CIE representative to contact you to answer any questions you may have.

Remember, if you are serious about learning electronics... or building upon your present skills, your best bet is to go with the electronics specialists — CIE. Mail the card or coupon today or write CIE (and mention the name and date of this magazine), 1776 East 17th Street, Cleveland, Ohio 44114.



Patterns shown on TV and oscilloscope screens are simulated.

CIE Cleveland Institute of Electronics, Inc.
1776 East 17th Street, Cleveland, Ohio 44114
Accredited Member National Home Study Council

YES... John, I want to learn from the specialists in electronics — CIE. Send me my FREE CIE school catalog — including details about troubleshooting courses — plus my FREE package of home study information. PE-50

Print Name _____
Address _____ Apt. _____
City _____
State _____ Zip _____
Age _____ Phone (area code) _____

Check box for G. I. Bill information: Veteran Active Duty
Mail today!

tion, 10-memory printing calculator with a screen display, entry correction and scroll button. A cassette mode permits plugging in "Videocade" electronic programs, which consist of an Action/Skill series, a Sports series, an Educational series, and a Strategy series. This programmable machine also features music. For example, in "Gunfight," the user operates the movable arm of a computer-generated "cowboy" to aim and fire at an opponent—assuming he is not hiding behind a movable cactus. If the player "Kills" the opponent, the latter dies on the screen to the sounds of "Taps" and "The Funeral March." The Arcade is priced at about \$290, while cassettes are \$20 each. At this writing, the model is awaiting FCC type approval.

Coleco Industries, Inc. also has an "Arcade" programmable game on the market. It's called, "Telstar Arcade," and features a three-sided console. One side has a built-in car steering wheel that acts as an input controller for auto racing games, another a pistol and holster for target and shooting games, and the third a set of knobs for paddle games such as tennis, hockey, etc. Games are determined by the programmed Telstar cartridge used, which is triangular in shape. The unit comes with a cartridge that contains programming for three games: "Road Race," "Quick Draw" and "Tennis." The console with one cartridge is priced between \$100 and \$125

at this writing, while other cartridges (unannounced) will be priced at \$20.

No TV Needed. Games that do not require a TV receiver have begun to enter the electronic-game market in force. Milton Bradley, for example, has introduced a hand-held game incorporating a microprocessor, called "Comp IV." When the \$30 game is first switched on, it selects one of 32,000 random-number combinations. By using the keyboard, a player enters his number guesses. LEDs display how close the player's guesses are to the game-selected number. The idea is to logically deduce the numbers and their order in as few tries as possible.

Comp IV can be programmed to operate with three, four, or five number strings to make the game as easy or as simple as one likes.

This MB game is built on a single board that utilizes a multikey keyboard and a TI 970 game chip. (The 970 is actually part of the new Texas Instruments TMS1000 series of p-channel MOS four-bit microprocessors. During its manufacture, however, a masking technique is used to program an on-board 1-k ROM that tailors the TMS-1000 to fit a customer's requirements in software and allows direct-drive for displays. The chip also supports 256 bits of RAM and an arithmetic unit.)

Milton Bradley was not alone in see-

ing the value of a microprocessor for nonvideo games. A TI system is also the integral component in "Code Name: Sector," a submarine pursuit game from Parker Brothers. This game is truly challenging. Two opponents compete against each other, each commanding a destroyer in an effort to sink a computer-controlled sub as it moves through 4800 possible sections of a nautical-chart board. Seven-segment and discrete-LED displays indicate speed, depth, range, and headings (directions) as opponents try to blow the sub out of the water. Collisions can occur to throw a player off course, and if a player misses the sub, the underwater craft not only moves on a secret course, it will fire back to put the attacker in a random position out of firing range.

Though "Code Name: Sector's" instructions are stored in ROM, a RAM system is used to temporarily store information on ship positions, compass headings, and speeds. Decoding for the displays is accomplished with a programmable logic array for conversions from BCD (binary coded decimal) to seven-segment format. A Klixon keyboard from TI is used to input information such as speed, steering, sonar control, etc. The entire system operates on a single 9-volt battery. It's priced at \$40.

Mattel Electronics has also come up with some innovative ideas on three pocket-size electronic games called

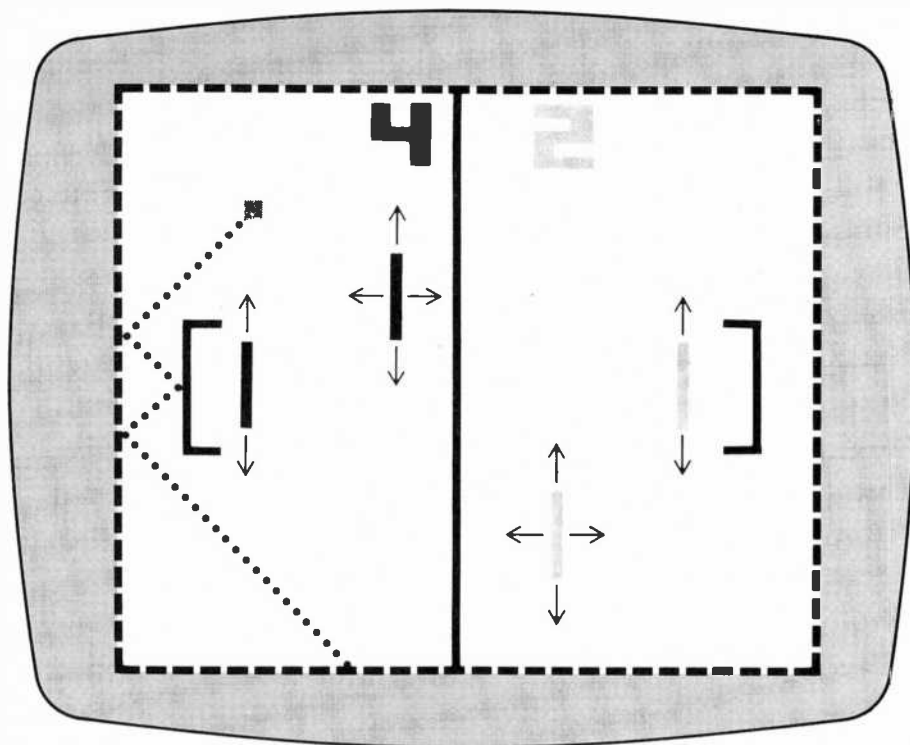

PIN CONFIGURATION 28 LEAD DUAL IN LINE

Top View			
V _{ss}	1	28	Background
Right Player Video	2	27	Blanking
Left Player Video	3	26	Explosion Envelope
Tank 1 Strobe	4	25	Gunfire Envelope
Left Track Forward	5	24	Tank 2 Strobe
Right Track Forward	6	23	Tank 2 Motor Sound
Right Track Reverse	7	22	Bearing Squeak
Left Track Reverse	8	21	Tank 1 Motor Sound
Fire Gun In	9	20	Explosion and Gunfire Noise
Game Reset	10	19	Clock Input (4.09MHz)
Test	11	18	Test-Do not connect
Test	12	17	Sync
Test	13	16	Color Burst Locator
Test	14	15	V _{cc}

Above is pin configuration for General Instrument's AY-3-8700 single-chip tank game. It provides 32 rotational angles of tank control and also has noise outputs.

Video screen (left) using GI's AY-3-8600 hockey game chip has two new provisions: lateral as well as vertical movement of forwards and space behind goal for puck to bounce off the wall instead of disappearing.

"Football," "Auto Race" and "Missile Attack." A LED array marks a player's position on the football field as he attempts to avoid other LED "tacklers" that are controlled by the game's electronics package. Seven-segment displays keep track of downs, time, and yardage to go. If a player scores a touchdown, the game plays the tune "Charge!"

In playing "Auto Race," you are racing around a four-lap LED-lighted course. Steering and speed/shift controls allow you to maneuver around opponent cars under the game's control. While playing, motor sounds are produced. You hear a beep to indicate a collision; a victory sound when and if you beat the seven-segment clock through the course.

In "Missile," a LED array indicates that enemy missiles are launched toward your "city." The object of the game is to use your anti-missile missiles to destroy the enemy missiles before they reach home turf. A seven-segment display keeps track of your "kills," but make one mistake, letting an enemy missile through, and the game plays "Taps" just after your city is destroyed.

The display is what makes the Mattel games unique. It is a cross between a hand-held calculator number display and a true video display, minus the video. Designed by Rockwell International, it consists of a matrix of 40 x 10 mil GaAs LED's. Three columns of seven vertical line segments make up the Auto Race and Missile Attack displays, while three rows of nine horizontal segments make up the display for the Football field runners. All multiplexing and buffering is accomplished with Rockwell's PPS-4/1 microprocessor. This dedicated chip contains all the software for all three Mattel games. Cost of these is \$29.95 for Football, \$24.95 each for Auto Race and Missile Attack.

Rockwell is also responsible for the design of another system, sold by Unisonic. Called the "Unisonic 21," it is a Blackjack card game that comes in both shirt-pocket and desk-top models. If you would like to calculate your odds before picking up the next electronic "card," you can flip a switch that converts the game into an eight-digit, four-function calculator.

Taking its game more seriously, Fidelity Electronics has developed the "Chess Challenger." It uses four alphanumeric displays and a keyboard. Moves are entered via the keyboard and shown on the displays. Two seconds later, the display indicates the machine's move. An average player will win 25% to

JANUARY 1978

MORE VIDEO GAMES



The Atari Video Computer System uses plug-in game cartridges, has two joy-stick controls, and includes a difficulty option switch.

CHANNEL F

FAIRCHILD VIDEO ENTERTAINMENT SYSTEM

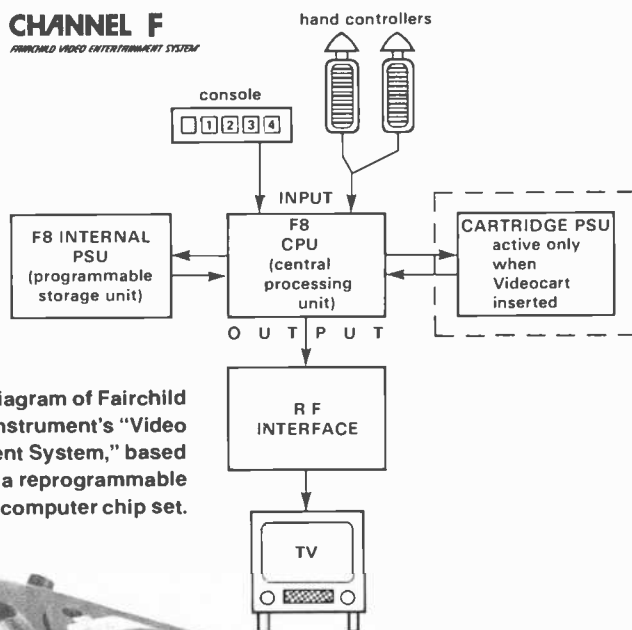

Block diagram of Fairchild Camera and Instrument's "Video Entertainment System," based on a reprogrammable microcomputer chip set.



The "Telstar Arcade" from Coleco Industries, Inc., includes "Road Race," "Quick Draw," and "Tennis" on one console.

Bally's "Professional Arcade" with two on-board games has 4-function, 10-memory printing calculator with screen display.



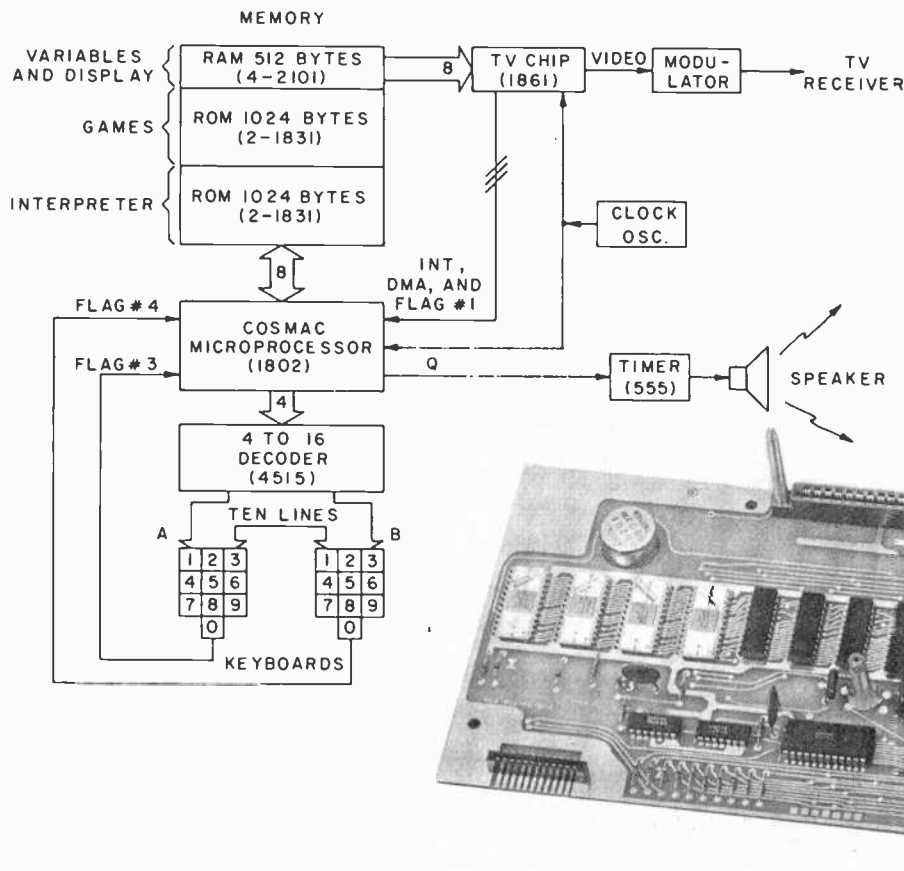

70% of the time in which case, a LED labelled "I LOSE" indicates the machine's defeat. With the "Chess Challenger," you move real chess pieces around a real chess board. (The chess board does not use the standard chess-square identifier terminology. Instead, the terminology is unique to the computer logic system around which the game is built.)

"Chess Challenger" employs a standard 8080 microprocessor chip, a ROM system for strategy storage, and a RAM system for game moves. The game sells for \$200 (Heath sells it for \$179.95, assembled), and for an extra \$75, it can be reprogrammed (another ROM installed) for tournament strength. The upgraded version begins a game by asking at which level you would like to play. You can begin at level 1 and, as you become more proficient, work up to level 3.

The game level approach is also used by Staid's "Compuchess," another chess game recently introduced. The \$159.95 hand-held game requires you to supply the chess board. It can be programmed for up to six different skill levels. Levels 1 and 2 are for teaching purposes; levels 3 to 5 are for players already familiar with the game. Because of all the algorithms performed at level 5, it takes the game nearly seven hours to respond to your move. Hence, levels 5 and 6, which require a couple of days to

respond, are for the chess-by-mail addict only.

Yet another computerized chess game—"Boris" from Applied Concepts—is a \$299.95 machine designed with both beginner and advanced chess players in mind. It features a programmable starting position, handicapping, en passant, castling, automatic queening, editing capabilities, timer, and an 8-digit alphanumeric readout. The computer concedes defeat by flashing "Congratulations" on the display.

The increasingly popular game of Backgammon has not been neglected, either. "Gammonmaster II" by Trycom Inc. and "Computer Backgammon" by Texas Micro Games, Inc. have both been announced and exhibited at shows. In both cases, the computer is a real thinking machine, being required to analyze the entire board before making its move against its human opponent.

National Semiconductor has not confined itself to the pure video game market. Based on its calculator-oriented processor system (COPS), NS has three versions of a learning game called QuizKid. The hand-held games present math problems of varying complexity and require answers within preset time limits. The latest QuizKid Racer game can operate as a single unit, or it can be linked by a cable to another Racer game

to allow two opponents to challenge each other while competing against the machine. The COPS series includes two single-chip microprocessors, the MM5799 and MM57140, 8 or 16 k of ROM, 1 k of RAM, and other IC's, including a printer interface chip.

The hand-held game, as a teaching aid for children, could prove an important tool in child education. Other manufacturers, such as Texas Instruments and APF, are also beginning to produce such games.

Still Many More. The number of manufacturers who produce electronic games seems endless, thanks to a steady stream of totally new chips being offered as off-the-shelf items to them. TI, for instance, has Space War, from its new line of game chips. GI has its "Gemini TV Games" IC's, which include cassette-programmable IC's designed around a CP1600 microprocessor and a system instruction ROM (2048 x 10 bit). With appropriate RAM's and graphics processor chips, games such as "Roadrace," "Submarine," "Dogfight," and "Blackjack" can be generated.

The most widely used GI chips employed by game makers are the 8500 and second-generation 8550 n-channel MOS devices. With just a few outboard components, these chips can provide

tennis, hockey, handball, practice, and two target games, the last with remote guns. On-screen scoring with sound effects are generated by the chips, as are color outputs for use with a color-generator circuit. It is this flexibility that has made the GI chips so attractive with such manufacturers as Magnavox, Lloyd's, Monteverdi, Venturi, Hanimex, etc. Simply jumpering or switching certain pins of the 28-pin IC adds as much complexity (and cost) to the final product as desired.

Speaking at last year's winter Consumer Electronics Show, Dr. E.A. Sack, Vice President for GI, stated that his company believes in the dedicated approach to microprocessor game designs. GI backed up this position by introducing its Gemini video game circuits that are capable of playing more than 50 different games. While some of the new chips allow a manufacturer to make stand-alone games that can be reprogrammed, others can be added to existing games that use the GI 8600 eight-game chip (tennis, hockey, soccer, squash, practice, gridball, basketball, and basketball practice). Using much of the 8699's video and player-control circuits and adding an 8603 chip, for example, the normal ball-type games can be transformed into a road race when game number 1 is selected on the control switch. The idea, of course, is to allow a manufacturer to upgrade his entire stock easily and relatively inexpensively simply by adding one IC chip.

GI has just recently begun delivery of its AY-3-8700 single-chip tank game. This is a 28-pin IC package that provides 32 rotational angles of tank control for two players. Video outputs from the chip include left and right player tanks, shells, shell bursts, mines, fixed barriers,

Microcomputers like Radio Shack's TRS-80 can be used to play video games or as educational tools.



MORE NONVIDEO GAMES



Three nonvideo games, clockwise from above: Parker Brothers' "Code Name: Sector," a microprocessor-based sub-pursuit game; National Semiconductor's "Quiz Kid" calculator; and Texas Micro Games' "Computer Backgammon."

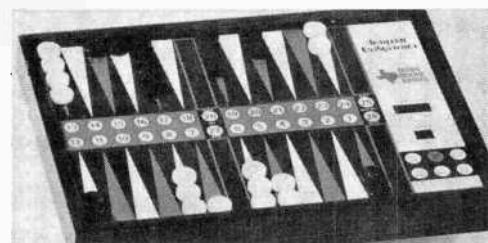

ers, score, blanking, background, sync, and color-burst locator. Audio output circuitry is just as complete with tank-1 and tank-2 motor sounds, bearing and track squeals, and explosion and gun-fire envelopes. The chips are \$9.95 each, but don't send in an order unless it is for 50,000 or more chips.

Among other companies in the electronic game business, APF Electronics has a broad line of video paddle games with two new additions—the Model 500 with 20 space-type games, including Space War, and an M1000 microprocessor programmable game at \$149.95.

Sears, too, has increased its line of games, which begins at \$20 and goes on up to a sophisticated programmable game that sells for \$179.95. Sears' program library ranges from anti-aircraft torpedo shooting to an outer-space game. Mid-priced dedicated games are available for other games like "Tank."

Microelectronic Systems' "Interact" is a joystick-and-keyboard-operated game that can be programmed by a tape system. Running at 810 bits/inch, the tapes set up the game to play Trail Blazers, Blackjack, or Regatta racing. You can also draw computerized color pictures on a TV screen. With a built-in cassette machine and alphanumeric keyboard input, it lists for \$249.

Even though game manufacturers are now designing games for the home, office, and shirt pocket, this is just the beginning of a whole new era of gamesmanship. Datatime Corp. may be saying this with its new wristwatch, which gives time and date on a liquid-crystal display as well as allowing you to play Jackpot, Dive, and Roulette. A backlit display on the \$100 timepiece keeps you in action no matter what the hour.

Too, let us not overlook the home computer while we're exploring electronic games. Though computers are at the peak of the triangle in terms of numbers expected to be sold this year (owing to higher costs), a myriad of fun games can be played on a TV screen if you have your own computer. There are more possibilities, in fact, than any programmable-type video game has because you can create your own game programs as well as having access to an overwhelming amount of game software and written programs.

In spite of predictions in numbers and dollars for the future of electronic games, perhaps their real interest for all of us was best expressed by Nolan Bushnell, Chairman of Atari: "Only after you've experienced the sheer joy of slaughtering your best friend will you know the true meaning of fun." ◇

Two sources of perfection in stereo sound.

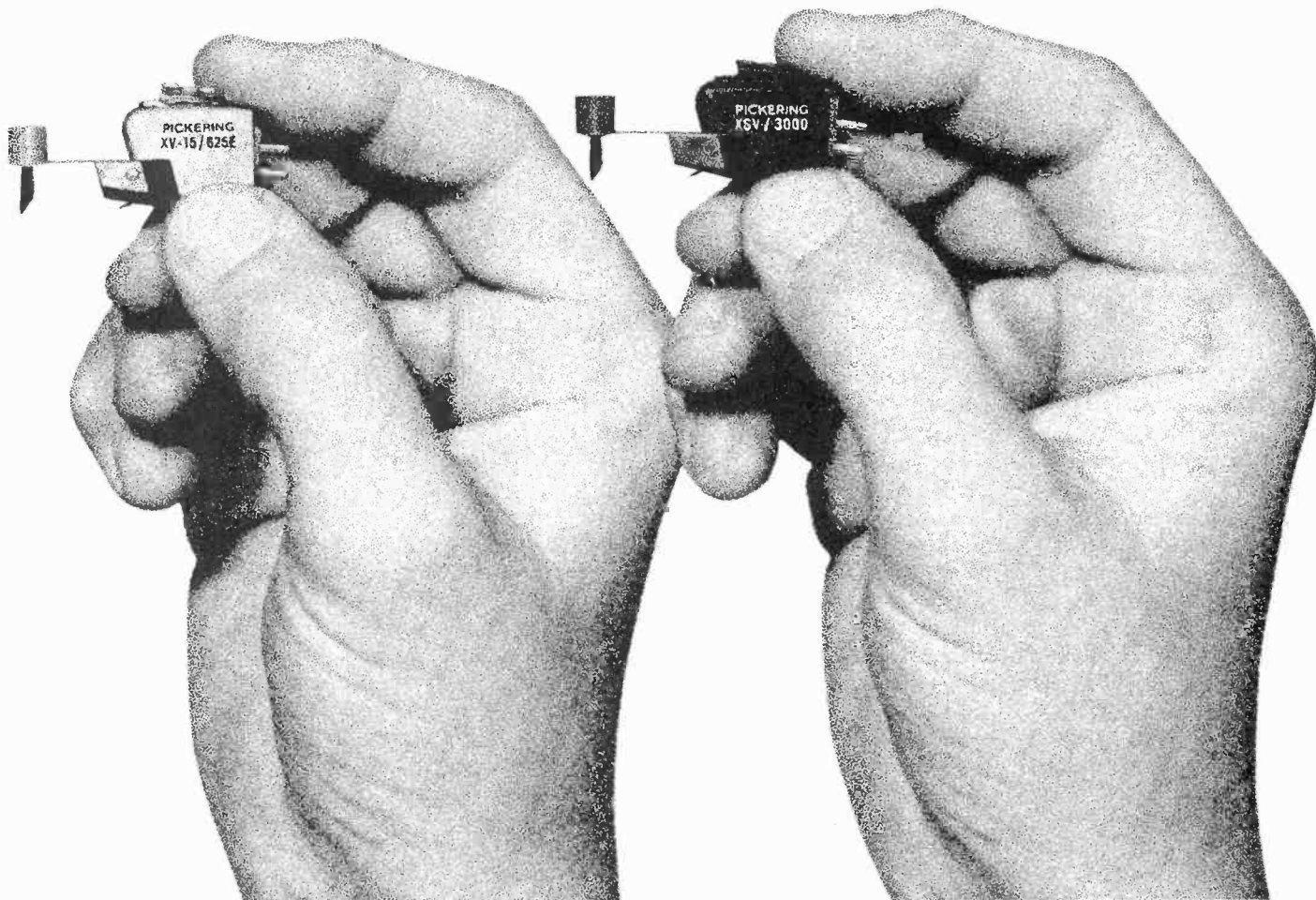

Match one to your equipment

"The right Pickering Cartridge for your equipment is the best Cartridge money can buy."

We've been saying that for years; and tens of thousands of consumers have profited by applying this principle in assembling their playback systems.

If you have a fine manual turntable, the XSV/3000 is a perfect choice.

If you have a high quality automatic turntable, then installing an XV-15/625E in its tone arm is a perfect choice.

The summary advice of **Stereo's** Lab Test, in an unusual dual product review, we think brilliantly states our position: "The XV-15/625E offers performance per dollar; the XSV/3000, the higher absolute performance level." That makes both of these cartridges **best buys!**

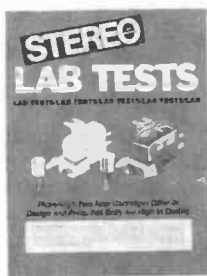

FREE!

Pickering's new XSV/3000 is a remarkable development. It possesses our trademarked Stereo-hedron Stylus Tip, designed to assure the least record wear and the longest stylus life achievable in these times with a stereo cartridge. Its frequency response is extraordinarily smooth and flat; its channel separation is exceptional; its transient response affords superb definition. It represents a whole new concept of excellence in stereo cartridges.

Read the whole evaluation report. Send for your free copy of the **Stereo** "Lab Test" reprint; write to Pickering & Co., Inc., 101 Sunnyside Blvd., Plainview, N.Y. 11803. Department PF:

 **PICKERING**

"for those who can hear the difference"

PICKERING & CO., INC., COPYRIGHT 1977



BUILD

“Charge!”

A digital electronic bugle-call generator with an audio amplifier for mobile or home use.

IF YOU have ever seen a Western movie, you're no doubt familiar with the bugle call played as the U.S. Cavalry charges over the hill to the rescue. This project generates that bugle call electronically. Because digital circuitry establishes the musical intervals between the notes, it will never drift out of tune. “Charge!,” as the project is called, can be built from readily available, inexpensive TTL logic, 555 timer IC's, and silicon transistors.

Two versions of the circuit are presented. One, incorporating a high-power output stage, requires a 12-volt dc supply and is well suited for use as a vehicle horn or a cheerleading device at parades and school sporting events. The low-power version, operated from the ac line, can be used as an annunciator, doorbell, alarm, or simply as an atten-

tion-getting conversation piece. Two controls allow the user to vary both the tempo and pitch of the bugle call.

About the Circuit. Free running timer IC1 and its associated components (Fig. 1) form a tone oscillator whose operating frequency is governed by the setting of R2. The oscillator output, a square wave with a duty cycle close to 50%, is frequency divided by factors of 10, 12, and 15 by IC2, IC3, and IC4, respectively. In this way the three tones that form the bugle call melody are generated. Digital frequency division ensures that the intervals between the three notes remain constant. However, the pitch of the bugle call can be varied by adjusting R2.

Square waves from IC1 are applied to the three frequency dividers simultane-

ously. The 7490 functions as a symmetrical $\div 10$ counter in the following manner. Input signals are routed to the internal $\div 5$ counter (pin 1). The output of this counter is connected to the input (pin 14) of the IC's $\div 2$ counter. Output signals appearing at pin 12 have a frequency one-tenth that of the input and a duty cycle of 50%. A $\div 12$ counter (IC3) is formed in a similar manner by interconnecting the $\div 6$ and $\div 2$ counters contained in a 7492 IC.

A different approach must be taken to realize a $\div 15$ function because 15 is not divisible by two and some other integer. In this project, a 74193 presettable up/down counter is used as the $\div 15$ stage. This counter IC has four data inputs (pins 15, 1, 10 and 9) and four corresponding outputs (pins 3, 2, 6 and 7). The counter outputs can be preset to

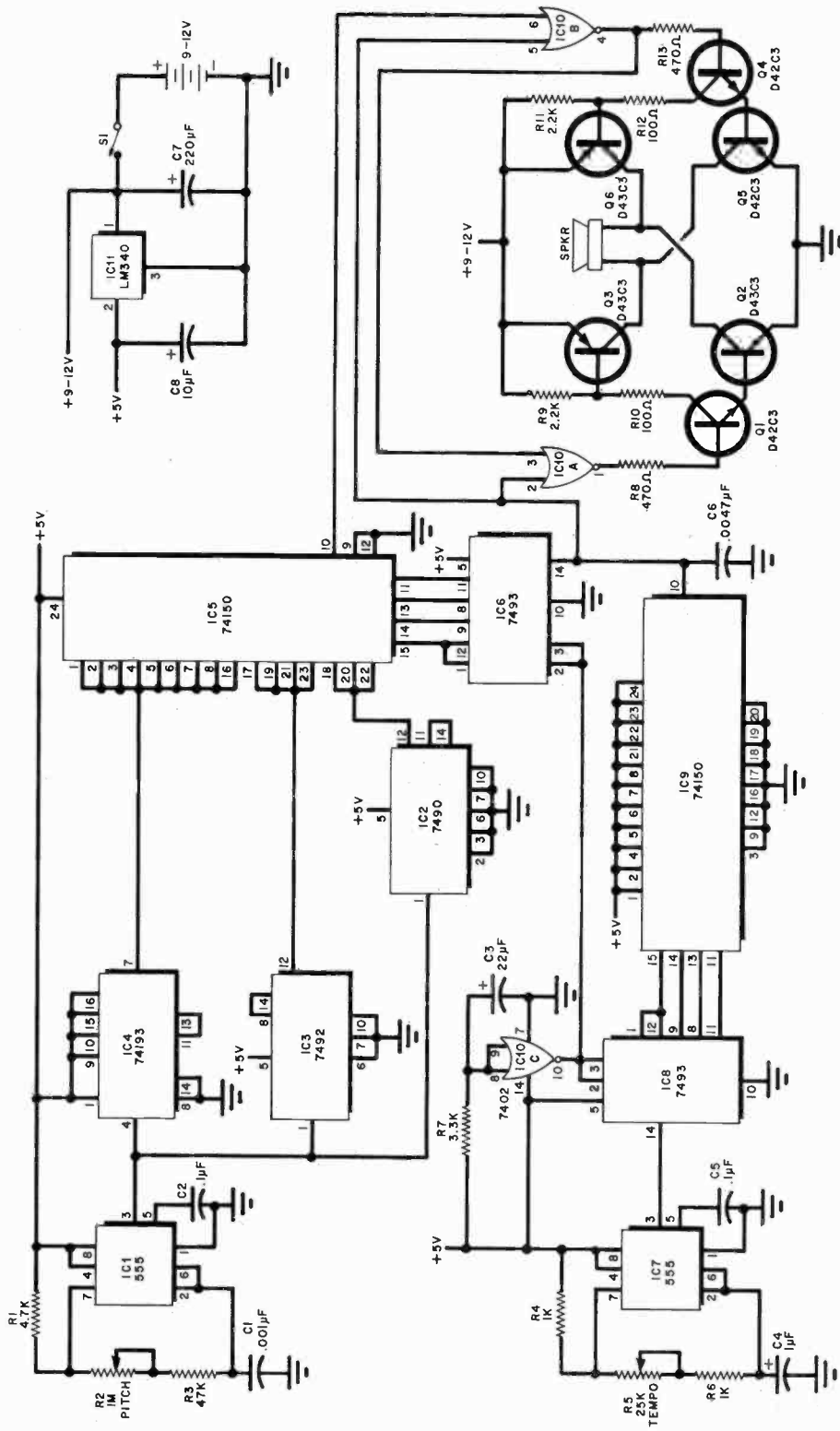

Fig. 1. Schematic diagram of "Charge!" Tempo and musical notes of the bugle call are generated digitally.

PARTS LIST

- C1—0.001- μ F disc ceramic capacitor
- C2, C5—0.1- μ F disc ceramic capacitor
- C3—22- μ F, 16-V electrolytic capacitor
- C4—1- μ F, 16-V electrolytic capacitor
- C6—0.0047- μ F disc ceramic capacitor
- C7—220- μ F, 16-V electrolytic capacitor
- C8—10- μ F, 16-V electrolytic capacitor
- IC1, IC7—NE555 timer
- IC2—SN7490 decade counter
- IC3—SN7492 \div 12 counter
- IC4—SN74193 synchronous 4-bit binary up/down counter IC with preset inputs
- IC5, IC9—SN74150 16-line to 1-line data selector/multiplexer
- IC6, IC8—SN7493 4-bit binary counter
- IC10—SN7402 quadruple 2-input NOR gate
- IC11—LM340 5-volt regulator
- Q1, Q2, Q4, Q5—Silicon npn power tab transistor (GE D42C3 or equivalent)
- Q3, Q6—Silicon pnp power tab transistor (GE D43C3 or equivalent)
- The following are $\frac{1}{4}$ -W, 10% carbon resistors:
 - R1—4700 ohms
 - R3—47,000 ohms
 - R4, R6—1000 ohms
 - R7—3300 ohms
 - R8, R13—470 ohms
 - R9, R11—2200 ohms
 - R2—1-megohm linear taper potentiometer
 - R5—25,000-ohm linear taper potentiometer
 - R10, R12—100-ohm, 1-W, 10% carbon composition resistor
- S1—Spst 3-ampere switch
- SPKR—8-ohm, 15-W weatherproof horn speaker
- Misc.—Printed circuit or perforated board, IC sockets, suitable enclosure, control knobs, heat sink (if necessary), heat sink paste, screw-type terminal strips, machine hardware, hookup wire, solder, etc.

form a four-bit binary number by applying four bits to the data inputs and grounding the load input (pin 11) momentarily. When this is done, the four bits applied to the inputs appear at the outputs.

After the load input returns to the logic one state, the IC can count down if pulses are applied to the count down in-

put (pin 4) while the count up input (pin 5) is at logic one, or count up if pulses are applied to the count up input while the count down input is at logic one. In this application, the 74193 is used as a down counter. It is loaded with the binary number 1111 (15_{10}), and is then allowed to count down as pulses are received from IC1. When the counter out-

put reaches 0000 (0_{10}) and the count down input falls to logic zero, a logic zero appears at pin 13, the borrow output of the IC.

The logic zero at the borrow output indicates that 15 pulses from IC1 have been counted by IC3 and that the IC must be preset again to 15 for the next counting cycle. By connecting all data

inputs to the +5-volt supply and the borrow output to the load input, the counter will automatically preset itself to 15 after it has counted down to zero. Square waves appearing at the Q output of the counter's D flip-flop (pin 7) are used as the output signal from this stage. The output of this flip-flop will be at logic one for seven pulses from IC1 and at logic zero for eight pulses. This results in a duty cycle of about 47%, which is reasonably close to 50%.

A sequential tone selector is formed by IC5, a 16-line to 1-line data selector/multiplexer and IC6, a 7493 four-bit binary counter. Pulses from the beat generator, which will be discussed later, are counted by IC6 over the range 0000₂ to 1111₂. The binary number generated by IC6 is applied to the data select inputs of IC5. As IC6 counts upward, IC5 sequentially selects signals from frequency dividers IC2, IC3, and IC4. The three tones produced by the counters appear at the data inputs of IC5 in the order in which they appear in the bugle call. In this way tones are selected and gated in proper sequence for application to the power amplifier.

The tempo at which the call is played is governed by the beat generator. This circuit also establishes the timing relationships between the notes and rests, and supplies a clock signal to counter IC6 in the tone selector circuit. The beat generator is formed by interconnecting IC7, a free-running 555 timer, IC8, a 7493 four-bit binary counter, and IC9, a 74150 16-line to 1-line data selector/multiplexer. The oscillating frequency of IC7, determined by the setting of potentiometer R5, sets the amount of time allotted to each beat.

A repetitive beat can be used due to the nature of the song. The notes in the bugle call are played in pairs. That is, one note is played, followed by a short

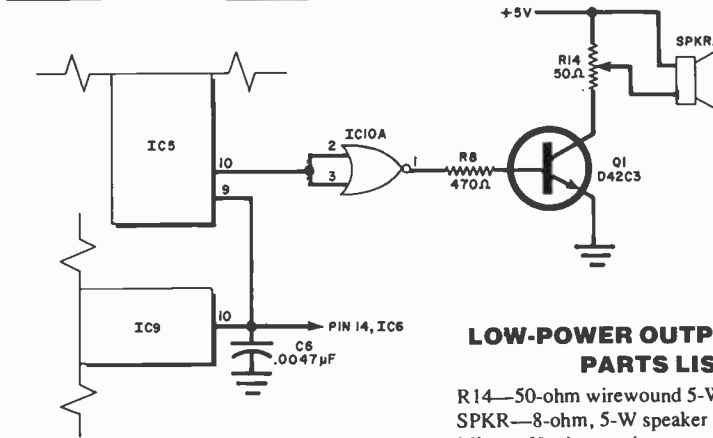

Fig. 2. Output stage for the low-power version.

LOW-POWER OUTPUT STAGE PARTS LIST

R14—50-ohm wirewound 5-W potentiometer
 SPKR—8-ohm, 5-W speaker
 Misc.—Hookup wire, small enclosure if speaker is mounted remotely, machine hardware, terminal strip, solder, etc.

rest, and then the next note is played, followed by a longer rest. All notes are of the same duration—five beats. The short rest separating the two notes forming a pair is one beat long. The longer rest separating pairs of notes is five beats long. Therefore, a total of 16 beats is required by one pair of notes and two rests (one short, one long).

Binary counter IC8 will count 16 pulses and automatically overflow to zero, providing a convenient way to determine the passage of 16 beats. The four binary outputs of the counter (pins 12, 9, 8 and 11) are connected to the four data select inputs of multiplexer IC9. The data inputs of the multiplexer are connected to either +5 volts or ground. The first five inputs (zero through four, pins four through eight) are tied to the +5-volt line. An internal NOR gate is the multiplexer's output stage, so a logic zero appears at pin 10 (the multiplexer output) for the first five beats. This allows NOR gates IC10A and IC10B to pass an inverted version of the output signal at pin 10 of multiplexer integrated circuit IC5.

Input five (pin 3) of multiplexer IC9 is connected to ground, so a logic one appears at the multiplexer's output on the sixth beat. This causes the outputs of IC10A and IC10B to remain at logic zero regardless of what is applied to the other input of each gate. No signals can pass to the power amplifier during this interval, resulting in a one-beat rest. Inputs six through ten, pins 2, 1, 23, 22, and 21, are connected to +5 volts. When IC9 selects input six, its output goes low, causing two things to happen. Decade counter IC6 counts up one pulse, allowing IC5 to select the next note. Also, NOR gates IC10A and IC10B pass signals from the tone multiplexer to the power amplifier. The output of IC9 remains low through the tenth beat.

The last five inputs, 11 through 15 at pins 16 through 20, are connected to ground. This causes the output of IC9 to go high, disabling the power amplifier. By this time, two notes have been played and the beat generator counter, IC8, has overflowed to 0000 and the beat sequence will repeat itself. The sequence must be repeated eight times for

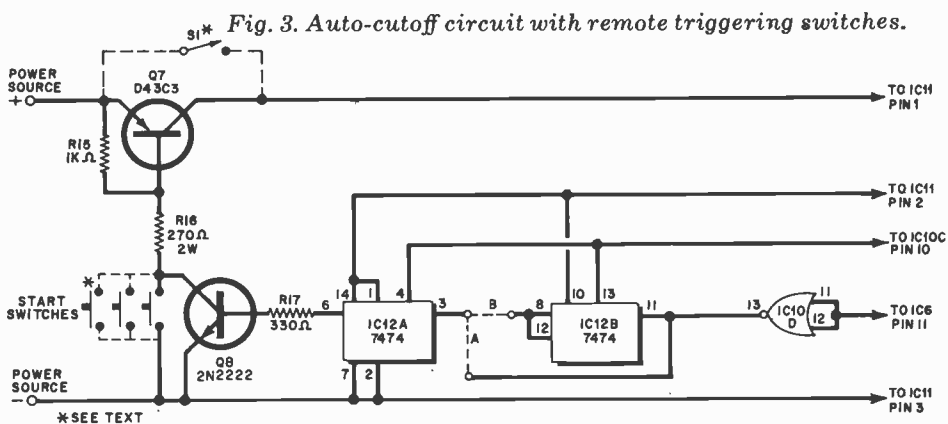

Fig. 3. Auto-cutoff circuit with remote triggering switches.

AUTOMATIC CUTOFF PARTS LIST

IC12—SN7474 dual D-type edge-triggered flip-flop
 Q7—Silicon pnp power tab transistor (GE D43C3 or equivalent)
 Q8—2N2222 npn switching transistor
 The following are 10% carbon composition resistors.
 R15—1000 ohms, 1/2 W
 R16—220 ohms, 2 W
 R17—330 ohms, 1/2 W
 S1—Spst 3-A switch (optional)
 Misc.—Normally open momentary-contact pushbutton switches (optional), IC socket, heat sink, mica washer, heat sink paste, machine hardware, hookup wire, solder, etc.

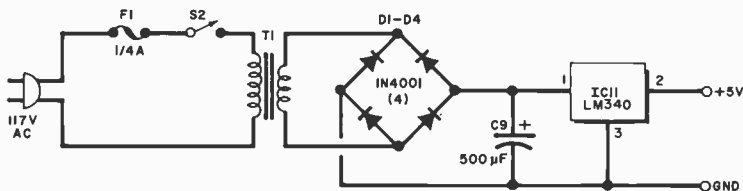

Fig. 4. Ac supply for low-power "Charge!"

LOW-POWER LINE-OPERATED SUPPLY PARTS LIST

C9—500-µF, 25-V electrolytic capacitor

D1 through D4—1N4001 silicon rectifier diode
 F1—¼-ampere fuse
 S2—Spst 1-ampere switch
 T1—12.6-V, 1-A filament transformer

all the notes to be selected and played. When all notes have been played, both beat generator counter *IC8* and note selector counter *IC6* will overflow to 0000, and the bugle call will repeat until power is removed. An auto start circuit comprising *IC10C*, *R7* and *C3* ensures that *IC6* and *IC8* start counting at 0000 when power is applied.

Transistors *Q1* through *Q6* and resistors *R8* through *R13* form the power amplifier. The tone selected by *IC5* is applied to one input of *IC10B*. The output of this gate provides base drive for *Q4* and is also applied to one input of *IC10A*. Gate *IC10A* inverts and passes the signal to *Q1* when the output of *IC9* is low. When the square wave applied to *IC10B* goes low, the output of the gate goes high, turning on transistors *Q4*, *Q5*, and *Q6*, which energize the speaker. The logic one at *IC10B*'s output also produces a logic zero at the output of *IC10A*, cutting off transistors *Q1*, *Q2*, and *Q3*.

When the output of *IC10B* goes low, *Q4*, *Q5* and *Q6* are cut off, the output of *IC10A* goes high, and *Q1*, *Q2*, and *Q3* turn on. Current again flows through the speaker, but in the opposite direction. The transistors are, of course, turning on and off at the audio frequency of the selected tone. This arrangement is considerably more complex than the more commonly used switching circuits, but provides much more output power.

The amplifier draws current directly from the power source. The TTL integrated circuits, however, require +5 volts, which is provided by *IC11*.

Circuit Options. Your particular application might not require the high output power and/or continuous play capability of the circuit shown in Fig. 1. Therefore, a low-power output stage (Fig. 2) and an automatic cutoff circuit (Fig. 3) are possible options.

The manual cutoff, high-power circuit will start playing the bugle call each time

power switch *S1* is closed. It will continue to play the call until *S1* is opened. This version of Charge! is suitable for use in a vehicle or as a cheerleading device. However, if the unit is intended for indoor use, the low-power output stage should be employed. (A line-powered supply for the low-power version is shown in Fig. 4.)

If Charge! is to be operated so that it plays the tune once after a momentary switch (such as a doorbell switch or magnetic door switch) closes, the automatic cutoff circuit should be included. Either circuit option can be employed separately, or both used together. The power supply shown in Fig. 4 can accommodate the auto cutoff as well as the low-power output stage.

The auto cutoff circuit controls power to regulator *IC11*. A momentary switch closure latches the circuit on until the bugle call has been played in its entirety. If the "A" wiring is used, flip-flop *IC12A* will then toggle and turn off *Q8*. This, in turn, cuts off pass transistor *Q7*. If the "B" wiring is used, *IC12A* will not toggle until the bugle call has been played twice. Of course, you can install an SPDT switch to select either the "A" or "B" connection. Similarly, you can connect power switch *S1* across *Q7* to provide a choice of either continuous or automatic cutoff operation.

Transistors *Q2* through *Q6* and resistors *R9* through *R13* are omitted in the low-power output stage. Gate *IC10A* inverts the tone square waves at the output of multiplexer *IC9* and applies them to the base of *Q1*. When the output of *IC10A* is high, *Q1* conducts and current flows through the speaker. Potentiometer *R14* functions as an output level control. When the output of *IC10A* is low, the transistor is cut off and the speaker coil passes no current. Referring to the previous description of the high-power output stage, it can be seen that the average current through the speaker is doubled by that circuit as compared to

the low-power stage. This results in a four-fold increase in output power.

If you decide to employ the low-power stage, be sure to connect the output of multiplexer *IC9* to the strobe input of multiplexer *IC5*. When the strobe input is high, the multiplexer output remains high no matter what logic levels appear at the data and data select inputs. A logic zero at the strobe input of *IC5* allows the chip to pass signals (in inverted form) from the selected input to the output. All other connections remain the same whether the high- or low-power output circuit is used.

Construction. Printed circuit, point-to-point, or Wire Wrap assembly techniques can be used. Parts placement is not critical. Wire Wrap sockets should be used with the IC's if this method of duplicating the circuit is chosen. Wire no smaller than No. 24 should be used for all power supply and output stage connections. All ground connections should be made to one common point.

If Charge! is housed in a metallic utility box, *IC11* should be mounted on the enclosure with thermal coupling through heat sink paste. The utility box will then be connected to the circuit common or ground. If desired, a small heat sink approximately 1" x 1" (2.5 x 2.5 cm) with ½" (1.3-cm) fins can be used with *IC11*. A heat sink is a necessity if the project is housed in a nonmetallic enclosure.

Power switch *S1*, PITCH control *R2*, and TEMPO potentiometer *R5* can be mounted at convenient spots on the enclosure. The power switch must be able to handle at least 3 amperes dc at 12 volts. If the automatic cutoff circuit is used, the momentary contact switches should be rated for 50 mA, and, if preferred, *S1* can be eliminated.

For automotive applications, tap +12 volts at a convenient point and route it to the project's power input. (Screw-type terminal strips mounted on the project enclosure simplify connections.) If the circuit is housed in a metallic enclosure, bolting it to the vehicle chassis will furnish a ground return. When connecting a speaker to the audio output, note that both sides of the speaker coil are floating. It's important, therefore, not to let one side of the speaker become inadvertently grounded. Mount the speaker, which should be a horn-type transducer for outdoor use, in or on the vehicle at a suitable location. The box housing the circuitry should be installed so that the power switch, TEMPO and PITCH controls can be easily reached. ◇



ONLY a few years ago, the spectrum analyzer was an exotic, expensive, and relatively unknown test instrument to most people in the audio industry. By contrast, spectrum analysis today is almost a household word (albeit not always fully understood) among audio design engineers, recording engineers, and technically minded hobbyists.

The spectrum analyzer is, in the frequency domain, what the oscilloscope is in the time domain. As shown in Fig. 1A, a scope displays the signal amplitude as

and duration, of pulses or signal level states are of greatest interest, making the scope the logical tool for digital circuit analysis. The frequency analysis of most complex digital signals would convey little or no information about their timing. On the other hand, the scope is of little value in distortion analysis of linear systems (such as hi-fi amplifiers). Unless the distortion is severe, the test signal looks like a "perfect" sine wave on the scope. The spectrum analyzer, however, clearly resolves the distortion

The Spectrum Analyzer in Hi-Fi Measurements

Frequency-domain instrument provides graphic solution of distortion products undetected by other means.

BY JULIAN HIRSCH

a function of time, which we know as the *waveform*. A laboratory-grade scope, with its accurately calibrated time base and deflection sensitivity, can be considered as a voltmeter with virtually instantaneous response, able to display and measure signal voltage variations over any selected period of time from micro-seconds to minutes.

Every signal also has a unique *spectrum signature* in the frequency domain which can be broken down into one or more different components whose amplitudes and frequencies are related to the amplitude and waveform of the signal (Fig. 1B). Mathematically, there is a direct relationship, via the Fourier transform, between the amplitude and frequency characteristics of a signal, so that the spectrum analyzer and oscilloscope actually display the same information in two very different ways. Each has its peculiar advantages and limitations for revealing certain characteristics of a signal. For example, in digital or pulse circuits, the time of occurrence,

components, whose frequencies and amplitudes can be determined directly from the display.

Types of Analyzers. Two basic types of spectrum analyzers are used in audio measurements. The so-called *real-time* analyzer is widely used for acoustic measurements, since it is able to display the distribution of energy throughout the entire audio spectrum. The frequency content of a musical performance or a recording can be analyzed as it takes place, hence the term "real time".

A real-time analyzer consists of a series of contiguous band-pass filters, whose cut-off slopes intersect at their -3-dB response frequencies. The filter group usually covers the entire audio band of 20 to 20,000 Hz, and their outputs are normally displayed as vertical lines on a cathode ray tube (CRT), the heights of the lines being proportional to the signal levels in the individual pass-bands. The filter outputs are electroni-

Fig. 1. Scope display (A) shows wave amplitude with respect to time, while spectrum analyzer (B) shows amplitude versus frequency.

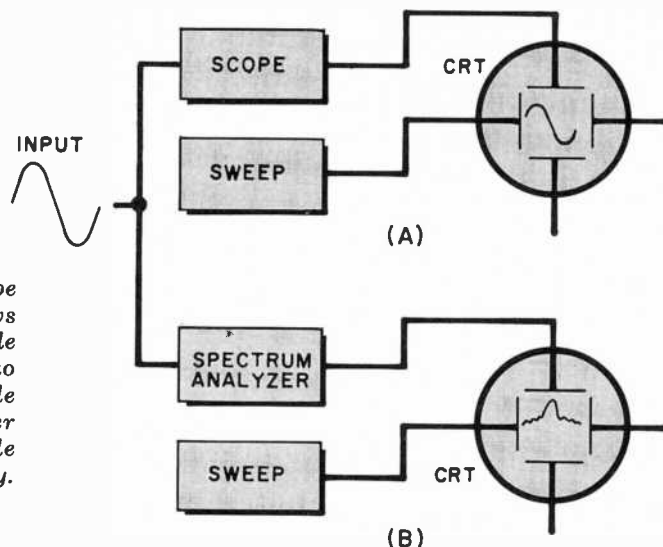

cally commutated rapidly enough to avoid a flickering display. For certain specialized applications such as monitoring programs at a recording console, an array of light emitting diodes (LED's) is sometimes used as an inexpensive substitute for a CRT display.

The individual filter bandwidths are typically a fixed percentage of their center frequencies (for example, $\frac{1}{3}$ octave or $\frac{1}{10}$ octave). For practical reasons, the "skirt" widths of the filters are quite broad, so that lower-order harmonics cannot be resolved. Also, the range of amplitudes that can be shown simultaneously on the display is rather limited, rarely exceeding 40 dB. These characteristics do not limit the application of real-time analysis to acoustic measurements, or other relatively broad-band measurements. However, for circuit measurements or performance testing, in which the presence and levels of distortion products or other spurious signals are of interest, the real-time analyzer lacks the frequency resolution (selectivity) and dynamic range to be a useful tool. For such applications, a *scanning analyzer* is used.

The scanning spectrum analyzer, as we still consider it, is basically a superheterodyne receiver with a highly selective i-f amplifier, whose local oscillator is tuned automatically and repetitively through a selected frequency range. As signals are "tuned in", their amplitudes are detected and used to deflect a CRT beam vertically. The horizontal sawtooth sweep voltage that deflects the CRT beam along its horizontal axis is also used to sweep the oscillator frequency, so that the horizontal axis becomes a frequency scale. This is shown in Fig. 2.

Most of us are accustomed to thinking

of a superheterodyne receiver as an r-f device, but the principle is applicable to any frequency range. For example, a low-frequency scanning (sweeping) spectrum analyzer typically uses a 100-kHz i-f with the oscillator sweeping from 100 kHz to 150 kHz. Thus, input signals from 0 to 50 kHz will be successively heterodyned to the intermediate frequency and displayed as "pips" on the CRT. Scanning analyzers normally have a number of selectable, fixed i-f bandwidths that make it possible to resolve and measure individual frequency components closely spaced in frequency. Since only one filter is involved, as compared to the dozens employed in real-time analyzers, the skirt selectivity of a scanning analyzer can be made very sharp without incurring prohibitive expense.

One might think that by simply sweeping the audio band at a rapid rate, comparable to the commutation rate of a real-time analyzer, a scanning analyzer could be used to make essentially "real-time" measurements. Unfortunately, electronic "laws" require that a high-resolution (narrow-band) analysis be made slowly. A finite time is required for the output of a filter to reach its final value after a signal is applied to its input, and with very sharp filters, this time can be in the order of seconds. A frequency band must be swept at a rate that allows each component of interest to remain within the filter pass-band long enough for the full output level to be reached. Even a relatively crude measurement over the 20-to-20,000-Hz band requires about 1 second, and high-resolution scans, even over limited bands, may take many minutes. Thus, the scanning analyzer is poorly suited to measuring

transient or nonrepetitive signals, and is most useful with continuous, or periodic signals—the types normally used in testing high-fidelity components.

Advantages of Spectrum Analyzers. The most common audio measurements (frequency and distortion) can be made with simpler, less expensive instruments than spectrum analyzers. What unique advantages of spectrum analysis justify its considerable cost? Most often, the speed of measurement is greatly increased. For example, a total harmonic distortion (THD) measurement with a null-type distortion analyzer is made by setting its controls for a reference full-scale meter indication, then tuning it to the fundamental signal frequency and carefully nulling it out with the controls. Depending on the specific design of the instrument, this can require 30 seconds to 1 minute each time the frequency is changed (although some recent analyzers have automatic nulling that reduces measurement time to a few seconds).

The distortion meter reading, known as the THD, includes all harmonics of the fundamental frequency, plus any noise, hum, and other spurious signals that may be present. It does not distinguish in any way between these several signals. Therefore, it is good practice to display the distortion products on an oscilloscope, which gives a rough indication of the residual signal components included in the THD measurement. In the case of the best modern amplifiers, whose distortion may be 80 to 90 dB below the fundamental (0.01% to 0.003%), the nulling process can be quite time consuming, and the oscilloscope usually shows that most of the "distortion" is really hum, hiss, or stray r-f pickup. A somewhat similar situation exists when making FM tuner measurements, since the signal may contain appreciable amounts of 19- and 38-kHz stereo sub-carrier signals in addition to noise and distortion. In fact, meaningful measurements of channel separation in most tuners cannot be made without some sort of filtering to remove these unwanted signal components which otherwise would mask the weaker signal crosstalk.

In contrast, a good spectrum analyzer shows the frequency and amplitude of each discrete frequency component, clearly separated on the CRT display (and usually in a single scan requiring only a second or two). All significant harmonic and intermodulation products can be readily identified and measured, even in the presence of much stronger

hum or noise signals. Since each harmonic is measured as "X dB" below the amplitude of the fundamental, it is necessary to convert the decibel readings to percentages, and combine all significant readings by taking the square root of the sum of their squares, to obtain a true total harmonic distortion reading (less noise and hum, of course). With the aid of a good scientific calculator, this is a simple and rapid procedure.

A major advantage of the scanning spectrum analyzer is its ability to discriminate against random noise. A THD meter, or any other wide-band instrument, is sensitive to noise over a wide range of frequencies. In general, this is "white" noise (equal energy per unit of bandwidth) so that each octave of frequency coverage contains as much energy as the total of all lower octaves. No matter how quiet an amplifier may be, if its distortion is very low, it is likely to be submerged in the noise, especially at low power levels. This is why THD measurements made on very clean amplifiers usually rise as the power output is reduced to a small fraction of one watt. The distortion is below the fixed noise level, which becomes a greater percentage of the reference level as power is reduced.

The narrow bandwidth of the spectrum analyzer drastically reduces its susceptibility to noise. Signal components which are totally submerged in noise in a wide-band measurement can easily be seen and measured with the analyzer. The resulting "THD" figure, computed as described previously, is not only lower than the reading of a distortion analyzer, but is more meaningful as well.

Applications. It would be impossible to list, even in a cursory manner, the many applications of a spectrum analyzer in audio equipment testing. In gener-

al, it can be used in any situation where one would use an oscilloscope, since it is capable of analyzing the same signal from a different viewpoint, so to speak. By viewing the signal simultaneously on a scope and an analyzer, the maximum amount of information can be obtained in a minimum time.

It is possible, by a simple heterodyning process, to generate a constant amplitude sine-wave signal at the exact frequency to which the analyzer is tuned. Sometimes this requires an accessory instrument, but many spectrum analyzers now have this capability built-in. If the signal is applied to the device under test, such as an amplifier or filter, and the output of the device is connected to the spectrum analyzer input, it becomes possible to measure frequency response characteristics over an almost incredible dynamic range. For example, if the rejection characteristics of a filter are to be measured conventionally using a broadband meter or chart recorder to display its output, it is difficult to measure the actual depth of the rejection notch, which can become obscured or filled in by noise, hum, or other extraneous signals. With the combination of an analyzer and synchronous sweeping generator, a narrow i-f bandwidth can be used to virtually eliminate noise, so that the lower limit of measurement is set only by the available signal voltage and the analyzer sensitivity. Measurement dynamic ranges of 100 to 120 dB are routine, and even greater ranges can be achieved with care.

Just as scopes are made with narrow or wide amplifier bandwidths, depending on their application, spectrum analyzers are available for all frequency ranges from subsonic to microwave. The resolution and stability requirements, and the input impedance required for the different frequency ranges vary widely, as do the specific applications.

Using an Analyzer. At Hirsch-Houck Laboratories, we have recently acquired a Hewlett-Packard 3580A spectrum analyzer. This is one of the most advanced scanning analyzers yet developed for the low-frequency range from 5 Hz to 50 kHz. The 3580A has a digital tuning dial that sets the frequency corresponding to either the start (low end) or the center of the swept range, anywhere in its 50-kHz operating range. The sweep width can be set (in steps having a 1,2,5 sequence) to values from 5 Hz to 5 kHz per horizontal division of the display, or 50 Hz to 50 kHz overall. Depending on the measurement requirements, the bandwidth (resolution) can be switched over a 1-to-300-Hz range, in a 1,3,10 sequence.

Earlier, we mentioned the importance of scanning slowly enough for the highly selective filter to "build up" to its full response. An ingenious interlocking logic system between the sweep width, bandwidth, and sweep time controls warns the user of excessive scanning velocity (the frequency range covered in a given time) by turning on a front-panel LED. In this case, the sweep must be slowed down, or the bandwidth increased, until the LED is extinguished. The scan time can be adjusted from 0.01 seconds per division to 200 seconds per division, corresponding to full scan times from 0.1 seconds to 2000 seconds (more than 33 minutes).

Since typical scanning times in audio measurements are often 10 seconds to a minute or more, an ordinary CRT display would be of little value (one would see only a slowly moving dot of light, rather than a complete trace). Sometimes a storage cathode ray tube is used to "hold" the display, but H-P has chosen to incorporate a highly effective digital storage system to achieve the same result with a relatively inexpensive, conventional cathode ray tube. A random

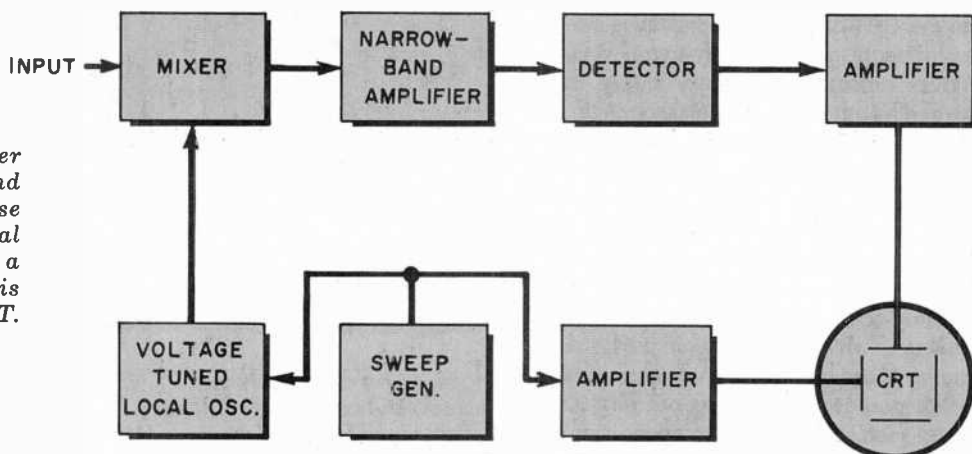

Fig. 2. A swept spectrum analyzer is basically a narrow-band superheterodyne whose voltage-controlled local oscillator is swept across a narrow frequency. Output is displayed on a CRT.

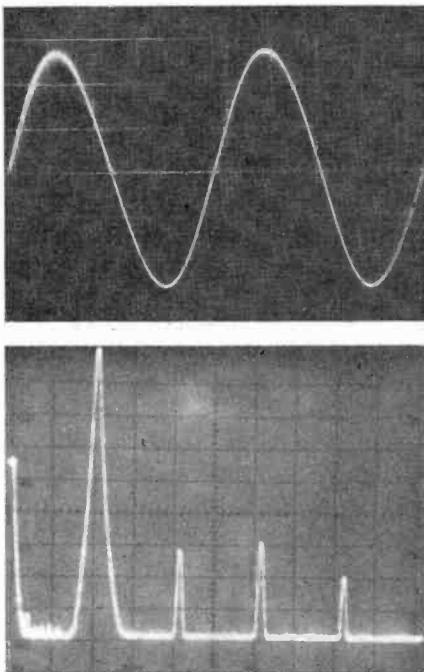

Fig. 3. Harmonics don't show in scope photo (A, top) of 1-kHz sine wave, but they do in photo of analyzer display (B, bottom).

access memory (RAM) is used to hold the horizontal and vertical CRT spot position information. The frequency scan data, corresponding to the horizontal axis of the display, is stored sequentially in the 1024 memory addresses of the RAM. At each address, the signal amplitude (vertical axis) is converted to an 8-bit "word" by an A/D (analog-to-digital) converter, and stored in that address. The 8 bits gives a total of 256 amplitude levels, and the maximum resulting error of 0.4% is well within the instrument's ratings. The information is stored in "real time", as it is being developed by the slow analyzer scan. However, it is simultaneously read out of the memory at a fixed rate of 50 times per second, passed through D/A (digital-to-analog) converters, and used to position the spot on the CRT display. The display is seen as a bright, nonflickering trace, which moves more or less slowly across the screen as the analyzer scan proceeds.

It is possible to store any one trace indefinitely by using the "single sweep" capability of the analyzer. If one wishes to store a trace and have it available for comparison to a later scan, pressing the STORE button on the panel retains the existing scan information in half the addresses, while the remaining 512 addresses are used for the subsequent scan storage. By reading out all 1024 addresses, one sees both scans simultaneously.

The amplitude display of the H-P 3580A has an effective range of about 90 dB, with each vertical division corresponding to a 10-dB level change. The amount of noise visible on the baseline depends on the i-f bandwidth and the signal characteristics, but in most cases signal measurements can be made over a range of more than 80 dB. For a more detailed study of small amplitude variations, the vertical scale can be changed to 1-dB per division, with the top 10 dB of the full display covering the entire screen height. In addition, there is a linear vertical scale, providing an absolute voltage readout. Depending on the input attenuator setting, a full-screen deflection can be obtained with signal amplitudes as great as 100 volts (across the 1-megohm input impedance of the analyzer) to as little as 100 nanovolts (0.1 microvolts).

An intriguing and unique feature of the 3580A is its "adaptive sweep". To accelerate a very slow scan analysis, when only a few signal components are expected to be present, the scan can be adjusted to speed up by a factor of about 20 times until a signal greater than the pre-determined level is encountered. At this point the sweep stops, "backs up" slightly in frequency, and scans through the signal at the selected slow rate, to give an accurate frequency and amplitude readout. Then, it speeds up until the next signal is encountered.

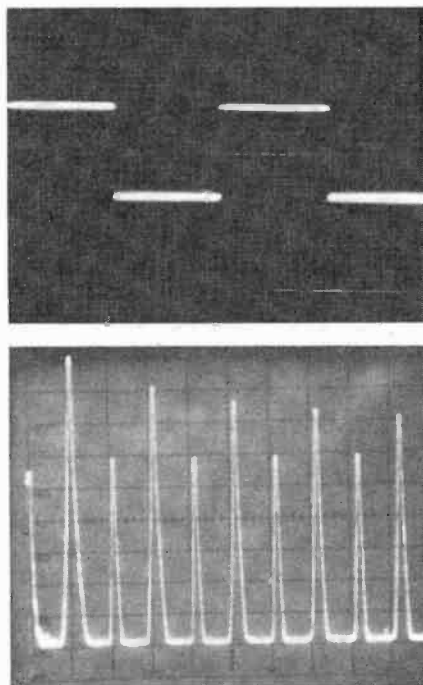

Fig. 4. Spectrum analyzer (B, bottom) shows undesirable even harmonics in square wave which appears clean on scope (A, top).

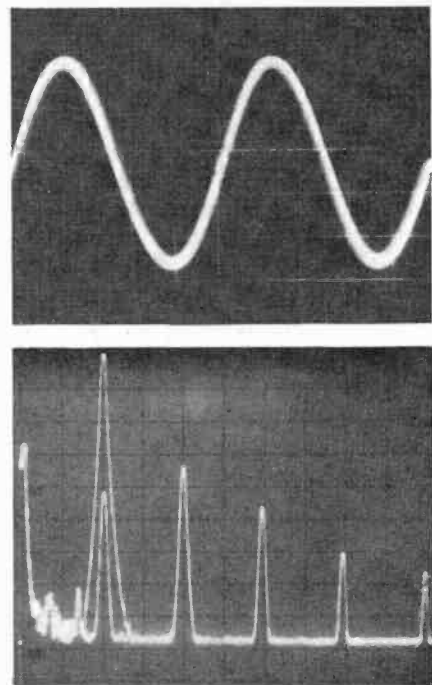

Fig. 5. Top (A) is output of one channel of FM tuner with 1-kHz signal. Spectrum analysis (below) shows 42-dB channel separation.

Especially in audio-frequency response measurements, it is often desirable to expand the lower frequency portion of the display to show greater detail in the few octaves which would otherwise be compressed into a small portion of a linear frequency scan. A logarithmic sweep is provided for this purpose, spreading the 20-to-20,000-Hz audio band across almost the full screen width in three equal decades of frequency.

Waveform Examples. To illustrate the capabilities of a high-resolution scanning spectrum analyzer in audio testing, we have taken photographs of its display in some typical measurement situations, contrasting them with the appearance of the same signal on an oscilloscope screen. Fig. 3A shows two cycles of a 1000-Hz sine-wave signal at an amplifier output. To the eye, it appears to be a pure, undistorted sine wave. The same signal displayed on the spectrum analyzer, sweeping from 0 to 5000 Hz is shown in Fig. 3B. The 2nd, 3rd, and 4th harmonics are visible, at amplitudes of -62 dB, -59 dB, and -70 dB. The equivalent THD reading (which was confirmed by our distortion analyzer) was 0.014%. Obviously, much lower distortion percentages, down to 0.003% or less, can be displayed on the analyzer screen.

To all appearances the 1-kHz square wave shown in Fig. 4A has good

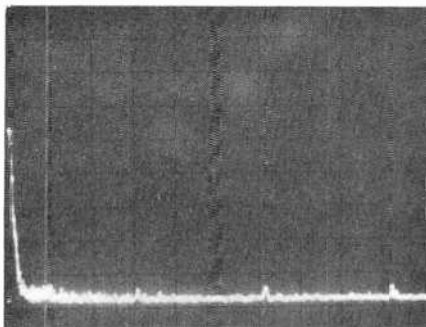

Fig. 6. Spectrum analysis of line power shows hum components at 60, 120, and 180 hertz.

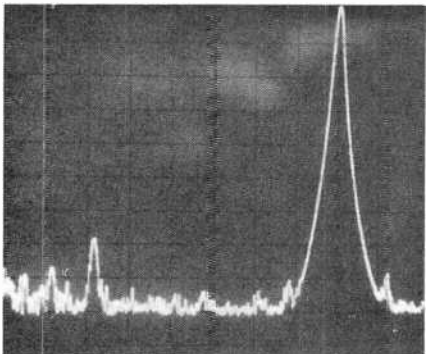

Fig. 7. Analysis of FM tuner has 1-kHz component at right, 400-Hz AM near left, indicating AM rejection is about 68 dB.

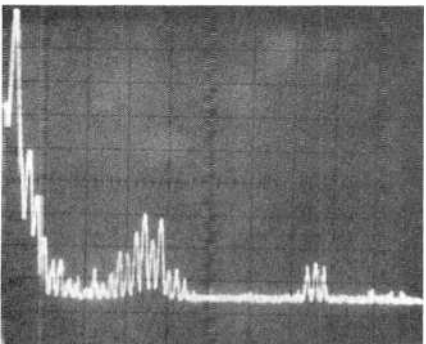
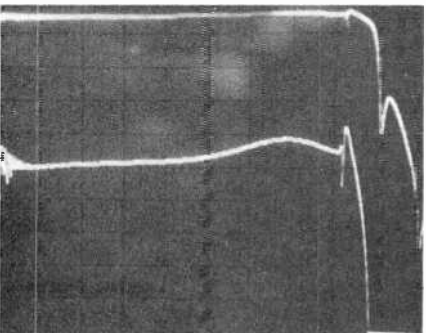

Fig. 8. Analysis of FM tuner has 1-kHz modulation signal followed by harmonics. Also shown are 19-kHz pilot carrier, its modulation products, and 38-kHz signal leakage.



symmetry and rise-time characteristics. The same signal, viewed on the spectrum analyzer scanning from 0 to 10 kHz (Fig. 4B) shows higher than theoretical amplitudes for the 3rd, 5th, 7th, and 9th harmonics, and the presence of all even harmonics (which should be entirely absent in a true square wave) at a level of about -30 dB, or 3%, relative to the fundamental frequency. The even harmonic content shows a lack of symmetry in the square wave, which is not easily seen in the scope photo.

We supplied an FM stereo tuner with an r-f signal modulated 100% in the left channel by a 1000-Hz sine wave. The tuner's left channel output is shown in Fig. 5A as it appeared on the scope, essentially a sine wave. However, in Fig. 5B, the spectrum analyzer displays both the left and right channel tuner outputs (using its storage facility), over a range of 0 to 5000 Hz. The fundamental 1000 Hz output is seen at two levels, showing that the channel separation of the tuner was a good 42 dB. Note that the various harmonics of the modulating frequency appear at the same amplitude in both channels. If the channel separation measurement had been made with a meter, the 2nd harmonic would have dominated the measurement, making the separation appear to be about 33 to 34 dB. The analyzer display also shows that the THD of the tuner under these conditions was 2.1%, or -33.7 dB.

We next examined the tuner output for signs of power line hum, using a 0-to-200-Hz sweep with an analyzer bandwidth of 1 Hz. The time required for this measurement (Fig. 6) was 500 seconds, or more than 8 minutes. The reference (0-dB) level was set to the output from a 100% modulated test signal. The presence of hum components at 60, 120, and 180 Hz can be seen, with respective amplitudes of -85 dB, -84 dB, and -84 dB.

Another common tuner measurement

is for AM rejection, using a signal which is frequency modulated 100% at 1000 Hz, and simultaneously amplitude modulated 30% at 400 Hz. The resulting spectrum centered at 700 Hz is shown in Fig. 7 with a scale factor of 0.1-kHz per division. At the right is the output from the FM modulation, and at the left is the 400-Hz component resulting from the tuner's inability to completely reject the AM portion of the signal. Nevertheless, the AM rejection of 68 dB represents excellent performance.

The total output of the FM tuner, over the full range of the analyzer, is shown in Fig. 8. The frequency scale is 5-kHz per division. At the left is the 1000-Hz audio output, followed by its harmonics. The 19-kHz pilot carrier leakage is down 68 dB (very good) and it is flanked by a number of modulation products. Note that any of these products below 15 kHz are more than 70 dB below program level, and therefore inaudible. Finally, there is a small amount of 38-kHz leakage from the multiplex demodulator, with adjacent sidebands at 37 and 39 kHz.

To make a frequency-response measurement on the tuner, we passed the synchronously swept signal from the spectrum analyzer through the Sound Technology 1100A Signal Conditioner (a precision FM preemphasis unit) and modulated the S-T 1000A Signal Generator with its output. Using the LOG sweep of the spectrum analyzer, we can see in Fig. 9A that the response is essentially flat to just beyond 15 kHz, dipping sharply at 19 kHz and higher frequencies. Noticing a "glitch" at about 10 kHz, we repeated the scan using the 1-dB per division amplitude scale, shown as the lower trace on the photo (again, a convenience afforded by the dual-trace storage capability of the instrument). This reveals a response flat within 1 dB from 20 Hz to just below 15 kHz, but with a definite, sharp irregularity at about 10 kHz. For a still better look, we repeated these measurements with the linear scan from 0 to 20 kHz (Fig. 9B). This shows the response "glitch" in better detail, and also shows that the high-frequency roll-off becomes significant above 14 kHz (the LOG scan cannot be read as accurately).

These examples illustrate but a few of the audio measurements which can be made more rapidly, thoroughly, and accurately with the spectrum analyzer than with more conventional instrumentation. With the addition of this powerful tool to our laboratory, we expect to provide even more definitive test information in our future product reports. \diamond

Fig. 9. Upper trace (A, left) shows tuner response flat to about 15 kHz. Note "glitch" at 10 kHz. Lower trace is on 1-dB scale. Linear scan (B, right) shows more detail.

FM tuner specifications can help you assess how well a given model will work in a particular area, given a good FM antenna. You won't find many of these specifications in most advertisements, but you will likely read them in manufacturers' literature on FM tuners (and on the tuner sections of receivers).

In the accompanying tables, you'll find the most important specifications (as listed by their manufacturers) for nearly 100 separate tuner models, grouped by suggested retail prices for easy comparison. Bear in mind, though, that man-

The dBf figure is significant for two reasons. First, because it measures power, not voltage, it is the same for measurements taken at a tuner's 300-ohm and 75-ohm antenna inputs. A tuner rated at 1.0 μV across its 75-ohm input (common practice, overseas) is *not* more sensitive than one rated at 2.0 μV across 300 ohms (as is the practice here)—both are equivalent to 11.2 dBf. Second, because the figures are logarithmic, as all dB figures are, they emphasize the real meaning of differences in sensitivity. A difference in tuner sensi-

microvolts are needed at a tuner's 75-ohm input as at its 300-ohm one; 75-ohm microvolt figures should therefore be doubled before comparing them with 300-ohm figures.)

Selectivity. This measures the tuner's ability to reject signals on frequencies near that of the station to which it is tuned. The alternate-channel selectivity figures given here indicate ability to reject signals 400 kHz above or below the desired frequency. An IHF selectivity figure of 70 dB, for example, means that it

BY IVAN BERGER, Senior Editor

1978 STEREO FM TUNER BUYING DIRECTORY

Specifications and features of today's most popular FM tuners

ufacturers reserve the right to change these suggested prices without notice, and dealers need not adhere to them.

Sensitivity. The single most-advertised tuner specification, IHF monophonic sensitivity, is among the least useful ones in judging tuner performance. This "usable sensitivity" figure defines the input signal a tuner requires for a signal-to-noise and distortion ratio of only 30 dB—hardly "usable," in hi-fi terms. Still, in many cases, it's the only sensitivity specification provided.

More significant is the second sensitivity figure, the signal needed for 50 dB of quieting—listenable, if still not quite hi-fi by current standards. Since most listening is done in stereo, the 50-dB *stereo* sensitivity figure is more significant still. Though *usable* sensitivity figures are usually given in microvolts of signal *voltage* level, the 50-dB figures are usually given in "dBf"—that is, dB above a signal *power* level of one femtowatt (10^{-15} watt).

tivity of 3 dBf always means one tuner is twice as sensitive as the other, whether the figures we're comparing are 9.8 and 12.8 or 35 and 38 dBf. But a sensitivity difference of 0.5 microvolts, quite significant when we're comparing 1.5 and 2.0 μV , is of almost no significance when comparing 35 with 35.5 μV .

Whether in dBf or μV , sensitivity is most important to listeners in weak signal areas. If that's your problem, try a better antenna before replacing your tuner. It can often make your current tuner the equivalent, for all practical purposes, of a rather more expensive one. Even if you then find you still need a better tuner, the new antenna will help your new model deliver all the performance you're paying for.

The smaller the sensitivity figure the better, whether it's expressed in microvolts across a 300-ohm input or in dBf. (Note that dBf, which expresses signal power, remains constant for both 75-ohm and 300-ohm antenna inputs. For the same power, only half as many

takes an alternate-channel signal 70 dB stronger than the desired-channel signal to produce interference 30 dB below the level of the desired signal. Interference from signals less than 70 dB stronger would produce much less interference than that.

Tuners with variable i-f bandwidth (see under *Features*) are more selective at their narrow-band settings. (However, not all makers of dual-bandwidth tuners give both narrow-band and wide-band figures.) The higher the selectivity, the less potential interference. High selectivity is especially desirable in suburban and metropolitan areas where signals from different towns or cities are sometimes found on alternate channels. (Selectivity figures for adjacent-channel signals—those 200 kHz above or below the desired frequency—are rarely published by manufacturers, and are always considerably lower than alternate-channel figures.)

Capture Ratio. FM tuners can distin-
(Continued on page 57)

FM TUNER COMPARISON TABLE

Make & Model	Price (\$)	Sensitivity in μV (&dBf)			Selectivity (HF) (indB)	Capture ratio (in dB)	Ultimate S/N (in dB)	Distortion (percent)		Separation (in dB) at 1K/10K Hertz	Rejection (in dB)			Meters ¹	Features				Remarks	
		IHF Mono	50-dB Quieting					Mono	Stereo		AM	Image	Spurious		Dolby	Deemphasis	Hi-Band	Rec. Osc.		Bandwidth
			Mono	Stereo																
I: UP TO \$200																				
Akai AT-2200	165	1.9(10.8)	— (—)	— (—)	60	1.3	70	0.3	0.5	40/—	50	55	85	S,C						
Akai AT-2400	185	1.8(10.3)	— (—)	— (—)	80	1.0	75	0.2	0.3	42/—	55	90	100	S,C			X			
Fisher FM2110	160	1.8(10.3)	2.8(14.1)	38(36.8)	70	1.0	72	0.4	0.5	40/30	60	60	85	S,C						
Harman-Kardon T403	195	1.7(9.8)	3.8(16.8)	45(38.3)	50	2.0	73	0.5	0.7	40/30	55	45	Q							
Heath AJ-1219	110	2.0(11.2)	— (—)	— (—)	60	2.0	—	—	—	—/40	50	—	—							
JVC JT-V31	170	1.9(10.8)	4.0(17.2)	40(37.2)	60	1.2	72	0.2	0.35	45/35	50	—	—	S,C						
JVC JT-V11	150	1.9(10.8)	— (—)	40(37.2)	60	1.0	72	0.2	0.4	40/30	—	—	—	S,C						
Kenwood KT-5300	140	1.9(10.8)	5.0(19.2)	— (—)	60	1.0	70	0.2	0.3	30/30	50	—	70	C						
Lafayette LT-40	150	2.0(11.2)	3.1(15.0)	39(37.0)	68	1.6	72	0.2	0.6	40/—	—	50	90	S,C						
Marantz 2100	200	1.9(10.8)	2.5(13.2)	40(37.2)	80	1.0	75	0.15	0.3	45/40	55	85	90	S,C	X					
Nikko FAM-450	140	2.0(11.2)	— (—)	— (—)	55	1.6	65	0.4	—	42/—	—	45	—			X				
Onkyo T-4	200	1.9(10.8)	3.5(16.1)	40(37.2)	60	1.5	70	0.2	0.4	40/30	50	60	85	S,C	X					
Optonica ST-1515	180	1.7(9.8)	5.5(20.0)	44(38.1)	60	1.2	72	0.2	0.3	45/35	50	82	80	S,C		X	X			
Pioneer TX-6500 II	200	1.9(10.8)	2.8(14.1)	44(38)	60	1.0	75	1.15	0.3	40/30	50	60	—	C						
Pioneer TX-5500 II	150	1.9(10.8)	2.8(14.1)	44(38)	60	1.0	72	0.15	0.3	35/30	50	60	—	C						
Realistic TM-1000	170	2.0(11.2)	— (—)	— (—)	65	2.0	—	—	—	35/—	—	—	—	S						
Rotel RT-725	200	1.8(10.3)	3.0(14.7)	44(38.1)	60	1.5	70	2.2	0.3	42/31	50	—	—	S,C		X	X			
Rotel RT-425	170	1.9(10.8)	3.1(15.0)	44(38.1)	50	1.5	70	0.2	0.3	40/30	50	—	—	C	X					
Sansui TU-3900	160	2.0(11.2)	— (—)	— (—)	60	2.0	70	0.3	0.4	40/—	—	55	70	S,C	X					
Sansui TU-217	175	1.85(10.5)	2.7(13.8)	— (—)	50	—	71	0.12	0.13	—/—	—	—	—	S,C						
Sanyo FMT 1001K	150	2.0(11.2)	— (—)	— (—)	—	1.0	70	0.4	—	40/—	55	60	—	C		X				
H.H. Scott T-516	150	2.2(12.0)	3.5(16.1)	70(42.1)	55	1.5	68	0.3	0.5	40/34	50	50	80	S		X				
Superscope T-210	105	— (—)	10(25.2)	55(40.0)	25	6.0	60	1.0	—	30/15	35	—	—	S						
Technics ST-7300	180	2.0(11.2)	3.0(14.8)	45(38.3)	75	1.0	75	0.5	0.5	45/35	55	55	80	S,C			X			
Webcor 291	130	— (—)	— (—)	— (—)	45	1.2	65	0.2	0.4	30/25	45	50	—	S,C						
Average	165	1.9	(16.2)	(38.1)	60	1.6	71	0.3	0.4	38/32	48	57	84							
II: \$201-\$280																				
Akai AT-2600	275	1.7(9.8)	— (—)	— (—)	100	1.0	75	0.2	0.2	45/—	55	110	110	S/D,C			X			
Armstrong 624	250	3.0(10.3)	— (—)	— (—)	56	1.75	65	0.2	0.2	40/—	50	50	—	S/C						
Fisher FM-2310	250	1.7(9.8)	2.5(13.2)	34(35.8)	75	0.8	75	0.1	0.15	46/36	65	80	100	S,C,M/D			X			
Hitachi FT-920	240	1.7(9.8)	3.5(16.1)	39(37.0)	80	1.0	74	0.15	0.25	45/—	55	85	100	S,C						
JVC JT-V71	270	1.8(10.3)	3.8(16.8)	38(36.8)	75	1.0	75	0.1	0.1	50/45	55	—	—	S,C		X				
Kenwood KT-7500	275	1.7(9.8)	2.8(14.1)	35(36.1)	30 ²	1.0 ²	75	0.08	0.1	50/43 ²	—	105	110	S,C			X			
					100 ³	2.0 ³				45/38 ³										
Mitsubishi DA-F10	260	2.5(13.2)	5.5(20.0)	55(40.0)	45 ²	0.8 ²	75	0.06 ²	0.1 ²	45/40 ²	55 ²	75	90	S,C			X			
					75 ³	1.5 ³		0.2 ³	—	35/30 ³	50 ³	—	—							
Nikko NT 850	230	1.8(10.3)	— (—)	— (—)	35 ²	1.0 ²	75 ²	0.08 ²	0.15 ²	48/40 ²	60	—	—	S,C		X	X	Multipath Indication.		
					90 ³	1.5 ³	70 ³	0.2 ³	0.4 ³	35/32 ³	—	—	—							
Onkyo T-9	280	1.7(9.8)	3(14.7)	35(36.1)	80	1.5	—	0.15	0.3	40/35	50	83	95	S,C	X	X	X			
Sansui TU-5900	230	1.8(10.3)	3.5(16.1)	45(38.3)	60	2.0	70	0.25	0.35	40/30	55	50	65	S,C	X	X				
H.H. Scott T-527	250	1.8(10.3)	3.5(16.1)	40(37.2)	55	1.5	68	0.3	0.5	40/34	50	70	80	S,C	X	X				
H.H. Scott T-526	230	1.9(10.8)	3.5(16.1)	40(37.2)	55	1.5	68	0.3	0.5	40/34	50	50	80	S,C	X					
Sherwood ST-8080	250	2.0(11.2)	— (—)	— (—)	—	1.0	70	—	—	45/—	55	85	—	S,C						
Sony ST-2950SD	220	2.0(11.2)	4.0(17.2)	50(39.2)	50	1.0	73	0.2	0.3	40/35	54	45	75	S,C	X	X				
Technics ST-8080	250	1.9(10.8)	2.5(13.2)	28(34.1)	85	1.0	75	0.15	0.3	45/35	55	85	95	S,C		X				
Toshiba ST-420	220	1.9(10.8)	— (—)	— (—)	70	1.0	72	0.2	0.3	45/—	55	85	100	S,C		X				
Yamaha CT-810	250	1.8(10.3)	3.2(15.3)	40(37.2)	80	1.0	80	0.08	0.1	50/45	55	90	100	S/Q,C		X	X			
Average	250	1.9	(16.0)	(37.3)	73	1.1	73	0.14	0.27	41/34	55	76	92							
III: \$281-\$380																				
Armstrong 623	359	3.0(10.3)	— (—)	— (—)	65	1.75	65	0.2	0.2	40/—	50	50	—	S/C			X ⁴			
Dynaco FM-5	319	1.75(10.1)	5.0(19.2)	— (—)	65	1.5	65	0.5	0.9	40/30	58	—	—	S,C,L			X			
Heath AJ-1515	380	1.8(10.3)	— (—)	— (—)	100	1.5	70	0.3	0.35	40/25	65	90	90	S,C			X			
Hitachi FT-920	300	1.6(9.3)	3.1(15.0)	34(35.8)	80	1.0	74	0.15	0.25	45/—	55	—	100	S/M,C						
Lux T-88V	345	2.0(11.2)	2.8(14.1)	— (—)	60	1.8	72	0.2	0.3	43/30	50	75	—			X				
Marantz 2120	300	1.8(10.3)	2.5(13.2)	35(36.1)	—	—	80	—	—	50/42	55	90	100	S,C	X ⁴	X	X	X		
Nikko Gamma 1	350	1.8(10.3)	4.5(18.3)	34(35.8)	35 ²	1.0	75 ²	0.05 ²	0.08 ²	50/40 ²	60	—	110	S,C			X	FM only.		
					85 ³	—	72 ³	0.08 ³	0.2 ³	35/32 ³	—	—	—							
Optonica ST-3636	300	1.7(9.8)	— (—)	— (—)	80	2.0	77	0.2	0.4	50/40	50	120	120	S,C/M			X			
Pioneer TX-8500 II	300	1.8(10.3)	3.5(16.1)	40(37.2)	35 ²	0.8 ²	79 ²	0.15	0.8 ²	45/35 ²	55	85	90	S,C		X	X	X		
					80 ³	2.0 ³	75 ³	0.15	0.9 ³	45/30 ³	—	—	—							
Rogers T-75, Series 2	319	1.5(8.75)	4.0(17.2)	30(34.7)	60	1.5	70	0.3	0.7	40/35	50	—	—							
Rotel RT-925	340	1.7(9.9)	3.0(14.7)	35(36.1)	80	1.5	70	0.1	0.3	45/31	60	—	—	S,C/M		X	X			
Sansui TU-717	320	1.75(10.1)	2.45(13.0)	40(37.2)	50 ²	1.2 ²	80	0.07 ²	0.07 ²	45/38	60	86	90	S,C		X	X	X		
					80 ³	1.7 ³	—	0.15 ³	0.22 ³	—	—	—	—							
Setton TUS-600	380	1.8(10.3)	4.0(17.2)	40(37.2)	80	1.5	70.5	0.09	0.11	55/45	65	—	—	S,C		X				
Sony ST-3950 SD	300	1.7(9.8)	3.0(14.7)	40(37.2)	80	1.0	75	0.15	0.25	40/35	56	80	90	S/M,C	X	X				
Sony ST-4950	350	1.9(10.8)	— (—)	— (—)	80	1.0	70	0.15	0.3	40/—	53	70	100	S/M,C			X			
Technics ST-8600	330	1.9(10.8)	— (—)	— (—)	85	1.0	80	0.15	0.2	—/—	—	—	95	S,C		X ²	X			
Yamaha CT-1010	350	1.9(10.8)	3.2(15.3)	40(37.2)	85	1.0	80	0.07	0.1	52/45	65	110	110	S/Q,C			X			
Average	350	1.85	(15.7)	(36.5)	78	1.3	74	0.18	0.33	45/36	57	72	100							

¹C = center of channel
D = deviation
d = digital indication
L = light indication

FM TUNER COMPARISON TABLE (Continued)

Make & Model	Price (\$)	Sensitivity in μ V (dBf)			Selectivity (MHz) (in dB)	Capture ratio (in dB)	Ultimate S/N (in dB)	Distortion (percent)		Separation (in dB) at 1K/10K Hertz	Rejection (in dB)			Meters ¹	Features					Remarks		
		IHF Mono	50-dB Quieting					Mono	Stereo		Mono	Stereo	AM		Image	Spurious	Dolby	Deemphasis	Hi-Blend		Rec. Disc.	Bandwidth
			Mono	Stereo																		
IV: \$381-\$600																						
Accuphase T-101	500	2.0(11.2)	4.5(18.3)	45(38.3)	55 ²	2.0	75	0.1	0.2	45/30	55	80	100	S,C,M				X	FM only.			
Dynaco AF-6	395	1.75(10.1)	5.0(19.2)	— (—)	100 ³	65	1.5	65	0.5	0.9	40/30	58	—	—	S,C,L				Kit \$269.			
Harman-Kardon Citation 18	595	2.0(11.2)	3.2(15.3)	40(37.2)	70	1.5	74	0.15	0.3	50/—	55	63	100	Q,CL					Kit only. Dig. synth. Autoscan & 3 presets.			
Heath AJ-1510A	500	1.8(10.3)	— (—)	— (—)	95	1.5	68	0.3	—	40/25	—	—	90	S/M			X					
Heath AN-2016 "Modulus"	600	1.7(9.8)	3.5(16.1)	35(36.1)	100	1.3	68	0.3	0.35	40/20	68	90	90	S,C	X ⁴				Kit only. Incl. 2/4-channel preamp. Dig. display. Dig. synth. 7 preselects. Autoscan.			
JVC T-3030	600	2.0(11.2)	3.8(16.8)	38(36.8)	70	1.0	75	0.08	0.1	50/45	65	110	110	SL	X		X		FM only. 3-i-f bandwidth.			
Kenwood L-07T	500	1.6(9.3)	2.8(14.2)	38(36.8)	30 ²	1.0 ²	80	0.08 ²	0.1 ²	50/45	65	110	110	S,C	X		X		FM only.			
Kenwood 600T	600	1.6(9.3)	2.8(14.1)	38(36.8)	110	0.8	84	0.05	0.08	50/45	65	120	120	S,C,M/D	X				FM only. 3-i-f bandwidth.			
Kenwood KT-8300	450	1.6(8.3)	2.8(14.1)	30(34.8)	40 ²	1.0 ²	78	0.08	0.1	50/45 ²	60	110	110	S,C,M/D	X		X					
Lux T-110	525	1.6(9.3)	2.2(12.0)	34(35.8)	70	1.3	78	0.08	0.08	48/38	53	100	—	S,C	X				FM only.			
Nakamichi 430	400	1.8(10.3)	4.0(17.2)	40(37.2)	60 ²	1.5 ²	70	0.06 ²	0.09 ²	50/35 ²	60	100	100	CL	X ⁴	X		X	FM only.			
Phase Linear 5000	499	2.0(11.2)	4.0(17.2)	30(34.7)	75	1.5	70	0.2	0.25	40/30	60	110	120	S,C,ML	X				FM only. With expanders.			
Philips AH673	600	1.6(9.3)	2.5(13.2)	30(34.7)	110	1.0	75	0.09	0.1	47/38	50	110	110	S,C/M					Audible multipath check.			
Pioneer TX-9500 II	400	1.5(8.7)	2.5(13.2)	35(36.1)	35 ²	0.8 ²	82	0.05 ²	0.07 ²	50/35 ²	65	120	110	S,C			X	X				
Rotel RT-1024	570	1.5(8.7)	2.1(11.6)	35(36.1)	80	1.0	75	0.1	0.2	47/35	60	—	—	S,C,M,D	X	X	X	X				
Sansui TU-9900	460	1.5(8.7)	3.0(14.7)	— (—)	55 ²	1.0 ²	80 ²	0.06 ²	0.08 ²	50/40 ²	58	96	100	S/M,C	X	X	X	X				
Sherwood HP-5500	500	1.6(9.3)	2.5(13.2)	25(33.2)	90 ²	3.0 ²	76 ²	0.5 ²	0.8 ²	30/30 ²	—	—	—	S,C	X	X						
Sony ST-5950 SD	470	1.5(8.7)	2.8(14.1)	35(36.1)	85	1.0	76	0.1	0.2	50/40	66	90	100	S/M,C	X							
Technics ST-9030	400	2.4(12.8)	4.4(18.1)	44(38.1)	25 ²	0.8 ²	90	0.08 ²	0.08 ²	50/40 ²	58 ²	135	135	S,C		X ⁵	X ⁵					
Average	510	1.7	(15.5)	(36.2)	87	1.2	75	0.14	0.2	47/36	60	104	109									
V: \$601 and up.																						
Accuphase T-100	750	2.0(11.2)	4.5(18.3)	45(38.3)	70	1.5	75	0.1	0.2	45/30	60	90	100	S,C,M					Digital synth. FM only. Audible multipath detector. 7-station preselect.			
Lux ST50	1495	1.7(9.8)	2.5(13.2)	35(36.1)	72	1.1	70	0.08	0.1	45/40	55	100	100	Sd	X	X						
McIntosh MR 78	899	2.0(11.2)	— (—)	— (—)	55 ²	2.5	75	0.2	0.2	40/—	—	100	100	S/M,C			X		FM only. 3-i-f bandwidths.			
McIntosh MR 77	699	2.0(11.2)	— (—)	— (—)	50	2.5	—	0.2	0.2	40/—	—	100	100	S,ML,C					FM only.			
McIntosh MR 74	699	2.5(13.2)	— (—)	— (—)	58	1.5	—	0.3	0.5	35/—	69	100	100	S,ML,C								
Nakamichi 630	630	1.5(8.7)	5.0(19.2)	— (—)	45 ²	1.0	55	0.05 ²	0.08 ²	55/35 ²	69	100	100	SL,CL	X	X		X	Combined with stereo preamp. FM only.			
RAM Audio 102	639	1.6(9.3)	2.2(12.0)	34.5(36.0)	90 ²	—	—	0.1 ²	0.1 ²	30/30 ²	—	—	—	S,C	X				FM only.			
Revox B760	1145	2.0(11.2)	2.0(11.2)	20(31.2)	80	0.9	75	0.15	0.15	42/—	70	106	106	S,C	X	X	X		Digital synthesis. 15-station preselect.			
SAE 8000/Mark VIII	650	1.6(9.3)	2.2(12.0)	25(33.2)	120	1.5	70	0.15	0.2	45/35	100	100	100	S,C	X				Digital readout. FM only.			
H.H. Scott T-33S	1000	1.8(10.3)	3.5(16.1)	40(30.3)	55	1.2	70	0.2	0.4	40/40	75	75	90	S,M	X				Dig. Synth. Pre-programmed channel select. Dig. readout. Built-in oscilloscope. 3-station preselect.			
Sequerra Model 1	3000	— (—)	1.7(9.8)	15.5(29)	100	0.75	75	0.07	0.07	52/38	70	90	—	Scope	X	X	X		Built-in oscilloscope.			
Sequerra Model 2	1750 ⁴	— (—)	1.7(9.8)	15.5(29)	100	0.75	75	0.07	0.07	52/38	70	90	—	S,M	X	X	X		3-station preselect.			
Setton RC3 X1000	3500	1.2(6.8)	5.0(19.2)	20(31.2)	—	1.0	72	0.2	0.4	55/30	—	80	90	SL,CL	X ⁵		X		Digital display. Built-in preamp.			
Sherwood Micro CPU 100	2000	1.7(9.8)	2.6(13.5) ²	30(34.7) ²	18 ²	0.5 ²	75	0.07 ²	0.15 ²	50/40 ²	65	130	130	S,M	X		X		Dig. Synth. FM only.			
Toshiba ST-910	1800	1.8(10.3)	— (—)	— (—)	80 ²	1.0 ²	—	0.1 ²	0.2 ²	45/35 ²	—	—	—	SL					Dig. synth. Autoscan. 7-sta. preselect. FM only.			
Yamaha CT-7000	1200	2.0(—)	— (—)	— (—)	18 ²	0.7 ²	78 ²	0.08 ²	0.15	50/35	60	120	120	S/Q,C		X ⁵	X					
Average	1390	1.5	(13.6)	(33.2)	81	1.2	74	0.13	0.18	45/33	67	100	104									

¹C = center of channel
²D = deviation
³d = digital indication
⁴L = light indication

⁵M = multipath
⁶Q = signal quality (S/N or signal-minus multipath)
⁷S = signal strength

⁸With I-f bandwidth set at "wide" position.
⁹With I-f bandwidth set at "narrow" position.
¹⁰Optional.

¹¹Automatic.
¹²Estimated.

(Continued from page 54)

guish between two signals on the same channel, even when they are of almost equal strength, suppressing the weaker to "capture" the stronger one. Capture ratio is the minimum ratio in dB between co-channel signals which will allow the tuner to suppress the weaker one's interference by 30 dB. The *smaller* this figure, therefore, the better. (Note that, unlike selectivity, capture ratio improves at a tuner's wide-band setting.) Capture ratio is likely to be most important for listeners in fringe areas equidistant from two stations on the same frequency.

Ultimate S/N. This is the maximum signal-to-noise ratio the tuner can deliver. Since most tuners will reach this maximum with signals of 65 dBf (978 microvolts) or less, ultimate S/N is usually measured at that point. The monophonic figure is listed here; the stereo figure would be lower. As with all signal-to-noise ratios, the higher the figure, the cleaner the sound.

Distortion. Manufacturers differ in their distortion specification methods. Some list harmonic distortion only at one frequency (usually 1 kHz), others list it at several. Some list harmonic distortion only, while others give intermodulation distortion figures, too. When only a single distortion figure is given, assume it to be harmonic distortion at 1 kHz, which is the figure listed here. Note that stereo distortion figures tend to be higher than mono.

Separation. This figure measures the crosstalk between stereo channels. The more separation, the greater the potential stereo effect. Since separation tends to decrease at higher audio frequencies, it is listed in the table, wherever possible, for both 1 kHz and 10 kHz. Separation commonly decreases at bass frequencies, too, but its effects are less audible at those frequencies.

AM Suppression. This has nothing to do with AM broadcasting, but rather with the tuner's ability to reject amplitude variations in the FM signal. This gives some indication of how well the tuner can cope with multipath interference, which causes such amplitude modulation of the FM signal.

Multipath interference, created by the simultaneous reception of a signal and of several delayed signal echoes, is most troublesome in cities and in moun-

tainous or hilly regions, where there are many reflective surfaces from which the signals can bounce. The higher the AM suppression figure, the more resistant the tuner is to such interference.

Image Suppression. This measures the tuner's ability to reject signals 21.4 MHz above the desired signal (21.4 MHz is twice the tuner's i-f frequency of 10.7 MHz). This is most important to those who live near airports, as air-to-ground channels (108-136 MHz) are within the image-frequency range for FM tuners.

Spurious Response Rejection. The interaction of two strong signals (neither of them necessarily within the FM band) can cause a tuner with a nonlinear front end to "receive" nonexistent signals which are actually the sum of or difference between the two interacting signals. A strong station's popping up at several points along the dial would be a typical spurious-response symptom. If your tuner suffers from this or other strong-signal overload problems, look for a tuner with a high spurious-response rejection figure.

Meters. Several types of meters are provided as tuning aids. *Center-channel* meters (C) help you tune accurately to the station's exact frequency. They're found on virtually all tuners except the lowest-priced ones—and some of the highest-priced tuners, whose digital-synthesis circuits render these meters superfluous because they always tune directly to the channel's center. *Signal-strength* meters (S) provide some help in finding the exact station frequency (the signal presumably peaks at that point), but are more useful in orienting the antenna for maximum signal strength.

Multipath meters (M) or *signal-quality* meters (Q) are even more useful in orienting the antenna, as they help you find the direction which yields the cleanest signal. (This may not necessarily be the same direction that yields the strongest one). *Deviation* meters (D) measure the station's modulation level, which you can use as a guide in setting modulation levels on your tape recorder when tapping off the air.

Oscilloscopes show multipath, tuning accuracy, modulation and signal level all at once; such a scope is built into the Sequerra Model 1; and many others have connections for use with external scopes. The Sequerra's scope also

shows the presence of other signals on nearby frequencies.

Features. We have listed here only some of the more common and significant features. A few significant ones are listed under "Remarks."

Dolby decoding is built into several of the tuners in our table, and available as a plug-in option for a few more. A *de-emphasis switch*, necessary for correct frequency response when using an external Dolby decoder, is available on several tuners also.

High-blend is a very useful aid in listening to marginal stations in stereo. By blending together the higher frequencies of both stereo channels, it reduces noise and distortion while maintaining separation at the middle frequencies to keep some stereo effect.

A *recording oscillator* is simply an aid to setting recording levels for taping off the air. The oscillator's output corresponds to the tuner's output at a specified signal modulation level (usually 50% modulation), allowing the recording level to be adjusted for best signal-to-noise ratio and minimum distortion.

Bandwidth switching allows the user to trade selectivity (at its maximum when the i-f bandwidth is narrowest) for better capture ratio, signal-to-noise ratio, distortion and separation (all best at wider bandwidths). When extra selectivity is needed to pick a particular station out from a clutter of strong ones on nearby frequencies, the user can narrow the tuner's bandwidth to get extra selectivity at the expense of a slight reduction in the other parameters. Tuners with three-position bandwidth selectors are noted under "Remarks."

Digital tuning comes in two flavors: Tuners with *digital displays* may be otherwise conventional in that they tune continuously across the FM band. *Digital synthesis* tuners, though, also have digitally controlled local oscillators that allow them to tune in direct jumps from one station frequency to another without observably moving through any of the frequencies between. This also simplifies the addition of such features as automatic scanning and station preselects, which are often found on such tuners.

There remain a few features and specifications which we have not listed. Some, such as i-f rejection, were omitted because they are of little practical significance to the listener. Others, such as muting and stereo threshold, are not listed consistently enough for us to cover them reliably. ◇

In the Black II



Performance, beauty, quality — three attributes that have always been the hallmarks of SAE products. SAE systems in the past have had them, this system's predecessor had them, and the new In The Black system has them and much more.

The 2900 Parametric Preamplifier offers our new flexible parametric tone control system, full dubbing and tape EQ. New phono and line circuitry results in unparalleled clarity and definition with distortion of less than 0.01% THD & IM.

The 2200 Stereo Power Amplifier with fully complementary circuitry delivers 100 Watts RMS per channel from 20-20K at less than 0.05% Total Harmonic Distortion, from 250mW to full rated power.

The 8000 Digital FM Tuner has linear phase filters, phase-lock multiplex, and of course, our famous digital readout tuning indicator system.

Combine these products together and you have a system that ensures superior performance in all areas, excellent control flexibility, and the sonic quality that is typically SAE.

SAE

Scientific Audio Electronics, Inc.
P.O. Box 60271 Terminal Annex, Los Angeles, CA 90060

HOW FM TUNERS WORK



PART 2 *The detector and modulation/demodulation circuits.*

BY JULIAN HIRSCH

LAST MONTH, in the first part of this article, we discussed the basic principles of frequency modulation and started dissecting the "innards" of an FM tuner by examining the front and the i-f section. We continue here with the detector section and stereo modulation and demodulation.

The Detector. The ratio detector is the most widely used circuit for converting FM r-f to audio signals. The Foster-Seely discriminator originally used in FM tuners has fallen into disuse. Quadrature detectors are sometimes found, especially in lower-priced tuners that use a single IC for i-f amplification, limiting, and detection functions. It also has the virtue of requiring only a single external tuned circuit, which simplifies alignment. A little-used detector with a clear theoretical advantage is the so-called "pulse counter," which generates a short pulse each time the 10.7-MHz i-f signal voltage crosses the zero axis. These pulses can be created with a constant amplitude and duration so that the average value of a series of pulses from an FM signal follows the modulating waveform. This is the most linear type of FM detector (it is often used to measure the inherent distortion of an FM signal generator) but it is rarely used in consumer products. Apparently its advantages are more theoretical than practical, due to limitations elsewhere in the broadcast chain. In other words, a tuner with a pulse counter detector does not necessarily have less distortion than one with a more conventional circuit.

Stereo Modulation/Demodulation. Earlier, we referred to the spectrum of a stereo FM signal as having a 38-kHz double-sideband, suppressed-carrier component that contains L - R program information. Figure 2 is a spectrum analyzer display of the composite

modulating signal from our Sound Technology Model 1000A signal generator with a 2000-Hz external signal used to 100% modulate the left channel. The frequency scale is 5000 Hz/division, with the scan covering from 0 to 50 kHz. The base band audio signal at 2000 Hz can be seen at the left with a 0-dB reference amplitude. The 19-kHz pilot carrier can be seen near the center, followed by the two difference sidebands spaced 2000 Hz above and below the 38-kHz carrier. The latter is suppressed to about 54 dB below the difference sidebands.

The relative amplitudes of the base band and subcarrier band signal levels vary in a complex manner according to the spatial distribution of the program. But the general appearance of the signal that modulates the transmitter, and which is recovered at the output of the tuner's detector, resembles the spectrum of Fig. 2.

Although this is one way to look at the stereo signal, it is easier to consider the signal as being created by a sampling process at the transmitter. The left and right channels are alternately selected at a 38-kHz switching rate, and the composite signal modulates the transmitter. Since the normal program bandwidth does not exceed 15 kHz, this meets the requirement that the sampling rate be at least twice the highest frequency in the program. The 38-kHz switching signal does not appear in the output of the switching system (except as the result of inevitable unbalance conditions). Hence, it is divided down to 19 kHz, after which it is transmitted with the audio and subcarrier programs as a pilot carrier.

There are several ways in which the composite detected signal can be separated into its left and right channel components in the tuner. Basically, tuners use the 19-kHz pilot carrier to either synchronize or generate (as by frequency doubling in a full-wave rectifier, or through a PLL) a 38-kHz demodulating

carrier. It is imperative that this signal be in-phase with the 38-kHz switching signal at the transmitter, since an error of a few degrees can seriously degrade channel separation.

In a switching demodulator, the composite signal is sampled by the 38 kHz waveform, which reverses the process employed at the transmitter and separates the composite signal into left and right channels. In a matrix demodulator, the composite signal is first separated by filters into the base band (up to 15,000 Hz) and the subcarrier band (23 to 53 kHz). The latter is detected in a balanced modulator, where it is heterodyned with the 38-kHz signal. The output of the modulator is the L - R program (the base band contains the L + R program). The two are then combined in a resistive matrix that adds and subtracts them to derive the left and right program channels.

Following separation, each program channel is individually deemphasized to compensate for the 75- μ s preemphasis used at the transmitter and usually passes through a low-pass filter to remove any residual 19- or 38-kHz signal components. These cannot be heard because the tuner's deemphasis reduces even the 19-kHz component to greater than 20 dB below the 100% modulation level. However, even at that level, the 19-kHz signal can interfere with the operation of a Dolby circuit, which interprets its presence as signifying high-frequency program content and alters its frequency response accordingly. With some tape recorders, it is also possible to have harmonics of the pilot carrier beat with the bias oscillator, giving rise to "birdies."

Ideally, the low-pass filter should have a flat response to 15,000 Hz but should attenuate 19-kHz signals (and those at

higher frequencies) by at least 30 dB. Such filters can be made, but they are relatively complex and costly, and most tuner manufacturers use simpler filters whose responses begin to roll off above 10,000 or 12,000 Hz and may be down 2 or 3 dB at 15,000 Hz. This is responsible for some of the subtle differences sometimes heard between tuners. In a few deluxe tuners, a switch allows the low-pass filter to be bypassed at the user's option, giving a flat high-frequency response (and with no ill effects, if neither Dolby processing nor tape recording is involved).

Other Features. The multiplex demodulator uses the 19-kHz pilot carrier in the received signal to operate a stereo indicator light. In the absence of the 38-kHz signal, the internal oscillator is disabled and the detected signal passes unchanged through both channels of the demodulator and goes to the amplifier as a mono signal. A control voltage from the tuner's limiter also disables the 38-kHz oscillator when the signal is too weak for noise-free stereo reception. The stereo/mono switch on most tuners does the same thing, under the listener's control.

Interstation noise muting is often controlled by the same signal-derived voltage that operates the stereo switching circuit. In some tuners, multiplex IC's contain muting circuits, while in other tuners, the muting voltage acts on the limiter IC. A preferable system, used in a few tuners, is to combine the signal sensing voltage with the detector output so that the tuner "un-mutes" only when a signal is sufficiently strong *and* when it is tuned with sufficient accuracy for low-noise, low-distortion reception.

Perhaps the most serious cause of distortion in FM reception is multipath in-

terference. When a signal is reflected to the tuner over several different path lengths, the various components arrive with random phase relationships. The result is a partial or total cancellation of some of the frequency components of the FM signal. This appears to the tuner like a severely distorted amplitude modulation of the signal. To the extent that the FM detector is able to respond to amplitude modulation, the audio output from the tuner will be distorted by the multipath condition.

The most effective way to deal with the multipath problem is to use a directional antenna, oriented to favor one component of the arriving signal (preferably the earliest arrival) over the others. The AM resulting from the multipath condition, and its distortion, will be reduced, depending on how "selective" the antenna is. If the distortion is not severe, it may not always be heard in an easily identified form. It is useful, therefore, to have some indication of the multipath condition as an aid to orienting the antenna.

For some years, this has been offered in the better tuners and receivers in the form of external oscilloscope jacks. The horizontal output is taken from the detector, so that it represents frequency deviation with the channel center located at the center of the CRT screen when a station is correctly tuned. The vertical output, taken from the limiter, is proportional to the amplitude of the signal as it reaches the limiter section of the tuner. The display traces the i-f passband of the tuner on the screen if there is no multipath distortion present, showing the peak deviation of the signal and whether it remains within the tuner's linear response region. Any amplitude modulation present in the signal appears as ripples on the top of the trace. (The antenna should be oriented to give the smoothest and most nearly horizontal display.)

In many cases a meter is used as a multipath indicator. Usually the signal strength meter can be switched for this purpose. The exact mode of operation of the multipath meter differs from one manufacturer to another, as does effectiveness. Typically, the meter "kicks" on program modulation if AM is present, so that the antenna can be adjusted for the steadiest pointer indication. Most meters are not sensitive enough to show up moderate amounts of multipath that would be instantly visible on an oscilloscope; fortunately, this level of distortion is not often disturbing to the listener. \diamond

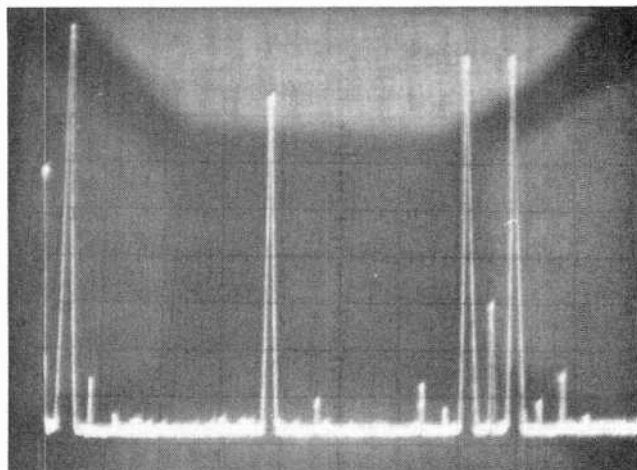
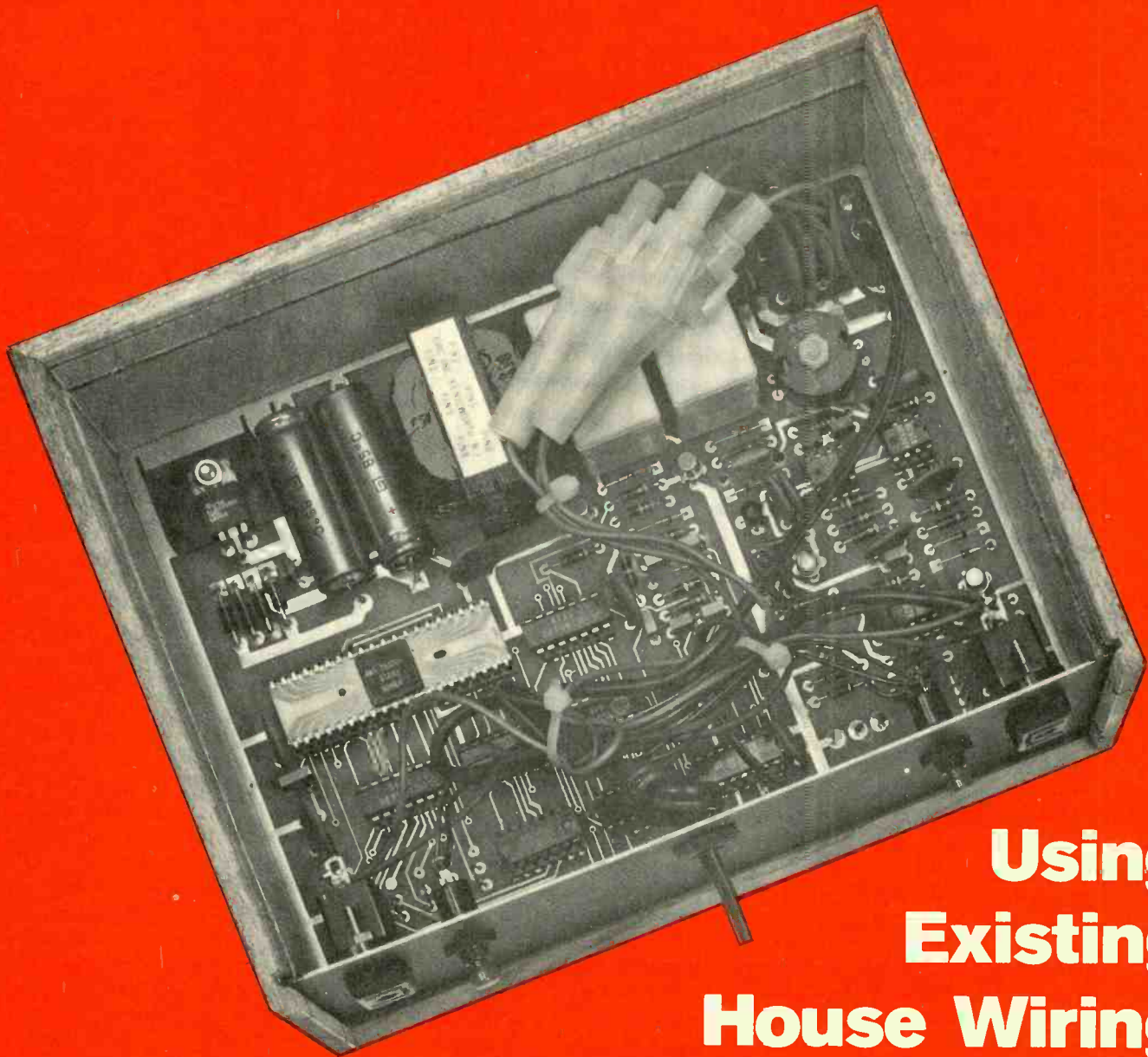

Fig. 2. Spectrum analyzer display of composite stereo modulation, with 100% modulation at 2000 hertz.



Using Existing House Wiring for Computer Remote Control

PART 2

How to build a typical remote.

BY DAN SOKOL, GARY MUHONEN, AND JOEL MILLER

LAST MONTH, we described the theory and construction of an Intelligent Remote Controller that utilizes a building's standard ac wiring for communicating between a computer and appliances. In this concluding part, we cover the details of a typical two-channel remote unit (sometimes called just a "remote") and

discuss some software to get the composite system "up and running."

The basic block diagram of a remote is shown in Fig. 1. Note that many sections of the remote resemble their counterparts in the controller because both devices can send and receive data over an ac power line.

How It Works. The user determines which remote he wishes to communicate with and what command he wishes to issue. For example, if he wants to toggle remote 41, a 233 must be outputted to the controller output port. The computer then executes the assembly language command OUT 5. (5 is the num-

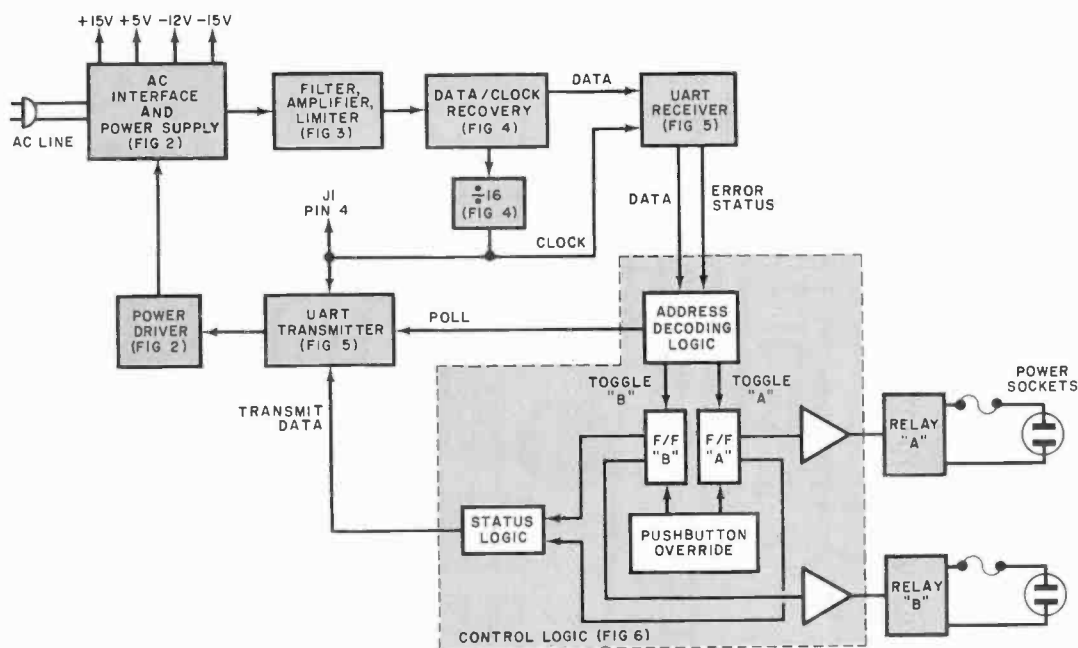

Fig. 1. Block diagram shows similarity of remote to last month's main controller.

ber of the output port while 233 is data.) The I/O port decoding logic on the controller board determines that the controller is being addressed with an output instruction. The controller UART transmitter then reads the data bus, formats the word, and sends it out to the power driver as a serial stream of data bits.

The power driver impresses the signal on the ac line via the ac interface adapter. The data appears on the ac line as a digitally modulated signal at about 50 kilohertz.

All the remotes are constantly monitoring the ac line for possible com-

mands. Each remote contains two independent channels, each capable of controlling one external device plugged into its power socket. This means that each remote is assigned two sequential addresses (selected by the user by putting jumpers on the remote board).

The signal received by the remote is coupled through an ac interface adapter tuned to 50 kHz. A high-pass filter (rolling off at 6 dB per octave below 20 kHz) removes the 60-Hz line frequency and all its relevant harmonics. The filtered output is amplified and used to drive a phase-locked loop (PLL). There, the vco

output from the loop is divided by 16 and used as the clock for the internal UART. The received data is recovered at the lock output of the PLL, and this signal is used as the input to the UART receiver.

When the receiver detects a data word, that word appears on its eight parallel output lines, along with error and flag information. The address and decode logic then determines whether or not that word is intended for that remote.

The three valid outputs from the address and decode logic are toggle-A, toggle-B, or poll. The latter is actually two commands—poll-A or poll-B—and the

C1, C2, C14, C15—0.1- μ F, 200-V capacitor
 C3—0.015- μ F capacitor
 C4, C5—0.001- μ F capacitor
 C6 through C10, C16, C17, C22 through C27,
 C34—0.1- μ F, 25-V capacitor
 C11—0.39- μ F capacitor
 C12, C18, C19, C28 through C33—0.01- μ F,
 200-V capacitor
 C20, C21—470- μ F, 25-V electrolytic
 D1 through D5, D10, D11—1N4148
 D6 through D9—1N4001
 F1— $\frac{1}{4}$ -A fuse and holder
 F2, F3—5-A fuse and holder
 IC1—TR1602 UART
 IC2, IC3—4069 CMOS hex inverter
 IC4, IC8—4001 quad 2-input NOR gate
 IC5—4011 quad 2-input NAND gate
 IC6—74C107 dual JK flip-flop
 IC7—74C30 8-input NAND gate
 IC9—74LS93 4-bit binary counter
 IC10, IC11—NE535 op amp
 IC12—NE567 PLL tone decoder

PARTS LIST

K1, K2—Spdt, 5-A contact-rating relay (Stan-
 cor MS64-931 or similar)
 Q1, Q2, Q4—2N2907 transistor
 Q3, Q5, Q6, Q7—2N2222 transistor
 Following resistors are $\frac{1}{4}$ -watt, 5% unless oth-
 erwise noted:
 R1—15,000 ohms
 R2—3900 ohms
 R3, R13, R17, R18, R19, R23, R24—1000
 ohms
 R4, R11—2200 ohms
 R5, R6—10,000 ohms
 R7, R8, R9, R20, R21, R22—3300 ohms
 R10—390 ohms
 R12—27,000 ohms
 R14—1800 ohms
 R15—1000-ohm, 10-turn trimmer potentiom-
 eter
 R16—10 ohms

R25—200 ohms
 R26, R28, R30—100,000 ohms
 R27, R29—270,000 ohms
 RV1, RV2,—V33MA1A varistor (GE)
 S ϕ S1—Spst normally open, pushbutton
 switch
 T1—Coupling transformer (see Note)
 T2—25-V CT 180-mA transformer
 VR1—7805 5-volt regulator
 VR2—79L12—12-volt regulator
 Misc.—In-line fuseholders (3), 117-volt,
 chassis-mount ac sockets (2), line cord,
 suitable enclosure, mounting hardware, etc.
 Note: The following are available from Moun-
 tain Hardware, Inc., P.O. Box 1133, Ben
 Lomond, CA 95005 (Tel: 408-336-2495):
 T1 (MH-T1) for \$6.00; complete kit for one
 dual-channel remote including walnut case
 for \$99.
 Diodes are identified by letters "CR" and IC's
 by letter "U" in parts placement guide in
 Fig. 7.

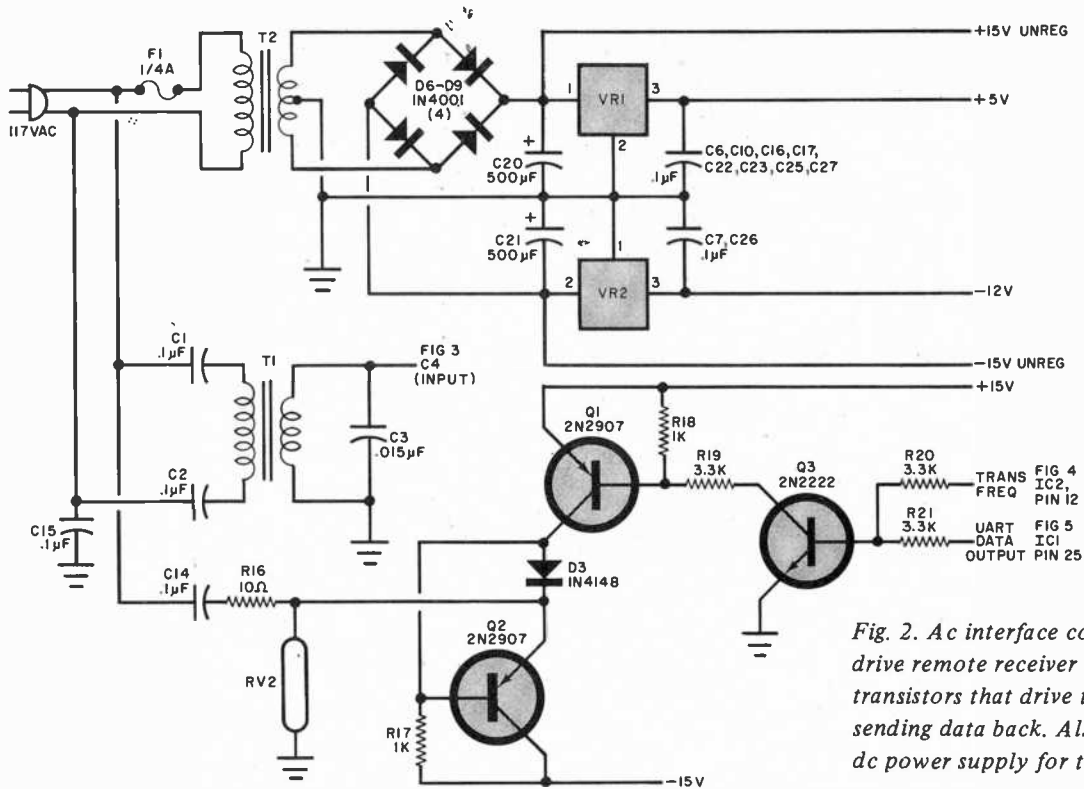

Fig. 2. Ac interface consists of T1 to drive remote receiver and three transistors that drive the ac line for sending data back. Also shown is the dc power supply for the remote.

status logic determines which of the two is acted upon.

A toggle command causes one of the two flip-flops to change states. This opens or closes a relay associated with that channel and controls the external device connected to that socket.

A poll command causes the status logic to place a word into the UART transmitter buffer in accordance with the following format. The first five bits of the data word contain the address of the remote channel being polled. The sixth bit contains the status of the remote device

(on or off), while the seventh bit is set to zero to inform the system that a remote is responding to the controller. This indicates to all other remotes that the digital word on the ac line is not a command. The word is then formatted by the UART transmitter and sent via the ac interface to the power line.

AC Interface and Power Supply.

This circuit (Fig. 2) forms the power supply to the electronic system and provides the interface between the digital receiver, the transmitter, and the ac line.

Transformer T2 and its associated components provide regulated +5 and -12 volts. Other components provide the unregulated ± 15 V required by the various circuits.

Transformer T1, resonant at 50 kHz, provides the actual interface and isolation from the ac line.

Filter, Amplifier, Limiter.

This circuit (Fig. 3) operates in exactly the same way as its companion circuit in the controller described last month. See the December issue for details.

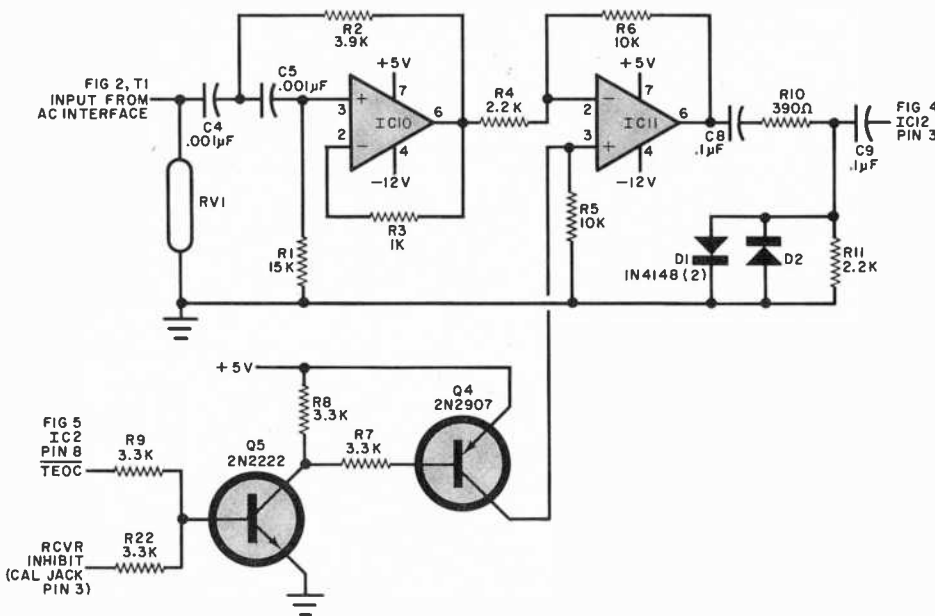

Next month, Part 3 will conclude this article with the final circuit discussions, construction and software.



This is Coby 1.™

A brand new electronic home control center that will change your way of life.

You can automate your home with the Coby 1 System.

- Coby 1 Control plugs in anywhere to give you computerized ON/OFF control over electrical devices in your home.
- It's the most sophisticated timer you can buy. It turns things on or off at precise times, at the preset intervals you select, and can be programmed up to 11 months in advance.
- It's an instant control center for electrical devices right from your bedside—or wherever you and Coby 1 Control happen to be.
- Its elegant digital clock gives you the month, day, hour, minute, and second, with accuracy to within five seconds per month.

COBY 1 CONTROL NEEDS NO WIRING —PLUGS IN ANYWHERE.

The compact control panel, which we call Coby 1 Control, plugs into any ordinary wall outlet, sending computer-coded pulses

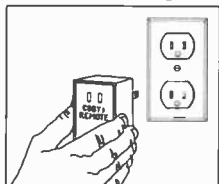

through your present wiring. The pulses trigger Coby 1 Remotes—small remote switches to go between plug-in appliances and wall sockets. Soon (by March) we will also have Coby 1 Remotes to replace wall switches and Coby 1 Remotes to take care of built-in appliances like water heaters and air conditioners. It's safe, simple, and sure. There's nothing like it.

A REMARKABLE APPLICATION BREAKTHROUGH IN MICROELECTRONICS AND PULSE-CODE COMMUNICATION.

The Coby 1 System™ is the result of brilliant engineering by a team of aerospace electronics people. Coby 1 Control includes an Intel 8085 Microprocessor—a complete tiny computer—plus control circuitry, power supply electronics, coding and signal-generating circuits, an emergency power cell, and memory. The memory contains 2048 words of low-power, programmable random access memory (RAM) and 2048 bytes of read-only memory (ROM). It stores device numbers, commands, and status information for up to one hundred Coby 1 Remotes.

The coding and signal-generating hardware translates commands and distributes them through your home wiring (but without interfering with any of your other appliances) to the Coby 1 Remotes, which decode the signals and turn things ON or OFF.

As you enter commands through the keyboard, the display lights up to confirm. It can also be used to review commands stored in memory. All programs are entered, stored, and modified through 12 function and control keys and a 10-key numeric pad (plus AM and PM keys).

ITS ACCURACY IS BLACKOUT-PROOF. Power blackout? Built-in battery power keeps Coby 1's memory fresh. Unlike a conventional timer or clock radio, Coby 1's clock won't lose a second. When power comes back on, the batteries automatically recharge. This feature also lets you unplug your control unit and

plug it in again anywhere. Its handsome digital clock gives you the year, month, day, hour, minute and second with accuracy to five seconds per month. The calendar will show the correct date until 2021.

We've protected Coby 1's sophisticated brain with a handsome, precision-aluminum package that is spillproof. Since Coby 1 has no moving parts, it requires no maintenance.



IT'S FUN TO USE COBY 1.

Each Coby 1 Remote is assigned an identification number. If the front hall lamp is Number One, you simply tell Coby 1 Control to turn Number One on or off—now, Tuesday, any day or every day, if you like. And if you've ever operated a pocket calculator, you'll have no problem whatsoever with Coby 1.

COBY 1 IS AMONG THE GREATEST LUXURIES YOU CAN OWN. Picture yourself on a frigid winter morning. Coby 1 can wake you with your hi-fi system and a lamp.

You rise to a warm bathroom. When you come out, the coffee is ready to pour. Coby 1 turns the hi-fi off and the TV on, while you enjoy your coffee and paper.

Coby 1 has warmed the car engine for you, so it starts readily and warms up quickly.

At bedtime, with Coby Control now plugged in at bedside, you turn off all the lights and switch off the TV—without getting up. You go to sleep knowing things will be ready for you again in the morning. If, during the night, you want to turn on the outside or living room light, you have the comfort and security of being able to do so from your bedside table.

IT'S A CARETAKER WHEN YOU'RE GONE.

Now you can go away for a week (or a month) and leave Coby 1 in charge. Consider a potential thief watching your house: lights (Nos. 1-6) go on and off as if people were moving around. The TV (No. 7) goes on; then goes off. Finally, the bathroom (No. 8) and bedroom lights (No. 9) go out. You can repeat the pattern daily or vary it for up to a year in cycles as short as a second or as long as 100 hours. Yet it will use less energy and suggest more activity than leaving lights or a radio on constantly.

When you come home, Coby 1 can have the house warm (or cool, in summer), the porch light on, the sofa lamp on, and the hi-fi on to welcome you.

CONSIDER THE ENERGY SHORTAGE. Coby 1 can do wonders for your electrical bill. It never forgets to turn things off. It can turn car heaters, air conditioners, or electric heaters on just far enough ahead to make things

comfortable—no need to have them on constantly. You can change the times from your easy chair. No mechanical timers; no wasted power.

WE'RE INTRODUCING THE COBY 1 SYSTEM AT A SPECIAL LOW PRICE. We're anxious to get the first factory run into the hands of users as quickly as we can because we're interested in how you put Coby 1 to work. So until February 15, 1978, we'll accept advance orders for a Coby 1 Control at \$399.00, the price to include a free Coby 1 Remote. Other remotes will be extra. Simply fill out the coupon and send it with your check, money order, or credit card data. You can also call in your order or get more information by calling (505) 526-3358. We'll ship your Coby 1 along with full instructions and suggestions on its use, after our first production run in January. We'll also include our 90-day parts-and-labor limited warranty.

WHO ENERGY TECHNOLOGY IS:

The company was started by the three of us, Brook Reece, Phil Reed, and Keith Burn. We developed the system ourselves. We're excited about Coby 1 because everyone we've talked to has expressed real interest in the product and sees a need for it.

We've been working on Coby 1 for months. Development and testing of production models is now complete. They'll be ready to ship in January. Dealer inquiries invited. Energy Technology, Incorporated, 1601 South Main St., P.O. Box Q, Las Cruces, NM 88001. Phone: (505) 526-3358



Mail to:

Energy Technology, Inc.

1601 South Main St., P.O. Box Q, Las Cruces, NM 88001

Put me down for one of the first Coby 1's. I understand that this is an advance order, and that shipment is expected after January 15, 1978.

Ship me one Coby 1 Control and one 10-amp plug-in Coby 1 Remote at the Special Introductory Price of \$399.00, shipping included. **\$399.00**

In addition, I want to order the following:

___ more 10-amp plug-in Coby 1 Remotes @ \$39.95 ___

___ 25-amp plug-in Coby 1 Remotes @ \$49.95 ___

Total ___

New Mexico residents: please add Gross Receipt tax

Check BA/V MC Total ___

Money Order MC Total ___

Card No.: _____

Interbank No. _____ Card Exp. date _____

Ship to _____

Address _____

City _____ State _____ Zip _____

PE 1/78

Signature _____

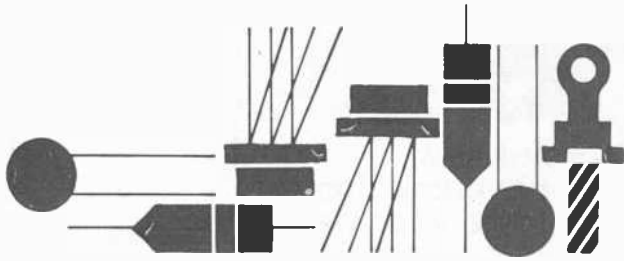

Solid State

By Lou Garner

"FOR I DIPT INTO THE FUTURE . . ."

THE WORDS in the title of this month's column are from Lord Tennyson's famous poem, "Locksley Hall." Written in the mid-1800's, it contained some rather startling predictions: the invention of the airplane, air freight service, great aerial battles, and, many feel, the formation of the United Nations, although he referred to it as "the Parliament of Man, Federation of the World."

Did Tennyson have the Gift of Prophecy? Did he receive advice from noted scientists? Or was he just plain lucky in his predictions? Perhaps none of these, perhaps a bit of each, but one thing is certain—long-range predictions always have been "safer" to make than short-term forecasts.

This explains, perhaps, why our annual guessing game with the electronics industry is such a challenge. It's strictly a short term proposition—one year! As always, we have a few predictions for 1978; but, first, let's check the record for 1977. Some of you may recall that, in my January 1977 column, I predicted the following:

- A drop in the price of simple pocket calculators to the "five-dollar" range. Right on! Not only are five-dollar (give or take a

buck) pocket calculators available from a number of sources, even lower prices may prevail during special sales. In early Fall, for example, a major national department store chain offered 8-digit LED "4-bangers" for less than three dollars each, with a limit of "two to a customer."

- Similarly, basic digital electronic watches, probably 3-function LED types, retailing in the ten-dollar range. Another winner! In last September's column, you may recall, I announced that Texas Instruments, Inc. had cut the suggested retail price of their Model 503 sports/youth watches to a low \$9.95. Since then, a number of watch manufacturers have introduced low-priced models, with some types available for less than eight dollars during special promotions.

- Basic microcomputer kits for less than fifty dollars each in small quantities, greatly expanding their appeal to hobbyists and experimenters. On target! In recent advertisements in these pages as well as in other electronics magazines, the Digi-Key Corporation (P.O. Box 677, Thief River Falls, MN 56701) has offered a basic 8080A chip kit for only \$49.95, plus handling. The kit includes an 8080A, an 8212, an 8224,

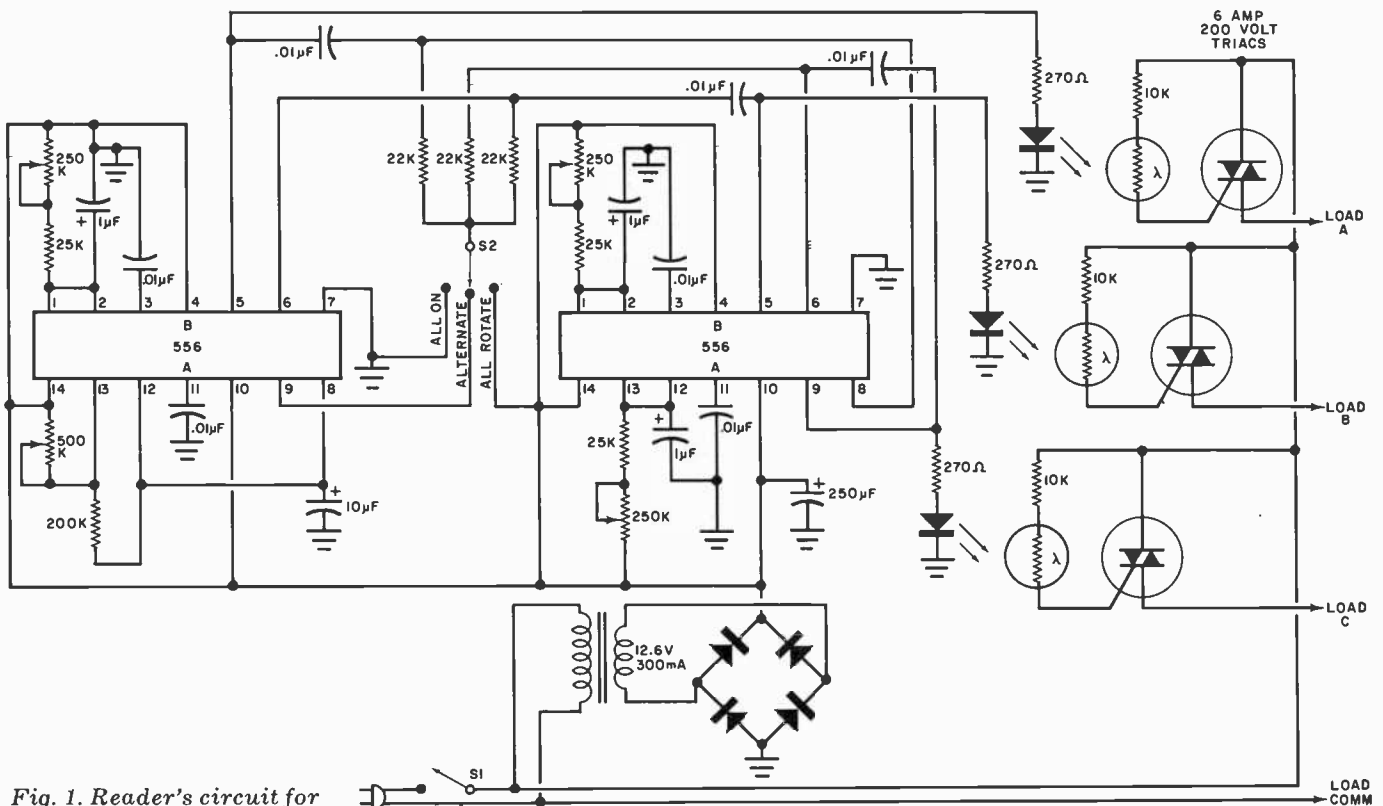

Fig. 1. Reader's circuit for flashing a string of lights.

- *The introduction of solid-state portable security alarm systems.* Portable, self-contained, fool-proof, and difficult to defeat, which business travelers, tourists, and campers can use to protect a motel or hotel room or, perhaps, even a tent or camper-trailer.
- *The development of a new type of solid-state sensor or transducer.* A number of new devices are needed in this area, for often the measurement or control system is superior in performance to the device used to interface with the rest of the physical world.
- *The development of a new family of logic devices.* For some time, now, TTL has been "King of the Mountain," even though challenged by I²L, low-power Schottky, and CMOS. The new family may be an adaptation of an existing technology, such as VMOS, or may represent a completely new concept. It's all a bit misty.
- *Dedicated home computers—not kits—in the \$200.00 price range.* Regardless of what the optimists believe, I can't visualize home computers as a mass market item unless the programming problem can be solved. Most people — other than hobbyists — look for products which save time, work and effort. And mental work (i.e., programming) is the toughest of all. Therefore, means must be used to greatly simplify or eliminate this task if computers are to achieve widespread public acceptance. . . . And, generally, this means a "dedicated" computer—one designed to perform a specific series of tasks with a minimum of input data.
- *The introduction of dual-technology IC's (not BiFET's, which are now available) but devices combining digital and analog (linear) circuits in a single package, if not on a single chip.* There is an increasing need for devices which can operate in both the linear and digital domains without costly A/D and D/A converters. Where there is a need, someone will find a suitable solution.

Reader's Circuit. Searching for an attention-getting display for their popcorn stand, the members of a local Jaycee club in Michigan looked at several ideas. Someone suggested a movie-style marquee with rotating lights. All agreed it was a terrific idea but, unfortunately, too costly for the budget, inasmuch as these displays required a motor-driven, heavy-duty sequential switch to activate the multiple lamp strings in order. Then one of our readers, Jim Harvey, WB8NBS (15026 Sunbury, Livonia, MI 48154), tackled the problem. Applying his ingenuity and doing a little research with Signetics Application Notes, Jim decided he could do the job electronically using solid-state circuitry and a combination of "junk box" and low-cost surplus components. His circuit, capable of flashing up to three strings of lamps, is illustrated in Fig. 1. Jim writes that his total cost (exclusive of lamps) was a fraction of the \$75.00 price asked for a motor-driven sequential switch.

Jim's design has a pair of 556 dual timers, IC1 and IC2, three simple opto-couplers, and three medium power Triacs, which serve to switch the (lamp) loads. Dc power is obtained from a simple supply comprising a 12.6-volt step-down transformer, a bridge rectifier, and a 250- μ F, 20-volt electrolytic capacitor. The Triacs are isolated from the control circuit by the opto-couplers. Three of the timer IC sections, IC1B, IC2A, and IC2B, are wired as one-shots, inter-connected through RC differentiating networks so that they trigger each other sequentially. The remaining timer section, IC1A, is connected as a free-running multivibrator with about a 4-second period. It is used in one mode to control the sequential circuits for special lighting effects.

Any of several operational modes can be selected by means of three-position switch S2. With this switch in its ALL ON position, the one-shot inputs are all grounded, forcing their outputs high and switching all three LED's on, thus activating the Triacs and furnishing line current to all lamp loads continuously. The ALL ON position is used both for general illumination and when the operator wishes to identify any burnt out lamps. In the ALL ROTATE position, S2 applies V_{CC} to the one-shot trigger inputs, permitting the circuits to cycle on and off sequentially and creating an optical rotation effect as lamp loads "A," "B," and "C" are switched on and off in order. Finally, with S2 in its ALTERNATE position, the free-running multivibrator (IC1A) serves to switch the one-shot trigger inputs alternately between ground and V_{CC}, causing the lamp loads to "rotate" for a half period (about 2 seconds) and then stop for a half period, repeating the cycle over and over.

With cost a critical factor, Jim used inexpensive, readily available components in his design. As indicated earlier, the IC's are type 556, while the Triacs are 200-V, 6-A types; any commercial units with these ratings should be acceptable. The optocouplers are home-made, with each consisting of a "jumbo" red LED, a small CdS photocell, a piece of heat-shrink tubing for assembly, and a dab or two of black paint. Except for the potentiometers, which may be either Trimpots or small volume controls, all resistors are standard 1/2-watt types. The electrolytic capacitors, identified by a polarity sign, are 20-volt units, while the other capacitors may be either low-voltage ceramics or small tubular paper or plastic film types. The bridge rectifier used in the dc power supply can be either a standard bridge assembly or four diodes with (at least) a 36-PIV rating and minimum 500-mA current handling capacity. Finally, power switch S1 may be a toggle, slide, or rotary spst unit, while function switch S2 is a single-pole, three-position lever or rotary type.

Since layout and lead dress are not overly critical, the flasher circuit may be assembled on perf board using point-to-point wiring or on a suitable pc board, at the builder's option. Heat sinks should be provided for the Triacs if they are to be loaded to near maximum ratings. All dc polarities must be observed, or course, and the assembled circuit should be double-checked for accidental shorts, opens, and wiring errors before power is applied. When connecting the load lamps, which are wired in parallel within each string, make sure that Triac maximum ratings are observed. While the 6-A Triacs can handle almost any standard 120-V incandescent lamp, the greater the number of lamps, the better the overall optical effect, hence low-wattage bulbs (7 1/2-W units or even 120-V Christmas tree strings) are preferred to permit a maximum number of lights within each string without overload. Naturally, the lamps in each load string should be arranged in alternate patterns to achieve the desired effect . . . A-B-C-A-B-C-A-B-C, and so on. Jim offers the following hints to insure optimum performance:

- (1) Since the one-shots require an initial trigger to begin cycling, the circuit may not operate if S2 is in its ALL ROTATE position initially. In this case, switch S2 to the ALL ON or ALTERNATE position momentarily before switching back to the ALL ROTATE position.
- (2) Once the display is operating in the ALL ROTATE mode, "tweak" each one-shot's potentiometer until equal on times are achieved for each load string . . . or simply until the effect is pleasing when viewed from a distance.
- (3) Finally, switch S2 to the ALTERNATE mode and adjust IC1A's potentiometer for the most eye-catching display. \diamond

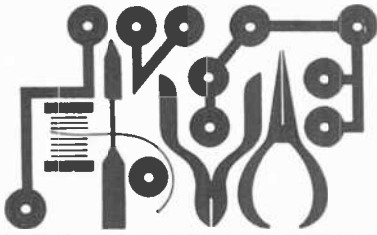

Experimenter's Corner

By Forrest M. Mims

READ/WRITE MEMORIES (RAM's), PART 2

IN LAST month's column we discussed the 7489 RAM, a TTL chip that can store up to sixteen 4-bit words. This month we'll complete our experiments with the 7489 and get to know the 74193 4-bit counter.

First, let's cover a few facts about the 7489 we didn't have room for last month. We already know that the 7489 is a RAM, that is, a random access, read/write memory. But did you know you can also think of the 7489 as a string of sixteen 4-bit latches? Each storage element in a 7489 is a latch flip-flop, so it's a perfectly valid way of describing the 7489.

Thinking of the 7489 as a string of 4-bit latches is a good way to better appreciate this important TTL memory chip. How would you like to make your own 7489 from a handful of 4-bit latches? I don't think you would. Besides the latches, you would need a decoder chip and some gates.

RAM Demonstration Circuit. Did you build the RAM demonstrator de-

scribed in last month's column? If so, you've probably learned a fair amount about working with bipolar (TTL) RAM's. If not, you might want to consider retrieving last month's POPULAR ELECTRONICS and collecting the necessary parts. You can buy 7489's for as little as a couple of dollars or so from suppliers who advertise in this magazine.

Programming. Let's discuss programming procedures for the RAM demonstrator. Programming is semi-automatic since the 7490 address pointer (see Figure 4 in last month's column)

will advance to the next address if you apply a single clock pulse. The best way to do this is to slow down the clock to about one pulse per second by adjusting the one-megohm potentiometer and disconnecting the clock input from pin 14 of the 7490. To advance the pointer to the next address, simply touch the clock lead to pin 14 of the 7490 long enough for the clock LED to flash one time.

After you learn to advance the 7490 in single address increments, you're ready to load data into the RAM. Set up the data by grounding the input pins that are to be at logic 0 and leave floating the inputs that are to be at logic 1. You can use switches or jumpers to load data.

Momentarily grounding the 7489's WE input (pin 3) will load the data word into the selected address slot. The word that was previously in the selected address will be lost. After the word is loaded, you're ready to move on to the next address. Remember, you're using a 7490 decade counter for an address pointer. That means you can select only the first ten (0000 through 1001) of the RAM's sixteen addresses.

If you want an easy way of knowing

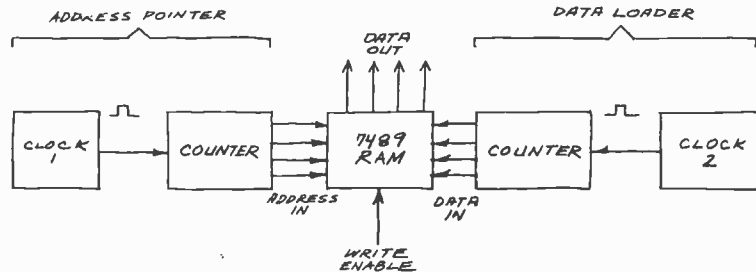

Fig. 2. Block diagram of pseudo-random data loader.

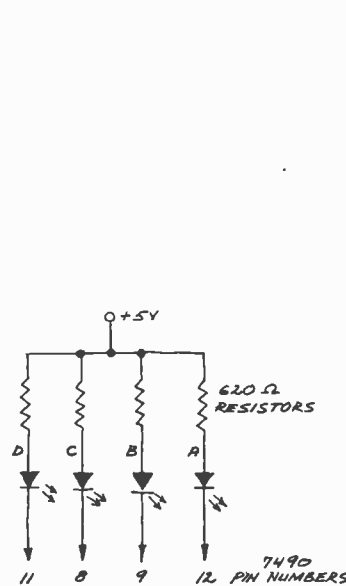

Fig. 1. Circuit indicates address pointer output.

JANUARY 1978

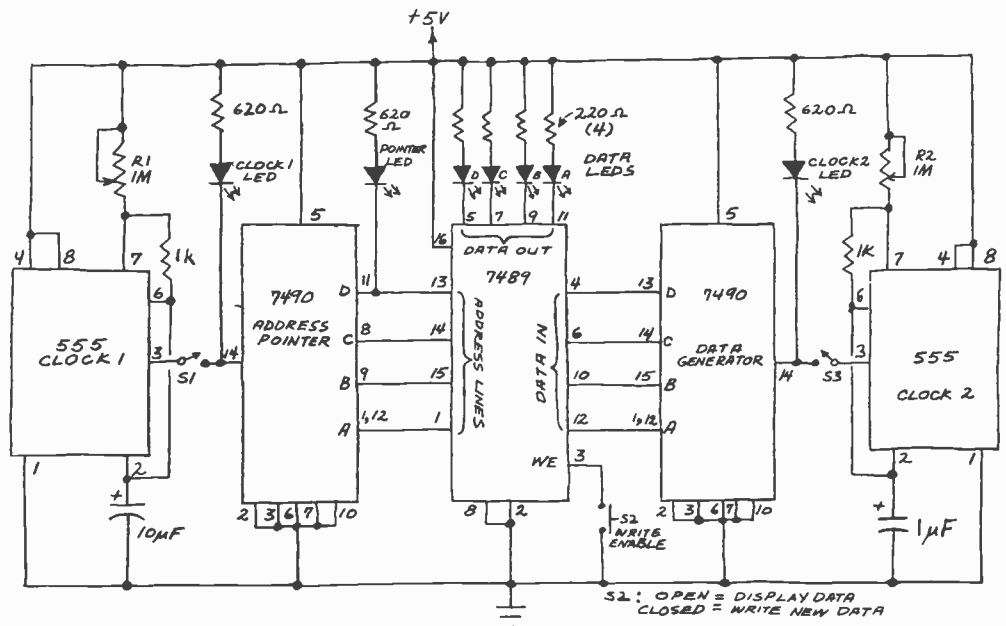

Fig. 3. Automated RAM demonstrator with pseudo-random data generator.

Includes
Functional
Tilt Stand!



NEW EICO 270 3 1/2 DIGIT DMM KIT ONLY \$79.95

Introductory Offer—FREE AC ADAPTOR

The first and only lab accuracy portable DMM Kit featuring MOS/LSI IC economy and reliability. Measures DC/AC Volts, Kilohms, DC/AC milliamps in 21 ranges. Polarity indicators and overload protection are provided, and 0.5 inch LED displays give easiest-to-read digital readout to 1999. The 270 features a basic 0.5% DC accuracy, 10 Megohm input impedance, low voltage drop in all current ranges and automatically-flashing overrange indicator. **Assembled \$109.95**

FREE '78 EICO CATALOG

Check reader service card or send 75¢ for first class mail. See your local EICO Dealer or call (516) 681-9300, 9:00 a.m.-5:00 p.m. EST. Major credit cards accepted.

EICO—108 New South Rd.
Hicksville, N.Y. 11802



CIRCLE NO. 12 ON FREE INFORMATION CARD



TVT-6
Low cost
Direct Video
Display

only \$35

Don Lancaster's ingenious design provides software controllable options including:

- Scrolling • Full performance cursor
- Over 2K on-screen characters with only 3MHz bandwidth
- Variety of line/character formats including 16/32, 16/64 even 32/64
- User selectable line lengths

TELL ME MORE!

() Send instruction manual for the TVT-6 Kit with full operational details. \$1 enclosed.

Name: _____

Address: _____

City: _____ State: _____ Zip: _____



() SEND FREE CATALOG

DEPT. I-P 1020 W. WILSHIRE BLVD., OKLAHOMA CITY, OK 73116

68 CIRCLE NO. 35 ON FREE INFORMATION CARD

exactly what address the 7490 is pointing to, connect LED's and 620-ohm series resistors between the four 7490 outputs (pins 11, 8, 9, and 12) and plus 5 volts. Be sure to arrange the LED's in the proper sequence (Fig. 1).

You don't really need to know to which address the 7490 is pointing if you let it recycle to address 0000. Then you can simply load ten words, one at a time, using the programming procedure outlined above.

How do you know when the 7490 is pointing to 0000? The pointer LED is on when the D bit in the address is logic 0 and off when it is logic 1, as shown:

Decimal count	Address pointer (7490 output)				Pointer LED
	D	C	B	A	
0	0	0	0	0	On
1	0	0	0	1	On
.
.
8	1	0	0	0	Off
0	1	0	0	1	Off

To find the 0000 address, slow the clock down and watch the pointer LED. Eventually it will turn off for two clock pulses. As soon as it flashes on again, disconnect the clock lead from pin 14 of the 7490. The RAM will be at address 0000 and you can begin programming.

Expanding the Demonstrator. It's easy to expand the RAM demonstrator by adding an automatic, pseudo-random data loader. The data loader is merely a decade counter that rapidly cycles between 0000 and 1001 again and again. The output lines of the counter are connected to the data inputs of the 7489. Whatever number is present when the 7489 is advanced to the next address is loaded into the RAM.

Figure 2 is a block diagram that shows how the data loader is connected to the RAM. As you can see, the data loader is identical to the combination clock and address pointer that automatically advances the RAM to its next address. The complete circuit diagram for the expanded circuit is shown in Fig. 3, where the data loader is literally a mirror image of the address pointer circuit.

Since you already know how the address pointer portion of the circuit works from last month's installment, there's no need to describe the detailed operation of the data loader here. You'll find a few operating tips helpful, however.

First, the RAM will accept (write) new data from the data loader when S2 (WRITE ENABLE) is closed. Otherwise, the RAM will continue to store any existing data. Second, both S1 and S3 should be closed when you want to load pseudo-random data, unless you want all the RAM addresses to contain the same number. (In that case, leave S3 off after the data loader reaches the number you want to store in each address.)

Third, remember to turn S2 off when you want to read out the contents of the 7489 with the help of the four output LED's. The LED's will be blanked (off) when S2 is on and data is being loaded. Finally, be sure to experiment with the settings of both R1 and R2. Decreasing the effective resistance of R2 increases the count rate of the 7490, and this will

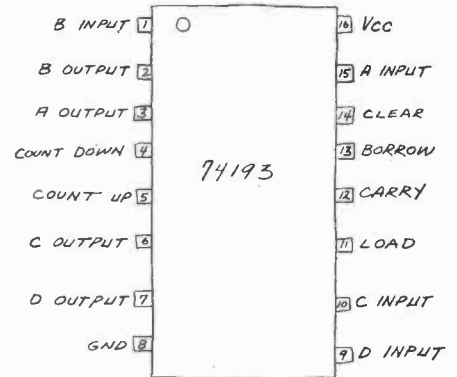

Fig. 4. 74193 pin diagram.

improve the "randomness" of the data loaded into the RAM. Similarly, lowering the resistance of R1 will speed up the address pointer and let you load new data in a fraction of a second.

Incidentally, be sure to slow down the address pointer with the help of R1 when you want to read out the data with the LED's.

Improving the Demonstrator. Since we're using a decade counter as an address pointer, we can only gain access to ten of the sixteen storage slots in the 7489. You can remedy this by replacing the 7490 address pointer (and the 7490 data loader if you want to load 1010 through 1111) with a 74193 4-bit (0000-1111) counter. Figure 4 is the pin diagram for this chip.

An important advantage of the 74193 is the CLEAR input (pin 14). In normal use, this input is grounded. Disconnecting the ground clears the counter to 0000. The 74193 has lots of other features including carry, borrow, count up, and count down. Its count can even be preset to any desired value between 0000 and 1111.



By John McVeigh

RECEIVER OVERLOAD

Q. A CB'er about a half mile away from my house uses a beam antenna and a power mike. When he transmits, he puts out a very strong signal (about 30 over on my S meter), and his audio is superb—no distortion at all. However, he causes interference to all the other channels. Sometimes, the signals on the other channels drop in strength (the S meter drops several S units) and my receiver gets very quiet. Why does this happen, and is there anything I can do to my radio to help stop the interference?—*Andy Gill, Carrollton, KY.*

A. You mention that the CB'er is putting out clean-sounding audio. This seems to

imply that he is not overmodulating his transmitter—which often occurs when a power mike is abused. If there was severe overmodulation, "splatter" would appear on many channels. But the situation sounds more like a case of receiver overload. If his signal is very strong, it can cause distortion and/or override the selective circuits in the receiver i-f and cause the automatic gain control to cut back on receiver gain. The net result is a reduction in signal strength on the channel you're tuned to.

There's no practical filter that could be inserted in the transmission line and would be sharp enough to attenuate the undesired signal but not affect the desired one. If your rig has an r-f gain control, you could try backing down on it. An

attenuator in the feedline to the receiver might help if you had separates, rather than a transceiver. You might try asking the CB'er to back off on the modulation, or perhaps turn his beam so that you're off its side!

SOUND VIA POWER LINE

Q. Instead of running extension speaker wires, I'd like to build a unit that would sense the audio signal over the ac wiring in my house. Another unit would pick up the signal at the wall socket and feed the signal to a speaker. Do you know where I can find suitable schematic diagrams?—*David Mast, Holland, MI.*

A. The January 1976 issue of POPULAR ELECTRONICS contains a construction project that does exactly what you're interested in. If you can't find that issue, you can order a back issue for \$1.50 (includes postage and handling) from the Ziff-Davis Consumer Service Division, 595 Broadway, New York, NY 10012. Readers outside the U.S. can order back issues for \$2.00. Copies are available for magazines from April 1974 through the present issue.

At last...DIP Jumpers for Faster & Easier connections.

AP DIP Jumpers are the low cost high quality solution to bussing between PC boards, mother boards, backplanes and more. Available in 14, 16, 24 and 40 pin single ended or double ended assemblies, in standard lengths of 6, 12, 24 and 36 inches. Each assembly has molded-on strain relief and line-by-line probeability. Contact material is non-corrosive nickel silver. Dielectric is 94 V-O rated. Cable options include stranded electric pink, rainbow or with ground plane.

Order from your AP distributor today. Our distributor list is growing daily. For the name of the distributor nearest you call Toll Free 800-321-9668.

Send for our complete AP catalog The Faster & Easier Book.

Faster & Easier is what we're all about.



AP PRODUCTS INCORPORATED

Box 110 • 72 Corwin Drive, Painesville OH 44077
(216) 354-2101 TWX: 810-425-2250

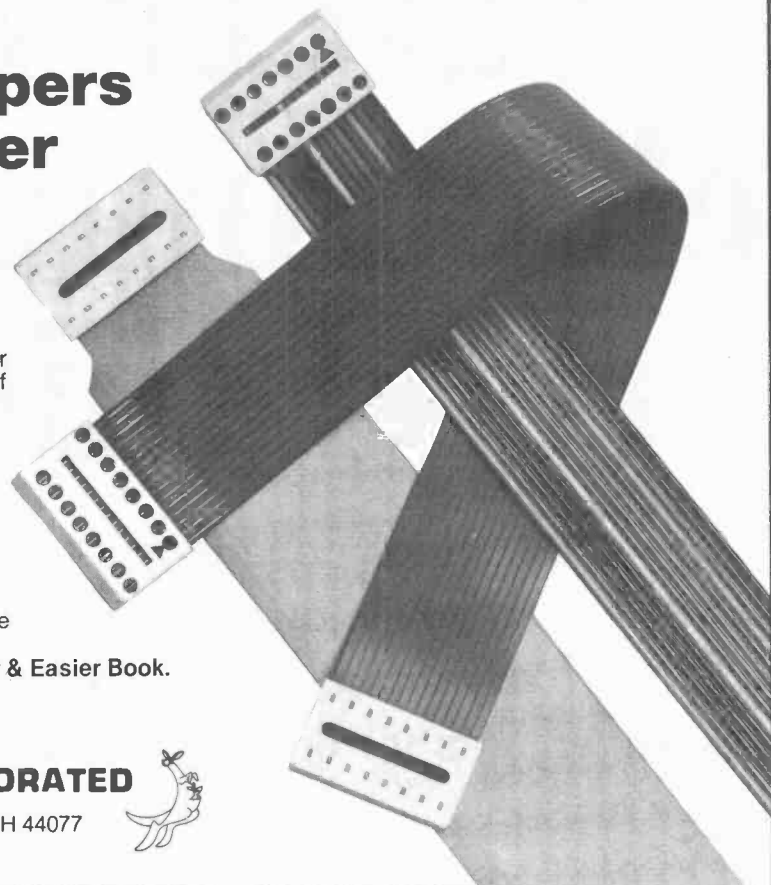

If you can't go to college for your career in electronics -read this!

**CREI brings college-level training
to you with eight educational
advantages, including special
arrangements for engineering degrees**

The best way to qualify for top positions and top pay in electronics is obviously with college-level training. The person with such training usually steps more quickly into an engineering level position and is paid considerably more than the average technician who has been on the job several years.

A regular college engineering program, however, means several years of full-time resident training—and it often means waiting several years before you can even start your career. This, of course, is difficult if you must work full time to support yourself and your family.

If your career in electronics is limited without college-level training, take a look at the advantages a CREI home study program can offer you.

1. Convenient Training

CREI brings the college to you. Through the convenience of home study, you receive exactly the same level of training you will find in any college or university offering programs in electronic engineering technology. With CREI, however, you can "go to college" whenever you have spare time at home or on the job.

2. Specialized Programs

With CREI, you enjoy the advantage of *specialized* training. That is, your program will include only those courses directly applicable to your career in electronics. We omit such courses as English, social studies and other subjects, which are usually required in resident schools. Therefore, with CREI, you move ahead faster to the more interesting and useful part of your training.

3. Practical Engineering

CREI programs give you a *practical engineering* knowledge of electronics. That is, each part of your training is planned for your "use on the job." By using your training, you reinforce the learning process. And by demonstrating your increased knowledge to your employer, you may qualify for faster career advancement.

4. Engineering Degrees

CREI offers you a number of special arrangements for earning engineering degrees at recognized colleges and universities. You can earn college credit while you are taking your CREI program or apply later, whatever is best for your career plans.

Career Training at Home

5. Unique Laboratory

Only CREI offers you the unique Electronic Design Laboratory Program. This complete college laboratory makes learning advanced electronics easier and it gives you extensive practical experience in many areas of engineering, including design of electronic circuits. No other school offers this unique program. It is a better "Lab" than we have found in many colleges. And the professional equipment included in the program becomes yours to keep and use throughout your professional career.

6. Wide Program Choice

CREI gives you a choice of specialization in 14 areas of electronics. You can select exactly the area of electronics best for your career field. You can specialize in such areas as computer electronics, communications engineering, microwave, CATV, television (broadcast) engineering and many other areas of modern electronics.

7. Prepared by Experts

Experts in industry and technical organizations of government develop CREI programs. Each part of your training is developed by a recognized expert in that area of electronics. That means you get the most up-to-date and practical instruction for your career.

8. Industry Recognition

That CREI training is recognized by industry and government is evident from the fact CREI provides training to advanced technical personnel in over 1,700 technical organizations. Many subsidize the training of their employees with CREI. If there is any question about the advantages of CREI training for you, ask your employer or any engineer to evaluate the outline of a CREI program for you.

Other Advantages

Of course, there are many other advantages to CREI training. For example, throughout your training, CREI's staff gives you personal instruction for each step of your program. And in many industrial areas, both in the U. S. and abroad, CREI Field Service Representatives provide a number of important personal services for your training and your career.

FREE Book

There isn't room here to give you all of the facts about career opportunities in advanced electronics and how CREI prepares you for them. So we invite you to send for our free catalog (if you are qualified). This fully illustrated, 80 page catalog describes in detail the programs, equipment and services of CREI.

Qualifications

You may be eligible to take a CREI college-level program in electronics if you are a high school graduate (or the true equivalent) and have previous training or experience in electronics. Program arrangements are available depending upon whether you have extensive or minimum experience in electronics.

Send for this **FREE** Book describing your opportunities and CREI college-level programs in electronics

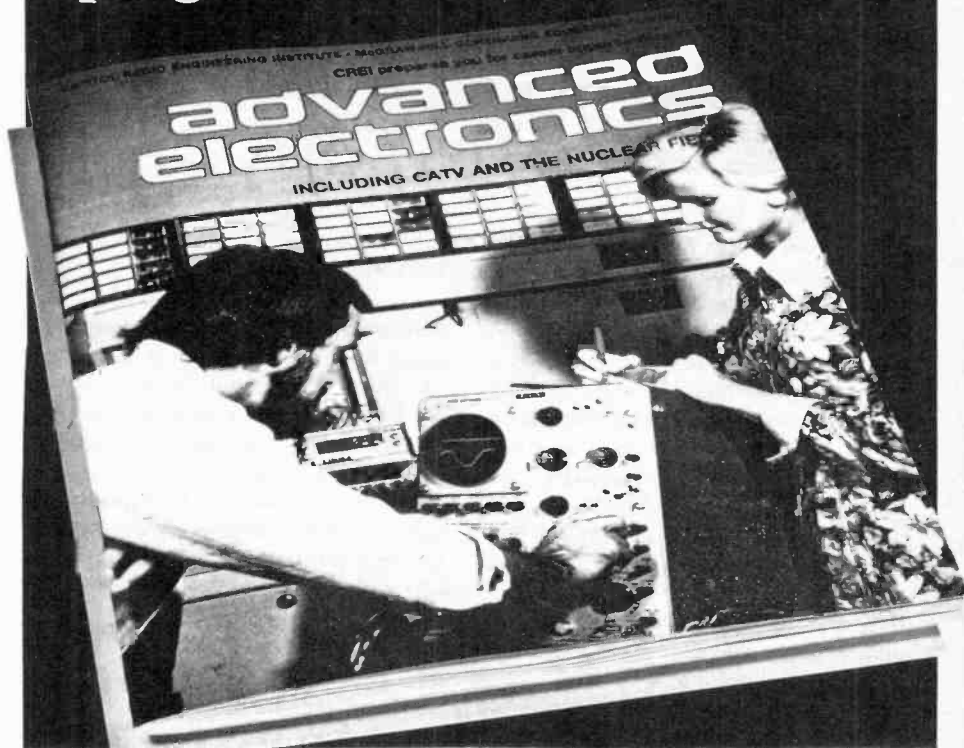

Mail card or write describing qualifications to

CREI **CAPITOL
RADIO
ENGINEERING
INSTITUTE**

McGraw-Hill Continuing Education Center
3939 Wisconsin Avenue Northwest
Washington, D.C. 20016

Accredited Member National Home Study Council

GI Bill

CREI programs are approved for training of veterans and servicemen under the G.I. Bill.





Product Test Reports

E.F. JOHNSON VIKING 4360 REMOTE CONTROL MOBILE AM CB TRANSCEIVER.

Features telephone-type handset and speaker interconnect box.



THE 40-channel Viking 4360 AM CB transceiver from E.F. Johnson differs from other digitally frequency-synthesized, remote-control mobile rigs in that it consists of three pieces. One is a telephone-type handset, the second is a main electronics unit that can be tucked out of sight, and the third is a small dashboard-mounted interconnect box that contains a 3" loudspeaker and numerical LED channel display. The handset assembly contains a small speaker, VOLUME and SQUELCH controls, and up- and down-channel push-buttons for switching to the various channels.

Other features found in this transceiver include: LED dimmer switch (off/dim/bright); external-speaker jack; non-switchable anl (automatic noise limiter); speech compressor circuit; and a transmitter output network designed to minimize harmonics that can cause TVI. Operation is from a nominal 13.8-volt dc, negative- or positive-ground source.

The main unit measures 8 $\frac{5}{8}$ "W \times 6 $\frac{1}{8}$ "D \times 2 $\frac{7}{8}$ "H (21.9 \times 15.6 \times 7.3 cm), while the interconnect box is 4 $\frac{1}{2}$ "W \times 3 $\frac{7}{8}$ "H \times 1 $\frac{5}{8}$ "D (11.4 \times 9.8 \times 4.1 cm), less mounting flanges. Supplied with handset and 8' (2.4-m) cable for interconnecting the main unit with the inter-

connect box, the transceiver's price is \$229.95.

Technical Details. The receiver employs double conversion to a 455-kHz i-f, which is obtained by heterodyning the CB signal with a local-oscillator signal that is 455 kHz lower in frequency than the input signal. The heterodyning signal is obtained by sum-mixing the output of the voltage-controlled oscillator (vco) in the PLL system with a 5120-kHz signal from a crystal-controlled oscillator. (The standard reference signal is also derived from the 5120-kHz oscillator.) The heterodyning signal is mixed down and digitally divided for a comparison reference that is fed to the phase comparator along with the standard reference to provide the error voltage for the vco.

The i-f selectivity is obtained with a lumped-constant, bandpass-coupled circuit. There are two i-f stages, a detector, an audio anl, and an audio preamplifier following the r-f section. An IC that contains the output stage (it also modulates the transmitter) rounds out the receiver section. An agc amplifier and detector system is included.

The channel-indicating system consists of the usual seven-segment LED

displays and decoder/driver electronics.

On transmit, the heterodyning signal from the receiver is shifted upward by 455 kHz to generate the on-channel carrier frequency. This signal then goes to a predriver, driver, and r-f output-power amplifier. A multi-element output network matches to 50-ohm loads and minimizes spurious output responses to maximize the attenuation in the TV range. On "power up," channel 19, the most popular CB highway channel, is automatically switched in.

The driver and power amplifiers are collector-modulated by the audio section in the receiver, where a compression circuit provides automatic modulation control. Transmit/receive transfer is via diode switches.

Laboratory Measurements. We measured a 0.55- μ V receiver sensitivity for 10 dB (S + N)/N at 30% modulation with a 1000-Hz test tone. The agc held the audio output to within 15 dB with a 20-dB r-f input change at 1 to 10 μ V and to 20 dB with an 80-dB input variation at 1 to 10,000 μ V. The squelch threshold range was 0.7 to 200 μ V.

Adjacent-channel rejection and desensitization measured 55 dB. Image rejection on channel 1 was 12 dB and gradually deteriorated to 5 dB on channel 40. I-f rejection was greater than 80 dB, and other unwanted signals were down a minimum of 40 dB.

The audio response at the 6-dB points varied between 240 to 2900 Hz and 215 to 3250 Hz, depending on the setting of the VOLUME control. Maximum sine-wave output at 10% THD measured 1 watt into 8 ohms. However, at the start of clipping and with 12.5% THD, the output measured 1.4 watts.

Powering the transceiver from a 13.8-volt dc source, we measured a transmitter carrier output of 3.75 watts. At microphone input levels 16 and 25 dB greater than that required for 50% modulation, the THD with a 1000-Hz signal was 3.5% and 11%, respectively, with the modulation averaging a nominal 90%. The THD with a 500-Hz tone under the same conditions was 6% and 24%.

Splatter greater than \pm 5000 Hz from the carrier was 60 and 55 dB down at +16- and +25-dB levels. However, the splatter with a 2500-Hz tone was nominally only 40 dB down. Nevertheless, at maximum voice levels, the splatter was more than 60 dB down. The modulation peaks held to just short of 100%.

The audio response measured 500 to 4000 Hz at the 6-dB points. Slight down-

ward modulation (negative carrier shift) was noted during these tests. The output frequency held to within ± 30 Hz, referred to +176 Hz on channel 21.

User Comment. The main electronics package that makes up this transceiver's system can be mounted up forward in a vehicle. Alternatively, it can be mounted under a seat or in the trunk. The interconnect box is designed to be installed on the dashboard or wherever its controls can be conveniently reached and its LED display affords an unobstructed view. This box has a toggle switch for turning on and off the power and dimming the channel displays.

Another switch permits the operator to select either the box speaker or the speaker in the microphone's housing. The speaker in the box faces downward. The handset connects to the interconnect box via a multipin connector at the end of its heavy coiled-cord cable.

The speaker in the handset is located at the top of the housing, while the microphone element is at the bottom. In the middle of the handset are two push-buttons, labelled PLUS and MINUS, for stepping through the channels in either an upward or a downward sequence.

Either button can be operated momentarily for single-step operation or held down for continuous (and fast) scanning of the channels. We determined that only a light tap of either button is all that is needed to step through the channels. One must be careful here to press and quickly release the button to avoid going into the scan mode.

The VOLUME and SQUELCH controls are thumbwheel types, located at the right side of the handset. With a little practice, one quickly becomes accustomed to this arrangement and the directions in which the controls must be rotated to obtain the desired effects.

The rationale behind the usual remote-control CB rig is to have the transceiver out of sight or in a safe place as a theft deterrent. With this rig, however, mounting of the interconnect box is somewhat revealing, though not on the order of conventional-type rigs. Even so, locating the main section of the system in the trunk should minimize the possibility of it being stolen.

Since the interconnecting cable between the box and main unit is just 8' long, for trunk installations it may be necessary to obtain Johnson's optional 12' extension cable.

Although the modulation distortion at low audio frequencies measured somewhat greater than usual at high compression levels, the transmissions sounded very good under most voice conditions. Additionally, adverse splatter was absent. The quality on receive was good, too.

As noted by our measurements, the image rejection on some channels was less than usual for a single conversion to a 455-kHz i-f.

The anl was not especially effective in our rigid bench tests with an impulse-noise generator. However, in on-the-road tests in our noisy vehicle, its performance was very good indeed.

Overall, the Viking 4360 transceiver is a most satisfactory performer. Of special importance is its user-operation conveniences. For example, the lightweight handset can be held comfortably, partly as a result of using a larger speaker in the interconnect box instead of in the handset itself. Also, the slight compromise of having a third small unit—the interconnect/speaker housing/channel display—makes it easier and safer for the driver to view under typical motoring situations. Lastly, the handset offers true one-handed operation.

CIRCLE NO. 104 ON FREE INFORMATION CARD

SENCORE MODEL DVM37 DIGITAL MULTIMETER

Portable DMM boasts 0.1% dc accuracy, automatic zero and switch-controlled probe.

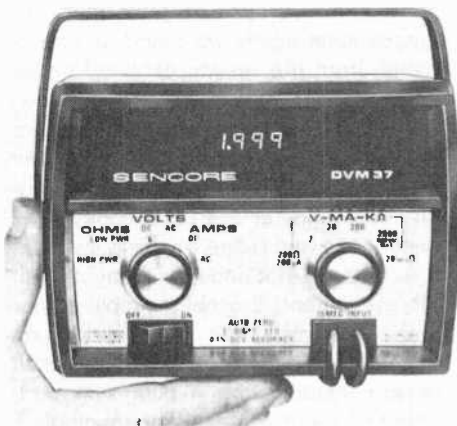

THE MODEL DVM37 digital multimeter from Sencore features a $3\frac{1}{2}$ -digit, 0.3" (7.6-mm) high red seven-segment LED display, 0.1% dc measuring accuracy, and 15- or 30-megohm input resistance to keep circuit loading and erroneous readings to a minimum. Automatic zeroing, polarity indication, and decimal-point placement provide for fast

direct measurements. The instrument is designed to permit resistance and ac and dc voltage and current measurements.

The multimeter measures 7"H x 5"W x 4"D (17.9 x 12.8 x 10.2 cm) and weighs 2.25 lb (about 1 kg), including its internal battery pack. Power for the DMM can be from throw-away standard

carbon-zinc or alkaline cells (four C size), rechargeable nickel-cadmium cells, or from an optional ac adapter/battery charger.

The Model DVM37 multimeter price is \$248. Available as options are a No. 39G90 ac power adapter/battery charger for \$9.95 and a No. HP200 50-kV high-voltage probe clip-on for \$25.

Technical Details. A total of 28 ranges is provided. Dc voltages can be measured in four ranges to 2, 20, 200, and 2000 volts full-scale with an accuracy of 0.1% (0.2% on the 2000-volt range). Resolution is 1 mV on the 2-volt range. The input resistance is 15 megohms, which can be extended to 30 megohms via a switch on the built-in probe. Using this switch rescales the ranges to 4, 400, and 2000 volts full-scale, with an accuracy of 1.1%. Ac re-

Put Professional Knowledge and a
COLLEGE DEGREE

in your Electronics Career through

**HOME
STUDY**

**Earn Your
DEGREE**

by correspondence, while continuing your present job. No commuting to class. Study at your own pace. Learn from complete and explicit lesson materials, with additional assistance from our home-study instructors. Advance as fast as you wish, but take all the time you need to master each topic. Profit from, and enjoy, the advantages of directed but self-paced home study.

The Grantham electronics degree program begins with basics, leads first to the A.S.E.T. degree, and then to the B.S.E.E. degree. Our free bulletin gives complete details of the program itself, the degrees awarded, the requirements for each degree, and how to enroll. Write for *Bulletin E78*.

Grantham College of Engineering
2000 Stoner Avenue
P. O. Box 25992
Los Angeles, CA 90025

Worldwide Career Training thru Home Study

CIRCLE NO. 17 ON FREE INFORMATION CARD

SAVE!

MONEY • TIME • FREIGHT

QUALITY STEREO EQUIPMENT
AT LOWEST PRICES.

YOUR REQUEST FOR QUOTA-
TION RETURNED SAME DAY.

FACTORY SEALED CARTONS—
GUARANTEED AND INSURED.

SAVE ON NAME BRANDS LIKE:

PIONEER	SANSUI
KENWOOD	DYNACO
SHURE	SONY
MARANTZ	KOSS

AND MORE THAN 50 OTHERS
BUY THE MODERN WAY
BY MAIL—FROM

ia
illinois audio

12 East Delaware
Chicago, Illinois 60611
312-664-0020

76 CIRCLE NO. 19 ON FREE INFORMATION CARD

jection is 60 dB at 50/60 Hz, and the input is protected to 2000 volts dc plus peak on all ranges.

There are four ac voltage ranges that go up to 2, 20, 200, and 1000 volts full-scale. Accuracy on the three low ranges is 0.5%, while on the 1000-volt range, it is 0.75%. Measurements can be made down to 1 mV on the 2-volt range. The input impedance is rated at 1.5 megohms shunted by less than 100 pF. The frequency response is from 40 to 5000 Hz ± 0.5 dB. The average-detecting measuring system provides rms readings. Input protection is to 2000 volts peak and dc or 1400 volts rms. The five ac and dc current ranges go to 200 μ A, 2 mA, 20 mA, 200 mA, and 2 A full-scale. Measuring accuracy is 0.3% on dc and 1.0% of reading plus three digits on ac. Resolution is rated at 0.1 μ A on the 200- μ A range. The internal shunt resistance on the respective ranges is 1000, 100, 10, 1, and 0.1 ohms. The voltage drop is 200 mV on the three lower ranges, 250 mV on the 200-mA range, and 1 volt on the 2-A range. The input is protected up to 2000 volts dc and peak.

Resistance measurements can be made with either high or low power. The high-power ranges (to 2 k, 20 k, 200 k, 2 megohms, and 20 megohms full-scale) deliver a 1-volt maximum test potential to the test probes. The low-power ranges (200 ohms, 2 k, 20 k, 200 k, and 2 megohms full-scale) deliver a 0.2-volt test potential to the probes. Accuracy is rated at 0.2% ± 3 digits on all but the 20-megohm range, where it is 0.5% ± 3 digits. Resolution is 0.1 ohm on the 200-ohm range. Maximum current through the resistance being measured is 1 mA, 100 μ A, 20 μ A, 1 μ A, and 0.1 μ A on the low-power-ohms ranges and 500, 50, 5, and 0.05 μ A for the high-power ranges. Input protection is provided to a maximum of 2000 volts dc and peak on all ranges.

The multimeter is made more useful by a permanently connected probe assembly, which consists of a flexible ground lead terminated in an insulated alligator clip and a signal lead terminated in the actual probe tip. Because these test leads are a permanent part of the DMM, they cannot be misplaced.

The special probe tip features two touch switches. The one labelled PUSH ON turns on power to the meter for as long as it is held down and instantly removes the power when released, which saves on battery power. Of course, the main power ON/OFF switch on the instru-

ment's front panel can be used to turn on the power for continuous operation when desired. The second probe switch, labelled ISO DCV+2, provides an extra 15 megohms of isolation for critical circuits where loading presents problems, as in oscillators, very-high-impedance CMOS circuits, and the like. Operating this switch not only adds isolation resistance. It also doubles the measurement capability of the range on which it is used, as mentioned above.

User Comment. For our tests, we installed four C cells in the DMM. Then we used our usual laboratory voltage and current standards and high-tolerance resistors to check out the various functions and ranges. In each case, the instrument performed comfortably within its published specifications.

After completing our standard bench tests, we put the DMM to work under actual in-service conditions for a month, both on a service bench and in a field-service vehicle, taking no particular care to treat it gently. At the end of the test period, we could find not one fault in the instrument's performance or handling, based on combined bench and field experience. In fact, we feel it was among the most convenient multimeters we have ever used for the full range of different test and measuring conditions encountered.

At the end of the in-service test, we again examined the DMM, both physically and electrically. The DMM easily survived the rough environment of a service van. When we performed accuracy tests again, we noted no degradation from the results obtained in the original bench tests.

We like Sencore's new approach to test probes, particularly the switch that allows us to control the power to the instrument right at the probe body. The impedance and range doubling switch is a nice touch that adds practical utility to the instrument. It greatly simplified our measurements under some very trying conditions. The body of the probe itself is triangular in shape, making it comfortable to handle and easier to manipulate under actual measuring conditions than is usually the case.

In sum, the Model DVM37 combines all the utility, accuracy, and human engineering one could expect of a well-designed digital multimeter. Its high-impact case and recessed control knobs are particularly suitable for the rigors of actual servicing conditions.

CIRCLE NO. 105 ON FREE INFORMATION CARD

POPULAR ELECTRONICS

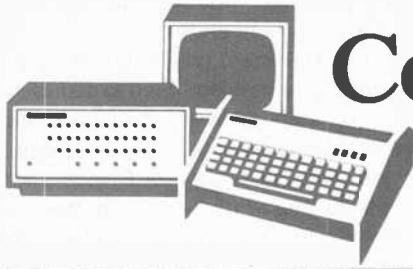

Computer Bits

BUS SYSTEMS

ALL HOBBYIST computers have some kind of bus system for tying the various computer elements together. Component computers use a "mother-board" which contains only the bus connected to a number of pc board sockets. Each component of the system such as the CPU board or a memory board plugs into a socket and communicates with the rest of the system over the bus. Even an all-on-one-board system has a bus running around on the board to connect the CPU, memories, and input/output circuits together. For expansion purposes, the on-board bus is usually brought out to the edge of the main board.

Actually a bus system by itself is nothing more than a set of parallel wires. These wires can be conveniently broken down into four major groups. The most basic is the *power* group which supplies operating voltages to the circuits tied to the bus. On some systems this may consist of only two lines—one for +5 volts and the other for ground while others may have three separate power voltages, typically +15, +5, and -15 volts. Some systems may even distribute *unregulated* power voltages on the bus expecting the individual circuits to regulate the voltages as required. Often several of the bus wires are assigned as grounds in order to reduce the possibility of ground loops.

The next major group is the *data lines*. These lines carry binary data around to the various system components. In most systems, data either flows from a peripheral device or memory into the CPU during a *read cycle*, or flows from the CPU to a memory or peripheral during a *write cycle*. One widely used bus system has 8 lines for carrying data from the CPU to other system components and 8 more lines for carrying data into the CPU from other components. Most other systems use a single set of 8 lines for both purposes forming what is called a *bidirectional* data bus. This is allowable because none of the available microprocessor chips can simultaneously read and write.

By Hal Chamberlin

Both schemes make use of integrated circuits having Tri-State® (National Semiconductor), sometimes called three-state, outputs which allow the outputs of several IC's on different boards to be tied onto the same bus lines. A three-state output can be in one of three conditions. Two of these are the familiar logic "0" and "1" states. The third is a *disabled* state in which the IC output essentially disconnects itself from the bus line. If only one of the three-state IC's connected to the bus line is enabled (in the "0" or "1" state) and all of the others are disabled, then the bus line assumes the logic state of the enabled IC output.

Another group is the *address lines*. Generally only the CPU supplies addresses, so frequently these are simply lines driven by the CPU and received by other system components.

The last major group is the *control signals*. These differ greatly in number and function among the various bus systems in common use; but in all cases they control the response of various system components. Many of the control signals are called *strokes*. Their purpose is to delay and qualify the response to an address or data change until the logic levels on the bus are stable. This prevents a response to erroneous address and data patterns caused by one bus line switching slightly faster than the others.

Occasionally the data lines and address lines are multiplexed onto the same physical bus wires. This is particularly advantageous in 16-bit systems since 16 bus lines and associated socket pins can be eliminated. In such a system, control lines indicate when an address or data appears on the bus. Flip-flop registers on the various system boards are used to remember the address while data transfer is taking place.

Often a bus system may have special features over and above what is required to read and write memory or I/O devices. One of these is called *direct memory access* or DMA. In a system with DMA capability, the CPU is not the only subsystem capable of generating

addresses and reading or writing memory. DMA I/O devices are also allowed to do these operations. In a system with DMA capability, the address lines must also have three-state capability.

DMA is typically used by video display and floppy disk subsystems. Both of these require data transfer at such a high speed that conventional program-controlled input/output techniques are not usable. In operation, a DMA device will temporarily stop the CPU and gain control of the bus for the duration of the data transfer. During this time, the full speed capability of the bus, which may easily reach 2-million bytes per second, can be utilized. When data transfer is complete, the CPU is allowed to resume normal operation. A couple of particularly sophisticated bus systems do not even stop the CPU during DMA operation. Instead, DMA transfers take place between the "cracks" when the CPU is not using the bus anyway.

The Altair Bus. By far the most popular bus system in use by hobbyists today is the original Altair bus. Although usually called the S-100 bus because of its 100 lines, its popularity approaches standardization. However, the fact re-

★ **FREE!** ★



**NEW CATALOG OF
HARD-TO-FIND
PRECISION TOOLS**

Jensen's new 144-page catalog is jam-packed with more than 3000 quality items. Your single source for hard-to-find precision tools used by electronic technicians, scientists, engineers, instrument mechanics, schools, laboratories and government agencies. This popular catalog also contains Jensen's world-famous line of more than 40 tool kits. Plus 10 pages of useful "Tool Tips" to aid in tool selection. Send for your free copy today!

JENSEN TOOLS & ALLOYS
1230 SOUTH PRIEST DRIVE · TEMPE, AZ 85281
A BLISS & LAUGHLIN Industry

CIRCLE NO. 25 ON FREE INFORMATION CARD

NEW ADDITION

Olson 8 "Erector Kit" COMPUTER SYSTEM

ONLY **\$499** SEMI-KIT

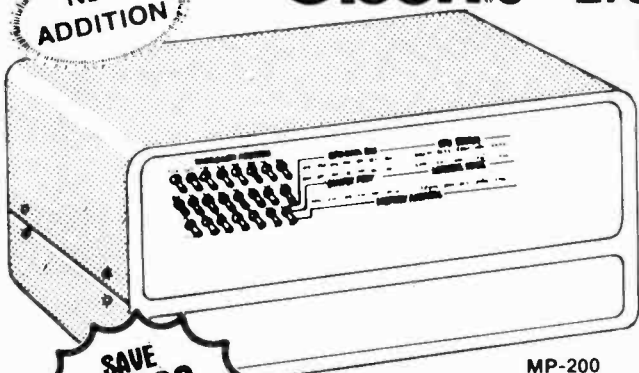

MP-200

SAVE 150.90
from reg. separate items price 649.90

- "The Electronic Erector Set"
- Ideal Kit For Amateur or Pro
- All You Need Is a Screwdriver To Assemble
- Boards Prewired Ready for Assembly Into Cabinet
- Shpg. wt. 15 lbs.

BONUS!
The 8080A Bug Book no charge with purchase of MP-200
BK-309 VALUE 9.95

SYSTEM INCLUDES:

Olson 8 Computer MP-100 (below)	229.95
Front Panel Display Control MP-102 (below)	189.95
Micro Processor Card MP-101 (below)	120.00
1 K PROM Memory	95.00
Dress Front Panel MP-103 (below)	15.00
REGULAR SEPARATE ITEMS PRICE	649.90

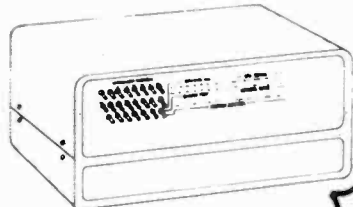

MP-210

\$750

SAVE 329.50
from reg. separate items price 1079.50

Factory Wired Version

- W/426 Page Bell & Howell Instruction Course
- Completely Factory Wired-Ready to Set-Up
- Shpg. wt. 15 lbs.

BONUS!
MP-201 2-Volume Bell & Howell Instruction Course No Charge With MP-210
89.50 VALUE

SYSTEM INCLUDES:

Olson 8 Computer MP-100 (below)	450.00	1 K PROM Memory. Wired	125.00
Wired	450.00	Dress Front Panel MP-103 (below)	15.00
Front Panel Display Control MP-102 (below) Wired	250.00	Bell & Howell Instr. Course MP-201	89.50
Micro-Processor Card MP-101 (below) Wired	150.00	REG. SEPARATE ITEMS PRICE	1079.50

Olson®

electronics

260 S. FORGE ST.
DEPT. I-7 AKRON, OHIO 44327

NAME _____
ADDRESS _____
CITY _____ STATE _____ ZIP _____

QTY.	STK#	DESCRIPTION	PRICE EA.	TOTAL

POSTAGE _____
TAX _____
TOTAL _____

mains that MITS introduced it in early 1975 with its Altair 8800 computer.

Of the 100 lines, only 81 are actually assigned. Six lines are used to distribute +8, +16 and -16 volts, all rectified and filtered but unregulated. Separate data-in and data-out groups of 8 lines each constitute the data lines. Another 16 lines form the address bus. There is an unusually large complement of 43 control lines; but they are not necessarily an advantage since they are provided in their raw, undecoded state.

The bus timing and control functions are entirely dependent on the 8080 CPU for which the bus was designed.

However, when newer microprocessors such as the 8085 or the Z80 are interfaced to the S-100 bus, true compatibility with the original bus specification can only be attained by adding circuitry to "fake" the same timing and control sequences as used by the 8080. Actually most peripheral board designs, particularly static memories, can tolerate considerable variation in timing and control details and still operate satisfactorily. However, more complex boards such as floppy disk controllers and graphic display interfaces may depend heavily on standard 8080 control timing. Thus, these more complex boards may not operate correctly with a Z80 CPU board that does a poor job of faking the 8080 control sequences.

Control and timing is not the only source of potential incompatibilities among "standard" S-100 boards. Some manufacturers have assigned their own functions to the 19 unused bus lines. Of course, with only 19 to go around, not everyone has assigned them to the same functions. Nevertheless, the S-100 bus is the closest thing to a standard bus this industry has.

Benton Harbor (Heath) Bus.

Another bus structure that has just been introduced with the announcement of the H8 microcomputer is the "Heath" bus. Unlike the S-100 bus, this one was carefully planned with the benefit of 2 years hindsight of the hobby computer market. Major differences are the much smaller number of lines, 50 instead of 100, and more generalized control signal assignments. The smaller number of bus lines and use of less expensive board-bus connectors greatly reduces the cost of a motherboard/bus system over the S-100 equivalent. Generalized control signals make the transition to newer processors more orderly.

Eight lines are used to distribute +18,

POPULAR ELECTRONICS

+8, and -18 volts, all unregulated. Four of these are grounds scattered among the other signals to further reduce noise. Although separate address and data busses are used, the data bus is bidirectional in order to conserve bus lines. The control signals are already decoded on the bus into the basic 4 operations; memory read, memory write, I/O read, and I/O write.

KIM-1 Bus. Probably the most popular "one board" microcomputer is the KIM-1. Although it has most of the subsystems needed for a complete system already on-board, it also has a 44-pin edge connector which brings the CPU bus out for expansion. While the busses described earlier were all TTL busses, capable of driving dozens of subsystems boards simultaneously, the KIM-1 bus is a "MOS" bus having limited drive capability. Using the signals raw, a maximum of four expansion boards can be driven and then only if they use "L" or "LS" TTL to connect to the bus. For greater expansion capability, a "bus expansion motherboard" can be used. This contains the typical parallel lines and board connectors as well as TTL buffers to drive a large number of

boards. One of these in effect converts the KIM-1 bus to an S-100 bus and allows all of the less sophisticated S-100 boards to be used with a KIM-1 system.

General Purpose Interface Bus (GPIB). All of the bus systems discussed so far have been processor busses. That is, they connect both memory and I/O boards to the CPU. Although they are very fast and relatively simple to interface to, operational speed restricts the overall length to two feet or less. Running the parallel lines over a longer distance than this produces intolerable noise and crosstalk as well as a general slowdown of all signals. What this means is that all interface boards *must* plug directly into the bus in the computer cabinet. Since input/output is usually done much more slowly than memory access, it would be nice to have a parallel I/O bus that can be run through a cable to a variety of peripheral devices.

One bus designed for just this purpose is the General Purpose Interface Bus (GPIB), developed by Hewlett-Packard and adopted as a standard by the IEEE. The bus consists of 16 lines, 8 of which are bidirectional data/

address lines and 8 of which are control lines. Although slower than the typical processor bus, it is much faster than a serial interface and uses full "handshake" control signal exchange to prevent data loss in the event a peripheral device is unable to receive data. Data transfers over the bus are in the form of 8-bit bytes and the control signals insure that devices on the bus are ready to receive or send data. Maximum bus length is about 16 feet, long enough to interconnect a table full of microcomputer peripherals. A maximum of 14 different devices can be addressed.

The significance of the GPIB is that the recently announced PET computer from Commodore has a GPIB connector on the back. Their plans call for interfacing add-on peripherals through this connector rather than adding boards inside the computer itself. Because of the large market expected for the PET computer and the fact that it is a formal industry standard not dominated by a single manufacturer, it is likely that the GPIB will soon become the preferred standard method of interfacing peripheral devices to a microcomputer. The familiar motherboard bus may disappear as 16k and 64k RAM chips make their appearance.◊

IN ELECTRONICS HAS THE LINE...

DIP/IC INSERTION TOOL WITH PIN STRAIGHTENER



MODEL INS-1416

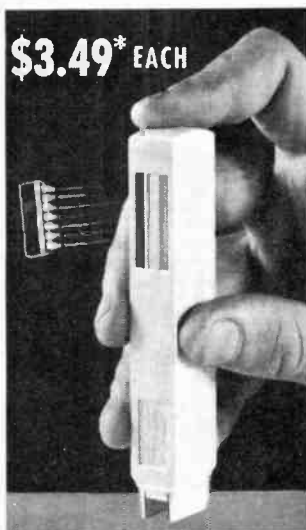

\$3.49* EACH

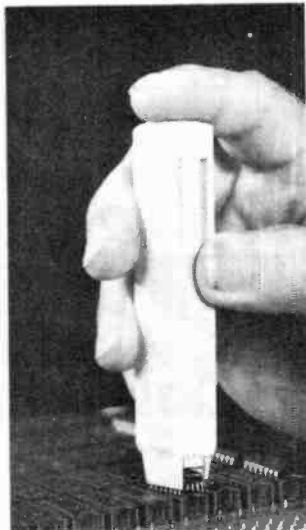
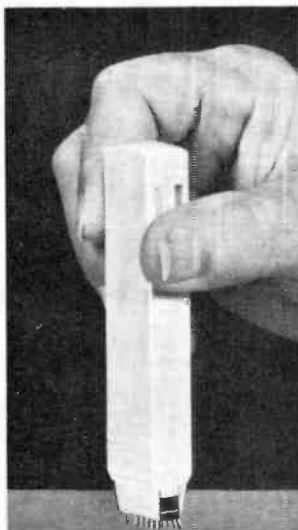

STRAIGHTEN PINS

RELEASE

PICK-UP

INSERT

* MINIMUM ORDER \$25.00, SHIPPING CHARGE \$1.00, N.Y. CITY AND STATE RESIDENTS ADD TAX

OK MACHINE AND TOOL CORPORATION

3455 CONNER STREET, BRONX, NEW YORK, N.Y. 10475 U.S.A.
PHONE (212) 994-6600 TELEX NO. 125091

CIRCLE NO. 32 ON FREE INFORMATION CARD

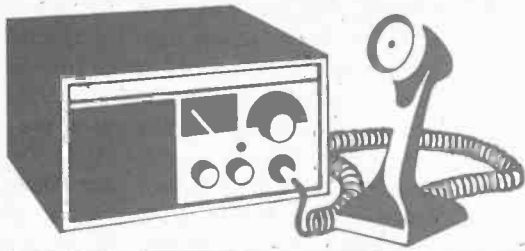

CB Scene

By Gary Garcia, KQI4178

AUTOMATIC TRANSMITTER IDENTIFICATION

MANDATORY USE of automatic transmitter identification systems (ATIS) was proposed (Docket 20351) in early 1975 as a means of alleviating the perplexing station identification problem and augmenting the enforcement efforts of the FCC. Two years later, in Docket 21137, the FCC again tendered the use of ATIS, this time for possible use on a voluntary basis. Here are some of the features of ATIS and its possible impact on the Citizens Band Radio Service.

Benefits. There are many benefits to be gained by CB'ers through the use of ATIS. Extensive application of ATIS will:

- Promote rules compliance, making for more reliable communications.
- Ease compliance with station identification requirements.
- Aid recovery of stolen transceivers.
- Simplify licensing procedures.
- Reduce necessary air time.

In addition, as pointed out by Stuart Lipoff of Arthur D. Little, Inc., ATIS and selective calling systems can easily be

integrated. On our crowded channels, the functions provided by such an integrated system will certainly be a valuable communications aid to CB'ers.

Methodology. The purpose of an automatic transmitter identification system is easily accomplished. A basic system is shown in Fig. 1. The identifying information is stored in ROM, and the transmission of this identifier is regulated by timer circuitry. The output of the memory is converted from parallel to serial form before being fed into an audio-frequency tone generator. Finally, the audio-frequency tones are input to the audio-frequency amplifier of the transceiver.

Note that ATIS functions between the microphone and the transceiver's audio-frequency amplifier. This facilitates the addition of ATIS to equipment currently in use. An ATIS module could easily be inserted between the microphone and the microphone jack of a transceiver. In fact, if the use of ATIS were approved by the FCC, we could

soon see commercial ATIS modules offered by those companies presently manufacturing automatic identification systems for the General Mobile Radio Service and amateur radio repeaters.

Your Electronic Fingerprint. The FCC has thus far proposed two methods of encoding the information used as identifier. Originally it was suggested that the identifier be transmitted in ASCII format by audio frequency-shift keying (AFSK) at a 100-baud rate. Using this method the identifier would be heard as a one-second burst. The audio-frequency tone used should not be over 4 kHz so as not to exceed FCC bandwidth limitations. In the first ATIS proposal, AFSK between two tones of 1115 and 1285 Hz is recommended.

Most recently, use of Morse Code transmitted at a rate of 25 words per minute has been suggested. On-off keying of a 750-Hz tone would be used here. The time required to transmit the identifier in this format is about five seconds. Currently, the EIA is working to standardize the format of signalling used in selective calling systems. It would be advantageous to use the same format for ATIS to allow integration of the two.

Whatever form of signalling and encoding is ultimately chosen, it probably will not be easily deciphered by the average CB'er. This will necessitate verbal transmission of callsigns in situations where the communicators require this information, such as when reporting an emergency on channel 9.

Another decision which must be made is what information to use as the identifier. If programming of the ATIS memory is to be done by manufacturers of CB transceivers and ATIS modules, it would be expedient to use, say, the serial number of the transceiver or module as the identifier. Programming of the licensee's callsign in the field, as was originally suggested by the FCC, would then be circumvented. However, if the transceiver's or module's serial number, or any other number other than the licensee's callsign, were used as an identifier, then the problem of station identification by use of the FCC-assigned callsigns remains unresolved. It is possible that the FCC would alter the regulations to allow identification by the number programmed into ATIS. Transmissions made using a transceiver equipped with ATIS, no matter what information is used as identifier, would all carry a unique "brand" which could be correlated with manufacturers' records to pro-

Fig. 1. Block diagram of a basic identification system.

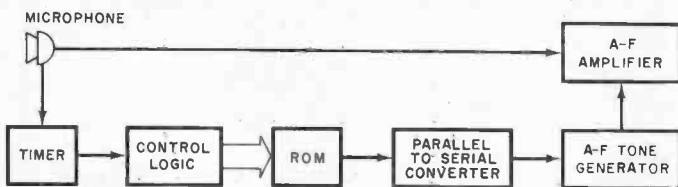

NEW!

DAVIS ELECTRONICS

Mini Counter



7208 60 MHz Kit \$119.95 Assembled 169.95
 7208A 600 MHz Kit .. \$149.95 Assembled 199.95

- All Metal Cabinet
- 8 Digit 4" LED Display
- Input Cable Included
- 12V Input Jack
- Crystal Time Base
- 115V or 12V Operation
- Push Button Controls
- Gate Light
- Completely Auto Decimal Point
- Selectable Gate Times (1 sec & .1 sec)
- State of the Art LSI Circuitry
- Sensitivity < 10 MV

ORDER NOW
Call Toll Free
1-800-828-7422





DAVIS ELECTRONICS 636 Sheridan Dr., Tonawanda, NY 14150 716/874-5848

CIRCLE NO. 9 ON FREE INFORMATION CARD

duce positive identification of the source of the transmissions.

Implementation. If ATIS were universally implemented on a mandatory basis, it would be necessary to retrofit the approximately 25-million CB transceivers now in use as well as all units "on the shelf." This is a seemingly impossible task. Certainly, if mandatory retrofitting of CB equipment with ATIS became law, it would just be another unenforceable regulation.

Voluntary implementation of ATIS is another possibility, as indicated in the

FCC's most recent proposal. Though this would make concurrence with station identification requirements easier for those who are willing to apply ATIS, we can hardly expect CB's bad guys (those who use excessive r-f power, work DX, broadcast obscenities, etc.) to subscribe to ATIS.

If ATIS is eventually implemented by the FCC it will probably be on a voluntary basis for equipment now in use. It is possible, of course, that manufacturers of CB transceivers will be compelled to incorporate ATIS into their products in the future. But it's doubtful that this will

occur on the present band. Certainly, if a new personal use radio service on a band other than 11 meters were opened to the public, ATIS will play an important part in helping the FCC police the band effectively. But initiating such a system would have to be mandatory at the onset, lest a situation similar to the present one develops. Besides, a new band is not in the cards in the near future.

For the present, it seems that the FCC will have to continue to rely on conventional, catch-as-catch-can enforcement techniques, as well as on self-policing among CB'ers. ♦

STATEMENT OF OWNERSHIP, MANAGEMENT AND CIRCULATION (Required by 39 U.S.C. 3685). 1. Title of Publication: Popular Electronics. A. Publication No. 438240 2. Date of filing: October 1, 1977. 3. Frequency of issue: Monthly. A. No. of issues published annually: 12. B. Annual subscription price: \$12.00. 4. Location of known office of publication: One Park Avenue, New York, New York 10016. 5. Location of the Headquarters or General Business Offices of the publishers: One Park Avenue, New York, New York 10016. 6. Names and complete addresses of publisher, editor, and managing editor: Publisher, Joseph E. Mesics, One Park Avenue, New York, New York 10016; Editor, Arthur P. Salsberg, One Park Avenue, New York, New York 10016; Managing Editor, John R. Riggs, One Park Avenue, New York, New York 10016. 7. Owner: Ziff-Davis Publishing Company, One Park Avenue, New York, New York 10016; Ziff Corporation, One Park Avenue, New York, New York 10016. 8. Known bondholders, mortgagees, and other security holders owning or holding 1 percent or more of total amount of bonds, mortgages or other securities: None.

10. Extent and nature of circulation	Average no. copies each issue during preceding 12 months	Actual no. copies of single issue published nearest to filing date
A. Total No. Copies Printed (Net Press Run)	480,817	490,875
B. Paid Circulation		
1. Sales through Dealers and Carriers, Street Vendors and Counter Sales	82,467	86,000
2. Mail Subscriptions	322,809	323,235
C. Total Paid Circulation (Sum of 10B1 and 10B2)	405,276	409,235
D. Free Distribution by Mail, Carrier or Other Means, Samples, Complimentary, and Other Free Copies	8,451	7,863
E. Total Distribution (Sum of C and D)	413,727	417,098
F. Copies not distributed		
1. Office Use, Left Over, Unaccounted, Spoiled After Printing	2,135	1,577
2. Returns from News Agents	64,955	72,200
G. Total (Sum of E, F1 and 2—should equal net press run shown in A)	480,817	490,875

11. I certify that the statements made by me above are correct and complete.

WILLIAM L. PHILLIPS, Assistant Treasurer

12. For Completion by Publishers Mailing at the Regular Rates: (Section 132.121. Postal Service Manual)

39 U. S. C. 3626 provides in pertinent part: "No person who would have been entitled to mail matter under former section 4359 of this title shall mail such matter at the rates provided under this subsection unless he files annually with the Postal Service a written request for permission to mail matter at such rates."

In accordance with the provisions of this statute, I hereby request permission to mail the publication named in item 1 at the phased postage rates presently authorized by 39 U. S. C. 3626.

WILLIAM L. PHILLIPS, Assistant Treasurer

JANUARY 1978

Bearcat[®] 210 Scanner



\$289.

The Bearcat 210 super synthesized receiver scans and searches over 16,000 different frequencies without expensive crystals. The Bearcat 210 covers 32-50, 146-174 & 416-512 Mhz., and has AC/DC operation. Save over \$60.00 now by ordering on our 24 hour toll-free credit card order line 800-521-4414. In Michigan and outside the U.S. call 313-994-4441. Add \$5.00 for shipping in the U.S. or \$9.00 for air UPS to the west coast. Charge cards or money orders only. Foreign orders invited.

COMMUNICATIONS ELECTRONICS
P.O. BOX 1002 DEPT. PE1
ANN ARBOR, MICHIGAN 48106



CIRCLE NO. 7 ON FREE INFORMATION CARD

"My father built this Schober Organ for me!"

You'd be proud to buy her an organ this good...but how would you feel if you'd also built it? It's a special kind of satisfaction. The gift of a lifetime of magnificent music, crafted with your own hands!

And you can do it! You need no prior electronic or mechanical abilities. Just the capacity to follow instructions. Every step is clearly detailed, every component is supplied. You'll find the assembly process as enjoyable as the music which follows!

And what music! For this is a truly fine instrument you will build. Far superior to most

"ready-made" organs...easily comparable to others at twice the price. Kit costs range from \$650 to \$2850 for all basic components, and you can purchase it in sections to spread costs out...or have two-year time payments.

When you've completed the basic organ, Schober offers a full complement of accessories...plus complete organ playing courses! People have been building Schober Electronic Organs for their daughters, sons, wives, husbands...for themselves...for 20 years now. Join the thousands of delighted Schober people.

You can have all the details, without cost or obligation. Just send the coupon for the fascinating Schober color catalog (or enclose \$1 for a record that lets you hear as well as see the quality of Schober). Why not clip it right now, before you forget?



The Schober Organ Corp., Dept. PE-75
43 West 61st Street, New York, N.Y. 10023

- Please send me Schober Organ Catalog.
 Enclosed please find \$1.00 for 12-inch L.P. record of Schober Organ music.

NAME _____
ADDRESS _____
CITY _____ STATE _____ ZIP _____

CIRCLE NO. 43 ON FREE INFORMATION CARD

SHOP YOUR NEARBY RADIO SHACK FOR QUALITY PARTS AT LOW PRICES!

Top quality devices, fully functional, carefully inspected. Guaranteed to meet all specifications, both electrically and mechanically. All are made by well known American manufacturers, and all have to pass

manufacturer's quality control procedures. These are not rejects, not fallouts, not seconds. In fact, there are none better on the market! Count on Radio Shack for the finest quality electronic parts.

TTL Digital ICs

First Quality

Made by National Semiconductor and Motorola



Type	Cat. No.	ONLY
7400	276-1801	35¢
7402	276-1811	39¢
7404	276-1802	35¢
7406	276-1821	49¢
7410	276-1807	39¢
7413	276-1815	79¢
7420	276-1809	39¢
7427	276-1823	49¢
7432	276-1824	49¢
7441	276-1804	99¢
7447	276-1805	99¢
7448	276-1816	99¢
7451	276-1825	39¢
7473	276-1803	49¢
7474	276-1818	49¢
7475	276-1806	79¢
7476	276-1813	59¢
7485	276-1826	1.19
7486	276-1827	49¢
7490	276-1808	79¢
7492	276-1819	69¢
74123	276-1817	99¢
74143	276-1828	1.19
74150	276-1829	1.39
74154	276-1834	1.29
74192	276-1831	1.19
74193	276-1820	1.19
74194	276-1832	1.19
74196	276-1833	1.29

Resistor and Capacitor Packs



Resistor and capacitor kits in handy plastic storage boxes you can use over and over again. Stock up!
 1/2 Watt, 10% Tolerance Resistors. 271-601 Pkg. of 350/9.95
 1/4 Watt, 5% Tolerance Resistors. 271-602 Pkg. of 350/9.95
 50WVDC Ceramic Disc Capacitors. 272-601 Pkg. of 175/9.95
 35WVDC Radial Lead Capacitors. 272-602 Pkg. of 35/9.95
 35WVDC Axial Lead Capacitors. 272-603 Pkg. of 36/9.95

Tantalum Capacitors

Maximum capacity in smallest size. Low ESR, highly stable electrical characteristics and low leakage. Radial leads.



Cat. No.	μF	Each	Cat. No.	μF	Each
272-1401	0.1	39¢	272-1407	2.2	45¢
272-1402	0.22	39¢	272-1408	3.3	45¢
272-1403	0.33	39¢	272-1409	4.7	49¢
272-1404	0.47	39¢	272-1410	6.8	49¢
272-1405	0.68	39¢	272-1411	10.0	49¢
272-1406	1.0	39¢			

Nos. 1401-1408, 35WVDC; 1409-1411, 16WVDC.

PC Board Accessories



8-piece photographic PC board processing kit — fastest, easiest way to produce perfect printed circuit projects.
 276-1560 12.95
 Etch-Resist Marking Pen. 276-1530 1.19
 Etchant Solution. 276-1535 1.89
 PC Board Assortment. 276-1573 1.98

Build an LED Digital Clock

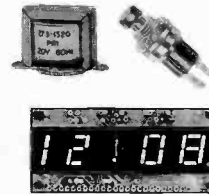
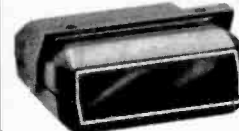

12-HR LED Clock Module. Just add a transformer and switches for a complete clock with 0.5" LED display. 277-1001 14.95
 Transformer for above. 120VAC 60 Hz. 273-1520 3.99
 SPST Miniature Pushbutton Switch. 275-1547 5/1.99
 Display Case. 1 1/8"x3 7/8"x4 1/8". 270-285 3.95

CMOS ICs

100% guaranteed electrically and mechanically

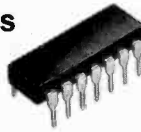

Type	Cat. No.	ONLY
74C00	276-2301	49¢
74C02	276-2302	49¢
74C04	276-2303	49¢
74C08	276-2305	49¢
74C14	276-2310	89¢
74C76	276-2312	89¢
74C90	276-2315	1.49
74C192	276-2321	1.69
74C193	276-2322	1.69
4001	276-2401	49¢
4011	276-2411	49¢
4013	276-2413	89¢
4017	276-2417	1.49
4020	276-2420	1.49
4027	276-2427	89¢
4049	276-2449	69¢
4050	276-2450	69¢
4511	276-2447	1.69
4518	276-2490	1.49

LED Digital Displays

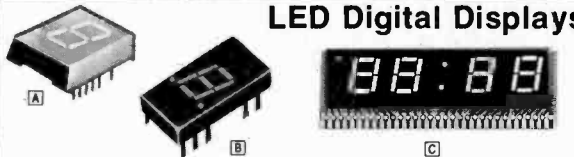

Digits	Size	Drive	Cat. No.	ONLY	Digits	Size	Drive	Cat. No.	ONLY
1	0.6"	Anod.	276-056	2.99	1	0.3"	Anod.	276-1210	4/6.99
1	0.6"	Cath.	276-066	2.99	1	0.3"	Cath.	276-1211	4/6.99
1	0.3"	Anod.	276-053	1.99	4	0.5"	Anod.	276-1201	6.95
1	0.3"	Cath.	276-062	1.99	4	0.5"	Cath.	276-1202	6.95

Power Supply Parts

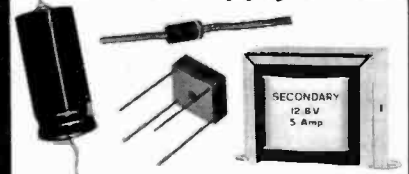

6-Amp Full-Wave Bridge Rectifier. 50 PIV. 276-1180 1.99
 50V 3-Amp Power Rectifier. 300-A surge. 276-1141 Pkg. 2/69¢
 Electrolytic Capacitors
 3300 μF at 35V. 272-1021 2.99
 5000 μF at 35V. 272-1022 3.49
 Heavy-Duty Transformers. All for 120VAC, 60 Hz.

Cat. No.	Volts	Current	Size	Each
273-1512	25.2 CT	2A	2 1/2"x2 1/2"	4.99
273-1513	12	5A	4x2x2 1/2"	8.95
273-1514	18 CT	4A	4x2x2 1/2"	8.95

IC Accessories

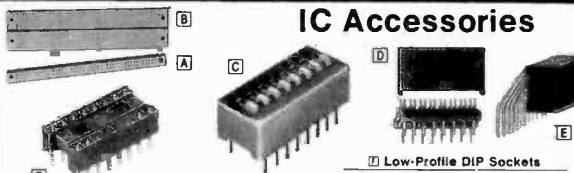

- ⓐ Bus Strip. 276-173 1.99
- ⓑ Experiment. Socket. 276-172 9.95
- ⓒ DIP Switch. 275-1301 1.99
- ⓓ DIP Header. 276-1980 1.29
- ⓔ Right Angle 16-Pin Socket. 276-1985 1.49

Low-Profile DIP Sockets

Pins	Cat. No.	Price
8	276-1995	2/59¢
14	276-1999	2/89¢
16	276-1998	2/89¢
28	276-1997	Ea. 89¢
40	276-1996	Ea. 99¢

Linear ICs

By National Semiconductor and Motorola — first quality

Type	Cat. No.	ONLY
301CN	276-017	49¢
324N	276-1711	1.49
339N	276-1712	1.49
386CN	276-1731	99¢
555CN	276-1723	79¢
556CN	276-1728	1.39
566CN	276-1724	1.69
567CN	276-1721	1.99
723CN	276-1740	69¢
741CN	276-007	49¢
741H	276-010	49¢
3909N	276-1713	99¢
3909N	276-1705	99¢
3911N	276-1706	1.99
4558CN	276-038	79¢
75491	276-1701	99¢
75492	276-1702	99¢
7805	276-1770	1.29
7812	276-1771	1.29
7815	276-1772	1.29

Computer Chips

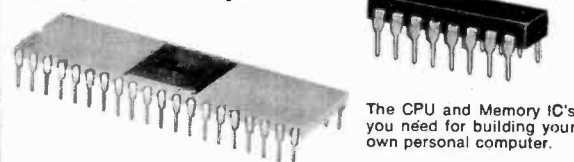

8080A Microprocessor. An 8-bit National Semiconductor chip in a 40-pin DIP. 100% Prime. 276-2510 17.95

2102 Static RAM. 1024-word by one bit read/write memory. Under 600 ns access time. 276-2501 2.49 Ea. or 8/14.95

Silicon Solar Cells



Produce Power from Light!
 2cmx4cm. 0.5V at 100mA. 276-120 2.99
 2cmx2cm. 0.5V at 60mA. 276-128 1.99

Clock Chips



50252. 12-hour clock, 24-hour alarm chip. With full specifications. 276-1751 6.99
 7001. 12-hour calendar alarm clock IC. With all data. 276-1756 10.95

WHY WAIT FOR MAIL ORDER DELIVERY? IN STOCK NOW AT OUR STORE NEAR YOU!

Radio Shack®

Prices may vary at individual stores and dealers

A TANDY COMPANY • FORT WORTH, TEXAS 76102
 OVER 6000 LOCATIONS IN NINE COUNTRIES

DIGI-KEY CORPORATION

Quality Electronic Components

800-24-6674

MINNESOTA RESIDENTS 218-681-6674

I.C.'S • RESISTORS • TRANSISTORS • CAPACITORS • DIODES • I.C. SOCKETS & PINS • SWITCHES
CLOCK MODULES • OPTOELECTRONICS • BREADBOARDING & TESTING DEVICES • DRAFTING SUPPLIES
DATA BOOKS • HEAT SINKS • WIRE • TOOLS • AND MORE... WRITE FOR FREE CATALOG

INTEGRATED CIRCUITS

TTL	74198	1.49	7415261	2.00	LF13741	1.76
7400	21	74199	1.80	7415262	1.80	LF13741
7401	21	74200	1.80	7415263	1.28	LM301AN
7402	21	74201	1.09	7415264	1.00	LM301A
7403	21	74202	1.09	7415265	1.00	LM308
7404	21	74203	1.09	7415266	1.00	LM309
7405	21	74204	1.09	7415267	1.00	LM311
7406	25	74205	1.09	7415268	1.00	LM317
7407	25	74206	1.09	7415269	1.00	LM317P
7408	25	74207	1.09	7415270	1.00	LM317CP
7409	21	74208	1.09	7415271	1.00	LM318
7410	21	74209	1.09	7415272	1.00	LM320M-5
7411	21	74210	1.09	7415273	1.00	LM320M-6
7412	21	74211	1.09	7415274	1.00	LM320M-13
7413	21	74212	1.09	7415275	1.00	LM320M-15
7414	21	74213	1.09	7415276	1.00	LM320M-151
7415	21	74214	1.09	7415277	1.00	LM320M-151
7416	21	74215	1.09	7415278	1.00	LM320M-151
7417	21	74216	1.09	7415279	1.00	LM320M-151
7418	21	74217	1.09	7415280	1.00	LM320M-151
7419	21	74218	1.09	7415281	1.00	LM320M-151
7420	21	74219	1.09	7415282	1.00	LM320M-151
7421	21	74220	1.09	7415283	1.00	LM320M-151
7422	21	74221	1.09	7415284	1.00	LM320M-151
7423	21	74222	1.09	7415285	1.00	LM320M-151
7424	21	74223	1.09	7415286	1.00	LM320M-151
7425	21	74224	1.09	7415287	1.00	LM320M-151
7426	21	74225	1.09	7415288	1.00	LM320M-151
7427	21	74226	1.09	7415289	1.00	LM320M-151
7428	21	74227	1.09	7415290	1.00	LM320M-151
7429	21	74228	1.09	7415291	1.00	LM320M-151
7430	21	74229	1.09	7415292	1.00	LM320M-151
7431	21	74230	1.09	7415293	1.00	LM320M-151
7432	21	74231	1.09	7415294	1.00	LM320M-151
7433	21	74232	1.09	7415295	1.00	LM320M-151
7434	21	74233	1.09	7415296	1.00	LM320M-151
7435	21	74234	1.09	7415297	1.00	LM320M-151
7436	21	74235	1.09	7415298	1.00	LM320M-151
7437	21	74236	1.09	7415299	1.00	LM320M-151
7438	21	74237	1.09	7415300	1.00	LM320M-151
7439	21	74238	1.09	7415301	1.00	LM320M-151
7440	21	74239	1.09	7415302	1.00	LM320M-151
7441	21	74240	1.09	7415303	1.00	LM320M-151
7442	21	74241	1.09	7415304	1.00	LM320M-151
7443	21	74242	1.09	7415305	1.00	LM320M-151
7444	21	74243	1.09	7415306	1.00	LM320M-151
7445	21	74244	1.09	7415307	1.00	LM320M-151
7446	21	74245	1.09	7415308	1.00	LM320M-151
7447	21	74246	1.09	7415309	1.00	LM320M-151
7448	21	74247	1.09	7415310	1.00	LM320M-151
7449	21	74248	1.09	7415311	1.00	LM320M-151
7450	21	74249	1.09	7415312	1.00	LM320M-151
7451	21	74250	1.09	7415313	1.00	LM320M-151
7452	21	74251	1.09	7415314	1.00	LM320M-151
7453	21	74252	1.09	7415315	1.00	LM320M-151
7454	21	74253	1.09	7415316	1.00	LM320M-151
7455	21	74254	1.09	7415317	1.00	LM320M-151
7456	21	74255	1.09	7415318	1.00	LM320M-151
7457	21	74256	1.09	7415319	1.00	LM320M-151
7458	21	74257	1.09	7415320	1.00	LM320M-151
7459	21	74258	1.09	7415321	1.00	LM320M-151
7460	21	74259	1.09	7415322	1.00	LM320M-151
7461	21	74260	1.09	7415323	1.00	LM320M-151
7462	21	74261	1.09	7415324	1.00	LM320M-151
7463	21	74262	1.09	7415325	1.00	LM320M-151
7464	21	74263	1.09	7415326	1.00	LM320M-151
7465	21	74264	1.09	7415327	1.00	LM320M-151
7466	21	74265	1.09	7415328	1.00	LM320M-151
7467	21	74266	1.09	7415329	1.00	LM320M-151
7468	21	74267	1.09	7415330	1.00	LM320M-151
7469	21	74268	1.09	7415331	1.00	LM320M-151
7470	21	74269	1.09	7415332	1.00	LM320M-151
7471	21	74270	1.09	7415333	1.00	LM320M-151
7472	21	74271	1.09	7415334	1.00	LM320M-151
7473	21	74272	1.09	7415335	1.00	LM320M-151
7474	21	74273	1.09	7415336	1.00	LM320M-151
7475	21	74274	1.09	7415337	1.00	LM320M-151
7476	21	74275	1.09	7415338	1.00	LM320M-151
7477	21	74276	1.09	7415339	1.00	LM320M-151
7478	21	74277	1.09	7415340	1.00	LM320M-151
7479	21	74278	1.09	7415341	1.00	LM320M-151
7480	21	74279	1.09	7415342	1.00	LM320M-151
7481	21	74280	1.09	7415343	1.00	LM320M-151
7482	21	74281	1.09	7415344	1.00	LM320M-151
7483	21	74282	1.09	7415345	1.00	LM320M-151
7484	21	74283	1.09	7415346	1.00	LM320M-151
7485	21	74284	1.09	7415347	1.00	LM320M-151
7486	21	74285	1.09	7415348	1.00	LM320M-151
7487	21	74286	1.09	7415349	1.00	LM320M-151
7488	21	74287	1.09	7415350	1.00	LM320M-151
7489	21	74288	1.09	7415351	1.00	LM320M-151
7490	21	74289	1.09	7415352	1.00	LM320M-151
7491	21	74290	1.09	7415353	1.00	LM320M-151
7492	21	74291	1.09	7415354	1.00	LM320M-151
7493	21	74292	1.09	7415355	1.00	LM320M-151
7494	21	74293	1.09	7415356	1.00	LM320M-151
7495	21	74294	1.09	7415357	1.00	LM320M-151
7496	21	74295	1.09	7415358	1.00	LM320M-151
7497	21	74296	1.09	7415359	1.00	LM320M-151
7498	21	74297	1.09	7415360	1.00	LM320M-151
7499	21	74298	1.09	7415361	1.00	LM320M-151
7500	21	74299	1.09	7415362	1.00	LM320M-151

8080A CHIP SET

ONE EACH 8080A, 8212, 8224 and 8228 PLUS
SIXTEEN 2102-1's — ALL FOR

\$49.95

MICROPROCESSORS

Best Values Yet!

8080A 8-BIT CPU, 2 USEC CYCLE \$12.95
8216 8-BIT I/O PORT \$ 3.95
8218 BI-DIRECTIONAL BUS DRIVER \$ 4.25
8224 CLOCK GENERATOR \$ 3.95
8228 SYSTEM CONTROLLER \$ 6.95
8251 COMMUNICATIONS INTERFACE \$12.95
8255 PERIPHERAL INTERFACE \$11.95
1702A 2K EPROM (256x8) \$ 6.95
2708 8K EPROM (1Kx8) \$29.50
2102A 1K RAM 500 NS \$ 1.75
5C14P 5 VOLT SCMP CPU \$ 9.95
2650 MICROPROCESSOR 1.25 MHZ-2 CLOCK 40 DIL \$24.95

WIRE WRAPPING WIRE IN BULK

Red or Black 30 ga. Kynar

100' \$2.00 500' \$8.50 1000' \$15.00

5% CARBON FILM RESISTORS

1/4 & 1/2 WATT SIZE

5% tolerance 5" or 100% positive 1.7" size

1000% tolerance 1.2" size

PLESSEY SAMPLER

AN ASSORTMENT OF METALIZED POLYESTER CAPACITORS

300 CAPS 18 VALUES \$26.00

MINIBOX METALIZED POLYESTER CAPACITORS

.001	14	11.5/10	9.00/C	.033	15	1.25/10	10.00/C
.002	14	1.5/10	9.00/C	.047	15	1.25/10	10.00/C
.003	14	1.5/10	9.00/C	.068	15	1.25/10	10.00/C
.004	14	1.5/10	9.00/C	.1	17	1.25/10	10.00/C
.006	14	1.5/10	9.00/C	.15	17	1.25/10	10.00/C
.01	14	1.5/10	9.00/C	.22	15	1.25/10	10.00/C
.022	15	1.25/10	10.00/C	.33	30	2.50/10	20.00/C
.033	15	1.25/10	10.00/C	.47	36	3.00/10	24.00/C

ELECTROLYTIC CAPACITORS

VALUE	RADIAL LEADS	AXIAL LEADS
.01	08 .65/10 5.41/C	11 90/10 7.65/C
.02	08 .65/10 5.41/C	11 90/10 7.65/C
.05	08 .65/10 5.41/C	11 90/10 7.65/C
.1	08 .65/10 5.41/C	11 90/10 7.65/C
.22	08 .65/10 5.41/C	11 90/10 7.65/C
.33	08 .65/10 5.41/C	11 90/10 7.65/C
.47	08 .65/10 5.41/C	11 90/10 7.65/C
.68	08 .65/10 5.41/C	11 90/10 7.65/C
1.0	08 .65/10 5.41/C	11 90/10 7.65/C
1.5	08 .65/10 5.41/C	11 90/10 7.65/C
2.2	08 .65/10 5.41/C	11 90/10 7.65/C
3.3	08 .65/10 5.41/C	11 90/10 7.65/C
4.7	08 .65/10 5.41/C	11 90/10 7.65/C
6.8	08 .65/10 5.41/C	11 90/10 7.65/C
10	08 .65/10 5.41/C	11 90/10 7.65/C
15	08 .65/10 5.41/C	11 90/10 7.65/C
22	08 .65/10 5.41/C	11 90/10 7.65/C
33	08 .65/10 5.41/C	11 90/10 7.65/C
47	08 .65/10 5.41/C	11 90/10 7.65/C
68	08 .65/10 5.41/C	11 90/10 7.65/C
100	08 .65/10 5.41/C	11 90/10 7.65/C
150	08 .65/10 5.41/C	11 90/10 7.65/C
220	08 .65/10 5.41/C	11 90/10 7.65/C
330	08 .65/10 5.41/C	11 90/10 7.65/C
470	08 .65/10 5.41/C	11 90/10 7.65/C
680	08 .65/10 5.41/C	11 90/10 7.65/C
1000	08 .65/10 5.41/C	11 90/10 7.65/C
1500	08 .65/10 5.41/C	11 90/10 7.65/C
2200	08 .65/10 5.41/C	11 90/10 7.65/C
3300	08 .65/10 5.	



NON-LINEAR SYSTEMS, INC.

PORTABLE 15 MHz OSCILLOSCOPE



The MS-15 miniscope is only 2.7" x 6.4" x 7.5", and weighs only 3 lbs. Vertical bandwidth is 15 MHz. The graticuled rectangular viewing area is four divisions high by five divisions wide. Division spacing is 0.25 inches. Internal and external triggering, automatic and line synchronization modes, and a horizontal input are provided. There are 12 vertical gain settings from 0.01 V to 50 V per division, and twenty one time base settings from 0.1 μ s to 0.5 μ s per division. An optional Power is provided by batteries or the 115 V, 60 Hz line.

MS-15 MINISCOPE \$289.00

41-140 CARRYING CASE 30.00

41-141 10 TO 1 PROBE 24.50

EXAR - INTEGRATED CIRCUITS

COMMUNICATION CIRCUITS	
XR-2208CP	Four-Quadrant Operational Multiplier \$5.20
PHASE-LOCKED LOOPS	
XR-210	FSK Modulator/Demodulator \$5.20
XR-215	General Purpose Phase-Locked Loop \$6.56
XR-2211CP	FSK Demodulator/Tone Decoder \$6.88
FUNCTION GENERATORS	
XR-205	Waveform Generator \$8.40
XR-2206CP	Monolithic Function Generator \$5.12
XR-2207CP	Current-Controlled Oscillator \$3.84
TONE DECODERS	
XR-567CP	Tone Decoder \$1.68
XR-2567CP	Dual Tone Decoder \$5.18
VOLTAGE REGULATORS	
XR-1468CN	Dual \pm 15 Volt Tracking Regulator \$3.84
XR-4194CN	Adjustable Dual Tracking Voltage Regulator \$4.56
XR-4195CP	Dual \pm 15V Tracking Voltage Regulator \$3.38
OPERATIONAL AMPLIFIERS	
XR-3403CP	Quad Operational Amplifier \$3.33
XR-4202CP	Programmable Quad Operational Amplifier \$3.60
XR-4212 CP	Quad Operational Amplifier \$2.05
XR-4558CP	Dual Operational Amplifier \$0.86
XR-4739CP	Dual Low-Noise Operational Amplifier \$1.15
TIMING CIRCUITS	
XR-320P	Timing Circuit \$1.52
XR-555CP	Timing Circuit \$1.07
XR-556CP	Dual 555 Timing Circuit \$1.82
XR-2240CP	Programmable Timing Circuit \$3.44
XR-2556CP	Dual 555 Timing Circuit \$3.20
INTERFACE CIRCUITS	
XR-2200CP	Hammer Driver \$1.17
XR-2201CP	High Voltage, High Current -2202CP/ Darlingon Transistor Arrays -2203CP/ -2204CP each \$2.25
XR-2271CP	Flourescent Display Drivers \$1.15
OTHER CIRCUITS	
XR-1310P	FM Stereo Demodulator \$3.20
XR-2264CP	Proportional Servo IC \$4.24
XR-4151CP	Voltage-To-Frequency Converter \$7.50

5% CARBON FILM RESISTOR ASSORTMENTS	
Each assortment contains 5 pct each of 10 different values	
Values included are shown in Ohms!	
% Watt 5% assortments \$1.75 ea.	% Watt 5% assortments \$1.85 ea.
Asst. 1: 10, 12, 15, 18, 22, 27, 33, 39, 47, 56	
Asst. 1A: 11, 13, 16, 20, 24, 30, 36, 43, 51, 62	
Asst. 2: 68, 82, 100, 120, 150, 180, 220, 270, 330, 390	
Asst. 2A: 75, 91, 110, 130, 160, 200, 240, 300, 360, 430	
Asst. 3: 470, 560, 680, 820, 1K, 1.2K, 1.5K, 1.8K, 2.2K, 2.7K	
Asst. 3A: 510, 620, 750, 910, 1.1K, 1.3K, 1.6K, 2K, 2.4K, 3K	
Asst. 4: 3.3K, 3.9K, 4.7K, 5.6K, 6.8K, 8.2K, 10K, 12K, 15K, 18K	
Asst. 4A: 3.6K, 4.3K, 5.1K, 6.2K, 7.5K, 9.1K, 11K, 13K, 16K, 20K	
Asst. 5: 22K, 27K, 33K, 39K, 47K, 56K, 68K, 82K, 100K, 120K	
Asst. 5A: 24K, 30K, 36K, 43K, 51K, 62K, 75K, 91K, 110K, 130K	
Asst. 6: 150K, 180K, 220K, 270K, 330K, 390K, 470K, 560K, 680K, 820K	
Asst. 6A: 160K, 200K, 240K, 300K, 360K, 430K, 510K, 620K, 750K, 910K	
Asst. 7: 1M, 1.2M, 1.5M, 1.8M, 2.2M, 2.7M, 3.3M, 3.9M, 4.7M, 5.6M	
Asst. 7A: 1.1M, 1.3M, 1.6M, 2M, 2.4M, 3M, 3.6M, 4.3M, 5.1M, 6.2M	
(%Watt assortment No. 7A does not include 5.6M)	
(%Watt assortment No. 7A does not include 5.1 or 6.2M)	
Asst. 8: (Consists of Asst's 1, 2, 3, 4, 5, 6 and 7)	
Asst. 8A: (Consists of Asst's 1A, 2A, 3A, 4A, 5A, 6A and 7A)	
Asst's 8 or 8A - %Watt \$10.95	%Watt \$11.55

COMPUTER INTERFACE CIRCUITS

1-8	10 UP	1-9	10 UP	1-9	10 UP	1-9	10 UP				
MH0026CN	\$ 2.60	\$ 2.20	SN7524N	\$ 1.50	\$ 1.35	DM8820N	\$ 2.20	\$ 1.75	AM8228PC	\$ 8.20	\$ 7.10
DS0056CN	5.88	4.70	SN7525N	1.40	1.25	DM8820AN	2.95	2.35	AM8238PC	6.20	7.10
DS3603N	4.10	3.30	SN751078N	2.58	2.06	DM8830N	2.95	2.35	9600PC	1.65	1.50
AM1488PC	2.10	1.65	SN751088N	2.58	2.06	DM8831N	3.25	2.80	9601PC	1.65	1.30
AM1489PC	2.10	1.65	SN75109N	2.58	2.06	DM8832N	3.25	2.80	9602PC	1.60	1.65
AM1489APC	2.10	1.65	SN75110N	2.58	2.06	DS8838N	2.95	2.35	9614PC	2.15	1.80
P3212	4.35	3.75	SN75234N	1.55	1.40	N8T268	3.10	2.70	9615PC	2.15	1.80
P3216	3.90	3.15	SN75235N	1.50	1.00	P8212	4.35	3.75	9616PC	3.15	1.60
DS3604AN	6.65	5.35	SN75238N	1.95	1.60	P8216	3.90	3.15	9617PC	2.15	1.80
SN7521N	1.40	1.25	SN75239N	1.50	1.25	AM8224PC	6.50	5.40	9620PC	3.00	2.50
P3226	3.90	3.15	SN75235N	2.60	2.35	P8226	3.90	3.15	9621PC	3.00	2.50

2900 SERIES BI-POLAR MICROPROCESSOR AND SUPPORT CIRCUITS

AM2901APC	\$22.00	\$17.40	AM2913PC	\$ 4.10	\$ 3.15	AM29700PC	\$ 5.65	\$ 4.50	AM29721PC	\$ 5.00	\$ 4.20
AM2901DC	29.40	22.05	AM2914DC	60.00	45.00	AM29701PC	5.65	4.50	AM29750DC	4.50	3.60
AM2902PC	3.82	3.18	AM2915APC	8.10	7.00	AM29702PC	5.65	4.50	AM29751DC	4.50	3.60
AM2905PC	8.10	7.00	AM2916APC	11.20	8.95	AM29703PC	5.65	4.50	AM29760DC	6.00	5.60
AM2906PC	11.20	8.95	AM2917APC	7.15	6.20	AM29704PC	15.75	12.60	AM29761DC	6.80	5.50
AM2907PC	7.15	6.20	AM2918PC	5.40	4.32	AM29705PC	15.75	12.60	AM29803DC	7.65	5.95
AM2909PC	8.95	7.15	AM2922PC	5.78	4.93	AM29720PC	5.00	4.20	AM29811DC	4.85	3.90
AM2911PC	5.95	4.75									

BI-POLAR MEMORY

AM27L500PC	\$ 5.00	\$ 4.20	AM27L508DC	\$ 4.50	\$ 3.60	P3101	\$ 4.40	\$ 3.50	MM6561N	\$ 4.40	\$ 3.50
AM27L501PC	5.00	4.20	AM27L509DC	4.50	3.60	P3101A	4.40	3.70	DM5599N	3.00	2.50
AM27L502PC	5.65	4.50	AM27L510DC	6.80	5.50	IM5501CPE	4.40	3.60	82523PC	4.75	2.00
AM27L503PC	5.65	4.50	AM27L511DC	6.80	5.50	MM6560N	4.40	3.50	93403PC	5.25	4.20

SILICON GATE MOS LSI

MK1002L	\$ 7.00	\$ 6.00	P3111	\$ 2.50	\$ 2.00	AM2806HC	\$ 7.00	\$ 5.60	C4702A	\$18.30	\$13.85
P1101A	4.08	3.25	P2111-1	2.50	2.00	AM2807PC	5.02	4.02	MM5025N	44.00	33.60
1402APC	4.42	2.75	P2112	2.50	2.00	AM2808PC	5.02	4.02	MM5026N	44.00	35.20
1403APC	4.42	2.90	P2112-2	3.70	3.00	AM2809PC	3.52	2.82	MM5027N	40.80	33.60
1404APC	4.42	2.75	P2401	24.00	17.55	AM2857PC	7.15	5.75	MM5055N	7.15	5.75
1405A	5.80	4.25	P2405	10.85	7.90	AM2896PC	5.00	4.50	MM5056N	7.15	5.75
1406	10.20	8.40	P250K	7.30	3.56	TMS3114NC	9.96	7.32	MM5057N	7.15	5.75
1407	10.20	8.40	P2512K	4.30	4.05	TMS3133NC	10.85	8.25	MM5058N	18.85	8.70
1506	4.05	3.24	P2521V	2.65	2.55	3341AFC	8.25	6.55	P8080A	10.60	15.85
1507	4.05	3.24	P2521V	2.65	2.55	3342AFC	8.25	6.55	93402APC	18.60	15.05
C1702A	18.30	13.85	P2535V	3.65	3.55	MM4025D	73.00	58.40	P8101	2.95	2.40
P2101	2.95	2.40	P2537V	4.90	4.02	MM4026D	73.00	58.40	P8102	2.90	1.80
P2101-1	4.20	3.40	P2602B	4.10	3.85	MM4027D	75.00	60.00	P8111	2.50	2.00
P2101-2	4.20	3.40	AM2802PC	4.42	2.75	MM4055D	16.00	12.80	P8251	12.50	11.50
P2101A	4.74	3.85	AM2803PC	4.42	2.75	MM4056H	11.50	9.20	P8255	12.50	11.50
P2101A-2	5.50	4.40	AM2804PC	4.42	2.75	MM4057D	16.00	12.80	8C702A	18.30	13.85
P2102	2.30	1.80	AM2805HC	3.70	3.56	MM4102P	21.60	18.00	AM9401P	16.88	13.50
P2102-1	3.45	2.80									

ALWAYS FIRST QUALITY COMPONENTS

ANCRONA INFORMATION NO. 101

Contains 236 pages of data, applications and cross reference information.

ONLY \$4.95

2N TRANSISTORS		7N TRANSISTORS		4N TRANSISTORS		2N TRANSISTORS		3N TRANSISTORS	
2N508A	80	2N2904A	36	2N3646	50	2N4921	60	2N5306	34
2N697	26	2N2905A	36	2N3646	22	2N4937	66	2N5306	26
2N698	80	2N2906A	36	2N3704	18	2N4937	66	2N5309	30
2N706	35	2N2906	20	2N3704	18	2N4963	110	2N5312	60
2N711	49	2N2906A	21	2N3707	18	2N4963	110	2N5321	60
2N718	40	2N2907A	28	2N3707	18	2N4968	120	2N5322	70
2N818	40	2N2924	20	2N3710	20	2N4968	120	2N5324	34
2N930	28	2N2926	15	2N3712	20	2N4974	30	2N5335	38
2N932	28	2N2926	15	2N3712	20	2N4974	30	2N5335	38
2N933	32	2N2926	15	2N3712	20	2N4974	30	2N5335	38
2N934	32	2N2926	15	2N3712	20	2N4974	30	2N5335	38
2N935	32	2N2926	15	2N3712	20	2N4974	30	2N5335	38
2N936	32	2N2926	15	2N3712	20	2N4974	30	2N5335	38
2N937	32	2N2926	15	2N3712	20	2N4974	30	2N5335	38
2N938	32	2N2926	15	2N3712	20	2N4974	30	2N5335	38
2N939	32	2N2926	15	2N3712	20	2N4974	30	2N5335	38
2N940	32	2N2926	15	2N3712	20	2N4974	30	2N5335	38
2N941	32	2N2926	15	2N3712	20	2N4974	30	2N5335	38
2N942	32	2N2926	15	2N3712	20	2N4974	30	2N5335	38
2N943	32	2N2926	15	2N3712	20	2N4974	30	2N5335	38
2N944	32	2N2926	15	2N3712	20	2N4974	30	2N5335	38
2N945	32	2N2926	15	2N3712	20	2N4974	30	2N5335	38
2N946	32	2N2926	15	2N3712	20	2N4974	30	2N5335	38
2N947	32	2N2926	15	2N3712	20	2N4974	30	2N5335	38
2N948	32	2N2926	15	2N3712	20	2N4974	30	2N5335	38
2N949	32	2N2926	15	2N3712	20	2N4974	30	2N5335	38
2N950	32	2N2926	15	2N3712	20	2N4974	30	2N5335	38

★ E-Z-HOOK ★

E-Z Hooks have been designed and field tested through the industry to save time and money in commercial electronic production and servicing. The spring-loaded hook attaches firmly, yet so gently it will not damage component — frees hands while testing. Durably constructed and fully insulated to a single contact point assuring true readings. Meets exacting laboratory and space age computer technology requirements. AVAILABLE IN 10 RETMA COLORS: Red, black, blue, green, orange, yellow, white, violet, brown or gray.

MICRO HOOK



XM Micro Hook (1.75" long < 1 gram) for difficult IC Testing. Permits hookups to delicate wires where weight and leverage may damage component. \$.85 ea
Specify color. ORDER P/N XM

Jumper with XM Micro Hooks

Order No.	Length	Price
204XM-12"	12"	\$1.80
204XM-24"	24"	\$1.80

Specify color.

XM-S MICRO HOOK SET (Includes 1 ea. red, black, blue, green, orange, yellow, white, brown, violet and gray Micro Hook). At this low price you can afford more than one set.

COMPLETE SET (10) MICRO HOOKS \$8.45

MINI HOOK



X100W Mini Hook (2.25" long) combines rugged construction, miniature size and Finger-eze Hypo Action for all the best test connections. Hook is large enough for component leads, yet small enough to get into tight places. \$.80 ea
Specify color. ORDER P/N X100W

Jumper with X-100W Mini Hooks

Order No.	Length	Price
204-12W	12"	\$1.70
204-24W	24"	\$1.70

Specify color.

Jumper X-100W Mini Hook to Stacking Banana Plug

Order No.	Length	Price
201W	32"	\$1.45

Specify color.

Jumper with X-100W Mini Hook

Order No.	Length	Price
201XM	32"	\$1.50

EXTRA LONG MINI HOOK

XL-1 Mini Hook (5.0" long) combines all the proven features of the X100W with an extra long body. It will make safe, short-free test connections in card racks and through deep wiring nest up to 4" . . . ORDER P/N XL-1



Specify color. \$1.30

JUMPER, XL-1 MINI HOOK TO STACKING BANANA PLUG



Order No.	Length	Price
201XL-1	32"	\$2.05

Specify color.

RCA COSMAC MICROPROCESSOR Integrated Circuits

Part No.	Description	Price
COP1824CD	32 x 8 Static CMOS Ram	\$7.75
COP1852CD	Byte I/O Port	8.25
COP1821CD	1024 x 1 Static CMOS Ram	14.75
COP1822CD	256 x 4 Static CMOS Ram	15.50
COP1857CD	Bus Separator/Buffer (Memory)	5.50
COP1857CD	Bus Separator/Buffer (I/O)	5.50

KIM-1 MICROCOMPUTOR

KIM-1—Computer Module from MOS Technology. 1K RAM, 2K ROM containing system executive, complete audio cassette interface, 15 bidirectional I/O lines, a 24 key keyboard and a six-digit LED display.

Documentation—KIM-1 Users Manual 6500 Hardware Manual, and 6500 Programming Manual.

Fully Assembled	Only
Fully Tested	\$245.00

Sanken Series SI-1000G amplifiers are self-contained power hybrid amplifiers designed for Hi-Fi, stereo, musical instruments, public address systems and other audio applications. The amplifiers have quasi-complementary class B output. The circuit employs flip-chip transistors with high reliability and passivated chip power transistors with excellent secondary breakdown strength. Built-in current limiting is provided for SI-1050G and all devices can be operated from a single or split power supply.

SI-1010G (10W output) . . . \$ 6.90
SI-1020G (20W output) . . . \$13.95
SI-1030G (30W output) . . . \$19.00
SI-1050G (50W output) . . . \$27.80

Data Sheet with Application Notes — \$0.50

QUITE PORTABLE VERY AFFORDABLE AND UNBELIEVABLY VERSATILE

the PET computer may very well be a lifetime investment



PET MODEL 2001

PET MODEL 2001

\$595.00 with 4K RAM
\$795.00 with 8K RAM

SPECIFICATIONS
 DIMENSIONS: LWD 18-1/2" x 16-1/2" x 14"
 WEIGHT: 44 lbs.

MEMORY
 RAM (user) 4K (8K OPT) exp to 32K
 ROM (resident operating system) 14K
 8K BASIC interpreter
 4K Operating system
 1K Diagnostic routine
 1K Machine language monitor

VIDEO DISPLAY UNIT
 9" b/w high resolution CRT • 1000 char display 40 col by 25 lines • 8x8 dot matrix for characters and continuous graphics • Auto scrolling from bottom of screen • Winking cursor with full motion control • Reverse field on all characters • 64 standard ASCU char; 64 graphic char.

KEYBOARD
 9 1/2" wide x 3" deep; 73 keys • All 64 ASCU characters available without shift • Calculator style numeric keypad • All 64 graphic and reverse field characters accessible from keyboard (with shift) Screen: Control clear and erase • Editing: Character insertion and deletion

CASSETTE STORAGE
 Fast redundant recording scheme assuring reliable data recovery • Modified drive for higher reliability of recording and record retention • High noise immunity, error detection and correction • Just standard audio cassette tapes • Tape files named.

OPERATING SYSTEM
 Supports multiple languages • Machine language accessibility • File management in operating system • Cursor control, reverse field and graphics under simple BASIC control • Cassette file management from BASIC • True random number generation of pseudo random sequence.

INPUT/OUTPUT
 All other I/O supported through IEEE-488 instrument interface which allows for multiple intelligent peripherals • All I/O automatically managed by operating system software • Single character I/O with GET command • Easy screen line/col capability • Flexible I/O structure allows for BASIC expansion with intelligent peripherals.

BASIC INTERPRETER
 Expanded BASIC • Upward expansion from current popular BASIC language • Strings, integers and multidim arrays • High-precision 110 significant digit • Direct memory access through PEEK and POKE commands

ALLOW 60 TO 90 DAYS DELIVERY

INTERASIL 8038 PRECISION WAVEFORM GENERATOR AND VCO

For simultaneous sine, square and triangular waveforms 001 Hz to 1 MHz.

PART NO. 8038CCPD \$4.20

AUDIO POWER AMPLIFIERS 5.5 WATT AN315

Designed for mobile radios, tape players, etc. Easy to use. High Gain — 53 dB (Closed Circuit). \$3.90 ea.

CAPACITORS

50V CERAMIC DISC \$1.00 Per Package

5pF 9/pkg	300pF 7/pkg	.0047mfd 9/pkg
15pF 9/pkg	330pF 7/pkg	.005mfd 9/pkg
25pF 9/pkg	390pF 7/pkg	.01mfd 9/pkg
27pF 9/pkg	470pF 7/pkg	.015mfd 8/pkg
47pF 8/pkg	560pF 7/pkg	.02mfd 8/pkg
68pF 8/pkg	680pF 7/pkg	.022mfd 8/pkg
100pF 8/pkg	.001mfd 9/pkg	.03mfd 8/pkg
150pF 8/pkg	.0015mfd 9/pkg	.039mfd 7/pkg
220pF 8/pkg	.0022mfd 9/pkg	.047mfd 7/pkg
270pF 7/pkg	.003mfd 9/pkg	.1mfd 6/pkg

PLESSEY POLYESTER MINI BOX

MF	V	S	MF	V	S	MF	V	S
001	1000	14	.012	630	14	.15	100	20
0012	1000	14	.015	400	15	.18	100	21
0015	1000	14	.018	400	15	.22	100	23
0018	1000	14	.022	400	15	.27	100	26
0022	1000	14	.027	400	15	.33	100	30
0027	1000	14	.033	250	15	.39	100	33
0033	1000	14	.039	250	15	.47	100	36
0039	630	14	.047	250	15	.56	100	44
0047	630	14	.056	250	15	.68	100	47
0056	630	14	.068	250	15	.82	100	54
0068	630	14	.082	250	17	1.0	100	60
0082	630	14	1.0	100	17			
01	630	14	12	100	18			

MATSUO DIPPED TANTALUM

MF	V	S	MF	V	S	MF	V	S
1	35	.33	2.2	20	.33	10.0	35	.90
15	35	.33	2.2	35	.40	15.0	20	.45
22	35	.33	3.3	35	.42	15.0	35	1.32
33	35	.33	4.7	35	.45	22.0	15	.45
47	35	.33	6.8	16	.40	33.0	20	1.32
68	35	.33	6.8	35	.45	47.0	20	1.53
1.0	35	.33	10.0	16	.42	68.0	16	1.62
1.5	35	.40	10.0	25	.45			

1% MICA 500V

51 PF .29	220 PF .41	1500 PF .60
62 PF .29	240 PF .46	2000 PF .60
75 PF .29	300 PF .50	2200 PF .60
82 PF .29	390 PF .50	4700 PF 1.80
100 PF .30	470 PF .50	5100 PF 1.80
120 PF .32	620 PF .52	10000 PF 3.60
150 PF .35	820 PF .53	
180 PF .41	1000 PF .60	

Intersil 3 1/2 DIGIT PANEL METER

LCD or LED KITS

BUILD A WORKING DPM IN 1/2 HOUR WITH THESE COMPLETE EVALUATION KITS



Test these new parts for yourself with Intersil's low cost prototyping kits, complete with A/D converter and LCD display (for the 7106) or LED display (for the 7107). Kits provide all materials, including PC board, for a functioning panel meter.

ICL7106EV (LCD) \$29.95 **ICL7107 (LED) \$24.95**

RESISTOR KITS 5% CARBON FILM RESISTORS

COMPLETE WITH STORAGE BIN

1/4 WATT KIT
 42 Different Values (68Ω to 4.7 MΩ)
 20 Each Value

1/2 WATT KIT
 42 Different Values (68Ω to 4.7 MΩ)
 20 Each Value

1/4W — \$24.90 PER KIT
 1/2W — \$25.90 PER KIT

CARBON FILM RESISTORS (5%)

Only in Multiples of 100 pcs per value (ohms)

1/4W	1/2W	1.0K	10K	100K	1.0M
11	110	1.1K	11K	110K	1.1M
12	120	1.2K	12K	120K	1.2M
13	130	1.3K	13K	130K	1.3M
15	150	1.5K	15K	150K	1.5M
16	160	1.6K	16K	160K	1.6M
18	180	1.8K	18K	180K	1.8M
20	200	2.0K	20K	200K	2.0M
22	220	2.2K	22K	220K	2.2M
24	240	2.4K	24K	240K	2.4M
27	270	2.7K	27K	270K	2.7M
30	300	3.0K	30K	300K	3.0M
33	330	3.3K	33K	330K	3.3M
36	360	3.6K	36K	360K	3.6M
39	390	3.9K	39K	390K	3.9M
43	430	4.3K	43K	430K	4.3M
47	470	4.7K	47K	470K	4.7M
51	510	5.1K	51K	510K	5.1M
56	560	5.6K	56K	560K	5.6M
62	620	6.2K	62K	620K	6.2M
68	680	6.8K	68K	680K	6.8M
75	750	7.5K	75K	750K	7.5M
82	820	8.2K	82K	820K	8.2M
91	910	9.1K	91K	910K	9.1M

SGS-ATES — AUDIO POWER AMPLIFIER IC'S

TBA800	5 watt	\$1.95
TBA8105	7 watt	2.10
TBA810AS	7 watt	2.10
TB 820	2 watt	1.35
TBA8305	4.2 watt	1.95
TCA940	10 watt	3.30
TDA2002	8 watt	4.20
TDA2010	12W Hi-Fi	5.25
TDA2020	20W Hi-Fi	6.00

MM6040 C-MOS PLL — a single-chip phase-locked loop intended for use as a frequency synthesizer in CB transceivers and other communications equipment.

TO 220 VOLTAGE REGULATOR FROM FAIRCHILD

7805C	5V	7815C	15V
7806C	6V	7818C	18V
7812C	12V	7824C	24V

2 for \$1.20

HYBRID AUDIO POWER AMPLIFIERS

SOCKET FOR SANKEN AUDIO AMPLIFIERS

FOR 10 & 20 W	A-518	\$9.95
FOR 30 & 50 W	A-5110	\$9.95

DIP SOCKETS

Profile	1-24	25-49	50 UP
LOW PROFILE SOLDER TIN	8 Pin .16 .15 .14	14 Pin .19 .18 .17	16 Pin .21 .20 .19
	40 Pin .52 .51 .50		
STANDARD SOLDER GOLD	8 Pin .30 .27 .24	14 Pin .35 .32 .29	16 Pin .38 .35 .32
	40 Pin 1.75 1.59 1.45		
WIREWRAPE GOLD (Level No. 3)	14 Pin .39 .38 .37	16 Pin .43 .42 .41	

ANCRONA

Send Check or Money Order to: P.O. Box 2208P, Culver City, Calif. 90230. Calif. residents add 6% sales tax. Minimum Order \$10.00. ADD \$1.00 to cover postage and handling. Master Charge and BankAmericard welcomed (include your card number and exp. date).

TELEPHONE ORDERS: Call (213) 641-4064

VISIT ONE OF OUR STORES TODAY

ANCRONA STORES DO NOT ACCEPT MAIL OR TELEPHONE ORDERS

CALIFORNIA ANCRONA 11080 Jefferson Blvd. Culver City, CA 90230 (213) 390-3595	CALIFORNIA ANCRONA 1300 E. Edinger Ave. Santa Ana, CA 92705 (714) 547-8424	ARIZONA ANCRONA 4518 E. Broadway Tucson, AZ 85711 (602) 881-2348
OREGON ANCRONA 1125 N.E. 82nd Ave. Portland, OR 97220 (503) 254-5541	GEORGIA ANCRONA 3330 Piedmont Rd. NE Atlanta, GA 30305 (404) 261-7100	TEXAS ANCRONA 2649 Richmond Houston, TX 77098 (713) 529-3489

7400N TTL

SN7400N	16	SN7472N	39	SN74160N	1.25
SN7401N	18	SN7473N	39	SN74161N	.99
SN7402N	20	SN7474N	35	SN74162N	1.95
SN7403N	20	SN7475N	50	SN74163N	.99
SN7404N	20	SN7476N	35	SN74164N	.99
SN7405N	20	SN7477N	5.00	SN74165N	.99
SN7406N	35	SN7478N	5.00	SN74166N	1.25
SN7407N	35	SN7479N	.99	SN74167N	2.10
SN7408N	20	SN7480N	.70	SN74170N	2.10
SN7409N	25	SN7481N	2.00	SN74171N	2.10
SN7410N	20	SN7482N	.39	SN74172N	1.50
SN7411N	.30	SN7483N	3.50	SN74174N	1.25
SN7412N	25	SN7484N	2.49	SN74175N	3.25
SN7413N	.69	SN7485N	45	SN74176N	.79
SN7414N	.70	SN7486N	75	SN74177N	.79
SN7415N	35	SN7487N	75	SN74178N	2.49
SN7416N	35	SN7488N	.49	SN74179N	2.49
SN7417N	35	SN7489N	.79	SN74180N	.99
SN7418N	39	SN7490N	.79	SN74181N	2.49
SN7419N	.39	SN7491N	.79	SN74182N	.95
SN7420N	20	SN7492N	.79	SN74183N	1.95
SN7421N	.39	SN7493N	.30	SN74184N	1.95
SN7422N	.39	SN7494N	3.00	SN74185N	1.95
SN7423N	.37	SN7495N	1.25	SN74186N	15.00
SN7424N	20	SN7496N	1.25	SN74187N	3.00
SN7425N	37	SN7497N	3.00	SN74188N	.95
SN7426N	37	SN7498N	3.00	SN74189N	1.79
SN7427N	37	SN7499N	1.95	SN74190N	1.79
SN7428N	42	SN7500N	.39	SN74191N	1.79
SN7429N	42	SN7501N	.39	SN74192N	.69
SN7430N	.25	SN7502N	.39	SN74193N	.89
SN7431N	25	SN7503N	.39	SN74194N	1.25
SN7432N	.35	SN7504N	.60	SN74195N	.75
SN7433N	.35	SN7505N	1.25	SN74196N	1.00
SN7434N	.21	SN7506N	1.00	SN74197N	1.00
SN7435N	.89	SN7507N	1.15	SN74198N	1.75
SN7436N	.89	SN7508N	1.15	SN74199N	1.75
SN7437N	.75	SN7509N	2.95	SN74200N	3.95
SN7438N	.75	SN7510N	3.25	SN74201N	1.79
SN7439N	.25	SN7511N	1.79	SN74202N	.95
SN7440N	.75	SN7512N	1.00	SN74203N	.95
SN7441N	.89	SN7513N	1.15	SN74204N	.25
SN7442N	.89	SN7514N	2.35	SN74205N	2.25
SN7443N	.75	SN7515N	2.00	SN74206N	6.00
SN7444N	.75	SN7516N	1.25	SN74207N	6.00
SN7445N	.75	SN7517N	3.00	SN74208N	6.00
SN7446N	.89	SN7518N	1.15	SN74209N	.95
SN7447N	.89	SN7519N	2.35	SN74210N	2.25
SN7448N	.89	SN7520N	2.00	SN74211N	6.00
SN7449N	.89	SN7521N	1.25	SN74212N	6.00
SN7450N	.89	SN7522N	1.25	SN74213N	6.00
SN7451N	.25	SN7523N	1.25	SN74214N	6.00
SN7452N	.25	SN7524N	1.25	SN74215N	6.00
SN7453N	.25	SN7525N	1.25	SN74216N	6.00
SN7454N	.25	SN7526N	1.25	SN74217N	6.00
SN7455N	.25	SN7527N	1.25	SN74218N	6.00
SN7456N	.25	SN7528N	1.25	SN74219N	6.00
SN7457N	.25	SN7529N	1.25	SN74220N	6.00
SN7458N	.25	SN7530N	1.25	SN74221N	6.00
SN7459N	.25	SN7531N	1.25	SN74222N	6.00
SN7460N	.25	SN7532N	1.25	SN74223N	6.00
SN7461N	.25	SN7533N	1.25	SN74224N	6.00
SN7462N	.25	SN7534N	1.25	SN74225N	6.00
SN7463N	.25	SN7535N	1.25	SN74226N	6.00
SN7464N	.25	SN7536N	1.25	SN74227N	6.00
SN7465N	.25	SN7537N	1.25	SN74228N	6.00
SN7466N	.25	SN7538N	1.25	SN74229N	6.00
SN7467N	.25	SN7539N	1.25	SN74230N	6.00
SN7468N	.25	SN7540N	1.25	SN74231N	6.00
SN7469N	.25	SN7541N	1.25	SN74232N	6.00
SN7470N	.25	SN7542N	1.25	SN74233N	6.00
SN7471N	.25	SN7543N	1.25	SN74234N	6.00
SN7472N	.25	SN7544N	1.25	SN74235N	6.00
SN7473N	.25	SN7545N	1.25	SN74236N	6.00
SN7474N	.25	SN7546N	1.25	SN74237N	6.00
SN7475N	.25	SN7547N	1.25	SN74238N	6.00
SN7476N	.25	SN7548N	1.25	SN74239N	6.00
SN7477N	.25	SN7549N	1.25	SN74240N	6.00
SN7478N	.25	SN7550N	1.25	SN74241N	6.00
SN7479N	.25	SN7551N	1.25	SN74242N	6.00
SN7480N	.25	SN7552N	1.25	SN74243N	6.00
SN7481N	.25	SN7553N	1.25	SN74244N	6.00
SN7482N	.25	SN7554N	1.25	SN74245N	6.00
SN7483N	.25	SN7555N	1.25	SN74246N	6.00
SN7484N	.25	SN7556N	1.25	SN74247N	6.00
SN7485N	.25	SN7557N	1.25	SN74248N	6.00
SN7486N	.25	SN7558N	1.25	SN74249N	6.00
SN7487N	.25	SN7559N	1.25	SN74250N	6.00
SN7488N	.25	SN7560N	1.25	SN74251N	6.00
SN7489N	.25	SN7561N	1.25	SN74252N	6.00
SN7490N	.25	SN7562N	1.25	SN74253N	6.00
SN7491N	.25	SN7563N	1.25	SN74254N	6.00
SN7492N	.25	SN7564N	1.25	SN74255N	6.00
SN7493N	.25	SN7565N	1.25	SN74256N	6.00
SN7494N	.25	SN7566N	1.25	SN74257N	6.00
SN7495N	.25	SN7567N	1.25	SN74258N	6.00
SN7496N	.25	SN7568N	1.25	SN74259N	6.00
SN7497N	.25	SN7569N	1.25	SN74260N	6.00
SN7498N	.25	SN7570N	1.25	SN74261N	6.00
SN7499N	.25	SN7571N	1.25	SN74262N	6.00
SN7500N	.25	SN7572N	1.25	SN74263N	6.00

20% Discount for 100 Combined 7400's

CMOS

CD4000	23	CD4044	89	CD4020	1.29
CD4001	.23	CD4045	89	CD4021	1.50
CD4002	.23	CD4046	2.50	CD4022	1.50
CD4003	1.19	CD4047	1.35	CD4023	1.50
CD4004	.23	CD4048	1.35	CD4024	1.50
CD4005	.49	CD4049	1.35	CD4025	1.50
CD4006	.49	CD4050	1.35	CD4026	1.50
CD4007	.49	CD4051	1.19	CD4027	1.50
CD4008	.49	CD4052	1.19	CD4028	1.50
CD4009	.49	CD4053	1.19	CD4029	1.50
CD4010	.49	CD4054	1.19	CD4030	1.50
CD4011	.23	CD4055	1.19	CD4031	1.50
CD4012	.23	CD4056	1.19	CD4032	1.50
CD4013	.23	CD4057	1.19	CD4033	1.50
CD4014	.23	CD4058	1.19	CD4034	1.50
CD4015	1.19	CD4059	1.19	CD4035	1.50
CD4016	.49	CD4060	1.19	CD4036	1.50
CD4017	1.19	CD4061	1.19	CD4037	1.50
CD4018	.49	CD4062	1.19	CD4038	1.50
CD4019	.49	CD4063	1.19	CD4039	1.50
CD4020	1.19	CD4064	1.19	CD4040	1.50
CD4021	1.19	CD4065	1.19	CD4041	1.50
CD4022	1.19	CD4066	1.19	CD4042	1.50
CD4023	1.19	CD4067	1.19	CD4043	1.50
CD4024	.23	CD4068	1.19	CD4044	1.50
CD4025	.23	CD4069	1.19	CD4045	1.50
CD4026	.23	CD4070	1.19	CD4046	1.50
CD4027	.23	CD4071	1.19	CD4047	1.50
CD4028	.23	CD4072	1.19	CD4048	1.50
CD4029	.23	CD4073	1.19	CD4049	1.50
CD4030	.23	CD4074	1.19	CD4050	1.50
CD4031	.23	CD4075	1.19	CD4051	1.50
CD4032	.23	CD4076	1.19	CD4052	1.50
CD4033	.23	CD4077	1.19	CD4053	1.50
CD4034	.23	CD4078	1.19	CD4054	1.50
CD4035	.23	CD4079	1.19	CD4055	1.50
CD4036	.23	CD4080	1.19	CD4056	1.50
CD4037	.23	CD4081	1.19	CD4057	1.50
CD4038	.23	CD4082	1.19	CD4058	1.50
CD4039	.23	CD4083	1.19	CD4059	1.50
CD4040	.23	CD4084	1.19	CD4060	1.50
CD4041	.23	CD4085	1.19	CD4061	1.50
CD4042	.23	CD4086	1.19	CD4062	1.50
CD4043	.23	CD4087	1.19	CD4063	1.50
CD4044	.23	CD4088	1.19	CD4064	1.50
CD4045	.23	CD4089	1.19	CD4065	1.50
CD4046	.23	CD4090	1.19	CD4066	1.50
CD4047	.23	CD4091	1.19	CD4067	1.50
CD4048	.23	CD4092	1.19	CD4068	1.50
CD4049	.23	CD4093	1.19	CD4069	1.50
CD4050	.23	CD4094	1.19	CD4070	1.50
CD4051	.23	CD4095	1.19	CD4071	1.50
CD4052	.23	CD4096	1.19	CD4072	1.50
CD4053	.23	CD4097	1.19	CD4073	1.50
CD4054	.23	CD4098	1.19	CD4074	1.50
CD4055	.23	CD4099	1.19	CD4075	1.50
CD4056	.23	CD4100	1.19	CD4076	1.50
CD4057	.23	CD4101	1.19	CD4077	1.50
CD4058	.23	CD4102	1.19	CD4078	1.50
CD4059	.23	CD4103	1.19	CD4079	1.50
CD4060	.23	CD4104	1.19	CD4080	1.50
CD4061	.23	CD4105	1.19	CD4081	1.50
CD4062	.23	CD4106	1.19	CD4082	1.50
CD4063	.23	CD4107	1.19	CD4083	1.50
CD4064	.23	CD4108	1.19	CD4084	1.50
CD4065	.23	CD4109	1.19	CD4085	1.50
CD4066	.23	CD4110	1.19	CD4086	1.50
CD4067	.23	CD4111	1.19	CD4087	1.50
CD4068	.23	CD4112	1.19	CD4088	1.50
CD4069	.23	CD4113	1.19	CD4089	1.50
CD4070	.23	CD4114	1.19	CD4090	1.50
CD4071	.23	CD4115	1.19	CD4091	1.50
CD4072	.23	CD4116	1.19	CD4092	1.50
CD4073	.23	CD4117	1.19	CD4093	1.50
CD4074	.23	CD4118	1.19	CD4094	1.50
CD4075	.23	CD4119	1.19	CD4095	1.50
CD4076	.23	CD4120	1.19	CD4096	1.50
CD4077	.23	CD4121	1.19	CD4097	1.50
CD4078	.23	CD4122	1.19	CD4098	1.50
CD4079	.23	CD4123	1.19	CD4099	1.50
CD4080	.23	CD4124	1.19	CD4100	1.50
CD4081	.23	CD4125	1.19	CD4101	1.50
CD4082	.23	CD4126	1.19	CD4102	1.50
CD4083	.23	CD4127	1.19	CD4103	1.50
CD4084	.23	CD4128	1.19	CD4104	1.50
CD4085	.23	CD4129	1.19	CD4105	1.50
CD4086	.23	CD4130	1.19	CD4106	1.50
CD4087	.23	CD4131	1.19	CD4107	1.50
CD4088	.23	CD4132	1.19	CD4108	1.50
CD4089	.23	CD4133	1.19	CD4109	1.50
CD4090	.23	CD4134	1.19	CD4110	1.50
CD4091	.23	CD4135	1.19	CD4111	1.50
CD4092	.23	CD4136	1.19	CD4112	1.50
CD4093	.23	CD4137	1.19	CD4113	1.50
CD4094	.23	CD4138	1.19	CD4114	1.50
CD4095	.23	CD4139	1.19	CD4115	1.50
CD4096					

The Incredible "Pennywhistle 103"

\$129.95 Kit Only

The Pennywhistle 103 is capable of recording data to and from audio tape without precise speed requirements for the recorder and it is able to communicate directly with another modern and terminal for telephone "hacking" and communications for the deaf. In addition, it is free of critical adjustments and is built with non-precision, readily available parts.

Data Transmission Method Frequency-Shift Keying, full-duplex (half-duplex selectable)

Maximum Data Rate 300 Baud

Data Format Asynchronous Serial (return to mark level required between each character)

Receive Channel Frequencies 2225 Hz for mark, 2275 Hz for space, 1070 space, 1270 mark, High - 025 space, 2225 mark

Transmit Sensitivity 46 dbm acoustically coupled

Transmit Level 15 dbm nominal, Adjustable from -6 dbm to +26 dbm

Receive Frequency Tolerance Frequency reference automatically adjusts to allow for operation between 1800 Hz and 2400 Hz

Optical Data Interface EIA RS-232C or 20 mA current loop (receiver is optoisolated and non-polar)

Power Requirements 120 VAC, single phase, 10 Watts

Physical All components mount on a single 5" by 9" printed circuit board. All components included.

Requires a VOM, Audio Oscillator, Frequency Counter and/or Oscilloscope to align

AM/FM 8-Track Stereo Receiver

With BSR Changer

Model 8365 \$149.95

- PLL System
- BSR Record Changer
- Side Controls
- Automatic AFC Control
- 4 Speaker Output
- Walnut finish vinyl covered wood veneer with smoke dust cover
- Size: 20" W x 9 1/4" H x 15 1/4" D

DIGITAL STOPWATCH

Model 8365 \$149.95

- Bright 6 Digit LED Display
- Times to 99 minutes 59.99 seconds
- Crystal Controlled Time Base
- Three Stopwatches on One
- Times Single Event - Split & Tailor
- Size 4.5" x 2.15" x .90" (4 1/4 ounces)
- Uses 3 Penrite Cells

Kit — \$39.95
Assembled — \$49.95
Heavy Duty Carry Case \$5.95

3 1/2 DIGIT DPM KIT

Model KB500 DPM Kit \$49.00
Model 311D-5C-5V Power Kit \$17.50

- New Bipolar Unit
- Auto Zeroing
- .5" LED
- Auto Polarity
- Low Power
- Single IC Unit

JE700 CLOCK

115 VAC KIT ONLY \$16.95

The JE700 is a low cost digital clock, but it is a very high quality unit. The unit features a simulated walnut case with dimensions of 6" x 2 1/2" x 1 1/2". It utilizes a MAN72 high brightness readout and the MM5313 clock chip.

HEXADECIMAL ENCODER 19-KEY PAD

\$10.95 each

- 10
- ABCDEF
- Shift Key
- 2 Optional Keys

INSTRUMENT/CLOCK CASE

\$3.95 ea.

Injection molded unit. Complete with red bezel. 4 1/2" x 4" x 1 1/8" H.

JE803 PROBE

\$9.95 Per Kit

The Logic Probe is a unit which is for the most part indispensable in trouble shooting logic families TTL, DTL, RTL, CMOS. It drives the power it needs to operate directly off of the circuit under test drawing a scant 10 mA max. It uses a MAN72 readout to indicate any of the following states: these symbols (H) (L) (LOW) (PULSE) (P) The Probe can detect high frequency pulses to 45 MHz it can't be used at MOS levels or circuit damage will result.

T-L 5V 1A Supply

\$9.95 Per Kit

This is a standard TTL power supply using the well known LM309 regulator IC to provide a solid 1 AMP of current at 5 volts. We try to make things easy for you by providing everything you need to make things, including the hardware for only

MICROPROCESSOR COMPONENTS

8080A CPU	\$16.00	CDP1802 CPU	\$19.95
8212 8 Bit Input/Output	4.95	MC6800 8 Bit MPU	24.95
8214 Priority Interrupt Control	15.95	MC6820 Periph. Interface Adapter	15.00
8216 Bi-Directional Bus Driver	6.95	MC6810A1 128 x 8 Static RAM	6.00
8224 Clock Generator/Driver	9.95	MC6830L8 1024 x 8 Bit ROM	15.00
8228 System Controller Bus Driver	10.95	280 CPU	29.95

CPU'S		RAM'S	
8080A Super 8008	16.00	1101 256 x 1	Static 5.149
2650 8 Bit MPU	26.50	2101 256 x 4	Static 5.95
98085 CPU	28.95	2102 1024 x 1	Static 1.75
SR'S		2107 5280	4096 x 1 Dynamic 4.95
2504 1024 Dynamic	3.95	2111 256 x 1	Static 6.95
2518 Hex 32 BIT	7.00	7489 16 x 4	Static 2.99
2519 Hex 40 BIT	7.00	8101 256 x 4	Static 5.95
2522 Dual 132 Bit SSR	4.00	8111 256 x 3	Static 6.95
2524 512 Dynamic	2.95	8599 16 x 4	Static 3.49
2525 1024 Dynamic	1.95	2102/91102	1024 x 1 Static 2.25
2527 Dual 256 BIT	3.95	2400 256 x 1	Static 6.95
2529 Dual 512 BIT	4.00	93421 256 x 1	Static 7.95
2532 Quat 80 BIT	3.95	MM5355 2K x 1	Dynamic 16 Pin 2 for 1.95
2533 1024 Static	5.95	UPD4142104K	8K x 1 Static 5.95
3341 Frio	6.95	PROMS	
7415670 16 + 1 J REG	3.95	17024 2048	Famos \$ 9.95
UART'S		5203 2048	Famos 14.95
AY-5-1013 30k Baud	\$5.95	82523 32 x 8	Open C 5.00
ROM'S		82513 32 x 8	Tri-state 5.00
2513Q2140 Char Gen. upper case	\$ 9.95	745287 1024	Static 7.95
2513Q2011 Char Gen. lower case	\$ 9.95	3601 256 x 4	Static 3.95
2516 Char Gen.	10.95	1770 8K	Static 13.95
MM5230 2048 BIT (512 x 4 on 256 x 8)	1.95	6301-1 16K	Erom 34.95
SPECIAL REQUESTED ITEMS		5301-1 1024	Tn-State Bipolar 3.49
FCM3817 \$5.00	11C90 19.95	6330-1 256	Open Collector Bipolar 2.95
AY-3-8500-1 8.95	4M3 3.95	CLOCK CHIPS	
AY-5-9100 17.50	8720 7.50	MM5300	\$9.95
AY-5-9200 14.95	8797 2.00	MM5311	4.95
AY-5-9500 4.95	HD0165 7.50	MM5312	9.95
AY-5-2378 10.95	MCM6571 13.50	MM5313	9.95
9374 1.55	MCM6574 13.50	MM5381	2.95
825115 25.00	MCM6575 13.50	MM584	9.95
	TIL308 10.50	CT7001	5.95

PARATRONICS

Featured on February's Front Cover of Popular Electronics

Logic Analyzer Kit Model 100A \$229.00/kit

Model 100A assembled \$295.00

- Analyzes any type of digital system
- Checks data rates in excess of 8 million words per second
- Trouble shoot TTL, CMOS, DTL, RTL, Schottky and MOS families
- Displays 16 logic states up to 8 digits wide
- See ones and zeros displayed on your CRT, octal or hexadecimal format
- Tests circuits under actual operating conditions
- Easy to assemble — comes with step-by-step construction manual which includes 80 pages on logic analyzer operation.

(Model 100A Manual - \$4.95)

PARATRONICS TRIGGER EXPANDER - Model 10

Model 10 Kit — \$229.00
Model 10 Assembled — \$295.00
Baseplate — \$9.95
Model 10 Manual — \$4.95

Model 100A Manual — \$4.95

100 MHz 8-Digit Counter

MAX-100 \$134.95

- 20 Hz-100 MHz Range
- 7 LED Display
- Crystal-controlled timebase
- Fully Automatic
- Portable — completely self-contained
- Size — 1.75" x 7.38" x 5.63"

Four power sources, i.e., 2x AA cells, 9V battery, 110 or 220V with charger, 12V with auto lighter adapter and external 7.2-10V power supply

Accessories for MAX 100: Mobile Charger Eliminator \$9.95, Charger/Eliminator \$11.00, Model 100 — CLA \$9.95, Model 100 — CAI \$9.95

CONTINENTAL SPECIALTIES

PROTO CLIPS

14 PIN	\$4.50
16 PIN	4.75
24 PIN	8.50
40 PIN	13.75

DESIGN MATES

DM1 - Circuit Designer	\$69.95
DM2 - Function Generator	\$74.95
DM3 - RC Bridge	\$74.95

Other CS Proto Boards

PB100 - 4.5" x 6"	\$ 9.95
PB101 - 5.8" x 4.5"	29.95
PB102 - 7" x 4.5"	39.95
PB103 - 9" x 6"	59.95
PB104 - 9.5" x 8"	79.95
PB203 - 9.75 x 6 1/2 x 2 3/4	80.00
PB203A - 9.75 x 6 1/2 x 2 3/4	129.95 (includes power supply)

LOGIC MONITOR for DTL, HTL, TTL or CMOS Devices \$84.95

CS QT PROTO STRIPS

OT-595	OT-595
OT-596	OT-185
OT-475	OT-125
OT-478	OT-85
OT-355	OT-75
OT-358	

OT type / #holes / price

OT-595	590	12.50
OT-596	590	7.50
OT-475	470	10.00
OT-478	470	2.25
OT-355	350	8.50
OT-358	350	7.00
OT-185	180	4.75
OT-125	120	3.75
OT-85	80	4.75
OT-75	70	3.00

Experimenter 300 \$ 9.95
Experimenter 600 \$10.95

\$5.00 Minimum Order — U.S. Funds Only
California Residents — Add 6% Sales Tax

Spec Sheets - 25¢ — Send 35¢ Stamp for 1978 Catalog Dealer Information Available

James ELECTRONICS

1021-A HOWARD AVE., SAN CARLOS, CA. 94070
PHONE ORDERS WELCOME — (415) 592-8097
All Advertised Prices Good Thru January

1978 CATALOG NOW AVAILABLE

BREAD BOARD JUMPER WIRE KIT

Each kit contains 350 wires cut to 14 different lengths from 0.1" to 5.0". Each wire is stripped and the leads are bent 90° for easy insertion. Wire length is classified by color coding. All wire is solid tinned 22 gauge with PVC insulation. The wires come packed in a convenient plastic box.

JK1 ... \$10.00 / kit

SOCKET JUMPERS

Mates with two rows of .025" sq. or dia. posts on patterns of 100° centers and shielded receptacles. Probe access holes in back. Choice of 6" or 18" length.

Part No.	No. of Contacts	Length	Price
924003-18R	26	18"	\$ 5.38 ea.
924003-6R	26	6"	4.78 ea.
924005-18R	40	18"	8.27 ea.
924005-6R	40	6"	7.33 ea.
924006-18R	50	18"	10.31 ea.
924006-6R	50	6"	9.15 ea.

JUMPER HEADERS

Solder to PC boards for instant plug-in access via socket-conductor jumpers. .025" sq. posts. Choice of straight or right angle.

Part No.	No. of Posts	Angle	Price
923863-R	26	straight	\$1.28 ea.
923873-R	26	right angle	1.52 ea.
923865-R	40	straight	1.94 ea.
923875-R	40	right angle	2.30 ea.
923866-R	50	straight	2.36 ea.
923876-R	50	right angle	2.82 ea.

INTRA-CONNECTOR

Provides both straight and right angle functions. Mates with standard .10" x .10" dual row connectors (i.e., 3m, Amnisey, etc.) Permits quick testing of inaccessible lines.

Part No.: 922576-26 No. of contacts: 26 Price \$6.90 ea.

INTRA-SWITCH

Permits instant line-by-line switching for diagnostic or OA testing. Switches actuated with pencil or probe tip. Mates with standard .10" x .10" dual-row connectors. Low profile design. Switch buttons recessed to eliminate accidental switching.

Part No.: IS-26 No. of contacts: 26 Price \$13.80 ea.

CRYSTALS

Part #	Frequency	Case/Style	Price
CV1A	1.000 MHz	HC33 U	\$5.95
CV2A	2.000 MHz	HC33U	\$5.95
CV2 D1	2.010 MHz	HC33U	\$1.95
CV3A	4.000 MHz	HC18U	\$4.95
CV7A	5.000 MHz	HC18U	\$4.95
CV12A	10.000 MHz	HC18U	\$4.95
CV14A	14.318 MHz	HC18U	\$4.95
CV19A	18.000 MHz	HC18U	\$4.95
CV22A	20.000 MHz	HC18U	\$4.95
CV30B	32.000 MHz	HC18U	\$4.95

CONNECTORS PRINTED CIRCUIT EDGE-CARD

156 Spacing-Tin-Double Read-Out

Bifurcated Contacts — Fits 054 to 070 P.C. Cards

15/30	PINS (Solder Eyelet)	\$1.95
18/36	PINS (Solder Eyelet)	\$2.49
22/44	PINS (Solder Eyelet)	\$2.95
50/100	PINS (Wire Wrap)	\$6.95
50/100A (.100 Spacing)	PINS (Wire Wrap)	\$6.95

25 PIN-D SUBMINATURE (RS232)

DB25P	PLUG	\$3.25
DB25S	SOCKET	\$4.95

HEAT SINKS

205-CB Beryllium Copper w-black finish for TO-5 \$ 2.25

291-36H Aluminum for TO-220 Transistors & Regulators \$ 2.25

680-75A Black Anodized Aluminum for TO-3 \$1.60

Dude 4 Black Anodized Aluminum — predrilled mounting holes for TO-3 — 4 1/4 x 1 1/4 x 2" \$1.75

Etch Kits

(cannot be shipped via air)

32 X A-1	P.C. Etch Materials Kit enough for 5 circuit boards	\$29.95 ea.
27 X A-1	Etched Circuit Kit	\$ 9.95 ea.

Plugboards

3662	5.5 X 4.5 x 1/16 Epoxy glass P-Pattern-44 P.C. Tabs spaced .155"	\$ 6.95 ea.
22144	Mating connector for plugboard — 22 pin double readout	\$ 2.95 ea.

88DOV Universal Microcomputer/Processor plugboard — Epoxy Glass — complete with heatsink and mounting hardware 5.313 X 10 X 1.16 copper clad \$19.95 ea.

1/16 VECTOR BOARD

Part No.	Holes	P-Pattern	Price
PHENOLIC	64P44 052X00P	4.50	6.50 1.72 1.54
	169P44 052X00K	4.50	17.00 3.69 3.32
EPDXY	64P44 062WE	4.50	6.50 2.07 1.86
GLASS	84P44 062WE	4.50	8.50 2.56 2.31
	169P44 062WE	4.50	17.00 5.04 4.53
	169P44 062WE	8.50	17.00 9.23 8.26
EPDXY GLASS	169P44 062WE1C	4.50	17.00 6.80 6.12

63 KEY KEYBOARD

This keyboard features 63 unenclosed SPST keys — unattached to any kind of P.C.B. A very solid molded plastic 13" x 4" base suits most applications.

HD0165 Encoder Chip (encodes 16 Keys)	\$7.95 ea.
AY-5-2376 Encoder Chip (encodes 88 Keys)	\$14.95 ea.

LOWEST PRICES ON PRIME TTL ICs

BASED ON OUR PLEDGE TO OFFER YOU THE LOWEST POSSIBLE PRICES ON PRIME TTL ICs. THIS MONTH WE HAVE REDUCED OUR ALREADY LOW PRICES, EVEN FURTHER, ON MANY ITEMS. HOWCOME? WE JUST NEGOTIATED A MULTI-MILLION UNIT CONTRACT FOR OUR INTERNATIONAL CUSTOMERS AND ARE HAPPY TO PASS ON THE SAVINGS TO YOU. AS ALWAYS, OF COURSE, WE GUARANTEE THAT

EVERY IC PURCHASED FROM US TO BE OF PRIME QUALITY AND WITH ORIGINAL MANUFACTURER'S FULL MARKING AND BRAND SYMBOL. NO RESETS, FUNCTIONAL ONLYS, OR FALLOUTS AT ICC. IN ADDITION, OUR VOLUME DISCOUNT SCHEDULE ALLOWS YOU TO MIX ALL YOUR REQUIREMENTS FOR EVEN GREATER SAVINGS.

7400\$ 14	747027	7416695	74LS0923	74LS13970	74LS38636	74S2571.15	74C1611.90
740115	747124	741673.20	74LS1021	74LS15165	74LS3931.65	74S2581.15	74C1621.90
740215	747224	741201.85	74LS1121	74LS15265	74LS4901.10	74S2802.25	74C1631.90
740315	747324	741211.10	74LS1227	74LS15366	74LS6702.29	74S2893.55	74C1642.95
740416	747425	7412285	74LS1340	74LS1541.00			74S3001.60	74C1652.95
740516	747525	7412375	74LS1485	74LS15562			74S3051.90	74C1731.60
740624	747629	7412469	74LS1526	74LS15662			74S3102.85	74C1741.95
740724	747729	7412570	74LS2023	74LS15762			74S3121.05	74C1751.95
740817	747827	741261.20	74LS2123	74LS15870			74S3131.55	74C1922.00
740917	747927	741271.20	74LS2223	74LS16082			74S3162.80	74C1932.25
741015	748024	7412865	74LS2631	74LS16182			74S3414.10	74C1952.25
741118	748131	7412975	74LS2726	74LS16282			74S3421.20	74C2008.25
741220	748240	7413075	74LS3023	74LS16382			74S3434.95	74C2212.00
741325	748350	7413175	74LS3230	74LS16498			74S3441.25	74C90196
741425	748450	741321.75	74LS3331	74LS16883			74S3622.15	74C90296
741522	748544	741332.80	74LS3831	74LS16983			74S3874.70	74C90396
741622	748644	7413495	74LS4026	74LS1701.60					74C90496
741722	748744	7413595	74LS4260	74LS1731.00					74C9056.80
741822	748844	7413675	74LS4775	74LS17475					74C90696
741922	748944	7413780	74LS4872	74LS17579					74C90796
742015	749040	7413880	74LS5125	74LS1812.50					74C9082.10
742115	749151	7413975	74LS5225	74LS19090					74C9093.95
742215	749240	7414049	74LS5425	74LS19190					74C9106.60
742325	749340	7414173	74LS5525	74LS19990					74C9181.90
742425	749440	7414273	74LS5735	74LS19290					74C9192.20
742525	749540	741431.30	74LS7435	74LS19390					74C9259.25
742622	749639	741441.30	74LS7637	74LS19485					74C9269.25
742719	749733	741451.00	74LS7836	74LS19550					74C9279.25
742823	749838	7414675	74LS8375	74LS19680					74C9289.25
742921	749935	741471.00	74LS851.30	74LS19780						
743021	750035	7414859	74LS8636	74LS2211.05						
743125	750159	7414957	74LS9050	74LS25180						
743223	750251	7415092	74LS9250	74LS25380						
743321	750349	7415162	74LS9350	74LS25770						
743425	750459	7415262	74LS9585	74LS25870						
743555	750579	7415362	74LS10735	74LS2591.60						
743655	750679	7415495	74LS10935	74LS26034						
743762	750765	7415595	74LS11235	74LS26626						
743862	750865	7415665	74LS11335	74LS27952						
743967	750972	7415765	74LS11435	74LS28372						
744015	751059	7415821	74LS12390	74LS29060						
744115	751159	7415921	74LS12546	74LS29590						
744215	751259	7416021	74LS12646	74LS29890						
744315	751359	7416121	74LS13272	74LS36552						
744415	751459	7416224	74LS13334	74LS36652						
744515	751559	7416324	74LS13635	74LS36752						
744615	751659	7416424	74LS13870	74LS36852						
744715	751759	7416524										

74S3121.05	74C17665	74LS19890	74S3131.55	74C1821.90	74S3162.80	74C1831.90
74S3162.80	74C1841.50	74S31785	74S31875	74C1842.95	74S3414.10	74C1851.90
74S3414.10	74C1851.20	74S31985	74S3421.20	74C1861.45	74S3434.95	74C1861.45
74S3421.20	74C1861.45	74S32090	74S3441.25	74C1871.95	74S3622.15	74C1871.95
74S3434.95	74C1871.95	74S32185	74S3674.70	74C1881.95	74S3874.70	74C1881.95
74S3441.25	74C1881.95	74S32285	74S3874.70	74C1892.25			74C1892.25
74S3622.15	74C1892.25	74S32385			74C1908.25			74C1908.25
74S3674.70	74C1908.25	74S32485			74C1952.25			74C1952.25
74S3874.70	74C1952.25	74S32585			74C2008.25			74C2008.25
		74C2008.25	74S32685			74C2212.00			74C2212.00
		74C2212.00	74S32785			74C90196			74C90196
		74C90196	74S32885			74C90296			74C90296
		74C90296	74S32985			74C90396			74C90396
		74C90396	74S33085			74C90496			74C90496
		74C90496	74S33185			74C9056.80			74C9056.80
		74C9056.80	74S33285			74C90696			74C90696
		74C90696	74S33385			74C90796			74C90796
		74C90796	74S33485			74C9082.10			74C9082.10
		74C9082.10	74S33585			74C9093.95			74C9093.95
		74C9093.95	74S33685			74C9106.60			74C9106.60
		74C9106.60	74S33785			74C9181.90			74C9181.90
		74C9181.90	74S33885			74C9192.20			74C9192.20
		74C9192.20	74S33985			74C9259.25			74C9259.25
		74C9259.25	74S34085			74C9269.25			74C9269.25
		74C9269.25	74S34185			74C9279.25			74C9279.25
		74C9279.25	74S34285			74C9289.25			74C9289.25
		74C9289.25	74S34385								

VOLUME DISCOUNT SCHEDULE

Merchandise Total	Discount
\$ 0.00-\$ 9.99 NET
\$ 10.00-\$ 24.99 LESS 5%
\$ 25.00-\$ 99.99 LESS 10%
\$ 100.00-\$ 999.99 LESS 15%
\$ 500.00-\$ 999.99 LESS 20%
\$1000.00 and up LESS 25%

STANDARD SHIPPING CHARGES

If your merchandise total is between:

Amount	Shipping Charge
\$ 0.00-\$ 4.99 add \$2.00
\$ 5.00-\$ 24.99 add \$1.00
\$ 25.00-\$ 49.99 add \$0.75
\$ 50.00-\$ 99.99 add \$0.50
\$100.00 and up NO CHARGE

The above charges include shipping via First Class Mail or UPS (your choice), and insurance on all domestic shipments.

SPECIAL SHIPPING CHARGES

Service	Charge
COD \$1.00-additional
Air Mail \$1.00-additional
Postal Insurance \$1.00-additional
Special Delivery \$1.25-additional

INTERNATIONAL COMPONENTS CORP.

1208 Bowling Street
Columbia, MO 65201 (314) 874-1150

For prompt 24-hour shipment of your order, we are glad to accept your Mastercharge or VISA (BankAmericard). COD orders are also accepted for same day shipment.



ELECTRONICS Market Place

CIRCLE NO. 20 ON FREE INFORMATION CARD

UNIVERSAL 4Kx8 MEMORY BOARD KIT \$69.95

32,2102-1 fully buffered, 16 address lines, on board decoding for any 4 of 64 pages, standard 44 pin bus

EXPANDABLE F8 CPU BOARD KIT \$99.00

featuring Fairbug PSU 1K of static ram, RS 232 interface, documentation, 64 BYTE register

4K BASIC FOR FAIRBUG F8 on paper tape \$25.00

C/MOS (DIODE CLAMPED)

74C1022	401222	402322	40482.25
74C1931.50	401340	402475	404960
400122	401595	402522	405040
400222	401640	402740	40561.50
40061.20	40171.05	402888	406680
400772	40181.00	402970	407172
400942	401925	403022	40761.05
401042	40201.05	40351.10		
401122	402296	404278		

WSU-30 Hand wire wrap tool used to wrap, unwrap & strip #30 wire \$5.30

#24, EIGHT CONDUCTOR SPECIFIED	DIP SOCKETS	#30 WIRE WRAP WIRE
14 PIN - \$2.28	50 SINGLE STRAND - 100'/\$1.40	
16 PIN - \$2.40	60 PIN - \$2.50	
100'/\$1.50		

2708 BK EPROM (4500 nsi)	\$15.75
2622 STATIC SHUT REG	\$ 1.95
2512 CHARACTER GEN	\$ 6.75
2518 HEX 32 BIT SR	\$ 3.50
TMS4050NL-4K dVys RAM	\$ 4.50
5203-2K EPROM	\$ 1.19
2102 1 1024 BIT RAM (4500 nsi)	\$ 3.50
2107B	\$ 1.95
MK4008P	\$ 3.50
5280 4K DYNAMIC RAM	\$ 4.75
1101A-256 BIT RAM	\$ 7.

hobbi house

Send for Free Hobbi House Catalog
969 BALL AVE., UNION, N.J. 07083

lowest prices



**MA1003
MOBILE CLOCK
MODULE (National)**

\$18⁹⁵ complete

Attaches directly to 9-12V Battery. Automatic Nighttime Dimming. Fluorescent Display gives Color Choice (Red, Blue, Green or Yellow) when used w/corresponding Color Filter. Includes — Module, Switches, Filter & Specs.

INTRODUCING ALL NEW 3-WAY AUTO SPEAKER STEREO SYSTEM

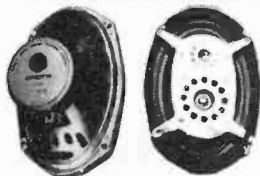

Two 6"x9" 20 ounce 3-Way Speakers complete with chrome accents padded vinyl grilles, mounting cables and hardware, **Only \$49.95**

3-WAY Concert Hall Sound

WOOFER — Heavy duty 6"x9" high compliance woofer, with foam rolled edge, delivers full bass ranges. Air suspension allows free cone response.

TWEETER — 2" Mylar cone supertweeter provides ultimate in high frequency reproduction.

MID-RANGE — Powerful 3" deluxe mid-range adds dimension to between frequency response for enhanced clarity in mid-range sound.

**\$99.95 AM/FM Casette Stereo \$99.95
WITH ENCLOSED SPEAKERS
Complete with all mounting hardware
NOT A KIT**

**12VDC Regulated CB Power Supply
Converts 120VAC to Regulated 12VDC
Use Car CB or Stereo at Home
Complete — NOT A KIT — \$18.95**

TRANSFORMER 6.3 volts at 1.2 amps — \$1.49

**DIFFUSED LEDs JUMBO RED LEDs
7/\$1.00 0.2", and Factory Prime 100/\$11.00**

**DL 741 Jumbo 7 Segment Displays
Common Anode — \$1.35**

Sound Actuated Switch — \$.85

6 FT LINE CORDS — 6 for \$1.00

Your Home for Quality Kits, Projects and Components
Toll-Free Wats Line — 800-631-7485 • Open Saturdays
In New Jersey Call (201) 964-5206

WESTINGHOUSE TUBE SPECIAL BOXED AND BRANDED

6GH8A	\$1.60
6LQ6/6JE6C	4.00
6DW4B/6CL3	2.00
3A3C	2.50
6HM5/6HA5	2.00
6FQ7/6CG7	1.60
6LB6	4.00
6GF7A	2.50
6BK4C/6EL4A	4.00
8FQ7/8CG7	2.00
6JS6C	4.00
12GN7A/12HG7	3.00
6GJ7/ECF801	2.00
17J28	2.00
5GH8A	2.50

Dual Range DIGITAL Voltmeter/ MULTI-METER kit \$29.95 DVM kit only

0 to + 2 Volts DC — 0 to + 2 Volts DC

• Features latest Technology DVM chip set

• Non Critical Comp.

• High Noise Rejection

• Accuracy to within .001

Contains — P.C. Boards; 4-large .50 Fairchild Readouts; Display Drivers; Op-Amps; Inverter; all electronic comp. Switches, Pots; Complete Instructions and Specs; & DVM Chip Set Requirements: Power Supply w/+5V, +15V and -15V.

OPTIONS — Set/Precision Resistors for Increasing Voltage Range up to 200 Volts — \$2.95

Complete Multi-Meter Kit including Power Supply — \$49.95

NEW KIT SPECIALS

MOTOR SPEED CONTROL / LIGHT DIMMER \$8.99

Adjust motor speed to suit application or use as a light dimmer control. A.C. operated. Case and assembly instructions included.

CODE PRACTICE OSCILLATOR \$10.

Practice Morse code with this battery operated (not included) compact portable code generator. Emits a loud pleasant tone. Case and assembly instructions included.

ELECTRONIC DICE \$15.

LED's arranged as dice. Each press of the toss switch generates a random roll of the dice. Operates on 9 volt battery (not included). Case and assembly instructions included.

ELECTRONIC COIN TOSS / DECISION MAKER \$9.95

Generates a statistically random "coin toss" for those difficult decisions requiring an unbiased guess. Great fun testing your ESP too. Battery operated (not included). Case and assembly instructions included.

T.V. SCRAMBLER \$12.99

Use to remotely blank out T.V. set during commercials or while answering phone. Can also be used as a high frequency oscillator. Battery operated (not included). Case and assembly instructions included.

F-M TRANSMITTER. \$13.99

Portable battery operated F-M transmitter enables you to broadcast over your F-M radio. Use as a portable microphone or in-house paging system

TTL POWER SUPPLY \$11.95

5 volt, 600ma., regulated power supply. Use to power all your TTL projects. Case and assembly instructions included.

AUDIO AMPLIFIER \$12

Use as a portable P.A. system or remote listening device. Easy to assemble, battery operated (not included) and great fun. Case and assembly instructions included.

NEON RANDOM BLINKER \$7.95

Randomly flashes six neon lamps. A-C operated. Case and assembly instructions included.

TRANSISTOR & SEMI- CONDUCTOR TESTER \$18.99

Use to check a wide range of bipolar transistors either in or out of circuit. Designed for dynamic testing for both NPN and PNP types. Attractive case and assembly instructions included.

TRANSISTOR CURVE TRACER \$49.95

Adapts to your scope to form a transistor tester that generates a family of characteristic curves to give you semi-conductor information not otherwise obtainable (beta, leakage current, forward resistance, etc.). Will test both signal and power devices. Case and assembly instructions included.

SIGNAL INJECTOR \$10.

Useful for checking and troubleshooting amplifiers, radios, stereos, etc. Generates a 1-KHZ tone with harmonics to 250 MHZ. Battery operated. Case and assembly instructions included.

Terms and Conditions

Orders Shipped Within 24 Hours
\$5.00 Minimum Order,
Telephone C.O.D.'s accepted.
\$15.00 Minimum Bank Americard/
MasterCharge order.
Add \$1.00 Postage for orders under \$10.00.
Outside Continental U.S. add postage - U.S. Funds.
N.J. Residents add 5% Sales Tax.
Money Back Guarantee.

MICROCOMPUTER

MICROPROCESSOR'S

F-8	19.95
Z-80	25.00
Z-80A	35.00
CDP1802CD	24.95
AM2901	22.95
6502	12.95
6800	19.95
8008-1	8.75
8080A	15.95
TMS-9900TL	89.95

6800 SUPPORT

6810P	4.95
6820P	8.00
6828P	11.25
6834P	16.95
6850P	9.95
6852P	11.95
6860P	14.95
6862P	17.95
6880P	2.70

Z80 SUPPORT DEVICES

3881	12.95
3882	12.95

F-8 SUPPORT DEVICES

3851	14.95
3853	14.95

DYNAMIC RAMS

1103	1.50
2104	4.50
2107A	3.75
2107B	4.50
21078-4	4.00
TMS4050	4.50
TMS4060	4.50
4096	4.50
4116	42.00
MM5270	5.00
MMS280	6.00
MCM6605	6.00

CHARACTER GENERATORS

2513 UP	6.75
2513 DOWN	6.75
2513 UP (5v)	9.95
2513 DOWN(5v)	10.95
MCM6571	10.80
MCM6571A	10.80
MCM6572	10.80
MCM6574	14.75
MCM6575	14.75

PROM'S

1702A	5.00
2704	15.00
2708	20.00
2716	38.00
3601	4.50
5203AQ	4.00
5204AQ	6.00
6834	16.95
6834-1	14.95
82S23B	4.00
82S129B	4.25
8223B	2.70

8080A SUPPORT DEVICES

8212	3.95
8214	9.95
8216	4.50
8224	4.95
8228	8.75
8238	8.00
8251	12.00
8253	28.00
8255	12.00
8257	25.00
8259	25.00

STATIC RAMS

	1-24	25-99	100
21L02 (450)	1.50	1.40	1.25
21L02 (250)	1.95	1.80	1.50
21L11	4.25	4.10	3.95
1101A	1.49	1.29	1.10
2101-1	2.95	2.75	2.60
2102	1.25	1.15	1.00
2102-1	1.50	1.30	1.15
2111-1	4.00	3.50	3.25
2112-1	3.00	2.80	2.69
2114	17.95	16.95	16.50
31L01	2.50	2.35	2.00
3107	3.95	3.70	3.25
4200A	12.95	12.50	11.95
4804/2114	17.95	16.95	16.50
5101C-E	11.95	11.25	10.25
74C89	3.25	3.05	2.85
74S201	4.50	4.30	4.25
7489	2.25	2.10	1.90
8599	1.88	1.75	1.60
9102BPC	1.65	1.45	1.30

KEYBOARD CHIPS

AY5-2376	13.95
AY5-3600	13.95

UART'S

AY5-1013A	5.50
AY5-1014A	8.95
TR-1602A	5.50
TMS-6011	6.95
IM-6402	10.80
IM-6403	10.80

FLOPPY DISC CONTROLLER

1771B	55.95
1771B-01	59.95

SHIFT REGISTERS STATIC

2518B	3.95
2533V	2.00
TMS3002	1.00
TMS3112	3.95
MM5058	2.00

KIM

KIM-1	245.00
6502	12.95
6520	9.00
6522	9.25
6530-002	15.95
6530-003	15.95
6530-004	15.95
6530-005	15.95

USRT

S-2350	10.95
WD16718	29.95

WAVEFORM GENERATOR

8038	4.00
MC4024	2.50
566	1.75

MISC. OTHER COMPONENTS

NH0025CN	1.70	P-3408A	5.00
NH0026CN	2.50	P-4201	4.95
N8T20	3.50	MM-5320	7.50
N8T26	2.45	MM-5369	1.90
74367	.90	DM-8130	2.90
DM8098	.90	DM8131	2.75
1488	1.95	DM-8831	2.50
1489	1.95	DM-8833	2.50
D-3207A	2.00	DM-8835	2.50
C-3404	3.95	SN74LS367	.90
		SN74LS368	.90

TV

Game Chip
TMS1955NL
Now Only \$10.95

PerSci DISK AND CONTROLLER

Use the PerSci Disk and Controller now with the Info 2000 Adapter for the S-100 Bus.

INFO 2000 "SPECIAL"

(includes Model 277 Dual Drive, Model 1070 Controller, Case with power supply and fan, and cable)

Model 277 Dual Diskette Drive	\$2,150
Model 1070 Controller	\$1,130
Slimline case with power supply and fan	\$740
Adapter for the S-100 Bus (Kit)	\$280
	\$120

JADE PARALLEL/SERIAL INTERFACE KIT

\$124.95 KIT

JADE VIDEO INTERFACE KIT

\$89.95 KIT

8K STATIC RAM BOARD

ASSEMBLED & TESTED

250ns.
350ns.
450ns.

\$199.95
\$189.95
\$169.95

- * WILL WORK WITH NO FRONT PANEL
- * FULL DOCUMENTATION
- * FULLY BUFFERED
- * S100 DESIGN
- * ADEQUATELY BYPASSED
- * LOW POWER SCHOTTKY SUPPORT IC'S

KIT

250ns.
350ns.
450ns.

\$169.95
\$139.95
\$129.95

IMSAI/ALTAIR **S-100** COMPATIBLE

JADE Z80 KIT

—with PROVISIONS for ONBOARD 2708 and POWER ON JUMP

\$135.00 EA. (2MHZ)
\$149.95 EA. (4MHZ)

BARE BOARD \$35.00

IMSAI/ALTAIR **S-100** COMPATIBLE

JADE 8080A KIT

— WITH EIGHT LEVEL VECTOR INTERRUPT

\$110.00 KIT
BARE BOARD \$35.00

JADE

Computer Products



5351 WEST 144th STREET
LAWDALE, CALIFORNIA 90260
(213) 679-3313

RETAIL STORE HOURS M-F 9-7 SAT. 9-5
Discounts available at OEM quantities. Add \$1.25 for shipping. California residents add 6% sales tax.

CATALOG FREE WITH \$10.00 ORDER



Radio Hut

Money back guarantee. No COD's. Texas residents add 5% sales tax. Add 5% for order for postage and handling. Orders under \$15.00 add 75 cents. Foreign orders add 20% for postage. For your convenience, call your Bank Americard or Master Charge orders in on our Toll Free Watts Line: 1-800-527-2304. Texas residents call collect: 1-214-271-8423.

(All prices subject to change without prior notice.)
P. O. Box 38323P
Dallas, Texas 75238

VARIABLE POWER SUPPLY KIT NO. 1 ONLY \$19.95

- Continuously variable from 5V to 20V
- Excellent regulation up to 1/2 Amp
- Kit includes all components
- Drilled fiberglass P.C. Board
- Case included
- 4400 MFD of filtering
- One hour assembly



This model will power a 5 watt transistorized CB Radio

LOOK AT THIS SPECIAL FROM RADIO HUT

Power Supply Kit: 5V1 amp reg., Line regulation .005%, Load regulation 50mV
Kit includes components, PC board, transformer, fuse and pilot light. Line cord not included.

Only \$6.50

60 Hz. Crystal Time Base for Digital Clocks \$4.50 Buy 2 for \$8.



- A. 60 Hz. output with accuracy comparable to a digital watch.
 - B. Directly interfaces with all MOS clock chips.
 - C. Super low power consumption (1.5 ma type.)
 - D. Uses latest MOS 17 stage divider IC.
 - E. Eliminates forever the problem of AC line glitches.
 - F. Perfect for cars, boats, campers, or even for portable clocks at ham field days.
 - G. Small size, can be used in existing enclosures.
- KIT INCLUDES CRYSTAL, DIVIDER IC, P.C. BOARD PLUS ALL NECESSARY PARTS & SPECS.

UNSCRAMBLER \$19.95



Plugs into earphone or external speaker of any Scanner or Monitor. Guaranteed to unscramble any 1085 call.

- Easily tuned
- Full instruction included
- Drilled fiberglass P.C. Board
- One Hour Assembly
- Punched Case

VARIABLE POWER SUPPLY KIT NO. 2

Same as above but with a 1 Amp output, also with case ONLY \$13.95

MA 1003 CAR CLOCK FROM NATIONAL INCLUDES SPECS. AND 3 SWITCHES. \$17.95

ALSO, THIS MONTH ONLY, FREE EDGE CONNECTOR.

7400 TTL DIGITAL CIRCUITS

7400	11	7430	13	7480	31	74153	61
7401	13	7432	23	7481	55	74154	98
7402	13	7433	26	7482	57	74155	89
7403	13	7437	23	7483	67	74156	89
7404	15	7438	23	7485	89	74157	55
74L04	29	7440	13	7489	1	74160	55
74S04	44	7441	76	7490	65	74161	65
7405	13	7442	47	7491	51	74163	65
7406	16	7443	59	7492	43	74164	85
7407	16	7444	59	7493	43	74165	89
7408	19	7446	68	7494	67	74174	85
7409	19	7447	68	7495	67	74175	85
7410	13	7448	71	7496	67	74180	67
7411	18	7450	13	74100	30	74181	133
7412	26	7451	13	74104	49	74182	68
7413	37	7453	13	74107	26	74191	98
7416	15	7454	13	74109	31	74192	79
7420	13	7459	13	74120	30	74189	81
7421	13	7470	27	74123	48	74194	81
7423	25	7472	25	74132	99	74195	69
7425	29	7473	29	74136	99	9316	85
7426	24	7474	29	74138	1	9601	3/51
7427	19	7475	47	74141	75	9L04	35
7428	26	7476	31	74151	61		

ITT HIGH LEVEL LOGIC

301	Dual 5 Input NAND Gate	15
302	Quad 2 Input Buffer open collector	18
303	Quad 2 Input NAND Buffer	15
311	Master Slave J/F	18
312	Dual JK Flip Flop	18
321	Dual 5 Input NAND Gate	18
322	Dual 5 Input NAND Gate	18
323	Quad 2 Input NAND Gate	18
324	Quad 2 Input NAND Gate	18
325	Dual 2 Dual 3 Input NAND Gate	13
326	Dual 2 Dual 3 Input NAND Gate	13
331	Dual 5 Input Expander	13
332	Hex Inverter	18
333	Hex Inverter	18
334	Hex Inverter	18
335	Hex Inverter	18
342	Dual One Shot Multivibrator	25
343	Dual 4 Bit Comparator	22
370	Quad Flip Flop	22
371	Decade Counter	30
372	Quad Ripple Counter	39
380	BCE to Decimal Decoder	39
381	BCE to Decimal Decoder	39

HOUSE # TTL IC'S

7400	10/1.00	Please specify	7437	6/1.00	300 KHz	\$1.50
7404	10/1.00		7438	6/1.00	3.57945	1.25
7408	10/1.00	that you	74141	3/1.00		
7420	10/1.00	are ordering	74153	3/1.00		

House Number TTL.

74LS00 LOW POWER SCHOTTKY

74LS00	21	74LS47	73	74LS136	37	74LS258	71
74LS02	21	74LS51	26	74LS138	71	74LS260	26
74LS03	21	74LS54	26	74LS139	71	74LS266	26
74LS04	28	74LS56	26	74LS145	100	74LS273	55
74LS05	28	74LS73	35	74LS151	70	74LS290	75
74LS08	21	74LS74	35	74LS153	70	74LS293	61
74LS09	28	74LS76	49	74LS155	69	74LS295	96
74LS10	21	74LS83	73	74LS156	70	74LS298	95
74LS11	21	74LS85	135	74LS157	75	74LS365	55
74LS13	45	74LS86	36	74LS158	71	74LS366	55
74LS14	99	74LS90	55	74LS160	85	74LS367	55
74LS15	26	74LS92	55	74LS161	85	74LS368	55
74LS20	24	74LS93	65	74LS162	85	74LS390	1.75
74LS21	28	74LS109	38	74LS163	85	74LS393	1.45
74LS22	28	74LS112	38	74LS164	1.49	74LS370	2.30
74LS26	32	74LS113	38	74LS168	85	74LS392	95
74LS27	32	74LS114	38	74LS169	85	74LS392	95
74LS30	26	74LS122	49	74LS170	1.69	74LS394	95
74LS32	32	74LS124	99	74LS173	1.10	74LS395	85
74LS37	32	74LS125	47	74LS174	1.00	74LS396	85
74LS38	32	74LS126	47	74LS175	81	74LS397	85
74LS40	26	74LS132	79	74LS190	95	74LS251	81
74LS42	65	74LS133	35	74LS191	95	74LS252	85
						74LS257	71

ITT MOS TO LED DRIVERS

ITT 501	Quad Seg. Dr.	35
ITT 502	Hex Digit Dr.	49
ITT 503	Quad Seg. Dr.	49
ITT 506	Hex Digit Dr.	49
ITT 508	8 Digit Dr.	49
ITT 509	8 Seg. Dr.	49
ITT 511	Quad Seg. Dr.	55
ITT 516	8 Digit Dr.	59

We have 100's of thousands of listed parts. These parts are 100% prime.

COUNTER AND CLOCK CHIPS

MKS50252	Clock Chip	\$4.99
MM5316	Clock Chip	3.75
MKS50250	Alarm Clock	3.75
MKS50380	Alarm Chip	2.95
FCM7010	Direct Drive Clock Chip	4.95
MKS5005	4 Digit Counter w/Latch	8.50
MKS5002	4 Digit Counter	8.95
MKS50395	6 Digit UP/Down Counter	12.95
MKS50397	6 Digit Elapsed Timer	12.95
CT5005	Calculator Chip w/Specs	1.25
MKS5021	Cal. Chip w/3 cl.	2.50

74H SERIES TTL

74H00	18	74H21	29	74H53	29	74H73	39
74H05	29	74H40	29	74H61	25	74H74	39
74H20	29	74H50	20	74H72	45		

TTL SPECIAL!

9002/7400	10/1.00
9003/7410	10/1.00
9004/7420	10/1.00
9006/7460	6/1.00
9007/7430	10/1.00
9009/7440	10/1.00
9016/7404	8/1.00
9024/7409	3/1.00
9300/7435	3/1.00

9000 series parts prime from ITT. Pin for Pin compatible with 7400 series.

SOCKETS

- 8 Pin Low Profile 20
- 14 Pin Low Profile 22
- 16 Pin Low Profile 25
- 18 Pin Low Profile 30
- 28 Pin Low Profile 69
- 40 Pin Low Profile 89

TRANSISTORS

INTERMIL DUAL TRANSISTORS Originally Cost \$3. each Similar to 2N913 2 Per Pack 2/51

GENERAL PURPOSE

2N 2905	PNP	4/51
2N 3904	NPN	8/51
2N 3906	PNP	8/51
2N 3932	Pre-Amp	25/51
2N 4400	NPN	10/51
2N 4402	NPN	10/51
EN 2222	NPN	8/51
EN 2507	PNP	8/51

POWER TRAN.

115 W 200V	NPN	9/5
TIP 29 (EP967)	NPN	4/51
TIP 30 (EP929)	PNP	4/51
TIP 31 P.C. Leads	NPN	5/51
MJE 2370		3/51
2N 3055		7/5
2N 2029 BY RCA		9/5
FET TIS 75 HOUSE #		5/51

CAPACITORS

AXIAL TYPE		ELECTROLYTIC		RADIAL TYPE	
20 MFD 250V	5/51	47 MFD	35V PC Leads	10/51	
25 MFD 25V	15/51	68 MFD	25V PC Leads	8/51	
200 MFD 25V	5/51	330 MFD	50V PC Leads	5/51	
470 MFD 35V	4/51	470 MFD	16V	4/51	
470 MFD 16V	4/51	1000 MFD	35V PC Leads	4/51	
500 MFD 35V	5/51				
2000 MFD 16V	3/51	150 PFD MICA 5%		10/51	

COMPUTER GRADE

1,900 MFD 35VWVDC (Mini)	3/52	68 PFD	50V	680 PFD	50V
8,000 MFD 15VWVDC 95 cents each		100 PFD	100V	301 PFD	50V
33,000 MFD 40VWVDC	\$4.00 Each	150 PFD	50V	202 MFD	50V
		220 PFD	50V	.01 MFD	200V
		330 PFD	50V	.02 MFD	200V
				.001 UF	500V
				.0015 UF	500V
				.005 UF	500V
				.01 UF	500V

TANTALUM

1 MFD20 WVDCPC Leads	15/51				
3.3 MFD35 WVDC PC Leads	8/51				
4.7 MFD10 WVDC PC Leads	5/51				
10 MFD20 WVDC PC Leads	8/51				
33 MFD10 WVDC	6/51				
22 UF10	10/51				

PC Leads 25/89 cents No Mix. Long Leads 25/89 cents No Mix.

RTL'S BY FAIRCHILD

The most popular digital IC's ever produced. Very hard to find!

UL DUAL 2 INPUT NOR	99
UL923 JK FLIP FLOP	\$1.19

CMOS

CD400	19	CD4017	95	CD4040	100	CD4071	19
CD4001	19	CD4018	95	CD4041	89	CD4072	19
CD4002	19	CD4019	19	CD4042	89	CD4073	35
CD4006	1.20	CD4020	97	CD4043	60	CD4508	2.80
CD4007	19	CD4021	97	CD4044	60	CD4510	1.00
CD4009	47	CD4022	97	CD4046	1.39	CD4512	1.10
CD4010	39	CD4023	19	CD4047	1.50	CD4518	1.10
CD4011	19	CD4024	75	CD4049	35	CD4518	1.10
CD4012	29	CD4025	19	CD4050	39	CD4520	69
CD4013	32	CD4027	39	CD4051	1.19	CD4528	85
CD4014	78	CD4028	85	CD4053	1.19	CD4072	45
CD4015	78	CD4029	99	CD4056	1.15	74C04	32
CD4016	32	CD4030	35	CD4066	78	74C107	79

DTL

932	Dual 4 Input Buffer	8/51
934	Dual 5 Input NAND Gate	10/51
941	One Shot Multivibrator	8/51
945	JK F/F	8/51
946	Quad 11 Input Gate NAND/NOR	8/51
948	JK F/F	8/51
950	F/F	10/51
951	One Shot Multivibrator	5/51
1800	(see 934 above)	10/51
1806	Quad 2 Input NAND Gate	10/51
9620	Dual JK F/F	8/51
9694	Dual JK F/F	8/51
9697	Dual JK F/F	8/51
9698	Dual JK F/F	8/51
9109	Hex Inverter	7/51
9110	Hex Inverter	7/51
9112	Hex Inverter	7/51
9114	Hex Inverter	7/51
9601	One Shot	3/51
9930	Quad 4 Input Ext. NAND	8/51
9932	Quad 2 Input NAND Buffer	8/51
9945	RS F/F	8/51
9946	Quad 2 Input NAND	8/51
9949	Quad 2 Input NAND	8/51
9951	Monostable Multivibrator	8/51
9962	Triple 3 Input NAND	8/51

BRIDGE RECTIFIERS

7805 Pos.	5V 1 Amp	99	7818 Pos.	18V 1 Amp	99
7806 Pos.	6V 1 Amp	99	7824 Pos.	24V 1 Amp	99
7808 Pos.	8V 1 Amp	99	7905 Neg.	5V 1 Amp	1.10
7812 Pos.	12V 1 Amp	99	7912 Neg.	12V 1 Amp	1.10
7815 Pos.	15V 1 Amp	99	7915 Neg.	15V 1 Amp	1.10

VOLTAGE REGULATORS

723 VOLTAGE REGULATORS

Output voltages variable from 2 volts to 37 volts. A very versatile and popular device. — 14 PIN DIP 69c

MOTOROLA VOLTAGE REGULATOR

MC1469R, TO-66, 9 lead package for 3 to 30V outputs. Provides 600 MA direct output or more by using an external power transistor. Regular catalog price — \$4.00 each; \$1.95 each

DIODES

1 Amp 200V	6/51
1 Amp 50V	\$90
6 Amp 50V	1.10
10 Amp 50V	1.25
25 Amp 50V	1.39

ZENER DIODES

IN 4002	1
---------	---



EXPANDO RAM KIT

32K FOR \$475.00

MEMORY CAPACITY
MEMORY ADDRESSING
MEMORY WRITE
PROTECTION

8K, 16K, 24K, 32K using Mostek MK4115 with 8K boundaries and protection. Utilizes DIP switches. PC board comes with sockets for 32K operation. Orders now being accepted. Allow 6 to 8 weeks for delivery.

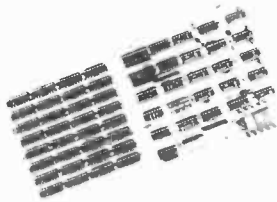

Buy an S100 compatible 8K Ram Board and upgrade the same board to a maximum of 32K in steps of 8K at your option by merely purchasing more ram chips from S.D. Sales! At a guaranteed price - Look at the features we have built into the board.

PRICES START AT \$151. FOR 8K RAM KIT

Add \$108.00 for each additional 8K Ram

8K FOR \$151.00

INTERFACE CAPABILITY
Control, data and address inputs utilizes low power Schottky devices

POWER REQUIREMENTS
+8VDC 400MA DC
+18VDC 400MA DC
-18VDC 30MA DC

on board regulation is provided. On board (invisible) refresh is provided with no wait states or cycle stealing required.

MEMORY ACCESS TIME
IS 375ns.
Memory Cycle Time is 500ns.

S.D. SALES NEW EXPANDABLE EPROM BOARD

16K or 32K EPROM \$49.95 w/out EPROM
Allows you to use either 2708's for 16K of Eprom or 2716's for 32K of Eprom.

KIT FEATURES:

1. All address lines & data lines buffered.
2. Quality plated through P.C. Board, including solder mask and silk screen.
3. Selectable wait states.
4. On board regulation provided.
5. All sockets provided w/board.

WE CAN SUPPLY 450ns 2708's AT \$11.95 WHEN PURCHASED WITH BOARD.

Z-80 CPU BOARD KIT — \$139.

CHECK THE ADVANCED FEATURES OF OUR Z-80 CPU BOARD: Expanded set of 158 instructions, 8080A software capability, operation from a single 5VDC power supply; always stops on an M1 state, true sync generated on card (a real plus feature!), dynamic refresh and NMI available, either 2MHZ or 4MHZ operation, quality double sided plated through PC board; parts plus sockets priced for all IC's. *Add \$10 extra for Z-80A chip which allows 4MHZ operation.
Z-80 chip with Manual — \$39.95

8K LOW POWER RAM — \$159.95

Fully assembled and tested. Not a kit. Inmsai — Altair — S-100 Buss compatible, uses low power static 21L02-500ns fully buffered on board regulated, quality plated through PC board, including solder mask, 8 pos. dip switches for address select.



4K LOW POWER RAM KIT

Fully Buffered — on board regulated — reduced power consumption utilizing low power 21L02 — 1 500ns RAMS — Sockets provided for all IC's. Quality plated through PC board. *Add \$10. for 250ns RAM operation.



The Whole Works - \$79.95

DIGITAL LED READOUT THERMOMETER — \$29.95

Features: Litronix dual 1/2" display. Uses Siliconix LD131 single chip CMOS A/D converter. Kit includes all necessary parts (except case); AC line cord and power supply included. 0-149° F.



MUSICAL HORN

One tune supplied with each kit. Additional tunes — \$6.95 each. Special tunes available. Standard tunes now available: — Dixie — Eyes of Texas — On Wisconsin — Yankee Doodle Dandy — Notre Dame — Pink Panther — Aggle War Song — Anchors Away — Never on Sunday — Yellow Rose of Texas — Deep in the Heart of Texas — Boomer Sooner — Bridge over River Kwai.

CAR & BOAT KIT \$34.95

HOME KIT \$26.90

Special Design Case \$3.50

Jumbo LED Car Clock Kit

FEATURES:

- A. Bowmar Jumbo .5 Inch LED array.
- B. MOSTEK — 50250 — Super clock chip.
- C. On board precision crystal time base.
- D. 12 or 24 hour Real Time format.
- E. Perfect for cars, boats, vans, etc.
- F. PC board and all parts (less case) Inc.

Alarm option — \$1.50

AC XFMR — \$1.50

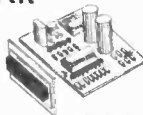

\$16.95

6 DIGIT ALARM CLOCK KIT

Features: Litronix dual 1/2" displays, Mostek 50250 super clock chip, single I.C. segment driver, SCR digit drivers. Kit includes all necessary parts (except case). Xfmr optional. Eliminate the hassle.
AC XFMR — \$1.50 Case \$3.50

5 Digit Countdown Utility Darkroom Timer Kit

Features: Large LED 1/2" displays oper. from 0.1 sec. to 59 min. 59.99 sec. 5A-115V. Relay included to control appliances. Operates on 115V AC. Displays can be turned off for total darkness while counting. All necessary parts included.
Special design case \$3.75.



\$44.95

6 Digit General Purpose or Computer Timer Kit — \$29.95

Features: Large LED 1/2" displays, Mostek 50397 counter display/driver, counts up to 59 minutes, 59.99 seconds with crystal controlled 1/100 second accuracy, operates on 115V AC or 12V DC supply. All necessary parts included. Special design case \$3.75.



Bowmar 4 Digit LED Readout Array Full 1/2" Litronix Jumbo Dual Digit LED Displays

4 JUMBO .50" DIGITS ON ONE STICK!
WITH COLONS & AM/PM INDICATOR
\$3.95

DL 722 - C.C.
DL 721 8 C.A.
99c

DL 728 - C.C.
DL 727 - C.A.
\$1.29

NEW COMPETITION CHESS TIME KIT WITH TWO INDEPENDENT FIVE DIGIT 1/2" LED DISPLAYS

The timers can be used independently or coupled. The timer can be set to 59 minutes 59.9 seconds at 0.1 intervals. Kit includes all necessary parts and an attractive woodgrain case.



\$79.95
Complete Kit

Low Cost Cassette Interface Kit

\$14.95

Features: K.C. standard 2400/1200 Hz, 300-Baud, TTL, I/O compatible, phase lock loop, 22 pin connector. Feeds serial data via microprocessors I/O ports and from cassette tape recorder. \$14.95



RAM'S

21L02 - 500NS	8/11.50
21L02 - 250NS	8/15.95
2114 - 4K	14.95
1101A - 256	8/54.00
1103 - 1K	35
MK 4115 - 8K	15.45
74S 200 - 256	3.95

HERMISTORS
MEPCO — NEW!
1.5K OHM
\$1/50.

TANTALUM CAPS
1 MFD. 20VDC
P.C. LEADS
15 for \$1.00

FLAT PACK IC ASSORT.
FLAT PACK 5400
SERIES SPECIAL
BUY FROM I.T.T.
20 Assorted
Devices for \$1.00

ELECTRICAL COIL
13T TYPE C
10T TYPE C
YOUR CHOICE
12/\$1

2 TRANSISTOR
AUDIO
amf. W/Specs.
6/\$1

TRIMMER POTS
10K, 20K, 25K
OHM; Mini for PC
boards.
YOUR CHOICE
10/\$1.

MICROPROCESSOR CHIPS

8212 - I/O port	3.50
8214 - P.I.C.	12.95
8216 - Non Invert Bus	4.95
8224 - Clock Gen.	4.95
8226 - Invert Bus	3.95
PIO for Z-80	14.95
CTC for Z-80	14.95
8228 Sys. Controller	8.20
8251 Prog. comm. Interface	10.95
8255 Prog. perip. Interface	13.50
8520 Dual Line Recv.	1.75
8830 Dual Line Dr.	1.75
2513 Char. Gen.	7.50
8838 Quad Bus. Recvr	2.00
74LS138N - 1/8 decoder	.99
8T97-Hex Tri-State Buffer	1.25
1488/1489 RS232	1.50
TR 1602B Uarr.	3.95

CPU'S

Z-80 Includes manual	29.95
Z-80A Includes manual	34.95
8080A CPU 8 BIT	11.99
8008 CPU 8 BIT	6.95

DISC CAPS
FOR BYPASS
01 MFD — 100
WVDC. PC Leads.
40/\$1.

BALUM
Used in TV Tuners
Can be rewound
for Ham freq.
6/\$1

STANDARD COILS
Use in TV Sets. 1.2
uh 5% and 1.5 uh
10%. Your choice.
12/\$1

AUTO COIL
TRANSF.
Ideal for the exper.
12/\$1

NEW CAMBION
JACKS
PART # 450-4352
Gold Plated
50/\$1.

SILICON
RECTIFIER
Special!
1N4007 1 AMP
1000 PIV.
PRIME UNITS
10/\$1.

PROMS

1702A - 1K - 1.5us	3.95 or 10/35.
2708 - 8K Intel - 450ns	14.95
5204 - 4K	7.95
825129 - 1K	2.50
2708S 8 8K signetics 650ns	9.95

PhotoCell Asst.
We bought almost
200K from a big US
mfg. Three product
families: small,
medium and dual
photoCells. Perfect
for all light sensi-
tive applications.
AMBER — 6 for \$1.
12/\$1.00

PLASTIC READ-
OUT FILTERS
Originally used in
desk top calculators.
Perfect for use
with LED and other
type readouts.
AMBER — 6 for \$1.
12/\$1.00

TTL ASSORTMENT
Contains a high
yield of usable parts.
50/\$1.50

RESISTOR
Special!
22 Ohm, 1 Watt.
Carbon Comp. 10%
Handy value. Par-
tial to make low ohm-
age power resistors.
Help! We bought
100,000 pieces!
25 for \$1.

DISC CAP ASST.
PC leads. At least
10 different values;
includes .001, .01,
.05 plus other stan-
dard values.
60/\$1.00

R.C. LEAD DIODES
1N4148/1N914
— 100/\$2.00
1N4002 - 1A
— 100 PIV
40/\$1.00

COUNTER CHIPS

MK50397 6 Digit elapsed timer	8.95
MK50250 Alarm clock	4.99
MK50380 Alarm chip	2.95
MK50396 6 digit up/down counter	12.95
MK5002 4 digit counter	8.95
MK5021 - Cal. chip sq. root	2.50

MICA TRIMMER
PC 402 Miniature
1.5 — 20 P.F.
P.C. Mount
4/\$1

MICRO-DIP \$1.95

New — Series 2300
The World's Smallest
Coded BCD Dual-In-Line
Switch! PC Mount
2300 02G BCD 1-2-4-8
2300 12G BCD 1-2-4-8
Compliment

JOY STICKS FOUR 100 K-OHMS POTS

Ideal for electronic games
\$3.95



STANDARD
ANT. TER.
Used for Ant. Hook-
up on all TV Sets.
121

Z-80 PROGRAMMING MANUAL

IN DEPTH DETAIL OF THE Z-80 CPU MICRO-COMPUTER

S. D. Sales Special
\$9.95

*Choose \$1. Free Merchandise From Asterisk Items on each \$15 order!

Texas Residents Call Collect:

214/271-0022

1-800-527-3460

DEALER INQUIRIES INVITED!

Terms - 60 Day

Money Back Guarantee!

CALL IN YOUR BANKAMERICARD (VISA) OR MASTER CHARGE ORDER IN OUR CONTINENTAL TOLL FREE WATTS LINE:

NO COD'S. TEXAS RESIDENTS ADD 5% SALES TAX. ADD 5% OF ORDER FOR POSTAGE & HANDLING. ORDERS UNDER \$10. ADD 75c HANDLING. FOREIGN ORDERS - U. S. FUNDS ONLY!

MORE THAN 20,000 DIFFERENT COMPONENTS

7400 TTL

7400	.18	7442	1.08	74107	.49
7401	.21	7448	1.15	74121	.55
7402	.21	7450	.26	74122	.49
7404	.21	7451	.27	74123	1.05
7405	.24	7453	.27	74125	.60
7407	.45	7454	.41	74126	.81
7408	.25	7460	.22	74132	3.00
7409	.25	7472	.39	74141	1.15
7410	.20	7473	.45	74150	1.10
7411	.30	7474	.45	74151	1.25
7413	.85	7475	.80	74153	1.35
7416	.43	7482	1.75	74154	1.54
7417	.43	7483	1.15	74157	1.30
7420	.21	7485	1.12	74161	1.45
7422	1.50	7486	.45	74164	1.65
7425	.43	7489	2.49	74165	1.65
7427	.37	7490	.69	74166	1.70
7428	.35	7491	1.20	74174	1.95
7430	.26	7492	.82	74175	1.95
7432	.31	7493	.82	74180	1.05
7437	.47	7494	.91	74181	3.55
7438	.40	7495	.91	74191	1.50
7440	.21	7496	.91	74195	1.00
7441	1.10	74100	1.25	74197	1.00

74L SERIES TTL

74L00	.33	74LS04	.45	74LS113	.98
74L10	.33	74LS10	.39	74LS138	1.89
74L30	.33	74LS20	.39	74LS174	2.50
74L42	1.50	74LS51	.39	74LS386	5.50
74L86	.69	74LS74	.65	74LS153	2.25
74LS00	.39	74LS112	.65	74S387	1.95

74H00 TTL

74H00	.33	74H11	.33	74H53	.39
74H01	.33	74H20	.33	74H55	.39
74H04	.33	74H21	.33	74H73	.59
74H05	.35	74H30	.33	74H74	.69
74H10	.33	74H40	.33	74H76	.65

MOTOROLA

MC663P	2.50	MC1460	3.95
MC666P	1.60	MC1469R	2.50
MC670P	1.60	MC1489	4.60
MC679P	2.50	MC1496	1.65
MC725P	1.50	MC1510G	8.00
MC789P	1.50	MC1514L	4.50
MC790P	1.50	MC1595L	6.25
MC817P	1.30	MC1723CL	3.60
MC836P	1.35	MC1741CG	1.20
MC844	1.25	MC1810P	1.25
MC853P	2.25	MC3004L	2.25
MC876P	2.25	MC3007P	2.25
MC1004L	1.25	MC3021L	2.15
MC1010L	1.25	MC3062L	2.65
MC1305	1.95	MC3062L	3.00
MC1352P	1.55	MC4024P	2.20
MC1357	1.70	MC4044P	4.80
MC1371	1.85	MC14507CP	1.25
MC1439	2.65	MC14511CP	2.76
MC1458P	.50	MC14512CP	1.70

C MOS

4001AE	.29	4023AE	.29
4002AE	.29	4024AE	1.50
4007AE	.29	4025AE	.35
4010AE	.58	4028AE	1.60
4011AE	.29	4029AE	2.90
4012AE	.29	4030AE	.65
4015AE	1.25	4037AE	4.50
4016AE	.65	4040AE	2.40
4018AE	1.10	4044AE	1.50
4019AE	.65	4049AE	.75
4020AE	1.75	4050AE	.75
4021AE	1.50		

LINEAR

75450BP	.49	LM301H	.35	LM741CH	.45
75451BP	.39	LM307H	.35	LM747	.90
75452BP	.39	LM309K	1.25	LM748H	.45
75453BP	.39	LM311H	.90	LM1458N	.80
75454BP	.39	LM318N	1.50	NE5566V	1.50
75491BP	.79	LM339N	1.85	NE5558	1.00
75492BP	.85	LM351AN	.65	NE5555V	1.60
CA3005	1.60	LM370N	1.25	NE5566	1.50
CA3006	3.50	LM380N	1.45	UA702	.80
CA3018	1.10	LM566	2.25	UA703CH	.45
CA3018A	1.60	LM711CH	.60	UA709CH	.30
CA3026	1.50	LM723H	.75	UA749CH	.45
CA3046	.35	LM741CN	.45		

IC's ON THE MOVE

BBD BUCKET BRIGADE DEVICE			
MM3001	19.50	MN3002	11.70
MM3003	9.45		
HALL IC:DN834	1.25	DN837	1.50
DN835	1.35	DN838(NEW)	

ZENER DIODES

1/2 Watt, ± 10%	\$.30	each to 33 V
1 Watt, ± 10%	\$.40	each to 33 V
Voltages to 200V, and ± 5% Available		

1 Megohm Potentiometer - Made by Clarostat. 7/8" diam., split, knurled shaft 1/2" long.
NT544 \$.39 Three for \$1.00

5400 SERIES

VOLT.REG

5400	1.00	5475	1.50	LM340K-5	1.95
5404	1.25	5486	1.90	LM340K-6	1.95
5410	1.00	5493	2.00	LM340K-8	1.95
5426	1.25	54100	1.80	LM340K-15	1.95
5473	1.50	54LS04	1.00	LM340K-18	1.95
				LM340K-24	1.95
				LM340T-5	1.75
				LM340T-8	1.75
				LM340T-8-1.75	
				LM340T-12	1.75
				LM340T-15	1.75
				LM340T-18	1.75
				LM340T-24	1.75

RESISTORS

1/4 Watt ± 5% Packed 5 of any one value \$.25
1/2 Watt ± 5% Packed 5 of any one value \$.30
STANDARD RESISTANCE VALUES

SEE OUR AD ON JAPANESE TRANSISTORS AND IC'S IN THIS ISSUE.

MINIMUM ORDER \$5.00

All orders add 1.00 Postage and Handling.

Canada \$1.50

N.J. Residents add 5% sales tax

ELECTROLYTIC CAPACITORS

2.2MF50	Axial Leads	.15	30MF25	Axial Leads	.18
3.3MF10	Axial Leads	.15	47MF25	Radial Leads	.19
3.3MF10	No Polarity	.15	47MF50	Radial Leads	.24
10MF25	Axial Leads	.15	100MF16	Radial Leads	.19
10MF50	Axial Leads	.16	100MF25	Radial Leads	.24
10MF150	Axial Leads	.20	500MF50	Axial Leads	.60
25MF35	Axial Leads	.18	1000MF35	Axial Leads	.65

MICROPROCESSOR

C1702A	9.95	2708	34.95	8008	19.95
2101	5.75	C5101-3	4.50	8080A	19.95
2102	1.75	MM5013	3.25	8224	10.45

Contact us for all your microprocessor needs.

NEW FROM NEWTONE

Regulated Power Supply Components Kit - Contains the components needed to build a fixed-voltage regulated supply including: 117/17V- 1 ampere Transformer, Bridge Rectifier, 2000 uF Capacitor, and a 1 ampere LM340 3-terminal IC Regulator. Makes a fine "on board" supply or use it for breadboarding. Components only. Specify 5, 6, 8, 12 or 15 volts. **NT525 \$4.99**

Pioneer 6" Speaker - 7 1/2-watt, 3.2-ohm speaker made the way speakers should be made. Has heavy-duty treated paper cone, protected magnet housing, and a ceramic terminal strip marked with polarity. A beautiful speaker at half the price you'd expect. **NT526 \$2.39 Three for \$6.00**

PC Boards - MIL grade, 1/16" glass-epoxy boards with 2-ounce copper on one side.

NT521 6"x3" \$.50, NT522 6"x6" \$.90 NT523 6"x8" \$1.20

Dry Transfer Patterns for PC Boards - Includes 0.1" spaced IC pads, donuts, angles, and 3-and 4-conductor pads. Over 225 patterns on a 2" x 7 1/4" sheet. **NT520 \$1.49**

3PDT - 24 Volt DC Relay - Potter & Bromfield KUP14D15. Each contact can handle 10 amperes at voltages to 240 Vac. Coil resistance is 450 ohms. A super buy! Limited quantities. **NT508 \$9.99**

5" Taunt-Band Meter - One milliampere full scale, 3 1/2", scale length. Coil resistance 465 ohms. Made by Modutec for Bose. Meter scale in VUs (-20 to +30). Meter is designed to be mounted coil up. Complete with "smoke" plastic cover. Over-all 5 1/8"x4". Meter face mounts in a 5 1/8"x2 3/8" cutout. A beautiful meter. **NT539 \$4.89**

Aluminum Knob - Solid machined aluminum knob with fluted sides made for Bose. Black front-face insert, black pointer line. Fits flat 1/4" shaft, does not require set screws. .8 high, .7 diam. Easily worth \$1.50 **NT540 \$.82 2 for \$1.50**

BOSE SPEAKERS

Bose has discontinued their original 301 System. New-Tone purchased the speakers remaining in inventory when the 301 was discontinued, and is offering them at prices that seem impossible. The speakers have been tested with the Bose "Tone Standard" as a reference and have been subjected to the Bose power-handling test which includes both fixed and sweep-frequency testing.

8-Inch Woofer (Bose Part No. 102606) has a free-air resonant frequency of 25-35 Hz., and has a 1.5", 8.5-ounce magnet. The upper tested-frequency is 4000 Hz.

3-Inch Tweeter (Bose Part No. 107376) has a free-air resonant frequency of 1200-1500 Hz., and has an upper tested-frequency of 16.5 kHz. **Supplies are limited. We urge you to take advantage of these prices and stock up for your future needs.**

Sorry, we have no information about the Bose enclosures or the crossover networks, nor do we have more specs. Bose says these data are proprietary information.

8" Woofer NT541 \$ 9.95
3" Tweeter NT542 \$ 3.95

RECTIFIERS

1N4001	1.00	2N2160	.65	MU4892.50
1N4002	.60	2N2646	.45	MU4893.50
1N4003	.80	2N2647	.55	MU4894.50
1N4004	.90	2N4851	.75	2N6027 .55
1N4005	1.00	2N4852	.75	2N6028 .70
1N4006	1.10	2N4870	.50	D5E37 .35
1N4007	1.20	2N4871	.50	MU10 .35
		MU4891.50	MU20	.40

UNIUNCTIONS

HARDWARE - SOCKETS

Nylon Screws, Nuts and Rivets - 50 piece assortment \$1.99
MK 20 TO-3 Mounting Kit \$5 for \$9.99
NT-505 Mica and bushing. Specify TO-3, TO-66 or TO-220
IC Socket 14-Pin DIL \$.25 each
IC Socket 16-Pin DIL \$.27 each
Wire Wrap 16-Pin DIL \$.32 each
10 sets for \$9.99

POPULAR JEDEC TYPES

1N34	.25	2N1540	.90	2N2712	.18	2N3394	.17	2N3856	.20	2N4402	.16
1N60	.25	2N1544	.80	2N2894	.40	2N3414	.17	2N3866	1.25	2N4403	.20
1N270	.25	2N1554	1.25	2N2903	3.30	2N3415	.18	2N3903	.16	2N4409	.20
1N914	.10	2N1560	2.80	2N2904	.25	2N3416	.19	2N3904	.16	2N4410	.16
1N4148	.25	2N1605	1.75	2N2904A	.30	2N3417	.20	2N3905	.16	2N4416	.75
1S1555	.35	2N1613	.50	2N2905	.25	2N3442	1.85	2N3906	.16	2N4441	1.00
		2N1711	5.0	2N2905A	.30	2N3553	1.50	2N3954A	3.75	2N4442	1.15
2N173	.75	2N1907	4.10	2N2906	.25	2N3555	2.45	2N3955	2.45	2N4443	1.35
2N338A	1.05	2N2102	.70	2N2906A	.30	2N3565	.20	2N3957	1.20	2N4852	.55
2N404	.75	2N2160	.70	2N2907	.25	2N3638	.20	2N3958	1.20	2N5061	.30
2N443	2.50	2N2218	.25	2N2907A	.30	2N3642	.20	2N4037	.60	2N5064	.50
2N508A	.45	2N2218A	.30	2N2913	.75	2N3643	.20	2N4093	85	2N5130	.20
2N706	.25	2N2219	.25	2N2914	1.20	2N3645	.20	2N4124	.16	2N5133	.15
2N718	.25	2N2219A	.30	2N3019	1.00	2N3646	.14	2N4126	.16	2N5138	.15
2N718A	.30	2N2221	.25	2N3053	.30	2N3731	3.75	2N4141	.20	2N5294	.50
2N918	.60	2N2221A	.30	2N3054	.70	2N3740	1.00	2N4142	.20	2N5296	.50
2N930	.25	2N2222	.25	2N3055	.75	2N3771	1.75	2N4143	.20	2N5306	.20
2N956	.30	2N2222A	.40	2N3227	1.00	2N3772	1.90	2N4220A	45	2N5400	.40
2N1302	1.25	2N2270	.40	2N3247	3.40	2N3773	3.00	2N4234	.95	2N5401	.50
2N1305	.75	2N2369	.25	2N3250	.50	2N3819	.40	2N4400	.16	2N5457	.35
2N1420	.20	2N2484	.32	2N3393	.20	2N3823	.70	2N4401	.16	2N5458	.30

ALL PARTS GUARANTEED WRITE FOR FREE CATALOG



NEW-TONE ELECTRONICS

PO BOX 1738A BLOOMFIELD, N.J. 07003
PHONE: (201) 748-6171, 6172, 6173

MINI-KITS

FM WIRELESS MIKE KIT

Transmits up to 300' to any FM radio. Sensitive mike input requires dynamic, crystal or ceramic mike. Runs on 3 to 9 volts.

LED BLINKY KIT

A great attention getter which alternately flashes 2 jumbo LEDs. Use for name badges, buttons or warning type panel lights.

SUPER-SNOOP AMPLIFIER

A super-sensitive amplifier which will pick up a pin drop at 15 feet! Great for monitoring baby's room or as a general purpose audio amplifier. Full 2 watts of output, runs on 6 to 12 volts, uses any type of mike. Requires 8-ohm speaker.

MUSIC LIGHTS KIT

See music come alive! 3 different lights flasher with music or voice. One light for lows, one for the midrange and one for the highs. Each channel individually adjustable, and drives up to 300 watts. Great for parties, band music, etc. Also includes...

SIREN KIT

Produces upward and downward wail characteristic of police siren. 200mw audio output, runs on 3-8 volts, uses 8-ohm speaker.

CODE OSCILLATOR KIT

Powerful 1-watt audio oscillator of approx. 1 kHz. Good for many uses. Great for warming alarm, battery checker, voltage indicator and code oscillator.

POWER SUPPLY KIT

Complete triple regulated power supply provides variable 0-5 volts at 200ma and +5 volts at 1 amp. 50mw load regulation, good filtering and small size. Kit lets transformers, requires 5-4V at 1 amp and 18 to 30VCT.

DECADE COUNTER PARTS KIT

Includes: 7490A 33 MHz counter, 7475 latch, 7447 LED driver, LED readout, current limit resistors, hook up details and instructions on how to build an easy low cost! fun counter! Kit of Parts, DCU-1.....\$3.50



Frequency Counter

\$79.95 KIT

You've requested it, and now it's here! The CT-50 Frequency Counter Kit has more features than counters selling for twice the price. Measuring frequency is now as easy as pushing a button, the CT-50 will automatically place the decimal point in all modes, giving you quick, reliable readings. Want to use the CT-50 mobile? No problem, it runs equally as well on 12 VDC as it does on 110 VAC. Want super accuracy? The CT-50 uses the popular TV color burst freq. of 3.579545 MHz for time base. Tap off a color TV with our adapter and get ultra accuracy — .001 ppm! The CT-50 offers professional quality at the unheard of price of \$79.95. Order yours today!

- CT-50, 60MHz Counter Kit \$79.95
- CT-50WT, 60 MHz counter, wired and tested \$159.95
- CT-600, 600 MHz prescaler option for CT-50, add... \$29.95

VIDEO TERMINAL KIT \$149.95

A compact 5 x 10-inch PC card that requires only an ASCII keyboard and a TV set to become a complete interactive terminal for connection to your microprocessor asynchronous interface. Its many features are single 5-watt supply, crystal controlled sync and baud rates (up to 9600 baud), 2 pages of 32 characters by 16 lines, read to and from memory, computer and keyboard-operated cursor and page control, parity error display and control, power-on initialization, full 64-character ASCII display, block-type see-thru cursor. Keyboard/computer control backspaces, forward spaces, line feeds, rev. line feeds, home, returns cursor. Also clears page, clears to end of line, selects page 1 or 2. Reads from or to memory. The card requires 5 volts at approx. 900 ma and outputs standard 75 ohm composite video.

- TH3216 Kit \$149.95
- TH3216, Assembled and Tested \$239.95
- VD-1, Video to RF Modulator Kit \$ 6.95

600 mHz Prescaler

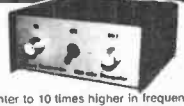

Fully assembled and tested. Extend the range of your counter to 10 times higher in frequency. Works with any counter. High sensitivity input with built-in on-chip pre-amp. PS-1B—10 \$59.95



UTILIZES NEW MOS-LSI CIRCUITRY SPECIFICATIONS

- Sensitivity: less than 25mV
- Frequency range: 5Hz to 60MHz, typically 65MHz
- Gate time: 1 second, 1/10 second, with automatic decimal point positioning on both direct and prescale
- Display: 8 digit red LED .4" height
- Accuracy: 10 ppm, .001 ppm with TV time base!
- Input: BNC, 1 meg ohm direct, 50 ohm with prescale option
- Power: 110 VAC 5 watts or 12 VDC @ 1 Amp
- Size: Approx. 6" x 4" x 2", high quality aluminum case
- Color burst adapter for .001 ppm accuracy available in 6 weeks. CB-1, Kit \$14.95



SIX DIGIT 12/24 HR CLOCK KIT

Want a clock that looks good enough for your living room? Forget the competitor's kludges and try one of ours! Features: Jumbo .4" digits, Polaroid lens filter, extruded aluminum case available in 5 colors, quality PC boards and super instructions. All parts are included, no extras to buy. Fully guaranteed. One to two hour assembly time. Colors: silver, gold, black, blue and bronze (specify).

- Clock Kit, DC-5 \$22.95
- Alarm Clock, DC-8, 12 hr. only \$24.95
- DC-5 with 10 min. ID timer \$25.95
- Mobile Version, DC-7 \$25.95
- Assembled and tested clocks available, add \$10.00 to kit price.

741 MINI DIP, house marked 10/\$2.00



Satisfaction guaranteed or money refunded. Orders under \$10 add 75¢ COD add \$5.00. NY add 7% sales tax.

CAR CLOCK KIT \$27.95



- 12/24 Hour, 12-Volt AC or DC
- High Accuracy (1 minute/month)
- 5 jumbo .4" LED readouts
- Easy, no-polarity hookup
- Display blanks with ignition
- Case, mounting bracket included
- Super instructions
- Complete Kit, DC-11 \$27.95

LINEAR

555	.50	309K	.99
556	.75	340K-12	.99
566	1.49	7805	.99
567	1.49	7812	.99
324	1.49	7815	.99
1458	.49	78MG	1.50
380	1.49	723	.49

REGS

NPN 2N3904 type	10/\$1.00
PNP 2N3906 type	10/\$1.00
NPN Power Tab 40W	3/\$1.00
PNP Power Tab 40W	3/\$1.00
FET MPF-102 type	3/\$2.00
UJT 2N2646 type	3/\$2.00
2N3055 NPN Power	.75

TRANSISTORS

NPN 2N3904 type	10/\$1.00
PNP 2N3906 type	10/\$1.00
NPN Power Tab 40W	3/\$1.00
PNP Power Tab 40W	3/\$1.00
FET MPF-102 type	3/\$2.00
UJT 2N2646 type	3/\$2.00
2N3055 NPN Power	.75

ramsey electronics

BOX 4072A ROCHESTER, NY 14610 (716) 271-6487

CIRCLE NO. 40 ON FREE INFORMATION CARD

TTL PLASTIC DUAL-IN-LINE I.C.				CMOS				CMOS				CMOS				TEXAS INSTRUMENTS I.C. SOCKETS (Low Profile Solder Tail)				
																Description				Unit Price
SN7400N	.12	SN7453N	.14	SN74132N	.69	SN74186N	7.50	CD4000BE	.13	CD4052BE	1.15	74C14/40014PC	.75	74C85/40085PC	1.20	8 Pin DIL (C840802)	.15			
SN7401N	.14	SN7454N	.14	SN74136N	.59	SN745188AN	1.85	CD4001BE	.16	CD4053BE	.89	74C85/40085PC	.65	80C97/40097PC	.65	14 Pin DIL (C841402)	.18			
SN7402N	.14	SN7460N	.14	SN74141N	.88	SN74190N	1.04	CD4006BE	.99	CD4060BE	.99	80C98/40098PC	.65	80C98/40098PC	.65	16 Pin DIL (C841602)	.19			
SN7403N	.14	SN7470N	.26	SN74142N	3.70	SN74191N	1.04	CD4007BE	.16	CD4066BE	.59	74C160/40160PC	1.50	74C160/40160PC	1.50	18 Pin DIL (C841802)	.25			
SN7404AN	.17	SN7472N	.25	SN74143N	3.98	SN74192N	.84	CD4008BE	.80	CD4068BE	.24	74C161/40161PC	1.50	74C161/40161PC	1.50	20 Pin DIL (C842002)	.39			
SN7405N	.17	SN7473N	.29	SN74144N	3.98	SN74193N	.84	CD4009BE	.37	CD4069BE	.24	74C162/40162PC	1.50	74C162/40162PC	1.50	22 Pin DIL (C842202)	.34			
SN7406N	.25	SN7474N	.28	SN74145N	6.59	SN74194AN	.89	CD4010BE	.37	CD4070BE	.24	74C163/40163PC	1.50	74C163/40163PC	1.50	24 Pin DIL (C842402)	.35			
SN7407N	.25	SN7475N	.46	SN74147N	1.58	SN74195N	.54	CD4011BE	.16	CD4071BE	.24	74C174/40174FC	1.40	74C174/40174FC	1.40	28 Pin DIL (C842802)	.34			
SN7408N	.17	SN7476N	.30	SN74148N	1.19	SN74196N	.87	CD4012BE	.16	CD4072BE	.29	74C175/40175FC	1.40	74C175/40175FC	1.40	28 Pin DIL (C842802)	.34			
SN7409N	.17	SN7480N	.35	SN74150N	.94	SN74197N	.73	CD4013BE	.29	CD4073BE	.29	74C192/40192FC	1.50	74C192/40192FC	1.50	40 Pin DIL (C844002)	.45			
SN7410N	.14	SN7481AN	.95	SN74151N	.61	SN74198N	1.64	CD4014BE	.74	CD4075BE	.29	74C193/40193FC	1.50	74C193/40193FC	1.50	40 Pin DIL (C844002)	.45			
SN7411N	.20	SN7482N	.55	SN74152N	3.45	SN74199N	1.64	CD4015BE	.74	CD4076BE	.98	74C194/40194FC	1.40	74C194/40194FC	1.40					
SN7412N	.21	SN7483AN	.65	SN74153N	.61	SN74221N	1.14	CD4016BE	.29	CD4078BE	.24	74C195/40195FC	1.40	74C195/40195FC	1.40					
SN7413N	.39	SN7484AN	1.50	SN74154N	.95	SN74246N	1.95	CD4017BE	.79	CD4081BE	.24									
SN7414AN	.62	SN7485N	.84	SN74155N	.70	SN74247N	1.70	CD4018BE	.79	CD4082BE	.29	SG3501AT	3.60	SG3501AT	3.60	Variable Dual Tracking Regulator ±35V ±9.5V				
SN7416AN	.24	SN7486N	.30	SN74156N	.64	SN74248N	1.75	CD4019BE	.38	CD4085BE	.75	SG3524J	7.25	SG3524J	7.25	Fixed ±15V Dual Tracking Regulator T05	2.35			
SN7417N	.29	SN7489N	1.85	SN74157N	.59	SN74249N	1.75	CD4020BE	.84	CD4086BE	.75	SG4501T	1.80	SG4501T	1.80	Fixed ±15V Dual Tracking Regulator T066	3.15			
SN7420N	.14	SN7490AN	.43	SN74159N	2.50	SN74251N	1.05	CD4021BE	.89	CD4502BE	1.15	RC1494TK	3.95	RC1494TK	3.95	5 Amp 5 Volt Positive Regulator T03	6.35			
SN7421N	.20	SN7491AN	.59	SN74160N	.85	SN74259N	1.35	CD4022BE	.89	CD4507BE	.39	RC1495TK	2.35	RC1495TK	2.35	7800 Series	.99			
SN7422N	.20	SN7492AN	.44	SN74161N	.85	SN74265N	.85	CD4023BE	.67	CD4510BE	1.05	78050K	6.35	78050K	6.35	TO-220 / LM340T	1.39			
SN7423N	.25	SN7493AN	.44	SN74162N	.85	SN74273N	1.35	CD4024BE	.67	CD4511BE	1.25	7800 Series	.99	7800 Series	.99	TO-5 / LM340H	1.49			
SN7425N	.25	SN7494AN	.69	SN74163N	.85	SN74276N	.75	CD4025BE	.16	CD4512BE	.69	78L00 AWC Series	.29	78L00 AWC Series	.29	TO-3 / LM340K	2.00			
SN7426N	.22	SN7495AN	.67	SN74164N	.98	SN74278N	1.99	CD4026BE	.39	CD4514BE	2.50	7800 Series	1.39	7800 Series	1.39	7800 Series	1.39			
SN7427N	.25	SN7496N	.65	SN74165N	.97	SN74279N	.57	CD4027BE	1.38	CD4515BE	2.50	TO-5 / LM340H	1.49	TO-5 / LM340H	1.49	TO-5 / LM340H	1.49			
SN7428N	.28	SN7497N	2.50	SN74166N	1.09	SN74283N	1.39	CD4028BE	.74	CD4516BE	.84	7800 Series	1.49	7800 Series	1.49	7800 Series	1.49			
SN7430N	.14	SN74100N	.97	SN74167N	2.75	SN74284N	4.50	CD4029BE	.78	CD4518BE	.84	TO-3 / LM340K	2.00	TO-3 / LM340K	2.00	TO-3 / LM340K	2.00			
SN7432N	.23	SN74104AN	.42	SN74170N	1.69	SN74285N	4.50	CD4030BE	.37	CD4519BE	.79	7800 Series	1.49	7800 Series	1.49	7800 Series	1.49			
SN7433N	.30	SN74105N	.42	SN74172N	8.75	SN74290N	.85	CD4031BE	1.60	CD4520BE	.79	TO-3 / LM340K	2.00	TO-3 / LM340K	2.00	TO-3 / LM340K	2.00			
SN7437N	.21	SN74107N	.28	SN74173N	1.24	SN74293N	.83	CD4033BE	.37	CD4519BE	.79	7800 AWC Series	.29	7800 AWC Series	.29	7800 AWC Series	.29			
SN7438N	.21	SN74109N	.47	SN74174N	.94	SN74294N	1.64	CD4038BE	1.60	CD4520BE	.79	TO-92	1.25	TO-92	1.25	TO-92	1.25			
SN7440N	.14	SN74110N	.52	SN74175N	.84	SN74351N	1.92	CD4034BE	2.95	CD4522BE	1.98	7900 Series	1.25	7900 Series	1.25	7900 Series	1.25			
SN7442N	.37	SN74111N	.69	SN74176N	.77	SN74365N	.65	CD4035BE	.98	CD4526BE	1.50	TO-220 / LM320T	1.25	TO-220 / LM320T	1.25	TO-220 / LM320T	1.25			
SN7443N	.68	SN74116N	1.50	SN74177N	.76	SN74366N	.65	CD4040BE	.99	CD4527BE	1.50	7900 Series	1.35	7900 Series	1.35	7900 Series	1.35			
SN7444AN	.85	SN74120N	1.40	SN74178N	1.19	SN74367N	.65	CD4041BE	.67	CD4528BE	1.20	TO-5 / LM320H	2.00	TO-5 / LM320H	2.00	TO-5 / LM320H	2.00			
SN7445AN	.65	SN74121N	.34	SN74179N	1.49	SN74368N	.65	CD4042BE	.58	CD4531BE	1.25	7900 Series	1.75	7900 Series	1.75	7900 Series	1.75			
SN7446AN	.70	SN74122N	.38	SN74180N	.67	SN74376N	.75	CD4043BE	.45	CD4539BE	1.20	TO-3 / LM320K	2.00	TO-3 / LM320K	2.00	TO-3 / LM320K	2.00			
SN7447AN	.59	SN74123N	.48	SN74181N	1.94	SN74390N	1.40	CD4044BE	.45	CD4555BE	.75	78MGT2C	1.20	78MGT2C	1.20	78MGT2C	1.20			
SN7448N	.69	SN74125N	.40	SN74182N	.59	SN74393N	1.40	CD4046BE	2.45	CD4556BE	.75	79MGT2C	1.20	79MGT2C	1.20	79MGT2C	1.20			
SN7450N	.14	SN74126N	.40	SN74184N	1.75	SN74426N	.45	CD4047BE	2.45	CD4581BE	2.25									
SN7451N	.14	SN74128N	.59	SN74185AN	1.74	SN74490N	1.90	CD4049BE	.34	CD4582BE	1.95	78GU1 TO-220	1.45	78GU1 TO-220	1.45	78GU1 TO-220	1.45			
								CD4050BE	.34	CD4585BE	1.80	79GU1 TO-220	1.25	79GU1 TO-220	1.25	79GU1 TO-220	1.25			
								CD4051BE	.89			78GK TO-3	1.80	78GK TO-3	1.80	78GK TO-3	1.80			
												79GK TO-3	2.10	79GK TO-3	2.10	79GK TO-3	2.10			



Our new comprehensive 1978 Catalogue, listing complete descriptions, illustrations and special monolithic pricing on over 10,000 items, is now available on request.

Active Electronic Sales Corp.

P.O. BOX 1035 FRAMINGHAM, MASSACHUSETTS 01701
OVER-THE-COUNTER SALES, 12 Mercer Rd., Natick, Mass. 01760 Behind Zayres on Rte. 9
Telephone Orders & Enquiries (617) 879-0077
MINIMUM ORDER \$10.00 + ADD \$2.00 TO COVER POSTAGE & HANDLING * Canadian customers add 15% for exchange and handling. All federal and provincial taxes extra. Foreign customers please remit payment on an international bank draft or international postal money order in American dollars.
IN CANADA 5651 Ferrier st. 44 Paqueton Dr. Unit 26
Montreal, Quebec H4A 3R5
2 Locations Tel: (514) 736-6426 Tel: (416) 676-3311

CIRCLE NO. 3 ON FREE INFORMATION CARD

EDMUND SCIENTIFIC

NEW WIDE FIELD TELESCOPE

Astroscan lets you enjoy clear, bright, wide-angle views of stars, moon, comets, etc. Completely portable, this unique 4 1/4", f/4 Newtonian reflector houses top quality optics. Designed for ease of handling and use, Astroscan weighs only 10 lbs. and stands 17" high. What an instrument!

No. 2001

\$149.95 Ppd.



KNOW YOUR ALPHA FROM THETA!

For greater relaxation & concentration, monitor your Alpha/Theta brainwaves with audio or visual signals on Biosone II. Features of \$200-up units. Incl. 3 feedback modes! 4-lb.

No. 1668 **\$149.95** Ppd.

No. 71,809 (FOR BEGINNERS) **\$59.95**

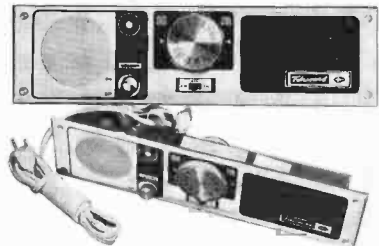

Free Catalog

STOP WATCH WITH PROFESSIONAL TIMING ACCURACY FOR ONLY \$39.95

Used at AAU, NCAA, and the Olympics this two function stop watch times single segments of events with time in/out delays. Press the button and stop watch displays time action stopped—then resumes with next button press. Accurate to 1 sec./yr.; bright LED display reads to 59.99.99, runs on disposable batts. (incl.); lanyard; 1-yr. warranty.

No. 1695 **\$39.95** Ppd.



SAVE 25%—DELUXE AM/FM WALL RADIO

Great surplus buy saves you 25% on brand new AM/FM Deluxe Wall Radio w/ handsome silver/black control panel. Mount anywhere den, kitchen, bedroom, office, workshop. Self-cont. Philco-Ford radio chassis (14 1/4 x 3 1/2 x 3 1/2") w/11 transistors, vol. control, AM/FM hi-sensitivity tuner, AFC, 2 3/4" dia. speaker, 7 1/2" 110V AC cord. Orig. cost \$30 ea. in 3000 quant. for nat'l motel chain. Buy several now.

No. 72,275 (READY TO PLAY) **\$22.50** Ppd.

MAX.-MIN. THERMOMETER FIND OUT HOW COLD IT WAS

This self-registering maximum-minimum thermometer shows high and low temperatures in 2° increments from -40 to +120 F. See how temperatures vary in a day or why fuel costs are so high for a given period. Resets with magnet. Mounting screws. 2 1/2 x 10 1/2".

No. 71,478

\$16.00 Ppd.



Free Catalog

TRACK & FORECAST THE WEATHER WITH YOUR HOME WEATHER STATION



The Edmund Deluxe Weather Station combines high quality instruments with the best forecasting materials. Measure wind speed, barometric pressure, precipitation, temperature, humidity, cloud types & wind-chill. Kit includes: wind speed indicator, rain gauge, holosteric barometer, thermometer, wet & dry bulb hygrometer, 372-pg. Weather Log, cloud chart, wind-chill chart, and U.S. Weather Bureau symbol log.

No. 80,216 **\$79.50** Ppd.

REST YOUR MIND WITH THE EDMUND PROFESSIONAL SOUND CONDITIONER

Unique new scientific device masks unwanted noise while adding restful, interesting background sounds. Modern electronics now simulates soothing sounds of ocean surf, falling rain, and a rushing waterfall. 5" dia. speaker, on-off volume controls, tone control, & 4 sound channel adjustments. 7 1/2" AC cord.

No. 72,293 **\$129.95** Ppd.



SUPER POWER FOR ANY AM RADIO
Antenna assist has pulled in station 1,000 miles off! No wires clips, grounding. Solid state. No batteries, tubes, plugs.

No. 72,095

\$19.95 Ppd.

ULTRA SELECT-A-TENNA

No. 72,147 **\$24.95** Ppd.

Send for your FREE 164 page Edmund Scientific Catalog with over 4000 bargains



SPOTTING SCOPE... TAKE A GOOD LOOK... AT NATURE, SPORTS & THE WORLD
Precision 10X spotting scope with fully-coated optics. 30mm objective lens has twice the light gathering power of standard 20mm lenses. Weighs a mere 11 oz. and offers a field of view of 183 ft. at 1,000 yds. 10" long.

No. 72,218 **\$19.95** Ppd.

ORDER FREE CATALOG HERE

TO ORDER PRODUCTS USE THIS COUPON

EDMUND SCIENTIFIC CO.
Dept. AV02, Edscorp Bldg.
Barrington, N.J. 08007

Send **GIANT 164 Page Catalog** packed with unusual bargains.

Name _____
Address _____
City _____
State _____ Zip _____

EDMUND SCIENTIFIC CO.
Dept. AV01, Edscorp Bldg.
Barrington, N.J. 08007



Charge my Amer. Exp. BAC (VISA) MC
Interbank # _____ Acct. # _____
Card # _____ Exp. Date _____
Sig. _____

Please send me the following items I have indicated below:

Stock No.	Qty.	Price
N.J. residents add 5% sales tax		Handling \$1.00

30 DAY GUARANTEE
You must be completely satisfied with any Edmund item or return it within 30 days for a full refund.

Name _____
Address _____
City _____ State _____ Zip _____

POLY PAK'S IS THE "BARREL KIT KING" OF THE WORLD!

Poly Pak's EXCLUSIVE Avg. Ship. Wt. 6 ozs.



100'S OF BARRELS PURCHASED!

For the first time anywhere, Poly Pak merchandisers introduce a new way in buying the economical way...

throughout the United States buy from various factories... their overruns in barrels, Poly Pak has done the same.

98 YOUR CHOICE OF ANY KIT Every kit carries a money back guarantee!

Buy 10 BARREL KITS AND CHOOSE THE 11TH KIT Free

BARREL KIT #239 SHIELDED CABLE 40-ft. \$1.98

POLY PAKS CHIPS AWAY IC & XTAL PRICES

BARREL KIT #225 SOUND TRIGGERS 3 for \$1.98

BARREL KIT #221 IC SOCKETS 8 for \$1.98

BARREL KIT #219 MIXED READOUTS 15 for \$1.98

BARREL KIT #244 HOBBY 1702A ROMS 3 for \$1.98

BARREL KIT #205 MINI BLOCK CAPACITORS 50 for \$1.98

BARREL KIT #184 1/4-WATT METAL FILM 150 for \$1.98

BARREL KIT #203 CALCULATOR KEYBOARDS 10 for \$1.98

BARREL KIT #201 6V INDICATORS w/leads 15 for \$1.98

BARREL KIT #200 6 DIGIT READOUT MODULES 5 for \$1.98

BARREL KIT #185 PC BOARDS 400 PARTS \$1.98

BARREL KIT #160 HOBBY VOLTAGE REGULATORS 10 for \$1.98

BARREL KIT #159 MODULAR SWITCHES 25 for \$1.98

BARREL KIT #149 ROCKER SWITCHES 12 for \$1.98

BARREL KIT #182 JUMBO RED LEDS 100 for \$1.98

BARREL KIT #177 LED DRIVER IC'S 30 for \$1.98

BARREL KIT #163 MINI TRIM POTS 30 for \$1.98

BARREL KIT #144 RCA PHONO PLUGS 40 for \$1.98

BARREL KIT #138 PANEL SWITCHES 30 for \$1.98

BARREL KIT #128 MINI-DIP IC'S 100 for \$1.98

BARREL KIT #109 TERMINAL STRIPS 100 for \$1.98

BARREL KIT #171 CAPACITOR SPECIAL 100 pcs. \$1.98

BARREL KIT #127 AXIAL ELECTROS 40 for \$1.98

BARREL KIT #126 UPRIGHT ELECTROS 40 for \$1.98

BARREL KIT #115 MOLEX SOCKETS 150 for \$1.98

BARREL KIT #108 MALF WATTERS 200 for \$1.98

BARREL KIT #107 TRANSISTOR ELECTROS 100 for \$1.98

BARREL KIT #104 SLIDE VOLUME CONTROLS 15 for \$1.98

BARREL KIT #107 SQUARE OHMS 50 for \$1.98

BARREL KIT #86 HOBBY LEDS 40 for \$1.98

BARREL KIT #83 LM-340T VOLTAGE REGULATORS 5 for \$1.98

BARREL KIT #76 1-WATT ZENERS 100 for \$1.98

BARREL KIT #54 6 & 8 DIGIT READOUTS 10 for \$1.98

BARREL KIT #40 HOBBY PNP TRANSISTORS 15 for \$1.98

BARREL KIT #28 2 WATTERS 100 for \$1.98

BARREL KIT #62 MIXED IC'S 100 for \$1.98

BARREL KIT #61 POLYSTYRENE CAPS 100 for \$1.98

BARREL KIT #56 POWERS! POWERS! 100 for \$1.98

BARREL KIT #31 METALLIC RESISTORS 100 for \$1.98

BARREL KIT #27 VOLUME CONTROL BONANZAI 30 for \$1.98

BARREL KIT #28 2 WATTERS 100 for \$1.98

BARREL KIT #36 GERMANIUM DIODES 200 for \$1.98

BARREL KIT #28 SLIDE SWITCHES 25 for \$1.98

BARREL KIT #35 NEON LAMPS 30 for \$1.98

BARREL KIT #24 6 & 8 DIGIT READOUTS 10 for \$1.98

BARREL KIT #30 PREFORMED RESISTORS 200 for \$1.98

BARREL KIT #27 PREFORMED DISCS 150 for \$1.98

BARREL KIT #26 PLASTIC TRANSISTORS 100 for \$1.98

BARREL KIT #25 METAL CAN TRANSISTORS 200 for \$1.98

BARREL KIT #21 POWER TAB TRANSISTORS 40 for \$1.98

BARREL KIT #19 DIPPEO MYLARS 60 for \$1.98

BARREL KIT #17 LINEARS AND 7400'S DIPS 100 for \$1.98

BARREL KIT #24 4000'S RECTIFIERS 100 for \$1.98

BARREL KIT #23 LINEAR OP AMPS DIPS 75 for \$1.98

BARREL KIT #22 LINEAR OP AMPS DIPS 75 for \$1.98

BARREL KIT #21 LINEAR OP AMPS DIPS 75 for \$1.98

BARREL KIT #18 LINEAR OP AMPS DIPS 75 for \$1.98

BARREL KIT #16 LINEAR OP AMPS DIPS 75 for \$1.98

BARREL KIT #14 PRECISION RESISTORS 200 for \$1.98

Send for your FREE POLY PAKS CATALOG FEATURING THE WORLD'S BEST BARGAINS IN ELECTRONICS

© Poly Paks Inc., Wakefield, Mass., U.S.A. 1977 CIRCLE NO. 37 ON FREE INFORMATION CARD

ELECTRONICS Market Place

Terms: Add postage Rated: net 30 Phone: Wakefield, Mass. (617) 245-3829

POLY PAKS P.O. BOX 942E LYNNFIELD, MA. 01940

New! ECONORAM VI™

**12Kx8 memory kit
for the Heath H8**
\$235.00

We proudly welcome our newest memory board family member, designed from the ground up for full compatibility with the Heath Company H8. Organized as two independent blocks, one 8K block and one 4K. Has the same basic features as our ECONORAM I™—all static design, switch selected protect and phantom, sockets for all ICs, full buffering—plus the required hardware and edge connector to mate mechanically with the H8. You can have our 12K board for the price of the Heath Company's 8K ... with the performance you've come to expect from products carrying the ECONORAM™ name.

ECONORAM II™



Popular 8K x 8 memory plugs into Altair, IMSA, other S-100 machines. Two independent 4K blocks with separate protect and vector interrupt provision if you try to write into protected memory. Handles DMA devices. Fully buffered. Tri-state outputs. Selectable write strobe. Sockets for all ICs. Join the thousands who have made this our most popular board!

Kit form \$130: assembled, tested warranted for 1 year \$150; SPECIAL - Four ECONORAM I™ kits \$475 (32K of memory)

ECONORAM III™

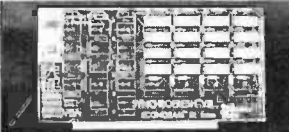

The first 8K x 8 dynamic RAM that performs well enough to merit the ECONORAM™ name. Not a kit— assembled, tested, ready to run in your S-100 machine. (Altair etc.). Low power. Configuration as 2 separate 4K blocks. Zero wait states with 8080 CPU.

Includes 1 year warranty **\$149.00**

Selected computer kits

10 SLOT MOTHERBOARD (\$90; 18 SLOTS \$124) These S-100 motherboards come with edge connectors and active termination circuitry.

ACTIVE TERMINATOR (\$29.50) Plugs into S-100 buss motherboards lacking active termination; cleans up the glitches associated with unterminated lines.

12 Volt, 8 Amp Power Supply Kit



\$44.50 brings you crowbar over-voltage protection, current limiting, output protection, and easy assembly. Use with ham, CB, automotive equipment when you need hefty AC power. Less case hardware.

GODBOUT

BILL GODBOUT ELECTRONICS
BOX 2355, OAKLAND AIRPORT, CA 94614

TERMS: Please allow up to 5% for shipping; (10% for 12V supply); excess refunded. Cal res add tax. COD orders OK with street address for UPS. VISA® /Mastercharge® orders call (415) 562-0636, 24 hours.

FREE FLYER: We carry many items of interest to all electronic hobbyists. Send us your name and address, we'll send you our current flyer.

CIRCLE NO. 16 ON FREE INFORMATION CARD

Operation Assist

If you need information on outdated or rare equipment—a schematic, parts list, etc.—another reader might be able to assist. Simply send a postcard to Operation Assist, POPULAR ELECTRONICS, 1 Park Ave., New York, NY 10016. For those who can help readers, please respond directly to them. They'll appreciate it. (Only those items regarding equipment not available from normal sources are published.)

I.T.T. Model 1735D oscilloscope. Schematics or information for power supply. Allen Currey, 330 Scott Dr., Silver Spring, MD 20904.

B&K TV Analyst Model 1075. Manual and/or schematic. Harry Matosian, 14035 Hartsook St., Sherman Oaks, CA 91423.

Halicrafter S-38C shortwave receiver. Schematic or any available information. Mark Stefanik, 20 Old Farm Rd., Cedar Knolls, NJ 07927.

REK-o-KUT Model R-34 manual turntable. Need drive belt. Arthur C. Reynolds, 1841 Isabella Ave., Monterey Park, CA 91754.

Novus Scientist PR calculator. Need Programs. E.C. Fante, 3085 Adams Way, Santa Clara, CA 95051.

Jefferson-Travis Radio Model 350-A-1. Schematics and any other information. Richard Harris, Box 518, Chase City, VA 23924.

Philco Standard shortwave radio Model 19A, Code 121. Schematic. R. Mills, 46 Harts Lane, Guelph, Ontario, CAN.

Sherwood SA-5200 tube-type stereo amplifier. Schematic. Fred Avery, Box 5883, Raleigh, NC 27607.

Pioneer Model SX-82 stereo receiver. Schematic and service manual. Eric Archer, 3402 Community Ave., Glendale, CA 91214.

Masco Commercial PA amplifier Model MA60. Operator's manual and schematic. Van Lynn Floyd, R.R. #1, Box 94, Johnson, KS 67855.

Halicrafter Model S40A. Prints and documentation. Richard Fumari, 33 Highland Ave., Yonkers, NY 10705.

International 100D Executive CB transceiver and external speakers meter. Schematics and service manual. Larry R. Jewell, 223 Cedar Springs Rd., Spartanburg, SC 29302.

Hammarlund Super-Pro Model ASP 779 shortwave receiver. Schematic, parts list, service and operator's manual. Nelson Allan, Box 164, New Hartford, NY 13413.

Friden (Singer) Model EC1114, 14 digit desk calculator. Schematic or service manual. Robert Miller, Rt. 1, Anadarko, OK 73005.

Dumont Model 208 oscilloscope. Schematic and service manual. Alex P. Cameron, Rt. 3 Box 93, Samson, AL 36477.

Tektronix, Inc. Model S-32 Serviscope oscilloscope. Otto R. Jans, 400 Grove St., Ridgewood, NJ 07450.

Heathkit Oscilloscope 10-21. Schematic. R.L. Conhalm, 1329 Stanley Ave., Dayton, OH 45404.

Feranti 3 Band, 220-V ac-dc, 6-tube receiver. Model # unknown. Schematic, company address. Stephen Ostrom, 2167 Beaumont Rd., Ottawa, Ontario, CAN K1H 5V2.

Seeburg Select-o-matic 100 Model M 100-B, Ser. 5830. **Seeburg** Wall-o-matic 100 Model 3W-1, Ser. 10203. Service manuals and sources. Rod Stebbell, 6155 Coonpath Rd., Carroll, OH 43122.

Harvey Wells Model TBS-50 Amateur Transmitter. Owner's manual and schematic. Patrick W. Keogh, 1404 So. 87th St., West Allis, WI 53214.

Grand 5-Brand Radio, Model FP-1211-G. Dial string instruction and diagram. Bernard Grupe, 3012 Highland Dr., Gary, IL 60013.

Gonset Communicator 2, 2-meter VFO, VHF Amp Model 3063. Manuals. Richard Dawson, 1308 F. St., The Dalles, OR 97058.

Vernon 47/26 Tape Recorder. Schematic. James L. Ne-gron, Box 162, Sandy Spring, MD 20860.

General Electric sweep generator Model ST-4A, **General Electric** marker generator ST-5A. Schematic, operating

POPULAR ELECTRONICS

DISCOUNT ON ALL IC'S AND LED'S 10% OFF ON \$25.00 15% OFF ON \$50.00

2708 FULL SPEED ROM \$14.95	5314 6 DIGIT CLOCK CHIP \$2.95
2102 500NS 1 K RAM \$1.29	74S200 256 BIT RAM TRI-STATE \$3.25
8080A, 8008 \$16.95	UART
LD110, LD111 3 1/2 DIGIT A/D CONVERTER SET \$24.75	AYS1013A \$6.95
82S23 256 BIT PROM \$2.95	2513 CHARACTER GEN 64 x 8 x 5 ASCII \$8.95

CERAMIC CAPACITORS 50V	
0-10	\$.16 ea
10-100	\$.05 ea
1pf	56pf 270pf .001uf
5pf	68pf 390pf .0047uf
7pf	82pf 470pf .01uf
10pf	100pf 600pf .01uf/1KV
22pf	120pf 820pf .022uf
27pf	150pf .030uf
33pf	180pf .050uf
47pf	220pf .1uf

IC SOCKETS	
Solder Tall - low profile	
8 pin	24 pin .42
14 pin	28 pin .59
16 pin	40 pin .69
18 pin	.79

LINEAR CIRCUITS			
LM300D	\$.71	LM372N	2.93
LM301CN	29	LM376CN	5.9
LM302H	65	LM380N	1.29
LM304H	.80	LM380-6CN	95
LM307CN	26	LM381N	1.75
LM307H	.30	LM382N	1.75
LM308H	.89	LM385K	.45
LM309H	1.05	NE551V	2.90
LM309K	.99	NE540L	2.90
LM310CN	1.07	NE548A	1.09
LM311CN	.89	NE550A	75
LM311H	.89	LM555CN	39
LM319N	1.13	LM556A	85
LM320K	5, 5, 2, 12, 15	LM560N	2.95
LM320T	5, 5, 2, 12, 15	LM565N	1.19
LM322N	1.59	LM566H	1.19
LM324N	1.52	LM567CN	1.49
LM329N	1.58	LM703H	59
LM340K	1.19	LM703CN	39
LM340T	1.19	LM709N	25
LM340T	1.19	LM709H	29
LM340T	1.19	LM710N	59
LM340T	1.19	LM711N	39
LM340T	1.19	LM723H	55
LM340T	1.19	LM723N	52

ELECTRONIC DOOR CHIME KIT

WITH T1 TMS 1000
MICROPROCESSOR CHIP
PROGRAMMED TO PLAY
24 DIFFERENT TUNES

INTERNATIONAL FLAVOR — PLAYS NATIONAL ANTHEMS OF U.S., BRITAIN, FRANCE, AND WEST GERMANY PLUS OTHER TUNES, CLASSICAL AND TRADITIONAL MELLODIES.

* SUPPLIED WITH ALL PARTS INCLUDING PCB BOARD, SPEAKER, CASE AND COMPLETE INSTRUCTION MANUAL WITH 16 FLUORESCENT DISPLAYS.

* USED 24V TRANSFORMER BATTERIES NOT SUPPLIED.

* LOW POWER ECONOMY DESIGN.

* INTERNAL SELECTION OF TUNE, VOLUME, PULSE AND TIMING FUNCTIONS.

* PROGRAMMED MATHEMATICALS TO PLAY IN PERFECT PITCH PERMANENTLY.

* ATTRACTIVE CASE, COMPACT WALL MOUNT.

\$39.50 SHIPPING \$1.00

For faster service
USE ZIP CODE
on all mail

Satisfaction guaranteed. Shipment will be made postage prepaid within 3 days from receipt of order. Payment may be made with personal check, charge card (include number and exp. date), or money order. Phone Orders — BoA and M/C card or C.O.D. **FREE CATALOG AVAILABLE ON REQUEST** Add \$1.00 to cover shipping and handling if order is less than \$10.00. California residents add sales tax. Include shipping expense for orders shipped out of U.S. and Canada approx. 10% of order.

INTERNATIONAL ELECTRONICS UNLIMITED
VILLAGE SQUARE, P.O. BOX 449, CARMEL VALLEY, CA 93924 USA
TELEPHONE 408 659-3171

CIRCLE NO. 21 ON FREE INFORMATION CARD

ACOUSTIC COUPLER BY NOVATION

\$47.50



This originate only coupler was manufactured for use in T.1. 725 data terminal. It is compatible with Bell 103 and 113 data sets or the equivalent. The coupler operates asynchronously to a maximum speed of 300 baud in the full or half duplex mode. All signal outputs are compatible with TTL. Transmitt freq. is 1270hz, for mark and 1070hz, for space. Receive freq. is 2225hz, for mark and 2025hz, for space. Unit requires +/- 12 volts and +5 volts for operation. Complete with schematic and all pertinent information. Fully reconditioned, calibrated, and guaranteed.

LOOK!

NEW! GREEN INSERT, DBM-25-S CONNECTOR SALE! SOLDER-CUP PINS. ONLY \$3.50 EACH 10 FOR \$32.50



NEW "AA" EVEREADY BATTERY Stack-up can. This super savings. ONLY \$2.5ea. 10 for \$2.00

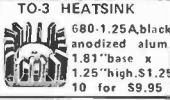

TO-3 HEATSINK 680.125A black 1.81" base x 1.25" high, \$1.25 10 for \$9.95

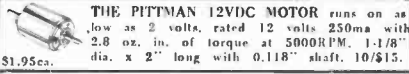

THE PITTMAN 12VDC MOTOR runs on as low as 2 volts, rated 12 volts. 250ma with 2.8 oz. in. of torque at 500RPM. 1-1/8" dia. x 2" long with 0.118" shaft. 10/\$15. \$1.95 ea.

SPRAGUE 36D POWERLYTICS

LIKE NEW PARTS AT USED PRICES! PULLED FROM NEW EQUIPMENT AND OFFERED TO YOU AT SUBSTANTIAL SAVINGS. AVAILABLE IN: 5500MFD @ 40V 8200MFD @ 25V YOUR CHOICE \$1.00 EA. 10 FOR \$7.95

EAGLE-PICHER BATTERY

CF6V5, 6 VOLT 5AH. SPILL-PROOF. RECHARGEABLE BATTERY. \$12.50EA. 10/\$99.95. NEW-1 YEAR WARRANTY.

BEST SELLERS!

KYNAR WIRE WRAP WIRE. Solid silver plated 30AWG available in blue, red, yellow, black, green, or white. 100' spool for \$2.50; 500' spool for \$5.95; 1000' spool for \$9.95. 26AWG red or black 500' spool for \$7.95; 1000' spool for \$12.50

60HZ. MINI KIT SPECIAL OFFER ON 60HZ. CRYSTAL TIME BASE KIT INCLUDES MM5369 AND 3579.54SKHZ. CRYSTAL WITH SCHEMATIC. \$3.95

12VDC COOLING FAN

THAT'S RIGHT! A 12VDC! IDEAL FOR SMALL COOLING PROBLEMS. 2 1/2" BLADE DIA. ONLY \$4.95

THERMALLOY THERMALLOY 6030B flat power device heat sink. heat sink. \$2.5ea. 10/\$1.98. \$7.5ea. 10/\$5.00

EDGE CONNECTOR

43/86 PIN DUAL READ-OUT. .156 SPACING WITH SOLDER EYELET PINS. USED, BUT YOU WILL LOVE THEM AT \$1.00 EACH.

HOOK-UP WIRE

Stranded 22 GA. available in white, brown, orange, red, black, blue, purple, yellow, green, or gray. 200 FT. SPOOL. \$3.50

MINIMUM ORDER \$10 SEND FOR FREE CATALOG

TERMS: Send check or money order. NO COD. Texas residents add 5% sales tax. Canada and Mexico add \$2.50. Overseas countries add \$5.00 for surface rates. We pay postage up to 10 pounds.

ACE ELECTRONIC PARTS 5400 MITCHELLDALE B-8 HOUSTON, TEXAS 77092 (713) 688-8114

CIRCLE NO. 2 ON FREE INFORMATION CARD

manuals. Richard Roggeveen, 5569 Dunsbury Ct., San Jose, CA 95123.

Knight Model 150 transmitter and R-99 receiver. Operating manual and schematic. Mike Libonati, 100 Sullivan St., New York, NY 10012.

Heathkit Model W-2 power amplifier. Need output transformer. John Milliron, 1115 Barkley Dr., Charlotte, NC 28109.

Paco Model S-55 oscilloscope. Schematic and operating manual. Ed Palmer, #26-67 Angus Rd., Regina, Sask. CAN S4R 3L1.

Military oscilloscope Model OS-4B/AP, # N383-46496A. Schematic and instruction manual. Carl G. Kramer, 2525 Midline Dr., York, PA 17404.

Schuttig & Co. Diversity Receiving TTY converter serial #61 made for U.S. Army Signal Corps. Information and schematics. Richard Dawson, 1308 F. St., The Dalles, OR 97058.

Philco Model 40-95 Code 122 console battery radio. Schematic, parts list, and source. Robert Michael, R.D. 3442, Fleetwood, PA 19522.

ABOUT YOUR SUBSCRIPTION

Your subscription to POPULAR ELECTRONICS is maintained on one of the world's most modern, efficient computer systems, and if you're like 99% of our subscribers, you'll never have any reason to complain about your subscription service.

We have found that when complaints do arise, the majority of them occur because people have written their names or addresses differently at different times. For example, if your subscription were listed under "William Jones, Cedar Lane, Middletown, Arizona," and you were to renew it as "Bill Jones, Cedar Lane, Middletown, Arizona," our computer would think that two separate subscriptions were involved, and it would start sending you two copies of POPULAR ELECTRONICS each month. Other examples of combinations of names that would confuse the computer would include: John Henry Smith and Henry Smith; and Mrs. Joseph Jones and Mary Jones. Minor differences in addresses can also lead to difficulties. For example, to the computer, 100 Second St. is not the same as 100 2nd St.

So, please, when you write us about your subscription, be sure to enclose the mailing label from the cover of the magazine—or else copy your name and address exactly as they appear on the mailing label. This will greatly reduce the chance of error, and we will be able to service your request much more quickly.

Same day shipment. First line parts only. Factory tested. Guaranteed money back. Quality IC's and other components at factory prices.

INTEGRATED CIRCUITS

Table listing various integrated circuits with part numbers and prices.

P.O. Box 4430C Santa Clara, CA 95054 (408) 988-1640



Table listing various electronic components and their prices.

3 1/2 Digit Multimeter \$49.95 Batt. oper. 1mV and .1NA resolution. Resistant to 20 meg. 1% accuracy. Small, portable, completely assy. in case. 1 year guarantee.

Not a Cheap Clock Kit \$14.95 Includes everything except case. 2-PC boards. 6-50' LED Displays. 5314 clock chip, transformer, all components and full instructions. Same clock kit with .80" dtsplays. \$21.95

Digital Temperature Meter Kit Indoor and outdoor. Automatically switches back and forth. Beautifully 50' LED readouts. Nothing like it available. Needs no additional parts for complete, full operation. Will measure -100° to +200°F, air or liquid. Very accurate. Complete instructions. \$39.95

Clock Calendar Kit \$19.95 CT0715 direct view chip displays date and time on 6' LEDs with AM-PM indicator. Alarm/doze feature includes buzzer. Complete with all parts, power supply and instructions, less case.

1977 IC Update Master Manual Final 1977 closest out \$15.00 while they last. 1978 Master available late Jan. 1978 \$30.00. Complete IC data selector, 1234 pg. master ref. guide, 17,000 cross references. Free update for 1977. Domestic postage \$2.00. Foreign \$5.00

RCA Cosmac VIP Kit 275.00 Video computer with games and graphics.

Original Cosmac "ELF" kit with PC board, monitor, power supply plus all parts and instructs. \$89.50 Board only 14.95

60 Hz Crystal Time Base Kit \$4.75 Converts digital clocks from AC line frequency to crystal time base. Outstanding accuracy. Kit includes: PC board, MM5369, crystal, resistors, capacitors and trimmer.

New Cosmac Super "ELF" RCA Cosmac expandable microcomputer w/HKX keypad Input and video output for graphics. Just turn on and start loading your program using the resident monitor on ROM. Pushbutton selection of all four CPU modes. LED indicators of current CPU mode and four CPU states. Single step op. for program debug. Built in pwr. supply, 256 Bytes of RAM, audio amp. & spkr. Detailed assy. man. w/PC board & all parts. Comp. Kit \$106.95 Custom hardware cab.; drilled front panel 19.75 Nicad Battery Backup Kit w/all parts 4.95 Fully wired and tested in cabinet 151.70 1802 software xchng. club; write for info.

Original Cosmac "ELF" kit with PC board, monitor, power supply plus all parts and instructs. \$89.50 Board only 14.95

4 1/2 Digit DMM kit \$85.00 Volts—ohms—milliammeter accuracy +/- 1 count. Ranges: Volts—2, 20, 200. Ohms —2K, 2meg, 20 meg. Ma—200, 2000. .4" display. Variable update rate. Comp. w/all parts, PC boards, instructs., less case.

Paratronics 100A Logic Analyzer Kit \$199.00

Converts an oscilloscope into a digital tester and analyzer. Trace computer program flow, monitor I/O sequences, etc. Trouble shoot all digital, CMOS and MOS families. 128 bit truth table (8 by 16 bits). Complete with case, parts and instructs. Model 10 Trigger Expander Kit expands Model 100A to 24 bits \$229.00. Model 150 Bus Grabber Kit \$369.00, a one board logic analyzer for S-100 bus applications. Instant access to 56 S-100 bus signals. Complete kit with all parts and instructs.

2.5 MHz Frequency Counter Kit Complete kit less case \$37.50

30 MHz Frequency Counter Kit Complete kit less case \$47.75 Prescaler Kit to 250 MHz \$19.95

Stopwatch Kit \$26.95 Full six digit battery operated. 2-5 volts. 3.2768 MHz crystal accuracy. Times to 59 min., 59 sec., 99 1/100 sec. Times std., split and Taylor. 7205 chip, all components minus case. Full instr. White or black plexiglass case. \$5.00

Auto Clock Kit \$15.95 DC clock with 4-50' displays. Uses National MA-1012 module with alarm option. Includes light dimmer, crystal timebase PC boards. Fully regulated, comp. instructs. Add \$3.95 for beautiful dark gray case. Best value anywhere.

TERMS: \$5.00 min. order U.S. Funds. Calif residents add 6% tax. BankAmericard and Master Charge accepted. Shipping charges will be added.

OUTSIDE OF JAPAN...

NEW-TONE ELECTRONICS Has the Largest Inventory of Original Japanese Components Anywhere!

•SONY•RIKYU•TOSHIBA•
 •NEC•HITACHI•MITSUBISHI•
 •SHINDENGEN•MITSUBISHI•
 •FUJITSU•FUJI-TEN•JRC•
 •SANYO•R-OHM•UNIDEN•
 •PANASONIC•CYBERNET•
 •SANKEN•NPC•ORIGIN•

PARTIAL LIST — CALL US FOR ALL YOUR DEVICE NEEDS

2SA49	.49	2SB492	1.00	2SC775	1.90	2SC1628	1.10
2SA101	.49	2SB495	.75	2SC776	2.50	2SC1669	1.25
2SA102	.49	2SB507	1.40	2SC777	4.95	2SC1674	.49
2SA200	.49	2SB511	1.50	2SC778	3.50	2SC1675	.49
2SA221	.79	2SB528	1.40	2SC781	2.50	2SC1678	2.00
2SA234	.59	2SB536	1.50	2SC783	2.95	2SC1679	2.95
2SA353	.69	2SB539A	4.70	2SC784	.49	2SC1684	.49
2SA377	1.89	2SB541	4.70	2SC785	.65	2SC1728	1.85
2SA387A	.69	2SB554	8.00	2SC788	2.95	2SC1730	.95
2SA473	1.25	2SB561	.60	2SC789	1.00	2SC1756	2.75
2SA483	2.79	2SB627	2.95	2SC790	1.50	2SC1760	1.60
2SA484	2.44			2SC793	2.50	2SC1816	3.50
2SA485	1.95	2SC32	1.35	2SC798	3.95	2SC1908	.49
2SA489	1.39	2SC116	3.00	2SC799	3.25	2SC1909	3.75
2SA495	.60	2SC172	1.75	2SC815	.55	2SC1957	1.00
2SA496	.99	2SC206	2.50	2SC828	.49	2SC1964	3.95
2SA497	1.44	2SC237	1.75	2SC829	.49	2SC1969	4.70
2SA509	.50	2SC281	.50	2SC830	2.95	2SC1973	.90
2SA525	1.95	2SC284	1.20	2SC838	.50	2SC1974	3.50
2SA537A	1.95	2SC287	1.25	2SC839	.50	2SC1975	3.50
2SA539	.60	2SC291	3.95	2SC853	.90	2SC2020	4.95
2SA561	.48	2SC325	3.95	2SC866	5.00	2SC2027	6.00
2SA562	.45	2SC367	.85	2SC867	6.00	2SC2028	.80
2SA564	.50	2SC371	.49	2SC870	.50	2SC2029	3.40
2SA565	1.05	2SC372	.49	2SC871	.50	2SC2034	2.95
2SA566	3.20	2SC373	.49	2SC900	.50	2SC2074	2.50
2SA606	1.69	2SC374	.49	2SC922	.69	2SC2075	4.00
2SA624	.99	2SC375	.49	2SC929	.49	2SC2091	2.50
2SA628	.49	2SC380	.49	2SC930	.49	2SC2092	3.25
2SA634	1.00	2SC381	.50	2SC938	.95	2SC2098	3.90
2SA636	1.25	2SC382	.55	2SC943	1.00	2SC2166	3.75
2SA640	.49	2SC384	.60	2SC945	.49	2SD45	4.95
2SA643	.60	2SC385	.70	2SC959	1.35	2SD68	.90
2SA659	.49	2SC386	.70	2SC960	2.95	2SD72	.80
2SA663	4.75	2SC387	.50	2SC984	.80	2SD77	1.50
2SA666	.69	2SC394	.49	2SC1000	.49	2SD81	3.95
2SA671	1.50	2SC403	.49	2SC1013	.95	2SD88	4.80
2SA672	.70	2SC454	.50	2SC1014	.95	2SD118	3.00
2SA673	.70	2SC458	.49	2SC1017	1.20	2SD130	1.20
2SA678	.65	2SC460	.49	2SC1018	1.00	2SD170	1.50
2SA679	4.95	2SC461	.49	2SC1030	2.80	2SD180	2.50
2SA680	4.95	2SC478	.80	2SC1034	5.60	2SD187	.49
2SA682	1.49	2SC481	1.50	2SC1047	.59	2SD188	2.70
2SA683	.60	2SC482	1.40	2SC1060	1.40	2SD201	4.50
2SA684	.60	2SC484	2.60	2SC1061	1.25	2SD213	4.95
2SA695	.60	2SC485	1.40	2SC1079	3.95	2SD217	3.80
2SA699	1.30	2SC486	1.50	2SC1080	3.95	2SD218	3.90
2SA699A	1.45	2SC493	3.50	2SC1096	.80	2SD227	.48
2SA705	.75	2SC494	4.50	2SC1098	1.00	2SD234	.85
2SA706	1.45	2SC495	.85	2SC1114	4.92	2SD235	.86
2SA715	1.35	2SC496	.85	2SC1115	3.00	2SD257	3.50
2SA719	.59	2SC497	1.40	2SC1116	4.25	2SD261	1.00
2SA720	.59	2SC502	1.50	2SC1116A	4.75	2SD287	3.70
2SA721	.59	2SC503	1.75	2SC1124	1.20	2SD288	1.50
2SA733	.49	2SC504	.75	2SC1162	1.00	2SD313	1.05
2SA740	1.95	2SC509	1.75	2SC1166	.48	2SD314	1.50
2SA745	4.50	2SC515	1.95	2SC1170B	4.95	2SD315	1.20
2SA747	5.75	2SC517	3.60	2SC1172	5.25	2SD318	1.95
2SA750	.49	2SC535	.55	2SC1173	.75	2SD325	.90
2SA756	3.30	2SC536	.49	2SC1175	.75	2SD330	1.50
2SA758	5.60	2SC537	.49	2SC1209	.75	2SD331	1.50
2SA777	.99	2SC538	.60	2SC1211	.59	2SD356	1.00
2SA816	.70	2SC563	.90	2SC1212	1.65	2SD358	1.10
2SA839	1.95	2SC580	1.95	2SC1213	.59	2SD360	1.05
		2SC608	5.95	2SC1226A	.85	2SD382	1.20
		2SC609	5.95	2SC1237	4.00	2SD427	2.55
2SB22	.65	2SC614	3.95	2SC1239	3.50	2SD525	1.50
2SB54	.49	2SC619	.65	2SC1306	3.50	2SCF6	1.25
2SB56	.95	2SC620	.49	2SC1307	4.75	2SCF8	3.50
2SB75	.48	2SC627	2.95	2SC1308	5.75	2SF8	3.00
2SB111	.59	2SC632	.60	2SC1312	.49	2SK19	1.25
2SB156	.95	2SC634A	.60	2SC1313	.49	2SK23A	1.00
2SB172	.60	2SC644	.49	2SC1317	.49	2SK30A	.75
2SB175	.60	2SC645	.60	2SC1318	.49	2SK33	90
2SB186	.49	2SC674	.60	2SC1327	.49	2SK34	90
2SB187	.55	2SC680	2.60	2SC1330	1.35	2SK40	1.30
2SB202	1.50	2SC684	1.20	2SC1342	.49	2SK55	1.00
2SB227	2.95	2SC693	.49	2SC1344	.49	3SK22	2.20
2SB234	2.95	2SC696	1.75	2SC1347	.85	3SK22Y	2.20
2SB235	7.95	2SC699	5.95	2SC1359	.65	3SK35	2.00
2SB270	.79	2SC708	1.75	2SC1360	.95	3SK39	2.00
2SB303	.49	2SC710	.49	2SC1362	.52	3SK40	2.00
2SB324	.60	2SC711	.49	2SC1364	1.10	3SK41	2.20
2SB337	1.35	2SC712	.49	2SC1377	4.80	3SK45	2.20
2SB370	.65	2SC715	.69	2SC1382	.95	3SK49	2.20
2SB405	.60	2SC717	.50	2SC1383	.50	JSP7001	.75
2SB407	1.35	2SC730	4.15	2SC1384	.80	MA26	.28
2SB415	.65	2SC731	3.00	2SC1402	3.60	MPS8000	1.25
2SB434	1.15	2SC732	.49	2SC1403	3.60	MPS8001	1.25
2SB435	1.35	2SC733	.49	2SC1419	.95	MPSU02	.50
2SB440	.60	2SC734	.49	2SC1447	.90	MPSU31	4.00
2SB461	1.60	2SC735	.49	2SC1448	1.00	MRF8004	3.00
2SB463	1.40	2SC738	.49	2SC1449	.85	SD1074	19.95
2SB471	1.40	2SC756A	2.40	2SC1475	1.25	SD1076	28.95
2SB472	2.60	2SC763	.49	2SC1507	1.40	4004	3.00
2SB474	1.10	2SC773	.60	2SC1509	.85	4005	3.00
2SB481	1.50	2SC774	1.50	2SC1624	1.10	40080	1.25

40081	1.50	S6087A	3.80
40082	3.00	S6087B	3.80
AN136	2.90	STK011	7.50
AN214	3.35	STK015	6.50
AN239	6.50	STK025	12.50
AN241	2.40	STK032	14.20
AN245	5.50	STK036	19.00
AN247	4.80	STK050	24.50
AN271	3.20	STK056	11.35
AN289	7.90	STK405	9.20
AN315	3.50	STK415	8.50
AN331	5.40	STK433	9.25
AN343	3.90	STK435	9.50
AN360	2.50	STK437	11.50
AN380	7.50	STK439	11.60
BA302	2.50	TA7028M	3.50
BA511	3.00	TA7045M	3.25
BA521	3.40	TA7051P	3.00
C3001A	2.95	TA7054P	3.05
CX075B	2.95	TA7055P	3.00
CX100D	8.50	TA7060P	1.40
CX101G	8.50	TA7061P	1.50
CX103D	8.50	TA7062P	1.50
CX104A	8.50	TA7063P	1.50
CX121A	7.50	TA7072	3.00
CX130A	7.00	TA7074	2.90
CX148	11.70	TA7075	3.75
CX149A	14.00	TA7076	3.75
DN834	1.50	TA7089	2.90
DN835	1.60	TA7102P	5.80
DN837	1.50	TA7106P	3.25
DN838	1.70	TA7120P	1.50
HA1151	3.20	TA7122	1.50
HA1157	4.20	TA7124	1.85
HA1158	4.20	TA7146P	3.75
HA1159	5.00	TA7148	3.90
HA1199	3.25	TA7149P	3.90
HA1202	2.20	TA7150P	3.75
HA1306	4.90	TA7153	6.90
HA1308	4.50	TA7167	6.20
HA1312	3.40	TA7200P	3.50
HA1314	4.20	TA7201P	4.50
HA1316	3.50	TA7202	4.50
HA1318	5.00	TA7203	4.25
HA1322	4.20	TA7204	3.70
HA1325	3.20	TA7205	3.60
HA1339A	4.95	TA7207	3.50
HA1342	4.50	TA7208	3.50
HA1366	4.20	TA7209	3.80
HA11112	8.90	TA7210	6.50
HA11113	6.50	TB800	4.40
HD3113	4.90	TB810DS	4.40
HD3127	7.80	TC4081P	1.75
LA1201	4.25	TC5080P	5.80
LA1240	3.30	TC5081P	3.60
LA1364	3.70	TC5082P	4.00
LA1366	4.25	TC9100P	8.50
LA1369	4.25	TD3400P	1.55
LA3155	2.25	TD3441AP	5.10
LA3201	1.95	TM4312P	1.00
LA3301	3.40	UH1C001	6.50
LA3310	4.20	UH1C003	6.50
LA3350	3.30	UH1C004	6.50
LA4000	7.50	UH1C005	6.50
LA4030	5.40	UH1C006	6.50
LA4031P	3.20	UPC16C	2.50
LA4032P	4.20	UPC20C	3.75
LA4051P	3.20	UPC30C	3.75
LA4101	3.20	UPC41C	2.80
LA4201	3.25	UPC48C	3.95
LA4400	3.40	UPC157CA	2.50
LA4420	3.40	UPC554C	2.50
LAD001	3.20	UPC555H	2.20
LD3040	1.60	UPC563H2	8.00
LD3120	2.40	UPC566H	1.25
M5112	8.40	UPC573C	3.25
M5151PR	7.80	UPC575C	2.60
M5152L	2.75	UPC576	3.25
M5192	4.80	UPC587C2	2.95
M5117L	2.00	UPC592H2	1.40
M51513L	5.10	UPC595C	2.95
MB3705	3.35	UPC596C	2.75
MN3001	19.50	UPC1001H2	3.50
MN3002	11.70	UPC1008C	5.75
MN3003	9.45	UPC1020H	3.25
MN3004	17.95	UPC1025H	3.50
MN3005	75.00	UPC1026H	3.10
MN6040	16.75	UPC1152H	3.95
MN6040A	16.75	UPC1154H	3.95
PLL01A</			

Electronics Classified

REGULAR CLASSIFIED: COMMERCIAL RATE: For firms or individuals offering commercial products or services, \$2.40 per word. Minimum order \$36.00. **EXPAND-AD* CLASSIFIED RATE:** \$3.60 per word. Minimum order \$54.00. Frequency discount; 5% for 6 months; 10% for 12 months paid in advance. **PERSONAL RATE:** For individuals with a personal item to buy or sell, \$1.40 per word. No minimum! **DISPLAY CLASSIFIED:** 1" by 1 column (2-1/4" wide), \$280.00. 2" by 1 column, \$560.00. 3" by 1 column, \$840.00. Advertiser to supply film positives. For frequency rates, please inquire.

GENERAL INFORMATION: Ad copy must be typewritten or clearly printed. Payment must accompany copy except when ads are placed by accredited advertising agencies. First word in all ads set in caps. All copy subject to publisher's approval. All advertisers using Post Office Boxes in their addresses **MUST** supply publisher with permanent address and telephone number before ad can be run. Advertisements will not be published which advertise or promote the use of devices for the surreptitious interception of communications. Ads are not acknowledged. They will appear in first issue to go to press after closing date. Closing Date: 1st of the 2nd month preceding cover date (for example, March issue closes January 1st). Send order and remittance to Classified Advertising, **POPULAR ELECTRONICS**, One Park Avenue, New York, New York 10016, Attention: Hal Cymes.

FOR SALE

FREE! Bargain Catalog—I.C.'s, LED's, readouts, fiber optics, calculators parts & kits, semiconductors, parts. Poly Paks, Box 942PE, Lynnfield, Mass. 01940.

GOVERNMENT and industrial surplus receivers, transmitters, snooperscopes, electronic parts, Picture Catalog 25 cents. Meshna, Nahant, Mass. 01908.

LOWEST Prices Electronic Parts. Confidential Catalog Free. KNAPP, 3174 8th Ave. S.W., Largo, Fla. 33540.

ELECTRONIC PARTS, semiconductors, kits. **FREE FLYER**. Large catalog \$1.00 deposit. BIGELOW ELECTRONICS, Bluffton, Ohio 45817.

RADIO—T.V. Tubes—36 cents each. Send for free catalog. Cornell, 4213 University, San Diego, Calif. 92105.

AMATEUR SCIENTISTS, Electronics Experimenters, Science Fair Students...Construction plans—Complete, including drawings, schematics, parts list with prices and sources...Robot Man — Psychedelic shows — Lasers — Emotion/Lie Detector — Touch Tone Dial — Quadraphonic Adapter — Transistorized Ignition — Burglar Alarm — Sound Meter...over 60 items. Send 50 cents coin (no stamps) for complete catalog. Technical Writers Group, Box 5994, University Station, Raleigh, N.C. 27607.

METERS—Surplus, new, used, panel or portable. Send for list. Hanchett, Box 5577, Riverside, CA 92507.

MECHANICAL, ELECTRONIC devices catalog 10 cents. Greatest Values — Lowest Prices. Fertik's, 5249 "D", Philadelphia, Pa. 19120.

SOUND SYNTHESIZER KITS—Surf \$12.95, Wind \$12.95, Wind Chimes \$17.95, Musical Accessories, many more. Catalog free. PAIA Electronics, Box J14359, Oklahoma City, OK 73114.

BUGGED??? New locator finds them fast. Write, Clifton, 11500-L N.W. 7th Avenue, Miami, Florida 33168.

YOU WILL SAVE BIG MONEY! Surplus, Clearouts, Bankruptcy, Inventory, Deals. Catalog \$1 (redeemable). ETCOA Electronics, Box 741, Montreal, H3C 2V2, U.S. Inquiries.

HEAR POLICE / FIRE Dispatchers! Catalog shows exclusive directories of "confidential" channels, scanners. Send postage stamp. Communications, Box 56-PE, Commack, N.Y. 11725.

UNSCRAMBLERS: Fits any scanner or monitor, easily adjusts to all scrambled frequencies. Only 4" square \$29.95, fully guaranteed. Dealer inquiries welcomed. PDQ Electronics, Box 841, North Little Rock, Arkansas 72115.

RECONDITIONED Test Equipment, \$0.50 for catalog. Walter's Test Equipment, 2697 Nickel, San Pablo, CA 94806.

POLICE/Fire scanners, large stock scanner crystals, antennas. Also CBs. Harvey Park Radio, Box 19224, Denver, CO 80219.

TELETYPE EQUIPMENT for sale for beginners and experienced computer enthusiast. Teletype machines, parts, supplies. Catalogue \$1.00 to: ATLANTIC SALES, 3730 Nautilus Ave., Brooklyn, NY 11224. Tel: (212) 372-0349.

WHOLESALE C.B., Scanners, Antennas, Catalog 25 cents. Crystals: Special cut, \$4.95, Monitor \$3.95. Send make, model, frequency. G. Enterprises, Box 461P, Clearfield, UT 84015.



**ORGAN KITS
KEYBOARDS**
THE ULTIMATE IN DESIGN
AND SOUND
Demo Record & Brochure \$1.00

Wurlitzer reproductions
DEVTRONIX ORGAN PRODUCTS, Dept. C
5872 Amapola Dr. • San Jose, CA 95129



BUILD STEREO SPEAKERS WITH JUST GLUE AND STAPLES.

Save up to 50% of the cost of ready-built speakers by assembling Speakerlab kits. We've done the design, carpentry and wiring, leaving you only the actual installation of the

speaker drivers. Most people take less than two hours to assemble a kit. Illustrated, easy-to-follow instructions check you each step of the way. (And if you still can't finish the kit, we'll do it for you for just the cost of return freight.)

When you're through, you have a high quality, multi-element stereo speaker with a resonance-free enclosure, fiberglass damping, a crossover with real L-pads, and drivers that are some of the best in the industry.

Send for our free 52-page catalog. It's practically a manual on speaker building and acoustics.

Speakerlab Inc., Dept. PE-F
5500 35th N.E., Seattle, WA 98105

BUILD AND SAVE. TELEPHONES, TELEVISION, DETECTIVE, BROADCAST Electronics. We sell construction plans with an Engineering Service. Speakerphones, Answering Machines, Carphones, Phonevision, Dialers, Color TV Converters, VTR, Games, \$25 TV Camera, Electron Microscope, Special Effects Generator, Time Base Corrector, Chroma Key, Engineering Courses in Telephone, Integrated Circuits, Detective Electronics. **PLUS MUCH MORE.** NEW Super Hobby Catalog PLUS year's subscription to Electronic News Letter, \$1.00. Don Britton Enterprises, 6200 Wilshire Blvd., Los Angeles, Calif. 90048.

NAME BRAND Digital/Analog Test Equipment. Discount prices. Free catalog. Salen Electronics, Box 82, Skokie, Illinois 60076.

SURPLUS COMPONENTS, Communication and test equipment. Illustrated catalog 25 cents. E. French, P.O. Box 249, Aurora, Illinois 60505.

CB RADIOS, monitors, crystals, CD ignitions. Southland, Box 3591-B, Baytown, Texas 77520.

TELEPHONES UNLIMITED, Equipment, Supplies, All types, Regular, Keyed, Modular. Catalog 50 cents. Box 1147E, San Diego, California 92112.

CARBON FILM RESISTORS 1/4W, 1/2W - 1.7 cents each. FREE sample / specifications. Other components. COMPONENTS CENTER, Box 134P, New York, N.Y. 10038.

PROFESSIONAL UNSCRABLERS — several models that fit any scanner. Free information. Capri Electronics, 8753T Windom, St. Louis, MO 63114.

UNSCRAMBLE CODED MESSAGES from Police, Fire and Medical Channels. Same day service. Satisfaction guaranteed. Don Nobles Electronics, Inc., Rt. 7, Box 265B, Hot Springs, Arkansas 71901. (501) 623-6027.

ANYONE CAN SOLDER WITH — DO-IT-YOURSELFERS!

Let Kester solder aid you in your home repairs or hobbies. A radio, TV, model train, jewelry, plumbing, etc. Save money — repair it yourself. Send self-addressed stamped envelope to Kester for a FREE Copy of "Soldering Simplified".

4201 Wrightwood Ave.
Chicago, Ill. 60639



USED TEST EQUIPMENT — Tektronix, HP, GR. Write: PTI, Box 8699, White Bear Lake, MN 55110. Phone: (612) 429-2975.

WEATHER MAP RECORDERS: Copy Satellite Photographs, National-Local Weather Maps. Learn How! \$1.00. Atlantic Sales, 3730 Nautilus Ave., Brooklyn, N.Y. 11224. Tel: (212) 372-0349.

SURPLUS ELECTRONICS
ATTENTION HOBBYISTS — SEND FOR YOUR FREE CATALOG

Great buys in tape drives, keyboards, power supplies, and transformers. We also have heat sinks, steel cabinets, I/O terminals, video displays, printers, and equipment cases. And of course components, fans, wire, and cable. Write now to

10 Flagstone Drive
Worldwide Electronics Hudson, NH 03051

AUDIO EXPERIMENTERS, Serious Music Synthesizer Stuff: literature, kits, components, circuits and more. Send SASE for FREE INFO. CFR Associates, POB F, Newton, NH 03858.

SEEKING ORIGINAL JAPANESE TRANSISTORS FOR CB AND STEREO REPAIR? Request complete list. Compare 1 to 9 prices. 2SC710, 59 cents; 2SC517, \$3.95; 2SC799, \$3.60; 2SC1306, \$4.40; 2SC1678, \$2.25; TA7205P, \$3.90; BA521, \$3.70, BA511, \$3.40. Fuji-Svea Enterprises, Dept. P, Box 40325, Cincinnati, OH 45240.

FREE CATALOG. Solar Cells, Nicads, Kits, Calculators, Digital Watch Modules, Ultrasonics, Stobes, LEDs, Transistors, IC's, Unique Components. Chaney's, Box 27038, Denver, Colorado 80227.

MAKE YOUR PLANS COME TRUE by using electronic kit of Touch Switch, Patrol Car Siren, Sound Switch, Singing Bird. Each Kit \$5.00 ppd. QMC, P.O. Box 4816, Irvine, California 92716.

SPEAKERS — Save 60%. Factory assembled or kits. Free catalog Quality Acoustics, 15428 Center, Harvey, Illinois 60426.

Build The Artisan Electronic Organ....
The 20th century successor to the classic pipe organ. Kits feature modular construction, with logic controlled stops and RAM Pre-Set Memory System. Be an ar-ti-san. Write for our free brochure. AOK Manufacturing, Inc. P.O. Box 445, Kenmore, WA 98028.

TRANSISTORS FOR CB REPAIR, IC's and diodes. TV audio repairs. 2SC799 — \$3.00, 2SC1306 — \$2.95, 2SC1307 — \$3.85, TA7205 — \$3.50, more. Free catalog and transistor. B&D Enterprises, Box 32, Mt. Jewett, PA 16740.

CRYSTAL CONTROLLED DIGITAL CROSSHATCH/DOT GENERATOR, Kit \$31.95, built \$41.95. Free Catalog. PHOTOLUMINE CORP., 118 East 28 Street, New York, NY 10016.

MAKE PROFESSIONAL QUALITY PC boards with silk-screen techniques. Complete information, \$4.95 postpaid. TerraTronic Research, Box 513JP, Quincy, Ill. 62301.

GOLDMINE OF PARTS, POWERFUL POWER SUPPLY, DOCUMENTATION, in complete CARTRIVISION electronic assembly. Perfect for MICROPROCESSOR and all electronic applications. \$24.95 total. Master Charge. BankAmericard. Free Brochure. MADISON ELECTRONICS, INCORPORATED, 369, Madison, Alabama 35758. SATISFACTION GUARANTEED.

17-DIGIT ELECTRONIC TIMEPIECE KIT. Simultaneous date, time, alarm, and timer readout, \$109.00. PINK NOISE GENERATOR KIT, \$9.95. West Side Electronics, Box 636-P2, Chatsworth, California 91311.

MUSIC — CMOS Envelope Generator — Attack - Fallback - Sustain - Decay: Versatile - Highest quality - Inexpensive. Plans \$2.50. POE, 18578 Haskins, Chagrin Falls, Ohio 44022.

UNREAL CATALOGS, Surplus, Factory Liquidations, Bankruptcy Inventories, Deals. Thousands of items at Bargain Surplus Prices. Rush \$1. Elcoa Electronics, 521 5th Ave., NYC, NY 10017.

NEW PERIODIC TABLE OF ELEMENTS. Atomic physics breakthrough now reveals precise atomic models of each element. Striking wall chart, \$3.00. Circlon, 29500 Greener Gorge, Enumclaw, WA 98022.

CB SWL LOG, 10 Code CB SWL Freqs log sheets only \$3.00. Tatinger, 4028 West 83th Street, Chicago, Illinois 60652.

TESLA COILS. 40 page booklet shows how to construct five coils from 50,000 to 5,000,000 volts. Arcs to 100". Also includes history, theory, 25 experiments and information you need to design tesla coils. Booklet \$10.00. High Tension Electronics, Box 1371, Garden Grove, California 92642.

LOWEST COMPONENT PRICES, test equipment & surplus. Free flyer. A&S Supply, 265 Willard, Quincy, MA 02169.

ULTRAVIOLET EPROM ERASER. Automatic. Handles all eprom types. \$98.00. Free data sheet. Kingston Laboratories, Box 894-P, Melbourne, Fla. 32901. (305) 723-2200.

GIVE MAKE, Model, we'll quote price. CB scanners ect. Randall's, 7035 N. 39th, Milwaukee, WI 53209. Scanner crystal certificates \$2.50 each.

X&K RADAR DETECTORS. Factory overstock sale of a nationally sold unit that is fully assembled and sold as is with schematic — untested and less case. Microwave parts alone worth twice this. X Band, \$29.95; XEK Band, \$39.95. Check or money order. KEC Electronics, 508 East Oak St., Lafayette, CO 80026. Tech. info. catalog 35 cents.

WIRE and cable. Send for free list. Ram Electronics, Box 336-P, Brookhaven, N.Y. 11719.

IMPROVE MOBILE C.B. output power up to 45%, cheap and simple to make accessory, complete instructions. \$1.00. R. Brodell, Box 530, Farmingdale, N.Y. 11735.

UNBELIEVABLE Goldmine of Electronic Schematics. 201 Dynamite Projects. \$9.99. Send for Free Project List. Professional FM Wireless Mic Plans. \$2.00. Spacetech, Box 182, Gillette, N.J. 07933.

PARALINE Manufactures and stocks transformers. Free Data. Paraline, Dept.-S, 515 S. Palm, Alhambra, CA 91803.

UNSCRAMBLER KIT: Tunes all scramble frequencies, may be built-in most scanners, 2-3/4 X 2-1/4 X 1/2. \$19.95. Factory built Code-Breaker. \$29.95. Free Catalog: KRYSTAL KITS, Box 445, Bentonville, Ark. 72712. (501) 273-5340.

BEARCAT 210/Regency Touch, \$259.95. All radios discounted. Call (707) 544-4388. McDonald, Box 7492(P), Santa Rosa, CA 95401.

SEKTRONIX USED EQUIPMENT bought and sold. Call: COM-TEC ASSOCIATES, 18 Gould Street, Stoneham, Mass. 02180. (617) 438-6190.

PLANS AND KITS

AMAZING ELECTRONIC PRODUCTS

LASERS SUPER POWERED, RIFLE, PISTOL, POCKET - SEE IN DARK - PYRO-TECHNICAL DE-BUGGING - UNCRAMBLERS - GIANT TESLA - STUNWAND - TV DISRUPTER - ENERGY PRODUCING, SCIENTIFIC DETECTION, ELECTRIFYING, CHEMICAL, ULTRASONIC, CB, AERO, AUTO AND MECH DEVICES, HUNDREDS MORE - ALL NEW PLUS INFO UNLTD PARTS SERVICE

INFORMATION unlimited
Box 626 Lord Jeffrey Pz. • Amherst, N.H. 03031

CATALOG \$1

FREE KIT Catalog contains Test and Experimenters' Equipment. Dage Scientific Instruments, Box 1054P, Livermore, CA 94550.

TIGER SST SIMPLI-KIT

FOR THE DO-IT-YOURSELFER NOW! a high quality CD Electronic Ignition System in kit form.

Contains all components and solder to build complete Solid-State Electronic CD Ignition System for your car. Assembly requires less than 3 hours.

- Increases MPG 15%
- Increases horsepower 15%
- Plugs and Points last 50,000 miles
- Eliminates 4 of 5 tune-ups
- Instant starting, any weather
- Dual system switch

Fits only 12 volt neg. ground... Only \$21.95 postpaid

Tri-Star Corporation
P.O. Box 1727 Grand Junction, Colorado 81501

NEW! CONVERT TV TO 6 FT. WIDE SCREEN!

Easy Do-It-Yourself Kit

Project a giant 5'x6' picture onto wall or screen. B&W/Color. Kit contains detailed plans, Inst., and Precision Lens System. Only \$15.95 ppd., or write for Free illustrated details.

The Macrocoma Co., Dept. DE
Washington Crossing, PA 18977

Guaranteed to Work!

MIXERS—Preamps—Speakers, Top Quality Kits—Plans—Parts. Send 25 cents for catalog. Audio Design & Engineering Co., P.O. Box 154, Lee, Mass. 01238. (413) 243-1333.

THE "KING OF KITS". Artisan Organ Kits feature all new modular construction, with logic-controlled stops and RAM Preset Memory System. Write for brochure to: AOK Manufacturing, Inc., P.O. Box 445, Kenmore, WA 98028.

ROBOT Plans That Work! \$5.00. American Robots, Dept. E, P.O. Box 1304, Tulsa, OK 74101.

FIVE LASER PLANS — \$8.00; Welding-Burning Laser plans — \$9.00. Catalog \$2.00. Solaser, PE 178, Box 1005, Claremont, California 91711.

NEGATIVE ion generator. Complete plans. \$10.00. Fascinating details. \$1.00. Golden Enterprises, Box 1282-PE, Glendale, Arizona 85311.

DIGITAL REVERB, Fully electronic. Plans and PCB available. Send SASE for free info. Neves, Box 10327, Stanford, CA 94305.

BUILD YOUR OWN UFO Detector with complete easy to follow plans. Three designs, \$3.00 postpaid. UFO Alert, P.O. Box 1741, Owensboro, KY 42301.

BUILD YOUR OWN SYMPHONY OF SOUND!

It's fun and easy—takes just minutes a day! Complete kits for organs, pianos, strings, rhythms, amplifiers, synthesizers. Also factory assembled. 104-page catalog \$2.00

WERSI
Wersi Electronics, Inc., Dept. ZD, Box 5318, Lancaster, PA 17602.

HIGH FIDELITY

DIAMOND NEEDLES and Stereo Cartridges at Discount prices for Shure, Pickering, Stanton, Empire, Grado and ADC. Send for free catalog. LYLE CARTRIDGES, Dept. P, Box 69, Kensington Station, Brooklyn, New York 11218. For Fast Service call Toll Free 800-221-0906.

BURGLAR ALARMS

Burglar-Smoke Fire Alarm Catalog

• Billions of dollars lost annually due to lack of protective warning alarms.

FREE CATALOG Shows you how to protect your home, business and person. Wholesale prices. Do-it-yourself. Free engineering service.

Burdex Security Co.

Box 82802 PE 018 Lincoln, Ne. 68501

QUALITY BURGLAR/FIRE ALARM equipment at discount prices. Catalog 50 cents. Steffens, Box 624C, Cranford, N.J. 07016.

WHY WORRY about leaving car lights on? ALARM ALERTS with pulsing tone. \$11.75. INFORMATION AVAILABLE. CFL Enterprises, Box 415, Export, PA 15632.

DON'T PURCHASE alarm equipment before getting our free value packed catalog. SASCO, 5619-C St. John, Kansas City, MO 64123. (816) 483-4612.

INVENTIONS WANTED

INVENTORS

RECOGNITION...FINANCIAL REWARD...OR CREDIT FOR "INVENTING IT FIRST" MAY BE YOURS!

If you have an idea for a new product, or a way to make an old product better, contact us, "the idea people" We'll develop your idea, introduce it to industry, negotiate for cash sale or royalty licensing. Write now without cost or obligation for free information. Fees are charged only for contracted services. So send for your FREE "Inventor's Kit." It has important Marketing Information, a special "Invention Record Form" and a Directory of 1001 Corporations Seeking New Products.

RAYMOND LEE ORGANIZATION
230 Park Avenue North, New York, NY 10017

At no cost or obligation, please rush my FREE "Inventor's Kit No. A-112"

Name _____

Address _____

City _____ State _____ Zip _____

Phone No _____ Area Code _____

FREE PAMPHLET: "Tips on Marketing Your Invention", from an experienced fee-based invention service company. Write: United States Inventors Service Company, Dept. T, 1435 G Street NW, Washington DC 20005.

INVENTIONS, IDEAS, WANTED! Presentation to Industry. IMI, Suite 1200-ZD, 401 Wood Street, Pittsburgh, Pennsylvania 15222.

TELEPHONES & PARTS

TELEPHONES GALORE, beautiful styles, colors, spectacular designs to enhance any decor. Lowest Prices! Full Details, \$1.00 refundable. Mailine, P.O. Box 570, Wall St. Sta., NYC, NY 10005.

TELEPHONES AND PARTS. Free catalog. Write: Surplus Saving Center, P.O. Box 117, Waymart, PA 18472.

YOUR TELEPHONE STORE. Free mail-order catalog of phones, cords, plugs, jacks, much more. Flemco, 20272 37th Ave. N.E., Seattle, Wash. 98155.

INSTRUCTION

LEARN ELECTRONIC ORGAN SERVICING at home all makes including transistor. Experimental kit—trouble-shooting. Accredited NHSC, Free Booklet. NILES BRYANT SCHOOL, 3631 Stockton, Dept. A, Sacramento, Calif. 95820.

SCORE high on F.C.C. Exams... Over 300 questions and answers. Covers 3rd, 2nd, 1st and even Radar. Third and Second Test, \$14.50; First Class Test, \$15.00. All tests, \$26.50. R.E.I., Inc., Box 806, Sarasota, Fla. 33577.

UNIVERSITY DEGREES BY MAIL! Bachelors, Masters, Ph.D's. Free revealing details. Counseling, Box 317-PE01, Tustin, California 92680.

SELF-STUDY CB RADIO REPAIR COURSE. THERE'S MONEY TO BE MADE REPAIRING CB RADIOS. This easy-to-learn course can prepare you for a career in electronics enabling you to earn as much as \$16.00 an hour in your spare time. For more information write: CB RADIO REPAIR COURSE, Dept. PE018, 531 N. Ann Arbor, Oklahoma City, Okla. 73127.

LEARN WHILE ASLEEP! HYPNOTIZE! Astonishing details, strange catalog free! Autosuggestion, Box 24-ZD, Olympia, Washington 98507.

GRANTHAM'S FCC LICENSE STUDY GUIDE — 377 pages, 1465 questions with answers/discussions — covering third, second, first radiotelephone examinations. \$13.45 postpaid. GSE, P.O. Box 25992, Los Angeles, California 90025.

INTENSIVE 5 week course for Broadcast Engineers. FCC First Class license. Student rooms at the school. Radio Engineering Inc., 61 N. Pineapple Ave., Sarasota, FL 33577 and 2402 Tidewater Trail, Fredericksburg, VA 22401.

1977 TESTS-ANSWERS for FCC First Class License. Plus "Self-Study Ability Test." Proven! \$9.95. Moneyback Guarantee. "FREE" BROCHURE. Command, Box 26348-P, San Francisco 94126.

NEW FCC License Exams and instructional material by author of published FCC License workbooks. Covers Second-First Classes and Radar. Hundreds of questions and answers with full solutions. Free counselling service. \$19.95. Victor Veley, P.O. Box 14, La Verne, Calif. 91750.

LEARN LANDSCAPING AT HOME. Start profitable business or hobby. Free booklet. Lifetime Career Schools, Dept. A-429, 2251 Barry Avenue, Los Angeles, California 90064.

WANTED

GOLD, Silver, Platinum, Mercury wanted. Highest prices paid by refinery. Ores assayed, Free circular. Mercury Terminal, Norwood, MA 02062.

TUBES

RADIO & T.V. Tubes—36 cents each. Send for free Catalog. Cornell, 4213 University, San Diego, Calif. 92105. TUBES receiving, factory boxed, low prices, free price list. Transletronic, Inc., 1365 39th Street, Brooklyn, N.Y. 11218A, Telephone: 212-633-2800.

TUBES: "Oldies", Latest. Supplies, components, schematics. Catalog Free (stamp appreciated). Steinmetz, 7519-PE Maplewood, Hammond, Ind. 46324.

TUBES, free low priced list. Specializing obsolete types. T.J., Inc., Box 43, Bradley Beach, N.J. 07720.

TAPE AND RECORDERS

8-TRACK and CASSETTE BELTS — money back guarantee. Long wearing. Free Catalog — \$3 minimum order. PRB Corp., Box 176, Whitewater, Wisconsin 53190.

GOVERNMENT SURPLUS

MANUALS for Govt Surplus radios, test sets, scopes. List 50 cents (coin). Books, 7218 Roanne Drive, Washington, D.C. 20021.

GOVERNMENT SURPLUS. Buy in your Area. How, where. Send \$2.00. Surplus, 30177-PE Headquarters Building, Washington, D.C. 20014.

JEEPS—\$59.30! CARS—\$33.50! 200,000 ITEMS—GOVERNMENT SURPLUS—Most COMPREHENSIVE DIRECTORY AVAILABLE tells how, where to buy—YOUR AREA—\$2.00—MONEYBACK GUARANTEE—Government Information Services, Department GE-7, Box 99249, San Francisco, California 94109. (433 California.)

GOV'T SURPLUS — buy direct from gov't. Complete info plus application form \$2.00. Info-Capsule A-1, P.O. Box 151, Shelocla, PA 15774.

DO-IT-YOURSELF

MODULAR TELEPHONES now available. Sets and components, compatible with Western Electric concept. Catalog 50 cents. Box 1147W, San Diego, California 92112.

TAPE-SLIDE SYNCHRONIZER, lap-dissolve, multiprojector audiovisual plans \$8.50. Free Catalog. Millers, 1896 Maywood, South Euclid, OH 44121.

REAL ESTATE

BIG...NEW...FREE...SPRING CATALOG! Over 2,500 top values coast to coast! UNITED FARM AGENCY, 612-EP, West 47th, Kansas City, MO 64112.

SERVICES

QSL CARDS 500/\$10. Sample. Bowman Printing, Dept. PE, 743 Harvard, St. Louis, MO 63130.

RUBBER STAMPS

RUBBER STAMPS, BUSINESS CARDS. Many new products. Catalog, Jackson's, Dept. K, Brownsville Rd., Mt. Vernon, Ill. 62864.

JANUARY 1978

MUSICAL INSTRUMENTS

UP TO 60% DISCOUNT. Name brand instruments catalog. Freeport Music, 114 G. Mahan St., W. Babylon, N.Y. 11704.

BUSINESS OPPORTUNITIES

I MADE \$40,000.00 Year by Mailorder! Helped others make money! Free Proof. Torrey, Box 318-NN, Ypsilanti, Michigan 48197.

FREE CATALOGS. Repair air conditioning, refrigeration. Tools, supplies, full instructions. Doolin, 2016 Canton, Dallas, Texas 75201.

MAILORDER MILLIONAIRE helps beginners make \$500 weekly. Free report reveals secret plan! Executive (1K1), 333 North Michigan, Chicago 60601.

GET RICH with Secret Law that smashes debts and brings you \$500 to \$5 Million cash. Free report! Credit 4K1, 333 North Michigan, Chicago 60601.

HIGHLY PROFITABLE ONE-MAN ELECTRONIC FACTORY

Investment unnecessary, knowledge not required, sales handled by professionals. Postcard brings facts about this unusual opportunity. Write today! Barta-DA, Box 248, Walnut Creek, CA 94597.

NEW LUXURY Car Without Cost. Free Details! Codex-ZZ, Box 6073, Toledo, Ohio 43614.

\$500 PER DAY POSSIBLE. New C.B. related business. Send 25 cents. P.A. Schubert Company, P.O. Box 187, Howell, Mich. 48843.

FREE REPORT: Big Money in Mail! Transworld-9K, Box 6226, Toledo, Ohio 43614.

GET RICH!!! Secret law erases debts. Free report exposes millionaire's secrets. Blueprints, No. EE1 453 W. 256, NYC 10471.

MECHANICALLY INCLINED Individuals desiring ownership of Small Electronics Manufacturing Business — without investment. Write: Marks, 92-K1 Brighton 11th, Brooklyn, New York 11235.

EARN IMMEDIATELY STUFFING ENVELOPES. \$300.00 Thousand Possible. Free supplies. Send Stamped envelope. Salamon Industries - PE4, 6059 W. 55th St., Chicago, IL 60638.

FIRMS SEEKING MAILERS, homeworkers, addressers, \$500.00 weekly possible. For list, rush \$2.00, stamped self-addressed envelope. Bruce Raber Company, Dept. 01, Greensburg, Kansas 67054.

GUARANTEED SECRETS of stuffing envelopes for comfortable income! Free! Wayne, Box 644ZD, Ottawa, Kansas 66067.

MAKE DURABLE building plastic easily. Waterproof, Fireproof, Economical. Bays Laboratory, Rt 1, Box 168, Cedaredge, CO 81413.

\$1,000 TO \$5,000 MONTHLY possible, work from your home, be your own boss. Details send 50 cents: Stray Enterprises, Box 6-D, Dept. PE, Concord, Ark. 72523.

PART-TIME CB DEALERS Wanted. McElectronics, Box 1385(P), Rohnert Park, CA 94928.

EARN \$1,000 monthly, spare time, at home. "GUARANTEED." Write: UNICORN, ZE1, 7350 Nugget, Colorado Springs, CO 80911.

EMPLOYMENT OPPORTUNITIES

ELECTRONICS/AVIONICS EMPLOYMENT OPPORTUNITIES. Report on jobs now open. Details FREE. Aviation Employment Information Service, Box 240E, Northport, New York 11768

TRANSLATORS required for freelance assignments in 30 languages. Electronics, physics, chemistry, etc. SCITRAN, P.O.B. 5456, Santa Barbara, CA 93108.

BOOKS AND MAGAZINES

FREE book prophet Elijah coming before Christ. Wonderful bible evidence. Megiddo Mission, Dept. 64, 481 Thurston Rd., Rochester, N.Y. 14619.

POPULAR ELECTRONICS INDEXES For 1976 now available. Prepared in cooperation with the Editors of "P/E." This index contains hundreds of references to product tests, construction projects, circuit tips and theory and is an essential companion to your magazine collection. 1976 Edition, \$1.50 per copy. All editions from 1972 onward still available at the same price. Add \$.25 per order for postage and handling, \$.50 per copy, foreign orders. INDEX, Box 2228, Falls Church, Va. 22042.

HOME ENTERTAINMENT FILMS

YOUR XMAS GIFT \$\$\$ GO FURTHER WITH SPORTLITE. Where Jesus Walked (filmed entirely in the Holyland), 400' S8 Eastman Color Sound, \$43.95 ea PPD. Ross Hunter's Airport (Burt Lancaster, Jacqueline Bisset) S8, 400' Color Snd, \$42.95 (you save \$7.). Universal 16mm B&W/Optical Snd 400' reel Horror Science Fiction — your choice The Mummy's Ghost (No. 1049), The Wolfman (No. 1050), Dracula (No. 1023) only \$33.95 ea + \$1. shipping (you save \$6.). For a laugh, Abbott & Costello in High Fliers (No. 816) & No Indians, Please (No. 808) 16mm B&W Snd \$32.95 ea + \$1. pstg. (this is 1976 price, save \$7.). LIMITED OFFER. For Speed Sports Fans, "Wheels Keep Rolling" '76 Indy '500' spectacular S8 color, 200' reel, \$18.95 ea PPD. Enclose ad with order. Columbia catalog \$0.85; Universal 8 catalog \$0.75; Sportlite forms \$0.35. SPORTLITE FILMS, Elect-1, Box 24-500, Speedway, Indiana 46224.

PERSONALS

MAKE FRIENDS WORLDWIDE through international correspondence. Illustrated brochure free. Hermes-Verlag, Box 110660/Z, D-1000 Berlin 11, Germany.

CHESS ENTHUSIASTS — play by mail. Free information for SASE. ARS-Chess, P.O. Box 1145, MacArthur Station, PA 15001.

MAGNETS

MAGNETS. All types. Specials-20 disc, or 10 bar, or 2 stick or 8 assorted magnets, \$1.00. Magnets, Box 192-H Randallstown, Maryland 21133.

HYPNOTISM

SLEEP learning. Hypnotic method. 92% effective. Details free. ASR Foundation, Box 23429EG, Fort Lauderdale, Florida 33307.

FREE Hypnotism. Self-Hypnosis. Sleep Learning Catalog! Drawer H400, Ruidoso, New Mexico 88345.

AMAZING self-hypnosis record releases fantastic mental power. Instant results! Free trial. Write: Forum (AA1), 333 North Michigan, Chicago 60601.

MISCELLANEOUS

1978 Electronic Experimenter's Handbook



This latest edition includes a Hobbyist and Microcomputer Section! It also features a host of exciting construction projects with complete construction plans, parts lists and printed-circuit board patterns. PLUS — A complete Home Computer Buying Directory with product specifications, latest prices, and photos. Only \$1.95!

Order your copy from ELECTRONIC EXPERIMENTER'S HANDBOOK, Consumer Service Division, 595 Broadway, New York, N.Y. 10012. Enclose \$2.50* (\$1.95 plus 55c postage and handling). Outside U.S.A. \$3. *Residents of CA, CO, FL, IL, MI, MO, NY STATE, DC and TX add applicable sales tax (Postage and handling charges non-taxable).

MPG INCREASED! Bypass Pollution Devices easily. REVERSIBLY!! Free details—Posco GEE1, 453 W. 256, NYC 10471.

STOP LOSING YOUR HAIR. Free information. Write: Cheveux, Box 171, Station F, Montreal, Canada H3J 2L1, Dept. 1. U.S. Inquiries.

Retail Display Plan

All magazine retailers in the United States and Canada interested in earning an allowance for the display and sale of publications of the Ziff-Davis Publishing Company are invited to write for details. Sales Manager, Select Magazines, 229 Park Avenue South, New York, New York 10003.



OUR OWN SOFTWARE OUR OWN HARDWARE

A perfect team from the Digital Group

Something new has been added to our great line of Digital Group hardware: DIGITAL GROUP SOFTWARE!

With all new languages, enhancements to existing languages and new sophistication designed to give the Digital Group system user the greatest capabilities yet available in a microprocessor.

Most importantly, you can rest assured that the same painstaking attention we devote to quality in our hardware has gone into Digital Group Software. Our software works — as simply as that.

Here are just a few of the Digital Group Software packages:

WOPROC

This simple-to-learn, user-oriented Word Processing System is text-editing and a whole lot more. WOPROC automatically takes care of the menial tasks of typing, easily corrects errors and prints exactly as you desire. In short, WOPROC doesn't stop at merely editing text: it also processes this text in a variety of ways. Use it to prepare and print anything that could be prepared with a typewriter.

CONVERS

Through incorporation of a variety of software concepts, CONVERS, a unique, highly-flexible package, has evolved. It offers a combination of easy programming, high memory efficiency and fast operating speed ideally suited for many types of applications.

The potential capabilities of this type of language are breathtaking, but for now the Digital Group recommends our preliminary version to those users already familiar with computers.

BUSINESS-BASIC

By adding a significant number of extensions, our standard Digital Group Maxi-BASIC has been converted to Business-BASIC — an extremely productive and powerful language for business-oriented microcomputer users.

OPUS/ONE and /TWO

These software packages are major extensions of BASIC-type languages. This language's major emphasis has been to maximize function and capability and is particularly well-suited to personal/business type applications.

Z80 ASSEMBLER II

An updated version of Z80 Assembler I with added capabilities.

We've tried to give you a glimpse of what Digital Group Software has in store for you. If you have one of our systems already, you know our quality. And if you're just looking around, take a look at our hardware.

Then you'll know how well our software works, too.

the digital group

po box 6528 denver, colorado 80206 (303) 777-7133

Jim-pak[®]

electronic components

One-Stop Component Center

QUALITY PRODUCTS

<p>TTL</p> <p>7409 7402 7404 7408 7410 7420 7430 7432 7442 7447 7473 7474 7475 7476 7485</p> <p>Low Power TTL Schottky</p> <p>74LS00 74LS02 74LS04 74LS08 74LS10 74LS12 74LS13 74LS14 74LS15</p> <p>C/MOS</p> <p>4000 4001 4010 4011 4013 4016 4017 4020 4023 4024</p>	<p>LINEAR</p> <p>LM301V LM307V LM339K LM331V LM320K 5(7905) LM320T 5(7905) LM320T12(7912) LM320T15(7915) LM339N LM340T-S178051 LM340T-S178121</p> <p>MICROPROCESSOR</p> <p>Z 80 8080A 8088 8224 8228 8800 8810 8830 AV'S-1013 2513/2140</p> <p>DIODES</p> <p>1N4733 1N4734 1N4742 1N4744</p> <p>TRANSISTORS</p> <p>C10681 2N2222A 2N2907A NJE2985 MJE3055</p>	<p>RESISTORS</p> <p>ASST 1 ASST 2 ASST 3 ASST 4</p> <p>CAPACITORS</p> <p>Aluminum Electrolytic</p> <p>1ml 50V 1.2ml 50V 10ml 50V 22ml 50V 47ml 50V</p> <p>Ceramic Disc</p> <p>0.01 50V 47ml 50V 0.01 50V 22ml 50V 330ml 50V 470ml 50V</p> <p>Dipped Tantalum</p> <p>1ml 35V 22ml 35V 33ml 35V 37ml 35V 88ml 35V 1ml 25V 1.5ml 35V</p>	<p>SWITCHES</p> <p>SPST 4 sts. dia. SPST 8 sts. dia. SPDT on-off-on toggle SPDT on-none-on toggle DPDT on-off-on toggle</p> <p>SOCKETS</p> <p>8 pin low profile 14 pin low profile 16 pin low profile 24 pin low profile 40 pin low profile Moore Pins</p> <p>14 pin wire wrap 16 pin wire wrap 24 pin wire wrap 40 pin wire wrap TO-3 Sockets TO-5 Sockets</p> <p>Display LECS Discrete</p> <p>5x7 dot matrix 300 com. anode 300 com. cathode</p> <p>600 com. anode 200 LED Lamp 14d</p> <p>CONNECTORS</p> <p>DB 25P Plug J875S Socket</p> <p>DATA BOOKS*</p> <p>7400/74LS Data Book CMOS/Linear Data Book Microprocessor/LED Data Book *JIM-PAK Products Only</p>
---	---	--	--

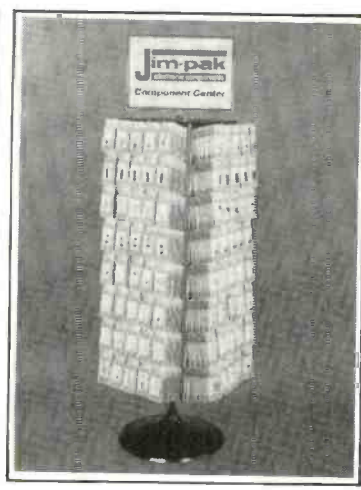

A component product line developed for the independent dealer. Guaranteed, nationally advertised products. Complete JIM-PAK program includes national advertising, direct mail programs, store display racks, stock rotation plan and return policy. For dealer information, write or call JIM-PAK, 1021 Howard Avenue, San Carlos, CA 94070 (415) 592-8097.



SEE YOUR LOCAL Jim-pak[®] DEALER TODAY...

- | | | |
|--|---|---|
| <p>ALABAMA
Mobile
<i>Lafayette Radio Electronics</i></p> | <p>LOUISIANA
Baton Rouge
<i>Davis Electronics Supply</i></p> | <p>OKLAHOMA
Owyan
<i>Sound Service</i></p> |
| <p>CALIFORNIA
Berkeley
Monterey
Palo Alto
Pasadena
Sacramento
Sacramento
San Carlos
San Francisco
San Jose
Vallejo
Walnut Creek</p> | <p>MARYLAND
Baltimore
Baltimore
Rockville
Towson</p> | <p>OREGON
Beaverton
Coos Bay
Ottawo
<i>Altair Computer Center
Herick Electronix
Miller Electronics</i></p> |
| <p>CANADA
Alberta (Calgary)
<i>The Computer Shop</i></p> | <p>MASSACHUSETTS
Medford
North Adams
Waltham</p> | <p>PENNSYLVANIA
Hershey
Pittsburville
<i>Microcomputer Systems Inc.
Computer Workshop
of Pittsburgh</i></p> |
| <p>CONNECTICUT
Bridgeport
<i>Computer World</i></p> | <p>MICHIGAN
Lansing
<i>Fulton Radio Supply</i></p> | <p>RHODE ISLAND
Cranston
Providence
<i>Jabhour Electronics City
Jabhour Electronics City</i></p> |
| <p>FLORIDA
Orlando
Tampa
Tampa</p> | <p>MINNESOTA
Duluth
Eagan
<i>Northwest Radio of Duluth
Dacom Amateur Radio Center</i></p> | <p>SOUTH CAROLINA
N.C. Charleston
<i>Technical Services Inc.</i></p> |
| <p>FRANCE
Paris
<i>Computer Boutique</i></p> | <p>MISSOURI
Parkville
<i>Computer Workshop of Kansas City</i></p> | <p>TENNESSEE
Memphis
Oak Ridge
<i>Sere-Rose & Spencer Electronics
Computer Denn</i></p> |
| <p>GEORGIA
Atlanta
<i>Atlanta Computer Mart</i></p> | <p>MONTANA
Billings
<i>Conley Radio Supply</i></p> | <p>TEXAS
Dallas
Houston
Houston
Sun Antonio
<i>Computer Shops Inc.
Altair Computer Center
Interactive Computers
Sherman Electronics Supply</i></p> |
| <p>HAWAII
Aiea
Honolulu
<i>Delcoms Hawaii
Integrated Circuit Supply</i></p> | <p>NEBRASKA
Lincoln
Omaha
<i>Altair Computer Center
Omaha Computer Store</i></p> | <p>VIRGINIA
Alexandria
Alexandria
Richmond
Springfield
<i>Computer Hardware Store
Computers Plus
Computers-To-Go
Computer Workshop
of North Virginia</i></p> |
| <p>IDAHO
Idaho Falls
<i>Audiotronics</i></p> | <p>NEVADA
Las Vegas
<i>Centur 23</i></p> | <p>WASHINGTON
Bellevue
Langview
Pasco
Spokane
<i>Altair Computer Center
Progress Electronics
Riverview Electronics
Personal Computers</i></p> |
| <p>ILLINOIS
Evanston
Groveland
Mount Prospect
Oak Park
<i>Itty Bitty Machine Co.
Moyer Electronics
Tri-State Electronics
Spectronics Inc.</i></p> | <p>NEW JERSEY
Hoboken
Ramsey
<i>Hoboken Computer Works
Typetronic Computer Store</i></p> | <p>WEST VIRGINIA
Martinsburg
Martinsburg
<i>The Computer Corner
Electro Distributing Co.</i></p> |
| <p>INDIANA
East Chicago
Hammond
<i>Acro Electronics
Quantum Computer Works</i></p> | <p>NEW YORK
Albany
New York
New York
Troy
<i>Fort Orange Electronics
The Computer Stores Inc.
Computer Mart of New York
Trojan Electronics
The Computer Corner</i></p> | <p>OHIO
Cincinnati
Cincinnati
Stuebenville
<i>Mead Electronics
Digital Design
Hosfelt Electronics</i></p> |



There are certain other instruments every serious musician should know how to play.

The implements used in every art form except music both create and preserve the art. If music isn't captured at the time it's created, it's gone forever.

But the instruments used to capture music can also be used to alter, refine and improve it.

Instruments like the A-2340SX and A-3340S 4-channel tape recorders with Simul-Sync for multitrack recording and over-dubbing, as well as mastering decks like the A-6100 and A-3300SX-2T for mixing down multichannel tapes to stereo.

Instruments like the Model 2A Mixing Console with an

MB-20 Meter Bridge for control of volume, tone, blend and spatial positioning. There are also microphones for every recording need along with accessories like the PB-64 Patch Bay and cables to help organize the process.

TEAC is the leader in multitrack. Less than a decade after multitrack equipment was introduced to the professional industry, TEAC introduced it to people serious about their music. Today, thousands of musicians and recordists are getting many of the important elements of the studio experience but without the studio bill. And TEAC continues its

commitment to multitrack excellence.

To find out more about the adventure of multitrack recording and to hear the quality of music that can be made on TEAC multitrack equipment, send \$2 to Dept. 38 for our "Home Made With TEAC" Album.* Or, if you can't wait to get your hands on the instruments every musician should know how to play, see your TEAC dealer now.

TEAC®

First. Because they last.

Multitrack

©TEAC 1977



*Offer good while supplies last. Void where prohibited by law. TEAC Corporation of America, 7733 Telegraph Road, Montebello, California 90640. In Canada TEAC is distributed by White Electronic Development Corporation (1966) Ltd.