

16-PAGE BONUS! SPECIAL FOCUS ON AUDIO

Popular Electronics®

WORLD'S LARGEST-SELLING ELECTRONICS MAGAZINE SEPTEMBER 1977/\$1.25

HOW TO CUSTOM DESIGN CASES FOR PROJECTS

UPGRADE YOUR OLD STEREO FM TUNER

An easy-to-add phase-locked-loop IC does the trick

FIELD REPORT:

CALIFORNIA HOBBYIST COMPUTER SHOW

TRANSFORMERLESS CIRCUIT DOUBLES DC VOLTS

TEST REPORTS: Akai GX-270DSS 4-Channel Tape Recorder
Speakerlab Model 7 Speaker System Kit
General Electric AM/SSB CB Mobile Transceiver
Aries "System 300" Electronic Music Synthesizer Kit

BUILD A 1/2-OCTAVE "REAL TIME" AUDIO ANALYZER

PE TESTED



303196 DRX 6450M090 141D NOV79
L DARKNELL JR
6450 WYRTLEWOOD DR
SAN JOSE CA 95129
09



Popular Electronics

Introducing the mobile that can move you out of the world of the ordinary and into the world of the serious CB'er. The Cobra 138XLR Single Sideband. Sidebanding puts you in your own private world. A world where there's less congestion. More privacy. More time to talk.



It's all possible because instead of 40 channels you get your choice of 120 channels. Both AM and SSB. And instead of 4 watts of legal power you get 12 watts of legal power. So you get almost double the range of AM.

With the 138XLR Single Sideband there's less background noise and less interference. So there's cleaner, clearer reception. Because like all Cobras, the 138XLR SSB is engineered to punch through loud and clear. Even in crowded metropolitan areas.

And like all Cobras it comes equipped with such standard features as an easy-to-read LED channel indicator. Switchable noise blanking and limiting. An RF/signal strength meter. And Cobra's exclusive DynaMike gain control.

You'll find the 138XLR SSB wherever Cobras are sold. Which is almost everywhere. Because Cobra's got a nationwide network of dealers and Authorized Service Centers offering sales, installation, service and advice. So come on in. And move on up.



Punches through loud and clear.

Cobra Communications Products
DYNASCAN CORPORATION
6460 W. Cortland St., Chicago, Illinois 60635

Write for color brochure
EXPORTERS: Empire • Plainview, N.Y. • CANADA: Atlas Electronics • Toronto

CIRCLE NO. 12 ON FREE INFORMATION CARD

UPWARD MOBILITY.



Burglar Alarm Breakthrough

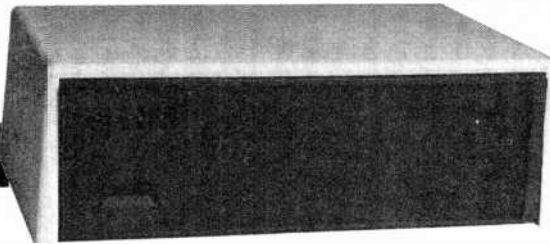

The Midex security computer looks like a handsome stereo system component and measures only 4" x 10 1/2" x 7".

A new computerized burglar alarm requires no installation and protects your home or business like a thousand dollar professional system.

It's a security system computer. You can now protect everything—windows, doors, walls, ceilings and floors with a near fail-safe system so advanced that it doesn't require installation.

The Midex 55 is a new motion-sensing computer. Switch it on and you place a harmless invisible energy beam through more than 5,000 cubic feet in your home. Whenever this beam detects motion it sends a signal to the computer which interprets the cause of the motion and triggers an extremely loud alarm.

The system's alarm is so loud that it can cause pain—loud enough to drive an intruder out of your home before anything is stolen or destroyed and loud enough to alert neighbors to call the police.

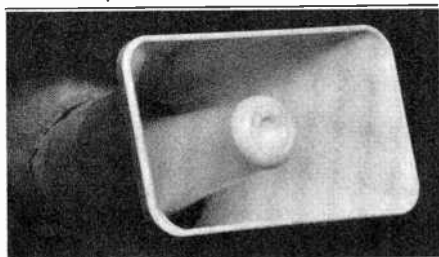

The powerful optional blast horns can also be placed outside your home or office to warn your neighbors.

Unlike the complex and expensive commercial alarms that require sensors wired into every door or window, the Midex requires no sensors nor any other additional equipment other than your stereo speakers or an optional pair of blast horns. Its beam actually penetrates walls to set up an electronic barrier against intrusion.

NO MORE FALSE ALARMS

The Midex is not triggered by noise or sound, temperature or humidity—just motion, and since a computer interprets the nature of the motion, the chances of a false alarm are very remote.

An experienced burglar can disarm an expensive security system or break into a home or office through a wall. Using a Midex system there is no way a burglar can penetrate the protection beam without triggering the loud alarm. Even if the burglar cuts off your power, the four-hour rechargeable battery pack will keep your unit triggered, ready to sense motion and sound an alarm.

DEFENSE AGAINST PEEPING TOMS

By pointing your unit towards the outdoors from your bedroom and installing an outside speaker, light, or alarm, your unit can sense a peeping tom, and frighten him off. Pets are no problem for the Midex. Simply put them in one section of the house and concentrate the beam in another.

When the Midex senses an intruder, it remains silent for 20 seconds. It then sounds the alarm until the burglar leaves. One minute after the burglar leaves, the alarm shuts off and resets, once again ready to do its job. This

shut-off feature, not found on many expensive systems, means that your alarm won't go wailing all night long while you're away. When your neighbors hear it, they'll know positively that there's trouble.

PROFESSIONAL SYSTEM

Midex is portable so it can be placed anywhere in your home. You simply connect it to your stereo speakers or attach the two optional blast horns.

Operating the Midex is as easy as its installation. To arm the unit, you remove a specially coded key. You now have 30 seconds to leave your premises. When you return, you enter and insert your key to disarm the unit. You have 20 seconds to do that. Each key is registered with Midex and that number is kept in their vault should you ever need a duplicate. Three keys are supplied with each unit.

As an extra security measure, you can leave your unit on at night and place an optional panic button by your bed. But with all its optional features, the Midex system is complete, designed to protect you, your home and property just as it arrives in its well-protected carton.

The Midex 55 system is the latest electronic breakthrough by the Midex Corporation—a company that specializes in sophisticated professional security systems for banks and high security areas. JS&A first became acquainted with Midex after we were burglarized. At the time we owned an excellent security system but the burglars went through a wall that could not have been protected by sensors. We then installed over \$5,000 worth of the Midex commercial equipment in our warehouse. When Midex announced their intentions to market their units to consumers, we immediately offered our services.

COMPARED AGAINST OTHERS

In a recent issue of Consumers Report, a leading consumer publication, there was a complete article written on the tests given security devices which were purchased in New York. The Midex 55 is not available in New York stores but had it been compared it would have been rated tops in space protection and protection against false alarms—two of the top criteria used to evaluate these systems. Don't be confused. There is no system under \$1,000 that provides you with the same protection as the Midex 55.

YOU JUDGE THE QUALITY

Will the Midex system ever fail? No product is perfect but judge for yourself. All components used in the Midex system are of aerospace quality and of such high reliability that they pass the military standard 883 for thermal shock and burn-in. In short, they go through the same rugged tests and controls used on components in manned space ships.

Each component is first tested at extreme tolerances and then retested after assembly. The entire system is then put under full electrical loads at 150 degrees Fahrenheit for a full week. If there is a defect, these tests will cause it to surface.

PEOPLE LIKE THE SYSTEM

Wally Schirra, a former astronaut and scientist, says this about the Midex 55, "I know of no system that is as easy to use and provides such solid protection to the home owner as the Midex. I would strongly recommend it to anyone. I am more than pleased with my unit."

Many more people can attest to the quality of this system but the true test is how it performs in your home or office. That is why we provide a one month trial period. We give you the opportunity to personally see how fail-safe and easy the Midex system is to operate and how thoroughly it protects you and your loved ones.

Use the Midex for protection while you sleep, to protect your home while you're away or on vacation. Then after 30 days, if you're not convinced that the Midex is nearly fail-safe, easy to use, and can provide you with a security system that you can trust, return your unit and we'll be happy to send you a prompt and courteous refund. There is absolutely no obligation. JS&A has been serving the consumer for over a decade—further assurance that your investment is well protected.

To order your system, simply send your check in the amount of \$199.95 (Illinois residents add 5% sales tax) to the address shown below. Credit card buyers may call our toll-free number below. There are no postage and handling charges. By return mail you will receive your system complete with all connections, easy to understand instructions and one year limited warranty. If you do not have stereo speakers, you may order the optional blast horns at \$39.95 each and we recommend the purchase of two.

With the Midex 55, JS&A brings you: 1) A system built with such high quality that it complies with the same strict government standards used in the space program, 2) A system so advanced that it uses a computer to determine unauthorized entry, and 3) A way to buy the system, in complete confidence, without even being penalized for postage and handling charges if it's not exactly what you want. We couldn't provide you with a better opportunity to own a security system than right now.

Space-age technology has produced the ultimate personal security system. Order your Midex 55 security computer at no obligation, today.

JS&A NATIONAL SALES GROUP

Dept. PE One JS&A Plaza
Northbrook, Ill. 60062 (312) 564-9000
CALL TOLL-FREE... 800 323-6400
In Illinois call... (312) 498-6900

©JS&A Group, Inc., 1977

NOW, SCANNING OVER 6000 FREQUENCIES IS AS EASY AS USING A PUSHBUTTON PHONE.



Introducing the incredible, new Bearcat 210.

The exciting, new Scanner Radio with the space-age, computer control center that brings in every available public service frequency with pushbutton ease.

Bearcat's new 210 is as easy to program as a pushbutton phone. You can select any of the public service bands (all the available local frequencies) simply by pushing buttons.

Simply punch in the frequency numbers on the computer control center keyboard. Hit the Enter button. And you're programmed.

A large, flashing, digital readout panel shows you each frequency you've selected.

The Bearcat 210 patented search capacity lets you explore the endless world of every available public frequency out there, too.

Best of all, you're no longer limited to a given band or set of frequencies. The new Bearcat 210 is synthesized. Space-age circuitry lets you forget crystals forever.

Let's look at some Bearcat 210 features. And facts.

5 BAND COVERAGE—Includes Low, High, UHF and UHF "T" public service bands, the 2-meter amateur (Ham) band, plus other UHF frequencies.

SCANS 20 CHANNELS PER SECOND—In half a second, the Bearcat 210 scans all 10 channels.

CRYSTAL-LESS—Space-age circuitry with 5 custom designed chips. You never have to buy a crystal.

TRACK-TUNING—Patented track tuning provides full-band coverage on every band.

AUTOMATIC LOCK-OUT—Locks out channels and "skips" frequencies not of current interest.

AC/DC—Mobile mounting bracket included.

SELECTIVE SCAN DELAY—Adds a two-second delay to prevent missing transmissions when "calls" and "answers" are on the same frequency.

AUTOMATIC SEARCH—New, patented feature searches out any active local public service frequency automatically. For more police, fire, marine, emergency calls. And much more.

THE NEW BEARCAT 210

THE MOST EXCITING THING THAT'S HAPPENED
TO SCANNING SINCE SCANNERS.

Electra Company
300 East County Line Road, South, Cumberland, Indiana 46229
Copyright 1977 Masco Corporation of Indiana

Popular Electronics®

WORLD'S LARGEST-SELLING ELECTRONICS MAGAZINE

FEATURE ARTICLES

PROS AND CONS OF MULTI-WAY SPEAKER SYSTEMS	Julian Hirsch	22
FIRST WEST COAST COMPUTER FAIRE	Tom Munnecke	74
HOW TO CUSTOM DESIGN PLASTIC CASES FOR PROJECTS	John Huff	81
ENGLISH-LANGUAGE SHORTWAVE BROADCASTS FOR SEPT. & OCT.	Richard E. Wood	114

CONSTRUCTION ARTICLES

1/2-OCTAVE REAL TIME AUDIO ANALYZER, PART I	Bob Jones & Richard Marsh	47
<i>Displays system output to permit accurate matching to room acoustics.</i>		
BUILD A TRANSFORMERLESS DC-TO-DC VOLTAGE DOUBLER	Marlowe J. Buchanan	55
BUILD "CABONGA" PART 2	James Barbarello	76

SPECIAL FOCUS: AUDIO

THE BASICS OF BUYING HI-FI COMPONENTS	William S. Gordon	57
DYNAMIC NOISE REDUCTION SYSTEMS AND EXPANDERS	Len Feldman	63
MATCHING TAPES TO RECORDERS	Martin Meyer	67
IC MULTIPLEX DECODER IMPROVES STEREO FM PERFORMANCE	Robert P. Balin	71
QUIZ OF AUDIO BASICS		

COLUMNS

STEREO SCENE	Ralph Hodges	14
<i>Records and the Vertical Angle.</i>		
SOLID STATE	Lou Garner	85
<i>IC Audio Preamplifiers.</i>		
EXPERIMENTER'S CORNER	Forrest M. Mims	94
<i>Laser Diodes.</i>		
HOBBY SCENE Q&A	John McVeigh	96
CB SCENE	Ivan Berger	103
<i>Better Emergency Services Are NEAR.</i>		
COMPUTER BITS	Hal Chamberlin	110
<i>Update on Microprocessor Developments.</i>		
DX LISTENING	Glen Hauser	112
<i>Publications.</i>		

JULIAN HIRSCH AUDIO REPORTS

AKAI MODEL GX-270D-SS FOUR-CHANNEL TAPE RECORDER	32
SPEAKERLAB MODEL S7 SPEAKER SYSTEM KIT	36

ELECTRONIC PRODUCT TEST REPORTS

GENERAL ELECTRIC MODEL 3-5825 AM/SSB CB TRANSCEIVER	97
ARIES SYSTEM 300 ELECTRONIC MUSIC SYNTHESIZER	98

DEPARTMENTS

EDITORIAL	Art Salsberg	4
<i>TV Electronic Games Grow Up.</i>		
LETTERS		6
OUT OF TUNE		6
<i>"Digital Capacitance Meter" (April 1977); "RC Circuit Quiz" (July 1977)</i>		
NEW PRODUCTS		8
NEW LITERATURE		11
OPERATION ASSIST		118
ELECTRONICS LIBRARY		119

POPULAR ELECTRONICS, September 1977, Volume 12, Number 3, Published monthly at One Park Avenue, New York, NY 10016. One year subscription rate for U.S. \$12.00; Possessions and Canada, \$15.00; all other countries, \$18.00 (cash orders only, payable in U.S. currency). Second Class postage paid at New York, NY and at additional mailing offices. Authorized as second class mail by the Post Office Department, Ottawa, Canada, and for payment of postage in cash.

POPULAR ELECTRONICS including ELECTRONICS WORLD, Trade Mark Registered. Indexed in the Reader's Guide to Periodical Literature.

COPYRIGHT © 1977 BY ZIFF-DAVIS PUBLISHING COMPANY. ALL RIGHTS RESERVED.

Ziff-Davis also publishes Boating, Car and Driver, Cycle, Flying, Modern Bride, Popular Photography, Skiing and Stereo Review.

Material in this publication may not be reproduced in any form without permission. Requests for permission should be directed to Jerry Schneider, Rights and Permissions, Ziff-Davis Publishing Co., One Park Ave., New York, NY 10016.

Editorial correspondence: POPULAR ELECTRONICS, 1 Park Ave., New York, NY 10016. Editorial contributions must be accompanied by return postage and will be handled with reasonable care; however, publisher assumes no responsibility for return or safety of manuscripts, art work, or models.

Forms 3579 and all subscription correspondence: POPULAR ELECTRONICS, Circulation Dept., P.O. Box 2774, Boulder, CO 80302. Please allow at least eight weeks for change of address. Include your old address, enclosing, if possible, an address label from a recent issue.

Popular Electronics®

JOSEPH E. MESICS
Publisher

ARTHUR P. SALSBERG
Editorial Director

LESLIE SOLOMON
Technical Editor

JOHN R. RIGGS
Managing Editor

IVAN BERGER
Senior Editor

ALEXANDER W. BURAWA
Features Editor

EDWARD I. BUXBAUM
Art Director

JOHN McVEIGH
Associate Editor

ANDRE DUZANT
Technical Illustrator

PATRICIA GIRRIER-BROWN
Production Editor

DORIS A. MATTHEWS
Editorial Assistant

Contributing Editors
Hal Chamberlin, Lou Garner, Glenn Hauser
Julian Hirsch, Ralph Hodges, Forrest Mims
Ray Newhall, Wilfred Scherer

JOSEPH E. HALLORAN
Advertising Director

JOHN J. CORTON
Advertising Sales

LINDA BLUM
Advertising Service Manager

PEGI McENEANEY
Executive Assistant

EDGAR W. HOPPER
Publishing Director

ZIFF-DAVIS PUBLISHING COMPANY
Editorial and Executive Offices
One Park Avenue New York, New York 10016
212-725-3500

Hershel B. Sarbin, President
Philip Korsant, Executive Vice President
Furman Hebb, Executive Vice President
John R. Emery, Sr. Vice President, Finance and Treasurer
Phillip T. Heffernan, Sr. Vice President
Edward D. Muhlfeld, Sr. Vice President, Sports Division
Philip Sine, Sr. Vice President
Frank Pomerantz, Vice President, Creative Services
Arthur W. Butzow, Vice President, Production
Lawrence Sporn, Vice President, Circulation
George Morrissey, Vice President
Sydney H. Rogers, Vice President
Sidney Holz, Vice President
Albert S. Traina, Vice President
Paul H. Chook, Vice President
Edgar W. Hopper, Vice President
Robert N. Bavier, Jr., Vice President
Charles B. Seton, Secretary

William Ziff, Chairman
W. Bradford Briggs, Vice Chairman

Midwestern Office
The Patis Group, 4761 West Touhy Ave.,
Lincolnwood, Illinois 60466, 312 679-1100
Thomas Hockney, Michael Neri, Gerald E. Wolfe
Western Office
9025 Wilshire Boulevard, Beverly Hills, CA 90211
213-273-8050; BRadshaw 2-1161
Western Advertising Manager: Bud Dean
Japan: James Yagi
Oji Palace Aoyama; 6-25, Minami Aoyama
6 Chome, Minato-Ku, Tokyo 407-1930/6821,
582-2851



The publisher has no knowledge of any proprietary rights which will be violated by the making or using of any items disclosed in this issue.



Editorial

TV ELECTRONIC GAMES GROW UP

The sale of home TV electronic games peaked during the Christmas season of 1976, followed by a severe decline in 1977. Was the estimated 3-million video games sold in '76 just a passing fancy of the American public? Obviously not, since manufacturers are now producing with the expectation that 1977 sales will easily be twice those of 1976. And nonvideo electronic games will certainly make their mark this year, too.

Home TV games did not move as well as anticipated during the first half of '77 for a variety of reasons: (1) Christmas doesn't last all year (though the interest in games should be year-round); (2) reduced selling prices on games disheartened many retailers, who placed them on the back shelves; (3) programmable games are just around the corner. Concerning the latter, there are two companies already marketing them—Fairchild, who can't seem to keep up with consumer demands at \$170 a game plus "cartridges," and RCA, just really entering the market with a \$150 programmable model.

Dramatic decreases in prices for the older, dedicated video games are anticipated, with prognosticators saying that they will simulate the price dip exhibited by calculators and digital watches. But with the new dedicated games, such as Atari's Tank™ (with sound effects and joy-stick controls) at a suggested retail price of \$65, don't expect \$9.95 paddleball/hockey sellers to be around just yet.

The future of home video games is extraordinarily bright. And speaking of brightness, I find it amusing that one major TV receiver manufacturer, who also produces a TV electronic game, indicates that its receiver CRT warranty will be voided if electronic games are displayed on it. I've been personally assured by a top executive in the company that they have not seen a single defective CRT with burn spots caused by video electronic games—even with "duds."

The burn-spot question arose last year because some coin-operated units in arcades did display such CRT marring after a considerable period of video-game use. Users of home video games, however, do not play them sufficiently, without shutoff, to cause CRT damage.

It's projected that programmable video games will account for some 20% of unit sales in 1977, rising to 33½% by 1980. The omnipresent microprocessor will also be utilized for nonvideo electronic games. Parker Brothers (of "Monopoly" fame) will soon market a nonvideo electronic game based on the old "Battleship" game, as an example. Another toy maker, Mattel, will offer hand-held missile, auto race and football games with LED score readouts . . . Fidelity Electronics will be presenting an electronic chess game that the user plays against . . . Tryom Inc. will enable you to pit your wits against a microprocessor in the game of backgammon . . . Unisonic has a four-function calculator that can also permit one to play blackjack, even changing the deal when 38 cards are played, a la Vegas rules.

Although the programmable microprocessor games are destined to take over the electronic game market, at least in dollars, the input medium used will not necessarily be the ROM-type cartridges now prevalent. Among other possibilities that may evolve are matchbook-size tape cartridges and magnetic cards. Regarding the latter, kilobyte cards can be produced much as record discs can and, therefore, offer the potential for very low costs. The four-stripe plastic cards now available provide 1024 bytes, enough for most game programs, unless you want a Star-Trek game. Then you'll need a full blown microcomputer system.

Clearly, microprocessors are changing the face of consumer electronic products for increased efficiency and, in the case of games, to add another leisure activity to our lives.

Art Salsberg

ONLY PIONEER COULD INTRODUCE A QUARTZ PHASE LOCKED LOOP TURNTABLE AND CALL IT A BARGAIN.

Today, there's nothing more accurate than a quartz phase locked loop turntable.

It's the kind of turntable they use at radio stations and recording studios. Where people are more interested in getting a great sound than getting a great price.

Well, Pioneer has just introduced the same kind of quartz turntable. Except ours was designed for people who *do* care about price.

It's called the PL570.

And like the professional quartz turntables you'll find in all those radio stations and recording studios across the country, it features a direct-drive motor that's quieter than ordinary motors.

Plus an electronic strobe circuit that lets you adjust the PL570 far more accurately than conventional strobes.

And the same kind of quartz phase locked loop technology that automatically corrects the turntable speed to account for things like the weight of the record and even

the amount of stylus pressure. So your records can always sound perfect, because they're always spinning perfectly.

But where the average quartz phase locked loop turntable offers you all this accuracy for around \$800, our new PL570 does it for under \$400. Which, you'll have to agree, is quite a bargain. (And that's even before you find out that the PL570 is one of the few fully-automatic quartz-lock turntables available today at *any* price.)

Of course, if you're looking for something a little less sophisticated than our PL570, there's still no need to look any further than Pioneer.

In all, we make eight high quality turntables. And while they may not all offer the same kind of features as our PL570, you can bank on at least one thing.

They all feature the same kind of value.

High Fidelity Components
PIONEER
WE BRING IT BACK ALIVE.

©1977 U.S. Pioneer Electronics, 85 Oxford Drive, Moon Twp., New Jersey 07074

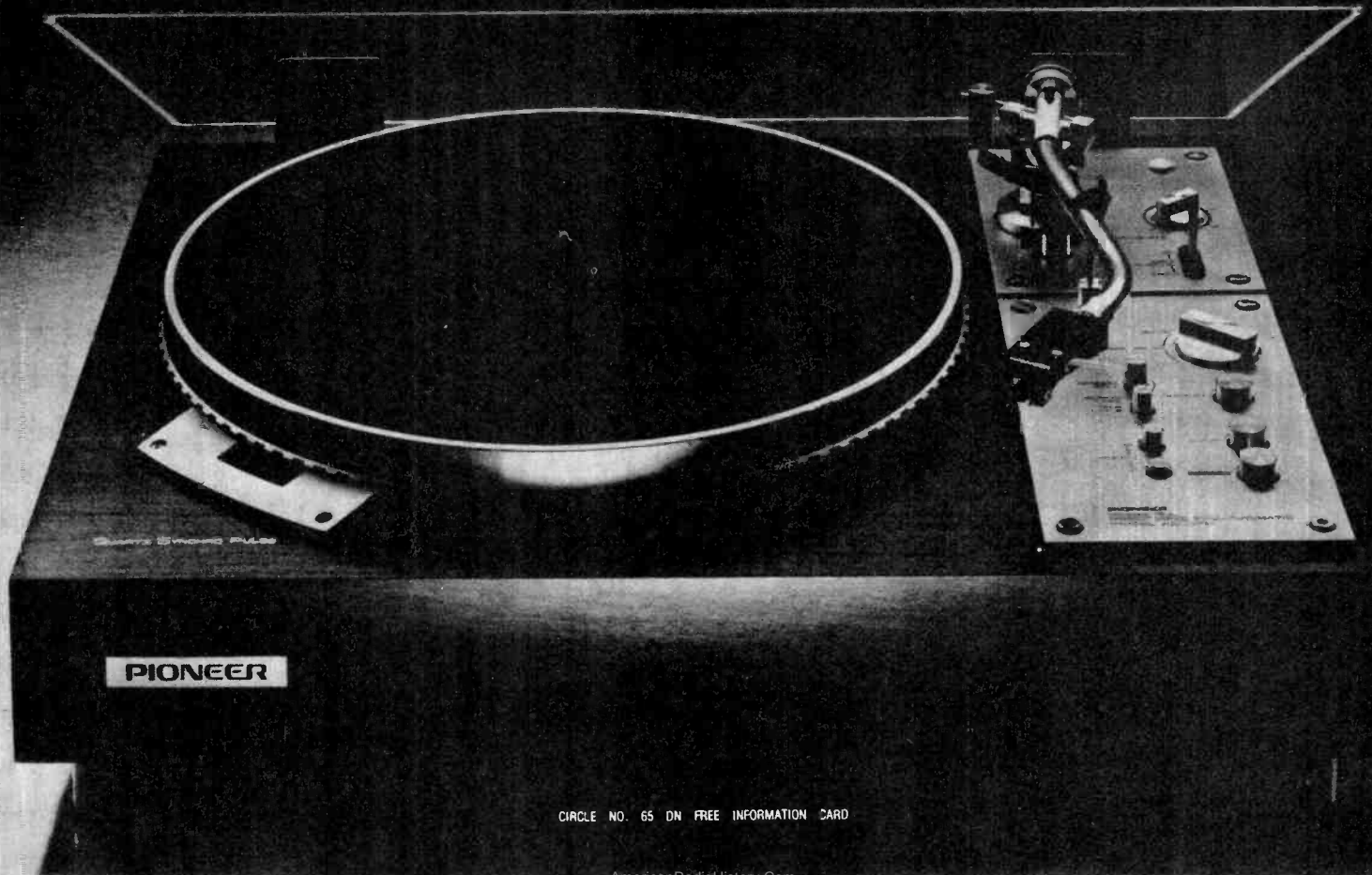

SAE Power

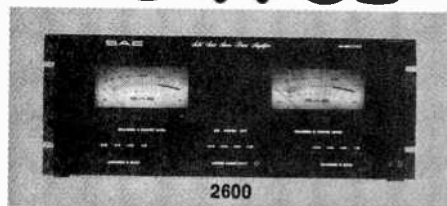

2600

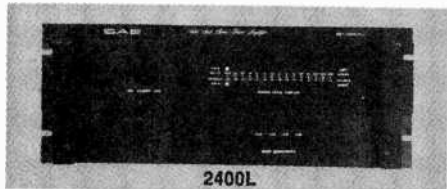

2400L

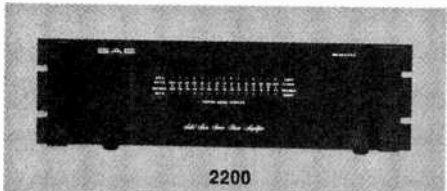

2200

SAE's goal today, just as it has been for over 12 years, is the design and production of fine audio components; which offer the best value in both sonic performance and quality construction. Our line of amplifiers stand as a testament to this goal.

First, their design — all SAE amplifiers have fully complimentary circuitry. In this unique design approach, not only the output (as in conventional amplifiers), but the drive and input stages are completely complimentary. This ensures low transient and steady-state distortion, plus full stability and fast overload recovery. Combine this with our high slew rate for accurate transient response, feedback gain controls which will not degrade the input signal (2600, 2400L), and monocoque construction with its low weight and high reliability (2200, 2400L).

The result is state-of-the-art performance, but to realize this performance we must have the second part of our goal — production. In order to ensure optimum performance from these unique design concepts, SAE retains total control over the manufacture, selection, and assembly processes. We maintain 40,000 sq. ft. of production area where the latest techniques in metal and circuit board fabrication, component selection and product assembly are employed. The result of these efforts is the line of high quality amplifiers pictured here, each an outstanding value in its power range and each a true SAE component where performance and value come together — that's SAE Power!

SAE

Scientific Audio Electronics, Inc.

P.O. Box 60271 Terminal Annex, Los Angeles, CA 90060

CIRCLE NO. 57 ON FREE INFORMATION CARD



Letters

CUTTING DOWN THREE BYTES

In "Debugging Aids" (Computer Bits, May 1977), Hal Chamberlain has mistakenly assumed that to insert a breakpoint in an 8080 program, a three-byte CALL instruction must be used. This gives the impression that a breakpoint feature on an 8080 is clumsy at best. We recommend that 8080 users initiate one of the RESTART (RST) instructions to implement a breakpoint feature in their software. The RESTART instructions are essentially one-byte CALL instructions and require only one memory location within the user's program for storage. In fact, the RST instruction is very similar to the BRK instruction of the 6502 microprocessor.

One nice feature of both the RST and BRK instructions is that both cause the incremented program counter (PC) to be saved on the stack. This makes the "print registers and continue" function very easy to implement on either of the microprocessors.—*Christopher A. Titus, Blacksburg, VA.*

A QUESTION OF LEGALITY

Your May 1977 article titled "Build a Legal In-Flight Airline Receiver" was cause for inquiries from persons concerned with the requirements of the Federal Aviation Regulations (FAR) and the legality of using the receiver while on board an airliner. From the description of the receiver, it would be considered a "portable electronic device" and, therefore, comes under the requirements of FAR 91.19, titled "Portable Electronic Devices." This regulation places the responsibility for determining that the receiver will not cause interference to the aircraft navigation and communication systems with the air carriers, who should approve its operation while on board their aircraft.—*John W. Flavin, Chief Avionics Staff, Flight Standards Service, FAA, Washington, DC.*

HI-FI FEEDBACK

I commend Ralph Hodges for the honesty of his observations and opinions expressed in the June 1977 Stereo Scene. I concur with his skepticisms on the validity of the "phase coherence" technique in speaker systems. While in theory it may produce better patterns on the CRT of an oscilloscope, its improvement of the sound as interpreted by the human ear-brain combination is questionable. The human brain is a remarkable decoding device of audio signals and is able to perceive "true" sound even through the phase distorting motion of turning one's head a fraction of an inch. The phase-coherent speaker

system can be valid only for a controlled and stationary listening device. Otherwise it becomes no better than a conventional speaker system.—*Michael P. Liben, New York, N.Y.*

I found "Instruments I Have Miked" (Stereo Scene, July 1977) totally engrossing. The article delivered a tantalizing amount of tips to use in professional recording that whetted my appetite to pursue a career in professional recording engineering. I would like to see a great deal more material published on this topic.—*H. Douglas Black, Raleigh, NC.*

APPRECIATES "ELF"

I would like to express my appreciation for the best project I have ever built from the pages of POPULAR ELECTRONICS—the "Cosmac Elf" microcomputer (August 1976). Now I would like to see you publish plans for a cassette interface and other peripherals, plus appropriate programming, for the Elf. Keep up the good work.—*Louis Choiniere, Barton, VT.*

HERB BRIER

Herbert S. Brier, W9AD, ex-W9EGQ, died May 21, 1977 at age 63. Herb was crippled by rheumatoid arthritis at the age of 12 and was unable to attend school past grade 7. In spite of this, he taught himself advanced mathematics, electronics, Spanish, and Braille. For 17 years he was POPULAR ELECTRONICS' Amateur Radio editor, and for years wrote the Novice column in CQ magazine. He wrote one book on amateur radio, and co-authored the VHF Handbook with William Orr, W6SAI. He held an Extra Class amateur license. During World War II, he ran the Gary (Indiana) emergency radio station, for which he received a citation. In later years, he maintained industrial electronic equipment in Gary and Chesterton, Indiana, and tutored local residents in electronics and amateur radio.

Out of Tune

In "Digital Capacitance Meter" (April 1977), one end of C3, in Fig. 2, should be connected to pin 9 of IC1, not pin 13 as shown. The normally open contact of S1 should be connected to pin 13 of IC1, not pin 9 as shown. Also, at the center of Fig. 3, the 1.5-k resistor should be 1.5 ohms. The second lowest range measures capacitances from 0.01 to 0.99 μ F. When the switch is placed in this position, it automatically inserts a decimal point in the proper location and the display gives the capacitance directly in microfarads.

In "RC Circuit Quiz" (July 1977), the differentiator should be circuit H, and the Integrator circuit J. The answers, as given, were reversed.

An Extraordinary Offer to introduce you to the benefits of Membership in

ELECTRONICS BOOK CLUB

take any **3** of these unique electronics books (value to \$51.75) for only **99¢** each

with a Trial Membership in the Book Club that guarantees to save you 25% to 75% on a wide selection of electronics books

All two-book sets count as only one of your three Selections.

1010-200 p.—Tower's International Transistor Selector—2nd Edition (\$9.95) 7"×10"

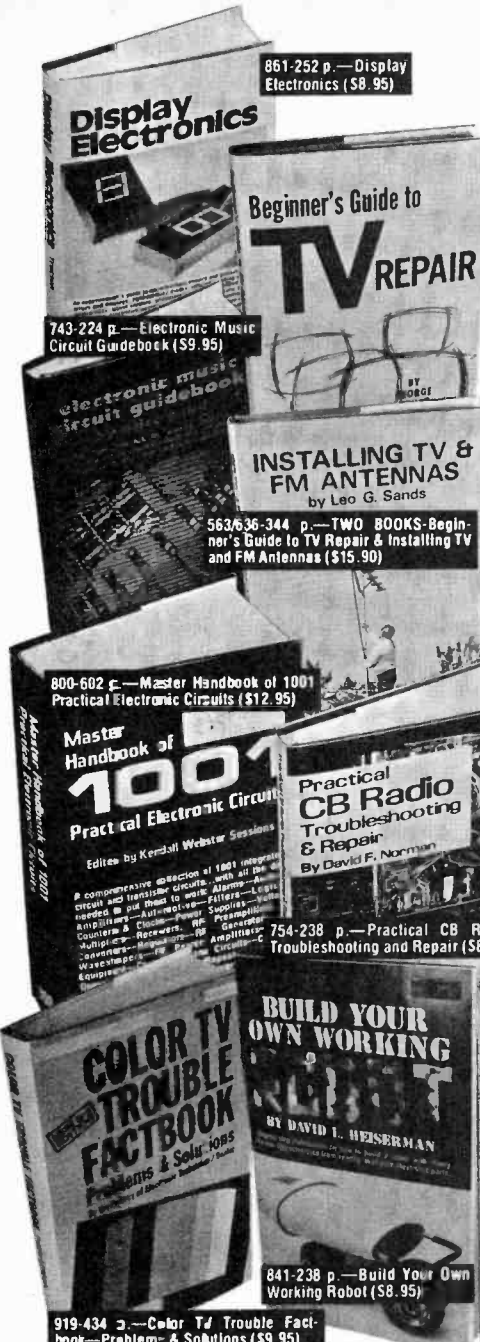

861-252 p.—Display Electronics (\$8.95)

743-224 p.—Electronic Music Circuit Guidebook (\$9.95)

INSTALLING TV & FM ANTENNAS by Leo G. Sands

563/636-344 p.—TWO BOOKS—Beginner's Guide to TV Repair & Installing TV and FM Antennas (\$15.90)

800-602 p.—Master Handbook of 1001 Practical Electronic Circuits (\$12.95)

Master Handbook of 1001 Practical Electronic Circuits Edited by Kendall Webster Sessions

Practical CB Radio Troubleshooting & Repair By David F. Norman

785-294 p.—Microprocessor/Microprogramming Handbook (\$9.95)

754-238 p.—Practical CB Radio Troubleshooting and Repair (\$8.95)

913-476 p.—The Complete Handbook of Electrical & House Wiring (\$10.95)

The Complete Handbook of Electrical & House Wiring

BUILD YOUR OWN WORKING ROBOT BY DAVID L. HEISERMAN

841-238 p.—Build Your Own Working Robot (\$8.95)

919-434 p.—Color TV Trouble Factbook—Problems & Solutions (\$9.95)

HOW TO READ ELECTRONIC CIRCUIT DIAGRAMS

510/628-487 p.—TWO BOOKS—How to Read Electronic Circuit Diagrams & Basic Electricity & Beginning Electronics (\$17.90)

INTERNATIONAL TRANSISTOR SELECTOR

BUILD-IT BOOK OF DIGITAL ELECTRONIC TIMEPIECES

905-294 p.—Build-It Book of Digital Electronic Timepieces (\$9.95)

How to Build Metal/Treasure Locators

909-140 p.—How to Build Metal/Treasure Locators (\$7.95)

780/790-350 p.—TWO BOOKS—111 Digital & Linear IC Projects & 21 Simple Transistor Radios You Can Build (\$15.90)

COMMERCIAL FCC LICENSE HANDBOOK

582-444 p.—Commercial FCC License Handbook (\$9.95)

21 SIMPLE TRANSISTOR RADIOS YOU CAN BUILD

ELECTRONIC CIRCUIT DESIGN HANDBOOK

101-416 p.—Electronic Circuit Design Handbook (\$17.95) 8½"×11"

May we send you your choice of these 3 practical, time and money-saving books as part of an unusual offer of a Trial Membership in Electronics Book Club?

Here are quality hardbound volumes, each especially designed to help you increase your know-how, earning power, and enjoyment of electronics. Whatever your interest in electronics, you'll find Electronics Book Club offers practical, quality books that you can put to immediate use and benefit.

This extraordinary offer is intended to prove to you, through your own experience, that these very real advantages can be yours... that it is possible to keep up with the literature published in your areas of interest, and to save substantially while so doing. As part of your Trial Membership, you need purchase as few as four books during the coming 12 months. You would probably buy at least this many anyway... without the substantial savings offered through Club Membership.

To start your Membership on these attractive terms, simply fill out and mail the coupon today. You will receive the 3 books of your choice for 10-day inspection. **YOU NEED SEND NO MONEY!** If you are not delighted, return the books within 10 days and your Trial Membership will be cancelled without cost or obligation.

ELECTRONICS BOOK CLUB, P.O. Box 10, Blue Ridge Summit, Pa. 17214

Facts About Club Membership

- The 3 introductory books of your choice carry publishers retail prices of up to \$51.75. They are yours for only 99¢ each (plus postage and handling) with your Trial Membership.
- You will receive the Club News, describing the current Selection, Alternates and other offerings, every 4 weeks (13 times a year).
- If you want the Selection, do nothing; it will be sent to you automatically. If you do not wish to receive the Selection, or if you want to order one of the many Alternates offered, you simply give instructions on the reply form (and in the envelope) provided, and return it to us by the date specified. This date allows you at least 10 days in which to return the form. If, because of late mail delivery, you do not have 10 days to make a decision and so receive an unwanted Selection, you may return it at Club expense.
- Personal service for your account—no computers used!
- To complete your Trial Membership, you need buy only four additional monthly selections or alternates during the next 12 months. You may cancel your Membership any time after you purchase these four books.
- All books—including the Introductory Offer—are fully returnable after 10 days if you're not completely satisfied.
- All books are offered at low Member prices, plus a small postage and handling charge. Prepaid orders shipped postpaid.
- Continuing Bonus: If you continue after this Trial Membership, you will earn a Dividend Certificate for every book you purchase. Three Certificates, plus payment of the nominal sum of \$1.99, will entitle you to a valuable Book Dividend of your choice which you may choose from a list provided Members.

ELECTRONICS BOOK CLUB

P.O. Box 10
Blue Ridge Summit, Pa. 17214

Please open my Trial Membership in ELECTRONICS BOOK CLUB and send me the 3 books circled below. I understand the cost of the books I have selected is only 99¢ each, plus a small shipping charge. If not delighted, I may return the books within 10 days and owe nothing, and have my Trial Membership cancelled. I agree to purchase at least four additional books during the next 12 months, after which I may cancel my membership at any time.

101	563/636	510/628	582	743
780/790	754	785	800	841
861	905	909	913	919
			919	1010

Name _____ Phone _____

Address _____

City _____

State _____ Zip _____

(This offer valid for new Members only. Foreign and Canada add 10%) PE-97

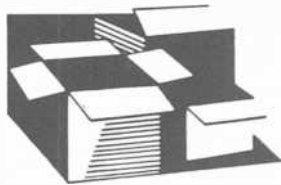

New Products

Additional information on new products covered in this section is available from the manufacturers. Either circle the item's code number on the Reader Service Card inside the back cover or write to the manufacturer at the address given.

SONY THREE-WAY SPEAKER SYSTEM

Sony's Model SU-3000 speaker system features a "carbocon" cone material that is claimed to provide reproduction that virtually mirrors the original sound. The three-way bass-reflex system is rated to be driven by 20 watts of amplifier power and to handle up to 150 watts over a frequency range of 35 to 20,000 Hz. Crossovers are at 600 and 5500 Hz, while woofer rolloff and tweeter turn-on are at a 12-dB/octave rate. The midrange driver and tweeter are fronted by radial diffusion elements which are said to smooth the frequency response and provide improved dispersion and imaging. Dual-slope level control network and adjustable midrange and tweeter controls permit adjustment to suit the listening room. Size is 34¼"H × 14¼"D × 13½"W (87 × 36.2 × 34.3 cm) and weight is 59 lb 9 oz (27 kg). \$300.

CIRCLE NO. 89 ON FREE INFORMATION CARD

BEARCAT PROGRAMMABLE SCANNER

Communications Electronics' new Bearcat 210 five-band programmable "super" synthesized scanning receiver needs no crystals. It gives the user push-button access to more than 16,000 different frequencies in the 32-to-50-, 146-to-174-, and 416-to-512-MHz ranges, which include frequencies on 2 me-



ters and the entire 0.75-meter amateur band. The synthesizer permits one to enter or change any 10 frequencies in seconds. The receiver scans entered frequencies at a rate of 20 channels per second. A digital input and display allows the operator to see the frequencies selected as well as those being received. Automatic search scanning and lock-out are included. Sensitivity is rated at 0.6µV for 12 dB SINAD on the low and high bands. \$319.95.

CIRCLE NO. 91 ON FREE INFORMATION CARD

MARANTZ STEREO RECEIVERS

Marantz has added three popularly priced AM/FM receivers to its line. Featuring dual-gate MOSFET front ends, the receivers are equipped with zone-detented tone controls for convenient variation of bass, midrange, and treble frequencies. Other features include Dolby FM de-emphasis (25-µs), full complementary symmetry direct-coupled amplifier section, phase-locked-loop multiplex demodulator, and quadraxial-ready jack so



that a 4-channel decoder can be connected should a standardized 4-channel FM broadcast system be approved by the FCC. The three new models are 2226 (26 watts), 2238 (38 watts), and 2252 (52 watts), all into 8-ohm loads. The 2226 is rated at no more than 0.2% THD with an 8-ohm load; the other two models, 0.1%. All models include separate FM-tuning and signal-strength meters.

CIRCLE NO. 92 ON FREE INFORMATION CARD

McKay DYMEK COMMUNICATIONS RECEIVER

McKay Dymek has introduced an all-wave, fully synthesized communications receiver covering the frequency range of 50 kHz to 29.7 MHz. The DR-22 is equipped with switch-selectable 4- or 8-kHz bandwidth ceramic filters. Preceding the ceramic filters are crystal filters at 30 MHz and 10.7 MHz. All AM broadcast, international shortwave, ham radio contacts, and CB channels are tuned in by means of a digital phase-locked-loop tuning system. A large five-digit LED readout indicates the frequency being received, which is selected by four rotary switches and a fine-tuning control with a ±5-kHz tuning range. Standard features include high-impedance audio output for recording, 455-kHz i-f output jack, mute control for use with transmitters, front-panel headphone jack, internal speaker and control switch, and external speaker connections. The receiver is housed in a textured black enamel case with teak wood sides and brushed aluminum face. Measures 17.5"W × 16"D × 5.1"H (44.5 × 40.7 × 13.0 cm). \$2,900.

CIRCLE NO. 93 ON FREE INFORMATION CARD

CONTINENTAL SPECIALTIES SOCKETS

Continental Specialties has two new "Experimenter" 300 and 600 solderless breadboarding sockets, which provide 94 five-point terminals, plus two 40-point bus strips for a total of 550 solderless tie-points. The 600, priced at \$10.95, has a 6/10" center channel, making it suitable for microprocessors, clock chips, RAM's, ROM's, and other larger DIP

packages. The 300 has a 3/10" center channel that is right for smaller DIP's. Both sockets also accept transistors, LED's, resistors, capacitors, pots and virtually all types of discrete components.

CIRCLE NO. 94 ON FREE INFORMATION CARD

HEATH AUDIO OSCILLATOR

Heath's IG-1272 low-distortion oscillator is designed for a variety of audio uses. It provides a low-distortion sine-wave output over a frequency range from less than 5 Hz to 100 kHz. It offers both pushbutton and variable-frequency operation. Output is said to be flat across its entire frequency range. Attenuation accuracy is ±0.2 dB. Hum and noise are rated at 0.01% or less. Includes an ac rms volts meter with a dB scale and a level control, plus an interval load (600 ohms) and external load switch. It comes with cable and clip leads as a kit for \$129.95, factory assembled (SG-1272). \$190.

CIRCLE NO. 90 ON FREE INFORMATION CARD

PANASONIC MOBILE CB TRANSCEIVER

Panasonic's Model RJ-3450 is a two-piece AM 40-channel rig. The CB transceiver is separate from its controls to allow the bulkier section to be hidden away under a seat or, with an optional extender cable, in the car's trunk. The remote-control microphone contains all controls, switches, and displays



(LED), as well as the speaker. The RJ-3450 also features a built-in scanner system that can be operated either automatically or manually. It can be set to either V (vacant) or B (busy) to automatically locate an open or a busy channel. In the manual position, channels can be stepped through, up or down, one at a time. Other controls are a squelch control, noise-blanker/anl switch, and a REG/CH-9 switch. \$229.95.

CIRCLE NO. 95 ON FREE INFORMATION CARD

EDMUND SCIENTIFIC BURGLAR ALARMS

Two new security alarms are being offered by Edmund Scientific. One is a portable that can

POPULAR ELECTRONICS

Understanding Digital Electronics

New teach-yourself courses

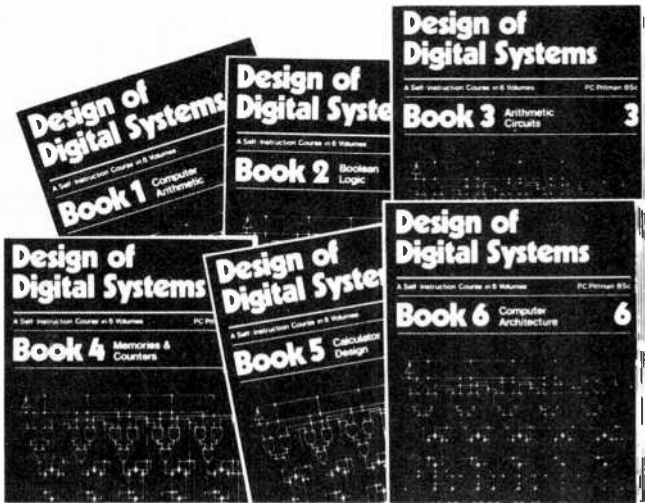

Design of Digital Systems is written for the engineer seeking to learn more about digital electronics. Its six volumes — each 11-1/2" x 8-1/4" are packed with information, diagrams and questions designed to lead you step-by-step through number systems and Boolean algebra to memories, counters and simple arithmetic circuits, and finally to a complete understanding of the design and operation of calculators and computers.

The contents of Design of Digital Systems include:

- Book 1** Octal, hexadecimal and binary number systems; conversion between number systems; representation of negative numbers; complementary systems; binary multiplication and division.
- Book 2** OR and AND functions; logic gates; NOT, exclusive-OR, NAND, NOR and exclusive-NOR functions; multiple input gates; truth tables; De Morgans Laws; canonical forms; logic conventions; Karnaugh mapping; three-state and wired logic.
- Book 3** Half adders and full adders; subtractors; serial and parallel adders; processors and arithmetic logic units (ALUs); multiplication and division systems.
- Book 4** Flip flops; shift registers; asynchronous and synchronous counters; ring, Johnson and exclusive-OR feedback counters; random access memories (RAMs) and read only memories (ROMs).
- Book 5** Structure of calculators; keyboard encoding; decoding display data; register systems; control unit; program ROM; address decoding; instruction sets; instruction decoding; control program structure.
- Book 6** Central processing unit (CPU); memory organization; character representation; program storage; address modes; input / output systems; program interrupts; interrupt priorities; programming; assemblers; computers; executive programs; operating systems and time sharing.

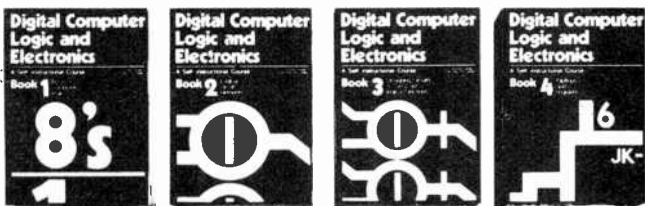

Digital Computer Logic and Electronics is designed for the beginner. No mathematical knowledge other than simple arithmetic is assumed, though the student should have an aptitude for logical thought. It consists of four volumes — each 11-1/2" x 8-1/4" — and serves as an introduction to the subject of digital electronics. Everyone can learn from it — designer, executive, scientist, student, engineer.

Contents include: Binary, octal and decimal number systems; conversion between number systems; AND, OR, NOR and NAND gates and inverters; Boolean algebra and truth tables; De Morgans Laws; design of logic circuits using NOR gates; R-S and J-K flip flops; binary counters, shift registers and half adders.

In the years ahead the products of digital electronics technology will play an important part in your life. Calculators and digital watches are already commonplace. Tomorrow a digital display could show your automobile speed and gas consumption; you could be calling people by entering their name into a telephone which would automatically look up their number and dial it for you.

These courses were written by experts in electronics and learning systems so that you could teach yourself the theory and application of digital logic. Learning by self-instruction has the advantages of being faster and more thorough than classroom learning. You work at your own pace and must respond by answering questions on each new piece of information before proceeding.

After completing these courses you will have broadened your career prospects and increased your fundamental understanding of the rapidly changing technological world around you.

The six volumes of Design of Digital Systems cost only: **\$19⁸⁸**

And the four volumes of Digital Computer Logic and Electronics cost only: **\$14⁸⁸**

But if you buy both courses, the total cost is only: **\$29⁹⁰**

a saving of over: **\$5⁰⁰**

SEVEN-DAY MONEY-BACK GUARANTEE: If you are not satisfied with your Cambridge course, return it within 7 days for a full refund.

To order your books, complete the order form below and send it together with your check or money order to GFN Industries, Inc., 6 Commercial Street, Hicksville, N.Y. 11801.

To: GFN INDUSTRIES, INC.

6 COMMERCIAL STREET, HICKSVILLE, NY 11801

Please send me:

___ Sets of Design of Digital Systems \$19.88 _____

___ Sets of Digital Computer Logic & Electronics \$14.88 _____

___ Sets of both courses \$29.90 _____

Sales tax (N.Y. residents) _____

Shipping and handling \$2.50 per set _____

Enclosed is check/mo (payable to GFN Industries, Inc.)

Total \$ _____

Name _____

Address _____

City/State/Zip _____

Prices include overseas surface mail postage.

PE-9B

be carried anywhere, while the other is designed for permanent installation. The latter is useful for cars, trucks, RV's, boats, and industrial plant protection, while the portable unit is for office and personal security. The portable alarm uses ultrasonics to secure a "protected" area. Each alarm is programmed with its own specific two-digit "off" code. Portable alarm No. 61,119 with 9-volt battery: \$79.00. The No. 61,120 12-volt permanent alarm, with lead-in wires: \$79.00.

CIRCLE NO. 96 ON FREE INFORMATION CARD

MXR NOISE-REDUCTION ACCESSORY

The MXR Comander is a noise-reduction device that is said to be capable of doubling the dynamic range of most open-reel and cassette tape decks. In operation, it compresses the dynamic range of signals being recorded and then expands them upon playback. The compression/expansion process is claimed to reduce noise and allow quiet passages to be heard while, at the same time, allowing musical peaks to be reproduced without distortion. The Comander is designed to process all frequencies at all levels in a similar manner, thereby eliminating the need for critical level adjustments. A switch is provided to bypass the Comander's circuitry, and a LEVEL MATCH control allows for compensation of level differences between the inputs and outputs of a tape deck. The system is designed for use on

three-head decks. Dynamic range is specified as being 100 dB and frequency response at 30 to 20,000 Hz ± 1 dB at 0 dBV.

CIRCLE NO. 97 ON FREE INFORMATION CARD

OK WIRE WRAP DISPENSER

The new WD Series Wire Wrap wire dispenser from OK Machine and Tool Corp. features a unique cutting and stripping capability. Wire is drawn out of the dispenser to the required length. Then a built-in plunger cuts the wire free, while a pull on the cut wire through the stripping blade removes the insulation without nicking the wire. The other end of the wire is just as neatly and quickly stripped away. The dispenser comes with a 50' (15-m) spool of AWG 30 (0.25-mm) industrial-quality Kynar[®] insulated silver-plated solid copper wire. Insulation is available in blue, white, red, and yellow. The dispenser is reusable when the wire runs out simply by inserting a new spool.

CIRCLE NO. 98 ON FREE INFORMATION CARD

JVC PORTABLE/HOME CASSETTE DECK

JVC America's Model CD-1636 portable/home stereo cassette deck, with its new super ANRS, is said to have reduced tape hiss and expanded dynamic range at high frequencies. A monitor speaker for field use is built-in. The deck is designed to operate for up to 12 hours with D-size batteries, but will

also operate from a 120 V ac power source for home use. Features include dual VU meters and battery condition checker, 3-digit tape counter with reset button, automatic tape stop, Sen-Alloy tape head for record/play and ferrite head for erase. Signal-to-noise ratio is rated at 54 dB, improved by 10 dB above 5 kHz with ANRS; wow and flutter, 0.08% rms; THD, 1.2% at 0 VU with standard tape, 1.5% with chrome tape. Frequency response is 45 Hz to 16 kHz ± 3 dB (chrome). Weight is 10.1 lbs. Measurements are 14 $\frac{1}{2}$ "W \times 9 $\frac{1}{2}$ "D \times 3 $\frac{3}{8}$ "H (37 \times 24 \times 10 cm). \$350.

CIRCLE NO. 99 ON FREE INFORMATION CARD

TURNER AM/FM/CB CAMOUFLAGE ANTENNA

A new "camouflage" AM/FM/CB antenna that features a new, easy-to-install design is available from Turner Division of Conrac Corp. The Model SK750 antenna is made to look and function like any other auto antenna, but provide full 40-channel coverage on CB with minimal VSWR. It has a removable 42" (106.7-cm) stainless steel whip and a mounting that adapts to sloping surfaces. The filters in the hermetically sealed watertight housing act as "band separators" to keep the AM/FM and CB signals from mixing. Suggested retail price is \$25.00. (The same antenna configuration is also available for CB only as the Model SK755 for \$19.95.)

CIRCLE NO. 100 ON FREE INFORMATION CARD

Aircommand 40-channel CB.



From the people who bring you Marantz—the world's finest stereo systems—comes the Aircommand CB-640—the finest in 40-channel CB. With Aircommand you get over 25 years experience in outstanding 2-way communications products.

Full 6 Watts of audio power. Provides plenty of punch so your speaker cuts through freeway noise.

Dual-conversion superheterodyne receiver with dual-cascaded ceramic filters. Together, both features provide the most complete rejection of unwanted signals, assuring you unsurpassed selectivity and sensitivity.

4 big Watts of RF power. Aircommand delivers the maximum power legally allowable to let you belt out the big sound.

100% modulation capability. Even when you talk softly into the mike, your message cuts through loud and clear, thanks to one of the most advanced mike preamp and compressor designs in CB today. With Aircommand, you don't have to spend an extra \$30 to \$40 on a "power mike." You can't buy better modulation than Aircommand.

Specially tailored frequency response.

LED 40-channel selection display. Easy-to-read, night or day.

8-LED (light emitting diode) meter display. Provides an easy-to-read display of SWR (standing wave ratio), modulation, and incoming or outgoing signal strength—instantly, accurately.

Special emergency Channel 9 scan with exclusive Aircommand "beep" alert. No matter what channel you're on, a special Aircommand CB-640 circuit continuously and silently monitors Emergency Channel 9. When someone starts transmitting on Channel 9, a unique "beep" alerts you, so you can tune yourself in and give assistance.

Public address capability. The versatile Aircommand CB-640 public address package lets you (1.) Talk into the CB mike and out an exterior public address speaker. (2.) Attach a tape recorder to the auxiliary jack on the

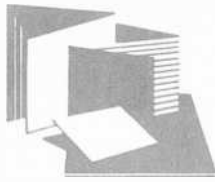

New Literature

CB INTERFERENCE CURES

Electronic Specialists offers a flyer describing cures for common FM, TV and audio interference caused by CB radios. Featured are solutions to problems such as interference picked up by stereo speaker leads and hi-fi phono inputs, and interference conducted over ac power lines. Address: Electronic Specialists Inc., Box 122, Natick, MA 01760.

RCA REPLACEMENT GUIDE

RCA offers its 1977 Solid State Replacement Guide, SPG-202T. The new 195-page guide cross references more than 123,000 solid-state devices, transistors, rectifiers, thyristors and IC's that can be replaced with RCA SK-Series types. Features of the publication are an index of SK-Series semiconductors and accessories, application information, line

drawings of dimensional outlines and terminal arrangements, and a listing of mounting hardware. Cost, \$1.50. Address: RCA Distributor and Special Products Div., PO Box 85, Rùnnemede, NJ 08078.

SILTRONIX ANALOG SWITCH HANDBOOKS

Two new publications from Siltronix facilitate analog switch system design. The first, titled "Analog Switches and Their Applications," is a 352-page handbook covering the theory and practical application of analog switches. It begins with an explanation of FET switch characteristics and driver circuits and moves on to multiplex systems, signal conversion, and n-path filters. Cost \$4.00. The second, "High Speed CMOS Analog Switches," is a 20-page catalog of Siltronix's DG3000 series CMOS analog switches. Available free. Address: Marketing Services Dept., Siltronix, Inc., 2201 Laurelwood Rd., Santa Clara, CA 95054.

MARINE RADIOTELEPHONE CATALOG

A new booklet from Motorola describes its line of Triton marine radiotelephones. Featured are the Triton 55/75, a fully synthesized unit with simplified channel identification, and the Triton SSB marine radiotelephone, which has FM reliability at distances greater than 30-40 miles. Other models described are

bridge-to-bridge marine radio telephones, vhf-FM limited Coast Guard Station models, and FM portables. Accessories are also listed. Address: Motorola Communications Group, Literature Distribution center, 1301 E. Algonquin Rd., Schaumburg, IL 60196.

MEMOREX VIDEO TAPE NEWSLETTER

Understanding the video picture is the topic of Vol. 3, No. 1 of SCAN, a 4-page newsletter for video-tape users offered by Memorex. The issue discusses how a video picture is created within a monitor/receiver and gives tips on troubleshooting the video playback system. Address: SCAN, Memorex Corp., PO Box 420, Santa Clara, CA 95052.

NEDA 1977 BATTERY INDEX

The National Electronic Distributors Association (NEDA) offers the 1977 Battery Index. A replacement guide for over 182 battery types, the index uses number suffixes to list batteries according to their group; rechargeable NiCd batteries and various groups of nonrechargeable types. Major manufacturers included are Bright Star Industries, Eveready, Mallory, Burgess, Inc., and Ray-O-Vac. Price 50 cents. Address: National Electronic Distributors Association (NEDA), 3525 W. Peterson Ave., Suite 601, Chicago, IL 60659.

...You never heard it so good!!!

CB-640 rear panel, and boom your tape out through the same external speaker. (3.) Mix your voice from the CB microphone with the program material on the tape recorder. Both voice and tape sound at the same time through the external speaker. (4.) Beam your received signal through the external speaker. **Built-in standing wave ratio circuitry.** Measures the efficiency of the antenna system for optimum performance. **Other outstanding features include:** Delta fine tuning control, digital synthesizer with phase-locked loop,

automatic noise limiting switch, noise blanking switch, squelch control, RF gain control.

Also available: Aircommand CB-140; Aircommand CB-340. All 3 units bring you state-of-art design, flawless craftsmanship and day-in, day-out reliability. Try them out now at your Superscope Aircommand dealer.

Aircommand by **SUPERSCOPE**

Selected for use by the California Highway Patrol.

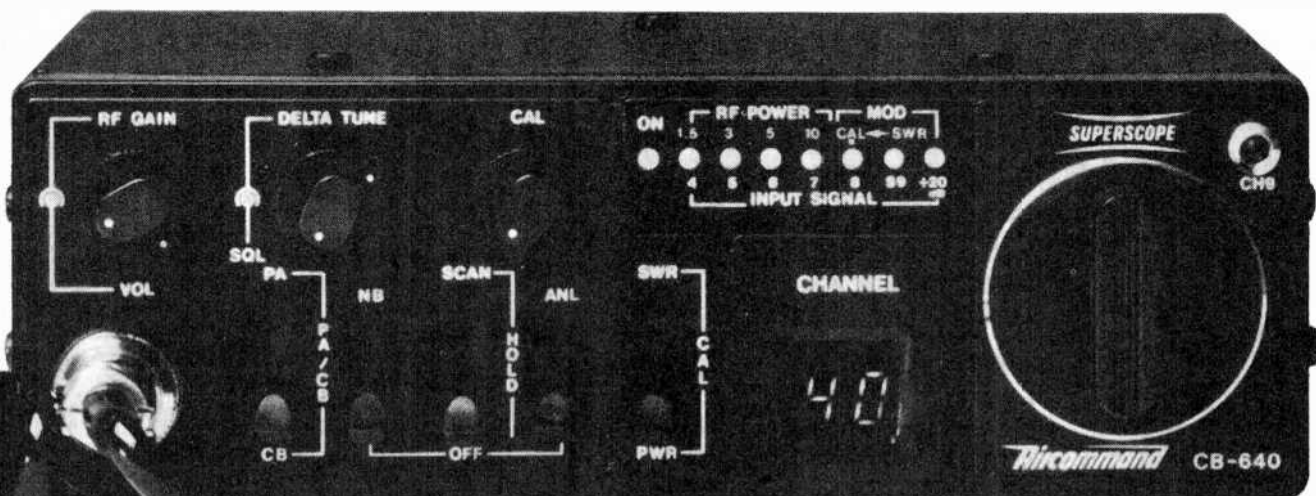

© 1977 Superscope, Inc., 20525 Nordhoff St., Chatsworth, CA 91311. Prices and models subject to change without notice.

Need a 3½ digit DPM?

Build your own LED or LCD panel meter and tailor it to fit your system.

No external active components.
Only 7 passive components needed
for an operating DPM.

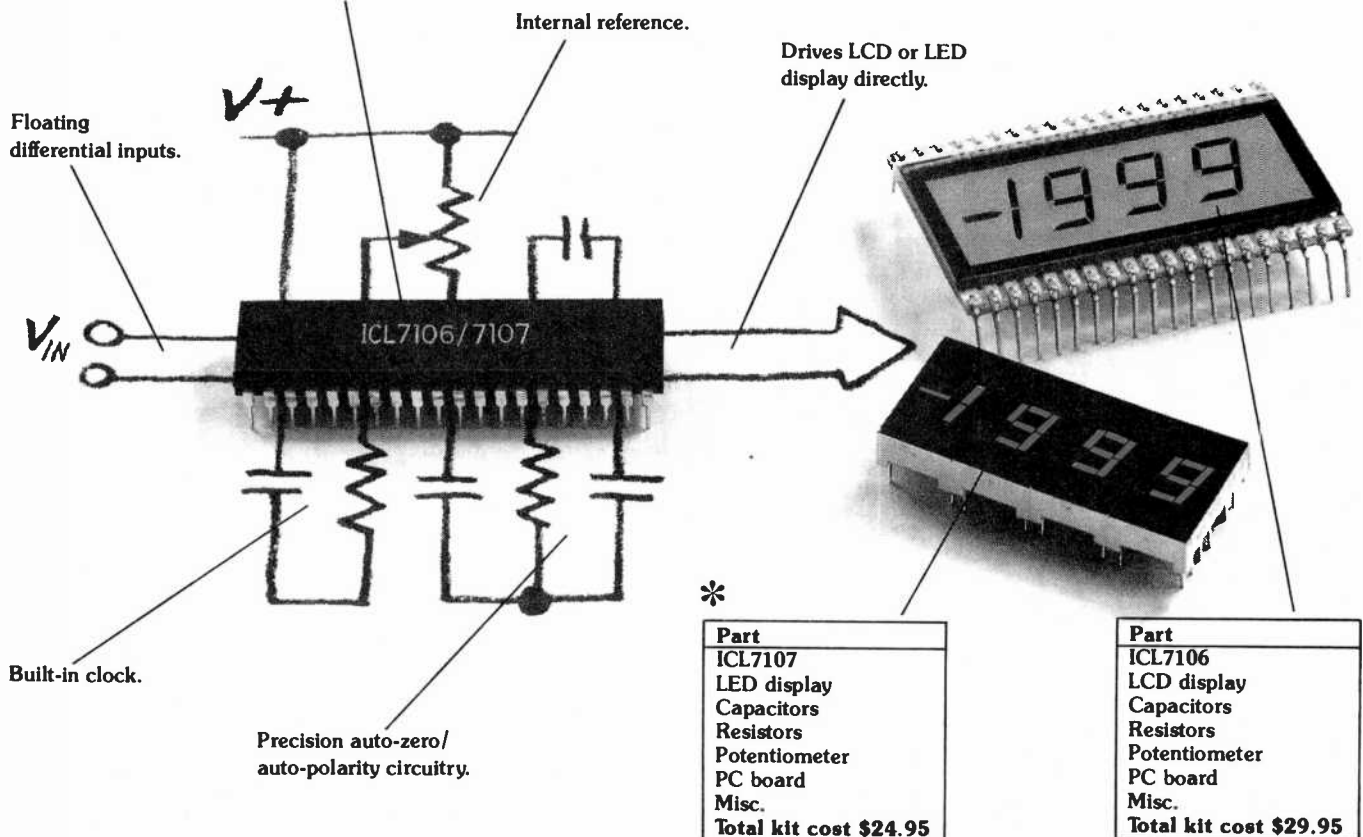

*

Part
ICL7107
LED display
Capacitors
Resistors
Potentiometer
PC board
Misc.
Total kit cost \$24.95

Part
ICL7106
LCD display
Capacitors
Resistors
Potentiometer
PC board
Misc.
Total kit cost \$29.95

Order from Intersil Stocking Distributors.

Arizona Phoenix: Liberty, (602)257-1272; Weatherford, (602)272-7144. **California** Anaheim: Weatherford, (714)547-0891, 633-9633. Costa Mesa: Schweber, (714)556-3880. El Segundo: Liberty, (213)322-8100. Glendale: Weatherford, (213)849-3451. Mountain View: Elmar, (415)961-3611. Pomona: Weatherford, (714)623-1261. San Diego: Liberty, (714)565-9171. Weatherford, (714)278-7400. Sunnyvale: Intermark, (408)738-1111. **Colorado** Commerce City: Elmar, (303)287-9611. Englewood: Weatherford, (303)761-5432. Wheatridge: Century, (303)424-1985. **Connecticut** Danbury: Schweber, (203)792-3500. Hamden: Arrow, (203)248-3801. **Florida** Clearwater: Diplomat / Southland, (813)443-4514. Hollywood: Schweber, (305)927-0511. Ft. Lauderdale: Arrow, (305)776-7790. **Georgia** Atlanta: Schweber, (404)449-9170. **Illinois** Elk Grove Village: Schweber, (312)593-2740. **Indiana** In-

dianapolis: Advent, (317)297-4910. **Maryland** Baltimore: Arrow, (301)247-5200. Rockville: Schweber, (301)881-3300. **Massachusetts** Billerica: Kierulff, (617)667-8331. Waltham: Schweber, (617)890-8484. Woburn: Arrow, (617)933-8130. **Michigan** Farmington: Sheridan, (313)447-3800. Troy: Schweber, (313)583-9242. **Minnesota** Bloomington: Arrow, (612)887-6400. Eden Prairie: Schweber, (612)941-5280. **Missouri** Kansas City: L-Comp, (816)221-2400. Maryland Heights: L-Comp, (314)291-6200. **New Jersey** Moorestown: Arrow, (609)235-1900. Somerset: Schweber, (201)469-6008. Totowa: Diplomat IPC, (201)785-1830. **New Mexico** Albuquerque: Century, (505)292-2700. **New York** Binghamton: Harvey Federal, (607)748-8211. Farmingdale: Arrow, (516)694-6800. Hauppauge: Components Plus, (516)231-9200. Rochester: Schweber, (716)461-4000. Westbury: Schweber,

Put it all together for as little as \$24.95*

Intersil's new single chip 3½-digit 7106 and 7107 A/D converters for LCD or LED displays.

Meet the latest in A/D converters: Intersil's 7106, the first single-chip CMOS A/D for driving LCD displays—including backplane—directly.

And the 7107, first single-chip CMOS A/D for driving instrument-size LED displays directly without buffering.

Each provides parallel seven segment outputs, ideal for DVMS, DPMs and anywhere modern digital displays are needed.

Both new devices provide cost advantages over multi-chip designs, because they require no additional active components. Both have internal reference and clock, and both are CMOS so you get low noise (12 to 15µV) comparable with the finest bipolar devices, and low power (10mW max. @ 10V). A few more features:

- ±1-count accuracy over the entire ±2000-count range.
- Guaranteed to read Zero for 0 Volts input.
- Provides true polarity at Zero count for precise null detection.
- Differential input from 200mV to 2.000V full scale.

Build a working DPM in ½ hour with these complete evaluation kits.

Test these new parts for yourself with Intersil's low-cost prototyping kits, complete with A/D converter and LCD display (for the 7106) or LED display (for the 7107). Kits provide all materials, including PC board, for a functioning panel meter. Available from Intersil stocking distributors.

Kit No. ICL7106EV/KIT (LCD), \$29.95 complete.

Kit No. ICL7107EV/KIT (LED), \$24.95 complete.



(516)334-7474. **North Carolina** Raleigh: RESCO, (919)832-2077. **Ohio** Beachwood: Schweber, (216)464-2970. Cincinnati: Sheridan, (513)761-5432. Dayton: Arrow, (513)253-9176. **Pennsylvania** Horsham: Schweber, (215)441-0600. Pittsburgh: Sheridan, (215)244-1640. **Texas** Dallas: Schweber, (214)661-5010; Weatherford, (214)243-1571. Houston: Schweber, (713)784-3600; Weatherford, (713)688-7406. **Utah** Salt Lake City: Century, (801)972-6969. **Washington** Bellevue: Liberty, (206)453-8300. Seattle: Weatherford, (206)243-6340. **Wisconsin** Oak Creek: Arrow, (414)764-6600. **Canada** Downsview, Ontario: Zentronics, (416)635-2822. Montreal, Quebec: Zentronics, (514)735-5361. Ottawa, Ontario: Zentronics, (613)238-6411. Vancouver, British Columbia: R.A.E. Ind., (604)687-2621.

SEPTEMBER 1977

INTERSIL



Stereo Scene

By Ralph Hodges

RECORDS AND THE VERTICAL ANGLE

WHAT THE world still lacks, surprisingly enough, is a really adequate conceptual model for a record player. To be sure, the overall principles have always been obvious: the groove undulates, thereby wiggling the stylus, which is connected to an electrical generator, etc. But the intimate geometry of the way a record is played, taking place as it does on what is really a submicroscopic scale, remains somewhat obscure. Vinyl indentation affects stylus tracing in ways that are not wholly understood; frictional drag and other forces on the stylus assembly alter the geometry of the tracing and transduction situations in complex ways: the rate of stylus and record wear—and the form in which it manifests itself—is not completely predictable. Periodically there are technical papers written to expand or refute existing theories of stylus-groove interaction, but the ultimately authoritative paper has yet to appear.

Fortunately, we don't have to fully understand the record player to use it. In fact, the system seems to be surprisingly tolerant of human error. A cartridge can be installed in a tonearm in five minutes, using the crudest "eyeballing" techniques for alignment, and almost no one will object to the audible results achieved thereby. Considering that the stylus inhabits a world in which the mi-

niscule wavelengths of visible light are beginning to become significant dimensions, its apparently obliging response to very slapdash alignment is a little unexpected.

In the back of many a well-furbished mind there has always been the nagging idea that this can't be right; that closer attention to record-player alignment *must* result in superior reproduction. The trouble is, no one's been able to demonstrate this to the satisfaction of the record-playing world at large.

The Shreve-Rabco Arm. About a year ago (November 1976) I wrote in this space of a modification to the Rabco SL-8 and SL-8E tonearms performed by Dr. David Shreve (Department of Mathematics, University of Wisconsin). At that time I referred only obliquely to several interesting claims made by Dr. Shreve, among them being that the vertical angle (the "rake angle," as it is often called) at which the stylus impinges on the record surface as viewed from the side is critical to within a very small fraction of a degree.

Dr. Shreve referred to his findings as being totally empirical, and he has never shown any inclination to "dignify" his claims with any nice, neat explanatory theory (although there are some very attractive ones free for the taking). His attitude has always been: "I can demonstrate the phenomenon, and if you can hear it (and apparently everyone has so far) you're free to make of it what you will."

I have been "making what I will" of all this ever since, and my conclusion—supported by the informed opinions of others who have looked into the matter—is that we have at hand a very basic and nontrivial demonstration of how disc-playing systems can be significantly improved.

The Scanning Aperture. Shortly after my first meeting with Shreve, I brought his work to the attention of Mitchell Cotter, founder and chief executive of Verion Audio and a researcher with a long and varied background in many areas of practical and theoretical audio. As it happened, Cotter was already convinced of these effects' existence, although he had not fared notably better than others in demonstrating their audibility. He was, however, somewhat surprised by Shreve's reports on the criticalness of the vertical angle. True, theory seemed to predict this, but theory had not quite been batting 1000 in corresponding to the perceived and/or measurable world of record playing.

What exactly *does* theory seem to predict? I couldn't begin to deal with the complexities here, even if they could be pursued profitably in a nonmathematical presentation. But some of the individual effects can be mentioned. Imagine viewing the stylus (a Shibata or other type of "line-contact" CD-4 stylus) from the side as it traces a record groove. If the rake angle is correct, the stylus' contact line will be parallel with the modulation angle of the groove. If it is not, the upper part of the stylus will either lead or lag the lower part in tracing the groove.

So far the situation seems analogous to tape-head alignment. When the azimuth of a playback head is disturbed, the "scanning aperture" corresponding to its gap becomes effectively wider, and high-frequency response begins to fall off in the same way as it would if the gap were physically wider. However, while the "effective" edge of the stylus is also a scanning aperture, a simple loss of high-frequency response is not the only predictable result of incorrect rake angle. Whether azimuth is right or not, a tape head is always scanning the flat plane of the tape surface. The stylus "sees" a flat plane from a modulated groove only when its rake angle is absolutely on the button. Otherwise it traces—or tries to trace—a curvature that can become rather complex, with the skewed contact line of the stylus doing its best to strike a rough average between the various groove contours it is encountering. Also, groove curvature is a definite factor in stylus indentation of the record material, so that a further ambiguity in tracing is introduced.

At this point, let's consider the several dimensions in which a stylus moves. Ideally, all its excursions take place within a curved plane—a section of the shell of a sphere that has its center at the sty-

(continued on page 20)

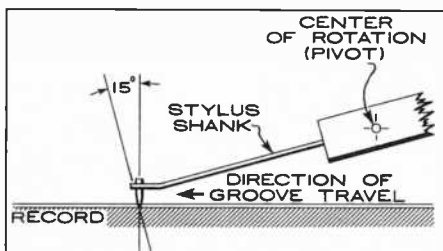

Diagram shows vertical tracking angle and stylus pivot point.

Precision and elegance. The newest Quartz-Servo by Sansui.

Introducing the Sansui SR-838, a luxurious new direct-drive turntable that performs silently with rare and fine precision. Free from howl and feedback, the SR-838 complements the superior tonal quality and the exciting standards of today's most sophisticated component systems.

The SR-838 Quartz-Servo direct-drive system delivers phono reproduction so accurate it may astonish you. By locking motor speed to the precise control of a highly refined quartz crystal, Sansui engineers have achieved platter speed deviation of less than 0.002%, and unusually low wow and flutter of less than 0.025%.

Sansui engineers have also designed a unique new tonearm for the SR-838. It features a Mass-Concentrated Fulcrum design, with wide-set pivot points, to suppress unwanted front-back/left-right vibrations. Inside the tubular tonearm is a special resin* that prevents resonance. And the entire unit is firmly mounted on a zinc die-cast base for the most stable performance you can find.

The Sansui SR-838 offers all the performance advantages you'd expect from a superior turntable, plus more. Such as fine pitch control, an electronic brake for speed changes, a skating force canceller, and an oil-damped cueing lever. And the newly designed rubber insulating feet provide superior feedback isolation.

On top it all, the SR-838 is a feast for the eyes as well as the ears. All controls are positioned up

front for easy access and operation. And the satiny piano lacquer finish glows with the elegance of simplicity.

See the SR-838, at less than \$390**, including base and dust cover, at your nearest franchised Sansui dealer. Hear it, and you'll discover that advanced technology and precision design do indeed make a difference. All the difference in the world.

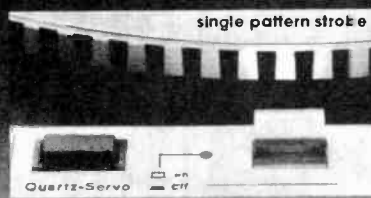
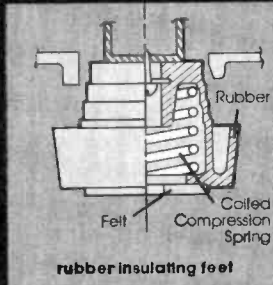

SANSUI ELECTRONICS CORP.
Woodside, New York 11377 • Gardena, California 90247
SANSUI ELECTRIC CO., LTD., Tokyo, Japan • SANSUI AUDIO EUROPE S.A., Antwerp, Belgium • In Canada Electronic Distributors

*Patent pending **Approximate nationally advertised value. Actual retail price is at the option of individual dealers



Learn digital computer

NRI is the only school to train you at home on a real digital computer.

Learn computer design, construction, maintenance and programming techniques on your own programmable digital computer.

Qualified technicians are urgently needed for careers in the exciting new field of digital and computer electronics . . . and the best way to learn digital logic and operations is now available to you in NRI's Complete Computer Electronics Course.

This exclusive course trains you at home on your own digital computer! This is no beginner's "logic trainer", but a complete programmable digital computer that contains a memory and is fully automatic. You build it yourself and use it to define and flow-chart a program, code your program, store your program and data in the memory bank. Press the start button and the computer solves your problem and

displays the result instantly.

The NRI digital computer is one of 10 kits you receive in the NRI Complete Computer Electronics Course. You build and use your own TVOM, and experiment with NRI's exclusive Electronics Lab. You perform hundreds of experiments, building hundreds of circuits, learning organization, operation, trouble-shooting and programming.

New NRI Memory Expansion Kit

The Model 832 NRI Digital Computer now comes with a new Memory Expansion Kit. Installed and checked out in 45 minutes, it doubles the size of the computer's memory, significantly increasing the scope and depth of your knowledge of digital computers and programming. With the large-scale IC's you get the only home training in machine language programming . . . experience essential to trouble-shooting digital computers.



electronics at home.

NRI offers you five TV/Audio Servicing Courses

NRI can train you at home to service Color TV equipment and audio systems. You can choose from 5 courses, starting with a 48-lesson basic course, up to a Master Color TV/Audio Course, complete with designed-for-learning 25" diagonal solid state color TV and a 4-speaker SQ™ Quadraphonic Audio System. NRI gives you both TV and Audio servicing for hundreds of dollars less than the two courses as offered by another home study school.



All courses are available with low down payment and convenient monthly payments. All courses

provide professional tools and "Power-On" equipment along with NRI kits engineered for training. With the Master Course, for instance, you build your own 5" wide-band triggered sweep solid state oscilloscope, digital color TV pattern generator, CMOS digital frequency counter, and NRI electronics Discovery Lab.



*Trademark of CBS Inc.

NRI's Complete Communications Course includes your own 400-channel VHF transceiver

NRI's Complete Communications Course will train you at home for one of the thousands of service and maintenance jobs opening in CB; AM and FM transmission and reception; TV broadcasting; microwave, teletype, radar, mobile, aircraft, and marine electronics. The complete program includes 48 lessons, 9 special reference texts, and 10 training kits. Included are: your own "designed-for-learning" 400-channel VHF transceiver; electronics Discovery Lab™; CMOS digital frequency counter; and more. You also get your all



important FCC Radio-telephone License, or you get your money back.



CB Specialist Course also available



NRI also offers a 37-lesson course in CB Servicing with your own CB Transceiver, AC power supply, and multimeter. Also included are 8 reference texts and 14 coaching units to make it easy to get your Commercial Radiotelephone FCC License.

You pay less for NRI training and you get more for your money.

NRI employs no salesmen, pays no commissions. We pass the savings on to you in reduced tuitions and extras in the way of professional equipment, testing instruments, etc. You can pay more, but you can't get better training.

More than one million students have enrolled with NRI in 62 years.

Mail the insert card and discover for yourself why NRI is the recognized leader in home training. Do it today and get started on that new career. No salesman will call.

If card is missing write:



NRI SCHOOLS
McGraw-Hill Continuing
Education Center
3939 Wisconsin Avenue
Washington, D.C. 20016

lus's pivot point. Also ideally, the shell is almost infinitely thin. However, especially in the case of a line-contact stylus, an error in rake angle "thickens" the shell, with resulting phase-time ambiguities. Such errors are inevitable; even vertical stylus excursions produce them. But at what point, if any, do they become audibly detrimental? And what is their effect when they combine with other errors in tracing geometry?

The Listening Approach. Since the means (the Shreve/Rabco arm) seemed to be at hand, we decided to let theory rest for the time being and work toward empirical findings with listening tests. The Rabco SL-8/SL-8E arm, as you may be aware, is (or was; it is no longer made) a radial-tracking mechanism. The arm carriage transits on an aluminum track that has vertical screws at either end to facilitate height and levelling adjustments. Thus the stylus rake angle can be varied minutely and repeatably even while a record is playing, without doing any great violence to other parameters of cartridge alignment (we invariably found ourselves working with a range of rake angles spanning considerably less than a degree of difference). This, plus its other refinements, made the arm a viable experimental tool in our judgment.

Once we (Dr. Shreve, Mitchell Cotter, and I, for the most part) had confirmed that we could hear these seemingly small differences and could agree on what the "right" sound was, we evolved individually for the most part, but with close agreement later on) a number of working hypotheses.

(1) The optimum vertical adjustment should not be the same for every record. Variables such as different record-cutter geometries, different cutting practices, and even different record thicknesses would logically prevent this.

(2) A warped record should make the optimum vertical adjustment less easy to achieve, if it could be achieved at all.

(3) Adjusting the carriage track of the arm so that it is not quite parallel with the record surface should result in a change of vertical angle over the record side, and therefore a change in the "sound." (It would also result in slight changes of other alignment parameters; the big questions concerned which changes, if any, would be most audible.)

(4) A true line-contact CD-4 stylus should be quite critical to adjust; and once properly adjusted, it might conceivably yield performance superior to that of a "conventional" stylus.

(5) A change in stylus force should change the rake angle, and hence the "sound."

After about a year of listening, our general observations are as follows.

(1) The optimum vertical angle is not the same for every record. With the records we have sampled we've encountered a range of "optima" spanning a mere 25 minutes (!) of arc. However, some records audibly perform quite badly when used with a different record's optimum setting, although they may sound very good when individually compensated for.

(2) Warped records are not as difficult to adjust for as anticipated. An attempt at explaining this must await further work. It is true that we've not been extraordinarily successful in obtaining warped and unwarped copies of the same record. It almost appears that a given release is either unwarped or warped, although the warps are usually not the same. We have not attempted to deliberately warp any records.

(3) Making the carriage track nonparallel to the record surface alters the sound over a record side in an identifiable way. Deliberately misaligning the effective length of the radial arm to create a similar change in lateral tracking-angle error over the record side does not seem to alter the sound as recognizably. But this test lacks a certain amount of rigor.

(4) CD-4 styli are typically easier to set at optimum vertical angle; the "optimum" is much less ambiguous. When so set, they consistently (audibly) outperform comparable cartridge models fitted with spherical or "conventional" bi-radial stylus tips.

(5) Altering the vertical stylus force seems to produce the expected change in "sound." In fact, in some cases small changes in stylus force have seemed to be as effective as small changes in vertical angle in achieving the most listenable results. (In all cases the stylus-force changes have been very small, and always well within the recommended tracking-force range of the cartridge's manufacturer. Measurement of the force, with one exceptional instance, has always been consistently repeatable with the Shreve arm and a tracking-force gauge of high reliability and resolution [within 1/10 gram].)

And What Is the Sound? While we agree when the verticle adjustment is correct to our ears, we do not always use the same language to describe what we hear when it is not to our liking. High

frequencies are affected most profoundly, to the point where sharp sibilance on voice recordings can be reduced to almost no sibilance. There is a noticeable change in the quality of whatever noise is present on the record, so that it becomes subjectively smoother, less obtrusive, and less troubled by what subjectively seems to be a periodic modulation effect. Whatever stereo perspective is present on the record seems dramatically enhanced, with sharper and stabler positioning of sound sources both left to right and forward to back (although we think we have occasionally discovered "faults" in the stereo perspective of some recordings as a result of optimum adjustment).

The Unanswered Questions. The vertical cutting angle adopted in making a record is established at the discretion of the mastering engineer. A fairly common practice is to use a special test record as a vertical reference while the cutting head is set up. However, we have heard of instances in which the cutter's vertical angle has been slightly modified to achieve a smoother or quieter cut.

The variations in vertical angle from record to record we have found are probably small enough to be accounted for by differences in test records, or even differences in set-up procedures when the same test record is used. However, the precise roles that these and other factors play in the vertical-angle situation are far from clear to us at present.

Several other questions remain. One concerns the matter of deformations in the ideally flat surface of the record, and what part they could or should play in properly defining the correct vertical angle. Another question asks whether there is (as would seem logical) an optimum relationship between rake angle, vertical tracking angle, and stylus force, since the first two would certainly change with an alteration of the third, but not necessarily in the same direction with respect to an optimum adjustment.

Perhaps the ultimate question is whether a significant number of commercially available arms and record players (as opposed to the custom-built and carefully adjusted equipment in our hands) can reveal the effects of these minute variations in alignment. Thanks to Mr. Cotter's efforts, the first tentative answer to this question seems to be moving toward a qualified "yes." And thus it appears certain that you'll have heard far from the last of this matter when you lay down this magazine. ◇



THE INTEGRATED DC AMPLIFIER HAS ARRIVED.

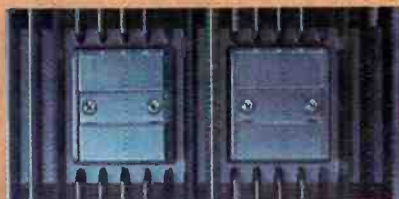

Gone is phase distortion. Gone is time-delay distortion.

The Kenwood KA-9100 integrated DC amplifier is here.

Its response is flat down to 0 Hz. It has three power supplies. The Total Harmonic Distortion is 0.03% over the full frequency range of 20-20k Hz. The Signal-to-Noise ratio is 83 dB at 2.5 mV. It has the best phono sensitivity (0.8 mV) of any integrated amplifier. For better heat dissipation, the KA-9100 has large heat sinks on either side.

It is an amplifier so advanced even the pre-amp has its own power supply.

It is the next generation Kenwood. The unit all others will be measured against. Just as they were when we pioneered dual power supplies.

The KA-9100 integrated DC amplifier. With 90 watts per channel, minimum RMS, at 8 ohms from 20 to 20,000 Hz with no more than 0.03% Total Harmonic Distortion.

And, as if all that wasn't enough, it costs less than \$500.*

KENWOOD

15777 S. Broadway, Gardena, CA 90248 • 72-02 Fifty-First Avenue, Woodside, NY 11377

Handles optional

*Suggested resale price. Actual prices are established by Kenwood dealers



Audio Reports

PROS AND CONS OF MULTI-WAY SPEAKER SYSTEMS

IT HAS long been recognized that a single loudspeaker cone cannot properly reproduce the full audible frequency range. Nevertheless, a single speaker is still widely used, as in TV receivers, automobile radios, and low-priced home radios and record players for that impossible task. Here, a degree of effectiveness is made possible only by a reduction in quality standards, which would not be acceptable in a high-fidelity system.

The examples mentioned above cannot be called "hi-fi" by any stretch of the imagination, although sometimes, against all reason, that claim is made for them. Even a minimum quality component speaker system uses at least two drivers to cover the audio range, and more expensive ones divide the audible spectrum into three or even four bands. It is thus quite natural to assume that more separate frequency bands in a speaker system result in better quality.

The foregoing assumption may be natural, but it is not necessarily correct. In fact, in the absence of other information, there is no reason to conclude that a three-way system is better than a two-way system or even as good. To see why this is so, let us consider the reasons for dividing up the reproduction task among several drivers.

To generate appreciable amounts of acoustic power at low frequencies, a large volume of air must be moved by the speaker cone. This can be done by using a large cone area with a relatively small excursion, or a smaller cone with a large excursion. Both methods are capable of good results, but the popular acoustic suspension speakers are based on the latter approach. To get a reasonably flat, smooth bass response, it is not sufficient simply to use the largest possible speaker diameter, or to increase the size of the enclosure. These two factors, together with a host of other speaker parameters, are interrelated. Once a certain performance standard has been decided upon, neither can be changed without a corresponding change in the other. The value of a proper bass speaker design is demonstrated by the many small speakers, with woofers only 6 to 8 inches in diameter, whose bass response extends to 40 Hz or even lower.

A larger cone diameter gives the designer several possible options for improved performance. The lower limit of the speaker's response could be extended (perhaps together with reduced distortion), or its efficiency could be increased. Since nothing in this

world is truly free, what disadvantages might result from such a change?

A woofer cone can deliver its calculated flat response only in the limited frequency range within which it moves as a piston. At higher frequencies, where the speaker diameter becomes an appreciable fraction of the acoustic wavelength, the response becomes irregular, as well as increasingly directional. The massive cone, which is advantageous for a woofer, becomes a liability at higher frequencies. Here, low moving mass is necessary to allow the cone to reverse direction hundreds or even thousands of times each second. Therefore, whatever the size of the woofer, above some selected frequency the signal energy must be diverted from it to another speaker more suitable for that range. The choice of a "crossover" frequency is not entirely arbitrary since it must take into account the high-frequency aberrations in the woofer's response, and the low-frequency limitations of the smaller speaker. A "tweeter," as the high-frequency driver is usually called, is much smaller in diameter than the woofer, and has a much lighter cone and voice coil structure. The low mass allows it to respond more rapidly to high-frequency signals, while its smaller diameter gives the sound a wide polar dispersion instead of "beaming" it forward, as happens when the cone diameter is comparable to the wavelength of the sound. At very high frequencies, even an ordinary tweeter cone may be too large to give the desired response, necessitating a second crossover to a still smaller speaker. This is known as a "three-way" system, in contrast to the simple "two-way" system comprised of a woofer and a single high-frequency driver.

Here are some considerations on the relationship between the size of the several drivers and the choice of crossover frequencies. In a typical small speaker system, with a woofer 8 inches or less in diameter, it is feasible to cross over to the tweeter as high as 2000 Hz, or even higher in some cases. At that frequency, a specially designed dome or small cone tweeter is used instead of merely a miniature version of the woofer. With a cone diameter of 1 to 1½ inches such a speaker can give satisfactory results up to 15,000 Hz or even beyond. While it is possible (and sometimes done) to cross over to a third "super tweeter" at a very high frequency, such as 7,000 to 10,000 Hz, the benefits would be negligible. The high-frequency dispersion

MAGAZINES AT DISCOUNT!

You SAVE up to 50%

Here's your chance for a real bargain bonanza on your favorite magazines. You may select as many as five of these titles at the special introductory rates shown below—up to 50% off! To order, indicate the magazines you want by inserting their code numbers in the boxes on the attached order card. Or write to: MAGAZINES AT DISCOUNT, A Division of Ziff-Davis Publishing Co., P.O. Box 2703, Boulder, Colorado 80322.

CODE NOS.

- (01) **BOATING** You pay only \$7.97
Reg. Rate: 12 Issues for \$12.00
- (70) **CAR CLASSICS** You pay only \$8.98
Newsstand Rate: 6 Issues for \$15.00
- (02) **CAR & DRIVER** You pay only \$4.99
Reg. Rate: 12 Issues for \$9.98
- (03) **CYCLE** You pay only \$4.99
Reg. Rate: 12 Issues for \$9.98
- (71) **FOUR WHEELER** You pay only \$5.49
Reg. Rate: 12 Issues for \$9.50
- (28) **MECHANIX ILLUSTRATED** You pay only \$5.96
Reg. Rate: 18 Issues for \$9.97
- (34) **PLAYBOY** You pay only \$12.00
Newsstand Rate: 12 Issues for \$19.00
- (06) **POPULAR ELECTRONICS** You pay only \$6.99
Reg. Rate: 12 Issues for \$12.00
- (07) **POPULAR PHOTOGRAPHY** You pay only \$4.99
Reg. Rate: 12 Issues for \$9.98
- (35) **POPULAR SCIENCE** You pay only \$5.97
Reg. Rate: 18 Issues for \$11.91
- (08) **PSYCHOLOGY TODAY** You pay only \$6.97
Reg. Rate: 12 Issues for \$12.00
- (56) **ROLLING STONE** You pay only \$9.00
Reg. Rate: 26 Issues for \$18.00
- (09) **SKIING** You pay only \$4.99
Newsstand Rate: 7 Issues for \$8.75
- (11) **STEREO REVIEW** You pay only \$3.99
Reg. Rate: 12 Issues for \$7.98
- (40) **TIME** You pay only \$12.50
Newsstand Rate: 25 Issues for \$25.00
- (41) **TV GUIDE** You pay only \$8.35
Lowest Available Sub. Rate for 32 Issues



might be improved by using a second, smaller tweeter, but the effect is likely to be rather subtle.

Suppose that a larger woofer, 10 or 12 inches in diameter, is used. Such a speaker cannot function optimally much above 1000 Hz, and the crossover to the next driver usually takes place between 500 and 1000 Hz. At that frequency, a small dome tweeter cannot be used either because its light voice coil could easily be burned out by the concentration of program energy in the midrange. Furthermore, the large cone excursions needed would be impractical for such a driver.

To cover this frequency, a larger version of the dome tweeter is sometimes used (this can be expensive). But more frequently, the midrange driver is a conventionally appearing cone unit that's about 3 to 5 inches in diameter. This can handle the midrange power, but its useful upper frequency limit is perhaps several thousand hertz. For full-range reproduction, there is a second crossover to a true tweeter, usually in the 3000-to-5000-Hz range. From this we can see that a speaker based on large low-frequency drivers or designed for use at high volume levels has to have three drivers do what can be done fairly well at lower levels by a smaller two-way system.

Sometimes we encounter four-way systems, although this is a refinement limited to fairly exotic and expensive speakers. Usually, a very small super-tweeter is added to a more conventional three-way system, with a crossover at 10,000 Hz or even higher. Alternatively, the fourth driver can be added at the

low-frequency end, crossing over from the woofer to an upper-bass or lower mid-range driver in the 100-to-300-Hz region. The upper-bass speaker is normally a small woofer that measures about 8 inches in diameter. Together with the higher frequency drivers, it acts as the woofer of a three-way system.

If a super tweeter is used, especially at frequencies near the limits of human hearing, its benefits may be marginal. Little program material has much content in that range, except for noise. Thus, the principal benefit of a super tweeter may be an airier quality due to improved dispersion.

The rationale for using a very low woofer crossover frequency is that the large woofer cone excursions at low frequencies tend to modulate higher frequencies in the program band handled by the woofer. Even if the speaker is perfectly linear, high frequencies radiated by a cone simultaneously handling low frequencies will be frequency-modulated (the Doppler effect). This produces a modulation distortion very much like that resulting from woofer nonlinearity. By restricting the woofer to a narrow frequency range, the likelihood of such intermodulation is reduced. Of course, this places an added burden on the next higher frequency driver, which often carries the bulk of the audible program content and must do so with a minimum of distortion.

We have seen how the number of crossovers in a speaker system is determined by the limitations of its individual drivers, the cabinet size, and the degree of

Great Jumpers are here!

State of the art
flat cable connector assemblies . . .
at affordable prices.

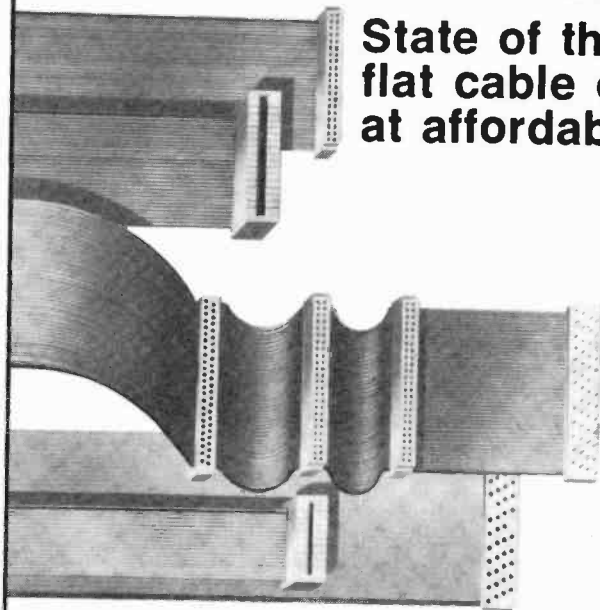

Great Jumpers come to you fully pre-assembled and fully pre-tested. Cable strain reliefs are integral to the molded-on connectors. And we've designed in complete line-by-line probeability with probe access ports behind each contact.

Our connectors are industry standard; two parallel rows of contacts, spaced every .1".

Great Jumpers come in five popular cable widths: 20, 26, 34, 40 and 50 lines wide, and in lengths ranging from 6" to 36".

Available now at the distributor near you who carries the A P Products Faster and Easier Line.

Our distributor list is growing daily. For the name of the distributor nearest you call Toll-Free 800-321-9668.

Send for our complete AP catalog, the Faster and Easier Book.

Faster and easier is what we're all about.



A P PRODUCTS INCORPORATED

Box 110 • 72 Corwin Drive Painesville, OH 44077 (216) 354-2101 TWX: 810-425-2250

Powerful in computing muscle, yet small in physical size, the Altair™680b offers many special features at an affordable price. Based on the 6800 microprocessor, the 680b comes with 1K of static RAM, Serial I/O port, PROM monitor and provisions for 1K of PROM as standard components. It's good thinking, when you're interested in making a modest investment on a highly reliable computer, to consider the Altair 680b.

Our PROM monitor eliminates the necessity for toggling front panel switches to load bootstraps or manipulate memory contents. Only a terminal and programming language are required for complete system operation. With Altair System software—Altair 680 BASIC, assembler and text editor—you may begin problem solving immediately with ease.

By adding the 680b-MB Expander card, many options are currently available:

*16K Static Memory Board—Increase your system memory with 16K bytes of fast access (215 ns), low power (5 watts per board) static RAM. 680 BASIC and assembler/text

editor are included free with purchase.

*Process Control Interface—A PC card that uses optically isolated inputs and relay outputs that transmit sensory information to and control signals from the computer. A diverse world of control applications is opened up with the Altair 680b-PCI.

*Universal Input/Output Board—If your I/O needs exceed the serial port already on the main board, augment your I/O channels with the 680b-U/I/O. By implementing the optional serial port and two parallel ports, you can simultaneously interface to four terminals.

*New Addition—Kansas City Audio Cassette Interface—Use the 680b-KCACR to interface your Altair 680b with an audio cassette recorder for inexpensive mass storage of programming languages, programs and data.

Available in either full front panel or turnkey models, the Altair 680b presents many computing capabilities at a low cost—without skimping on performance. See it today at your local Altair Computer Center or contact the factory for further details.



Good Thinking.

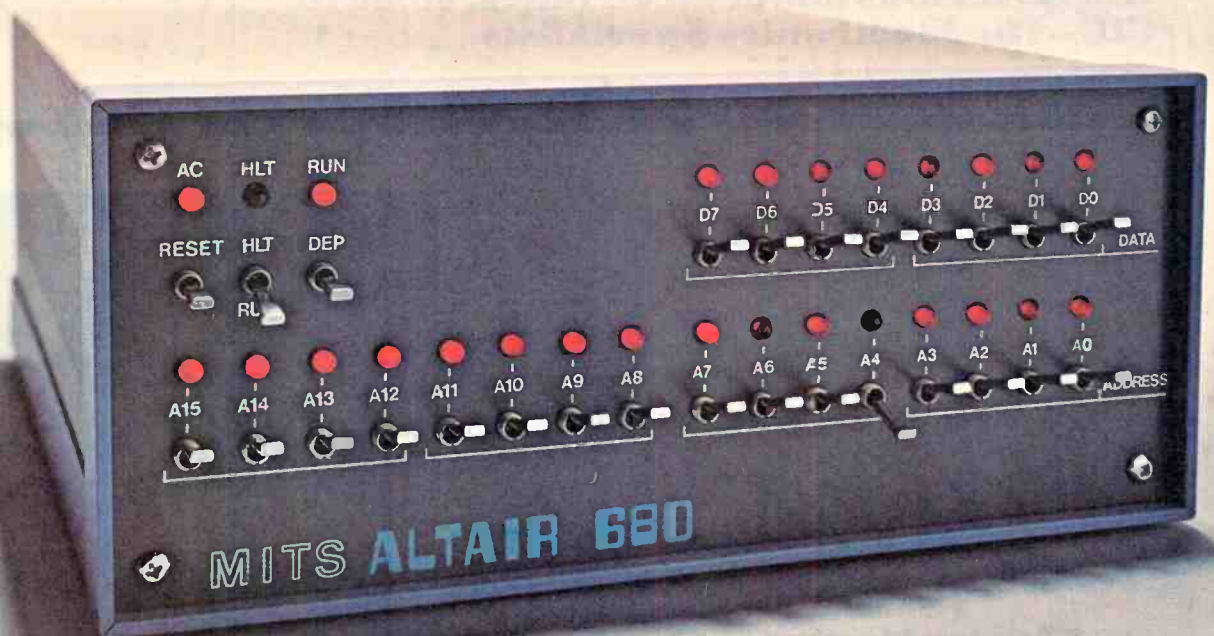

2450 Alamo S.E. Albuquerque, New Mexico 87106
dealer inquiries invited.

CIRCLE NO. 38 ON FREE INFORMATION CARD

At CIE, you get electronics career training from specialists.

If you're interested in learning how to fix air conditioners, service cars or install heating systems – talk to some other school. But if you're serious about electronics, come to CIE – The Electronics Specialists.

John E. Cunningham

**Special Projects Director
Cleveland Institute of Electronics**



My father always told me that there were certain advantages to putting all your eggs in one basket. "John," he said, "learn to do one important thing better than anyone else, and you'll always be in demand."

I believe he was right. Today is the age of specialization. And I think that's a very good thing.

Consider doctors. You wouldn't expect your family doctor to perform open heart surgery or your dentist to set a broken bone, either. Would you?

For these things, you'd want a specialist. And you'd trust him. Because you'd know if he weren't any good, he'd be out of business.

Why trust your education and career future to anything less than a specialist?

You shouldn't. And you certainly don't have to.

FACT: CIE is the largest independent home study school in the world that specializes exclusively in electronics.

We have to be good at it because we put all our eggs in one basket: electronics. If we hadn't done a good job, we'd have closed our doors long ago.

Specialists aren't for everyone.

I'll tell it to you straight. If you think electronics would make a nice hobby, check with other schools.

But if you think you have the cool — and want the training it takes — to make sure that a sound blackout during a prime time TV show will be corrected in seconds — then answer this ad. You'll probably find CIE has a course that's just right for you!

At CIE, we combine theory and practice. You learn the best of both.

Learning electronics is a lot more than memorizing a laundry list of facts about circuits and transistors. Electronics is interesting because it's based on some fairly recent scientific discoveries. It's built on ideas. So, look for a program that starts with ideas — and builds on them.

That's what happens with CIE's Auto-Programmed® Lessons. Each lesson uses world-famous "programmed learning" methods to teach you important principles. You explore them, master them completely... before you start to apply them!

But beyond theory, some of our courses come fully equipped with the electronics gear to actually let you perform hundreds of checking, testing and analyzing projects.

In fact, depending on the course you take, you'll do most of the basic things professionals do every day — things like servicing a beauty of a Zenith color TV set... or studying a variety of screen display patterns with the help of a color bar generator.

Plus there's a professional quality oscilloscope you build and use to "see" and "read" the characteristic waveform patterns of electronic equipment.

You work with experienced specialists.

When you send us a completed lesson, you can be sure it will be reviewed and graded by a trained electronics instructor, backed by a team of technical specialists. If you need specialized help, you get it fast... in writing from the faculty specialists best qualified to handle your question.

People who have known us a long time, think of us as the "FCC License School."

We don't mind. We have a fine record of preparing people to take... and pass... the government-administered FCC License exams. In fact, in continuing surveys nearly 4 out of 5 of our graduates who take

the exams get their Licenses. You may already know that an FCC License is needed for some careers in electronics — and it can be a valuable credential anytime.

Find out more! Mail this card for your FREE CATALOG today!

If the card is gone, cut out and mail the coupon.

I'll send you a copy of CIE's FREE school catalog, along with a complete package of independent home study information.

For your convenience, I'll try to arrange for a CIE representative to contact you to answer any questions you may have.

Remember, if you are serious about learning electronics... or building upon your present skills, your best bet is to go with the electronics specialists — CIE. Mail the card or coupon today or write CIE (and mention the name and date of this magazine), 1776 East 17th Street, Cleveland, Ohio 44114.



Patterns shown on TV and oscilloscope screens are simulated.

CIE Cleveland Institute of Electronics, Inc.

1776 East 17th Street, Cleveland, Ohio 44114
Accredited Member National Home Study Council

YES... John, I want to learn from the specialists in electronics — CIE. Send me my FREE CIE school catalog — including details about troubleshooting courses — plus my FREE package of home study information. **PE-42**

Print Name _____

Address _____ Apt. _____

City _____

State _____ Zip _____

Age _____ Phone (area code) _____

Check box for G.I. Bill information: Veteran Active Duty

Mail today!

subjective refinement that is desired. (It is difficult, if not impossible, to actually measure the benefits of some multi-way speaker systems, especially in view of the aberrations introduced by any crossover network, let alone a four-way network.)

Having made side-by-side comparisons between two- and three-way systems based on similar drivers and cabinet dimensions, we can attest to the added openness imparted by a good three-way design. It is a fairly subtle effect, however, and might not be detectable without such a comparison. On the other hand, we have often been impressed by the similarity in sound quality between some good, small two-way speaker systems and vastly larger (and more expensive) three- or four-way systems. There is not much mystery to this effect, since it means that the speakers involved have been designed to give a uniform energy response with better than average dispersion. Their similarity is clearly evident in the measured frequen-

cy response. Consequently, it is not surprising that they sound very much alike in their basic octave-to-octave balance and freedom from coloration. The low-frequency limitations of the small speakers are usually evident only below 50 Hz or so, where most programs have little energy.

The Speakerlab 7 speaker reviewed here is a three-way system, and from its use of two full-size (10- and 12-inch) woofers it is easy to understand why a three-way design was necessary. The first crossover at 700 Hz was dictated by the high-frequency limitations of the woofers, and a rather large horn driver was needed in the midrange to operate down to that frequency. A horn of this size cannot do a good job at the highest audio frequencies, making it necessary to cross over to a second smaller horn at 5000 Hz. A speaker with the efficiency and power handling ability of this one could not have been made with a simple two-way configuration or in a smaller cabinet. ◇



AKAI MODEL GX-270D-SS FOUR-CHANNEL TAPE RECORDER

Synchronous recording function permits multitrack taping.



Paradoxically, at a time when interest in quadraphonics is not especially strong,

a number of open-reel tape recorders on the market feature 4-channel capabilities. The indication here is that home recordists are using these decks to build up multitrack recordings in a manner similar to that used by professional recording studios, rather than for recording and listening to 4-channel tapes.

Akai's Model GX-270D-SS 4-channel open-reel tape recorder is in this category, having the synchronous recording capability that makes it possible to obtain multitrack recordings. Its "Quadra Sync" recording system can be used in both the 2- and 4-channel modes. The deck also features a direct-driven cap-

stan, 7½- and 3¾-ips (19.1 and 9.5 cm/s) speeds, and a bidirectional playback feature for stereo operation. The transport is solenoid controlled.

The recorder measures 18.3"H × 17.3"W × 7.5"D (46.5 × 44 × 19.5 cm) and weighs 39.2 lb (17.8 kg). Its nationally advertised value is \$875.

General Description. An ac servo motor is used to directly drive the capstan of the recorder, eliminating the belts and pulleys usually found in tape drives. Pushbutton switches are used to select the operating speed and simultaneously switch in the appropriate equalization characteristic. The hubs can accommodate tape reels up to 7" (17.8 cm) in diameter. Each hub is driven by its own eddy-current motor.

The bidirectional playback mechanism can be initiated either automatically by conducting foil on the tape's leader or manually by pressing a switch. The main transport functions are controlled by six pushbutton switches, through solenoid actuators. They include normal and fast speeds in both directions, STOP, and REC interlock functions. A "flying start" recording can be made from play by simultaneously holding down the normal play button and pressing the REC button. A separate PAUSE button stops the tape without engaging the recording function.

A small PITCH CONTROL knob to the left of the tape heads can be used to adjust the tape speeds over a nominal ±5% range. It has a detented center position, which gives the nominally correct tape speed. This control operates when the transport is in both the record and the playback modes. So, it can be used to correct the pitch of a reference track when making a Quadra Sync recording. Below the PITCH CONTROL are the POWER switch and two TAPE SELECTOR buttons (for low-noise and wide-range tapes) and the speed selector buttons.

There are five pushbuttons in the Quadra Sync system. Four are for individual channel selection and the fifth allows you to select either the 2- or the 4-channel mode of operation.

Four VU meters light according to the mode selected. In the 2-channel mode, only the channels 1 and 3 meters light, while in the 4-channel mode, all four meters light. A red light above each meter glows when that channel is in the recording mode. This gives a very clear indication of the operation of the Quadra Sync system, since pressing any of the system's buttons disables the erase and record function for that channel, simultaneously extinguishing the corresponding red light.

The settings of the concentric playback level controls do not affect the meter readings. A MONITOR switch con-

President. Better than CB really has to be.

Nobody needs a 134 MPH sports car to get to work and back. And you probably don't need a CB as good as a President. But maybe... just maybe... you want one.

You want 40 channels. You want all the little extras like variable mike gain, delta tune, LED channel readout and ANL.

Every single President CB—not just one in twenty—is thoroughly tested to make sure it works perfectly before it leaves the factory.

And every single President



incorporates high technology like IC chips and our new compression circuit for superior talk power.

Maybe we've gone too far with the simple CB. But maybe... just maybe... you won't settle for anything less.

PRESIDENT

Engineered to be the very best.

President Electronics, Inc.
16691 Hale Avenue · Irvine, CA 92714 · (714) 556-7355
In Canada: Lectron Radio Sales Ltd., Ontario



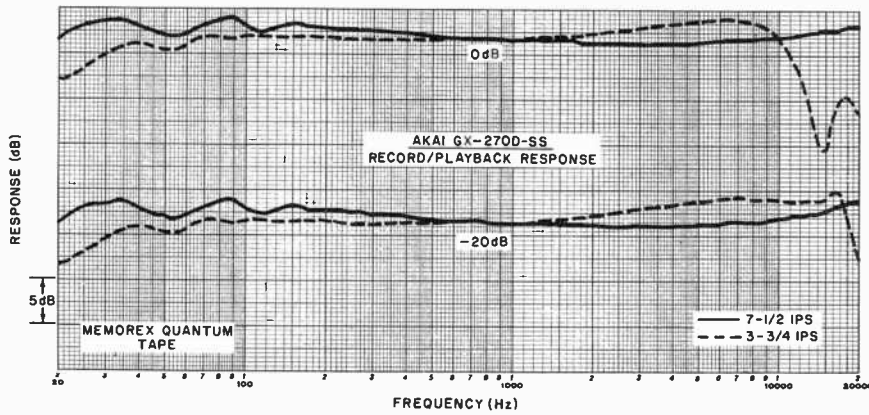

Record/playback response using Memorex Quantum tape at 7½ and 3¾ ips.

nects either the input signal or the playback amplifier output to the line output terminals. Four separate ¼" (6.4-mm) phone jacks are provided for the microphones, which should be medium impedance (600-ohm) dynamic types. There are also two stereo phone jacks for monitoring the front and rear channels. For best results, the phones should have an 8-ohm impedance. Below each VU meter is a concentric pair of recording level controls for that meter's channel (one each for the mic and line inputs, which can be mixed).

On the rear of the recorder are the four pairs of line inputs and outputs and a socket for an optional remote control accessory.

The specifications of the Model GX-270D-SS are consistent with the requirements for a high-quality home tape recorder. Based on the use of Scotch 211 or an Akai tape, they include: frequency response to 21,000 Hz at 7½ ips and to 15,000 Hz at 3¾ ips; with wow and flutter less than 0.07% and 0.1% at the two speeds; less than 1% distortion at 1000 Hz and 0 VU; and better than 54 dB S/N ratio, referred to a +6-VU recording level.

Laboratory Measurements. The

record/playback frequency response of the tape deck was measured with several types of tape, using the "wide range" selector position, to determine which best matched the factory settings of the recorder. Although the differences were not large, we found that Memorex Quantum gave the best results; it was subsequently used for the remainder of the tests. Akai SRT-F and Scotch 212 were quite similar to it in performance, while TDK Audua and Maxell UD35-7 had a rising high-end response.

The 7½-ips frequency response was ±2 dB from 20 to 24,500 Hz at a 20-dB recording level and was virtually the same at 0 dB. There was no sign of tape saturation at 0 dB with any of the tapes used. The 3¾-ips response was within ±2.5 dB from 30 to 18,500 Hz, and tape saturation rolled off the 0-dB output above 7000 Hz.

The playback frequency response, measured with Ampex test tapes, was within ±1.5 dB from 50 to 15,000 Hz at 7½ ips. It was ±1.5 dB from 50 to 7500 Hz at 3¾ ips. Both results represent the frequency limits of the tapes.

A line input of 75 mV or a microphone input of 0.28 mV was necessary for a 0-dB recording level. The playback level from a 0-dB recording was 0.89 volt with

the Memorex tape. (It varies somewhat with the tape used.) The playback distortion at 0 dB at either speed was 0.38% to 0.40%, which is well below the rated value. The reference 3% distortion was reached at a recording input of +10 dB.

The unweighted S/N ratio, referred to the 3% distortion level, was 59 dB at both speeds. With IEC "A" weighting, it was 65.5 dB. With CCIR/ARM weighting, the S/N was 61 dB at 3¾ ips and 64 dB at 7½ ips. The noise level through the microphone inputs was only 3.5 dB higher than through the line inputs.

The flutter of the GX-270-SS was a very low 0.04% at both speeds, which is probably the result of using a direct-drive capstan motor. The PITCH CONTROL had a range of +6.6% to -4.8% at 3¾ ips, and from +5.5% to -4.1% at 7½ ips. In fast forward and rewind, an 1800' (550-m) reel of tape was handled in 100 seconds. The meters responded more slowly than real VU meters, indicating 80% of steady state on 0.3-second tone bursts. The headphone volume was not adjustable and was quite low with 200-ohm phones but fairly good with 8-ohm phones.

User Comment. The operation of the recorder was simple and straightforward, for both conventional operation and for making "Quadra Sync" recordings. The solenoids, which operated with audible "clunks," had a logic system that enabled the buttons to be operated in any sequence without going through STOP. Pressing a normal speed button while the tape was in fast motion (or going in the opposite direction) brought the tape to a smooth, swift stop, after which it paused for a few seconds before resuming play.

On the machine tested, we did not find any effect on the sound when we operated the TAPE SELECTOR buttons. Neither the frequency response, nor the distortion, nor the noise level were affected by this control in any way that we could hear or measure. Also, although the head cover carries the inscription "Auto Reverse," this feature is not mentioned in the instruction manual, nor are there any instructions given on how to install the conductive tape for automatic reversal. A couple of pieces of foil are included with the recorder, with a cryptic statement that they should be installed on either the dull side or the shiny side of the tape. We tried both, and the system operated properly with the foil on either side of the tape. Even if the autoreverse feature is not used, it is still very convenient to be able to play the second pair of

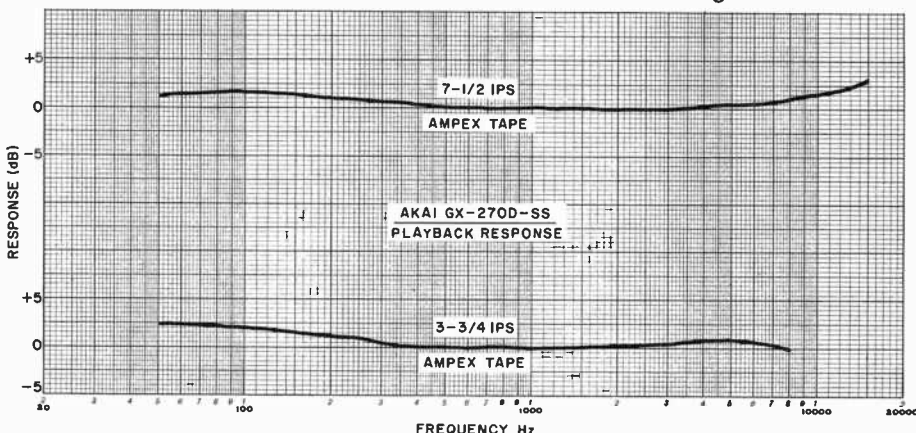

Playback frequency response of the recorder using Ampex test tapes.

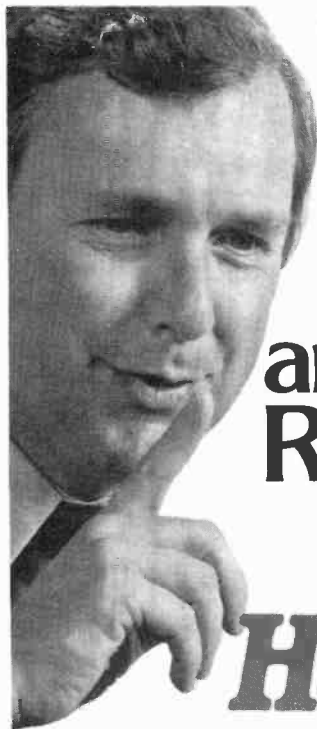

You've got a secret

with the amazing Realistic® One-Hander™.

How's a CB bandit going to take your CB if he doesn't even know you've got one? That's the secret of the One-Hander. Since all controls you need are in the palm-sized handset, you can mount the tiny transceiver case permanently out of sight — in the glovebox, under dash or seat, even in the trunk using a special extension cable. When you leave your vehicle, unplug the handset and lock it up or take it with you. The One-Hander is safer and easier to use while driving — no reaching and fumbling around to make adjustments. Built-in noise blanker and limiter chop out ignition-type noise. Two ceramic filters and push-pull audio circuitry. Improved auto-modulation for FULL talk power, always. With mounting bracket, cables for 12 VDC positive or negative ground. Thieves hate the Realistic One-Hander. But you'll love it. Just 169.95* at your nearby Radio Shack.

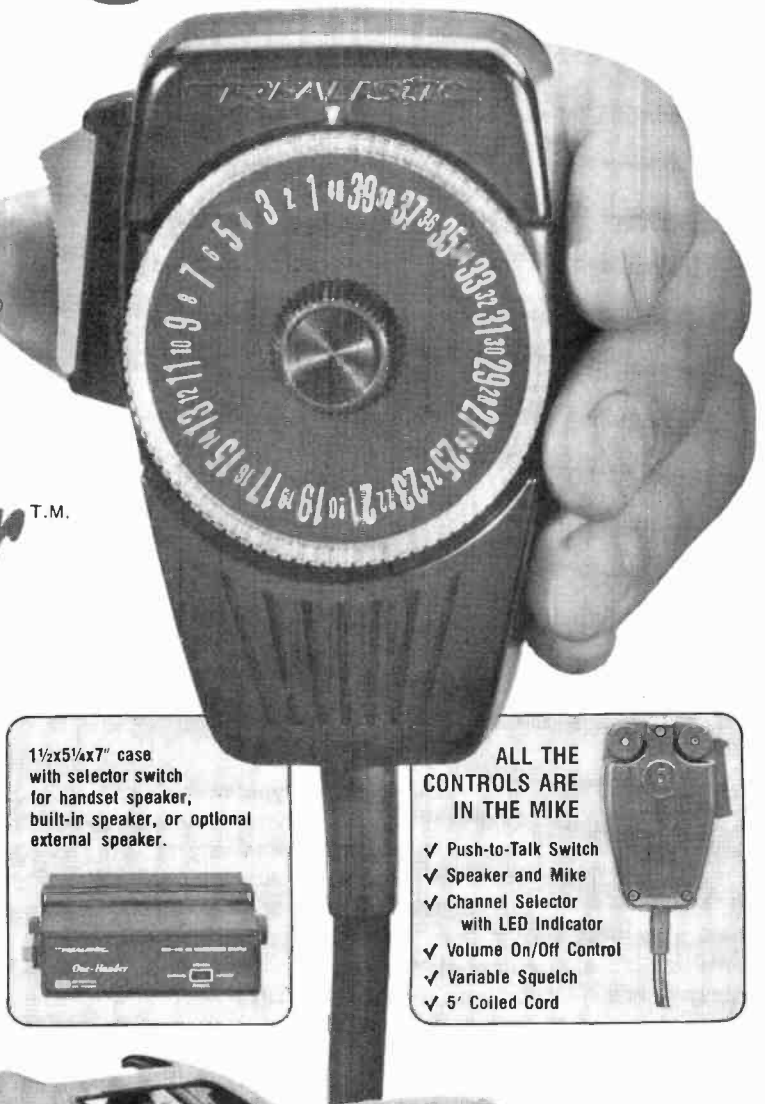

1½x5¼x7" case with selector switch for handset speaker, built-in speaker, or optional external speaker.



ALL THE CONTROLS ARE IN THE MIKE

- ✓ Push-to-Talk Switch
- ✓ Speaker and Mike
- ✓ Channel Selector with LED Indicator
- ✓ Volume On/Off Control
- ✓ Variable Squelch
- ✓ 5' Coiled Cord



Trunk-mount your One-Hander: Special 16½-foot cable runs from trunk under carpet to plug-in jack on dash. Everything's hidden! Cable (21-600) just 29.95*.



FREE! New '78 Catalog
Come in for your copy and see what's *really* new in electronics. 164 pages, 100 in full color. 2000 exclusive items.

SOLD ONLY WHERE YOU SEE THIS SIGN:

Radio Shack®

A TANDY COMPANY • FORT WORTH, TEXAS 76107
OVER 5000 LOCATIONS IN NINE COUNTRIES

*Retail Prices May Vary at Individual Stores and Dealers

tracks at the touch of a button, without interchanging the reels.

At 7½ ips, the sound quality of the recorder leaves little to be desired. When we recorded interstation hiss from an FM tuner, we could hear only a minute brightening of the playback in comparison to the incoming signal. This was

consistent with the measured frequency response of the recorder. But at 3¾ ips, the brightness was quite noticeable, even without an A-B comparison.

This deck will appeal most to the serious amateur recordist who wants to try his hand at multi-track-sync recording. It is a versatile machine, equally at home

with recording and playing back 2- and 4-channel tapes or with creating one's own "professional"-style recordings. We were impressed by the manner in which it surpassed every one of its published specifications, usually by a wide margin.

CIRCLE NO. 102 ON FREE INFORMATION CARD

SPEAKERLAB MODEL S7 SPEAKER SYSTEM KIT

Assemble-it-yourself, three-way speaker system employs four drivers.

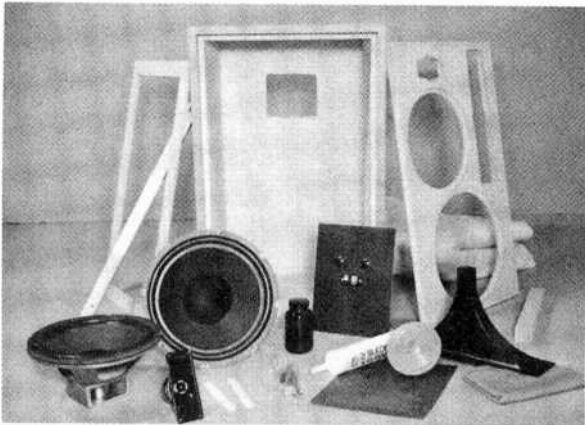

The Model S7 three-way speaker system is one of the six speaker kit models from

Speakerlab. This second from the top-of-the-line kit features an air-suspension system to achieve good bass response in a relatively small enclosure. (Top of the line has a folded-corner-horn design.)

As with all speaker systems kits from Speakerlab, the Model S7's enclosure box is supplied already assembled, requiring only the application of an oil finish (materials supplied) to complete the "wood work." The various elements in the kit—drivers, crossover network, fiberglass insulation, etc.—are mechanically mounted and interconnected.

The Model S7's transducer complement consists of a horn tweeter, horn midrange driver, 12" (30.5-cm) cone-

type woofer, and 10" (25.4-cm) cone-type woofer. Crossover frequencies are nominally at 700 and 5000 Hz, and L pads are provided for adjusting the mid-range driver and tweeter balance. Zeners protect the tweeter.

Speakerlab recommends that an amplifier rated at a minimum of 15 to 25 watts/channel be used to drive the Model S7 speaker systems. Maximum guaranteed safe power for the speaker systems is 150 watts rms/channel. Nominal impedance is 4 ohms.

The front and back of the speaker system's walnut-veneer enclosure are made of ¾" (19.1-mm) thick particle board, while the remainder of the box has an additional layer of ¾" plywood added to its thickness. The enclosure measures 29"H × 18"W × 15½"D (73.7 × 45.7 × 38.4 cm). The assembled speaker system weighs 85 lb (38.6 kg). Price is \$279 per speaker system kit.

Kit Assembly. The Speakerlab kit contained everything required to assemble, wire, and finish the speaker system except scissors, stapler, caulking gun, and sandpaper. (The last item is used to gently sand the edges of the box and any rough spots.) A cartridge of silicone rubber adhesive, supplied with the kit, is used instead of screws for driver and subassembly mounting.

The prewired crossover network/input terminal/L pad assembly mounts first over its cutout in the cabinet via a bead of silicone adhesive. Next, the fiberglass wool sheets are cut with scissors to rough sizes and then stapled to all internal walls of the speaker cabinet except the front panel. Once this is done, short lengths of Velcro fastener tape are stapled to the front panel at all four corners.

The front board on which the drivers mount fastens to the cabinet via a thick bead of silicone rubber adhesive between it and the enclosure's particle board liner. A 2" × 2" (5.1 × 5.1 cm) brace is then white glued between the inside rear wall and the rear wall of the front panel between the woofer cutouts to add rigidity and to reduce the possibility of mechanical resonances in the bass range. Finishing nails driven through both walls into the ends of the brace keep the brace from moving while the glue is setting.

Heavy-gauge wires with push-on terminals connect to the drivers from the crossover/L-pad assembly. The drivers then mount in their respective cutouts with the aid of beads of silicone rubber adhesive. No screws are used to hold the drivers in place. The silicone adhe-

(Continued on page 42)

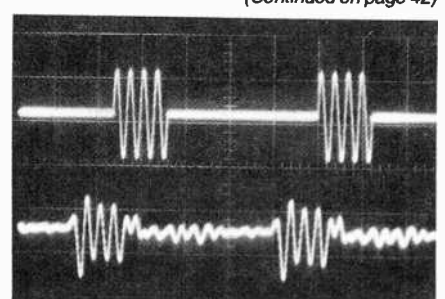
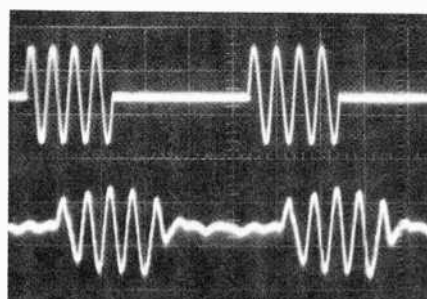
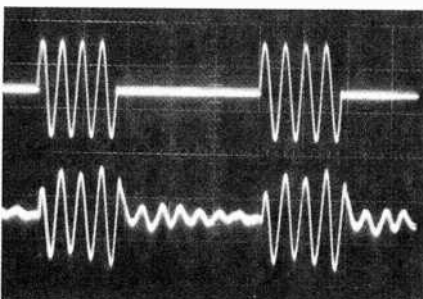

Tone-burst response for (left to right) 100, 1000, and 7000 Hz.

SWTPC announces first dual minifloppy kit under \$1,000



Now SWTPC offers complete best-buy computer system with \$995 dual minifloppy, \$500 video terminal/monitor, \$395 4K computer.



\$995 MF-68 Dual Minifloppy

You need dual drives to get full benefits from a minifloppy. So we waited to offer a floppy until we could give you a dependable dual system at the right price.

The MF-68 is a complete top-quality minifloppy for your SWTPC Computer. The kit has controller, chassis, cover, power supply, cables, assembly instructions, two highly reliable Shugart drives, and a diskette with the Floppy Disk Operating System (FDOS) and disk BASIC. (A floppy is no better than its operating system, and the MF-68 has one of the best available.) An optional \$850 MF-6X kit expands the system to four drives.



\$500 Terminal/Monitor

The CT-64 terminal kit offers these premium features: 64-character lines, upper/lower case letters, switchable control character printing, word highlighting, full cursor control, 110-1200 Baud serial interface, and many others. Separately the CT-64 is \$325, the 12 MHz CT-VM monitor \$175.



\$395 4K 6800 Computer

The SWTPC 6800 comes complete with 4K memory, serial interface, power supply, chassis, famous Motorola MIKBUG[®] mini-operating system in read-only memory (ROM), and the most complete documentation with any computer kit. Our growing software library includes 4K and 8K BASIC (cassettes \$4.95 and \$9.95; paper tape \$10.00 and \$20.00). Extra memory, \$100/4K or \$250/8K.

Other SWTPC peripherals include \$250 PR-40 Alphanumeric Line Printer (40 characters/line, 5 x 7 dot matrix, 75 line/minute speed, compatible with our 6800 computer and MITS/IMSAI); \$79.50 AC-30 Cassette Interface System (writes/reads Kansas City standard tapes, controls two recorders, usable with other computers); and other peripherals now and to come.

Enclosed is:

- _____ \$1,990 for the full system shown above (MF-68 Minifloppy, CT-64 Terminal with CT-VM Monitor).
- _____ \$995 for the Dual Minifloppy
- _____ \$325 for the CT-64 Terminal
- _____ \$175 for the CT-VM Monitor
- _____ \$395 for the 4K 6800 Computer

_____ \$250 for the PR-40 Line Printer
 _____ \$79.50 for AC-30 Cassette Interface
 _____ Additional 4K memory boards at \$100
 _____ Additional 8K memory boards at \$250
 _____ Or BAC # _____ Exp. Date _____
 _____ Or MC # _____ Exp. Date _____
 Name _____ Address _____
 City _____ State _____ Zip _____

CIRCLE NO. 59 ON FREE INFORMATION CARD

AmericanRadioHistory.Com



Southwest Technical Products Corp.

219 W. Rhapsody, San Antonio, Texas 78216
London: Southwest Technical Products Co., Ltd.
Tokyo: Southwest Technical Products Corp./Japan

Should your career in electronics go beyond TV repair?

**CREI prepares you at home
for broader and more advanced
opportunities in electronics —
plus offers you special arrangements
for engineering degrees**

There is no doubt television repair can be an interesting and profitable career field. TV repair, however, is only one of the many career areas in the fast growing field of electronics.

As an indication of how career areas compare, the consumer area of electronics (of which TV is a part) makes up less than one-fourth of all electronic equipment manufactured today. Nearly twice as much equipment is manufactured for the communications and industrial fields. Still another area larger than consumer electronics is the government area. That is the uses of electronics in such areas as research and development, the space program, and others.

Just as television is only one part of the consumer field, these other fields of electronics are made up of many career areas. For example, there are computer electronics, microwave and satellite communications, cable television, even the broadcast systems that bring programs to home television sets.

As you may realize, career opportunities in these other areas of electronics are mostly for advanced technical personnel. To qualify for these higher level positions, you need college-level training in electronics. Of course, while it takes extra preparation to qualify for these career areas, the rewards are greater both in the interesting nature of the work and in higher pay. Furthermore, there is a growing demand for personnel in these areas.

Unlike most other home study schools, CREI programs are devoted exclusively to preparing you for careers in advanced electronics. All of CREI programs are college level. And CREI gives you both theory and practical experience in advanced electronics.

Unique Design Lab

A unique feature of CREI training is its Electronic Design Laboratory Program, which trains you to actually design circuits. It also helps you understand the theories of advanced electronics and gives you extensive practical experience in such areas as tests and measurements, breadboarding, prototype construction, circuit operation and behavior, characteristics of electronic components and how to apply integrated circuits.

Career Training at Home

Only CREI offers this unique Lab Program. It is a complete college lab and, we believe, better than you will find in most colleges. The "Lab" is one of the factors that makes CREI training interesting and effective. And the professional equipment in this program becomes yours to keep and use throughout your professional career after you complete the training.

Engineering Degree

CREI offers you special arrangements for earning credit for engineering degrees at certain colleges and universities as part of your home study training program. An important advantage in these arrangements is that you can continue your full time job while "going to college" with CREI. This also means you can apply your CREI training in your work and get practical experience to qualify for career advancement.

Wide Choice of Programs

CREI gives you a choice of specialization in 14 areas of electronics. You can select exactly the area of electronics best for your career field. You can specialize in such areas as computer electronics, communications engineering, microwave, CATV, television (broadcast) engineering and many other areas of modern electronics.

FREE Book

In the brief space here, there isn't room to give you all of the facts about CREI college-level, home study programs in electronics. So we invite you to send for our free catalog (if you are qualified to take a CREI program). The catalog has over 80, fully illustrated pages describing your opportunities in advanced electronics and the details of CREI home study programs.

Qualifications

You may be eligible to take a CREI college-level program in electronics if you are a high school graduate (or the true equivalent) and have previous training or experience in electronics. Program arrangements are available depending upon whether you have extensive or minimum experience in electronics.

Send for this **FREE** Book describing your opportunities and CREI college-level programs in electronics

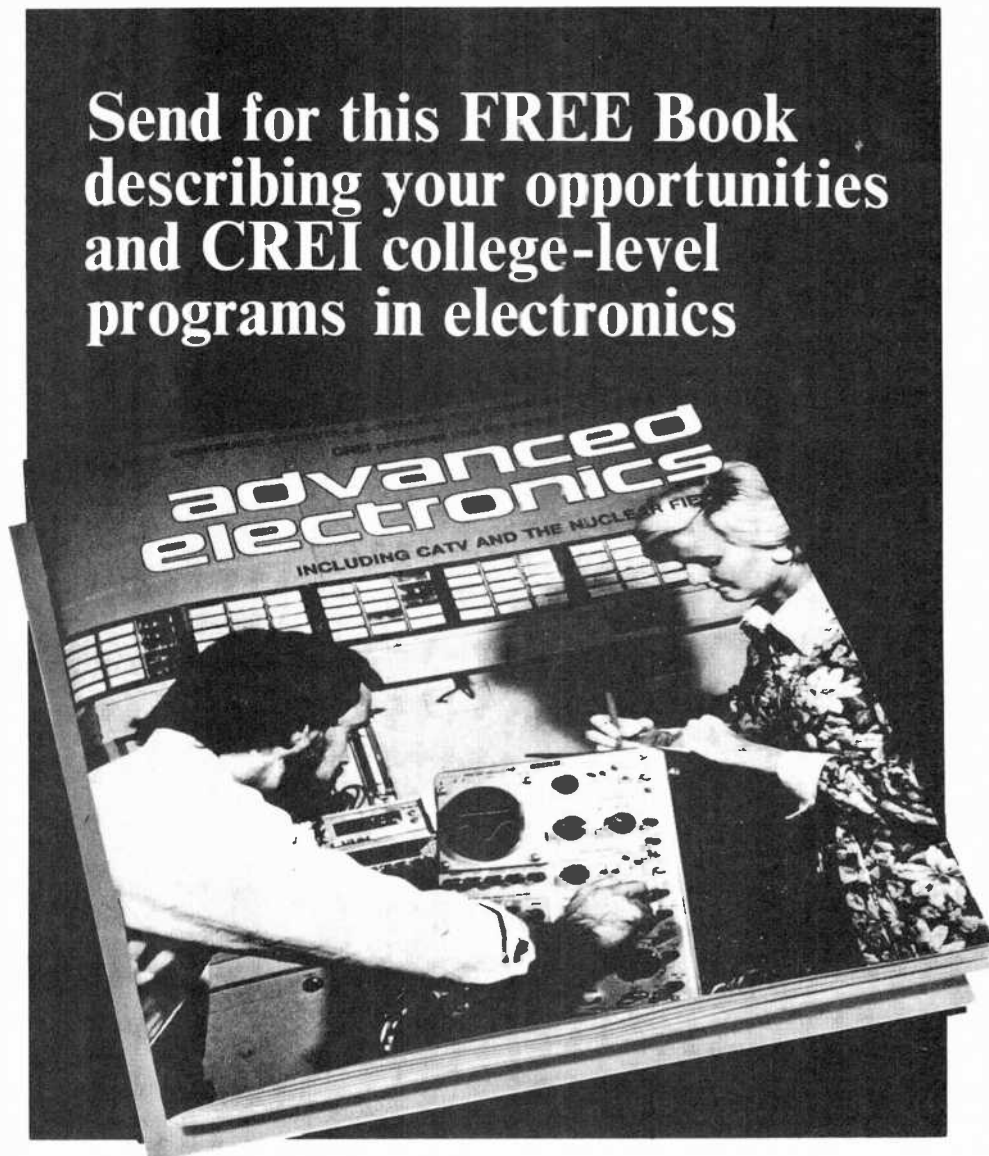

Mail card or write describing qualifications to

CREI **CAPITOL
RADIO
ENGINEERING
INSTITUTE**

McGraw-Hill Continuing Education Center
3939 Wisconsin Avenue Northwest
Washington, D.C. 20016

Accredited Member National Home Study Council

GI Bill

CREI programs are approved for training of veterans and servicemen under the G.I. Bill.



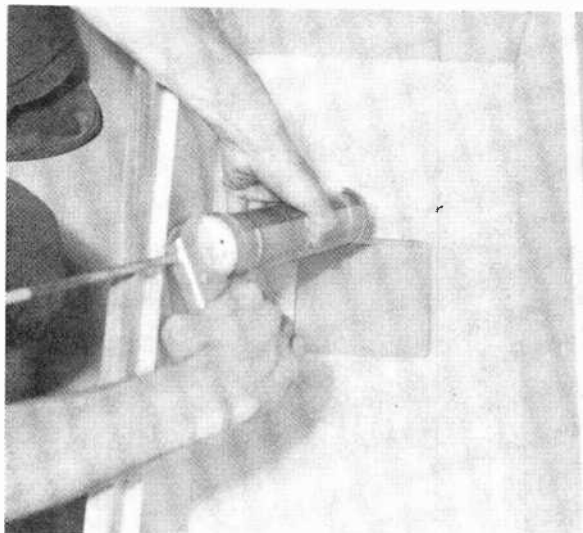

Using a caulking gun, a bead of silicone rubber adhesive is applied around the opening in the enclosure for mounting the electronic assembly.

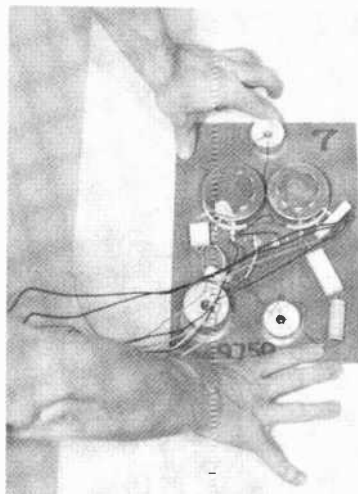

The prewired assembly, holding the crossover network, input terminal, and L pads is pressed into the adhesive.

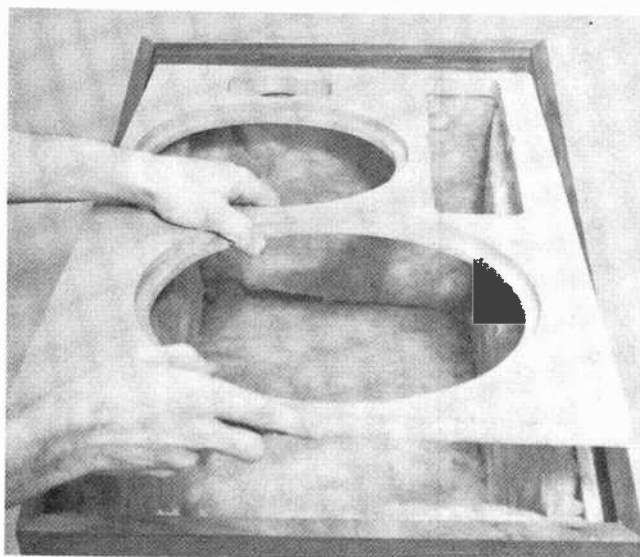

Cabinet is lined with fiberglass and front panel attached, the latter again secured by adhesive.

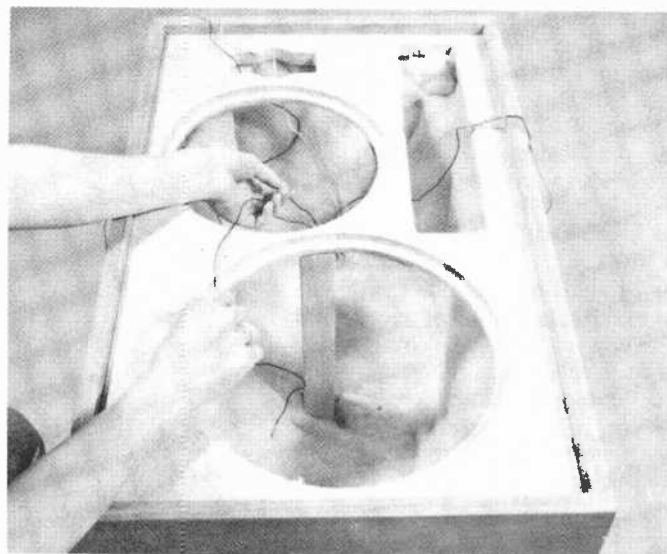

Crossover network leads are pulled through the driver openings. Note supporting wood brace.

sive serves as both mounting and air sealing mediums. The front panel cutout for the horn tweeter is slightly longer in length to permit the driver to slip into place. Consequently, once the tweeter is in place, two small pieces of wood, supplied trimmed to the proper sizes, are glued to the panel to cover up the openings at both ends of the driver horn.

A choice of two different ways of finishing the grille assembly is possible with the materials supplied in the kit. One is a plain flat grille that merely requires the grille cloth to be stretched over and stapled to a ready-made frame. The other is to make the grille assembly three dimensional. To do this, four pieces of wood are glued together to form a frame that is then glued to the ready-made frame. After rounding the edges of the frame, the grille cloth is

stretched over the whole and stapled into place. In either case, Velcro strips are fastened to the frame at the inside rear corners to hold the grille assembly in place.

We allowed four hours for the cemented pieces to set before using the speaker system, which was lying on a floor so that the full weight of the drivers bore down on the silicone adhesive cement/gaskets. We tested the speaker systems beforehand, though, propping them up just enough to permit us to connect cables from our amplifier to them and to permit us to adjust the balance controls.

Once the cements had set and we were satisfied with the operation of the speaker systems, we used No. 150 dry sandpaper to smooth all exterior surfaces of the cabinets. Then we proceeded to pour small amounts of the oil sup-

plied with the kit on one side after another, rubbing it in lightly with No. 400 wet-paper sandpaper. Excess oil was wiped off with a paper towel. Then we allowed the wood to soak up the oil and dry for about two hours. For the finishing touch, we installed the grille assembly, and the system was ready to go to work.

Laboratory Measurements. The middle and high-frequency response of the speaker system was measured in the reverberant field of our room at a distance of 12' to 15' (3.7 to 4.6 m) from the drivers and with the midrange and tweeter level controls set to maximum. To eliminate room interactions at low frequencies, the woofer response was measured separately, with the microphone placed in the plane of the mounting board. Since the system has two dif-

IF YOU'RE WAITING FOR SOLDERLESS BREADBOARDS TO BE FASTER, EASIER, MORE VERSATILE AND LOWER-PRICED...

Incredibly inexpensive. EXPERIMENTOR solderless sockets begin at \$5.50* (\$4.00* for the 40 tie-point quad bus strip). A spool of solder costs more.

Mix and match. Use large and small chips in the same circuit without problems. There are two sizes of EXPERIMENTOR sockets with 3/10th and 6/10th centers.

Full fan-out. A CSC exclusive. The only solderless breadboard sockets with full fan-out capabilities for **micro-processors** and other larger (0.6") DIP's.

Microprocessors and other complex circuits are easy to develop. EXPERIMENTOR quad bus strips give you 4, 8 or 16 buses to simplify your breadboards

Infinitely flexible. Circuits can go in any direction, up to any size. All EXPERIMENTOR sockets feature positive interlocking connectors that snap together. Horizontally and/or vertically. And un-snap to change a circuit whenever you wish.

Easy Mounting. Use 4-40 screws from the front or 6-32 self-tapping screws from the rear. Insulated backing lets you mount on any surface.

EXPERIMENTOR 350. \$5.50* 46 five-point terminals plus two 20-point bus strips. 0.3" centers; 3/8 x 3 1/2 x 2"

EXPERIMENTOR 650. \$6.25* 46 five-point terminals plus two 20-point bus strips. 0.6" centers; 3/8 x 3 1/2 x 2 1/4"

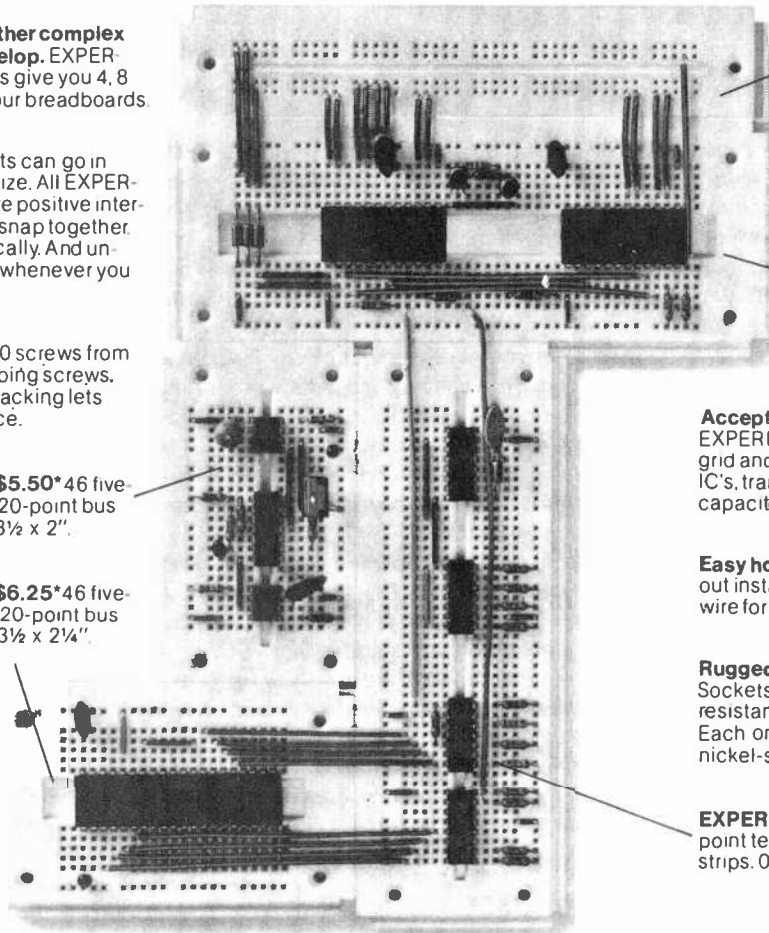

EXPERIMENTOR QUAD BUS STRIP. \$4.00* Four 40-point bus strips. 3/8 x 5 3/4 x 3/4"

Designated tie-points. Simplify translation from breadboard to PC-boards or wiring tables.

EXPERIMENTOR 600. \$10.95* 94 five-point terminals plus two 40-point bus strips. 0.6" centers; 3/8 x 6 x 2 1/4"

Accepts all standard components. EXPERIMENTOR sockets conform to an 0.1" grid and are DIP compatible. Also accept IC's, transistors, diodes, LED's, resistors, capacitors, transformers, pots, etc.

Easy hookup. Components push in and pull out instantly. Use #22-30 solid AWG wire for jumpers.

Rugged, dependable construction. Sockets are constructed from abrasion resistant materials and withstand 100°C. Each one features non-corrosive nickel-silver contacts.

EXPERIMENTOR 300. \$9.95* 94 five-point terminals plus two 40-point bus strips. 0.3" centers; 3/8 x 6 x 2"

WHAT ARE YOU WAITING FOR?

Discover today how solderless breadboarding can save time and money on every circuit you build. Get acquainted with EXPERIMENTOR™ sockets and how they simplify circuit design, assembly and testing. Eliminate the hassles and component damage of soldering. No special hardware or jumper cables required, either. And the price is so low, it's hard to believe.

See your CSC dealer today. Or call 203-624-3103 (East Coast) or 415-421-8872 (West Coast) for the name of your local stocking distributor and a full-line catalog.

CONTINENTAL SPECIALTIES CORPORATION



44 Kendall Street, Box 1942, New Haven, CT 06509
203-624-3103 TWX 710-465-1227
West Coast 351 California St, San Francisco, CA 94104
415-421-8872 TWX 910-372-7992
MEXICO ELPRO, S.A., Mexico City 5-23-30-04
CANADA Len Finkler Ltd., Ontario

SEE US AT WESCON SHOW BOOTH # 1114, 1116 & 1118.

CIRCLE NO. 14 ON FREE INFORMATION CARD

AmericanRadioHistory.com

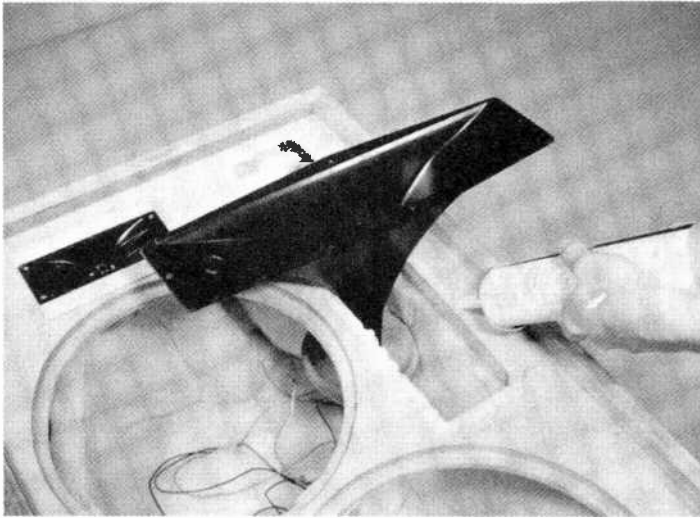

The midfrequency horn driver is prepared for enclosure mounting.

ferently sized woofers, separate measurements were made on each.

The reverberant frequency response was very good. Also, the woofer response was smooth and flat, without a glitch in the upper part of its range. When the two curves were spliced together, the response was within ± 3 dB from 35 to 6000 Hz and rose at higher frequencies. Of course, the shape of the high-frequency curve would vary considerably with different settings of the level controls.

The reasons for using two different woofers are not obvious, since the measured frequency response from each was the same, although the larger cone delivered about 2 dB more output. The output of the woofer reached a maximum between 60 and 80 Hz, falling at a rate of 24 dB/octave below 60 Hz and at about 6 dB/octave above 80 Hz.

The rated impedance of the speaker system is 4 ohms, a fact that was con-

firmed by our tests. It measured 4 ohms at 2 Hz and in the 100-Hz region, with a bass resonance rise to 15 ohms at 50 Hz. The impedance was in the 10-to-12-ohm range at all frequencies above a few hundred hertz.

User Comment. For most of our listening tests, the speaker systems were on tilt stands supplied by Speakerlab. This raised the cabinets about 8" (20.3 cm) above floor level and tilted them back to provide better coverage for the typical seated listener.

In our live-versus-recorded test, the Speakerlab S7 was highly accurate in the upper midrange and at high frequencies. We observed some added warmth in the lower midrange. It did not show up on the response curve, however, and may have been associated with the room's characteristics.

The S7's 4-ohm speaker impedance gives one a sense of higher speaker effi-



Completed system without grille.

ciency as compared to equivalent 8-ohm speakers since it draws more power at a given volume-control setting. Note, however, that one cannot safely use two sets of speaker systems when using 4-ohm ones, even if the remotes are 8-ohm types, as most amplifiers will not be able to handle it. For obtaining maximum power from one set of speakers, however, the 4-ohm types are ideal.

All in all, this is a very fine speaker system. We found it to be equally suited to all kinds of music. Since its balance must be set by ear, the end result naturally depends on the builder's ability to set up both balance controls properly. (Instructions are provided with the kit.)

Assembling this kit was an interesting job. The instruction manual was clearly written and illustrated, and most informative. It took us about two hours to complete each speaker system, excluding waiting time for glue drying. Not having any screws to which to secure the speaker elements eliminated the possibility of damaging the cone by mistakenly moving the driver above it owing to the always surprising heavy weight of the element. But, even if this or any other damage is done, the manufacturer will send a new part, no questions asked. And if you happen to be the unhandiest person around and cannot complete the kit, Speakerlab will finish it for you at no charge (customer pays freight). If you should need help with the kit, there's a toll-free number where you can obtain fast, free assistance.

For those who want to make their own enclosures, speakers and the crossover can be purchased separately for \$191 each channel.

For more information, write Speakerlab, 5500 35th Ave., N.E., Seattle, WA 98105.

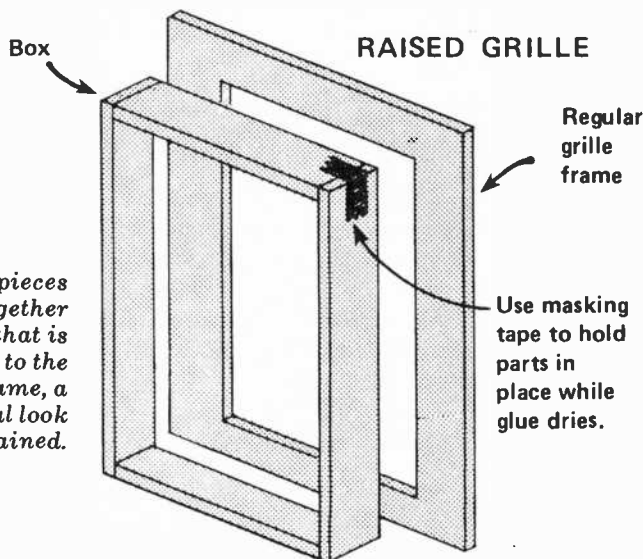

By using four pieces of wood glued together to form a box that is then glued to the regular frame, a three-dimensional look for grille is obtained.

Why you should buy a digital multimeter from the leader in digital multimeters.

If you're shopping for your first multimeter, or moving up to digital from analog, there are a few things you should know.

First, look at more than price. You'll find, for instance, that the new Fluke 8020A DMM offers features you won't find on other DMMs at any price. And it's only \$169.*

Second, quality pays. Fluke is recognized as the leading maker of multimeters (among other things) with a 30-year heritage of quality, excellence and value that pays off for you in the 8020A.

Third, don't under-buy. You may think that a precision 3½-digit digital multimeter is too much instrument for you right now. But considering our rapidly changing technology, you're going to need digital *yesterday*.

If you're just beginning, go digital.

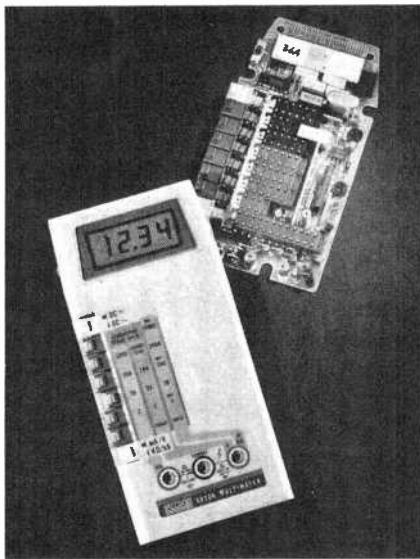

Why not analog? Because the 8020A has 0.25% dc accuracy, and that's *ten*

times better than most analog meters.

Also, the 8020A's digital performance means things like 26 ranges and seven functions. And the tougher your home projects get, the more you need the 8020A's full-range versatility and accuracy. The 8020A has it; analog meters don't.

If you're a pro.

You already know Fluke. And you probably own a benchtop-model multimeter.

Now consider the 8020A: smaller in size, but just as big in capability. Like 2000-count resolution and high-low power ohms. Autozero and autopolarity. And the 8020A is MOV-protected to 6000V against hidden transients, and has overload protection to 300V ac.

Nanosiemens?

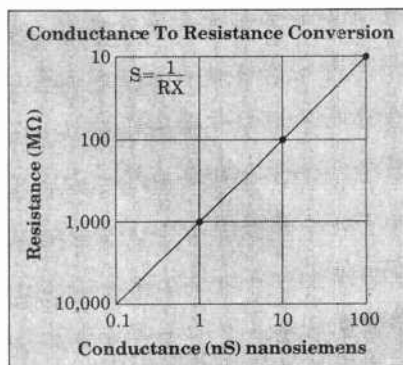

Beginner or pro, you'll find the meter you now have can't measure nanosiemens. So what? With the 8020A *conductance* function, you can measure the equivalent of 10,000 megohms in nanosiemens. Like capacitor, circuit board and insulation leakage. And, you can check transistor gain with a simple, homemade adapter. Only with the 8020A, a 13-oz. heavyweight that goes where you go, with confidence.

What price to pay.



\$169.*

Of course, you can pay more. Or less. In fact, you could pay almost as much for equally compact but more simplistic meters, and get far less versatility. And, the 8020A gives you the 'plus' of custom CMOS LSI chip design, and a minimum number of parts (47 in all). All parts and service available at more than 100 Fluke service centers, worldwide. Guaranteed, for a full year.

Rugged. Reliable. Inexpensive to own and to operate; a simple 9V battery assures continuous use for up to 200 hours.

Where to buy.

Call (800) 426-0361 toll free. Give us your chargecard number and we'll ship one to you the same day. Or, we'll tell you the location of the closest Fluke office or distributor for a personal hands-on feel for the best DMM value going.

*U.S. price only

Fluke 8020A DMM for Home Electronics Experts: \$169



1808-7001

You're looking at the world's best-designed tonearm.

This is a Dual tonearm. It can make a big difference in the way your records sound. And how long they last.

The four-point gyroscopic gimbal is widely acknowledged to be the finest suspension system for a tonearm. It pivots the tonearm precisely where the vertical and horizontal axes intersect. The arm remains perfectly balanced in all planes of movement.

Further, the straight-line tubular design achieves the shortest distance between pivot and stylus. That's basic geometry. Curving the tonearm adds mass, decreases rigidity and makes the arm prone to lateral imbalance.

The vernier counterbalance permits you to balance the tonearm with micrometer-like precision. Tracking force is applied so that the stylus remains perpendicular to the record, even if the chassis is not level.

All this serves to establish and maintain the correct cartridge-to-groove relationship. So the stylus can trace the rapidly changing undulations of the groove walls freely, precisely and with the lowest practical force. In short, flawless tracking.

Despite the advantages of the gimbal-mounted tonearm, you won't find many around. But now, you will find one on every Dual turntable. Even our lowest-priced model, the new, fully automatic 1237.*

It's one more example of Dual's total commitment to engineering excellence.



Dual

For the life of your records

United Audio, 120 So. Columbus Ave., Mt. Vernon, NY 10553

*Less than \$135. Other Duals to \$400. Actual resale prices are determined individually by and at the sole discretion of authorized Dual dealers.

CIRCLE NO. 4 ON FREE INFORMATION CARD

www.dual.com

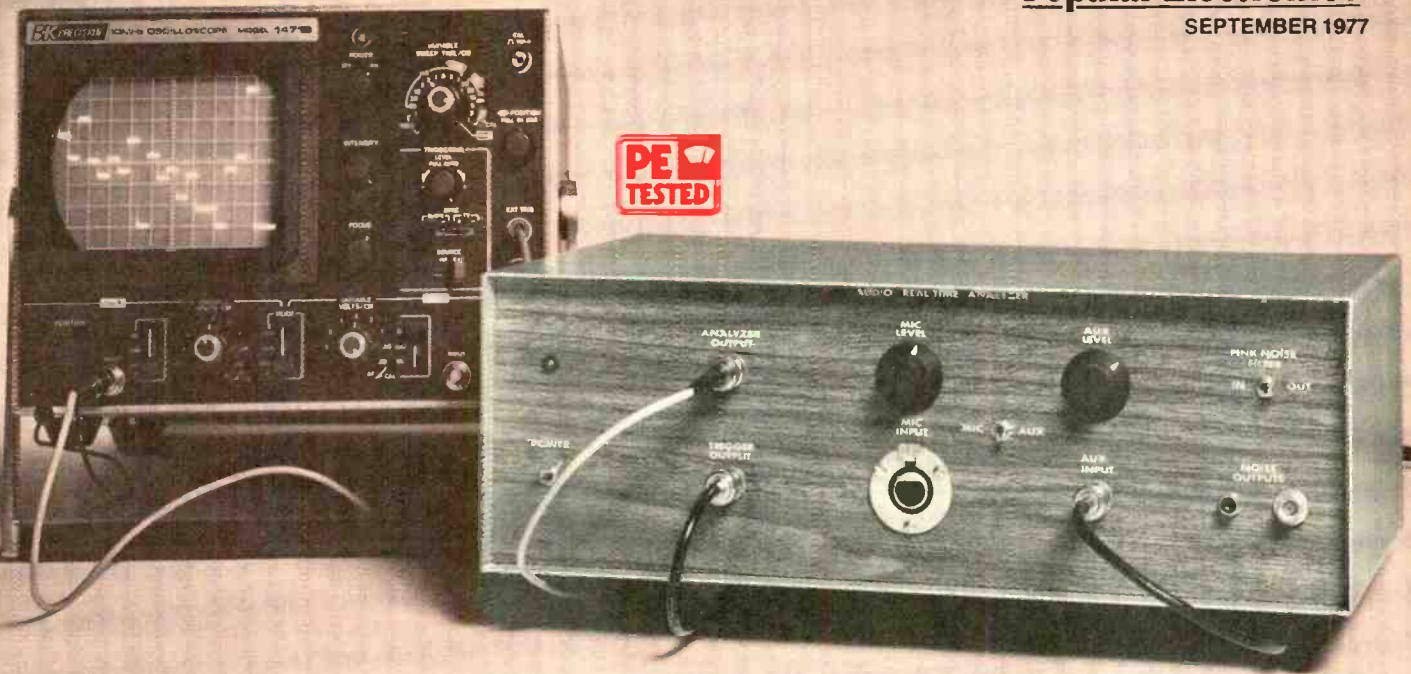

1/2-Octave Real Time Audio Analyzer

BY BOB JONES AND RICHARD MARSH

Used with a mike and oscilloscope, it displays system output to permit accurate matching to room acoustics.

PART 1

IT'S COMMON knowledge that an equalizer can shape a sound system's frequency response. But adjusting multiple equalizer bands for flat audio response in a room is a challenge. This project, an audio Real Time Analyzer, provides a solution to the problem. It generates a graphic representation of the system's output with sufficient detail (20 half-octave bands) to allow quick, accurate matching to room acoustics when used with a calibrated microphone and a dc-coupled oscilloscope.

Furthermore, the RTA can be used to check the frequency response of such components as preamps, power amplifiers, etc. The RTA can also function as a sound pressure meter, as a noise analyzer (energy per frequency band), and as an aid in the design of speaker systems and crossovers.

A block diagram of the RTA is shown in Fig. 1. Input signals are selected by *S1* from MIC or AUX sources. Microphone signals are boosted to line level by a preamp with a gain of 200. A buffer am-

plifier then passes the MIC or AUX signal to twenty half-octave active bandpass filters. Each filter passes only that portion of the input signal within its pass-band. These filtered ac components are then rectified by diodes (one for each filter) and smoothed by RC combinations. The resulting dc levels, proportional to the amount of energy within each pass-band, are scanned sequentially by a 24-channel multiplexer. Finally, the multiplexed signal is buffered and presented at the RTA output.

At this point, dc levels can be applied to the vertical amplifier of the oscilloscope. Variations in vertical deflection from one band to the next will linearly reflect differences between dc levels, and hence between the energies contained in the filter passbands. However, in audio work, voltage variations are usually expressed in decibels. A logarithmic converter has therefore been incorporated into the RTA, allowing direct readout of signal levels in dB from the CRT trace. The multiplexing and display func-

tions of the RTA are carried on so quickly that all bands are shown simultaneously or in "real time."

Circuit Details. The input stage of the Analyzer is shown schematically in Fig. 2. A balanced differential amplifier, *IC1*, allows the use of long lines and low-impedance microphones due to its good common mode rejection characteristics. This amplifier has a voltage gain of 200, determined by *R2* and *R4*, and boosts microphone input signals to line level. External frequency compensation for the op amp is provided by *R6* and *C1*. Capacitor *C2* prevents any dc level at the output of *IC1* from reaching microphone level control *R7*.

Signals from either the microphone preamp or a source connected to the AUX input are selected by *S1* and applied to buffer amplifier *IC2*. Frequency compensation is provided by *C3*. The low-impedance output of *IC2* drives the parallel inputs of the half-octave filters.

Each active filter employs one IC (*IC3*

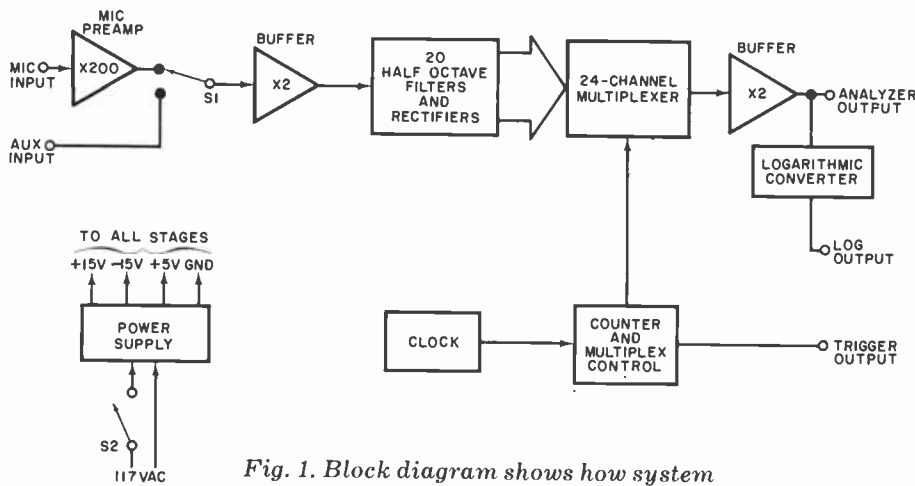

Fig. 1. Block diagram shows how system operates. All bands are shown in real time.

PARTS LIST

C1, C106, C118 through C165—0.01- μ F, 50-V disc ceramic capacitor
 C2, C4—15- μ F, 10-V tantalum capacitor
 C3, C45 through C64—20-pF, 5%, 500-V silver mica capacitor
 C5 through C44—See text and Table I. Close tolerances are essential.
 C65 through C104—1- μ F, 50-V 1 ceramic capacitor
 C105—1.5- μ F, 50-V ceramic capacitor
 C107—500- μ F, 50-V electrolytic capacitor
 C108, C109—50 μ F, 50-V electrolytic capacitor
 C110, C111—10- μ F, 20-V tantalum capacitor
 C112—50- μ F, 10-V tantalum capacitor
 C113 through C117—See Part II
 D1 through D20—1N4148 switching diode
 D21 through D24—1N4003, HEP R0052 or equivalent
 F1—1-ampere slow-blow 3A6 fuse
 IC1—LM725CH operational amplifier
 IC2, IC3 through IC22—LM301AH operational amplifier
 IC23—NE555 timer
 IC24, IC26—SN7490 decade counter
 IC25—SN7404 hex inverter
 IC27—9301 (Fairchild, or equiv.) BCD-to-decimal decoder*
 IC28 through IC30—AM3705D (National Semiconductor, or equiv.) PMOS eight-channel multiplexer**
 IC31—LM741CH operational amplifier
 IC32—MC7815CP or HEP C6114P +15-volt voltage regulator
 IC33—MC7805 or HEP C6110P +5-volt voltage regulator
 IC34—MC7915CP or HEP C6123P -15-volt voltage regulator
 J1—Microphone connector (Cannon XLR-3-13 or equivalent)
 J2 through J4—BNC connector
 LED1—20-mA LED (TIL32 or equivalent)
 The following resistors are 1/8-watt, 1% tolerance, metal-film components.
 R1 through R3—1000 ohms

R4, R5—200,000 ohms
 R35 through R74—See text and Table I.
 The following resistors are 1/4-watt, 5% tolerance carbon components.
 R6—47 ohms
 R9, R12, R14, R95 through R114, R138, —10,000 ohms
 R10, R11—100,000 ohms
 R13—5000 ohms
 R115 through R134—3.3 Megohms
 R135—330 ohms
 R136—560 ohms
 R137—20,000 ohms
 R139—300 ohms
 R7—10,000-ohm, single-turn Cermet potentiometer*
 R8—100,000-ohm, single-turn Cermet potentiometer*
 R15 through R34—50,000-ohm, 20-turn, Helitrim Cermet potentiometer (Beckman 66X or equivalent)*
 R75 through R94—100,000-ohm, single-turn miniature Cermet trimmer potentiometer (Beckman 91W or equivalent)*
 S1—Dpdt miniature toggle switch
 S2—Spst miniature toggle switch
 T1—Triad F91-X universal transformer or equivalent 40-volt center-tapped transformer.*
 Misc.—IC sockets or Molex Soldercons, printed circuit boards, heat sinks, line cord, fuseholder, pc board spacers, suitable enclosure, knobs, coaxial cable, hookup wire, machine and self-tapping hardware, solder, etc.
 Note: The following is available from Southwest Technical Products Corp; 219 W. Rhapsody, San Antonio, TX 78216: set of three etched and drilled pc boards for \$19.00

*Available through distributors such as Allied Radio or Newark Electronics.

**Consult a National Semiconductor local distributor or sales representative.

Q. When properly adjusted, the bandwidth of each filter is exactly one-half octave. With filter center frequencies spaced one-half octave apart, the skirts of the filter response curves will cross over 12 to 18 dB down. This is satisfactory for most audio work.

To achieve the value of Q necessary for narrow bandwidth, the resistors and capacitors in the series and parallel legs of each filter must have close tolerances. Resistors should have tolerances no greater than 1%, and capacitors no greater than 3%. Band-to-band variations in filter gain can be trimmed by LEVEL ADJUST potentiometers R75 through R94. Each filter output is rectified and filtered into a proportional dc voltage by D1 through D20, C85 through C104, R95 through R114 and R115 through R134. A long time constant is employed in the RC filter to average low-frequency components and reduce display bounce.

The digitally controlled multiplex system requires a reference time base or clock. In this project, IC23, a free-running 555 IC timer, generates the necessary clock pulses (Fig. 4). Duty cycle and frequency are determined by R135, R136, and C105. Too high a frequency causes excessive display bounce with a varying input such as random noise. Too low a clock frequency results in display flicker which is hard on the eyes. A clock rate of 2000 Hz was chosen to avoid both undesirable effects.

Clock pulses are applied to IC24, a 7490 decade counter wired to count from 0 to 7, then reset to 0 on the eighth clock pulse. Therefore, a total of eight different output states on three data lines (2⁰, 2¹, 2²) are available. These outputs allow selection of any one of eight FET gates in a 3705 PMOS IC multiplexer. All required decoding circuitry is on the 3705 chip. Of course, twenty channels are needed, not just eight. This is why IC26 and IC27 (7490 and 9301, respectively) are employed. The multiplex circuit is shown in Fig. 5. Each 3705 (three required for 24-channel capacity) has an enable line (E). This allows sequential multiplexer activation.

Decade counter IC26 (7490) is wired to count from 0 to 2, and then reset to 0 on the next pulse from IC25F. For the first seven clock pulses (refer to timing diagram Fig. 6), IC26 has a 0 output. This is decoded by IC27, a 9301 BCD-to-decimal decoder, as a select line one (MPX1 Select) command. Accordingly, multiplexer IC28 is activated. The rectified outputs of the first eight filters are

(continued on page 50)

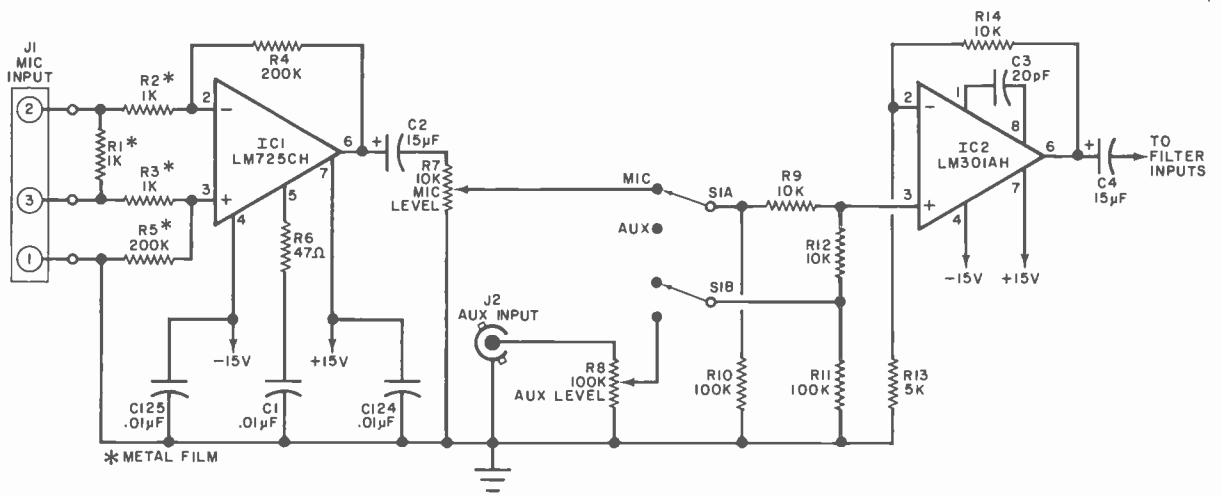

Fig. 2. Input stage includes a balanced differential amplifier, IC1, and buffer, IC2.

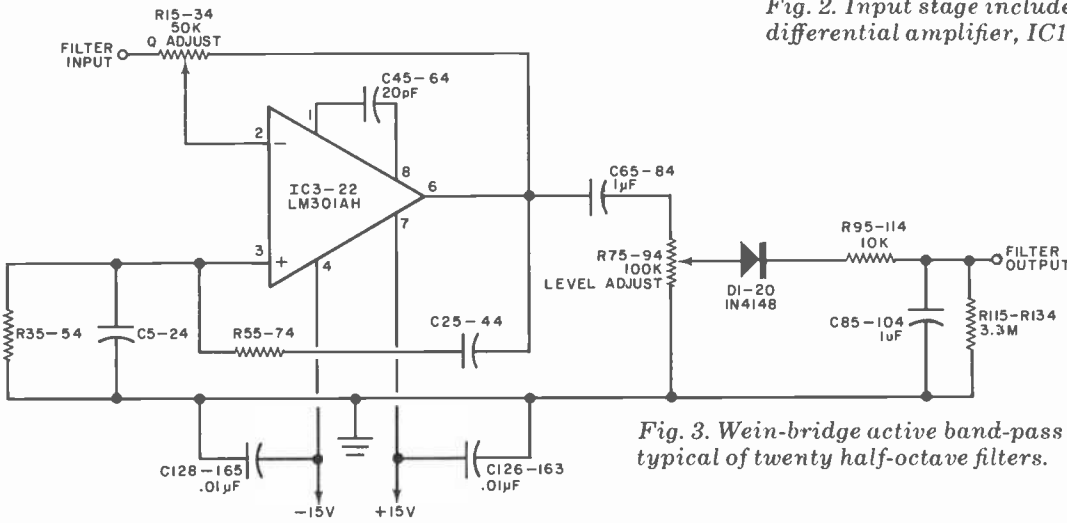

Fig. 3. Wein-bridge active band-pass filter, typical of twenty half-octave filters.

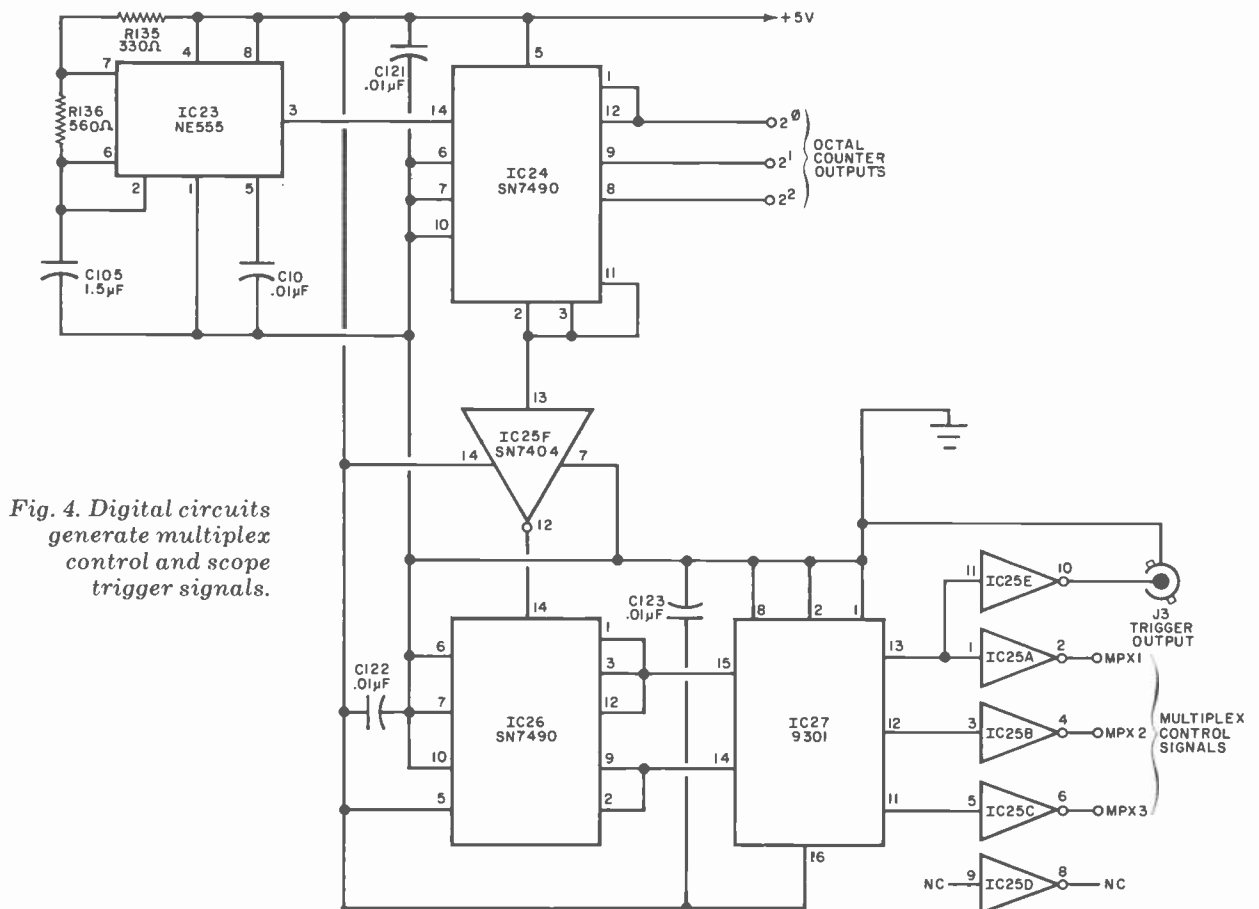

Fig. 4. Digital circuits generate multiplex control and scope trigger signals.

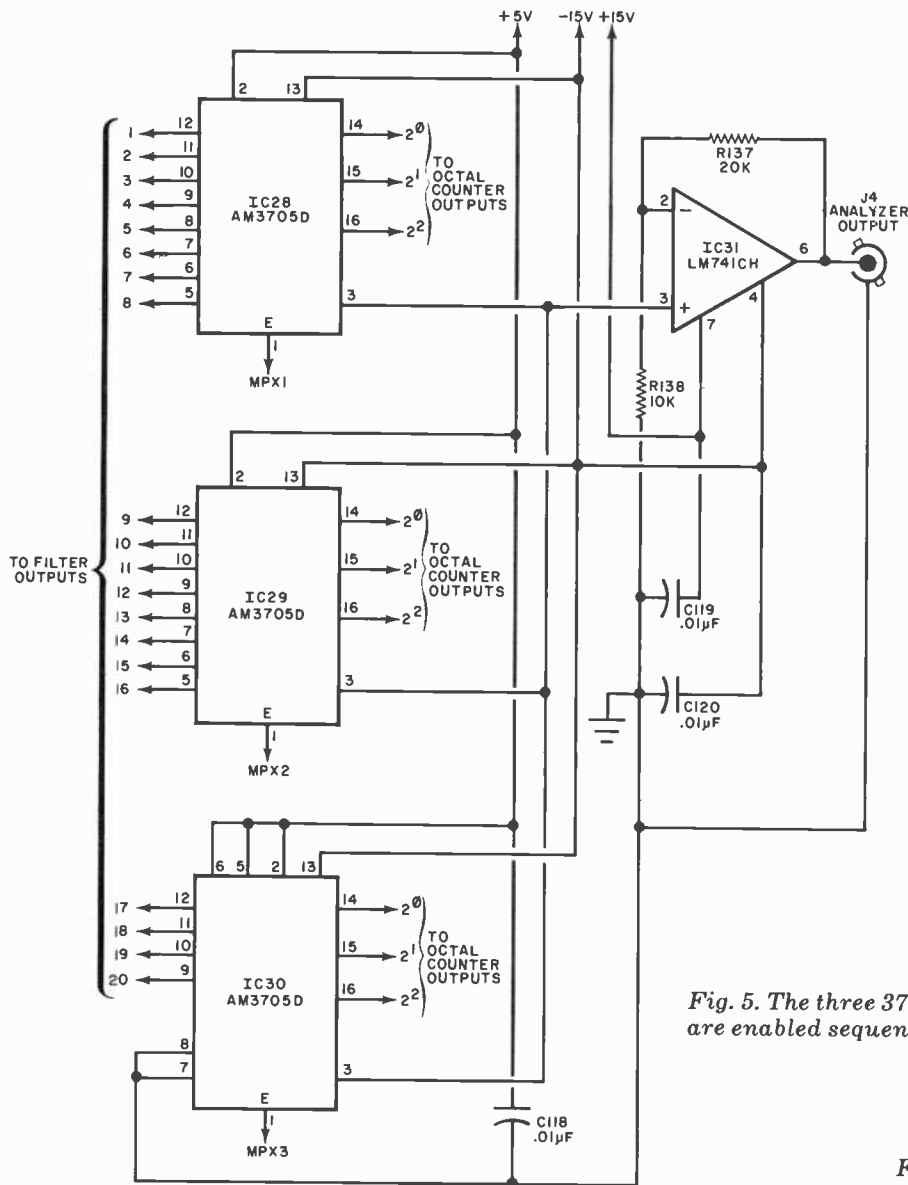
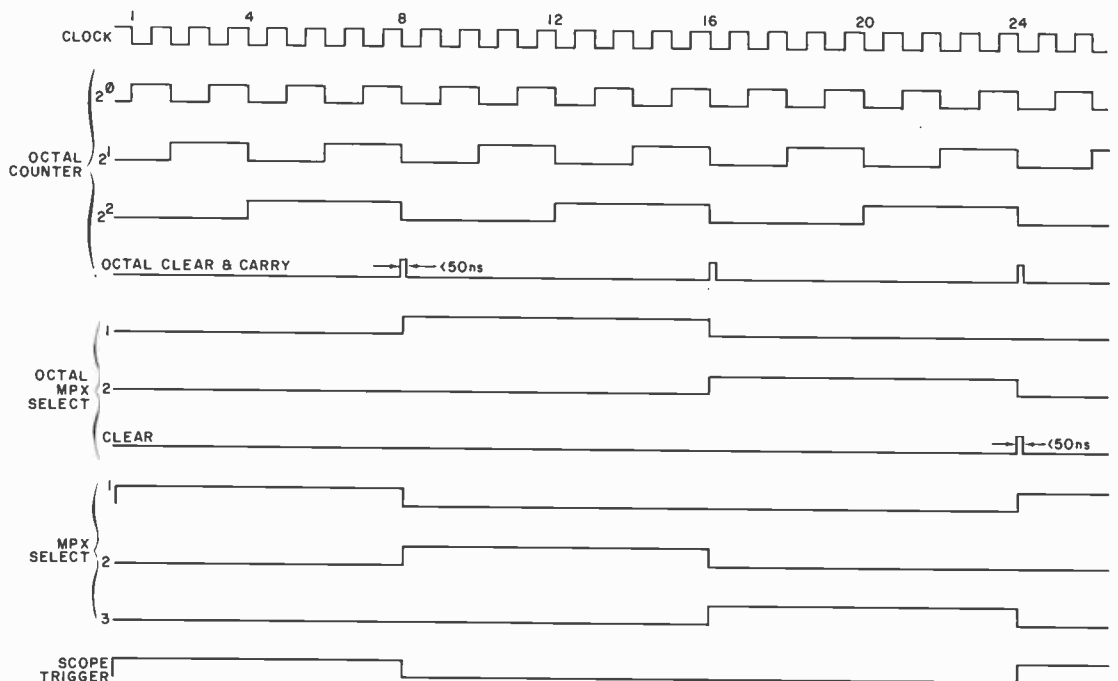

Fig. 5. The three 3705 multiplexer IC's are enabled sequentially.

scanned and sequentially passed to output buffer amplifier IC31, a 741 op amp with a voltage gain of two. On the eighth clock pulse, IC24 will revert to a 0 output, IC26 will increment to 1, causing MPX2 Select to go high and activating IC29. Thus, the outputs of filters 9 through 16 are scanned and passed to IC31. On the sixteenth clock pulse, IC24 causes IC26 to increment to 2, and IC27 issues an MPX3 Select command which enables IC30. Accordingly, the rectified outputs of filters 17 through 20 are scanned and passed to the buffer. At clock pulses 21 and 22, a ground (0 volt) is sent to the scope for base line reference. At clock pulses 23 and 24, IC30 sends +5 volts (boosted by IC31 to 10 volts) to the scope for maximum level reference. (Input signal levels should be adjusted to fall within these extremes.) At clock pulse 24, IC24 and IC26 reset themselves to zero, MPX1 Select again goes high and the process is repeated. Also, a positive-going transition at clock pulse 24 is used for scope triggering.

The power supply for the Analyzer is shown schematically in Fig. 7. Transformer T1 (40 V CT) and diodes D21 through D24 form a bridge rectifier. Ca-

Fig. 6. The timing diagram below shows the clock waveform (top) and the events that occur at various clock pulses.



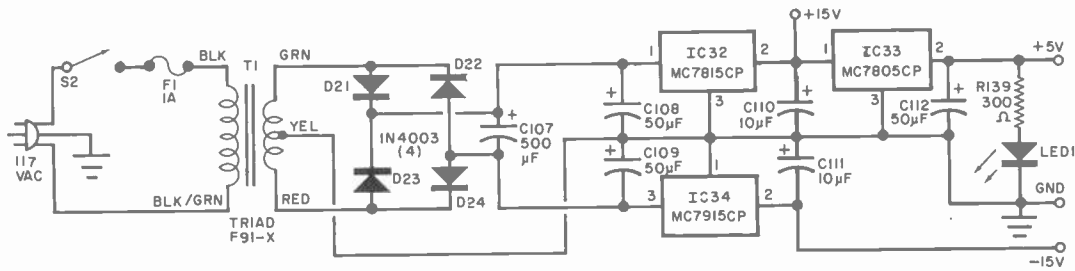

Fig. 7. Schematic of power supply circuit shows bridge rectifier and voltage regulators.

TABLE I—FILTER VALUES

Filter	Center Frequency f_c (Hz)	Resistors (ohms)	Capacitors (μ F)
1	22.4	R35, R55—68, 100	C5, C25—0.1
2	31.5	R36, R35—75,000	C6, C26—0.068
3	45	R37, R57—51,100	C7, C27—0.068
4	63	R38, R58—38,300	C9, C29—0.047
5	90	R39, R59—38,300	C9, C29—0.047
6	125	R40, R60—26,100	C10, C30—0.047
7	180	R41, R61—26,100	C11, C31—0.033
8	250	R42, R62—28,700	C12, C32—0.022
9	355	R43, R63—46,400	C13, C33—0.01
10	500	R44, R64—31,600	C14, C34—0.01
11	710	R45, R65—31,600	C15, C35—0.0068
12	1000	R46, R66—23,700	C16, C36—0.0068
13	1400	R47, R67—23,700	C17, C37—0.0047
14	2000	R48, R68—23,700	C18, C38—0.0033
15	2800	R49, R69—26,100	C19, C39—0.0022
16	4000	R50, R70—38,300	C20, C40—0.001
17	5600	R51, R71—28,700	C21, C41—0.001
18	8000	R52, R72—42,200	C22, C42—470pF
19	11200	R53, R73—31,600	C23, C43—470pF
20	16000	R54, R74—28,700	C24, C44—360pF

capacitors C107, C108, and C109 provide input ripple filtering to IC voltage regulators IC32, IC33, and IC34. Capacitors C110, C111, and C112 provide output filtering. Resistor R139 limits current to LED1, the front panel power indicator.

Construction. The RTA is most easily assembled on three printed circuit boards (four if the optional log converter is desired). Etching and drilling and component placement guides for the Digital and Power Supply Board, Filter Board 1, and Filter Board 2 are shown in Figs. 8, 9, and 10, respectively. (See Table I for RC values for each filter.)

Mount all components on the pc boards using the minimum heat and solder required for good connections. Pay close attention to the polarity and basing of electrolytic (aluminum and tantalum) capacitors, diodes, transistors, and integrated circuits. The use of IC sockets or

Fig. 8A. Parts placement guide for digital and power supply board. See next page for etching and drilling.

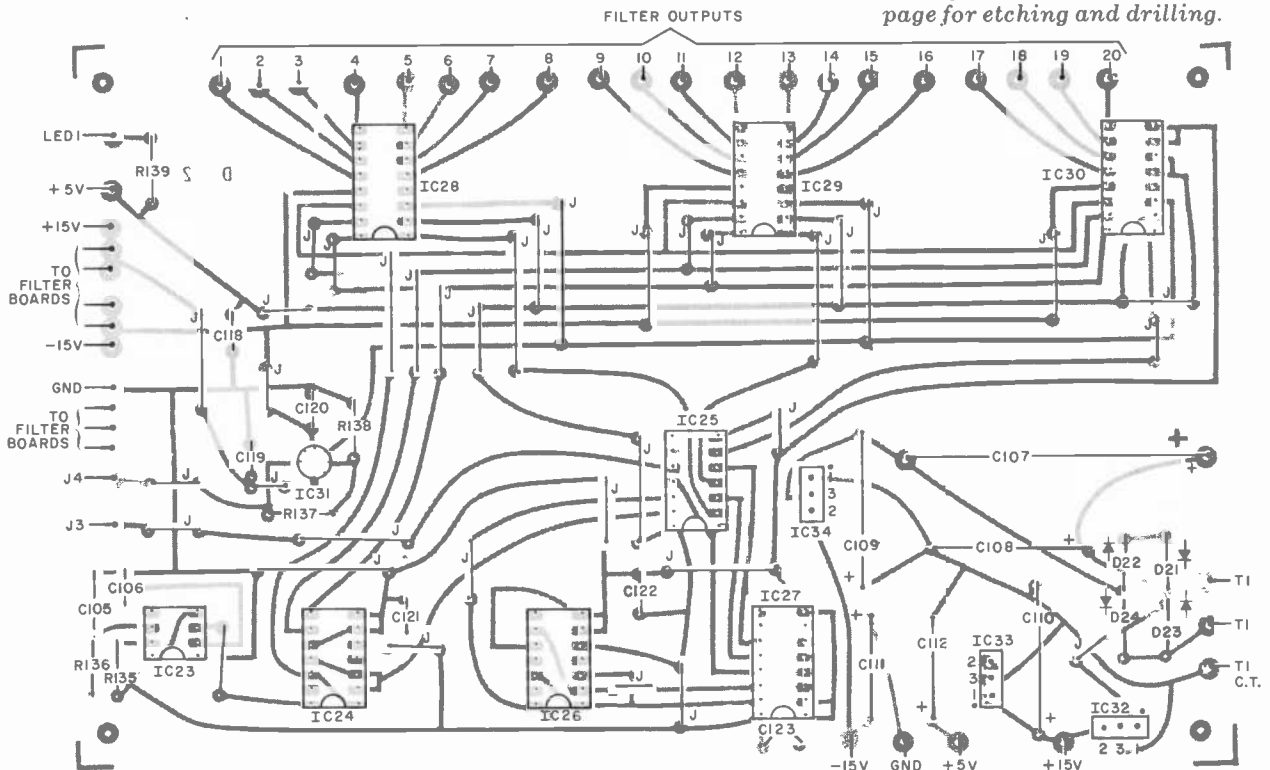

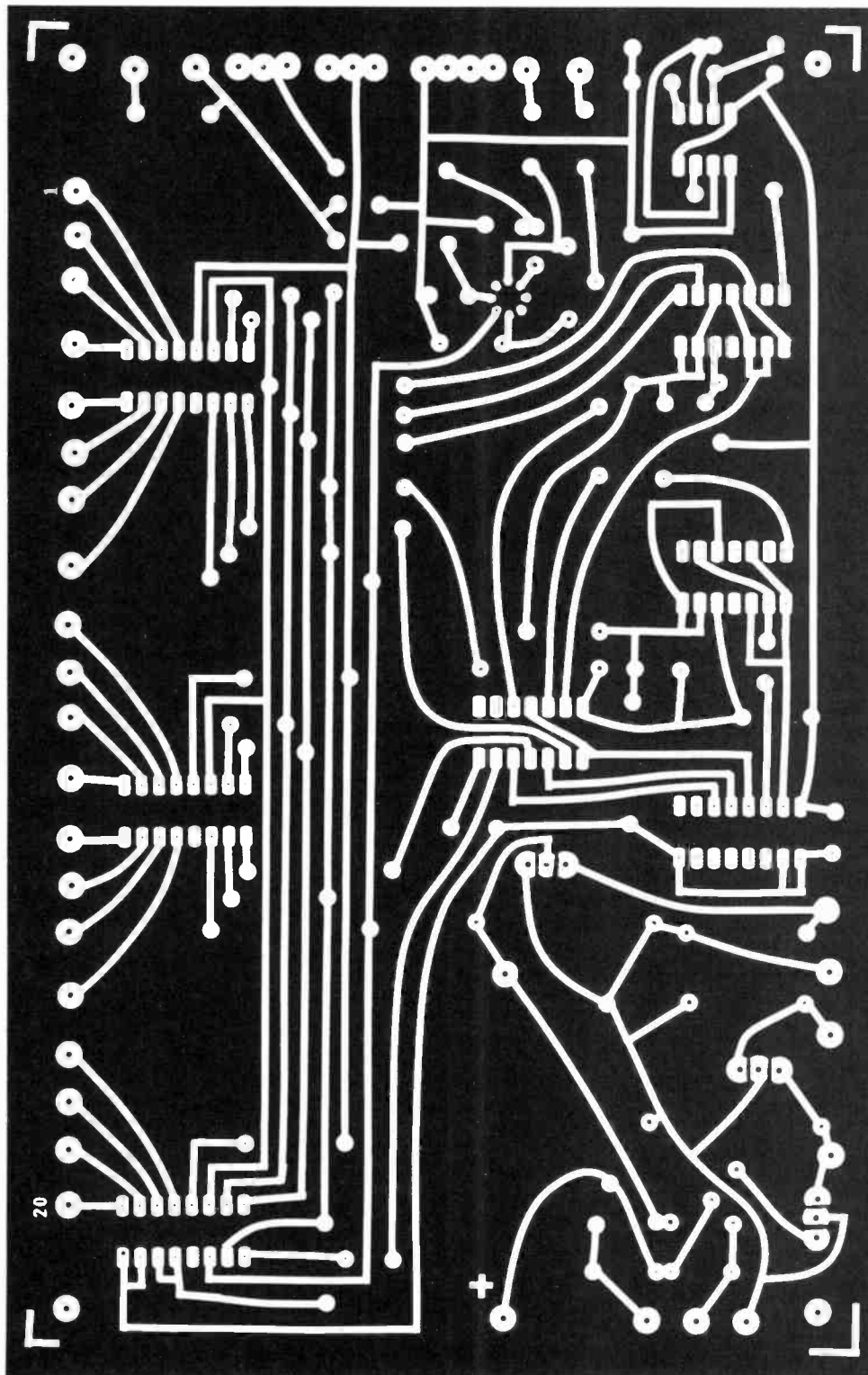

Fig. 8B. Etching and drilling guide for digital and power supply board.

Molex Soldercons for all IC's is recommended. All signal lines to and from the boards should be shielded (small-diameter coax is ideal). The power transformer should be mounted as far away from the boards as possible to minimize hum.

This transformer (T1) is a "universal" transformer, and not all of its color-coded leads are used. Cut short any unused

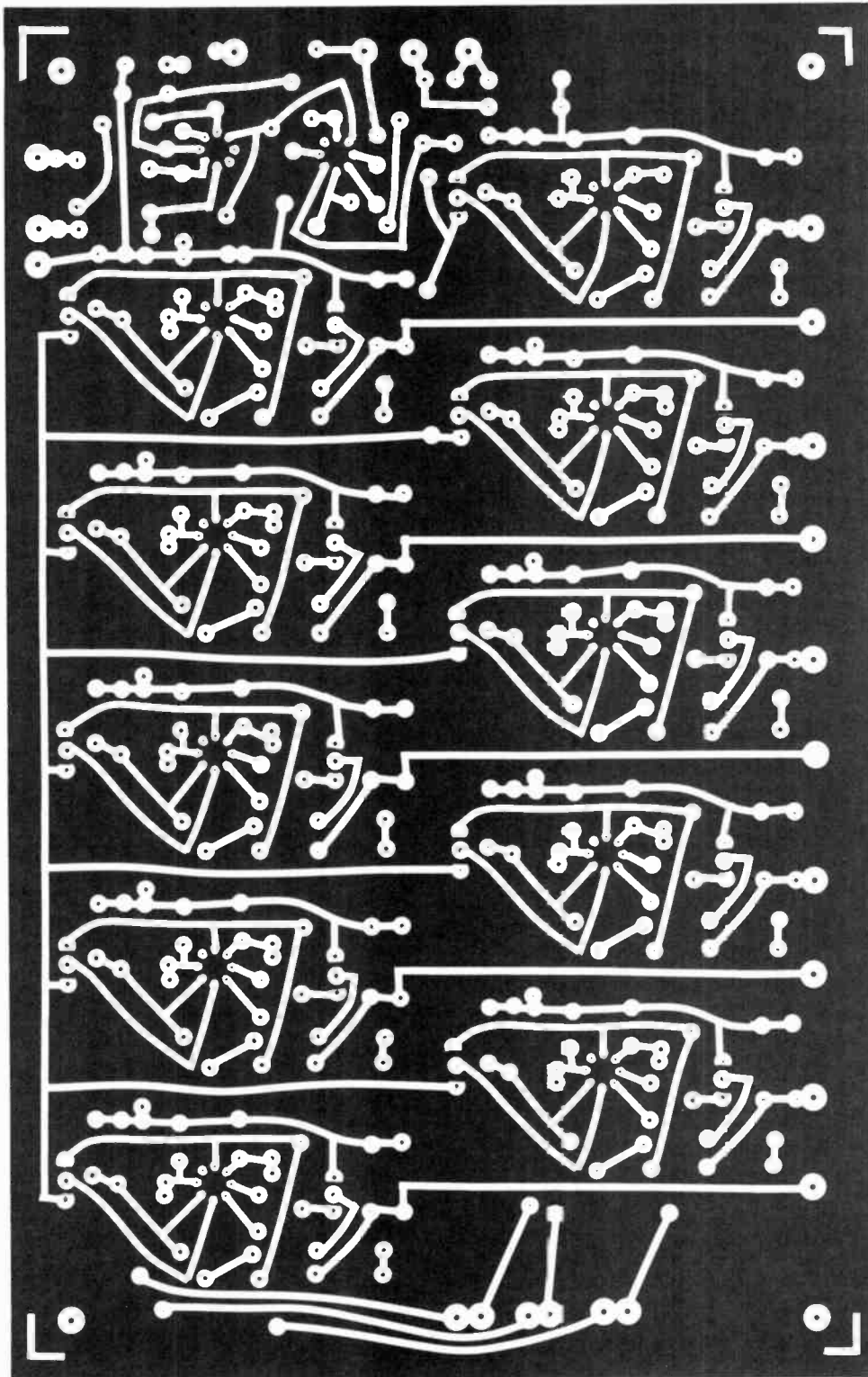

Fig. 9A. Use this pc board for Figs. 9B and 10 on next page.

leads and cover the ends with heat-shrink tubing. Also, be sure to use heat sinks on the voltage-regulator IC's.

In the authors' prototype, the pc boards (except the log converter) were stacked to conserve space. If you want to stack the boards, be sure to leave sufficient clearance for easy access to the LEVEL ADJUST and Q ADJUST potentiom-

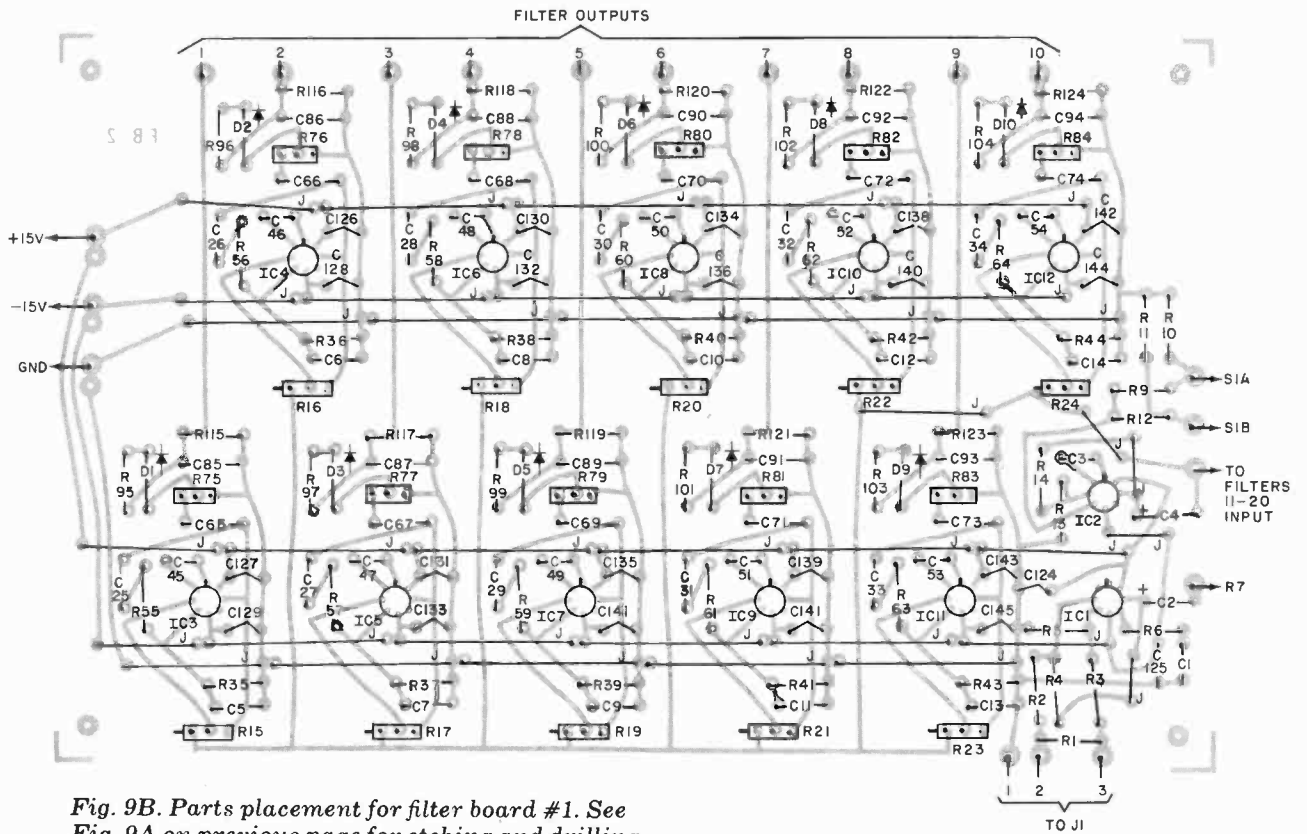

Fig. 9B. Parts placement for filter board #1. See Fig. 9A on previous page for etching and drilling.

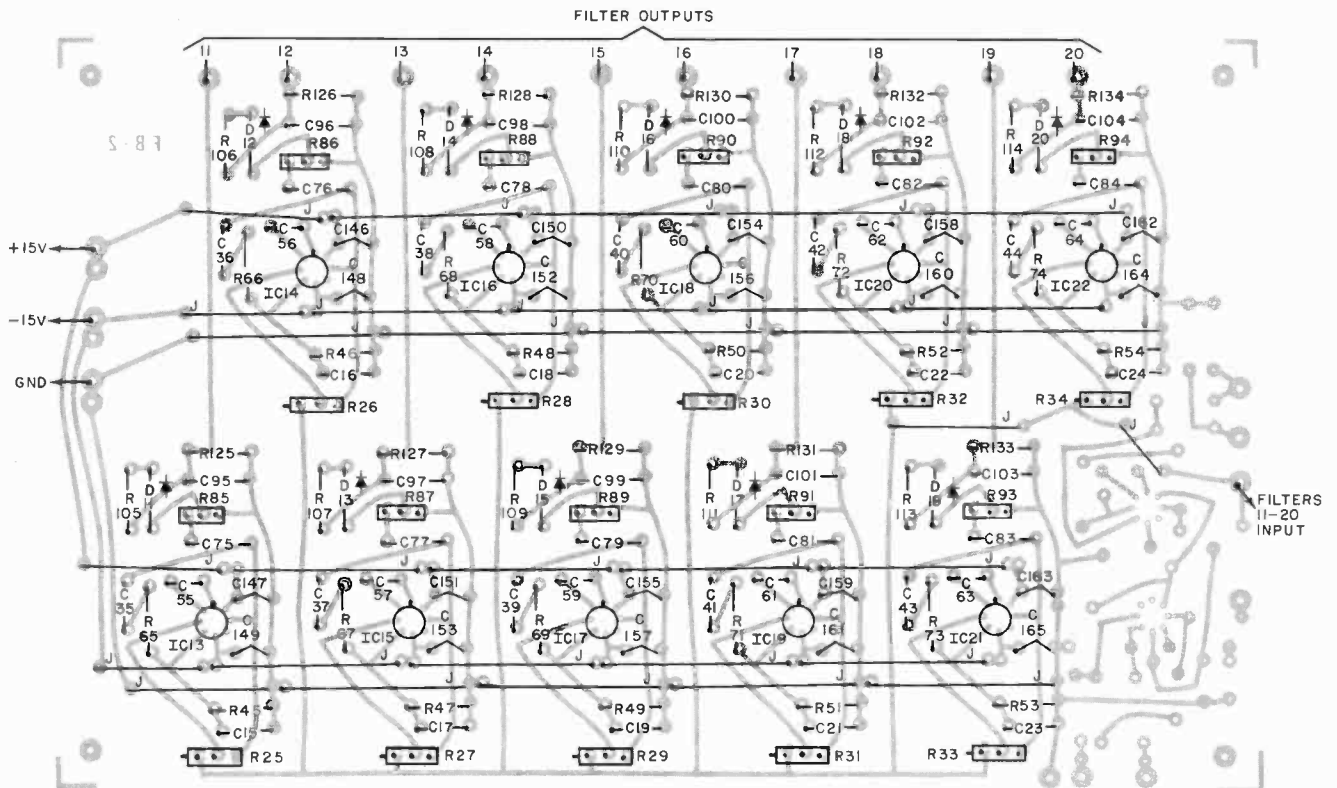

Fig. 10. Parts placement for filter board #2. See Fig. 9A for etching and drilling.

eters. These controls should be mounted on the filter boards so that all adjustment screws point toward power supply pads and away from input pads.

The prototype was enclosed in a 15" x

10" x 5" (38.1 x 25.4 x 12.7 cm) metal cabinet. Switches *S1* and *S2*, LEVEL controls *R7* and *R8*, jacks *J1* through *J5*, and *LED1* were mounted on the front panel. The fuseholder and line cord

strain relief were mounted on the rear.

Part II of this article will describe an optional log converter for direct readout of the scope trace in dB. Calibration and RTA use will also be covered. ◇

BUILD A TRANSFORMERLESS DC-TO-DC VOLTAGE DOUBLER

High-efficiency, high-current solid-state circuit doubles the input dc level.

BY MARLOWE J. BUCHANAN

FOR MANY years, the only reasonable nonmechanical means of generating high dc potentials from low voltages in the medium-to-high-power range has been the oscillator-driven transformer. This type of converter has two major drawbacks—the average experimenter may not have the knowledge or the materials to design and build his own transformer/converters, and the power consumption is relatively high, making the converters inefficient at currents much below their ratings.

The capacitive voltage doubler described here is superior to normal converters in many applications. For example, it can be used to extend the range of a low-voltage power supply or to run a

medium-power audio system in a vehicle. Capable of very high efficiencies, the converter can easily be adapted to the voltage and power needed.

Circuit Operation. Basically, the circuit shown in Fig. 1 acts as a set of high-speed electronic switches that alternately charge C3 and C4 to the supply voltage and then connect the capacitors in series with the supply and load. The output load in effect "sees" the sum of the voltages across C3 and C4 and the supply voltage. Since C3 and C4 are driven 180° out-of-phase, this is a true full-wave voltage doubler.

Transistors Q7 and Q8 and their associated components form a multivibra-

tor that has an operating frequency of roughly 6000 Hz with a 12-volt dc input supply. This oscillator produces two square waves that are 180° out-of-phase with each other and are used to drive Q5, Q6, Q9, and Q10. Resistors R1 through R4 are selected to limit base current to 3 mA. Drive transistor pairs Q5/Q9 and Q6/Q10 produce equal and opposite square waves that have extremely fast rise and fall times and are capable of sinking or sourcing a minimum of 100 mA to the output transistor pairs (Q1/Q2 and Q3/Q4).

When Q7 conducts, Q2, Q3, Q5, and Q10 are driven into saturation. Capacitor C3 charges through Q2 and D3, while C4 discharges through Q3, D2 and

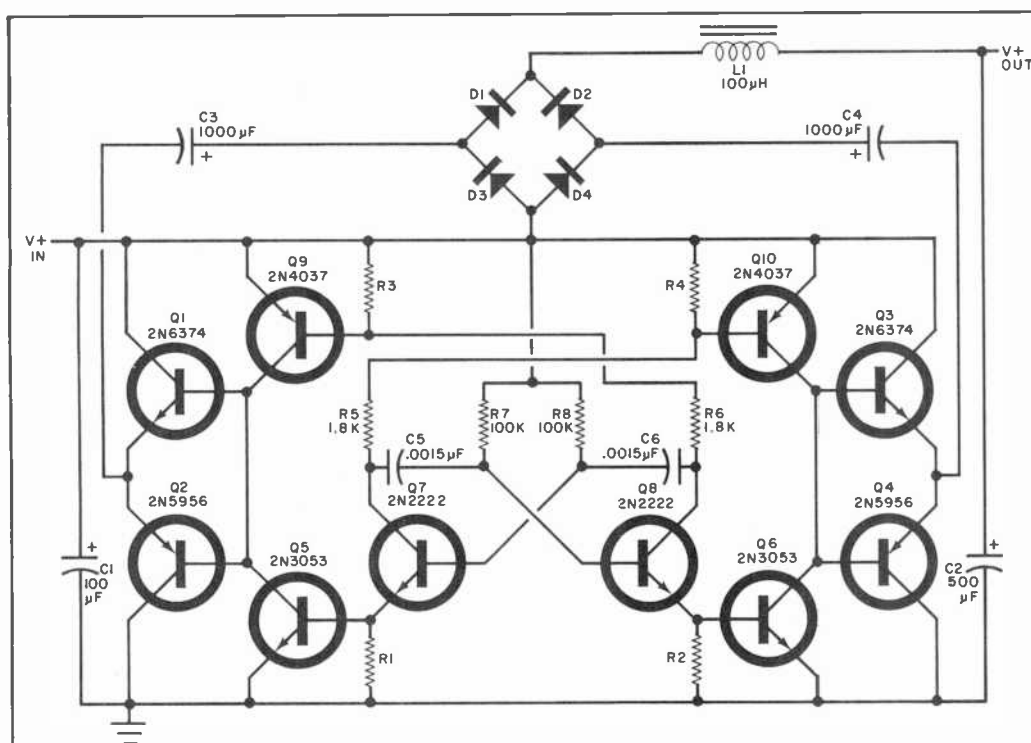

Fig. 1. The boosted dc output voltage is the sum of input dc plus charge on C3 and C4. The two capacitors are oppositely charged by multivibrator.

PARTS LIST

C1—100- μ F, 25-V electrolytic capacitor
 C2—500- μ F, 50-V electrolytic capacitor
 C3, C4—1000- μ F, 50-V electrolytic capacitor
 C5, C6—0.0015- μ F, 50-V capacitor
 D1 through D4—50-V, 6-A rectifier diode (or bridge)
 L1—100- μ H, 4-A, 0.1-ohm dc resistance (or less) choke

Q1, Q3—2N6374 or similar transistor
 Q2, Q4—2N5956 or similar transistor
 Q5, Q6—2N3053 or similar transistor
 Q7, Q8—2N2222 or similar transistor
 Q9, Q10—2N4037 or similar transistor
 Following resistors are 1/4 or 1/2 watt, 10%:
 R1 through R4—For input of 6 volts, omit; for

9 V, use 1000 ohms; for 12 V, use 330 ohms; for 15 V, use 180 ohms; for 18 V, use 120 ohms; for 21 V, use 100 ohms; for 24 V, use 82 ohms.
 R5, R6—1800 ohms
 R7, R8—100,000 ohms
 Misc.—10-watt heat sink, suitable enclosure, heavy-gauge wire, mounting hardware, etc.

Empire's Blueprint For Better Listening

No matter what system you own, a new Empire phono cartridge is certain to improve its performance.

The advantages of Empire are threefold.

One, your records will last longer. Unlike other magnetic cartridges, Empire's moving iron design allows our diamond stylus to float free of its magnets and coils. This imposes much less weight on the record surface and insures longer record life.

Two, you get better separation. The small, hollow iron armature we use allows for a tighter fit in its positioning among the poles. So, even the most minute movement is accurately reproduced to give you the space and depth of the original recording.

Three, Empire uses 4 poles, 4 coils, and 3 magnets (more than any other cartridge) for better balance and hum rejection.

The end result is great listening. Audition one for yourself or write for our free brochure, "How To Get The Most Out Of Your Records." After you compare our performance specifications we think you'll agree that, for the money, you can't do better than Empire.



EMPIRE

Already your system sounds better.

Empire Scientific Corp.
Garden City, New York 11530

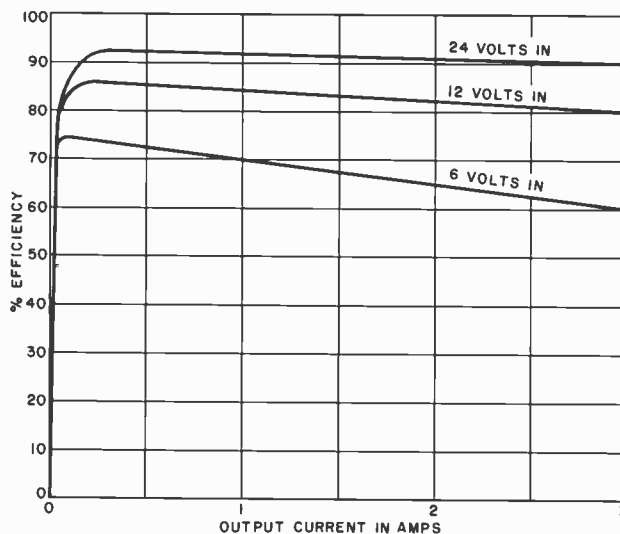

Fig. 2. With 12-volt power source, the efficiency remains above 80% even with full load. The higher the input voltage, the higher the efficiency.

the output load. When $Q8$ conducts, the process reverses itself, with $C3$ discharging through the output load, $Q1$, and $D1$, while $C4$ charges through $Q4$ and $D4$. Capacitor $C1$ helps prevent high-frequency pulses from entering the supply, while $L1$ and $C2$ filter the output.

Construction. Since circuit operation is not critical, any convenient means of construction can be used to build the converter. However, for maximum efficiency and minimum ripple, the following should be observed:

Keep all leads, especially those to the output devices, as short as possible. Even the minor inductance of long wires can cause ripple in the output at the high switching frequency used in this voltage converter.

Use 12- or 14-gauge wire for power lines and making connections to output transistors $Q1/Q2$ and $Q3/Q4$. If you elect to assemble the circuit on a printed circuit board, use at least $\frac{1}{4}$ " (6.4-mm) wide copper traces to interconnect the output devices. These measures will eliminate resistive voltage losses.

Connect $C1$ as close as possible to the emitter leads of $Q5/Q6$ and $Q9/Q10$ to minimize ripple feedback into the voltage source.

No heat sinking is required for outputs up to 1 ampere. At higher currents, $Q1$ to $Q4$ must be on a heat sink that has a thermal resistance of $5^\circ\text{C}/\text{watt}$.

Use. The major loss of efficiency in a capacitive voltage doubler is the inherent voltage drop across the diodes and output transistors. Hence, it is not possible to exactly double the supply voltage, the difference being 1.4 volts with no load to 4.8 volts with a 3-ampere load. Since these losses are a fixed function of the output current, overall efficiency

will increase dramatically with higher operating potentials, as shown in Fig. 2. Efficiencies in excess of 98% at several hundred watts can be achieved by a capacitive voltage doubler adapted for 100 volts input. These doublers also have very low ripple, typically less than 200 mV at a 3-ampere output.

The other loss of efficiency is the power consumed by the multivibrator and drive transistors. This is generally less than 150 mW at a 12-volt dc input, which accounts for the circuit's ability to achieve high efficiencies over 98% of its operating range. This sharply contrasts with the much lower efficiencies obtainable with transformer-based converters.

If the circuit shown in Fig. 1 does not satisfy your needs, there are a number of adaptations you may wish to try. For example, higher currents or potentials can be handled by substituting appropriately rated devices and slightly altering the multivibrator. Higher efficiencies can be obtained by substituting germanium power transistors for $Q1$ through $Q4$ and replacing the rectifiers with four suitable germanium power rectifiers (transistors with the base tied to the collector or emitter). For currents less than 100 mA, $Q1$ through $Q4$ can be omitted; $C2$, $C3$, $C4$ need be rated at only $50\ \mu\text{F}$; and the rectifier diodes ($D1$ through $D4$) can be rated at 1 ampere each.

A voltage tripler can be made by adding two $1000\text{-}\mu\text{F}$ capacitors and another bridge rectifier between ground and the common emitters of the output transistors. However, triplers work at lower efficiencies and with considerably reduced output current capability.

It is possible to use the output of one doubler as the input voltage source for another doubler. Two doublers connected in this manner provide about 36 volts output from a 12-volt battery. \diamond

Special Focus on AUDIO

- THE BASICS OF BUYING HI-FI COMPONENTS
- DYNAMIC NOISE REDUCTION SYSTEMS AND EXPANDERS
- MATCHING TAPES TO RECORDERS
- IC MULTIPLEX DECODER IMPROVES STEREO FM PERFORMANCE
- QUIZ OF AUDIO BASICS

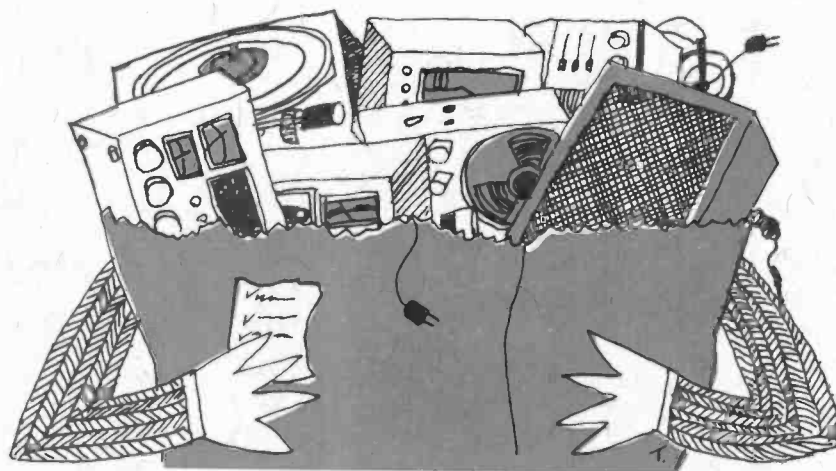

The Basics of Buying HI-FI COMPONENTS

YOU can run down to your neighborhood appliance store, hand the clerk around \$99.95, and come away with a "home music system" that will deliver music received via AM or FM broadcasting and probably play records as well. Or, you can go to your favorite furniture shop and spend a few hundred dollars or more for a console cabinet containing unspecified electronic elements that will do the same thing. Finally, you can shop for individual audio components, spending anywhere from a few hundred dollars to many thousands of dollars and, again, end up with a home music system that reproduces radio broadcasts, records, and even tape recordings. These three divergent approaches to home music reproduction

have some things in common—but they are also poles apart in terms of the kind of sound you will hear.

Crammed inside the \$99.95 compact system and the one-piece console are circuits which pick up radio signals and translate them back to audio signals, circuits which amplify the minute signals picked up by a self-contained record player with its tonearm and cartridge, and even a pair of loudspeakers which translate all these signals back to audible sound. Audio electronics can be further broken down into the "tuner" or radio section, the "preamplifier" or control section, and the "power-amplifier" section which activates the loudspeakers. Even a tiny portable transistorized radio contains all these elements, but you

would hardly classify the sound you hear from such a portable as "high fidelity."

In order for a loudspeaker (or, a pair of loudspeakers in the case of stereo or four loudspeakers for quadrasonic sound) to reproduce music, its cone or diaphragm must vibrate, for sound is nothing more than rapid compressions or expansions of the air around us. When the air vibrates rapidly, we hear a high-pitched tone. Slower vibrations of air impinge upon our hearing mechanism to create the hearing sensation of a low-pitched note—or one of low frequency. But, whenever a pair of loudspeakers is mounted in the same cabinet as the delicate record-playing tonearm and pickup, the fairly violent vibrations of that speaker (needed to re-

produce sound) are also transmitted via the cabinet structure to the tone-arm and pickup, the fairly violent vibrations of that speaker (needed to reproduce sound) are also transmitted via the cabinet structure to the tone arm and its phono pickup stylus. If you try to turn up the volume to life-like levels, the vibrations generated by the speaker system can initiate a "vicious circle." They are re-amplified by the record player, reproduced as greater and greater vibrations from the speakers and so on, until the entire system takes off in an annoying "howl" which is called, "acoustic feedback."

Interestingly, most all-in-one systems do not exhibit this phenomenon. The reason they don't is because the electronics built into such systems is generally restricted in its ability to reproduce all musical tones in their proper relative intensity. Since low-frequency tones (bass) involve more intense vibrations, the ability of the electronics of such systems to reproduce those tones is often severely restricted. In other words, you don't hear all the music contained in the actual record!

The first requisite of a true high-fidelity system is that it reproduce all musical tones faithfully. So it's imperative that loudspeakers are separated from the rest of the system—a condition easily achieved with separate components. Faithfulness of musical reproduction also means that sounds must not contain more tones than were present in the original program. In high-fidelity terms, that means low or negligible distortion. Distortion, broadly defined, includes any extraneous sounds such as harmonically related tones, electrically generated hum, or random noise or hiss. In short, the reproduced music should be an exact replica of the original performance as contained in the record or other program source. The minimal electronics, poor-quality record players, and under-sized, un baffled loudspeakers contained in most all-in-one radio-phonographs and "compacts" are simply incapable of this kind of reproduction.

Building-block Flexibility. There are other distinct advantages in the component approach to high-fidelity sound. Over the brief history of high fidelity we have witnessed a progression from monophonic sound (in which all music is reproduced in one-dimensional form from a single loudspeaker), to two-dimensional stereophonic sound (in which two speakers are used to give the listener an added sense of spatial real-

ism), to 4-channel or quadraphonic sound (in which the listener gains true concert-hall ambience reproduced from four properly positioned loudspeakers). Owners of "compacts" or consoles found their equipment hopelessly obsoleted as each of these advances gained acceptance. Owners of quality component systems, on the other hand, were able to update and add to their basic systems without any loss of their original investment.

Clearly, this building-block approach to good sound makes sense economically. As a further example, suppose that your primary interest is in a good record-playing system. You might elect to purchase a system consisting of a good amplifier, a pair of speakers, and a separate turntable or record-playing system at the outset. Then, if taste and budget dictate, you can add a stereo FM/AM tuner at a later date, connecting it in seconds to the system you already enjoy. You might also wish to upgrade one component in a system while retaining the others, which is easily achievable with an audio component system. Finally, you might even want to add tape recording and playback facilities to your expanding system by purchasing a tape deck of the open-reel, cassette, or cartridge variety. All of these added program sources will utilize the basic amplifier electronics and speaker systems purchased initially. You may even want sound in other listening rooms (a bedroom, or a den). This can be provided by the addition of another pair of speakers which can be connected to most high-fidelity component amplifiers or receivers and switched in by means of suitable front-panel controls. Moreover, one can add an equalizer, noise-reduction system, or other accessory component to an audio component system in order to obtain more realistic sound.

Electronic Options. There are three

basic approaches to assembling the electronics of a hi-fi system. The most popular of these involves the purchase of a component called a receiver. This single unit will contain all the circuitry needed to pick up AM, FM, and stereo-FM radio signals, the necessary preamplifier and control circuits whereby program sources are selected and adjusted for proper listening, and the power amplifier section needed to drive the loudspeaker systems.

In the early days of hi-fi, all-in-one receivers were rather limited in their ability to deliver sufficient power to the loudspeakers. Today, you will find all-in-one receivers which boast power-output ratings higher than 100 watts per channel. Because all of the electronics is combined on a single chassis, the receiver represents the most economical approach to a hi-fi component system. A common power supply, a single front panel, a single cabinet enclosure and other parts-in-common result in savings that cannot be obtained from wholly separate components.

Nevertheless, a visit to your hi-fi dealer will reveal an array of separate amplifiers as well. So-called integrated amplifiers combine two of the three previously referred to electronic sections—the preamplifier-control portion and the power-amplifier section. We already mentioned a possible reason for choosing this option. You may want to forego FM and AM radio at the outset and concentrate on good record reproduction (or possibly tape). A tuner can always be purchased later and will interconnect easily with any integrated amplifier, even if your purchase is made many years from now. Furthermore, you will often find that an integrated amplifier has additional control refinements and perhaps more signal input facilities than an all-in-one receiver—another possible reason for its selection as the basic component of a system. You may also

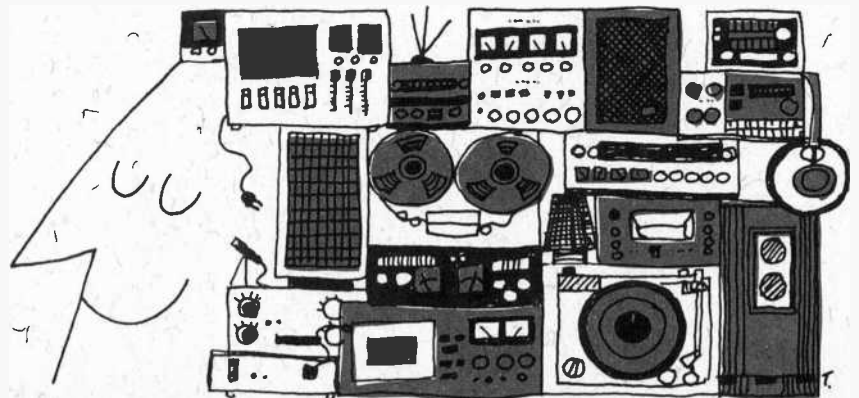

be able to purchase a more powerful integrated amplifier for the same amount of money that would be required for a more moderately powered complete receiver unit.

A third option, offering perhaps the greatest flexibility of all (and generally the most costly), is to purchase a separate tuner, a separate preamplifier-control unit, and a separate *basic power amplifier*. This arrangement is not nearly as popular as the other two, and usually represents the choice of those audio enthusiasts who demand the ultimate in flexibility, superior performance specifications (lowest distortion and very-high-power-output capability), and other operating features not found either in complete receivers or integrated amplifiers.

Irrespective of which of these three types of component systems you choose to assemble, you'll want to familiarize yourself with the more important technical performance specifications listed in manufacturers' advertising brochures. Tuner, preamplifier, and amplifier specifications mean the same thing whether they are used to describe those individual sections in a complete receiver, an integrated amplifier, a separate tuner, a separate preamplifier-control unit, or a basic power amplifier.

What about 4-channel sound? Multiple-channel sound is certainly not new. As early as the 1930's, moviegoers thrilled to the multi-channel Walt Disney production of "Fantasia," in which listeners were surrounded by music reproduced over as many as six separate speaker systems. For many years, recording studios have used multiple tape tracks to record individual instrumentalists and vocalists under optimum studio conditions. These tape "tracks" were then "mixed down" to two-channel "stereophonic" final products in the form of stereo records. Only in 1970 did 4-channel sound reach the home music listener—first as 4-channel tapes and later in a variety of disc formats.

Musically, there are two distinct approaches to 4-channel sound. The "classical" approach involves the reproduction of the ambience of the concert hall itself. Any concert goer will readily admit that much of the sound he or she hears at a live concert is reflected from the walls and ceiling of the hall itself, rather than from the performers on stage. It is this ambient quality which distinguishes the live performance from its recorded and reproduced equivalent in a home listening room of restricted dimensions. By recording two additional channels, using microphones at the rear

of the concert hall and reproducing these channels over similarly positioned speakers behind the listener, it is possible to create a sense of vast space in the home listening environment which is not achievable with conventional two-channel reproduction systems.

Given the extra pair of channels, it is also possible to assign different instruments or soloists to specific channels so that the listener finds himself in the center of the "performance" when playing back recordings. This alternate recording approach to quadraphonic sound is particularly effective when applied to modern pop and rock music, affording the listener a sense of involvement not otherwise attainable.

Recording four channels on tape is relatively simple. Both 8-track cartridges and open-reel tapes have multitrack capability. Cassettes do not.

In the case of phonograph records, there are two basic systems. One called "matrixing," is a process of combining or encoding the four original program channels into two complex audio programs. These two "encoded" channels can then be applied to the record groove much like a stereo program. Suitable decoder circuits, often built into a four-channel amplifier or receiver, "decode" the two channels into four separate signals approximating those which were recorded at the beginning of the process.

The two most popular matrix techniques currently in use in the United States are the SQ system, developed by CBS and the QS system developed by Sansui. Both are capable of excellent 4-channel reproduction and each can be further enhanced by the addition of circuits called "4-channel logic" which increase apparent separation between channels. In addition to matrix records, there are also so-called discrete or CD-4 records which actually contain four separate programs in the single record groove. Because of the very high frequencies contained in these CD-4 discs (developed jointly by RCA and the Japan Victor Company of Japan), a new cartridge or phono pickup is required. Moreover, a turntable used for playing CD-4 records should have low-capacitance phono cables for best results.

A 4-channel home music system is necessarily more costly than a stereo system of equal power and performance capabilities. Any 4-channel system requires four separate loudspeakers as well as four amplifiers (the latter often combined in one unit).

Before deciding whether to buy 2- or 4-channel equipment, listen to each type

of system in a properly equipped demonstration room at your audio dealer. Bear in mind that, whether you elect to buy 4-channel or stereo, the important criteria of low distortion, good frequency response, and adequate power output apply to each type of system. If your budget is limited, you might be better off starting with a good stereo component system rather than settling for an inferior quadraphonic system. Separately available decoders, demodulators, and extra amplifiers and speakers can be added to any existing stereo sound system at any time in the future.

Hi-Fi Shopping Tips. Shopping for a hi-fi component system can be fun—or it can be a frustrating experience. There are four general sources of supply. (1) You can visit an audio specialist dealer who sells nothing but high-fidelity component equipment. (2) You can shop in a branch of one of the many electronic-supply stores that sell other specialized electronic equipment in addition to hi-fi, but generally have listening rooms set aside for hi-fi component selection. (3) You can order components from a variety of mail-order or catalogue houses (some of whom also have retail stores in many cities), or (4) you can visit a "discount" establishment which has a variety of merchandise available in sealed factory cartons but provides no facilities for equipment auditioning. Your choice of supplier will generally depend upon how much (or how little) personalized service you require.

The first two categories of retail establishments generally offer the most service. If you are starting from "scratch," it is essential that you be able to listen to the components you plan to buy. As a matter of fact, the first components you should select are your loudspeakers, since there is the greatest variation in sound amongst the hundreds of speaker models currently available. Zeroing in on the loudspeakers that sound best to you also puts you in a better position to decide on how powerful an amplifier or receiver you will need, since some speakers require far more power than others to deliver a given loudness level.

Generally, the well-equipped audio dealer who offers auditioning facilities and technically trained sales personnel will offer less of a discount than the "mail order" or "warehouse" type of retailer, since his overhead costs are higher. In return for the somewhat higher price you pay, you will obtain the aforementioned advantages that may or may not be important to you. ◇

Dynamic Noise Reduction Systems and Expanders

BY WILLIAM S. GORDON

THE QUEST for noise reduction in high-fidelity equipment has challenged audio engineers for decades. As far back as 1947, H. H. Scott introduced a "Dynaural Noise Suppressor," to deal with the noise problem; and the Dolby noise-reduction system (professional version) was demonstrated in the mid-sixties. The age of noise suppression was really ushered in for serious audiophiles, however, when the Dolby NR system was incorporated into cassette decks in the late sixties.

Since then, a great deal has been done to make noise reduction a realistically inexpensive and practical means of obtaining the maximum enjoyment out of hi-fi equipment. In this article, we will examine a host of noise-reducing systems that have come onto the consumer market and describe how the different schemes work.

Two Categories. Noise-reduction systems can be grouped into two categories: Those that rely on preprocessed (encoded) signals and those that operate on "raw" (unprocessed) signals. Examples of the first category are the Dolby A and B systems, JVC's Automatic Noise Reduction System (ANRS), and the dbx system. In the latter category are Phase Linear's "Autocorrelator," Philips' Dynamic Noise Limiter (DNL), and Burwen's noise-reduction system.

The devices that encode the signal before recording or transmission first pass the signal through an encoder and then through a decoder. In essence, these "two-pass" systems are noise-preventive devices because they do nothing to remove noise already in the program but attempt to prevent it from creeping in between the encoder and decoder. The unencoded "single-pass" systems attempt to remove noise already in the program.

Two-pass processors generally employ complementary signal compressors and expanders, called companders. During processing, the dynamic range of the signal is compressed so that a two-fold increase in the input signal causes

less than a two-fold increase in the output. The actual input/output characteristic depends on the compression ratio used. For example, a 3:2 ratio causes a 2-dB output increase for every 3-dB increase in the level of the input signal. This means that a 60-dB dynamic range can be compressed into an output signal with only a 40-dB range.

Compression is important because the dynamic range of many program sources exceeds the range of modern state-of-the-art hi-fi equipment, especially tape recorders and FM tuners. A symphony orchestra can have an 80-dB dynamic range, but a recorder might have a range of only 55 or 60 dB. By using a 2:1 compression ratio, the entire 80-dB orchestra range can be compressed down to 40 dB, which is well within the average recorder's capabilities to handle.

The signal-to-noise ratio (S/N) can give you an idea of the capabilities of a piece of equipment. The maximum level a device can handle is determined by the point at which distortion reaches an unacceptable level (generally 3% THD in consumer equipment and 1% in pro-

fessional equipment). The minimum level that can be handled is determined by the "noise floor." Signals that are lower in level than the residual noise of the equipment are lost in the hiss and hash at the noise floor.

With sufficient compression, a wide dynamic range program can be squeezed into the limited range available in a tape recorder. This assures that the program peaks will not be too high to handle, while keeping the minimal signals above the noise floor.

A compressed signal must be expanded to restore its original dynamic range. An expander is the mirror image of a compressor. In it, a two-fold increase in program level at the input results in a greater than two-fold increase in the expander's output signal. To restore the original dynamics of the signal in the above example, a 2:3 expansion ratio would be used. Hence, the 40-dB compressed signal would be expanded back up to its original 60-dB dynamic range. This opens up the top of the range and simultaneously pushes down the noise floor. The net effect appears as a reduction in the residual noise, so

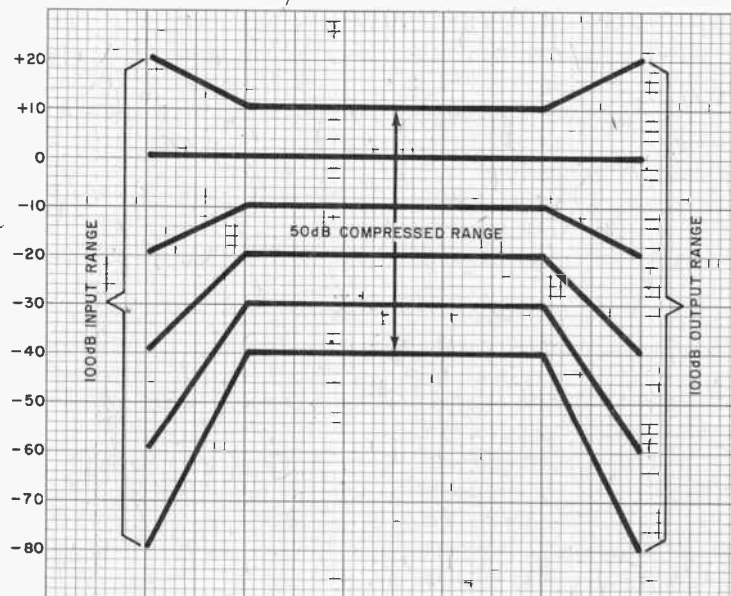

The 2:1 linear compander characteristic of the dbx system illustrates how dynamic range is compressed and then restored.

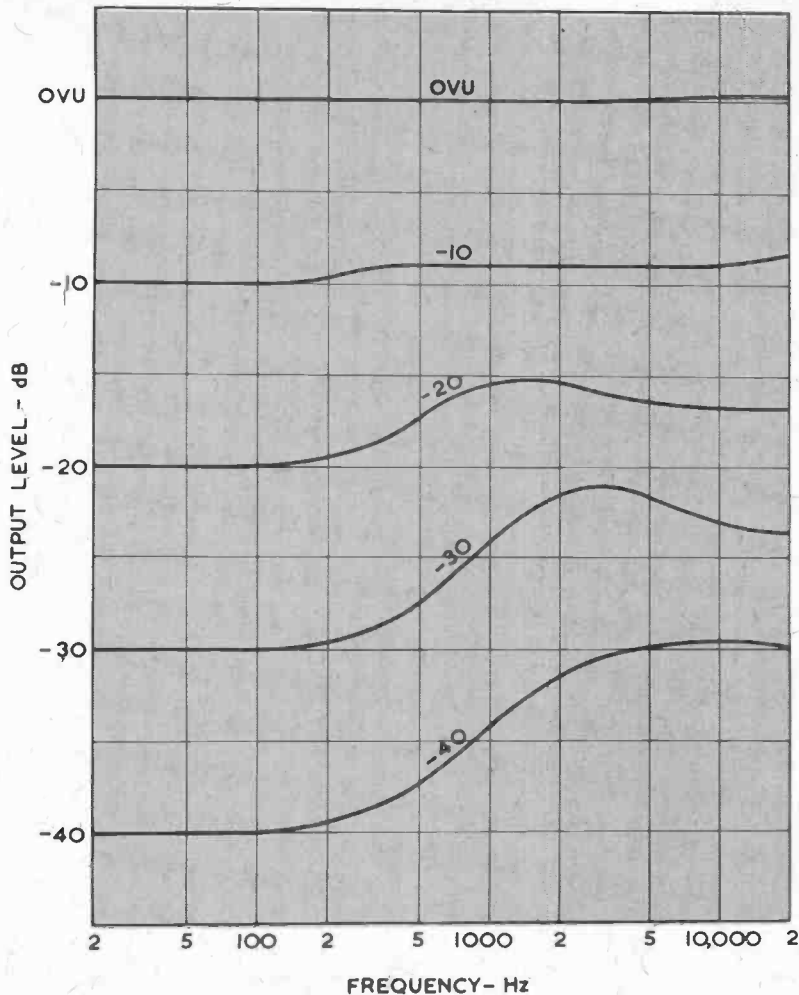

Dolby encoding characteristics show output level changes in decibels versus frequency over entire 20-to-20,000-Hz range.

the system qualifies as a "noise-reduction" system.

How Companders Work. Compressors and expanders are basically amplifiers whose gain is varied by a voltage. (Such a device is known as a voltage-controlled amplifier, or vca.) They also include detectors that measure the signal level and produce the voltage that controls the gain of the amplifiers.

The time constants of the detector circuits must be chosen very carefully. If they are too short, the detector responds very rapidly and follows the low-frequency signals. The vca's gain "chases" the low-frequency signals, increasing distortion and modulating the rest of the signal with a low-frequency tone. A very long time constant causes the detector to respond very slowly to the average signal level. Sudden transients get through before the gain of the vca can be reduced. The transient will not be compressed and will cause the system to overload. Since the transient is detected, the signal for the vca to reduce its gain will be delayed. Then, an audibly discrete inter-

val later, the vca's gain reduces where no reduction is required and a "dropout" will be heard in the program.

Another audible flaw in wideband, widerange companders is "breathing." When the input signal disappears or is greatly reduced in level, the gain of the compressor increases and boosts the level of any noise present in the signal. When the music level increases, the level of the noise decreases, and when the music level decreases, the noise floor comes up. As the system operates under these conditions, it sounds like it is "breathing." Note that this is not noise introduced by the recorder between the compressor and expander (which is reduced by compander action) but noise in the signal prior to compression.

Enter the Dolby System. The Dolby noise-reduction system was originally designed to combat the problems inherent in companders. The professional Dolby A system divides the frequency spectrum into four bands, each of which is processed separately. This was done so that an increase in midband energy

would not reduce the level of the lows and highs. Where there might be a lot of midband energy but little high-frequency content, the processor reduces the midband level to avoid overloading the recorder. At the same time, it keeps the gain at the high end up so that the highs are not pushed down near the noise floor. This is important because psychoacoustic tests reveal that low-frequency signals do not mask high-frequency noise, nor do high-frequency signals mask low-frequency noise. (Masking psychoacoustically makes one less aware of noise when a strong signal is present than when it is absent. Masking of noise is effective only in the frequency range of the signal; hence, Dolby's use of the four-band approach to the problem.)

The Dolby system employs the processor only on low-level signals, which are boosted above the noise floor, while high-level signals emerge unchanged. The lower the level of the signal, the greater the boost. Hence, the processor is used only when signal levels approach the noise floor. The action of the system is less noticeable to the listener and overcomes the objections of previous full-range companders.

The final improvement in the Dolby system is that the attack time of the compressor is variable. If the signal level increases dramatically, the attack time is very fast to minimize the time the system is overloaded. For less severe increases in level, the attack automatically slows down to minimize low-frequency distortion and modulation of the music by low-frequency tones.

Having become the standard of the professional recording industry, the Dolby A system was later simplified and became the Dolby B system familiar to consumer products. The B system reduces cost by processing signals in only the band where high-frequency hiss resides. To make it more effective, the processor's upper frequency cutoff is made to automatically vary with signal level. As the level drops, the system processes a larger bite of the upper-frequency band. Since hiss is the major source of audible noise in hi-fi tape recording, the system is quite effective.

Since only low-level signals are processed by the Dolby A and B system and in the consumer B version only a portion of the audible band is processed, there is a limit to how much noise reduction can be achieved. In the case of the B system, this is approximately 10 dB. And since the processor does not operate over the entire dynamic range of the

signal, the signal must be standardized and matched for the decoder to properly track the encoder. Hence, the reference level, the so-called "Dolby Level," must be maintained to calibrate the chain.

It is the signal itself that "tells" the decoder where and how much expansion to use. If the level into the decoder is too low, the expansion will begin at too high a level. This will upset the original balance of the program. Similarly, if the input to the decoder is too high, expansion will not occur soon enough.

JVC followed Dolby's lead with its ANRS device, which functions in a manner quite similar to the operation of the Dolby B system. In fact, Dolby B tapes can be decoded by the ANRS circuit with quite good results.

The dbx System. The foremost competitor of the Dolby system is the noise reduction system developed by dbx Inc. This is a "classical" compander in that it operates over the entire dynamic range of the music. However, it has improvements over previous companders that make its action virtually inaudible.

The dbx system is a linear 2:1 compander that compresses the 80-dB dynamic range of the symphony orchestra down to a mere 40 dB. On the decoding end, the 40-dB range is expanded back up to 80 dB, pushing down the noise that was introduced by the tape-recording process to an inaudible level.

Since the dbx system operates linearly over the full dynamic range, matching of signal levels is not particularly important. Any 1-dB rise in input results in a 2-dB rise at the output of the expander. There is no "threshold" below which the system operates as there is in the Dolby B system. (Note, however, that any irregularities in recorder frequency response or any amplitude perturbations, such as dropouts, that are introduced will be magnified by a ratio of 2:1.)

One way dbx avoids the problems of classical companders is that it employs an rms detector to drive the vca, rather than the usual peak or average detector used by previous companders. The rms detector measures the power of the signal and is unaffected by the phase distortion introduced in the taping process. Peak or averaging detectors, on the other hand, are affected by phase shifts.

Another solution is the use of variable attack times that quickly respond to large changes in level and slowly respond to small changes. Both attack and release times vary with the signal level and are optimized to simulate the time response of the human ear.

The final solution is the use of high-frequency preemphasis before compression with complementary de-emphasis after expansion. This helps to reduce the effect of breathing by a factor of 12 dB.

The S/N improvement of the dbx system is in the range of 40 dB, which contrasts sharply with the 10-dB improvement provided by the Dolby B system. Although the Dolby system has a huge head start in the recording industry, there may soon come a time when the system developed by dbx will replace it as the standard one in use.

Single-Pass Systems. So far, our commentary has focused on two-pass systems designed to reduce noise only during the recording (or transmitting) process. Such systems do not reduce the noise already in the program. A great deal of work has been done to remove the noise already in the program, and the result is the single-pass system.

Two of these new systems are the Philips DNL and Burwen DNF that are both dynamic low-pass filters. The Philips system was developed specifically to reduce noise in unencoded cassette recordings. (It is not widely available in the U.S.) The Burwen system is more flexible and can be used for tapes and discs. Both systems consist of low-pass filters whose cutoff frequencies are automatically controlled by the program level. When there is a lot of high-frequency program energy, the filter "opens up" to let it through. Then when the high-frequency program energy is small, the cutoff frequency of the filter shifts downward to cut out the highs and the hiss. In essence, if there is enough high-frequency program energy to mask the hiss, the bandwidth of the DNF opens up to 30,000 Hz. But if the highs are missing and, hence, are unavailable to mask the hiss, the bandwidth narrows. In the absence of any signal, the Burwen DNF system starts to roll off above 500 hertz.

The constants of the detector circuit that senses the program level are critical. The filter must open up rapidly to let a transient through and should close down rapidly to prevent a burst of noise from following a brief transient or record tick. However, too fast a response tends to be audible. Consequently, the attack and release times are made variable according to the magnitude of the signal change. Depending on the program material and the control settings, the newest Burwen system provides from 5 to 14 dB of noise reduction. Since it is a

single-pass system, it operates on any program source.

The Phase Linear "Autocorrelator" is more complex than the dynamic noise filters. It actually attempts to distinguish between music and noise by electronic means. Noise is typically random in nature and contains many frequency components that are not related to each other, which makes it incoherent or uncorrelated. Music, on the other hand, contains mathematically related tones and is coherent, with a high correlation factor. The Autocorrelator consists of band-pass filters and a circuit that analyzes the signal for its degree of correlation. If it determines that the signal is music, it passes it through and those filters that correspond to the harmonics of the signal are activated to pass the overtone structure. If the signal is determined to be noise, the filters close down. It is obvious that this is a more sophisticated approach to noise elimination than the dynamic noise filter.

Another sophisticated type of noise-reducing device is SAE's Model 5000 pop and click filter. The premise used here is that clicks and pops are characterized by a rapid rise and decay, while music should exhibit a more gradual decay. Once a click or pop has been detected, that section of the program is gated out and the previous program section is recalled and inserted in its place. Since the click or pop is very short in duration (on the order of 1 ms), this substitution goes undetected by the ear.

Most of the time, the Model 5000 remains completely passive. A threshold control establishes the sensitivity of the detection circuit. This is necessary because different records may exhibit slightly different characteristics.

Conclusion. So far, noise-reduction systems have provided some impressive results. The effort to develop better systems is still going strong, but what the future has in store is difficult to predict. As things now stand, the most dramatic steps have been taken to reduce noise. Most of what is left is the refinement of the systems we now have and the addition of a few more decibels of noise reduction.

One or more of the noise-reducing devices we have mentioned certainly has a place in every high-quality hi-fi system. In fact, we can expect to see these devices incorporated into higher-quality hi-fi amplifiers and receivers in the future, just as all high-fidelity cassette decks now have noise-reduction systems built into them. ◇

Matching Tapes to Recorders

BY LEN FELDMAN

WHETHER you own a new open-reel tape deck or a super-performing stereo cassette deck, you'll have to decide which type of tape to use to get the best possible performance. If cassettes are what you need, you can buy a 60-minute (C-60) cassette tape for as little as 99¢ or you can spend up to \$5.00 for the same amount of recording time. In the case of open-reel tapes, an 1800-ft (550-m) reel may cost less than \$6.00 or you may spend more than twice that amount for the same tape length. Which kind of tape you buy will depend on the type of recording you intend to do and the kind of tape deck you own.

For open-reel tape, selection involves physical considerations almost as much as electrical performance or fidelity. Broadly speaking, the two basic "grades" of tape are "standard and "high-energy," each of which requires a different bias setting on your machine. Lower priced standard tapes often have more residual noise and somewhat poorer frequency response than "premium" tapes, though they may be suitable for noncritical recording applications.

Generally, 1-mil-thick tape, with its 1800-ft capacity on a 7-in. (17.8-cm) reel, offers the best compromise between tape storage bulk and playback quality. Almost all open-reel tapes use ferric-oxide particle coatings even though there are still some differences between the products of different manufacturers. Mechanical differences in reel construction and accuracy of tape splitting and dimensions and uniformity of coatings account for the wide differences in prices.

In contrast to open-reel tape recording, the quality of recording obtained with a cassette deck is more critically dependent on the compatibility (or lack of it) between the tape and the machine with which it is used. A growing number of tape deck manufacturers make specific recommendations of tapes that work best with their products. However, even these suggestions require an understanding of the kind of recording to be made and the nature of different tape formulations.

Correct Bias. A high-frequency bias signal must be added to the program signal to be recorded to reduce the dis-

tortion normally caused by the nonlinear transfer characteristic of magnetic tape. However, not all tape formulations require the same amount of bias for best results. Normally, ferric-oxide coated tapes require less bias than do chromium-dioxide (CrO₂) tapes. Several new formulations that combine ferric-oxide particles with other elements such as cobalt (in a single-compound layer) also require the high bias settings of CrO₂.

In cassette tape testing, most manufacturers determine the correct reference bias for a given tape by recording a fairly high frequency (usually around 6300 Hz) onto the tape while observing playback output as bias is gradually increased. At some bias setting, the output reaches a peak, after which a further increase causes the output level to drop off. The reference bias for the tape is set at the point where the output level has dropped off by about 2.5 dB beyond peak. Usually, a standard reference tape is tested in this way, and its optimum bias point is identified as the "0 dB" reference bias. Then, the tape under investigation is compared with the 0-dB reference bias specified in dB.

In Fig. 1 are shown the results of this test when performed on a well-known, low-noise, ferric-oxide tape. The optimum bias has been established at a -1-dB setting, relative to the standard

0-dB bias point. In Fig. 2, the same test was performed on a CrO₂ cassette; and the optimum point for bias was +2 dB (with reference to the standard 0-dB bias point of the reference tape). This means that the CrO₂ tape requires a bias setting that is 3 dB higher than that for the low-noise, ferric-oxide sample.

For any practical tape, the bias strength that results in the highest output at middle and low frequencies is greater than the ideal for high frequencies. Conversely, if the bias is adjusted to favor the highs, the middle and low frequencies suffer in terms of realizable output. Whatever bias point is selected, some degradation of signal-to-noise (S/N) ratio and overload distortion will occur in some part of the audio frequency spectrum. While increased bias tends to reduce distortion, no one setting can guarantee overall distortion reduction by the maximum amount at all frequencies. Thus, bias settings are always a compromise, and the best tape permits the most favorable compromise.

To demonstrate the effect of overbiasing and underbiasing, we recorded a continuously sweeping series of frequencies (20 to 20,000 Hz) on a strip of ferric-oxide tape at a fairly high recording level. The results are shown in Figs. 3 (underbiasing) and 4 (overbiasing). Note in Fig. 3 that high-frequency re-

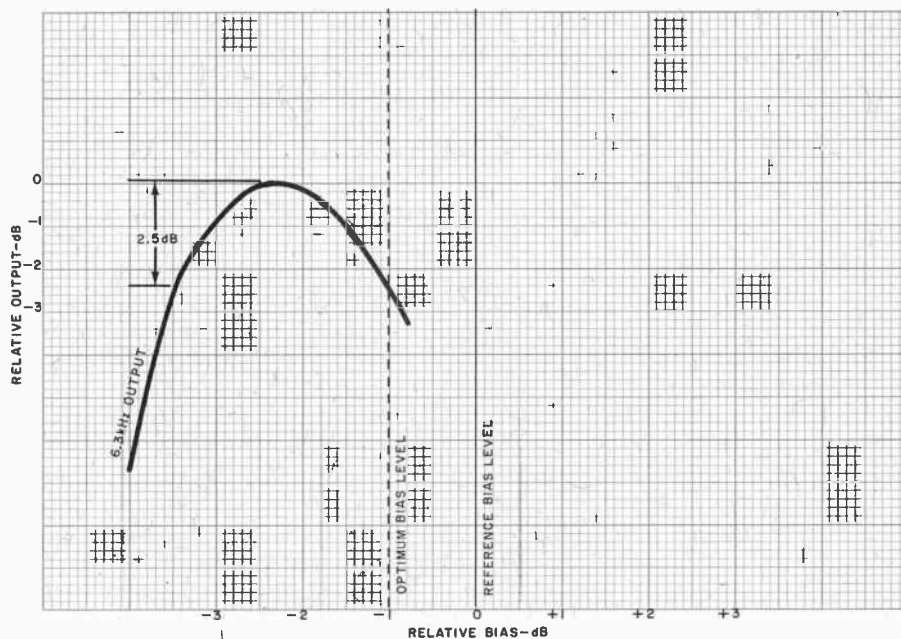

Fig. 1. Determining the bias level for a sample low-noise tape.

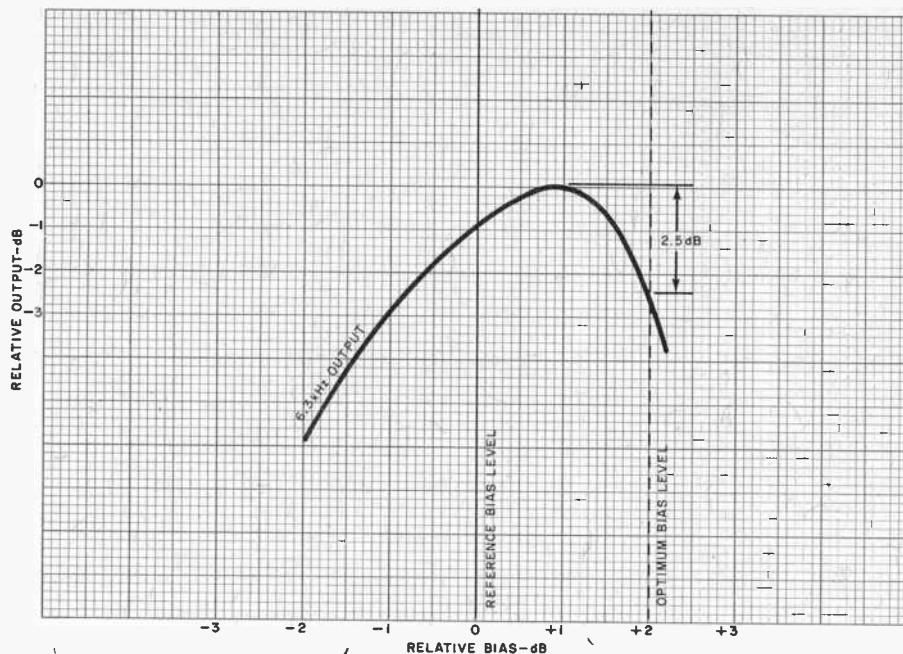

Fig. 2. Determining the bias level for a sample of CrO₂ tape.

response obtained in the underbiased condition is excellent. In fact, there is even a slight rise in response above 10,000 Hz before the response rolls off in the 20,000-Hz region. In Fig. 4, however, the response begins to fall off gradually above 1000 or 2000 Hz and really takes a giant dip beyond 10,000 Hz. Each vertical division in the photo equals 10 dB of amplitude.

From the results shown in Figs. 3 and 4, one might conclude that the best performance from any tape is obtained with underbiasing. However, the curves do not reveal what happens to harmonic distortion if a given tape's bias is set too low. In Fig. 5, the spectrum analyzer was used once more to examine the distortion and noise components of a reproduced 1000-Hz signal, as recorded on the underbiased deck. The large spike at the center represents the desired fundamental output (1000 Hz), while the spikes to the right, notably at 3000 and 5000 Hz, are components of third- and fifth-harmonic distortion. The third-harmonic component is only about 33 dB below the fundamental or about 2.2% of the signal content. The random spikes represent residual tape noise as reproduced during playback of the 1000-Hz recorded signal.

Figure 6 shows what happens to a 1000-Hz signal in the overbias condition that resulted in the frequency response of Fig. 4. The third-harmonic distortion component has gone down to about 44 dB below the fundamental. This corresponds to distortion of about 0.6% but there is little if any evidence of fifth-har-

monic contribution, and the general random noise content is much lower.

Equalization. Once the proper bias for a given tape has been selected, it is still possible to tailor the frequency-response capabilities of that tape by a process called equalization. Up to a certain frequency, if a recording is made on magnetic tape, the playback system "reads" that signal with a rising amplitude characteristic as the frequencies are increased. Since we want a "flat" frequency response, a rolloff in response is built into the playback electronics so that the net response, hopefully, will be flat.

Playback equalization in a tape deck is generally standardized and fixed to obtain reasonably flat playback results from any tape recorded on one tape deck and played back on another.

Recording equalization, however, is variable and is designed to match the particular tape you use and generally involves a specified amount of treble "boost" added to the record electronics to compensate for the high-frequency rolloff that occurs above a given high frequency. As with bias, record equalization is often adjustable by means of a switch on the deck's control panel. Most equalization switches have only two or three positions that generally approximate the right playback conditions for many of the tapes on the market.

In recent years, manufacturers of cassettes have tried to make tapes that give best results when used with the most commonly available equalization set-

tings of most machines. The two most popular settings of equalization are 70 and 120 μ s, the figures representing the time constant provided by the resistor-capacitor combination that gives the required 6-dB/octave response slope. The 120- μ s equalization setting begins to boost high frequencies during recording at a lower turnover point than does the 70- μ s setting that has been standardized for CrO₂ tapes and some of the more exotic ferric-cobalt tapes.

Let us see what happens to the response if the wrong setting is used for a given tape during the recording process. For one series of tests, a ferric-cobalt tape requiring the 70- μ s equalization was used. After adjusting the bias for optimum, the proper equalization switch position was set and a frequency response check was run. The result (the lower trace in Fig. 7) shows a good, flat response curve, similar to that shown in Fig. 3, but with somewhat greater rolloff at the high end because of the correctly adjusted bias. Without altering the bias setting, the run was repeated with the 120- μ s equalization setting. The result is the upper trace in Fig. 7. Overboosting during recording resulted in an overemphasized rising high-end response during playback.

Next, a low-noise ferric-oxide tape was tried. It normally requires the 120- μ s equalization characteristic. With this equalization and the correct bias setting, we obtained the upper trace in Fig. 8. The response is nice and flat to well beyond 15,000 Hz. In a second sweep, the equalization switch was set to 70 μ s; and, as can be seen in the lower trace, the response during playback rolled off severely, starting at about 2000 Hz.

Characteristics. Here are details on other key specifications.

Sensitivity of a given tape is the decibel difference between the output and input levels when an input 20 dB below the reference level (0 dB) is recorded on a tape. If the recorder used for this test has been biased properly, equalized flat and input/output adjusted to be equal for a standard reference tape (a German DIN standard, known as Bezugsband 4.75/3.81 tape is often used as the standard), the data obtained is the sensitivity of the tape under test relative to the reference tape. For cassette tapes, 333- and 12,500-Hz tones are used for sensitivity tests. Typical results obtained for standard and high-output tapes are plotted against bias settings in Fig. 9. As can be seen at the "optimum bias" inter-

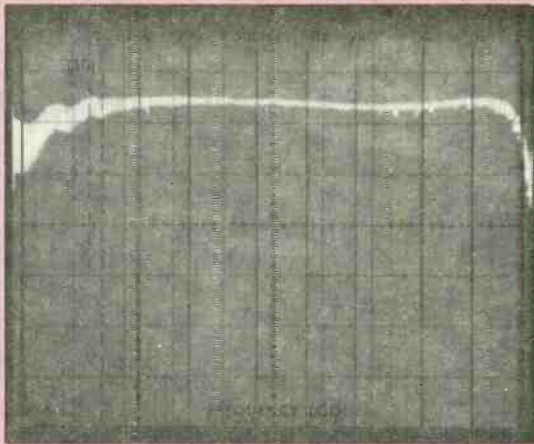

Fig. 3. Too low a bias may improve a tape's high-end response but degrade other performance characteristics.

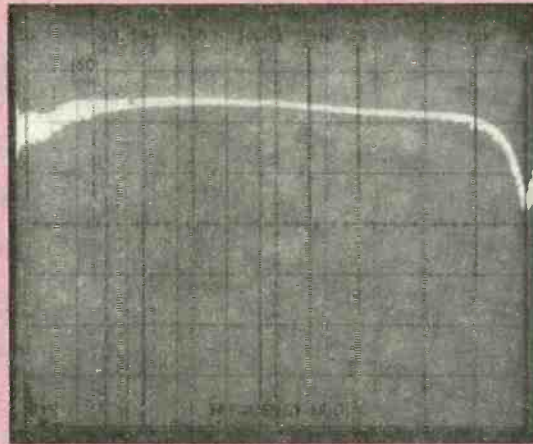

Fig. 4. Overbiasing causes high-frequency roll-off in tape playback as shown here.

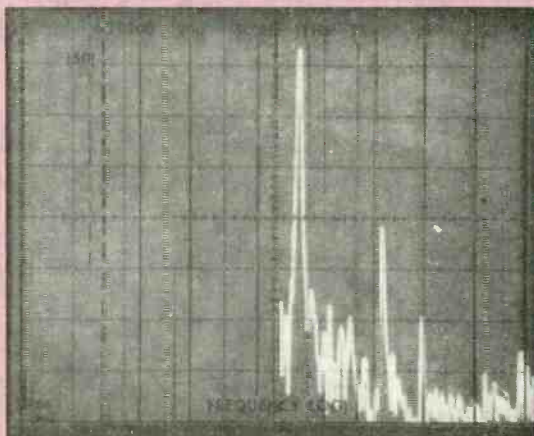

Fig. 5. Under-biased tape sample reproduces 1-kHz signal with high third-order harmonic distortion.

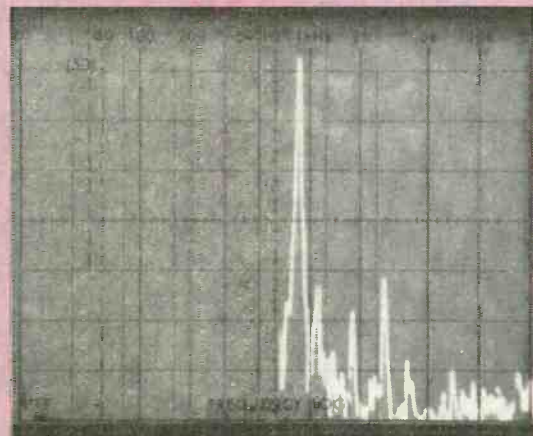

Fig. 6. Increased bias lowers third-order harmonic distortion content for this 1-kHz recorded test signal.

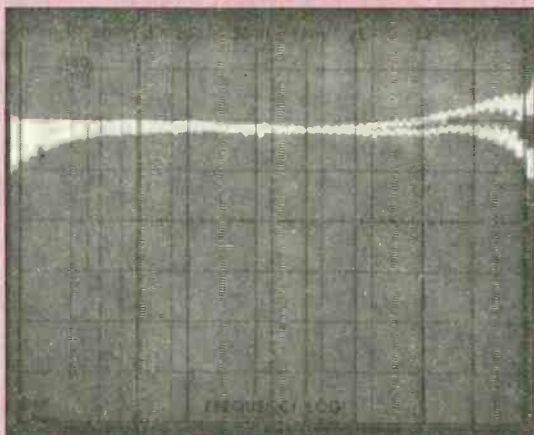

Fig. 7. Upper trace, with rising high-end response during playback occurs when sweep frequencies are recorded onto tape requiring CrO₂ equalization with switch set to "standard" position. Lower sweep was plotted using correct setting.

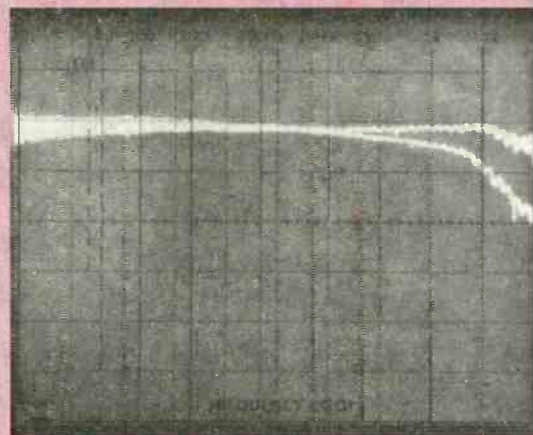

Fig. 8. When CrO₂ equalization setting is used with standard ferric-oxide tape, response at high end has severe rolloff (lower trace). Upper trace shows response obtained with correctly set equalization switch for this tape.

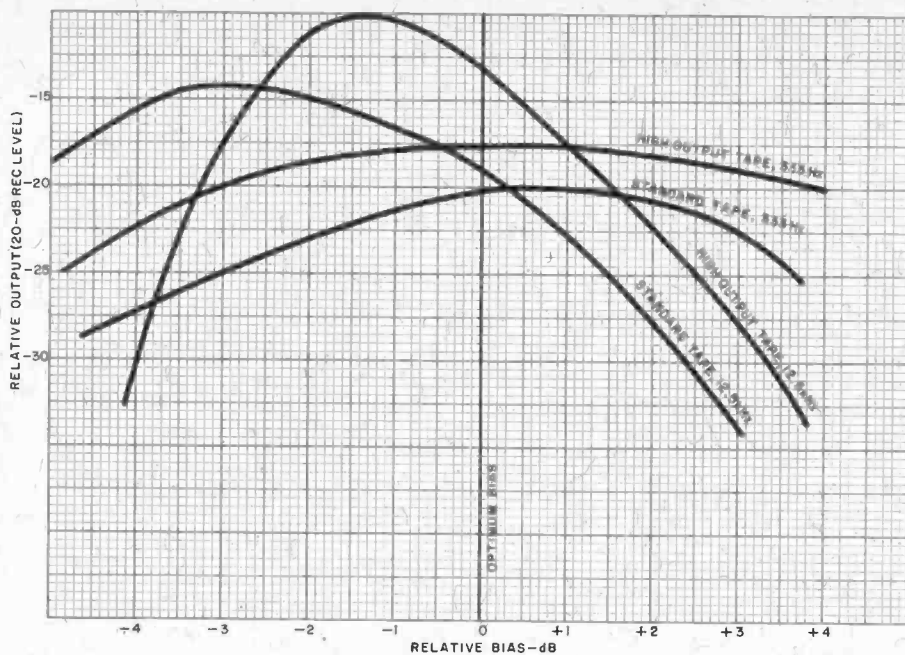

Fig. 9. Relative output sensitivities of standard and high-output tapes.

section, the high-output tape is more sensitive than the standard tape by nearly 2 dB at middle frequencies and by 6 dB at 12,500 Hz. This means that the higher-output tape affords a few extra decibels of dynamic range above the noise threshold.

Maximum modulation level is the recorded output level of a given tape that exhibits 3% third-order harmonic distortion. It is sometimes plotted as a function of bias level. In Fig. 10, are plotted the maximum output levels of two different tapes that have widely differing maximum output-level characteristics. The frequency used for maximum output lev-

el in cassettes is usually 333 or 1000 Hz. Some tape manufacturers also specify maximum output at a high frequency; in the case of cassette tapes, a 12,500-Hz signal is usually used for these tests.

Biased tape noise is also often specified by tape makers. This is the level of residual tape noise (referred to a specific reference level) when it has been recorded with bias signal only and with the bias signal weighted or modified by the use of a standard noise-weighting network. The biased tape-noise level for the two tapes tested in connection with maximum output level is also shown in Fig. 10. The difference between the noise

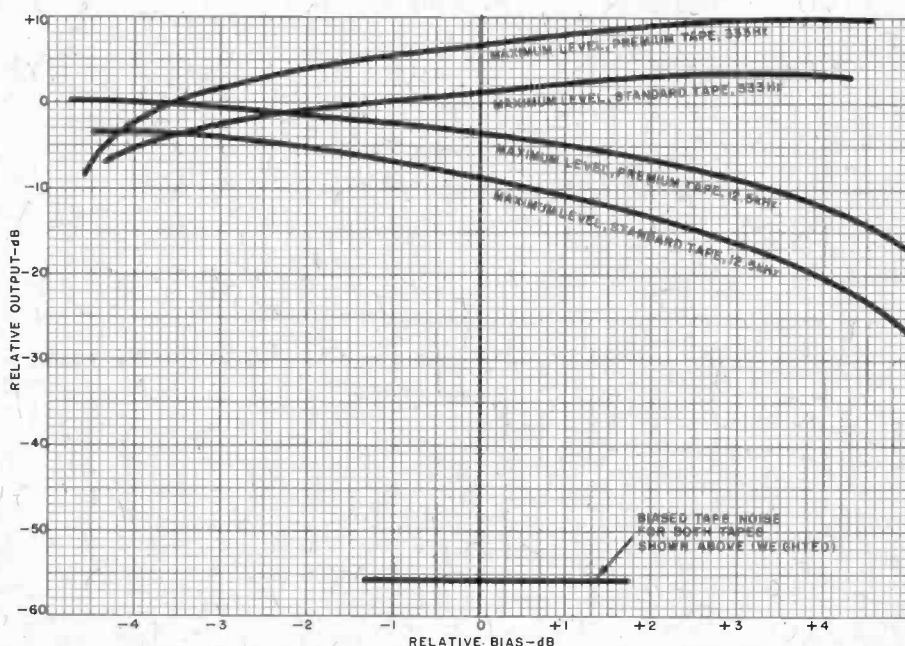

Fig. 10. Maximum output levels and biased tape noise for two types of tape.

level and the maximum modulation constitutes the maximum dynamic range of each tape.

Tape Is Different. As we have seen, tape cannot be looked upon in the same way that we consider other program sources in high fidelity, such as phonograph discs or FM signals. All discs are recorded with the same equalization and, therefore, only one fixed setting of playback equalization (RIAA) is required in preamplifier circuits. There are, of course, differences in disc quality that result from the use of different grades of vinyl from which discs are pressed. However, these differences are minor when compared with the differences that exist among the many grades of cassette tapes available.

Radio FM signals also employ a form of equalization known as "preemphasis," which has long been standardized in this country. Hence, all tuners provide correct deemphasis for FM reception, and difference in program quality depends on signal strength and the overall quality of a tuner or receiver.

In our discussion of the electrical properties of cassette tapes, we haven't stressed mechanical properties. These include: accuracy of tolerances maintained in the cassette housing (which can affect smoothness of tape travel); uniformity of magnetic coating and smoothness of the coated surface (both of which, if poor, can cause dropouts or momentary lapses of reproduced sound); tensile strength of the plastic base material itself (poor tensile strength can lead to tearing or stretching after repeated use); friction-reducing techniques used to insure smooth, uniform tape motion within the cassette housing; etc.

All of these qualities, in some measure, determine the price of a cassette and its usefulness for recording applications. Obviously, if all you want to record are baby's first words or a business conference, response to beyond 15,000 Hz is of little importance. (Though mechanical reliability of the cassette itself may be of as great importance as if you were recording a once-in-a-lifetime live concert over FM.) On the other hand, if you want the finest results from your cassette deck (or even from your open-reel machine), it pays to research the question of which tape is best for you. It is important to choose the brand and type whose formulation in relation to the switch setting available on your tape deck has the right "compromises" for your needs. ◇

IC Multiplex Decoder

Improves Stereo FM Performance

TODAY'S state-of-the-art audio components yield levels of performance unattainable a few years ago. However, most of us can't update our sound systems as frequently as technological advances are made. This project—an add-on phase-locked-loop multiplex decoder—will allow the user to improve the stereo FM demodulation of an existing receiver or tuner for about \$25. Only a few hours of assembly and alignment time is required. The PLL decoder will not only improve channel separation and lower distortion levels, but will also select deemphasis time constants for standard and Dolby-FM broadcasts.

About the Circuit. The heart of the PLL multiplex demodulator is the LM1800A, an IC manufactured by Na-

tional Semiconductor. A block diagram of the LM1800A is shown in Fig. 1. The phase-locked loop comprises a voltage controlled oscillator (vco), frequency dividers, phase detectors, low-pass filtering and an error amplifier. Also included are a voltage regulator allowing operation from 12-to-24-volt supplies, automatic stereo monaural switching, and use of a stereo indicator lamp.

In the absence of an input signal, no error signal is generated and the vco oscillates at a frequency designated as f_0 . When a composite FM signal is applied to the input, the loop phase detector generates an error signal which is filtered and amplified. This amplified error voltage shifts the oscillating frequency of the vco to exactly 76 kHz. Filtering performed at the phase detector and error

amplifier prevents modulation of the vco by the input signal.

The vco input frequency is divided by two, resulting in a 38-kHz carrier used in the synchronous demodulation of the composite signal. Passing the 38-kHz signal simultaneously through a pair of $\div 2$ counters produces two 19-kHz signals which are applied to the IC's two phase detectors. If the 19-kHz pilot signal drops below the level at which a satisfactory stereo signal can be recovered, an electronic switch causes the IC to produce a monaural output.

The schematic diagram of the complete multiplex detector is shown in Fig. 2. Input signals are capacitively coupled by C5 to level control R5. Capacitor C4 passes the composite FM input to the base of Q1, which amplifies it to a level

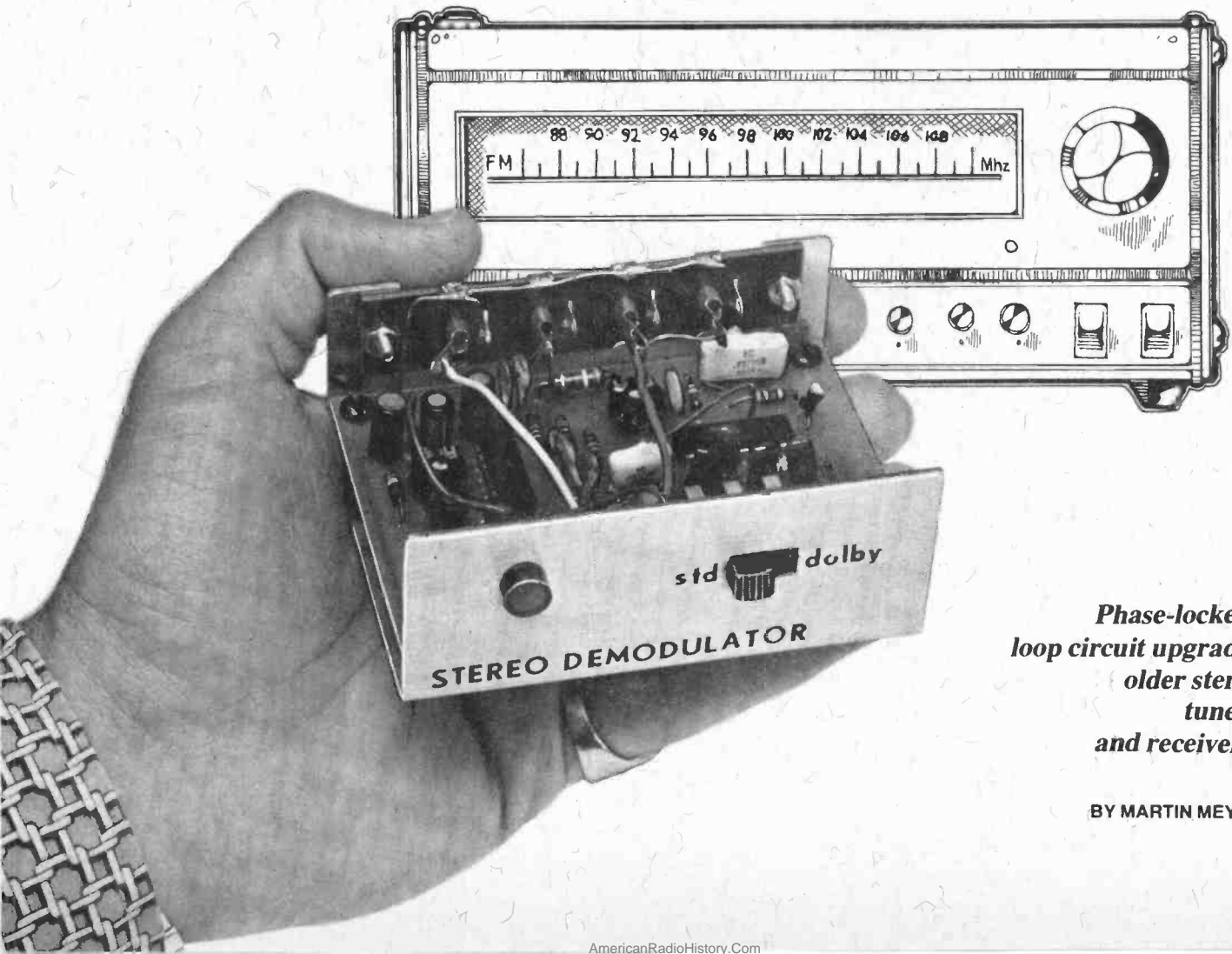

Phase-locked-loop circuit upgrades older stereo tuners and receivers.

BY MARTIN MEYER

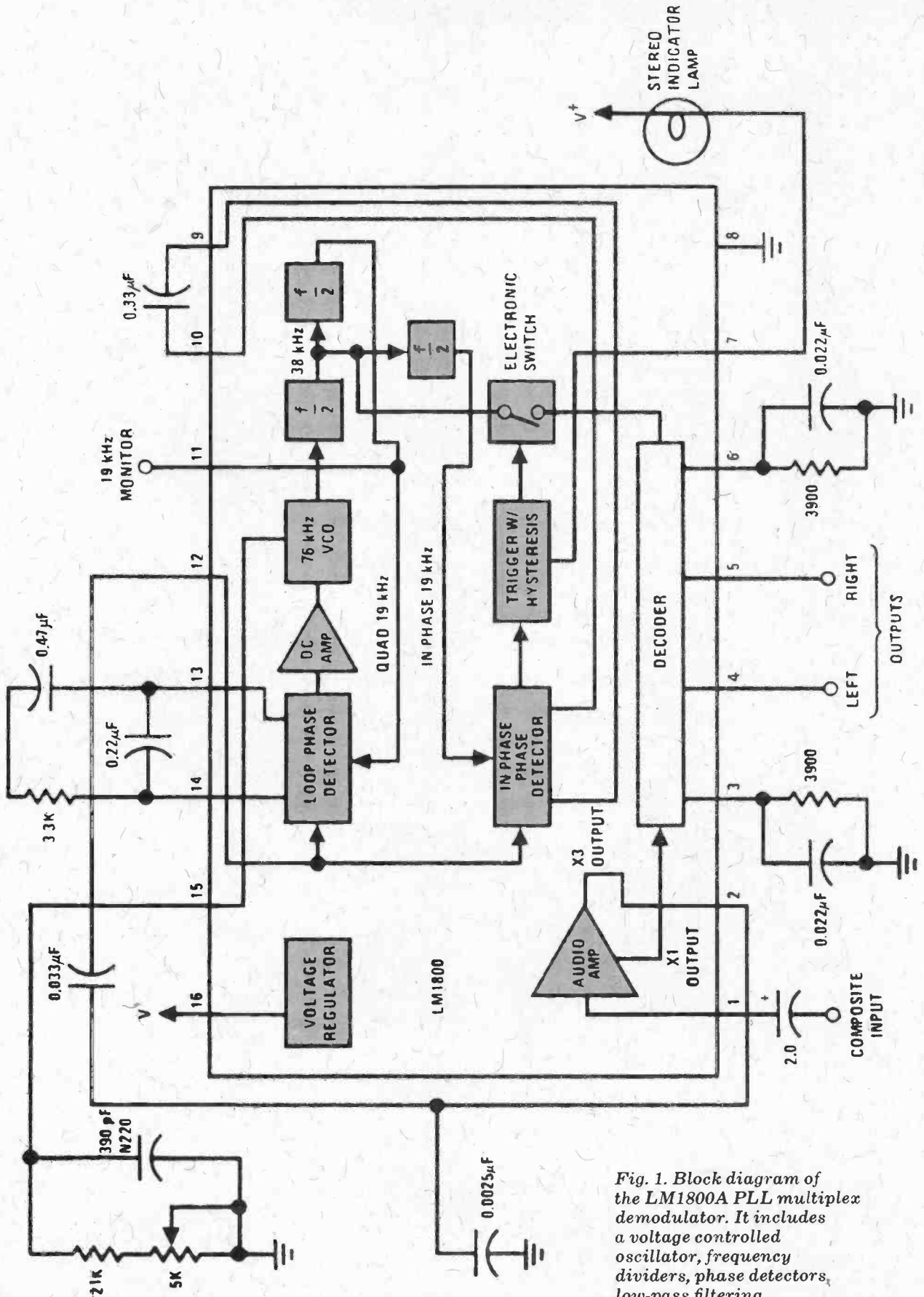
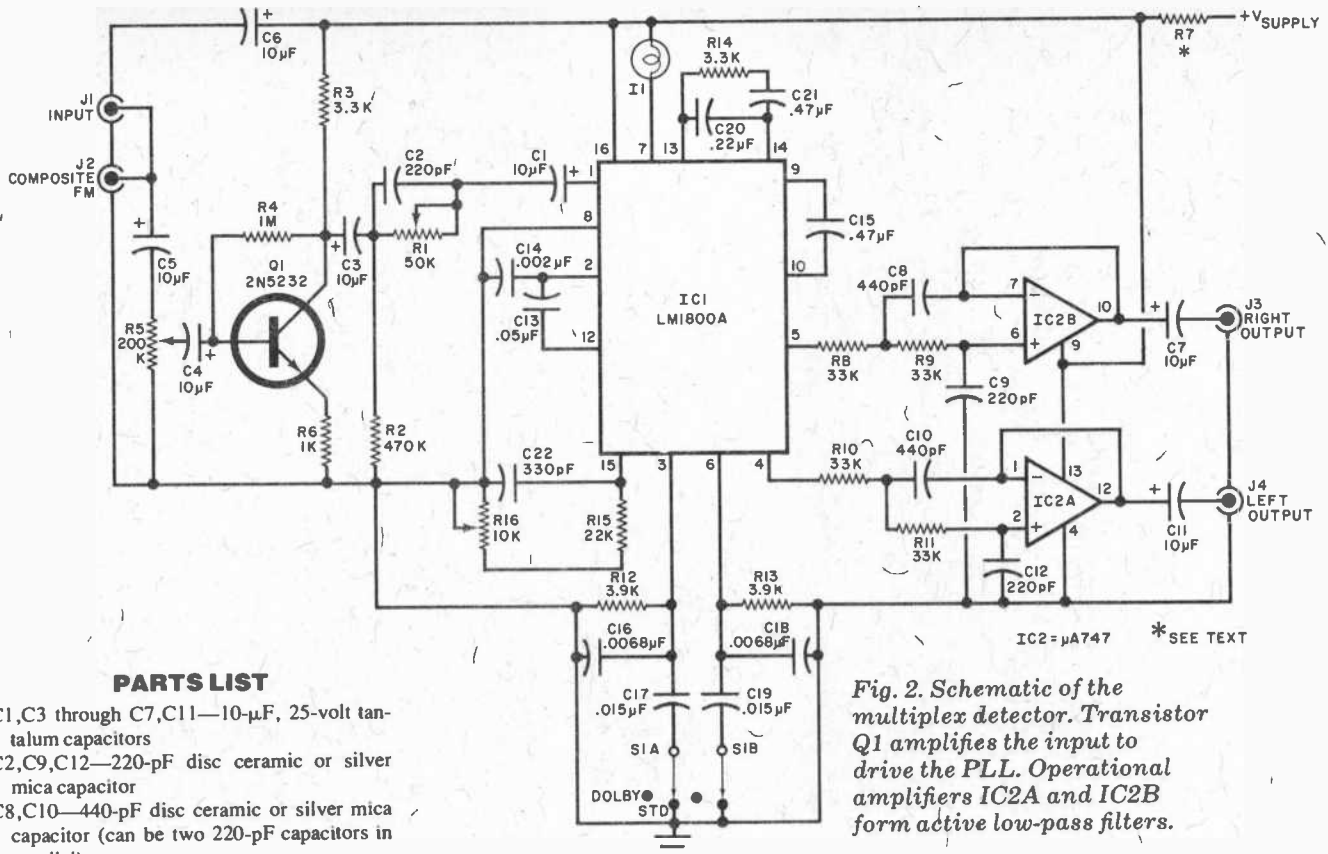

Fig. 1. Block diagram of the LM1800A PLL multiplex demodulator. It includes a voltage controlled oscillator, frequency dividers, phase detectors, low-pass filtering and error amplifier.



PARTS LIST

- (C1, C3 through C7, C11)—10- μ F, 25-volt tantalum capacitors
- C2, C9, C12—220-pF disc ceramic or silver mica capacitor
- C8, C10—440-pF disc ceramic or silver mica capacitor (can be two 220-pF capacitors in parallel)
- C13—0.05- μ F disc ceramic capacitor
- C14—0.002- μ F disc ceramic capacitor
- C15, C21—0.47- μ F Mylar capacitor
- C16, C18—0.0068- μ F, \pm 10% Mylar capacitor
- C17, C19—0.015- μ F, \pm 10% Mylar capacitor
- C20—0.22- μ F Mylar capacitor
- C22—330-pF disc ceramic or silver mica capacitor
- I1—12-V, 35-mA pilot light
- IC1—LM1800A PLL multiplex decoder
- IC2—747 dual operational amplifier
- J1 through J4—RCA phono jacks
- Q1—2N5232 npn silicon transistor
- The following are linear-taper, pc trimmer potentiometers:
 - R1—50,000 ohms
 - R5—200,000 ohms
 - R16—10,000 ohms
- The following are 10% tolerance, 1/4-watt carbon-composition fixed resistors:
 - R2—470,000 ohms
 - R3, R14—3300 ohms
 - R4—1 Megohm
 - R6—1000 ohms
 - R7—See text.
 - R8 through R11—33,000 ohms
 - R12, R13—3900 ohms
 - R15—22,000 ohms
- S1—Dpdt slide or toggle switch
- Misc.—Printed circuit board, suitable enclosure, hookup wire, shielded cable, pilot light jewel, hardware, solder, etc.
- Note—The following are available from Neronics Research and Development, Ltd., 333 Litchfield Road, New Milford, CT 06776: complete kit including all components, pc board, screened enclosure, less audio cables, \$24.95; complete kit as above but less screened enclosure, \$19.95. U.S. residents add \$1.50 postage and handling; Canadians add \$3.00. For receiver connection info, send schematic, SAS envelope and \$1 (free if purchasing kit). Connecticut residents add 7% sales tax.

Fig. 2. Schematic of the multiplex detector. Transistor Q1 amplifies the input to drive the PLL. Operational amplifiers IC2A and IC2B form active low-pass filters.

that will properly drive the phase-locked loop. The parallel combination C2R1 provides compensation for high-frequency rolloff in the tuner's i-f and detector stages. Resistors R12 and R13 and capacitors C16 through C19 provide deemphasis for multiplex decoder IC1. When S1 is in the STD position, the standard 75- μ s FM deemphasis characteristic appears. Placing S1 in the DOLBY position changes the deemphasis to 25 μ s, which corresponds to the reduced preemphasis used in Dolby-encoded broadcasts.

Operational amplifiers IC2A, IC2B, and their associated components form active low-pass filters with 16,000-Hz cutoff frequencies and 12-dB/octave slopes. These filters attenuate any 38-kHz carrier and 67-kHz SCA components which would otherwise appear at the left and right audio outputs. If allowed to pass, these signals could cause beats and whistles when program material is recorded on tape. Indicator I1 glows in the presence of stereo pilot carrier. Jack J2 is wired in parallel with input jack J1, providing access to the composite FM signal for such accessories as 4-channel and SCA demodulators.

Construction. Printed circuit guides for the project are shown in Fig. 3. Mount all components on the board, paying close attention to pin basing and

polarities of semiconductors and electrolytic capacitors. Power can be tapped from any +12- to +24-volt dc source. The tuner's i-f stage or existing multiplex decoder is usually powered by a +15- to +20-volt supply which can be utilized for this purpose. Select the value of R7 in kilohms according to the equation:

$$R7 = (V \text{ supply} - 12) / 55$$

A one-watt carbon composition resistor will have adequate heat dissipation capability for this application.

The tuning lamp used in the author's prototype (and supplied with the kit) draws 35 mA at 12 volts. If you substitute another incandescent lamp or a LED and current limiting resistor, modify the equation for the value of R7. Replace the 55 mA in the denominator with the sum of 20 mA (the current required by the PLL and active filters) and the

TABLE I
LM1800A SPECIFICATIONS

Stereo Separation—100 Hz:	40 dB
1000 Hz:	45 dB
10,000 Hz:	45 dB
SCA Rejection:	50 dB
Total Harmonic Distortion:	0.2 %
Ultrasonic Frequency Rejection:	45 dB

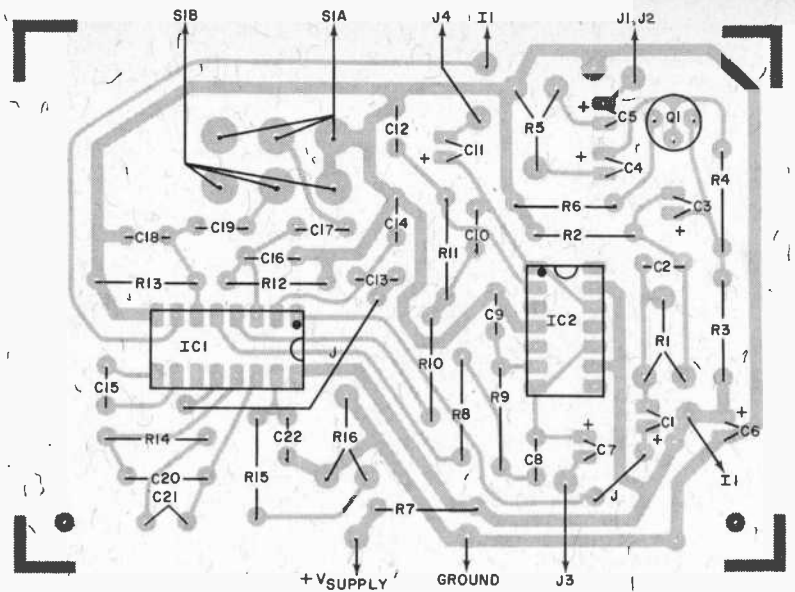
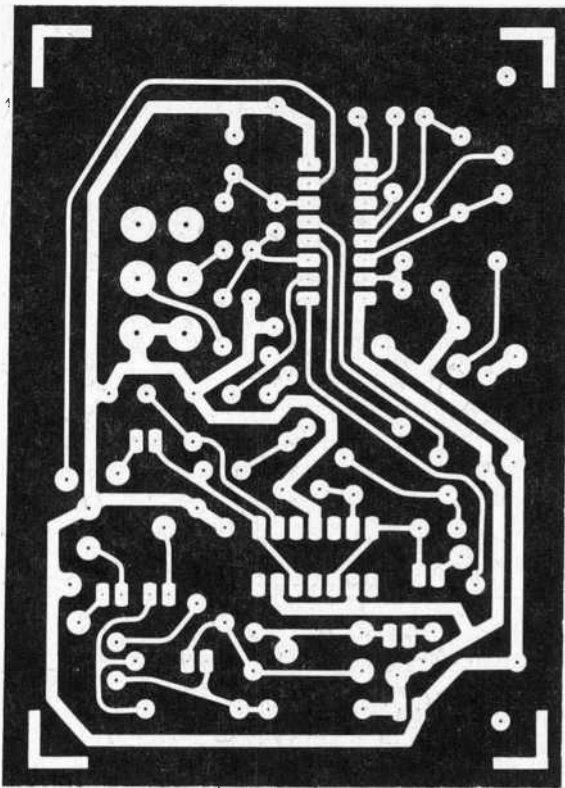

Fig. 3. Etching and drilling guide for multiplex decoder is shown at left. Component placement guide is above.

current required by the indicator. For example, if a LED and resistor drawing 20 mA are used, the denominator would be 40 mA.

The project can be mounted in the tuner cabinet or housed in a separate enclosure. If it is placed in the tuner cabinet, mount S1 on the rear panel of the tuner and connect it to the pc board via low-capacitance shielded cable such as RG-59-U. The same type of cable should also be used to conduct the composite FM signal from the detector output to the input of the multiplex decoder.

If your tuner or receiver has a "composite FM" or "FM detector" output jack, the required signal is available there. If not, you will have to locate the FM detector and tap the signal at that point. The partial schematic of a typical FM receiver is shown in Fig. 4. The composite signal is obtained by disconnecting the existing multiplex decoder and tapping the signal at point A.

The left and right audio outputs are available at jacks J3 and J4. If you are using the project in place of the multiplex decoder in a tuner, you can either use

these jacks in place of those in the tuner, assuming the decoder is mounted externally. If it is mounted internally, you can disconnect the outputs of the existing multiplex decoder from the output jacks on the tuner's rear panel and connect the outputs of the decoder's active filters.

Similarly, if you have a receiver and are mounting the project in an external enclosure, you can connect the decoder's outputs to the tape monitor circuit. Mounting the decoder inside the receiver cabinet suggests an internal connection. Remove the output leads at the ex-

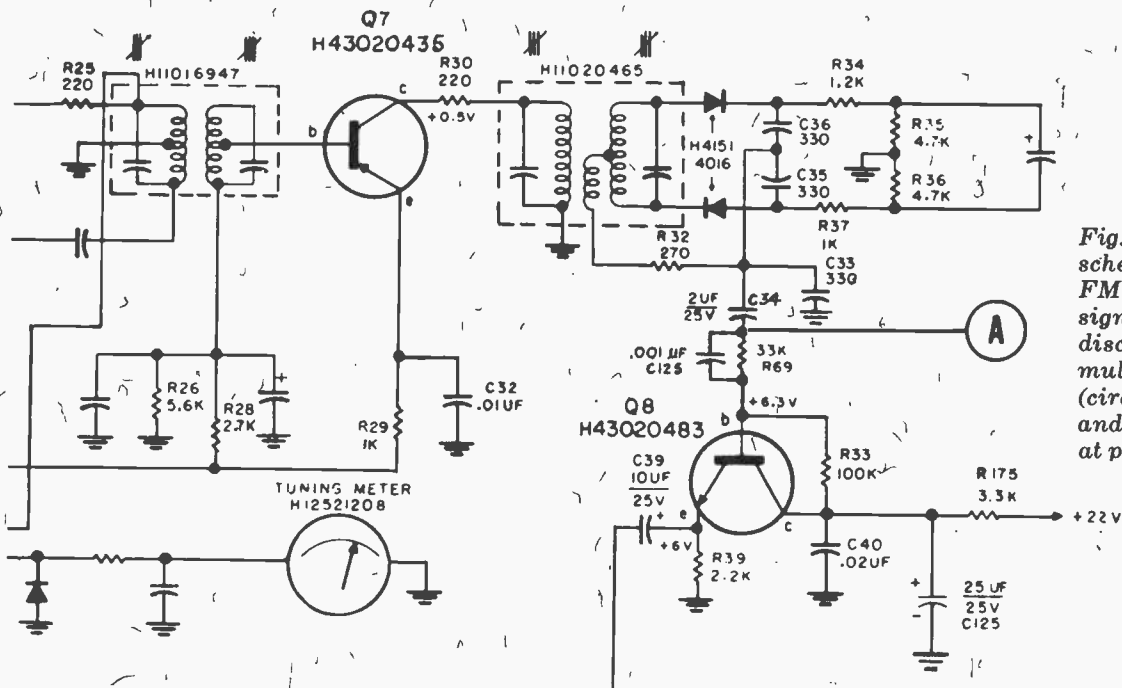

Fig. 4. Partial schematic of typical FM receiver. Composite signal is obtained by disconnecting existing multiplex decoder (circuit below C34) and tapping signal at point A.

isting multiplex decoder running to the appropriate lugs on the receiver's MODE switch. Then connect them to the decoder's active filter outputs.

Alignment. When properly aligned, the project will provide performance as outlined in Table I—assuming no degradation in the tuner's i-f and FM detector. Two typical receivers were used with the PLL decoder. Results are shown in Table II. The alignment procedure about to be described requires no test instruments, but will yield good results. The author was able to improve the stereo separation only 2 dB when instrument alignment was performed with an expensive FM stereo generator.

Rotate potentiometers *R1* and *R16* to the midpoint of wiper travel, and *R5* for maximum signal drive at the base of *Q1*. Turn on your receiver and tune in a station broadcasting in stereo. Indicator *I1* should glow. If not, adjust *R16* until it does. Then turn *R16* fully clockwise. If *I1* still glows, adjust *R5* until the indicator just goes out. Slowly rotate *R16* counter-

	Sony STR-6060FW		Harman Kardon SR900	
	Before	After	Before	After
Stereo Separation—100Hz:	20 dB	32 dB	25 dB	30 dB
1000 Hz:	28 dB	42 dB	32 dB	42 dB
10,000 Hz:	18 dB	30 dB	25 dB	33 dB
Total Harmonic Distortion (1000 Hz):	0.5%	0.3%	0.6%	0.25%

clockwise until the lamp begins to glow. Note the position of the control. (It may be necessary to adjust *R5* slightly.)

Next, turn *R16* fully counterclockwise, adjusting *R5* again if necessary to extinguish the lamp. Slowly rotate *R16* clockwise until the lamp glows, noting the position of the control. Set *R16* midway between the two positions noted. Adjust *R5* until the lamp goes dark, then slowly turn it until the lamp just starts to glow. Advance the wiper of *R5* another 10°. This will properly tailor the input level to decoder *IC1*.

Potentiometer *R1* is included in the circuit for adjustment if test equipment or

a cooperative FM broadcast engineer is available. Since all stations must conduct tests and certify the quality of their signals once a year, you can easily check out adjustments. Call several local stations and ask when they will perform the tests. If it is late at night, the engineer might turn off a channel for 30 seconds or so. While only one channel is being transmitted, adjust *R1* for maximum separation at any mid-band frequency. Note, however, the setting of *R1* will not have a critical effect on the performance of the decoder and can simply be left midway between the two adjustment extremes. ◇

Quiz of Audio Basics

BY ROBERT P. BALIN

1 Which of these audio waveforms indicates the use of tremolo and which is vibrato?

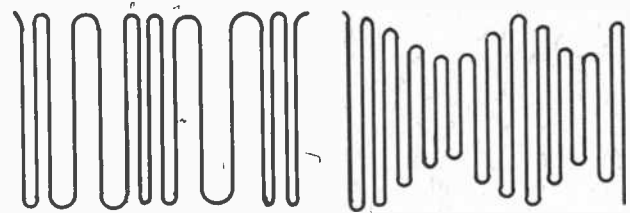

A

B

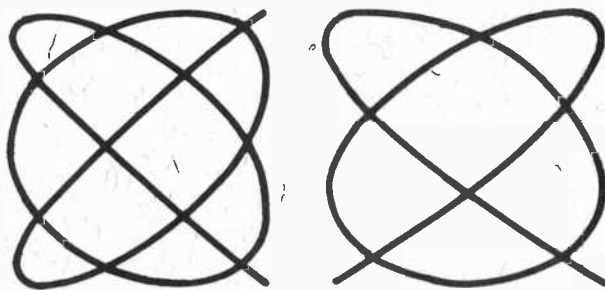

A

B

2 If the vertical frequency used to produce these Lissajous patterns is 1000 Hz, which has a horizontal frequency of 1200 Hz and which is 1250 Hz?

3 With this crossover network, which speaker is the woofer and which the tweeter?

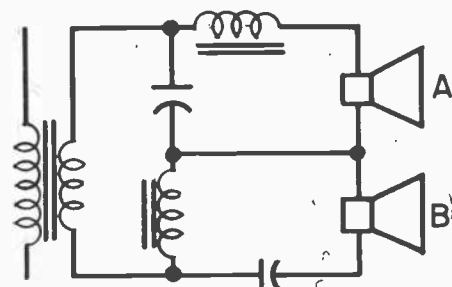

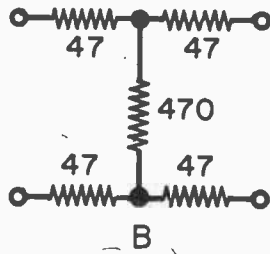
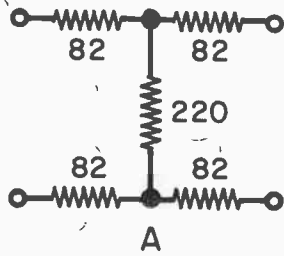

4 Of these 300-ohm attenuator pads, which produces a 6-dB signal voltage loss and which a 12-dB loss?

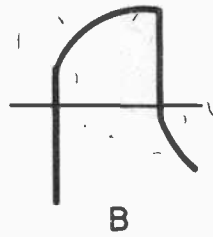
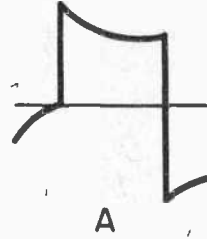

5 Which of these square-wave audio test signals indicates low-frequency attenuation and which high-frequency?

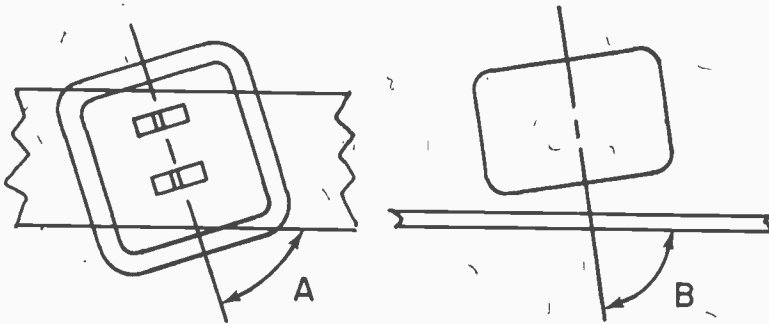

6 Which tape-head condition produces an azimuth error and which a zenith error?

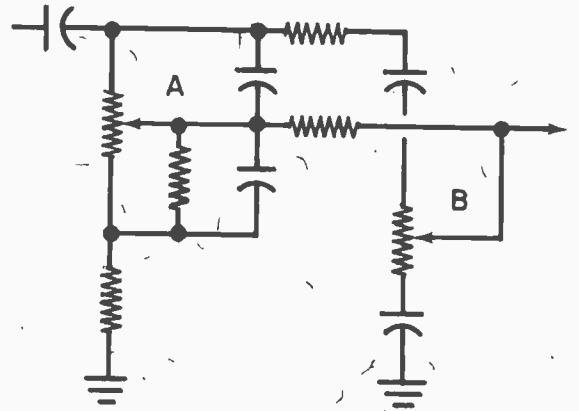

7 In this phono-amplifier tone control circuit, which pot is for treble and which is for bass?

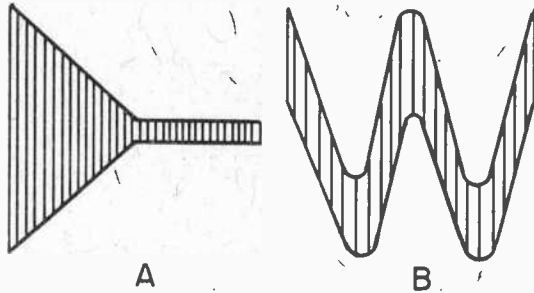

8 Which audio test signal has been affected by intermodulation and which by overmodulation?

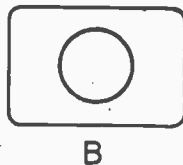
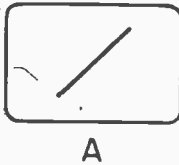

9 Which scope pattern indicates that two audio sine waves are in phase and which that they are 90° out of phase?

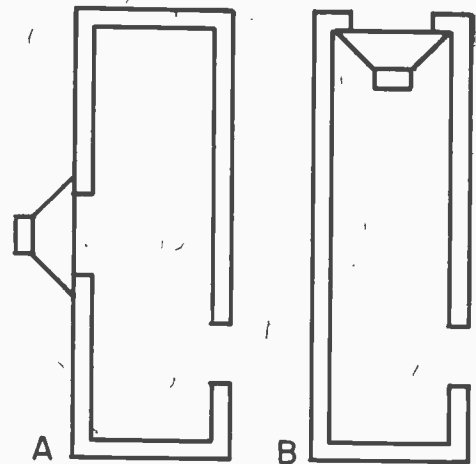

10 Which speaker baffle is known as a resonant column and which as an air coupler?

- 1. Tremolo, B; vibrato A.
- 2. 1200 Hz, A; 1250 Hz, B.
- 3. Woofer, A; tweeter, B.
- 4. 6-dB, B; 12 dB, A.
- 5. Low-frequency, A; high, B.
- 6. Azimuth, A; Zenith, B.
- 7. Treble, B; bass, A.
- 8. Intermodulation, B; over, A.
- 9. In phase, A; 90° out, B.
- 10. Column, B; coupler, A.

- 1. Tremolo, B; vibrato A.
- 2. 1200 Hz, A; 1250 Hz, B.
- 3. Woofer, A; tweeter, B.
- 4. 6-dB, B; 12 dB, A.
- 5. Low-frequency, A; high, B.
- 6. Azimuth, A; Zenith, B.
- 7. Treble, B; bass, A.
- 8. Intermodulation, B; over, A.
- 9. In phase, A; 90° out, B.
- 10. Column, B; coupler, A.

ANSWERS

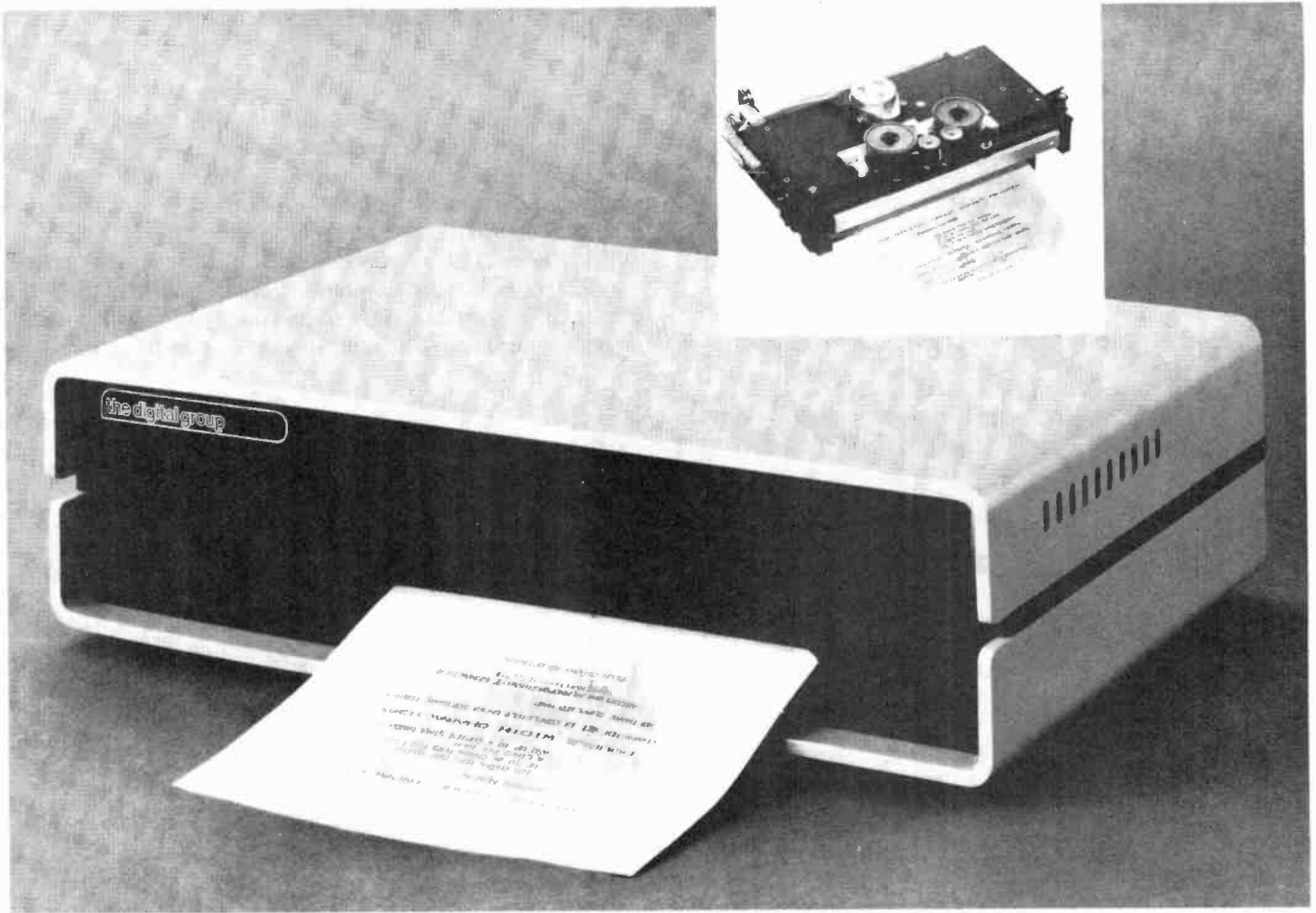

Print Your Heart Out.

With help from the Digital Group, naturally.

Now, that small computer system you own or have been considering for personal or business use suddenly becomes a lot more usable—with the addition of a full-size *impact* printer from the Digital Group. A printer designed for small computers that need big output (like yours).

With the Digital Group printer, you can print your heart out...and it won't cost an arm and a leg. The Digital Group printer is available for less than \$500. That's right—\$500.

Just look at these specifications:

- Fast—120 characters per second
- 96 characters per line
- 12 characters per inch horizontal
- 6 lines per inch
- Makes up to 4 copies simultaneously
- Character set and pitch variable under software control—double width characters, etc.
- 5 x 7 character matrix
- Ribbon has built-in re-inkers for a life of 10,000,000 characters
- Paper can be either a standard 8½-inch roll, fanfold or cut page
- Interfaces to 8-bit parallel ports

There are lots of capabilities and outstanding features of the Digital Group printer...and (as always) the best news is our price. Kit prices start as low as \$495 for the printer and interface card. It simply can't be beat.

Find out all the facts about the Digital Group printer now. Just fill in the coupon below or give us a call for the details. We think you'll find a place for our printer in your system ...and in your heart.

the digital group

P.O. Box 6528
Denver, Colorado 80206
(303) 777-7133

Quick. I want to print my heart out.
Send me all the details on your full-size impact printer.

Name _____

Address _____

City/State/Zip _____

Please print.

FIRST WEST COAST COMPUTER FAIRE BY TOM MUNNECKE

SAN FRANCISCO was the setting last April for the First West Coast Computer Faire, which may become the Woodstock of the personal computing movement. Almost 13,000 people attended the 165 exhibits, 107 lectures, 17 home-brew demonstrations and two banquets.

The crowd was as kaleidoscopic as one would expect in San Francisco. Among them were a blind man seeking braille production equipment and voice synthesizers; Berkeley pamphleteers warning of government restrictions against home computers; artists looking for a new medium for artistic ex-

pression; and a father looking for aids for his deaf child.

Banquet speakers told of the coming revolution in home computing. Ted Nelson predicted that the "cybecrud" coming out of the large computers would be counteracted by the masses of personal computers. What used to be a topic for science fiction writers has come true, with the help of MPU's.

There were 37 conference sessions, covering everything from "Tutorials for the Computer Novice" to "Heretical Proposals." Commercial exhibitors had on display all their latest products, including electronic music synthesizers, speech

1



2



4



1 Prototype of Commodore's PET 2001, an "appliance-type" computer based on the 6502 MPU. Computer provides built-in BASIC, a graphics or character-oriented CRT, cassette storage, and 4k of RAM in a factory-assembled unit.

2 A portion of the exhibit hall, where 165 vendors displayed their wares to 12,750 people. The crowd and the size of the exhibition made it almost impossible to see all of the interesting computers on display.

3 Dr. Franz Frederick, Lafayette, Indiana, shows his "turtle" to Michael Rubinstein. Built in three weeks from surplus parts, it is controlled by a homebrew 6800 system to draw pictures while moving about the floor.

synthesizers and recognizers, and 64k memory boards.

A new class of computers emerged at the Faire—the so-called appliance computer. Meant to be purchased much as one would buy a television receiver or stereo tuner, these computers are complete systems that require no assembly. Apple Computers, Inc., showed the Apple II, a 10-lb (4.5-kg) microcomputer with keyboard, color-TV and audio cassette interfaces, game paddle, and BASIC built-in for \$1300. Commodore International had a working prototype of its PET 2001 computer, which has a CRT, keyboard, cassette drive, IEEE 488 interface, and built-in BASIC; price goal is the \$500-\$600 range. Commodore sees the personal computing market as a

merger of the electronic games and calculator markets and expects the same dramatic decline in prices as more of the semiconductor manufacturers join in the competition.

There was a general air of amazement at both the number and sophistication of the products offered by the vendors. Since the January, 1975 POPULAR ELECTRONICS article introducing the Altair 8800 microcomputer, a dozen new companies have emerged to offer Altair-compatible mainframes; memory boards have increased 16 times in capacity; an array of compatible peripherals is being offered; and a whole new generation of computers has emerged. And all those people came to San Francisco to see it happen. ◇



3



5



6

4 Angela and Joanna Prelesnik, of Santa Clara, react to the PET's showing of their lunar landing module's crash on the moon. MOS Technology 6502 architect Chuck Peddle is shown looking on at left.

5 Dennis Wong, from Mountain View, shows his computer-based payroll system for small businesses. System consists of a Processor Tech. SQL microcomputer, a North Star Floppy Disk, and Memorex printer, all for less than \$3000.

6 Rich Gold's "Mr. Computer" is based on a KIM-1 and 200-byte program. Its coded messages (via LED displays in its mouth) are interpreted by Rich in storybook form. He plans to add video graphics and electronic music output.



BUILD Cabonga

PART 2

How to use various accessories to achieve greater flexibility.

BY JAMES BARBARELLO

LAST MONTH, we described the circuitry and construction of the Cabonga electronic percussion synthesizer. Now here are four accessories—the Snare Drum Adapter, the Auto Trigger, the Sound Modifier, and the Combiner/Power Pack. Methods of interconnecting them with each other and the Cabonga will be shown. The result of these patches will be a flexible and expandable percussion synthesizer system.

The Cabonga has two jacks which, until now, you have not used. They are marked EXTERNAL TRIGGER and EXTERNAL POWER. The EXTERNAL TRIGGER jack will be used with the Auto Trigger and the Snare. The EXTERNAL POWER jack will accept ± 9 volts from the Combiner/Power Pack. Actually, all Cabonga system components could be powered by 9-volt batteries. Cost, however, makes this an unattractive proposition in a multi-component system.

The Combiner/Power Pack will not only provide ± 9 volts dc (if 117 volts ac is available), but also includes a unity-gain active mixer. This mixer will sum up to five input signals and present them at a low-impedance output. In practice, all Cabonga components will operate with supplies ranging from ± 8 to ± 15 volts dc. Accordingly, the Combiner/Power Pack does not include such features as voltage regulation, foldback current limiting, etc. If you're a purist, you can add them; but you will probably not be able to hear any difference.

The schematic of the Combiner/Power Pack is shown in Fig. 6. A full-wave bridge composed of *D1* through *D4* rectifies ac from *T1*, a 12.6-volt, 1.2-ampere center-tapped transformer. Pulsating dc produced by the bridge is filtered by

electrolytic capacitors *C1* and *C2*. The ± 9 -volt output of the power supply is routed to jacks *J1* through *J6* and to *IC1*, the unity-gain summing amplifier.

Etching and drilling and parts placement guides are shown in Fig. 7. Be sure to observe polarities and pin basing

of semiconductors and electrolytic capacitors. The Combiner/Power Pack should be housed in an enclosure measuring about $9\frac{1}{4}'' \times 4'' \times 2\frac{1}{2}''$ ($23.5 \times 10.2 \times 6.4$ cm). The top and bottom of each wall should be rabbeted to provide a $\frac{3}{8}''$ (9.5-mm) deep $\times \frac{1}{4}''$ (6.4-cm)

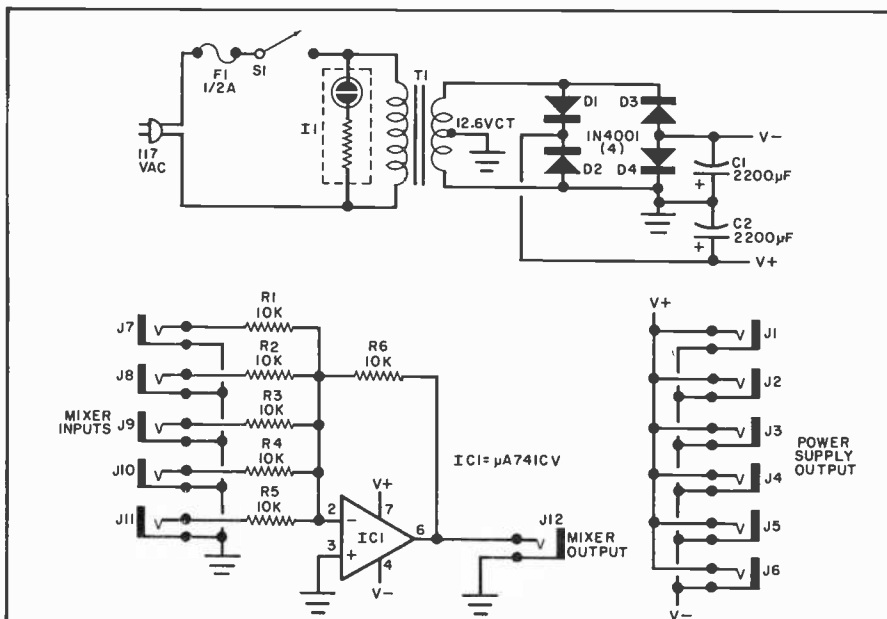

COMBINER/POWER PACK PARTS LIST

- C1, C2—2200- μ F, 16-V electrolytic capacitor
- D1 through D4—1N4001 silicon diode
- F1— $\frac{1}{2}$ -ampere fuse
- I1—120-V ac neon pilot lamp assembly (Radio Shack 272-703 or equivalent)
- IC1— μ A 741CV operational amplifier
- J1 through J6—Miniature phone jack
- J7 through J12—Standard phone jack
- R1 through R6—10,000-ohm, $\frac{1}{4}$ -watt, 10% carbon composition resistor
- S1—SPST switch
- T1—12.6-V, 1.2-A transformer
- Misc.—Printed circuit board, ac line cord, etc. See photo p. 80 for kit prices.

Fig. 6. Schematic of Combiner/Power Pack. The former is a full-wave rectifier with filters.

BILL OF MATERIALS

- 1—Piece $\frac{1}{32}''$ aluminum $8\frac{3}{8}'' \times 2-15/16''$
- 1—Piece $\frac{1}{16}''$ phenolic stock $1\frac{3}{4}'' \times 1\frac{1}{4}''$
- 2—Pieces $\frac{3}{4}''$ pine or plywood $9\frac{1}{2}'' \times 2\frac{1}{2}''$
- 2—Pieces $\frac{3}{4}''$ pine or plywood $3-1/16'' \times 2\frac{1}{2}''$
- 1—Piece $\frac{1}{4}''$ plywood $8-7/16'' \times 3''$
- 1—Piece $\frac{1}{8}''$ rubber matting $8-7/16'' \times 3''$
- 1—Piece black vinyl $28'' \times 5''$
- 10—No. 4 $\times \frac{1}{2}''$ sheet metal screws
- 1— $\frac{3}{8}''$ grommet
- Misc.—Contact cement, etc.

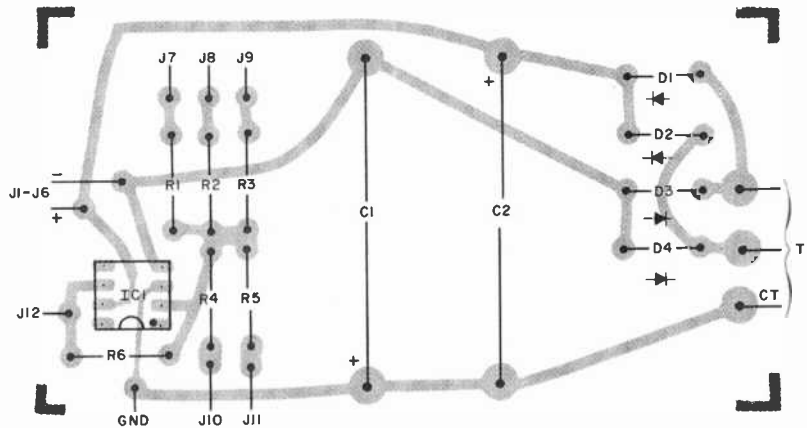
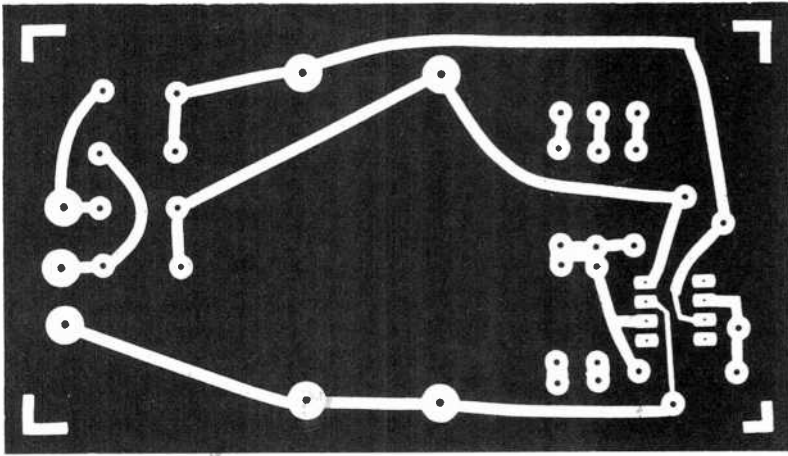

Fig. 7. Guides for Combiner/Power Pack board.

"shelf" on which to mount the top and bottom plates. This will enable the plates to be flush with the top and bottom of the walls. Round all top and bottom edges of the walls with sandpaper.

Form a top plate from an $8\frac{3}{8} \times 2\text{-}15/16$ " (21.3- \times 7.5-cm) piece of $1/32$ " (0.8-mm) aluminum stock. Holes should be drilled for the mixer input and output and power output jacks, for the line cord, power switch and pilot light. The power output jacks, as well as the EXTERNAL POWER jacks on the Cabonga components, must be isolated from the aluminum top plates. This is because the "ground" portions of the jacks are at -9 volts. Isolation can be ensured by drilling the holes for the jacks with $7/16$ " (1.1-cm) bits. The jacks should be mounted on a $1\frac{3}{4} \times 1\frac{1}{4}$ " (4.4- \times 3.2-cm) piece of $1/16$ " (1.6-mm) phenolic.

An $8\text{-}7/16 \times 3$ " (21.4- \times 7.6-cm) piece of $1/4$ " (6.4-mm) plywood forms the bottom plate. If you wish, you can fashion a sheet of ribbed rubber runner to the outer surface of the bottom plate with contact cement. The runner will provide an antiskid surface for the Combiner/Power Pack. The case can be covered with a 28×5 " (71.1- \times 12.7-cm) piece of black vinyl. Secure the vinyl to the case with contact cement by wrapping it around the perimeter. At each

corner, slit the vinyl and trim it as necessary. Carefully fold the vinyl over the top and bottom edges and into the rabbets.

Wire the jacks, switch, etc., according to the schematic diagram. When all connections have been made, secure *T1* and the pc board to the bottom plate, and the top and bottom plates to the case. Make one patch cord from a convenient length of shielded audio cable, terminating its ends with miniature phone plugs and prepare one patch cord terminated with standard phone plugs for each Cabonga. Also make one terminated with miniature phone plugs and one terminated with subminiature phone plugs for each Auto Trigger or Snare.

To test the Combiner/Power Pack, plug one power patch cord (terminated with miniature phone plugs) into a power output jack. Then connect the line cord

to a wall socket and close *S1*. Indicator *I1* should glow. Attach the negative probe of a voltmeter to the barrel of the miniature phone plug, and the positive probe to the plug tip. The meter should read 17 to 20 volts dc. If you read only half of this voltage or zero volts, turn off the Combiner/Power Pack and disassemble the enclosure. Check your wiring for shorts. When the reading is correct, attach the negative probe to the aluminum top plate and the positive probe to the plug tip. A reading of 8.5 to 10 volts dc should be obtained.

Turn off the power by opening *S1*. Then remove the patch cord from the power plug. As the plug barrel comes out of the jack, it momentarily touches both terminals of the jack and shorts them together. The Combiner/Power Pack's supply can take a direct short for a second or two without damage to its components. As a rule, however, you should turn off the power before making any power patch cord changes.

Connect a Cabonga to the power supply and mixer circuits to verify that both are functioning correctly. Successively try each power and mixer input jack to be sure they are correctly wired.

The Modifier. Most often, the damped sinusoidal output of the Cabonga is the signal you will use. But there will be times when a certain amount of clipping is needed. For example, the peaks of the Cabonga output should be clipped somewhat to get a "crisp" sound like that of a good bongo. This also produces a better sounding tom-tom.

The schematic diagram of the Modifier is shown in Fig. 8. The circuit is simply a 100-ohm potentiometer. It presents a variable load of from 0 to 100 ohms to the output stage of the Cabonga. As the load resistance decreases below the value required for "crispness," various sound effects can be obtained. Although the load resistance as seen by the Cabonga varies, the Combiner/Power Pack input sees a constant 100-ohm signal voltage source.

The Modifier, as well as the Auto Trig-

Fig. 8. Modifier is simple potentiometer circuit shown here.

MODIFIER PARTS LIST

J1, J2—Standard phone jacks
R1—100-ohm, linear-taper potentiometer
Note—See photo p. 80 for kit price.

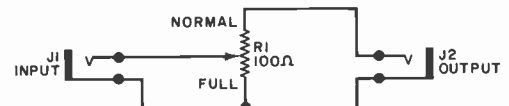

BILL OF MATERIALS

Same as for Auto Trigger, less phenolic stock and one $3/4$ " diameter knob.

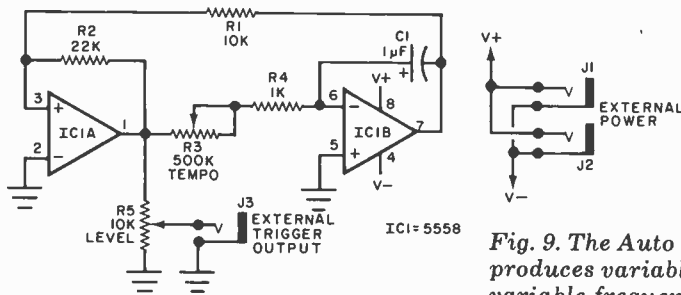

AUTO TRIGGER PARTS LIST

- C1—1- μ F, 16-volt electrolytic capacitor
- IC1—5558 dual operational amplifier
- J1, J2—Miniature phone jack
- J3—Subminiature phone jack
- R1—10,000-ohm, $\frac{1}{4}$ -watt, 10% carbon composition resistor
- R2—22,000 ohm, $\frac{1}{4}$ -watt, 10% carbon composition resistor
- R3—500,000-ohm, audio-taper potentiometer
- R4—1000-ohm, $\frac{1}{4}$ -watt, 10% carbon composition resistor
- R5—10,000-ohm, linear-taper potentiometer

BILL OF MATERIALS

- 1—Piece $\frac{1}{32}$ " aluminum 4" \times 2"
- 2—Pieces $\frac{3}{4}$ " pine or plywood 5- $\frac{1}{16}$ " \times 2"
- 2—Pieces $\frac{3}{4}$ " pine or plywood 2- $\frac{1}{16}$ " \times 2"
- 1—Piece $\frac{1}{8}$ " rubber matting 4- $\frac{3}{4}$ " \times 2- $\frac{3}{4}$ "
- 1—Piece $\frac{1}{16}$ " phenolic stock 1 $\frac{1}{2}$ " \times $\frac{1}{2}$ "
- 1—Piece black vinyl 16 $\frac{1}{2}$ " \times 3 $\frac{1}{2}$ "
- 4—No. 4 \times $\frac{1}{2}$ " sheet metal screws
- 2— $\frac{3}{4}$ " diameter knobs

Fig. 9. The Auto Trigger produces variable-level, variable-frequency square waves.

R5—10,000-ohm, linear-taper potentiometer
Misc.—Printed circuit board, hookup wire, etc. See photo p. 80 for kit prices.

ger and Snare, should be housed in enclosures measuring about 5 $\frac{1}{4}$ " \times 3 $\frac{1}{8}$ " \times 2" (13.4 \times 7.9 \times 5.1 cm). The enclosures should be constructed from the same materials as used for the Cabonga itself and the Combiner/Power Pack, rabbeted, and finished with black vinyl and rubber matting. Top plates can be made from 4" \times 2" (10.2- \times 5.1-cm) pieces of $\frac{1}{32}$ " (0.8-mm) aluminum stock. Two standard phone jacks and the 100-ohm potentiometer are mounted on the Modifier top plate. Wire them as per Fig. 8.

To test the Modifier, patch the output of the Cabonga to input jack J1, and the output of the Modifier (J2) to the mixer input of the Combiner/Power Pack. Place R1 in its NORMAL position. Play the Cabonga and slowly rotate R1 toward its FULL position. You will notice that the sound becomes "crisp." As the control is rotated further, the sound will become more and more distorted and lower in volume. At the extremity of wiper travel, the output will be a steady oscillation if your potentiometer's minimum resistance closely approaches zero ohm. (This will not damage the Cabonga output state.)

The Auto Trigger. Before we discuss the Auto Trigger, let's review how the Cabonga has been triggered until now. When the head is struck, switch S1 closes and applies a pulse to the active filter, resulting in a damped sinusoidal output. The amplitude of the trigger pulse determines the amplitude of the output signal. Jack J1 (EXTERNAL TRIGGER) is connected in parallel with S1 so

that an external pulse source can cause the generation of a percussive output.

The Auto Trigger is such a pulse source. It produces a variable level (0 to 9 volts), variable-frequency (0.5-to-400-Hz) square waves. Its circuit, shown schematically in Fig. 9, is not complicated. Only seven components are used. Operational amplifier IC1A, one half of a 5558 dual op amp IC, is used as a comparator. The other half, IC1B, is used as an integrator. When the comparator output changes states, a pulse is generated. This pulse is integrated by IC1B into a ramp whose slope depends on the amount of signal current supplied to the integrator, and thus on the values of R3 and R4. When the output of the integrator reaches one-half of the supply voltage, the comparator changes states again. The process then repeats itself.

Resistors R3 and R4, and capacitor C1 determine the frequency of oscillation. It can be varied over a wide range by adjusting TEMPO control R3. The upper limit of oscillation is governed by R4. Square waves appear at the output of IC1A and are coupled to J3 by LEVEL control R5. Power is derived from the Combiner/Power Pack and coupled to J1 or J2. An extra power jack is provided for patching to other accessories.

Etching and drilling and parts placement guides for a suitable schematic are shown in Fig. 10. Be sure to observe the polarity of C1 and the pin basing of IC1 when mounting them on the board. Construct an enclosure and top plate to the dimensions and style previously described. Note that jacks J1 and J2 must

be isolated from the aluminum top plate, which is at ground potential.

Connect a power patch cord between the Combiner/Power Pack and J1 or J2 of the Auto Trigger. Then connect a patch cord terminated with subminiature phone plugs between the Cabonga's EXTERNAL TRIGGER jack (J1) and the Auto Trigger output (J3). Turn the Auto Trigger's TEMPO and LEVEL controls fully clockwise. Then close the Combiner/Power Pack's power switch and monitor the mixer output. You will hear an output signal about once every two seconds. As the TEMPO control is rotated, the trigger rate will increase. Rotating the LEVEL control will vary the output signal's volume from minimum to maximum.

The Snare Drum Adapter. The snare sound is the most difficult to synthesize because a snare drum produces three different sounds simultaneously. As the drumstick strikes the top head, the sharp sound of the strike is heard. At the same time the sound of the drum itself (actually a medium-size tom-tom) is produced. The bottom head also vibrates and causes the snare wires touching it to move.

We can synthesize this complex sound by combining three different components: a high-level, short-duration pulse; an exponentially damped sine wave; and filtered noise. The damped sinusoid is already available at the Cabonga output. We can therefore use the Cabonga to trigger an accessory that

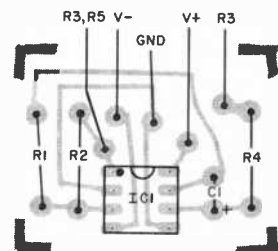
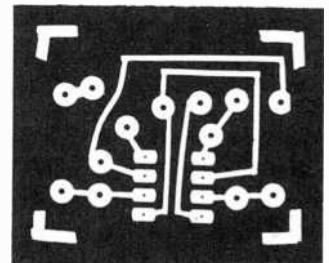

Fig. 10. Guides for Auto Trigger board.

will produce the other two components and mix them all together to produce a synthesized snare.

That is exactly what the Snare Drum

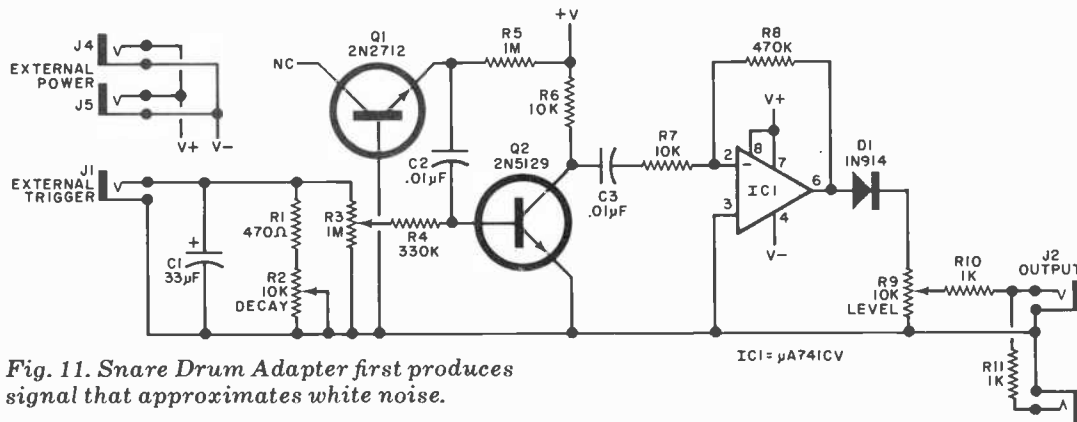

Fig. 11. Snare Drum Adapter first produces signal that approximates white noise.

SNARE DRUM ADAPTER PARTS LIST

- C1—33- μ F, 16-volt electrolytic capacitor
- C2, C3—0.01- μ F disc ceramic capacitor
- D1—1N914 or 1N4148 silicon diode
- IC1— μ A 741CV operational amplifier
- J1—Subminiature phone jack
- J2, J3—Standard phone jack
- J4, J5—Miniature phone jack

- Q1—2N2712 npn silicon transistor
 - Q2—2N5129 npn silicon transistor
- The following fixed resistors are 1/4-watt, 10% carbon composition components.
- R1—470 ohms
 - R4—330,000 ohms
 - R5—1 megohm
 - R6, R7—10,000 ohms
 - R8—470,000 ohms

- R10, R11—1000 ohms
 - R2, R9—10,000-ohm, linear-taper potentiometer
 - R3—1-megohm trimmer potentiometer
- Misc.—Hookup wire, printed circuit board, etc. See photo p. 80 for kit prices.

BILL OF MATERIALS

Same as for the Auto Trigger

Adapter does. It is shown schematically in Fig. 11. Noise generator *Q1* produces a continuous signal that approximates white noise. Capacitor *C2* couples the noise to the base of *Q2*.

When a voltage spike is applied to the Snare's EXTERNAL TRIGGER jack (*J1*), it charges *C1*. Such a spike is available when the Cabonga's trigger switch closes as the head is struck. Depending on the values of *R1* and *R2*, the voltage across *R3* decays exponentially with a time constant equal to the product of *C1* and (*R1*+*R2*). A portion of this voltage envelope (determined by the setting of *R3*) is also applied to the base of *Q2* via

R4. The voltage envelope causes *Q2* to conduct and pass the noise signal.

Transistor *Q2*'s output is filtered and capacitively coupled by *C3* to a high-gain amplifier. At the input to op amp *IC1*, the signal comprises a high-level spike and a very low-level noise component. Amplifying the signal by a factor of 47 (determined by the ratio *R8/R7*) produces a useful effect. The initial spike, whose amplitude is already approaching the positive supply voltage, is relatively unaltered while the noise component is amplified and equalized in level with the spike.

However, the high gain has an unde-

sirable side effect—it greatly accentuates the internal noise of the inexpensive op amp. To eliminate this noise, *D1* is placed in series with the op amp output. The diode will not pass signals below 0.7 volt, so the unwanted noise, which would sound like a low-level hiss, is eliminated but the desired signal is allowed to pass. In the process, we get a bonus—the noise is made to sound more realistic by clipping off its bottom half. Resistors *R10* and *R11* combine the Cabonga and Snare waveforms into a single output, available at output jack *J2*. Potentiometer *R9* serves as a LEVEL control for the snare signal.

Etching and drilling and component placement guides are shown in Fig. 12. Mount the components on the board, observing polarities and pin basing of the semiconductors and electrolytic capacitors. Construct an enclosure and top plate to the dimensions and style previously described. Note that jacks *J4* and *J5* must be isolated from the aluminum top plate, which is at ground potential. Trimmer potentiometer *R3* is installed on the pc board. The other potentiometers are mounted on the top plate.

Patch external power to *J4* or *J5*, and run patch cords from the Cabonga output and external trigger jacks to *J3* and *J1*, respectively. Interconnect the Snare

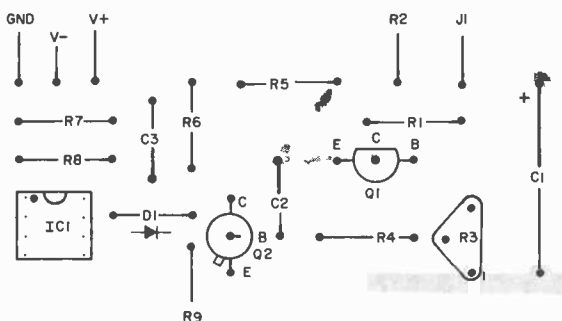

Fig. 12. Use the etching and drilling guide below and component placement at left to make Snare Drum Adapter board.

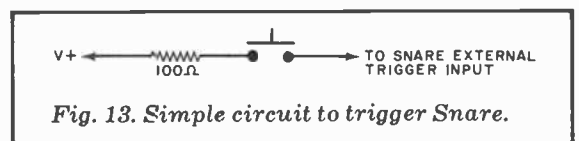
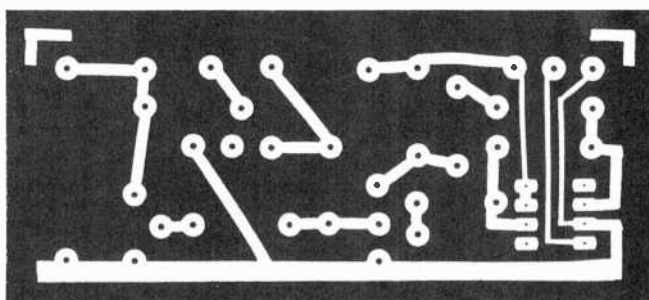
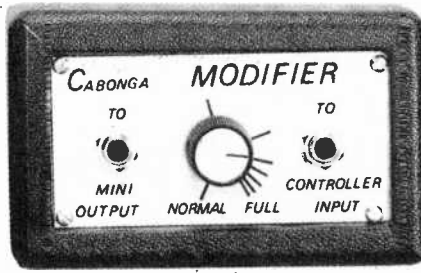

Fig. 13. Simple circuit to trigger Snare.



output (J2) to the Combiner/Power Pack's mixer input. Place the thumbwheel of R3 at the midpoint of its rotation. While striking the Cabonga drum head, adjust the setting of R3 in either direction until you obtain the most pleasing sound. As you strike the head, you will hear the sound of the strike, the tom-tom and the noise simultaneously. The relative loudness of the strike sound as compared to the noise is governed by R3, so you might have to make a compromise adjustment of the trimmer potentiometer. Adjust the output level to obtain a balanced snare sound.

Use the circuit shown in the Fig. 13 to trigger the Snare. It will result in a fair approximation of a cymbal. Then trigger the Snare with the Auto Trigger. For a different effect, prepare a patch cord from a single piece of stranded hookup wire. Solder the hookup wire to the tips of two subminiature phone plugs. Connect the patch cord to the Auto Trigger output and the Snare EXTERNAL TRIGGER input. Turn both Snare controls to maximum. By adjusting the Auto Trigger TEMPO and LEVEL controls, you can create such effects as the sound produced by a biplane.

Using the Cabonga System. The Cabonga and its accessories form an expandable synthesizer system. As with any electronic musical instrument, the best way to realize its full potential is to experiment. Here are some hints. It is always best to turn off the power before making any patch cord changes. As previously mentioned, this prevents inadvertent damage to the power supply diodes. It's the only restriction on use of the system that should be observed. Let your imagination dictate system configurations and patches.

Cabonga accessories are shown here and below. Following are available from JAL Assoc., Box 107, Eatontown, NJ 07724: Combiner/P-P pc board at \$3.50, complete kit, \$27; Snare pc board, \$3.50, complete kit, \$16.95; Auto Trig. pc board, \$1.50, complete kit, \$12.95; Modifier complete kit, \$7.50. All postpaid. NJ residents add 5% sales tax.

A three-head system is shown in Fig. 14. (You may prefer a fivehead system.) Cabonga 1 is set up as a snare, Cabonga 2 as a tom-tom and Cabonga 3 as an automated bass drum, resulting in an electronic drum set. Set the Modifier control to give a crisp tom-tom sound.

The Controller and Power Pak is necessary to connect all the other units together.



As mentioned in Part I of this article, the Cabongas can be interconnected via their EXTERNAL TRIGGER jacks. Tune two Cabongas an octave apart and interconnect them. You will note that the sound produced is much fuller than that from just one. Another possibility using four Cabongas is as follows. Tune two (A and B) as a Conga set and two (C and D) as a pair of Bongos. Interconnect A to

On the more practical side, you can use a number of Cabongas and Modifiers to make a fairly realistic steel drum set. The Modifier, as previously mentioned, is most useful when synthesizing a Bongo or tom-tom.

Those are some ideas to get you started. As you experiment more and more, you will probably create sounds that no one else has even thought of! ◇

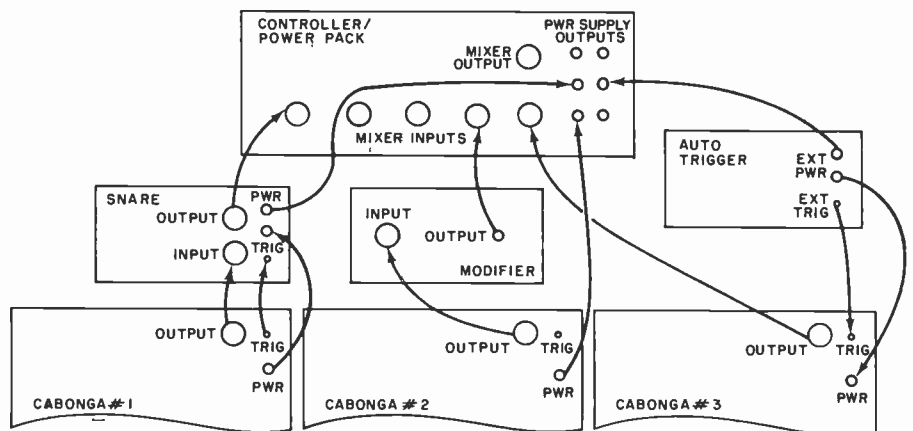

Fig. 14. This interconnection diagram shows how to set up a three-headed Cabonga system.

C and B to D. When you play either the Congas or Bongos, you'll hear both pairs simultaneously.

The Auto Trigger can be used in many different ways. Adjust its output frequency for about 2 Hz and use it to trigger the Cabonga. Briskly rotating the Cabonga PITCH control back and forth will produce an effect reminiscent of the "musical percolator" that appeared in television coffee commercials.

By increasing the tempo and rotating the PITCH control from minimum to maximum, you'll hear a sound effect common to science fiction movies. If the tempo is set just right, you will hear an "echo" as the bubbling sound increases in pitch. Stepping up the tempo even more causes the sound to become a continuous oscillation. The Cabonga then acts like a variable bandpass filter (waa waa), and the PITCH control functions as the bandpass frequency selector. You can also trigger the Snare with the Auto Trigger to create such sounds as that from a locomotive, breathing, and others which are difficult to describe!



HOW TO CUSTOM DESIGN PLASTIC CASES FOR PROJECTS

BY JOHN HUFF

An auto-clock case is used to describe cutting, bending, joining, etc.

YOUR electronic projects deserve to be housed in attractive and reasonably priced "custom designed" cases. As a modern hobbyist, you don't have to make do with utility boxes that do not complement your projects. Instead, you can design your own inexpensive and attractive plastic cases, thanks to the ready availability of acrylic plastic sheets and tubes.

Acrylic plastic is easier to work with than wood—and with the same tools used in woodworking. It can be cut, filed, sanded, glued, and even bent to permanently conform to a desired shape. Available under such brand names as Plexiglas, Lucite, and Safe-t Vue, it comes in crystal clear, color-tinted transparent, translucent, and opaque sheets in 1/16", 1/8", and 1/4" (1.6, 3.2, and 6.4 mm) thicknesses.

This article describes how to work with acrylic plastic to custom design and fabricate cases for your electronic projects. To illustrate the step-by-step procedure to use, we also include a digital Kar Klok project to assemble (see box). The Kar Klok is built around National Semiconductor's new MA1003 clock module, a printed circuit assembly containing a four-digit 0.3" (7.6-mm) high fluorescent display, time base, clock chip, and all necessary driving circuitry.

Working With Acrylic. Just about any brand of acrylic plastic can be used by the electronics hobbyist because all

have the same basic physical properties. However, some types of acrylic are easier to work with than are others. Most acrylic pieces made by the cast method can be cemented together with a solvent that actually dissolves the mating surfaces and forms a monolithic weld joint in minutes. More difficult to work with are the acrylics made by a continuous conveyor-belt process, which require a

thickened type of cement (airplane dope) that takes an hour or more to set. Needless to say, cast acrylic, such as Plexiglas G, is your best first choice. Ask for Plexiglas G (or similar cast-type acrylic) at your local hardware or hobby/craft store.

Acrylic sheets come with a special protective paper on both surfaces to prevent scratches. This paper makes an ex-

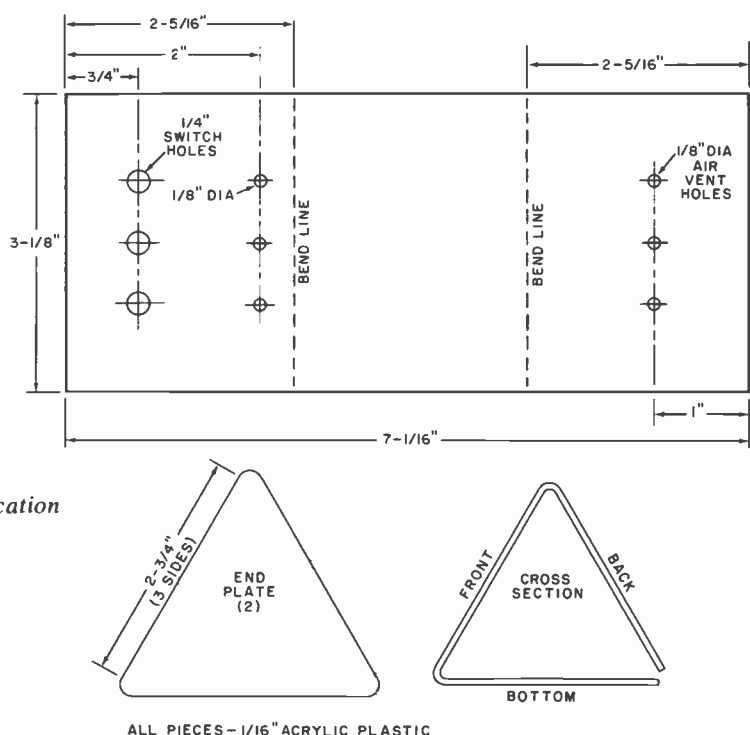

Fig. 1. Fabrication details for the Kar Klok case.

cellent surface for marking cutting lines and the centers of holes to be drilled.

The plastic can be cut with a saw or a special scribing tool. You can use a jig-saw, hacksaw, coping saw, or saber saw for cutting. However, scribing is easier if all you have to do is cut straight lines. Curved lines and circles still require cutting with a saw.

The fabrication details for the Kar Klok (see box) case are shown in Fig. 1. Mark all necessary lines and hole centers on the protective paper on the acrylic sheet.

The scribing tool, which sells for about \$2.00 wherever the plastic is sold, looks like a miniature harpoon. In use, the sharp point of the tool is guided along the cut line with moderate downward pressure, using a straight edge, as shown in Fig. 2. Once the line is scribed, the plastic is placed over the edge of a table, scribed line up and in direct alignment with the edge of the table, and struck sharply on the side overhanging the table. The snapping action yields a very straight, clean edge. The snapped edges must then be lightly smoothed with fine sandpaper before being cemented. Edges that are not to be cemented can be buffed to a crystal sheen with a drill-mounted muslin wheel and a special buffing compound (about \$3.00 for wheel and compound) or with fine steel wool and soap and water.

Cutting holes is done with ordinary drill bits, as shown in Fig. 3. It is important to note that during the drilling operation, the sheet of plastic must be firmly held or clamped to a piece of wood to prevent it from riding up the bit and cracking. Square and rectangular slots can be made by drilling a small hole and cutting with a coping saw.

Since the Kar Klok case pictured in the lead photo and dimensioned in Fig. 1 is triangular in shape, it is necessary to bend the acrylic plastic sheet to conform to this shape. The trick to making accurate bends is to use a bending jig and heat only those portions of the plastic that are to be bent. Do not heat the entire surface of the plastic.

Acrylic plastic bends at about 300° F (about 150° C). It bends best if the protective paper is peeled off before the heat is applied. You can heat the plastic along the bend line in several ways, the easiest of which is to use the specially made strip heater element that sells for about \$8.00 from the same dealers who handle the plastic. This heater element requires a simple wood strip that keeps it about 1/4" (6.4 mm) away from the plastic. Detailed instructions come with the element.

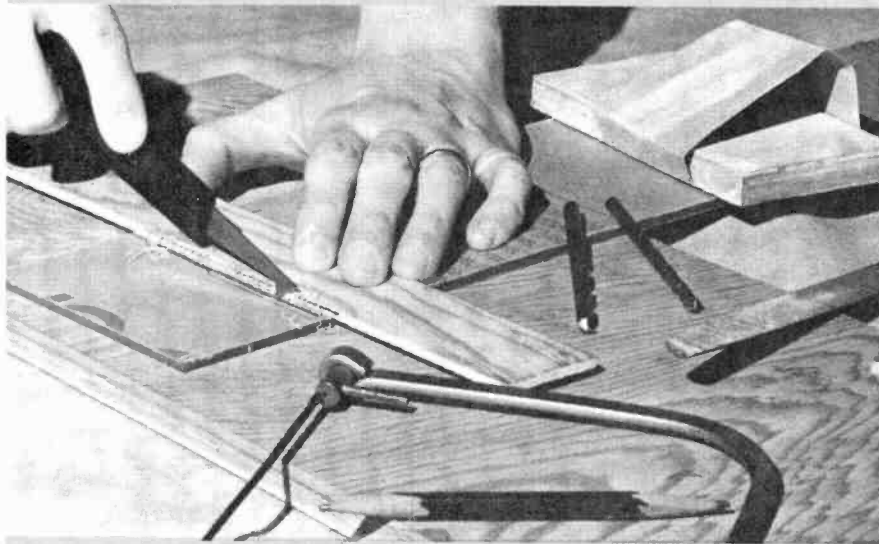

Fig. 2

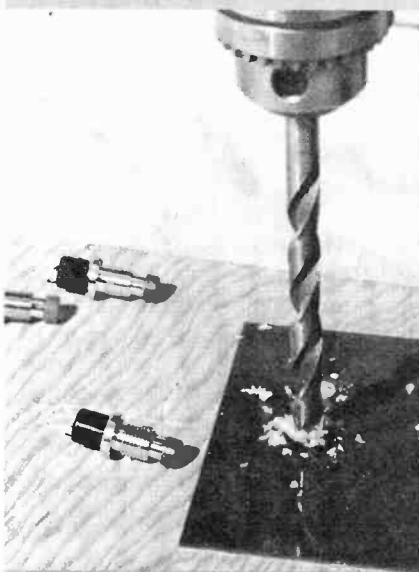

Fig. 3

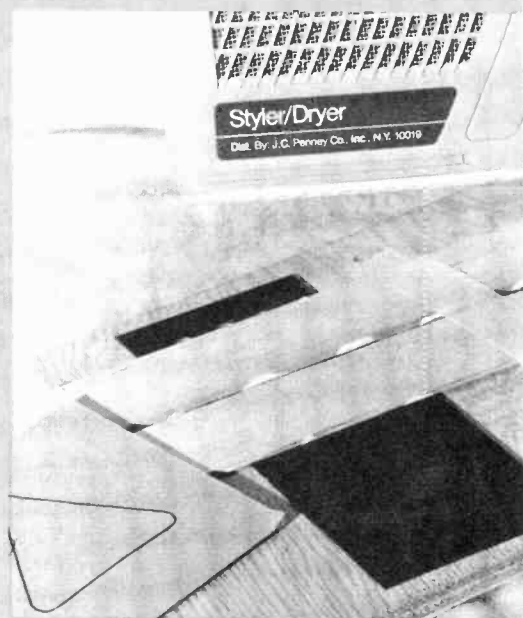

Fig. 4

Fig. 2. The acrylic scribing tool, obtainable wherever the plastic is sold, looks like a small harpoon and is used to scribe a line, following a straight edge, where the plastic is to be broken.

Fig. 3 Acrylic is easily drilled by holding the plastic firmly to a wooden base. Here, holes are being drilled for pushbutton switches. Square and rectangular slots can be made by drilling a hole and cutting with a coping saw.

Fig. 4. Acrylic bends at about 300° F. Here strips of wood faced with cloth for protection, are placed on both sides of bend mark and heat is applied by a 1000-watt hair dryer.

Fig. 5. Heat for bending can also be obtained from a 500-watt photoflood bulb.

Fig. 6. Once the plastic has been heated, it can be bent using a jig as shown here. Note that the actual cross-section of the case has been drawn on the bottom of the jig. Jig corners are 4-inch nails.

Fig. 7. Acrylic solvent cement is easily applied and dries in minutes.

Here one end of the clock case is being glued to the main frame.

Fig. 8. If preferred, an acrylic cylinder can be used for the body of the clock with square end pieces as shown here.

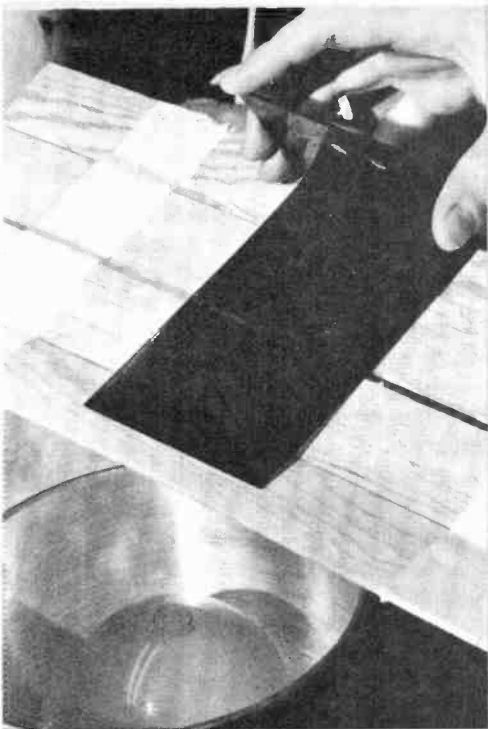

Fig. 5

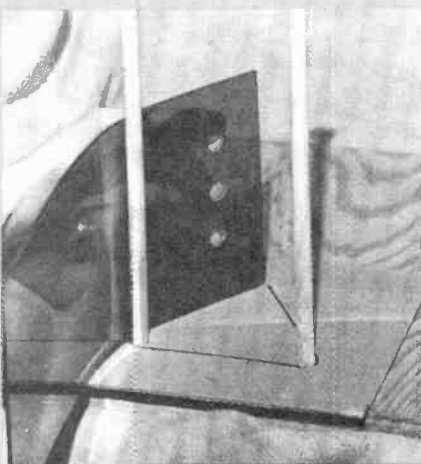
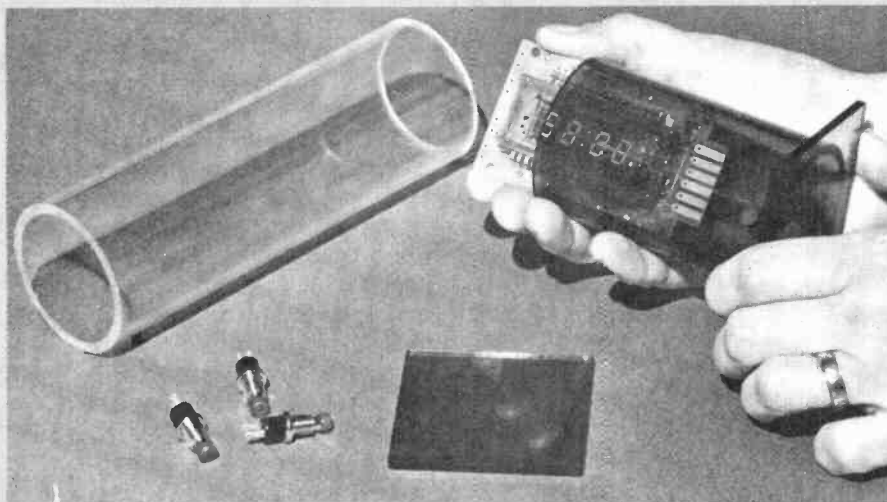

Fig. 6



Fig. 7

Fig. 8



Another bending technique is to place the plastic sheet on a flat surface, place a 1/4" thick strip of wood on both sides of the bend line (face the strips with soft cloth or cotton to prevent them from scratching the plastic), and use a blow-type hair dryer to heat along the line. Details are shown in Fig. 4. The hair dryer must be rated at a minimum of 1000 watts. How well it heats the plastic depends on the chemistry of the particular sheet of acrylic you use. Do not hold the dryer too close to the plastic or the air flow will be restricted and the heat fuse will blow.

Still another approach that works for heating the plastic is to use a 500-watt photoflood lamp. Again, use wood strips to frame the bend line. Hold the plastic about 10" (25.4 cm) away from the lamp as shown in Fig. 5.

Once the plastic has been heated, it can be bent to shape using a bending jig as shown in Fig. 6. Note here that, to get the angles correct during bending, the actual-size cross-section of the body of the clock case is drawn on the base of the jig. A 4" (10.2-cm) long nail is then driven into the indicated corners of the drawing and the plastic is aligned with the drawing and gently bent around the nails. When the bending operation is complete, there will be a small open slot where the ends of the plastic sheet do not quite meet. This slot is used for running the wires between the vehicle's electrical system and the clock module, without drilling holes.

Next, cut the triangular end pieces for the case from the same plastic sheet from which the case body was cut, using Fig. 1 as a guide. After sanding the edges smooth and buffing them, cement one side piece to the case body as shown in Fig. 7. Slip the clock module into the case. Then fasten down the pushbutton switches in their appropriate holes and route the electrical-system hookup wires through the slot in the body of the case. Cement the other side piece to the case.

Decide where in your vehicle you want to mount the Kar Klok and cement Velcro strips to the bottom edges of the case end pieces with the solvent cement and to the dashboard with a silicone adhesive. Finally, route the wires coming from the clock module into your vehicle's electrical system (see box for hookup details). The use of Velcro strips to mount the clock allows you to remove the clock and put it out of sight to reduce the possibility of theft.

A Simpler Case. Perhaps you do not

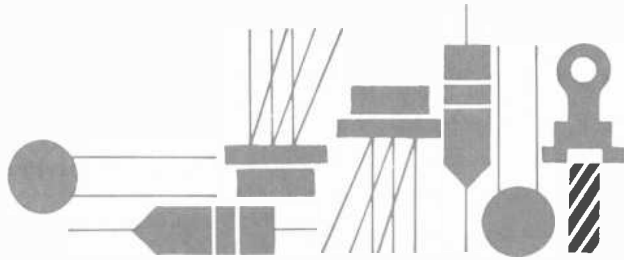

Solid State

By Lou Garner

IC AUDIO PREAMPLIFIERS

SEMICONDUCTOR devices have been used in audio amplifiers ever since the transistor first became a practical commercial product. In fact, to a large degree it was the continuing search for improved and more efficient audio amplifiers and switches which led to the invention of the transistor by scientists of the Bell Telephone Laboratories in the late 1940's. The first consumer application of transistors was as audio amplifiers in hearing aids, followed shortly thereafter by their use in the audio sections of AM radio receivers and as preamplifiers for vacuum tube operated audio systems. As time passed, the mass production of junction transistors for the hearing aid industry resulted in a surplus of units which didn't meet the critical requirements of hearing aid designs but which, nonetheless, were excellent amplifiers. These devices were made available to the retail market through local distributors as moderately priced "experimenter's transistors," opening a whole new field for the experimenter and hobbyist.

Originating back in the heydays of vacuum-tube amplifiers, the preamplifier often was an afterthought—that is, an extra retrofitted circuit used to boost relatively weak signals prior to processing by a conventional amplifier. Sometimes the preamp, as it came to be known, was incorporated as part of an external signal source, such as a condenser microphone or magnetic phono pickup. In other cases, the preamp was an add-on circuit mounted directly on the main amplifier chassis and using the same power source. In still other cases, it was a separate piece of self-contained equipment with an integral supply as well as input and output jacks. In those early days, the preamp generally was a single- or dual-stage circuit designed to furnish some frequency compensation as well as modest gain. It seldom was equipped with gain or tone con-

trols, however, for these were found in the main amplifier assembly.

Today's preamp designs range from simple single-purpose configurations to complex circuits with nearly as many controls as an oscilloscope. Depending on equipment performance requirements, the preamp may be used only as a buffer or isolation amplifier. More often, it serves to provide additional gain and impedance matching as well as frequency compensation, equalization, and control. While early solid-state audio preamps usually employed from one to four discrete transistors, current designs commonly feature one or more integrated circuits. General-purpose operational amplifiers are perhaps the most widely used devices as preamps, with FET-input types increasingly popular among design engineers because of their high input impedance characteristics.

Typical IC audio preamp designs are illustrated in Figs. 1 through 4. Abstracted from manufacturers' data sheets, application notes and similar published literature, these circuits all feature standard devices and commercial components and, therefore, are suitable for a variety of experimenter and hobbyist projects. Generally, layout and lead dress are not overly critical as long as good wiring practice is observed. This permits the circuits to be assembled using standard construction techniques, including pc or perf boards, solderless wirewrap, or conventional point-to-point wiring. In general, too, dc circuit power may be obtained either from batteries or well filtered and regulated ac line operated power supplies, at the builder's option. Since the required assembly and wiring time is but a few man-hours for most of the circuits, the designs are excellent for weekend projects.

Selected from data sheets published by the Signetics Corporation (811 East Arques Ave., Sunnyvale, CA 94086), the four simple audio preamp circuits shown in Fig. 1 are based on the NE542 dual low-noise preamp IC. However, the general designs may be used with a variety of amplifier IC's having similar electrical characteristics, including the LM381, LM381A, and LM387, with few, if any, changes in component values. Of course, pin connections vary with different IC's and an adjustment in dc supply voltages may be required for some types to achieve optimum performance. Of the four IC's in-

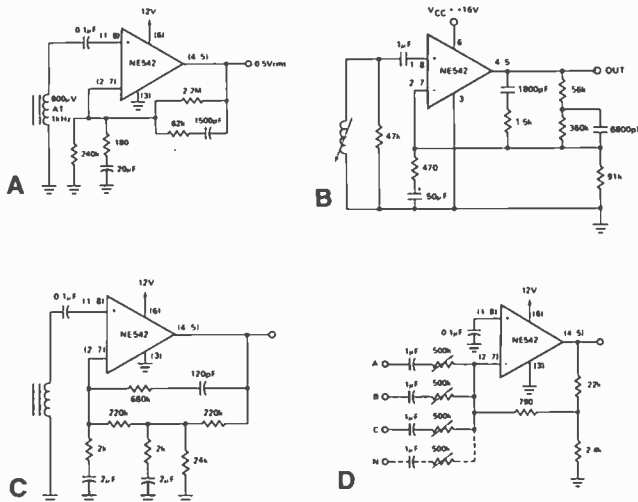

Fig. 1. Audio preamp circuits: (A) tape playback; (B) RIAA phono; (C) NAB tape preamp; (D) mixer.

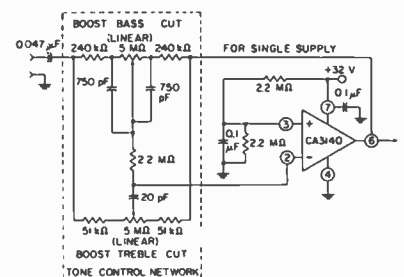

Fig. 2. This Baxandall tone control circuit uses a BIMOS unit.

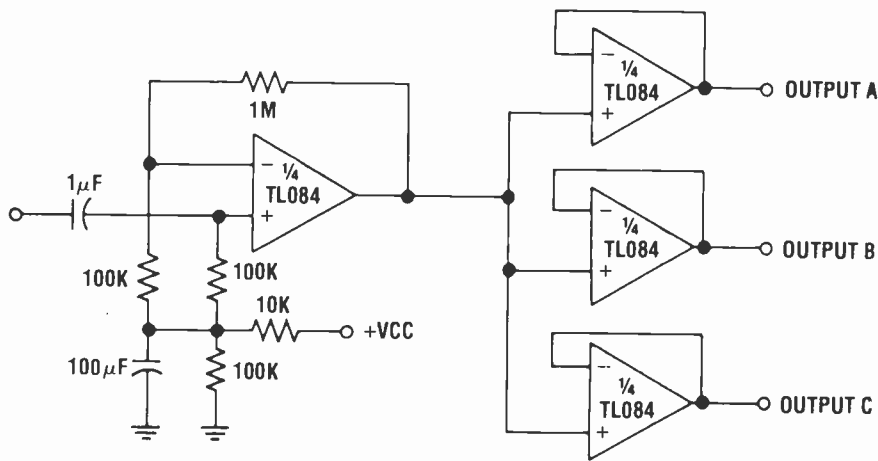

Fig. 3. This audio distribution amplifier circuit features multiple isolated outputs and can be used effectively in electronic musical instruments to achieve special effects.

dedicated, types NE542 and LM387 are supplied in 8-pin Mini-DIP's, while types LM381 and LM381A are furnished in standard 14-pin DIP's. All contain dual amplifiers, permitting a single device to be used for two-channel (stereo) systems.

A typical magnetic tape playback preamp circuit is illustrated in Fig. 1A. Requiring relatively few components, the circuit will deliver 0.5 V rms output when driven with an 800- μ V input signal (nominally, at 1 kHz) by the pickup coil. A modified preamp design providing RIAA equalization for use with standard magnetic phono cartridges is given in Fig. 1B. Intended primarily for broadcast equipment applications, a two-pole fast turn-on NAB tape preamp circuit is shown in Fig. 1C. Finally, a multiple input audio mixer circuit with independent gain controls is illustrated in Fig. 1D. All four preamp circuits are designed for operation on conventional single-ended dc power supplies.

Featuring a BIMOS device, the Baxandall tone-control circuit shown in Fig. 2 is one of a number of suggested applications described in a 20-page data brochure (File No. 957) published by RCA (Solid State Division, Box 3200, Somerville, NJ 08876) for the CA3140 op amp family. As described in April's column, the CA3140 is a dual-technology unit which combines a high-impedance MOSFET input stage with a bipolar output amplifier in a single op amp. The CA3140 devices are furnished in standard 8-lead TO-5 type metal cases. Using linear potentiometers, the Baxandall circuit, according to RCA, can furnish up to ± 15 dB bass and treble boost or cut at 100 Hz and 10 kHz, respectively, while providing a full peak-to-peak output of up to 25 V to at least 20 kHz. The amplifier's output is only -3 dB down at 70 kHz from its 1-kHz reference

level. With the controls set for a flat frequency response, the circuit offers unity (0 dB) gain. As shown, the circuit is intended for operation on a single-ended dc power supply. It can be modified easily for operation on a dual ± 15 -V dc source, however, simply by removing the offset bias network and returning pin 3 (+input) to circuit ground while connecting pin 4, bypassed to ground with a 0.1- μ F capacitor, to the negative supply terminal rather than to ground; all other circuit connections remain unchanged.

In contrast to the multiple input mixer described earlier (Fig. 1D), the audio distribution amplifier circuit illustrated in Fig. 3 features multiple isolated outputs. It can be used effectively in electronic musical instruments for special effects as well as in PA, music distribution, and intercom systems requiring multiple drives for several power amplifiers to achieve high output levels. It also can be used in light organ, audio control, and test instrument designs. Abstracted from 20-page Bulletin CB-248, published by Texas Instruments, Inc. (P. O. Box 5012, Dallas, TX 75222), the distribution amplifier employs a type TL084 quad operational amplifier. A member of TI's BIFET family, the TL084 comprises four identical JFET input op amps in a single 14-pin DIP. The device can be operated on dc supply voltages of up to ± 18 V, with each amplifier section offering an input impedance of 10^6 megohms, a unity gain bandwidth of 3 MHz, a slew rate of 12V/ μ s, internal compensation, and continuous integral output short-circuit protection. Individual amplifier pin connections are not identified in the schematic diagram because the amplifier sections are interchangeable and the final selection can be made best by the equipment designer to achieve optimum layout and lead

Fig. 4. An audio preamp complete with gain as well as bass and treble tone controls.

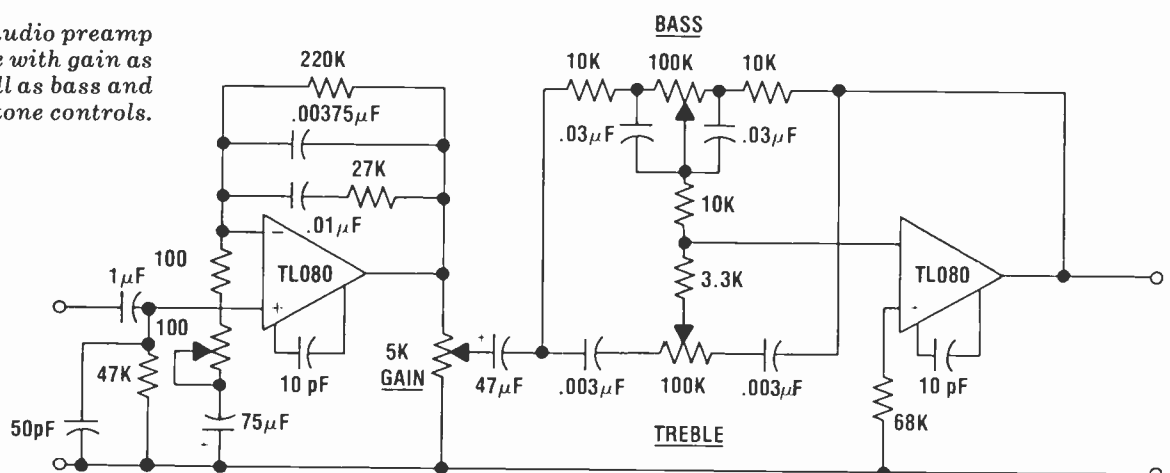

dress. In all cases, however, dc power supply connections are to pins 4 (+) and 11 (-).

Another TI BIFET circuit is given in Fig. 4—an audio preamp complete with gain as well as bass and treble tone controls. Intended for general purpose applications, the preamp can provide more than adequate drive for standard power amplifier designs. The circuit features the TL080, a single JFET input op amp which is offered in both 8-pin MiniDIP and TO-99-L style packages. Except for requiring external compensation (10-pF capacitors), the TL080's electrical characteristics are essentially similar to those of the individual amplifiers in the TL084, discussed earlier. The device's pin assignments are the same as those of such standard op amps as the LM301A, LM308, and μ A748.

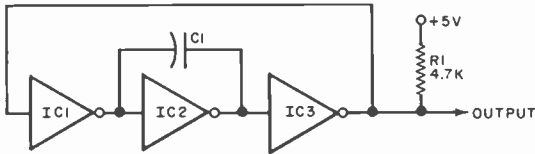

Fig. 5. Square-wave oscillator circuit can deliver signals from 1 Hz to 1 MHz as value of feedback capacitor is varied.

Right On! In last January's annual "predictions" column, you may recall, I predicted a further breakthrough in the pricing of digital electronic watches . . . that commercially available watches would be offered in the "ten-dollar range." Ah so! Texas Instruments, Inc., which originally broke the twenty-five dollar price barrier for digital watches, per an even earlier prediction, *has done it again!* In a recent press release, TI announced a reduction in the suggested retail list price of its model 503 sports/youth watches from \$19.95 to a low \$9.95!

Reader's Circuits. If the bulging mail bag is any indication, many of our readers have been quite busy devising and testing new circuits.

While on the subject of mail—a personal word to those of you who may have written and not received answers to your letters and postcards. The volume of mail generated by a magazine with a readership of 400,000 is simply too much for one guy to acknowledge personally. However, be assured that all letters are read and given full consideration. If you don't receive an answer to your inquiries promptly (or even at all), it isn't due to a lack of interest. It's simply because we don't have time. But please, please keep us posted about your interests and keep sending those interesting circuits.

We have a twenty-year old French-Canadian reader, Guy Isabel (1725, Henri-Bourassa East Blvd., Apt. 25, Montreal, Quebec, H2C 1J8, Canada), to thank for the simple and inexpensive square-wave oscillator circuit illustrated in Fig. 5. It is capable of delivering signals at frequencies ranging from 1 Hz to 1 MHz as the feedback capacitor's value, C_1 , is varied from 300 μ F to 300 pF. The circuit may be used as a "clock" in digital applications, as a simple square-wave generator for test instruments, or as a basic tone source for alarms and electronic musical instruments.

The duty cycle is approximately 50% and is independent of the feedback capacitor's value. The three active devices making up the oscillator, IC_1 , IC_2 , and IC_3 , are three sections of a standard type 7405 TTL open-collector hex inverter. Pull-up resistor R_1 is a half-watt unit, while capacitor C_1 may be a ceramic, plastic-film, paper or electrolytic type, depending on

MAKE GREAT CONNECTIONS!

IC SOCKETS

3 Level Wire Wrap Gold

Pin	1-9	10-24	25-100
14pin	.38	.37	.36
16pin	.42	.41	.40
18 pin	.73	.65	.59
24pin	1.00	.91	.83
40pin	1.61	1.51	1.37

Low Profile D.I.P. Solder tail, (TIN)

Pin	1-9	10-24	25-100
8 pin	.15	.15	.14
14pin	.18	.17	.16
16pin	.20	.19	.18
18pin	.27	.26	.25
20pin	.29	.28	.27
22pin	.35	.34	.33
24pin	.36	.35	.34
28pin	.42	.41	.40
40pin	.60	.57	.53

SINGLE END

Pin	6"	17"	18"	24"	36"	48"
14 pin	1.51	1.62	1.72	1.83	2.05	2.35
16 pin	1.64	1.76	1.87	1.99	2.21	2.44
24 pin	2.49	2.69	2.88	3.08	3.48	3.87

DOUBLE END

Pin	6"	17"	18"	24"	36"	48"
14 pin	2.76	2.87	2.97	3.06	3.30	3.51
16 pin	3.01	3.13	3.24	3.36	3.58	3.81
24 pin	4.55	4.75	4.94	5.14	5.54	5.93

DUAL IN-LINE PLUGS Use for mounting diodes, resistors, jumpers, etc.

Pin	1-24	25-49	1-24	25-99
8 pin	.46	.39	.10	.09
14 pin	.48	.40	.10	.09
16 pin	.56	.47	.10	.09
24 pin	.79	.72	.15	.13
40 pin	\$1.23	\$1.08	.25	.22

S-100 BUS CONNECTORS 2 x 50 x .125" \$3.75
 WIRE WRAP TERMINATIONS \$3.75
 SOLDER TAIL TERMINATIONS \$3.75
 4 S-100 CONNECTORS - ANY MIX - \$14.00

YES! WE HAVE WIRE-WRAPPING TOOLS

Hobby-Wrap-30 & 30M

Wire wrapping, stripping, unwrapping tool for AWG 30 on Q25 (0.63mm) Square Post

Regular Wrap	WSU 30	\$5.95
Modified Wrap	WSU 30M	\$6.95

FREE! Free 50' wire with either tool

Only \$34.95
Batteries not included.
Replacement Bit BT-30...\$2.95

Minimum Order, USA, \$10
Foreign, \$15 in US Funds.
Surface Shipping Prepaid.
Add 50c insurance

tri-tek, inc.
6522 R NORTH 43RD AVENUE,
GLENDALE, ARIZONA 85301

SEND FOR FREE CATALOG
CIRCLE NO. 60 ON FREE INFORMATION CARD

PRINTED CIRCUIT KITS MAKE CARDS QUICKLY

32XA-1 kit

ONLY Vector kits contain:

- Positive photo-resist coated AND uncoated copper laminate—no messy photo-reversal—no spraying, dipping, or baking.
- 4 types of art aids: rub transfers, ink, tape, cut and peel—use 1 or all.
- 1:1 circuit art rub transfers—IC sets, pads, lines, connectors, symbols, letters, and numbers.
- Everything included—just add water and sunlamp or bright sunshine.
- Liquid etchant and developer—no dry chemical mixing problems.

AND

- Process choices—make circuit on copper and etch for 1 card. Make circuit on film, expose, develop and etch for 1 or many cards.

ART AIDS	+	mylar film	+	sunlamp cards	+	developer & etchant	=	1 or many PC's
	+	card	+	etchant	=	1PC		

32XA-1 kit makes 7 PC cards, \$28.00, 32X-1 starter kit makes 2 cards, \$11.50

Vector Electronic Co., 12460 Gladstone Av., Sylmar, CA 91342
510177

CIRCLE NO. 61 ON FREE INFORMATION CARD

The better the training the better you'll

Send for
FREE
illustrated
career
guide

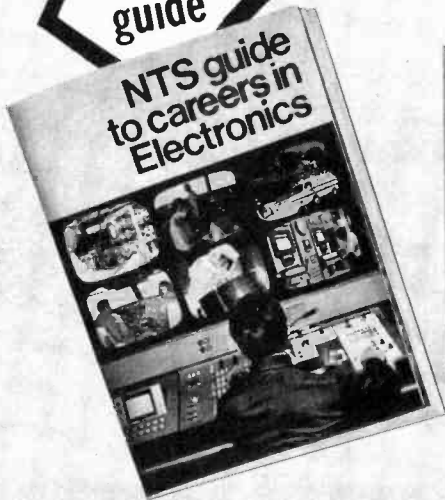

IN-CIRCUIT TRANSISTOR TESTER

COMPU-TRAINER

TROUBLESHOOTER
VOM

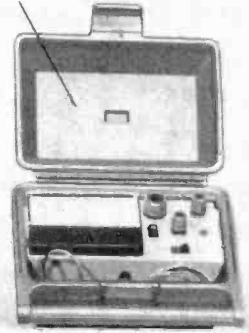
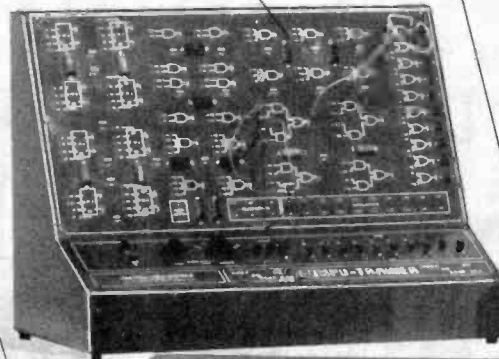

SOLID-STATE
OSCILLOSCOPE

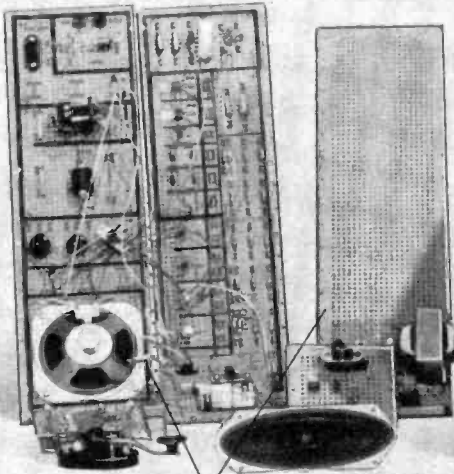

ELECTRO-LAB



(Simulated TV Reception)

As an NTS student you'll acquire the know-how that comes with first-hand training on NTS professional equipment. **Equipment you'll build and keep.** Our courses include equipment like the **NTS/Heath GR-2001 computerized color TV (25" diagonal)** with varactor diode tuning and digital read-out channel selection; (optional programming capability and digital clock avail.).

Also pictured above are other units — 5" solid state oscilloscope, vector monitor scope, solid-state stereo AM-FM receiver with twin speakers, digital multimeter, and more. It's the kind of better equipment that gets you better equipped for the electronics industry.

This electronic gear is not only designed for training; it's field-type — like you'll meet on the job, or when you're making service calls. And with NTS easy-to-read, profusely illustrated lessons you learn the theory behind these tools of the trade.

Choose from 12 NTS courses covering a wide range of fields in electronics, each complete with equipment, lessons, and manuals to make your training more practical and interesting.

Compare our training; compare our lower tuition. We employ no salesmen, pay no commissions. You receive all home-study information by mail only. All Kits, lessons, and experiments are described in full color. Most liberal refund policy and cancella-

and the equipment be equipped.

COMPARE OUR
KITS AND LESSONS.
COMPARE OUR
TUITION.

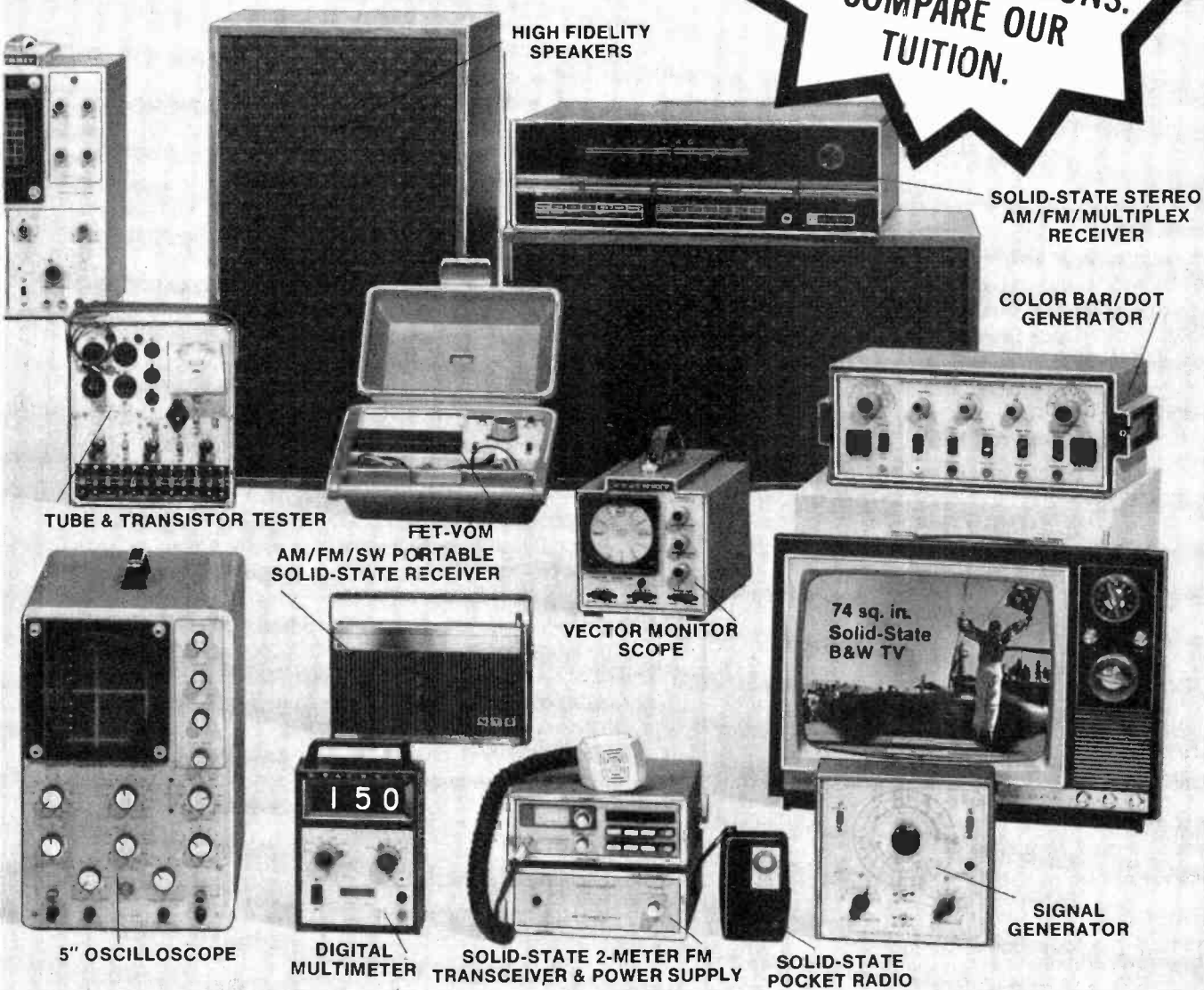

tion privileges spelled out. Make your own comparisons, your own decision. Mail card today, or clip coupon if card is missing.

NO OBLIGATION. NO SALESMAN WILL CALL

APPROVED FOR VETERAN TRAINING

Get facts on new 2-year extension

NATIONAL TECHNICAL SCHOOLS

TECHNICAL-TRADE TRAINING SINCE 1905
Resident and Home-Study Schools
4000 So. Figueroa St., Los Angeles, Calif. 90037

NATIONAL TECHNICAL SCHOOLS
4000 South Figueroa St., Los Angeles, Calif. 90037
Please send FREE Color Catalog and Sample Lesson.
NO OBLIGATION. NO SALESMAN WILL CALL.

Dept 205-097

- | | |
|---|--|
| <input type="checkbox"/> Color TV Servicing | <input type="checkbox"/> Electronics Technology |
| <input type="checkbox"/> B & W TV and Radio Servicing | <input type="checkbox"/> Computer Electronics |
| <input type="checkbox"/> Electronic Communications | <input type="checkbox"/> Basic Electronics |
| <input type="checkbox"/> FCC License Course | <input type="checkbox"/> Audio Electronics Servicing |

NAME _____ AGE _____

ADDRESS _____ APT # _____

CITY _____ STATE _____

Please fill in Zip Code for fast service _____

- Check if interested in G.I. Bill information.
 Check if interested ONLY in classroom training in Los Angeles.

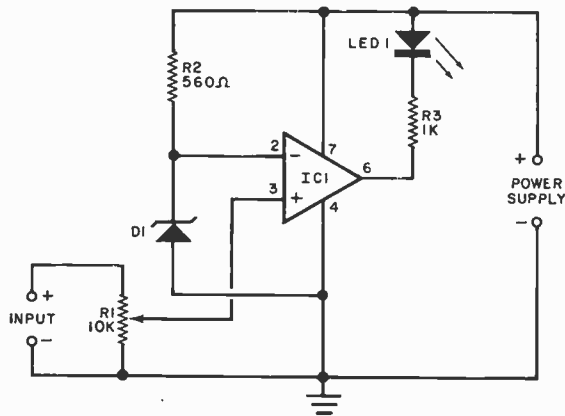

Fig. 6. This dc low-voltage monitoring circuit uses a standard op amp IC as a voltage comparator and to drive the LED output indicator.

value. With neither parts placement nor wiring arrangement critical, the circuit can be assembled in a small metal or plastic case with an integral dc power source as a self-contained instrument or incorporated as part of a more complex piece of equipment, at the individual builder's option.

Ted Reiter (1442 Brook Drive, Titusville, FL 32780), a frequent contributor to these pages, suggests that his dc low-voltage monitoring circuit might be of value to other experimenters and hobbyists. Ted's circuit, Fig. 6, uses a standard op amp, IC1, as a voltage comparator and output indicator

driver. In operation, a portion of the monitored voltage, determined by R1's adjustment, is compared to a fixed voltage obtained from a zener reference network, R2-D1, by IC1. As long as the monitored voltage remains at or above its present monitor point (determined by R1's setting), the output indicator, LED1, remains dark. If the voltage drops below this level, however, the indicator is activated.

The circuit can be set to operate within millivolts of a chosen setpoint level. Standard components are used in the design: IC1 is a type 741 op amp, R1 a conventional potentiometer, R2 and R3 one-quarter or one-half watt resistors, D1 a 3.3-volt zener, and LED1 a familiar red LED. A 12-volt dc power supply is suitable for monitoring input voltages of up to 12 volts, but a 15-volt power supply should be used for higher levels (up to 13.8 V). Since the circuit is essentially a dc amplifier, neither layout nor lead dress are critical.

Seeking a simple combination clock and single-pulse signal source for his digital experiments, Charles D. Baker (1141-18 Minto Ave., Kenora P9N 3K1, Ontario, Canada), devised the circuit in Fig. 7. Intended for operation on a standard TTL 5-volt dc source, the instrument can be used as a conventional clock, a two-phase clock, or a manually operated single-pulse generator.

The instrument's single active device is a standard TTL hex inverter, IC1. Three of the inverter sections are coupled together as a ring oscillator, with feedback capacitor C1 determining the frequency of operation (or clock rate). Shunt resistor R2 biases one inverter section into its active region to insure oscillation. Two of the sections are interconnected as a modified one-shot, delivering a negative-going output pulse, while the remaining section serves as a conventional inverter/buffer to deliver positive-going pulses.

The instrument's mode of operation is determined by function switch S1. When S1 is in its PULSE position, output pulses are delivered each time pushbutton switch S2 is depressed, discharging C2 through R4, and delivering a step signal through series isolating resistor R1. Between pulses, C2 is recharged through R5. When S1 is in its CLOCK position, the ring oscillator drives the one-shot through R1, and a continuous series of positive- and negative-going pulses is developed at a rate determined by C1's value.

Readily available components are used in the circuit. The hex inverter is a standard 7404. Capacitor C1's value and type are determined by the clock rate needed; and C2 is a

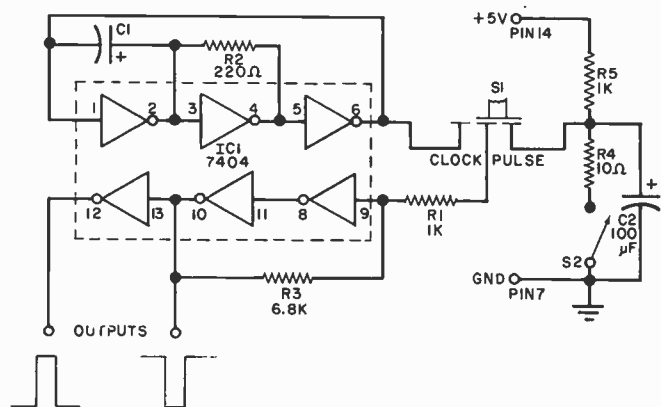

Fig. 7. Simple circuit using standard TTL hex inverter can be used as a conventional clock, two-phase clock, or single-pulse generator.

computer depot[®] Inc.
(Credit Cards Accepted)

3515 W. 70TH ST. • MPLS., MN 55435 • (612) 927-5601

SPECIALS			
PARTS			
7405	\$.15	7476	\$.30
7410	.15	7492	.35
7427	.20	7493	.35
7442	.40	7496	.50
7446	.60	74121	.30
74123	\$.60	74145	.50
74150	1.00	74151	.60

SYSTEMS	
IMSAI 8080 Assembled Systems with 22 Slot Mother Board	ONLY \$850.00
IMSAI 8080 Kit Form same as above	ONLY \$700.00
EDGE CONNECTORS S-100 Type	SAVE \$ 12.00
TARBELL TAPE INTERFACE KIT	ONLY \$110.00
OLIVER PAPER TAPE READERS	ONLY \$ 69.95

BOOKS	
T.V. TYPEWRITER COOKBOOK By Don Lancaster	\$ 9.95
ACTIVE FILTER COOKBOOK By Don Lancaster	\$14.95
BASIC BASIC By James S. Coan	\$ 7.95
BUG BOOKS	
I + II Both for	\$17.00
III	5.00
IV	15.00
TRANSISTOR TRANSISTOR LOGIC	\$ 6.50
BASIC Albrecht	\$ 4.95
FAIRCHILD MOS DATA BOOK	\$ 2.95
FAIRCHILD LINEAR TC	\$ 3.49
FAIRCHILD L.P. SCHOTTKY + MACRO LOGIC TTL	\$ 2.95
BASIC FOR BEGINNERS	\$ 7.95

ACCESSORIES	
E + L INSTRUMENTS	
SK10 Bread Board Socket	REG. \$16.50 NOW \$15.00
FAIRCHILD TECHNOLOGY KIT	
Automobile Clock Kit	\$40.00
AP PRODUCTS	
IC Test Clip 14 pin	REG. \$ 4.50 NOW \$ 4.00
HUNTER TOOLS	
Continuity Tester	REG. \$ 3.49 NOW \$ 3.00

100- μ F, 6-volt electrolytic. Function switch S1 is a spdt toggle, slide, or lever switch, while S2 is a spst, momentary contact, NO pushbutton switch.

At the builder's option, the instrument may be housed in a small metal box, a plastic case, or in a probe body. If assembled in a box or case where there is ample space, the builder may wish to include several different values for C1, selectable by means of a multi-position rotary switch, to provide a choice of clock rates. Typical values may range from a fraction of 1 μ F to as high as several thousand μ F. According to Charles, the ring oscillator can be operated at rates from 1 Hz to 1 MHz, depending on C1's value.

Device/Product News. A new series of high-voltage, high-current, silicon npn transistors, types RCA9113, RCA9113A, and RCA9113B, has been announced by RCA's Solid State Division (Box 3200, Somerville, NJ 08876). Designed for use in off-line switch-mode power supplies, inverters, converters, pulse-width-modulated regulators, and motor controls, the new transistors feature high-voltage capability, fast switching speeds, and low saturation voltages, together with high SOA ratings for both forward- and reverse-bias conditions. With a peak collector current rating of 22 A and a maximum power dissipation of 175 W (at 25°C), the new transistors are supplied in standard TO-3 packages.

Motorola Semiconductor Products, Inc. (Box 20912, Phoenix, AZ 85036) has announced some new devices of potential interest to hobbyists and experimenters, including an extremely stable 2.5-V reference source and a monolithic automotive electronic ignition control IC.

Designed for critical instrumentation and D-A converter

applications, the new voltage-reference source, type MC1403/1503, features a maximum output voltage variation of only 1% (± 25 mV) and a typical temperature coefficient of 10 ppm/°C. It also features a line regulation of 3 mV (max) at input voltages from 4.5 to 15 V or 4.5 mV (max) from 15 to 40 V, together with a load regulation of 10 mV (max) at output currents from 1 to 11 mA.

Intended for circuits utilizing a flux-averaging sensor instead of conventional ignition "points" and condensers, the ignition control IC, type MC3333, is designed to drive a Darling-ton power transistor which supplies the current required by a high-energy ignition coil. Housed in a 14-pin DIP, the MC-3333 can operate at battery voltages from 4 to 24 volts.

Fairchild's Optoelectronics Division (4001 Miranda Ave., Palo Alto, CA 94303) has plunged into the hobbyist market with the introduction of a series of electronic construction kits. Designated as *Solid State Technology Kits™*, the new line includes an alarm clock-calendar (Model 0100), a wall clock (Model 0101), and an automotive digital clock. All of the kits feature LED displays. Future products planned for the line include additional clocks, a DVM and a frequency counter.

Meanwhile, another Fairchild division (Components Group, 464 Ellis Street, Mountain View, CA 94042) has announced a new 2-A monolithic voltage regulator designed primarily for use in power supplies for home-base CB radio equipment. The new device, type μ A78CB, features a fixed output voltage of 13.8 volts, internal thermal overload protection, short-circuit limiting, a peak current capability of better than 4 A, and an output voltage tolerance of 5% over the 0° to 125°C temperature range. Available in both TO-3 and TO-220 packages, the new regulator can dissipate up to 20 watts. \diamond

STAY TURNED ON with your low power FRIENDS FROM CIS

Autoranging DMM \$ 99.95
Frequency Counter \$119.95
Logic Probe \$ 34.95

Liquid crystal displays, plus CMOS designed testers offer you long life from a single 9 volt battery.

AUTORANGER™ DMM. Fast responding 3.5 digit liquid crystal display with full automatic operation. Autoranging up to 1000 volts and 2000 K Ω . Automatic zeroing. Automatic polarity sensing. Protected to 600 vdc. 10 Meg Input. Resolution 1 mv. Accuracy DCV 0.5% reading - 1 digit. All for \$99.95.

30 MHz FREQUENCY COUNTER. Liquid crystal 6 digit display allows 8 digit Resolution when switching the range to an overflow condition. 200 mv rms sensitivity and input of 10 K Ω minimum. RCA phono connection. \$119.95.

PROBIT™ LOGIC PROBE. Tests TTL/CMOS pulses-down to 35 NS and frequencies up to 40 MHz. Uses 7 segment LED display — "FI", "L", "dot" for pulses. Flexible, detachable tip plus "Micro-Hooks" for power. Includes pocket carrying case. \$34.95.

FREE 15 DAY TRIAL. Be convinced or get your money back. Full 90 day warranty. Each tester shipped complete with battery, schematic, assembly drawing, parts lists.

For More Convenience, Call Now With Your Order
TOLL FREE: 1-800-527-4634
(Texas Residents 1-214-234-4173)



Yes, Send _____ DMM Autoranger™ @ \$99.95
Send _____ Frequency Counters @ \$119.95
Include _____ DMM/FC Carry Cases @ \$3.95
Send _____ Logic Probes @ \$34.95
Add Shipping \$2.00 each
(Texas Residents add 5% sales tax)

Control & Information
Systems, Inc.
10 Spring Valley Village
Richardson, Texas 75080

_____/M/C _____ BFC # _____
_____/Check or MO enclosed.

Name _____
Street _____
City _____
State _____ Zip _____



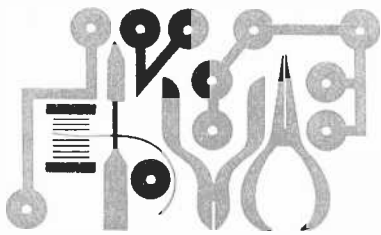

Experimenter's Corner

By Forrest M. Mims

LASER DIODES

IN OCTOBER the semiconductor laser diode will celebrate its fifteenth birthday! Even in this era of complex integrated circuits, the laser diode remains one of the most remarkable electronic components yet invented.

In some ways the laser diode closely resembles its first cousin, the light emitting diode (LED). For example, both diodes produce infrared or visible light when electrons recombine with holes at a forward-biased pn junction.

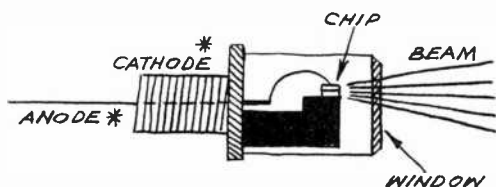

* USUAL POLARITY. REFER TO INFORMATION SUPPLIED WITH YOUR LASER

The electrons are excited to a higher than normal energy level, enabling them to cross the potential barrier formed by the junction. When they fall into holes after crossing the junction, they give up their excess energy in the form of radiated heat and light. The better the diode is, the more light than heat it produces.

This method of light generation, is called *spontaneous emission*, as it's pretty much a random process. Electrons and holes recombine whenever the opportunity presents itself, and the result is a chaotic jumble of light waves. Fortunately, the relatively constant energy levels the electrons can occupy before crossing the junction limits the energy each electron can absorb. This restricts the radiated light to a reasonably narrow band of wavelengths (100-150 nanometers). Light is emitted at a *much* faster rate (within a few tens of nanoseconds) than that from most other sources. That's why LED's and laser diodes are ideal for detection, ranging,

and communications applications.

The laser diode is nothing more than a carefully made LED with an ultra-flat junction and two tiny mirrors. The mirrors face one another and produce the internal feedback which leads to *stimulated emission of radiation*, the process responsible for laser action. Stimulated emission occurs naturally when a light photon emitted by an excited electron strikes a second excited electron and forces it to recombine with a hole. The

Fig. 1. How a typical laser diode works.

result is *two* photons having almost identical frequency and traveling in perfect phase with one another. As you can see, stimulated emission is a type of amplification. Normally it occurs only rarely, but the two feedback mirrors of a laser cause stimulated photons to be reflected back and forth within the laser material and the result is a cascade of oscillating photons—or laser light.

Most laser diodes are made by producing precise, sandwich-like junctions in wafers of gallium arsenide (GaAs) or other efficient light-producing semiconductors. The wafers are then cleaved into thin bars, which are sawed into individual laser chips several mils on a side (about the size of the dot on this letter "i"). The cleaving process gives each chip two perfectly parallel facets which serve as the mirrors. Individual chips are usually installed in a protective package with a plastic (OK) or glass (much better) window and a miniature, built-in heat sink (Fig. 1).

Driving Laser Diodes. Both LED's and laser diodes will produce recombination radiation when driven at very low levels of forward current. Lasers, however, will not lase until the forward current exceeds a level called the *threshold* (J_{th}). Above J_{th} , the optical power from the laser increases linearly with current. Many lasers will emit several watts or more when pulsed with 10- or 20-ampere pulses.

You may have read about the new generation of laser diodes which can be operated *continuously* without having to be cooled to the temperature of liquid nitrogen. Primarily designed for high-bandwidth communications through glass fibers, these lasers are a delight to use, but are temperature-sensitive and limited to several milliwatts of output power. They are not yet available at hobbyist prices.

Single heterostructure (SH) lasers, the kind you can buy at bargain prices from some of the suppliers who advertise in POPULAR ELECTRONICS, have a J_{th} of 5-10 amperes. Apply this much current to a SH laser diode and the chip will literally explode! The only safe way to drive an SH laser without cooling it with liquid nitrogen is to use current pulses no more than 200 nanoseconds wide.

The avalanche transistor circuit shown in Fig. 2 offers an excellent way to generate high-current pulses only 50-75 nano-seconds wide. Different transistors avalanche at different voltages, so you'll have to select a specific transistor for your particular laser. Briefly, you should *NOT* connect a laser to the circuit until you have selected and verified the operation of Q1. Remember—laser diodes don't like too much

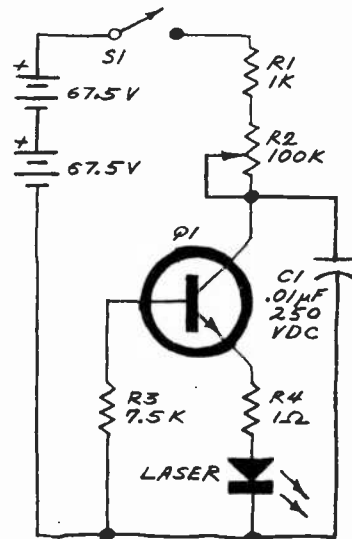

Fig. 2. Avalanche transistor circuit.

drive current! A good rule of thumb is to limit the maximum current to 2.5-3 times the threshold current. Both values are usually supplied with the laser.

Select Q1 by connecting a short copper wire in place of the laser and a fast oscilloscope (at least 15 MHz) across current monitor R4. This resistor must be carbon composition, NOT wire-wound. Use ten 10-ohm carbon resistors in parallel if you can't find a suitable 1-ohm component. Keep all leads in the current discharge path (Q1, C1, R4, and the LASER) as short as possible. The height of the pulses on the scope screen in volts will equal their peak current in amperes. Many, but not all, transistors will oscillate in this circuit. You should have good results with most common npn silicon switching transistors such as 2N914, 2N2222, 2N3643, 2N4400, 2N5188, HEP50, etc.

After the driver circuit is working and Q1 is selected and in the circuit, you can install the laser. Pay attention to its polarity! Don't expect a spectacular red beam. Although the beam is truly impressive to see, it's invisible. To verify its presence, you'll need a photodetector sensitive to the 900-nanometer infrared radiation. Silicon photodiodes driving fast amplifiers work best. Phototransistors and silicon solar cells are marginal detectors because they have very slow response times. Photoresistors simply will not work.

To see the beam you'll need an infrared image converter such as a snooper-scope or silicon vidicon TV camera. The cheapest way to see the beam is to order a plastic, phosphor-coated infrared viewing card from Kodak Special Products Sales, Rochester, NY 14650. The viewing card costs about \$30—but that's a bargain compared to the cost of an image converter.

With the help of an image converter or viewing card you can quickly squeeze the 20- x 40-degree beam from the laser into a pencil-thin beam as narrow as that emitted by the popular helium-neon laser. All you need is a convex f1 lens. A good source for lenses and other optics is the Edmund Scientific Co., Edscorp Bldg., Barrington, NJ 08007.

Safety Considerations. Fortunately, the beam emitted by most laser diodes is reasonably safe because of its low average power. Nevertheless, as with any bright light source, you should avoid viewing the beam directly. You should also avoid pointing the beam at other persons or toward reflective surfaces.

The Affordable Programmable

Never Before A Fully Programmable Calculator Available To The Scientific Community At Such A Low Cost!

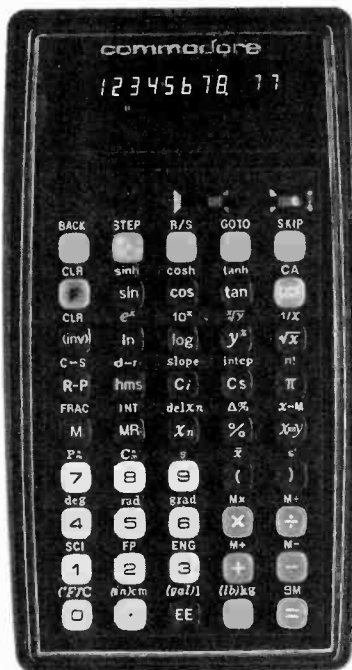

by Mail Order
\$59.95

CALL TOLL FREE
800-621-8318
24 HOURS - 7 DAYS

SUMMARY OF SPECIFICATIONS

- 12 DIGIT RED L.E.D. DISPLAY entries or results in 3 modes, scientific, fixed point or engineering
- PROGRAMMABLE—72 Keystroke program storage
- TRIG FUNCTIONS—Calculates in radians or degrees or grads
- HYPERBOLIC FUNCTIONS
 - Ln, log, e^x, 10^x
- POWERS Y^x, Roots^x, Y^{1/x}
- FUNCTIONS OF X—1/x, X
- LINEAR REGRESSION: TREND ANALYSIS: SLOPE AND INTERCEPT
- STATISTICAL: Σ +, Σ -, averages, standard deviation, variance, permutations, combinations
- PERCENTAGE CALCULATION—add on/discard/percentage
- AND CHANGE SIGN KEY
- 10 MEMORIES—7 functions—M+, M-, MR, Mx, M+, STORE, 9M
- DEGREES/DEGREE, MINUTE, SECONDS CONVERSION
- RADIAN/DEGREE CONVERSION
- POLAR/RECTANGULAR CONVERSION
- 8 METRIC CONVERSIONS
- SPHERICAL/CARTESIAN CONVERSIONS

The Commodore PR (Personal Resource) 100—Allows You To Personally Program According To Your Own Problem-Solving Needs!

WHY A PROGRAMMABLE?

The Commodore PR-100 Programmable Calculator introduces a new, innovative dimension in highly sophisticated mathematical and scientific problem-solving. It decentralizes and personalizes the decision-making power of the computer, bringing to you what was never before available in a programmable calculator with such features, yet at an amazingly affordable price.

Method of Entry: The Commodore PR-100 is designed for "Think and Touch" operation utilizing an algebraic mode of entry. You can enter equations which have up to 4 levels of parenthesis. Add to these features the 10 memory registers, and you can work the most complicated mathematical, scientific, engineering, business, statistical and combinational functions. Furthermore, you can also perform unit conversions: metric to English and English to metric.

Keyboard: The keyboard consists of 40 keys and 2 switches. 35 keys are for number and function entry. 10 of these keys are dual function (shifted keys).

SPECIALIZED FUNCTIONS:

Most of the important functions found on large scale computer systems are finally now available to you on the ultimate hand-held programmable calculator: iterative and recursive problem solving techniques; looping; conditional and unconditional branching.

ADVANTAGES OF THIS PROGRAMMABLE:

Consider for a moment the advantages of the Commodore PR-100. In terms of increased productivity you can now achieve the capability of: optimizing mathematical and scientific models; making trend and risk analyses; projecting and forecasting more accurately; performing statistical reductions; automating time-consuming "number-crunching."

The PR-100 is also a pre-programmed calculator that can achieve a multitude of functions: Basic + - × ÷ and = functions; clear entry or the entire calculation; Hyperbolic functions include: sinh, cosh, arc cosh and arc tan; Trigonometric functions include: sin x, cos x, tan x, arc sin x, arc cos x, and arc tan x. Calculates in radians, degrees or gradians. Enter x 0° to 360° (0 to 2π) or multiples of 360° (2 π). Natural Log (Ln x). Common Log (log x). Exponential (e^x). Antilog (10^x). Algebraic Functions include: x, x², 1/x. Powers: (Y^x); π (pi). Change Sign (+/-); x ↔ y exchange function; Parenthesis () enter equations that contain up to 4 levels of parenthesis without using temporary or intermediate storage.

Memory Functions: The PR-100 has 10 separate memory registers. For each memory there are 7 operations that can be performed: memory storage and clear, recall, addition, subtraction, multiplication, division and performs the desired functions on each memory.

NO LANGUAGE TO LEARN

Truly this programmable calculator is a powerful personal scientific and mathematical computing resource. And you don't need to know programming to make it work for you. There is no special language to learn. The entry system is so easy and flexible to use that you can apply it quickly to your own personal problem-solving techniques and style.

Special Functions of the PR-100: To allow you greater flexibility in programming, there are 3 special functions: 1. HALT—The program will halt and allow the user to read or enter data. 2. GOTO—Allows branching from one section of a program to another. 3. SKIP—Allows conditional flow of a program on an intermediate result; that is—the program goes one way if an answer is negative and another way is positive.

Loading, Editing and Modifying Programs: You can single step through a program to check it out, backstep through a program, easily read entered steps and modify a single step of a program.

Now personal programming is here. A step-function increase in capability over sophisticated slide-rule calculators. Capability you won't fully discover until you own a PR-100 yourself. Fill out the coupon below or call our toll free number for your two week trial.

The Commodore PR-100 is powered by rechargeable NiCad batteries and is furnished with an AC adapter/charger, leatherette carrying case and full instruction booklet. One year manufacturer's warranty. Dimensions: 3 1/4" x 6 1/2" x 1 1/8" Weight: 4 oz.

Compute With It For Two Weeks—No Obligation

Please send _____ Commodore PR-100 Calculator(s) at the Introductory price of only \$59.95 (plus \$3.95 shipping and insurance) each. If not completely satisfied, I can return it within two weeks for a prompt refund.

Instead, I/we would like to take advantage of your quantity price offering of \$54.95 (plus \$3.95 shipping and insurance) each. OFFER GOOD ONLY ON QUANTITY ORDERS OF 6 UNITS OR MORE! You can save \$30.00!

Check or M.O. Enclosed (Ill. residents add 5% sales tax)
 Please charge my credit card checked below:
 American Express BankAmericard Carte Blanche
 Diners Club Master Charge

Credit Card # _____

Master Charge Bank # _____ Exp. Date _____

Name _____

Address _____

City _____ State _____ Zip _____

Signature _____ PE-9/77



Send Coupon To:
Contemporary Marketing, Inc.
790 Maple Lane, Bensenville, Ill. 60106
Call Toll Free 800-323-2272, Ill. call: 312-595-0461

By John McVeigh

MULTIPLEXED LED DISPLAYS

Q. In the Solid State Column on p.73 of the August 1976 issue, I saw the schematic for a stopwatch with a 6-digit display. Each segment's like digits (a through g) are connected in parallel, but none of the common cathodes of each display is grounded. Can you explain how the circuit works?—Santiago M. Quijano U., Bogota, Columbia.

A. This is an example of a multiplexed display (see diagram). When a particular SEGMENT ENABLE switch is closed, the anodes of all like segment diodes—say, segment a in digits 1 and 2, represented as 1a and 2a—are connected through a current-limiting resistor to the positive supply. However, unless the DIGIT ENABLE switches are closed, the cathodes are left floating above ground and no current can flow through the diodes. Thus the LED segments remain dark.

Now, if DIGIT ENABLE switch 1 is closed but switch 2 left open and SEGMENT ENABLE switches a through f are closed, digit 1 will form a "0." Opening DIGIT ENABLE switch 1, closing switch 2 and closing SEGMENT ENABLE switch g will cause digit 1 to go dark and cause digit 2 to form an "8." If this process is repeated very quickly, the two digits will appear to form "08" without any display flicker.

This is the basic principle of operation in a multiplexed LED display. Gates and

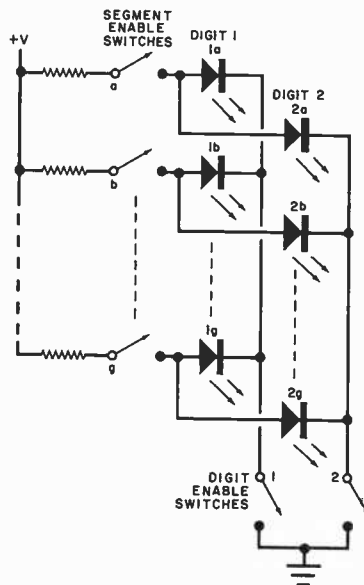

counters take the place of the mechanical switches, with their outputs either sourcing or blocking (segment enable outputs) current or sinking or blocking (digit enable outputs) current. A high-speed clock provides the necessary time reference. A large-scale integration chip (LSI) such as the Intersil ICM7205 contains all multiplex circuitry "on board." That's why the common cathodes are not shown grounded in the stopwatch schematic. The major advantage of multiplexed over direct-drive LED displays is reduced current demand—an important consideration in battery-powered equipment.

CAR CLOCK POWER SUPPLY

Q. I plan to build a digital clock/timer using a clock chip and a crystal-controlled time base. Do you have a circuit to reduce the car's 12-volt power source to +5-V dc with adequate regulation for the IC's?—Tom Ritch, Austin, TX.

A. You can use an LM309K IC regulator to step the 12 volts down to 5 volts regulated, as shown in the figure. Be sure to adequately heat sink the IC. Capacitors are used on both sides of the regulator to keep noise off the line, thus improving the stability of the regulator.

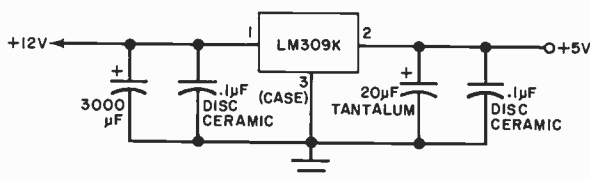

RESISTOR QUIZ

I would like to thank all the readers who have written in response to the Resistor Quiz in the July issue. Although some wrote suggesting answers such as 0 ohm, 1/4 ohm, 1/3 ohm, and 2/3 ohm, most arrived at the correct answer of 1/2 ohm. As you will recall, the problem involved finding the effective resistance between points A and B in the infinite matrix of 1-ohm resistors. Of those who reported the correct answer, some used a "shotgun" approach by having a computer solve the problem for a very large but finite matrix. Others suggested the following, elegant solution.

Connect a one-ampere current source between node A and infinity so that 1 ampere flows into node A. By symmetry, the current will split into four 1/4-ampere components, each of which will flow through one of the four resistors. Then

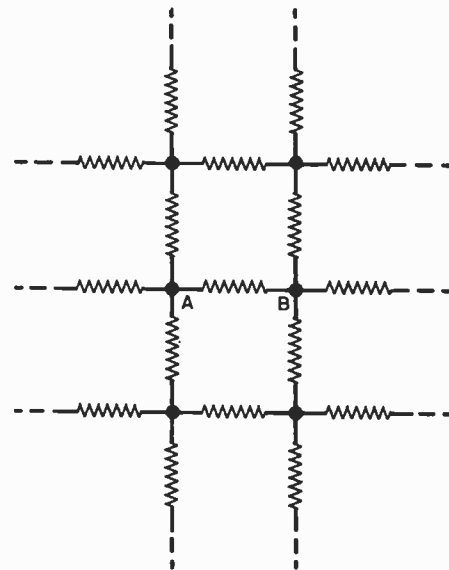

remove the current source and connect it between node B and infinity so that 1 ampere flows from node B. Again, the symmetry of the lattice dictates that 1/4 ampere will flow into node B from each of the four resistors connected to it.

The superposition theorem allows us to sum the resulting currents from both configurations. Accordingly, the current through the resistor connected directly between A and B is 1/4 + 1/4 or 1/2 ampere. By Ohm's law, the voltage across the resistor, E_{AB} , is 1/2 ampere times 1 ohm, or 1/2 volt. Ohm's law also tells us that the effective resistance between A and B is E_{AB} divided by I_T , the total current in the matrix. In this case, I_T is one ampere. Thus, R_{AB} , the effective resistance between A and B, is 1/2 volt divided by 1 ampere, or 1/2 ohm.



Product Test Reports

GENERAL ELECTRIC MODEL 3-5825

AM/SSB CB TRANSCEIVER

Features high average modulation and good noise suppression.



GENERAL ELECTRIC's Model 3-5825 AM/SSB transceiver is designed to provide total communication capability on the Citizens Band. It operates on all 40 channels and employs a digital frequency synthesis system and the now customary seven-segment LED channel display. Special features to be found in this transceiver include internal burn-out circuit protection, an antenna-failure indicator (AWI), and a quick-release mobile-mounting setup.

The transceiver also has the following complement of controls and features: RF GAIN, SQUELCH, CLARIFIER, and VOLUME controls; illuminated S/r-f meter; switchable anl/noise blanker; AM/LSB/USB mode selector; transmitter-on LED and modulation peak indicator; automatic level control (alc) and automatic modulation control (amc); HI/LO TONE switch; detachable dynamic microphone; PA operation; jacks for external speakers; bottom-facing speaker; operation from a 12-volt dc negative- or positive-ground power system; reverse-polarity protection; line filter; and electronic switching and voltage regulation.

The transceiver measures 10 5/8"D × 7 1/2"W × 2 1/2"H (27 × 19.1 × 6.4 cm). \$329.95.

Technical Details. On SSB, the receiver employs single conversion to a 10,695-kHz i-f and uses a crystal filter for selectivity and sideband selection.

Three 10,695-kHz i-f stages, two of which are direct coupled, precede the SSB product detector, while carrier injection is provided by a 10,695-kHz crystal oscillator (bfo). A second conversion to 455 kHz is employed for AM, which uses a ceramic filter for selectivity.

A diode-protected transistor stage precedes the first mixer. The second mixer, used for AM, is of the balanced-diode type. Three 455-kHz i-f stages precede the AM diode envelope detector and agc, following which is the anl that can be switched in and out simultaneously with the noise blanker. The latter employs an r-f amplifier, detector, and pulse amplifier that cause the output of the first mixer to be interrupted (gated) by the noise pulses.

The audio section, including the power-output amplifier, is incorporated into a single integrated circuit. The squelch system is a three-stage amplified system that is activated by the agc.

A phase-locked-loop (PLL) scheme is used for frequency control. It contains the usual 10,240-kHz crystal oscillator, from which the standard reference is derived. This oscillator is also used for the second conversion to 455 kHz for AM reception.

The voltage-controlled oscillator (vco) at the first mixer functions at a frequency 10,695 kHz higher than the CB signal. Its comparison signal is obtained through a down mixer and a 10,052.5-

kHz crystal oscillator and dividing setup that is controlled by the channel selector switch. This signal is applied to an IC phase comparator, along with the standard reference. The LED display consists of the usual decoder/driver circuitry.

On transmit in the AM mode, a 10,695-kHz crystal signal from the bfo is difference-mixed with the vco signal to provide the on-channel carrier. The mixer is followed by a two-stage r-f preamplifier, driver, and final power amplifier. The latter two stages are collector-modulated as usual from the audio section in the receiver, which contains automatic modulation control (amc). A multi-section output network provides impedance matching to 50-ohm loads and attenuation of harmonics.

An Antenna Warning Indicator (AWI) comes on if a short or open circuit or other malfunction in the antenna system causes a high SWR to be detected by a sensing element in the transmitter. This indicator immediately apprises the user of a problem. It functions only on AM. If the malfunction is not noticed immediately, the manual states that built-in circuit protection will permit the transmitter to be operated for up to five minutes before damage occurs.

The usual type of SSB transmitting system is used in this transceiver. It consists of a balanced modulator and crystal sideband filter, followed by the transmitter mixer, where the signal is combined with the 10,695-kHz crystal signal for USB use. This crystal signal is shifted to 10,692 kHz, along with a +3000-Hz change in the vco to set up the initial signal at the proper side of the filter for LSB use.

Laboratory Tests. The receiver's sensitivity measured 0.8 μ V for 10 dB (S + N)/N with 30% modulation at 1000 Hz on AM with a nominal 0.5- μ V signal at 6 dB (S + N)/N. In either case, it produced a maximum sine-wave audio output of 3.25 watts at less than 2% THD with a 1000-Hz test signal into 8 ohms. SSB sensitivity was nominally 0.18 and 0.1 μ V for 10 and 6 dB S/N.

Operating from the standard test source of 13.8 volts dc, the transmitter carrier output on AM was 3.75 watts. Up to 100% modulation was possible, and at microphone levels 25 dB more than needed for 50% modulation, the THD with a 1000-Hz signal was less than 2% (10% with a 400-Hz signal). Adjacent-channel splatter with 1000-Hz or voice signals was at least 60 dB down and no overmodulation was observed. The 6-dB audio response was 500 to 2400

Hz, and transmitter frequency tolerance was within ± 2 Hz of -83 Hz.

The r-f power output on SSB was 9 watts PEP using test tones and 12.75 watts PEP during voice operation. The unwanted-sideband and carrier suppression were 55 dB on USB and 60 dB on LSB. The audio response was 300 to 2800 on LSB and 380 to 3100 Hz on USB. Third-order distortion products were 29 dB below two test tones (35 dB below PEP) at 10 watts PEP, while at 12 watts PEP, they were 23 dB below test tones (29 dB below PEP). Above 10 watts PEP, some flattopping was noted, accounting for the deterioration we observed at 12 watts PEP.

The range of the squelch threshold was 0.5 to 550 μ V. The agc held the audio output level to within 8 dB on AM and 13 dB on SSB with an r-f input change of 20 dB at 1 to 10 μ V. It held to 15-dB on AM and 20 dB on SSB with an 80 dB change at 1 to 10,000 μ V. The S meter registered S9 with a nominal 50- μ V input signal.

Image rejection was 65 dB (primary) and 60 dB (secondary). I-f and other unwanted spurious-signal rejection measured greater than 80 and 60 dB, respectively. AM adjacent-channel rejection and desensitization was 58 dB mini-

mum. Unwanted sideband suppression was at least 60 dB at 1000 Hz. The 6-dB audio response was 575 to 1600 Hz on AM and 600 to 2000 Hz on SSB (the clarifier control works only on SSB receive), with the upper end extending 300 to 400 Hz higher with the tone control set to HI.

User Comments. As our measurements indicate, receiver sensitivity, selectivity, and unwanted-signal responses, plus the use of the r-f gain control, provided good reception under adverse conditions. The ANL/NB combination enhanced receiving performance, with our lab tests showing that the original S/N versus sensitivity was maintained in the presence of impulse noise 100 dB above 1 μ V/MHz bandwidth. Vehicle tests were also excellent.

We obtained good quality and high audio output power even with weak r-f signal levels. Use of the tone control let us set up the sound to suit our own taste. In this respect, the HI tone position provided us with the best intelligibility. On the other hand, the LO position helped to minimize noise.

The transmitter performed nicely, providing high average modulation levels without overmodulation or adverse splatter. The excellent unwanted-side-

band suppression on SSB made dual-channel operation (simultaneous use of one frequency with two separate conversations, one on LSB and the other on USB) possible without interference between the two.

The transceiver is enclosed in a well-shielded case. The rotary controls are clearly identified and convenient to use. The mode and channel selector knobs have grip bars for easy operation. We particularly like the mode switch setup at the top of the panel, with the center position for AM and the LSB and USB positions to the left and right.

Another nicety is that the clarifier control has ± 1 to ± 5 calibration points, with a detent at the center position. This makes for quick retuning.

The edgewise meter is somewhat easier to read than is usually the case. Miniature toggles are used for switching some functions, such as the tone control (which has fixed HI and LO settings).

Aside from good overall performance and convenient handling, the transceiver offers the mobile user the advantages of SSB for enhanced CB communication. Of course, the inclusion of AM operation allows the user to communicate where the "other" station is not equipped for SSB.

CIRCLE NO. 103 ON FREE INFORMATION CARD

ARIES SYSTEM 300 ELECTRONIC MUSIC SYNTHESIZER

Has five-octave keyboard and 12 functional modules.

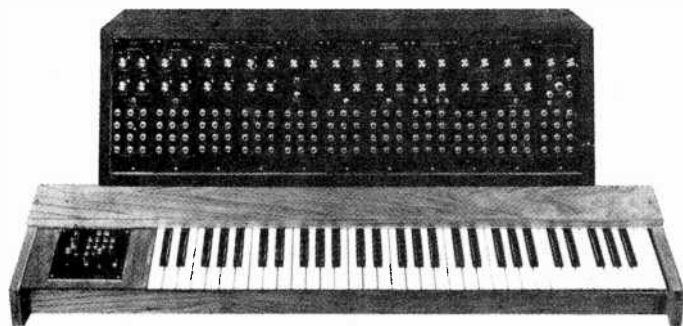

THE ELECTRONIC music synthesizer has added a whole new dimension to modern music. The basic characteristic that sets it apart from other musical instruments is flexibility. A synthesizer can produce almost as many different sounds as the player can imagine. That's why electronic music comprising many synthesizer tracks is so dramatic, and why many rock bands now use the synthesizer as a primary keyboard instrument.

The Aries System 300 is a two-voice, modular electronic music synthesizer. It has a five-octave keyboard with key-

board interface and 12 functional modules: two envelope generators; voltage-controlled amplifier (vca); two voltage-controlled oscillators (vco's); voltage-controlled filter (vcf); dual low-frequency oscillator/lag/inverter; sample-and-hold/clock/noise generator; balanced modulator; dual mixer; power supply; and an audio output/power control module. Cases, keyboard, and modules are available separately (see box). The keyboard in its case measures 43"L \times 10"D \times 4"H (110 \times 25.4 \times 10.2 cm) and the synthesizer cabinet measures 34½"L \times 10"H \times 10"D (88 \times 25.4 \times 25.4 cm).

General Description. At the heart of the System 300 synthesizer is the AR-317 voltage-controlled oscillator (vco) module. It produces and simultaneously provides four waveforms at amplitudes of 10 volts peak-to-peak. The ± 5 -volt sine, sawtooth, and triangle waves are centered on a 0-volt reference, while the variable-width pulse output oscillates between 0 and 10 volts.

Exponential circuitry provides 1-volt/octave (1/12-volt/semitone) control over a very wide range. Two potentiometers and a RANGE switch permit manual control from 0.03 to 30 Hz and from 16 to 16,000 Hz. External control voltages can determine the output frequency over a 0.002-to-50,000-Hz range. Four control inputs, one with a level control, are provided. The control inputs are summed so that each +1-volt input doubles and each -1-volt input halves the output frequency. Inputs are also provided for pulse-width modulation and frequency syncing with an external square-wave or pulse generator.

The basic waveform produced by this

module is the triangle. Its frequency is determined by an exponential current source varied by the control inputs. The source provides charging current for timing capacitors selected by the RANGE switch. A loop composed of two operational transconductance amplifiers, a complementary pair of bipolar transistors, and a JFET generate the triangle waveform.

The triangle wave is buffered and presented at the appropriate output jack. It also drives an open-loop op amp and a waveform converter circuit, which results in variable-width (5% to 95%) pulse and sinusoidal outputs. The sawtooth is generated by a separate loop driven by a secondary output of the exponential current source. This sawtooth circuit is pulse synchronized to the main oscillator loop.

The AR-312 envelope generator produces a 0-to-10-volt signal that is normally used as a control input for a vca or voltage-controlled filter (vcf). The ATTACK, DECAY, SUSTAIN, and RELEASE controls shape the output waveform. When a positive gate signal is applied to the input, the envelope generator can accept trigger pulses. Upon receipt of a trigger pulse, the generator's output in-

creases exponentially from 0 to 10 volts, at a rate determined by the setting of the ATTACK control. The attack time is variable from 2 ms to 4 s. A level detector conducts when the output reaches 10 volts, causing the main timing capacitor to discharge at a rate determined by the setting of the DECAY control. The output voltage decays exponentially until it equals a threshold selected by the SUSTAIN control and remains at this level until the gate signal is removed. When this occurs, the output exponentially decays to 0 volt at a rate determined by the setting of the RELEASE control.

Four outputs (wired in parallel) and two gate and trigger inputs are provided. Pressing a MANUAL GATE switch activates and triggers the envelope generator. When the button is released, the output signal decays to ground. This module also includes a four-jack, front-panel patch point.

Dynamic control of an audio signal is performed by the AR-316 vca, which is designed around a CA3080 operational transconductance amplifier. One of two op amps sums four control inputs (one with an attenuator); the other serves as an output gain stage. Setting the MODE switch to LIN causes the vca's gain to be

determined by the ratio (control voltage)/10. In the EXP position, the gain is determined by the formula gain (dB) = 10(V - 10), where V is the control voltage in volts. This allows a 10-dB/volt control.

Four audio inputs, two of which are connected by level controls, can be applied and summed by the CA3080. An INITIAL GAIN control acts as a front-panel master gain control. Depending on its setting and the magnitude of the control inputs, the gain will vary from -100 to 0 dB. The vca can handle audio inputs up to ±10 volts peak and control inputs up to +10 volts maximum.

Control over the tonal characteristics of synthesizer waveforms (and those of other electrical musical instruments) is furnished by the AR-327 multimode vcf. Audio input signals are summed by an op amp mixer and passed through one or more active filters. Control inputs are mixed by another op amp, whose output drives an exponential generator module. The module controls op amps that set the frequency response of the active filters. Low-pass, high-pass, band-pass, and peak/notch outputs are available simultaneously. (The notch or peak mode is switch selectable.) Response is 12

Listen to what the world is saying. . .

THE YAESU FRG-7 MARK II. . .

ACCLAIMED THE FINEST ALL-BAND RECEIVER IN ITS PRICE CLASS. . .AND MORE!



Professional critics have been loud in their acclaim for the YAESU FRG-7 solid state synthesized 500 kHz to 29.9 MHz all band receiver. Triple-conversion, the AC, 12V DC, or flashlight battery operated receiver provides exceptional sensitivity, dial accuracy and rock-like stability of reception. Mate it with the YAESU QTR-24 world time clock and you'll know the exact time, night or day anywhere! Try it at your YAESU dealer or write for full information. . .NOW! (UL approved)



QTR-24
World Clock

**Dealer
Inquiries
Welcomed**

YAESU
The radio.



Yaesu Electronics Corp., 15954 Downey Ave., Paramount, CA 90723 ■ (213) 633-4007
Yaesu Electronics Corp., Eastern Service Ctr., 613 Redna Ter., Cincinnati, OH 45215

dB/octave, and Q is adjustable from 0.5 to 512 by means of a RESONANCE control. One audio and one control input are connected to front-panel attenuators.

Exponential control, an important vco feature, is also provided. The cut-off frequency of the filter increases one octave for each +1-volt increase of the control input and decreases one octave for each -1-volt increase. A FREQ control, together with any control inputs, determines the cutoff frequency over a 16-to-16,000-Hz range.

Three modules contain independent circuits that perform separate functions. The AR-324 module has two low-frequency oscillator's (lfo's) that simultaneously provide ± 5 -volt triangle, 0-to-10-volt sawtooth, and 0-to-10-volt square-wave outputs over a frequency range of 0.3 to 30 Hz. The oscillators can be synchronized to an external pulse or square-wave generator by means of a SYNC input. As in the vco, the sawtooth is generated independently. Differentiated pulses from the square-wave circuit control the discharge of the capacitor across which the sawtooth is developed. Thus, the sawtooth is synchronized to the other waveforms.

The lag circuit in this module is essentially a low-pass filter. A potentiometer determines the time constant (1 ms to 1 s) of an RC circuit. The output of the lag is buffered by a unity-gain voltage follower. Also included in the module is a variable-gain inverter. Inputs are coupled to a standard op-amp inverter through a variable attenuator. The maximum voltage gain is -1. Both the lag and inverter can handle peak signals of ± 10 volts.

The second multifunction module is the AR-318 sample-and-hold/clock/noise generator. When a positive-going pulse is applied to the trigger input of the sample-and-hold circuit, a FET switch turns on and allows a capacitor to charge up to half the instantaneous signal voltage. (The input is passed through a 2:1 attenuator.) The switch then turns off to prevent the capacitor from further charging or discharging.

A FET op amp output buffer multiplies the capacitor voltage by two and presents it at the sample-and-hold output. When a positive signal of at least 2 volts is applied to the GATE input, the FET switch is kept on continuously. In this "track-and-hold" mode, the input follows the output exactly. If the gate signal is removed, the output remains at the instantaneous signal voltage at the time of removal. The circuit can also be activated by a MANUAL TRIGGER switch.

The clock is a voltage-controlled, low-frequency oscillator with 0-to-10-volt sawtooth, square-wave, and trigger (narrow pulse) outputs. The frequency range is 0.3 to 30 Hz. Inputs are provided for frequency modulation and syncing to an external pulse or square-wave source. A switch allows either the clock or an external source to provide trigger and gate signals for the sample-and-hold circuit.

The third function of this module is to provide three noise signals. White noise is developed by amplifying and filtering the output voltage from a reverse-biased transistor junction. Pink noise is obtained by passing the white noise through a -3-dB/octave low-pass active filter. The pink noise is rectified, filtered, and amplified to create a slowly varying random waveform. The random and pink-noise outputs are 4 volts rms, with equal energy per cycle between 0.4 and 7 Hz and equal energy per octave between 16 and 16,000 Hz, respectively. The 7-volt rms white-noise signal has equal energy per cycle between 16 and 16,000 Hz.

The AR-315 module contains a balanced modulator and two general-purpose attenuators. The balanced modulator has X and Y inputs. Signals applied to these inputs are fed to a four-quadrant multiplier IC whose output drives an op amp in the differential mode. When the circuit is properly trimmed, the output voltage is $XY/10$, where X and Y are the input signal levels in volts. If either or both inputs is zero, the output is zero. The levels can be independently controlled for each input. The two attenuators in the module can be used at any point in a synthesizer patch.

Signal summing is performed by the AR-323 dual mixer. Each mixer has four inputs, two of which have polarity selection switches and level controls. This allows both addition and subtraction of audio signals, envelopes, etc. Outputs are provided for the A and B mixer separately, as well as combined A + B and A - B. These allow the module to be used as a single eight-input mixer. Six op amps are used for signal summing and inverting. Maximum signal levels are ± 10 volts.

The voltages required by the various modules in the system (+5, +15, -15 volts) are supplied by the AR-322 power supply module. IC voltage regulators, large heat sinks, and electrolytic capacitors are used in the module. The three current-limited (1-ampere) output voltages are available at three parallel-wired octal sockets.

The AR-326 output and power control module switches ac from the line to the power supply and contains two independent audio output amplifiers. The amplifiers are each mounted on separate pc cards and consist of an op amp driver and a complementary pair of transistors operating in class AB. The output signals are routed to a headphone jack and two output phono jacks. The module can drive headphones, high-impedance (40 ohms or more) speakers, or power amplifiers. Two four-jack patch points are provided as are jacks at which +10 and -10 volts are available. The power supply's ac line switch and pilot light are mounted on the front panel of the AR-326 module.

All of the modules described so far mount in the AR-310 cabinet. Eleven modules (all but the power supply) have front panels and all of these except the output power and control module plug into 22-pin edge connectors, which bus power from the power supply module.

Patching can be accomplished in one of two ways. First, patch cords terminated with miniature phone plugs can be inserted into front-panel jacks. This allows the user to make hundreds of different patch combinations according to his own ideas of how the synthesizer should be used. Alternatively, all inputs and outputs at the edge connectors can be hard-wire patched, or limited-patch switching can be developed via the edge connectors.

Also included in the System 300 are the AR-311 keyboard, AR-313 keyboard interface, and AR-320 keyboard case. The preassembled keyboard has 60 precision resistors that form a voltage divider. One set of gold-plated key contacts connects a specific tap on the voltage divider to the keyboard voice bus. The voltage on this bus depends on the specific key depressed. The lowest key produces 0 volt and the highest, five octaves away, produces 5 volts. Each ascending key produces an 83.3-mV increase over the key to the left, resulting in 1 volt/octave voicing.

The keyboard voice voltage tracks the lowest key depressed. However, another "auxiliary voice" voltage is developed when two keys are pressed simultaneously. The magnitude of this voltage depends on the keyboard interval created by the two keys. A second set of gold-plated contacts is used to generate gate and trigger signals.

The AR-313 keyboard interface produces four output signals. The GATE signal is at +10 volts and remains on as long as any key is held down. The TRIG-

GER output is a ± 10 -volt, 1-ms pulse that appears each time a key is pressed. The VOICE output is a dc voltage that is proportional to the lowest key held down. It remains at its last level after the key is released.

When the interface is properly tuned and trimmed, the lowest key (C) produces a 0-volt "voice" signal. The C# key produces 83.3 mV, etc. Hence, each octave adds one volt, which raises the output frequency of the vco by one octave. The "aux voice" output appears only when more than one key is pressed at the same time. Its voltage is proportional to the interval between the highest and lowest keys depressed. When one or no key is depressed, this output is 0 volt.

The interface's TUNING control adds or subtracts voltage from the VOICE output over a 1.5-octave range. It has no effect at or near its center position. Glide or slur from one key to the next is provided by the portamento circuit. The PORTAMENTO control determines the glide time that is essentially independent of the keyboard interval in the NORMAL mode. In the LINEAR mode, the glide takes longer for larger intervals. Placing

ARIES SYSTEM 300 ELECTRONIC MUSIC SYNTHESIZER	
AR-311 Keyboard	\$119.00
AR-313 Keyboard Interface	67.00
AR-320 Keyboard Case	48.00
AR-312 Envelope Generator (2, each)	55.00
AR-327 Multimode VCF	149.00
AR-316 VCA	63.00
AR-315 Balanced Modulator and Attenuators	62.00
AR-317 VCO (2, each)	115.00
AR-318 Sample-and-Hold/Clock/ Noise Generator	59.00
AR-323 Dual Mixer	65.00
AR-324 Dual LFO/Lag/Inverter	65.00
AR-322 Power Supply	92.00
AR-326 Output and Power	59.00
AR-310 Synthesizer Cabinet	89.00
System Price (Kit form)	1195.00
System Price (Assembled)	1895.00

the PORTAMENTO switch in the OFF position disables the circuit.

The AUX TRIM and VOICE TRIM are front-panel screwdriver-type controls that are used to set the output intervals to 1 volt/octave. After initial adjustment, they need not be disturbed.

Assembling the Kit. This is a fairly complex kit to assemble. Actually, it is a collection of mini-kits. Each of the modules can be assembled and tested independently. After completing the power supply module, we put together the synthesizer cabinet from pre-cut lumber. Then we installed the power supply and edge connectors to be ready for each of the other modules.

Next, we assembled the keyboard, keyboard interface, and keyboard case. The keyboard case comes pre-cut and drilled, and the keyboard itself is pre-assembled. The interface circuitry is housed on two printed circuit boards. The interface boards (as well as those in the other modules) are not silk screened with component locations, but assembly was not difficult because larger-than-life parts placement diagrams were provided with the instructions.

wire wrapping center

<p>NEW HOBBY WRAP MODEL BW 630</p> <p>Battery wire wrapping tool</p> <p>\$34.95 ONLY COMPLETE WITH BIT AND SLEEVE</p>	<p>STRIP/WRAP/UNWRAP TOOL MODEL WSU-30</p> <p>\$5.95*</p>	<p>RIBBON CABLE ASSEMBLY</p>	<p>DIP SOCKETS</p>
<p>DIP IC INSERTION TOOL WITH PIN STRAIGHTENER</p> <p>MODEL INS-1416</p> <p>\$3.49*</p>	<p>WIRE DISPENSER MODEL WD-30-B</p> <p>\$3.45*</p>	<p>PRE-CUT PRE-STRIPPED WIRE</p>	<p>WIRE WRAPPING KIT</p> <p>\$15.45*</p>

*MINIMUM ORDER \$25.00. SHIPPING CHARGE \$1.00. N.Y. CITY AND STATE RESIDENTS ADD TAX

OK MACHINE AND TOOL CORPORATION

3455 CONNER STREET, BRONX, NEW YGRK, N.Y. 10475 U.S.A.
PHONE (212) 994-6600 TELEX NO. 125091

With two exceptions, each Aries module worked perfectly the first time it was powered. One was due to a wiring error. The other was a result of a marginal circuit's design given tolerance of parts. Trouble was experienced with the dual lfo's. Correct waveforms were obtained at the square and triangle wave outputs, but a +10-volt level appeared in place of the sawtooth outputs. Aries was contacted for advice by telephone. Following a few suggestions from Jim Bastable (now one of the Aries partners), the beginnings of a sawtooth appeared.

Further experimentation on our and Aries' parts resulted in a solution to the problem, which involved a few changes in component values. Aries has modified the circuit in line with our results, and informed us that although previous module purchasers had not contacted them about the sawtooth, they would all be informed of the change.

We performed the various circuit adjustments with the aid of a multimeter, frequency counter, and oscilloscope. These instruments are not absolutely necessary for making the adjustments, but they do make them easier to perform and yield accurate results. Easy-to-follow trim instructions are provided with each module.

The last part of assembly was to finish the wood that makes up the two cases. This is an option left to the builder's tastes, but it is well worth the effort, since it results in an instrument that looks as good as it sounds. Two coats of stain and then two coats of polyurethane were applied to all exterior surfaces of the keyboard and synthesizer cabinets.

Total assembly time for the System 300 was about 95 hours, not including the three hours or so required for trimming adjustments. We noted during assembly that all components supplied were of high quality. In many cases, components with tolerances closer than specified in the parts lists were supplied.

User Comment. Modern electronic music synthesizers fall into two categories, performance types and studio types. The performance synthesizer is polyphonic, computerized, and looks like and is played in a manner similar to an electronic organ. The studio synthesizer, on the other hand, is usually monophonic or has two- or three-note chord capabilities. Most studio synthesizers are made up of combinations of different modules that are designed to be interconnected as required by jacks and patch cords. With this type of instrument, the musician has a more deliber-

ate, subtle control over each note he generates. He can patch as conditions require. As each note is generated, he can record it and, at the end, perform a mix-down to obtain the final "composition."

The Aries System 300 is decidedly a studio synthesizer. It looks solid and substantial. More importantly, it sounds as good as it looks.

The fact that this is a kit and is modular in design gives the user a wide range of possibilities for designing the instrument to meet his own specialized needs.

We were impressed with the way Aries has covered the classical spectrum of function modules in the System 300. As laid out, the system gives the musician a practically infinite palette. Each of the modules that make up the system performed with clean precision, and we were unable to exhaust the patch combinations possible.

On the negative side, we found the control parameters to be too husky and too responsive. We would have preferred to be able to spread the control over a larger, smoother range. For example, the amplitude of a control signal applied to the vco for vibrato (frequency modulation) had to be cranked down to the very threshold of the input level control to be within acceptable limits. We could have passed the control voltage through one of the two attenuators and thence to the input level control, but that would have been awkward and wasteful.

A similar problem was noted with the noise generator. It would have been preferable if the noise generators had had built-in attenuators because noise is seldom used at full volume. Patching the noise signal from its source to an attenuator and then to another module is a nuisance. In short, the Aries synthesizer is a bit too spunky, and it has too many muscles.

For us, the ultimate test of any synthesizer is in musical composition, using multitrack overdubbing. We usually try to construct a piece in four stages, using simul-sync on a 4-track tape recorder. Using the System 300, we began by patching up an automatic percussion rhythm, using white noise and a sine wave at low audio frequency. The sampler module was used to control the filter's cutoff frequency. (Signals were taken from the filter's bandpass output.) The pulse output of a low-frequency oscillator was used to trigger the envelope generator. The result was a pseudo bass drum and brushed cymbal. The drum, controllable from the keyboard, was played as a bass line rhythm on the

first track of the 4-track tape recorder.

Next, we set up and played a chromatic cymbal on track two to complement the walking bass. Then a voice patch with an envelope and vibrato that approximated the human voice was recorded on track three as a melodic figure manipulated in conventional ballad fashion. Finally, a supporting contrapuntal line was added, using a stringy sound. When we were through, we were pleased with the result. The Aries system had accomplished everything we asked of it.

In sum, the Aries System 300 is for serious music and meticulous recording applications. It was obviously designed by an engineer who takes pride in his craft. The system may be a bit complicated and clumsy to program, but then it is definitely not a toy. However, we learned at press time that another model, using the same internal design, will be available to permit one to override the patch-cord interconnect system at will. This would give the option of using the unit as a highly flexible studio synthesizer or as a "live" performance synthesizer with less control flexibility. So it is possible, you see, to have your cake and eat it, too.

(The User Comments in this report were prepared by Robert A. DeVoe, Professor of Education at Fairleigh Dickinson Univ. in New Jersey. Mr. DeVoe has conducted radio and classroom courses in the Humanities and Electronic Music and is an accomplished composer of electronic music. His work has won the Armstrong award for excellence in FM broadcasting and the John Hay Fellows Award in Humanities. He is also the author of *Electronmusic: A Comprehensive Handbook*, published by Electronic Music Laboratories, Inc., Box H, Vernon, CT 06066.)

CIRCLE NO. 104 ON FREE INFORMATION CARD

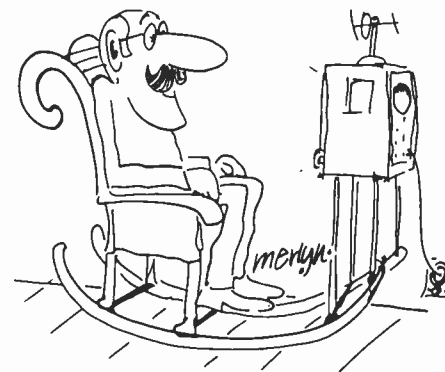

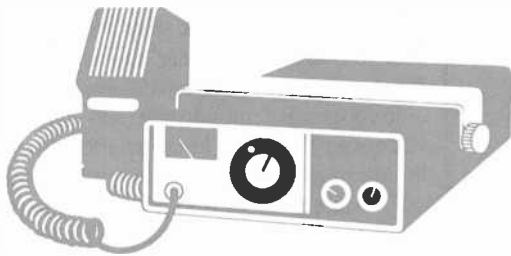

CB Scene

By Ivan Berger

BETTER EMERGENCY SERVICES ARE NEAR

THE ODDS on someone's hearing when you call for help on Channel 9 are going up. The government is raising them. And you can help.

The government's goal is to knit together law-enforcement officials, medical and emergency services, automobile clubs and such volunteer CB monitoring groups as REACT and ALERT into a network which will put every CB-equipped car in the country within reach of fast emergency assistance. To implement that goal, a new program has been set up that's called National Emergency Aid Radio, or NEAR.

Independent efforts at coordinating CB with emergency services have been going on successfully for years, of course. REACT and the other monitor groups, for example, have teams to listen to Channel 9 in systematic shifts, so that there is always someone there to hear and relay calls for help. Several states have equipped their highway patrol cars with CB. Some Smokeys have even equipped their official vehicles at their own expense.

The results have been impressive. Where the police are equipped to hear them, CB'ers now often report to Smokey, telling him of reckless drivers, accidents, traffic jams, hazardous conditions and other emergencies. Such experiences doubtless helped the Department of Transportation's National Highway Traffic Safety Administration (NHTSA) to recognize CB radio communication as "the only existing method convenient to the public at large by which the motorist can enter the response system from his vehicle," and to set up NEAR.

The program will be federally funded, but must be implemented by the individual states. That leaves it up to each

state to decide how it will allocate its NEAR funds: to buy CB equipment for local police and emergency services, to set up public information programs, to train CB monitors in emergency reporting procedures, and to pay the costs of administering NEAR. States may even elect not to participate at all.

Those states which do participate will be assigned easily-recognized call signs for use in legally communicating with other CB operators. These call signs will consist of the letter "K," the state's two-letter abbreviation, and the number 0911—"KNY-0911" for New York, for instance, or "KCA-0911" for California. (Since each state government is a single licensee, all its CB units share a single call sign.)

No money is allocated for direct use by volunteer monitors. However, there are ways that they can benefit indirectly. Local or state governments can set aside space in government facilities for volunteers' use, and may even provide equipment there. But the equipment will remain the government's, not the volunteers'. NEAR funds can also cover expenses directly relating to monitoring activities, such as long-distance telephone calls made in response to emergencies.

Where groups like REACT will benefit directly is in closer contact between government and volunteers. We understand that each state *must* collaborate with volunteer monitors (and with other volunteer groups, such as Civil Defense) in setting up a NEAR Advisory Council and a NEAR plan. Without such collaboration, the state won't qualify for Federal NEAR funds.

The volunteer monitor groups must meet several criteria, though. For instance, they must be primarily devoted to emergency communications monitor-

AVANTI® HIGH PERFORMANCE C.B. ANTENNAS

40 CHANNEL ENGINEERED

ASTRO PLANE™ CB Base Antenna Co-inductive

The omni-directional CB antenna that radiates from the top — for greater range and performance. 4.46 db gain over isotropic — stronger signal, clearer reception. No coils to burn or short. Vertical polarity. Patent #3587109
Model AV-101...price \$39.95
2.8x more power
E.R.P.

Avanti CB base antennas
from \$20.50 to \$404.00



RACER 27™ CB Mobile Antenna Magnetic mount

Easy to mount on roof or trunk for car, van or truck — no holes to drill — fast removal for hide away or car washing. Strong magnet assures position. Mylar pad guards vehicle finish.

Hermi-coil (Hermetically sealed coil) — A special molding process provides a weather-proof coil environment. Helps maintain the characteristic antenna impedance, even in damp or salt water atmosphere. Hermi-coil also helps eliminate internal surface leakage.

Ribbed base — Provides a long leakage path used in high voltage insulators, spark plugs, etc.

Specifications: Electrical ¼ wave length
• Unity gain • 27 MHz
• V.S.W.R. — 1.3:1 or better
• Coil — shunt fed hermicoil

MODEL AV-727 Mobile Antenna System with 48" whip, 17' coaxial cable with magnetic mount. 40 channel \$32.95

Avanti makes a complete line of high performance mobile CB antenna systems from \$11.95 to \$72.50



FREE 24 PAGE CATALOG

avanti

Avanti Research & Development, Inc.

Established 1964

340 Stewart Ave., Addison, IL 60101 USA

creators of the
famous

© Copyright 1977
All rights reserved



CIRCLE NO. 8 ON FREE INFORMATION CARD



Theirs:

Julian S. Martin
 HI-FI STEREO BUYERS' GUIDE, March-April, 1976

"Superb from every viewpoint. An outstanding achievement in headphone design. One of the most comfortable."

The Len Feldman Lab Report
 TAPE DECK QUARTERLY, Winter, 1975

"Response of these phones extends uniformly from 20 Hz to over 22,000 Hz with no more than ± 2 dB variation over this entire range...this is nothing short of incredible."

New Equipment Reports
 HIGH FIDELITY, January, 1976

"The sound quality the AT-706 presents [to you] is exceptional: very wide range and smooth...Within this excellent operating range the sound is exceedingly clean and open...an extremely fine stereo headset."

If you asked the critics they'd tell you to listen critically to a variety of products before you buy. We agree. Because the more carefully you listen, the more you'll be impressed by the sound of Audio-Technica.

AT-706

Electret Condenser
 Stereo Headset \$129.95

Our finest Personal Transducer

 **audio-technica.**
 • INNOVATION □ PRECISION □ INTEGRITY

AUDIO-TECHNICA U.S., INC., Dept. 107P, 33 Shiawassee Avenue, Fairlawn, Ohio 44313
 Available in Canada from Superior Electronics, Inc.



ing, have demonstrated their capabilities and earned community support, and have state or national affiliations.

Independent monitoring will still be encouraged. NEAR funds spent on public information and education will probably result in more and more CB users' learning what Channel 9 is for and how to use it. This part of the program has already borne some fruit. It's a handy, common-sense book called the *Citizens Band Monitor Guide*. Some of its hints and reminders struck are especially worth noting.

Four C's. The book stresses the four "C's": an effective NEAR monitor should be Calm, Courteous, Correct and Concise. The book gives some specific tips on how to accomplish this:

- "The monitor must remain the link between the need and the help until that help arrives. That includes getting and relaying further information from the caller, and relaying or giving advice on life-saving or other emergency procedures that the caller may be able to handle in the meantime.

- "Keep in mind that most calls for help come from a place of stress. The caller may be excited, shaken, alarmed, frantic and even hostile. Your job is to remain clam and instill calm and confidence in your caller. . . . However, you should *not* tell him to 'calm down.' This will only make him think you don't appreciate the seriousness of the situation."

- The *Guide* gives two pages of suggestions on how to deal with such common and uncommon emergencies as aircraft accidents, fires, lost children, stalled cars and tornados. For each of 26 such incidents, it suggests what information a monitor should elicit from the caller, which government services should be alerted, and what special instructions should be relayed back to the caller. (Oddly, I noticed no sign of another common-sense suggestion: that the phone numbers of all these services should be kept at the monitoring station.)

- 10-codes are listed in large type, for easy reading. But the *Guide* also points out that "You should *never* use 10-codes with parties who would not understand them," though "you should be able to understand them, nevertheless."

- Get the information in a regular sequence. You can't ask everything at once, and you have to ask important things first." The book suggests one possible such sequence: first ask the nature of the problem, then the caller's

location and phone number (if applicable), then the specific location of the incident, the caller's name, and more details of the incident itself.

● "Explain why it will take time to check for information, and that you will call back. A party waiting on a 'dead phone' may become irritable and uncooperative."

● To simplify evaluation of the NEAR program's effectiveness, a monitor log-book designed for input to a computer will be made available. This will be for use only by Monitor Base Stations designated by State CB NEAR Programs. Data to be filled in includes the time delay between occurrence of the incident and notification, nature of the incident, type of response agency notified, and the time the action was completed, as well as identification of the calling source and the monitor unit.

● Monitors should be able to identify an emergency's location even when the caller is a stranger to the area. The *Guide* suggests that monitors equip themselves with road, street and topographical maps and guides.

● Monitors should use words and phrases that are easy to transmit and understand, should avoid local jargon which callers en route through the area might misunderstand, and should speak slowly and clearly.

● For clarity, it's wise to learn the International Phonetic Alphabet (Alpha, Bravo, Charlie, Delta, etc.), but not to overuse it. If reception is clear and the name is common, it's enough to relay it as 'S-M-I-T-H, Smith.' You don't have to slow it down to "Sierra, Mike, India, Tango, Hotel."

A NEAR monitor log has been designed, too, that's divided into sections: (1) identification, (2) incident, (3) location, (4) notification source, (5) action taken. The latter's time is to be expressed in 24-hour clock time. The forms can be produced locally for distribution to monitors. Interestingly, forms can be used for input to a computer so that information can be readily extracted. Number codes are used throughout, even for the type of emergency.

If you'd like to read the whole *Citizens Band Monitor Guide*, it's available for 80¢ a copy (\$1.00 minimum on mail orders) from the Superintendent of Documents, U. S. Government Printing Office, Washington, DC 20402. Order Stock No. 050-003-00235-6.

You can also find out who's working on NEAR in your state by contacting REACT, 111 E. Wacker Dr., Chicago, IL 60601. ◇

FREE

McIntosh CATALOG and FM DIRECTORY

Get all the newest and latest information on the new McIntosh Solid State equipment in the McIntosh catalog. In addition you will receive an FM station directory that covers all of North America.



MX 113

FM/FM STEREO - AM TUNER AND PREAMPLIFIER

SEND TODAY!

McIntosh Laboratory, Inc.
East Side Station P.O. Box 96
Binghamton, N.Y. 13904
Dept. PE

NAME _____

ADDRESS _____

CITY _____ STATE _____ ZIP _____

If you are in a hurry for your catalog please send the coupon to McIntosh. For non rush service send the *Reader Service Card* to the magazine.

CIRCLE NO. 37 ON FREE INFORMATION CARD

BYTE
The Small Systems Journal

Isn't it time you had your own personal computer?

Read **BYTE**, the leading consumer publication covering the fantastic new field of personal computer applications. Today, large scale integration has made it possible for the individual to enjoy the unique benefits of a general purpose computing system. Now, an entire micro industry markets microcomputer related items, products that range from computer system kits to peripherals, software and literature on the subject. But where should you go for all the details about your personal involvement in computer technology?

Read **BYTE**, the Small Systems Journal devoted exclusively to microcomputer systems. Every issue a monthly compendium of lively articles by professionals, computer scientists, and serious amateurs.

Fill in subscription coupon today, or phone your request directly — call 617/646-4329 and ask for your subscription. Read your first copy of **BYTE**, if it's everything you expected, honor our invoice. If it isn't, write 'CANCEL' across invoice and mail it back. You won't be billed and the first issue is yours.

Allow 6 to 8 weeks for processing.

BYTE Subscriptions Dept. 07 C
P.O. Box 361
Arlington, Mass. 02174

Please enter my subscription to **BYTE**...

\$12 One Year \$22 Two Years \$32 Three Years

Bill me Check Enclosed

Bill BankAmericard Bill Master Charge

Credit Card Number

Credit Card Expiration Date _____

Name (Please Print) _____

Address _____

City _____ State _____ Zip _____

CIRCLE NO. 10 ON FREE INFORMATION CARD

Heathkit®

FALL 1977

New THE HEATHKIT COMPUTERS

The "total system" computer products for home, hobby, educational and business applications. With powerful software to get you up and running fast, superior documentation and service support, sensational low prices too. They're the ones you've been waiting for! See pages 2-11.



N8 8-Bit Digital Computer, pages 4-5



H8 Video Terminal, page 9

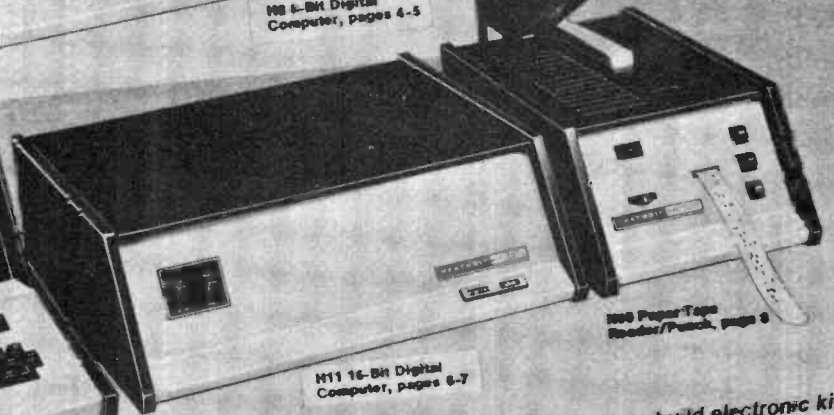

M11 16-Bit Digital Computer, pages 6-7

100 Paper Tape Reader/Punch, page 8

Plus the world's largest selection of quality easy-to-build electronic kits

Heath-recommended electronic products

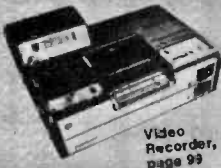

Video Recorder, page 99



Telephone Answerer, page 79



Indoor Greenhouse, page 78

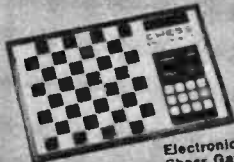

Electronic Chess Game, page 77

© 1977 Heath Company
See index on page 2

New Kit Products for FALL



Active Audio Processor, page 39



Low-Priced Oscilloscope, page 88



Electronic Digital Scale, page 104



FET Multimeter, page 63

HEATHKIT MAIL ORDER CATALOG 81
"Heath" and "Heathkit" are registered trademarks of Heath Company

Heath Company, Dept. 010-330
Benton Harbor, Michigan 49022

POPULAR ELECTRONICS

FREE!

The NEW Heathkit catalog introducing our complete line of personal computers and many more, exciting, fun-to-build electronic kits

NEW! H8 8-Bit Digital Computer

This 8-bit computer based on the famous 8080A microprocessor features a Heathkit exclusive "intelligent" front panel with octal data entry and control, 9-digit readout, a built-in bootstrap for one-button program loading, and a heavy-duty power supply with enough capacity for plenty of memory and I/O interfaces. It's easier and faster to use than most other personal computers and it's priced low enough for any budget.

NEW! H11 16-Bit Digital Computer

Heath, the world's largest kit manufacturer, and Digital Equipment Corporation, the leader in minicomputer systems, combine to bring you today's most sophisticated personal computer. Features include DEC's 16-bit LSI-11 CPU, 4096 x 16 read/write MOS memory expandable to 20K (up to 32K words total), priority interrupt, DMA operation and more. Complete systems software for fast and efficient operation is included!

NEW! H9 Video Terminal

This full ASCII terminal system features a bright 12" CRT, with both long and short-form displays, all standard serial interfaces, plus a fully wired and tested control board. Has auto-scrolling, cursor with full positioning controls, full-page or line-erase modes, a transmit page function, and a plot mode for simple curves and graphs. The H9 is compact, attractive and easy to build. It's compatible with all Heathkit computers as well as most others through standard interfacing.

NEW! H10 Paper Tape Reader/Punch

Complete mass-storage peripheral using low-cost paper tape. Features a solid-state recorder with stepper motor drive, totally independent punch and reader modes and a copy mode for fast, easy tape duplication. Reads at 50 characters per second, punches at 10 characters per second. For use with Heathkit computers and most others.

Other Heathkit computer products include a cassette recorder/player for mass storage, teleprinter, self-instructional programming courses, a complete library of the latest computer books, plus software, memory expansion cards, I/O cards and lots more — everything you need to make Heath your personal computing headquarters!

NEW! Kit products for fall

An exciting selection of new kits includes an active audio processor to give your present hi-fi system better dynamic range and reduced noise levels, a new medium-power stereo FM-AM receiver, an electronic digital scale that shows you weight in big, bright easy-to-read numbers, and new test instruments including a low-priced precision oscilloscope and an easy-to-use FET multimeter.

NEW! Heath-recommended electronic products

These unique new products are recommended by Heath because of their excellent quality and outstanding value. The Sony Betamax™ videotape recording system using exclusive ultra-compact 2-hour Sony cartridges; an electronic greenhouse with automatic temperature and humidity controls; a computer based electronic chess game; and a sophisticated multi-cartridge microprocessor-based video game. All are high quality, fully assembled, tested and priced low to give you the kind of value you expect from Heath.

PLUS nearly 400 other superb, easy-to-build, money-saving products. You'll find a complete line of digital electronic clocks and weather instruments, plus useful and unique items for your car, home or office. There are many more exciting products to read about too! Home convenience items like a practical freezer alarm, a touch-control light switch, intercoms and a unique programmable doorbell. Automotive instruments and accessories, marine equipment, model aircraft Radio Control gear, security systems and more. Plus our world-famous Amateur Radio equipment and test and service instruments.

These are among the nearly 400 quality, fun-to-build kits described in this new Heathkit catalog. Kits for every interest. All with the world-famous Heathkit assembly manual — a step-by-step instruction guide that makes kitbuilding easy and leaves nothing to chance. And all backed by our "We won't let you fail" promise. Find out about the satisfaction, savings and FUN of kitbuilding.

Send for your
FREE copy today!

HEATH Schlumberger	Heath Company, Dept. 010-330 Benton Harbor, Michigan 49022
Please send me my FREE Heathkit Catalog. I am not on your mailing list.	
Name _____	
Address _____	
City _____	State _____
Zip _____	
CL-637	



Computer Bits

By Hal Chamberlin

UPDATE ON MICROPROCESSOR DEVELOPMENTS

OVER THE past year, there has been a flood of new microprocessor IC's and related peripheral IC's coming on the market. Many have been rumored in the past but are now finally available. These new IC's are important to casual as well as advanced computer hobbyists because they will show up shortly in new hobbyist-oriented equipment offerings.

One obvious overall trend in microprocessor IC's has been toward true single-chip central processing units or even complete computers. With today's CPU chips, one merely adds memory, address decoding, and bus buffering to have a complete, expandable computer. The newest "computers on a chip" have the CPU, erasable read-only memory, read-write memory, and a couple of input-output ports all in one IC! Although these are not as easily expanded, they are ideal for use in terminals or intelligent game machines.

Another trend is toward I/O systems on a single chip. The TMS5501 IC from Texas Instruments, for example, combines a complete UART with baud-rate generator for serial I/O, a parallel input port, a parallel output port, 5 (count them) interval timers, and a vectored interrupt system into one IC! Another example is the MCS6530 from MOS Technology (now part of Commodore) and Synertek. This IC offers 1k bytes of read-only memory, 64 bytes of read-write memory, two *bidirectional* (programmable for input or output) parallel ports, and a very versatile interval timer. As a matter of fact, two of these are used in the KIM-1 to hold the monitor and provide its extensive I/O capabilities.

Complete peripheral controllers are also appearing in chip form. Most notable is the fact that no fewer than three different floppy-disk controller IC's are now available. Most of them are flexible enough to handle the disk formats in common use by hobbyists as well as the

"standard" and more complex IBM format for which the chips were designed. Another IC that has been announced but is not yet available is a video display chip with *programmable* line length and number of lines. Even the character read-only memory is built-in.

Memory developments certainly have not taken a vacation either. Static 4k memory chips have become cost effective alternatives to the common 1k 2102 chips and are now appearing in 16k-byte memory boards for the hobbyist. Earlier problems with dynamic memory chips have been overcome by correct board design and will be emerging as the price-performance leader in memory for the hobbyist since 4k dynamic memory chips are now selling for as little as \$2.70 in large quantities. Finally, the availability of 16k dynamic memory IC's makes possible the single-board "full gallon" (64k) memory system. In fact, IMSAI has announced a 64k memory board for its systems.

The 8080 Field. Even though the 8080 is the most popular microprocessor chip for hobbyist systems and has also enjoyed considerable success in

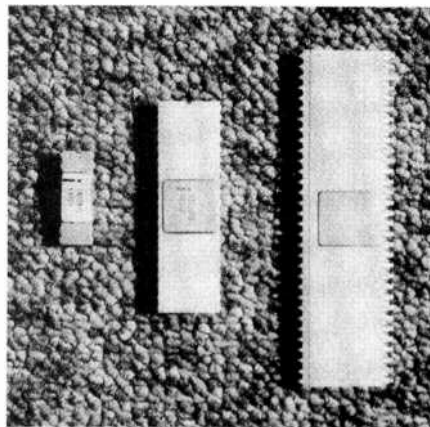

Size of microprocessors grows in proportion to sophistication of internal logic. Left to right, an 8008, 8080, and the latest 16-bit micro, a 9900 IC.

commercial systems, many significant improvements in the family have become available in the last year. Improved versions of the original 8080 that run at higher speeds are now available. The fastest is the 8080A-1 which can run at a clock speed of 3.125 MHz or over 60% faster than the standard 8080. Of course these higher speeds require faster memory to be of any benefit but many of the newer memory boards run fast enough.

To most people however, the most significant development is of course the Z-80. This microprocessor chip was introduced by Zilog, a spinoff company from Intel, the originators of the 8080. The Z-80 is fast; selected versions run at 4-MHz which is twice as fast as the 8080. Additionally, some instructions require fewer clock cycles to execute than the 8080 equivalents. The main attraction of the Z-80 for hobbyists however has been its extended instruction set. Besides all of the 8080 instructions, the Z-80 has many new ones. The most impressive class is the block search and move instructions. A single instruction, after the proper parameters have been loaded into registers, can perform a function that normally requires an entire subroutine. Besides the obvious savings in memory space, the block instructions execute much faster than the subroutine would. Other improvements are indexed addressing modes which simplify some types of programming and a duplicate set of registers which eliminates the need to save registers during interrupt.

One of the newest developments from Intel is designated the "MCS-85" family. Central to this family of chips is the 8085 microprocessor. This chip essentially combines the CPU, clock generator, and system bus controller functions onto one IC. In addition, 4 individually maskable vectored interrupts are included right on the CPU chip thus solving a bad problem with the original 8080. One of the most significant improvements is relaxed bus timing specifications. At equivalent throughput speeds, the 8085 allows memory access to stretch out as long as 1025 ns whereas the 8080 allows only 570 ns thus requiring a memory almost twice as fast. Even when the 8085 is sped up 50% to 3 MHz, the 575 ns allowed for memory access is longer than an 8080 at normal speed thus allowing a faster system without faster memory. Even with all of these improvements, the 8085 will execute all 8080 programs without changes.

Other 8-Bit Processors. Of course

the other microprocessor manufacturers have not twiddled their thumbs over the past year. Motorola has just announced faster versions of its popular 6800. The MC68A00 runs 50% faster at 1.5 MHz and the MC68B00 runs fully twice as fast at 2 MHz. Likewise, the 6502 microprocessor from MOS Technology is available in higher speed versions. The A suffix part is twice as fast at 2 MHz, the B suffix runs at 3 MHz, and the "dash C" part smokes at 4 MHz. Remember when comparing clock speeds that the above chips generally accomplish about as much in one clock cycle as an 8080-type chip does in three clock cycles.

National Semiconductor's SC/MP microprocessor has also been improved. It is now an n-channel MOS chip which means easier interfacing and a single 5-volt power supply. Additionally the speed has been doubled to 4 MHz (which is divided by 4 internally). Even with these improvements, its price remains the same.

The F-8 microprocessor originated by Fairchild normally requires at least two chips to make a complete CPU. However Mostek has recently announced a single chip F-8 that combines memory, an interval timer, and I/O ports all on the same chip.

16-Bit Microprocessors. To many people the ultimate hobby computer simply must have a full 16-bit minicomputer style instruction set. Accordingly, recent developments in 16-bit microprocessors are of great interest. A significant trend with the 16-bitters has been to try to get it all on one chip even if it means a larger IC package as shown in the photo.

The PACE was the first single-chip 16-bit microprocessor to be introduced. Although National Semiconductor has not made any significant improvements in the chip itself, the price has improved considerably. From an initial figure of nearly \$200 (in 100 quantity), the price has recently fallen to only \$20.

Speaking of price reductions, the CP1600 processor by General Instruments has been recently repriced at \$8! The architecture is somewhat strange but the price is hard to beat and it is a 16-bit device.

Another 16-bit processor which has been rumored for awhile is now available. It is the 9900 from Texas Instruments. This IC is unique in many respects. Most striking is the 64-pin package which looks more like a small printed circuit board with leads than a ceramic

IC. The instruction set in many ways resembles that of a DEC PDP-11, a very popular minicomputer. An interesting design innovation is that the "registers" are not in the CPU but are in regular read-write memory. Another feature is the inclusion of real multiply and divide instructions which take only about 20 microseconds to execute. The standard 9900 requires a 16-bit wide memory but a "soon-to-be-introduced" version (the 9980) can work with an 8-bit data bus and memory while retaining the same extensive 16-bit instruction set. This means that CPU boards using the 9980 might be compatible with the S-100 bus structure. The 9980 will also be packaged in a more conventional 40-lead package.

Bipolar Bit Slices. While not really microprocessor chips, the bipolar bit slices are building blocks that can be used to design custom computers and instruction sets with much less effort and far fewer parts than would be required with standard logic. Since they are made with high-speed Schottky transistors rather than MOS transistors, the speed of a system constructed with bipolar slices is much greater. Major innovations in this area are sharply lower prices and the availability of 4-bit wide units along with a host of support chips. Of significance to the hobbyist is the fact that a couple of hobbyist manufacturers are readying CPU boards made with the bit slices. These will be compatible with the S-100 bus and immediately provide the user with a vastly superior CPU while still using the rest of the existing system. Since the bit slices are *microprogrammed*, it is possible that a standard feature would be an *emulation mode* in which the instruction set of a popular microprocessor such as the 8080 would be recognized as well as the improved instruction set offered with the new CPU.

Bipolar bit slices will probably also show up in specialized floating-point arithmetic units. The purpose of these is to execute the arithmetic operations needed by BASIC language systems much faster than typical software routines do.

If the past is any indication, new microprocessor developments will continue to be made at an ever accelerating pace.

Correction. In last month's column, the price of the Heathkit H9 CRT terminal was given as \$350. It should have been \$530. ◇

Autoranging Frequency Counting to 60 MHz with 1 Hz Resolution

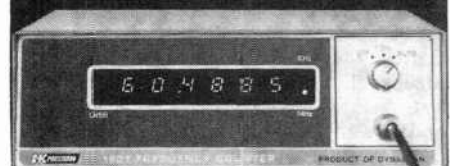

B&K-PRECISION MODEL 1801 \$240

- For laboratory, production line or maintenance applications
- Automatic ranging, 20 Hz to 40 MHz is guaranteed...readout to 60 MHz is typical
- TTL circuitry updates the six-digit display five times per second
- Resolution to 1 Hz obtained by suppressing digits above 1 MHz when switching to 1 SEC mode



MHz display of
3.579548 MHz input (AUTO mode)

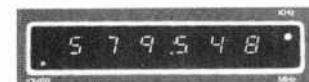

KHz display of overflow of
3.579548 MHz input (1SEC mode)

- Available for immediate delivery, from local B&K-PRECISION distributors
- 10-day free trial offer

B&K PRECISION
PRODUCTS OF DYNASCAN

6460 West Cortland Avenue
Chicago, Illinois 60635 • 312/889-9087
In Canada: Atlas Electronics, Toronto

CIRCLE NO. 68 ON FREE INFORMATION CARD

Put Professional Knowledge and a
COLLEGE DEGREE
 in your Electronics Career through
HOME STUDY

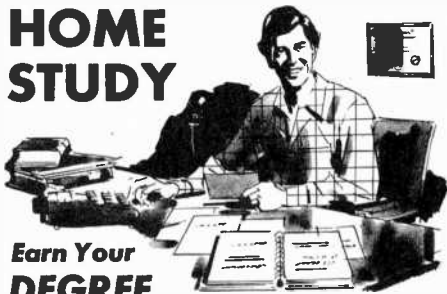

Earn Your DEGREE

by correspondence, while continuing your present job. No commuting to class. Study at your own pace. Learn from complete and explicit lesson materials, with additional assistance from our home-study instructors. Advance as fast as you wish, but take all the time you need to master each topic. Profit from, and enjoy, the advantages of directed but self-paced home study.

The Grantham electronics degree program begins with basics, leads first to the A.S.E.T. degree, and then to the B.S.E.E. degree. Our free bulletin gives complete details of the program itself, the degrees awarded, the requirements for each degree, and how to enroll. Write for *Bulletin E-77*.

Grantham College of Engineering

2000 Stoner Avenue

P. O. Box 25992

Los Angeles, CA 90025

Worldwide Career Training thru Home Study
 CIRCLE NO. 29 ON FREE INFORMATION CARD

KIT TOOL

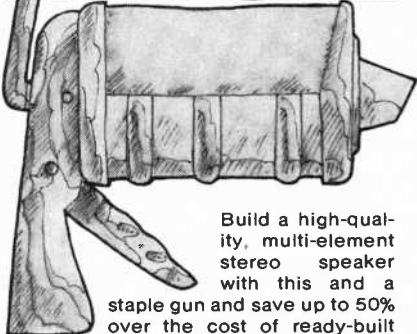

Build a high-quality, multi-element stereo speaker with this and a staple gun and save up to 50% over the cost of ready-built speakers. No cabinetry. No soldering. Just affordable quality with a few hours work. Send for our free 48-page catalog-manual if you think you could handle it.

I can handle it. PE-E
 Send me my free 48-page catalog-manual.

NAME _____
 ADDRESS _____
 CITY _____ STATE _____ ZIP _____

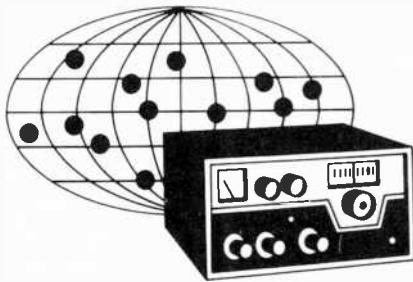

DX Listening

By Glenn Hauser

PUBLICATIONS

AN AMAZING amount of excellent printed material relating to international radio is available, once you know how to get it. Most of it you would never find, no matter how long you looked, even in the largest libraries. It's produced by enthusiastic individuals, with expertise in their specialties, even though they are nonprofessionals. Here's a selection of such publications, and how to get them.

Review of International Broadcasting is a monthly magazine in which listeners exchange views on programming. It fills the vacuum left by most DX clubs, which emphasize picking up stations, rather than listening to their programming—which, after all, is the reason stations broadcast. Sample, 50¢ or 12 issues for \$6.00 from Glenn Hauser, WUOT, University of Tennessee, 245 C&E Bldg., Knoxville, TN 37916.

Down Under DX Survey, a quarterly, mimeographed bulletin, concentrates on Asian stations, with extensive band surveys, special reports, etc. Only active contributors may join the group, but anyone may order individual issues, for 6 IRC's (International Reply Coupons) from Down Under DX Circle, 7 Donald Road, Burwood, Victoria, Australia 3125.

Far Eastern DX Review is a similar bulletin compiled by four Japanese experts (in English), but is monthly and Xeroxed. Samples are 8 IRC's or \$2. A year by air is \$20, or by surface mail, \$15, from Japanese Association of DXers, Box 1766 Tokyo Central, Tokyo 100-91, Japan.

Russian Reporting Guide is a separate JADX publication, available for 4 IRC's from the address above. Claims to be "the most detailed guide for reporting in Russian and for understanding domestic services in the USSR."

USSR High-Frequency Broadcast Newsletter provides otherwise hard-to-get schedules of Soviet transmissions based on monitoring: including educated guesses on the transmitter sites actually used, contradicting official informa-

tion from the USSR itself. Sample for SASE, or 12 issues of the approximately monthly publication for only \$3, from Roger Legge, Box 232, McLean, VA 22101.

World Broadcasting Information is a weekly compilation of schedules, and monitored developments in broadcasting, by and for professionals, but available to individual subscribers. Costs vary around \$60 per year, but a free sample is offered from: Organiser, News & Publications, BBC Monitoring Service, Caversham Park, Reading, England.

DX Information Service Catalog is free from Radio Nederland, Box 222, Hilversum, Holland. Lists free technical courses, antenna booklets, etc.

Mail-a-Prop is a two-page fortnightly summary of propagation condition predictions, compiled by George Jacobs, primarily for amateurs, but also can be applied by listeners to other bands. Sample and rates from Mail-a-Prop, Box 86, Northport, NY 11768.

SPEEDX Utility Guide attempts to do for nonbroadcast listening what the World Radio-TV Handbook does for broadcasting. This year's edition is \$6.95 from SPEEDX, Box E, Elsinore, CA 92330.

Listen to the World on Shortwave—Ask Me! Red and white vinyl bumper stickers are also available from SPEEDX, at 50¢ each.

Handler Enterprises, P.O. Drawer CC, Northfield, IL 60093, offers a free catalog of its reasonably priced station lists, primarily of military and government utility stations, difficult to obtain elsewhere.

GILFER Associates provides a number of books about aspects of DX listening, and a line of equipment. Ask for catalog. GILFER, Box 239, Park Ridge, NJ 07656.

National Radio Club provides extensive reprints of technical and nontechnical articles dealing with mediumwave reception and gear; for a list, send an SASE to NRC Publications Center, Box 401, Gales Ferry, CT 06335.

Worldwide TV-FM DX Association

does the same with articles on vhf/uhf reception and equipment. Ask for a catalog from WTFDA Reprint Service, Box 202, Whiting, IN 46394.

ANARC Directory of DX Club Publications extends even further the list given here. Send a #10 SASE with 24¢ postage to Association of North American Radio Clubs, 557 N. Madison Ave., Pasadena, CA 91101.

EDXC List of 600 DX Publications of the World is available for 5 IRC's from European DX Council, Box 250325, D-4630 Bochum, German Federal Republic.

International Broadcast Institute publishes case studies of broadcasting in different countries, intended for scholars, but may be of interest to the serious DX listener. Ask for a list of publications available, from IBI, Tavistock House East, Tavistock Square, London, WC1H 9LG, England.

Comings & Goings. South Africa's Radio Five, the successor to Mozambique's "LM Radio", planned to come up in August via two new 100-kW short-wave transmitters, probably using 31 or 41m in the daytimes, and 75m at night. Meanwhile, the international service, Radio RSA is overhauling its four 250-kW transmitters and replacing them with three 500-kW senders.

Radio Voice of the Gospel, a Lutheran station in Ethiopia, was nationalized in March, and renamed Radio Voice of Revolutionary Ethiopia. The latest schedule we have shows the only frequencies in use to be 6015 and 7180 kHz, opening at 1300 GMT in Somali, when they should be audible in western North America via long path, but not during the English program at 1630.

Both Vatican Radio in Italy for the Catholics, and HCJB in Ecuador for the Evangelical Protestants, are installing 500-kW transmitters and gigantic rotatable antennas to improve their outreach.

Australia is planning a new domestic shortwave service for its Northern Territory, transmitted both from Darwin, and from Adelaide, South Australia. Also, \$63 million (Australian) has been appropriated to modernize Radio Australia overseas transmitters in Victoria, and further expansion on the west coast is also being considered including between Australia and overseas.

Radio Nacional Brasilia abruptly suspended its international service in mid-June, citing technical reasons. The reasons were really political, however. The Brazilian government couldn't wait until next year when RNB is slated to get five **POPULAR ELECTRONICS**

The All-American Wide Receiver



DRAKE SPR-4 Short Wave Receiver

- Direct Frequency Dialing • All Solid State
- Programmable Coverage • FET Circuitry

A general purpose receiver, the SPR-4 may be programmed to suit any interest: SWL, Amateur, Laboratory, Broadcast, Marine Radio, etc. Freq. Coverage: 150-500 KHz plus any (23) 500 KHz ranges, .500 to 30 MHz.

- FEATURES:**
- Linear dial with 1 KHz read-out
 - 4-pole crystal filter in first IF
 - 4-pole LC filter in second IF
 - Three bandwidths: 0.4 KHz, 2.4 KHz, and 4.8 KHz for: CW, SSB, AM
 - Superior cross-modulation and overload performance
 - Power: 120 VAC, 220 VAC, or 12 VDC
 - Crystals supplied for LW, BC and seven SW bands
 - Built-in speaker
 - Notch Filter.

ACCESSORIES: 100 KHz calibrator, noise blander, DC power cord, loop antenna, crystals for other ranges.

For complete details contact:



R. L. DRAKE COMPANY

540 Richard St., Miamisburg, Ohio 45342, Phone: (513) 866-2421 • Telex: 288-017

CIRCLE NO. 18 ON FREE INFORMATION CARD

Try this exciting new hobby!

Build your own electronic concert organ. It's easy. No technical knowledge required. Just follow the clearly pictured instructions of the famous Wersi do-it-yourself system. Choose from seven different models. Send \$2.00 (refundable) with coupon for colorful 104 page catalog.



Wersi Electronics, Inc.
Dept. 42, Box 5318
1720 Hempstead Road
Lancaster, PA 17601

Enclosed is \$2.00 for my copy of your 104 page catalog.

Name _____
Address _____
City _____ State _____ Zip _____

CIRCLE NO. 62 ON FREE INFORMATION CARD

BUILD YOUR OWN

BIG SCREEN COLOR TV!

YOU ASKED FOR IT!

WE HAVE RECEIVED THOUSANDS OF INQUIRIES!

YOU REQUESTED PLANS FOR A BIG SCREEN TV THAT WOULD: utilize any portable TV as an image source - require a minimum of floor space - be a beautiful piece of furniture.

NOW - EXTRON IS HAPPY TO ANNOUNCE

THE NEW LIFESCREEN II

The LIFESCREEN was designed for the Do-It-Yourself enthusiast who wishes to have the enjoyment and excitement of a professional Big Screen TV - but refuses to pay the \$1500 to \$4000 that most manufacturers charge for this luxury.

FACTS

The special LIFESCREEN Lens and Front Surface mirror supplied by Extron are the same type used by major Big Screen TV manufacturers (Sony, Muntz, etc.). THESE PROFESSIONAL COMPONENTS SHOULD NOT BE CONFUSED WITH THE CHEAP PLASTIC MAGNIFYING IMITATIONS NOW FLOODING THE MARKET BECAUSE OF THE POPULARITY OF BIG SCREEN TV.

The EXTRON TV Screen - the same used by the major Big Screen TV manufacturers - is 16 TIMES BRIGHTER than a flat matte surface and 6 TIMES BRIGHTER than most flat beaded movie screens. Its parabolic shape rejects extraneous light, concentrating a highly efficient and directionally selective television image that is exceptionally sharp and colorful.

COMPLETE LIFESCREEN II PACKAGE: \$299

COMPLETE LIFESCREEN I PACKAGE: \$269

THE EVERYTHING GUARANTEE

EXTRON GUARANTEES EVERYTHING: THE PROFESSIONAL QUALITY, ACCURACY OF DESCRIPTION, AVAILABILITY AND PROMPT DELIVERY OF COMPONENTS DESCRIBED IN THIS AD. If, after building your LIFESCREEN PROJECTION SYSTEM, you are not satisfied for any reason, return all components to EXTRON, 8831 Sunset Boulevard, West Hollywood, California for instant refund of the purchase price.

The SELF-CONTAINED internal projection TV that will utilize any transistor portable TV (12" to 19") ... requires only 2 x 4 feet of floor space - fits neatly against any wall ... and lends its beauty to the decor of any room.

COMPONENT LIST

- 1 set of LIFESCREEN II Plans
- 1 Portable transistor Color TV (12" to 19")
- 1 LIFESCREEN Lens
- 2 LIFESCREEN Front Surface Mirrors: one 8" x 10" and one 14 3/8" x 20"
- 1 EXTRON LS 50 Screen, 32" x 40" / 50" Diag.

- PLEASE RUSH ME ONE COMPLETE SET OF LIFESCREEN I PLANS @ \$9.00
- PLEASE RUSH ME ONE COMPLETE SET OF LIFESCREEN II PLANS @ \$9.00
- PLEASE ALSO SEND ME THE ITEMS CHECKED BELOW:
- LIFESCREEN LENS @ \$150.00
- LIFESCREEN FRONT SURFACE MIRROR, 8" x 10" @ \$20.00
- LIFESCREEN FRONT SURFACE MIRROR, 14 3/8" x 20" @ \$30.00
- EXTRON LS 50 SCREEN 32" x 40" / 50" Diagonal @ \$90.00
- COMPLETE LIFESCREEN I PACKAGE @ \$269.00
- COMPLETE LIFESCREEN II PACKAGE @ \$299.00

All Prices F.O.B. factory - Cal. residents add 6% sales tax.

TOTAL: \$ _____

EXTRON LIFESCREEN PROJECTION SYSTEM
8831 Sunset Boulevard,
West Hollywood, California 90069

Name _____
Address _____
City _____ State _____ Zip _____

CARD NAME _____
CARD NUMBER _____
EXPR. DATE _____

INFO PAK - 50¢

CIRCLE NO. 26 ON FREE INFORMATION CARD

- Sporting Events Are An Experience As Exciting as Being There!
- Movies Are Seen The Way They Were Meant To Be Seen!
- Ping And Other Video Games Are More Exciting Than Ever!
- Can Be Used With Video Tape Playback Equipment!

THE ORIGINAL LIFESCREEN I



THE INDEPENDENT projection system that can be used with ANY SIZE screen up to 80" Diagonal - one of the many reasons for its tremendous success.

- COMPONENT LIST
- 1 set of LIFESCREEN I Plans
 - 1 Sharp 13" Model 13A21 Color TV or Sony 15" Model KV 1541R Color TV.
 - 1 LIFESCREEN Lens
 - 1 LIFESCREEN Front Surface Mirror, 8" x 10"
 - 1 EXTRON LS 50 Screen 32" x 40" / 50" Diagonal.

LARGER SCREENS can be ordered through EXTRON (67" or 80" Diag.)



NEW EICO 700 FREQUENCY COUNTER KIT \$69⁹⁵

At last! A digital counter every CB'er/Hobbyist can afford. Exclusive transmitter-keyed "sniffer" circuit activates counter only on transmit, giving accurate readout of channel frequency. Standard coax connectors and mounting brackets make mobile installation a snap. IC Digital circuitry. Freq. range: 5 Hz-27 MHz (all 40 CB channels) Accuracy: ± 1 PPM ± 1 Digit. Readout: Five 0.5" LED Displays; 10 MHz crystal oscillator KHz/MHz Timebase switch; Compact design: 2 $\frac{3}{8}$ " H x 6 $\frac{1}{8}$ " W 5 $\frac{1}{16}$ " D. **Assembled \$99.95**

FREE '78 EICO CATALOG

Check reader service card or send 75¢ for first class mail. See your local EICO Dealer or call (212) 272-1134, 9:00 a.m.-5:00 p.m. EST. Major credit cards accepted.

EICO—283 Malta St.,
Brooklyn, N.Y. 11207



CIRCLE NO. 20 ON FREE INFORMATION CARD

SAVE!

MONEY • TIME • FREIGHT

QUALITY STEREO EQUIPMENT
AT LOWEST PRICES.

YOUR REQUEST FOR QUOTA-
TION RETURNED SAME DAY.

FACTORY SEALED CARTONS—
GUARANTEED AND INSURED.

SAVE ON NAME BRANDS LIKE:

A.D.C.	KLH
A.R.	SHURE
DYNACO	KOSS
SONY	FISHER

PIONEER

AND MORE THAN 50 OTHERS
BUY THE MODERN WAY
BY MAIL—FROM

Department 217S
12 East Delaware
Chicago, Illinois 60611
312-664-0020

CIRCLE NO. 32 ON FREE INFORMATION CARD

new transmitters. It decided instead to take RNB off the air so its one transmitter could be used for domestic broadcasts into Amazonia—where foreign broadcasts have been dominating the airwaves. No date of return was given, and there was a note of sadness in announcer John Morris's voice. We'll certainly miss this friendly, soft-line station.

But another friendly Latin American station made a comeback in June—Radio Clarin, from the Dominican Republic. They've had power supply problems for their 50-kW transmitter on 11700 kHz. Rudy Espinal, host of the English program at 2330 GMT, on his

first day back on the air, intimated that the time would be changed, or there would be an additional broadcast at a more convenient hour for Europe.

BBC's Far Eastern Station is moving from Malaysia across the Straits to Singapore. As the move is in phases, for a time BBC will be broadcasting from both countries, and not telling us which frequency is from which.

WYFR is also moving, from Massachusetts to Florida, near Lake Okeechobee, where there's more room for expansion; they too will be broadcasting from both locations until the move is complete. ◇

ENGLISH-LANGUAGE SHORTWAVE BROADCASTS FOR SEPT. & OCT.

by Richard E. Wood

TO EASTERN NORTH AMERICA				
TIME-EOT	TIME-GMT	STATION	QUAL*	FREQUENCIES, MHz
6:28 a.m.-8:00 p.m.	1028-2400	**Montreal, Canada (Northern Service)	G	9.625, 11.72 (includes French, etc.)
7:00-7:25 a.m.	1100-1125	Tirana, Albania	F	9.50, 11.985
7:00-9:00 a.m.	1100-1300	Melbourne, Australia	G	9.58
		London, England	G	5.99 (via Sackville), 6.195 (via Antigua)
7:00-10:00 a.m.	1100-1400	**V.O.A., Washington, USA	G	5.955, 9.73
8:00-8:30 a.m.	1200-1230	Jerusalem, Israel	G	11.655, 15.23, 15.415, 17.795, 17.815
8:00-8:55 a.m.	1200-1255	Peking, China	F	11.685
8:10-8:30 a.m.	1210-1230	**Santiago, Chile	G	9.566, 11.81, 15.15
8:15-8:30 a.m.	1215-1230	Athens, Greece	P	15.345, 17.83
		HCJB, Quito, Ecuador	G	11.745
8:30-9:00 a.m.	1230-1300	Stockholm, Sweden	G	15.305
8:30-9:20 a.m.	1230-1320	Trans-World Radio, Bonaire, N.A.	G	15.255 (Sat., to 1420 Sun.)
8:30-11:30 a.m.	1230-1630	HCJB, Quito, Ecuador	G	11.745, 15.115
9:00-9:25 a.m.	1300-1325	Helsinki, Finland	G	15.105
9:00-9:30 a.m.	1300-1330	London, England	G	5.99 (via Sackville), 6.195 (via Antigua), 11.775 (via Antigua; Sat., Sun. from 1200)
9:15-9:45 a.m.	1315-1345	Berne, Switzerland	G	15.14
10:00-10:15 a.m.	1400-1415	**Montreal, Canada	G	15.29, 17.78
10:00-10:30 a.m.	1400-1430	Stockholm, Sweden	G	15.305
11:00 a.m.-12 noon	1500-1600	London, England	G	17.84 (via Ascension), 9.58 (via Sackville Sat., Sun.)
11:15-11:30 a.m.	1515-1530	Athens, Greece	F	11.73, 15.345, 17.83
12 noon-12:15 p.m.	1600-1615	London, England	G	9.58 (via Sackville), 17.84 (via Ascension)
12 noon-12:30 p.m.	1600-1630	Oslo, Norway	F	15.175 (Sun.)
12:04-12:56 p.m.	1604-1656	**Paris, France	G	11.705, 11.89, 11.93, 11.965, 15.20, 15.30, 15.425, 17.72, 17.795 (from Sept. 24: 1704-1756)
12:15-1:09 p.m.	1615-1709	London, England	G	9.58 (via Sackville; Sat., Sun. 1745)
12:42-12:50 p.m.	1642-1650	Hilversum, Holland	G	15.19, 17.775, (alt. 17.825; Mon. Fri. via Bonaire)
12:45-1:00 p.m.	1645-1700	**Montreal, Canada	G	15.325, 17.82
1:00-4:00 p.m.	1700-2000	**Kuwait, Kuwait	G	9.555, 12.085 (varies)
2:00-2:30 p.m.	1800-1830	**Montreal, Canada	G	15.26, 17.82
		**Kampala, Uganda	F	15.325 (Tues., Thur., Sat., Sun.)
2:50-4:00 p.m.	1850-2000	**Abidjan, Ivory Coast	G	11.92 (Sun.)
3:00-3:30 p.m.	1900-1930	**Montreal, Canada	G	15.26, 17.82
		**Tehran, Iran	F	9.022, (from Oct.: 2000-2030)
3:00-6:00 p.m.	1900-2200	**Jeddah, Saudi Arabia	F	11.855
3:30-4:00 p.m.	1930-2000	**Montreal, Canada	G	11.855, 15.325, 17.735
		**Baghdad, Iraq	F	9.745
4:00-4:30 p.m.	2000-2030	Jerusalem, Israel	G	7.4125, 9.63, 9.815
4:00-5:00 p.m.	2000-2100	Accra, Ghana	F	11.85 (irregular)
4:00-5:20 p.m.	2000-2120	**Hilversum, Holland	G	11.73 (via Talata)†
4:30-5:00 p.m.	2030-2100	**Montreal, Canada	G	11.855, 15.325, 17.82
4:50-5:50 p.m.	2050-2150	**Havana, Cuba	G	11.865, 17.75
5:00-5:50 p.m.	2100-2150	**Johannesburg, S. Africa	F	5.98, 7.27, 9.585
5:15-6:00 p.m.	2115-2200	London, England	G	9.58, 11.78

5:30-6:50 p.m.	2130-2250	Hilversum, Holland	G	9.715, 11.73 (exc. Sun.)†
6:00-6:15 p.m.	2200-2215	*Belgrade, Yugoslavia	F	6.10, 7.24, 9.62
6:00-6:30 p.m.	2200-2230	Oslo, Norway	F	11.85, 15.175 (Sun.)
6:00-6:45 p.m.	2200-2245	London, England	G	6.175, 9.51 (both via Sackville), 9.58, 11.78
6:00-7:15 p.m.	2200-2315	**Cairo, Egypt	G	9.805
6:00-8:00 p.m.	2200-2400	Montreal, Canada	G	5.96 (Mon.-Fri.)
6:00-8:30 p.m.	2200-0030	Ankara, Turkey	G	9.515, 11.88
6:30-7:00 p.m.	2230-2300	Jerusalem, Israel	G	7.4125, 9.435, 9.63, 9.815, 11.655
		Moscow, U.S.S.R.	G	5.94, 6.125, 7.10, 7.115, 7.205, 7.355, 7.44
6:30-7:20 p.m.	2230-2320	Johannesburg, S. Africa	G	5.98, 9.585, 11.90
6:30-8:30 p.m.	2230-0030	Ankara, Turkey	G	9.515, 11.88
6:45-7:30 p.m.	2245-2330	London, England	G	5.975, 6.175, (via Sackville), 7.325, 9.58
6:50-7:10 p.m.	2250-2310	*Santiago, Chile	F	9.566, 11.81, 15.15
7:00-7:30 p.m.	2300-2330	Stockholm, Sweden	G	6.045, 6.12, 9.695
		London, England	G	5.975, 6.175 (via Sackville), 7.325, 9.58 (via Ascension)
		Vilnius, U.S.S.R.	G	7.15, 7.215, 7.245, 7.29, 7.32, 7.40
7:00-7:50 p.m.	2300-2350	**Buenos Aires, Argentina	G	11.71 (Mon.-Fri.)
7:00-9:30 p.m.	2300-0130	Moscow, U.S.S.R.	G	5.94, 6.125, 7.10, 7.115 (via Bulgaria), 7.205, 7.355, 7.44
			G	11.755
7:30-7:55 p.m.	2330-2355	Helsinki, Finland	P	11.755
7:30-11:30	2330-0330	London, England	G	5.975, 6.12 (via Sackville), 6.175 (via Antigua), 7.325, 9.51 (via Sackville; from 0030, Greenville), 9.58 (from 0030, via Ascension)
7:45-8:45 p.m.	2345-0045	Tokyo, Japan	F	11.705, 15.30
8:00-8:25 p.m.	0000-0025	Tirana, Albania	G	7.065, 9.75
8:00-8:30 p.m.	0000-0030	Oslo, Norway	F	6.18, 9.645 (Sun.)
8:00-8:55 p.m.	0000-0055	Sofia, Bulgaria	G	9.70 (alternate 9.705, 7.115)
		Peking, China	G	11.675, 11.945, 15.06
8:00-9:00 p.m.	0000-0100	**VOA, Washington, USA	G	6.19, 9.67, 11.83, 11.895
8:00-10:45 p.m.	0000-0245	**Luxembourg	F	6.09
8:00 p.m.-1:06 a.m.	0000-0506	**Montreal, Canada (Northern Service)	F	6.195, 9.625 (includes Eskimo, etc.)
8:15-8:30 p.m.	0015-0030	Athens, Greece	F	9.76, 11.73
8:15-8:45 p.m.	0015-0045	Brussels, Belgium	F	9.725 (varies)
8:40 p.m.-1:00 a.m.	0040-0700	HCJB, Quito, Ecuador	G	6.095, 9.56, 11.915
9:00-9:15 p.m.	0100-0115	Vatican, City	G	5.995, 6.015, 9.605, 11.70
9:00-9:20 p.m.	0100-0120	Rome, Italy	F	6.01, 9.575
9:00-9:30 p.m.	0100-0130	Montreal, Canada	G	9.535
9:00-9:45 p.m.	0100-0145	Berlin, Ger. Dem. Rep.	P	9.73
9:00-9:55 p.m.	0100-0155	Prague, Czechoslovakia	G	5.93, 7.345, 9.54, 9.63, 9.74
9:00-11:00 p.m.	0100-0300	Melbourne, Australia	F	15.32, 17.795
9:00-11:30 p.m.	0100-0330	Havana, Cuba	G	9.685, 11.725
9:00 p.m.-12 midt.	0100-0400	Madrid, Spain	G	6.065, 11.88 (exc. Sun.)
9:10-9:30 p.m.	0110-0130	*Santiago, Chile	F	9.566, 11.81, 15.15
9:30-9:50 p.m.	0130-0150	Cologne, Ger. Fed. Rep.	G	6.01, 6.04 (via Antigua), 6.075, 6.10 (via Malta), 9.565, 9.605, 11.685 (via Malta)
			G	6.20, 7.30
9:30-9:55 p.m.	0130-0155	Tirana, Albania	G	6.155, 9.77
		Vienna, Austria	P	6.155, 9.77
9:30-10:25 p.m.	0130-0225	Bucharest, Rumania	F	5.99, 6.19, 9.57, 9.69, 11.775, 11.94
9:30-11:00 p.m.	0130-0300	Moscow, U.S.S.R.	G	5.94, 6.07 (via Sofia), 6.125, 7.105, 7.115 (via Bulgaria), 7.205, 7.355, 7.44
9:45-10:15 p.m.	0145-0215	Berne, Switzerland	G	5.965, 6.135, 9.725, 11.715
10:00-10:30 p.m.	0200-0230	Budapest, Hungary	F	6.00, 7.215, 9.585, 11.91 (Exc. Sun.)
		Oslo, Norway	P	6.18, 9.645 (Sun.)
		Montreal, Canada	G	9.605, 9.655
		Warsaw, Poland	P	6.095, 6.135, 7.27, 9.675, 11.815, 11.84, 15.12
10:00-10:55 p.m.	0200-0255	Peking, China	F	9.94, 12.015, 12.055, 15.06
10:00-11:20 p.m.	0200-0320	Hilversum, Holland	G	6.165 (via Bonaire)†
10:00-11:30 p.m.	0200-0330	Cairo, Egypt	G	7.12, 9.475
10:10-10:30 p.m.	0210-0230	**Santiago, Chile	F	9.566, 11.81, 15.15
10:15-10:30 p.m.	0215-0230	Athens, Greece	F	9.76, 11.73
10:30-10:55 p.m.	0230-0255	Tirana, Albania	G	6.20, 7.30
10:30-11:00 p.m.	0230-0300	Stockholm, Sweden	F	6.115, 9.695
10:30-11:15 p.m.	0230-0315	Berlin, Ger. Dem. Rep.	P	9.73
11:00-11:30 p.m.	0300-0330	Budapest, Hungary	F	6.00, 7.215, 9.585, 11.91 (Tues., Fri.)
		Kiev, U.S.S.R.	G	5.98, 7.215, 7.245, 7.39, 7.40, 9.78
		Lisbon, Portugal	F	6.025, 11.935
11:00-11:35 p.m.	0300-0335	Warsaw, Poland	P	6.095, 6.135, 7.27, 9.675, 11.815, 15.12
11:00-11:55 p.m.	0300-0355	Peking, China	G	7.12, 9.78 (both via Tirana)
		Buenos Aires, Argentina	G	9.69 (Mon.-Fri.)
		Prague, Czechoslovakia	G	5.93, 7.345, 9.54, 9.63, 9.74
11:00 p.m.-12 mdt.	0300-0400	Moscow, U.S.S.R.	G	5.94, 6.07 (via Sofia), 6.125, 7.115 (via Bulgaria), 7.205, 7.355, 7.44
11:10-11:30 p.m.	0310-0330	**Santiago, Chile	F	9.566, 11.81, 15.15

Includes
Functional
T'it Stand!

NEW EICO 270 3½ DIGIT DMM KIT ONLY \$79.95

Introductory Offer—FREE AC ADAPTOR

The first and only lab accuracy portable DMM Kit featuring MOS/LSI IC economy and reliability. Measures DC/AC Volts, Kilohms, DC/AC milliamps in 21 ranges. Polarity indicators and overload protection are provided, and 0.5 inch LED displays give easiest-to-read digital readout to 9999. The 270 features a basic 0.5% DC accuracy, 10 Meg-ohm input impedance, low voltage drop in all current ranges and automatically-flashing overrange indicator. Assembled \$109.95

FREE '78 EICO CATALOG

Check reader service card or send 75¢ for first class mail. See your local EICO Dealer or call (212) 272-1134, 9:00 a.m.-5:00 p.m. EST. Major credit cards accepted.

EICO—283 Malta St.,
Brooklyn, N.Y. 11207



CIRCLE NO. 20 ON FREE INFORMATION CARD

FREE catalog

of over
2000
small tools,
measuring
instruments,
and supplies



National Camera
2000 West Union Ave., Dept. HA
Englewood, Colo., U.S.A. 80150

CIRCLE NO. 40 ON FREE INFORMATION CARD

THE PAIA 8700 COMPUTER/CONTROLLER

An exceptional price on an applications oriented 6503 based micro-processor system



\$149.95

THE IDEAL, LOW COST SOLUTION TO IMPLEMENTING THOSE WILD COMPUTER BASED CONTROL SYSTEMS YOU'VE BEEN DREAMING OF!

PAIA software currently available or under development includes: Music synthesizer interface; Home applications package including: multi-zone fire/burglar alarm, real time clock, energy saving heat/air conditioning control, computer generated "door-bell"; Model railroad controller and more.

8700 COMPUTER/CONTROLLER KIT \$149.95
(requires 5v. @ 1.2A.; 12v. @ 150ma.)

Shipped direct from PAIA (add \$3.00 postage)
Also available at FULL LINE computer stores

DETAILS IN OUR FREE CATALOG

PAIA • DEPT. 9-P • 1020 W. Wilshire Blvd. •

Oklahoma City, OK 73116

0056 CIRCLE NO. 46 ON FREE INFORMATION CARD

Now! Write and run machine language programs at home plus design circuits using a microprocessor!

microprocessor/ minicomputer

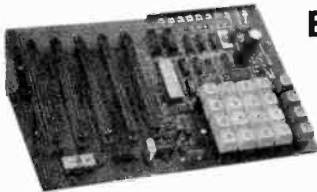

ELF II

\$99.95

SEND TODAY

NETRONICS R&D LTD., Dept. PE97
Phone (203) 354-9375
333 Litchfield Road, New Milford, CT 06776

Yes! I want to run programs at home and have enclosed: \$99.95 plus \$3 p&h for ELF II kit. Featured in POPULAR ELECTRONICS. Including all components plus everything needed to write and run machine language programs plus the new Pixie chip that lets you display video graphics on your TV screen. Designed for engineers, students and hobbyists who need training in computer programming and micro-processor circuit design. Features RCA 1802 COSMAC COS/MOS 8-bit microprocessor addressable to 64k bytes, 256 byte RAM, full hex keyboard, two hex-digit output display, crystal clock for timing applications and double-sided plated-through pc circuit board. Requires 6.3 VAC transformer. Optional 5 card expansion bus (less connectors) for memory expansion, cassette I/O, A to D and D to A converters, PROM and a host of other I/O's. Manual includes instructions for assembly, testing, programming, video graphics and games plus how to receive ELF Users' Club bulletins.

\$149.95 plus \$3 for ELF II wired & tested. (Includes 6.3 VAC power supply and RCA 1802 User's Manual.)

\$5.00 for RCA 1802 User's Manual. Connecticut residents please add sales tax.

NAME _____

ADDRESS _____

CITY _____ STATE _____ ZIP _____

Send me information on your other kits!

11:30-11:55 p.m.	0330-0355	Tirana, Albania Vienna, Austria	G P	6.20, 7.30 6.155, 9.77
11:30 p.m.-12:30 a.m.	0330-0430	London, England	G	5.975, 6.175 (via Antigua)
11:30 p.m.-12:50 a.m.	0330-0450	Havana, Cuba	G	9.685, 11.725, 11.76
12:00 mdt.-12:15 a.m.	0400-0415	Budapest, Hungary	F	6.00, 7.215, 9.585, 11.91 (Tues., Fri.)
12:00 mdt.-12:25 a.m.	0400-0425	Bucharest, Rumania	F	5.99, 6.155, 6.19, 9.57, 9.69, 11.775, 11.94
12:00 mdt.-12:30 a.m.	0400-0430	Oslo, Norway	F	6.18, 9.645 (Sun.)
12:30-1:00 a.m.	0430-0500	London, England Tirana, Albania	G G	6.175 (via Antigua) 7.30, 9.48
12:50-2:00 a.m.	0450-0600	Havana, Cuba	G	11.725, 11.76
1:00-1:15 a.m.	0500-0515	Jerusalem, Israel	G	5.90, 7.425, 9.63, 9.82, 11.96, 12.045
1:00-1:30 a.m.	0500-0530	Lisbon, Portugal	F	6.025, 11.935
1:00-2:30 a.m.	0500-0630	London, England	G	6.175, 9.51 (both via Antigua)
2:30-3:30 a.m.	0630-0730	London, England	G	6.175 (via Antigua)

TO WESTERN NORTH AMERICA

TIME-PDT	TIME-GMT	STATION	QUAL*	FREQUENCIES, MHz
4:00-4:15 a.m.	1100-1115	Tokyo, Japan	P	5.99
4:00-5:25 a.m.	1100-1225	Trans-World Radio, Bonaire, N.A.	G	11.815
4:00-6:00 a.m.	1100-1300	London, England	G	5.99 (via Sackville), 6.195 (via Antigua),
4:00-7:00 a.m.	1100-1400	**VDA, Washington, USA **4VEH, Cap-Haitien, Haiti	G G	5.955, 9.73 9.77, 11.835
5:00-5:15 a.m.	1200-1215	Tokyo, Japan	P	5.99
5:00-5:30 a.m.	1200-1230	**Tashkent, U.S.S.R.	F	9.60, 11.925
5:10-5:30 a.m.	1210-1230	**Santiago, Chile	F	6.195, 9.566, 11.81
5:15-5:30 a.m.	1215-1230	HCJB, Quito, Ecuador	G	11.745
5:15-5:45 a.m.	1215-1245	Copenhagen, Denmark	F	15.165 (Sat.)
5:30-6:20 a.m.	1230-1320	Trans-World Radio Bonaire, N.A.	G	15.255 (Sat.); 1420 Sun.)
5:30-9:30 a.m.	1230-1630	HCJB, Quito, Ecuador	G	11.745, 15.115
6:00-6:15 a.m.	1300-1315	Tokyo, Japan	P	5.99
6:00-6:30 a.m.	1300-1330	London, England	G	5.99 (via Sackville), 6.195 (via Antigua), 11.775 (via Antigua; Sat., Sun. from 1200)
6:30-6:50 a.m.	1330-1350	**Santiago, Chile	F	6.195, 9.566, 11.81
6:30-8:00 a.m.	1330-1500	**Delhi, India	F	11.81
7:00-7:30 a.m.	1400-1430	Tokyo, Japan **Tashkent, U.S.S.R.	G G	9.505 9.60, 11.925
7:00-8:20 a.m.	1400-1520	**Hilversum, Holland	G	11.74 (via Talata)†
7:00-9:55 a.m.	1400-1655	Manila, Philippines (VOP)	F	9.58 (Closes 1555 Sun.)
8:00-8:15 a.m.	1500-1515	Tokyo, Japan	G	9.505
8:00-9:00 a.m.	1500-1600	London, England	G	17.84 (via Ascension) also 9.58 (via Sackville Sat., Sun.)
9:00-9:15 a.m.	1600-1615	Tokyo, Japan	G	9.505
9:00-9:15 a.m.	1600-1615	London, England	G	9.58, 15.365 (via Sackville), 17.84 (via Ascension)
9:04-9:56 a.m.	1604-1656	**Paris, France	G	11.705, 11.89, 11.93, 11.965, 15.20, 15.30, 15.425, 17.72, 17.80, 17.82, 17.85, (after Sept. 24; 1704-1756)
9:15-9:45 a.m.	1615-1645	Copenhagen, Denmark	F	15.165 (Sat.)
9:15-10:09 a.m.	1615-1709	London, England	G	9.58, 15.365
9:42-9:50 a.m.	1642-1650	Hilversum, Holland	G	15.19, 17.775 (alt. 17.825; Mon.-Fri., via Bonaire)
10:00-10:15 a.m.	1700-1715	Tokyo, Japan	G	9.505
10:00 a.m.-1:00 p.m.	1700-2000	**Kuwait, Kuwait	G	9.555, 12.085 (varies)
10:09-10:45 a.m.	1709-1745	London, England	G	15.365; Sat. Sun. also 9.58 (both via Sackville)
11:00-11:15 a.m.	1800-1815	Tokyo, Japan	G	9.505
11:00-11:30 a.m.	1800-1830	**Kampala, Uganda Oslo, Norway	F F	15.325, (Tues., Thur., Sat., Sun.) 11.85, 15.175 (Sun.)
11:45 a.m.-1:00 p.m.	1845-2000	**Abidjan, Ivory Coast	G	11.92 (Sun.)
12 noon-12:10 p.m.	1900-1910	**Papeete, Tahiti	F	11.825, 15.17 (exc. Sun.)
12:00-12:15 p.m.	1900-1915	Tokyo, Japan	G	15.105
1:00-1:15 p.m.	2000-2015	Tokyo, Japan	G	15.105
1:00-2:20 p.m.	2000-2120	Hilversum, Holland	G	11.73 (via Talata)†
1:15-2:00 p.m.	2015-2100	**Kampala, Uganda	F	9.73 (Sun., Mon. Wed., Fri.)
1:30-1:50 p.m.	2030-2050	**Santiago, Chile	F	9.566, 11.81, 15.15
2:00-2:15 p.m.	2100-2115	Tokyo, Japan	G	15.105
2:00-3:00 p.m.	2100-2200	**Brasilia, Brazil	G	11.78 (alternates 15.245)
12:15-3:00 p.m.	2115-2200	London, England	F	9.58, 11.78
3:00-3:15 p.m.	2200-2215	Tokyo, Japan	G	15.105
3:00-4:30 p.m.	2200-2330	London, England	G	6.175, 9.51 (both via Sackville)
3:00-5:00 p.m.	2200-2400	**VDA, Washington, USA Montreal, Canada	G F	17.82, 17.895, 21.61 5.96 (Mon.-Fri.)
3:30-4:00 p.m.	2230-2300	Jerusalem, Israel	G	7.4125, 9.815, 11.655
3:30-4:20 p.m.	2230-2320	Johannesburg, S. Africa	G	5.98, 9.585, 11.90
3:30-5:30 p.m.	2230-0030	Moscow, U.S.S.R.	G	9.635, 12.05, 15.14, 15.18, 15.455, 17.72
3:50-4:10 p.m.	2250-2310	**Santiago, Chile	F	9.566, 11.81, 15.15
4:00-4:30 p.m.	2300-2330	Tokyo, Japan Vilnius, U.S.S.R.	G G	15.105 9.61, 11.69, 15.10
4:30-6:00 p.m.	2330-0100	FEB, Manila, Philippines	F	17.81

Use Quick-Wedge to fasten leads, wire in panelights, connect test equipment, install components

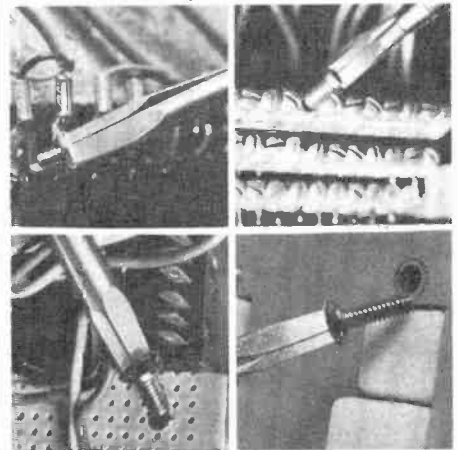

They do all that ordinary screwdrivers do, PLUS they hold and start the screw



QUICK-WEDGE 17 sizes

Screw-holding screwdrivers

Unconditionally guaranteed.
BUY A SET TODAY

See your dealer or write to:
Kedman Company, P.O. Box 25667,
Salt Lake City, Utah 84125
CIRCLE NO. 36 ON FREE INFORMATION CARD

© 1977



You can build a better organ than you can buy!

A magnificent Schober Electronic Organ

What a marvelous way to put your special talents to work! With our Schober Electronic Organ Kits and your skill, you can build yourself some very special satisfaction, and a lifetime of great music!

Schober Organs are literally far superior to comparably-priced "ready-made" units. You could actually pay twice as much and get no better organ... and miss the fun of assembling it yourself. A PC board at a time, component by component, you'll assemble your own "king of instruments." And when you're done, you'll wish there was more to do. And there is! For then, Schober will help you learn to play, even if you've never played a note before!

Schober Organ Kits range from \$650 to \$2850, and you can purchase in sections to spread costs out... or have two-year time payments.

Just send the coupon for the fascinating Schober color catalog (or enclose \$1 for a record that lets you hear as well as see Schober quality.)

The Schober Organ Corp., Dept. PE-72
43 West 61st Street, New York, N.Y. 10023

Please send me Schober Organ Catalog.
 Enclosed please find \$1.00 for 12-inch L.P. record of Schober Organ music.

NAME _____
ADDRESS _____
CITY _____ STATE _____ ZIP _____

CIRCLE NO. 56 ON FREE INFORMATION CARD

117

4:30-8:30 p.m.	2330-0330	London, England	G	6.12 (via Sackville), 6.175 (via Antigua), 9.51 (via Sackville; from 0030, via Greenville), 9.58 (from 0030, via Ascension)
5:00-5:15 p.m.	0000-0015	Tokyo, Japan	G	15.105
5:00-6:00 p.m.	0000-0100	**VOA, Washington, USA	G	11.83, 11.895, 15.40
5:30-6:00 p.m.	0030-0100	Moscow, U.S.S.R.	G	9.635, 9.78, 12.05, 15.14, 15.18, 15.445
		Kiev, U.S.S.R.	G	9.61, 11.69, 15.10
5:40 p.m.-12 mdt.	0040-0700	HCB, Quito, Ecuador	G	6.095, 9.56, 11.915
6:00-6:15 p.m.	0100-0115	Tokyo, Japan	G	15.105
6:00-6:30 p.m.	0100-0130	Moscow, U.S.S.R.	G	9.635, 9.78, 12.05, 15.14, 15.455
6:00-7:00 p.m.	0100-0200	Taipei, Taiwan	F	15.425, 17.89
6:00-8:00 p.m.	0100-0300	Melbourne, Australia	G	15.32, 17.795
6:00-9:00 p.m.	0100-0400	Madrid, Spain	G	6.065, 11.88 (exc. Sun.)
6:10-6:30 p.m.	0110-0130	*Santiago, Chile	F	6.195, 9.566, 11.81, 15.15
6:30-7:00 p.m.	0130-0200	Moscow, U.S.S.R.	G	9.635, 9.78, 11.86, 12.05, 15.14, 15.455
6:30-7:30 p.m.	0130-0230	Tokyo, Japan	G	15.195, 15.42, 17.725, 17.825
7:00-8:00 p.m.	0200-0300	Moscow, U.S.S.R.	G	9.635, 9.735, 9.78, 11.86, 12.05, 15.14, 15.455
7:30-8:00 p.m.	0230-0300	Stockholm, Sweden	P	6.115, 9.695
8:00-8:15 p.m.	0300-0315	Tokyo, Japan	G	15.105
8:00-8:30 p.m.	0300-0330	Kiev, U.S.S.R.	G	9.58, 9.635, 9.78, 11.86
		Montreal, Canada	G	5.96, 6.00, 9.605, 9.655
		Moscow, U.S.S.R.	G	9.735, 12.05, 15.455
8:00-8:50 p.m.	0300-0350	Taipei, Taiwan	G	11.825, 15.345, 17.89
8:00-8:55 p.m.	0300-0355	Peking, China	G	7.12 (via Tirana) 9.46, 9.78 (via Tirana), 11.65, 12.055, 15.06, 17.53
8:00-9:20 p.m.	0300-0420	**Johannesburg, S. Africa	F	5.98, 7.27
8:10-8:30 p.m.	0310-0330	**Santiago, Chile	F	6.195, 9.566, 11.81, 15.15
8:20-9:25 p.m.	0320-0425	**TIFC, San Jose, Costa Rica	F	5.055, 6.035, 9.645, (opens 0300 Sat., Sun.)
8:22-8:28 p.m.	0322-0328	Erevan, U.S.S.R.	G	9.54, 11.69, 11.75, 15.14 (Sat./Tue./Wed./Fri.)
8:30-9:15 p.m.	0330-0415	Berlin, Ger. Dem. Rep.	P	5.955, 6.08, 9.73
8:30-9:30 p.m.	0330-0430	Moscow, U.S.S.R.	G	6.03, 6.07, 6.15, 6.185, 7.13, 7.175, 9.58, 9.635, 9.735, 9.78
8:30-10:00 p.m.	0330-0500	London, England	G	6.175 (via Antigua)
9:00-9:15 p.m.	0400-0415	Tokyo, Japan	G	9.505
9:00-9:30 p.m.	0400-0430	Oslo, Norway	F	11.87 (Sun.)
		Budapest, Hungary	F	6.00, 7.215, 9.585, 11.91 (Tue. Fri.)
		Montreal, Canada	G	5.96, 9.655
9:00-9:55 p.m.	0400-0455	Peking, China	G	11.65, 12.055, 15.06, 17.53
9:30-10:00 p.m.	0430-0500	Berne, Switzerland	G	6.045, 9.725
		Vienna, Austria	P	6.015
		Sofia, Bulgaria	G	7.115, (alternate 9.70, 9.53)
9:30 p.m.-12:30 a.m.	0430-0730	Moscow, U.S.S.R.	G	6.03, 6.07, 6.15, 6.185, 7.13, 7.175, 7.29, 9.58, 9.635, 9.735
10:00-10:15 p.m.	0500-0515	Jerusalem, Israel	F	5.90, 7.4125, 9.63, 9.82, 11.96, 12.045
		Tokyo, Japan	G	9.505
10:00-10:30 p.m.	0500-0530	Lisbon, Portugal	F	6.025, 11.935
10:00-11:20 p.m.	0500-0620	Hilversum, Holland	G	6.165, 9.715, (via Bonaire)†
10:00-11:30 p.m.	0500-0630	London, England	G	6.175, 9.51, (both via Antigua)
10:00 p.m.-12 mdt.	0500-0700	**Wellington, New Zealand	G	6.105, 9.54
10:30-10:50 p.m.	0530-0550	Cologne, Ger. Fed. Rep.	G	5.96 (via Antigua) 6.10 (via Malta), 6.185, 9.545, 9.625 (via Montserrat)
11:00-11:15 p.m.	0600-0615	Tokyo, Japan	G	9.505
11:00-11:30 p.m.	0600-0630	Oslo, Norway	P	9.645, 11.87 (Sun.)
11:00 p.m.-12 mdt.	0600-0700	Buenos Aires, Argentina	G	9.69 (Mon.-Fri.)
11:25 p.m.-1:55 a.m.	0625-0855	**Kuala Lumpur, Malaysia	G	9.75, 15.29
11:30 p.m.-12:30 a.m.	0630-0730	London, England	G	6.175 (via Antigua)
11:30 p.m.-12:50 a.m.	0630-0750	**Hilversum, Holland	G	9.63 (via Bonaire)†
11:30 p.m.-1:00 a.m.	0630-0800	Havana, Cuba	G	9.525
12:00-12:15 a.m.	0700-0715	Tokyo, Japan	G	9.505
12:00-3:30 a.m.	0700-1030	**Wellington, New Zealand	G	6.105
1:00-1:15 a.m.	0800-0815	Tokyo, Japan	G	9.505
1:00-3:00 a.m.	0800-1000	Manila, Philippines (VOP)	F	11.85
1:00-7:00 a.m.	0800-1400	**Port Moresby, Papua-New Guinea	G	4.89
2:00-2:15 a.m.	0900-0915	Tokyo, Japan	G	9.505
2:30-2:50 a.m.	0930-0950	**Santiago, Chile	G	6.195, 9.566, 11.81
3:00-3:30 a.m.	1000-1030	Tokyo, Japan	G	5.99
3:00-3:50 a.m.	1000-1050	Pyongyang, Dem. P. Rep. Korea	G	7.203
3:50-4:10 a.m.	1050-1110	**Santiago, Chile	G	6.195, 9.566, 11.81

* Reception quality, East Coast (West Coast) location: G good, F fair, P poor

** Not intended for North America, but receivable satisfactorily

† As of November, Radio Nederland, Hilversum, will reduce duration of English broadcasts from current 100 minutes to 50 minutes. Some starting times may change.

Days refer to local date in target area.

PRICE WAR

AMERICA'S #1 VALUE LEADER
STEREO CORPORATION OF AMERICA



AUDIO DISCOUNTING STARTED IN NEW YORK & NOW WITH THE END OF FAIR-TRADE WE ARE SURE THAT NO ONE CAN BEAT OUR PRICES:
 ● WE DISCOUNT OVER 60 MAJOR BRANDS
 ● OVER 10 YEARS OF RELIABLE SERVICE IN THE MAIL ORDER FIELD.
 ● LARGEST INVENTORY/LOWEST PRICES! WE GET THE BEST DEALS FROM THE MANUFACTURERS; YOU GET THE BEST DEAL FROM US. DON'T DELAY!!!

WRITE US NOW FOR LOWEST PRICE QUOTE

WRITE OR CALL FOR FREE STEREO PRICE CATALOG

SHOP BY PHONE! (212) 253-8888
 N.Y. TIME
 9-5 MON. THRU SAT.
 Mastercharge/BankAmericard

STEREO CORPORATION OF AMERICA

P-E 1629 Flatbush Ave., Brooklyn, New York 11210

CIRCLE NO. 67 ON FREE INFORMATION CARD

Operation Assist

If you need information on outdated or rare equipment—a schematic, parts list, etc.—another reader might be able to assist. Simply send a postcard to Operation Assist, POPULAR ELECTRONICS, 1 Park Ave., New York, NY 10016. For those who can help readers, please respond directly to them. They'll appreciate it. (Only those items regarding equipment not available from normal sources are published.)

United States Radio and TV Corp. "Neurodyne" electric receiver (chassis 41—circa 1920's). Schematic diagram and parts list. John C. Whybrew, Box 387, Upland, IN 46989.

Heathkit Model 05 oscilloscope. Need service manual or any repair information. Andy Foremiak, Box 224, North Tonawanda, NY 14120.

Zenith combination AM, FM100, FM45 and 78 record player (chassis #8C21). Schematics and parts list or service manual. Dennis Main, Rt. 6, Box 218, Muncie, IN 47302.

Paco Model S-50 push-pull oscilloscope. Schematics and/or parts source. G. Denman, Rt. 3 Box 164, Grapeland, TX 75844.

Standard Model SR-500U AM/FM stereo receiver. Need H-203 IC (Sanyo part number LD 3141). William F. Gerdes, 732 Bowen St., Oshkosh, WI 54901.

Waterman Model S-14-B oscilloscope. Manual or schematic. Xam Mark 2TA solid-state stereo amplifier. Output transistor number and/or schematic. John Schmitt, Jr., 16 Carlson Parkway, Cedar Grove, NJ 07009.

Weston Model 802 VU meter. Need source to match replacement in Dumont 137-P mixer. Rich Adams, 2303 DuLaire Rd., Greensboro, NC 27407.

Tektronix Type 315R oscilloscope. Schematic and/or operation manual. Tom Ramos, 2813 15th Ave. So., Minneapolis, MN 55407.

Bradford Model 51847 multiband portable radio. Schematic and/or service manual. Rex Faulkner, 2677 Estelle Ct., Smyrna, GA 30080.

Friden Model 130 calculator. Triumph Model 850 oscilloscope. Superior Instruments Model TV-50A "Genometer" signal generator. Lear vhf-if receiver, LRA-6A if receiver and RT-10E transmitter, and Omnirange Model 2214A converter. Schematics, operation manuals and service information. James Marple, 2801 Sequoia Ln., Arlington, TX 76010.

Trilo Model 9R-59D radio. Operation manual needed. Ed Davis, 831 N. Superior Ave., Decatur, GA 30033.

Hallcrafters Model S-22R (U.S. Navy version). Schematic and any other available information. T. Thompson, 330 Sunset Blvd. S.W. #19, Renton, WA 98055.

Hammarlund Model CB-23 transceiver. Schematic and/or service manual. E.R. Stutler, 934 Edison Ave., New Port Richey, FL 33552.

RCA Model WO-56A oscilloscope and Dumont Type 304A oscilloscope. Schematic and/or service calibration data. Mr. James A. Fillingham, Rte. 1 Box 380-A, Pelzer, SC 29669.

Philco Model 39-7 radio/phono combination console. Any available information. Don Sherr, 509 Hannes St., Silver Spring, MD 20901.

Nipon Model 141-DA "Basicom" electronic calculator. Schematic needed. Dale Williams, 134 Stage Rd., Newport News, VA 23606.

Bogen Model CHB-100 PA amplifier. Schematic, parts list or manual. Brian Burke, 5737 S. Maryland, Chicago, IL 60637.

Hammarlund Model HQ-100 receiver. Schematic, alignment information or any available data. Jeff Kientz, 15 E. Forest, Columbia, MO 65201.

Sencore "Caddy" bar generator. Owners manual needed. Wilbur Hostetter, 12472 136th St., Largo, FL 33540.

Accurate Instrument Co. Model 157 tube tester. Operating instructions needed. Ralph A. Ladnier, 4026C FCN, McGuire AFB, NJ 08641.

Grundig Model 8034-3435 (chassis #2) stereo record player. Schematic diagram needed. M.A.H. Siddiqi, 2121 N. Western Ave., Chicago, IL 60647.

Precise Model 30 oscilloscope. Need operating instructions. Anthony Vitale, 5222 9th Ave., Brooklyn, NY 11220.

Treat yourself to a new direct reading DVM today.



DVM35

POCKET PORTABLE
ANALOG REPLACEMENT
3-digit, 1% DCV
Battery or AC
Only \$134



DVM36

LAB ACCURATE
POCKET PORTABLE
3½ digit, .5% DCV
Battery or AC
Only \$158



DVM32

BENCH & FIELD MASTER
3½ digit, .5% DCV
Battery or AC
Only \$198



DVM38

"PRIME" STANDARD AT
YOUR FINGERTIPS
3½ digit, .1% DCV
Auto-Ranging
Only \$348

A COMPLETE LINE OF DVMs TO FILL YOUR EVERY NEED OR WANT.

You can be sure more times in more circuits, under more adverse conditions, with greater versatility, accuracy, and meter protection than any other digital multimeters on the market today; and for less money, too. 10 Day Free Trial: Try any of these famous DVMs for 10 days. If the DVMs in use don't prove exactly what we say, return them to your Sencore FLPD Distributor.

Want more information? We would like to tell you all about the Sencore DVMs by sending you a 24-page Sencore News, a six-page brochure, and the name of your nearest Sencore Distributor today... simply write or circle reader's service number.

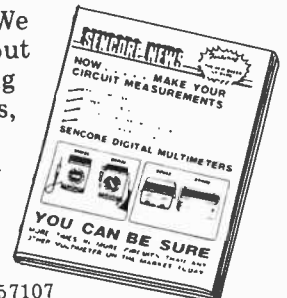

3200 Sencore Drive, Sioux Falls, SD 57107

SENCORE

CIRCLE NO. 64 ON FREE INFORMATION CARD

POPULAR ELECTRONICS



Electronics Library

110 CMOS DIGITAL IC PROJECTS

by R.M. Marston

If the schematics and typeface look a little different, it's because this book was first published in England. After a short introduction to COSMOS, the 110 projects are divided into six chapters of increasing complexity: 15 inverter, gate and logic circuits, 25 multivibrators, 10 dc lamp control, 25 relay switching, 25 sound generator and alarm, and 15 counting and dividing circuits. Nearly every circuit uses the RCA CD4001 quad 2-input NOR gate (same as Motorola MC14001); though the CD4013 dual D-type flip-flop (Motorola MC14013) is used a couple of times.

Published by Hayden Book Co., 50 Essex St., Rochelle Park, NJ 07662. 114 pages. \$4.95 soft cover.

ARRL HAM RADIO OPERATING GUIDE

by the ARRL Headquarters Staff

This operating manual introduces the reader to the many different operating practices and interests within the hobby of amateur radio. It contains ten chapters, entitled: Getting Started; Message Handling—Fun with a Purpose; Contests—a Sure Way to Sharpen Skills; The Basic Intrigue of DX; Logging + QSLing = Awards; Repeaters—All the Ins and Outs; The Flea-Power Challenge; Communicating Visually; Vhf/uhf—Searching for New Horizons; Oscar—the New Frontier. Included are tips on operating frequencies, propagation conditions on each band, power levels, and a helpful appendix.

Published by the American Radio Relay League, 225 Main Street, Newington, CT 06111. 128 pages (8 1/4" x 11"). \$4.00 in the USA and possessions, \$4.50 elsewhere (soft cover).

LIGHT-BEAM COMMUNICATIONS

by Forrest Mims, III

The use of light beams to convey information is covered in this book. The history of the science is traced from primitive signal fires to sophisticated laser-beam communications links. Modern systems are covered by analysis of modulators, transmitters, detectors, transmission lines (fibre optics and waveguides), carrier sources, receivers, and "antennas." Atmospheric absorption is also discussed. The final chapter highlights experimental and operational systems developed since 1960.

Published by Howard W. Sams & Co., 4300 W. 62nd St., Indianapolis, IN 46206. 160 pages. \$4.95 soft cover.

POPULAR ELECTRONICS



Revolutionary! Sound-shaping taping mike.

Never before — a single microphone that gives you the versatility of 16 microphones! Four tiny frequency filter switches built into the new Shure 516EQ E-Qualidyne Microphone let you tailor sound for studio effects in virtually any recording situation: flick a switch to add sizzle

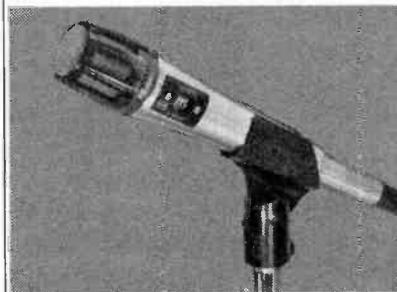

to vocals . . . flick another switch to highlight the sound of a bass drum. You can even compensate for the acoustic response of a room — right from the microphone! In all, the 516EQ creates 16 different response variations that can add a new, professional sound to every tape you make. Available singly or in pairs for stereo recording. Ask to hear a recorded demonstration at your participating Shure dealer.

Shure Brothers Inc.
222 Hartrey Ave., Evanston, IL 60204
In Canada: A. C. Simmonds & Sons Limited



Manufacturers of high fidelity components, microphones, sound systems and related circuitry.

CIRCLE NO. 69 ON FREE INFORMATION CARD

ELECTRONICS MARKET PLACE

REGULAR CLASSIFIED: COMMERCIAL RATE: For firms or individuals offering commercial products or services. \$2.25 per word. Minimum order \$33.75. **EXPAND-AD CLASSIFIED RATE:** \$3.35 per word. Minimum order \$50.25. Frequency discount; 5% for 6 months; 10% for 12 months paid in advance. **READER RATE:** For individuals with a personal item to buy or sell. \$1.35 per word. No minimum! **DISPLAY CLASSIFIED:** 1" by 1 column, \$260.00. 3" by 1 column, \$780.00. Advertiser to supply film positives. For frequency rates, please inquire.

GENERAL INFORMATION: Payment must accompany copy except when ads are placed by accredited advertising agencies. First word in all ads set in caps. All copy subject to publisher's approval. All advertisers using Post Office Boxes in their addresses **MUST** supply publisher with permanent address and telephone number before ad can be run. Advertisements will not be published which advertise or promote the use of devices for the surreptitious interception of communications. Ads are not acknowledged. They will appear in first issue to go to press after closing date. Closing Date: 1st of the 2nd month preceding cover date (for example, March issue closes January 1st. Send order and remittance to **POPULAR ELECTRONICS**, One Park Avenue, New York, New York 10016. Attention: Hal Cymes.

FOR SALE

FREE! Bargain Catalog—I.C.'s, LED's, readouts, fiber optics, calculators parts & kits, semiconductors, parts. Poly Paks, Box 942PE, Lynnfield, Mass. 01940.

GOVERNMENT and Industrial surplus receivers, transmitters, snooperscopes, electronic parts, Picture Catalog 25 cents. Meshna, Nahant, Mass. 01908.

LOWEST Prices Electronic Parts. Confidential Catalog Free. KNAPP, 3174 8th Ave. S.W., Largo, Fla. 33540.

ELECTRONIC PARTS, semiconductors, kits, FREE FLYER. Large catalog \$1.00 deposit. BIGELOW ELECTRONICS, Bluffton, Ohio 45817.

RADIO—T.V. Tubes—36 cents each. Send for free catalog. Cornell, 4213 University, San Diego, Calif. 92105.

AMATEUR SCIENTISTS, Electronics Experimenters, Science Fair Students... Construction plans—Complete, including drawings, schematics, parts list with prices and sources... Robot Man — Psychedelic shows — Lasers — Emotion/Lie Detector — Touch Tone Dial — Quadraphonic Adapter — Transistorized Ignition — Burglar Alarm — Sound Meter... over 60 items. Send \$50 cents coin (no stamps) for complete catalog. Technical Writers Group, Box 5994, University Station, Raleigh, N.C. 27607.

METERS—Surplus, new, used, panel or portable. Send for list. Hanchett, Box 5577, Riverside, CA 92507.

MECHANICAL, ELECTRONIC devices catalog 10 cents. Greatest Values — Lowest Prices. Fertik's, 5249 "D", Philadelphia, Pa. 19120.

POLICE/Fire scanners, large stock scanner crystals, antennas. Also CBs. Harvey Park Radio, Box 19224, Denver, CO 80219.

TELETYPE EQUIPMENT for sale for beginners and experienced computer enthusiast. Teletype machines, parts, supplies. Catalogue \$1.00 to ATLANTIC SALES, 3730 Nautilus Ave., Brooklyn, NY 11224. Tel: (212) 372-0349.

ELECTRONIC Ignition: Capacitor-Discharge, pointless, Auburn Sparkplugs. Wheel Stabilizers. Information 20 cents. Anderson Engineering, Epsom, N.H. 03234.

WHOLESALE C.B., Scanners, Antennas, Catalog 25 cents. Crystals: Special cut, \$4.95. Monitor \$3.95. Send make, model, frequency. G. Enterprises, Box 461P, Clearfield, UT 84015.

COMPUTER HOBBYISTS—classified advertising newsletter. \$3.75/year. Free Sample. **ON LINE**, 24695 Santa Cruz Hwy., Los Gatos, CA 95030.

SOUND SYNTHESIZER KITS—Surf \$12.95, Wind \$12.95, Wind Chimes \$17.95, Electronic Songbird \$6.95, Musical Accessories, many more. Catalog free. PAIA Electronics, Box J14359, Oklahoma City, OK 73114.

BUGGED??? New locator finds them fast. Write, Clifton, 11500-L N.W. 7th Avenue, Miami, Florida 33168.

YOU WILL SAVE BIG MONEY! Surplus, Clearouts, Bankruptcy, Inventory, Deals. Catalog \$1 (redeemable). ETCOA Electronics, Box 741, Montreal, H3C 2V2. U.S. Inquiries.

HEAR POLICE/FIRE Dispatchers! Catalog shows exclusive directories of "confidential" channels, scanners. Send postage stamp. Communications, Box 56-PE, Commack, N.Y. 11725.

UNSCRAMBLERS: Fits any scanner or monitor, easily adjusts to all scrambled frequencies. Only 4" square \$29.95, fully guaranteed. Dealer inquiries welcomed. PDQ Electronics, Box 841, North Little Rock, Arkansas 72115.

RECONDITIONED Test Equipment. \$0.50 for catalog. Walter's Test Equipment, 2697 Nickel, San Pablo, CA 94806.

CARBON FILM RESISTORS 1/4W, 1/2W - 1.7 cents each. FREE sample / specifications. Other components. COMPONENTS CENTER, Box 134P, New York, N.Y. 10038.

RADAR DETECTOR KIT. Build a long range radar detector with over one mile range. Kit comes with complete documentation and drilled, etched and plated PC board. Only \$4.95. Thousands sold nationally. Satisfaction guaranteed. Same day shipment. J.B. Saunders Company, 3050 Valmont, Boulder, Colorado 80301.

BUILD YOUR OWN SPEAKERS AND SAVE UP TO 50%

Send for our free, fact-packed 44-page catalog/manual and learn how to assemble your own multi-element stereo speakers from scratch or from kits. Our catalog includes chapters on design, construction, x-overs, enclosures, midranges, woofers, tweeters and horns. Write us today.

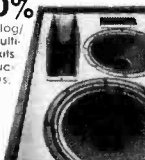

SPEAKERLAB
Dept. PE-A, 5500 35th N.E.
Seattle, Washington 98105

LINEARS				CMOS				CMOS				CMOS				TEXAS INSTRUMENTS			
																I.C. SOCKETS			
																(Low Profile Solder Tail)			
																Description			
																Unit Price			
SH0002CH	LMH0002CH	5.40	LM710CH	55	LM3018H	1.10	CD4000BE	.13	CD4052BE	1.15	74C14/40014PC	.75							
SH2001CH		5.55	LM711CH	55	LM3046N-14	.52	CD4001BE	.16	CD4053BE	.89	74C85/40085PC	1.20							
LM300H		.79	LM715CH	3.85	LM3086	.59	CD4002BE	.16	CD4055BE	1.29	80C97/40097PC	.65							
LM301AH		.39	LM720CN-14	.79	LM3089	1.98	CD4006BE	.99	CD4060BE	.59	80C98/40098PC	.65							
LM301AN-8	(Mini Dip)	.29	LM723CH	.48	LM3302N	.65	CD4007BE	.16	CD4066BE	.99	74C160/40160PC	1.50	8 Pin DIL	(C840802)	.15				
LM302H		2.25	LM723CN-14	.43	LM3401N	.65	CD4008BE	.80	CD4068BE	.24	74C161/40161PC	1.50	14 Pin DIL	(C841402)	.18				
LM304H		.79	LM725CH	2.40	LM3403N	1.20	CD4009BE	.37	CD4069BE	.24	74C162/40162PC	1.50	16 Pin DIL	(C841602)	.19				
LM305H		.79	LM726CH	6.50	LM3900N	1.20	CD4010BE	.37	CD4070BE	.24	74C163/40163PC	1.50	18 Pin DIL	(C841802)	.29				
LM306H		1.10	LM727CH	11.95	LM4136N	1.20	CD4011BE	.16	CD4071BE	.24	74C174/40174PC	1.40	20 Pin DIL	(C842002)	.35				
LM307H		.36	LM723CN-14	.95	RC4131N-8	(Mini Dip)	.80	CD4012BE	.16	CD4072BE	.29	74C175/40175PC	1.40	22 Pin DIL	(C842202)	.34			
LM307N-8	(Mini Dip)	.35	LM734CN-14	2.75	RC4151N-8	(Mini Dip)	5.00	CD4013BE	.29	CD4073BE	.29	74C192/40192PC	1.50	24 Pin DIL	(C842402)	.34			
LM308H		.89	LM739CN-14/LM381	.99	8700CJ	.95	CD4014BE	.74	CD4074BE	.29	74C193/40193PC	1.50	28 Pin DIL	(C842802)	.45				
LM308N		.79	LM740CH/NE536T	8.95	8701CN	22.85	CD4015BE	.74	CD4076BE	.98	74C194/40194PC	1.40	40 Pin DIL	(C844002)	.65				
LM309H		.79	LM741CH	.37	8702CN	29.50	CD4016BE	.29	CD4078BE	.24	74C195/40195PC	1.40							
LM309K	(T03)	1.45	LM741CN-14	.33	8703CJ	11.10	CD4017BE	.79	CD4081BE	.24									
LM310H		1.25	LM741CN-8	(Mini Dip)	.25	8704CJ	13.95	CD4018BE	.79	CD4082BE	.29								
LM311H		.79	LM747CN-14	.49	8705CN	29.50	CD4019BE	.38	CD4085BE	.75	SG3501AT	3.60	±5V Dual Tracking Regulator						
LM312H		1.55	LM747CH	.59	8750CJ	11.50	CD4021BE	.89	CD4086BE	.75	SG4501T	1.80	±15V Dual Tracking Regulator						
LM318H		1.25	LM748CN-8	(Mini Dip)	.35	9400CJ	5.95	CD4022BE	.89	CD4502BE	1.15	RC4194TK	3.95	Variable Dual Tracking Regulator ±35V ±9.5V					
LM323K		5.60	LM748CH	.36	SN72L044N	2.30	CD4023BE	.16	CD4507BE	.39	RC4195T	2.35	Fixed ±15V Dual Tracking Regulator T05						
LM324N		.79	LM749CN-14	1.25	TL080CP	1.49	CD4024BE	.67	CD4510BE	1.05	RC4195TK	3.15	Fixed ±15V Dual Tracking Regulator T066						
LM339N		.79	LM750CN-14	3.25	TL081CP	.69	CD4025BE	.16	CD4511BE	1.25	78H05KC	6.35	5 Amp 5 Volt Positive Regulator T03						
LM341H		.99	LM776CH	3.25	TL082CP	1.29	CD4026BE	.16	CD4512BE	.69	7800 Series	.99	Positive Voltage Regulators (Plastic) 1 amp						
LF355L		1.49	LM777CH	2.00	TL083CN	1.65	CD4027BE	.38	CD4514BE	2.50	TO-220 / LM340T	5, 6, 8, 12, 15, 18, 24 Volts							
LF356L		1.49	LM791KC	12.75	TL084CN	1.69	CD4028BE	.74	CD4515BE	2.50	78M00 Series	1.39	Positive Voltage Regulator 1/2 Amp						
LF357L		1.75	LM796CH/MC1496G	1.10	TL089CL/HA2905	14.50	CD4029BE	.78	CD4516BE	.84	TO-5 / LM340H	5, 6, 8, 12, 15, 18, 24 Volts							
LM358P		.65	LM1312N-14	1.98	TL182CN/DG182	1.98	CD4030BE	.37	CD4518BE	.84	7800 Series	1.49	Positive Voltage Regulator 1 Amp						
LM376N-8	(Mini Dip)	.99	LM1436CH	1.79	TL185CN/DG185	1.98	CD4033BE	1.60	CD4519BE	.79	TO-3 / LM340K	2.9	Positive Voltage Regulator 100 MA						
LM393P		.75	LM1437N-14	.45	TL188CN/DG188	1.98	CD4034BE	2.95	CD4520BE	.79	TO-92	2.6, 5, 6, 2, 8, 2, 12, 15 Volts							
LM555N-8	(Mini Dip)	.34	LM1458H	.72	TL191CN/DG191	1.98	CD4035BE	.98	CD4522BE	1.98	7900 Series	1.25	Negative Voltage Regulator 1 Amp						
LM556N-14		.75	LM1458N-8	(Mini Dip)	.48	TL497CN	1.98	CD4040BE	.99	CD4526BE	1.50	TO-220 / LM320T	5, 6, 8, 12, 15, 18, 24 Volts						
LM702CH		.69	LM1488D	1.25	ULN2001AN	1.10	CD4042BE	.58	CD4527BE	1.50	79M00 Series	1.35	Negative Voltage Regulator 1/2 Amp						
LM706APC		1.75	LM1489D	1.25	ULN2002AN	1.10	CD4043BE	.45	CD4528BE	1.20	TO-5 / LM320H	2.6, 5, 6, 8, 12, 15, 20, 24 Volts							
LM709CN-8	(Mini Dip)	.37	LM1489AD	1.25	ULN2003AN	1.10	CD4044BE	.45	CD4531BE	1.25	7900 Series	1.75	Negative Voltage Regulator 1 Amp						
LM709CN-14		.28	LM1495N-14	1.49	ULN2004AN	1.10	CD4046BE	2.45	CD4539BE	1.20	TO-3 / LM320K	1.20	Fixed ±15V Dual Tracking Regulator 4 Terminal						
LM709CH		.40	LM1496N-14	.99			CD4047BE	2.45	CD4555BE	.75	78MGT2C	1.20	Positive Voltage Regulator						
							CD4049BE	.34	CD4556BE	.75	79MGT2C	1.20	In Line Adjustable 4 Terminal						
							CD4050BE	.34	CD4582BE	.95		1.45	Adjustable Positive Voltage Regulator						
							CD4051BE	.89	CD4585BE	1.80	79GU1 TO-220	1.25	Adjustable Negative Voltage Regulator						
											79GK TO-3	1.80	Adjustable Positive Voltage Regulator						
											79GK TO-3	2.10	Adjustable Negative Voltage Regulator						



Our new comprehensive 1977 Fall Catalogue, listing complete descriptions, illustrations and special monolithic pricing on over 10,000 items, is now available on request.

Active Electronic Sales Corp.

P.O. BOX 1035 FRAMINGHAM, MASSACHUSETTS 01701

Telephone Orders & Enquiries (617) 879-0077 New Catalogue available on request

NOW IN CANADA 5647 Ferrier st. 44 Fasken Dr-Unit 25 **MINIMUM ORDER \$10.00 * ADD \$1.00 TO COVER POSTAGE & HANDLING * Canadian customers add 30% for duty and handling. All federal and provincial taxes extra**

2 Locations Montreal, Quebec Tel: (514) 735-6429 Rexdale, Ontario Tel: (416) 677-4287

7400 TTL				3400 SERIES				MOTOROLA CIRCUITS				JAPANESE CIRCUITS									
7400	21	7442	108	74121	55	5400	100	5475	150	MC725P	150	MC1741CG	98	AN136	290	HA1312	405	STK056	1135	TA7201P	640
7401	21	7448	115	74122	49	5404	125	5486	190	MC740L	155	MC1806P	98	AN203	375	HA1322	520	STK415	1150	TA7203P	700
7402	21	7450	26	74123	105	5410	100	5493	200	MC790P	150	MC1810P	98	AN208	475	HA1339	520	TA7045A	350	TA7204P	650
7405	21	7451	27	74125	60	5426	125	54100	180	MC832P	48	MC2053L	45	AN210	310	LA1201	425	TA7054P	305	TA7205P	650
7406	45	7453	27	74126	81	5473	150	54LS04	100	MC1004L	125	MC3004L	132	AN211	330	LA1364	470	TA7055P	550	TA78005M	290
7407	45	7454	41	74132	300					MC1008L	125	MC3006P	144	AN214	490	LA1366	600	TA7060P	1.85	TA78005M	1.95
7407	45	7460	22	74141	115					MC1010L	125	MC3007P	132	AN217	330	LA1367	590	TA7061P	2.25	TA78012M	2.50
7408	25	7472	39	74150	110					MC1036L	125	MC3021P	215	AN229	635	LA3301	4.85	TA7149P	4.00	TA78012P	1.95
7409	25	7473	45	74151	135					MC1037L	125	MC3021P	215	AN234	575	LA4030	4.85	TA7063P	2.25	TA78015M	2.50
7410	20	7474	45	74153	125					MC1036L	125	MC3021P	215	AN239	650	LA4031P	3.50	TA7074P	4.90	TA78015P	1.95
7411	30	7475	80	74154	125					MC1352P	105	MC3062L	300	AN241	320	LA4051P	4.65	TA7075P	4.90	TC9100P	1200
7413	85	7482	175	74155	121					MC1406CP	395	MC4024P	220	AN245	650	T8A105	3.50	TA7076P	4.55	UPC16C	2.50
7416	43	7483	115	74157	130					MC1468R	290	MC14502CP	118	AN277A	395	LD3080	4.00	TA7089P	2.90	UPC20C	5.00
7417	43	7485	112	74161	145					MC1469R	250	MC14502CP	118	AN288	480	LD3120	3.10	TA7102	5.15	UPC41C	3.95
7420	21	7486	45	74164	165					MC1510G	800	MC14507CP	82	AN328	405	M5112	5.40	TA7106P	3.25	UPC48C	3.95
7422	150	7489	249	74165	165					MC1514L	450	MC14510CP	240	AN343	390	M5115PR	4.80	TA7120P-C	2.20	UPC563H2	3.00
7423	47	7490	69	74166	170					MC1550G	450	MC14511CP	276	BA511	350	M5155	2.85	TA7122P	2.30	UPC566H	2.25
7427	37	7491	120	74174	95					MC1558	437	MC14512CP	192	BA521	395	SG613	5.40	TA7124P	1.85	UPC575C	4.10
7428	33	7492	82	74175	195					MC1595L	625	MC14519CG	94	HA1158	630	STK011	10.50	TA7146P	4.10	UPC1001H2	5.15
7430	26	7493	82	74180	105					MC1596G	3.25	MC14528CP	174	HA1159	630	STK015	6.50	TA7150P	4.55	UPC1020H	5.50
7432	31	7494	91	74181	355					MC1723CG	125	MC4044P	480	HA1202	310	STK025	14.20	TA7153P	6.90	UPC1025	5.50
7437	47	7495	91	74191	100									HA1306W	520	STK032	12.50	TA7200P	625		
7438	40	7496	91	74195	100																
7440	21	74100	125	74197	130																
7441	110	74107	49	74298	130																

74L SERIES TTL					
74L00	33	74LS04	45	74LS113	98
74L10	33	74LS10	39	74LS138	189
74L30	33	74LS20	39	74LS174	250
74L42	150	74LS51	39	74LS386	550
74L86	69	74LS74	65	74LS153	225
74LS00	39	74LS112	65	74LS387	195

74H00 TTL					
74H00	33	74H11	33	74H53	39
74H01	33	74H20	33	74H55	39
74H04	33	74H21	33	74H73	59
74H05	35	74H30	33	74H74	59
74H10	33	74H40	33	74H76	60

ELECTROLYTIC CAPACITORS		CARBON RESISTORS	
		Minimum 5 Pcs Per Value	
2.2MF50	AXIAL LEADS	15	QUANTITY
3.3MF10	AXIAL LEADS	15	PRICING
3.3MF10	NO POLARITY	15	5-25 30-95 100-495
10MF25	AXIAL LEADS	15	%w5% .06 05 04
10MF50	AXIAL LEADS	15	%w5% .08 07 06
10MF150	AXIAL LEADS	20	STANDARD RESISTANCE VALUES
25MF35	AXIAL LEADS	15	OHMS
30MF25	AXIAL LEADS	15	10 270 820 4.7K 27K
47MF25	RADIAL LEADS	15	22 300 910 5.1K 33K
47MF50	RADIAL LEADS	15	47 330 1.0K 6.8K 47K
100MF16	RADIAL LEADS	15	51 470 1.5K 7.5K 100K
100MF25	RADIAL LEADS	20	100 510 2.2K 8.2K 330K
500MF50	AXIAL LEADS	60	150 560 2.7K 10K 1.0M
1000MF35	AXIAL LEADS	65	220 680 3.3K 15K
			240 750 3.9K 22K

JAPANESE TRANSISTORS * CB. INDUSTRIAL									
2SA52	60	2SC206	1.00	2SC774	1.75	2SC1173	95	2SD77	1.00
2SA316	75	2SC240	1.10	2SC775	2.75	2SC1175	65	2SD81	3.25
2SA473	1.95	2SC281	6.5	2SC776	3.00	2SC1209	85	2SD88	1.50
2SA489	80	2SC320	7.5	2SC777	4.00	2SC1213	75	2SD118	3.25
2SA490	70	2SC352	7.5	2SC778	4.00	2SC1226A	1.25	2SD130	1.25
2SA505	70	2SC353	7.5	2SC781	3.00	2SC1237	4.50	2SD141	2.25
2SA564	50	2SC371	7.0	2SC784	7.0	2SC1243	1.50	2SD170	2.00
2SA628	65	2SC372	7.0	2SC785	1.00	2SC1293	85	2SD180	2.75
2SA643	85	2SC394	7.0	2SC789	1.00	2SC1306	4.75	2SD201	1.75
2SA647	2.75	2SC458	7.0	2SC793	2.50	2SC1307	5.75	2SD218	4.75
2SA673	85	2SC460	7.0	2SC796	3.15	2SC1308	4.75	2SD235	1.00
2SA679	3.75	2SC478	.80	2SC797	2.50	2SC1317	.80	2SD300	2.50
2SA682	85	2SC481	1.5	2SC798	3.10	2SC1318	7.0	2SD313	1.10
2SA699	1.50	2SC482	1.75	2SC799	4.25	2SC1325	4.95	2SD315	.75
2SA699A	1.45	2SC491	2.50	2SC802	3.75	2SC1327	7.0	2SD316	2.50
2SA705	.55	2SC495	1.10	2SC803	4.00	2SC1338	1.75	2SD317	1.25
2SA815	.85	2SC497	1.60	2SC815	7.5	2SC1346	8.0	2SD318	.95
2SA816	85	2SC502	1.50	2SC828	7.5	2SC1347	.80	2SD325	1.25
				2SC829	7.5	2SC1364	1.50	2SD341	.95
2SB22	.65	2SC517	4.25	2SC830	1.60	2SC1377	5.50	2SD350	3.25
2SB54	.70	2SC535	7.5	2SC838	7.0	2SC1383	7.5	2SD352	.80
2SB56	.70	2SC536	.65	2SC839	8.5	2SC1384	8.5	2SD380	5.70
2SB77	.70	2SC537	.70	2SC922	5.5	2SC1409	1.25	2SD389	.75
2SB128	2.25	2SC563	2.50	2SC929	7.0	2SC1410	1.25	2SD390	.75
2SB152	4.50	2SC607	1.25	2SC930	.65	2SC1447	1.25		
2SB173	.55	2SC614	3.80	2SC938	.65	2SC1448	1.25	2SF8	3.00
2SB175	.55	2SC615	3.90	2SC943	1.50	2SC1449	1.30	2SCF8	3.50
2SB178	1.00	2SC616	4.15	2SC945	.65	2SC1475	1.50	2SCF6	1.25
2SB186	.60	2SC617	4.25	2SC959	3.15	2SC1507	1.25	HEPS3001	3.25
2SB187	.60	2SC620	.80	2SC960	2.75	2SC1509	1.25	JSF7001	.75
2SB235	7.00	2SC627	1.75	2SC984	1.50	2SC1569	1.25	MRF8004	3.00
2SB303	3.00	2SC642	3.50	2SC986	4.90	2SC1674	1.75	MPS8000	1.25
2SB324	1.00	2SC643	3.75	2SC1010	.80	2SC1675	1.75	MPS8001	1.25
2SB337	2.10	2SC644	.70	2SC1012	.80	2SC1678	5.50	MPSU02	.50
2SB367	1.80	2SC681	2.50	2SC1013	1.50	2SC1679	4.75	MPSU31	4.00
2SB370	.65	2SC684	2.10	2SC1014	1.50	2SC1756	1.25	SK3047	3.75
2SB405	.85	2SC687	2.50	2SC1017	1.50	2SC1760	2.15	SK3048	3.25
2SB407	1.65	2SC696	3.00	2SC1018	1.50	2SC1816	4.50	SK3049	4.75
2SB415	.85	2SC699	4.75	2SC1030	4.75	2SC1908	7.0	SK3054	1.25
2SB461	1.25	2SC710	.70	2SC1051	2.50	2SC1909	4.75	2SK19	1.75
2SB463	1.65	2SC711	.70	2SC1060	7.5	2SC1957	1.50	2SK30	3.00
2SB471	1.75	2SC712	.70	2SC1061	1.65	2SC1973	1.50	2SK33	1.20
2SB474	1.50	2SC713	.70	2SC1069	3.55	2SC1974	4.90	2SK41	1.75
2SB476	1.25	2SC731	3.00	2SC1079	3.75	2SC1975	4.90	SK322Y	2.75
2SB481	2.10	2SC732	.70	2SC1080	3.75	2SC2028	1.10	SK340	2.75
2SB492	1.25	2SC733	.70	2SC1096	1.20	2SC2029	4.75	SK345	2.75
2SB495	.95	2SC735	.70	2SC1098	1.15	2SC2074	3.00	SK349	2.75
2SB507	.90	2SC739	.70	2SC1115	2.75			4004	3.00
2SB511	.70	2SC715	.70	2SC1166	.70	2SD45	2.00	4005	3.00
2SB531	3.00	2SC756	3.00	2SC1167	4.25	2SD65	.75	40080	1.25
2SB558	3.50	2SC762	1.90	2SC1170	4.00	2SD68	.90	40081	1.50
2SB135	.95	2SC773	.85	2SC11728	4.25	2SD72	1.00	40082	3.00

MISC CIRCUITS		POSITIVE VOLTAGE REGULATORS	
BC184L	60	LM309K	195
CA3001	75	LM351AN	70
CA3005	80	LM741CP	40
CA3006	110	LM1458M	65
CA3018	160	MFC9020	115
CA3018A	160	MRR9	

ANYONE CAN SOLDER WITH DO-IT-YOURSELFERS!



Let Kester solder aid you in your home repairs or hobbies. A radio, TV, model train, jewelry, plumbing, etc. Save money — repair it yourself. Send self-addressed stamped envelope to Kester for a FREE Copy of "Soldering Simplified".

KESTER SOLDER / 4201 Wrightwood Ave. Chicago, Ill. 60639

BUILD AND SAVE. TELEPHONES, TELEVISION, DETECTIVE, BROADCAST Electronics. We sell construction plans with an Engineering Service. Speakerphones, Answering Machines, Carphones, Phonevision, Dialers, Color TV Converters, VTR, Games, \$25 TV Camera, Electron Microscope, Special Effects Generator, Time Base Corrector, Chroma Key. Engineering Courses in Telephone, Integrated Circuits, Detective Electronics. **PLUS MUCH MORE.** NEW Super Hobby Catalog PLUS year's subscription to Electronic News Letter, \$1.00. Don Britton Enterprises, 6200 Wilshire Blvd., Los Angeles, Calif. 90048.

NAME BRAND Digital/Analog Test Equipment. Discount prices. Free catalog. Salen Electronics, Box 82, Skokie, Illinois 60076.

USED TEST EQUIPMENT — Tektronix, HP, GR. Write: PTI, Box 8699, White Bear Lake, MN 55110. Phone: (612) 429-2975.

DIGITAL TACHOMETER 4-6-8 cylinder two digit display. Complete \$59.95. Cosmos Electronics, P.O. Box 33278, Seattle, WA 98133.

AMAZINGLY Low component prices! Ask for free flyer. Write: EEP, 11 Revere Place, Tappan, NY 10983.

SURPLUS COMPONENTS, Communication and test equipment. Illustrated catalog 25 cents. E. French, P.O. Box 249, Aurora, Illinois 60505.

TELEPHONES UNLIMITED, Equipment, Supplies, All types, Regular, Keyed, Modular. Catalog 50 cents. Box 1147E, San Diego, California 92112.

POWERFUL, ADJUSTABLE, REGULATED, THREE OUTPUT POWER SUPPLY and 900 easily removable parts in complete CARTRIVISION television recorder electronic assembly with documentation. Perfect for MICROPROCESSOR, IC, transistor, television, CB radio applications. \$24.95 total. Free brochure. BankAmericard, Master Charge. MADISON ELECTRONICS, INCORPORATED, 369, D55, Madison, Alabama 35758. SATISFACTION GUARANTEED.

YES, YOU CAN BUILD AN ELECTRONIC ORGAN

That has a PIPE ORGAN SOUND

With DEVTRONIX easy to build assemblies. Own the ultimate in organ design & sound at 1/3 the cost of commercial organs.

BROCHURE AND DEMO RECORD \$1.00

Dept. C
5872 Amapola Dr.
San Jose, CA 95129

CB RADIOS, monitors, crystals, CD ignitions. Southland, Box 3591-B, Baytown, Texas 77520.

MODULAR SYNTHESIZERS THAT REALLY PERFORM

Write to:
ARIES MUSIC INC.
P.O. BOX 3065
SALEM, MA 01970

PROFESSIONAL UNSCRAMBLERS — several models that fit any scanner. Free information. Capri Electronics, 87537 Windom, St. Louis, MO 63114.

UNSCRAMBLE CODED MESSAGES from Police, Fire and Medical Channels. Same day service. Satisfaction guaranteed. Don Nobles Electronics, Inc., Rt. 7, Box 265B, Hot Springs, Arkansas 71901. (501) 623-6027.

ANYTHING ELECTRONIC — we've got it. Catalog \$1.00. Razon, Box 1224, Cupertino, Calif.



MICRO MINI MIKE™ WIRELESS MICROPHONE

World's smallest; solid state, self-contained. Picks up and transmits most sounds without wires up to 300 ft. through FM Radio. Use as mike, amp, alarm & alert sys., hot line, baby sitter, etc. Money back guarantee. B/A, M/C, COD, etc. \$18.95 plus \$1.00 post & hdg. Calif. res. add tax. Mail orders. Qty. Disc. Avail. **AMC SALES, INC.** Dept. 23, Box 928 + Downey, Calif. 90241

NEGATIVE ION Generator. \$275.00. Complete kit \$165.00. Construction plans \$10.00. Golden Enterprises, Box 1282PE, Glendale, Arizona 85311.

UNBELIEVABLE Goldmine of Electronic Schematics. Over 2000, Useful, Novel, and Amazing Projects. Only \$9.99! Money Back Guarantee. Send for Free project list. Space-tech, Box 182, Gillette, N.J. 07933.

WEATHER MAP RECORDERS: Copy Satellite Photographs, National-Local Weather Maps. Learn How! \$1.00. Atlantic Sales, 2730 Nautilus Ave., Brooklyn, N.Y. 11224. Tel: (212) 372-0349.

FREE CATALOG of Electronics parts, kits, semi's, spectacular savings. Diamondback, Box 194P, Spring Valley, Ill. 61362.

120 VOLTS 3000 WATTS from your vehicles alternator. Simple plans \$3.00. Steriek, Box 15532, Long Beach, Calif. 90815.

NEED TECHNICAL INFORMATION??? New directory lists 101 sources of FREE publications/handbooks relating to Microcomputers, Communications, General Electronics... Write Technical Publications, 1405B Richland, Metairie, LA 70001.

VIDEO TAPE RECORDERS: Norelco LDL 1000/52 Records and Plays on 1/2 Inch tape. Guaranteed Excellent! \$260.00, UPS Postage Paid. Gordon K. Kapes, 1127 Ridgewood Drive, Highland Park, Illinois 60035.

TELEPHONES, Wide Selection. Phone cords, plugs, jacks, etc., including modular. Free catalog. Flemco Sales, 20272 37th Ave., N.E., Seattle, WA 98155.

AUDIO EXPERIMENTERS, Serious Music Synthesizer Stuff. literature, kits, components, circuits and more. Send SASE for FREE INFO. CFR Associates, POB F, Newton, NH 03858.

UNSCRAMBLER SUPER SALE: Our famous Code-Breaker works with all scanners and tunes all scramble frequencies only \$29.95. COD's (501) 273-5340. Mail orders to: KRISTAL KITS, BOX 445, BENTONVILLE, AR 72712.

ADVANCED MICROCOMPUTER PRODUCTS

MICROPROCESSORS		PROM'S	
8008	1.94	8201	1.94
8018	1.94	8202	1.94
8028	1.94	8203	1.94
8038	1.94	8204	1.94
8048	1.94	8205	1.94
8058	1.94	8206	1.94
8068	1.94	8207	1.94
8078	1.94	8208	1.94
8088	1.94	8209	1.94
8098	1.94	8210	1.94
8108	1.94	8211	1.94
8118	1.94	8212	1.94
8128	1.94	8213	1.94
8138	1.94	8214	1.94
8148	1.94	8215	1.94
8158	1.94	8216	1.94
8168	1.94	8217	1.94
8178	1.94	8218	1.94
8188	1.94	8219	1.94
8198	1.94	8220	1.94
8208	1.94	8221	1.94
8218	1.94	8222	1.94
8228	1.94	8223	1.94
8238	1.94	8224	1.94
8248	1.94	8225	1.94
8258	1.94	8226	1.94
8268	1.94	8227	1.94
8278	1.94	8228	1.94
8288	1.94	8229	1.94
8298	1.94	8230	1.94
8308	1.94	8231	1.94
8318	1.94	8232	1.94
8328	1.94	8233	1.94
8338	1.94	8234	1.94
8348	1.94	8235	1.94
8358	1.94	8236	1.94
8368	1.94	8237	1.94
8378	1.94	8238	1.94
8388	1.94	8239	1.94
8398	1.94	8240	1.94
8408	1.94	8241	1.94
8418	1.94	8242	1.94
8428	1.94	8243	1.94
8438	1.94	8244	1.94
8448	1.94	8245	1.94
8458	1.94	8246	1.94
8468	1.94	8247	1.94
8478	1.94	8248	1.94
8488	1.94	8249	1.94
8498	1.94	8250	1.94
8508	1.94	8251	1.94
8518	1.94	8252	1.94
8528	1.94	8253	1.94
8538	1.94	8254	1.94
8548	1.94	8255	1.94
8558	1.94	8256	1.94
8568	1.94	8257	1.94
8578	1.94	8258	1.94
8588	1.94	8259	1.94
8598	1.94	8260	1.94
8608	1.94	8261	1.94
8618	1.94	8262	1.94
8628	1.94	8263	1.94
8638	1.94	8264	1.94
8648	1.94	8265	1.94
8658	1.94	8266	1.94
8668	1.94	8267	1.94
8678	1.94	8268	1.94
8688	1.94	8269	1.94
8698	1.94	8270	1.94
8708	1.94	8271	1.94
8718	1.94	8272	1.94
8728	1.94	8273	1.94
8738	1.94	8274	1.94
8748	1.94	8275	1.94
8758	1.94	8276	1.94
8768	1.94	8277	1.94
8778	1.94	8278	1.94
8788	1.94	8279	1.94
8798	1.94	8280	1.94
8808	1.94	8281	1.94
8818	1.94	8282	1.94
8828	1.94	8283	1.94
8838	1.94	8284	1.94
8848	1.94	8285	1.94
8858	1.94	8286	1.94
8868	1.94	8287	1.94
8878	1.94	8288	1.94
8888	1.94	8289	1.94
8898	1.94	8290	1.94
8908	1.94	8291	1.94
8918	1.94	8292	1.94
8928	1.94	8293	1.94
8938	1.94	8294	1.94
8948	1.94	8295	1.94
8958	1.94	8296	1.94
8968	1.94	8297	1.94
8978	1.94	8298	1.94
8988	1.94	8299	1.94
8998	1.94	8300	1.94

LOGOS! THE BEST BK RAM KIT

The last word in BK Ram Boards. Special Price only \$219.95

Features:
• Low-power 21102, 4501n, Ony Switch
• Selectable addressing down to 256
• Byte blocks, No wait states, fully buffered, battery back-up.

Plus the first 32K Static Memory Board Uses 2114-K RAMS

16K	\$ 579.95
24K	\$ 679.00
32K	\$ 1099.95

(Note, supplying content on 2114 availability. Allow 30 days.)

TV GAMES

AY38500 VTRMS 1955 ONLY \$16.95
AY38500 (European Version) ONLY \$24.95

TV KIT NO. 1 PCB, Chip, Inst. \$29.95

TV KIT NO. 2 Part's-less chassis \$39.95
Repairable sold for \$89.95!

MM53104 Clock Drive Chip \$16.95
LM1889 Modulator 3.75
RF Modulator Model 1021 Assembled \$8.95

SPECIALS

8107	\$1.99
8126	2.99
8097/8260	6.99
8268	5.95
8269	5.95
8270	5.95
8271	5.95
8272	5.95
8273	5.95
8274	5.95
8275	5.95
8276	5.95
8277	5.95
8278	5.95
8279	5.95
8280	5.95
8281	5.95
8282	5.95
8283	5.95
8284	5.95
8285	5.95
8286	5.95
8287	5.95
8288	5.95
8289	5.95
8290	5.95
8291	5.95
8292	5.95
8293	5.95
8294	5.95
8295	5.95
8296	5.95
8297	5.95
8298	5.95
8299	5.95
8300	5.95

Plus huge back-up inventory with special pricing for VOLUME requirements. Call for a quotation.

ADVANCED MICROCOMPUTER PRODUCTS

COMPUTER KITS

MOT MEK8000 D2 235.00
KIM I 6502 Kit 245.00
AMI EVK 99 Kit 133.00
Intercept Jr 1100 Kit 281.00
Tami Computerbook 450.00
NSC Scamp Kit 95.00
NSC Keyboard Kit 95.00
IMSAI 8080A w/22 751.00
PIC-B Priority 125.00
SIO Kit 125.00
Cromenco Z 2 145.00
Bytesaver 195.00
Bytesaver w/PROM 215.00
D-7A 145.00
J5 Joystick 65.00
BK EPROM/RAM Kit 295.00
ZPU Kit 295.00

S-100 COMPATIBLE PRODUCTS

Logic 1 & 8 Ram Board 1219.95
801C 8K Ram Board 1198.00
8K EPROM Board (801C compatible) 125.00
Universal Board w/Institution 138.95
32K Static Ram Board Kit 5109.95
Tublet Cassette I/O 5170.00

All Shipments FCM or UPS. Orders under \$100.00 add 5% handling and postage. Orders over \$100.00 add 2.5% handling & postage. Mastercharge/BankAmericard/CC accepted w/25% deposit. California Residents add 6% tax. Foreign Orders add 8% handling. All items prime factory tested guaranteed. Same day shipment. Add 25 cents for Oats.

CHAR GEN/ENCODERS/UARTS

51883 8.95 \$2350 UART 10.95
1602B 5.50 16718 Astros 29.95
AY51013A 5.50 14818 13.95
AY51013 5.95 1472 13.95

MM5320 TV Switch Gen 7.95
MM5369 Pre-driver 3.95
MM5376 Calc Chip 2.95
CT7001 Clock Chip 4.95
MM5314 Clock Chip 4.95
MM5316 Clock Chip 4.95
MM5375 Clock Chip 4.95

RC32133 Uppercase 9.95
AY5278 Keyboard Encoder 14.95
AY5360 Keyboard Encoder 14.95
MM6571 Char Gen 19.95
MM6574 Char Gen 19.95
MM6575 Char Gen 19.95

RC32133 Lower Case 9.95
RC32133 Upper Case 9.95
AY5278 Keyboard Encoder 14.95
AY5360 Keyboard Encoder 14.95
MM6571 Char Gen 19.95
MM6574 Char Gen 19.95
MM6575 Char Gen 19.95

AY5367 DVM Chip 12.95
WD1941 Dual Baud Gen 9.95
M5503F Counter 6.95
AY5367 DVM Chip 12.95
WD1941 Dual Baud Gen 9.95
MC14745PI 16.95
MC14741 Baud 12.95

Radio Hut

Money back guarantee. NO COD'S. Texas residents add 5% sales tax. Add 5% of order for postage and handling. Orders under \$15.00 add 75 cents. Foreign orders add 10% for postage.

For your convenience, call your BankAmericard or Master Charge orders in on our Toll Free Watts Line: 1-800-527-2304. Texas residents call collect: 1-214-271-8423.



P. O. Box 38323P
Dallas, Texas 75238



Memorex computer boards with IC's, diodes, transistor, etc. 5 Boards containing 100 - 200 IC's
ONLY \$ 4.25

BRIDGE RECTIFIERS

6 Amp	50V	1.10
10 Amp	50V	1.25
25 Amp	50V	1.39

RESISTORS

Over 50,000,000 in stock

330 ohm	22K ohm
470 ohm	27K ohm
680 ohm	33K ohm
1K ohm	39K ohm
1.2K ohm	43K ohm
2.2K ohm	47K ohm
3.3K ohm	82K ohm
4.7K ohm	100K ohm
6.8K ohm	150K ohm
10K ohm	220K ohm
20K ohm	

1/8 W only
1/2 W only

All resistors are P.C. Lead but are not pull offs
100 min. order for each value
NO MIX 100/99

MK 5005

4 digit counter/latch decoder; 7 segment output only. 24 pin dip with specs.
\$ 8.00 EACH

UNSCRAMBLER KIT for all Scanners

- Tunes easily
 - Full instructions included
 - Easy to install
 - 3 1/2" x 3 1/2" x 1 1/2"
- Only \$19.95**

PLASMA DISPLAY KIT

Kit Includes: 12 digit display .4" Character Power supply for display above Complete specs for hookup.

Line cord Not Included. **ONLY \$ 3.95**



SPECIAL DEVICES

82S23	2.19
2513	10.00
2102-1	.99
1101A	.75
1103A	1.10
8T13	1.50
8T97	1.25
MM5233	1.50
300KC xtal	1.50

REGULATORS

7805	7818
7806	7824
7808	7905
7812	7912
7815	7915

Your Choice \$.95

READOUTS

- Best Value!**
- FND70 .4"C.C. .59
FND800 .8"C.C. 1.69
T1 6 digit array C.C. 3/1.00
MAN 8 .3"CA Yellow .89
LT767 .7" C.C. 4 digit stick **\$ 3.95**



WATERGATE SPECIAL

Telephone Relay automatically starts and stops tape recorder. No batteries required. Kit complete with drilled P.C. Board.
Parts and Case **ONLY \$ 10.95**

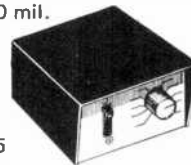

VARIABLE POWER SUPPLY KIT NO. 1

- *Continuously variable from 5V to 20V
- *Excellent regulation up to 500 mil.
- *4400 Mfd of filtering
- *Drilled fiberglass PC Board
- *One hour assembly
- *Kit includes all components
- *Case Included **ONLY \$ 10.95**

VARIABLE POWER SUPPLY KIT NO. 2

Same as above but with 1 amp output, also with case. **ONLY \$ 13.95**

CLOCK KIT



Kit includes
• LT701 clock module
• Power Supply
• Punched Case
• 12 hour operation only
Complete except for line cord

ONLY \$ 14.95
LT701E 12 hour clock
LT701G 24 hour clock

BATTERY CLIPS

Standard 9V battery clip with 4-1/2" tinned leads. 25/\$1.00

TRANSISTORS - DIODES

*MJE1103	3/1.00
MJ3001	1.30
2N2222	6/1.00
2N2369	6/1.00
2N2905	4/1.00
2N2907	15/1.00
2N3806	6/1.00
2N4400	6/1.00
2N4443 SCR	3/1.00
1N4004	15/1.00
1N4007	10/1.00
1N4148 (1N914)	20/1.00
3N201 VHF Pre amp	.80
D40C1 Power Darl	8/1.00
EN930	.20
IN746	.25

*House numbered and P.C. Lead

T T L

7400	.17	7473	.21
7401	.17	74H74	.45
7402	.17	7474	.35
7403	.17	7475	.55
74H04	.25	7476	.35
74S04	.30	7480	.45
7404	.17	7483	.76
7406	.25	7485	.89
7408	.17	7485	.35
7409	.17	7490	.71
7410	.17	7491	.71
7411	.25	7492	.71
7413	.45	7493	.67
7420	.17	7494	.90
7421	.17	7495	.71
7423	.35	7496	.85
7425	.27	74100	.96
7426	.25	74121	.31
7427	.17	74123	.61
7430	.25	74125	.44
7432	.30	74141	.71
7437	.35	74145	.97
7438	.35	74151	.71
7440	.17	74153	.81
7442	.60	74154	.97
7443	.60	74161	.91
7444	.65	74163	1.05
7446	.85	74164	1.05
74L47	1.75	74174	.91
7447	.81	74175	1.40
7448	.81	74180	.76
7450	.20	74181	2.25
7451	.17	74191	1.20
7453	.17	74192	1.20
7454	.17	74193	.95
7470	.35	74S195	1.05
7472	.21	74195	.65

LINEARS

LM301	30
LM307	30
LM309K	95
LM311	85
LM377	1.85
LM380 (8 pin)	75
LM3900	30
LM710	25
LM711	25
LM723	40
LM741	25
LM748	25
NE553	1.95
NE555	.40
NE556	95
NE565	95
NE566	95
NE567	1.0
1458	49
RCA3043	75
75491	.30
75492	.30

60 Hz L(•)(•)K

Crystal Time Base Kit - Kit enables a MOS clock circuit to operate from a DC power source. Ideal for car, camper, van, boat, etc.
60Hz output with an accuracy of .005% (typ.) Low power consumption 2.5 ma (typ.). Small size will fit most any enclosure. Single MOS IC oscillator/divider chip 5-15 volts DC operation.

ONLY \$ 5.95
2 for \$10.00

NOW! For the Dallas Area Residents.
Come Visit Our Retail Store.
3717 Lincoln Court, Garland, Texas
Tues. - Fri. 10 AM to 6 PM
Sat. 10 AM to 3 PM
CLOSED MONDAY

SOCKETS

14 pin	.22
16 pin	.25
18 pin	.25
24 pin (ww only)	.95
28 pin	.35
40 pin	.50

CMOS SALE

CD4000	.16
CD4001	.16
CD4002	.16
CD4007	.16
CD4009	.45
CD4010	.45
CD4011	.16
CD4012	.16
CD4013	.29
CD4014	.75
CD4015	.75
CD4016	.29
CD4017	.80
CD4018	.80
CD4019	.39
CD4020	.85
CD4021	.90
CD4022	.90
CD4024	.70
CD4025	.19
CD4027	.39
CD4028	.75
CD4029	.99
CD4030	.16
CD4031	2.30
CD4035	.99
CD4040	1.00
CD4041	.69
CD4042	.59
CD4043	.60
CD4044	.59
CD4046	.90
CD4047	.59
CD4049	.35
CD4050	.35
CD4051	.90
CD4053	.90
CD4056	1.00
CD4058	.90
CD4060	1.00
CD4066	.69
CD4069	.30
CD4071	.16
CD4076	.99
74C04	.29
74C107	.29
CD4116	.39
CD4507	.40
CD4512	.50
CD4516	.85
CD4518	.85
CD4520	.85

L S

74LS00	.26	74LS145	1.00
74LS02	.26	74LS151	.70
74LS03	.26	74LS153	.70
74LS04	.30	74LS155	.69
74LS05	.32	74LS156	.76
74LS08	.26	74LS157	.95
74LS09	.26	74LS158	.85
74LS10	.26	74LS160	.85
74LS11	.35	74LS161	.85
74LS13	.58	74LS162	.85
74LS14	1.05	74LS163	.85
74LS15	.26	74LS168	.85
74LS20	.24	74LS169	.85
74LS21	.35	74LS170	2.00
74LS22	.35	74LS173	1.10
74LS26	.35	74LS174	1.00
74LS27	.35	74LS175	1.00
74LS30	.34	74LS190	.95
74LS32	.35	74LS191	.95
74LS37	.33	74LS192	.95
74LS38	.38	74LS193	.95
74LS40	.34	74LS366	.95
74LS42	.80	74LS195	.95
74LS51	.26	74LS196	.85
74LS54	.26	74LS197	.85
74LS55	.26	74LS251	.85
74LS73	.75	74LS253	.85
74LS74	.49	74LS257	.85
74LS76	.49	74LS258	.85
74LS86	.45	74LS260	.26
74LS90	.85	74LS266	.26
74LS92	1.00	74LS279	.55
74LS93	1.00	74LS290	.75
74LS109	.49	74LS293	.75
74LS112	.49	74LS295	.95
74LS113	.40	74LS298	.95
74LS114	.40	74LS365	.55
74LS125	.55	74LS366	.55
74LS126	.65	74LS367	.55
74LS132	1.00	74LS368	.55
74LS133	.35	74LS390	1.75
74LS136	.39	74LS393	1.45
74LS138	.85	74LS670	3.25
74LS139	.85		

ORDER BY PHONE. Charge your order to BankAmericard or Master Charge.

USE OUR TOLL FREE WATTS

1-800-527-2304

SPECIAL FIVE ★ STAR EDITION

★ Check the Stars for Special Values ★

<p>Still the Biggest, Brightest, "Bestest" .5" LED, 6 DIGIT AC/DC ALARM CLOCK KIT & ELAPSED TIMER \$19.95 Complete</p> <ul style="list-style-type: none"> • PC Board Drilled & Silk Screened (Includes Xtal Time Base Circuitry) • 5375 Nat. Clock Chip & Fairchild Displays • Includes EVERY part required for clock and all options except Cabinet and Crystal Time Base components. If desired, see below. • Brightness Control • Freeze feat. on every mode • Field Tested over 1 Yr. • Most Important — Complete Instructions, schematics Pictorials, layouts — everything for trouble free assembly <p>OPTIONS — XTAL Time Base Components - \$2.95 when purchased w/clock Wood Clock Cabinet (A) — \$4.00</p>	<p>WOODEN CLOCK CABINETS</p> <p>Includes: Filter & Back Walnut Grain or Black Leatherette (A only) \$5.00 ea.</p> <p>Dimensions (Inside) A — 1-13/16"H, 5 1/2"W, 4 3/4"D B — 1 7/8"H, 4 3/4"W, 4 3/4"D Extra Filters — Red, Smoke Blue, Amber, & Green — \$6.00</p>	<p>AC/DC - ALARM Clock Kit - 12/24 Hr.</p> <p>\$7.50 quantities of 1-5 \$6.50 quantities of 6 & up</p> <ul style="list-style-type: none"> • Displays Hrs. & Min. - Switch to Min. & Secs. on Command. • AM/PM Indication • Field Tested for 6 months <p>The kit will include a 5316 National Clock Chip, 4 Fluorescent Display tubes, all electronic components, switches, controls & complete instructions, specs, etc. for clock and all optional Features. Other parts required or if desired are as follows:</p> <ul style="list-style-type: none"> • PC Board, Drilled — \$3.00 • Xformer (for AC oper.) — \$1.00 • Speaker Alarm Kit — \$2.00 • Plexiglas Case (Kit) — \$2.00 w/purchase of clock
--	---	---

<p>CLOCK CHIPS</p> <table border="0"> <tr><td>MM5314</td><td>.....</td><td>\$3.50</td></tr> <tr><td>MM5316</td><td>.....</td><td>3.50</td></tr> <tr><td>MM5387 (Hi Cur. 5316)</td><td>.....</td><td>3.95</td></tr> <tr><td>MM5375</td><td>.....</td><td>3.95</td></tr> <tr><td>CT7001</td><td>.....</td><td>7.95</td></tr> <tr><td>CT7010</td><td>.....</td><td>6.95</td></tr> </table> <p>IC SOCKETS</p> <table border="0"> <tr><td>8,14,16,18 Pin</td><td>..</td><td>5 for 1.00</td></tr> <tr><td>24 Pin & 28 Pin</td><td>..</td><td>3 for 1.00</td></tr> <tr><td>40 Pin</td><td>.....</td><td>2 for 1.00</td></tr> </table>	MM5314	\$3.50	MM5316	3.50	MM5387 (Hi Cur. 5316)	3.95	MM5375	3.95	CT7001	7.95	CT7010	6.95	8,14,16,18 Pin	..	5 for 1.00	24 Pin & 28 Pin	..	3 for 1.00	40 Pin	2 for 1.00	<p>TRANSFORMERS</p> <table border="0"> <tr><td>Plug type-12VAC 250MA</td><td>.....</td><td>2.50</td></tr> <tr><td>PC Mnt.-12VAC 250MA</td><td>.....</td><td>1.50</td></tr> <tr><td>Bkt Mnt.-5VAC 6 Amp</td><td>.....</td><td>4.95</td></tr> </table> <p>DIODES</p> <table border="0"> <tr><td>IN4001-IN4007 Mix</td><td>..</td><td>50 for 4.00</td></tr> <tr><td>IN914 or IN4148</td><td>.....</td><td>20 for 1.00</td></tr> <tr><td>2.5 Amp 1000 Volts</td><td>..</td><td>5 for 1.00</td></tr> </table>	Plug type-12VAC 250MA	2.50	PC Mnt.-12VAC 250MA	1.50	Bkt Mnt.-5VAC 6 Amp	4.95	IN4001-IN4007 Mix	..	50 for 4.00	IN914 or IN4148	20 for 1.00	2.5 Amp 1000 Volts	..	5 for 1.00
MM5314	\$3.50																																												
MM5316	3.50																																												
MM5387 (Hi Cur. 5316)	3.95																																												
MM5375	3.95																																												
CT7001	7.95																																												
CT7010	6.95																																												
8,14,16,18 Pin	..	5 for 1.00																																												
24 Pin & 28 Pin	..	3 for 1.00																																												
40 Pin	2 for 1.00																																												
Plug type-12VAC 250MA	2.50																																												
PC Mnt.-12VAC 250MA	1.50																																												
Bkt Mnt.-5VAC 6 Amp	4.95																																												
IN4001-IN4007 Mix	..	50 for 4.00																																												
IN914 or IN4148	20 for 1.00																																												
2.5 Amp 1000 Volts	..	5 for 1.00																																												

★ **MA1003 MOBIL CLOCK MODULE (National) \$21.95** ★

Florescent Display gives Color Choice (Red, Blue, Green or Yellow) when used w/corresponding Color Filter
Includes — Module, Switches, Filter & Specs

7 SEG LED DISPLAYS

.33" Type 707/MAN-1 14 Pin Dip Common Anode or Cathode
\$.59 ea. 10 for \$5.00

★ **ADJUSTABLE AC VARIABLE VOLTAGE CONTROLLER \$4.95 ea.** ★

Solid State *Assembled (not a kit)*

110 Volt — 10 Amps

USES — Motor Controller, Dimmers, Any Variable AC Voltage Application

60 HZ. CRYSTAL TIME BASE KIT \$4.95

Use with Digital Clocks for 12VDC or Portable Operation
KIT INCLUDES:
PC Board, 5369 Divider Chip
3.5795 MHZ XTAL & All Other Parts
Complete Instructions

★ **6 Digit LED Stop-Watch Kit \$29.95 complete** ★

Split Time Taylor Time

FEATURES: Reads minutes, seconds, & 100ths of seconds
6 bright easily readable digits
Needs only 9 volt Xistor battery

KIT INCLUDES: • HAND HELD CASE DESIGNED FOR ABOVE
• Latest Technology Intersil Mos Chip # 7205
• 3.2768 MHz Crystal • Variable Trimmer Cap
• 2 mini slide & 3 MOM. PB Switches
• 3 pairs (6) digits Double Digit LED Displays
P.C. BOARD for above and all components

Voltage Regulators

Positive-To 220 Pkg.		Negative-To 220 Pkg.			
7805	\$1.00	7905	\$1.25
7806	1.00	7912	1.25
7812	1.00	7915	1.25
7815	1.00	To-3 Pkg.		
7824	1.00	LM309K	1.25

LED'S

Jumbo Red LED's 10 for 1.00 100 for 9.00
25 Pk. LED's Asstd. Sizes & Colors 2.50
Bi-Polar LED Red/Green 1.00

Transistors		Bridges			
2N2222A	4/1.00	1 1/2 Amp 200 volt	3/1.00
2N3904 type NPN	8/1.00	6 Amp 600 volt	3/2.00
2N3906 type PNP	8/1.00	25 Amp 200 volt	3/5.00
2N3055 (NPN TO-3)75	Prescalars		
2N4904 (PNP TO-3)85	95H90	8.95
			11C90	14.95

Big Digits *Big Bargain Price*

THE BIG ONE .8" LED Alarm Clock Kit \$17.95 Complete



simple construction

Includes: Power Supply, Speaker, IC Socket
PC Board, Clock Chip, Switches
Fairchild .8" Display Module, xistors, resistors, capacitors.
Complete Instructions

Features: • Hrs. & Min. Switch to Min. & Sec. on Command
• 12 Hr. - 24 Hr. Alarm
• 10 Min. Snooze
• AM/PM Indicators
• Sleep Output

OPTION — Wood Clock Cabinet (B) — \$4.00 w/purchase of clock

Dual Range DIGITAL Voltmeter Kit \$39.95 Complete

0 to ± 2 Volts DC — 0 to ± 2 Volts DC

- Features latest Technology DVM chip set
- Non Critical Comp.
- High Noise Rejection
- Accuracy to within .001

Contains — P.C. Boards; 4-large .50 Fairchild Readouts; Display Drivers; Op-Amps; Inverter; all electronic comp; Switches, Pots; Complete Instructions and Specs; & DVM Chip Set.

Requirements: Power Supply w/+5V, +15V and -15V.
OPTIONS — Set/Precision Resistors for Increasing Voltage Range up to 200 Volts — \$2.95

NOTE — Complete Specs, Schem. etc., for Multi-Meter

The SUPER COMPACT \$13.95 Complete



Includes: All Parts, PC Board
Power Supply & Case
Colors: Black, Silver, or Gold
Size: 4.75" x 1.8" x 1.4"
Material: Extruded Alum.

OPTION — Temperature Ind. Front Panel — \$3.00

Features:
4-large .4" LED Displays
12/24 hour Format

BankAmericard-Master Charge Minimum \$10.00 on Charge Call Your Order In For Immediate Shipment 201-755-0590 Effective after Sept. 11th

Hrs.: Mon. thru Friday - 9:00 A.M. to 6:00 P.M.
Tues. & Thursday - 7:00 P.M. to 10:00 P.M.

Terms & Conditions: Orders must incl. Ck. - No COD's - Add \$1.00 handling for orders under \$25.00 - Outside Cont. USA add Total Postage - 10% Air Mail - N.J. resid. add 5% Tax

6 DIGIT LED MOBILE Clock Kit & Elapsed Timer \$27.95 Complete

4" Digits 12 or 24 Hr. Quartz Crystal Controlled
12 Volt DC or AC operation



- Protection from noise & High Impulses
- Display Blanking Capability
- Battery Back-Up Capability
- Size 4" x 1 1/4" x 4 1/2"
- Rugged High Impact ABS
- Recessed Front Switches

OPTION — AC Adaptor \$2.50

HOBB-Y-TRONIX, INC.

351 Rahway Road, Edison, N.J. 08817
Phone: 201-755-0590 — Phone effective 9/12/77



Watch for our supermarket bargains each month!

any way you look at it

POLY PAKS® IS THE WORLD'S LARGEST ELECTRONIC SUPERMARKET

DISCOUNT SEP. 77 POP ELECTRONICS SPECIALS

FEATURING THE BARGAINS OF THE MONTH!!!!

\$5.50 TV GAME JOY STICK

Includes four 100K pots
For TV & computer games, and quadrophonic balancing! 1 1/2 x 1 1/2 x 1 1/2. With 1" handle. Wt. 6 ozs.
Cat. No. 9E3508



RCA High quality "POCKET" VOM

• 1000 ohms per volt
Model WV-539A. Features 1% precision, movements diode protected against burnout. Measures DC volts 0-16-160-1000; AC volts 0-16-150-1000; DC current 0-160ma; resistance X1000. Sensitivity 1000 ohms/volt AC-DC. Uses penlite cell, not included. Size 2 3/4 x 3 1/2 x 1 3/4. Wt. 5 ozs.
Cat. No. 9E3921

\$8.88



SPECIAL THIS AD G-E "BLUE" FLUORESCENT READOUTS

Bright blue 7-segment characters, 0.57" high! 1.5V filament. 24V characters. Common cathode. Fits standard 9-pin tube socket. Driven directly by MM5316. Wt. 3 ozs. Cat. No. 9R3684

\$1.00 each

MM5316 Clock Chip — \$2.95
Cat. No. 9E1759



6-DIGIT CAR CLOCK KIT

For auto, plane, boat, vans, etc. Top quality & accuracy at the lowest price! Displays hours, minutes & seconds in 12 hour format. Controls for fast & slow set. Attractive grey cabinet with chrome trimmed red lens. Only 4 x 4 1/2 x 1 3/4". Complete "Clock" kit, 12 VDC. Wt. 14 ozs.

\$2200 KIT
REG. \$26.88

Cat. No. 9E3852

- Crystal controlled time base!
- Easy to assemble and install!
- Bright RED 0.35" LED digits!



J. C. PENNEY'S 8-Track TAPE TRANSPORT

Excellent replacement or design your own quality tape system! Automatic or manual track selection with program indicator lights. Player shuts off automatically when tape runs out. Built-in low-distortion preamp and wow free motor. With Input & output cables. Requires external power supply. With instructions. Size 9 x 6 x 3 1/2". Wt. 4 lbs. Cat. No. 9E3010

\$12.95

- 11.5 VAC fan-cooled motor
- Slides easily into modular cabinet
- Shielded preamp



SPECTROL "SKINNY-TRIMS" 3/8" Sq. POTENTIOMETERS

Choose ANY 3 **\$1.19**

- 9E3863 25 Turn upright, 10K
- 9E3864 25 Turn flat, type 64, 100K
- 9E3866 Single turn flat, type 63, 100K

OHMS: 10, 20, 50, 100, 200, 500, 1K, 10K, 100K, 500K, 1M

CODE: *Available in all types *Available in Cat. No. 9E3863 only.



WYS We know we have the lowest prices!!

Buy 10 15% OFF
Buy 100 25% OFF

Order by Cat. No. 9E1981

Type	Sale	Cat. No.	Price	Type	Sale	Cat. No.	Price
SN7400	.20	SN7460	.20				
SN7401	.14	SN7461	.14				
SN7402	.14	SN7462	.14				
SN7403	.14	SN7463	.14				
SN7404	.17	SN7464	.17				
SN7405	.18	SN7465	.18				
SN7406	.19	SN7466	.19				
SN7407	.24	SN7467	.24				
SN7410	.14	SN7468	.14				
SN7411	.19	SN7469	.19				
SN7413	.39	SN7470	.39				
SN7414	.61	SN7471	.61				
SN7415	.24	SN7472	.24				
SN7416	.24	SN7473	.26				
SN7417	.24	SN7474	.26				
SN7418	.24	SN7475	.26				
SN7419	.24	SN7476	.33				
SN7420	.14	SN7477	.33				
SN7421	.26	SN7478	.33				
SN7422	.26	SN7479	.33				
SN7423	.24	SN7480	.33				
SN7424	.24	SN7481	.33				
SN7425	.24	SN7482	.33				
SN7426	.24	SN7483	.33				
SN7427	.24	SN7484	.33				
SN7428	.24	SN7485	.33				
SN7429	.24	SN7486	.33				
SN7430	.14	SN7487	.33				
SN7431	.14	SN7488	.33				
SN7432	.24	SN7489	.33				
SN7433	.24	SN7490	.33				
SN7434	.24	SN7491	.33				
SN7435	.24	SN7492	.33				
SN7436	.24	SN7493	.33				
SN7437	.24	SN7494	.33				
SN7438	.24	SN7495	.33				
SN7439	.24	SN7496	.33				
SN7440	.14	SN7497	.33				
SN7441	.14	SN7498	.33				
SN7442	.14	SN7499	.33				
SN7443	.14	SN7500	.33				
SN7444	.14	SN7501	.33				
SN7445	.14	SN7502	.33				
SN7446	.14	SN7503	.33				
SN7447	.14	SN7504	.33				
SN7448	.14	SN7505	.33				
SN7449	.14	SN7506	.33				
SN7450	.14	SN7507	.33				
SN7451	.14	SN7508	.33				
SN7452	.14	SN7509	.33				
SN7453	.14	SN7510	.33				
SN7454	.14	SN7511	.33				
SN7455	.14	SN7512	.33				

POLY PAKS "RAMS" 2102-1 PRICES

New from top U.S.A. makers. Tested for 500 sec. speed. Cat. No. 9E3548

8 FOR \$9.95



"POCKET" VOM

SAVE \$2.00 REG. \$15.88

1% precision resistors. Input impedance 20,000 ohms/volt. AC Measures DC volts 0-25-50-250-500-2500; AC volts 0-10-50-100-500-1000; DC current 0-50ma-2.5ma-250ma-Ohms x10, x1000. Measures dBm -20 to +22. Size: 3 x 5 1/2 x 2 1/4". Thumbwheel ohms adjust. Unbreakable 34" test probes. Uses AA penlite cell, not included. Wt. 16 ozs. Cat. No. 9E3580

\$13.88

- Mirrored 3" scale!
- 20,000 ohms per volt!
- Overload protection!



"CB" POWER SUPPLY \$19.95

Ideal for CB's, Ham rigs, tape decks & more! Modern cabinet, 5 x 4 1/2 x 2 1/4". With on/off switch, LED lamp, built-in circuit breaker, 115 VAC 60 Hz. Wt. 5 lbs. Cat. No. 9E3452

- 12 VDC @ 3 Amps output
- Regulated, continuous duty

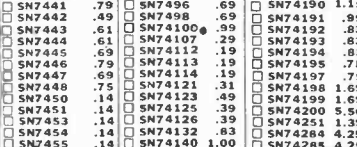

DIP Switches Your Choice

Reg. \$1.69 ea.

9E3668	2	We've sold 'em as high as \$2.98 each. You can mix 'em when you buy. All SMD, fits 4-pin DIP socket. Wt. 1-oz.
9E3669	3	
9E3021	4	
9E3670	5	
9E3671	6	
9E2677	7	



"CB" POWER SUPPLY \$19.95

Ideal for CB's, Ham rigs, tape decks & more! Modern cabinet, 5 x 4 1/2 x 2 1/4". With on/off switch, LED lamp, built-in circuit breaker, 115 VAC 60 Hz. Wt. 5 lbs. Cat. No. 9E3452

- 12 VDC @ 3 Amps output
- Regulated, continuous duty



BARREL KITS

Every kit carries money back guarantee.

EXCLUSIVE

TEST 'EM YOURSELF 'N SAVE

Buy 10 BARREL KITS AND CHOOSE THE 11TH KIT FREE

<h4>BARREL KIT #203</h4> <h5>CALCULATOR KEYBOARDS</h5> <p>10 for \$1.98</p> <p>It's true! 20-key, 4 function keyboards at ridiculous give-away. Wt. 12 ozs. Cat. No. 9E3254</p>	<h4>BARREL KIT #201</h4> <h5>6V INDICATORS</h5> <p>15 for \$1.98</p> <p>Test lamp manufacturer dumps inventory! Worth 69¢ ea. Like grain-o-wheat. Cat. No. 9E3330</p>	<h4>BARREL KIT #200</h4> <h5>6 DIGIT READOUT MODULES</h5> <p>5 for \$1.98</p> <p>Barrels and barrels and no time to test. Calculator and driver chips beneath epoxy on back. Wt. 6 ozs. 9E3515</p>	<h4>BARREL KIT #188</h4> <h5>400 PARTS</h5> <p>\$1.98</p> <p>Includes resistors, caps, diodes, IC's, for PC work, some on PCB boards. Dumped into barrels by factories, 100% material. 12 ozs. Cat. No. 9E3401</p>	<h4>BARREL KIT #184</h4> <h5>1/4 WATT METAL FILM</h5> <p>150 for \$1.98</p> <p>100% metal film resistors. Long Leads. 9E3413</p>	<h4>BARREL KIT #221</h4> <h5>IC SOCKETS</h5> <p>8 for \$1.98</p> <p>Mfr unloaded Four 14-pin, four 18-pin. Solder tail, lo-profile. No. 9E3621</p>
<h4>BARREL KIT #163</h4> <h5>MINI TRIM POTS</h5> <p>30 for \$1.98</p> <p>Asst. values 100 to 1 meg. What a buy. Single turn. 1/2 W. Wt. 6 oz. 9E3345</p>	<h4>BARREL KIT #180</h4> <h5>HOBBY VOLTAGE REGULATORS</h5> <p>20 for \$1.98</p> <p>LM-309K TO-3 barreled, but by the pound, but you want to check 'em? Your gain. Wt. 20 ozs. 9E3330</p>	<h4>BARREL KIT #154</h4> <h5>CLOCK CHIPS</h5> <p>20 for \$1.98</p> <p>We gathered an assortment of clock chips, alarm, extenders, beepers, who knows! mixed. Cat. No. 9E3306</p>	<h4>BARREL KIT #127</h4> <h5>AXIAL ELECTROS</h5> <p>40 for \$1.98</p> <p>Asst. capacitors and voltages. Cat. No. 9E3227</p>	<h4>BARREL KIT #118</h4> <h5>UPRIGHT ELECTROS</h5> <p>40 for \$1.98</p> <p>1mf to 300mf in mixture of voltages. 100% marked 'n good. 9E3228</p>	<h4>BARREL KIT #112</h4> <h5>MOLEX SOCKETS</h5> <p>200 for \$1.98</p> <p>100% good. Cat. No. 9E3400</p>
<h4>BARREL KIT #109</h4> <h5>TERMINAL STRIPS</h5> <p>100 for \$1.98</p> <p>Wide asst. of terminal strip connectors, from 1 contact up. Strip manufacturers barrel dump is your gain. Wt. 1 lb. Cat. No. 9E3136</p>	<h4>BARREL KIT #104</h4> <h5>SLIDE VOLUME CONTROLS</h5> <p>10 for \$1.98</p> <p>Factory same as 400-mw's. Never-to-see-again offer, 6, 8, 10, 12, 15v. under 100¢. Double plug. Cat. No. 9E2741</p>	<h4>BARREL KIT #101</h4> <h5>RESISTOR SPECIAL</h5> <p>200 for \$1.98</p> <p>Includes: 1/4, 1/2, 1, 2, watters, carbon. 8 oz. 100% good. 9E3054</p>	<h4>BARREL KIT #99</h4> <h5>PHOTO ELECTRIC CELLS</h5> <p>10 for \$1.98</p> <p>Asst. GE types, CDS types. Mixed by factory. Big job for us to separate. 100% good. Cat. No. 9E3052</p>	<h4>BARREL KIT #93</h4> <h5>HALF WATTERS</h5> <p>200 for \$1.98</p> <p>Resistor factory tried to mix up by mixing 100% color-coded resistors in barrel. But value is there. 4 oz. 9E3046</p>	<h4>BARREL KIT #87</h4> <h5>100 ON BOARD</h5> <p>100 for \$1.98</p> <p>Hobby and untested, factory mixed in barrels. Linears, 7400's, ROMS, DTL's, recitators, clock and calculator chips and more. Wt. 12 ozs. Cat. No. 9E2860</p>
<h4>BARREL KIT #83</h4> <h5>LM-340T VOLTAGE REGULATORS</h5> <p>15 for \$1.98</p> <p>Factory rejects, hobby, cosmetic rejects. May include 6, 8, 12, 15, 18 or 24 volts. TO-220 power tab. Wt. 4 ozs. Cat. No. 9E2635</p>	<h4>BARREL KIT #76</h4> <h5>1-WATT ZENERS</h5> <p>100 for \$1.98</p> <p>Factory same as 400-mw's. Never-to-see-again offer, 6, 8, 10, 12, 15v. under 100¢. Double plug. Cat. No. 9E2741</p>	<h4>BARREL KIT #71</h4> <h5>CAPACITOR SPECIAL</h5> <p>100 pcs. \$1.98</p> <p>micra, molded, plastics, ceramics, discs, etc. Nifty! 100% good. Cat. No. 9E2738</p>	<h4>BARREL KIT #68</h4> <h5>2 WATTERS</h5> <p>100 for \$1.98</p> <p>100% good. Suppliers throw 'em in the barrel. It's a 1! gold mine. All marked. Cat. No. 9E2735</p>	<h4>BARREL KIT #65</h4> <h5>MIXED READOUTS</h5> <p>10 for \$1.98</p> <p>Factory returns — such numbers as MAN-4's, MAN-7's, MAN-3's, 11 barrels 400 time to separate! Hobby. Cat. No. 9E2733</p>	<h4>BARREL KIT #61</h4> <h5>POLYSTYRENE CAPS</h5> <p>100 for \$1.98</p> <p>Finest caps made. As a sample we bought 10 barrels from factory, mixed values; all good. Cat. No. 9E2729</p>
<h4>BARREL KIT #54</h4> <h5>6 & 8 DIGIT READOUTS</h5> <p>10 for \$1.98</p> <p>Bargain of a lifetime. We got a barrel of 'em, but no time to test. Untested & hobby. Multiplexed, blisdoor type. Wt. 8 ozs. Cat. No. 9E2722</p>	<h4>BARREL KIT #40</h4> <h5>HOBBY PNP POWER TRANSISTORS</h5> <p>15 for \$1.98</p> <p>Popular germanium and silicon TO-18's, factory "off-spec" and fallout. 100% hobby, no opens, no shorts! Wt. 16 ozs. Cat. No. 9E2618</p>	<h4>BARREL KIT #39</h4> <h5>HOBBY NPN POWER TRANSISTORS</h5> <p>15 for \$1.98</p> <p>Factory fallouts and "off spec" TO-3 powers, 100% hobby, no opens, no shorts! Wt. 1 lb. Cat. No. 9E2617</p>	<h4>BARREL KIT #35</h4> <h5>NEON LAMPS</h5> <p>30 for \$1.98</p> <p>100% good. Famous NE-2's. All prime, but factory made millions and barreled 'em. Your advantage. Cat. No. 9E2613</p>	<h4>BARREL KIT #31</h4> <h5>METALLIC RESISTORS</h5> <p>100 for \$1.98</p> <p>Made mostly by Corning. The finest resistor made. Mostly 1/2 watters. 1% to 5% tol. & a barrel of values. Cat. No. 9E2609</p>	<h4>BARREL KIT #27</h4> <h5>PREFORMED DISCS</h5> <p>200 for \$1.98</p> <p>We got barrels of 1/4 and 1/2 watters for PC use. 100% V. 100% watters. No. 9E2608</p>
<h4>BARREL KIT #26</h4> <h5>PLASTIC TRANSISTORS</h5> <p>100 for \$1.98</p> <p>Untested and hobby transistors, TO-92 (TO-18), asst. 2N numbers, asst. manufacturers. Wt. 8 ozs. 9E2604</p>	<h4>BARREL KIT #25</h4> <h5>METAL CAN TRANS</h5> <p>100 for \$1.98</p> <p>Factory unloaded barrels of prime, hobby and untested TO-9's, TO-1's, and TO-18 transistors. Marked and unmarked. Wt. 20 ozs. 9E2603</p>	<h4>BARREL KIT #20</h4> <h5>LONG LEAD DISCS</h5> <p>100 for \$1.98</p> <p>"suction" sale! Prime, marked only. Long leads. Cat. No. 9E2598</p>	<h4>BARREL KIT #19</h4> <h5>DIPPED MYLARS</h5> <p>60 for \$1.98</p> <p>Finest capacitors made, shiny finish. Imagine factory dumping 'em in barrels, who knows! Untested, hobby. Wt. 14 ozs. Cat. No. 9E2415</p>	<h4>BARREL KIT #14</h4> <h5>PRECISION RESISTORS</h5> <p>200 for \$1.98</p> <p>Marked and unmarked 1/4, 1/2, 2 watters. No. 9E2428</p>	<h4>BARREL KIT #11</h4> <h5>POWER TAB TRANSISTORS</h5> <p>40 for \$1.98</p> <p>NPN, plastic TO220 type. Assorted 2N numbers. No. 9E2425</p>
<h4>BARREL KIT #7</h4> <h5>VOLUME CONTROL</h5> <p>30 for \$1.98</p> <p>100% good. Singles, duals, variety of values, styles, big ones — small ones. Cat. No. 9E2421</p>	<h4>BARREL KIT #3</h4> <h5>1N4148/9/14</h5> <p>100 for \$1.98</p> <p>Imagine famous switching diodes at these prices! Cat. No. 9E2418</p>	<h4>BARREL KIT #2</h4> <h5>LINEAR OP AMPS, DIPS</h5> <p>75 for \$1.98</p> <p>Un tested! \$1.98! May include 709's, 741's, 703's, 560 series, 565 line. 9E2416</p>	<h4>BARREL KIT #1</h4> <h5>SN7400 DIP IC'S</h5> <p>75 for \$1.98</p> <p>Marked 14 and 16 pin dips, may include gates, flip-flops, registers, counters, who knows! Untested, hobby. Wt. 14 ozs. Cat. No. 9E2415</p>	<p>Terms: Add postage. Rated: net 30 Phone: Wakefield, Mass. (617) 245-3829 Retail: 16-18 Del Carmine St., Wakefield.</p>	<p>SALE Send for FREE Fall-Winter CATALOG C.O.D.'s MAY BE PHONED</p>

S.D. SALES CO. P.O. BOX 28810 -D DALLAS, TEXAS 75228

★ Imsai - Altair "A" Compatible Kits ★

Z-80 CPU KIT COMPLETE - \$149. kit

Z-80 Chip & Manual \$49.95

Z-80 Manual - \$7.50 Separately

From the same people who brought you the \$89.95 4K RAM KIT. We were not the first to introduce an Imsai/Altair compatible Z-80 Card, but we do feel that ours has the best design and quality for the lowest price! The advance features of the Z-80 such as an expanded set of 158 instructions, 8080A software compatibility, and operation from a single 5VDC supply, are all well known. What makes our card different is the extra care we took in the hardware design. The CPU card will always stop on an M1 state. We also generate TRUE SYNC on card, to insure that the rest of your system functions properly. Dynamic memory refresh and NMI are brought out for your use. Believe it or not, not all of our competitors have gone to the extra trouble of doing this. As always this kit includes all parts, all sockets, and complete instructions for ease of assembly. Because of our past experience with our 4K kit we suggest that you order early. All orders will be shipped on a strict first come first served basis. Dealers inquiries welcome on this item. Kit includes Zilog Manual and all parts. Kit shipped with 2 MHz crystals.

THE WHOLE WORKS \$89.95 4K LOW POWER RAM BOARD KIT

Imsai and Altair 8080 plug in compatible. Uses low power static 21L02-1 500 ns. RAM'S. Fully buffered, drastically reduced power consumption, on board regulated, all sockets and parts included. Premium quality plated through PC Board. *For 250 ns RAM's add \$10.00*

NEW! DESIGN CONSOLETTA KIT - \$89.95

S.D. Sales announces the inexpensive way to beat the wire wrap jungle. Our latest kit gives you 124 solderless quick connect terminals, enough for eight 16 pin IC's and provides 50 x 8 common buss matrix. Has regulated +5VDC and +/- 15VDC, all at 1 AMP. Voltage regulation at 100%. Also includes a pulse generator variable from 10hz to 50mhz and .01 sec. to 100 nano seconds. Generator output is +5V. In kit form only and includes all parts, sockets: front panel measures 7 1/4" x 8 1/4", and hardware. case not available.

CAR/BOAT KIT *New Item!*
\$34.95
Music to your Ears!

MUSICAL HORN
Musical Horn Kit for car, boat, or home. Plays any tune from Mozart to Led Zeppelin. Change tunes in seconds; complete solid state electronics. Standard or custom tunes available at \$6.95 each (you supply us with the sheet music - we supply electronics for your favorite tune.) One song supplied with original order. Standard tunes available: DIXIE - EYES OF TEXAS - ON WISCONSIN - YANKEE DOODLE DANDY - NOTRE DAME FIGHT SONG - PINK PANTHER - AGGIE WAR SONG - ANCHORS AWAY - NEVER ON SUNDAY - BRIDGE OVER RIVER QUI - CANDY MAN.

HOME KIT
\$26.90
Home kit includes speaker which operates from your door bell. When door bell is pushed your favorite tune is played. Car/boat kit DOES NOT include speaker. Uses standard Bohm PM speaker. Allow 4 weeks delivery on both kits.

Limited Quantity!
\$9.95 kit

6 DIGIT ALARM CLOCK KIT

We made a fantastic kit even better. Redesigned to take advantage of the latest advances in IC technology. Features: Litronix Dual 1/2" displays, Mostek 50250 super clock chip, single I.C. segment driver, SCR digit drivers. Greatly simplified construction. More reliable and easier to build. Kit includes all necessary parts (except case). For P.C. board add \$3.00; AC XFMR add \$1.50. Do not confuse with Non-Alarm kits sold by our competition! Eliminate the hassle - avoid the 5314!
NEW! WITH JUMBO LED READOUTS!

1000 MFD Filter Caps Rated 35 WVDC Up-right style with PC leads. Most popular value for hobbyists. 4/\$1.00	SLIDE SWITCH Assortment Our best seller. Includes miniature and standard sizes, single and multi-position units. All new. 12/\$1.00	POWER RESISTOR 15 OHM 25W BY CLAROSTAT 75¢ ea.	RESISTOR ASSORTMENT 1/4W 5% & 10% PC leads. A good mix of values! Special! 200/\$2.	P.C. LEAD DIODES 1N4148/1N914 100/\$2. 1N4002 - 1A 100 PIV 40/\$1.	Just received a good mixed lot of National TO-92 plastic transistors. PNP & NPN, even a few FET's. 40-50% y-i-d. Untested. Asst. 500/\$3.	DISC CAP ASSORTMENT P.C. Leads. At least 10 different values. Includes .001, .01, .05 plus other standard values. 60/\$1.00
---	---	---	---	---	--	---

AMD-1702A
Huge Factory Purchase
FACTORY PRIME UNITS! BRAND NEW!
1.5 Micro-Seconds Access Time.
10/\$40. \$4.95 ea.

★ *Special!* ★
3.579545 MHz Time Base Crystal \$1.25
28 PIN SOCKETS 3 for \$1.00
11,000 MFD 50WVDC Computer Grade Cap \$3.00 each
39 MFD 16 V Mallory Electrolytic 15 for \$1.00

FACTORY PRIME!
21L02-1
Not only are our RAM'S faster than a speeding bullet but they are now very low power. We are pleased to offer prime new 21L02-1 Low Power and Super Fast RAM'S. Allows you to STRETCH your power supply farther and at the same time keep the wait light off!
500ns 8/\$12.95
250ns 8/\$15.95

IC'S REMOVED FROM PC BOARDS ALL TESTED; FULL SPEC.
Great Buy!
IC's from XEROX
1402 A Shift Regulator - 50c MH0025CN - 55c
7400 - 9c 7402 - 9c 7404 - 9c 7406 - 11c 7407 - 11c 7410 - 9c 7416 - 13c 7420 - 9c
7430 - 9c 7440 - 9c 7437 - 10c 7438 - 10c 7451 - 9c 7474 - 16c 7475 - 24c 7486 - 16c
7493 - 26c 74121 - 22c 74123 - 32c 74151 - 9c 74155 - 22c 74193 - 35c 8233 - 35c Intel - 1302 - 45c

MOS 6 DIGIT UP/DOWN COUNTER
40 PIN DIP. Everything you ever wanted in a counter chip. Features: Direct LED segment drive, single power supply (12 VDC TYPE), six decades up/down, pre-loadable counter, separate pre-loadable compare register with compare out-put. BCD and seven segment outputs, internal scan oscillator, CMOS compatible, leading zero blanking, 1MHz. count input frequency.
\$12.95 Exclusive! \$12.95

CALL IN YOUR BANK-AMERICARD OR MASTER CHARGE ORDER IN ON OUR CONTINENTAL UNITED STATES TOLL FREE WATTS LINE:
1-800-527-3460
Texas Residents Call Collect:
214/271-0022

TERMS:
Money Back Guarantee!
NO COD'S. TEXAS RESIDENTS ADD 5% SALES TAX. ADD 5% OF ORDER FOR POSTAGE & HANDLING. ORDERS UNDER \$10.00 ADD 75c. FOREIGN ORDERS - U.S. FUNDS ONLY!

Orders over \$15. - Choose \$1. FREE MERCHANDISE!

GODBOUT

BILL GODBOUT ELECTRONICS
BOX 2355, OAKLAND AIRPORT, CA 94614

TERMS: Prices good through end of magazine cover date. Cal res add tax. BankAmericard® /VISA® /Mastercharge® orders (\$15 min) call (415) 562-0636, 24 hrs. Allow up to 5¢ shipping (more for power supplies); excess refunded. COB orders OK with street address.

ADD 24K OF MEMORY TO YOUR COMPUTER — \$450

Now you can buy 3 of our popular 8K ECONORAM II™ boards for \$450. Features? All static design (eliminates dynamic timing hassles); tri-state outputs; configured as two separate, independent 4K blocks with individual protect for each block; zero wait states (4 MHz 2-80x; use 1 wait state, implemented on board); provides vector interrupt if write attempted in protected block. Fully buffered. Fully socketed. True low power.

- #SPC-24 Three 8K ECONORAM II kits.....\$450.00
- #CK-008 8K ECONORAM II (kit form).....\$163.84
- #CK-010 Same but assembled, tested, 1 yr warr...\$188.50
- #CK-007 4K ECONORAM II (kit form).....\$100.00
- #CK-009 Same but assembled, tested, 1 yr warr...\$120.00

FOR MORE DETAILS, COMPONENTS + MUCH MORE...

SEND FOR OUR FLYER

CIRCLE NO. 28 ON FREE INFORMATION CARD

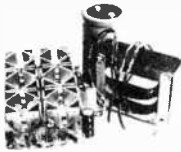

12A at 50% duty cycle. .05V regulation, current limiting, crowbar over-voltage protection. Easy to build, compact kit. Excellent for powering ham, CB, and automotive equipment from the AC line. Please include sufficient postage; case & hardware not included.

12V 8A SUPPLY \$39.95

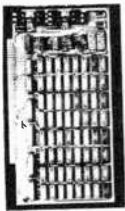

MOTHERBOARDS 10 SLOT \$ 90 18 SLOT \$ 124

Both kits include edge connectors. Active terminations reduce noise, crosstalk, and other buss gremlins.

INTERDESIGN 101 PULSE GENERATOR

\$88

Portable, rechargeable, 10% -90% duty cycle, .1 Hz to 2 MHz.

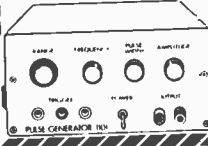

PARTS SPECIALS

- #SPC-22 Prime 8080A...\$12.95
- #SPC-23 Fast 2708...\$25.00

For faster service

USE ZIP CODE

on all mail

PROMS PROGRAMMED — New low prices — 13 cents stamp brings information. Or send \$1 check for program cards, specs, PROM postage credit. RBH Enterprises, Box 12344, Wichita, KS 67277.

COMBO ORGAN 61 Note C to C includes Synthesizer — Piano Section — 1' 2' 4' 8' 16' Percussion Rotary Sustains — Case Vinyl and Stand. Special \$325.00. Elm Systems, 205 East 17th Street, New York, New York 10003.

SNOOPERSCOPE, see in total darkness with infrared viewing device. Detailed construction plans, \$3.50. Argyre, Box 1570, Laporte, TX 77571.

PC BOARDS from your art. Send SASE for info. Assembly Systems, Box 221, Wadsworth, OH 44281.

8080 OCTAL REFERENCE CARD. Program your 8080 CPU in easy Octal. Complete reference card with op codes, S-100 pin-outs, ASCII, \$1.25 postpaid. ThinkerToys, 1201-10th St., Berkeley, CA 94710.

FREE CATALOG. Solar Cells, Nicads, Kits, Calculators, Digital Watch Modules, Ultrasonics, Strobes, LEDs, Transistors, IC's, Unique Components. Chaney's, Box 27038, Denver, CO 80227.

SEEKING JAPANESE TRANSISTORS FOR CB REPAIR? Request list. Fuji-Svea Enterprises, Dept. P, Box 40325, Cincinnati, OH 45240.

PRINTED CIRCUIT BOARDS from artwork, magazine layouts. Fast service. OMEGA ENTERPRISES, Box 48239, Niles, Ill. 60648.

MICROCOMPUTER SYSTEMS. Troubleshooting Techniques-Digital Gate Decode Chart, both \$5.00. Micro Info Assoc., Box 849, Castroville, Calif. 95012. Calif. residents add 6% tax.

CLASSIFIED ADVERTISING ORDER FORM

1	2	3
4	5	6
7	8	9
10	11	12
13	14	15
16	17	18
19	20	21
22	23	24
25	26	27
28	29	30

PRINT NAME _____

ADDRESS _____

CITY _____

STATE _____

ZIP _____

SIGNATURE _____

PE-977

Please refer to heading on first page of this section for complete data concerning terms, frequency discounts, closing dates, etc. WORD COUNT: 15 WORD MINIMUM. Include name and address.

_____ Words

- \$2.25 (Commercial Rate)
- \$1.35 (Reader Rate)
- \$3.35 (Expand-Ad Rate)

Payment of \$ enclosed for _____ insertions.

AmEx BAC

MC Diners

CHARGE: for _____ insertions.

You will be billed monthly.

Account # _____

Expiration Date _____

Master Charge Interbank # (4 digits above name) _____

SIGNATURE MUST BE PROVIDED BELOW.

Toshiba Transistor Amplifier Module

XM-670

4.99
Reg. 6.99

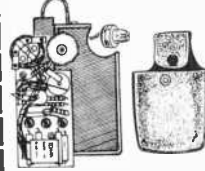

•Experimenters Delight

•100's of Uses •Some Marred & Soiled

BSR
METROTEC

Smoke & Fire

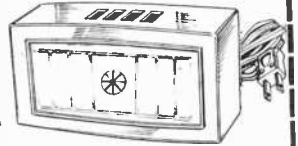

XM-646

Detector

14.99
Reg. 19.99

•Protect Your Family From Fire and Killer Gases
•117 VAC Powered

NICKEL CADMIUM "AA" Pen-Lite Cells

\$1 BA-341 Ea.

•1.2 Volt Rechargeable
•For Radios and Calculators Etc.



	Reg.	Now
AM Pushbutton Auto Radio-New, AU-580	10.99	9.99
Sonar 30-50 MHz (3-Ch.) plus AM std. Broadcast Pocket Receiver, RA-577	39.00	29.99
Sonar 150-174 MHz (3-Ch.) plus AM std. Broadcast Pocket Receiver, RA-422	39.00	29.99
Electronic Camera Shutter Assembly, XM-637		1.49
Singer 12 Digit MOS Calculator Chip with Data Sheet, XM-635	2.90	2.29
UHF Varactor Tuner, Data Incl., XM-676	1.99	1.49
Electronic "Choo-Choo" Module for Model Railroad, AM-549	1.99	.99
Siphon Pump-6 ft. Squeeze Type, XM-675	.59	.39
6 VDC to 12 VDC Converter, AU-297	16.00	7.00
4 Channel Converter for Car Stereo, HF-216	7.98	2.00
Timing Motor 1 Rev. Every 4 Hours 120 VAC., MO-407	1.69	.99
Telectron Digital Clock Movement, 1/4" Numerals, 117 VAC., 60 Hz. Removed from Equip., SW-853	5.99	4.99
2 1/4" 60 Ohm Speaker, SP-435	1.19	.69
AM-FM-MPX Receiver Chassis, Solid State 11-12 VAC Input. Tape Out Jacks, RA-574	9.99	7.99
Universal AC Adapter, 117 VAC Input, 6-7.5 and 9 VDC Output @ 300 Ma., BA-159	7.00	4.99

FREE CATALOG

Olson[®] electronics

260 S. FORGE ST.

DEPT. 13 AKRON, OHIO 44327

NAME _____

ADDRESS _____

CITY _____

STATE _____

ZIP _____

Send Olson Cat.

ENCLOSE POSTAGE AND SALES TAX
QTY. STK. # Description Price Total
Ea.

CIRCLE NO. 44 ON FREE INFORMATION CARD
SEPTEMBER 1977

MIND-ABSORBING PROJECTS FOR EXPERIMENTERS AND HOBBYISTS

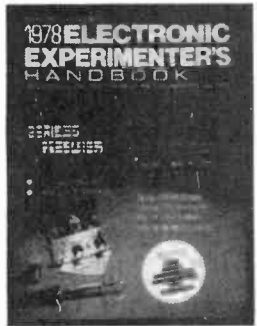

ELECTRONIC EXPERIMENTER'S HANDBOOK

Published each year by the editors of Popular Electronics, here's the one publication that helps you get it together... with a score of build-it-yourself projects.

The all-new 1978 edition goes on sale nationally October, 1977

It will again be packed with features and articles and complete lab-tested instructions that are sure to guarantee successful days and months of mind absorbing projects for fun and practicality.

**RESERVE
YOUR COPY NOW
AT THE
PRE-PUBLICATION
PRICE OF
ONLY \$1.50**

This offer is being made to readers of Popular Electronics only. Regular price is \$1.95; mail order \$2.50. Save money and enjoy the convenience of having the 1978 ELECTRONIC EXPERIMENTER'S HANDBOOK mailed to you from first-off-the-press copies when published. Complete the Reservation Form and return it promptly with your remittance.

PRE-PUBLICATION RESERVATION FORM

Electronics Experimenter's Handbook Consumer Service Division 595 Broadway, N.Y., N.Y. 10012 PE-977

Enclosed is \$1.50* (outside U.S.A. \$2) for my copy of the 1978 ELECTRONIC EXPERIMENTER'S HANDBOOK to be mailed to me in October, 1977 when published.

Print Name _____
Address _____
City _____
State _____ Zip _____

*Residents of CA, CO, FL, IL, MI, MO, NY STATE, DC and TX add applicable sales tax.

CARTVISION OWNERS! Sony Color Tuner/Modulator plugs into Cartvision. Record off channels not viewed. Record without TV on. Play into any TV without interfacing. \$250.00. (Specify channel 3/4). D.H.V., Inc., Box 12, Langhorne, Pennsylvania 19047.

ALL SOLID STATE DIGITAL OSCILLOSCOPE, digital memory dual trace, 1mV Dc-5MHZ, batt. operated, 2X2.5" display pocketsize, complete PLANS, PICTURES, parts list & sources \$15. Pictures-info \$1. SEECOM, Box 1274, Tustin, CA 92680.

ALL TOP QUALITY BRANDS COMPONENTS. No down payment. 36 hour delivery anywhere in U.S. No-Lemon Guarantee. Altec, Bose, Cerwin-Vega, DBX, Infinity, Lux, Micro-Acoustics, OHM, Phase-Linear, others. International Hi-Fi Distributors, Moravia Center Industrial Park, Balto., Maryland 21206. Phone: (301) 488-9600.

FREQUENCY LISTS: Shortwave and VHF-UHF. Military, Aviation, Satellite, Police, more. Sample \$2.00. Catalog 50 cents. HANDLER, Box 253, Deerfield, Illinois 60015.

HARDCOPY: Attachment converts most electric typewriters to microcomputer printout. Free Brochure. Stout Micro-computer, Box 1573, Fremont, CA 94538.

BOOKS AND MAGAZINES

ELECTRONICS DICTIONARY — 688 page industry standard reference filled with 18,000 up-to-date technical definitions and diagrams. Outstanding \$6.95 retail value for \$4.50 wholesale price (postage included). ANRI, P.O. Box 3727, Torrance, CA 90510.

TECHNICAL MANUALS — Ameco, Arri, Cowan, Giffler, Rider, RCA Radio Callbook, Sams, Tab, T.I. Postage 35 cents bk, ppd. Five. Madison Electronics, 1508 McKinney, Houston, Texas 77002.

FREE book prophet Elijah coming before Christ. Wonderful bible evidence. Megiddo Mission, Dept. 64, 481 Thurston Rd., Rochester, N.Y. 14619.

BURGLAR ALARMS

WHY WORRY about leaving car lights on? **EASILY INSTALLED ALARM** alerts, with pulsing tone. \$12.95. CFL Enterprises, P.O. Box 415, Export, PA 15632.

NEW SUPER SENSITIVE HOME/AUTO BURGLAR ALARM SYSTEM

Patented Electronic Perimeter Devices Easily Installed by Almost Anyone.

On guard against burglars by means of loud alarm triggered by break-in attempts. Almost uncanny the way it senses danger from unauthorized intruders. Requires NO switches, door cords, shunt locks, for traps or delays. So nearly wireless one small Control with sensors can protect up to 50 GLASS doors, windows, walls, Etc. using one single 28 gauge wire. Great opportunity for persons seeking professional protection at low cost. Send \$1.00 for Full details.

KING RESEARCH LABS, INC.

312/344-7877

801 South 11th Avenue, Maywood, IL 60153

PROTECTION! Build your own fire/burglar alarm. Complete plans. Send \$5.50 to: Triangle, Box 9244, Wichita, KS 67277.

Burglar. Smoke Fire Alarm Catalog

• Billions of dollars lost annually due to lack of protective warning alarms.

FREE CATALOG Shows you how to protect your home, business and person. Wholesale prices. Do-it-yourself. Free engineering service.

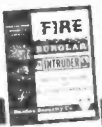

Burdex Security Co.

Box 82802 PE-097 Lincoln, Ne. 68501

EDI

VOICE ACTIVATED SOLID STATE SWITCH
Controls when activated and operates when activated in moment. Fully adjustable. Full 5 positions sensitivity adjustment.

Special **\$.88**
S-45

5CP1 OSCILLOSCOPE TUBE
Lumiled Quantity

- New Dumont 5CP1 Scope Tube
- Used In Many Older Test Bench Oscilloscopes
- Stock One Now In Your Oscilloscope Usage
- One

N-189 \$44.00 Value **4.88**

24-KEY DESK CALCULATOR KEYBOARD

- Teach-type contacts
- Complete in excel build
- Frame holds keys and 4 side switches
- 5 1/8" x 3 1/4" x 1 3/4"
- Highest point = 1 1/8" Lowest point = 1/8"
- Shipping wt 1 lb

E-206 **.99**

DIGITAL CLOCK MOVEMENT

- Form Strip Numerals 5 1/8 High
- Made By Shureco South, Mod #11P 408
- 120V AC 60Hz
- Size 4 3/8" W x 1 1/4" H x 3 D
- Shipping wt 1 lb

2.99

4-DIGIT TTL GENERAL CONTROL RESETTABLE COUNTER

- 120 Volt, 60-Hz
- Model #CE40AS402
- Minimum Make Time .050 Second.
- Break Time .050 Second
- Enclosed In Tamperproof Case
- Shipping Wt 1 Lb

N-98 **1.99** 3/16.50

2" PANEL METER 50-0-50 UA DC MICROAMMETER

- Wide View Panel Meters
- 2-3/8" x 1-13/16" Face
- Mounts In 1 1/2" Hole

F-20 **1.99**

4-RANGE DIGITAL READDOUT INTERVAL TIMER KIT

- 4 time functions: 1:00 Sec., 1:00 Sec., 1:00 Min., 1:00 Min.
- 1/2" High Nixie Tube Readouts
- For darkroom use in both processing & enlarging processes
- As a timer for sport & contest events (stop switch)
- Provides timed 120V AC outlet and SP. NO contact to trigger buzzer alarm or visual signals
- Full Wiring Instructions included — No Cabinet Or Case Available For Timer.

E-207 **100.00 VALUE** Accurate to 1/10 of 1% **19.99** **SPECIAL**

DYNAMIC DIGITAL TRANSISTOR CHECKER

Tests transistors in circuit or out of circuit. The Dynamic Transistor Checker lets you match transistors in working circuits to improve the operation. It will test: Go and No Go all currents from 5ma to 50ma, and will show current gain, electrical open and short circuits. Tests low, medium and high power transistors both PNP and NPN types. Complies with transistor socket test clips and leads. Uses VM2 or C19V battery. Size of case: 6 1/2" x 3 3/4" x 2"

E-144 **9.99**

DC POWER SUPPLY

The DC power supply will deliver four ranges of DC voltages 4.5V, 8V, 9V and 12V. It will supply a fully filtered output of one of these voltages at 150 milliamper capacity. Can be used for any DC power supply within the voltage range and capacity. Such as operating a small battery radio, operating a small calculator, or powering miscellaneous laboratory experiments. Uses standard 117V 60C AC power. Output binding posts accepts wire or banana plugs. With 4 1/2 Ft. cord and plug. Size of case: 5" x 2 1/2" x 1 1/2"

F-145 **15.88 Value** **5.99**

TRANSISTORIZED SIGNAL TRACER
EDI Special!!

This transistorized signal tracer can be used by technicians and service men to audibly trace signals of RF and F, and audio circuits from the antenna to the speaker stage by stage. An ideal tool for servicing audio equipment, amplifiers, tuners, receivers, turntables, etc. Has 2" speaker and test leads. Uses N556 9V transistor battery. Size of case: 5" x 2 1/2" x 1 1/2"

Was 17.88 **7.77**

22-RANGE BENCH STYLE MULTI-TESTER WITH DECIBEL SCALE

- Taut-Band Suspension Meter
- Extra Wide Two Color Mirrored Scale Assures Accurate Readings

SPECIFICATIONS:

Sensitivity: 30,000 Ohm Volt DC 10,000 Ohm Volt AC DC
Vols: 0.5 2.5 5 15 50 250 500 1,000 2,500 AC Volt 15 50 150 500 1,000 DC Current: 50ma 5ma 50ma 150ma 500ma 5 Amp Ohms: RX1 RX100 RX10K Desc: 20 to +62dB Size: 4 1/2" x 7" x 3 1/2"

Was 39.88 **F-496 26.88**

SEND FOR FREE CATALOG
with hundreds of electronic items

Minimum order \$10.00. All items are priced to sell. No handling charge. No tax. All items subject to change without notice. List price on order also has last price. Some items may be out of stock. Quantities and subject to price change.

EDI
Dept. PE1, 4900 Elston, Chicago, IL 60630 • Tel: 312-283-4800

CRYSTALS

THESE FREQUENCIES ONLY

Part #	Frequency	Case/Style	Price
CY1A	1.000 MHz	HC33 U	\$5.95
CY2A	2.000 MHz	HC33 U	\$5.95
CY2.01	2.010 MHz	HC33 U	\$1.95
CY5A	4.000 MHz	HC18 U	\$4.95
CY7A	5.000 MHz	HC18 U	\$4.95
CY12A	10.000 MHz	HC18 U	\$4.95
CY14A	14.31818 MHz	HC18 U	\$4.95
CY19A	18.000 MHz	HC18 U	\$4.95
CY22A	20.000 MHz	HC18 U	\$4.95
CY30B	32.000 MHz	HC18 U	\$4.95

XR-2206KB Kit \$29.95 Special XR-2206KA Kit \$19.95

WAVEFORM GENERATORS	XR-555CP	\$ 9.95	TIMERS	XR-320P	\$ 1.55
XR-205	XR-320P	1.55	XR-555CP	XR-555CP	1.85
XR-2206CP	XR-2206CP	3.20	MISCELLANEOUS	XR-2566C	3.20
XR-2207CP	XR-2207CP	3.25	XR-2211CP	XR-2240CP	3.25
STEREO DECODERS	XR-1136	99	PHASE LOCKED LOOPS	XR-210	5.20
XR-1310CP	XR-1458	3.85	XR-210	XR-215	6.60
XR-1310EP	XR-1458	3.80	XR-215	XR-567CP	1.95
XR-1800P	XR-1489	4.80	XR-567CP	XR-567CT	1.70
XR-2567	XR-2208	5.20	XR-567CT		

CONNECTORS

PRINTED CIRCUIT EDGE-CARD

156 Spacing-Tin-Double Read-Out

Biturcated Contacts — Fits .054 to .070 P.C. Cards		
15/30	PINS (Solder Eyelet)	\$1.95
18/36	PINS (Solder Eyelet)	\$2.49
22/44	PINS (Solder Eyelet)	\$2.95
50/100	PINS (Wire Wrap)	\$6.95
50/100A (1.100 Spacing)	PINS (Wire Wrap)	\$6.95

25 PIN-D SUBMINIATURE

DB25P	PLUG	\$3.25
DB25S	SOCKET	\$4.95

3 1/2 DIGIT DVM KIT

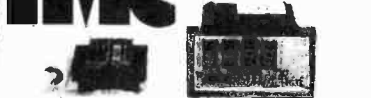

This 0-2 VDC, .05 per cent digital voltmeter features the Motorola 3 1/2 digit DVM chip set. It has a 4 LED display and operates from a single +5V power supply. The unit is provided complete with an injection molded black plastic case complete with Bezel. An optional power supply is available which fits into the same case as the 0-2V DVM allowing 117 VAC operation.

- A. 0-2V DVM with Case \$49.95
- B. 5V Power Supply \$14.95

Etching Kits

27 X A-1	P.C. Etch Materials Kit enough for 5 circuit boards	\$29.95 ea.
27 X A-1	Etched Circuit Kit Complete kit — only add water	\$ 9.95 ea.
3662	6.5 x 4.5 x 1/16 Epoxy glass P-Pattern-44 P.C. Tabs-spaced 156"	\$ 6.95 ea.
22/44	Mating connector for plugboard — 22 pin double readout	\$ 2.95 ea.
8800V	Universal Microcomputer/Processor plugboard — Epoxy Glass — complete with heatsink and mounting hardware 5.313 X 10 X 1/16 copper clad	\$19.95 ea.

1/16 VECTOR BOARD

Part No.	0.1" Hole Spacing	P-Pattern	W	L	Price	2 Up
PHENOLIC	64P42 062X4XP	4.50	6.50	1.75	1.54	
	169P42 024X4XP	4.50	17.00	1.69	3.22	
EPOLY GLASS	64P44 062	4.50	6.50	2.07	1.86	
	64P44 062	4.50	8.50	2.56	2.31	
	169P44 062	4.50	17.00	5.04	4.53	
	169P48 062	8.50	17.00	9.23	7.86	
EPOLY GLASS COPPER CLAD	169P44 062C1	4.50	17.00	6.80	6.12	

SLIT-N-WRAP WIRE WRAP TOOL

- Slits and opens insulation exposing bare wire
- No pre-cutting or pre-stripping.
- Comes complete with 2 - 100 ft spools #28 AWG wire

Model P180 \$24.50

HEXADECIMAL ENCODER 19-KEY PAD

• 1 - 0
• ABCDEF
• Return Key
• Optional Key (I/Period)
• — Key

\$10.95 each

63 KEY KEYBOARD

HD0165	16 LINE TO FOUR BIT PARALLEL KEYBOARD ENCODER	\$7.95
--------	---	--------

This keyboard features 63 unswitched SPST keys unattached to any kind of P.C.B. A very solid molded plastic 13" x 4" base suits most applications.

\$24.95

TOOLS

A97MS	Diagonal Cutter - 4" semi-flush cut	\$8.50 ea.
A110MS	Chain Nose Pliers - 4 1/2" long	7.50 ea.
T-6	Wire Stripper - #16 to #26 gauge	3.75 ea.
55B	Wire Stripper - #10 to #20 gauge	2.50 ea.
CS-8	Cutter-Crimper Tool - 8 1/4" long	8.50 ea.
Nibbling Tool	Cuts, Trims or Notches Metal up to #18 gauge	6.95 ea.
Nibbling Tool Replacement Punch		3.75 ea.

PERMACEL® P-29 PLUS Electrical Tape - All Weather
1-9 Rolls \$7.99 each 10-up Rolls \$6.95/10 roll package

MICROPROCESSOR COMPONENTS

8080A CPU	\$19.95	8228 System Controller - Bus Driver	\$10.95
8212 8 Bit Input/Output	4.95	MC6800L 8 Bit MPU	35.00
8214 Priority Interrupt Control	15.95	MC68020 Periph. Interface Adapter	15.00
8216 Bi-Directional Bus Driver	6.95	MC6810AP1 128 x 8 Static RAM	6.00
8224 Clock Generator/Driver	10.95	MC6830L8 1024 x 8 Bit ROM	18.00
CDP1802 - with user manual	39.95	Z80 CPU	49.95

CPU'S			RAM'S	
8080 Super 8080	24.95	1101 256 x 4	Static	\$ 1.49
8080A 8 Bit MPU	19.95	2101 256 x 4	Static	1.75
2650 8 Bit MPU	26.50	2102 1024 x 1	Static	4.95
2504 SR'S		2107-5280 -896 x 1	Dynamic	5.95
1024 Dynamic	\$ 3.95	2111 256 x 4	Static	6.95
2518 Hex 32 Bit	7.00	7-89 16 x 4	Static	1.39
2519 Hex 40 Bit	4.00	8101 256 x 4	Static	6.95
2524 512 Dynamic	2.49	8111 256 x 4	Static	6.95
2525 1024 Dynamic	6.00	8999 16 x 4	Static	1.39
2531 Dual 256 Bit	3.95	91102 1024 x 1	Static	6.25
2539 Dual 512 Bit	4.00	74200 256 x 1	Static	2.95
2532 Quad 80 Bit	3.95	93471 256 x 1	Static	2.95
2533 1024 Static	Special 5.95	MMS520 2K x 1	Dynamic	2 for 1.00
1341 Fds.	6.95	PROMS		
74LS670 16 x 4 Reg	3.45	11024 2048	FAMOS	\$ 9.95
		5301 2048	FAMOS	14.95
		82523 32 x 8	Open C	5.00
		825123 32 x 8	Tristate	5.00
		74S28 1024	Static	7.00
		3601 256 x 4	Fast	3.95
		12706 8K	Erprom	29.95
		6301-1 1024	In-State Bipolar	3.40
2513(21-40) Char Gen - upper case	\$ 9.95	6330-1 256	Open Collector Bipolar	2.95
2513(3021) Char Gen - lower case	9.95	6331-1 256	In-State Bipolar	2.95
2516 Char Gen	10.95			

SPECIAL REQUESTED ITEMS

ICM3817	5 5.00				
AY-3-8500-1	\$16.95			8197	2.00
MC3061P	3.50	CD4508	6.75	825115	25.00
MC4018P (174116)	7.50	CD4515	6.50	5841	9.95
MC14580	3.50	CD4520	2.70	MKS50240	17.50
MC14562	14.50	MCMS571	17.50	11130	19.95
CD4059	9.95	MCMS574	17.50	DS90DS08SCH	3.75
CD4070	9.95	MCMS575	17.50	14L308	10.50
MC14409	14.95	MC14419	14.95	ICM7208	22.00
MC14410	14.95	ICM7045	24.95	ICM7207	7.50
				HD0165	7.95

PARATRONICS

Featured on February's Front Cover of Popular Electronics

Logic Analyzer Kit **MODEL 100A** \$189.00/Kit

ALLOW 1 TO 3 WEEKS DELIVERY

Some applications are:

- Troubleshooting microprocessor address, instruction, and data flow
- Examine contents of ROMS
- Tracing operation of control logic
- Checking counter and shift register operation
- Monitoring I/O sequences
- Verifying proper system operations during testing

• Analyzes any type of digital system

• Checks data rates in excess of 8 million words per second

• Trouble shoot TTL, CMOS, DTL, RTL, Schottky and MOS families

• Displays 16 logic states up to 8 digits wide

• See ones and zeros displayed on your CRT, octal or hexadecimal format

• Tests circuits under actual operating conditions

• Easy to assemble — comes with step-by-step construction manual which includes 80 pages on logic analyzer operation.

TRIGGER EXPANDER — Model 10
Adds 16 additional bits — Connects direct to Model 100A (Optional baseplate permits mounting up to 100A for integrated units) (Baseplate — \$12.00) Model 10 — \$229.00

BUGBOOK

Continuing Education Series

BUGBOOK I & II - Basic concepts of TTL Logic — over 90 experiments	\$17.00/set
BUGBOOK IIa - Introduces UART — recommended for RTTY enthusiasts	\$5.00/book
BUGBOOK III - Explores 8080 chip — introduces Mark 80 Microcomputer	\$15.00/book
555 TIMER APPLICATIONS SOURCEBOOK WITH EXPERIMENTS — over 100 design techniques	\$6.95/book
CMOS-M-DESIGNERS PRIMER AND HANDBOOK a complete CMOS instruction manual	\$6.00

Introductory Offer — all 6 books (worth \$49.95) SPECIAL - \$42.95

CONTINENTAL SPECIALTIES

PROTO BOARD 6	Other CS Proto Boards	PROTO CLIPS
\$15.95	PB100 - 4.5" x 6" \$ 19.95	14 PIN \$4.50
(6" long X 4" wide)	PB101 - 5.8" x 4.5" 29.95	16 PIN 4.75
	PB102 - 7" x 4.5" 39.95	24 PIN 8.50
	PB103 - 9" x 6" 59.95	
	PB104 - 9.5" x 8" 79.95	DESIGN MATES
	PB203 - 9.75 x 6 1/2 x 2 1/4 75.00	DM1 - Circuit Designer 54.95
	PB203A - 9.75 x 6 1/2 x 2 1/4 120.00 (includes power supply)	DM2 - Function Generator 69.95
MAX-100 Frequency Counter 20 MHz-100MHz — 8 digit — 6 LED Available September 15, 1977 \$134.35	Logic Monitor \$84.95 for DTL TTL or CMOS Devices	DM3 - RC Bridge 59.95

QT PROTO STRIPS

01-595	01-185	01-355	01-75
01-596	01-186	01-356	01-76
01-475	01-126	01-476	01-85
01-478	01-125	01-477	01-86
01-479	01-85	01-480	01-87
01-481	01-86	01-482	01-88
01-483	01-87	01-484	01-89
01-485	01-88	01-486	01-90
01-487	01-89	01-488	01-91
01-489	01-90	01-490	01-92
01-491	01-91	01-492	01-93
01-493	01-92	01-494	01-94
01-495	01-93	01-496	01-95
01-497	01-94	01-498	01-96
01-499	01-95	01-500	01-97

\$5.00 Minimum Order — U.S. Funds Only California Residents — Add 6% Sales Tax Spec Sheets - 25¢ — Send 35¢ Stamp for 1977A Catalog Dealer Information Available

NOW OPEN SATURDAYS

James ELECTRONICS

1021-A HOWARD AVE., SAN CARLOS, CA. 94070
PHONE ORDERS WELCOME — (415) 592-8097
All Advertisers Prices Good Thru September

Timeband

Trademark of Fitch Camera and Instrument Corporation

Digital Alarm Clocks

C-500 - Ivory Case \$16.95
C-500B - Ebony Case \$16.95

- 24 hour alarm
- Date Button
- 100% Solid State
- Large Red LED Display (8 night)
- AM/PM Indicator
- Seconds display at touch of button
- Power failure indicator
- One year factory warranty

C-8211 Woodgrain Case \$19.95

Timeband LAMP CLOCK

Model C-590 (Ivory) \$29.95

- 24 hour alarm
- Doze button
- Alarm-on indicator
- 8" high Red LED Display
- AM/PM Indicator
- High intensity lamp
- Lamp shuts off when collapsed

DIGITAL AUTO INSTRUMENTS

SEVEN DIFFERENT INSTRUMENTS! MEETS OR EXCEEDS ORIGINAL AUTOMOTIVE SPECS

Please specify which one of the seven models you want when ordering — these do not all come in one unit. Each model must be bought separately.

1 TACHOMETER 10-9900 RPM 4, 6 or 8 Cylinders \$16.95

2 WATER TEMP 100-250°F \$16.95

3 FUEL LEVEL Percentage Low Fuel Indicator \$16.95

4 SPEEDOMETER 0-99 MPH \$16.95

5 OIL PRESSURE 0-80 PSI \$16.95

6 OIL TEMP 200-350°F \$16.95

7 BATTERY MONITOR ±1 Volts From 11-15 VDC \$16.95

BRIGHT YELLOW ORANGE 3" LED DISPLAY

Kit includes case, bracket and all components — complete. Nothing else to buy! 12 Volt NEG GND. DIMENSIONS 4 1/2" x 4" x 2" KIT: \$49.95 ASSEMBLED: \$59.95

DIGITAL STOPWATCH

- Bright 6 Digit LED Display
- Times to 59 minutes 59.99 seconds
- Crystal Controlled Time Base
- Three Stopwatches on One
- Times Single Event — Split & Taylor
- Size 5" x 2 1/2" x 90" (4 1/2" overlay)
- Uses 3 Penic Cells

Kit — \$39.95
Assembled — \$49.95
Heavy Duty Carry Case \$5.95

Stop Watch Chip Only (7205) \$19.95

QUARTZ DIGITAL AUTO CLOCK OR ELAPSED TIMER!

Elapsed Timer: Hrs, Mins and Secs 12 or 24 Hr Capacity Simple Reset - Start Pushbutton Control

Complete kit includes mounting bracket, case and all components, nothing else to buy. Features MM5314 chip. Large 4 LED's. Accuracy better than ± min per mo. internal battery backup 12 volt non-polar operation.

DIMENSIONS 4 1/2" x 4" x 2" 12 or 24 HOUR MODE

Kit: \$29.95
Assembled: \$39.95

CASE ONLY (includes hardware, mounting bracket and bezel) \$6.50

JE700 CLOCK

The JE700 is a low cost digital clock, but is a very high quality unit. The unit features a simulated walnut case with dimensions of 6 x 2 1/2 x 1". It utilizes a MANT7 high brightness readout, and the MM5314 clock chip.

12 or 24 Hour 115 VAC \$17.95

DIGITAL CLOCK KIT — 3 1/2" INCH DIGITS

4 DIGIT KIT \$49.95	4 DIGIT ASSEMBLED \$59.95
6 DIGIT KIT \$69.95	6 DIGIT ASSEMBLED \$79.95

This clock features big 3 1/2" high digits for viewing in offices, auditoriums, etc. Each digit is formed by 31 bright 0.2" LED's. The clock operates from 117 VAC, has either 12 or 24 hr. operation. The 6 digit version is 27" x 3 1/2" x 1 1/2" and the 4 digit is 18" x 3 1/2" x 1 1/2". Kits come complete with all components, case and transformer.

Specify 12 or 24 Hour When Ordering

JE803 PROBE

The Logic Probe is a unit which is for the most part indispensable in trouble shooting logic systems. TTL, DTL, RTL, CMOS. It detects the power it needs to operate directly off of the circuit under test, drawing a scant 10 mA max. It uses a MAND readout to indicate any of the following states by these symbols: H (1 LOW), 0 (PULSE), P (The Probe can detect high frequency pulses up to 5 MHz. It can be used at MOS levels or circuit damage will result)

\$9.95 Per Kit printed circuit board

TL 5V 1A Supply

This is a standard TTL power supply using the well known LM309K regulator IC to provide a solid 1 AMP of current at 5 volts. We try to make things easy for you by providing everything

7400N TTL

SN7400N	16	SN7459A	25	SN74154N	1.00
SN7401N	16	SN7460N	22	SN74155N	1.00
SN7402N	21	SN7470N	45	SN74156N	1.00
SN7403N	16	SN7472N	39	SN74157N	99
SN7404N	18	SN7473N	37	SN74158N	99
SN7405N	24	SN7474N	32	SN74160N	1.25
SN7406N	20	SN7475N	56	SN74161N	99
SN7407N	29	SN7476N	32	SN74163N	99
SN7408N	25	SN7479N	5.00	SN74164N	1.10
SN7409N	25	SN7480N	5.00	SN74165N	1.10
SN7410N	18	SN7482N	98	SN74166N	1.25
SN7411N	30	SN7483N	2.49	SN74167N	99
SN7412N	33	SN7485N	9.00	SN74170N	2.10
SN7413N	45	SN7486N	39	SN74172N	8.50
SN7414N	70	SN7488N	3.50	SN74173N	1.95
SN7415N	35	SN7489N	3.50	SN74174N	1.25
SN7416N	35	SN7490N	45	SN74175N	99
SN7420N	21	SN7491N	75	SN74176N	90
SN7421N	33	SN7492N	49	SN74177N	90
SN7422N	49	SN7493N	49	SN74180N	99
SN7423N	37	SN7494N	79	SN74181N	2.49
SN7425N	29	SN7495N	79	SN74182N	99
SN7426N	29	SN7496N	89	SN74184N	1.95
SN7427N	37	SN7497N	4.00	SN74185A	2.20
SN7429N	42	SN74100N	1.00	SN74186N	15.00
SN7430N	37	SN74107N	3.00	SN74187N	1.00
SN7432N	31	SN74121N	39	SN74188N	3.99
SN7437N	27	SN74122N	39	SN74189N	1.15
SN7438N	27	SN74123N	5.00	SN74191N	1.25
SN7439N	25	SN74125N	5.00	SN74192N	8.95
SN7440N	15	SN74126N	3.00	SN74193N	6.00
SN7441N	89	SN74132N	1.09	SN74194N	1.25
SN7442N	59	SN74136N	95	SN74195N	7.5
SN7443N	75	SN74141N	1.15	SN74196N	1.25
SN7444N	75	SN74142N	4.00	SN74197N	7.5
SN7445N	75	SN74143N	4.50	SN74198N	1.75
SN7446N	81	SN74144N	4.50	SN74199N	1.75
SN7447N	69	SN74145N	1.15	SN74200N	5.59
SN7448N	79	SN74147N	2.35	SN74229N	5.00
SN7449N	26	SN74148N	2.00	SN74231N	1.75
SN7451N	20	SN74150N	1.00	SN74232N	1.00
SN7453N	27	SN74151N	7.9	SN74255N	6.00
SN7454N	20	SN74153N	8.9	SN74267N	7.5

Many others available on request
20% Discount for 100 Combined 7400's

CMOS

CD4000	25	CD4030	65	74C24N	75
CD4001	25	CD4031	65	74C10N	65
CD4002	25	CD4032	1.45	74C20N	65
CD4006	2.50	CD4040	2.85	74C30N	65
CD4007	2.50	CD4041	1.90	74C42N	1.15
CD4009	59	CD4044	1.50	74C73N	1.50
CD4010	59	CD4046	2.51	74C74	2.15
CD4011	25	CD4047	2.75	74C80N	3.00
CD4012	25	CD4049	7.9	74C95N	2.00
CD4013	47	CD4050	1.79	74C107N	1.25
CD4016	56	CD4051	2.95	74C151	2.90
CD4017	1.35	CD4052	2.95	74C154	4.00
CD4019	55	CD4060	3.25	74C157	2.15
CD4020	1.49	CD4066	1.75	74C160	2.25
CD4022	1.24	CD4069	1.15	74C161	65
CD4023	25	CD4071	45	74C163	3.00
CD4024	1.50	CD4081	45	74C164	3.25
CD4025	25	CD4111	2.50	74C173	2.60
CD4026	\$3.99	CD4501	2.50	74C231	2.75
CD4027	69	MC14568	3.00	74C195	2.75
CD4028	1.65	74C00N	39	MC1404	4.50
CD4029	2.90	74C02N	55	MC14016	5.00

LINEAR

LM300H	80	LM325N	1.55
LM301H	35	LM314N	1.75
LM301CN	35	78V05	1.75
LM302H	75	LM309N	1.15
LM303H	1.00	LM373N	2.25
LM303CN	95	LM377N	4.00
LM305H	35	LM380N	1.39
LM305CN	1.00	LM390N	2.95
LM309H	1.00	LM393N	5.00
LM309CN	1.10	LM392N	1.79
LM309K	99	NE501K	6.00
LM310CN	1.15	NE510A	8.00
LM311H	90	MC555N	1.00
LM311N	90	NE536T	6.00
LM318CN	1.50	NE540L	6.00
LM319N	1.30	NE550N	7.99
LM320K-5	1.35	LM350V	49
LM320K-12	1.35	NE561B	5.00
LM320K-15	1.35	NE562B	5.00
LM320T-5	1.75	NE565A	1.25
LM320T-12	1.75	NE565N	1.75
LM320T-15	1.75	NE565CN	1.25
LM320T-12	1.75	NE567N	1.50
LM320T-15	1.75	NE567V	1.50
LM320T-18	1.75	LM320N	1.15
LM320T-24	1.75	LM709N	29
LM323K-5	9.95	LM709N	29
LM324N	1.80	LM710N	79
LM329N	1.70	LM711N	39
LM340K-5	1.85	LM723N	3.50
LM340K-8	1.95	LM723N	3.50
LM340K-12	1.95	LM729N	1.00
LM340K-15	1.95	LM731N	2.50
LM340K-18	1.95	LM731CN	3.00
LM340K-24	1.95	LM741-14N	39
LM340T-5	1.75	LM747N	79
LM340T-8	1.75	LM747N	79
LM340T-12	1.75	LM748N	39
LM340T-15	1.75	LM303N	39
LM340T-18	1.75	LM304N	1.19
LM350N	1.00	LM1307N	85
LM351CN	65	LM1307N	2.95

74LS00 TTL

74LS00	29	74LS159	1.95
74LS02	29	74LS151	1.55
74LS03	29	74LS152	1.89
74LS04	35	74LS157	1.55
74LS05	35	74LS162	2.25
74LS06	29	74LS163	2.25
74LS10	29	74LS164	1.95
74LS13	69	74LS170	1.95
74LS15	1.75	74LS181	1.25
74LS20	29	74LS192	2.85
74LS26	39	74LS199	2.85
74LS27	39	74LS199	2.85
74LS30	29	74LS199	1.89
74LS32	39	74LS199	1.89
74LS40	39	74LS199	1.89
74LS41	29	74LS199	1.89
74LS53	29	74LS199	1.89
74LS54	29	74LS199	1.89
74LS55	29	74LS199	1.89
74LS73	49	74LS199	1.89

CLOCK CHIPS

MM5309	6 Digit, BCD Outputs, Reset Pin	\$9.95
MM5311	6 Digit, BCD Outputs, 12 or 24 Hour	4.95
MM5312	4 Digit, BCD Outputs, 1 PPS Output	4.95
MM5314	6 Digit, 12 or 24 Hour, 50 or 60 Hz	4.95
MM5316	6 Digit, Alarm, 1 PPS Output	6.95
MM5318	Video Clock Chip, For Use With MM5341	9.95
CT7001	6 Digit, Calendar, Alarm, 12 or 24 Hour	5.95

DATA HANDBOOKS
7400 Pin-out & Description of 5400/7400 ICS \$2.95
CMOS Pin-out & Description of 4000 Series ICS \$2.95
Linear Pin-out & Functional Description \$2.95
ALL THREE HANDBOOKS \$6.95

Timeband by FAIRCHILD

— Watches —
Men's & Ladies

- Solid State
- Displays hour, minute, second, month & day
- Free set of replacement batteries
- Choose LED or LCD styles
- One year factory warranty

T249 White w/bracelet \$19.95
T248 Yellow w/bracelet \$22.95
LED

T237 White w/bracelet \$29.95
T236 Yellow w/bracelet \$25.95
LED

TC625 White w/strap \$28.95
TC624 Yellow w/strap \$34.95
LCD

Ladies LCD
LADIES LED

CHANNEL F

FAIRCHILD VIDEO ENTERTAINMENT SYSTEM

- Freeze Action • Speed Option
- Automatic time and scorekeeping
- Battery-free AC operation
- Dual controls w/8-way action
- Built-in Pro Hockey and Tennis games
- Easy hook-up on any B/W or Color TV
- Factory warranty

Channel F — Additional cartridges — \$17.95 ea.

0811 — Tic-Tac-Toe/Shooting Gallery
0812 — Quad-doodle/Doodle
0813 — Backjack (1 or 2 players)
0814 — Spiffire (1 or 2 players)
0815 — Spacerw (2 players)
0816 — Desert Fox/Shooting Gallery
0817 — Magic Numbers (computer logic)
0818 — Spiffire (1 or 2 players)
0819 — Drag strip (1 or 2 players)
0820 — Maze (2 players)
0821 — Baseball (2 players)

DISCRETE LEADS

XC209	Red	10S1	XC211	Red	10S1
XC209	Green	4S1	XC211	Green	1S1
XC209	Orange	4S1	XC211	Yellow	4S1
XC209	Yellow	4S1	XC211	Orange	4S1

200' dia. 085' dia.

KC22	Red	10S1	XC526	Red	4S1
KC22	Green	4S1	XC526	Green	4S1
KC22	Yellow	4S1	XC526	Yellow	4S1
KC22	Orange	4S1	XC526	Orange	4S1
SSL-22	RT	4S1	XC526	Clear	7S1

UL338

DISPLAY LEADS

MAN 1	Common Anode	270	2.95	MAN 3640	Common Cathode orange	300	1.75
MAN 2	5 - 7 Dot Matrix	300	4.95	MAN 4710	Common Anode-Red	400	1.95
MAN 3	Common Cathode	125	3.10	DL701	Common Anode-red	300	99
MAN 4	Common Cathode	187	1.95	OL704	Common Cathode	300	99
MAN 5	Common Anode	300	1.75	DL707	Common Anode	300	99
MAN 7G	Common Anode-green	300	1.95	MAN 47-0	Common Anode-Red	400	99
MAN 7Y	Common Anode-yellow	300	1.95	DL741	Common Anode	600	1.50
MAN 12	Common Anode-green	300	99	DL742	Common Anode	600	2.25
MAN 64	Common Anode-red	400	99	DL750	Common Cathode	600	2.49
MAN 74	Common Cathode	300	1.50	DL 338	Common Cathode	110	50
MAN 82	Common Anode-yellow	300	99	FND70	Common Cathode	250	75
MAN 84	Common Cathode-yellow	300	99	FND503	Common Cathode	500	1.00
MAN 3620	Common Anode	300	1.75	FND507	Common Anode	560	1.00

FCS 8000A — 3 1/2 Digit — .8" Display

NEW! 25 Pin Version with color & amp/m indicator

- Connects almost one for one with 381T, 3817A or D (3817 available at \$5.00 each)
- Typical segment current 8mA except colon, 10 hrs b & c and 10 mA, a & d which are 15 mA
- Forward voltage drop: 1.5 volts

HP 5082-7300 Series — Multi-Digit

- 1/2" Ht. • Common Cathode • Dip Package
- 3 to 5 volts @ 5 mls per segment
- 7 segment Monolithic • Red Display

2 Digit \$.79
3 Digit \$.89
4 Digit \$.99
5 Digit \$ 1.19

IC SOLDERTAIL — LOW PROFILE (TIN) SOCKETS

8 pin	1-24	25-49	50-100	24 pin	1-24	25-49	50-100
14 pin	1-17	18-31	32-63	28 pin	1-17	18-31	32-63
16 pin	1-19	20-33	34-67	36 pin	1-19	20-33	34-67
18 pin	1-21	22-35	36-69	40 pin	1-21	22-35	36-69
22 pin	1-27	28-41	42-83				

SOLDERTAIL STANDARD (TIN)

14 pin	5-27	25	24	28 pin	5-27	25	24
16 pin	30	27	25	36 pin	1-17	18	15
18 pin	25	32	40	40 pin	1-19	15	15
24 pin	49	45	42				

SOLDERTAIL STANDARD (GOLD)

8 pin	5-30	27	24	24 pin	5-27	25	24
14 pin	35	32	29	28 pin	1-17	18	15
16 pin	38	35	32	36 pin	1-17	14	26
18 pin	52	41	41	40 pin	1-19	15	15

WIRE WRAP SOCKETS (GOLD) LEVEL #3

10 pin	5-45	41	37	24 pin	1-17	15	95
16 pin	43	42	41	28 pin	1-14	125	130
18 pin	75	68	62	36 pin	1-19	145	130
				40 pin	1-175	155	40

50 PCS. RESISTOR ASSORTMENTS \$1.25 PER ASST.

ASST. 1 5 ea. 27 OHM 33 OHM 39 OHM 47 OHM 56 OHM 1/4 WATT 5% 50 PCS

ASST. 2 5 ea. 68 OHM 82 OHM 100 OHM 120 OHM 150 OHM 1/4 WATT 5% 50 PCS

ASST. 3 5 ea. 1.2K 1.5K 1.8K 2.2K 2.7K 1/4 WATT 5% 50 PCS

ASST. 4 5 ea. 2K 3K 3.9K 4.7K 5.6K 6.8K 1/4 WATT 5% 50 PCS

ASST. 5 5 ea. 56K 68K 82K 100K 120K 1/4 WATT 5% 50 PCS

ASST. 6 5 ea. 390K 470K 560K 680K 820K 1/4 WATT 5% 50 PCS

ASST. 7 5 ea. 2.7M 3.3M 3.9M 4.7M 5.6M 1/4 WATT 5% 50 PCS

ASST. 8R Includes Resistor Assortments 1-7 (350 PCS.) \$7.49 ea.

\$5.00 Minimum Order — U.S. Funds Only
California Residents — Add 6% Sales Tax

Spec Sheets — 25c — Send 35c Stamp for 1977A Catalog
Dealer Information Available

James Electronics

1021-A HOWARD AVE., SAN CARLOS, CA. 94070
PHONE ORDERS WELCOME — (415) 592-8097
All Advertised Prices Good Thru September

WIRE WRAP CENTER

HOBBY-WRAP TOOL-BW-630

- Battery Operated (Size C)
- Weighs ONLY 11 Ounces
- Wraps 30 AWG Wire onto Standard DIP Sockets (.025 inch)
- Complete with built-in bit and sleeve

\$34.95 (batteries not included)

WIRE-WRAP KIT — WK-2-W
WRAP • STRIP • UNWRAP

- Tool for 30 AWG Wire
- Roll of 50 Ft. White or Blue 30 AWG Wire
- 30 pcs. each 1", 2", 3" & 4" lengths — pre-stripped wire.

\$11.95

WIRE WRAP TOOL WSU-30
WRAP • STRIP • UNWRAP — \$5.95

WIRE WRAP WIRE — 30 AWG
25 ft. min. \$1.25 50 ft. \$1.95 100 ft. \$2.95 1000 ft. \$15.00
SPECIFY COLOR — White - Yellow - Red - Green - Blue - Black

WIRE DISPENSER — WD-30
• 50 ft. roll 30 AWG KYNAR wire wrap wire \$3.45 ea.
• Cuts wire to desired length
• Strips 1" of insulation Specify — Blue-Yellow-White-Red

HEAT SINKS

205-418 680-75A

205-CB Beryllium Copper w/Black finish for TO-5 \$ 25
291

PLANNING TO MOVE?

Let us know 8 weeks in advance so that you won't miss a single issue of **POPULAR ELECTRONICS**.

Attach old label where indicated and print new address in space provided. Also include your mailing label whenever you write concerning your subscription. It helps us serve you promptly.

Write to: P.O. Box 2774, Boulder, CO 80322 giving the following information:

Change address only Extend my subscription

ENTER NEW SUBSCRIPTION

1 year \$12.00 Payment enclosed (1 extra BONUS issue)
Allow 30-60 days for delivery. Bill me later

AFFIX OLD LABEL

If you have no label handy, print OLD address here.

Name _____ please print

Address _____

City _____

State _____ Zip _____

NEW ADDRESS HERE 0210

Name _____ please print

Address _____ Apt. _____

City _____

State _____ Zip _____

Additional postage on foreign orders: add \$3 a year for Canada, \$5 a year for all other countries outside the U.S. and its possessions. Cash only on foreign orders, payable in U.S. currency.

PLANS AND KITS

AMAZING ELECTRONIC PRODUCTS

LASERS SUPER POWERED, RIFLE, PISTOL, POCKET SEE IN DARK • PYRO-TECHNICAL DE-BUGGING • UNCRAMBLERS • GIANT TESLA • STURWARD • TV DISRUPTER • ENERGY PRODUCING, SCIENTIFIC DETECTION, ELECTRIFYING, CHEMICAL, ULTRASONIC, CB, AERO, AUTO AND MECH DEVICES, HUNDREDS MORE • ALL NEW PLUS INFO UNLIMITED PARTS SERVICE

INFORMATION unlimited
CATALOG #1 Box 626 Lord Jeffery PZ • Amherst, N.H. 03001

FREE KIT Catalog contains Test and Experimenter's Equipment. Dage Scientific Instruments, Box 1054P, Livermore, CA 94550.



TIGER SST
SIMPLI-KIT

FOR THE DO-IT-YOURSELFER

NOW! a high quality CD Electronic Ignition System in kit form.

Contains all components and solder to build complete Solid-State Electronic CD Ignition System for your car. Assembly requires less than 3 hours.

- Increases MPG 15%
- Eliminates 4 of 5 tune-ups
- Increases horsepower 15%
- Instant starting, any weather
- Plugs and Points last 50,000 miles
- Dual system switch

Fits only 12 volt neg. ground... Only \$21.95 postpaid

Tri-Star Corporation
P.O. Box 1727 Grand Junction, Colorado 81501

POCKET COLOR/BAR GENERATOR kit, 16 patterns, \$49.95. Plans, \$4.95. Workshop, Box 393PE, Bethpage, New York 11714.

SCA-ADAPTER kit for FM radio. See Poptronics October 1974. For experienced builders. \$13.50 postpaid. Communications Poly Services, Box 3251C, Westford, Mass. 01886.

SMOKE/GAS ALARM Kit, with plug-in transformer, \$19.95. Romar Systems, 85-76th Street, Brooklyn, New York 11209.

THE "KING OF KITS": Artisan Organ Kits feature all new modular construction, with logic-controlled stops and RAM Preset Memory System. Write for brochure to: AOK Manufacturing, Inc., P.O. Box 445, Kenmore, WA 98028.

FREQUENCY COUNTER: 30/300 MHz, miniportable 2"x4"x4-1/2", 7 digit, .0001% accuracy, internal batteries/external 8-15 vdc. Construction plans, \$5.00 — Complete kit, \$119.95 — Wired and tested, \$149.95. Wilson Products, Box 5516-AI, Walnut Creek, CA 94596.

HIGH FIDELITY

DIAMOND NEEDLES and Stereo Cartridges at Discount prices for Shure, Pickering, Stanton, Empire, Grado and ADC. Send for free catalog. LYLE CARTRIDGES, Dept. P, Box 69, Kensington Station, Brooklyn, New York 11218.

TUBES

RADIO & T.V. Tubes—36 cents each. Send for free Catalog. Cornell, 4213 University, San Diego, Calif. 92105.

TUBES receiving, factory boxed, low prices, free price list. Translateronic, Inc., 1365 39th Street, Brooklyn, N.Y. 11218A, Telephone: 212-633-2800.

TUBES: "Oldies", Latest Supplies, components, schematics. Catalog Free (stamp appreciated). Steinmetz, 7519-PE Maplewood, Hammond, Ind. 46324.

HYPNOTISM

SLEEP learning. Hypnotic method. 92% effective. Details free. ASR Foundation, Box 23429EG, Fort Lauderdale, Florida 33307.

FREE Hypnotism. Self-Hypnosis. Sleep Learning Catalog! Drawer H400, Ruidoso, New Mexico 88345.

AMAZING self-hypnosis record releases fantastic mental power. Instant results! Free trial. Write: Forum (AAR), 333 North Michigan, Chicago 60601.

INTERNATIONAL ELECTRONICS UNLIMITED

10% OFF WITH \$25 ORDER
15% OFF WITH \$100 ORDER
THESE DISCOUNTS APPLY TO TOTAL OF ORDER — SPECIALS INCLUDED

LED DISPLAYS

DL10A	RED CA. 27" LHD	\$1.8A
DL 707	RED CA. 30" RHD	1.40
DL 507	RED CA. 30" RHD	1.40
FND 98B	RED CC. 35" RHD	1.80
DL 702	RED CC. 30" LHD	1.30
HBN 74R	RED CC. 30" RHD	1.40
DL 500	RED CC. 30" RHD	1.40
MAN3	GREEN CA. 27" LHD	1.30
MAN8	YELLOW CA. 27" LHD	1.30
MAN2	YELLOW CA. 3" LHD	2.10
MAN6	RED CA. 6" LHD	2.10
DL747	RED CA. 4" LHD	2.30

LINEAR CIRCUITS

300	\$ 7.71	373	2.42	723	.62
301	.29	376	.68	733	.89
304	.80	380	1.30	739	1.07
305	.71	380-8	1.25	741	.32
307	.26	382	1.75	747	.71
308	.89	381	1.75	748	.35
309K	1.35	382	1.75	758	.62
310	1.07	350	2.95	3900	.49
311	.95	550	.79	3900	.49
319	1.13	555	4.5	7524	.71
1207	1.29	556A	1.19	7525	.90
1206	1.39	560	3.39	8038	4.25
122	1.70	562	3.39	8064	2.25
324	1.52	565	1.18	75150	1.75
339	1.58	567	1.95	75452	.35
340K	1.69	709	.26	75453	.35
3407	1.49	710	.35	75491	.71
372	2.93	711	.26	75492	.80

SPECIAL DEVICES

372	AF-IF Strip Detector DIB	2.93
546	AM Radio Receiver Subsystem	.75
1310	FM Stereo Demodulator DIP	2.90
1496	Balanced Modulator-Demodulator	.99
1800	Stereo multiplexer DIP	2.48
ULN288	FM Gain Block 34db (typ) mDIP	1.18
ULN2209	FM Gain Block 48db (typ) mDIP	1.35
2513	Character Generator 64x8x5 DIP-24	10.20
3096	Transistor Array DIP-14	.73

TTL

7400	.13	7451	.17	74153	.89
7401	.16	7453	.17	74154	1.20
7402	.15	7454	.17	74155	.97
7403	.15	7461	.17	74156	.97
7404	.16	7464	.35	74157	.99
7405	.19	7465	.35	74158	.79
7406	.26	7470	.30	74160	1.23
7407	.28	7472	.30	74161	.97
7408	.29	7473	.35	74162	1.39
7409	.19	7474	.28	74163	1.09
7410	.16	7475	.49	74164	.99
7411	.25	7476	.30	74165	.99
7412	.43	7481	.68	74170	2.10
7414	.65	7485	.88	74173	1.49
7416	.35	7486	.40	74174	1.23
7417	.35	7489	2.25	74174	1.49
7420	.16	7490	.43	74175	.97
7422	.30	7491	.75	74176	.89
7423	.29	7492	.48	74171	.84
7425	.27	7493	.48	74180	.90
7426	.26	7494	.78	74181	2.45
7427	.29	7495	.79	74182	.79
7430	.20	7496	.77	74184	1.90
7432	.23	74100	.80	74185	2.20
7437	.25	74105	.64	74187	5.75
7438	.25	74107	.37	74190	1.15
7440	.15	74121	.38	74191	1.25
7441	.89	74122	.38	74192	.95
7442	.59	74123	.65	74193	.85
7443	.73	74125	.54	74194	1.25
7444	.73	74126	.58	74195	.74
7445	.73	74127	.89	74196	1.25
7446	.81	74141	1.04	74197	.73
7447	.79	74145	1.04	74198	1.73
7448	.79	74150	.97	74199	1.69
7450	.17	74151	.79	74200	5.45

IC SOCKETS

Solder Tail - low profile

8 pin	\$.17	24 pin	.42
14 pin	.20	28 pin	.59
16 pin	.22	40 pin	.69
18 pin	.29		

Date sheets on request. Add 30¢ each if item is priced below \$1.00 each.

MEMORIES

1101	\$.69
1103	.69
1702A	5.95
5262	.99
74S200	3.25
82S23	2.75
93410	1.39

SPECIALS

301	mDIP	.19
723	.49	
733	TO-5	.59
380-8	mDIP	1.09
565	1.49	
739	.89	
75491	mDIP	.59
75150	.99	

7410 Triple 3 input NAND gate .12
7438 Quad 2 input NAND buffer (o.c.) .17
7442 BCD to decimal decoder .39
7453 Exp. AND-OR-INVERT gate .35
7474 Dual D flip-flop .19
7493 4 Bit binary counter .29
74121 One shot .29
74153 Dual four-input multiplexer .69

2708 \$16.95
1 x 8K EROM

4 Digit Clock Kit

M45312 and 4 N571 27" displays 12-24 hours, 50-60 Hz. One P.C. board accommodates clock, displays, and all necessary transistors, resistors, capacitors, diodes, 2 switches, complete instructions and schematics for assembly.

CK4-2 \$10.95

M55369 Divider mDIP

Crystal 3.58 MHz color TV \$2.35
\$1.50

CARBON FILM RESISTORS ±5%

ALL STANDARD VALUES

QTY.	PRICE (each)	PRICE (Minimum 10 per value)
0-10	\$.10 ea	
10-100	\$.10 ea	\$.05 ea
100-1000		\$.04 ea

Transformer

117 VAC - 12V 300 ma wall mount \$4.95

UART

AYS1013A \$6.95

CENTRAL PROCESSING UNIT

8008 \$16.95
8080A \$16.95

METAL FILM RESISTORS

ALL STANDARD VALUES ± 1% ¼ WATT

QTY	PRICE (each)	PRICE (MINIMUM 10 PER VALUE)	PRICE (MINIMUM 100 PER VALUE)
0 - 10	\$.20		
10 - 100	\$.20	\$.15	
100 - 1000		.10	\$.09
1000 -		.10	.08

MM 5330

4 1/2 DIGIT DVM LOGIC \$6.95

LH 0070

BCD BUFFERED REF. \$6.95

MM 5616

QUAD BI-LATERAL SWITCH \$1.25

TANTALUM CAPACITORS

Solid dipped +20%

.1 mid	35V	\$.25	10 mid	16V	\$.40
.33 mid	35V	.25	10 mid	25V	.45
1 mid	35V	.25	15 mid	10V	.45
2.2 mid	20V	.25	15 mid	20V	.45
2.2 mid	35V	.30	22 mid	16V	.45
3.3 mid	35V	.30	33 mid	10V	.40
4.7 mid	16V	.30	47 mid	6V	.40
6.8 mid	6V	.30	56 mid	6V	.45
6.8 mid	50V	.40	150 mid	15V	.50

RESISTOR KIT

1/4 WATT 04255
1/2 WATT 04505
2200 resistors 44 values
supplied in a 15 drawer
60 compartment storage
cabinet - table or wall
mount Ready to use

~~\$79.95~~ ea \$59.00
SHIPPING CHG \$2.00

RESISTOR ASSORTMENT
50 RESISTORS PER VALUE

1.5	47	470	3.9K	33K	150K	1.0M
3.3	68	680	4.7K	39K	220K	1.5M
6.8	100	1.0K	6.8K	47K	270K	2.2M
10	150	1.5K	10K	68K	470K	3.3M
15	220	2.2K	15K	100K	680K	4.7M
22	270	2.7K	22K			
36	330	3.3K	27K			

FREE CATALOG AVAILABLE ON REQUEST

Satisfaction guaranteed. Shipment will be made postage prepaid within 3 days from receipt of order. Payment may be made with personal check, charge card (include number and exp. date), or money order. Phone Orders — BoIA and M/C card or C.O.D.

Add \$1.00 to cover shipping and handling if order is less than \$10.00.
California residents add sales tax. Include shipping expense for orders shipped out of U.S. and Canada approx. 10% of order.

INTERNATIONAL ELECTRONICS UNLIMITED
VILLAGE SQUARE, P.O. BOX 449
CARMEL VALLEY, CA 93924 USA
PHONE (408) 659-3171

DIGI-KEY CORPORATION

Quality Electronic Components

DON'T FORGET OUR DISCOUNTS WHEN COMPARING PRICES MICROPROCESSORS

Best Values Yet!

8080A	8-BIT CPU, 2 USEC CYCLE	\$12.95
8212	8-BIT I/O PORT	\$ 3.95
8216	BI-DIRECTIONAL BUS DRIVER	\$ 4.25
8224	CLOCK GENERATOR	\$ 3.95
8228	SYSTEM CONTROLLER	\$ 6.95
8251	COMMUNICATIONS INTERFACE	\$12.95
8255	PERIPHERAL INTERFACE	\$11.95
1702A	2K EPROM (256x8)	\$ 6.95
2708	8K EPROM (1Kx8)	\$29.50
2102-1	1K RAM 500 NS.	\$ 1.79
SC/MP	5 VOLT SC/MP CPU	\$ 9.95
2650	MICROPROCESSOR 1.25 MHZ-2 CLOCK 40 DIL.	\$24.95



DIAMOND
See Our Catalog For More Diamond Tool

4 1/4" Length
MS54
\$6.58



AC-E 200-K
Part No. 923333
\$18.95

- Two 5 way binding posts
- Size: 4-9/16" by 5-9/16"
- Kit form - lowest cost

Digi-Key Stocks the Entire AP Line



WSU-30 Regular W/Pap ... **\$5.95**
WSU-30M Modified Wrap ... **\$6.95**

8080A CHIP SET

ONE EACH 8080A, 8212, 8224 and 8228 PLUS SIXTEEN 2102-1's — ALL FOR

\$49.95

PRICE BREAKTHROUGH ON 74LS'

74LS00	28	74LS30	28	74LS90	57	74LS157	75	74LS249	79
74LS01	28	74LS32	33	74LS92	57	74LS158	75	74LS249	79
74LS02	28	74LS33	33	74LS93	57	74LS160	102	74LS253	84
74LS03	28	74LS38	33	74LS107	39	74LS161	102	74LS257	75
74LS04	29	74LS42	38	74LS109	39	74LS162	102	74LS258	85
74LS05	29	74LS42	67	74LS112	39	74LS163	102	74LS266	39
74LS08	29	74LS47	79	74LS113	39	74LS164	102	74LS283	79
74LS09	29	74LS48	77	74LS114	39	74LS166	114	74LS290	65
74LS10	28	74LS51	28	74LS125	49	74LS171	102	74LS293	65
74LS11	28	74LS54	28	74LS126	49	74LS172	102	74LS365	67
74LS12	28	74LS55	28	74LS132	81	74LS173	134	74LS366	67
74LS13	47	74LS57	39	74LS136	39	74LS174	106	74LS367	67
74LS14	102	74LS74	39	74LS138	63	74LS175	62	74LS368	67
74LS15	28	74LS75	53	74LS139	73	74LS190	118	74LS386	39
74LS20	28	74LS76	39	74LS151	75	74LS191	118	74LS670	234
74LS21	28	74LS78	39	74LS153	75	74LS196	86	74LS672	234
74LS22	28	74LS79	39	74LS154	110	74LS197	86	81LS96	77
74LS26	33	74LS86	39	74LS157	75	74LS247	79	81LS97	77
74LS27	33	74LS156	75	74LS157	75	81LS98	77	81LS98	77

STRIPS — WRAPS — UNWRAPS

TOTALLY ASSEMBLED CRT AT LOWER THAN KIT PRICE

CRT TERMINAL
\$895.00
MANUAL ONLY
\$2.00



Bishop Graphics 5" x 6"
1/4 Scale PC Design Template
\$12.50

The Digi-Key Catalog features many more quality Bishop Graphics products.

INTEGRATED CIRCUITS TTL, CMOS, LINEAR

7400	21	7476	32	74181	215	4012	23	4520	114
7401	21	7480	70	74182	79	4013	40	4527	168
7402	21	7482	70	74184	219	4014	96	4528	88
7403	21	7483	70	74185	219	4015	96	4585	123
7404	21	7485	89	74186	350	4016	40	2102-1	179
7405	21	7486	89	74189	350	4017	105	8080A	1295
7406	25	7489	219	74190	123	4018	1.05	CA3046	75
7407	25	7490	44	74191	123	4019	23	LM2011N	125
7408	21	7491	70	74192	88	4020	114	LM3092	180
7409	21	7492	44	74193	88	4021	114	LM324A	128
7410	21	7493	44	74194	88	4022	96	LM340T-5	125
7411	21	7494	70	74195	88	4023	23	LM340T-6	125
7412	21	7495	70	74196	67	4024	84	LM340T-7	125
7413	25	7496	70	74197	88	4025	23	LM340T-12	125
7414	89	74100	128	74198	149	4026	168	LM340T-15	125
7416	25	74107	30	74199	149	4027	114	LM340T-18	125
7417	25	74109	33	74200	109	4028	89	LM340T-24	125
7420	21	74121	35	74209	55	4029	114	LM3900N	88
7421	21	74122	44	74365	67	4030	23	LM3909N	69
7423	35	74123	61	74366	67	4033	151	MC1456V	100
7425	35	74125	40	74367	67	4034	250	MC1488V	53
7426	25	74126	40	74368	67	4035	114	MC1302P	115
7427	33	74132	70	8093	40	4040	114	NE532T	324
7428	28	74141	88	8096	67	4041	79	NE540L	204
7430	21	74159	33	8095	67	4042	79	NE555V	48
7432	25	74147	163	8096	67	4043	70	NE556A	88
7433	30	74148	130	8097	67	4044	70	NE560B	383
7437	25	74150	116	8098	67	4045	138	NE561B	383
7438	25	74151	40	8099	67	4046	40	NE567V	126
7440	21	74153	65	75450	88	4050	40	NE65A	125
7442	53	74154	103	75451	88	4051	126	NE66V	128
7443	63	74155	70	75452	61	4052	126	NE67V	126
7445	70	74156	70	75453	61	4053	96	uA709CV	44
7446	70	74157	70	75454	61	4060	158	uA710CA	44
7447	70	74160	88	75491	81	4066	79	uA711CA	50
7448	70	74161	88	75492	81	4067	79	uA712CA	50
7450	21	74162	88	75493	109	4072	23	uA733CA	75
7451	21	74163	88	75494	119	4073	23	uA741CA	44
7453	21	74164	96	82525	219	4073	23	uA747CA	70
7454	21	74165	115	4005	23	4074	23	uA780CV	125
7459	21	74166	126	4001	23	4082	23	uA780CV	125
7460	21	74170	264	4002	23	4029	79	uA780CV	125
7470	30	74173	142	4006	123	4510	114	uA780CV	125
7472	30	74174	98	4007	23	4511	105	uA781CV	125
7473	30	74175	98	4008	79	4514	280	uA781CV	125
7474	30	74176	79	4009	44	4515	280	uA781CV	125
7475	49	74177	79	4010	44	4516	23	uA7824CA	125
		74180	70	4011	23	4518	114		

LED DIGITS and LAMPS

IND357	375'	Single Digit	CC	\$1.35
IND500	5'	Single Digit	CC	\$1.35
IND507	5'	Single Digit	CC	\$1.35
IND800	8'	Single Digit	CC	\$2.50
IND807	8'	Single Digit	CC	\$2.50
NSM323	3'	Dual Digits	CC	\$2.60
NSM374	3'	Dual Digits	CC	\$2.60
NSM383	3'	Dual Digits	CC	\$2.60
NSM384	5'	Dual Digits	CC	\$2.60
NSM783	7'	Dual Digits	CC	\$3.00
NSM784	7'	Dual Digits	CC	\$3.00
NSL905B	1 1/4"	Lamp		\$12.00/100
NSL905B	1 1/4"	Lamp		\$18.00/100

SILICON TRANSISTORS

MP5918	16	1.55/10	MP5364D	16	1.55/10	PN5133	16	1.55/10
MP5930	16	1.55/10	MP5364I	16	1.55/10	PN5134	16	1.55/10
MP5930A	16	1.55/10	MP5364J	16	1.55/10	PN5137	16	1.55/10
MP5932	16	1.55/10	MP5364K	16	1.55/10	PN5138	16	1.55/10
MP5932A	16	1.55/10	MP5364L	16	1.55/10	PN5139	16	1.55/10
MP5932B	16	1.55/10	MP5364M	16	1.55/10	PN5210	16	1.55/10
MP5932C	16	1.55/10	MP5364N	16	1.55/10	PN3055	68	6.59/10
MP5932D	16	1.55/10	MP5364O	16	1.55/10	MJ2955	99	9.20/10
MP5932E	16	1.55/10	MP5364P	16	1.55/10	MJ2956	48	4.50/10
MP5932F	16	1.55/10	MP5364Q	16	1.55/10	MJ2957	28	2.60/10
MP5932G	16	1.55/10	MP5364R	16	1.55/10	MJ2958	99	9.20/10
MP5932H	16	1.55/10	MP5364S	16	1.55/10	MJ2959	99	9.20/10
MP5932I	16	1.55/10	MP5364T	16	1.55/10	MJ2960	99	9.20/10

SEND FOR OUR FREE CATALOG

WE STOCK A WIDE VARIETY OF PARTS NOT IN THIS AD PLUS MANY SPECIALLY PRICED BARGAINS!

5% CARBON FILM RESISTORS

1/4 & 1/2 WATT SIZE
3 pcs/value 5¢ ea., 100 pcs/value 1.7¢ ea.,
1000 pcs/value 1.2¢ ea.

CLOCK MODULES

The MA1000 and MA1010 series clock modules by Metrol Semiconductor are fully assembled and tested clocks using a 4 digit LED display and an CMOS integrated circuit on the same board. Simply connect switches and our special transformer and you have a fully functioning clock.

The MA1000 clock module is a fully assembled and tested 12 hour clock using a high brilliance green fluorescent display and crystal time base making it perfect for car, boat or other portable use. It operates directly from 12 volts DC so no transformer is needed. Our price includes three push button switches for setting the time.

MA1002A	12 LED 12 Hour Clock Module	\$10.50	MA1010A	12 LED 12 Hour AM PM Clock Module	\$13.00
MA1002A SET	12 LED 12 Hour Clock Module & Transformer	\$13.95	MA1010A SET	12 LED 12 Hour AM PM Clock Module & Transformer	\$16.45
MA1002C	12 LED 24 Hour Clock Module	\$10.50	MA1010C	12 LED 24 Hour AM PM Clock Module	\$13.00
MA1002C SET	12 LED 24 Hour Clock Module & Transformer	\$13.95	MA1010C SET	12 LED 24 Hour AM PM Clock Module & Transformer	\$16.45
MA1003	12 Hour 24 Hour 12 Hour 30 Min Clock	\$24.95			

MA1002 0.5" High Digits

Actual Size: 1.375" x 3.05"

MA1010 0.84" High Digits

Actual size: 1.75" x 3.75"

ELECTROLYTIC CAPACITORS

VALUE	RATINGS	REEL LEADS	REEL LEADS	VALUE	RATINGS	REEL LEADS	REEL LEADS		
47/50V	.08	.65/10	.11	90/10	100/50V	.21	1.17/10	29	2.30/10
1/50V	.08	.65/10	.11	90/10	220/10V	.13	1.08/10	18	1.42/10
2/250V	.08	.65/10	.12	90/10	220/25V	.25	2.66/10	43	3.43/10
3/350V	.08	.65/10	.12	100/10	220/63V	.15	1.16/10	20	1.55/10
4/735V	.08	.65/10	.12	95/10	220/25V	.21	1.71/10	29	2.35/10
4/735V	.08	.65/10	.12	100/10	220/50V	.25	2.63/10	35	2.79/10
10/15V	.08	.65/10	.11	90/10	220/50V	.29	2.35/10	40	3.21/10
10/25V	.08	.65/10	.12	100/10	330/6V	.14	1.12/10	19	1.48/10
10/35V	.09	.70/10	.13	110/10	330/10V	.15	1.16/10	21	1.64/10
10/50V	.10	.75/10	.14	115/10	330/16V	.21	1.66/10	31	2.45/10
22/16V	.08	.67/10	.12	100/10	330/25V	.23	1.86/10	38	3.07/10
22/25V	.09	.70/10	.13	105/10	330/25V	.23	2.66/10	43	3.43/10
22/25V	.11	.85/10	.15	119/10	330/50V	.34	4.30/10	60	4.81/10
22/50V	.12	1.00/10	.17	132/10	470/6V	.15	1.21/10	20	1.61/10
33/16V	.09	.75/10	.12	100/10	470/10V	.21	1.71/10	31	2.45/10
33/25V	.10	.81/10	.14	115/10	470/16V	.23	1.81/10	33	2.66/10
33/35V	.11	.85/10	.15	119/10	470/25V	.29	2.35/10	43	3.43/10
33/50V	.12	.90/10	.16	126/10	470/50V	.41	3.27/10	47	3.78/10
47/10V	.09	.71/10	.13	104/10	470/50V	.54	4.30/10	75	6.03/10
47/16V	.10	.75/10	.14	115/10	1000/6V	.22	1.90/10	35	2.76/10
47/25V	.11	.80/10							

MOVIE FILMS

MOVIES FROM: COLUMBIA PICTURES/WARNER BROS. the greatest films in Super 8, sound or silent, "Lawrence of Arabia", "Summer of '42", all your favorites. Send for your free catalog to Columbia Pictures 8mm Films, Dept. PE, 711 Fifth Avenue, New York, New York 10022.

BUSINESS OPPORTUNITIES

I MADE \$40,000.00 Year by Mailorder! Helped others make money! Free Proof. Torrey, Box 318-NN, Ypsilanti, Michigan 48197.

HOW TO MAKE \$2,000 WEEKLY at home using other people's money. Guaranteed. Free Details. Richlieu, Box 25357, Dept. F8, Houston 77005.

NEW LUXURY Car Without Cost. Free Details! Codex-ZZ, Box 6073, Toledo, Ohio 43614.

FREE CATALOGS. Repair air conditioning, refrigeration. Tools, supplies, full instructions. Doolin, 2016 Canton, Dallas, Texas 75201.

MAILORDER MILLIONAIRE helps beginners make \$500 weekly. Free report reveals secret plan! Executive (1K9), 333 North Michigan, Chicago 60601.

GET RICH with Secret Law that smashes debts and brings you \$500 to \$5 Million cash. Free report! Credit 4K9, 333 North Michigan, Chicago 60601.

HIGHLY PROFITABLE ONE-MAN ELECTRONIC FACTORY

Investment unnecessary, knowledge not required, sales handled by professionals. Postcard brings facts about this unusual opportunity. Write today! Barta-DV, Box 248, Walnut Creek, CA 94597.

MECHANICALLY Inclined individuals desiring ownership of Small Electronics Manufacturing Business — without investment. Write: Marks, 92-K9 Brighton 11th, Brooklyn, New York 11235.

The J.M.J. DIGITAL DISPLAY BEZEL FOR APPEARANCE AND PERFORMANCE!

Now you can add a truly professional appearance to your digital projects and improve their performance as well. . . With the JMJ BEZEL. It will vastly improve the readability of the display and put a finishing touch on any front panel. And that's important, for obviously, the display is the most looked-at feature on any piece of digital equipment.

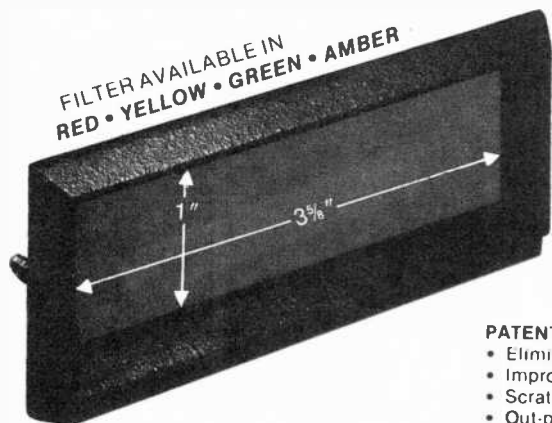

\$4.95 EACH
(Please order by color)

UNIVERSAL SIZE HANDLES MOST REQUIREMENTS

DEALERS INQUIRIES INVITED

ATTENTION CLOCK BUILDERS

Adapters for mounting clock modules and clock displays directly to the JMJB-EZEL. Assures perfect alignment and simplifies mounting (Please Order by Number).

\$.69 ea.

ADAPTER #1 (Fits the following)

National	Liton	Texas Inst.	Bowmar
MA 1001	LT 601	TIL 364	Opti-Stick
MA 1002	LT 442	thru	
NSB5917	LT 446	TIL 372	
NSB5921	LT 447		
NSB5922			

ADAPTER #2 (Fits the following)

National	Liton
MA 1010	LT 701
MA 1012	
MA 1013	

ADAPTER-3 (Universal Mount) For mounting any PC Board to the JMJB-EZEL (Requires two mounting holes in PC Board).

TERMS: Minimum Order \$4 95
Add \$1 00 for Postage & Handling
N J Residents Add 5% Sales Tax
Send Check or M O — No COD s

PATENTED CHROMAFILTER® SCREEN

- Eliminates glare and reflections
- Improves contrast and readability
- Scratch resistant—easily cleaned
- Out-performs circular polarized types
- Available in four colors

DIE CAST METAL FRAME

- Nonreflective black finish
- Durable—heat resistant
- Integral 6-32 mounting studs
- No exposed hardware
- Mounts in panels up to 3/16" thick
- Includes all hardware and a special template for easy installation.

© Panelgraphic Corp., W. Caldwell, N.J.

NAME		
ADDRESS		
CITY	STATE	ZIP
<input type="checkbox"/> J.M.J. BEZELS at \$4.95 EA. (COLOR: _____)		
<input type="checkbox"/> ADAPTERS at \$.69 EA. (NUMBER: _____)		
POSTAGE & HANDLING		1.00
5% N.J. SALES TAX		
AMOUNT ENCLOSED		
J.M.J. TECHNICAL PRODUCTS, INC. BOX 26, KENDALL PARK, N.J. 08824		

\$500 PER DAY POSSIBLE. New C.B. related business. Send 25 cents. P.A. Schubert Company, P.O. Box 187, Howell, Mich. 48843.

BORROW \$25,000 interest-free!! . . . keep indefinitely. Anyone! Free Report. Executive-PE9, Box 368, Buford, Georgia 30518.

INVENTIONS WANTED

INVENTORS: Manufacturers Need New Products. Free "Recommended Procedure," by a creative fee-based invention service company. Washington Inventors Service, 422-T Washington Building, Washington, D. C. 20005.

INVENTORS

RECOGNITION...FINANCIAL REWARD...OR CREDIT FOR "INVENTING IT FIRST" MAY BE YOURS!

If you have an idea for a new product, or a way to make an old product better, contact us, "the idea people" We'll develop your idea, introduce it to industry, negotiate for cash sale or royalty licensing. Write now without cost or obligation for free information. Fees are charged only for contracted services. So send for your FREE "Inventor's Kit." It has important Marketing Information, a special "Invention Record Form" and a Directory of 1001 Corporations Seeking New Products.

RAYMOND LEE ORGANIZATION
230 Park Avenue North, New York, NY 10017

At no cost or obligation, please rush my FREE "Inventor's Kit No. A-112"

Name _____
Address _____
City _____ State _____ Zip _____
Phone No. _____ Area Code _____

FREE PAMPHLET: "Tips on Marketing Your Invention", from an experienced fee-based invention service company. Write: United States Inventors Service Company, Dept. T, 1435 G Street NW, Washington DC 20005.

FREE

BA's 1978 ANNUAL CATALOG!

260 PAGE RADIO, TV & ELECTRONIC CATALOG

BA THE WORLD'S MOST COMPLETE CATALOG OF EVERYTHING IN ELECTRONICS
burstein-applebee

WRITE FOR YOUR FREE COPY NOW!

Your buying guide for Everything in Electronics... Stereo, Hi-Fi, TVs, Radios, Tape Recorders, CB, Kits, Tools, Books and Electronic parts.

BURSTEIN-APPLEBEE
Dept. PE-9 3199 MERCIER
KANSAS CITY, MO. 64111

NAME _____
ADDRESS _____
CITY _____
STATE _____ ZIP _____

INSTRUCTION

LEARN ELECTRONIC ORGAN SERVICING at home all makes including transistor. Experimental kit—trouble-shooting. Accredited NHSC, Free Booklet. NILES BRYANT SCHOOL, 3631 Stockton, Dept. A, Sacramento, Calif. 95820.

SCORE high on F.C.C. Exams... Over 300 questions and answers. Covers 3rd, 2nd, 1st and even Radar. Third and Second Test, \$14.50; First Class Test, \$15.00. All tests, \$26.50. R.E.I., Inc., Box 806, Sarasota, Fla. 33577.

UNIVERSITY DEGREES BY MAIL! Bachelors, Masters, Ph.D's. Free revealing details. Counseling, Box 317-PE9, Tustin, California 92680!

SELF-STUDY CB RADIO REPAIR COURSE. THERE'S MONEY TO BE MADE REPAIRING CB RADIOS. This easy-to-learn course can prepare you for a career in electronics enabling you to earn as much as \$16.00 an hour in your spare time. For more information write: CB RADIO REPAIR COURSE, Dept. PE09, 531 N. Ann Arbor, Okla. City, Okla. 73127.

LEARN WHILE ASLEEP! HYPNOTIZE! Astonishing details, strange catalog free! Autosuggestion, Box 24-ZD, Olympia, Washington 98507.

GRANTHAM'S FCC LICENSE STUDY GUIDE — 377 pages, 1465 questions with answers/discussions — covering third, second, first radiotelephone examinations. \$13.45 postpaid. GSE, P.O. Box 25992, Los Angeles, California 90025.

INTENSIVE 5 week course for Broadcast Engineers. FCC First Class license. Student rooms at the school. Radio Engineering Inc., 61 N. Pineapple Ave., Sarasota, FL 33577 and 2402 Tidewater Trail, Fredericksburg, VA 22401.

HIGHLY EFFECTIVE Degree Program in Electronics Engineering. Advance rapidly! Our 31st Year. Free literature. Cook's Institute, Box 20345, Jackson, Miss. 39209.

1977 TESTS-ANSWERS for FCC First Class License. Plus "Self-Study Ability Test." Proven! \$9.95. Moneyback Guarantee. "FREE" BROCHURE. Command, Box 26348-P, San Francisco 94126.

GET your Commercial FCC License. New Exams by author of successful published workbooks of FCC Practice Tests. 500 Questions Second Class, \$11.95; 200 First Class, \$7.95; 100 Radar, \$4.95; Postpaid. Save, all three \$19.95. Complete mathematical solutions. Free counselling service. Victor Veley, P.O. Box 14, La Verne, Calif. 91750.

RADIO BROADCASTING: Become a DJ-engineer, start your own station, receive free tapes-records. Learn details free. "Broadcasting", Box 5516-AI, Walnut Creek, CA 94596.

TAPE AND RECORDERS

RENT 4-Track open reel tapes—free brochure. Stereo-Parti, P.O. Box 7, Fulton, CA 95401.

8-TRACK and CASSETTE BELTS — money back guarantee. Long wearing. Free Catalog — \$3 minimum order. PRB Corp., Box 176, Whitewater, Wisconsin 53190.

GOVERNMENT SURPLUS

MANUALS for Govt Surplus radios, test sets, scopes. List 50 cents (coin). Books, 7218 Roanne Drive, Washington, D.C. 20021.

GOVERNMENT SURPLUS. Buy in your Area. How, where. Send \$2.00. Surplus, 30177-PE Headquarters Building, Washington, D.C. 20014.

JEeps, TRUCKS, Typically from \$52.40 ... Automobiles, Boats, Motorcycles, Airplanes, Oscilloscopes, Tools, Clothing, Sports, Camping, Photographic, Electronics Equipment ... 200,000 Bid Bargains Nationwide Direct from Government ... Low as 2 cents on Dollar! Surplus Catalog and Sales Directory \$1.00 (refundable). National Surplus Center, 240 Eastcass-PEL, Joliet, Illinois 60432.

PERSONALS

MAKE FRIENDS WORLDWIDE through international correspondence. Illustrated brochure free. Hermes-Verlag, Box 110660/Z, D-1000 Berlin 11, Germany.

MUSICAL INSTRUMENTS

UP TO 60% DISCOUNT. Name brand instruments catalog. Freeport Music, 114 G. Mahan St., W. Babylon, N.Y. 11704.

HOME ENTERTAINMENT FILMS

EVERYBODY LOVES MOVIES! Order these Alfred Hitchcock thriller specials. "Frenzy" or "Psycho" 200' Super 8 silent \$7.95 ea — Super 8-mag sound, \$16.95 ea ppd (you save \$2.00). Or 400' S-8 color-sound "Frenzy" or "The Birds" only \$45.95 ea ppd. Or "Psycho" S-8 B&W sound \$35.95 ppd (you save \$5.00 per print incl. postage). Comedy gala Abbott & Costello "In Society" and A&C meet the "Key Stone Kops". Universal Super 8 B&W-sound \$35.95 ea ppd. Also Marx Brothers in "Monkey Business". Limited Offer. Reserve Right to limit quantity. Send for Columbia catalog, \$0.85; Universal 8 catalog, \$0.75; Sportlite forms, \$0.35. SPORTLITE, Elect-9, 20 N. Wacker Dr., Chicago, IL 60606.

RUBBER STAMPS

RUBBER STAMPS, BUSINESS CARDS. Many new products. Catalog. Jackson's, Dept. K, Brownsville Rd., Mt. Vernon, Ill. 62864.

REAL ESTATE

BIG...FREE...FALL CATALOG! Over 2,500 top values coast to coast! UNITED FARM AGENCY, 612-EP, West 47th, Kansas City, MO 64112.

EMPLOYMENT OPPORTUNITIES

ELECTRONICS/AVIONICS EMPLOYMENT OPPORTUNITIES. Report on jobs now open. Details FREE. Aviation Employment Information Service, Box 240E, Northport, New York 11768.

TREASURE FINDERS

SERIOUS COIN SHOOTERS — Semtech's solid-state METL-SENSOR pin-points ALL metal objects, yet defines the target before you dig. FOR FREE literature write Semtech Corporation, 652 Mitchell Rd., Newbury Park, Calif. 91320.



NEW LSI TECHNOLOGY

FREQUENCY COUNTER

TAKE ADVANTAGE OF THIS NEW STATE-OF-THE-ART COUNTER FEATURING THE MANY BENEFITS OF CUSTOM LSI CIRCUITRY. THIS NEW TECHNOLOGY APPROACH TO INSTRUMENTATION YIELDS ENHANCED PERFORMANCE, SMALLER PHYSICAL SIZE, DRASTICALLY REDUCED POWER CONSUMPTION [PORTABLE BATTERY OPERATION IS NOW PRACTICAL], DEPENDABILITY, EASY ASSEMBLY AND REVOLUTIONARY LOWER PRICING!



SIZE:
3" High
6" Wide
5 1/2" Deep

1 3/4 LBS.
COLOR:
BLACK

FEATURES AND SPECIFICATIONS:



DISPLAY: 8 RED LED DIGITS .4" CHARACTER HEIGHT
GATE TIMES: 1 SECOND AND 1/10 SECOND [AUTO DEC. PT. PLACEMENT]
RESOLUTION: 1 HZ AT 1 SECOND, 10 HZ AT 1/10 SECOND.
FREQUENCY RANGE: 10 HZ TO 60 MHZ. [65 MHZ TYPICAL].
SENSITIVITY: 10 MV RMS TO 50 MHZ, 20 MV RMS TO 60 MHZ TYP.
INPUT IMPEDANCE: 1 MEGOHM AND 20 PF.
[DIODE PROTECTED INPUT FOR OVER VOLTAGE PROTECTION.]
ACCURACY: ± 1 PPM [± .0001%] AFTER CALIBRATION TYPICAL.
STABILITY: WITHIN 1 PPM PER HOUR AFTER WARM UP [0.01% XTAL IC PACKAGE COUNT: 8 [ALL SOCKETED]]
INTERNAL POWER SUPPLY: 5.2 V DC AT 800 MA. REGULATED.
INPUT POWER REQUIRED: 8-12 VDC OR 115 VAC AT 50/60 HZ.
POWER CONSUMPTION: 4 WATTS
INPUT CONNECTOR: BNC TYPE

ORDER BY PHONE OR MAIL
COD ORDERS WELCOME

KIT #FC-50 C	60 MHZ COUNTER WITH CABINET & P.S.	\$119.95
KIT #PSL-350	350 MHZ PRESCALER [NOT SHOWN]	23.95
KIT #PSL-650	650 MHZ PRESCALER [NOT SHOWN]	29.95
MODEL #FC-50WT	60 MHZ COUNTER WIRED, TESTED & CAL.	165.95
MODEL #FC-50/600 WT	600 MHZ COUNTER WIRED, TESTED & CAL.	199.95

KIT #FC-50C IS COMPLETE WITH PREDRILLED CHASSIS ALL HARDWARE AND STEP-BY-STEP INSTRUCTIONS. WIRED & TESTED UNITS ARE CALIBRATED AND GUARANTEED. PRESCALERS WILL FIT INSIDE COUNTER CABINET.

TERMS: FOR SHIPPING, HANDLING & INSURANCE TO US & CANADA ADD 5% ALL OTHERS 10%. FLORIDA RES. ADD 4% SALES TAX. COD CHARGE \$1.00.

OPTOELECTRONICS, INC.

BOX 219 • HOLLYWOOD, FLA. 33022 • (305) 921-2056

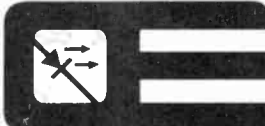

CIRCLE NO. 45 ON FREE INFORMATION CARD

E-Z-HOOK

E-Z Hooks have been designed and field tested through the industry to save time and money in commercial electronic production and servicing. The spring-loaded hook attaches firmly, yet so gently it will not damage component - frees hands while testing. Durably constructed and fully insulated to a single contact point assuring true readings. Meets exacting laboratory and space age computer technology requirements. AVAILABLE IN 10 RETMA COLORS: Red, black, blue, green, orange, yellow, white, violet, brown or gray.

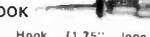
MICRO HOOK

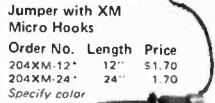
 XM Micro Hook (1.75" long < 1 gram) for difficult IC Testing. Permits hook-ups to delicate wires where weight and leverage may damage component. . . . \$80 ea.
 Specify color. ORDER P/N XM

Jumper with XM Micro Hooks

 Order No. Length Price
 204XM-12" 12" \$1.70
 204XM-24" 24" 1.70
 Specify color.

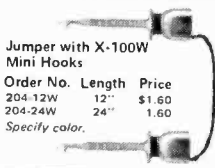
XMS MICRO HOOK SET (Includes 1 ea. red, black, blue, green, orange, yellow, white, brown, violet and gray Micro Hook). At this low price you can afford more than one set.
COMPLETE SET (10) MICRO HOOKS \$7.95

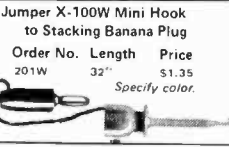
MINI HOOK

X100W Mini Hook (2.25" long) combines rugged construction, miniature size and Finger-zip Hypo Action for all the best test connections. Hook is large enough for component leads, yet small enough to get into tight places. . . . \$75 ea.
 Specify color. ORDER P/N X100W

Jumper with X-100W Mini Hooks

 Order No. Length Price
 204-12W 12" \$1.60
 204-24W 24" 1.60
 Specify color.

Jumper X-100W Mini Hook to Stacking Banana Plug

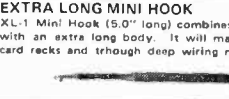
 Order No. Length Price
 201W 32" \$1.35
 Specify color.

Jumper with X-100W Mini Hook 201XM 32"

 Order No. Length Price
 201XM 32" \$1.40
 Specify color.

EXTRA LONG MINI HOOK

 XL-1 Mini Hook (5.0" long) combines all the proven features of the X100W with an extra long body. It will make safe, short-free test connections in card racks and through deep wiring nest up to 4". . . . ORDER P/N XL-1
 Specify color. \$1.25

JUMPER, XL-1 MINI HOOK TO STACKING BANANA PLUG

 Order No. Length Price
 201XL-1 32" \$1.95
 Specify color.

NEW from FLUKE - MODEL 8020A
THE DMM FOR THE PROFESSIONAL

 • 200 Hr Battery Life
 • 26 Ranges for 7 Functions
 • 2000 Count Resolution
 • High-Low Power Ohms
 • Autozero and Auto-polarity
 • MOV-protected to 6000V against hidden transients and overload protection to 300 V AC
 • Diode Test Function
 • Conductance Function checks leakage resistance to 10,000 meg ohms
 • Size: HWL (7.1x3.4x1.8 IN)
 ONLY \$169.00
 (18.0x8.6x4.5 cm)
 • Weight: 13 oz.

2N TRANSISTORS

2N5088	80	2N2904A	36	2N3702	18	2N4058	25	2N4922	60	2N5306	34	2N5824	25
2N5091	26	2N2905	34	2N3704	18	2N4060	25	2N4924	60	2N5308	34	2N5826	25
2N5099	80	2N2905A	36	2N3705	18	2N4061	25	2N4926	60	2N5310	34	2N5828	25
2N5105	35	2N2906	24	2N3707	18	2N4062	25	2N4928	60	2N5312	34	2N5830	25
2N5111	49	2N2906A	21	2N3708	20	2N4063	1.10	2N4930	1.10	2N5314	70	2N5832A	40
2N5118	40	2N2907	24	2N3709	20	2N4064	1.10	2N4932	1.10	2N5316	70	2N5834	40
2N5184	40	2N2907A	24	2N3710	20	2N4065	1.10	2N4934	1.10	2N5318	70	2N5836	40
2N5188	40	2N2924	20	2N3711	20	2N4066	1.10	2N4936	1.10	2N5320	70	2N5838	40
2N5192	26	2N2925	22	2N3712	20	2N4067	1.10	2N4938	1.10	2N5322	70	2N5840	40
2N5193	26	2N2925A	22	2N3713	20	2N4068	1.10	2N4940	1.10	2N5324	70	2N5842	40
2N5194	32	2N2926	30	2N3714	20	2N4069	1.10	2N4942	1.10	2N5326	70	2N5844	40
2N5195	32	2N2926A	30	2N3715	20	2N4070	1.10	2N4944	1.10	2N5328	70	2N5846	40
2N5196	32	2N2927	30	2N3716	20	2N4071	1.10	2N4946	1.10	2N5330	70	2N5848	40
2N5197	32	2N2927A	30	2N3717	20	2N4072	1.10	2N4948	1.10	2N5332	70	2N5850	40
2N5198	32	2N2928	30	2N3718	20	2N4073	1.10	2N4950	1.10	2N5334	70	2N5852	40
2N5199	32	2N2928A	30	2N3719	20	2N4074	1.10	2N4952	1.10	2N5336	70	2N5854	40
2N5200	32	2N2929	30	2N3720	20	2N4075	1.10	2N4954	1.10	2N5338	70	2N5856	40
2N5201	32	2N2929A	30	2N3721	20	2N4076	1.10	2N4956	1.10	2N5340	70	2N5858	40
2N5202	32	2N2930	30	2N3722	20	2N4077	1.10	2N4958	1.10	2N5342	70	2N5860	40
2N5203	32	2N2930A	30	2N3723	20	2N4078	1.10	2N4960	1.10	2N5344	70	2N5862	40
2N5204	32	2N2931	30	2N3724	20	2N4079	1.10	2N4962	1.10	2N5346	70	2N5864	40
2N5205	32	2N2931A	30	2N3725	20	2N4080	1.10	2N4964	1.10	2N5348	70	2N5866	40
2N5206	32	2N2932	30	2N3726	20	2N4081	1.10	2N4966	1.10	2N5350	70	2N5868	40
2N5207	32	2N2932A	30	2N3727	20	2N4082	1.10	2N4968	1.10	2N5352	70	2N5870	40
2N5208	32	2N2933	30	2N3728	20	2N4083	1.10	2N4970	1.10	2N5354	70	2N5872	40
2N5209	32	2N2933A	30	2N3729	20	2N4084	1.10	2N4972	1.10	2N5356	70	2N5874	40
2N5210	32	2N2934	30	2N3730	20	2N4085	1.10	2N4974	1.10	2N5358	70	2N5876	40
2N5211	32	2N2934A	30	2N3731	20	2N4086	1.10	2N4976	1.10	2N5360	70	2N5878	40
2N5212	32	2N2935	30	2N3732	20	2N4087	1.10	2N4978	1.10	2N5362	70	2N5880	40
2N5213	32	2N2935A	30	2N3733	20	2N4088	1.10	2N4980	1.10	2N5364	70	2N5882	40
2N5214	32	2N2936	30	2N3734	20	2N4089	1.10	2N4982	1.10	2N5366	70	2N5884	40
2N5215	32	2N2936A	30	2N3735	20	2N4090	1.10	2N4984	1.10	2N5368	70	2N5886	40
2N5216	32	2N2937	30	2N3736	20	2N4091	1.10	2N4986	1.10	2N5370	70	2N5888	40
2N5217	32	2N2937A	30	2N3737	20	2N4092	1.10	2N4988	1.10	2N5372	70	2N5890	40
2N5218	32	2N2938	30	2N3738	20	2N4093	1.10	2N4990	1.10	2N5374	70	2N5892	40
2N5219	32	2N2938A	30	2N3739	20	2N4094	1.10	2N4992	1.10	2N5376	70	2N5894	40
2N5220	32	2N2939	30	2N3740	20	2N4095	1.10	2N4994	1.10	2N5378	70	2N5896	40
2N5221	32	2N2939A	30	2N3741	20	2N4096	1.10	2N4996	1.10	2N5380	70	2N5898	40
2N5222	32	2N2940	30	2N3742	20	2N4097	1.10	2N4998	1.10	2N5382	70	2N5900	40
2N5223	32	2N2940A	30	2N3743	20	2N4098	1.10	2N5000	1.10	2N5384	70	2N5902	40
2N5224	32	2N2941	30	2N3744	20	2N4099	1.10	2N5002	1.10	2N5386	70	2N5904	40
2N5225	32	2N2941A	30	2N3745	20	2N4100	1.10	2N5004	1.10	2N5388	70	2N5906	40
2N5226	32	2N2942	30	2N3746	20	2N4101	1.10	2N5006	1.10	2N5390	70	2N5908	40
2N5227	32	2N2942A	30	2N3747	20	2N4102	1.10	2N5008	1.10	2N5392	70	2N5910	40
2N5228	32	2N2943	30	2N3748	20	2N4103	1.10	2N5010	1.10	2N5394	70	2N5912	40
2N5229	32	2N2943A	30	2N3749	20	2N4104	1.10	2N5012	1.10	2N5396	70	2N5914	40
2N5230	32	2N2944	30	2N3750	20	2N4105	1.10	2N5014	1.10	2N5398	70	2N5916	40
2N5231	32	2N2944A	30	2N3751	20	2N4106	1.10	2N5016	1.10	2N5400	70	2N5918	40
2N5232	32	2N2945	30	2N3752	20	2N4107	1.10	2N5018	1.10	2N5402	70	2N5920	40
2N5233	32	2N2945A	30	2N3753	20	2N4108	1.10	2N5020	1.10	2N5404	70	2N5922	40
2N5234	32	2N2946	30	2N3754	20	2N4109	1.10	2N5022	1.10	2N5406	70	2N5924	40
2N5235	32	2N2946A	30	2N3755	20	2N4110	1.10	2N5024	1.10	2N5408	70	2N5926	40
2N5236	32	2N2947	30	2N3756	20	2N4111	1.10	2N5026	1.10	2N5410	70	2N5928	40
2N5237	32	2N2947A	30	2N3757	20	2N4112	1.10	2N5028	1.10	2N5412	70	2N5930	40
2N5238	32	2N2948	30	2N3758	20	2N4113	1.10	2N5030	1.10	2N5414	70	2N5932	40
2N5239	32	2N2948A	30	2N3759	20	2N4114	1.10	2N5032	1.10	2N5416	70	2N5934	40
2N5240	32	2N2949	30	2N3760	20	2N4115	1.10	2N5034	1.10	2N5418	70	2N5936	40
2N5241	32	2N2949A	30	2N3761	20	2N4116	1.10	2N5036	1.10	2N5420	70	2N5938	40
2N5242	32	2N2950	30	2N3762	20	2N4117	1.10	2N5038	1.10	2N5422	70	2N5940	40
2N5243	32	2N2950A	30	2N3763	20	2N4118	1.10	2N5040	1.10	2N5424	70	2N5942	40
2N5244	32	2N2951	30	2N3764	20	2N4119	1.10	2N5042	1.10	2N5426	70	2N5944	40
2N5245	32	2N2951A	30	2N3765	20	2N4120	1.10	2N5044	1.10	2N5428	70	2N5946	40
2N5246	32	2N2952	30	2N3766	20	2N4121	1.10	2N5046	1.10	2N5430	70	2N5948	40
2N5247	32	2N2952A	30	2N3767	20	2N4122	1.10	2N5048	1.10	2N5432	70	2N5950	40
2N5248	32	2N2953	30	2N3768	20	2N4123	1.10	2N5050	1.10	2N5434	70	2N5952	40
2N5249	32	2N2953A	30	2N3769	20	2N4124	1.10	2N5052	1.10	2N5436	70	2N5954	40
2N5250	32	2N2954	30	2N3770	20	2N4125	1.10	2N5054	1.10	2N5438	70	2N5956	40
2N5251	32	2N2954A	30	2N3771	20	2N4126	1.10	2N5056	1.10	2N5440	70	2N5958	40
2N5252	32	2N2955	30	2N3772	20	2N4127	1.10	2N5058	1.10	2N5442	70	2N5960	40
2N5253	32	2N2955A	30	2N3773	20	2N4128	1.10	2N5060	1.10	2N5444	70	2N5962	40
2N5254	32	2N2956	30	2N3774	20	2N4129	1.10	2N5062	1.10	2N5446	70	2N5964	40
2N5255	32	2N2956A	30	2N3775	20	2N4130	1.10	2N5064	1.10	2N5448	70	2N5966	40
2N5256	32	2N2957	30	2N3776	20	2N4131	1.10	2N5066	1.10	2N5450	70	2N5968	40
2N5257	32	2N2957A	30	2N3777	20	2N4132	1.10	2N5068	1.10	2N5452	70	2N5970	40
2N5258	32	2N2958	30	2N3778	20	2N4133	1.10	2N5070	1.10	2N5454	70	2N5972	40
2N5259	32	2N2958A	30	2N3779	20	2N4134	1.10	2N5072	1.10	2N5456	70	2N5974	40
2N5260	32	2N2959	30	2N3780	20	2N4135	1.10	2N5074	1.10	2N5458	70	2N5976	40
2N5261	32	2N2959A	30	2N3781	20	2N4136	1.10	2N5076	1.10	2N5460	70	2N5978	40
2N5262	32	2N2960	30	2N3782	2								

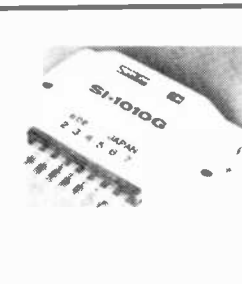

HYBRID AUDIO POWER AMPLIFIERS

- Multi-purpose linear amplifiers for commercial and industrial applications.
- Less than 0.5% harmonic distortion at full power level.
- 1/2 dB response from 20 to 100,000 Hz.
- Single or split (dual) power supply.
- Rugged, compact and lightweight packages.
- Built-in current limiting for SI-1050G and efficient heat radiating construction.

TYPICAL CONNECTIONS

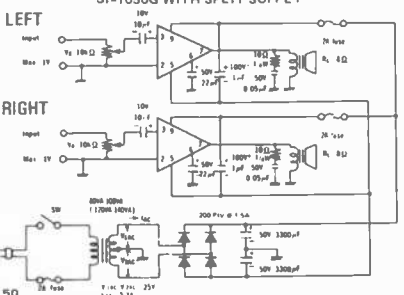

SANKEN Series SI-1000G amplifiers are self-contained power hybrid amplifiers designed for Hi-Fi, stereo, musical instruments, public address systems and other audio applications. The amplifiers have quasi-complementary class B output. The circuit employs flip-chip transistors with high reliability and passivated chip power transistors with excellent secondary breakdown strength. Built-in current limiting is provided for SI-1050G and all devices can be operated from a single or split power supply.

SI-1010G (10W output) ... \$ 6.90
 SI-1020G (20W output) ... \$13.95
 SI-1050G (50W output) ... \$26.80

Data Sheet with Application Notes - \$0.50

MICROPROCESSOR CRYSTALS

*FREQUENCY (MHz)	HOLDER	PART NUMBER	PRICE
1.00	HC33	CY1A	\$8.55
2.00	HC33	CY2A	6.75
3.2768	HC33	CY3B	4.80
4.00	HC18	CY3A	4.80
4.434	HC18	CY4C	4.80
5.00	HC18	CY7A	4.80
5.068	HC18	CY5B	4.80
5.7143	HC18	C85C	4.80
6.00	HC18	CY6B	4.80
10.00	HC18	CY12A	4.35
14.31818	HC18	CY14A	4.35
15.00	HC18	CY15A	4.35
18.00	HC18	CY19A	4.35
20.00	HC18	CY22A	7.20
23.684	HC18	CY23B	4.35
27.00	HC18	CY27A	4.35
32.00	HC18	CY30B	4.35

MICROPROCESSOR & SUPPORT CIRCUITS

P8080A	17.50	AM8238PC	8.20	M-0026CN	5.00
C8080A	19.50	C8251	14.30	M-0026CH	5.50
K1072A	13.40	C8255	13.50	P2701	2.90
C2708	33.50	P2405	9.50	P2701 I	4.20
P8212	4.10	2812C	4.30	P2702	1.70
P8214	8.95	2524V	4.00	P1202 I	3.45
P8216	3.90	2925V	2.40	P2111	3.40
AM8224PC	6.20	25233V	4.90	P2111 I	3.70
P8228	3.90	NT826B	3.10	P2112	2.90
AM8228PC	8.20	NT897	1.60	P2112 I	3.70



MOTOROLA'S EDUCATOR II MICROCOMPUTER HEP KIT

- Motorola M6800 Technology
- Test as you build in easy steps - normally one evening assembly
- Completely self contained with all parts, cabinet and instructional manual

Get started in the fascinating world of Micro Computers for only **\$169.95**



EDUCATOR II POWER SUPPLY KIT

- 5 V @ 1.0 Amp
- Designed specifically for Educator II Microcomputer Kit
- Complete Kit - all parts, cabinet and construction manual **\$29.95**

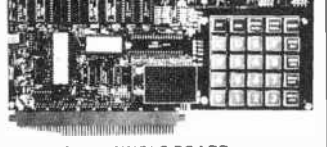

NEC SINGLE BOARD MICROCOMPUTER FOR LEARNING 8080A MICROCOMPUTER SYSTEM

- Single board microcomputer system.
- On board displays and keyboard.
- Powerful monitor program in factory coded ROM.
- Easy system operation.
- CMOS RAM battery back up capability.
- Provisions for audio cassette tape for external storage.
- System expandability.
- Battery operation capability.
- Instructive program examples for learning.
- Informative documentations.

7400N SERIES	7453N	7454N	7459N	7472N	7473N	7474N	7475N	7476N	7477N	7478N	7479N	7480N	7481N	7482N	7483N	7484N	7485N	7486N	7487N	7488N	7489N	7490N	7491N	7492N	7493N	7494N	7495N	7496N	7497N	7498N	7499N	7500N																																																																																																																																																																																																																																																												
7400N	16	22	22	22	22	22	22	22	22	22	22	22	22	22	22	22	22	22	22	22	22	22	22	22	22	22	22	22	22	22	22																																																																																																																																																																																																																																																													
7401N	16	22	22	22	22	22	22	22	22	22	22	22	22	22	22	22	22	22	22	22	22	22	22	22	22	22	22	22	22	22	22																																																																																																																																																																																																																																																													
7402N	26	7472N	48	74151N	110	74279N	110	74293N	50	74LS107N	46	74LS109N	46	74LS109N	200	74LS110N	64	74LS129N	176	74LS113N	64	74LS129N	176	74LS114N	92	74LS299N	614	74LS129N	176	74LS114N	92	74LS299N	614																																																																																																																																																																																																																																																											
7403N	26	7473N	48	74151N	110	74279N	110	74293N	50	74LS107N	46	74LS109N	46	74LS109N	200	74LS110N	64	74LS129N	176	74LS113N	64	74LS129N	176	74LS114N	92	74LS299N	614	74LS129N	176	74LS114N	92	74LS299N	614																																																																																																																																																																																																																																																											
7404N	22	7474N	42	74154N	110	74298N	110	74365N	80	74LS129N	176	74LS113N	64	74LS129N	176	74LS114N	92	74LS299N	614	74LS129N	176	74LS113N	64	74LS129N	176	74LS114N	92	74LS299N	614	74LS129N	176	74LS114N	92	74LS299N	614																																																																																																																																																																																																																																																									
7405N	23	7475N	60	74155N	110	74300N	36	74LS129N	176	74LS113N	64	74LS129N	176	74LS114N	92	74LS299N	614	74LS129N	176	74LS113N	64	74LS129N	176	74LS114N	92	74LS299N	614	74LS129N	176	74LS114N	92	74LS299N	614																																																																																																																																																																																																																																																											
7406N	36	7476N	60	74156N	110	74300N	36	74LS129N	176	74LS113N	64	74LS129N	176	74LS114N	92	74LS299N	614	74LS129N	176	74LS113N	64	74LS129N	176	74LS114N	92	74LS299N	614	74LS129N	176	74LS114N	92	74LS299N	614																																																																																																																																																																																																																																																											
7407N	36	7477N	60	74157N	110	74300N	36	74LS129N	176	74LS113N	64	74LS129N	176	74LS114N	92	74LS299N	614	74LS129N	176	74LS113N	64	74LS129N	176	74LS114N	92	74LS299N	614	74LS129N	176	74LS114N	92	74LS299N	614																																																																																																																																																																																																																																																											
7408N	28	7478N	160	74158N	130	74301N	44	74LS129N	176	74LS113N	64	74LS129N	176	74LS114N	92	74LS299N	614	74LS129N	176	74LS113N	64	74LS129N	176	74LS114N	92	74LS299N	614	74LS129N	176	74LS114N	92	74LS299N	614																																																																																																																																																																																																																																																											
7409N	28	7479N	160	74159N	130	74301N	44	74LS129N	176	74LS113N	64	74LS129N	176	74LS114N	92	74LS299N	614	74LS129N	176	74LS113N	64	74LS129N	176	74LS114N	92	74LS299N	614	74LS129N	176	74LS114N	92	74LS299N	614																																																																																																																																																																																																																																																											
7410N	24	7480N	120	74160N	130	74302N	32	74LS129N	176	74LS113N	64	74LS129N	176	74LS114N	92	74LS299N	614	74LS129N	176	74LS113N	64	74LS129N	176	74LS114N	92	74LS299N	614	74LS129N	176	74LS114N	92	74LS299N	614																																																																																																																																																																																																																																																											
7411N	27	7481N	120	74161N	130	74302N	32	74LS129N	176	74LS113N	64	74LS129N	176	74LS114N	92	74LS299N	614	74LS129N	176	74LS113N	64	74LS129N	176	74LS114N	92	74LS299N	614	74LS129N	176	74LS114N	92	74LS299N	614																																																																																																																																																																																																																																																											
7412N	38	7482N	180	74162N	140	74303N	36	74LS129N	176	74LS113N	64	74LS129N	176	74LS114N	92	74LS299N	614	74LS129N	176	74LS113N	64	74LS129N	176	74LS114N	92	74LS299N	614	74LS129N	176	74LS114N	92	74LS299N	614																																																																																																																																																																																																																																																											
7413N	48	7483N	240	74163N	140	74303N	36	74LS129N	176	74LS113N	64	74LS129N	176	74LS114N	92	74LS299N	614	74LS129N	176	74LS113N	64	74LS129N	176	74LS114N	92	74LS299N	614	74LS129N	176	74LS114N	92	74LS299N	614																																																																																																																																																																																																																																																											
7414N	116	7484N	240	74164N	140	74303N	36	74LS129N	176	74LS113N	64	74LS129N	176	74LS114N	92	74LS299N	614	74LS129N	176	74LS113N	64	74LS129N	176	74LS114N	92	74LS299N	614	74LS129N	176	74LS114N	92	74LS299N	614																																																																																																																																																																																																																																																											
7415N	116	7485N	240	74165N	140	74303N	36	74LS129N	176	74LS113N	64	74LS129N	176	74LS114N	92	74LS299N	614	74LS129N	176	74LS113N	64	74LS129N	176	74LS114N	92	74LS299N	614	74LS129N	176	74LS114N	92	74LS299N	614																																																																																																																																																																																																																																																											
7416N	42	7486N	180	74166N	140	74303N	36	74LS129N	176	74LS113N	64	74LS129N	176	74LS114N	92	74LS299N	614	74LS129N	176	74LS113N	64	74LS129N	176	74LS114N	92	74LS299N	614	74LS129N	176	74LS114N	92	74LS299N	614																																																																																																																																																																																																																																																											
7417N	42	7487N	180	74167N	140	74303N	36	74LS129N	176	74LS113N	64	74LS129N	176	74LS114N	92	74LS299N	614	74LS129N	176	74LS113N	64	74LS129N	176	74LS114N	92	74LS299N	614	74LS129N	176	74LS114N	92	74LS299N	614																																																																																																																																																																																																																																																											
7418N	42	7488N	180	74168N	140	74303N	36	74LS129N	176	74LS113N	64	74LS129N	176	74LS114N	92	74LS299N	614	74LS129N	176	74LS113N	64	74LS129N	176	74LS114N	92	74LS299N	614	74LS129N	176	74LS114N	92	74LS299N	614																																																																																																																																																																																																																																																											
7419N	42	7489N	180	74169N	140	74303N	36	74LS129N	176	74LS113N	64	74LS129N	176	74LS114N	92	74LS299N	614	74LS129N	176	74LS113N	64	74LS129N	176	74LS114N	92	74LS299N	614	74LS129N	176	74LS114N	92	74LS299N	614																																																																																																																																																																																																																																																											
7420N	22	7490N	58	74170N	200	74LS151N	32	74LS153N	88	74LS155N	150	74LS157N	88	74LS158N	99	74H01	32	74LS159N	110	74LS160N	125	74H02	32	74LS161N	125	74H03	32	74LS162N	125	74H04	32	74LS163N	125	74H05	32	74LS164N	125	74H06	32	74LS165N	125	74H07	32	74LS166N	125	74H08	32	74LS167N	125	74H09	32	74LS168N	125	74H10	32	74LS169N	125	74H11	32	74LS170N	125	74H12	32	74LS171N	125	74H13	32	74LS172N	125	74H14	32	74LS173N	125	74H15	32	74LS174N	125	74H16	32	74LS175N	125	74H17	32	74LS176N	125	74H18	32	74LS177N	125	74H19	32	74LS178N	125	74H20	32	74LS179N	125	74H21	32	74LS180N	125	74H22	32	74LS181N	125	74H23	32	74LS182N	125	74H24	32	74LS183N	125	74H25	32	74LS184N	125	74H26	32	74LS185N	125	74H27	32	74LS186N	125	74H28	32	74LS187N	125	74H29	32	74LS188N	125	74H30	32	74LS189N	125	74H31	32	74LS190N	125	74H32	32	74LS191N	125	74H33	32	74LS192N	125	74H34	32	74LS193N	125	74H35	32	74LS194N	125	74H36	32	74LS195N	125	74H37	32	74LS196N	125	74H38	32	74LS197N	125	74H39	32	74LS198N	125	74H40	32	74LS199N	125	74H41	32	74LS200N	125	74H42	32	74LS201N	125	74H43	32	74LS202N	125	74H44	32	74LS203N	125	74H45	32	74LS204N	125	74H46	32	74LS205N	125	74H47	32	74LS206N	125	74H48	32	74LS207N	125	74H49	32	74LS208N	125	74H50	32	74LS209N	125	74H51	32	74LS210N	125	74H52	32	74LS211N	125	74H53	32	74LS212N	125	74H54	32	74LS213N	125	74H55	32	74LS214N	125	74H56	32	74LS215N	125	74H57	32	74LS216N	125	74H58	32	74LS217N	125	74H59	32	74LS218N	125	74H60	32	74LS219N	125	74H61	32	74LS220N	125	74H62	32	74LS221N	125	74H63	32	74LS222N	125	74H64	32	74LS223N	125	74H65	32	74LS224N	125	74H66	32	74LS225N	125	74H67	32	74

ACOUSTIC COUPLER

\$47.50



This coupler was manufactured by Novation, Inc., Tarzana, Ca. for use in Texas Instruments model 725 Electronic Terminal. It is compatible with Bell 103 and 113 data sets or the equivalent. The coupler operates asynchronously to a maximum speed of 300 baud in the full or half duplex mode. All signal outputs are compatible with TTL. Transmitt. freq. is 1270Hz. for mark and 1070Hz. for space. Receive freq. is 2225Hz. for mark and 2025Hz. for space. Unit requires 2 1/2 volts and 45 volts for operation. Complete with schematic and all pertinent information fully reconditioned, calibrated and guaranteed.

RS232 to TTL to RS232 converter kit.....\$4.50 (includes P.C. board and schematic)

DO-IT-YOURSELF AND SAVE!

NEW!

ETCH MATERIAL

ACE Makes It Easy With Etch Powder. Etch 'em To Your Own Specifications.

EP-1.....makes.....1qt.....\$1.50
EP-2.....makes.....1gal.....\$3.50 (with instructions)

PRINTED CIRCUIT BOARDS

G-10 1/16" Unetched Copper Clad
1oz. 2-sided or 2 oz. 1-sided

SIZE	1	10	100
3"x6"	.50	2.50	19.95
5"x7"	.75	4.00	29.95
6"x6"	.75	4.00	29.95
4"x12"	1.00	5.00	39.95

contact ACE for quotes on custom sizes

KYNAR WIRE WRAP WIRE

Solid Silver Plated 30 AWG Blue, Red, Yellow, Black, Green, or White.

100' Spool.....\$2.50
500' Spool.....\$9.95
25' AWG Red or Black
500' Spool.....\$7.95
1000' Spool.....\$12.50

PLEASE SPECIFY COLOR

10V 200ma P.C. mount 1 1/4" x 1 3/8" w x 1 1/8" thick. PRI: 117V 10/31/95 100/\$99.50

SPECTROL 10-TURN PRECISION POT

10k ohm 25% Lin. 2.25x.75x.10 (.875" dia.) \$2.50 10 for \$19.95

EAGLE-PICHER

CG6V5 6volt 5A.H. spill-proof, rechargeable battery. \$12.50/ea. 10/\$99.95

NEW-1 YEAR WARRANTY

TRIAC

G.E. SC51B 15A 200V in press fit case. Ideal for color organs. 10 for \$7.50 \$1.00 ea.

COMPUTER GRADE CAPS

32D COMPULYTIC 5900MF-60VDC 10/12.50
36D COMPULYTIC 5000MF-60VDC 10/19.00

6310

1392 turns 50mh 66ma 10 for \$2.95

MINI KIT

60HZ. CRYSTAL TIME BASE SPECIAL OFFER ON MINI KIT INCLUDES MM5369 and 3579.545KHZ. CRYSTAL with SCHEMATIC. \$3.95

STANDARDS KIT

An assortment of precision components for calibration of test equipment. Kit includes (10) assorted 1% capacitors, (10) assorted 0.01% resistors, and (1) temperature compensated zener reference diode. ONLY \$6.95

PITTMAN 12 VOC MOTOR

The Pittman runs on as low as 2 volts, rated 12 volts 250 ma., 2.8 inch oz. torque at 5000RPM. 1 1/8" DIA X 2" long with 0.118" shaft. New. Guaranteed. 10 for \$15.00

10K LINEAR POT

1 1/2" shaft 1 1/4" dia. base \$7.50/ea

HEWLETT PACKARD

7730 3" char. RED common anode \$1.50 4 for \$5.95

ROCKER SWITCH

4 Amp 125 VAC. 5 Amp 125 VDC. 1.5 Amp 250 VAC. 2 Pol. - 3 Pos. Specially: Spring loaded center off, or 3 position lock. \$4.9 ea. 10/\$2.50 1000/\$50.00

PVC HOOKUP WIRE

bag of ass. colors in 3 10 ft. lengths. Ideal for any wiring project. approx. 100' \$1.00

BISMUTH ALLOY

MELTS IN BOILING WATER for. ingot \$3.95 lib. \$9.95 FUN TO PLAY WITH!

6" POWER CORDS

BLACK OR WHITE 10 FOR ONLY \$2.95

HEAT SINK

Thermalloy p/n 6030B. Ideal for flat power devices. 1" x 1 1/8" high \$2.5 ea. 10/\$1.98

24V RELAY

KHS17D11 4PDT 3 amp. herm. sealed Pulled from new equipment \$3.98/ea.

1.0CITE SUPERBONDER

Bonds Rubber, Plastic, Metal in Seconds. Compare at \$1.98 for 0.1oz. elsewhere. Comparable with Eastman 910. 1oz. Bottle \$4.95

DYNAMIC RAM

TMS40301L 4096-BIT low power 400MW. removed from sockets tested and guaranteed. \$9.95/ea. with 22 pin socket and data. 8 FOR \$64.95

ROTARY SWITCHES

Rated 250 ma @ 28 VDC. Single pole, 10 position, non-shorting. Model 87 by Spectrol. (P.C. mount) \$7.12 Screwdriver Adjust \$7.9 Knob Adjust \$9.11

HEAT SHRINK TUBING ASST.

25/16" LENGTHS VARIOUS SIZES AND COLORS \$2.95

TEFLON TUBING ASSORTMENT

25/16" LENGTHS VARIOUS SIZES AND COLORS \$1.95

ARNOLD CORE

135 MH per 1000 turns. 1" ID x 1 7/8" OD x 3/4" THK. p/n A-759135-2 \$1.50 ea. 100 for \$98.00

LITTLE VINYL FEET

self-sticking square or round feet. ACE SPECIAL SHEET OF 50 \$1.00

ZENER DIODE

1N752 5.6V 400mW 100 for \$5.95 1000 for \$49.95

HARDWARE

1/2LB. MIXED ELECTRONIC HARDWARE.....\$1.00

PERMA-FLEX TAPE

3/4" wide x 66' long. All weather, 8000V (.085 thick) Black. \$1.00 per roll, \$7.95 per 10 roll package. UL APPROVED

SLIDE SWITCH

SPST 4A@125VAC 1-1/8" mt. ctrs. 4" leads 100 for \$3.50

PHOTO-FLASH CAP

600mfd 360v (3/4" x 1" dia.) 1-1/8 ea. 10 for \$15.00

WIRE DISPENSER

With 50' roll of 30AWG Kynar. Cuts the wire to length. Strips 1" of insulation. Refillable spool. BLUE, YELLOW, WHITE, or RED

TEFLON TUBING CLEAR 18 GA.

Extremely high operating temperature range and chemical inertness. Will not crack or become brittle. Remains flexible throughout entire operating temp. range. 100' roll \$4.95 1000' roll \$24.95

ACE ELECTRONIC PARTS

5400 MITCHELLEDALE B-8 HOUSTON, TEXAS 77092 PH. 713-688-8114

TERMS: Include check or money order. NO C.O.D. Texas residents add 5% sales tax. Canada and Mexico add \$2.50. Overseas countries add \$5.00 for surface rates. We pay postage up to 10 pounds.

\$100 FOR \$19.8

INCLUDES TTL MEMORY, AND SPECIAL FUNCTION IC's. ALMOST ALL MARKED. OUR TEST SHOW VERY HIGH YIELD.

WRITE FOR FREE CATALOG

UNIVERSAL 4K x 8 MEMORY BOARD KIT

\$74.50
32-2102-1 fully buffered, 16 address lines, on board decoding for any 4 of 64 pages, standard 44 pin bus.

EXPANDABLE F8 CPU BOARD KIT

\$99.00
featuring Fairbug PSU 1K of static ram, RS 232 interface, documentation, 64 BYTE register CD4046 - \$2.20

4K BASIC FOR FAIRBUG F8

on paper tape \$25.00

C/MOS (DIODE CLAMPED)

74C10	-22	4012	-22	4023	-22	4042	-78
74C193	-1.50	4013	-40	4024	-75	4046	-2.25
4001	-1	4015	-95	4025	-22	4049	-40
4002	-2	4016	-40	4026	-40	4050	-40
4006	-1.20	4017	-1.05	4028	-88	4055	-1.50
4007	-2	4018	-1.00	4029	-1.10	4066	-80
4009	-4	4019	-25	4030	-22	4071	-27
4010	-4	4020	-1.05	4033	-1.50	4076	-1.05
4011	-22	4022	-95	4035	-1.10		

WSU-30 Hand wire wrap tool used to wrap, unwrap & Strip #30 wire

\$5.95

#24, EIGHT CONDUCTOR SPECTRA FLAT CABLE 100'S/15.50	DIP SOCKETS 8 PIN - 22 24 PIN - 40 14 PIN - 25 28 PIN - 50 16 PIN - 28 40 PIN - 60 18 PIN - 30	#30 WIRE WRAP WIRE SINGLE STRAND 100'S/14.60
---	--	--

2708 8K EPROM \$24.95	2522 CHARACTER SHIFT REG \$1.95
2513 CHARACTER GEN \$9.95	2518 4X 32 BIT SR \$2.50
2102 11024 BT RAM \$1.29	5280 4K DYNAMIC RAM \$4.75
1101A 256 BIT RAM \$85	MM5203 UV PROM \$6.95
1702A UV PROM \$4.95	5204 4K PROM \$10.95
AY-5-1013 UART \$6.95	

LED READOUTS

FND 359 C.C. 4" \$5.50 HP 7740 3" C.C. \$1.25
FND 70 C.C. 4" \$5.50 MAN-7.3" C.A. \$9.95
FND 503 C.C. 5" \$8.50 NS 33-3 dig. array \$7.75
FND 510 C.A. 5" \$8.50 DI 747 C.A. \$1.95

PRINTED CIRCUIT BOARD

4 1/2" x 6 1/2" SINGLE SIDED EPOXY BOARD 1/16" thick unetched \$5/2.60

7 WATT LD-65 LASER DIODE IR \$8.95

2N 3820 P FET \$4.45	2N 5457 N FET \$4.45
2N2646 \$4.45	ER 900 TRIGGER DIODES \$4.10
2N 6028 PROM LUJT \$6.50	

MINIATURE MULTI-TURN TRIM POTS

100, 500, 1K, 2K, 5K, 10K, 25K, 50K, 100K, 200K, 500K 1 Meg. \$7.5 ea. \$3/2.00

MULTI-TURN TRIM POTS Similar to Bourns 3010 style 3/16" x 5/8" x 1 1/4" 50, 100, 1K, 10K, 50K ohms \$1.50 ea. \$3/4.00 VERIPAX PC BOARD This board is a 1 1/16" single sided paper epoxy board, 4 1/2" x 6 1/2" DRILLED and ETCHED which will hold up to 21 single 14 pin IC's or 8, 16, or LSI DIP IC's with buses for power supply connector. \$4.00 MM 5691 YELLOW-GREEN \$9.90 BIPOLAR LED \$5.50 FP 100 PHOTO TRANS. \$5.50 RED, YELLOW, GREEN or AMBER LARGE LED'S \$61.00 1L-5 (MCT-2) \$7.75 MOLEX PINS 1000/51.00 10 WATT ZENERS 3.9, 4.7, 5.6, 8.2, 12, 15, 18, 22, 100, 150, or 200V. ea. \$6.001 WATT ZENERS 4.7, 5.6, 6.0, 12, 15, 18 or 22V. ea. \$2.25 MC6860 MODEM CHIP \$9.95 Silicon Power Rectifiers | | | |-----------------------------|--| | PRV 1A 3A 12A 50A 125A | | | 100 06 .14 .30 .80 3.70 | | | 200 07 .20 .35 1.15 4.25 | | | 400 09 .25 .50 1.40 6.50 | | | 600 11 .30 .70 1.80 8.50 | | | 800 15 .35 .90 2.30 10.50 | | | 1000 20 .45 1.10 2.75 12.50 | | SILICON SOLAR CELLS 2 1/4" diameter 4V at 500 ma. \$4.00 / 2V at 200 ma. \$2.00 REGULATORS | | | |------------------------------|---------------------------------------| | 309K \$9.50 | 340K-5,12,15 \$8.50 | | 723 \$7.50 | or 24V. \$8.50 | | LM 376 \$6.00 | 340T-5, 6, 8, 12 \$15.18 or 24V\$1.10 | | 320K-5 or 15V \$1.40 | 78 MG \$1.35 | | 320T-5, 12, 15 or 24V \$8.75 | 79 MG \$1.35 | RS232 CONNECTORS DB 25P male \$2.95 DB 25F female \$3.50

TRANSISTOR SPECIALS

2N3585 NPN Si TO 66	\$3.60
2N3772 NPN Si TO 3	\$1.95
2N1546 PNP GE TO 3	\$1.75
2N4908 PNP Si TO 3	\$1.00
2N6056 NPN Si TO 3 Darlington	\$1.70
2N5086 PNP Si TO 92	4/5 \$1.00
2N4898 PNP TO 66	\$1.50
2N404 PNP TO 5	5/5 \$1.00
2N3919 NPN Si TO 3 RF	\$1.80
MPSA 13 NPN Si TO 92	3/5 \$1.00
2N3767 NPN Si TO 66	\$1.70
2N2222 NPN Si TO 18	5/5 \$1.00
2N3055 NPN Si TO 3	\$1.70
2N3904 NPN Si TO 92	5/5 \$1.00
2N3906 PNP Si TO 92	\$1.50
2N5996 NPN Si TO 220	\$1.50
2N6109 PNP Si TO 220	\$1.55
2N3638 PNP Si TO 5	5/5 \$1.00
2N6517 NPN TO 92 S	3/5 \$1.00

TTL IC SERIES

7400 - 14	7445 - 15	74150 - 90
7401 - 14	7446 - 65	74151 - 60
7402 - 14	7447 - 65	74152 - 60
7403 - 14	7448 - 65	74154 - 95
7404 - 18	7450 - 15	74155 - 70
7405 - 18	7472 - 29	74157 - 58
7406 - 25	7473 - 29	74161 - 85
7407 - 25	7474 - 29	74163 - 80
7408 - 18	7475 - 45	74164 - 95
7409 - 17	7476 - 30	74165 - 95
7410 - 14	7480 - 35	74173 - 120
7411 - 20	7483 - 52	74174 - 95
7412 - 20	7485 - 87	74175 - 82
7413 - 39	7486 - 30	74176 - 75
7414 - 63	7489 - 1.85	74177 - 75
7416 - 25	7490 - 42	74180 - 65
7417 - 25	7491 - 58	74181 - 190
7420 - 14	7492 - 43	74190 - 100
7425 - 25	7493 - 45	74191 - 100
7426 - 22	7494 - 70	74192 - 83
7427 - 25	7495 - 65	74193 - 83
7430 - 14	7496 - 65	74194 - 85
7432 - 25	74107 - 28	74195 - 52
7433 - 21	74121 - 33	74251 - 26
7438 - 21	74123 - 65	74279 - 87
7440 - 14	74125 - 40	75324 - 1.75
7441 - 70	74126 - 40	75491 - 65
7442 - 40		75492 - 65

MINIATURE DIP SWITCHES

CTS-206-4 Four SPST switches in one midsize package \$1.75
CTS-206-8 Eight SPST switches in a 16 pin dip package \$1.95

5/8 SPST Miniature reed, relay, normally open. 330 Ohm coil resistance \$78.35/200

ALCO MINIATURE TOGGLE SWITCHES

MTA 106 SPDT \$1.20
MTA 206 DPDT \$1.70

Full Wave Bridges

PRV	2A	6A	25A
200	75	1.25	2.00
400	95	1.50	3.00
600	1.20	1.75	4.00

SANKEN AUDIO POWER AMPS

Si 1010 G 10 WATTS \$7.95
Si 1020 G 20 WATTS \$15.95
Si 1050 G 50 WATTS \$27.95

TANTALUM CAPACITORS

22UF 35V 5 \$1.00	68UF 35V 3 \$1.00
47UF 35V 5 \$1.00	22UF 35V 5 \$4.00
68UF 35V 5 \$1.00	30UF 6V 5 \$1.00
1UF 35V 5 \$1.00	33UF 35V 5 \$4.00
2.2UF 20V 5 \$1.00	47UF 20V 5 \$3.50
3.3UF 35V 4 \$1.00	68UF 15V 5 \$5.00
4.7UF 15V 5 \$1.00	10UF 25V 5 \$2.50

M/001 ALARM CLOCK CHIP \$5.75

74LS SERIES

74LS00 - 23	74LS125 - 65	LM 101 - 75
74LS02 - 23	74LS126 - 65	LM 307/1748 - 30
74LS03 - 23	74LS132 - 80	LM 307 - 30
74LS04 - 28	74LS138 - 72	LM 308 - 95
74LS05 - 28	74LS139 - 72	LM 311 - 95
74LS06 - 23	74LS145 - 1.15	LM 318 - 1.35
74LS09 - 33	74LS151 - 98	LM 319 - 1.35
74LS10 - 23	74LS153 - 93	LM 324 - 1.05
74LS11 - 23	74LS155 - 1.40	LM 339 - 1.10
74LS13 - 50	74LS156 - 95	LM 377 - 2.50
74LS15 - 23	74LS157 - 98	LM 380 - 95
74LS20 - 23	74LS160 - 1.02	LM 381 - 1.25
74LS21 - 23	74LS161 - 1.02	LM 382 - 1.25
74LS22 - 23	74LS162 - 1.10	LM 537 - 2.50
74LS27 - 27	74LS163 - 1.02	LM 553 - 2.50
74LS30 - 23	74LS168 - 1.10	LM 555 - 4.40
74LS32 - 33	74LS169 - 1.10	LM 556 - 8.00
74LS37 - 37	74LS173 - 1.10	
74LS40 - 27	74LS174 - 1.05	660 - 2.00
74LS41 - 23	74LS175 - 1.22	565 - 1.10
74LS42 - 23	74LS190 - 1.50	566 - 1.50
74LS43 - 23	74LS191 - 1.50	567 - 1.50
74LS44 - 23	74LS192 - 1.75	703 - 90
74LS49 - 49	74LS193 - 1.75	709 - 95
74LS50 - 89	74LS258 - 1.38	LM 1310 - 2.50
74LS52 - 43	74LS267 - 66	CA 3047 - 95
74LS53 - 40	74LS196 - 99	711 - 35
74LS74 - 40	74LS197 - 99	741 C or V - 35
74LS76 - 40	74LS267 - 1.35	747 - 65
74LS90 - 89	74LS268 - 1.38	LM 1310 - 2.50
74LS92 - 85	74LS269 - 38	1456 - 95
74LS93 - 85	74LS266 - 66	1458 - 60
74LS109 - 50	74LS366 - 66	CA 3046 - 75
74LS112 - 43	74LS367 - 66	CA 3047 - 95
74LS113 - 43	74LS368 - 66	3900 - 4.90
74LS114 - 43	74LS390 - 2.20	8038CC - 3.90

TRIACS

PRV	1A	10A	25A	1.5A	6A	35A
100	40	70	1.30	40	50	1.20
200	70	110	1.75	60	70	1.60
400	110	160	2.60	100	1.20	2.20
600	170	230	3.60	150	3.00	

SCR'S

Terms: FOB Cambridge, Mass. Send Check or Money Order. Include Postage, Minimum Order \$5.00, COD'S \$20.00

Send 25¢ for our catalog featuring Transistors and Rectifiers 145 Hampshire St., Cambridge, Mass.

SOLID STATE SALES

P.O. BOX 74A SOMERVILLE, MASS. 02143 TEL. (617) 547-4005

WE SHIP OVER 95% OF OUR ORDERS THE DAY WE RECEIVE THEM

The source of perfection in stereo sound... Pickering's new XSV/3000

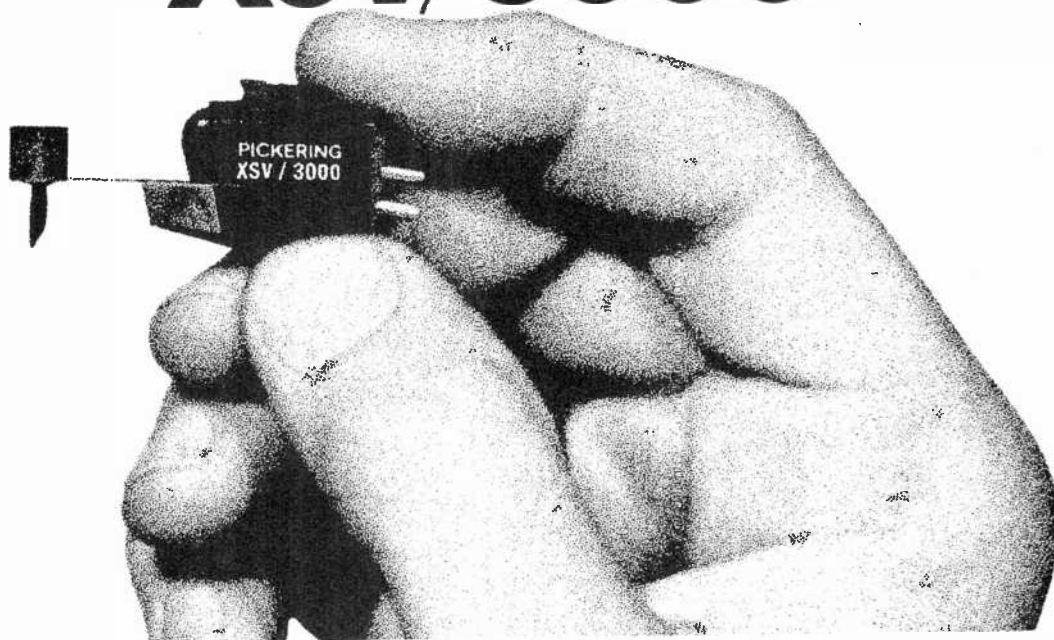

The reviewers applaud as never before!

"... we don't see how you can do better at any price."
Hirsch-Houck Laboratories. Stereo Review. February 1977

"The new unit offers the stereo performance of the XUV/
4500Q (or perhaps a little better than that) at a lower
price. It seems hard to go wrong with such a combina-
tion."

CBS Technology Center. High Fidelity. February 1977

"Congratulations to all concerned on a fine contender
amongst the world's best stereo pick-ups."

John Borwick. Gramophone. United Kingdom 1977

Pickering's new XSV/3000 is a remarkable develop-
ment. It possesses a totally new and different design that
makes it the precursor of a whole new generation of so-
phisticated, advanced stereo cartridges.

This has been made possible by technological advances
in two areas. **First**, it has an unusually tiny, samarium
cobalt (rare earth) magnet of remarkably high power that

permits extremely low mass, and also offers high output.
Second, this cartridge features the new Stereohedron™
stylus tip, a Pickering first! This extraordinary shape has a
far larger bearing radius, which provides increased con-
tact area in the record groove. This assures gentler treat-
ment of the record groove, longer record life, and also,
far longer stylus life.

This cartridge provides remarkably smooth and flat fre-
quency response; its channel separation is exceptional,
its transient response possesses superb definition.

Truly, Pickering's XSV/3000 represents a whole new
concept of excellence in stereo cartridges... the true
Source of perfection in stereo sound.

For further information write to
Pickering & Co., Inc. Dept. PE,
101 Sunnyside Blvd., Plainview,
New York 11803



"for those who can **hear** the difference"

PICKERING & CO., INC., COPYRIGHT 1977

CIRCLE NO. 48 ON FREE INFORMATION CARD



When you've got a Pace CB radio,



you've got the world by the ears.

There are millions out there with their ears on waiting to talk to you Pace to Pace.

And with a Pace CB two-way radio you've got every bit of power the law allows. And features to cut through interference and "bleeders" from other channels.

What's more, it's assembled with computerized circuitry and it's 100% solid state, so it's as trouble-free as a CB can be.

It all adds up to your voice getting out

there clearer and with less distortion, and the other guy's voice coming back just as clear.

To learn more, drop into a Pace place near you. The dealer will tell you just how economical and easy-to-install a Pace is. He'll help you choose the one that's just right for you, too.

Ask him for the world by the ears. He'll know which CB you're talking about.



PACE CB 8015

pace
 PACE CB / PACE TWO-WAY RADIO PRODUCTS
 BY PATHCOM INC., HARBOR CITY, CA 90710

CIRCLE NO. 47 ON FREE INFORMATION CARD