

Popular Electronics®

WORLD'S LARGEST-SELLING ELECTRONICS MAGAZINE

14278

A  **FIRST!**

Now You Can Enjoy HI-FI Remote Sound

**WITHOUT RUNNING WIRES
AROUND THE HOUSE**



PROJECTS:

- **Build a Digital Stopclock**
- **Voltmeter Measures to Beyond 20 MHz**

FEATURES:

- **How to Use CB Radio
"Buzz" Words**
- **Introduction to
Radio Astronomy**

TEST REPORTS:

- B-I-C Belt-Drive Record Changer**
- Pickering Stereo Phono Preamp**
- Tram AM CB Mobile Transceiver**
- Heath Color Organ**

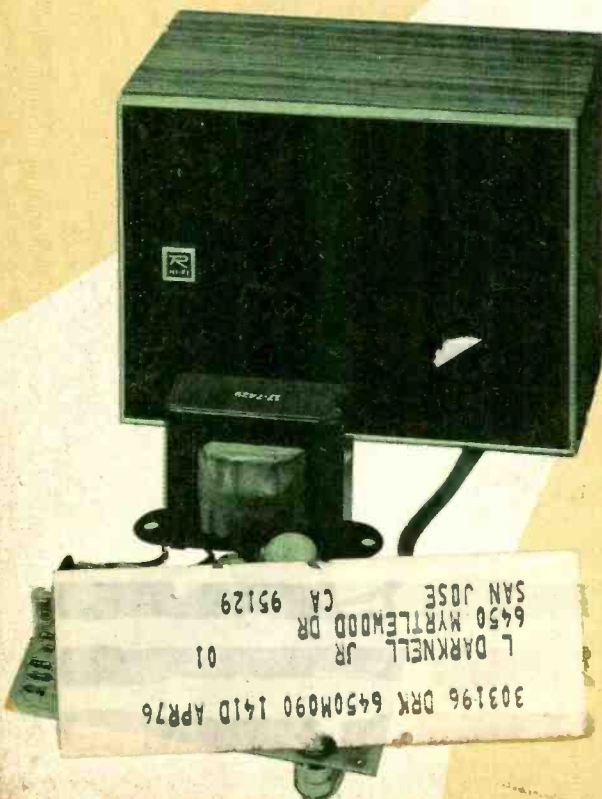



We don't just talk quality

We build quality. That's why Cobra CB radios are engineered and built to operate at peak performance under all conditions. But we don't stop there. Our concern for quality assures you of performance that makes using your CB more enjoyable. And our dealers and distributors are concerned about customer service.

All this—because, like you, we're serious about CB.



Cobra

Products of Dynascan

1801 W. Belle Plaine Ave., Chicago, Illinois 60613 (312) 327-7270

CIRCLE NO. 13 ON FREE INFORMATION CARD

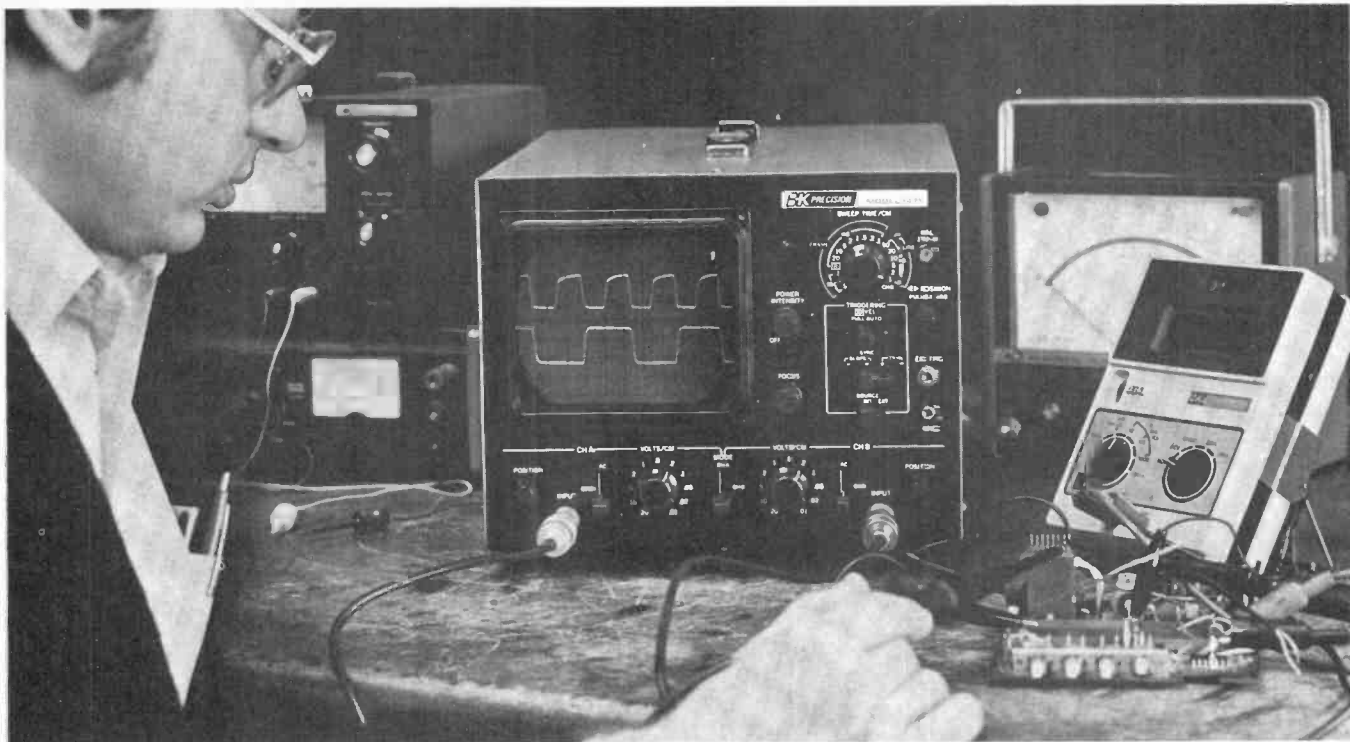

Remember when a good dual trace scope cost less than \$500? It does again.

Model 1471 Dual Trace Oscilloscope \$495

As the B&K-Precision Model 1471 rolls back the economic calendar, it significantly advances performance capabilities of 10MHz oscilloscopes. Model 1471 shares many of the performance and convenience features of our higher priced scopes, benefiting from Dynascan's position as a leading supplier of medium bandpass scopes.

Deflection factor is 0.01V/cm to 20V/cm in 11 ranges. Model 1471 has 18 calibrated sweeps— $1\mu\text{SEC}/\text{cm}$ to $.5\text{SEC}/\text{cm}$ and sweep to 200nSEC/cm with 5x magnification. Regulation maintains calibration accuracy from 105 to 130VAC. Rise time is 35nSEC. Automatic triggering is obtained on waveforms with as little as 1cm deflection. Dual trace display mode automatically shifts between CHOP and ALTERNATE as sweep time is changed, speeding set-up.

Front panel X-Y operation uses matched vertical amplifiers, preserving full calibration accuracy for both amplitude and phase. The intensity modulation input (Z axis) is compatible with TTL, permitting use in character display systems, and for time or frequency markers. Bright blue P31 phosphor makes any waveform easy to see. Circuit board with plug connectors permit easy user maintenance. BNC connectors. Operates on 117/230-VAC 50/60Hz.

- 10 MHz Bandwidth—useable to 15 MHz
- Mode automatically shifts between CHOP and ALTERNATE as you change sweep time
- Bright blue P31 phosphor
- 18 calibrated sweeps— $1\mu\text{SEC}/\text{cm}$ to $.5\text{SEC}/\text{cm}$
- Sweep to 200nSEC/cm with 5X magnification
- Maintains calibration accuracy over 105-130VAC range
- Front panel X-Y operation using matched vertical amps
- Input grounding switches
- TV sync separators
- Check most digital logic circuitry including CMOS
- Character display applications using TTL Z-axis intensity modulation
- BNC connectors

In-Stock Free Trial

Model 1471, or any B&K-Precision oscilloscope, can be obtained from your local distributor—or call Dynascan. You'll find the scope you need in stock today. Write for detailed specifications.

B&K PRECISION

PRODUCTS OF DYNASCAN

1801 W. Belle Plaine • Chicago, Illinois 60613

ALTAIR 4K's

~~\$264~~

\$195!

NEW ALTAIR I/O CARDS

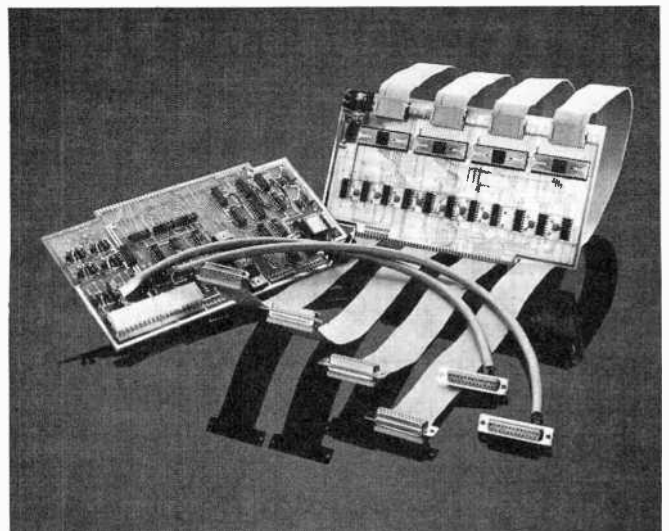

The price of the ALTAIR 4K memory boards from MITS was incorrectly listed at \$264 in the "MITS-MAS" Christmas Catalog printed in December's *Popular Electronics*. Unfortunately, the price change came after the catalog was printed.

The ALTAIR 4K board provides 4,096 words (bytes) of dynamic RAM (Random Access Memory) for the ALTAIR 8800. Each individual board contains memory protect circuitry and address selection circuitry for any one of 16 starting address locations in increments of 4K. The maximum access time of the ALTAIR 4K board was recently reduced from 300 nanoseconds to 200 nanoseconds.

Dynamic memory was chosen for the ALTAIR 4K board because it is generally faster and requires less current than static memory (a 4K static card that meets ALTAIR bus drive specifications requires close to three times the 5 volt current of dynamic memory).

Other ALTAIR 8800 memory options include a 1K (1,024 words) and a 2K (2,048 words) static memory card. These low power static memory cards contain memory protect features and have a maximum access time of 850 nanoseconds.

ALTAIR 8800 Memory Prices:

4K Dynamic.....	\$195 kit and \$275 assembled
2K Static.....	\$145 kit and \$195 assembled
1K Static.....	\$ 97 kit and \$139 assembled

Prices, delivery and specifications subject to change.

MIT S

"Creative Electronics"

MIT S/6328 Linn N.E., Albuquerque, NM 87108 505/262-1951

Two new ALTAIR 8800 I/O boards are now in production. These include a serial interface (88-2SIO) that can be ordered with one or two ports, and a parallel interface (88-PIO) that can be ordered with up to four ports.

Each port of the new Serial interface board is user-selectable for RS232, TTL, or 20 milliamp current loop (Teletype). The 88-2SIO with two ports can interface two serial I/O devices, each running at a different baud rate and each using a different electrical interconnect. For example, the 88-2SIO could be interfaced to an RS232 CRT terminal running at 9600 baud and a Teletype running at 110 baud.

An on-board, crystal-controlled clock allows each port to be set for one of 12 baud rates: 37.5, 75, 110, 150, 300, 450, 600, 1200, 1800, 2400, 4800, or 9600. Baud rates are the speed at which data is transferred between the computer and the I/O device.

Each port of the new Parallel interface provides 16 data lines and four controllable interrupt lines. Each of the data lines can be used as an input or output so that a single port can interface a terminal requiring 8 lines in and 8 lines out—or it can interface two input devices such as a paper tape reader and a keyboard—or two output devices such as a paper tape punch and printer—or any combination for custom applications. All data lines are fully TTL compatible.

ALTAIR 8800 Interface Prices:

88-2SIO Serial Interface.....	\$115 kit and \$144 assembled
88-SP additional 88-2SIO port.....	\$ 24 kit and \$ 35 assembled
88-4PIO Parallel Interface with one port.....	\$ 86 kit and \$112 assembled
88-PP additional 88-4PIO port.....	\$ 30 kit and \$ 39 assembled

Popular Electronics®

WORLD'S LARGEST SELLING ELECTRONICS MAGAZINE

FEATURE ARTICLES

AN INTRODUCTION TO RADIO ASTRONOMY	David Heiserman	41
<i>A simple telescope system will get you into a fascinating new hobby.</i>		
I²L—A NEW TRANSISTOR LOGIC FAMILY	William D. Haffner	56
<i>Provides high speed and low power requirements.</i>		
ENVELOPE GENERATORS & SEQUENCERS FOR ELECTRONIC MUSIC	Don Lancaster	58
<i>Shaping tones or notes and determining combinations or order.</i>		

CONSTRUCTION ARTICLES

A WIRELESS AUDIO SYSTEM FOR REMOTE SPEAKERS	Jim Sherwin	35
<i>High-quality remote sound without running wires.</i>		
BUILD A \$25 HIGH-FREQUENCY VOLTMETER	Thomas H. Sear	46
<i>Measures up to 90 volts from dc to beyond 20 MHz.</i>		
A DIGITAL STOPCLOCK FOR SHORT & LONG EVENT TIMING	Michael S. Robbins	48
<i>Times to 10 hours in 0.1-second intervals.</i>		
THE PROGRAMMABLE MUSIC BOX, PART 2	Mitchell Waite & Larry Brown	53
<i>Adding a 256-word memory and programming notes.</i>		

COLUMNS

STEREO SCENE	Art Salsberg	18
<i>Audio Potpourri.</i>		
SOLID STATE	Lou Garner	79
<i>Prophecies for Next Year.</i>		
TEST EQUIPMENT SCENE	Leslie Solomon	83
<i>Making Good Use of Noise.</i>		
COMPUTER BITS	Jerry Ogdin	88
<i>Interrupts & Real-Time.</i>		
CB SCENE	Sherman P. Wantz	91
<i>How to Use CB Radio "Buzz" Words.</i>		
ART'S TV SHOP	Art Margolis	93
<i>The Bewildering Brightness.</i>		
AMATEUR RADIO	Herbert S. Brier	96
<i>Using Slow-Scan TV.</i>		
HOBBY SCENE Q & A	John McVeigh	98
EXPERIMENTER'S CORNER	Forrest Mims	101
<i>Using an Optoisolator.</i>		

PRODUCT TEST REPORTS

BIC MODEL 980 MULTIPLE PLAY MANUAL RECORD PLAYER	68
PICKERING MODEL PP-1 PHONO PREAMPLIFIER	69
TRAM XL AM CB TRANSCEIVER	70
HEATHKIT MODEL TD-1006 4-CHANNEL COLOR ORGAN KIT	72
SENCORE MODEL CR31 CRT TESTER & RESTORER	73

DEPARTMENTS

EDITORIAL	Art Salsberg	4
<i>Buzz Words & OEM Distributors.</i>		
LETTERS		6
NEW PRODUCTS		12
NEW LITERATURE		16
ELECTRONICS LIBRARY		99
OPERATION ASSIST		100
ADVERTISERS INDEX		119

POPULAR ELECTRONICS, January 1976, Volume 9, Number 1, Published monthly at One Park Avenue, New York, NY 10016. One year subscription rate for U.S., \$6.98; U.S. Possessions and Canada, \$7.98; all other countries, \$8.98. Second Class postage paid at New York, NY and at additional mailing offices. Authorized as second class mail by the Post Office Department, Ottawa, Canada and for payment of postage in cash. Subscription service and Forms 3579; P.O. Box 2774, Boulder, CO 80302.

POPULAR ELECTRONICS including ELECTRONICS WORLD, Trade Mark Registered. Indexed in the Reader's Guide to Periodical Literature. COPYRIGHT © 1975 BY ZIFF-DAVIS PUBLISHING COMPANY. ALL RIGHTS RESERVED.

Ziff-Davis also publishes Boating, Car and Driver, Cycle, Flying, Modern Bride, Popular Photography, Skiing and Stereo Review.

Editorial correspondence: POPULAR ELECTRONICS, 1 Park Ave., New York, NY 10016. Editorial contributions must be accompanied by return postage and will be handled with reasonable care; however, publisher assumes no responsibility for return or safety of manuscripts, art work, or models.

Forms 3579 and all subscription correspondence: POPULAR ELECTRONICS, Circulation Dept., P.O. Box 2774, Boulder, CO 80302. Please allow at least eight weeks for change of address. Include your old address, enclosing, if possible, an address label from a recent issue.

EDGAR W. HOPPER
Publisher

ARTHUR P. SALSBERG
Editorial Director

LESLIE SOLOMON
Technical Editor

JOHN R. RIGGS
Managing Editor

ALEXANDER W. BURAWA
Feature Editor

EDWARD I. BUXBAUM
Art Director

JOHN McVEIGH
Assistant Editor

ANDRE DUZANT
Technical Illustrator

PATRICIA BROWN
Editorial Assistant

LOU GARNER
GLENN HAUSER
JULIAN D. HIRSCH
RALPH HODGES
ART MARGOLIS
FORREST MIMS
JERRY OGDIN
WILFRED M. SCHERER
Contributing Editors

JOSEPH E. HALLORAN
Advertising Director

JOHN J. CORTON
Advertising Sales

LINDA BLUM
Advertising Service Manager

PEGI McENEANEY
Executive Assistant

STANLEY NEUFELD
Associate Publisher

ZIFF-DAVIS PUBLISHING COMPANY
Popular Electronics
Editorial and Executive Offices
One Park Avenue New York, New York 10016
212-725-3500

Hershel B. Sarbin, President
Furman Hebb, Executive Vice President
Vincent Perry, Financial Vice President and Treasurer
Phillip T. Heffernan, Senior Vice President, Marketing
Edward D. Muhlfield, Senior Vice President, Sports Division
Philip Sine, Senior Vice President
Frank Pomerantz, Vice President, Creative Services
Arthur W. Butzow, Vice President, Production
Lawrence Sporn, Vice President, Circulation
George Morrissey, Vice President
Sydney H. Rogers, Vice President
Sidney Holtz, Vice President
Al Traina, Vice President
Philip Korsant, Vice President
Paul H. Chook, Vice President, Market Planning
Charles B. Seton, Secretary
Edgar W. Hopper, Vice President, Electronics Div.
William Ziff, Chairman
W. Bradford Briggs, Vice Chairman

Midwestern Office
The Pattis Group, 4761 West Touhy Ave.,
Lincolnwood, Illinois 60644, 312 679-1100
GERALD E. WOLFE, THOMAS HOCKNEY
Western Office
9025 Wilshire Boulevard, Beverly Hills, CA 90211
213 273-8050; BRadshaw 2-1161
Western Advertising Manager, BUD DEAN

Japan: James Yagi
Oji Palace Aoyama; 6-25, Minami Aoyama
6 Chome, Minato-Ku, Tokyo 407-1930/6821,
582-2851



The publisher has no knowledge of any proprietary rights which will be violated by the making or using of any items disclosed in this issue.



Editorial

BUZZ WORDS & OEM DISTRIBUTORS

Esoteric expressions used by people in special fields can drive "out" groups up the wall. The latter often view such jargon as an exercise in pretentiousness. And in some cases, this is true. Usually, however, buzz words favored by the "in" people represent easy shortcuts to quick communication.

For example, what audiophile would use the term "intermodulation distortion"? It's "IM," of course. Does an electronics experimenter talk about "100 picofarads"? Nonsense! It's "100 puffs." Hams, too, have buzz words that mark them as cognoscenti, as do other groups such as CB'ers. In fact, a list of buzz words for the latter is included in this issue to ease the entry pains for CB newcomers.

You don't have to be an expert to use buzz words successfully. A recent article on the lives of prominent women pointed out that Claire Booth Luce (her husband founded *Time*, you recall) used buzz words effectively in many fields to reinforce the authoritativeness of her assertions.

There's a host of microprocessor buzz words that have touched our sensibilities recently. Schweber Electronics just published a glossary of these new words. It's called "Microprocessor Buzz Words" and is an interesting compilation, with words such as "port"—the microprocessor's contact with the outside world. The glossary is FREE when requested on letterhead. This means that, if you work for an OEM electronics company, representing a potential customer, you can get it. Good luck on obtaining the booklet (address: Jericho Turnpike, Westbury, NY 11590).

I say "good luck" because most OEM distributors won't deal with hobbyists. (I'm digressing here, but one thing always leads to another.) This view was succinctly summed up to me by Harold H. Powell, President of Powell Electronics, Philadelphia, PA. He said his company uses video terminals to quote price and delivery on a real-time basis though inventory is spread throughout the country. The system is not suited to processing many small orders for one-time customers, he concluded.

We surveyed 25 of the largest OEM distributors in the country (with 315 stocking locations) on their policies regarding sales to nonindustrial accounts. Only three responded favorably: Almo Electronics Corp., Philadelphia, PA; Semiconductor Specialists, Chicago, IL; and Summit Distributors, Buffalo, NY. Some didn't reply.

How sad—for those who won't sell retail, and for us. I do believe that a retail, cash-only, minimum-dollar-order (say, \$15 minimum) counter would be profitable for many of these distributors. A vacuum certainly exists in the walk-in electronic parts retail business; that is, local retailers with broad parts inventories. With so many electronics hobbyists in the country (PE has close to 400,000), spending substantial money for devices that include expensive MPU's, one would think that there is sufficient motivation to serve them.

FREE

The world's largest catalog of electronic kits

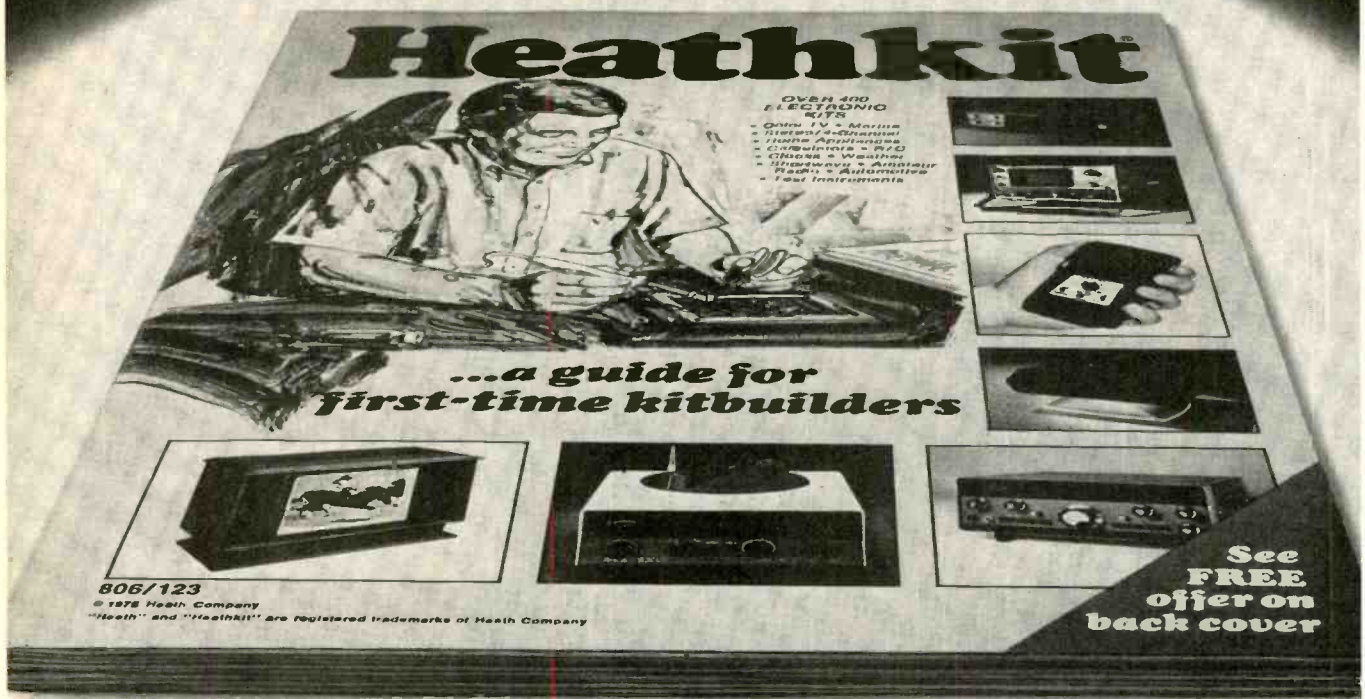

- Laboratory Breadboard • Oscilloscopes • Frequency Counters
- Digital Multimeters • Amateur Radio Gear • Color TV's
- Hi-Fi Components • Radio Control Electronics
- Automotive, Fishing, Marine & Aircraft Accessories — over 400 kits in all!

Every Heathkit product comes with a fully-illustrated, step-by-step assembly manual that tells you everything you need to know to make kitbuilding fun and easy. Thousands of people have discovered the satisfaction — and savings — of handcrafting a fine piece of electronic equipment. You can build it better ... let us show you how.

Send for a free copy of the Heathkit Catalog today!

Heath Company, Dept. 10-13
Benton Harbor, Michigan 49022

HEATH	
Schlumberger	
Send to: Heath Company, Dept. 10-13 Benton Harbor, Michigan 49022	
Yes, please rush my FREE Heathkit Catalog!	
Name _____	
Address _____	
City _____	State _____ Zip _____
CL-579	

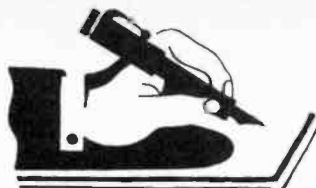

Letters

THE CASE FOR TAPE HEAD PHASING

In his reply to reader mail with reference to his "Notes on Head Alignment" (August 1975), Mr. Hodges stated that he does not

understand why phasing should be of any practical consequence in consumer tape recorders. Be assured that there is at least one application where phasing is important: the dubbing of SQ- or QS-encoded records on tapes when the tape deck has separate record and playback heads. Improper phasing will "confuse" the matrix decoder on playback.

I have devised a relatively simple way of adjusting the phasing between two tracks when an oscilloscope isn't handy. First, roughly align the heads as described in Mr. Hodges' column. Then combine the left and right channel outputs through two equal-value (say, 4700-ohm) resistors. Then fine adjust the heads using the same

procedure as before, this time maximizing the combined output, while monitoring a VTVM, TMM, or DMM connected between the junction of the two resistors and circuit ground.

As a final check, record a tone that sweeps from about 1000 to 15,000 Hz and play it back while monitoring the recorder's output. Improper phasing will produce serious peaks and dips within the band, especially at the high end.—*D. Chan, La Salle, Quebec, Can.*

USING TACHOMETER ON CD IGNITION

I would like to know if the tachometer described in your June issue (Build a Digital Marine/Auto Tachometer') will work with either a conventional ignition or a CD system.—*John Barnhart, New York, NY.*

The type of ignition system has nothing to do with the operation of the tachometer, which is concerned only with the timing of the motor when it is running.

WORKING WITH MOS DEVICES

The instructions for safe handling of MOS devices ("Senior Scientist Calculator," October 1975) don't seem quite right. Isn't it dangerous to ground yourself when working with electrical appliances? Shock can result from touching a point connected to the "hot" side of the ac line.—*Douglas Peters, Jersey City, NJ.*

Yes, you're right. The third step on page 38 should read: "Ground yourself; wrap a length of wire mesh around your wrist, connect the free end of the mesh to a 1-megohm resistor, and terminate the free end of the resistor at a cold water pipe if metallic plumbing joints are used in the system, or to the grounding screw of an electrical outlet."

SCA DECODER

I'm having some difficulty getting the SCA Decoder from "Experimenting with Phase-Locked Loops" (October, 1975) to work. I've doublechecked my wiring and it looks OK. Any ideas?—*Edward Fagan, Portsmouth, NH*

First modify the circuit as follows: R13 should be 100 ohms. Ground pin 1, and remove the connection between pins 7 and 8. If you have connected the input of the SCA decoder to the standard output jacks of your tuner, there might not be enough drive signal, due to the effects of de-emphasis and SCA traps. If your tuner has a "Composite Output" or FM Detector Output" jack, connect the decoder input to that point. If you have an older tuner without such a jack (multiplex output jacks usually won't provide enough SCA signal), tap some of the signal directly from the discriminator output. If this loads down the circuit, use resistive coupling.

NEW COMPACT handic[®] cb

The Dependable/Economy Sized CB From Sweden



If you don't need 23 channels...

But you need big, professional CB power . . . and all the special, "no frills — no gimmick" features that only Handic offers. Handic has the answer with two new, 3 Ch. & 6 Ch. rigs that save time & money.

These compact, economy sized CB's are small enough to fit in a sports car dashboard — big enough to deliver the pro power you demand of a mobile or base station. Performance? It's Handic all the way . . . with advanced design electronics made to perform under Sweden's tough

geographic and climatic conditions. This means you get: 0.5% sensitivity; 5 Watt Output; 0.2 μ V Spurious Emission — that's 250% better than FCC requirements. And, Handic's unique $\pm .003\%$ crystal frequency tolerance, again exceeding our own FCC specs. Check the new Handic compacts . . . Model 305, 3-Ch; Model 605, 6-Ch. Discover the smart way to use CB. Ask your dealer. Remember Handic has its own orange color, symbol of CB excellence. Ch-13 crystal supplied.

Send For FREE Catalog!

Handic CB radios include: mobile/base transceivers; hand-held personal portable CB systems; scanners with FM radio option; antennas; microphones; selective call; and a full line of accessories.

14340 N.W. 60th Ave., Washington Bldg.
Miami Lakes, Fla. 33014 (305) 558-1522
In Canada: Scotomm Radio Inc., Chomedey, Laval, Quebec



handic[®]
U.S.A. inc.



THE DEPENDABLE CB FROM SWEDEN

THINKING ABOUT A "6800" TYPE COMPUTER?

It seems that a great many people came to the same conclusion that we did here at SwTPC. The M6800 is an outstanding processor and makes a great computer — "BUT" — Not all computers using the M6800 processor are the same. May we suggest that you consider the following features when you make your choice.

IT IS A COMPLETE 6800 SYSTEM?

You cannot get all of the advantages of the 6800 system with only the processor chip. Unless the whole 6800 family of chips is used you cannot possibly get all of the versatility and superior performance that the system is capable of providing. If for instance the design does not use the MC6820 parallel and the MC6850 serial integrated circuits for interfacing, you lose the programmable interface feature that makes it so easy to interconnect the computer system with outside devices such as terminals, printers, disks, etc.

IS THE SOFTWARE COMPATIBLE OR UNIQUE?

If the design does not use the "Motorola" Mikbug[®] ROM, then the software and programs that will run on the system are probably unique to

that particular brand of computer. SwTPC uses the standard Motorola MCM6830L7 ROM. This provides automatic loading and an operating system that is compatible with other systems using the standard widely sold Motorola evaluation set. As an owner of our 6800 computer system, you are eligible for membership in the Motorola Users Group. If you join you have access to a library of programs that will run on your system. Editor and assembler programs are available directly from SwTPC.

CAN THE SYSTEM BE EXPANDED AT A REASONABLE COST?

Some of the limited systems being offered at lower prices can be expanded only with difficulty. Check the amount of memory that can be added and at what cost. How many additional interfaces can be added, if any. How much of the above can be run off of the power supply provided with the system? The SwTPC 6800 can be expanded up to 16K words of memory in the standard cabinet and with the power supply provided. It may also be expanded up to eight interface (I/O) boards for external devices by simply plugging in the cards. Memory is \$125.00 for each 4,096 words of expansion and inter-

face cards are only \$35.00 for serial or parallel types.

Memory expansion will be essential if you ever intend to use a resident assembler, or higher level languages such as APL or BASIC on your system. Assembler programs typically require a minimum of 4,096 words of memory and higher level languages require even more.

HOW DO YOU ENTER AND READ DATA?

Let's hope it is by way of a TTY, or video terminal. No one with a serious computer application would consider attempting to enter data from a switch and status light console. These may be educational, but they sure aren't practical. Calculator keypads and digital readouts are not much better. There is no substitute for a full alphanumeric keyboard and terminal system display for serious work.

Mikbug[®] is a registered trademark of Motorola Inc.

SWTPC 6800

Computer System

with serial interface and 2,048 Words
of memory \$450.00



Enclosed is \$450 for my SwTPC Computer Kit Send Data

or BAC _____ # _____

or MC _____ Ex Date _____

NAME _____

ADDRESS _____

CITY _____ STATE _____ ZIP _____

Southwest Technical Products Corp., Box 32040, San Antonio, Texas 78284

Four different schools give you this 25" DIAGONAL hobby-kit TV...

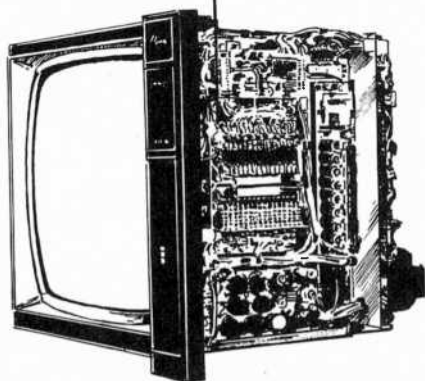

No other home training school gives you both an exclusive solid state color TV and an SQ® Quadraphonic Receiver complete with four speakers . . . all in one course. You get both for less than the tuition cost of TV or Audio alone from the next leading school. And only NRI's Master Course in Color TV/Audio servicing lets you train on equipment designed specifically for training with exclusive "power-on" features.

NRI doesn't give you hobby kits or commercial sub-assemblies. We invested the time and money to design equipment with learning in mind.

Only NRI gives you this 25" DIAGONAL designed-for-learning Color TV...

It's the only way you can (1) get the feel of typical commercial circuitry, (2) learn bench techniques while building complete units from the "ground" up, (3) perform over 35 "in-set" experiments during construction, and (4) end up with a 25" diagonal solid-state color TV with console cabinet and a 4-channel quadraphonic Audio Center.

NRI passes the savings on to you

NRI can save you money because our engineering eliminates the cost of buying from an outside source. We pay no salesman's commission. Students are enrolled by mail only. The savings are passed on to you in the form of low tuition fees, extras like the TV's console cabinet and the four speaker Quad System; a 5" triggered sweep

oscilloscope, CMOS digital frequency counter, and an integrated circuit color TV pattern generator. Where NRI supplies a professional color

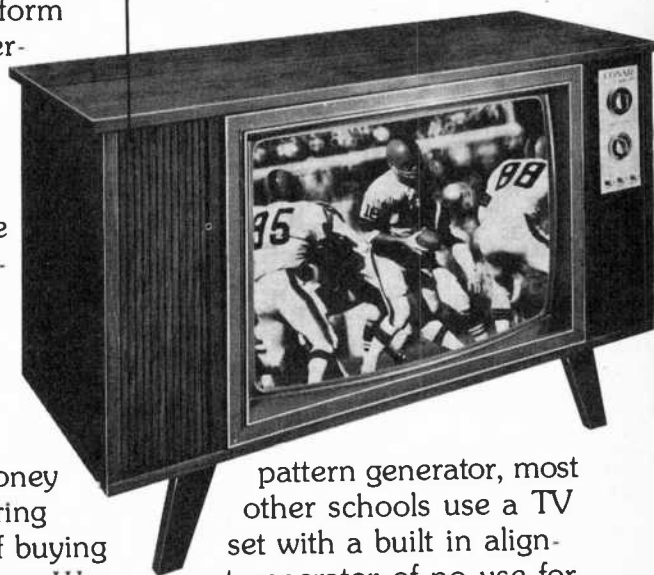

pattern generator, most other schools use a TV set with a built in alignment generator of no use for servicing other sets. Only NRI designs, engineers, and supplies training kits specifically for learning and professional use. You can pay hundreds of dollars more for a similar course and not get a nickel's worth more in training and equipment.

...plus complete Quadraphonic Audio Center!

More know-how per dollar

That's what it all boils down to, the quality of training you get for the money you spend. In our 62-year history, more than a million students have come to NRI and we're fully approved for career study under the G.I. Bill. We must be teaching something right.

Some of those "right" things are bite-size lessons to ease understanding and speed learning . . . personal grading of all tests, with comments or explanations where needed . . . a full-time staff of engineer/instructors to help if you need it . . . plenty of kits and experiments to give you hands-on training . . . and fully professional

programs oriented to full or part-time career needs.

Widest Choice of Courses with CB, Digital Computer, and other career opportunities

NRI offers not one, but five excellent TV/Audio servicing courses so you can tailor your training to your budget.

Or you can study other opportunity fields like Digital Computer Electronics, Citizens Band Radio, Communications, Aircraft or Marine Electronics, Mobile Radio, and more. Send

for our free catalog and see for yourself that no one gives you more training and equipment for your dollar. There's no obligation, and no salesman will call.

If card is missing, write to:



NRI SCHOOLS
McGraw-Hill Continuing
Education Center
3939 Wisconsin Avenue,
Washington, D.C. 20016

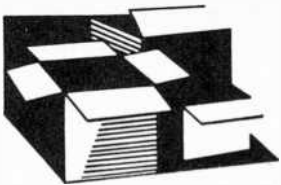

New Products

Additional information on new products covered in this section is available from the manufacturers. Either circle the item's code number on the Reader Service Card inside the back cover or write to the manufacturer at the address given.

UNIVERSAL LOGIC FAMILY PULSER

Kurz-Kasch announces its new Model HL-583 in-circuit simulator or logic-state pulser for use with RTL, HTL, DTL, TTL, and CMOS. It delivers a HIGH-level pulse exceeding the value required by these families to yield a logic one, and a Low-level pulse below the value required to yield a logic zero. Selection of one-shot or continuous operation is made by a slide switch on the probe barrel. \$96.00

CIRCLE NO. 84 ON FREE INFORMATION CARD

MARANTZ AM/FM STEREO TUNER

Marantz's new Model 150 AM/FM stereo tuner has a built-in 3" (7.6-cm) oscilloscope, Dolby noise reduction circuitry, and a phase-locked-loop multiplex detector. It also boasts an 18-pole linear-phase i-f filter



and flywheel tuning. Switching functions include STEREO ONLY, HI BLEND, MUTING, and MONO. The scope can be used for 2- and 4-channel audio balancing, tuning, and multipath adjustments. \$599.95.

CIRCLE NO. 85 ON FREE INFORMATION CARD

AOS TWO-WAY LOUDSPEAKER SYSTEM

Analog & Digital Systems announces its new Model L400 bookshelf speaker system, a two-driver, two-way acoustic-suspension unit. A long-throw 7-inch woofer, with a resonant frequency of 30 Hz, operates over a range of 30 to 1500 Hz. A 1-inch soft-dome tweeter is suspended in a sealed acoustic chamber with a special damping fluid. The tweeter covers the 1500-20,000 Hz range, and is said to have flat response, wide dispersion, and good transient response. Air-core inductors and metal-film capacitors are used in the cross-over network. Impedance is 5 ohms minimum. An 85-dB SPL is produced with 2 watts rms input at a distance of 10 ft. The

L400 weighs 16 lb (7.3 kg), measures 17-3/4" H x 10" W x 8 1/2" D (45.1 x 25.4 x 21.6 cm). Cabinet finish is natural walnut, and the speaker grille (removable) is black double knit. \$90.00.

CIRCLE NO. 86 ON FREE INFORMATION CARD

JERROLD TV SIGNAL INDICATOR

The Jerrold "Levelite" checks signal levels at a TV set's antenna or MATV input terminals and provides a go-no go visual indication (LED) of the presence of a signal. The



brightness of the LED also gives some indication of signal strength. It can be set for either distant or local signals. Battery-operated, it is hand-held and has adapters for connection to various types of terminals. \$47.50

CIRCLE NO. 87 ON FREE INFORMATION CARD

CUSHCRAFT BASE ANTENNA

The Model CX-1000 by Cushcraft is an omnidirectional base station antenna using a coaxial stub matching system. The manufacturer states that heavy-gauge aluminum tubing is used along with stainless steel fasteners. Accepts any mast up to 1 3/8" (3.5 cm), and is designed for use with 52-ohm coax.

CIRCLE NO. 88 ON FREE INFORMATION CARD

E.F. JOHNSON CB RADIOTELEPHONE

The Messenger 130A is a new version of E.F. Johnson's radiotelephone handset CB mobile transceiver. Features new noise suppression circuitry, a molded speaker grille and integrated mounting fins. Can be used with positive or negative ground



sources, and has the option of private listening with automatic speaker silencing when the handset is lifted. The transceiver covers 23 channels and has PA capabilities. \$199.95

CIRCLE NO. 89 ON FREE INFORMATION CARD

SURVEYOR PROGRAMMABLE SCANNER

The new Model 10-P Programmable Scanner from Surveyor Manufacturing is a solid-state, dual-conversion receiver that covers the vhf HI, LO or uhf bands. A priority switch is also featured. This allows the search of Channel 1 every 1.75 seconds. Channel 1 will lock in its signal even though another channel is being received. Has squelch, volume, and manual/automatic scan controls, as well as built-in telescoping whip antennas. \$189.00

CIRCLE NO. 91 ON FREE INFORMATION CARD

CONTINENTAL SPECIALTIES BREADBOARDING KIT

The new Proto-Board 6 by Continental Specialties offers 630 component tie points and 6 14-pin DIP IC capacity. The kit includes one QT-47S breadboarding socket, two QT-47B bus strips, four 5-way binding posts, a metal ground and base plate, rubber feet, and hardware. All connections between components can be made with #22 hookup wire. Measures 6" W x 4" D (15.24 x 10.2 cm). \$15.95

CIRCLE NO. 92 ON FREE INFORMATION CARD

AMTRONCRAFT STEREO AMPLIFIER KIT

Amtroncraft announces its new Model UK 192 stereo power amplifier in kit form. Its rated output power is 50 W rms/channel at 1% THD. Claimed frequency response is within 2 dB from 10 to 10,000 Hz. Input

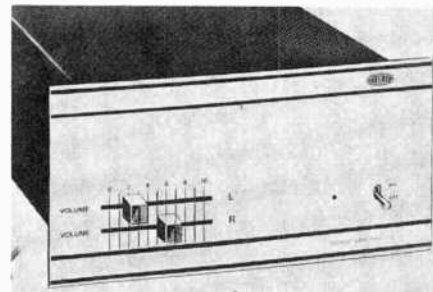

sensitivity is 1 V for full power output. Input and output impedances are rated at 1000 and 4 ohms respectively. Requires a 55-V dc power supply, such as the company's UK 665. \$139.95

CIRCLE NO. 93 ON FREE INFORMATION CARD

ADJUSTABLE CALCULATOR STAND

The CalCradle Executive, by one-up, inc., is a calculator stand that tilts and pivots to the angle required for glare-free viewing and easy keyboard operation of a pocket calculator. Accepts both horizontal and vertical models, and completely disassembles for storage. The CalCradle Executive is made of clear acrylic and chrome. \$12.98. Address: one-up, inc., 1303 Avocado, Suite 235, Newport Ctr, Newport Beach, CA 92660.

SHAKESPEARE STATION MONITOR

Shakespeare's new base station monitor, "The Defender," measures r-f power out-

POPULAR ELECTRONICS

5 WAYS TO STOP WASTING TIME IN ELECTRONICS.

1. Stop wasting your time soldering. Save hours of soldering, desoldering, re-soldering with QT sockets and bus strips. Connect and disconnect resistors, capacitors, transistors, IC's etc., literally as fast as you can push in—or pull out—a lead. Make instant interconnections with short lengths of wire. And interlock sockets and bus strips for infinite expandability on bench, chassis, plug-in cards, etc. At \$2.00-12.50*, you'll wonder how you've done without them!

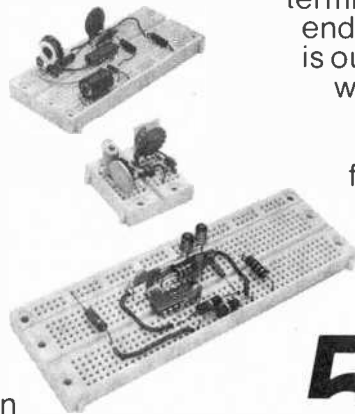

popular solderless breadboarding system... our Proto-Board® line. For just \$15.95*, you can have our PB-6 Proto-Board kit. Takes about 10 minutes to assemble, and gives you 630 solderless QT terminals. On the other end of the spectrum is our giant PB-104, with 3,060 solderless terminals for \$79.95*, or only 2.6¢ apiece! You can choose from a variety of models, with or without regulated power supplies.

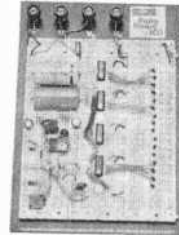

2. Stop wasting your time designing circuits. Design Mate™ 1 will help, by providing you with QT hookup versatility (see above), a continuously-variable 5-15V, 600mA 1%-regulated supply, and a voltmeter to monitor supply or circuit. Plug it in, turn it on and start designing more by soldering less. At \$49.95*, you can afford to.



3. Stop wasting your time testing. On DIP IC's, finding the lead

you want—and making sure you don't short others—can be as delicate as surgery. Until you discover our handy Proto-Clip™... the instant, short-proof way to test IC's up to 24 pins. Available without cable or with cable, they're the most economical and foolproof IC test aids on the market.

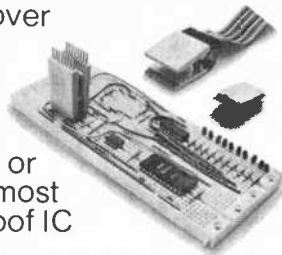

5. Stop wasting your time testing. You can own the test gear you need at economical prices. Our Design Mate 2, for instance, gives you a 3-waveform function generator—sine, square and triangle—from 1 Hz to 100 kHz... for just \$64.95*. Design Mate 3 R/C bridge provides 5%-accurate measurements of unknown resistors and capacitors from 10 ohms to 100 meg and 10 pF to 1 uF, with built-in LED null indication. Price is a "micro" \$54.95*. And as you're reading this, we're busy adding new low-priced, high-quality Design Mates.

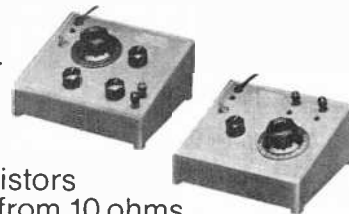

Stop wasting your time reading. Send for the complete CSC catalog and distributor list... and start making more of your time in electronics.

*Manufacturer's recommended retail.

4. Stop wasting your time breadboarding. Small budgets or big requirements are no obstacle to owning and enjoying today's most

CONTINENTAL SPECIALTIES CORPORATION



44 Kendall Street, Box 1942
New Haven, CT 06509 • 203-624-3103 TWX: 710-465-1227
West Coast office: Box 7809, San Francisco, CA
94119 • 415-421-8872 TWX: 910-372-7992
Canada: Len Finkler Ltd., Ontario



WEN SOLDERING GUN KIT

Wen Products' Model 222K5 Soldering Gun Kit includes a single-post soldering gun (Model 222), a fine (25-100 W) and a regular (100-200 W) tip, and a flat-iron attachment which seals plastic bags drymounts photos, and aids in furniture repair. Also includes a plastic cutting attachment for cutting plastic sheets, burning wood and leather designs, and working with plastic or asphalt tile. The soldering gun features Automatic Thermal Regulation, which is said to minimize idle current through the tip, but provides full heat flow when needed.

CIRCLE NO. 94 ON FREE INFORMATION CARD

CIRCLE NO. 95 ON FREE INFORMATION CARD

put, SWR, and percent modulation when inserted in the coax line between transmitter and antenna. Pushbutton switches select the meter function. Also built-in is an antenna matcher to convert reactive loads to 50-ohm resistive ones. A switch controls the matcher in/out function. \$99.95

TECHNICS DIRECT-DRIVE RECORD CHANGER

Technics by Panasonic announces its new Model SL-1350 direct-drive record changer/turntable. The changer will handle a stack of six records, and can be put immediately into the shut-off mode without having to play through the stack. Manual operation is also possible. The SL-1350 features a gimbal-suspended, low-friction, modified-S type tonearm for



stereo and CD-4 cartridges. The tonearm has two-way damped cueing, antiskating adjustment, and counterweight arm balancing and tracking force adjustments. An aluminum die-cast platter weighs 3.9 lb (1.8 kg), and has raised dots along its outer edge for stroboscopic speed checks. A built-in flasher is used for these adjustments, which can be made at 33½ and 45 rpm, at line frequencies of either 50 or 60 Hz. A hinged dust cover is included. \$349.95

CIRCLE NO. 96 ON FREE INFORMATION CARD

LEADER HAM OSCILLOSCOPE

Leader Instruments' new Model LBO-310Ham oscilloscope monitors waveforms in the receiver i-f section as well



as SSB, AM, and RTTY outputs. The 3-inch (7.6-cm) scope has a vertical sensitivity of 20 mV/division and a bandwidth of dc to 4 MHz. Proper RTTY and SSB tuning may be made with the help of a built-in two-tone generator. With the LA-31 adapter (\$22.95), the scope provides continuous monitoring of r-f output to 500 W over a frequency range of 1.8 to 54MHz with vertical sensitivity of 1 W/division into 50- or 75-ohm impedances. \$269.95.

CIRCLE NO. 97 ON FREE INFORMATION CARD

AT LAST...A HANDSOME DIGITAL ELECTRONIC TIMEPIECE WITH PRECISION ACCURACY...FOR ONLY \$109.95

Parrott Precision Electronics proudly presents the Condor and the Squire. The face of these fine watches appears completely black until you're ready to use it. Just touch the tiny button at the 2 o'clock position and the time, in hours, minutes and seconds, will be clearly displayed in bright numerals. A touch of the button at the 8 o'clock position will illuminate today's date.

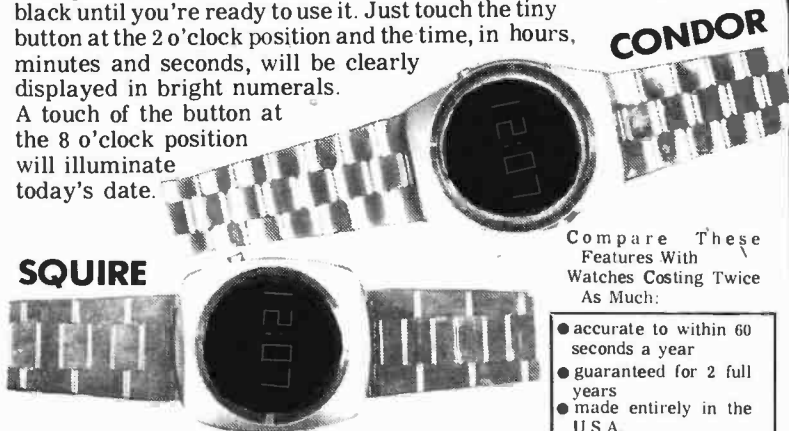

Compare These Features With Watches Costing Twice As Much:

- accurate to within 60 seconds a year
- guaranteed for 2 full years
- made entirely in the U.S.A.
- "HOLD" Circuit For Time Setting.
- BATTERY SAVER circuit.

Easy to set, never needs cleaning or winding, extremely shock resistant... these luxurious watches come with complete instruction booklets and a full TWO-YEAR GUARANTEE from date of purchase.

The new Condor and Squire digital electronic watches can be purchased only through the mail with the coupon below or by calling 615-528-6502 between 10 a.m. and 11 p.m. EST. Telephone orders will be accepted only if MASTER CHARGE or BANK AMERICARD are used. The first 1,000 telephone customers will receive their order for \$95.00. No COD orders please. Residents of Tennessee must add a 5 percent sales tax.

Enclosed is my check Money order BANK AMERICARD
 MASTERCHARGE Acct. No. _____
 Interbank No. _____ Exp. Date _____
 Total enclosed: \$ _____
 Name _____
 Address _____
 City _____ State _____ Zip _____

Condor: number ordered — Yellow Gold White Rhodium
 Squire: number ordered — Yellow Gold White Rhodium



Parrott
PRECISION ELECTRONICS

Suite 6, 440 North Washington Ave.,
Cookeville, Tennessee 38501.

CIRCLE NO. 60 ON FREE INFORMATION CARD

PASS TO VICTORY

The quarterback is picking just the right spot to call a screen pass. He passes. The running back carries the ball to a touchdown. Victory!

Pick yourself the right CB radio. No problems to tackle when you own a PACE CB radio. They're designed to carry your conversations with clarity and high performance. The quarterback gets total support from his team on the field. In the same manner will you get total Pace support in the field. From our experienced service centers coast to coast. From our retailers and distributors. Grant yourself that victorious feeling and pass along, "I own a PACE CB."

When you've got a Pace, you've got the world by the ears.

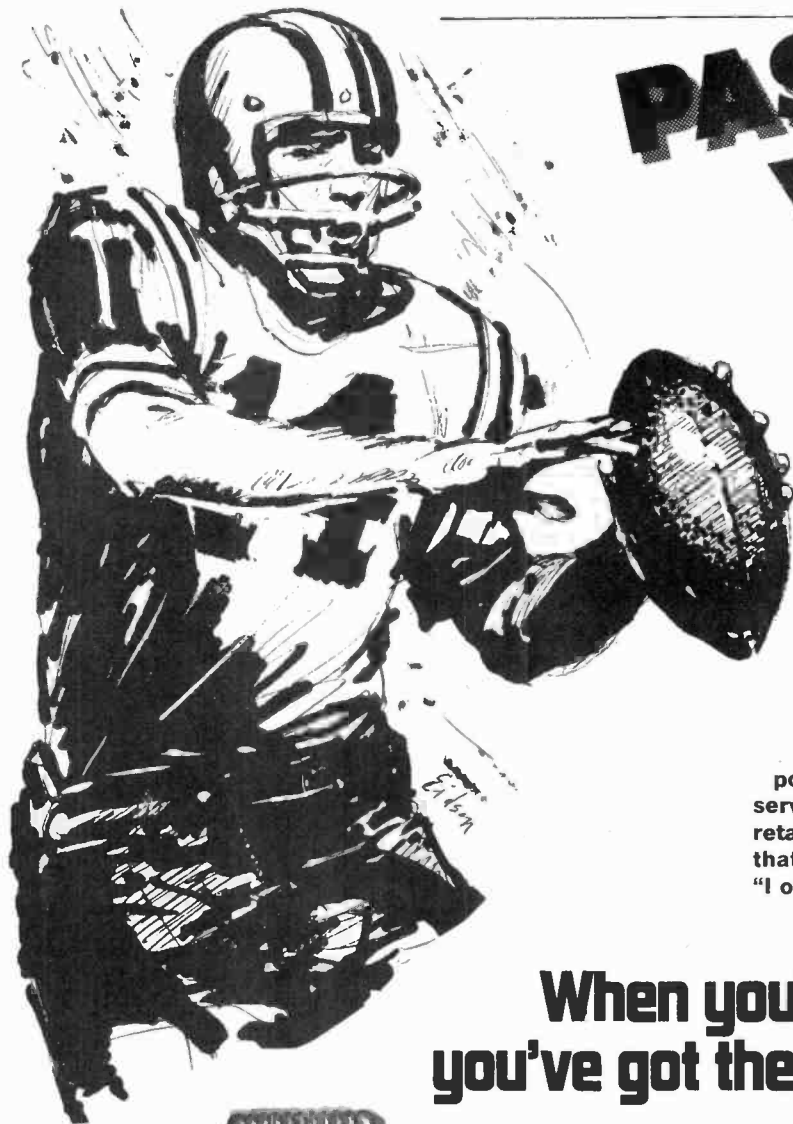

CB 145

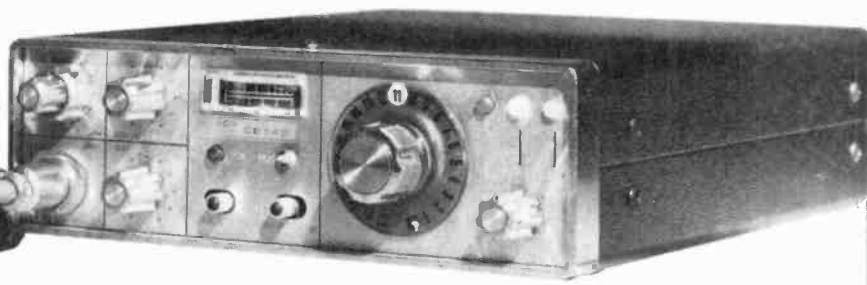

((p))
PACE

See Your Dealer Now. Get this super deluxe model to transmit and receive messages while driving the wintery highways. Pickup the weather information you need. *Let others know.*
Suggested list price \$209.95.

((p)) PATHCOM INC. PACE TWO-WAY RADIO PRODUCTS

02102

24049 S. Frampton Ave., Harbor City, CA. 90710

Available In Canada from Superior Electronics Inc.
Export (all other parts of the world): 2200 Shames Dr., Westbury, N.Y. 11590.

CIRCLE NO. 41 ON FREE INFORMATION CARD

**NOW there's a quick,
easy way for you**



**to learn . . . review . . . improve your
understanding of Electronics fundamentals.**

That's right. A new "audio visual" learning experience in basic Electronics and Electricity. Quick. Easy. And it's fun, too.

Four pre-recorded cassette tapes take you right into a classroom in Electronics. Eleven class sessions in all . . . it's just like you are there! You'll listen to a CIE instructor and his students explore AC/DC, transistors, circuits, cells, batteries, IC's, electronic symbols and other meaningful subjects.

As you listen, you'll follow along through six instruction manuals that contain over 150 easy-to-understand illustrations, photos, and diagrams. Sit back, relax, and learn.

Nearly 3 hours of recorded, programmed instruction . . . designed and developed to help you grasp the all-important basic theories and applications of Electronics and Electricity.

Order your exciting Audio Visual "Class in Electronics" TODAY and qualify for this special Bonus Offer.

**BONUS
OFFER**

Order now and receive a one-year *FREE* subscription to the bi-monthly *CIE Electron* newspaper. Packed with timely, thought-provoking electronics articles — new developments — service tips — job opportunities. *Free* with each order.

**You must be completely satisfied or return the material within
10 days for a complete — no questions asked — refund.**

RUSH me your no-risk Audio Visual program that combines sight and sound in a new, exciting learning experience and put me down for a *FREE* one-year subscription to the *CIE Electron*.

Check One, please

- #01-122. Set includes instruction manuals, 4 recorded cassette tapes, binder/file. \$24.95 (Ohio Res. add 5½% Sales Tax)
- #01-124. Set includes Cassette Tape Recorder, 4 recorded cassettes, remote-control mike and stand, earphone, AC adapter, power cord, batteries, 6 instruction manuals, binder/file. \$49.90 (Ohio Res. add 5½% Sales Tax)

Enclosed is my . . .

- Check
- Money Order (BC-20-75)

Print Name _____ Age _____

Address _____ Apt. _____

City _____

State _____ Zip _____

CIE Bookstore

1776 E. 17th Street • Cleveland, Ohio 44114
Educational/Entertainment values by mail
Subsidiary of Cleveland Institute of Electronics Inc

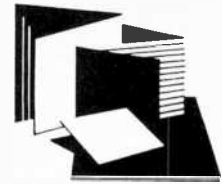

New Literature

SIMPSON TEST EQUIPMENT CATALOG

A 60-page catalog (No. 4400) from Simpson Electric Co. describes their line of analog, digital, and Analed panel meters, chart recorders, meter relays, pyrometers, controllers, test equipment and a variety of portable instrumentation. It is illustrated with photographs, line drawings, and charts which provide information such as ranges, calibration, dimensions and weights. Included are prices for all models and accessories. Address: Simpson Electric Co., 853 Dundee Ave., Elgin, IL 60120.

SHURE HIGH-FIDELITY CATALOG

The latest high-fidelity catalog (AL210-P) from Shure Brothers includes a selection guide to replacement styli for nearly all cartridges it has manufactured in the past 15 years. Includes trackability, stylus configuration, and tracking forces. Also highlights two tonearms, a stereo preamplifier, headphone amplifier, and stylus force gauge. Address: Shure Brothers Inc. 222 Hartrey Ave. Evanston, IL 60204.

AUTO RADIO INTERFERENCE REPORT

A report detailing a technique for reducing automobile ignition interference is now available. A team at Stanford Research Center was able to reduce radio noise from a 1972 American car by a factor of from 5 to 10 (varying with frequency) over a range of 20 to 1000 MHz. A few low-cost electrical components must be added, which according to tests have no undesirable effects on the car's operation or level of exhaust emissions. A copy of the report, Accession No. PB 239-471 is available for \$6.25. Address: National Technical Information Service, Springfield, VA 22161.

THYRISTOR GATE NOISE

The latest in the Westinghouse semiconductor Tech Tips series covers noise discrimination in thyristor firing circuits. "Noise Discrimination For Your Firing Circuit," Tech Tip 4-4, discusses the effects of false triggering caused by energization or de-energization of reactive loads in the vicinity of thyristors. The article provides typical circuit diagrams, design charts, and equations to help the designer develop noise-discrimination circuitry to suppress gate-lead transients. Address: Semiconductor Division, Westinghouse Electric Corp., Youngwood, PA 15697

For the \$400-class CB customer Realistic has what's really new and 4000 places to find it.



Reading time 48 seconds:

Not everyone has four C-notes to lay out for hobby or business equipment. But on the other hand, the new Realistic Navaho TRC-57 actually costs no more than a basic 35mm SLR camera. And for 399.95* you get an AM/SSB base/mobile transceiver with everything you'd expect — plus a lot you wouldn't. + Digital phase-locked synthesizer and crystal lattice filter for unusual selectivity. + Automatic modulation gain control for full power always, whether you talk loud or soft. + ANL and blanker for chopping out noise. + LED-indicator AM/USB/LSB mode lights. + Separate SWR and S/RF power meters that turn red on transmit. + Precise LED-readout clock switchable for 12 or 24-hour time. And of course it's FCC Type Accepted and UL listed. The new Navaho. You get something more by accepting nothing less!

*Retail price may vary at individual stores and dealers.



FREE! NEW 1976
RADIO SHACK
CATALOG

164 PAGES • OVER 2000 ITEMS

Get your copy today at our
nearest store or dealer.
Or write:

Radio Shack
P.O. Box 1052
Fort Worth, Texas 76101

642

(Please Print)

Name _____ Apt. # _____

Street _____

City _____ State _____ Zip

SOLD ONLY WHERE YOU SEE THIS SIGN:

Radio Shack®

A TANDY CORPORATION COMPANY



Just Say
"Charge It"
at participating stores



Stereo Scene

By Art Salsberg
(Ralph Hodges returns next month.)

AUDIO POTPOURRI

HERE ARE some kernels of audio information, ranging in variety from adjusting speaker-system level controls to the different hearing perceptions of left-handed and right-handed people.

Loudspeaker Behavior. Loudspeakers and drivers were once designed by intuition and practical experience. The empirical approach is disappearing, however. With the growing use of mathematical models, cone geometry and material can be chosen to obtain a specific frequency response.

Phillips Research Labs (in the Netherlands), for example, uses a computer program to solve driver behavior problems, such as determining frequency characteristics of the sound wavefront and radiated power as a function of cone material. Theoretical results are verified by viewing driver motion holographically. Typical results are shown in Figs. 1 and 2. At low frequencies, the cone vibrates as a rigid surface. But above a certain point, standing waves begin to appear on the cone. For example, Fig.

1 reveals loops and nodes beginning to appear at the periphery of an 8-inch (20.3-cm) cone driven at 2000 Hz. When the input signal is raised to 9000 Hz, as pictured in Fig. 2, the entire surface is covered with loops and nodes, and little sound is radiated.

Setting Speaker Level Controls. Literature from Speakerlab of Seattle, WA, sets down an interesting method of adjusting speaker level controls—you know, those tweeter and midrange level controls usually on the rear of the enclosure. According to author Pay Snyder, the center settings of these controls do not necessarily provide flat response, due to production variations in speaker sensitivities. (Room acoustics can play a part, too!)

He suggests setting amplifier tone controls to "flat" and the balance control so that only one speaker is playing. Listen to a familiar piece of music with the level controls at minimum, which should leave you with sound coming only from the woofer. Slowly turn up the midrange control until you hear sound coming from this driver as well as the woofer. Continue increas-

ing the level until the sounds from the two drivers blend and seem to come from a point midway between the two.

Next, follow the same procedure with the tweeter level control, increasing it until the tweeter's output blends with that of the other two, and does not appear to be coming from a separate point source. Snyder suggests adjusting the speaker in place to compensate for reflections, keeping your head down close to the enclosure. This method doesn't require test instruments, and equally important, it saves a lot of energy expended by jumping up and down to "hear" the system with a new setting!

New Audio Power Ruling. The FTC has a new interpretation of its "Rule on Audio Power Disclosure." The agency has backed off from its original requirement that amplifiers be operated at $\frac{1}{3}$ rated power for one hour before testing. This is not the way amplifiers are used in the home, where musical passages require peak power for only short periods of time, and the average power seldom reaches the $\frac{1}{3}$ conditioning level. So, fuses popped, relays opened, or output transistors overheated during the pre-test conditioning, especially in high-power amplifiers.

If the ruling was maintained, many manufacturers faced the choice of de-rating their products' power outputs, or improving thermal transfer through extra heat sinking or forced-air cooling. The former would place some manufacturers at a competitive disadvantage, while the latter course would have substantially increased costs.

Bedeveled by this requirement, nearly two-dozen manufacturers requested a reinterpretation of the conditioning procedure, supporting their contentions with test data. In response, the FTC approved automatic recycling, allowing equipment to cut off or go on automatically until a total of one hour of "on" time is accumulated. Furthermore, if thermal buildup is a problem, tests may commence at low output power to permit cooling.

Live Recording. If you've ever struggled with miking live performances (and haven't we all!), you'll appreciate the tips offered by Shure Bros., 222 Hartrey Ave., Evanston, IL 60204, in its free brochure #AL 493. It describes in nontechnical terms how to mike voices and instruments, in-

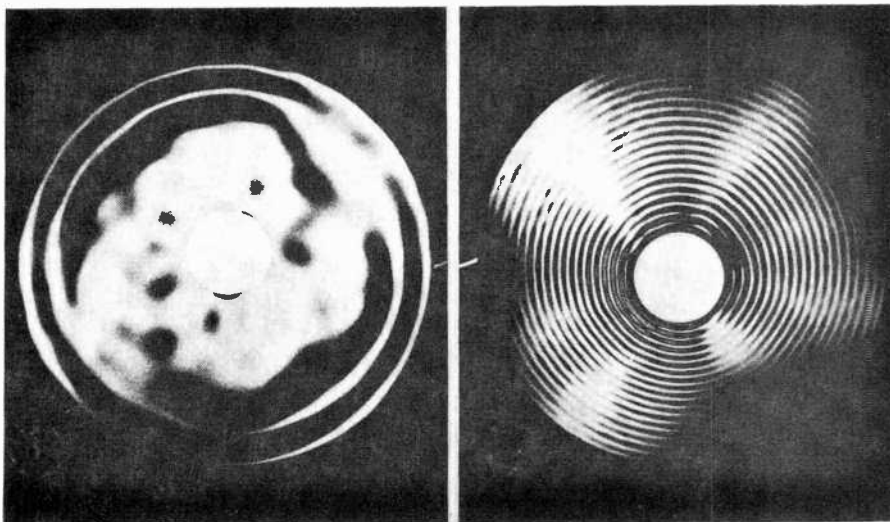

Figs. 1. (left) and 2. Holograms of motion in drivers.

READERS' BONANZA!



Get up to 50% off on your choice of these outstanding publications

Here's a great offer for readers from the publishers of Psychology Today, Skiing, Popular Photography and all the other outstanding publications shown on this page.

Select any of the publications you see here—and subscribe to them at discount rates of up to 50% off.

Whether your particular thing is skiing, boating or photography... electronics, flying, cycling or cars... stereos, news, psychology or sports... we're sure you'll spot a magazine here that can meet your special interest. No need to stop with just one, either, since

you may select as many as four at our special introductory rates—up to 50% off.

So why hesitate? Select the publications you wish to receive—and save from 99¢ to \$6.00 on your selections.

To enter your subscriptions, simply check off the publications you want on the postpaid card, detach it and mail. If the card is missing, order your subscriptions by writing to Magazines At Discount, a division of Ziff-Davis Publishing Company, P.O. Box 2779, Boulder, Colorado 80302.

HERE'S WHAT YOU SAVE:

Boating—1 year	
Newsstand Price:	\$12.50
Regular Subscription Price:	\$ 9.00
	You pay only \$ 4.50
Car & Driver—1 year	
Newsstand Price:	\$12.00
Regular Subscription Price:	\$ 7.98
	You pay only \$ 3.99
Cycle—1 year	
Newsstand Price:	\$ 9.00
Regular Subscription Price:	\$ 7.98
	You pay only \$ 3.99
Flying—1 year	
Newsstand Price:	\$12.00
Regular Subscription Price:	\$ 9.98
	You pay only \$ 5.99
Playboy—1 year	
Newsstand Price:	\$16.00
	You pay only \$10.00
Popular Electronics—1 year	
Newsstand Price:	\$ 9.00
Regular Subscription Price:	\$ 6.98
	You pay only \$ 5.99

Popular Photography—1 year	
Newsstand Price:	\$12.00
Regular Subscription Price:	\$ 8.98
	You pay only \$ 4.49
Psychology Today—1 year	
Newsstand Price:	\$12.00
Regular Subscription Price:	\$12.00
	You pay only \$ 6.00
Stereo Review—1 year	
Newsstand Price:	\$12.00
Regular Subscription Price:	\$ 7.98
	You pay only \$ 3.99
Skiing—1 year	
Newsstand Price:	\$ 7.00
Regular Subscription Price:	\$ 6.98
	You pay only \$ 3.49
Sports Illustrated—24 issues	
Newsstand Price:	\$18.00
Regular Subscription Price:	\$ 7.53
	You pay only \$ 4.97
Time—25 issues	
Newsstand Price:	\$18.75
Regular Subscription Price:	\$10.50
	You pay only \$ 8.75



cluding piano, and specifies the types of mikes best suited for certain instruments. For example, the brochure states that a mike with a rising response gives maximum brightness when used near strings; one with a great proximity effect gives best low-frequency response when positioned at the resonant underside of a piano.

Thus, two mikes are needed with a grand piano, and one of the secrets divulged here is that the mikes must be out of phase with each other.

The Luxury Class. Along with Rolls Royce convertibles and platinum jewelry, there is a category of audio equipment that simply ignores a "tight

money" economy. Pictured here are a few new initiates to this elite club. They are: Infinity Systems' Servo-Statik 1A speaker system, which consists of two electrostatic screens, and a "base cube" containing an 18-inch (45.6-cm) woofer with its own 150-W dc servo amplifier. Only \$4000. Note that separate stereo amplifiers for the mid-range (100 to 250 W) and tweeter (35 to 125 W) sections must be added. Then there's the Gale GT2101 optical servo turntable, with modernistic plexiglass and stainless-steel design. Speed is monitored on a three-digit LED display, referenced to a quartz crystal oscillator. Only \$1,875 (less tone arm and cartridge, of course). Another entry is the Luxman M-6000 stereo power amplifier, rated at 300 W/channel into 8 ohms, both channels driven, with no more than 0.05% THD and IM, from 20 to 20,000 Hz. It features sophisticated thermal- and current-activated protection networks, with a 5-second (nominal) stabilization period monitored by a LED before speaker outputs are activated. Price is \$2,995, or about \$26 per pound.

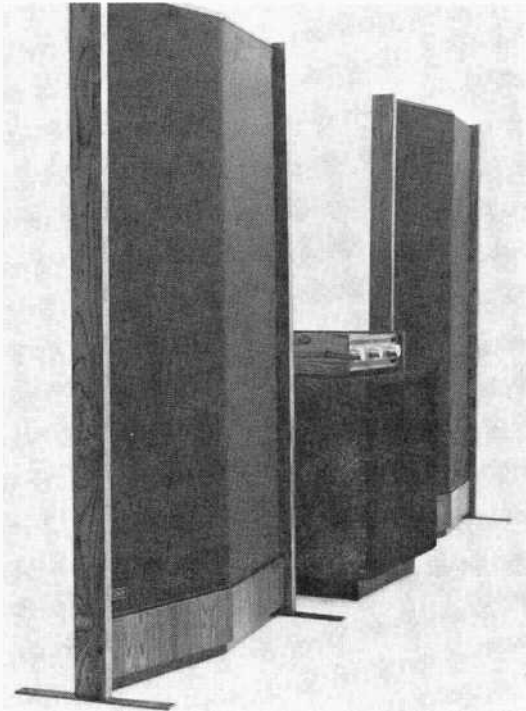

Infinity Systems Servo-Statik 1A has two electrostatic screens and separate 18-inch woofer with amplifier.



Luxman M-6000 stereo power amplifier provides 300 watts per channel into 8 ohms both channels driven.

Gale GT2101 optical servo turntable is made of plexiglass and stainless steel with LED speed readout.

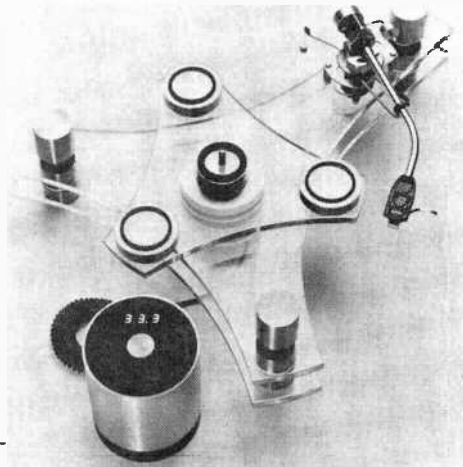

Are You Left Eared or Right Eared?

According to an article in *Scientific American*, October 1975, right- and left-handed people perceive auditory illusions in different ways. In a computer-controlled experiment, reactions were monitored to a sequence of tones whose amplitudes, frequencies, and durations were precisely regulated. Tonal sequences were presented to the subjects through headphones so that when one ear received a high (800-Hz) tone, the other received a low (400-Hz) tone.

Right-handed subjects tended to localize the high tones in the right ear, alternately hearing the low tones in the left ear. Oddly enough, the results were the same when the headphones were reversed. Lefties, interestingly, were just as likely to localize the high tone in the left ear as in the right, according to the report.

The Next Sound You Hear...

In the past, the program material you listened to often dictated the quality of audio equipment you purchased. It was commonplace for audio salesmen to divide their customers into two groups—those who listened to classical music and those who didn't. The former were led to higher-quality components, while jazz, pop, and rock

You make a tape with time and thought. Carefully chosen selections recorded in the sequence that most pleases you. The musical coherence and perception is yours, a personal expression. And when the time is right to share



that experience with someone you care for, having to stop and turn the tape over can break the mood you worked to create. Interruptions like that don't happen with the A-4300. You

can enjoy continuous music on both sides of a tape with the automatic reverse function. And with automatic repeat, a favorite tape will play as long as you like. Whether you want the music up front or in the background, the A-4300 can give you solid music for the better part of an evening.



Check out the A-4300, and listen to it for as long as you like. Just call (800) 447-4700* for the name of your nearest TEAC retailer. In Illinois, call (800) 322-4400.

TEAC

The leader. Always has been.
TEAC Corporation of America
7733 Telegraph Road
Montebello, Ca. 90640
© TEAC 1975

when you don't want the music to stop
TEAC A-4300

You'd never suspect that Bob Gordon leads a double life

By day,
he's a 9-to-5 man.

By night,
an explorer in a field
that really interests him!

There was something different about Bob Gordon. Something you couldn't quite put your finger on. He was good at his job. And he took pains to do it well. But on certain evenings, at the stroke of 5, he'd be the first one out the door and on the bus.

The way he'd rush, people would often ask, "Doing something special *again* tonight?"

"Sure am!" he'd laugh. And off he'd go.

What his pals were never told was that after dinner Bob would head for his basement. There, on a simple old wooden table, was something very different from Bob Gordon's 9-to-5 routine.

It was a challenge. A challenge that seemed to change him into another person. Now, at last, he could work with his own two hands—roll up his sleeves, to probe, experiment, and learn. Assemble advanced electronic equipment, including a 25"-diagonal color TV with digital features! And all the while gaining important new occupational skills.

How he started...

Not long ago, Bob Gordon filled out and mailed a card much like the one attached to this page. At the time, he had almost no experience in electronics. But he did have two important qualifications: desire and ambition. Plus a knack with tools and an urge to put them to work.



And that can be your starting point, too.

Right now, you stand where Bob Gordon stood when he first started out. It's up to you to provide the ability and enthusiasm. Bell & Howell Schools, a leader in electronics education, will provide the opportunity to learn and grow—right in your home!

Bob is already on the verge of having real skills in electronics. And, almost before you know it, you can be there, too.

Learning electronics at home—what's in it for you?

When you take Bell & Howell Schools' at-home learning course in Home Entertainment Electronic Systems, you develop a lot of important skills. First, you'll gather the know-how to troubleshoot and service most models of hi-fi amps, intercoms, automobile receivers, PA systems, and AM/FM tuners.

By the end of the program, you'll know how to service most models of color and black-and-white TV's.

While no school can guarantee a job or income opportunity--

our course teaches skills that qualify you to seek out an electronics job, advance in the one you may already hold, or further your education in electronics.

An independently conducted survey shows that most of our graduates feel they have gained one or more career advancement benefits from the course. (Survey results are available upon request.)

How you gain so much from Bell & Howell Schools' home-learning program...

How can you pick up skills without quitting your job or traveling to night school? You certainly won't do it just by reading a stack of textbooks. That's not the sort of thing that would make Bob Gordon (or you) rush home from work—not by a long shot!

You need actual electronic equipment to work and learn with. And that's what you'll have. Of course, we'll start you off with the basic principles. You'll build and test simple circuits with the Lab Starter Kit we'll send you.

Then you'll move up to the Electro-Lab® Electronics Training System. Piece by piece, you'll actually build a design console and put together circuits without soldering. You'll construct a digital multimeter to measure voltage, current, and resistance. You'll assemble a solid-state "triggered-sweep" oscilloscope to monitor and analyze IC circuitry.

When components for the TV arrive, you'll already be comfortable with electronic concepts



and equipment. And once you assemble that 25"-diagonal color TV, you'll understand the technology behind no-warm-up tuning, automatic channel selection, on-screen time and channel digits, plus a great deal more!

Home learning with a personal touch.

At Bell & Howell Schools, we try not to keep a student waiting. Should a question come up, we invite you to use our *toll-free phone-in service*. Talk to one of our instructors—he'll either have your answer or know where to get it in a hurry.

Face-to-face "Help Sessions" are another useful service of the Home Entertainment Electronics course. They are held in fifty cities throughout the U.S. at various times of the year. You can discuss electronics in person with trained instructors, talk of your experiences and ambitions with fellow students.

These extras are part of a carefully planned program developed by Bell & Howell Schools. Experience with thousands of at-home learners has refined our teaching methods—and is helping make the path to a Technician Certificate a little easier. A Certificate currently being pursued by over 100,000 students!

Mail the postpaid card today for all the facts—decide after you get them!

We invite you to fill out and mail the attached card now, while it's within reach. It asks no commitment on your part—just offers full details on how to learn electronics at home and enjoy it.

Who knows? You may soon be leading a double life like Bob Gordon.

And when friends ask, "Can you really service TV's?"—you'll answer with a grin. "I not only know how to service them, I know how to *build* them!"

Note: When taken for vocational purposes, this program is approved by the state approval agency for Veterans' Benefits.

If card has been used, write to:
An Electronics Home Study School
DEVRY INSTITUTE OF TECHNOLOGY

806R1



BELL & HOWELL SCHOOLS

4141 Belmont, Chicago, Illinois 60641

ulated TV test pattern

"Electro-Lab®" is a registered trademark of the Bell & Howell Company.

Do your stereo system a favor—

UPGRADE!

Convert your System from Ceramic to Magnetic Cartridge with Pickering's new preamplifier.

You'll appreciate this easy, low cost method for getting so much more out of your stereo system. Use it to help get real hi fi from your system.

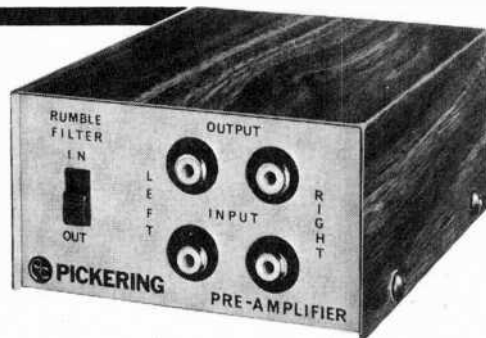

SPECIFICATIONS FOR THE PP-1 PREAMPLIFIER

Input Impedance: 47,000 ohms	Signal to Noise Ratio: 60 dB Min.
Gain @ 1 kHz: 38 dB	Crosstalk: Better than 60 dB
Frequency Response RIAA 30-15000 Hz: ±2 dB	Rumble Filter: Attenuates rumble frequencies a minimum of 15 dB

AUDIOPHILE NET
\$29⁹⁵

STEREO CONVERSION KIT (PP1/V15 AT-2) consists of the Pre-Amplifier and Pickering's V-15 AT-2 cartridge (which is listed at \$24.95). Total Value \$54.90 for only \$39.95.



"for those who can hear the difference"

For further information write Pickering & Co., Inc. Dept. PE, 101 Sunnyside Blvd., Plainview, N.Y. 11803

CIRCLE NO. 43 ON FREE INFORMATION CARD



We're one of the country's largest Mail Order Houses of Stereo Equipment and Musical Instruments.

Our volume buying power enables us to pass the savings on to you. Listen to us ... You can't go wrong.

Fill out this coupon and mail to address below for our latest Free Catalogs.

Name _____
Address _____
City _____
State _____ Zip _____

AUDIO CATALOG
 MUSICAL INSTRUMENT CATALOG

PE-1

STEREO DISCOUNTERS

7A AYLESBURY ROAD □ TIMONIUM, MD. 21093

(301) 252-6880

CIRCLE NO. 55 ON FREE INFORMATION CARD

DIXIE SAVE ON Brand Name Audio Components BY MAIL

Write Today for Our FREE Audio Catalog

DIXIE is one of the oldest and largest audio component mail order houses in the country. Our prices on brand name components are actually LOWER than "Discounters". See our new catalog or call us for a price quote. Everything shipped factory-sealed with full manufacturer's warranty.

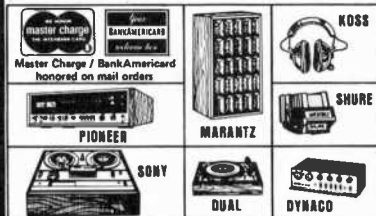

DIXIE HI-FIDELITY PE-1

5600 Second St., N. E., Washington, D. C. 20011
Phone: 1-202-635-4900

Please rush me your FREE Audio Catalog and complete information. I understand there is no obligation.

Name _____
Address _____
City _____
State _____ Zip _____

listeners were often told that top-notch equipment wasn't really needed for their uses.

Those days are gone! Today's listeners to nonclassical music now need high-quality audio gear just as much as those who prefer orchestral and chamber music. This is especially true of progressive-rock and jazz fans. Electronic instruments, such as synthesizers, have wrought this change. So have the more complex drum techniques that have evolved, which make strong use of cymbals to create a continual music line.

Representative of what one can expect from jazz and rock releases in the not-too-distant future is the use of a new instrument, the Syntar, manufactured by Electronic Music Labs, Vernon, CT. It's a marriage of the full-blown synthesizer and the electric guitar. A fiberglass-body Armstrong guitar is used, with each string controlling a separately programmable synthesizer. Therefore, a guitarist can simulate traditional instrument voices of wind and percussion, as well as special sound effects. Further, through the appropriate use of envelope generators and filters, such guitar feats as infinite sustain, polytonal slides, and deriving full chords from a single plucked note will now be made possible.

I listened to a demonstration cassette tape, and there's no doubt that a top-quality audio system would be required to appreciate the type of music the instrument can generate. Two of the finer guitarists around, John McLaughlin of the *Mahavishnu Orchestra*, and Steve Howe of the *Yes*, are said to be currently mastering the Syntar. (Sorry, the tape isn't available.)

And Next. Input jacks on the back of an audio amplifier or receiver are not restricted to use with tape decks, noise-reduction units, and record players. All manner of input equipment can be utilized, such as rhythm boxes. A new device I recently discovered is a harmonica pickup designed to be used with most Chromatic harmonicas. It plugs into the Aux jack and you'd be astonished at the "big sound" it makes possible. Frequency response is said to be 500 to 14,000 Hz; output, -57 dB; impedance, 90 kilohms; volume control, a 1-meg linear pot. A kit is available for \$24.95 (about 1/2 the price of an assembled unit) from Barrie Sound Studios, 377 W. Montgomery Ave., North Wales, PA 19454.

POPULAR ELECTRONICS

"Breaker . . . Breaker . . ."

Break-through with **BREAKER!**

The New Freedom Line of CB Mobile and Base Antennas and Accessories made in the U.S.A. for communications between people.

A wide selection of "revolutionary" new CB High Efficiency communications antennas of superior strength, electronically and physically, for all the talk power your CB rig will deliver—coming and going in the 27 Megahertz frequency band.

Mobile Breaker antennas for cars, trucks, trailers, sports cars, station wagons, motorcycles, boats. Breaker base station antennas to communicate with mobiles and hand helds . . . all designed specifically for the outstanding transmission and reception of CB signals.

The high quality and materials of the Breaker CB antennas and accessories assure you the maximum in performance for many years and at reasonable cost. Performance-tested Breaker CB antennas offer you these advantages plus more:

- ★ Easily adjust for lowest VSWR
- ★ Long-life stainless steel and fiberglass whips
- ★ Highest quality coaxial cable with solderless connections
- ★ Innovative engineering designs
- ★ Packaged for quick, easy installation to get you on the air fast, complete with cables and hardware

All Breaker antennas are American made in Arlington, Texas. In keeping with the tradition of the Bi-Centennial they are proudly named after our revolutionary heroes and places. Red, white and blue are also the colors of Breaker. Chosen because we too are very proud of our heritage and contribution to making exciting products for use by people communicating with people. See and buy the Freedom line of Breaker antennas and accessories at your nearest electronic distributor. Look for the red, white and blue packaging.

WRITE FOR FREE CATALOG.

GEORGE WASHINGTON

**West Coast Mirror Mount
Dual Truck, RV Antennas
Model 10-200**

Weather resistant dual 57" stainless steel whip antennas with static arrestor tips. Secure horizontal or vertical mounting to West Coast side view truck type mirrors. Twin antennas co-phased for more directional power and easily adjustable for fine tuning. Hermetically sealed, white oversized ABS center load. Dual 18' low-loss coaxial phasing harnesses with solderless connectors and quick disconnect PL-259 plugs. Complete with corrosion resistant mounting hardware.

INDEPENDENCE

**Gutter Mount Antenna
Model 10-245**

Low-profile 21" stainless steel whip antenna with static arrestor and flex-natic shock spring. Fits practically any vehicle rain gutter. No interference with door opening or passenger exit. Heavy-duty molded clamp bracket insulates and supports antenna. Center loaded ABS load coil for excellent transmission and reception. 14' coaxial cable with solderless connector and quick-disconnect PL-259 plug. Complete with corrosion resistant mounting hardware.

THE PATRIOT

**Omni-directional
¼-Wave Base Antenna
Model 11-101**

High in quality, performance and efficiency, low in cost. Has three 108" quarter wave tubular aluminum radials plus a quarter-wave radiator (vertical element). Heavy-duty U-clamp fits mast up to 1½" diameter. Built-in lightning protector. SO-239 style connector mount. Mates with PL-259 plug. Shunt loaded coil. Heavy duty insulated molded clamp bracket. Easy to assemble and dis-assemble. Fixed construction.

PAUL REVERE

**Roof Mount Antenna
Model 10-215**

Special "power-plus" 42" base-loaded roof mount with long-life stainless steel whip, rugged stainless steel shock spring and high-quality 16-ft. shielded coax cable and solderless connections for fast "on-the-air" installation. Named after the famed communicator and hero of revolutionary era.

THE MINUTEMAN

Trunk Mount Antenna Model 10-230

Sturdy, durable, no-hole required in trunk of vehicle. Super 44" stainless steel whip, base loaded low-profile antenna with stainless shock absorbing spring chrome plated brass bell housing. 16-foot shielded coaxial cable and solderless connections.

"Just say it with Breaker!"

BREAKER
CORPORATION

1101 Great Southwest Parkway
Arlington, Texas 76011

CIRCLE NO. 51 ON FREE INFORMATION CARD

If you can't go to college for your career in electronics —read this!

CREI brings college-level training to you with eight educational advantages, including special arrangements for engineering degrees

The best way to qualify for top positions and top pay in electronics is obviously with college-level training. The person with such training usually steps more quickly into an engineering level position and is paid considerably more than the average technician who has been on the job several years.

A regular college engineering program, however, means several years of full-time resident training—and it often means waiting several years before *you can even start your career*. This, of course, is difficult if you must work full time to support yourself and your family.

If your career in electronics is limited without college-level training, take a look at the advantages a CREI home study program can offer you.

1. Convenient Training

CREI brings the college to you. Through the convenience of home study, you receive exactly the same level of training you will find in any college or university offering programs in electronic engineering technology. With CREI, however, you can “go to college” whenever you have spare time at home or on the job.

2. Specialized Programs

With CREI, you enjoy the advantage of *specialized* training. That is, your program will include only those courses directly applicable to your career in electronics. We omit such courses as English, social studies and other subjects, which are usually required in resident schools. Therefore, with CREI, you move ahead faster to the more interesting and useful part of your training.

3. Practical Engineering

CREI programs give you a *practical engineering* knowledge of electronics. That is, each part of your training is planned for your “use on the job.” By using your training, you reinforce the learning process. And by demonstrating your increased knowledge to your employer, you may qualify for faster career advancement.

4. Engineering Degrees

CREI offers you a number of special arrangements for earning engineering degrees at recognized colleges and universities. You can earn college credit while you are taking your CREI program or apply later, whatever is best for your career plans.

Career Training at Home

5. Unique Laboratory

Only CREI offers you the unique Electronic Design Laboratory Program. This complete college laboratory makes learning advanced electronics easier and it gives you extensive practical experience in many areas of engineering, including design of electronic circuits. No other school offers this unique program. It is a better "Lab" than we have found in many colleges. And the professional equipment included in the program becomes yours to keep and use throughout your professional career.

6. Wide Program Choice

CREI gives you a choice of specialization in 14 areas of electronics. You can select exactly the area of electronics best for your career field. You can specialize in such areas as computer electronics, communications engineering, microwave, CATV, television (broadcast) engineering and many other areas of modern electronics.

7. Prepared by Experts

Experts in industry and technical organizations of government develop CREI programs. Each part of your training is developed by a recognized expert in that area of electronics. That means you get the most up-to-date and practical instruction for your career.

8. Industry Recognition

That CREI training is recognized by industry and government is evident from the fact CREI provides training to advanced technical personnel in over 1,700 technical organizations. Many subsidize the training of their employees with CREI. If there is any question about the advantages of CREI training for you, ask your employer or any engineer to evaluate the outline of a CREI program for you.

Other Advantages

Of course, there are many other advantages to CREI training. For example, throughout your training, CREI's staff gives you personal instruction for each step of your program. And in many industrial areas, both in the U. S. and abroad, CREI Field Service Representatives provide a number of important personal services for your training and your career.

FREE Book

There isn't room here to give you all of the facts about career opportunities in advanced electronics and how CREI prepares you for them. So we invite you to send for our free catalog (if you are qualified). This fully illustrated, 80 page catalog describes in detail the programs, equipment and services of CREI.

Qualifications

You may be eligible to take a CREI college-level program in electronics if you are a high school graduate (or the true equivalent) and have previous training or experience in electronics. Program arrangements are available depending upon whether you have extensive or minimum experience in electronics.

Send for this **FREE Book** describing your opportunities and CREI college-level programs in electronics

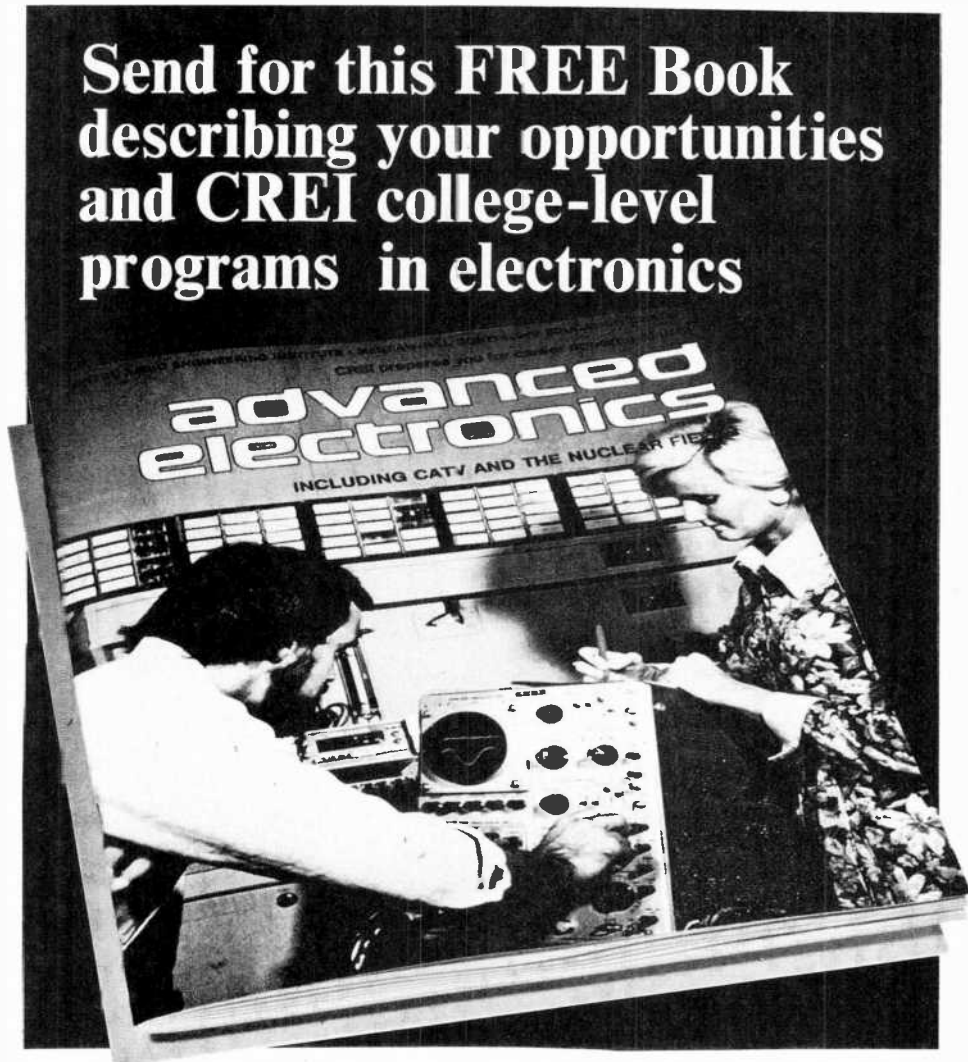

Mail card or write describing qualifications to

CREI **CAPITOL
RADIO
ENGINEERING
INSTITUTE**

McGraw-Hill Continuing Education Center
3939 Wisconsin Avenue Northwest
Washington, D.C. 20016

Accredited Member National Home Study Council

GI Bill

CREI programs are approved for training of veterans and servicemen under the G.I. Bill.

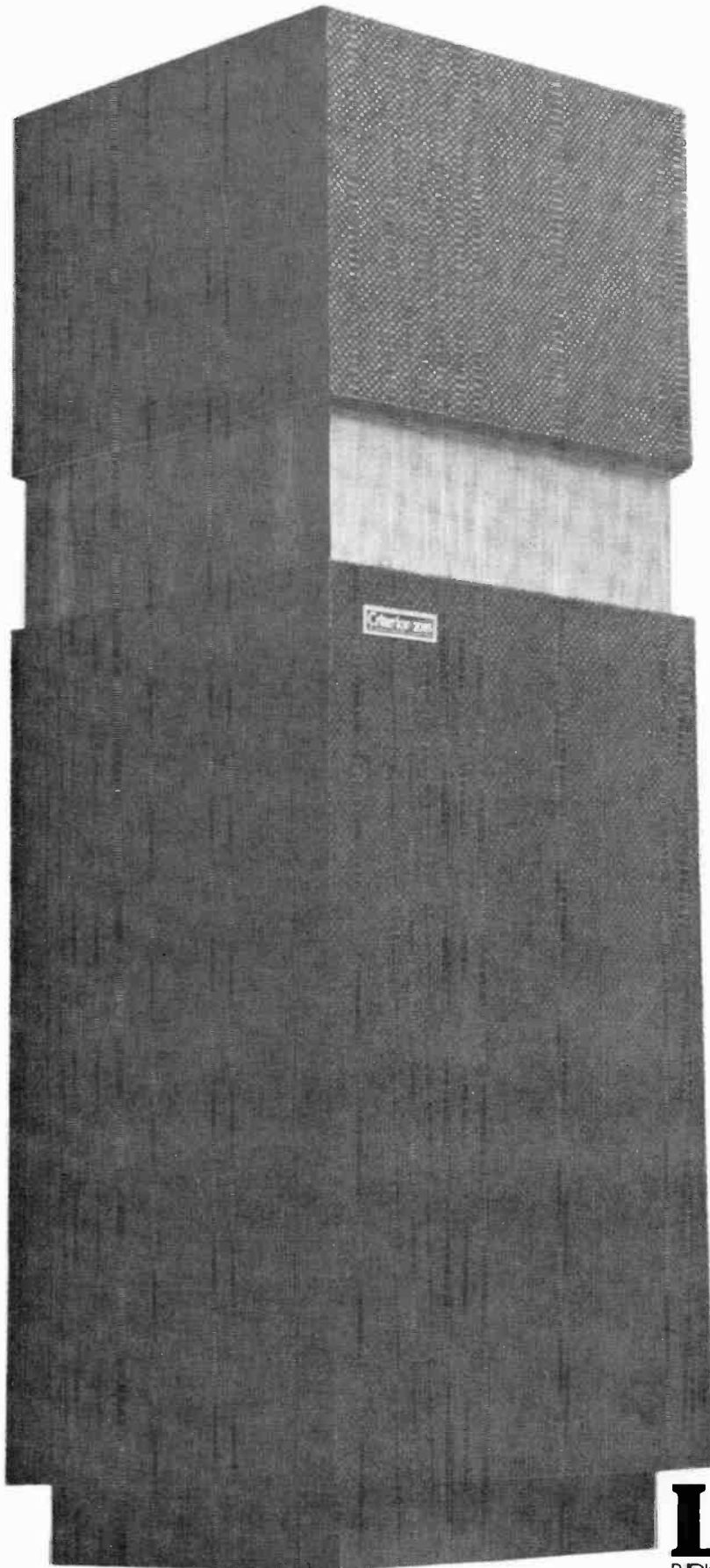

BEEN
DISSATISFIED
IN THE PAST?

HERE'S A
PRESENT
FROM
THE
FUTURE.

This is our Criterion 2005 Heil Air-Motion Transformer Speaker System.

Incredible purity, astonishing clarity and definition are achieved through the use of the Heil Air-Motion Transformer Tweeter. Tastefully encased in a simple, uncluttered column, the 2005's "corona field" Heil Air-Motion Transformer reveals every important characteristic that the ear has been longing to hear. The 2005 offers outstanding dispersion to the highest frequencies, essentially flat response to beyond 22,000 Hz and complete freedom from fatigue producing distortion. The 2005 has a continuously variable control allowing infinite high frequency adjustment to balance with the acoustics of any room. Advanced engineering, outstanding performance and uncluttered styling. You'll find them all in the 2005. And you'll find the 2005 in any of our coast-to-coast electronic shopping centers and associated stores.

199.95

ELECTRONICALLY SPEAKING,
WHO KNOWS BETTER THAN

Lafayette
RADIO ELECTRONICS & SHOPPING CENTERS

© LAFAYETTE RADIO ELECTRONICS CORPORATION 1975

CIRCLE NO. 29 ON FREE INFORMATION CARD

CONNECTING extension speakers to one's stereo system or rear speakers for a four-channel setup is a terrifying task for many people. It often means running speaker wires through walls and floors, hiding them under a carpet, or tacking them to baseboards. Presented here is a "wireless" system that eliminates this problem!

The new system uses existing ac power lines, operating in an FM mode. The result is good-quality audio (wide frequency response and low distortion) and a high order of noise immunity.

To overcome the old obstacles of the wireless medium (noise, narrow bandwidth, etc.), as in AM wireless intercoms, the Wireless Hi-Fi System employs an FM carrier, phase-locked-loop (PLL) and voltage-controlled-oscillator (vco) IC's. The result claimed by the author is a 30-to-17,000-Hz ± 0.2 dB frequency response, 2% total harmonic distortion (THD), and excellent noise immunity for a fine signal-to-noise (S/N) ratio of -50 dB unweighted, at 2 watts power output into an 8-ohm speaker. (How to achieve higher power output is discussed later in this article.) In addition, putting the signal on the ac line will generally assure good reception at all power outlets in your home—even if the transmitter and receiver are on *opposite* sides of the line.

CONSTRUCTION

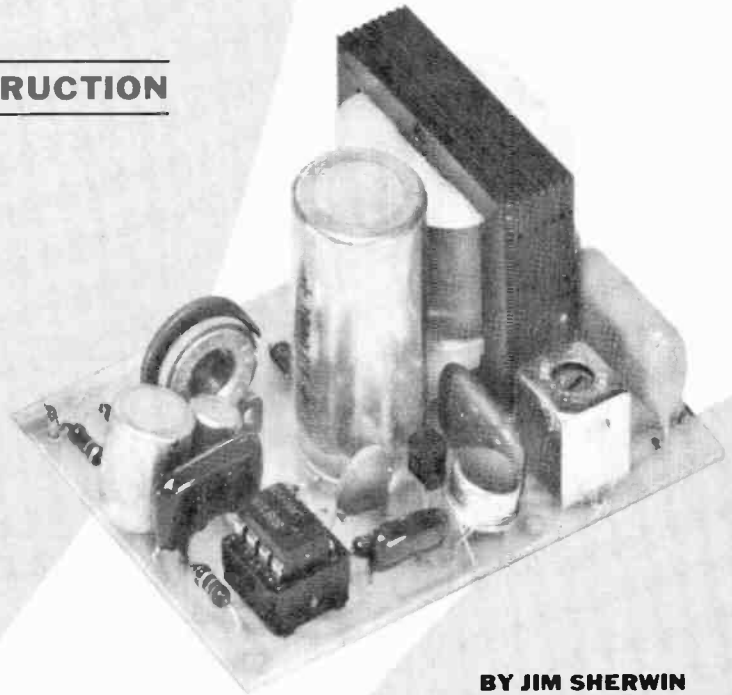

BY JIM SHERWIN

A Wireless Audio System for Remote Speakers

Now you can enjoy high-quality remote sound without running wires around the house.

As structured, the system will accommodate a monophonic signal. To transmit stereo, two systems can be used, each tuned to a different carrier frequency. The drive signals can be taken from the tape monitor and tape output jacks of your amplifier. If your hi-fi system doesn't have these jacks, the signal can be taken from across the speaker terminals, but the advantage of a fixed level will be lost.

About the Circuit. The transmitter, shown schematically in Fig. 1, uses voltage-controlled oscillator IC1 to drive the Q1 amplifier. The dc power bus is regulated by IC2.

Two inputs are provided so that both left and right channels from a stereo system can be combined for transmission to a remote speaker system. For a monophonic source, resistors R7 and R8 can be eliminated and

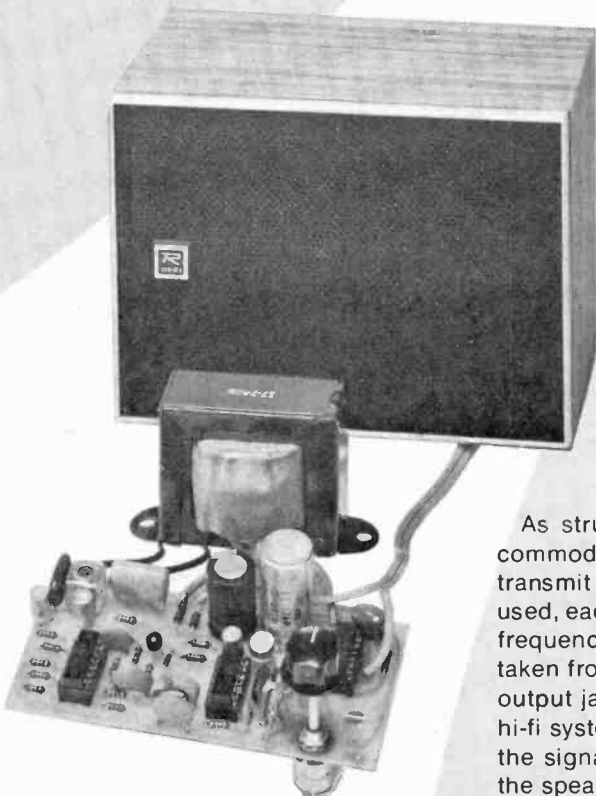

Fig. 1. Two inputs are provided for the transmitter. For a monophonic source, R7 and R8 can be eliminated.

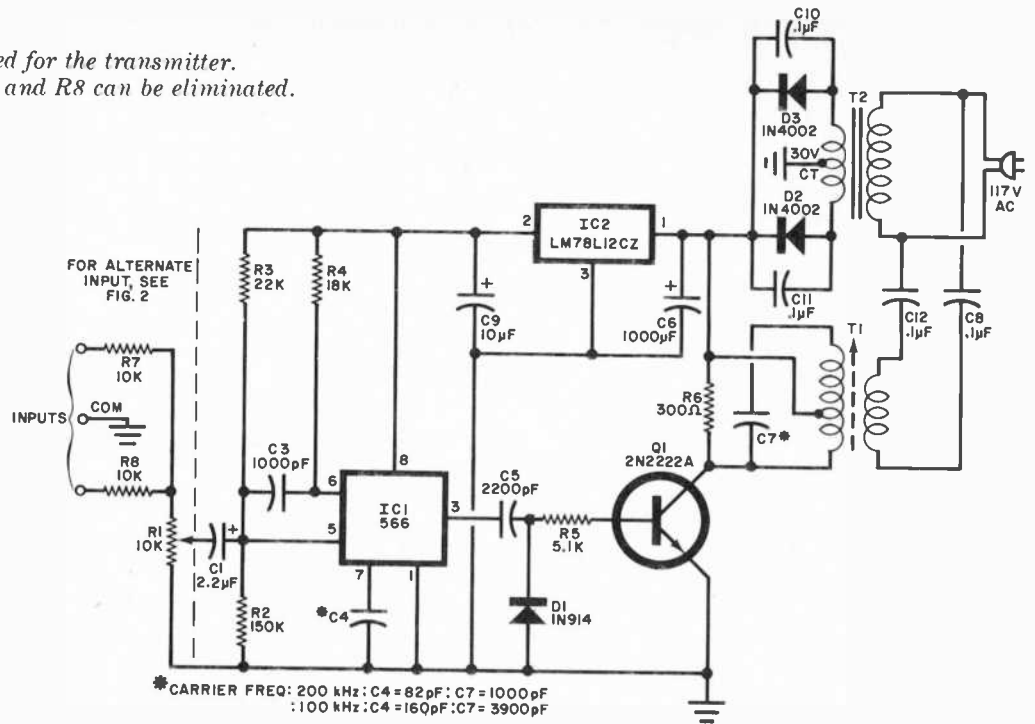
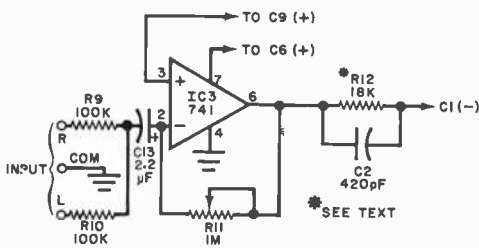

Fig. 2. Use the circuit below to provide pre-emphasis for the transmitter in Fig. 1.



POPULAR ELECTRONICS' performance tests verified that the S/N ratio measured -65 dB, exceeding the author's claimed -50 dB. With "A" weighting it was -93 dB. At 0.9 W, distortion was 0.98%; at 2.5 W, it was 4.9%. Frequency response was 30 to 17,000 Hz ± 0.5 dB—Ed.

the input signal fed directly to the top of potentiometer R1. If you want to use the system to feed one channel from a stereo system to the other side of the room, for example, omit R8 and install a 470-pF capacitor across R7. This will improve the frequency response so that it goes out to about 20,000 Hz.

The alternate input circuit shown in Fig. 2 should be used in either of two situations. First, if you are tapping the signal(s) from a high-impedance source, the 10,000-ohm resistor(s) could load down the driving signal in a mono circuit, or introduce unacceptable crosstalk between the two channels of a stereo system (as applied to the main power amplifier). If so, the circuit of Fig. 2 will provide the higher

TRANSMITTER PARTS LIST

- C1, C13*—2.2- μ F, 50-volt electrolytic capacitor
- C2*—420-pF mica capacitor
- C3—1000-pF disc capacitor
- C4—See Fig. 1 for value
- C5—2200-pF disc capacitor
- C6—1000- μ F, 25-volt electrolytic capacitor
- C7—See Fig. 1 for value
- C8, C10, C11, C12—0.1- μ F, 200-volt film capacitor
- C9—10- μ F, 16-volt electrolytic capacitor
- D1—1N914 silicon diode
- D2, D3—1N4002 rectifier diode
- IC1—566C voltage-controlled oscillator integrated circuit
- IC2—78L12CZ—12-volt regulator integrated circuit
- IC3*—741C operational amplifier integrated circuit.

- Q1—2N2222A transistor
- R1—10,000-ohm pc-type potentiometer
- R11*—1-megohm pc-type potentiometer
- The following resistors are 1/2 watt:
- R2—150,000 ohms, 10%
- R3—22,000 ohms, 10%
- R4, R12*—18,000 ohms, 5%
- R5—5100 ohms, 10%
- R6—300 ohms, 5%
- R7, R8—10,000 ohms, 10%
- R9*, R10*—100,000 ohms, 10%
- T1—Line-coupling transformer (see text)
- T2—Power transformer with 30-volt center-tapped, 50-mA secondary (Triad No. F133P or similar)
- Misc.—Printed circuit board; line cord; machine hardware; hookup wire; solder; etc.
- *Optional preemphasis circuit components.
- Note—See Fig. 3 Parts List for availability of parts.

degree of isolation required. The parallel combination R12-C2 will smooth out the frequency response of the system. To make up for losses in the RC combination, gain is provided (between unity and 10) by op amp IC1. Gain is controlled by feedback resistor R11.

Because the system's noise immunity is good, no preemphasis/deemphasis is required. However, if you wish to experiment, the alternate input circuit should be used, with a higher RC time constant. For standard 75- μ s preemphasis, R12 should be changed to 180,000 ohms. Then, all program material above 2120 Hz will be emphasized before it enters the transmitter. As above, op amp IC1 provides gain (set by R11) to balance out losses in the preemphasis net-

work. Of course, if preemphasis is introduced in the transmitter, deemphasis must then be incorporated into the receiver.

The free-running frequency, f_c , of voltage-controlled oscillator IC1 in Fig. 1 is determined by the values of R4 and C4. The sensitivity of the vco with the biasing shown and a V_{cc} of +12 volts is about $\pm 0.66f_c/V$. For minimum distortion, the deviation should be limited to $\pm 10\%$, which means that the maximum input signal level at pin 5 of IC1 should be 0.3 volt peak-to-peak. The output voltage from the tape monitor or tape output jack of an audio system may range from 0.4 to 1.5 volts rms; therefore, R1 is provided so that an appropriate modulation level can be set.

The frequency-modulated output at

pin 3 of *IC1* is roughly a 6-volt peak-to-peak square wave. This signal is used to modulate the *Q1* r-f oscillator, which uses tuned transformer *T1* as its collector load. Because *T1* is tuned to f_c by adjusting its slug and *C7*, it serves as a high-impedance collector load, which eliminates the need for additional current limiting for *Q1*. Because the collector signal can have as much as a 50-volt peak-to-peak amplitude, *Q1*'s breakdown point must be high. The transistor specified for *Q1* in the Parts List has a 60-volt breakdown to provide a margin of safety. The modulated r-f output from the transmitter

is coupled to the power line via *C8* and *C12*.

Note that Fig. 1 specifies values for *C4* and *C7* for either 100- or 200-kHz operation. Also note that capacitors *C10* and *C11* are connected across rectifier diodes *D2* and *D3*. These capacitors reduce the small step transient that might be present across the silicon diodes whose upper harmonics fall within the frequency of interest.

The job of the receiver is to amplify, limit, and demodulate the received FM signal riding on the ac power line which can have high-amplitude noise

transients. In addition, the receiver must also provide an audio mute in the absence of a carrier.

The circuit shown in Fig. 3 picks up the incoming FM signal and tunes to the carrier frequency via the *T1/C2* circuit. This signal is then applied to a two-stage limiting amplifier (composed of elements inside transistor array *Q1*), phase-locked loop *IC1*, audio amplifier *IC2*, and a mute circuit made up of *Q1E* and discrete transistor *Q2*.

The FM carrier is coupled to the primary of tuned transformer *T1* through *C1* and *C21*. The secondary of

Fig. 3. In the receiver, the value of *C10* must be increased for de-emphasis, if preemphasis is used in transmitter.

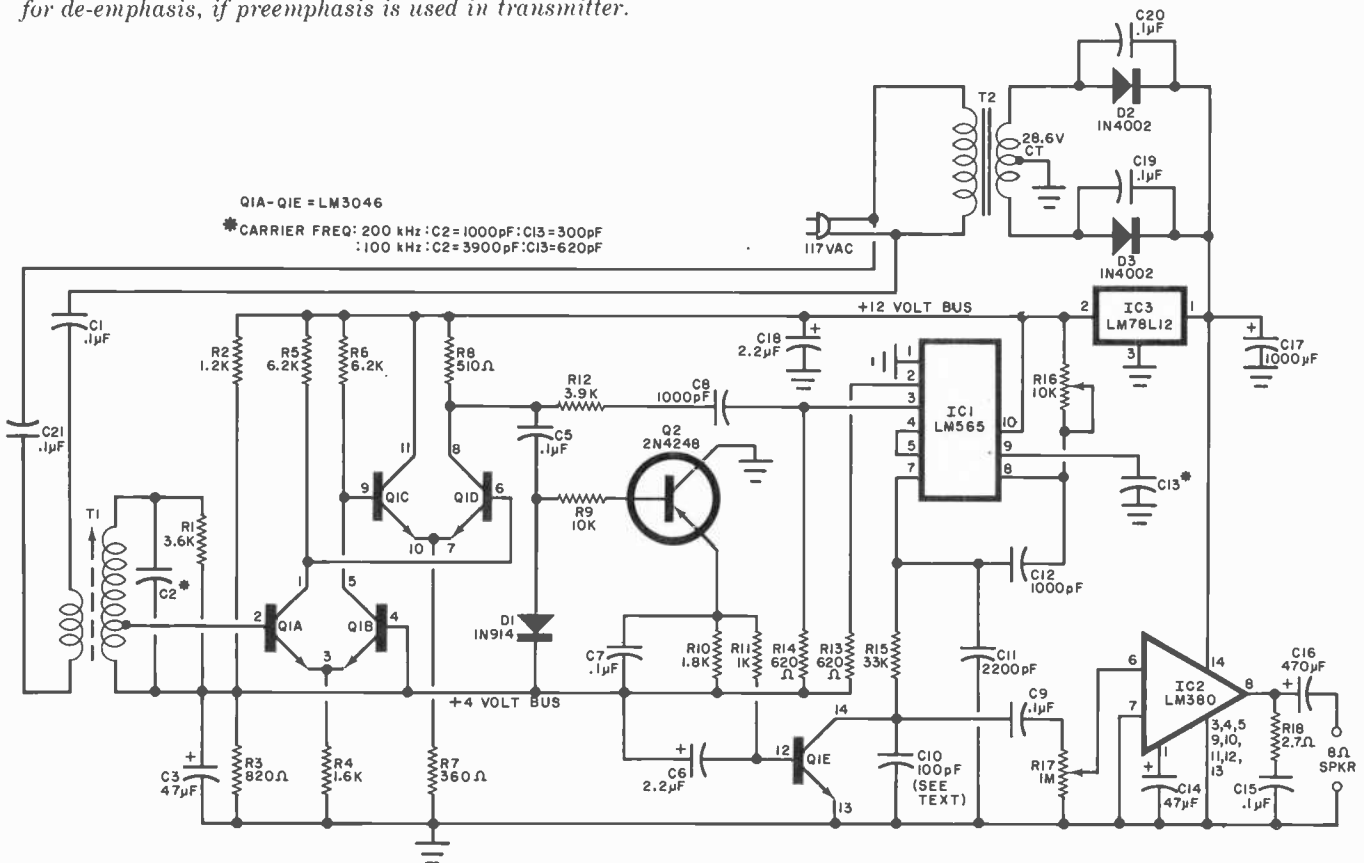

RECEIVER PARTS LIST

C1, C9, C19, C20, C21—0.1- μ F, 200-volt film capacitor
C2—See Fig. 3 for value
C3, C14—47- μ F, 16-volt electrolytic capacitor
C4—Not used
C5, C7, C15—0.1- μ F, 25-volt disc capacitor
C6, C18—2.2- μ F, 25-volt electrolytic capacitor
C8, C12—1000-pF disc capacitor
C10—100-pF disc capacitor (see text)
C11—2200-pF disc capacitor
C13—See Fig. 3 for value
C16—470- μ F, 25-volt electrolytic capacitor
C17—1000- μ F, 25-volt electrolytic capacitor
D1—1N914 silicon diode
D2, D3—1N4002 rectifier diode
IC1—565C phase-locked loop integrated circuit

IC2—LM380 audio amplifier integrated circuit (National)
IC3—78L12CZ 12-volt regulator integrated circuit

Q1 (A to E)—LM3046 transistor array (National)
Q2—2N4248 transistor.

The following resistors are 1/2 watt:

R1—3600 ohms, 5%
R2—1200 ohms, 5%
R3—820 ohms, 5%
R4—1600 ohms, 5%
R5, R6—6200 ohms, 5%
R7—360 ohms, 5%
R8—510 ohms, 5%
R9—10,000 ohms, 10%
R10—1800 ohms, 5%
R11—1000 ohms, 5%
R12—3900 ohms, 10%
R13, R14—620 ohms, 5%
R15—33,000 ohms, 10%
R18—2.7 ohms, 10%
R16—10,000-ohm pc-type potentiometer

R17—1-megohm potentiometer
T1—Line-coupling transformer (see text)
T2—Power transformer with 26.8-volt center-tapped, 1-ampere secondary (Triad No. F40X or similar)

Misc.—Printed circuit board; line cord; machine hardware; hookup wire; solder; etc.

Note—The following items are available from American Scientific Corp., 1957 Old Middlefield Rd., Mountain View, CA 94043; etched and drilled transmitter pc board for \$3; etched and drilled receiver pc board for \$5.50; transmitter *IC*'s and transistors and Toko line-coupling transformer for \$6.00; receiver *IC*'s and transistors and Toko transformer for \$10.50; complete transmitter kit for \$18.95, plus \$1.00 shipping; complete electronics receiver kit for \$27.95, plus \$1.00 shipping. National Semiconductor *IC*'s are available, singly or in quantity from OEMorsco, 2403 Charleston Rd., Mountain View, CA 94043.

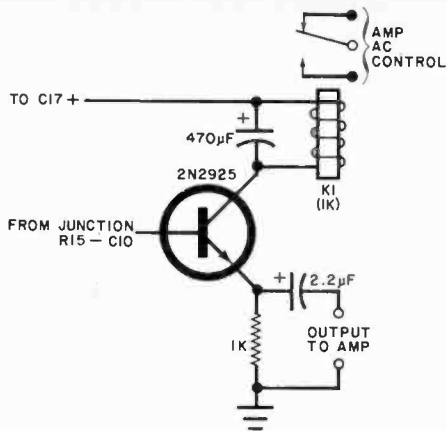

Fig. 4. Use this circuit to change receiver output for more power.

T1 is tuned by C2, while R1 lowers the Q of the circuit to permit it to accept the $\pm 10\%$ modulation and to prevent excessive ringing on noise spikes. Such ringing would cause the mute circuit to deactivate. The secondary of T1 is tapped to match the input impedance of Q1A. The recovered carrier at the secondary of T1 can have an amplitude of between 0.2 and 45 volts peak-to-peak. The 17:1 turns ratio from the full secondary to the tap reduces the amplitude of the recovered carrier so that the base of Q1A "sees" a signal that ranges from 12 mV to 2.6 volts peak-to-peak.

The two-stage limiter amplifier composed of Q1A through Q1D operates as a fairly fast comparator whose slew rate is about 70 volts/ μ s and gain is about 3000. The output from this limiter is a roughly 7-volt peak-to-peak square wave that has rise and fall times of 100 ns. (Any fairly fast comparator that delivers more than 5 volts output could be used as the limiting amplifier. However, the transistor array specified is a low-cost item that has the advantage of containing an extra-high beta transistor, Q1E, which is used as the mute switch.) The 7-volt peak-to-peak output of the limiting

amplifier is applied directly to the mute detector, Q2, but is reduced to about 1 volt by the attenuator consisting of R12 and R14 before being applied to PLL IC1.

The PLL operates as a narrow-band filter that tracks the incoming FM signal and provides a low-distortion demodulated audio output whose signal-to-noise (S/N) ratio is high. The oscillator inside the PLL is set to free-run at a frequency near that of the car-

rier by the choice of value for C13 and setting of R16.

If 75-microsecond preemphasis is used, increase the value of C10 to 2200 pF. Increasing this capacitor's value will reduce the carrier level in the audio line at the expense of high-frequency audio response.

The mute circuit quiets the receiver when no carrier is present. Without this circuit, an excessive noise level would result as the PLL attempts to

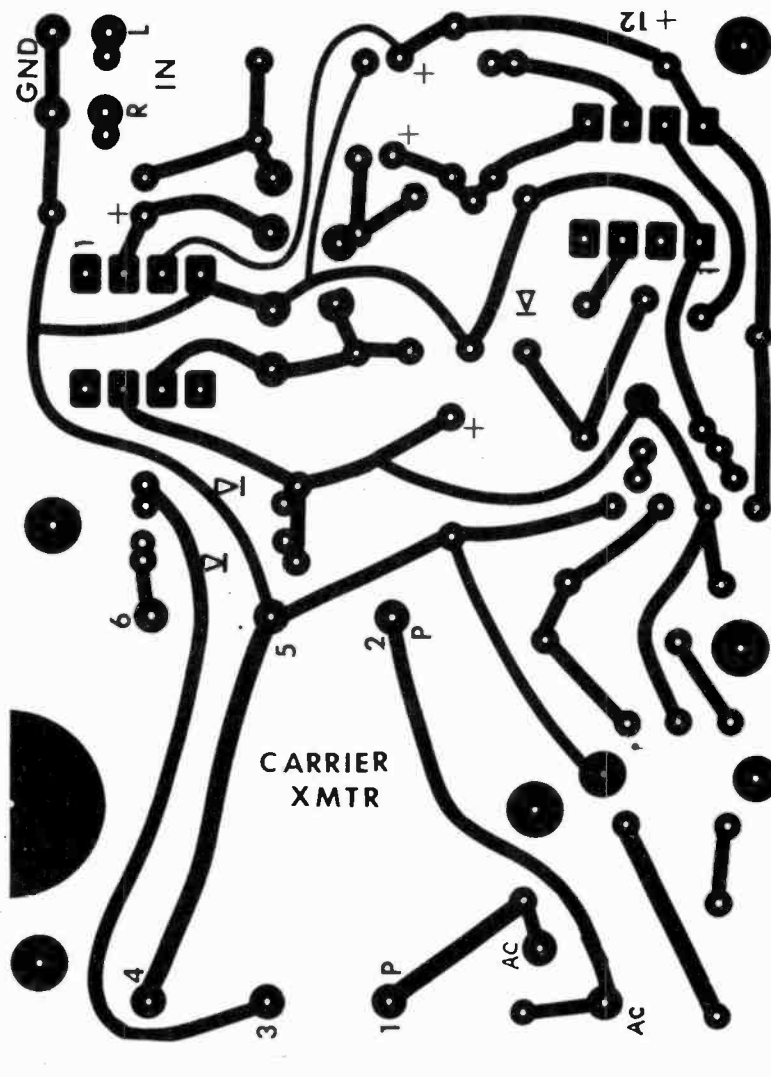

A

Fig. 5. Etching and drilling guide for the transmitter are shown above (A). Component placement for standard transmitter is at left (B). If pre-emphasis is used, the component placement at right is necessary (C).

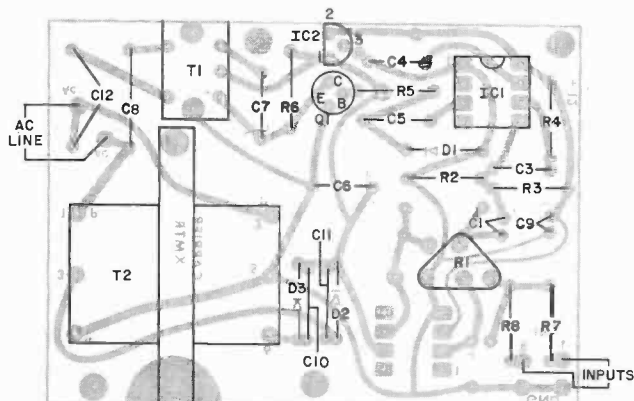

B

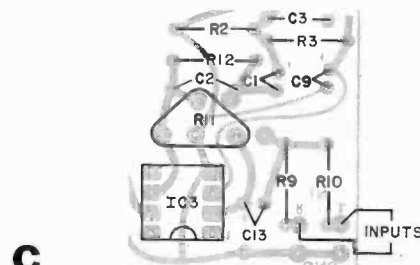

C

lock onto noise spikes when the transmitter is shut off. The mute detector is composed of $C7$, $D1$, and $Q2$. Note that an emitter-follower transistor stage is used in place of a diode to give the peak detector a high input and a low output impedance. This permits the peak detector to shunt 1 to 2 mA of bias away from $Q1E$, without loading the limiter amplifier.

With no carrier present, the +4-volt line biases $Q1E$ into conduction via $R10$ and $R11$, shorting the audio signal to ground. When a carrier is present, the 7-volt square wave from the limiter amplifier is peak detected, producing a negative output that is integrated by $R9$ and $C7$, averaged by $R10$ across $C7$, and further integrated by $C6$ and $R11$. The resultant -4-volt output subtracts from the +4-volt bias to deprive $Q1E$ of base current. This transistor cuts off and allows the demodulated audio signal to pass to the audio amplifier. Peak detector integration and averaging prevents random noise spikes from deactivating the mute when no carrier is present.

Audio amplifier $IC2$ supplies about 2 watts of audio power to an 8-ohm speaker connected across the output of the receiver. Although this amount of power is adequate for casual and background-music listening, if you want to drive relatively inefficient hi-fi speaker systems, you'll have to modify the output of the receiver to drive a hi-fi amplifier. The circuit shown in Fig. 4 does this. To use it, audio power amplifier $IC2$ is removed from the receiver circuit and the Fig. 4 circuit goes into the receiver as specified. This switching circuit operates from the mute signal so that when the transmitter is switched on, the relay will energize to apply power to the external power amplifier. In this manner, the power amplifier will automatically switch on when a signal is received. Standby power is less than 1 watt.

Construction. The transmitter is best assembled on a printed circuit board, the etching and drilling guide for which is shown actual size in Fig. 5A. In Fig. 5B is the component placement diagram for the board, while the detail in Fig. 5C shows the additions and changes to be made when preemphasis is used in the transmitter. When comparing B and C, note that $R1$ is eliminated from the former and $R11$ is installed in the latter, displaced one pad space to the left but oriented the same.

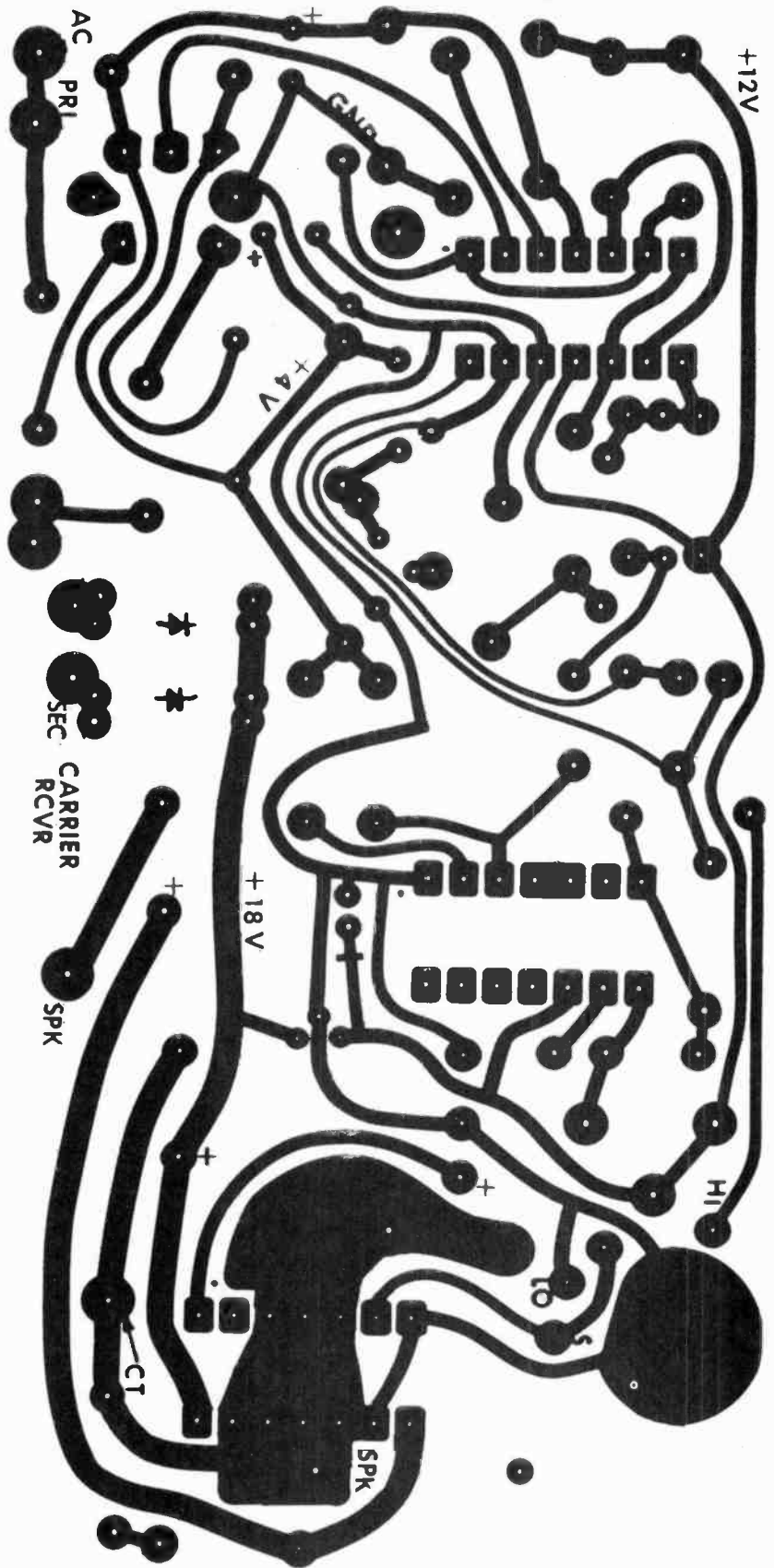

A
 Fig. 6A. Etching and drilling guide for the receiver is shown above. The component placement diagram (Fig. 6B) is on next page.

THE SILENCER

Your ears are burning with amplified noise. Even though your system is delivering sound accurately, it's also doing an efficient job of pumping out noise . . . accurately. Ideally, music should be recreated against a dead silent background. The Phase Linear 1000 accomplishes just that with two unique systems: The Auto Correlator Noise Reduction and the Dynamic Range Recovery Systems.

★ It improves the overall effective dynamic range and signal/noise ratio 17.5 dB in any stereo system with any stereo source.

★ The Auto Correlator reduces hiss and noise 10 dB without the loss of high frequencies and without pre-encoding.

★ The Dynamic Range Recovery System restores 7.5 dB of dynamic range without pumping and swishing.

★ Plus, it removes hum, rumble and low frequency noises, without the loss of low frequency music.

★ WARRANTY: 3 years, parts and labor

Even the finest stereo systems are limited in performance by the quality and nature of the recording. With the Phase Linear 1000, these limitations are overcome. Added to any receiver or preamplifier, it gives you the most significant improvement in sound reproduction for the money . . . more than any other single piece of equipment you could add to your system. Ask your dealer for an audition. The silence is deafening.



*Phase
Linear
1000*

Phase Linear Corporation,
20121 48th Avenue W.
Lynnwood, Washington 98036

CIRCLE NO. 63 ON FREE INFORMATION CARD

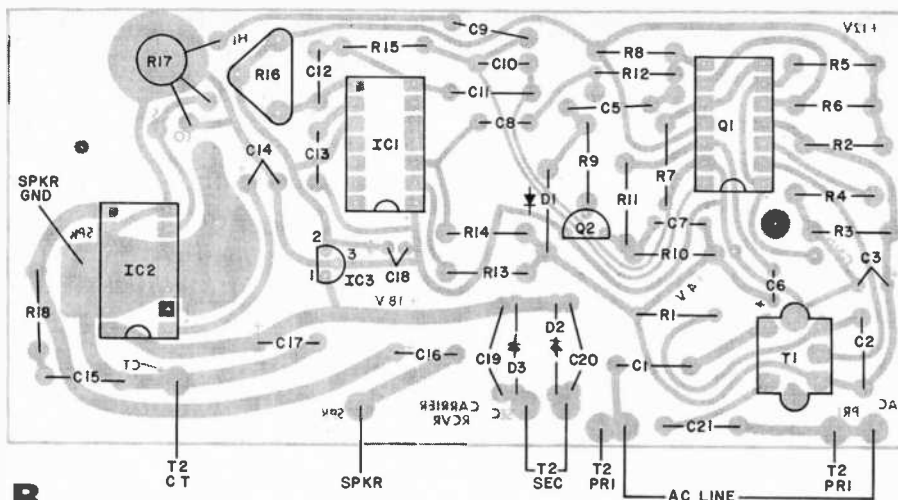

B

Fig. 6B. Component placement diagram for the receiver is shown above. Foil pattern (Fig. 6A) is on previous page.

Line-coupling transformer *T1* can be made from a 455-kHz AM i-f transformer. In rewinding the turns, the secondary is made up of four turns, while 154 turns are used in the primary, tapped 29 turns from one end of the coil. You can use the wire originally wound on the transformer or 41 AWG enameled wire for the turns.

As with the transmitter, the receiver is best assembled on a printed circuit board. The etching and drilling guide and components placement diagram are shown in Fig. 6A & B.

Line-coupling transformer *T1* is constructed in the same manner as described for *T1* in the transmitter, except that primary is composed of 4 turns the secondary 154 turns, tapped 9 turns from one end.

Adjustments. Make sure that the transmitter and receiver are operating at the same frequency. (See Figs. 1 and 3 for values of frequency-determining components.) Plug the transmitter and receiver into ac outlets and use an oscilloscope or ac voltmeter to check the amplitude of the waveform across the secondary of *T1* in the receiver. There is no need at this time to have the carrier modulated.

Adjust the slugs in the *T1*'s in both the transmitter and the receiver for maximum signal amplitude across the secondary of *T1* in the receiver. If the receiver is to be located some distance from the transmitter or on the opposite side of a 117/220-volt service line, *T1* will have to be readjusted in the receiver to maximize rejection of ac line noise.

The free-running frequency of the PLL in the receiver is trimmed by adjusting *R16*, which should initially be

set near the center of its range. Rotate *R16*'s wiper slowly in both directions until the PLL loses lock, indicated by a sharp increase in noise and a distorted output from the receiver. Note the two positions where drop-out occurs; center *R16* between these two points. A finer adjustment may be required to obtain minimum noise if an SCR light dimmer is in operation.

The final adjustment is for modulation amplitude in the transmitter. Connect an audio signal source to the input of the transmitter and adjust *R1* for a signal amplitude of about 0.1 volt rms maximum at the input (pin 5) of *IC1*. This can also be accomplished by carefully listening to the receiver while adjusting *R1* in the transmitter until the sound just distorts and then backing off a little.

Because a single transmitter/receiver system will suffice for a monophonic sound system or for one channel of a stereo system, a second receiver and transmitter will be required for stereo sound over the wireless medium. In this case, one transmit/receive system would be tuned to 100 kHz and the other to 200 kHz. You can also use a pair of transmit/receive systems for the rear channels in a 4-channel system to avoid running cables all over your listening room. Again, you would use a different carrier frequency for the different channels.

One final note: Although we have mentioned using carrier frequencies of 100 kHz and 200 kHz for a two transmit/receive system, this spacing needn't be 100 kHz apart. For most purposes, a 40-kHz spacing will do, while still providing maximum frequency response from the system. ♦



Yerkes Observatory photograph

Get into this fascinating new hobby with a simple homebrew telescope system.

BY DAVID HEISERMAN

RADIO astronomy has changed our understanding of the universe. Behind this new science is an electronic, rather than an optical "eye," called the *radio telescope*. It was the radio telescope that first brought to our attention the existence of quasars, pulsars, and galaxies that seem to disappear at the very brink of space and time.

Shortly after World War II, radio astronomy became a serious science. The wartime effort brought tremendous advances in communication and radar receivers and antennas that had the bandwidths, low noise levels, and high gain characteristics required for radio astronomy. Professional astronomers seized the opportunity to explore the universe by studying the radio signatures of planets, stars, and galaxies. The amateur astronomer, however, has shown uncharacteristic shyness toward radio astronomy.

Part of the amateur's reluctance to get involved in radio astronomy has been the lack of budget-priced "viewing" equipment. Though this may have been an obstacle in the past, vhf and uhf equipment and devices are now readily available for amateur use.

In this article, we will discuss radio astronomy in general terms to introduce amateur optical astronomers and non-astronomers to this fascinating and relatively new hobby. We will discuss what a radio telescope is and how to listen to the cosmos with a simple homemade telescope.

Tuning In the Stars. The stars that fill the nighttime skies with their twinkling blue-white light visible to the human eye emit electromagnetic energy in the visible spectrum. It is to these that the optical astronomer aims his telescope. Many large objects in space also emit electromagnetic energy at longer wavelengths, in the shf, uhf, and even vhf portions of the radio spectrum. Obviously, no optical telescope allows the human eye to view these wave-lengths. For these, you need a radio telescope.

The real impact of radio astronomy has not come from matching up light and radio waves from visible stars. Most of the stars visible to the human eye generate relatively low amounts of energy in the radio spectrum. In contrast, the most powerful radio sources outside our solar system include dis-

tant galaxies, dense star clusters, and remnants of exploded star systems.

Consequently, a simple backyard radio telescope can (and does) readily respond to colliding galaxies on "the other side of the universe," though it cannot detect radiation from well-known stars like Vega and Sirius. Furthermore, a simple radio telescope can pick up radiation from sources that are optically obscured by clouds of gas and dust, a condition that exists when an optical telescope is turned toward the center of the Milky Way galaxy. Also, radio telescopes can "see" through clouds, air pollution, and high ambient light at night and can be used for daylight "viewing."

The universe is literally alive with white-noise radio "static." Every hot object—which includes stars, galaxies, etc.—emits broadband radio energy that has an intensity roughly proportional to its temperature. As illustrated in Fig. 1, this kind of *thermal* radiation rises in intensity through the vhf and uhf parts of the radio spec-

Figures 1, 2, and 3 are from the author's book "Radio Astronomy for the Amateur," published by Tab Books, Blue Ridge Summit, PA.

Fig. 1. Relative intensity of thermal and nonthermal sources across the spectrum.

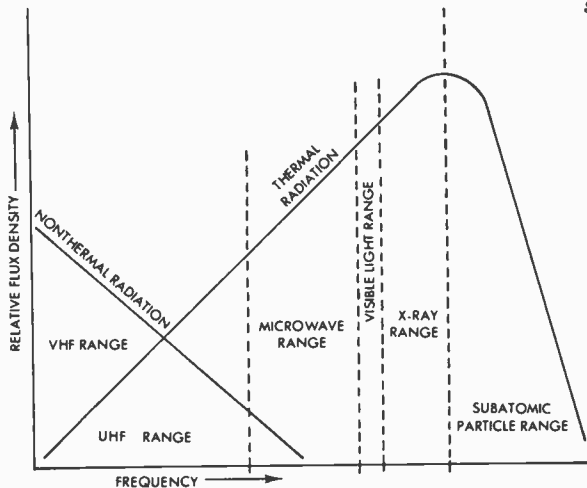

trum. It reaches a peak just beyond the visible wavelengths.

There are also nonthermal sources of radio noise in space. Most such sources are created by high-velocity electrons whipping through intense magnetic and gravitational fields that surround most stars and galaxies. Note from Fig. 1 that the intensity of nonthermal radiation is highest at the low end of the vhf radio band.

Many radio sources in space generate noise that is both thermal and nonthermal. The significance of this is that an amateur astronomer has the option of observing the sources anywhere across the radio spectrum. Some sources, however, tend to generate larger doses of radio energy at one end or the other of the spectrum. The sun and Jupiter are classic examples of predominantly nonthermal sources of radio energy.

The sun is our most powerful radio source. While it generates much high-frequency thermal radiation, intense nonthermal signals from sunspots and solar flares make it an excellent subject for the novice radio astronomer. The planet Jupiter is the next strongest radio source. Since it is rather cold, its thermal radiation is negligible (as far as amateurs are concerned). Jupiter's powerful gravitational field, however, sweeps gigantic swarms of electrons through the planet's upper atmosphere, creating noise that can be heard easily on a radio telescope (as low as 21 MHz).

There is a third class of radiation, known as the 21-cm hydrogen line, that is of special interest to radio astronomers. Hydrogen atoms make up an overwhelming majority of all the matter in the universe. They radiate

a "resonant" energy at a constant frequency of 1.428 GHz. Anywhere there is hydrogen, this radiation is present. Hence, professional radio astronomers have keyed most of their research to the 21-cm band. Unfortunately for amateurs, 21-cm equipment with the proper specifications is either too elaborate or too expensive—or both—for the average amateur's budget. Until microwave equipment becomes available with more suitable

specifications at a lower cost, there is little an amateur radio astronomer can contribute at 21 cm. Even so, there is a lot for the amateur astronomer to see at the lower vhf and uhf frequencies.

The most fruitful working range for amateur radio astronomers is in the vhf and uhf bands where nonthermal and thermal sources have about the same energy levels. The technology is fairly well established in this range, and few professional radio astronomers have done work here.

The Radio Telescope. From a block-diagram point of view, a radio telescope is little more than a directional antenna, wideband receiver, and some type of recording/readout device. Adding a device for aiming the antenna and calibrating the receiver complete the picture.

Whenever a radio source in space enters the antenna's beam pattern, the readout device registers a gradual increase in noise signal level. The signal in most cases is pure white-noise static. As the source passes through the center of the beam, the readout device will show a peak noise level. Then, the noise level drops off as the object moves away from the antenna. The

TABLE 1—ANTENNA AND MOUNTING CHARACTERISTICS

	Advantages	Disadvantages
Antenna:		
Multi-element beam (YAGI)	Moderate to high gain; relatively simple construction; many impedance-matching options	Narrow bandwidth; polarized in one plane
Beam array	High gain; any linear polarization possible; many impedance-matching options	Mechanically awkward; requires great deal of working space
Single helix	Inherently wideband; circular polarization; moderate gain; responds to circular or any plane polarization	Mechanically awkward in vhf range; polarized in one "sense" (left- or right-handed).
Helical array	Inherently wideband; high gain; responds to linearly or circularly polarized signals	Mechanically awkward in vhf range; "sense" conscious.
Parabolic reflector	Extremely directional; high gain	Very difficult to build
Mounting:		
Fixed	Simple construction	Not steerable in any plane
Altitude	Relatively simple construction	Azimuth is fixed
Altazimuth	Fully steerable	Relatively complicated construction; awkward in lower vhf range; works in horizon coordinates
Equatorial	Fully steerable; work in celestial coordinates	Complicated construction

TABLE 2—RECEIVER CHARACTERISTICS

Receiver Type	Advantages	Disadvantages
Shortwave communications	High gain; suitable converters and preamplifiers available	Narrow bandwidth
Commercial FM	Good gain; wideband; low noise	Restricted to 88-108-MHz
Custom-designed homemade	High gain; wide bandwidth; low noise	Requires know-how to build and align
TV tuner	Readily available; wide bandwidth	Low gain; poor noise figures

stronger the radio source, the higher the peak signal response.

Anyone familiar with communication systems will find the purpose of each element in a radio telescope system rather obvious, but a brief summary is in order. The antenna picks up radio signals from remote sources. The antenna mounting steers the antenna to the point in the skies from which the signal originates. The receiver then tunes, amplifies, and detects the signal. Finally, the recording system displays or records the results. The special requirements imposed on these common system components, however, require further discussion.

The antenna, for example, must have a higher power gain than is normally required for communication purposes, and it must be highly directive. Only antennas with gain figures in excess of 10 dB are worth considering for serious radio astronomy work. The major lobe should have a width of no greater than 30° between the half-power points. By the same token, the bandwidth of the antenna should be 2 MHz or more.

Although parabolic antennas seem

to be the hallmark of professional radio astronomy, they are not the best choice for amateur astronomers, especially newcomers. Considering both practical and theoretical features; a tuned multi-element beam antenna is the best all-around choice for a vhf radio telescope system, while a quad helix array performs better in the uhf range. Table 1 summarizes the advantages and disadvantages of antenna systems in the light of amateur radio astronomy.

Most amateur radio astronomers find that they spend considerable time and effort designing, building, and debugging the antenna and antenna mounting system. While receivers and recording devices with the necessary specifications are available commercially, the antennas are not. The ultimate success or failure of a radio astronomy system rests heavily on the quality and proper selection of an antenna system, making the extra time and effort very worthwhile.

As far as the receiver is concerned, it must have high gain, low noise, good stability, and wide bandwidth. These particular requirements are almost

self-contradictory, and run-of-the-mill radio construction projects seldom meet them. Fortunately, there are some ready-made systems that can do the job.

Any wideband radio receiver that has a sensitivity of 5 μ V or better is suitable for amateur radio astronomy work. Shortwave communication receivers can be used, provided they have a sensitivity on the order of 0.5 μ V to make up for their narrow predetection bandwidth. Commercial FM receivers work rather well in a vhf radio telescope system because most of them have good sensitivity figures and a wide predetection bandwidth. (Incidentally, there is no need to disable the FM detector or limiter stage to get satisfactory results from an FM receiver. The receiver passes wideband noise whenever there is no carrier present.)

It is tempting to try using a uhf TV receiver to work the uhf end of the radio astronomy spectrum. However, while TV receivers have the required bandwidth, they have intolerably low sensitivity figures. The wideband characteristic never quite makes up for the poor sensitivity, and any attempt to use a TV receiver is bound to produce disappointing results. Table 2 compares the various types of receivers available.

The data readout or recording device, the final stage in the system, can be as simple as a voltmeter or as complex and expensive as a chart recorder. In any case, it must provide information with reasonable precision and reliability. Table 3 lists the relative advantages and disadvantages of three types of recording devices.

Few amateur radio astronomers can resist the temptation of listening to the hissing signals from the cosmos through a loudspeaker. With the notable exception of signals from Jupiter, radio signals from space are not very exciting to hear. A loudspeaker is nevertheless a popular kind of auxiliary "readout" device for amateur radiotelescopes.

The basic specifications for simple radio telescopes are summarized in Table 4.

Getting Started. Doing anything really useful with a radio telescope requires at least a nodding acquaintance with basic astronomy. A radio astronomer must be able to aim his antenna at a particular target or know what sources are passing through the

TABLE 3—RECORD/READOUT DEVICE CHARACTERISTICS

Monitor Device	Advantages	Disadvantages
Voltmeter	Readily available	Requires constant attention during recording sessions
Chart recorder	Requires little or no attention during recording sessions; provides permanent record of raw data	Initially expensive
Tape recorder	Requires little or no attention during recording sessions; provides permanent record of raw data; can be used for other purposes	Data must be transcribed

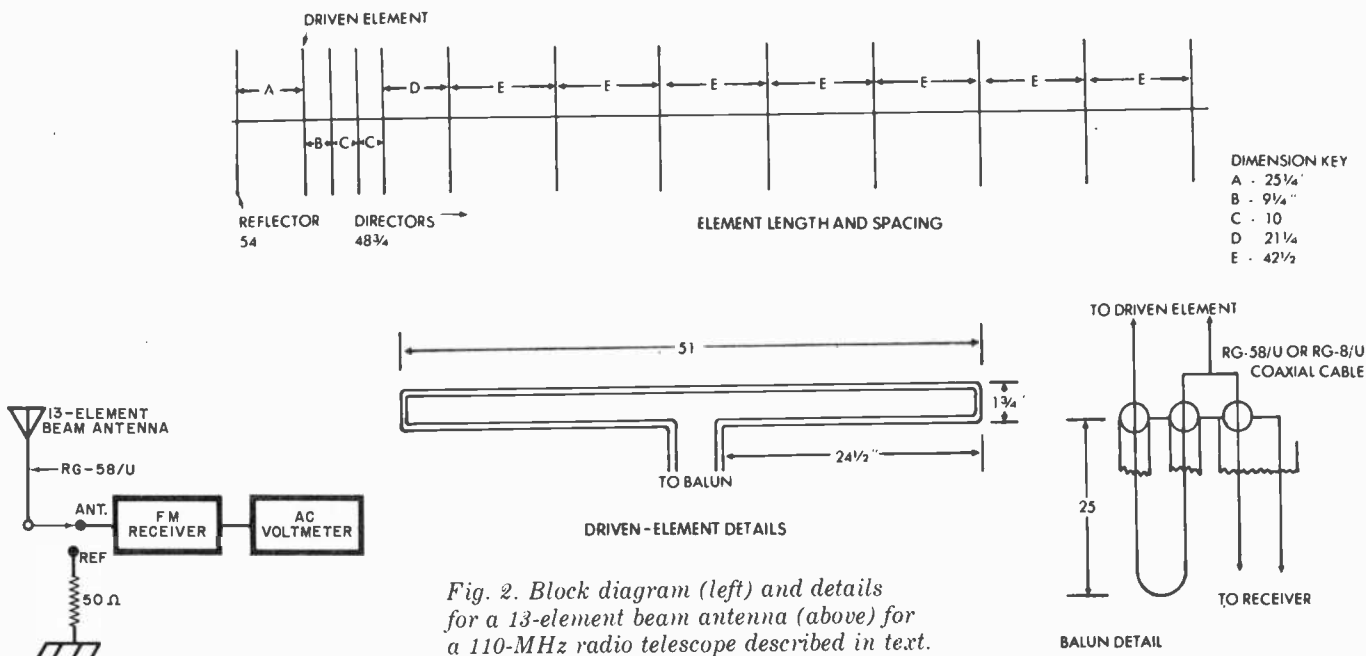

Fig. 2. Block diagram (left) and details for a 13-element beam antenna (above) for a 110-MHz radio telescope described in text.

lobe pattern of his antenna at a given time. So, he must be able to read star maps and interpret prediction tables. However, an experimenter doesn't have to be familiar with astronomy to set up a simple telescope and get it working.

The 110-MHz radio telescope system illustrated in Fig. 2 can be assembled for about \$30, assuming you already have an FM receiver and a voltmeter. A beginner can assemble this system, use it to spot a couple of radio sources, and finally determine for himself whether or not he wants to learn more about astronomy and build another system suitable for more extensive projects.

Although most of the time and money involved in this 110-MHz system goes into building the antenna and its mounting, there is really nothing unusual about it. It is a standard 13-element yagi array cut for a center frequency of 110 MHz. The elements can be made from heavy aluminum wire and mounted on a boom made up of 8' (2.5-m) long sections of 1 1/2" (3.8-cm) diameter aluminum tubing. Mount the boom assembly on a standard 2" (5.1-cm) diameter steel mast to raise the balance point of the boom about 16' (5 m) above ground level. Experimenters who are uncertain about construction techniques for this type of antenna should look up further details in *Radio Astronomy for the Amateur* by this author (TAB Books, Blue Ridge Summit, PA 17214). This book also contains all the information you'll need to get seriously into radio astronomy on an amateur level. Alter-

natively, you can consult a recent edition of *The ARRL Antenna Book* for antenna construction tips.

Fix the antenna mounting so that it always aims the boom due south. The boom must be mounted so that it can be adjusted in altitude (pivot up and down). Use a length of RG-58/U coaxial cable to carry the antenna signal to the input of a moderately good FM receiver. An impedance-matching transformer can be used to match the 50-ohm impedance of the antenna/cable to the 300-ohm impedance of the antenna input circuit on most FM receivers. (The matching transformer isn't absolutely necessary for trial runs.) Then, connect a voltmeter that has a 1- or 1.5-volt ac range across the receiver's speaker output terminals. The meter will now register the system's output noise level.

A switch at the antenna input on the receiver can be used to replace the antenna with an equivalent-value load resistor. Since the resistor generates a negligible amount of noise, any noise detected by the voltmeter while the re-

sistor is in the circuit represents the receiver's inherent noise level. Switching the antenna back into the system will always cause a rise in the noise level. The increase in noise level represents the signal level present at the antenna.

The sun is usually the best subject for trying out a new radio telescope, mainly because it is so easy to find and is such a powerful radio source. To check out this simple system, adjust the altitude of the antenna so that it points directly at the sun when it crosses the celestial meridian (an imaginary line that runs from directly overhead down to the southern horizon). Make this initial adjustment about two hours before the crossing is to occur.

All readings described here were taken with the receiver tuned to 110 MHz, as determined with the aid of an r-f signal generator. The treble control on the receiver was set to maximum and the afc switch to off. The volume control must be set for full audio gain while taking readings, but it can be turned down at other times if the hiss-

TABLE 4—BASIC SPECIFICATIONS FOR SIMPLE RADIO TELESCOPE

Parameter	Minimum	Nominal	Excellent
Antenna gain	10 dB	15 dB	20 dB
Receiver sensitivity	5 μ V	1 μ V	0.5 μ V
Receiver bandwidth	100 kHz	2 MHz	6 MHz

Note: *Minimum* is capable of detecting signals from sun, Jupiter, Cassiopeia A and galactic plane; *nominal* and *excellent* are capable of working at least five sources outside solar system.

ing sound becomes a nuisance.

Switch to the resistor and note the voltmeter reading. If possible, use the meter's zero-adjust control to set the meter pointer to zero. If this isn't possible, set the pointer for the lowest possible reading and note it on a sheet of paper. Now, switch to the antenna and note the new reading. Subtract the previous (reference) reading from the new reading to obtain a fairly good

estimate of the background noise being picked up by the radio telescope.

Take both readings in a similar fashion at 30-minute intervals over a period of four hours or so. Always note the time and difference between readings. When the experiment is completed, the data should show a distinct rise in the noise levels as the sun passes through the beam pattern.

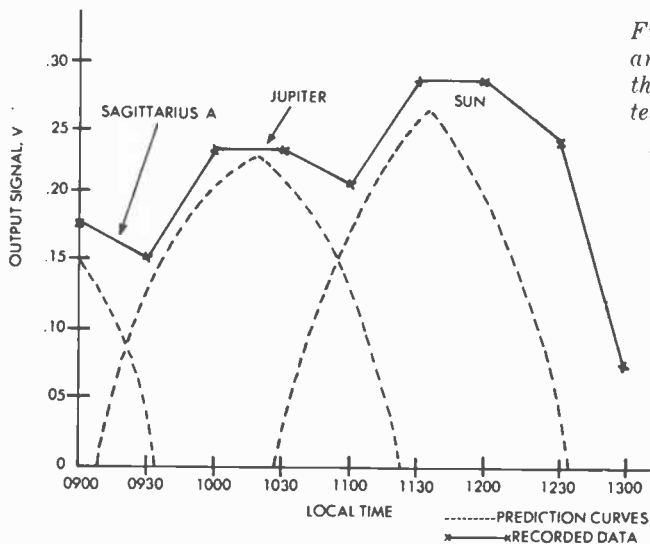

Fig. 3. Results of an experiment with the 110-MHz radio telescope system.

Illustrated in Fig. 3 are the results of a four-hour recording session identical to that described above. The plotted data (solid lines) show signals arriving from three different sources: Sagittarius A, Jupiter, and the sun. Sagittarius A, a powerful radio source representing the center of our galaxy, was just moving away from the antenna when the session began. Jupiter then moved into the beam, followed by the sun. Three powerful radio sources are not always lined up in this way, so an experimenter shouldn't be disappointed if his data shows only a single response representing the sun.

Our simple 110-MHz system is capable of detecting signals from at least seven different radio sources of extraterrestrial origin. These include: the sun, Jupiter, Sagittarius A, Cassiopeia A, Taurus A, and Virgo A. Electronics experimenters who are unfamiliar with the locations of the constellations listed here can seek the aid of an experienced amateur astronomer.

Our simple radio-astronomy system has a secondary application as a bonus. It makes an excellent system for FM DX'ing. ♦



12 REASONS YOUR CAR NEEDS TIGER CDI

Instant starting in any weather - Eliminates tune-ups - Increases gas mileage - Increases horsepower 15% - Improves acceleration and performance - Spark plugs last up to 70,000 miles - Reduces engine maintenance expense - Amplifies spark plug voltage to 45,000 volts - Maintains spark plug voltage to 10,000 RPM - Reduces exhaust emissions - Dual ignition switch - An Unconditional LIFETIME GUARANTEE - Installs in 10 minutes on any car with 12 volt negative ground - No rewiring - Most powerful, efficient and reliable Solid State Ignition made.

SATISFACTION GUARANTEED or money back

TIGER 500 assembled \$53.95
TIGER SST assembled \$42.95

Post Paid in U.S.A.

Send check or money order with order to:

Tri-Star Corporation
P. O. Box 1727 C
Grand Junction, Colorado 81501

DEALER INQUIRIES INVITED
CIRCLE NO. 58 ON FREE INFORMATION CARD

FREE

McIntosh CATALOG and FM DIRECTORY

Get all the newest and latest information on the new McIntosh Solid State equipment in the McIntosh catalog. In addition you will receive an FM station directory that covers all of North America.

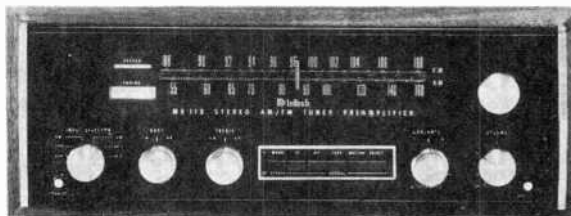

MX 113

FM/FM STEREO - AM TUNER AND PREAMPLIFIER

SEND TODAY!

McIntosh Laboratory, Inc.
East Side Station P.O. Box 96
Binghamton, N.Y. 13904
Dept. PE

NAME _____

ADDRESS _____

CITY _____ STATE _____ ZIP _____

If you are in a hurry for your catalog please send the coupon to McIntosh. For non rush service send the Reader Service Card to the magazine.

CIRCLE NO. 32 ON FREE INFORMATION CARD



BUILD A \$25 HIGH-FREQUENCY VOLTMETER

Measures up to 90 volts from dc to beyond 20 MHz.

BY THOMAS H. SEAR

There has long been a need for an inexpensive, easy-to-use bench instrument that could measure the voltage levels of signals at frequencies into the MHz range. Now, for less than \$25 you can build a broadband voltmeter that accurately measures from dc to frequencies over 20 MHz at amplitudes up to 90 volts in five overlapping voltage ranges.

The heart of this meter is a thermal converter similar to the type used in professional instruments to perform voltage calibrations to frequencies of 1 GHz. The converter is essentially a straight wire heater, which is connected in series with the current to be measured, and a thermocouple that measures the mid-point temperature of the heater. The thermocouple gen-

erates a dc voltage that is approximately proportional to the square of the current. (Fig. 1).

The important characteristic of the thermal converter is that its response is relatively independent of waveform and frequency variations. The unit used in this voltmeter is designed to operate between dc and 10 MHz with excellent accuracy and up to 65 MHz with only a 3% error. To get accurate results at, say, 65 MHz, a more sophisticated construction of the converter would be required.

How It Works. As shown in Fig. 2, R1 through R4 make up a voltage divider, with values selected to limit the voltage across TC1, the thermal converter, to 0.45 V. The dc output of TC1 is connected to the noninverting input of operational amplifier IC1, which is connected as a dc amplifier. Resistors R5 and R6 determine the gain of IC1, whose output drives M1 a 50- μ A meter. Potentiometer R7 is used to calibrate the circuit and the meter, while R8 is adjusted to set the zero point of the meter movement.

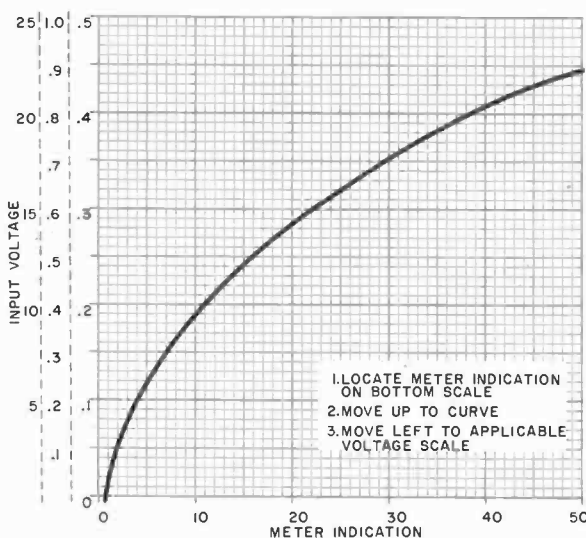

Fig. 1. Output of thermal converter varies with the square of the input. Use this curve to calibrate meter.

divider and TC1, where r-f signals may be present, and all leads should be kept as short as possible, there are no special precautions to be observed in wiring the voltmeter. However, it is advisable to keep the r-f and dc portions separated as much as possible to avoid pickup.

The IC and resistors can be mounted on perforated phenolic board, with the five connectors, meter, switch, and two potentiometers on the front panel of a suitable enclosure. The resistors in the voltage divider are standard 5% units, R1, R3, and R4 being made up of two resistors either in series or parallel, to obtain the required value. The closer you can come to the required value, the better the accuracy of the meter. A precision resistance measuring bridge can be used to get even better accuracy.

Calibration. Before turning on the power, be sure that the meter needle is at its zero mark, using the mechanical zero adjustment on the meter itself if necessary. Set R7 to its center position, turn on the power (S1), and wait a few minutes for the circuit to stabilize.

Then adjust R8 to set the meter pointer to zero.

Because TC1 is a thermal device, it will generate a slight output due to the ambient temperature. It will also indicate above zero following each measurement until it returns to the ambient temperature. For this reason, R8 should not be used to adjust the zero after each measurement. Use R8 only after the temperature has stabilized for 5 or 10 minutes.

With the power on and the meter

zeroed, connect a known dc voltage to the appropriate input jack. The 22.5-volt input (J2) is recommended because calibrating on that range will distribute the voltage divider errors more evenly. Wait about 10 seconds for TC1 to stabilize. Then adjust R7 to obtain the correct meter reading as determined by the graph in Fig. 1. The calibration will be as good as the degree to which the input voltage is known. (Three fresh 1.5-volt dry cells will provide a calibration voltage very close to 4.8 volts.)

Caution. Although the circuit is conservatively designed to protect TC1, the device can be easily damaged by excessive current. Even brief currents of 5 mA or more in the input divider circuit can burn out TC1. Always start measurements using the 90-V range and move down to the lower ranges only if the meter indication is 5 divisions or less. Never connect a voltage to an input jack when you know the voltage is higher than the range for that jack. Also, never change the amplitude or frequency of the input signal without first reducing it to zero since transients could damage the thermal converter.

Use. Always remember to allow the voltmeter to warm up for a few minutes.

Keep in mind that the meter's repeatability may be an order of magnitude better than most instruments to which you may compare it. To avoid confusion, set this meter to a reference indication and then compare it to another instrument. This voltmeter is very sensitive in the upper third of the scale, and a small voltage change that may not be noticed on a conventional multimeter can amount to several divisions on this meter.

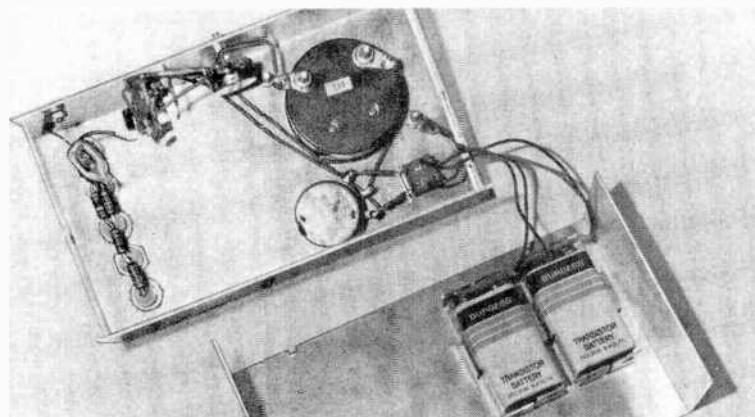

Photo of prototype shows layout of components.

PARTS LIST

B1, B2—9-volt battery
 IC1—709 op amp
 J1 to J5—BNC female connector (Amphenol UG-1094/U or similar)
 M1—0-50- μ A meter (Radio Shack 22-051 or similar)
 R1—13,500-ohm, 1/2-W, 5% resistor (select 56,000 and 18,000 ohms in parallel)
 R2—3600-ohm, 1/2-W, 5% resistor
 R3—720-ohm, 1/2-W, 5% resistor (680 and 39 ohms in series)
 R4—90-ohm, 1/2-W, 5% resistor (68 and 22 ohms in series)

R5—1000-ohm, 1/2-W, 5% resistor
 R6—1-megohm, 1/2-W, 5% resistor
 R7—250,000-ohm miniature potentiometer
 R8—50,000-ohm potentiometer
 S1—Dpst switch
 TC1—Thermal converter (Best Products, Ltd., Model S-7. Available from Best Electronics Div., 1211 E. Denny Way, Seattle, WA 98122 at \$10.30 each, plus postage.)
 Misc.—Battery holder (2), suitable enclosure (LMB 138), knob (2), mounting hardware, etc.

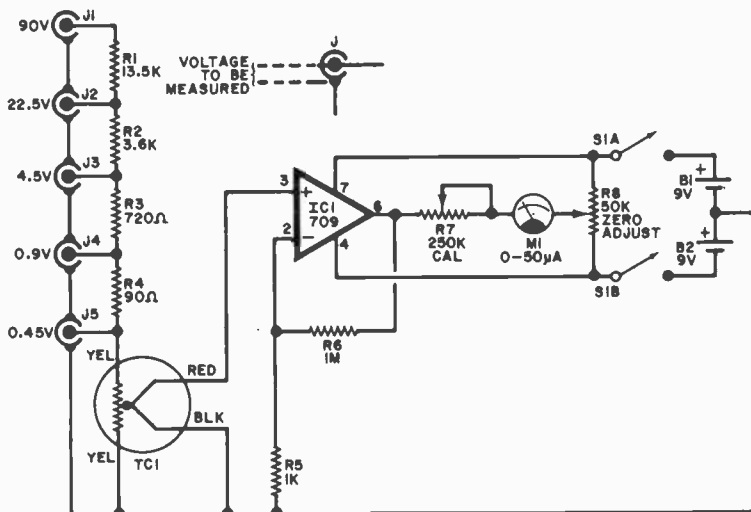

Fig. 2. Schematic of the voltmeter. Select and combine resistors to obtain proper values as given in Parts List.

A DIGITAL STOPCLOCK FOR SHORT AND LONG EVENT TIMING



Times events to 10 hours in 0.1-second intervals.

BY MICHAEL S. ROBBINS

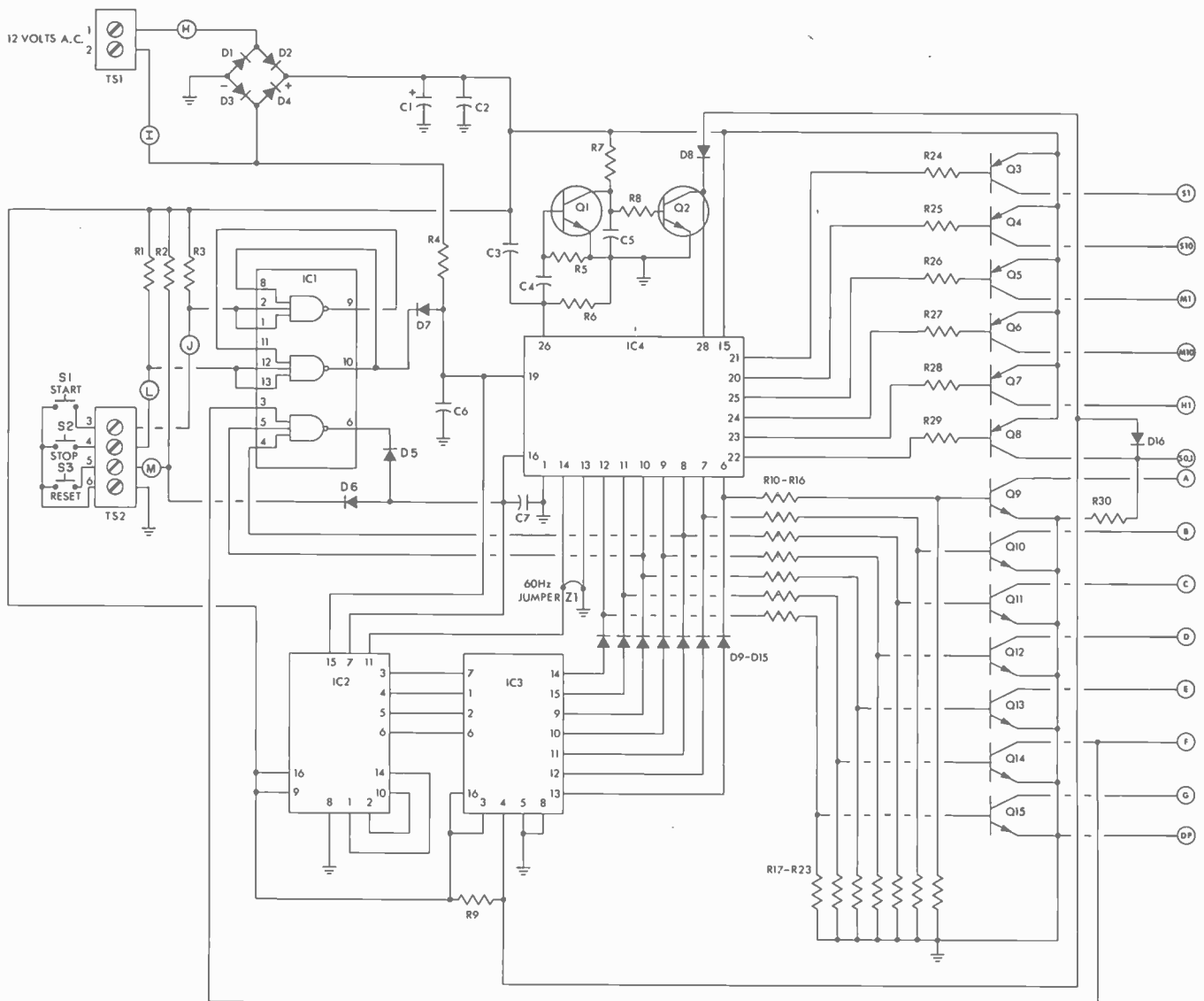

WOULD you like to know precisely how long a recording session runs; how long it takes to make one lap around the track; or how long that new amplifier has been cooking on the bench? Here is a new six-digit stopclock that can do it—counting and displaying elapsed time up to ten hours by tenths of a second.

The heart of the stopclock is the new National Semiconductor MM5309 PMOS integrated circuit. It is identical to the MM5311-5314 series of clock IC's with one important exception. The "hold" pin has been replaced by a "reset" pin, which allows all of the counters to be reset to zero. This means that all of the on-chip counters can be reset to zero as required in a stopclock.

In this project the 5309 is used with three other IC's to provide 0.1-s counting with stop, start, and reset controls. Power is provided by a 12-volt trans-

former, and either 60- or 50-Hz line power can be used. Although the 5309 has outputs for either a 12- or a 24-hour display, in this case we use only a 10-hour display with the initial zero blanked and the sixth digit used for displaying tenths of a second. (For example, the display is 9:00:00.0 instead of 09:00:00.0.)

Later in this article, we will describe some practical circuits to use in actuating the stopclock for timing different types of events.

How It Works. As shown in Fig. 1, the output of IC4 is in a multiplex seven-segment format, with each LED display turned on for one-sixth of the display cycle. The seven segment lines coming from Q9 through Q15 carry the segment information to all six digits (DIS1 through DIS6), while the six digit-enable lines coming from Q3 through Q8 turn on the digits one at a

time. The display cycle occurs at about a 1000-Hz rate, so that any display flicker is not noticeable.

Transistors Q1 and Q2 function as an interdigit blanking generator to prevent segment ghosting or afterglow. All segments are shut off for an instant before the digits are switched.

Since IC4 counts in seconds, IC2 and IC3 are required to provide a 0.1-s count. The first section of IC2 divides the 60-Hz line frequency down to 10 Hz, while the second section counts the 10-Hz pulses and delivers a BCD output. The count is repetitive, going from zero through nine. The reset line of IC2 (pin 7) is connected to the reset line of IC4 (pin 16) to insure that the two IC's count in synchronism after both are reset.

To display the output of IC2, the BCD signal must be converted to a seven-segment format. This is performed by IC3. To eliminate the need

PARTS LIST

C1—2000- μ F, 16-volt electrolytic capacitor
C2,C5—0.1- μ F, 20-volt disc capacitor

C3—0.02- μ F disc capacitor
C4,C7—0.01- μ F disc capacitor
C6—0.002- μ F disc capacitor
D1 through D4—1N4001 rectifier diode
D5 through D16—1N914 switching diode
IC1—CD4023AE (RCA) or MC14023CP (Motorola) integrated circuit
IC2—MC14566CP (Motorola) integrated circuit

IC3—MC14511CP (Motorola) integrated circuit

IC4—MM5309 (National) integrated circuit

DIS1 through DIS6—Seven-segment LED display (Litronix DL747 or similar)

Q1,Q2,Q9 through Q15—2N5172, MPS5172, or MPSA20 transistor

Q3 through Q8—2N4403 transistor

The following resistors $\frac{1}{4}$ watt, 10%:

R1,R2,R3,R30—1000 ohms

R4,R6,R7—100,000 ohms

R5,R17 through R23—10,000 ohms

R8,R9—470,000 ohms

R10 through R16—2000 ohms

R24 through R29—470 ohms

R31 through R37—120 ohms

R38—270 ohms

S1,S2,S3—Normally-open spst pushbutton switch

TS1—Two-lug screw-type terminal strip

TS2—Four-lug screw-type terminal strip

Misc.—Chassis box; printed circuit boards (2); 74 Molex Soldercons or one 28-pin, two 16-pin, and one 14-pin IC sockets; 2 small L brackets (optional); four spacers; four rubber feet; red acrylic display filter; machine hardware; hookup wire, solder; etc.

Note: The following are available from Caringella Electronics, Inc., P.O. Box 727, Upland, CA 91786: etched and drilled main pc board No. DSC-IPC for \$7.95; etched and drilled display board No. DSC-IAPC for \$6.95; complete kit of parts, including cabinet, hardware, etc., No. DCS-1K for \$74.95 plus \$2 shipping. California residents, please add 6% sales tax on all items. There are no kits available for the circuits shown in Fig. 4.

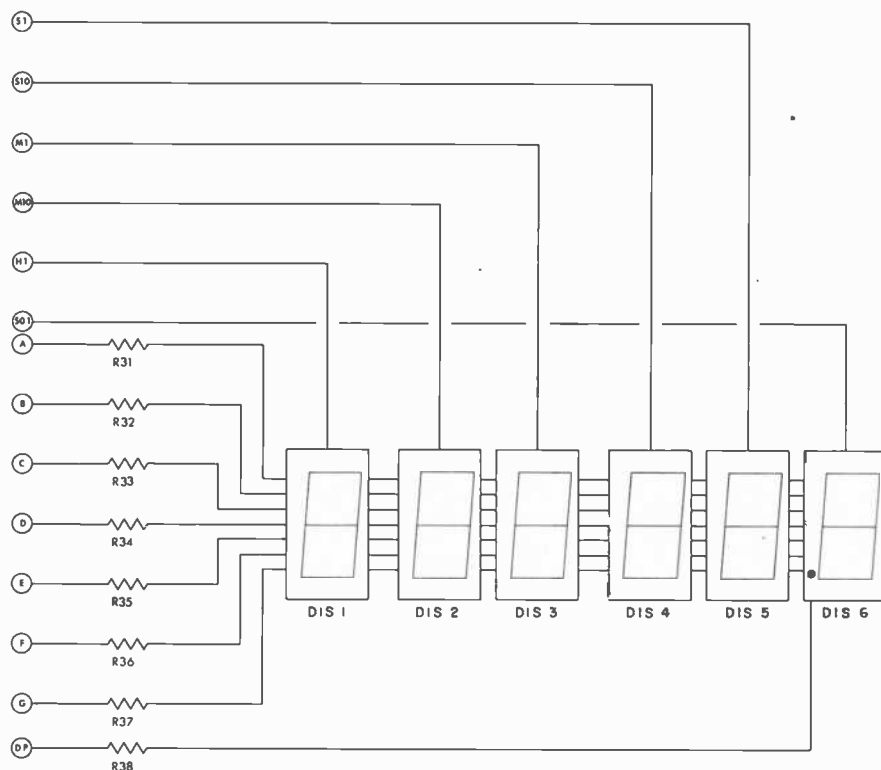

Fig. 1. Complete schematic of stopclock is shown above and on opposite page.

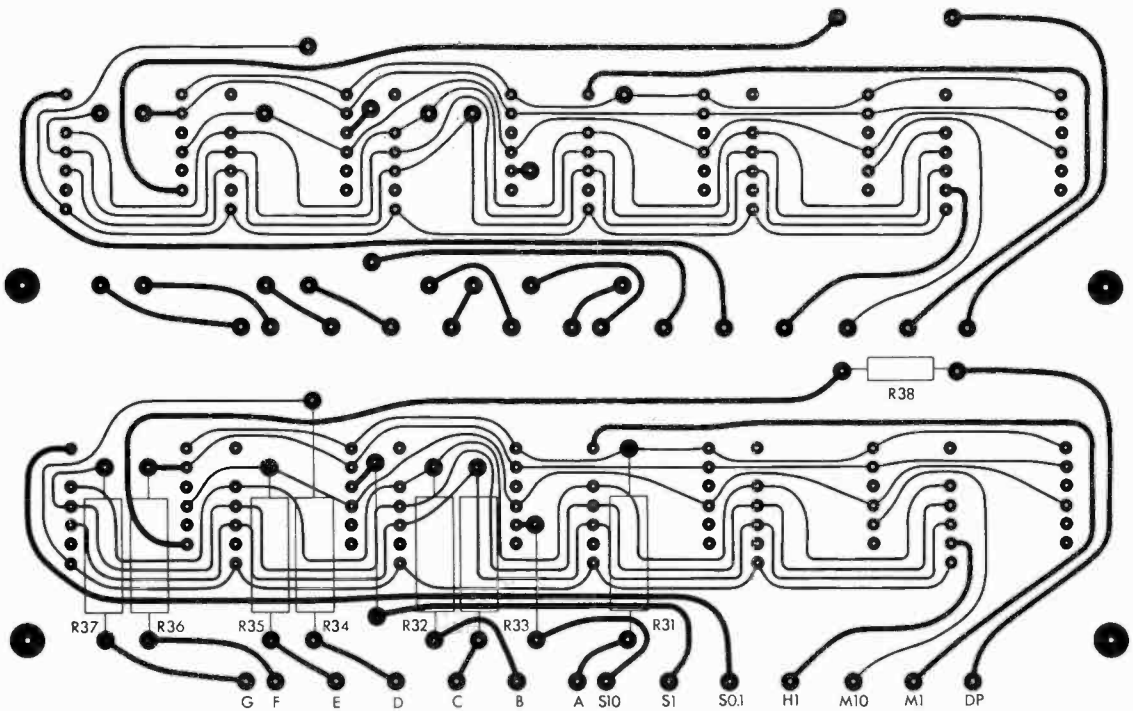
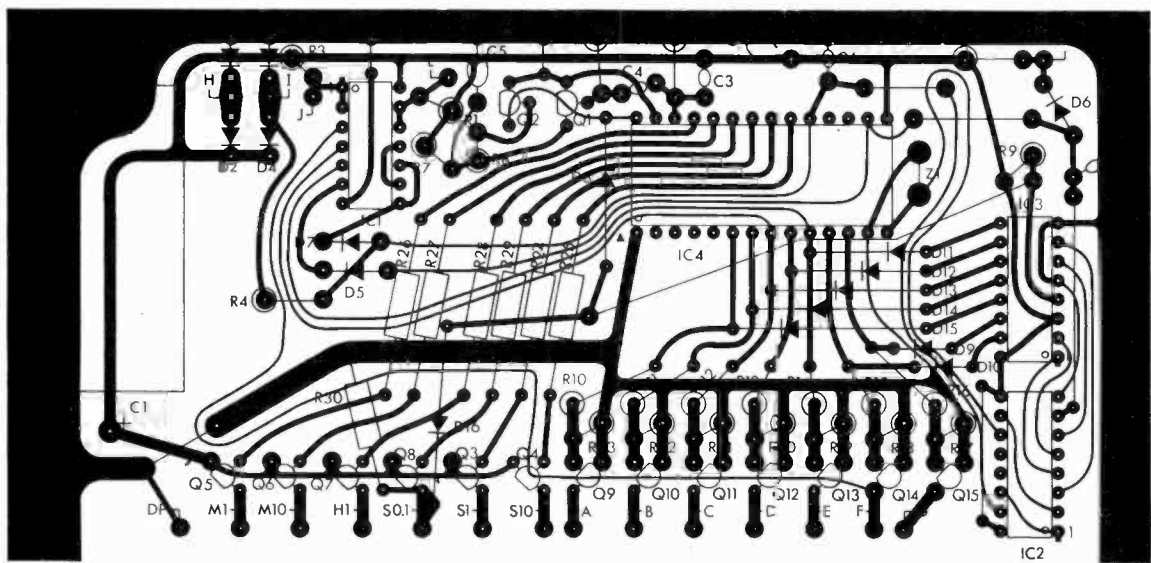
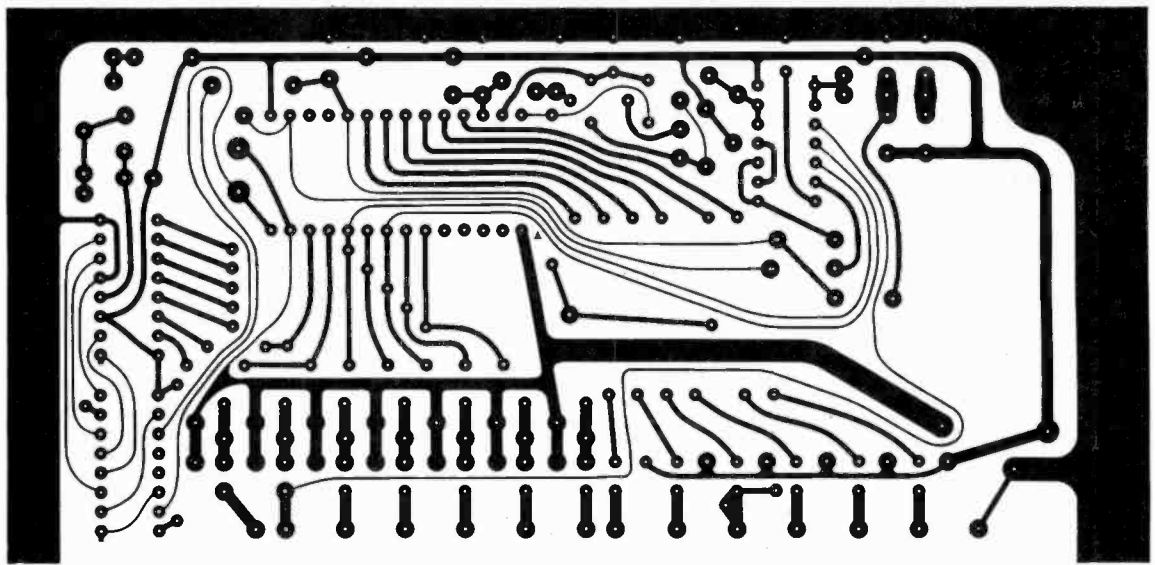

Fig. 2. Etching and drilling guides with component layout diagrams for the two pc boards.

for additional transistors to drive the 0.1-s display (*DIS6*), the outputs of *IC3* are connected through *D9* through *D15* to the outputs of *IC4*. Since *IC4* is off due to the leading-zero blanking interval when it would normally display the 10's of hours, this time slot can be used for the 0.1-s display. Thus, the H10 output of *IC4* is used to turn on and off *IC3* and enable *DIS6*.

Now, what happens when the H10 10's of hours display is supposed to be on as it normally would be after a 9:59:59 count? Without *IC1*, *DIS6* would display a random character. One NAND gate in *IC1* is used to detect this random digit and reset *IC2* and *IC4* to zero. In this manner, the stopclock is reset 0.2 second after the 10:00:00 count pulse, thus producing an effective timing range of 9:59:59.9 counts.

The other two gates in *IC1* are connected as an RS latch to turn on and off the time base. Operating *S2* causes pin 9 of *IC1* to drop to zero. Diode *D7* is then forward biased, preventing the ac signal from reaching *IC2* and *IC4*. Operating *S1* raises pin 9 to about 12 volts and effectively removes *D7* from the circuit, allowing the ac timing signal to reach the counters, and the count changes every 0.1 second.

Jumper *Z1* between pins 13 and 14 of *IC4* causes the input sections of *IC2* and *IC4* to divide by six for use on the 60-Hz power line. For 50-Hz operation, no jumper is needed.

Construction. The stopclock is best assembled on two printed circuit boards, the etching and drilling and component placement guides for which are shown in Fig. 2. The circuit is split between the main and display boards as shown by the two sections in Fig. 1.

Leaving installation of the IC's until last, wire the main board as shown, taking care to properly orient the filter capacitor, diodes, and transistors. Note in Fig. 3 that some resistors mount upright. Install Molex Soldercons® or regular IC sockets in the locations for the IC's, but don't install the IC's just yet.

Next, wire the display board as follows. First install and solder the resistors into place on the foil side of the board. Trim away excess lead lengths. Then install and solder into place the displays, *DIS1* through *DIS6*, on the blank side of the board. Interconnect the two boards with lengths of hookup

wire connected between similarly labelled pads on both boards. Solder 5" (12.7-cm) lengths of hookup wire to the pads identified in Fig. 2 by the letters H through L.

Fasten the display board to the main board with two small L brackets, threaded spacers, and machine screws; and mount another pair of spacers at the back of the main board. Then mount the entire assembly inside the chassis box, via the spacers, with four machine screws and lockwashers. Glue a red acrylic filter behind the front panel of the chassis box over the display "window." Then mount *TS1* and *TS2* on the rear panel of the box and *S1*, *S2*, and *S3* on the top.

Connect and solder the free ends of the wires coming from holes H and I to the lugs of *TS1* and the free ends of the J, K, L, and M wires to lugs 3, 6, 4, and 5, respectively of *TS2*. Solder 5" lengths of hookup wire to each of the lugs on *TS2* and wire them to the switches as shown in Fig. 1. Label *TS1* 12 VOLTS AC and lugs 3 through 6 on *TS2* STOP, START, RESET, and GROUND, respectively. Then label switches *S1*, *S2*, and *S3* STOP, START, and RESET, respectively.

Practicing the usual precautions for handling MOS devices, install the IC's in their respective locations via the Soldercons or sockets. Make certain that you orient them properly. (On the case of each IC is a dot for easy identification of pin 1.)

Operation and Use. When power is first applied to the stopclock, random numbers will be displayed. Depressing RESET switch *S3* resets all displays to zero. When START switch *S1* is momentarily closed, the stopclock should begin counting at a 0.1-s rate and the *DIS6* digit should be a blur. Let the stopclock run for a few minutes. Then hit STOP switch *S2*. The display should immediately grind to a halt and remain locked onto the last count after releasing *S2*.

To be of any use as an events timer, the stopclock must be stopped and started in a manner that produces meaningful information. The simplest approach would be to use the switches on the top of the cabinet to initiate the count and stop it. For remote operation, an identical set of pushbutton switches can be connected to *TS2* (paralleling *S1*, *S2*, and *S3*) via a cable. The best way by far of tripping and stopping the count is to let the event being timed operate the stopclock.

Bear in mind that each of the three circuits operated by the pushbutton switches in Fig. 1 is held at +12 volts by *R1*, *R2*, and *R3*. To enable an input, the bottom ends of these resistors must be connected to ground. Therefore, any external switching device connected to *TS2* must have an on resistance of less than 100 ohms and an off resistance in excess of 10,000 ohms. In the momentary-on condition, the external switching device must be capable of handling 12 mA of current.

As shown in Fig. 4A, relay contacts operated by some remote device can be used to trip any one or more of the *S1*, *S2*, *S3* functions. The circuit is closed by applying energizing power to the relay coil. If the relay is a latching type (mechanical or electrical), some means must be provided to open its contacts after each closure.

Optoelectronic couplers make ideal interfaces for the stopclock whenever the controlling circuit is at a different voltage from that used in the timer's circuit or has potentially damaging spikes. An optoelectronic coupler consists of a light source (usually a LED) and a light sensor (usually a phototransistor) facing each other in a light-tight case. The source and sensor are electrically isolated from each other. The Motorola 4N28 optoisolator, one of the more common types available, is shown connected to *TS2* on the stopclock in Fig. 4B. A separate optoisolator circuit can be used on each of the START, STOP, and RESET inputs. Each is separately tripped by momentarily applying a dc voltage to the source circuit.

The circuit in Fig. 4C can be used to

Fig. 3. Photo of internal layout. Note some resistors are vertical.

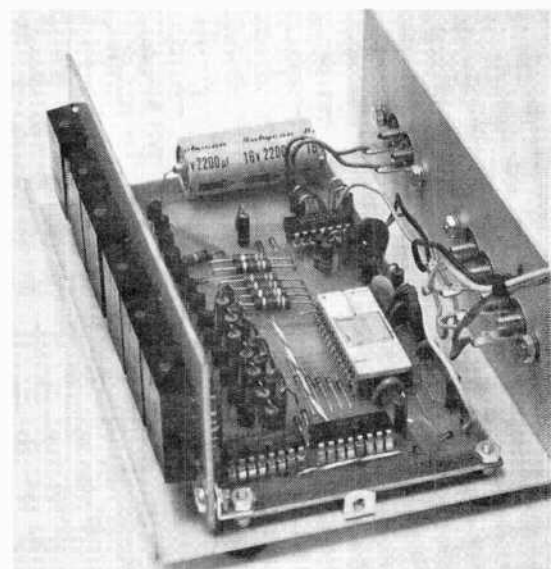

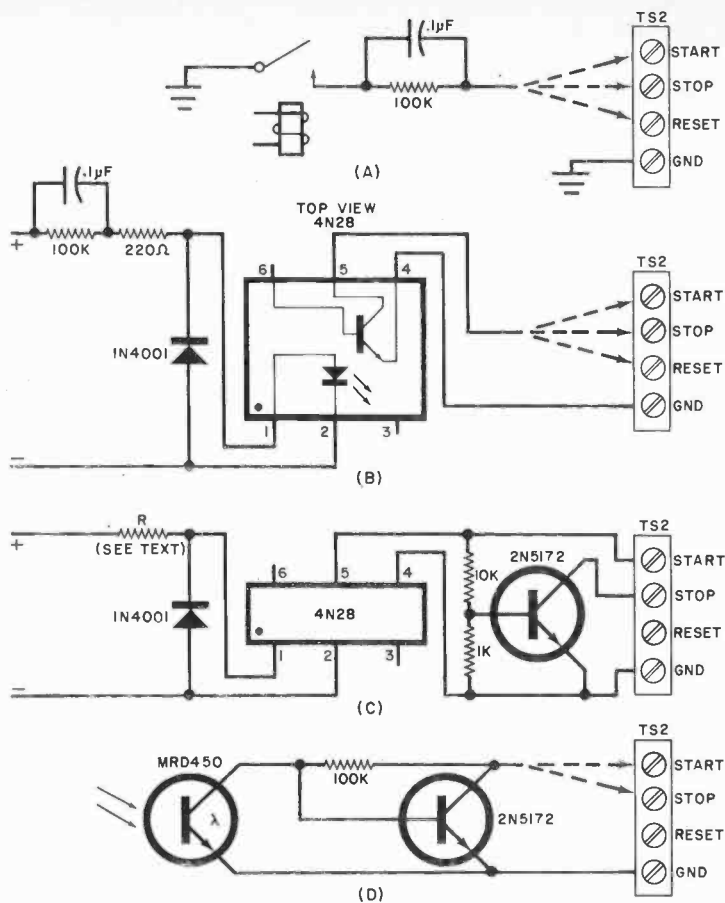
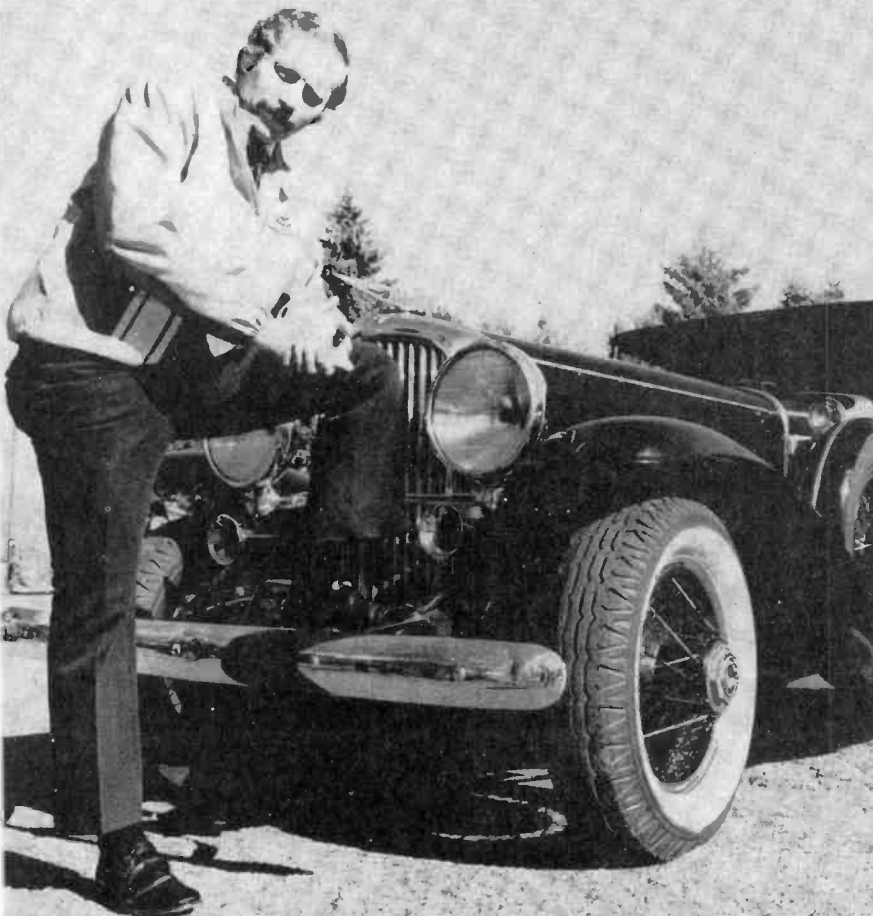

Fig. 4. Stopclock can be operated by a relay (A); an optoisolator (B and C); or a phototransistor (C).

measure running (or on) times. Resistor R should be selected to limit the current through the diode to about 40 mA. For example, to measure the running time of a battery-powered cassette recorder that has a 12-volt dc motor, the value selected for the resistor in ohms is equal to $(V-1.2)/A$, where $V=12$ volts and $A=40$ mA. In this case, $R=270$ ohms. The circuit connects across the tape recorder's motor.

The length of time it takes a vehicle (including toy trains and cars) to traverse a prescribed distance is often of interest. Light-beam tripping is a convenient way of starting and stopping the count. The circuit for accomplishing this is shown in Fig. 4D. Almost any type of light source, including an ordinary flashlight, can be used in this scheme. Depending on the distance between the light source and phototransistor, it may be necessary to use lenses to focus the beam. (Lenses may not be necessary in timing toys unless the distance is more than a few inches.) Although a Motorola MRD450 phototransistor is specified in the diagram, the value of the resistor can be adjusted to allow the circuit to accommodate just about any other phototransistor. ♦

You don't have to buy a new car to get an electronic ignition.



Most of you know the evaluation of automotive electrical systems . . . an evaluation characterized only occasionally by efficiency and performance. I know that, and that's why I use the Delta Mark Ten B CDI on all my cars, new and old. And believe me, you don't have to have a new car to appreciate the best electronic ignition available today. Study these features and you'll know what I mean.

1. Mark Ten and Mark Ten B Capacitive Discharge Ignition Systems are manufactured by Delta Products, Inc., a company with a conscience, and with a proven record of reliability both in product and in customer relations.
2. The Mark Ten CDI's really do save money by eliminating the need for 2 out of 3 tune-ups. Figure it out for yourself. The first tune-up or two saved pays for the unit, the rest is money in your pocket. No bunk!
3. Because the Mark Ten CDI's keep your car in better tune, you actually can save on expensive gasoline.
4. With a Mark Ten, spark plugs stay clean and last longer . . . fouling is virtually eliminated.



No matter what kind of car you drive, it too can use a Delta quality lift.

I want to know more about Mark Ten B CDI's. Send me complete no-nonsense information on how they can improve the performance of my car.

Name _____
 Address _____
 City _____ State _____ Zip _____



DELTA PRODUCTS, INC.

P.O. Box 1147, Dept. PE, Grand Junction, Colo. 81501
 303-242-9000

Mark Ten B, assembled	\$64.95 ppd	Standard Mark Ten, assembled	\$49.95 ppd
Mark Ten B, kit	\$49.95 ppd	Deltakit®	\$34.95 ppd

CIRCLE NO. 16 ON FREE INFORMATION CARD

THE PROGRAMMABLE MUSIC BOX PART 2

How to add 256 words of memory, plus music box applications.

BY MITCHELL WAITE AND LARRY BROWN

In Part 1 of this article, we discussed the circuit and construction procedure for the basic programmable music box, which contains a 40-note static memory system. This month, we will describe a 256-word memory add-on that greatly expands the programmability and playing time of the music box.

Because the music box uses an un-addressed shift register for storage, increasing the size of the usable memory is simple. The add-on memory system is built around three dual 256-bit shift registers. The entire memory circuit can be assembled on a small printed circuit board and connected to the music box by a multi-conductor cable.

About the Circuit. The complete schematic diagram of the memory ex-

tender is shown in Fig. 1. Note that a 16-conductor cable is used to connect the memory module to the main music box circuit board. This cable carries all the required power, clock and input/output data. (Power is obtained from the music box.)

The clock signal from the music box board is fed to Q1, Q2, and Q3, which shape the leading edge of the clock signal to match the requirements of memory chips IC1, IC2, and IC3. All three IC's are clocked simultaneously. Information is stored when the RECIRC input is disabled.

The data on input lines I1 through I6 changes with instructions from the music box. The memory is clocked once for each change. Output lines O1 through O6 feed the stored data back to the music box when a tune or melody is to be played.

Construction. In Fig. 2 are shown the actual-size etching and drilling and component placement guides for the memory extender module. Wire the board as shown, reserving installation of the IC's for last. Mount and solder into place IC sockets or Molex Soldercons[®] at the IC locations. Then connect the leads on one end of a length of 16-conductor cable to the pads labelled 1 through 16 on the memory module. Remove IC1 from the basic music box, and solder the free ends of the cable to the same numbered pads in IC1's location on the main circuit board which is located inside the music box.

Next, exercising the usual precautions for handling MOS devices, install IC1, IC2, and IC3 in their sockets on the memory board. Check to make sure that all IC's, transistors, and

Fig. 1. Schematic of the memory extender. Numbered terminals are connected to main board in music box.

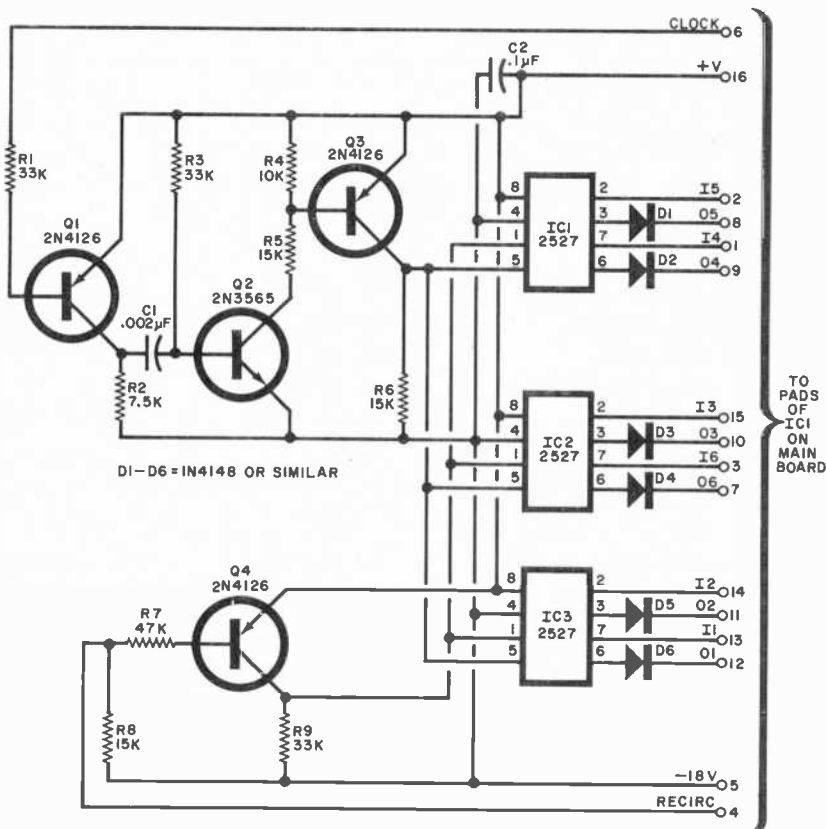

PARTS LIST

- C1—0.002- μ F, 100-volt Mylar capacitor
- C2—0.1- μ F, 50-volt Mylar capacitor
- D1 through D6—1N4148 or similar diode
- IC1 through IC3—2527 dual 256-bit shift register IC (Signetics)
- Q1, Q3, Q4—2N4126 or similar transistor
- Q2—2N3565 or similar transistor
- The following resistors are 1/4 watt, 5%.
- R1, R3, R9—33,000 ohms
- R2—7500 ohms
- R4—10,000 ohms
- R5, R6, R8—15,000 ohms
- R7—47,000 ohms
- Misc.—Printed circuit board; sockets or Molex Soldercons for IC's; 16-conductor cable; hookup wire; machine hardware; solder; etc.
- Note: The following items are available from Cal Kit, P.O. Box 877, Sebastopol, CA 95472: Complete kit of memory extender module parts, including drilled and solder-plated pc board, flat 16-conductor cable, and mounting hardware. No. MC1-6 for \$54.00. IC1, IC2, and IC3, No. MC1-8, for \$43.00; three IC sockets, No. MC1-11, for \$3.00; pc board No. MC1-7 for \$8.00; telephone interface kit No. MC1-5 for \$11.00. All items shipped postpaid and insured. California residents, please add 6% sales tax.

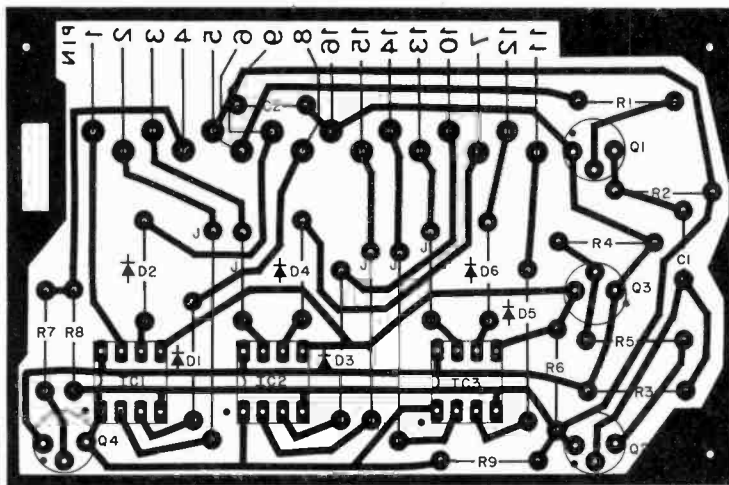
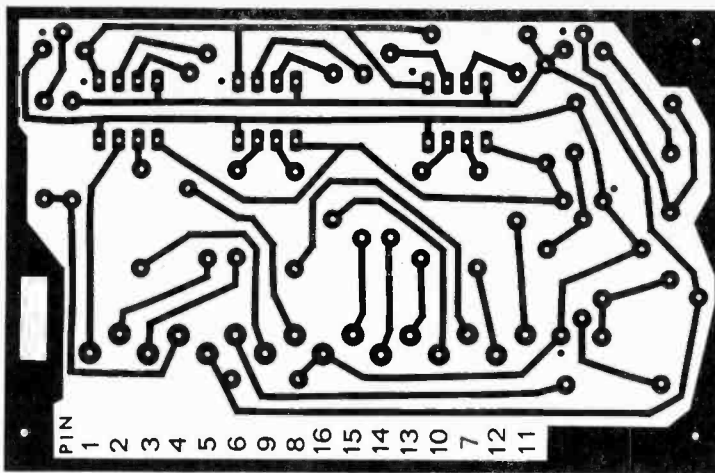

Fig. 2. Etching and drilling guide (top) and component layout.

diodes are properly oriented. Turn over the circuit board and check all soldered connections. Reflow the solder around any connection that appears questionable. Finally, check the board's conductor pattern against the etching and drilling guide in Fig. 2, particularly between the closely spaced IC pads, for solder bridges.

Power requirements for the memory module are significantly greater than those for the original 40-note memory. If you decided to use battery power for the original music box, it will be necessary to use a heavier-duty battery when the memory extender is added. Switch to an Eveready No. 276 or RCA No. VS306 heavy-duty 9-volt battery, which should provide about 60 hours of useful life.

Operation. A set of programming forms can simplify writing and storing melodies in the music box, regardless of which version you build. Note that the addition of the memory extender module does not alter the manner in which the music box is programmed

and played. It simply provides an expanded memory.

You can make your own programming form by laying out three horizontal rows of boxes numbered from 1 to 40 for the 40-word memory or from 1 to 256 when the memory extender is used. Label the top row NOTE, the middle OCTAVE, and the bottom SPACE. For simplicity, leave the OCTAVE and/or SPACE (remove) squares for each note blank if neither switch is to be depressed during programming and shade in the boxes where the switch or switches are to be closed.

As an example of programming, let us use the first two measures of "Call Me Irresponsible." In sheet music form, they would look like this:



"Call Me Irresponsible" by Sammy Cahn and James Van Heusen. Copyright © 1962 & 1963 by Paramount Music Corp.

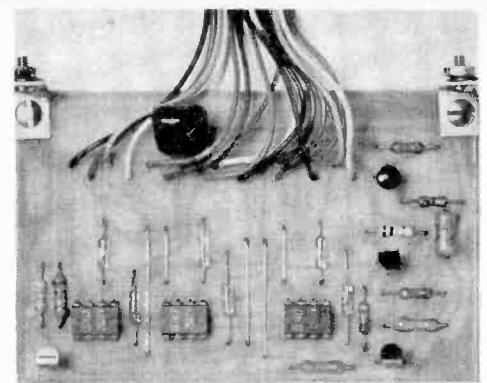

Photo of memory extender board.

First, record each note above its symbol. Next, determine the duration of the shortest note. In our example, there are two half notes, one quarter note, four eighth notes, and a quarter note. This means that a memory "word" is worth one eighth note, the shortest note in the brief melody. A quarter note will then require two words of memory, a half note four words, and so on.

Determine how many words of memory each note requires and write this number beside the note's letter. In our example, "call" and "me" are half notes. Since a half note is the same duration as four eighth notes, the first number is a 4. The next note is for "ir..." (first syllable in "irresponsible"), which is a quarter note, or two eighth notes long. So, note B has a 2 after it. Continue to do this to all notes until you have used up the melody or run out of memory.

NOTE	C	C	C	C	D	D	D	D	B	B	C	D
OCTAVE												
SPACE												
	1	2	3	4	5	6	7	8	9	10	11	12

	D	D ^b	C	C	D	D	D	D	E	E	E	E	C [#]	D
	13	14	15	16	17	18	19	20	21	22	23	24	25	26

	E	E	E	E ^b	D	D	D	D	*					
	27	28	29	30	31	32	33	34	35	36	37	38	39	40

* STOP SWITCH UP SWITCH DOWN

Program for "Call Me Irresponsible."

Now, determine where the spaces are to go. The first entry, C, is a half note. Since it requires four words to create a half note, the first three words have no space between them, which means the spaces should be removed by operating the SPACE REMOVE switch on the Music Box. To prevent the last word from running into the next note, your programming form should have a

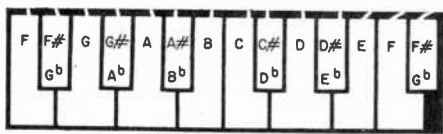

Keyboard of the music box.

Program for "If I Were A Rich Man" from "Fiddler on the Roof."

(COPYRIGHT © 1964 The New York Times Music Corporation (Sunbeam Division). All rights administered by The New York Times Music Corp. Used by Permission. All rights reserved.)

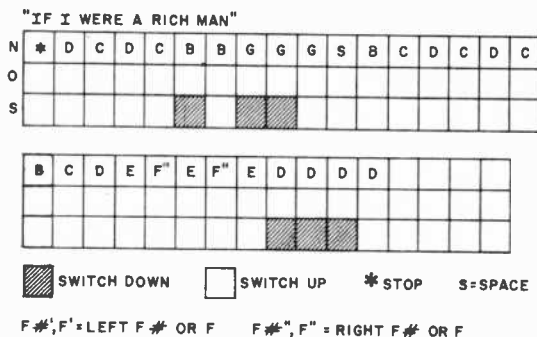

blank in the SPACE row. You indicate this on your sheet music by entering a 3 after the "C4" entry. The entry "C43" is now interpreted as note C with four words of memory required and the first three spaces removed. Continue to calculate where to remove spaces for the rest of the notes in the melody. If a note is to be in the upper octave, indicate this by underlining the entry on the sheet music form.

In our example, the curved line between the two D notes on the scale forms the "spon" (of "irresponsible"), which means that the two notes are run together. Therefore, you must remove a space from the first D note.

All that remains now is to enter the data onto your programming form. We will use only the first note (C43) to illustrate how this is done; all other entries on the form are made in a similar manner. In the top row, enter a C in boxes 1 through 4. Since the note is not in the upper octave, leave blank the first four blocks in the second row. You want to remove the spaces between only the first three eighth notes, which means you have to fill in the first three boxes in the bottom row.

Programming this note is a relatively simple procedure. Touch the programming probe to the C key,

press the SPACE REMOVE switch and hold it, press the WRITE & STEP switch three times, release the SPACE REMOVE switch, and press the WRITE & STEP switch once again. Proceed to the next note. Programming form for another tune is shown above.

Applications. With the memory extender added to the music box, some interesting programming possibilities are possible. You can, for example, write a long melody into the memory. Alternatively, you can write several shorter tunes, which can be played on demand by touching the keyboard probe to the START key or having a doorbell switch close the same circuit. If each tune starts with a "stop" code, only one melody will play each time the start circuit is activated.

Another way you can use the music box, in either version, is to program the tune you want and accompany it on another instrument or by singing the tune. This approach is better than using a tape recorder because the playback rate of the music box can be increased or slowed down *without changing the pitch*. (Any time you change the speed of a tape recorder, you also change the pitch.)

You can even use the music box as a variable-speed metronome, with or

without accented beat. With a little imagination, it can be programmed to play the rhythm accompaniment to your music.

To use the music box as an unusual replacement for a conventional doorbell or chime system, locate and disconnect the doorbell's pushbutton switch leads at the transformer. Connect these two wires to the main circuit board in the music box via pads 36 (+V) and 35 (start). You can then feed the output of the music box to a power amplifier to obtain attention-getting volume.

If local laws permit, you can build the music box/telephone interface shown in Fig. 3. The actual-size etching and drilling guide and components placement diagram for this circuit are shown in Fig. 4. The telephone interface detects the 20-to-90-Hz ringing voltage that normally operates the phone's bell and uses this voltage to strike (ionize) neon lamp 11. The lamp is optically coupled, via a light-tight shield, to light-dependent resistor LDR1. The LDR is connected to the main board via pads 35 and 36. When the ringing signal occurs, the music box triggers on until the receiver is lifted off the hook or the ringing stops. Because the circuit has a high series resistance, it will not interfere with normal telephone operation. And the optical coupling eliminates any danger to the telephone system by accidental hookup of the power supply to the ac power line.

If you are a radio amateur, you can program short Morse code messages, such as a CQ followed by your call letters. By using a relay in the collector of the audio output circuit, you can key a transmitter.

You can wire two music boxes so that one clock controls both to allow you to play two-note chords in real time. If you have an electronic music synthesizer, you can use the output lines of the music box to drive the synthesizer's control circuits, creating some interesting sequences not possible with a conventional keyboard. ♦

Fig. 3. Schematic for a telephone interface to go with the music box.

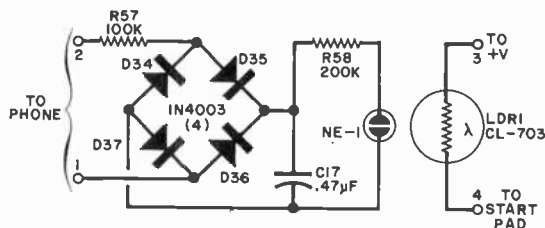
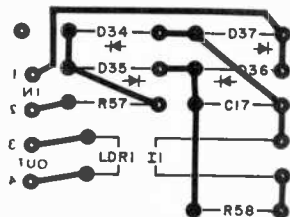
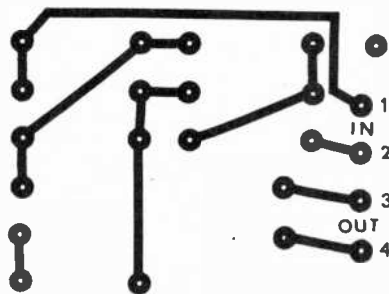

Fig. 4. Etching and drilling guide and component layout for the telephone interface.





A New Transistor Logic Family

New techniques provide high speed with low power requirements.

IN A seemingly endless quest for ever smaller and faster circuits, semiconductor researchers have developed a number of different transistor logic families. Among those that have already made their splash are: direct-coupled transistor logic (DCTL), resistor-transistor logic (RTL), resistor-capacitor transistor logic (RCTL), diode-transistor logic (DTL), transistor-transistor logic (TTL), and most recently metal-oxide semiconductor (MOS) and complementary-symmetry MOS (CMOS) logic.

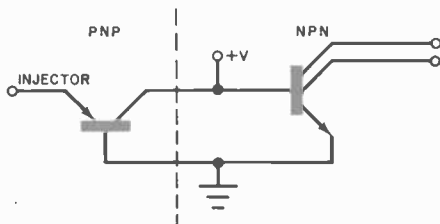

Fig. 1. The npn transistor is an inverter; the pnp serves as a current source as well as load.

Now, a promising newcomer has been added to the list. It goes under the name integrated injection logic, or I²L. Said to be as much as two years ahead of the previous state of the art, it employs the same proven manufacturing process as used for TTL. The IC's have high packaging density, have speeds approaching TTL, and consume only about a hundredth of the power of equivalent TTL devices.

Injection logic achieves its high performance by reducing a logic gate to a single complementary transistor pair as illustrated by the basic gate in Fig.

1. The vertical (nnp) transistor operates as an inverter, while the lateral (pnp) transistor serves as both the current source and load. By contrast, a typical TTL gate requires six or eight transistors and must have source or load resistors.

When the I²L gate is formed on silicon, both transistors are merged into the area of a single multiple-emitter transistor. This eliminates space-consuming device isolation, which, in addition to the absence of resistors, accounts for I²L's circuit density. That density can be up to 100 times greater than is possible with TTL. For example, as many as 3000 logic gates, or 10,000 bits of memory, can be packed on a single I²L chip. The table compares several of the more important parameters for I²L and TTL devices.

Perhaps the most revolutionary attribute of I²L technology is its versatility. Furthermore, I²L circuits can easily interface with other circuits. It enables

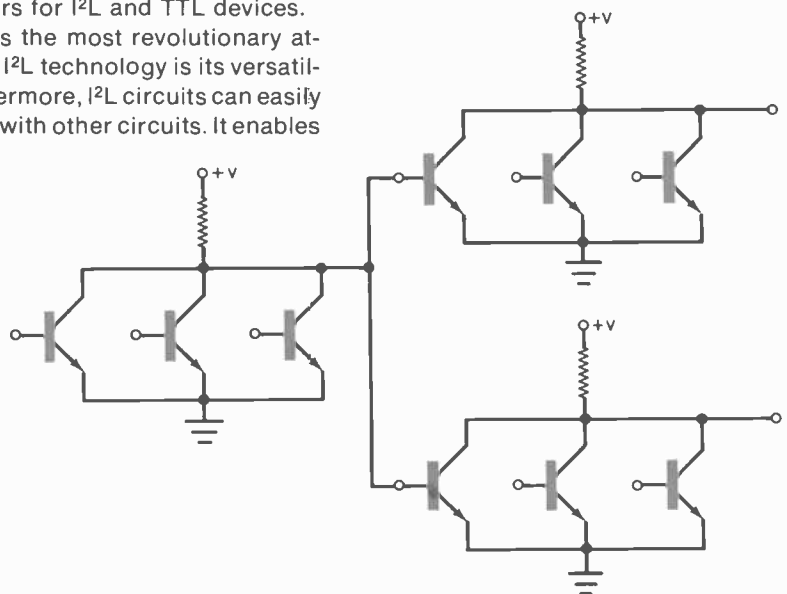

Fig. 2. A DCTL circuit which can be made smaller using I²L.

the designer to put both digital and analog circuits on the same chip. Because it uses thoroughly proven manufacturing techniques, it is low in cost and lends itself to the full range of microcircuit applications.

Evolution of I²L. The advantages of I²L came from shrinking DCTL, shown in Fig. 2, into a compact equivalent structure. The input circuit consists of three transistors in parallel. If one or more of these transistors is conducting, they act as short circuits, preventing current from flowing through the load gates. When all input transistors

COMPARISON OF TTL AND I²L DEVICES

Parameter	I ² L	TTL
Packing density	120-200 gates/mm ²	20 gates/mm ²
Gate delay	25-250 ns	10 ns
Power dissipation (per gate)	6 nW - 70 μW	10 mW
Supply voltage	1 - 15 V	3 - 7.3 V
Logic voltage swing	0.6 V	5 V
Current range	1 nA - 1 mA	2 mA

are cut off, current flows through the load gate transistors. This circuit action produces the common NOR logic function.

By replacing the three load resistors with an active current source, I²L simplifies the rather bulky DCTL. Then, the transistors with connected bases are replaced with a multiple-collector (nnp) transistor. This is easy to do because all of the DCTL transistors have a common grounded emitter. In most I²L gates, a simple pnp transistor

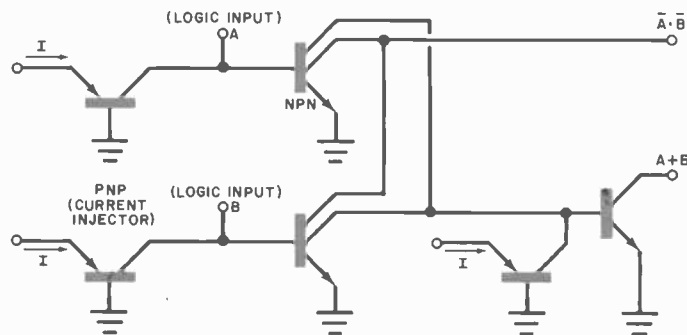

Fig. 3. A simple NAND gate using integrated injection logic.

serves as the active current source by injecting minority carriers into the emitter of the npn transistor. A light source can be used for injection in electro-optical applications.

The refinement of the DCTL gate results in the complementary transistor pair shown in Fig. 1. It can be seen that the base current of the npn transistor is common to the collector of the pnp current source, while the base of the current source is common to the emitter of the npn transistor. The emitter of the pnp transistor, called the injector, is common to all I²L gates on a chip.

The circuit shown in Fig. 3 is an example of the simplest version of an I²L NAND gate. Positive NAND logic is implemented by using the multiple-collector npn transistor as an inverter. Positive NOR logic can also be performed by OR'ing the I²L gate outputs.

The npn transistor is normally biased on (low output) by the current-injector pnp transistor, which is connected between the base of the npn transistor and the external current source. Switching action is accomplished by steering the injector current. This is done by controlling the input voltage, V_{BE} , to the gate. A low input voltage of less than V_{BE} (750 mV) pulls injector current out of the input through the on, or low, output of the driving gate. Thus, deprived of its base current, the npn transistor cuts off and the output goes high. This NAND circuit is converted to NOR logic by wiring the outputs as shown in Fig. 3.

Device Construction. Because of the common elements described above, the entire I²L gate takes up the space of a single multiple-emitter transistor when laid out on silicon. Here's how this is done:

The high density of I²L is due in large part to its simplicity and economy of design. The n+ region in Fig. 4 serves as a common ground plane to interconnect all grounded-emitter transistor gates on the chip. The n region above the n+ region is both the emitter of the vertical (npn) transistor and the base of the lateral (pnp) transistor. The two p regions serve as the base of the npn transistor and also as the collector of the pnp transistor. The two n+ regions are the multiple collector of the npn transistor. Finally, metalized connectors are added to provide interconnection between the gates. Notice that the pnp transistor is integrated into the npn transistor. It doesn't exist as a discrete component, yet it can supply injection current for a series of npn gates.

The result of this manufacturing technique is the smallest component size of any current IC manufacturing technology. The I²L gate is less than one-tenth the size of conventional TTL or CMOS gates. Even the latest LSI forms of TTL gates occupy four times as much space as the I²L gate.

Two Types. Although I²L is a young technology, two different versions are already in production. One is the iso-

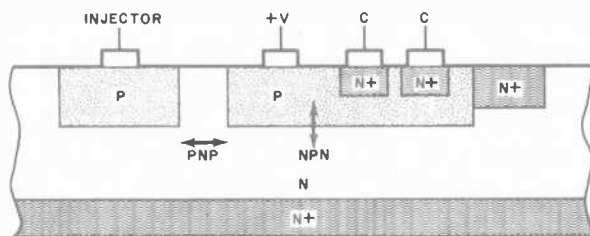

Fig. 4. Simplified diagram shows how I²L is constructed.

lated variety that uses a reverse-biased pn junction for component isolation. Since this completely isolates adjacent devices, it is used in I²L chips that contain mixed functions. Such functions as LED drivers, memory decoders, current regulators, op amps, comparators, oscillators, and TTL or ECL devices can be combined on a single monolithic chip. Texas Instruments has in production an isolated I²L digital watch chip that measures 1/8" (3.2 mm) on a side and contains logic, timing, and display drivers. The chip is approximately 25% smaller than the typical MOS versions. This chip is being used in a digital watch made by Benrus. An advantage of I²L in this application is that cost can be reduced by using crystals operating at 4 MHz. This is not possible when using CMOS.

Also on the market is a 100-ns medium-performance TI RAM (74S209) with I²L gates as the memory and TTL circuits as peripheral interface elements.

The second type of device in production is the nonisolated I²L chip, used in very complex digital IC's. Isolation is not required because all circuits on the chip are I²L devices. Consequently, higher functional density is achieved when compared to isolated I²L chips. The first LSI digital circuit built with nonisolated I²L technology is the Texas Instruments SBP0400 4-bit microprocessor. This chip has more than 1450 gates in a single 40-pin IC package. To date, it is the most complex standard bipolar chip in production. It has features that could be duplicated only by using 30 to 40 small- and medium-scale TTL IC's.

A Look Into the Future. As impressive as today's I²L devices are, even better ones are coming. Right now on the way are DVM circuits, high-frequency counters, digital tuners, read-only memories (ROM's), read logic for calculators, touch-control and linear circuits for radio and TV, and circuits for telephone touch-dialing systems.

Intensive research and development continues to increase the speed of experimental devices. For example, researchers at IBM's Semiconductor Development Laboratories in West Germany are using Schottky-diode clamps on I²L outputs to decrease gate delays. They estimate that speeds faster than 5 ns will be obtained in the near future.

ENVELOPE GENERATORS & SEQUENCERS FOR ELECTRONIC MUSIC

Shaping tones or notes and determining combinations or order.

BY DON LANCASTER

ANY electronic music system needs some means for specifying the shape and sequence of the tones or notes produced. The equipment to accomplish this can range from an extremely simple keyboard-controlled on/off manual to elaborate sequential attack/sustain/decay generators and on up to complete digital computer synthesis sequencing that specifies everything about the notes and their time order.

Any device that shapes the individual notes is called an envelope generator or ASD (attack/sustain/decay) controller. If some circuitry is determining what tones or notes are to

follow in a given combination or order, we call it a sequencer. Sequencers can operate on fixed rhythm and chording patterns, on random patterns from a composer circuit (as "teach-and-learn" devices), or as part of an elaborate computer system that bases what it will do on a set of compositional guidelines.

We have already seen in previous articles on electronic music that, if we obtain a waveform that represents the amplitude-versus-time of a desired note, all we must do is route it through a keyer or vca to let it modulate either a basic frequency reference or a complex tonal structure. Either way, we

eventually end up with a tone whose frequency and amplitude components are specified throughout its duration. So, where does the initial envelope waveform come from and how do we generate it?

Envelope Generation. In Fig. 1 are illustrated some of the things we might want to build into a single note or tone. For the sake of simplicity, assume that the frequency structure of the tone will remain constant for the tone's duration. (If it does not, simply use more of the same techniques, routing some of the envelope commands to filters instead of to keyers or vca's.) This leaves us with the basic amplitude shape shown. Now, let us examine the individual parts of our note.

ATTACK is the initial rise time of the note. It usually ranges from a few to several hundred milliseconds. Attack waveforms often have a rising exponential, while linear and capacitor charging waveforms are more often used in electronic music since they are much simpler to generate. With the exception of horn blips, the exact changes in the total attack time do not usually have a profound effect on the final tone structure.

HORN BLIP is a characteristic single or double impulsive "blip" that often appears in a horn voicing, giving it the characteristic "bite" of the trumpet and other brass instruments. It is often obtained electronically by summing a brief impulse wave shape with the normal envelope waveform.

PEAK VALUE is the maximum amplitude, often reached at the end of the

Oberheim Electronics DS-2 Digital Sequencer

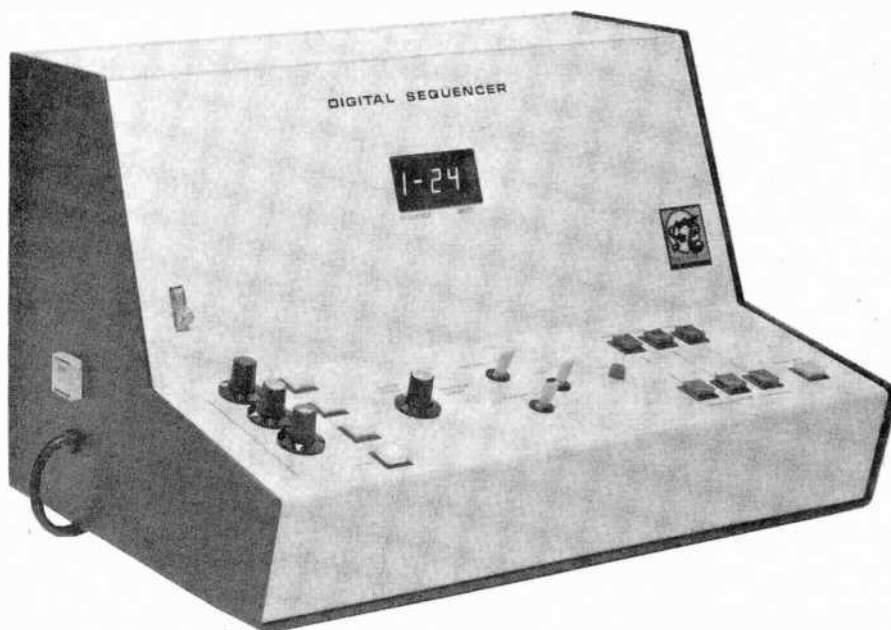

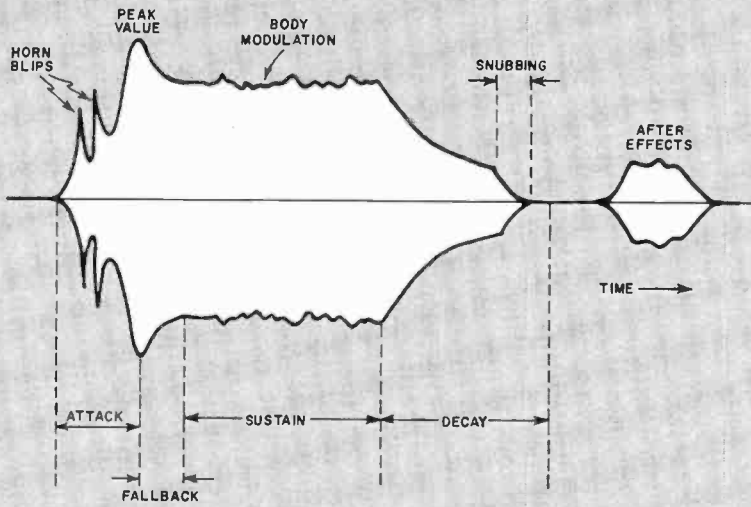

Fig. 1. Envelope of a note showing various characteristics.

attack period. Some traditional instrument imitations—particularly the English horn—have a two-value attack in which much of the initial amplitude is rapidly reached. This is followed by a much slower rising response to the peak value.

FALLBACK is the portion of the waveform from peak level down to zero or some intermediate level. Many voices—particularly percussion—drop rapidly from a peak to some intermediate level as initial transients and other high-frequency effects rapidly die down. A classic example of this is a bell that gives an initial loud "clang," followed by a long drawn out pure bell tone. Fallback is essential for most percussion voices, particularly in piano synthesis.

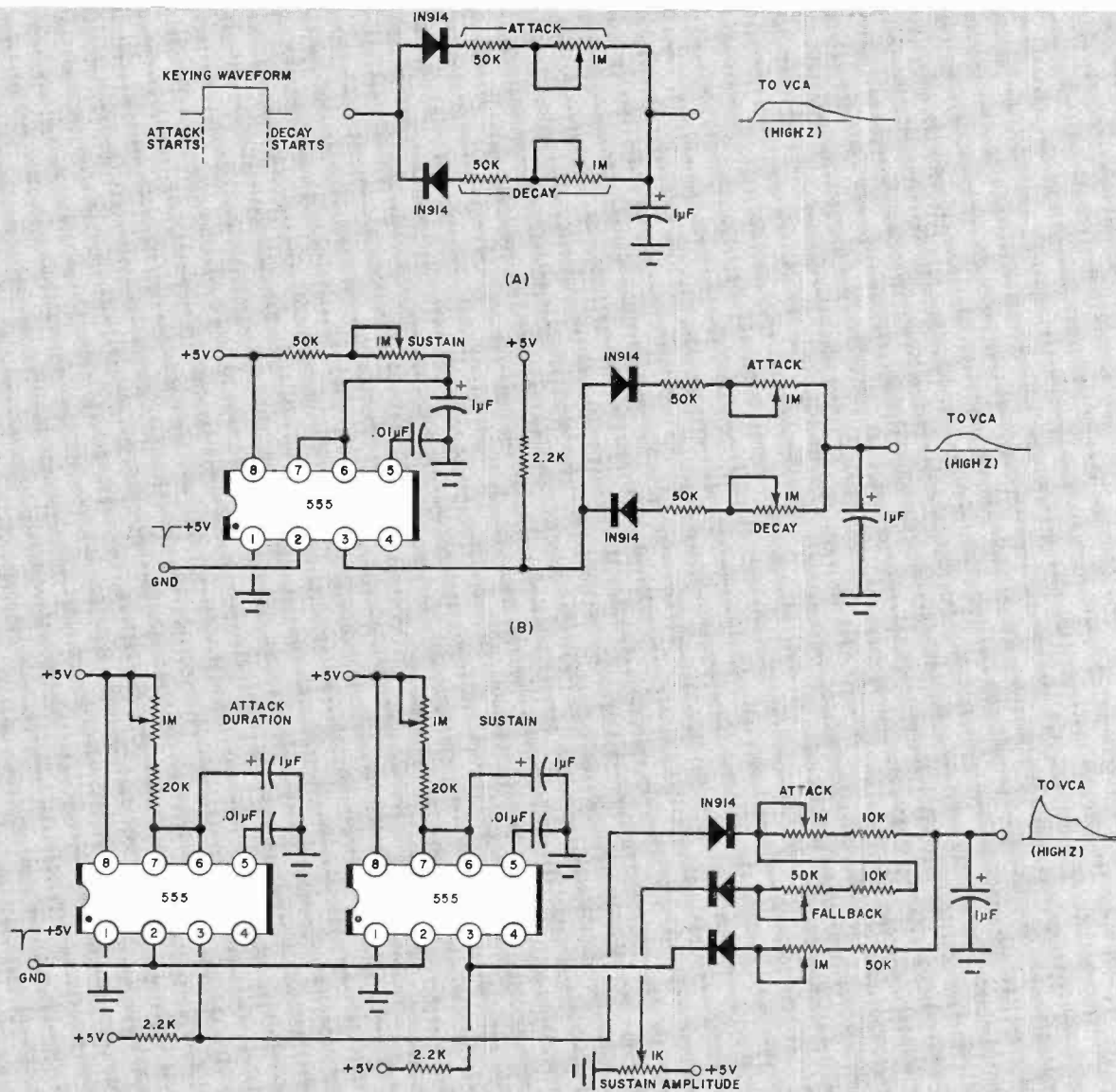

Fig. 2. At (A) is simple attack/sustain/fallback/decay circuit controlled by musician. Circuits (B) and (C) perform same function but are controlled by monostable oscillators.

SUSTAIN is the dwell period during which a note remains at relatively constant amplitude. It can be very short in duration or missing altogether in a percussion note. In fact, a percussion can be redefined as a note with a short or missing sustain time that is not under the immediate control of the musician. If the musician can hold the note for a controlled time, we have a non-percussion voice.

BODY MODULATION is any additional amplitude effect that is added to the note during the sustain period. A deep 6- or 7-Hz tremolo characteristic of piccolo or flute voice is one possibility. Another is the addition of random noise variations to break up an "exactitude" (electronic sound). In traditional instruments, this might take the form of wind noise, bowing noises, etc. At the other extreme, we could use all random noise for the body of the note, as is the case with some percussion effects. As the noise is filtered more and more, the greater the degree of filtering, the more it will appear as a pure tone. Hence, with either filtering or randomizing techniques, we can obtain anything from a purely random hiss to a pure "code practice oscillator" tone. The most musical of the effects are obviously between these limits.

DECAY is the drop-off at the end of the note. In reality, the decay is almost always exponential in form, although higher-frequency components often drop off at exponential rates that are different from those for the lower-frequency components. Decay times range from a fraction of a second to several seconds and are usually much longer than the attack times. (This can be reversed in electronic circuits to yield a "tape played backwards" type of effect.)

Since the decay is the last thing to occur in a note, and since it is relatively long in duration, obtaining the best waveform possible here is very important. A true exponential decay (or—better yet—several of them working on different harmonic components) must be used. A linear decay approximation will sound unreal. A truncated decay will sound even worse. And a decay that does not quite go to zero will produce note feedthrough and background noise. Fortunately, the normal RC discharge of a capacitor is a simple exponential decay, although you must be sure the level to which you are discharging represents the zero-amplitude point of

your keyer or vca without truncation or feedthrough.

SNUBBING is a truncation technique that is used when you want to purposely terminate the decay cycle early. This snubbing most often crops up when you are synthesizing the release of a piano key. A snubbing waveform is usually nothing but a sudden speeding up of the decay time constant, causing a very rapid (but usually a non-zero) decay.

AFTER EFFECTS can be reverberation, echo, or any of a number of special effects. They are normally generated separately with the aid of a reverberation or tape-delay technique.

If we examine all of the characteristics wanted in a note, we can see that we need an attack/fallback/sustain/decay waveform as our basic envelope generation technique. Onto this, we can add such things as horn blips, noise modulation, snubbing, and echo effects to increase the range of total variations at our command.

while circuit (B) performs the same functions but this time is controlled by a single monostable oscillator (555). By overlapping the attack and decay times, we can get a percussion voice with zero sustain.

Circuit (C) has added to it a second monostable oscillator to provide complete control of attack/fallback/sustain/decay shaping. All three circuits are based on charging a capacitor with one resistor that sets the attack time and a second resistor to discharge the capacitor and set the decay time. In circuit (C), a second resistor also discharges the capacitor at the end of the attack period but shuts off automatically whenever the remaining capacitor voltage drops below the sustain amplitude value. You can also vary circuit (C) to permit sequential operation of the monostable oscillators with the first controlling attack, a second fallback, a third sustain, a fourth decay, a fifth snubbing, and so on.

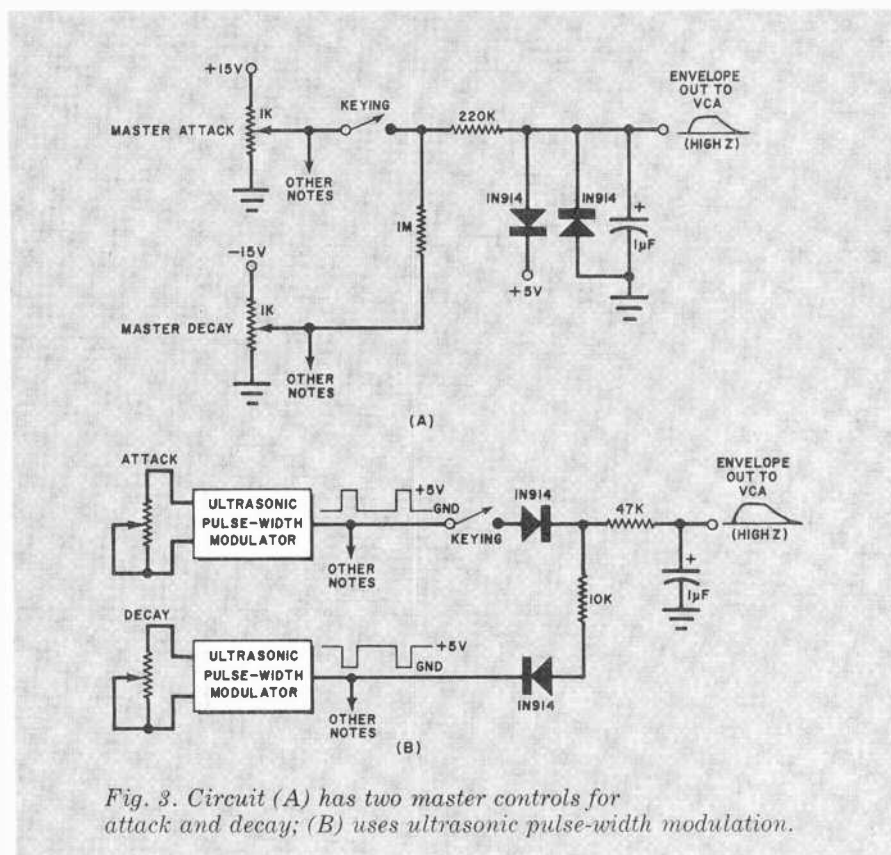

Fig. 3. Circuit (A) has two master controls for attack and decay; (B) uses ultrasonic pulse-width modulation.

Now, let us turn to some simple circuits that will do the job.

Envelope Circuits. Three simple attack/sustain/fallback/decay circuits are shown in Fig. 2. Circuit (A) is a simple attack/sustain/decay that is under the control of the musician,

All three circuits shown in Fig. 2 can be only lightly loaded, which means that they can be connected to a keyer or vca that has a high input impedance, on the order of more than 3 megohms. A simple voltage follower, FET follower, or emitter follower circuit can be added as required for a

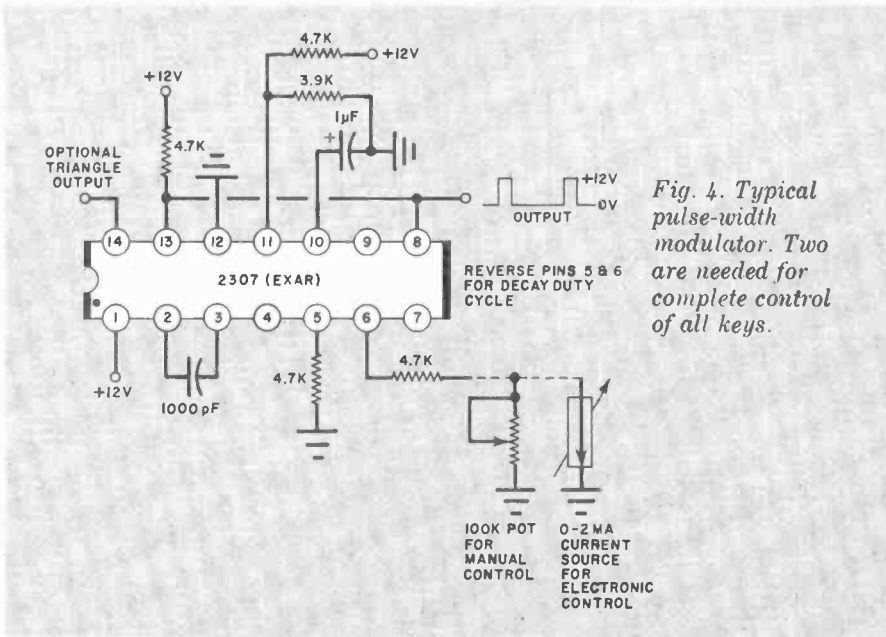

Fig. 4. Typical pulse-width modulator. Two are needed for complete control of all keys.

lower impedance keyer or gain control circuits.

Each of these circuits must have its attack and decay times set separately. The problem now is how to obtain polyphonic operation so that only one or a very few controls set the overall attack for all notes simultaneously, while a second group of controls is assigned to the decay function. Two possible approaches are illustrated in Fig. 3, one of which is a brand new and very powerful technique.

In circuit (A) is a MASTER ATTACK for all the notes and a MASTER DECAY control that serves all notes in a polyphonic instrument. Keying charges the output capacitor in the positive direction, increasing the volume of the vca until a potential slightly greater than 5 volts is reached. At this point, the positive clamping diode goes into conduction and limits the capacitor voltage to a maximum amplitude value. Releasing the key discharges the capacitor, eventually clamping at ground potential at the note's end.

For long attack and decay times, the charge rate is exponential (actually one minus the exponential on the charge cycle and the exponential on the discharge cycle). However, as either the attack or decay times are shortened, the charging rates become more linear. This would be objectionable but for the fact that the linear rates are associated with the shorter times and are thus difficult to notice. Nevertheless, this is an extremely simple and useful polyphonic circuit.

The better technique is shown in circuit (B). This technique is called ultrasonic pulse-width modulation

(UPWM). It is fully polyphonic, can be controlled by digital logic or some other easy means, and provides true exponential decay characteristics that are instantly variable, even from a remote location, over a wide range.

The trick to this circuit's operation is to rapidly switch resistors inside and outside the charging circuit. A 47,000-ohm resistor appears as a 47,000-ohm resistance when current is flowing through it. Reduce the current to zero, and the resistor behaves like an infinite resistance. Pass cur-

rent through it for one-tenth the steady-state current time, and the resistor would appear to have a value of 470,000 ohms, which most conveniently gives us the ability to remotely control dozens or even hundreds of resistors (and the resulting attack and decay times) simultaneously.

To accomplish the above, we have two pulse sources whose duty cycles are controlled by potentiometers or control voltages. These operate at ultrasonic frequencies, charging and discharging the envelope capacitor in very small steps. The slope of each step is set by the charging or discharging resistor, while the total height of each step is set by the ratio of the on to the off times of the modulator. Since each step is a tiny fraction of a decibel in height, and since there are many thousands of them during the envelope generation period, the net result is the same as if the capacitor were charged and discharged.

A typical pulse-width modulator is shown in Fig. 4. While the IC costs about \$4 (from EXAR Inc., 750 Palomar Ave., Sunnyvale, CA 94086), only two are needed for complete control of all keys, with low-cost diodes doing the actual switching. In this setup, the attack waveform is routed through the keyboard's contacts. If this is objectionable, a CMOS logic gate or analog switch can be substi-

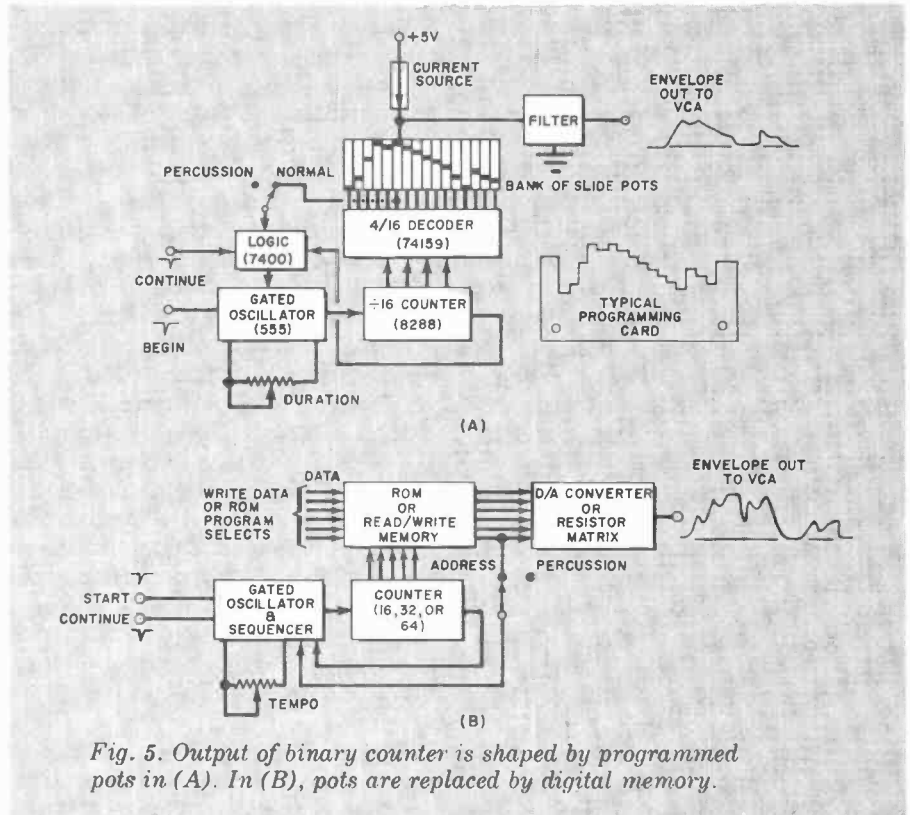

Fig. 5. Output of binary counter is shaped by programmed pots in (A). In (B), pots are replaced by digital memory.

tuted as the control element, since the signal is really a digital waveform up to the diodes. This technique can easily be extended to include fallback, percussion, and other effects.

Purely digital techniques can also be used for generating the envelope, but as of now, their added complexity limits them to monophonic instruments or, at best, to a time-shared or priority hierarchy in an instrument. Two typical digital circuits are shown in Fig. 5.

In circuit (A), we use an input time reference from a start/stop oscillator to count out 16 counts of a binary counter. Each count is decoded and routed to a slide-type potentiometer. Using slide pots, you can "draw" the waveform you want and set the total duration with the frequency of the time references. You can let the circuit go completely around for a nonpercussion voice. Releasing the key then continues the cycle. So, when you press a key, you generate the first five levels of the envelope. It then sticks in, say, position 5 for as long as the key is held down. On releasing the key, the note will continue through the decay cycle. As with most envelope schemes, some type of memory, usually a sample-hold or a digital latch, is essential if the key's frequency is to be remembered after the key is released.

The main advantage of the slide-pot scheme is its extreme versatility, especially since you can generate all manner of envelope shapes that are unreal or extremely difficult to generate with a traditional instrument. These include echo, multiple bursts, reverse attack, etc. One limitation of this scheme is that you really should use more than 32 slide pots, and another is that the tolerance of the pots can be rather restrictive as you are setting each slider to a slightly different value from its neighbor.

Programming the circuit is quickly accomplished with a plastic program card, first homing the sliders and then using the card to set them to the desired values. Once your favorite envelopes are chosen, you can install fixed resistor matrices that can be switched into the circuit in place of the pots in either preset or stop fashion.

Circuit (B) replaces the analog slide pots with a purely digital memory. For initial setups and experiments, you can use a read/write or random-access memory (RAM). For performance and concert use, a read-only memory (ROM) can be used to rapidly

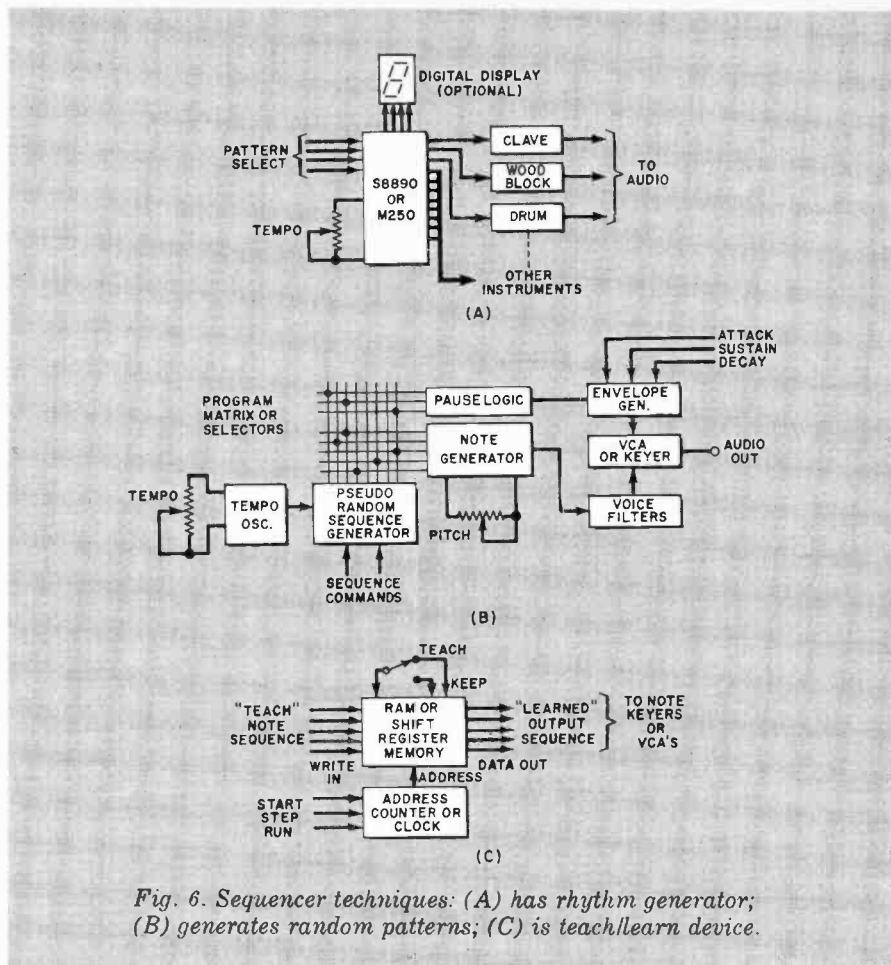

Fig. 6. Sequencer techniques: (A) has rhythm generator; (B) generates random patterns; (C) is teach/learn device.

select any of a number of fixed envelopes.

Sequencers. Three popular sequencer techniques are shown in Fig. 6. A sequencer governs the order and combinations the notes follow, rather than the shape of each individual note. Technique (A) has a rhythm generator or sideman. An early version of these circuits appeared in POPULAR ELECTRONICS as the "Drummer Boy" (July 1971). Today, you can do the whole thing with a single S8890 IC from American Microsystems, Inc. (3800 Homestead Rd., Santa Clara, CA 95051) or the M250 IC from SGS-ATES (435 Newtonville Ave., Newtonville, MA 02160). The IC's are available at about \$25 in unit quantities. Both IC's generate the combination rhythm patterns for rhythm accompaniment and are available in a standard pattern (traditional rhythms) as well as in custom patterns at much higher cost. Electrically, the IC's operate in much the same manner as circuit (B) in Fig. 5.

Circuit (B) in Fig. 6 is a composer/synthesizer that employs a pseudo-random sequencer to generate ran-

dom tone patterns. These patterns are combined with program selectors and pause selectors to generate hundreds of thousands of tonal sequences, and at around \$50 cost much less than most synthesizers. One such random-pattern generator was the "Psychtone I" that appeared in this magazine as a construction article in February 1971 and is still available in kit form from Southwest Technical Products Corp., 219 West Rhapsody, San Antonio, TX 78216.

Circuit (C) in Fig. 6, a variation of circuit (B) in Fig. 5, is a teach/learn sequencer. A commercial version called the Model DS-2 is available from Oberheim Electronics (1549 Ninth St., Santa Monica, CA 90401). Teach/learn devices of this type can employ either RAM's or shift-register memories. One good choice for experimenters would be the Signetics hex 32- and hex 40-bit shift registers (2518 and 2519), particularly since they are beginning to appear on the so-called "surplus" market for as little as 25¢ each. Brand new IC's directly from the factory are currently selling for less than \$5 and form the basis for many teach/learn music experiments.

Triplett 310 mini-VOM's fit your hand and your wallet...

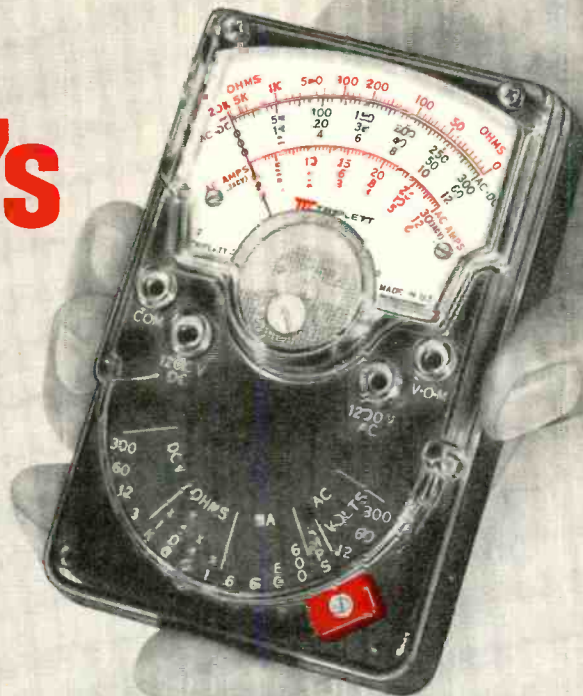

only \$49



The high quality Triplett 310 is a little all-in-one VOM. This made in the U.S.A. VOM gets around a lot for half fare. It packs most of the features you'd expect to find only on a meter twice the size and price. It fits in your shirtpocket easily. The small size and its versatility is a boon to field servicemen as well as circuit designers, technicians, electrical maintenance engineers, and the price is right for vocational and hobbyist use.

A newly designed high impact, drop resistant case makes it practically indestructible . . . 20K ohms/volt DC and 5K ohms/volt AC ranges provide plenty of sensitivity for most applications . . . and, there's diode overload protection with a fused R X 1 ohm range. The single range selector switch is a real time saver for reading 0 - 1200 DC or AC volts, 0 - 20 megohms, and 0 - 600 micro-amps or 0 - 600 milliamps at 250 millivolts.

Comes complete with 42" leads, alligator clips, batteries and instruction manual. Accessories triple the versatility of a 310. Adding the Model 10 clamp-on ammeter allows you to measure AC currents easily with one hand.

Visit your local distributor or Mod Center and shake hands with a real bargain.



TRIPLETT
BLUFFTON, OHIO 45817

Triplett. The easy readers

CIRCLE NO. 59 ON FREE INFORMATION CARD

From CIE — Cleveland Institute of Electronics

learn by doing!

Perform more than 200 exciting experiments with CIE's fascinating **ELECTRONICS LABORATORY PROGRAM!**

Put theory... into practice



You get your own Experimental Electronics Laboratory... work with components comparable to those used by industry!

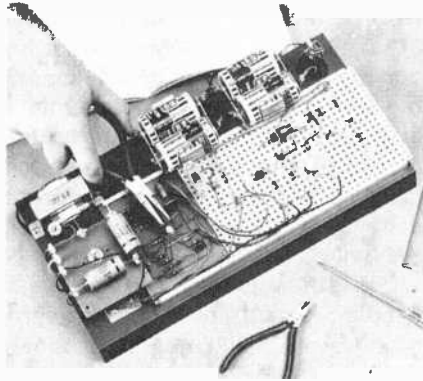

With CIE's Experimental Electronics Laboratory, you'll perform actual experiments and become adept at handling components. This valuable "hands on" experience helps you learn the "how" as well as the "why."

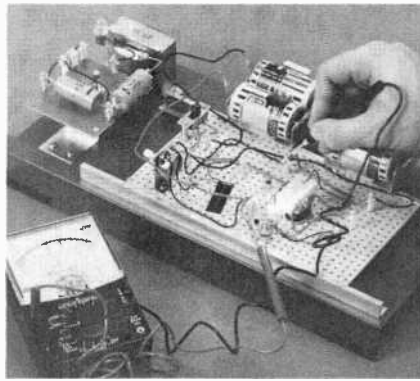

Testing and troubleshooting are an important part of your learning experience. Included in your laboratory is a precision "multimeter" to diagnose electrical and electronic troubles quickly and accurately.

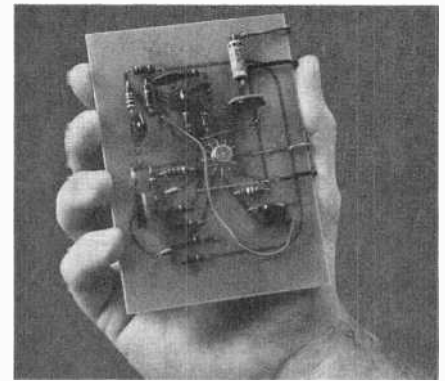

Modern space-age components like this IC (integrated circuit) are professional quality and can be used again and again in many of your projects. Lesson by lesson, piece by piece your knowledge grows!

Prepare now for a rewarding career in Electronics . . . the Science of the Seventies.

Electronics miracles are changing today's world with breathtaking speed.

This growth in electronics technology has generated a need for electronics technicians trained in theory and practice to build the products, maintain them, and troubleshoot them during the Seventies and beyond.

Don't just wait for something to "happen" in your present job. Get ready now for a career you'll really enjoy . . . with the opportunity for a good income and the chance for advancement.

Practical experience with experiments

"Hands on" experience helps to reinforce basic theory. When you learn by doing, you discover the "how" as well as the "why." You'll find out for yourself the right way as well as the wrong way to use electronic components. How to construct your own circuits, to discover trouble spots and learn how to fix them.

CIE offers a number of laboratory courses where you learn Electronics by "doing it yourself." You work with your own hands on electronics components and lab equipment. This combination of "head and hands" learning *locks in* your understanding of the crucial principles you'll use on the job in your new career.

And you do it all at home, in your spare time, at your best study pace. CIE's outstanding lessons allow you to progress step by step. An instructional technique time-tested for over 40 years of specialized electronics independent home-study training.

Importance of an FCC License and our Warranty

If you want to work in commercial broadcasting . . . television or AM or FM broadcasting . . . as a broadcast engineer, federal law requires you to have a First Class Radiotelephone License. Or if you plan to operate or to maintain mobile two-way communications systems, microwave relay stations or radar and signaling devices, a Second Class FCC License is required.

Even if you aren't planning a career which involves radio transmission of any kind, an FCC License is valuable to have as Government certification of certain technical skills. It's a job credential recognized by some employers as *evidence* that you really know your stuff.

To get an FCC License, you must pass a licensing exam administered by the government. And we are confident you can successfully earn your license, if you're willing to put forth an effort, because the vast majority of CIE students have. In fact, based on continuing surveys, close to 9 out of 10 CIE graduates passed their FCC exams!

That's why we can offer this Warranty: when you successfully complete any CIE career course which includes FCC License preparation, you will be able to pass the Government FCC Examination for the License for which the course prepared you or you will be entitled to a full refund of an amount equal to the cash price of tuition for CIE's Course No. 3, "First Class FCC License," in effect at the time you enrolled. This warranty is good from the date you enroll until the last date allowed for completion of your course.

That's it! We *warrant* that you will get the License you trained for.

You'll have attractive job opportunities

There have already been many exciting developments and breakthroughs in Electronics and some people might assume there will be no new frontiers . . . no new worlds to conquer. Not so.

Electronics is still growing. In nearly every one of the new and exciting fields of the Seventies you find electronics

skills and knowledge in demand. Computers and data processing. Air traffic control. Medical technology. Pollution control. Broadcasting and communications. Once you have the solid technical background you need, you can go after the career field you want . . . work for a big corporation, a small company, or even go into business for yourself.

Yes, Electronics can be the door to a whole new world of career opportunities for you. And CIE training can be your key.

Send for FREE school catalog

Discover the opportunities open to people with electronics training. Learn how CIE career courses can help you build new skills and knowledge and prepare you for a meaningful, rewarding career. We have courses for the beginner, the hobbyist, for the electronics technician, and for the electronics engineer. Whether you are just starting out in Electronics or are a college-trained engineer in need of updating (or anywhere in between), CIE has a course designed to fit your background, experience, and future goals.

Send today for our FREE school catalog and complete career information. For your convenience, we will try to have a representative call to assist in course selection. Mail reply card or coupon to CIE . . . or write: Cleveland Institute of Electronics, Inc., 1776 East 17th Street, Cleveland, Ohio 44114. Do it TODAY.



Approved Under G.I. Bill

All CIE career courses are approved for educational benefits under the G.I. Bill. If you are a veteran or in service now, check box for G.I. Bill information.

CIE Cleveland Institute of Electronics, Inc.
1776 East 17th Street, Cleveland, Ohio 44114
Accredited Member National Home Study Council

Please send me your FREE school catalog and career information package.

I am especially interested in:

- | | |
|--|--|
| <input type="checkbox"/> Electronics Technician | <input type="checkbox"/> Industrial Electronics |
| <input type="checkbox"/> FCC License Preparation | <input type="checkbox"/> Electronics Engineering |
| <input type="checkbox"/> Color TV Maintenance | <input type="checkbox"/> Other _____ |
| <input type="checkbox"/> Mobile Communications | |

Print Name _____

Address _____

Apt. _____

City _____

State _____

Zip _____

Check box for G.I. Bill information. Veteran On Active Duty

PE-90



Product Test Reports

ABOUT THIS MONTH'S HI-FI REPORTS

The British Industries Co. Model 980 Multiple Play Manual Record Player is, to our knowledge, the first successful adaptation of a belt drive to an automatic record changer. This electronically controlled player offers almost every design and operating feature one could desire, plus a high level of performance, at a reasonable price.

Pickering's PP-1 preamplifier equalizes and amplifies the output of a magnetic cartridge, delivering a signal suitable for the high-level input of any amplifier or receiver. It makes it possible to use a second record player with amplifiers not equipped with two magnetic-cartridge inputs, as well as up-dating an older amplifier which was originally designed for use with ceramic cartridges.

—Julian D. Hirsch

B•I•C MODEL 980 MULTIPLE PLAY MANUAL RECORD PLAYER

Automatic turntable with belt drive.



At the top of the British Industries Co. line of "Programmed Multiple Play Manual Turntables" is the Model 980. It may well be the first belt-driven automatic changer.

The turntable's 12" (30.5-cm) non-ferrous platter is belt-driven to operate at either 33 1/3 or 45 rpm by a 24-pole synchronous motor. This low-speed motor, operating at 300 rpm (which corresponds to 5 Hz), places most of the rumble frequencies below the audible range. In contrast, the usual four-pole motor revolves at 1800 rpm,

which puts the rumble frequencies at a very audible 30 Hz.

Mounted in its walnut base, with dust cover in place, the record player measures 17 1/16"W × 14 11/16"D × 7"H (43 × 37 × 18 cm). The basic turntable retails for \$199.95, while an optional walnut base and dust cover are priced at \$16.95 and \$9.95 respectively.

General Description. For single-play operation, a short spindle that rotates with the record goes into the center of the platter. When operating in the multi-play mode, this spindle is replaced with a taller automatic spin-

dle. Unlike other record changers, this player does not depend on the automatic spindle to lift or support the record stack while a record is being dropped to the turntable. A post just outside the rim of the record helps do the supporting. The spindle contains only a slim rod that pushes the bottom record off the ledge of the support. Only a slight force is required for this action, well within the capabilities of the belt-drive system.

The tubular tonearm is mounted on needle-bearing gimbal pivots, with a rotating elastically mounted counterweight. A scale on one of the gimbal rings is calibrated from 0 to 4 grams at 0.25-gram intervals for setting stylus tracking force. Separate levers are provided for setting the tracking force and antiskating compensation. Normally set to coincide, both levers can be moved in a single operation. If desired, however, they can be set separately.

Unlike other cartridge shells with which we are familiar, this one does not plug or slide into the tonearm. A four-pin plug on its side mates with a connector on the tonearm, with a single nut locking it into place. A screwdriver adjustment tilts the entire shell for the correct vertical tracking angle. (A plastic jig is supplied for setting the correct stylus overhang for minimum stylus tracking error.) At the end of the shell is a small sliding lever that is used for setting the vertical angle for single or multiple play. For multiple play, the angle is set for the center of a maximum six-disc stack.

The record player's operating controls are grouped on a panel along the right side of the motorboard. At the rear is a lever that is used for modifying the antiskating compensation for conical and elliptical styli. Next is the cueing lever that operates the cueing system whose action is damped in both directions. A small knob near the base of the tonearm lets the user adjust the damping for a descent of from one to three seconds. The speed-select control is a slide lever.

A slide-type "programming" lever comes next. Because this record changer does not employ the center spindle to sense the presence or absence of records to control the automatic changing mechanism, it must be preprogrammed for the number of discs in a stack or for the number of times a single disc is to be played. The control has positions for OFF, MAN, and 1 through 6, the last for the number of

discs in the stack or the number of times a single disc is to be played. The final control is labelled CYCLE.

The player's motor drive and control system employs a stable oscillator that generates a 60-Hz drive that is independent of power-line frequency and voltage. A small knob at the left front of the system's base permits the platter's speed to be trimmed by $\pm 3\%$. Stroboscope markings under the platter can be viewed through a window on the motorboard. There are separate markings for 50- and 60-Hz power-line feeds and for both operating speeds.

In the single-play mode, a disc is placed on the platter with the short spindle, the programming control is set to position 1, which starts the platter rotating, and the CYCLE button is lightly touched. The pickup automatically indexes for a 12" diameter when the speed selected is 33 1/3 rpm or for 7" diameter when the speed is 45 rpm. After the disc has been played, the tonearm automatically returns to its rest post and the player shuts off. For straight manual operation, or if a non-standard combination of record size/speed is involved, the programmer control is set to MAN, which starts the platter rotating, and the tonearm is positioned by hand. The only automatic operations in the manual mode are tonearm return and system shutoff.

For multiple-play operation, the automatic spindle is inserted and a stack of up to six discs is loaded onto it and the side support post. The programmer is set to the number of discs loaded, and the CYCLE button is pressed. This button, incidentally, requires only 90 grams of operating force and a travel of just 1/16" (1.6 millimeters).

Laboratory Measurements. For our tests, we inserted a good-quality phono cartridge into the player's tonearm shell. The tonearm resonance was at 8 Hz at about a 7-dB amplitude, which is an indication that the tonearm's mass is compatible with the majority of today's high-compliance cartridges.

The calibrations on the tracking force dial were exact, within the 0.05-gram resolution of our force gauge, and the force did not change by any detectable amount from the first to the last disc in our 1/2" high stack. The tracking error of the tonearm was as low as we have ever measured on a pivoted tonearm of comparable dimensions. Between radii of 2.5" (6.35 cm) and 6" (15.84 cm), the maximum error was less than 0.3°/in. At the inner radius, it was essentially zero. The tonearm and cable wiring capacitance was 120 pF, which is slightly higher than desirable, but usable with CD-4 cartridges.

Similar to most antiskating systems we have used, this player's system had to be set about 1 gram higher than the tracking force for optimum compensation. This is not a critical adjustment, and for most purposes the indicated settings should prove satisfactory. The cueing system operated smoothly, with no outward drift during tonearm descent. The rate of descent was adjustable over a range from 2.5 to 4 seconds.

The operating speeds were exact when the stroboscope pattern was stationary. They did not vary by any appreciable amount when the line voltage was changed over a 100-to-135-volt range. At 95 volts, the speed slowed by an insignificant 0.3%. The vernier (speed-trim) range was

from +4.3% to -2.9% at 33 1/3 rpm and from +3.8% to -3.4% at 45 rpm. There was a very slight drift in speed during the first half hour or so of operation, which was barely detectable on the stroboscope.

The unweighted rms wow and flutter were each 0.03% to 0.04% at both speeds. The unweighted rumble was -32 dB, essentially in the horizontal plane. The ARLL audibility weighting yielded a very good -61-dB figure. The change cycle in automatic operation required 12 seconds, which is about average for record changers.

User Comment. The problems that a pure belt-driven system presented to designers of record changers in the past have obviously been overcome in this model. As a result, its wow, flutter, and rumble specifications are astonishingly good for a changer, being in a class with many of the fine single-play turntables.

Operating the changer is different in at least one respect from others we have examined, however. For example, lacking a spindle sensor to control the changing mechanism, one must count the number of discs in a stack and "program" the player. Also, for those who like to switch cartridges for, say, playing records singly or automatically, there's a mechanical hassle involved in the use of a tiny securing nut.

Other, more expensive changers have special features that justify their prices, but in basic performance parameters—the ones that affect what you hear—the Model 980 takes a back seat to none. Equally important, this performance is obtainable at a moderate cost.

CIRCLE NO. 80 ON FREE INFORMATION CARD

PICKERING MODEL PP-1 PHONO PREAMPLIFIER

Updates low-cost music systems for use of magnetic cartridge.

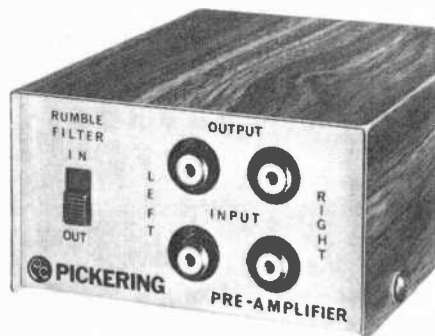

The Pickering Model PP-1 phono preamplifier is designed for use in upgrading low-cost music systems by permitting the replacement of ceramic cartridges with magnetic units. The type of record player equipped with a ceramic cartridge, of course, does not have the equalizing preamplifier

needed for a magnetic cartridge. In most cases, however, the tonearm of the record changer will accommodate a standard magnetic cartridge with 1/2-in. (12.7-mm) centers. The preamp can also be used to connect a second record player to an amplifier equipped for only one magnetic-cartridge input.

General Description. The self-powered preamp measures 4 3/8"D x 3 1/2"W x 2"H (11.1 x 8.9 x 5.1 cm). Its two input jacks accept the signal cables from the record player's cartridge, while a pair of shielded cables (not furnished) go from the preamp's

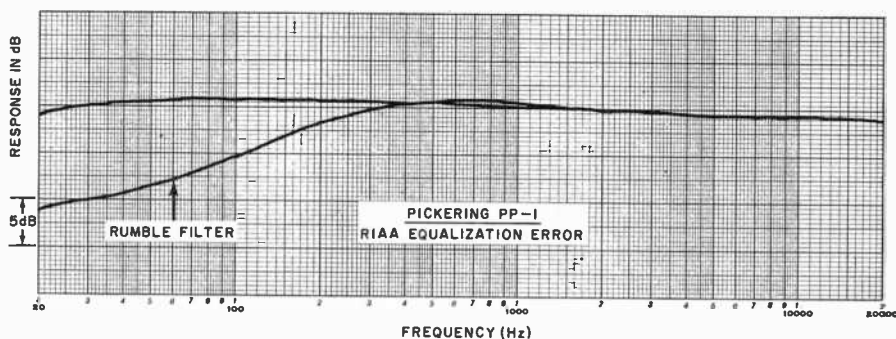

output jacks to the Aux inputs of an amplifier. Because no power switch is provided on the preamp, the line cord should be plugged into a switched convenience outlet on the amplifier.

The specifications of the preamp are limited to the fundamental characteristics of a phono preamp. The input impedance of 47,000 ohms matches all current stereo cartridges. The gain at 1000 Hz is 38 dB, and the RIAA equalization is rated to be within ± 2 dB of the ideal characteristic from 30 Hz to 15,000 Hz. The S/N is stated as being at least 60 dB, and crosstalk between channels at better than 60 dB down.

A rumble filter is included in the preamp in the expectation that many systems in which it will be used will have inexpensive record changers whose relatively high rumble cannot be reproduced by a ceramic cartridge but might prove troublesome with a

magnetic pickup. The filter is rated to provide at least 15 dB attenuation of rumble frequencies.

The retail price of the Pickering Model PP-1 preamp is \$29.95.

Laboratory Measurements. With a 10-mV input producing a 1-volt output, the measured 1000-Hz gain of the preamp was 40 dB. The maximum undistorted output was 2.5 volts, which suggest the advisability of using relatively low-output magnetic cartridges (ones with, say, no more than a 5-mV output level) to minimize distortion from preamplifier overload on loud recorded passages.

The crosstalk at 1000 Hz was -64 dB. The S/N ratio, referred to 1 volt output, was a good 69 dB (unweighted). It improved to 72 dB when the rumble filter was switched in, which reduced the small amount of power-line hum in the output. With IEC "A"

weighting, corresponding to the subjective effect of the noise, the S/N was an impressive 77 dB, with or without the filter. The distortion was too low to be measured accurately at most usable output levels, being submerged in the low hum and noise output. At 2 volts output, the 1000-Hz THD was an insignificant 0.05 percent.

The RIAA equalization was better than ± 1 dB from 20 Hz to 20,000 Hz. The rumble filter began to roll off the response below 300 Hz, with the -3 -dB point at 170 Hz. It reached a maximum attenuation of 10 dB at frequencies below 40 Hz. Unlike many phono preamps, the equalization of the PP-1 was virtually unaffected by the inductance of the phono cartridge. Whatever the cartridge extracts from the disc will be passed on intact to the amplifier.

User Comment. We found that the preamp does a fine job in its intended application. We connected the preamp to the Aux inputs of our regular hi-fi amplifier and used an Ortofon Model M15E cartridge (quite a bit higher in quality than would normally be used in such a conversion) for our listening test. The results were first rate, sonically indistinguishable from the performance of the cartridge through the usual PHONO inputs.

CIRCLE NO. 81 ON FREE INFORMATION CARD

TRAM XL AM CB TRANSCEIVER

Mobile rig has excellent noise limiting and modulation control.



The Tram XL mobile AM CB transceiver measures a compact 6.3"D x 5.5"W x 2"H (16 x 14 x 5 cm), yet delivers "big" performance on all 23 channels using crystal-controlled frequency synthesis. Good receiver sensitivity and selectivity, excellent automatic noise limiting (anl), an easy-to-read meter, operation at full legal power with clean modulation,

and an unusually good automatic modulation control (amc) system are its attributes.

Other features are: adjustable squelch, PA operation, built-in speaker, external-speaker jacks, microphone, theft-deterrent mobile mounting hardware, 12-volt positive- or negative-ground power system, zener-diode voltage regulation,

reverse-polarity protection, and line filter.

The transceiver retails for \$159.95.

The Receiver. An unusual aspect of the double-conversion receiver used is the absence of an r-f input amplifier preceding the first mixer. However, good sensitivity is still obtainable, as indicated by our measurement of 0.55 μ V for 10 dB (S+N)/N at 30% modulation with a 1000-Hz test tone. This is close to the average generally achieved with receivers that are equipped with an r-f amplifier. Without the amplifier, chances of signal overloading are minimized. The result is that the XL's receiver section has better signal-handling ability than is usually the case. Good image rejection, measured at 62 dB, is achieved by two loosely coupled tuned circuits at the input and the transmitter antenna matching network. Protective diodes are provided in the receiver's input.

The intermediate frequencies are

7.8 MHz and 455 kHz. A 7.8-MHz band-pass circuit between the two mixers aids unwanted signal rejection, which measured 60 dB over most of the range. As often occurs in this type of conversion and synthesis, a spurious response can be produced by a signal near 30 MHz. The rejection factor for this "image" was 36 dB. Rejection of the 7.8-MHz i-f in the 455-kHz stage was 60 dB.

Selectivity is obtained through the use of a ceramic filter. Adjacent-channel rejection was nominally 53 dB, and the overall response, including that of the receiver's audio section, was 350 to 3300 Hz.

A single diode is used for detection and agc. The agc, applied to the two mixers, held the audio output to within 7 dB with a 20-dB r-f input change at 1 to 10 μ V and to 12 dB with a 60-dB input change at 10 to 10,000 μ V.

The meter does double duty as a signal-strength and transmitter-output indicator. Readings of about S9 were obtained with input signals of 50 to 100 μ V. The thermistor-stabilized squelch was adjustable for thresholds of 0.35 to 550 μ V.

A series-gate anl follows the detector. The audio section of the receiver consists of three stages that end with a class-B amplifier stage, which provided a measured output of 3 watts at 6% distortion into an 8-ohm load using a 1000-Hz test tone.

The Frequency Synthesizer. A conventional frequency-synthesis system is employed in the transceiver. It utilizes 10 crystals, six of which are in the 11.8-MHz region and the remainder in the 7.5-MHz region. Pairs of crystals are used to create the local oscillator signal at the first mixer to generate the 7.8-MHz i-f when combined with a given CB channel signal. A 7.345-MHz crystal is used for heterodyning at the second mixer to produce the second i-f.

The Transmitter. On transmit, the synthesizer's output is combined with a 7.8-MHz crystal-controlled signal to produce the on-channel carrier. The carrier is filtered against spurious responses by a triple-tuned bandpass circuit. The rest of the transmitter consists of a conventional r-f amplifier, driver, and power amplifier system. A multi-section pi network minimizes harmonics and matches the output to 50-ohm transmission-line/antenna systems. The r-f output

measured 4 watts when the transceiver was powered up from a 13.8-volt supply.

The audio section of the receiver, used for modulating the collectors of the driver and power amplifier stages, is preceded by a speech amplifier that is automatically switched in when the rig is on transmit.

The amc in this transmitter differs from the usual compression system. The collector and emitter leads of a transistor are connected across the speech amplifier's input. A dc control voltage, obtained by sampling the modulating voltage through a voltage-doubler system, is applied to the transistor's base. When the modulating voltage rises above the level required for 100% modulation, the resulting dc control voltage reduces the collector-emitter resistance of the transistor, causing it to reduce the speech input level. It thus acts as an automatic volume control that compensates for excessive speech levels as needed to prevent overmodulation. The result is extraordinarily good amc performance.

Raising the microphone input level 20 dB above that required to produce 100% modulation maintained a clean sine wave at full modulation, without clipping or negative-peak crossover. Under these conditions (20 dB compression), the distortion with a 1000-Hz test tone was only 5% and adjacent-channel splatter was down 55 dB. With a 2500-Hz tone, it was 40 dB down, and with voice modulation, it was 60 dB down. Using a 400-Hz tone, most CB transceivers have high distortion products, but with the XL, even with 20 dB of compression, the distortion was only 8.5%.

Referred to 1000 Hz, the audio response was 475 to 5000 Hz at the 6-dB points. A 2-dB rise occurred at about 2000 Hz. The frequency tolerance of the transmitter was within \pm 150 Hz at 80° F (27.3° C).

User Comment. The transceiver is built into a tough Cylolac plastic case. Miniature slide switches are provided for CB/PA mode selection and activating and deactivating the anl. The channel selector knob is easy to grip. Aside from having white position indicators, the VOLUME and SQUELCH controls also have tabs that let the user "feel" as well as see their positions. Although the edgewise meter movement isn't large, it's well-illuminated and has a pointer that's easy to see.

ALLISON 'OPTO-ELECTRIC' The BEST...the ULTIMATE of ALL Ignition Systems!



(We challenge ANYONE to dispute this Fact!)



Never wears out or needs any Maintenance!



gives you Maximum Power with continuous PEAK PERFORMANCE

...while reducing Maintenance and Operating Costs!



★ The Allison OPTO-ELECTRIC System eliminates the Points and Condenser, replacing them with an OPTO-ELECTRIC TRIGGER, using a Light-Emitting Diode and Photo transistor. The System operates on a beam of Light. As there are NO moving parts in rubbing contact, "Friction-wear" is completely eliminated...Timing adjustments are PERMANENT.

● Gives 40-Times more Timing accuracy than ANY system using "Mechanical" Breaker-Points! UNLIMITED RPM! "Electronically-Controlled" DWELL automatically supplies HIGHEST Performance at both Low and High speeds. Spark strength does not fall off at high RPM. POSITIVE SPARK helps eliminate "Misfire" for faster acceleration and improved Engine Performance. Sparkplugs LAST 3 to 10-Times LONGER.

● Easier Starting under any condition! Smoother running... (NO TIMING FLUCTUATION as with Magnetic Impulse Units). All SOLID-STATE Components. UNAFFECTED BY Temperature, Moisture, or Vibration! Only Highest grade materials used... Guarantees you Solid, Dependable Performance!

● PERFECT TIMING INCREASES Engine Efficiency and Gas Mileage. SAVES Precious Fuel! Allison gives you MAXIMUM Engine Efficiency 100% of the Time... and that's the name of the game for the BEST in GAS MILEAGE AND ECONOMY.

★ Perfect Timing and Dwell never change.

● Pays for itself! Eliminates ignition Tune-Ups forever! "INFINITE LIFE"...Once installed...Never needs replacing!



★ PROVEN RELIABILITY!

Each Unit Tested to 15,000 RPM.

● Road and Race Proven. (Opto-Electric Systems won at INDY Two years in a row!)



You CAN install the ALLISON System in ALL the U. S. made & Foreign Cars! (4, 6, or 8-Cylinder).

"EASIEST-TO-INSTALL" UNIT ON THE MARKET. (Not necessary to dismantle Distributor as with other systems).

★ If you want the BEST, and SAVE! This is IT!

ORDER with CONFIDENCE... SATISFACTION GUARANTEED or Full Refund

10-YEAR FACTORY WARRANTY! (Free Repair or Replacement)

● Send Check or M/O

State Make, Year, Engine Size. (Calif. Res. add Tax).

★ (So New...it's Sold ONLY FROM FACTORY DIRECT).

● You may use your MASTER CHARGE or BANKAMERICARD. Send us (1) Your Number, (2) Interbank No., (3) Exp. Date.

★ Before buying any other Type ignition system...

Send Postcard for our FREE BROCHURE.

★ If you have already installed a C-D ignition system, Modernize and Increase its Efficiency... CONVERT YOUR "C-D" UNIT TO BREAKERLESS! Opto-Electric "TRIGGER UNIT"...Only \$34.95

● Our BEST Salesmen are the users of our ALLISON System!



● America's Oldest and Largest Mfg. of Opto-Electronic Ignition Systems.

ALLISON
AUTOMOTIVE COMPANY

1267 - P, East EDNA PL., COVINA, CAL. 91722

CIRCLE NO. 3 ON FREE INFORMATION CARD

The speaker is mounted facing up, which can present a problem for under-the-dash mounting. However, an external speaker can be used.

The fine performance of the transceiver is evident from our test results. We especially liked the ability of the

amc system to deliver a clean, fully-modulated signal without splatter over a wide range of voice levels—even when we shouted directly into the microphone.

The effectiveness of the anl was equal to or better than that of many

noise-blanker/anl systems. At least 60-dB attenuation of high impulse-noise peaks was measured with no noticeable vehicle ignition noise and only a non-interfering trace during weak-signal conditions.

CIRCLE NO. 82 ON FREE INFORMATION CARD

HEATHKIT MODEL TD-1006 4-CHANNEL COLOR ORGAN KIT

New approach provides unusual effects.

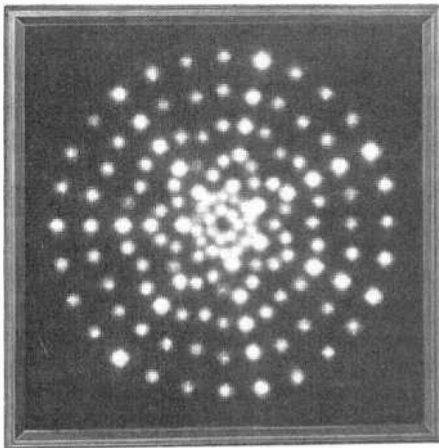

Though the popularity of the color organ declined somewhat a few years ago, it is back again in a form that promises to put it at the top of the audio-visual field once more. The Heathkit Model TD-1006 takes a sharp departure from the display format that was adopted by manufacturers a number of years ago. Instead of randomly positioning a number of colored lamps, the TD-1006 employs a balanced geometric pattern that seems to pulsate, explode in a fireworks display, and pinwheel as the music goes through the octaves and runs through a wide decibel range.

For want of a better descriptive, the Model TD-1006 is a "picture" color organ. Four channels of colored lights and their driving circuitry are housed in a walnut-grained vinyl-clad cabinet that measures 22¾" square × only 4½"D (57.8 × 57.8 × 11.4 cm) and weighs 18 pounds (8.2 kg). The system can be hung on a wall or stood on the floor or on a shelf. Retail price of the kit is \$79.95.

General Description. The color organ is built around a conventional amplifying system whose output goes to four bandpass filters. The center frequencies of the filters are roughly 80, 350, 1000, and 3000 Hz. Each bandpass filter's output goes through

a separate rectifier circuit to an SCR that, in turn, drives the channel's respective colored light string. Red lights are used in the lowest-frequency channel, followed by blue, green, and amber lamps as the frequency goes up.

The drive signal for the color organ is taken from across the speaker terminals or the speaker output of an amplifier or receiver. The system's 5000-ohm input impedance is designed to have only a minimal loading effect on the driving amplifier. To obtain the full 25-dB dynamic range from the color organ, an input signal level range of 1 to 28 volts is required.

The color organ has its own built-in power supply. The colored lamps consist of strings of miniature Christmas tree lights that require up to 117 volts of drive potential, which is controlled by the SCR's.

There is only one external control on the color organ. This is the power on/off switch that is ganged with the SENSITIVITY control. Inside the cabinet, on the main printed circuit board assembly, are eight more trimmer controls, two assigned to each channel (string of colored lights).

Externally, the color organ resembles a flat, square speaker system. Its front panel, behind which is located the display board, is covered with a black fine-mesh fabric. Directly behind the fabric is a lensed clear plastic sheet. The lamps are set into clear plastic "flower buds" that spread the point-source illumination out into a star-like pattern. Tiny lenses in the clear plastic sheet and the mesh fabric have a further effect on the dispersion of the light from the individual lamps. (The fabric also prevents the backscatter of the light from within the color organ and limits the amount of ambient room lighting that can enter the display.)

There are 35 of each color lamps in the color organ's display, adding up to a total of 140 point sources of light

when the system is driven by a wide-spectrum signal. The lamps are arranged in a star-burst pattern whose radials alternate in color. The display's density is greatest at its center, where a single circle of red lamps is located. The center is the only circle that has a single color. All outer circles have two or more colors of lamps.

Assembling the Kit. Assembly of the matte-black display board consists of mounting eight wood blocks and the hardware for securing the power supply and main pc board assemblies. Then the strings of lamps are plugged into the hole matrix. The lamps must be individually removed from their bases during installation and replaced immediately thereafter. Since these are series-string lights, each must be checked out before proceeding to the next string. (If one lamp in a string is burnt out or not making contact, none of the lamps in the string will come on.)

Next comes the gluing of the black fabric to the clear plastic sheet. Since the fabric must be stretched during this procedure, the task might have proved difficult. However, Heath thoughtfully provides not only the glue for the job, but the clamps to hold the fabric taut as well.

Mounting the components on the two printed circuit boards takes up the next portion of the assembly procedure. Neither board is crowded, which greatly simplifies wiring. This done, the rest of the work is mainly mechanical. All told, it took us some six hours to assemble the kit, working from the well-written and excellently illustrated assembly manual.

After allowing the color organ to "burn in" for the recommended period of time, we proceeded to the adjustment steps. Less than a half hour later, we were ready to put the color organ into our music system.

User Comment. Although we had gone through the fad era of the color organ and had been sated the way so many other people were, we were pleasantly surprised when we first

turned on the new Heath color organ and played some music while watching the display. After living with it for several months, we find this color organ's effect as refreshing as it was the day we first turned it on.

One must see the TD-1006 perform to really appreciate it. As the frequencies in the music change and the signal level rises and falls, the starburst pattern of lights explodes, pinwheels, pulse-beats and throbs, expands outward and folds back on itself. Transients are captured in a nova-like display, and when all the lights are on and flickering with the rise and fall in signal level, there is a jewel effect.

While the color organ responds to all types of music, it appears to have an affinity for the pure tones of the synthesizer whose psycho-visual effects can be "mind blowing." With classical and most modern (not rock) music, the effect is highly appealing. So far, our favorite selection is

Tomita's synthesizer arrangement of "Pictures at an Exhibition" (RCA), which has a number of special passages that appear to bring out the color organ's full effects.

Viewing conditions are best maximized when room lighting is low and not aimed directly at the display. Also, the best effect is achieved when the display is viewed head-on; the further off-axis you get, the more blurred the display becomes. (This isn't surprising, considering the double lensing system used.)

Most amplifiers and receivers capable of developing a few watts of output power (assuming a signal level of some 15 or more volts) will drive the color organ. One type of receiver that shouldn't be used is AM. Since the color organ uses SCR's to control the lamp strings, every time the SCR's go through zero crossing they generate noise that can be picked up by the standard AM receiver.

CIRCLE NO. 90 ON FREE INFORMATION CARD

SENCORE MODEL CR31 CRT TESTER & RESTORER

Versatile, easy-to-use TV service instrument.



TV PICTURE tube testers and restorers are among the most valuable instruments a TV service technician can own—whether he is a full-time shop owner or a part-timer. The expenditure for such an instrument can be quickly recovered, and its profit-making potential is great. Furthermore, the service technician can operate in a more professional manner when he uses a CRT tester/restorer. The new Sencore Model CR 31 "Super Mac" is in the Cadillac class of CRT tester/restorers. What it offers are versatility, simplified operation, a choice of "safe" and "last resort" CRT restoration steps, and high accuracy. Self-contained in a luggage-type case, the CR 31 measures 12¼"H × 11"W × 7"D (30.6 × 27.5 × 17.5 cm) and weighs 13¼ lb (5.9 kg.). Price is \$395.00.

JANUARY 1976

General Description. The inside cover of the CR31 contains 15 CRT plug-in sockets that enable one to make tests on virtually any CRT, color or black-and-white, including the RCA 110", 17" Trinitron and GE's Quad-line. There is also mounting space for a handful of extra sockets, which will be made available by the manufacturer when new CRT's are released.

The electronic portion of the instrument is in two parts: "CRT & Circuit Tester" and "Beam Builder." Depressing a rocker switch illuminates the section chosen. Testing a CRT starts with the left section. "CRT & Circuit Tester." Moving its rotary function switch to LINE VOLTS gives the user the ac volts reading on a big 6" × 4½" color-coded meter. If the TV receiver is operating on line voltage below its minimum requirement, a

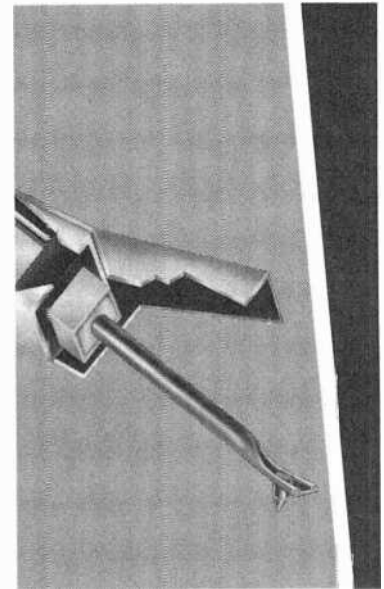

This protects your most expensive hi-fi investment.

Trying to economize by putting off the replacement of a worn stylus could be like throwing away five dollars every time you play a record. Since the stylus is the single point of contact between the record and the balance of the system, it is the most critical component for faithfully reproducing sound and protecting your record investment. A worn stylus could damage your record collection. Insure against this, easily and inexpensively, by having your dealer check your Shure stylus regularly. When required, replace it immediately with a genuine Shure replacement stylus. It will bring the entire cartridge back to original specification performance.

Shure Brothers Inc.
222 Hartrey Ave., Evanston, IL 60204
In Canada: A. C. Simmonds & Sons Limited

SHURE



* FREE! 1976 Stereo Directory & Buying Guide with the purchase of a Shure V-15 Type III, or the M95 series, M75 Type II or M91 series of cartridges. Simply send us your warranty card with the notation "Send Free Buying Guide" before March 1, 1976. (Offer subject to supply and may be withdrawn at any time.)

CIRCLE NO. 51 ON FREE INFORMATION CARD 73

You may not know how good you are. But ETI will show you how good you can be.

Perhaps you've heard about all the activity going on in the world of electronics. And maybe you've wondered if it wouldn't pay *you* to get into this exciting field.

Now is your chance to prove just how good you can be in any one of a number of well-paying jobs in electronics. The

Electronics Technical Institute can train you at home, in your spare time. And faster than you dare hope.

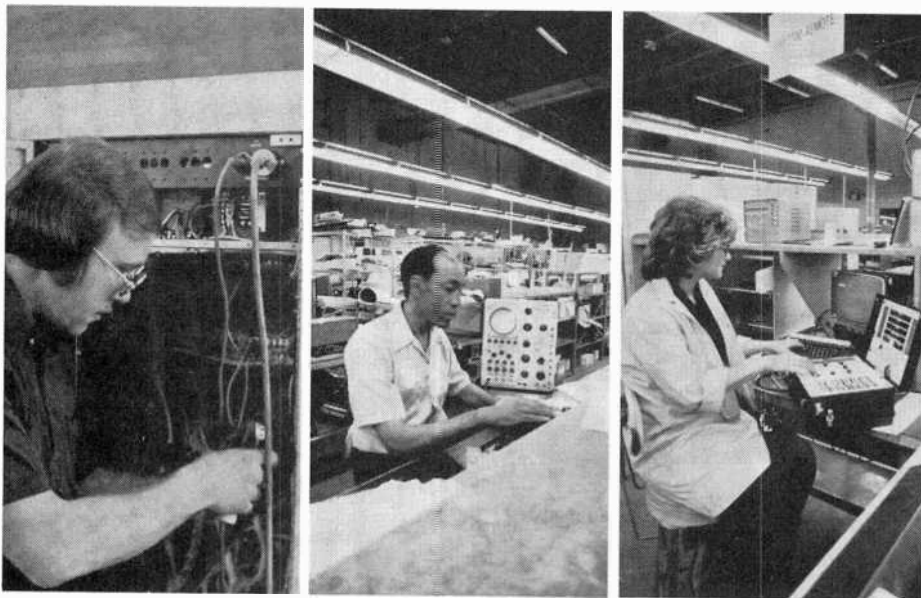

Take your choice. Whether your choice is TV and radio servicing, an FCC-licensed job, computers, solid-state specialties, electronics drafting, or any one of a number of good jobs in electronics, ETI can help you make it through solid, thorough training.

You can start from the beginning. Even if you know nothing about electronics, you can start your career with Fundamentals of Electronics, a course which features ETI's special, exclusive, simplified system of teaching called *Autotext*. It's also been called one of the most efficient methods of home study ever developed. You learn fast, learn well and keep what you learn. What's more you'll *enjoy* learning.

Your ETI instructor—an all-pro. Working with you will be your personally assigned ETI instructor, a professional in both home study and electronics.

Licensed by the State of New Jersey, he knows how to move you ahead quickly.

His friendly but straight-from-the-shoulder comments and suggestions at the end of

each assignment will help you take on the next one with enthusiasm and confidence.

ETI—a leader in home study. Working for you is the reputation of a school—ETI—that began as the Marconi Institute back in 1909. Employers and professional people respect the work of ETI, because they know its instruction is thorough, complete, and up-to-the-minute in every respect. And thousands of ETI graduates now working in electronics attest to the same thing.

Hands-on training and experience. It is not all study when you take an ETI course. In many phases of your training, you use specially developed Project Kits for vital, hands-on experience. You learn by doing, from the very beginning to the completion of

the basic units. As you learn, you build confidence in your ability to get the job done and done well.



Check it all out.

If what we've said seems too good to be true, we'd like you to make us prove it. And you can do that very easily—with absolutely no obligation

on your part—by mailing the coupon or card today. We'll send you all the facts—all the proof you need—in a free, fully illustrated, 48-page Career Book. No salesman will call.

We do believe you owe it to yourself to learn all you can about the many opportunities awaiting you in electronics. The new ETI Career Book will give you the facts you need to decide on a future in electronics, and how you can attain your goal through one of ETI's 18 different courses and programs.

Now it's up to you to take the first step toward an exciting job in electronics.



And that first step is easy. Simply complete the card or coupon and mail today for your free 48-page ETI Career Book.

Electronics Technical Institute

Division of Technical Home Study Schools

Electronics Technical Institute • Dept. 2-473-016
Little Falls, New Jersey 07424

Send my free Career Book!

Tell me how I can get ahead in Electronics through ETI. I've checked the fields of special interest to me.

- | | | |
|---|---|--|
| <input type="checkbox"/> TV/Audio Servicing | <input type="checkbox"/> Computers | <input type="checkbox"/> Business and Engineering |
| <input type="checkbox"/> Black & White Color Solid State CATV Closed Circuit Video Recorders Radio Hi-Fi Stereo | <input type="checkbox"/> Digital Electronics Computer Technology Computer Programming | <input type="checkbox"/> Fundamentals Electronics Drafting Industrial Electronics Advanced Electronics Industrial Instrumentation Electronics Technology Medical Electronics |
| <input type="checkbox"/> Communications FCC License Aircraft Marine Mobile Two-Way Microwave | | |

Check here for Veteran information.

Name _____ (please print)

Address _____

City _____ State _____ Zip _____

step-up transformer can be tried. Focus and high-voltage tests can be made via a built-in 10-kV probe and, if required, a 50-kV adaptor probe. The TV receiver can be plugged into the instrument's convenient front-panel ac outlet. Determining that the above is satisfactory, tests on the CRT itself can be started. (The foregoing can be bypassed, of course, if the CRT's heater doesn't light up.)

Using a handy 36-page set-up booklet stored in the case's compartment gives rapid access to all the information needed to test and rejuvenate CRT's. This includes listings of CRT types with instrument settings for filament voltage, bias, voltage range for focus and HV, and plug-in socket number. After attaching the proper socket to the CRT and connecting the CR31's coupling to it, you're ready to start. Setting FILAMENT VOLTAGE from 0 to 14 volts and "fine tuning" it with a FILAMENT-SET control, you simply turn the function switch to HEATER-CATHODE SHORT and read the meter, followed by a CONTROL-GRID SHORT test. If a short is indicated, you can flip the main selector switch to the BEAM BUILDER position. This mode is used to clear G1 shorts. Depressing a pushbutton discharges a high-voltage capacitor between the cathode and G1. This can be done to any of the three guns in a color picture by depressing R/B&W, G or B buttons.

If the CRT passes the foregoing test, you need simply move the rotary switch to GUN BALANCE while in the CRT & CIRCUIT TESTER mode. Here, each gun's G2 control is adjusted so that the meter pointer hits the same indicated line on the meter, providing the lowest emission level. Switching to EMISSION gives a direct meter reading that shows good, bad or ? for each CRT gun, measuring true beam current at maximum emission.

If emission isn't satisfactory, you've got five cracks at improving it. Firstly, there are two REJUVENATE positions in the BEAM BUILDER mode. These positions accelerate the beam current and/or increase filament voltage temporarily to bring new emitting material to the surface of the cathode. Even if you hold the pushbutton down, the system will discharge and, therefore, not allow you to use excessive rejuvenation. (You might also try raising filament voltage in delayed steps and testing for emission to see if an improvement is noted, which is a sixth option). If all three CRT guns show

poor emission, then you can try RESTORATION. The CR 31 offers three CRT restoration choices. The AUTO CYCLE position applies a constant dc voltage between the cathode and the control grid for about four seconds (a screw-driver adjustment permits this time to be increased or decreased), then removes the voltage for about 2 seconds. The cycle is repeated three times while the pushbutton is depressed. Two MANUAL RESTORE positions are also available, where the user controls the amount of time the system is working. In MANUAL 1, maximum cathode current is limited to 100 mA, whereas in MANUAL 2, current is limited to 150 mA. The latter is a last-resort method.

Restoration is actually the reactivation of the electron-emitting properties of the CRT cathode, so that it can emit large quantities of electrons to eliminate degradation due to slight amounts of gas within the tube.

If emission is satisfactory, a LIFE TEST is made. This lowers the filament voltage so that you can estimate how much life is left in the old CRT by observing meter readings. An AUTOMATIC TRACKING test is made next, in the CRT & CIRCUIT TESTER mode. This test is accomplished without any additional balancing or settings by simply moving the function switch to AUTOMATIC TRACKING and noting whether the meter indicates good or bad. Using a Sencore-patented circuit, emission information for each color gun is stored and compared on the basis of the industry 1.5:1 ratio standard. If the tracking reads "Bad," then the color picture will either be too green, too blue, or too red, depending on which gun's emission is too low; black-and-white pictures on color receivers also display tinges of color if tracking is poor.

User's Report. The CR31 "Super Mac" was in our hands for a few months. Testing a myriad of CRT's with it, we found it to be as complete a CRT tester and restorer as one could hope to use. We brightened up a host of formerly low-brightness pictures, removed a G1 short, and vastly improved tracking on many other color TV receivers. (In instances where all guns could not be equalized, adjusting the set's screen-grid controls did the trick). In one case, we ruined a CRT using the CR31's MANUAL 2 restoration, but this tube was gone to begin with. In another instance, however, we "saved" a similar defective CRT. Also,

we were unable to correct one CRT with a G1 short, deducing, therefore, that it was a mechanical problem. So out of nine cases, we restored six CRT's to satisfactory condition, and detected one receiver where the fault wasn't with the CRT (it was HV trouble).

The instrument was especially easy to use. The test steps are made in logical order, the number of settings is minimal, and test results are garnered most efficiently. We especially liked the automatic tracking feature, which didn't require any calibration. The wide choice of rejuvenate/restore operations, running from ultra-safe to risk, was most welcome too.

About the only negative comments we could find to make about the CR31 is that it's not tiny and lightweight, and it costs a lot of bucks. But its size and weight can be handled without trouble and is well worth carrying along because, unlike other instruments, it can generate income that you would otherwise never earn. Even testing a CRT and showing a customer the results on the big meter is an important plus in your favor. Insofar as cost is concerned, you get what you pay for. And the CR31 has it all.

With over 10 percent of all TV problems reported to be due to the big tube, having an accurate CRT tester and restorer is an important asset to a TV service technician. Though it might initially seem as if the technician will lose money by restoring a defective CRT to good operating condition, it can actually make money for the servicer. Most TV men offer to refund part or the whole of a CRT restoration bill when called to eventually replace it with a new CRT. Thus, there's assurance that the business will eventually come to the servicer in the end, not to mention other service calls for the satisfied customer and new ones for neighbors. It's clear then, that if you're going to stay in the TV business, it pays to own a CRT tester and restorer.

One has to be sure to forewarn a customer that there is a risk involved before undertaking CRT restoration. Just as with a medical operation, there's always a chance that something will go wrong. But without undertaking such correction, a new CRT would be needed. Happily, the CR31 offers many "safe" restoration tests, with only one holding the high risk of final ruin. However, the customer has nothing to lose at this point anyway.

CIRCLE NO. 83 ON FREE INFORMATION CARD

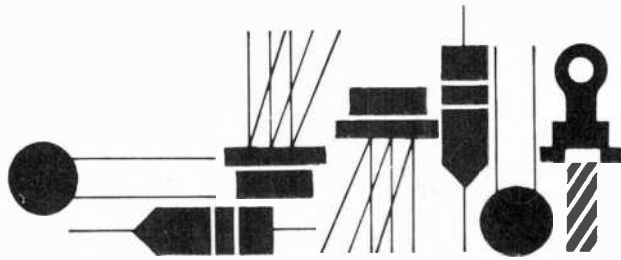

Solid State

By Lou Garner

PROPHECIES FOR NEXT YEAR

IF YOU'RE a newcomer to these pages, let me explain that I like to play an annual guessing game with the electronics industry, predicting what new semiconductor products will be introduced during the coming year, price trends, and technical innovations. While, over the years, my record has been pretty good, the game is doubly difficult during periods of recession or inflation, because manufacturers may delay the introduction of new products, waiting for more favorable markets; and what, normally, would be price cuts may become a matter of simply holding to current prices.

Having made my excuses, let's see how well I did with the predictions made in last January's column. As many of you may recall, I predicted:

- *A price breakthrough on solid-state imaging devices, and the possible introduction of a low-priced solid-state video camera.* On target! The construction of such a camera from an inexpensive kit was described in this magazine in the February, 1975 issue ("Build CYCLOPS," by Terry Walker, Harry Garland and Roger Melen).
- *The development of personal health monitors for patients subject to sudden attacks or seizures.* Score a partial. While I envisioned a device about the size of a hearing aid, the LEAA (Law Enforcement Assistance Administration) placed a contract for the development of such a device about mid-1975. The LEAA contract calls for a device about the size of a wrist watch that provides a readout of pulse rate, body temperature and blood pressure. It is intended to inform law enforcement officers of possible physical problems that might interfere with the performance of their duties during periods of stress. Since the instrument is being developed under government contract, it may be some time before comparable commercial instruments are available.
- *Digital electronic watches in the range of \$50 to \$60.* Another bull's-eye! Not only are a variety of watches available in this price range, but, by watching for sales or going to a discount house, you might be able to pick up a nice digital electronic watch for less than forty dollars.
- *A digital MPG (miles-per-gallon) meter for automotive applications.* Zero on this one! Despite the continuing energy shortage and the ever-increasing cost of gasoline, no manufacturer has introduced such a product as of the present writing. One firm (SpaceKom, Inc., Box 10, Goleta, CA 93017) has been offering an analog solid-state MPG meter for some time. While standard vacuum gauges can be used, under some conditions, to estimate gas mileage, a true digital MPG meter for the average motorist awaits future development "back at the drawing board."
- *A low-cost electronic calculator designed specifically for the children's market.* Right on! Announced mid-1975 and designed to appeal to children as well as adults with a sense of humor, *Mickey Math*TM features a colorful picture of cartoon favorite Mickey Mouse[®] arrayed in a sorcerer's costume. Furnished with an illustrated instruction booklet written for the younger set, the instrument is a full four-function, algebraic logic calculator with a floating decimal and six-digit readout. The instrument is offered mail-order by the JS & A National Sales Group (4200 Dundee Road, Northbrook, IL 60062).
- *An increasing variety of multipurpose consumer and office electronic products.* Another winner! Space limitations prohibit a listing of all the new products introduced during the year, but among the more interesting were Garrett's "Incredible Time Machine." Designed for desk use, it combines in one instrument a signal alarm; digital calendar with memory (for special days), full-function calculator, digital stopwatch/timer and a digital electronic clock. The "Time Machine" was merchandised by The Gallery (a division of the Amsterdam Co., Amsterdam, NY 12010).
- *The development of low-cost portable electronic games, based on calculator technology.* Reluctantly, a miss. In my opinion, calculator devices could be used in the creation of a variety of both children and adult games which combine skill with chance (or luck, if you prefer). Apparently, the industry doesn't agree because, unless I've missed an announcement, no such games have been offered to the general public.
- *The development of a high-output or high-intensity LED.* On target again! Several semiconductor manufacturers have introduced high-output LEDs. Data Display Products (5428 W. 104th St., Los Angeles, CA 90045), for example, offers a number of LED's with a brightness comparable to that of incandescent lamps (typically, 50 mcd for red, 35 mcd for amber, and 16 mcd for green). Some of the units have built-in resistors and are based so that they can be used as direct replacements for corresponding incandescent pilot bulbs.
- *The development, although not necessarily the commercial production, of solid-state energy control centers for homes and offices.* Score another bulls-eye! Actually, sophisticated solid-state energy control systems have been available for large scale applications for several years, as mentioned succinctly by reader Charles R. Morford (of Honeywell, Inc.) in last May's *Letters* section. Mr. Morford, in fact, chided me slightly for my prediction. While efficient, however, such systems are expensive and

THE COMPLETE DVM



\$348

FOR FASTER, MORE RELIABLE MEASUREMENTS

A NEW STANDARD IS BORN

High accuracy you can trust . . .
Versatile measuring capabilities . . .
An efficient, easy to operate meter . . .
All at an affordable price . . .
That's the DVM38 . . . The complete DVM that sets new performance standards in 4 key areas.

A NEW ACCURACY STANDARD

The 3½ digit, .1% accuracy is backed by a 15 meg Ω input impedance, compared to 10 meg Ω input of conventional DVM's, which guarantees up to 50% greater accuracy with 1/3 less circuit loading on every measurement for high accuracy you can trust.

A STANDARD IN CAPABILITIES

The DVM38 is more accurate in MDRE circuits with these versatile ranges: 100 μ V to 2000V DC, 1KV AC; .01 Ω to 20 meg Ω ; 0.1 μ A to 2A . . . Plus

HI and LO ohms and a 50KVDC range with accessory Hv probe.

A NEW STANDARD IN SPEED AND EASE OF OPERATION

Large pushbuttons and callouts — no need to hunt and peck. Large .4" L.E.D.'s with direct readout, down to V and mV indicators. SINGLE STEP AUTO-RANGING for maximum resolution and efficiency. 2KV DC protection minimizes downtime.

THE AFFORDABLE STANDARD

There are few .1% DVM's less expensive — there are none as complete in this price range, plus backed by a LIFETIME guarantee against factory workmanship errors.

THE DVM38 A NEW STANDARD IN DVM'S FOR SPEED, VERSATILITY AND ACCURACY.

DVM38 BACKED BY SENCORE'S 100% MADE RIGHT LIFETIME GUARANTEE

SENCORE 3200 Sencore Drive, Sioux Falls, S.D. 57107
Phone 1-605-339-0100 TWX. 910-660 0300
CIRCLE NO. 50 ON FREE INFORMATION CARD

their use is limited, for practical purposes, to large commercial operations. What I had in mind was an effective control center for the average home or small office as a substitute for, say, a conventional bi-metallic electro-mechanical thermostat. Happily, a major semiconductor manufacturer has developed just such an instrument. Although not yet in commercial production, the unit utilizes a solid-state temperature sensing IC, an SCR, a triac, and several diodes, and is intended for use as a direct replacement for conventional thermostatic controls.

Things to Come. Having missed a couple of my predictions for 1975, I suspect that either my crystal ball has a hairline crack or that there is a defective PROF (programmable read only future) IC in the support circuitry. Despite my qualms, here goes for 1976:

- *The introduction of additional special-purpose calculators utilizing nonvolatile memories* (similar to the one used in the Mostek CheckMaster™). Perhaps it might be a calorie counter for weight-watchers, a perpetual inventory unit for stores and manufacturers, or a mileage/trip expense calculator for travelers and business men.

- *Digital electronic watches retailing for less than \$25.00*—despite continuing protestations from industry officials that the "electronic watch market will not follow the path of the calculator market." Where there's a market, there's a way, and Timex, among others, has demonstrated that there is a market for inexpensive watches.

- *More so than in previous years, 1976 should be the year of the programmable calculator, with an expansion in the variety of types offered, a general drop in prices, and the*

possible use of nonvolatile memories to retain programs. Today's programmable pocket calculators fall into two categories: those with volatile program memories and those which use accessory devices, such as magnetic cards, to store entered programs. I feel there is a need for a programmable calculator with an integral nonvolatile memory. I mean one which will retain an entered program until deliberately erased or modified, even if the unit is switched "off," and which does not rely on external accessories.

- *The introduction of pocket calculators featuring internal access connectors or jacks.* Considering the overall capabilities of pocket calculators, the addition of I/O (input/output) connectors would greatly increase their versatility. Such jacks would permit their use as counters, for example, or permit data to be recorded on accessory equipment. In addition, an output jack would permit a pocket calculator to be used as a portable control unit for various types of electronic instruments or as an input device for computers and microprocessors.

- *The development of higher density memory chips.* Considerable work is already in progress in this area, with several firms reporting positive results. Utilizing a combination of ion implantation and electron-beam lithography techniques, IBM's Research Division, for example, has already achieved a ten-fold increase in the packing density of LSI memory chips on an experimental basis. The IBM process permits the fabrication of memory chips with a storage density of five million bits per square inch.

- *The use of microprocessor IC's in automotive applications, at least on an experimental basis.* With its powerful computational and control capabilities, the microprocessor is a "natural" for monitoring such things as spark intensity, air/fuel ratio, engine speed, oil pressure, oil, coolant, atmospheric and engine temperatures, atmospheric pressure, relative humidity, exhaust characteristics, and engine loading, making automatic adjustments to achieve optimum overall performance. Such units also could serve to monitor critical areas and to alert the driver to possible danger or the impending need for repairs.

- *A substantial drop in the prices of microprocessor and memory IC's.* This will occur despite a continuing inflationary trend. As the costs of microprocessors and memory chips drop, these devices will become increasingly popular for experimenter and hobbyist projects. There should be a corresponding drop in the prices of minicomputers, whether factory-assembled or in kit form.

- *The introduction of a moderately priced thermoelectric module for the experimenter and hobbyist market.* The response to our discussion of TE modules in last February's column was so great that we feel sure that some progressive manufacturer will recognize the market possibilities of a moderately priced device. Chances are the device, when offered, will carry rather broad "specs," as did the early experimenter's transistors.

Readers' Circuits. If reader response is any criteria, LED flasher circuits continue to be very popular with experimenters and hobbyists. Among recent contributions is the dual flasher circuit in Fig. 1. Submitted by Ferdi Baler (1551 A. Day Ave., San Mateo CA 94403), the circuit features a type 74123 TTL dual monostable multivibrator, IC1, and is designed for operation on a standard 5-volt dc source.

Happy Bicentennial '76

for far-out
IC checking...
try these high-performance
Super-Grip™
IC Test Clips

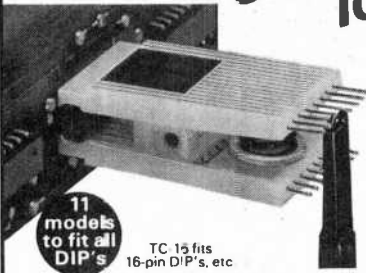

11 models to fit all DIP's
TC 15 fits 16-pin DIP's, etc.

for fast, non-shorting access to all leads on dual-in-line IC packages

No more shorting across DIP leads... just quickly clip on an IC TEST CLIP to bring DIP leads out for safe attachment of scope probes and other leads. Ideal for signal input, tracing, troubleshooting, etc. Patented precision, "contact comb" design guarantees no shorting between DIP leads. Probes can hang "no-hands" free on Test Clip terminals in card racks (unique — see photo). Engineered Mechanical clamping plus gold-plated phosphor bronze terminals provide superior electrical contact. Also unequaled as a DIP removal tool.

Model	Row-To-Row Dim.	Part Number	Price
TC-8	.3 IN.	923695	\$7.35
TC-14	.3 IN.	923698	4.50
TC-16	.3 IN.	923700	4.75
TC-16 LSI	.5/.6 IN.	923702	8.95
TC-18	.3 IN.	923703	10.00
TC-20	.3 IN.	923704	11.55
TC-22	.4 IN.	923705	11.55
TC-24	.5/.6 IN.	923714	13.85
TC-28	.5/.6 IN.	923718	15.25
TC-36	.5/.6 IN.	923720	19.95
TC-40	.5/.6 IN.	923722	21.00

All products guaranteed to meet or exceed published specifications.

Particular?
try this high-performance
circuit-builder's
Super-strip™



840 solderless plug-in tie-points

holds up to 9 14-pin DIP's

fastest, most reliable method known...to build, test and modify experimental circuits

8-bus distribution system plus universal .1" by .1" matrix of solderless, plug-in tie points all in one integral device.

Accepts all DIP's and discretes with leads up to .032" dia.

Interconnect with any solid wire up to No. 20 A.W.G.

ORDER BY PART NUMBER

923252 (nickel-silver terminals)..... \$17.00
923748 (gold-plated terminals)..... \$18.90

High-performance A.P. Super-Strip component matrices consist of 128 terminals of 5 tie points each. The 8 buses of 5 connected 5-tie-point terminals are for voltage, ground, reset and clock lines, shift command, etc. New, non-shorting, instant-mount backing and quick-removal screws are supplied... use several Super-Strips to create large-scale breadboards on panels up to 1/8" thick.



SEND ORDERS TO:
A.P. PRODUCTS INCORPORATED
Box 110-H • Painesville, OH 44077 • 216/354-2101

DEALER INQUIRIES INVITED

A.P. PRODUCTS INC. Box 110-H, Painesville, OH 44077		QTY	PART NO.	\$ EACH	\$ TOTAL
BankAmericard & Master Charge cards honored.					
ACCOUNT NUMBER		Merchandise Total			
NO. ABOVE NAME (MC)		Sales Tax (OH & CA)			
SIGNATURE		Shipping (see below)			
PRINT NAME		TOTAL ENCLOSED			
ADDRESS		SHIPPING/HANDLING Up to \$10.00 . . . \$1.00 \$10.01 to 25.00 . . . 1.50 25.01 to 50.00 . . . 2.00 50.01 to 100.00 . . . 2.50 100.01 to 200.00 . . . 3.00			
CITY STATE ZIP		ORDERS SUBJECT TO ACCEPTANCE AT FACTORY Company P.O.'s F.O.B. Painesville			

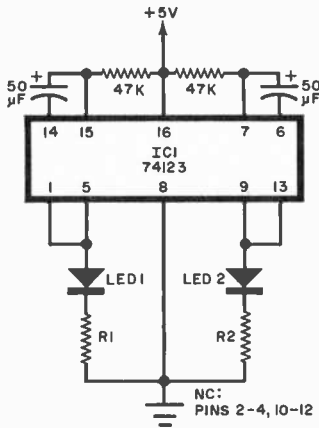

Fig. 1. Dual LED flasher circuit. Several of these can be cascaded for sequential flashing.

The circuit's flashing rate is determined by the two RC time constants, and different capacitor values may be used, if desired, to adjust the rate to meet individual requirements. The resistors are 1/4- or 1/2-watt types, the capacitors 5-to-10 volt electrolytics. Select current-limiting resistors R1 and R2 (generally 100 to 400 ohms) to produce equal brightness in both LED's.

According to Ferdi, his design differs from previously published circuits in that several of the flashers may be cascaded for special effects. Simply open the connection between pins 1 and 5 and, instead, connect pin 5 of the first IC to pin 1 of the next, continuing to the last IC and finally completing the loop by connecting pin 5 of the last IC back to pin 1 of the first. With this arrangement, the various LED's will flash *in sequence*, with on-times proportional to the R-C time constants in each stage. Cascaded multi-stage flashers may be used in direction indicators, advertising displays, and in similar applications.

One of our overseas readers, Yves Soussi (15 parc de Bearn, 92210, St. Cloud, France), contributed the touch-switch circuit in Fig. 2. It is designed to switch a standard ac load, such as a lamp, fan motor, or display actuator, on or off each time a pair of conductive terminals is touched lightly. The circuit is of particular interest because it utilizes an IC in conjunction with a variety of discrete semiconductor devices—a transistor, triac, and diode.

In operation, IC1, a dual "D" type flip-flop, provides two functions. Half of the IC serves as a monostable circuit, actuated by impulses received from the touchplate, while the other half acts as a divide-by-two counter. The counter

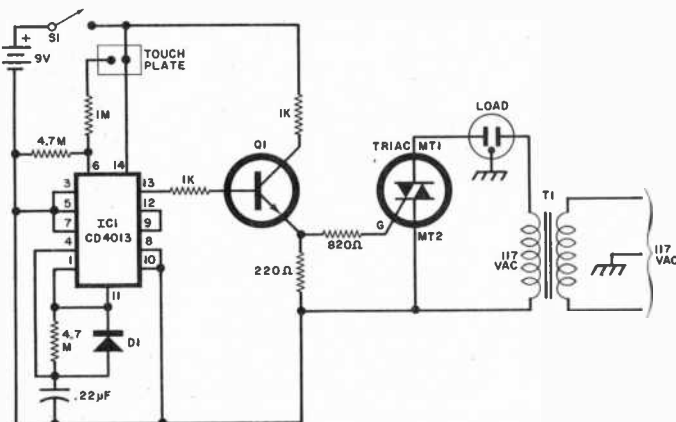

Fig. 2. Touch-switch circuit uses an integrated circuit in conjunction with discrete devices.

Systems Research, Inc.



Systems Research, Inc. presents — A Complete Microcomputer for only *\$575. The SRI-500

Includes TTY and RS-232 Interfaces. Connects to any 20MA loop teletype. Enclosed in a compact, desk top unit, it contains 1K (word) RAM**, expandable Prom, power supply and extra main board connectors to accept many options. The SRI-500 series is designed around the new Mostek F-8, an 8 bit processor with a designers development program residing in the program storage unit, making programming an easy task even for the inexperienced user.

* Special introductory offer

** Additional Ram available

Available Options

SRI-510 Keyboard (provides full keyboard control) **\$125**

SRI-520 Video Interface (RF or Video) **\$175**

SRI-530 Cassette Interface **\$ 75**

Complete Blackjack game program to demonstrate or exercise the SRI-500 (Specify paper tape or Cassette) free with order of SRI-500 (limited offer)

All items completely assembled and tested — allow 60-90 days delivery time. All items shipped postpaid.

Send Cash or check for:

_____ ea. SRI-500 \$ _____ ea. SRI-510 \$ _____
 _____ ea. SRI-520 \$ _____ ea. SRI-530 \$ _____

Mastercharge # _____ Interbank # _____
 BankAmericard # _____ Exp. Date _____
 Signature _____

Systems Research, Inc.
 P.O. Box 151280
 Salt Lake City, Utah 84115
 (801) 942-1093

CIRCLE NO. 57 ON FREE INFORMATION CARD



Now... \$50 VOM features for only \$19.95*

We'll stack up our new, economical WV-547A against any other general purpose VOM selling for up to \$50. Here's why:

- Large, no-stick, taut-band, diode-protected meter.
- Accuracy $\pm 3\%$ DC, $\pm 4\%$ AC with 20,000 Ohms/Volt DC sensitivity.
- 5 functions, 19 ranges, with 1% precision resistors on all ranges.
- Rugged, high-impact plastic case.
- Includes test leads. Carrying case also available.

See the WV-547A for yourself at any one of the more than 1,000 RCA Distributors worldwide. Or contact: RCA Distributor and Special Products Division, Bldg. 206-2, Cherry Hill Offices, Camden, N.J. 08101 (Phone 609 779-5715)

*Suggested Price

RCA Electronic Instruments

CIRCLE NO. 46 ON FREE INFORMATION CARD

circuit furnishes base current to Q1 which, in turn, supplies a gate signal to the triac, switching ac power through the load. Basic circuit power is furnished by a 9-volt transistor battery, with load power supplied by an ac line.

Yves has specified standard, easily available components in his design. The IC is a COS/MOS type CD40-13 (RCA), Q1 a 2N2222 general-purpose npn transistor, D1 a 1N647 or 1N914 diode, and the triac an SC 142 (GE). In practice, almost any sensitive gate triac can be used with the control circuit, provided its current rating is adequate for the external load. Actually, S1 may be omitted, if desired, for the control circuit's current drain is quite low. The touchplate is a hand-assembled unit consisting of a small piece of insulating material, such as perf board, and a pair of small conductors, such as metal thumb tacks, copper strips, machine screws, or nail heads.

The circuit's layout and lead dress should not be overly critical but, of course, good wiring practice should be observed. The standard precautions applying to MOS type devices should be followed when wiring the IC in place to avoid damage. For safety's sake, the isolation transformer must be used between the circuit's ac terminals and the power line.

Device/Product News. If you're working with equipment using nickel-cadmium batteries, you'll find it worthwhile to investigate the ICM7201 low-battery-voltage indicator. Manufactured by Intersil, Inc. (10900 N. Tantau Ave., Cupertino, CA 95014), the device is a monolithic IC comprising four npn transistors and seven internal resistors. Assembled in a 4-lead TO-72 case, the ICM7201 is designed to switch an external LED on whenever its source voltage drops below 2.9 volts, the recommended warning level for a rechargeable 3-cell nickel-cadmium battery, thus alerting the user that a recharge is needed.

RCA's Solid State Division (Box 3200, Somerville, NJ 08876) has announced the commercial availability of a new microprocessor family featuring CMOS technology. Included in the family are the CDP1801 CMOS 8-bit microprocessor, a "Microkit" hardware support kit, microprocessor manuals, and software development packages. The CDP1801's low power requirements (60 mW typically at 2 MHz) and broad supply-voltage tolerance (3 to 15 volts dc, unregulated) makes it particularly appropriate for automotive and portable equipment applications. The full-voltage version is available at \$56.00 each in unit quantities, while a special 5-volt version, type CDP1801C, is offered at \$40 each in small quantities (1 to 99).

If you are considering assembling your own calculator, keep in mind the DS8864 display driver introduced recently by the National Semiconductor Corp. (2900 Semiconductor Drive, Santa Clara, CA 95051). A LED-to-MOS interface device that includes a battery-condition sensing circuit, the DS8864 requires only 900 to 1200 μ A drive current, yet contains nine independent digit drivers designed to sink up to 50 mA from a common-cathode LED display operating in a multiplexed mode. The unit's built-in battery-condition sensing circuit turns on the decimal point of the left-most digit when the battery voltage drops below 6.5 volts. The DS8864 is supplied in a 22-pin Epoxy-B DIP. The only other components needed for a complete calculator are a 22-position keyboard, a spst switch, a 9-volt battery, a MM5738 calculator IC, and an NSN-98A 9-digit LED display unit. ◆

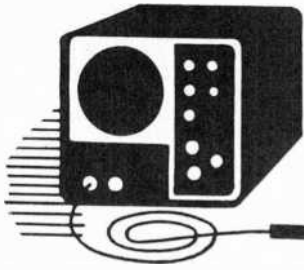

Test Equipment Scene

By Leslie Solomon

MAKING GOOD USE OF NOISE

IF YOU ask a typical electronic hobbyist or service technician to list the electronic problems that give him the most difficulty, there is a good chance that circuit noise will be somewhere near the top. Most of us consider noise the bane of our existence. We can determine that it exists in a circuit; but the problem is to find a cause and a remedy.

In discussing noise, the first thing to do is define what we're talking about. There are a number of sources of this troublemaker, among them is *thermal agitation*, a result of the random motion of molecules. This motion occurs in all matter that is at a temperature above absolute zero. Such noise is independent of frequency and is proportional to the absolute ($^{\circ}\text{K}$) temperature. (Remember those cryogenic devices used in deep space antennas?) The noise is also proportional to the resistive component of the impedance across which the thermal agitation is produced and the bandwidth (the wider you open the window, the more dirt comes in).

A second type of noise is *shot noise*, which is a result of uneven cathode emission in vacuum tubes, or *recombination noise* in many types of semiconductors.

The list of noise sources goes on and on, but the result is always unwanted noise. To keep the noise down, many circuit designers use "low-noise" resistors in the front end of the circuit. (Keep in mind that everything that shows up in the first stage is amplified in later stages—internal noise as well as the desired signal.) A similar design device is to use FET's (which have no real recombination noise) in the front end instead of bipolar transistors.

Using Noise in Testing. There is, actually, a bright side to the noise problem, despite what you might think about the unwanted intruder. Are you

aware that noise makes a dandy tool in testing? A circuit that deliberately generates noise is shown below. It generates a controllable (by the potentiometer) amount of noise (the same as the hiss you hear when a receiver is not tuned to a station) just about evenly distributed across the r-f spectrum.

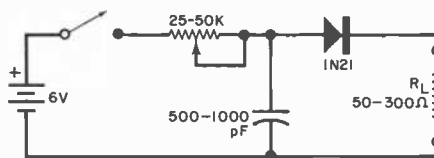

Essentially the circuit is a forward-biased diode whose fluctuating current is generated across a load resistor. The value of the load resistor is the same as the input impedance of the receiver or other device being tested. To use the circuit to determine the noise level of a receiver (for example), start by connecting an audio-frequency voltmeter, which has a decibel scale, to the receiver's audio output terminals.

Connect the noise generator, with the power off, to the receiver antenna terminals making sure that the load resistor you choose is the same as the receiver input impedance. Turn the receiver on with the agc off. Then set the r-f and audio gain controls to obtain a clearly identifiable dB indication on the meter. (Be sure you are not tuned to a station.) This will be the reference noise level. Turn on the noise generator and adjust its potentiometer to get a just-perceptible increase in the hiss level. Note the ratio of the two meter indications.

This approach, though not allowing the measurement of the actual noise level due to the diode being used, will allow you to compare the noise levels of two receivers. It will also allow you to "fine tune" the receiver's front-end circuits. Then, if necessary, you can

replace noisy resistors or transistors to get the best noise level (the largest number of dB on the output voltmeter when the noise generator is on) out of the receiver.

Pruning an Antenna. R-f noise can also be used to prune an antenna for maximum efficiency. In this case, a noise bridge is used and the procedure will be of interest to CB'ers who want to get the most out of their limited transmitter power. Many people have worked on their antenna with an SWR bridge to get conditions as good as possible, but they still can't get a 1:1 ratio.

There are several commercial noise bridges available, usually consisting of a wide-band r-f noise generator to drive a bridge. The bridge then compares an unknown impedance (in this case the antenna) against a calibrated potentiometer. The receiver is then used as a tunable null indicator to determine when the antenna is really matched to the desired frequency.

With the noise bridge driving the antenna, all you do is tune the receiver for the deepest null and read the antenna impedance off the calibrated potentiometer dial. Now you can determine whether the antenna is cut for the desired frequency and what the impedance really is. Armed with this information, you can then hack and chop until your antenna is on the button and doing a good job. In this way, whip antennas can be matched to mobile rigs to improve transmission range.

A noise bridge can also be used to check noise levels in audio equipment and see if resistor and/or transistor replacements would improve audio quality. ♦

COMING UP IN THE FEBRUARY

Popular Electronics*

BUILD THE TV DAZZLER

PHOTOPHONE LIGHT COMMUNICATOR

THE 1976 COLOR TV RECEIVERS

HIGH-POWER MOBILE STEREO AMPLIFIER

TEMPERATURE METER FOR \$15

PRODUCT TEST REPORTS:

Dual Stereo Cassette Deck

Jensen OPC-21 Speaker System

Browning Golden Eagle Base Station

Triplet Model 60 VOM

The better the training the better you'll

Send for
FREE
illustrated
career
guide

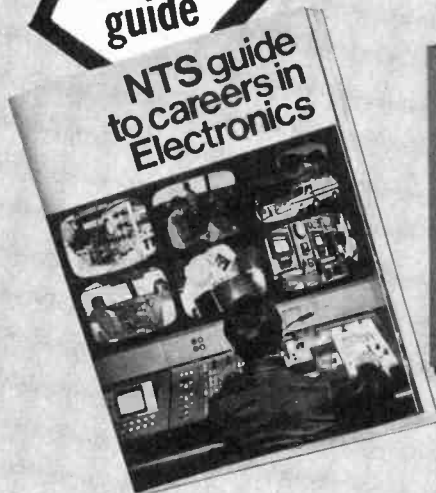

COMPU-TRAINER
IN-CIRCUIT TRANSISTOR TESTER
TROUBLESHOOTER
VOM

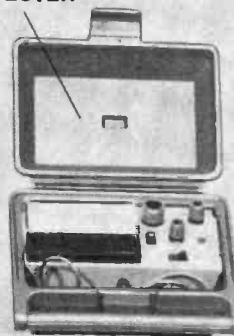
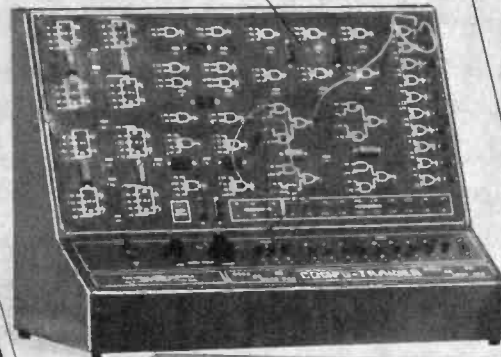

SOLID-STATE
OSCILLOSCOPE

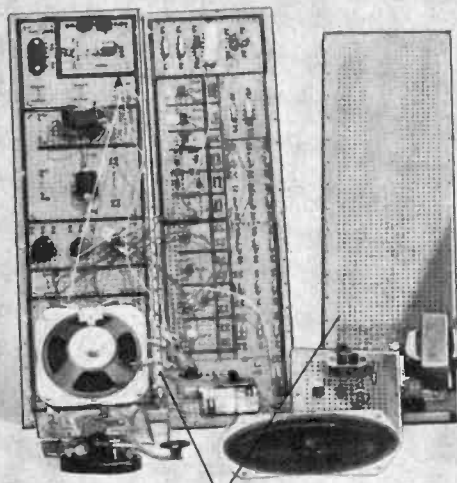

ELECTRO-LAB



(Simulated TV Reception)

As an NTS student you'll acquire the know-how that comes with first-hand training on NTS professional equipment. **Equipment you'll build and keep.** Our courses include equipment like the **NTS/Heath Digital GR-2000 Solid State color TV** with first-ever features like silent varactor diode tuning; digital channel selection, (with optional digital clock), and big 315 sq. in. ultra-rectangular screen.

Also pictured above are other units — 5" solid state oscilloscope, vector monitor scope, solid-state stereo AM-FM receiver with twin speakers, digital multimeter, and more. It's the kind of better equipment that gets you better equipped for the electronics industry.

This electronic gear is not only designed for training; it's field-type — like you'll meet on the job, or when you're making service calls. And with NTS easy-to-read, profusely illustrated lessons you learn the theory behind these tools of the trade.

Choose from 12 NTS courses covering a wide range of fields in electronics, each complete with equipment, lessons, and manuals to make your training more practical and interesting.

Compare our training; compare our lower tuition. We employ no salesmen, pay no commissions. You receive all home-study information by mail only. All Kits, lessons, and experiments are described in full color. Most liberal refund policy and cancella-

POPULAR ELECTRONICS

and the equipment be equipped.

COMPARE OUR
KITS AND LESSONS.
COMPARE OUR
TUITION.



tion privileges spelled out. Make your own comparisons, your own decision. Mail card today, or clip coupon if card is missing.

NO OBLIGATION. NO SALESMAN WILL CALL

APPROVED FOR VETERAN TRAINING

Get facts on new 2-year extension

NATIONAL TECHNICAL SCHOOLS

TECHNICAL-TRADE TRAINING SINCE 1905
Resident and Home-Study Schools
4000 So. Figueroa St., Los Angeles, Calif. 90037

JANUARY 1976

NATIONAL TECHNICAL SCHOOLS Dept. 205-016
4000 South Figueroa St., Los Angeles, Calif. 90037
Please send FREE Color Catalog and Sample Lesson.
NO OBLIGATION. NO SALESMAN WILL CALL.

Color TV Servicing
 B & W TV and Radio Servicing
 Electronic Communications
 FCC License Course

Electronics Technology
 Computer Electronics
 Basic Electronics
 Audio Electronics Servicing

NAME _____ AGE _____

ADDRESS _____ APT # _____

CITY _____ STATE _____

Please fill in Zip Code for fast service _____

Check if interested in G.I. Bill information.
 Check if interested ONLY in classroom training in Los Angeles.

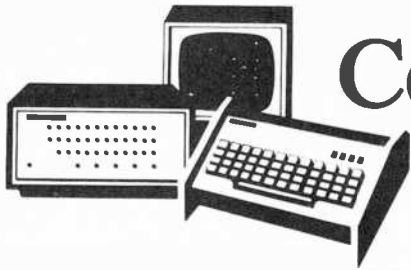

Computer Bits

By Jerry Ogdin

INTERRUPTS AND REAL-TIME

HOBBYIST applications of computers fall into two general categories: intellectual pursuits and practical uses. In intellectual pursuits, simplicity is generally the keyword and all the unessential details are stripped away to reveal the underlying simplicity. In practical (real) applications, however, we can't afford that luxury, and it is in these useful areas that the realities of "real time" operation strike home.

In any computer, the instructions are sequentially executed until the specific goal is accomplished, and all this happens without regard to the onward march of time. However, once you are forced to write a program that must finish within some limited amount of time, you are in the "real time" domain. A computer program to read thermostats once every fifteen minutes is not difficult at all. But a program that is required to shut off a valve when water reaches a certain level must be very short, unless you want to risk a flood.

In real-time programming, it is generally not too difficult to write a program that can perform the required work in the allotted time and produce the requisite output signals. What is difficult is sensing the external conditions so that the program can be activated. Ideally, the real-time program

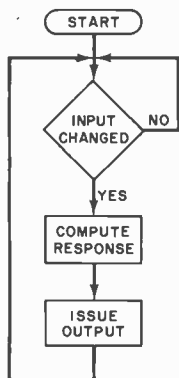

Fig. 1. Real-time looped program.

can be made to sit in a loop, sampling some input signal until the appropriate event occurs to activate the rest of the program and produce (hopefully) the appropriate response (see Fig. 1). However, this simple scheme limits the computer to handling one and only one chore at a time. The major virtue of a computer is its ability to do many things and do them all fast. It seems a shame, then, to limit the entire computer to continuously executing one sequence of input testing instructions.

If you want to install a computer in the basement to monitor and control many of the sub-systems in the house (heating and air conditioning plant, burglar and fire alarm system, night lights, and a small diskette file that holds your family financial records, for example), you will need to "service" a wide range of input signals. Any of these signals can arrive at any random time, and unless you can afford to ignore some of them it is important that you create a hardware and software combination that is foolproof. This can be done with the *interrupt* circuitry of the computer or microprocessor.

An interrupt is a special kind of external signal that notifies the computer to pause in its current task, do something else for a while and then resume the interrupted task. For example, if you are reading a newspaper and the phone rings (you answer, talk, hang-up and resume reading the newspaper), you've been interrupted. Similarly, when the computer is executing a program to compute and generate some output, we should design the hardware and software to be interruptable. Then, when some new external stimulus comes along (via the interrupt hardware), the currently executing program is suspended and the interrupt-servicing software is activated. When the interrupt service subroutine is finished, it will cause the

interrupted program to be re-activated.

An elegantly simple interrupt system is used in the popular Intel 8080A microprocessor. As shown in Fig. 2, the external signals are applied to an input called INT (interrupt). When the computer is about to fetch the next

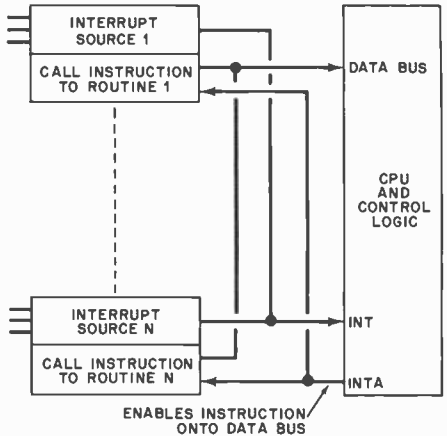

Fig. 2. Diagram shows how the interrupt works in the 8080A.

instruction in sequence, it senses the INT condition and does two things: it issues an interrupt acknowledgement signal (INTA) which allows the external hardware to supply an instruction to the CPU instead of the memory; and it inhibits the incrementing of the internal program location counter. Otherwise, instruction execution proceeds normally.

The interrupting equipment is then responsible for supplying the CPU with an instruction in the 8080's architecture. The interrupting hardware places an eight-bit instruction on the data bus whenever the interrupt acknowledgement signal (INTA) appears. This instruction is a subroutine call which causes the current program location counter contents to be pushed onto the stack in memory and is the first step in the process called "preserving the state of the program." After the subroutine call instruction preserves the interrupted program's next-instruction address, it places a specified address into the program counter; that is the address of the interrupt servicing program. At this point, the interrupt servicing program may not modify anything in the computer or memory without tampering with the execution of the interrupted program.

When any program is in execution, part of the status of that program is in the CPU's registers. The contents of the program location counter and the accumulator and the flag bits are all

important. If any of these is changed from outside the program, then the program's correct execution is nearly always prevented. The interrupt servicing program must preserve this part of the interrupted program's status, and in most computers there are instructions that allow the state to be preserved by copying the CPU registers into memory (Fig. 3). It is this particular operation that the 8008 is unable to perform without some extra outside hardware. The 8080, however, has a set of instructions for preserving the state of the computer; for example, the PUSH instructions save the relevant information in the stack. The 6800 microprocessor automatically preserves the entire state of the CPU on the stack whenever an interrupt is sensed.

```

; INTERRUPT SERVICE ROUTINE
; (INTERRUPT #7)
      ORG      56
; COMES HERE TO SERVICE INTERRUPT AUTOMATICALLY
      PUSH    PSW      ; PRESERVE STATE
      PUSH    B        ; OF INTERRUPTED
      PUSH    D        ; PROGRAM
      PUSH    H
; INTERRUPT SERVICE ACTIONS HERE
      LXI    H,COUNT
      INR   M
      POP   H        ; RESTORE STATE
      POP   D
      POP   B
      POP   PSW
      EI           ; RE-ENABLE INTERRUPTS
      RET          ; GO BACK

```

Fig. 3. Routine to allow state to be preserved by copying the CPU registers into the memory.

After the interrupted program's state has been preserved, the interrupt servicing program performs its work. Generally, the minimum amount of work is accomplished. The longer the interrupt servicing program takes, the more likelihood there is that some other interrupt will be lost. The absolute minimum is to record the fact of the interrupt somewhere in memory. Each time the interrupt occurs, a specific location in memory is incremented by one; and, whenever the interruptable software gets time, the counter is examined and the appropriate actions are taken. The interruptable software then decrements the counter by one to account for the action taken.

After the interrupt servicing routine is finished, the entire state of the computer is restored to the conditions that existed *prior* to the interrupt. The registers of the CPU are restored from

memory. The execution of a subroutine return instruction will cause the interrupted program's program location counter to be restored. The interrupted program then continues as if nothing had happened.

There is a potential problem that arises at the interface between the real-time interrupt servicing program and the non-real-time "background" software. There is a part of each routine, called the "critical section" where confusion may reign unless some care is taken. Imagine the worst possible case: the interruptable program is interrupted just at the instant that it is about to examine the interrupt counter. In most computers, the counter must be fetched up from memory into a CPU register to be examined and decremented and then re-

stored to memory. This sequence must not be interrupted. If it can be interrupted, you may not get the expected results. The best way to avoid this problem is to prevent the interrupts from being serviced while the interrupt counter is being examined or modified (Fig. 4). There are instructions in all computers that can be used to disable and then re-enable interrupts.

The interrupt then, is basically a hardware trick to allow us the illusion of having two or more different cooperating computers sharing a common memory. It is important not to let the interrupt service routines do too much as they may be difficult to debug if they are complex, and the effects of the bugs may be obscure and seemingly unrelated. If the interrupt service routines are simple, they will be easy to "prove" correct without

QUICK.... what number is this?



If you have to read your microcomputer like this--bit by bit, from rows of lights--the computer's making *you* do *its* work. And if you have to use rows of toggle switches to program it, you might wonder why they call the computer a labor-saving device!

Contrast the layout of a typical pocket calculator. A key for each number and function; six easy-to-read digits. Why not design microcomputers like that?

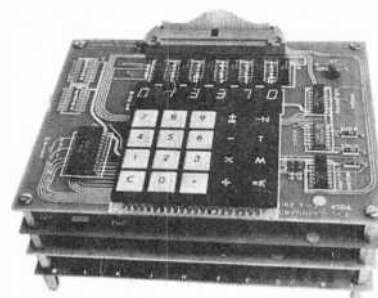

Here they are! The *modular micros* from Martin Research. The keyboard programs the computer, and the bright, fully-decoded digits display data and memory addresses. A Monitor program in a PROM makes program entry easy. And, even the smallest system comes with enough RAM memory to get started!

Both the *MIKE 2* system, with the popular 8008 processor, and the 8080-based *MIKE 3* rely on the *same* universal bus structure. This means that accessories--like our 450 ns 4K RAM--are compatible with these and other 8-bit CPUs. And, systems start at under \$300! For details, write for your...

FREE CATALOG!



**MIKE 2
MANUAL...**
This looseleaf book includes full information on the *MIKE 2* system, with schematics.

Price for orders received by November 15, 1975... **\$19**
Includes a certificate worth \$10 towards a modular micro system, good 90 days. (Offer valid, USA only.) After 11/15: \$25.



Martin Research / 3336 Commercial Ave.
Northbrook, IL 60062 / (312) 498-5060

TV DAZZLER MEMORY

Our 4KRA-4 Static Memory Modules are being used by both the hardware and software designers of the TV DAZZLER™ Color Graphics device. This 4096 word LOW POWER Static RAM Memory is plug-in compatible with the Altair 8800, and is the most reliable Read/Write Memory on the market today. Don't be misled by "undirected" statements, the 4KRA-4 uses less POWER than any 2K word Static Memory using 2102 or 8101 memory IC's and under worst case conditions only slightly more than dynamic memories. The 4KRA-4 can even store data reliably when powered by just two standard "D" cells!

NEW LOW PRICE! — \$139.00 MASS STORAGE

We've got the least expensive efficient method for storing and retrieving DAZZLER programs and pictures. Our CDS VIII Cassette Data Systems uses standard cassettes to give you fast access to up to 600,000 data characters or program instructions. That's enough storage for a lot of DAZZLER patterns! The CDS VIII System includes one or two high speed multiple motor cassette transports, transport controller, and interface to the 8800 computer. This complete Mass Storage System is packaged in an attractive, rugged enclosure.

We are working on a comprehensive Cassette Operating System program we call PTCOS. PTCOS lets you create program files and handle large blocks of data when running BASIC or Assembly Language programs. With PTCOS the computer thinks the CDS VIII is a floppy disk!

DAZZLER CONSOLE

To control the DAZZLER effectively, some kind of control console device is needed other than the 8800 front panel switches. You could use a teletype, but TTY's are expensive, noisy, and waste paper. Why not use an inexpensive black and white TV monitor and our plug-in compatible Video Display Module? The VDM-1 will take data from any of your input devices, whether TTY keyboard, tape or disk. It provides all the necessary circuitry to generate sixteen lines of 64 characters each with both upper and lower case letters. The display format is much easier to read than any ordinary TV Typewriter, and the VDM-1 displays twice as much data per line!

Our display module provides real power to write, format, and edit any type of program. Driving software is included FREE!

For more details on these and other 8800 plug-in compatible modules, write to:

Processor Technology
2465 Fourth Street
Berkeley, Ca. 94710

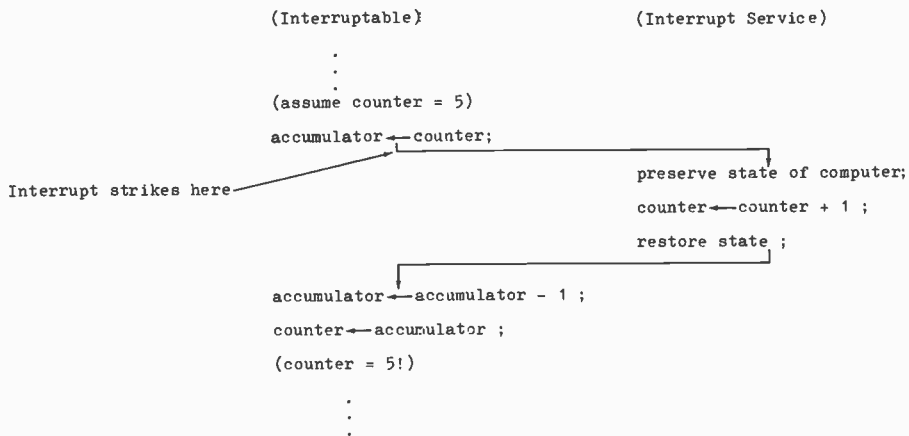

Fig. 4. Instructions can be used to disable and then re-enable interrupts.

much ado. Interrupts, like any other riches, can be overindulged; so resist the impulse.

We Get Letters. Since we introduced the HIT (Hobbyist Interchange Tape) system in our September 1975 column, we have received a considerable amount of mail concerning it. There are a number of such cassette systems, each manufacturer using his own scheme. At a November meeting in Kansas City, Mo., an effort was made to establish a standard format. Looks like a 1200/2400-Hz system will be adopted. We'll keep you posted on the future developments.

The HIT format was not suggested as a computer industry standard, but as a simple, low-cost, easy-to-implement system for hobbyists so that they could exchange data and programs. In fact, one supplier of OEM kits (Cramer Electronics) has its software recorded in the HIT format, and a HIT interface is included in their kits.

News Items. AMD announced an OEM price reduction on its 8080A (to below \$30), and Intel followed suit. Then, Texas Instruments announced its 16-bit 9900. Not due until March, the 9900 operates at about the same speed as the 8080, but will probably cost about \$50. When price reductions start on the OEM level, they eventually sift down to the hobbyists.

Hobbyist Clubs. Information on computer hobbyist clubs continues to come in. In addition to the ones listed below (to which we will add from time to time), check out your local high schools and universities. Many of them have clubs which were formed by students, with outsiders generally welcome to join.

California

Homebrew Computer Club, 193 Thompson Sq., Mountain View, CA 94043.

Sacramento Minicomputer Users, Box 741, Citrus Heights, CA 95610.

San Diego Computing Society, c/o Gary Mitchell, Box 35, Chula Vista, CA 92012.

Southern California Computer Society, Box 987, S. Pasadena, CA 91030.

UCLA Computer Club, 3514 Boelter Hall, UCLA, Los Angeles, CA 90024.

29 Palms Area, Sgt. Wesley B. Isrigg, Box 3558, C&E Schools M.C.B., 29 Palms, CA 92278; or Sgt. Stanley E. Herr, 13-C Copper Dr. M.C.B., 29 Palms, CA 92278.

Colorado

The Digital Group, Box 6528, Denver, CO 80209

Illinois

Chicago Users Group, c/o Robert Swartz, 195 Ivy Lane, Highland Park, IL 60035.

Massachusetts

Boston Area, c/o John Vullo, 21 Sunset Ave., N. Reading, MA 01864.

Minnesota

Bit Users Assoc., Resource Access Center, c/o Richard B. Koplou 3010 4th Ave. So., Minneapolis, MN 55408.

Southeast Minn. Amateur Computer Club, 2122 NW 17 Ave., Rochester, MN 55901.

New Jersey

Amateur Computer Society of N.J., 72 S. Railroad Ave., Staten Island, NY 10305.

Ohio

"Universe Unlimited" Users Group, c/o John E. Kabat, 11918 Forrest Ave., Cleveland, OH 44120.

Oklahoma

Oklahoma City Club, 2412 SW 45th, Oklahoma City, OK 73119.

Pennsylvania

Pittsburgh Area Computer Club, c/o Fred Kitman, 400 Smithfield St., Pittsburgh, PA 15222

Texas

Texas Computer Club, c/o L. Walker, Rt. 1, Box 272, Aledo, TX 76008.

Canada

Canadian Computer Club, c/o G. Pearen, 861 11th St., Brandon, Manitoba, Canada R7A 4L1.



BY SHERMAN P. WANTZ

CB Scene

HOW TO USE CB RADIO "BUZZ" WORDS..

INTERSTATE truckers, abetted by a growing number of mobile and base station operators, meet each day, on Citizens Band (CB) channel ten. They use a colorful—often cryptic—language to communicate with one another.

The glossary below has been developed to help CB newcomers interpret the special terms used most frequently on the interstate highway channel and elsewhere in the CB Class D frequency spectrum. Save this list and add new terms and meanings

to it as they develop among the truckers.

Using CB jargon correctly is interpreted by some as a mark of sophistication. Anytime you cannot remember the "proper" term to use, however, plain old everyday English will do. Even on channel ten.

TERM	MEANING	TYPICAL USE	TERM	MEANING	TYPICAL USE
Back	Over	Back to you.	Come again	Repeat your last transmission	Come again?
Back door	Rear of vehicle	I'm watching your back door (protecting you from being overtaken un-awares by police).	Comeback	Return call	Thanks for the comeback.
Back down	Drive slower	Smokey's ahead. Better back it down.	Come on	Over, invitation to transmit	What's your twenty? Come on.
Back out	Stop transmitting	I'm going to back out of here.	County mounty	Sheriff's deputy	Two county mounties are parked under the bridge.
Barefoot	CB set output signal not additionally amplified.	I'm running this rig barefoot.	Covered up	Interferred with	You were covered up that time
Base station	CB set operated from a fixed location	I'm operating here from my base station.	Cut the coax	Turn off CB set	I'm going to cut the old coax now.
Beam	Type of directional antenna	I've got my beam on you now.	Bodacious	Shamelessly strong	You've got a real bodacious signal up here.
Big switch	Turn off CB set	I'm going to pull the big switch.	Ears	CB set	Got your ears on?
Big 10-4	Acknowledged with enthusiasm	That's a big 10-4.	Eighteen wheeler	Truck and trailer	How about that north-bound eighteen wheeler?
Bleeding	Interference from a nearby CB channel	A local (station) is bleeding all over you.	Eights (eighty-eights)	Goodbye (from amateur radio 88's meaning "love and kisses.")	Threes and eights to you.
Break	I'd like to interrupt	Break, break.	Eyeball	Face-to-face meeting	Can we get together for an eyeball?
Breaker	One who interrupts	Go ahead, breaker.	Feed bears	Pay a fine for speeding to highway patrol	I can't afford to feed any bears.
Catch	Talk to	We'll catch you later.	Final	Last transmission	I'll turn it over to you for your final.
Chicken coop	Weigh station for trucks	The chicken coop is closed.	Flip flop	Trucker's return trip	We'll catch you on the flip flop.
Clear	Out, final transmission	We're clear	Four wheeler	Automobile	You've got a southbound four wheeler.

TERM	MEANING	TYPICAL USE	TERM	MEANING	TYPICAL USE
Getting out	Being heard	Just wanted to see if I was getting out.	Over shoulder	Behind	If you're at the truck stop I'm over your shoulder.
Good buddy	Salutation used by truckers	What's the smokey situation, good buddy?	Peanut butter in ears	Not listening to CB set	Guess he's got peanut butter in his ears.
Gone	Final transmission, or going to switch to another channel?	We're gone.	Putting on	Strength of signal	What kind of a signal am I putting on you?
Green stamps	Money paid in fines for for traffic violations	I'll back her down. I don't have any more green stamps.	Radio check	Reception	Give me a radio check, please.
Hammer	Truck's accelerator	There aren't any smokies ahead so let the old hammer down.	Read	Hear	I read you loud and clear.
Handle	Operator's assumed name	The handle here is "Bikini Watcher."	Rig	CB set	What kind of a rig are you using?
High gear	Use of transmitter power amplifier	See if my signal changes when I shift into high gear.	Roger	I acknowledge	Roger on that.
Holler	Call	I gave you a holler, but you didn't come back.	Scatterstick	Vertical antenna with ground plane	I'm using a scatterstick at the moment.
Home twenty	At home	I'm at my home twenty right now.	Seventy-three	Best regards (amateur radio term)	Seventy-threes and hope to catch you later.
How about?	Calling	How about that "Bikini Watcher" one time?	Shout	Call	Thanks for the shout.
Landline	Telephone call	I'll give him a landline and pass the info.	Ski, short skip	Atmospheric conditions that permit contacts greater than line-of-sight distances.	Sorry. Those short skip stations have you covered up.
Lay an eye on	See	Can you lay an eye on me yet?	Smokey-the-Bear, smokies	Highway patrol troopers	A smokey is on the move, heading east.
Linear	Extra power amplifier used to increase CB transmitter output	Are you using a linear or are you running barefoot?	SWR	Standing wave ratio	This antenna gives me a two-to-one SWR.
Local yokel	City police officer	There's a local yokel northbound on the move.	Taking pictures	Radar operated speed indicator	The smokies are taking pictures.
Mail	Overheard conversation	I've been sitting here reading the mail	Ten-four?	Do you understand?	Is that a ten-four?
Mercy.	Aah. Pause. Speech habit have no particular meaning	Mercy, that's a big ten-four.	Ten roger	I acknowledge	That's a ten roger.
Mile markers	Small signs along interstate highways	The smokey is located at the 142 mile marker.	Tijuana taxi	Police car	I've got a Tijuana taxi in sight.
Mobile	CB set mounted in a vehicle	I'm talking from my mobile.	Thermos bottle	Tanker truck	I'm pushing the white thermos bottle.
Modulate	To talk with	I think I modulated with you last week.	Threes	Seventy-three, best regards	Threes to you.
Move	In motion	That smokey is on the move.	Throwing	Transmitting	What kind of a signal am I throwing at you?
Negative	No	That's a negative.	Trip	Strong signal	You're making a fine trip down here.
Negative contact	station being called failed to respond	Negative contact. I'm gone.	Twenty	Ten-twenty, location	What's your twenty?
Negative copy	Did not hear response by the station called	Negative copy. We're by.	Walked all over	Overpower by a stronger signal	Come again. Somebody just walked all over you.
Negatory	No, negative	Ne-ga-tory (said slowly for added emphasis).	Wallpaper	Postcard acknowledging a two way contact	Give me your twenty and I'll send you some wallpaper
One time	For a short contact	Calling that "Bikini Watcher" one time.	Wall-to-wall	Loud and clear	I'm hearing you wall-to-wall.
On the side	Standing by (listening) on the channel	We'll be on the side.	Wrapper	Paint job on car	That northbound smokey is in a plain white wrapper.
			XYL	Ex-young lady, wife	How's your XYL?
			YL	Young lady	I met your YL at the last eyeball.



Art's TV Shop

By Art Margolis

THE BEWILDERING BRIGHTNESS

JONATHAN, my next door neighbor, was waiting in my driveway as I pulled up in the service van after a busy day at the shop. I honked to my wife to start dinner. Lea looked out the window, saw Jonathan and nodded knowingly. I was going to have to help him out again before I ate.

Jonathan blurted as I stepped out of the truck, "Art, I want to show you something. It will only take a minute." I smiled, but my stomach was growling.

I followed him into his basement where he had set up his workbench. On the table was a new modular Zenith TV with the back off. Its shipping carton lay nearby. Jonathan is an accountant, but he enrolled in a home-study TV service course as a leisure pursuit.

He was supplementing the course with my advice, usually before dinner.

He said, excitedly, "The TV came from the school today. It's a honey!" I looked it over. It was the 19FC45 chassis. I had installed and worked on quite a few of them recently.

His voice saddened, "I began the checkout and I must be doing something wrong—it doesn't do what the book says it should."

"Let's take a fast look," I said, trying to console him. I plugged in the cheater cord. The sound came on, and the high-voltage circuits crackled to life. The raster's brightness gradually increased. I noticed there was a slight bloom to the picture so I adjusted the brightness control. There was definite

expansion at higher levels of brightness. At low levels, the raster lost its blooming quality and filled the screen properly. "Is that the trouble?" I asked. "The picture is blooming somewhat. It's supposed to stay the same size at all brightness levels.

He pulled out the instruction manual and examined it. "Yeah, you're right. That's the trouble. It's blooming, but that's not what I meant."

I looked at him quizzically. He went on, "I was doing Experiment 9. When I got to the BRIGHTNESS LIMITER adjustment, my results didn't agree with the manual."

"Run through it again," I said.

He nodded and began the numbered sequence. First he pulled the cheater out. Then he disconnected the i-f cable from the i-f strip, and attached his voltmeter across a 3-watt resistor near the flyback. He plugged in the cheater again and the receiver came alive. "Watch this," he said turning the BRIGHTNESS LIMITER control. The meter needle held still. "The voltage is supposed to vary," he moaned, "and be set at 1.7 volts."

My stomach was snarling for food, but I couldn't resist the puzzle. I took the instruction manual and opened to the foldout schematic (Fig. 1).

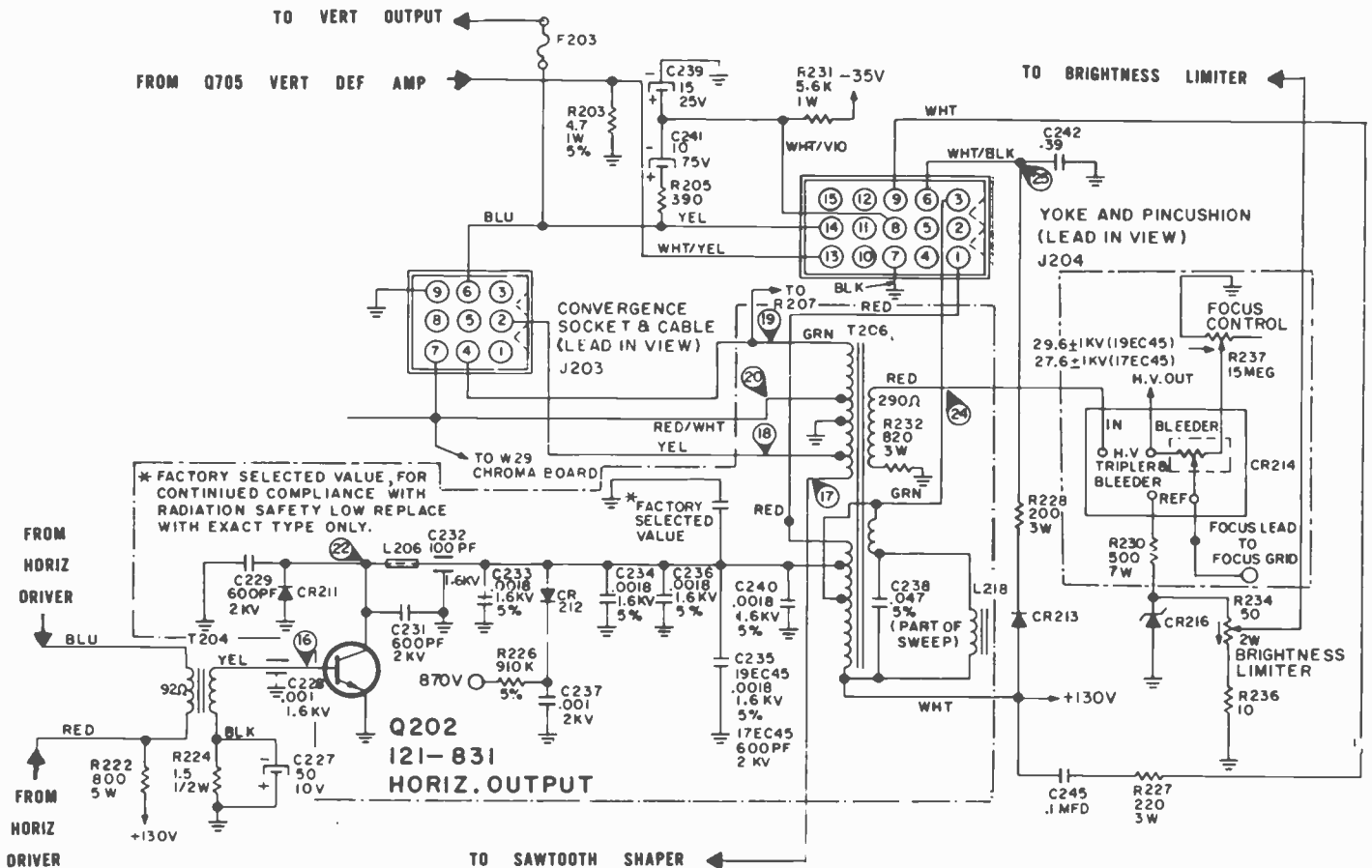

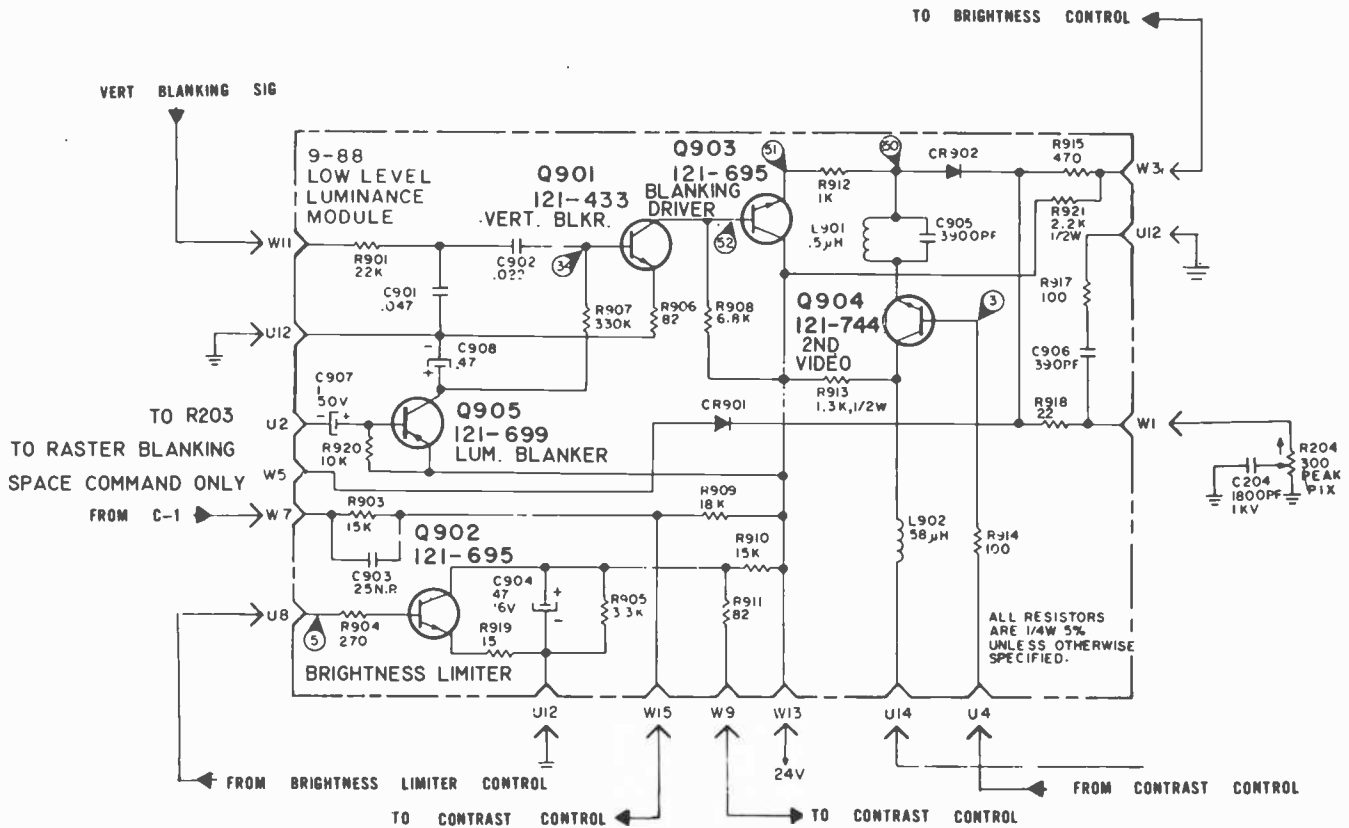

Fig. 2. Schematic of luminance module.

The 3-watt, 820-ohm resistor, R232, was connected from the bottom of the tertiary flyback winding to ground. The desired voltage drop (1.7 V) occurs when the proper amount of current passes through the flyback winding. This monitors the amount of beam current. Too much current would cause the high voltage to drop, producing the "blooming" effect.

The BRIGHTNESS LIMITER control is connected to the voltage tripler with a zener diode through a 500-ohm, 7-watt resistor (R230). This trio picks off a positive pulse and transmits it through a 270-ohm resistor on the LUMINANCE MODULE (Fig. 2) to the base of the brightness limiter transistor.

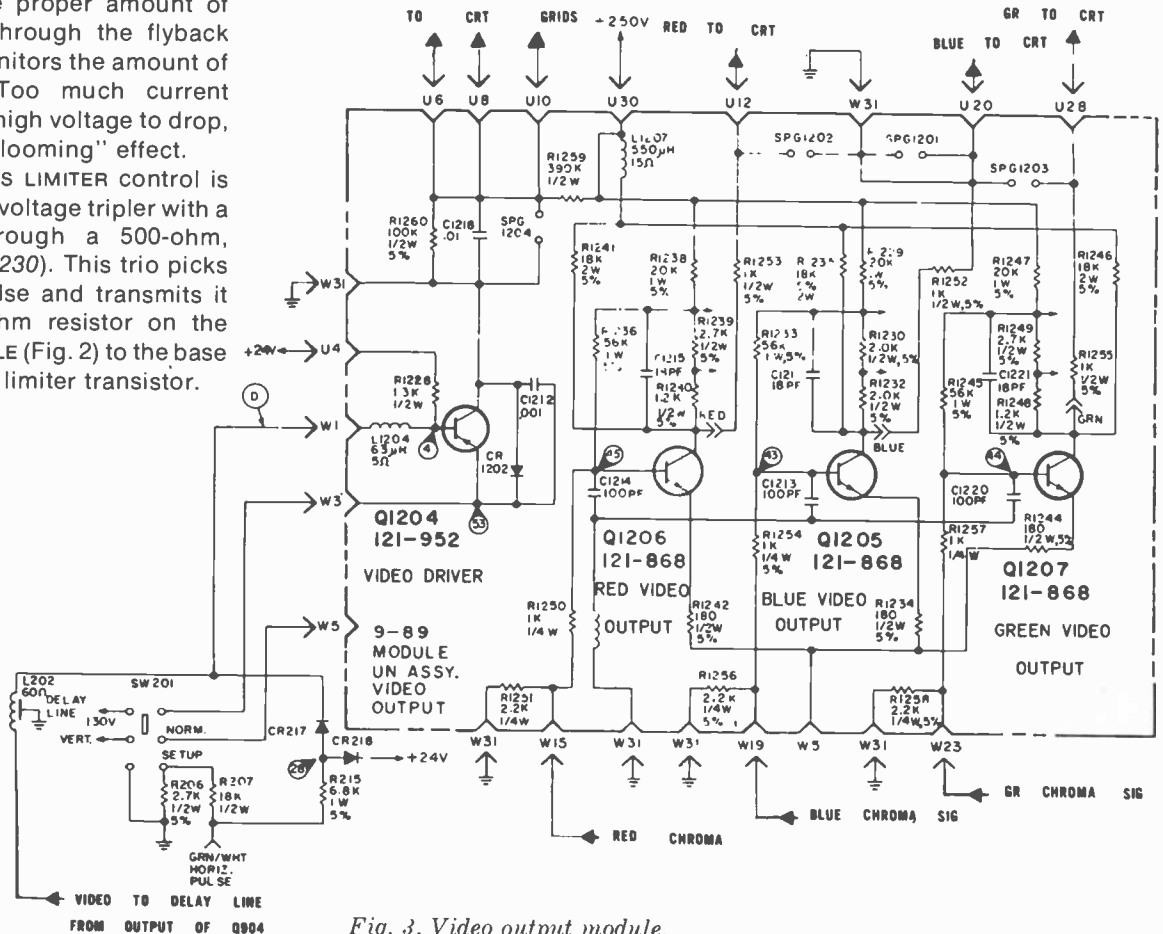

Fig. 3. Video output module.

This transistor amplifies and inverts the pulse which is then fed to C904, a 47- μ F filter capacitor. The latter changes the pulse to a smooth dc voltage, which is fed through the CONTRAST control to the base of Q904, the second video amplifier.

The luminance output of Q904 is coupled to the base of Q1204, the video driver (Fig. 3) through the DELAY LINE (L202). This transistor drives the emitters of the three chroma outputs (Q1205, Q1206, Q1207).

When the outputs of the three chroma stages are low, the CRT cathode voltage goes positive and cuts off the electron beams. If the color outputs are high, the beams flow toward the control grids. In this way, the level of conduction of transistor Q902 produces the brightness limiting.

I said to Jonathan, "Bring in my module caddy." He disappeared, and while he was gone, I turned on his scope and connected the probe to the base of Q902. The positive pulse from the BRIGHTNESS LIMITER control should have appeared, but there was nothing there. Jonathan returned.

I opened the caddy. As luck would have it, I didn't have the luminance module. Instead, I pulled out my bundle of jumper leads. I've found that working on these modular TV's demands a lot of them!

Removing the luminance module from its prongs, I attached a jumper from each connector on the module to the module's chassis-mounted connector pins. Then I made sure I connected the jumpers to the correct points.

Since I had no pulse on the Q902 input, I disconnected the jumper from the U8 connector pin. Then I turned on the receiver, and touched the probe to the BRIGHTNESS LIMITER control wiper. The pulse was there! The scope indicated that its amplitude was about 2 V (p-p) as it should be.

That meant the flyback circuit was good. As a double check, I reconnected the jumper. The pulse was gone again! Something in the luminance module was killing the pulse.

I explained to Jonathan what I had discovered, who was quickly jotting down notes. He had been watching the technique with the jumper cables carefully, and now knew that trick of the trade.

He examined the schematic carefully. I recognized something of my way of doing things as he intoned,

"The prime suspects are thus Q902, R904, C904, R919 and R905, in that order. Right?"

"Right," I answered. "I have to eat now, so check them out yourself." As I left with my module caddy, he had his nose buried in the circuit.

Dinner was going great when Jonathan burst in the back door. I quickly put a hunk of steak in my mouth thinking that I would have to run back to his basement—the week before he had fried a power transformer!

He held a little transistor in his palm. "Recognize Q902? It was shorted, base to collector. The control's working perfectly now. No more blooming!"

I nodded and cut another piece of steak. He looked annoyed, "Come on back and I'll show you."

Meanwhile Lea brought out a tax form she was having trouble with. "Jonathan," she started.

He held up his hand, "I'm sorry Lea, but it will have to wait till later tonight, after I eat." ♦

Memory Mania!

4K — \$215!

8K — \$402!

12K — \$562!

16K — \$696!

IT'S ALL DYNAMIC MEMORY!

The SPHERE Memory board. Is designed to hold 16K of Memory on one board. 2107A-8 memory chips are used on this board and are designed in 4K increments to allow choice of 4, 8, 12, or 16K. Each memory chip is socketed and is delivered to you completely assembled and tested. The PC memory board connects to the CPU board tri-state buffered bus cables. The memory locations are strap selectable as to order of addressing. Those memory mania purchasers of 12 or 16K who have, or who buy, any SPHERE Computer System will get absolutely free the SPHERE extended BASIC compiler. All documentations will be included.

THE MORE THE MEMORY...THE MERRIER.

AND...If you're not into computers yet...Look at this:

- \$622** CPU Board: 8 bit parallel microprocessor with 4K dynamic memory. 1K EPROM containing program development system or Basic language subset or your specific application software. Real-Time Clock, bus cable structure and 16 lines of digital I/O optional.
- \$207** CRT Board: generates 64 character ASCII character set which is displayed on 16 lines by 32 characters (5 x 7 matrix). Electronics will display on television set or video monitor.
- \$160** Keyboard: ASCII type alpha/numeric keyboard with numeric and cursor keypad.
- \$219** Communications Board: includes FSK Modem (110 to 600 baud) originate/answer with cassette or telephone interface includes serial I/O capabilities (110 to 9600 baud) it is EIA, TTL, TTY, current loop I/O and RS 232 compatible.
- \$160** PIM: Peripheral Interface module, 64 digital I/O board allowing complete interfacing with printer and Floppy Disks Systems.
- \$96** Power Supply: produces 5 volts at 5 amps, 12 volts at 3 amps, -5 volts at 400ma, -12 volts at 400ma.

Or...you can buy the combination of the above assembled in an attractive chassis with line printer and/or Floppy Disks starting at \$1400 for assembled systems, while kits start at \$860!

Check with us on our options too, from Light Pens, to Color and B/W graphics terminal, line printers, Disks etc.

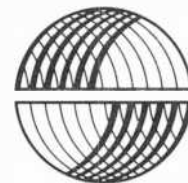

SPHERE
CORPORATION

791 South 500 West Dept. 128 (801) 292-8466
Bountiful, Utah 84010

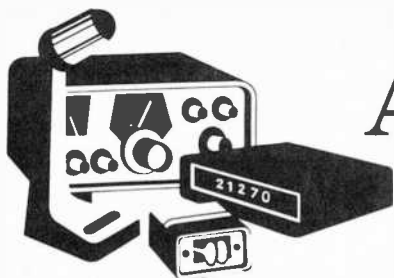

Amateur Radio

By Herbert S. Brier

SLOW-SCAN TELEVISION

THE DREAM of long-distance amateur video communication was made practical by Copthorne MacDonald's article "A New Narrow Image Transmission System" in *QST* (August and September 1958). "Cop" developed a system of transmitting TV signals requiring the same bandwidth as an ordinary SSB voice signal, opening up the possibility of DX TV work on the hf amateur bands. As a result, you can now tune around the bands and hear a number of raspy "slow-scan" (SSTV) signals, especially around 3.84, 7.22, and 14.23 MHz.

Slow Scan Vs Fast Scan. Predictably, the fundamental difference between conventional fast-scan and slow-scan TV lies in the rates at which their pictures are "taken" and "developed." A fast-scan camera splits the incident image into 525 narrow horizontal lines, scans them all in 1/30th of a second, and repeats the entire procedure 30 times a second. The position of the scan point is controlled by the horizontal and vertical sweep circuits within the camera. The varying amount of light reflected from the televised object causes the photosensor in the camera tube to generate a proportional voltage signal.

This signal modulates (usually AM) the carrier, and is recovered by the video detector in the TV receiver. It is then used to control the intensity of the electron beam striking the phosphors on the picture tube's face. At the same time, the position of the beam is controlled by the sweep circuits in the

receiver, which are locked in step with those in the camera by sync pulses.

Although the beam does not stay at any one part of the picture screen for more than a small fraction of a millisecond, the compound's lasting phosphorescence or "persistence," together with the response of the human eye, enables us to see an "even" picture.

Slow-scan cameras and picture tubes act in much the same way, but at a much more relaxed pace. In this scheme, an image is scanned from top to bottom in eight seconds! Also, it is broken down into only 120 lines, and the repetition rate is seven frames per minute.

As the bandwidth of an information channel is directly proportional to how many bits are handled in one time unit, SSTV signals take up a tiny slice of the spectrum when compared to fast-scan channels (6 MHz each). In fact, the "bit rate" (the rate at which units of information are sent) is so slow that it's practically impossible to send it by conventional AM. "Cop" elegantly solved the problem by frequency modulating an audio subcarrier, which in turn "amplitude modulates" the transmitter. As shown in Fig. 1, the standard subcarrier frequency is 1200 Hz. Black is at 1500 Hz, and 2300 Hz represents white. Sync pulses appear between 1200 and 1500 Hz (black), thus they do not appear in the received picture. Only 1100 Hz of bandwidth is required!

Due to their short "persistence," fast-scan cameras and picture tubes can not be used in SSTV work. The illuminated portions at the left of one line would fade before those on the right were "developed." Consequently, a longer lasting "glow" is needed, which is accomplished by a CRT with a P7 phosphor. When P7 is struck by an electron beam, it glows brightly. But as the beam moves on,

the original glow disappears and is replaced by a fainter afterglow that persists for many seconds. A discernible image will remain on the tube for about two minutes.

Equipment Requirements. To get started in SSTV, you'll first need a receiver capable of receiving SSB signals (usually no problem) and an SSTV monitor. This can be a commercial, ready-to-operate unit (there are several on the market), or a home-brewed unit. If you replace the P1- or P4-phosphor CRT in an oscilloscope, you'll have the nucleus of a monitor. A converter that processes the audio output of the receiver into a form usable with the scope can be fairly easily built.

Something new on the slow-scan scene are scan converters, which use A/D and D/A converters, digital memories and shift registers to generate a picture compatible with a standard home TV receiver. They are generally available with raw video and/or modulated (Ch. 2 or 3) r-f outputs. They also allow the use of fast-scan surplus closed-circuit cameras in your SSTV pursuits. Although the units are fairly expensive, they will be attractive to many newcomers to SSTV because the cost of a special slow-scan monitor is eliminated. Coupled with home TV receivers, these converters can produce higher-quality images than those on conventional slow-scan monitors. Further, they usually have "freeze" modes which will store and/or display a received picture as long as power is applied.

To transmit slow-scan images, you will need a video sensor, a modem, and an SSB transmitter. The sensor may either be a vidicon coupled with an electromechanical shutter device, or a flying spot scanner (the less expensive approach). The modem converts the video and sync information into audio tones which modulate the transmitter. If you're lucky enough to have a scan converter, a standard Vidicon or CCD camera can be used. For more information, consult the sources listed in the box.

What's happening on SSTV? Hundreds of U.S. and Canadian operators are working each other and the world regularly near 14.23 MHz. Don, W9NTP, recently returned from a long trip on which he carried SSTV gear. He worked many U.S. amateurs from Easter Island and other exotic points. Barry Goldwater, K7UGA, on his trip to Southeast Asia, plugged SSTV

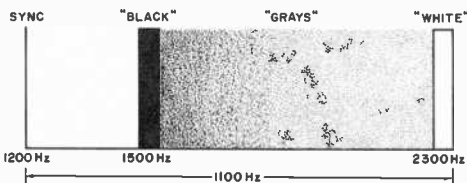

Fig. 1. Frequencies of audio tones determine shading on SSTV picture.

SSTV INFORMATION SOURCES:

"Slow-Scan Television Handbook," by Don Miller, W9NTP, and Ralph Taggart, W8DQT. \$3.00, 73 Inc., Peterborough, NH 03458.

"Specialized Communications Techniques for the Radio Amateur," \$3.00, ARRL, 225 Main St., Newington, CT 06111

Robot Research, Inc., 7591 Convoy Ct., San Diego, CA 92111.

Summer Electronics & Engineering Co., Box 572, Hendersonville, TN 37075.

Venus Scientific, Inc., 399 Smith St., Farmingdale, NY 11735

equipment into existing SSB rigs and was quite active for a while.

License Requirements. One potential roadblock to getting started in SSTV below 28.5 MHz is the necessity of having an Advanced or Extra Class license. This is one *more* reason to upgrade! Generals can use SSTV above 28.5 MHz, and Tech's can engage in this type of work on their phone frequencies above 50 MHz. There is quite a contingent of SSTV'ers on 114 and 220 MHz in the Los Angeles area.

Incidentally, because SSTV modulating signals are actually audio tones, pictures can be recorded on an ordinary tape or cassette recorder.

Novice Roundup. The 1976 ARRL "Novice Roundup" will occur be-

tween 0100 GMT, January 31, and 2359 GMT, February 8. Operating a maximum of 30 hours during this period, Novices work everyone, and other amateurs work only Novices. U.S. and Canadian stations exchange RST and their ARRL sections. Others substitute country for section. A complete two-way exchange earns one point. Total score equals the number of contact points (after duplicates are deleted!) plus the highest speed shown on the contestant's ARRL Code-Proficiency certificate multiplied by the number of sections and other countries worked. Complete rules and score sheets are available from ARRL, 225 Main St., Newington, CT 05111, on request accompanied by a stamped, self-addressed envelope.

Amateur License Courses. The Indianapolis American Red Cross Amateur Radio Club, 10th and Central Aves., Indianapolis, IN, will sponsor a General Class license course starting January 12, 1976. The course will be held every Monday between 7:30 and 10:00 p.m. Everyone 16 years or older or who holds a Novice license is eligible for the course. Instructor is John Jacobs, Jr., WB9KSZ, assisted by Robert Foot, K9KGJ. The LREC Amateur Radio Club, 2814 Empire Ave., Burbank, CA 91504, also starts its new General Class course, January 12, after the conclusion of its last Novice session. Bill Welsh, W6DDB, is the instructor. ◆

FREE EICO CATALOG

346 Ways To Save On Instruments, Burglar Alarms, Automotive & Hobby Electronics!

The more you know about electronics, the more you'll appreciate EICO. We have a wide range of products for you to choose from, each designed to provide you with the most pleasure and quality performance for your money. The fact that more than 3 million EICO products are in use attests to their quality and performance.

"Build-it-Yourself" and save up to 50% with our famous electronic kits.

For latest EICO Catalog on Test Instruments, Automotive and Hobby Electronics, Eicocraft Project kits, Burglar-Fire Alarm Systems and name of nearest EICO Distributor, check reader service card or send 50¢ for fast first class mail service.

**EICO—283 Malta Street,
Brooklyn, N.Y. 11207**

*Leadership in creative electronics
since 1945.*



Sun, Fun, Surf, & Circuits

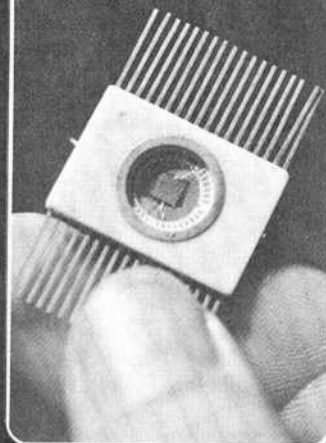

Imagine a curriculum in Electronics Technology that includes field trips to the Bahamas and the Florida Keys. Florida Institute of Technology offers you this and more. Our fully-accredited two year Associate of Science degree program in

Electronics Technology provides a unique balance between the academic and the practical.

This course offers specialization options in Marine, Communications, or Industrial technology. Our coeducational campus is set in 84 acres of tropical palms bordering the Indian River at Jensen Beach, Florida.

For further information return coupon to:

Florida Institute of Technology

720 S. Indian River Drive, Jensen Beach, Fla. 33457

Name _____

Street _____

City _____ Zip _____ Age _____

Veteran

PE1-76

The \$300 alternative.

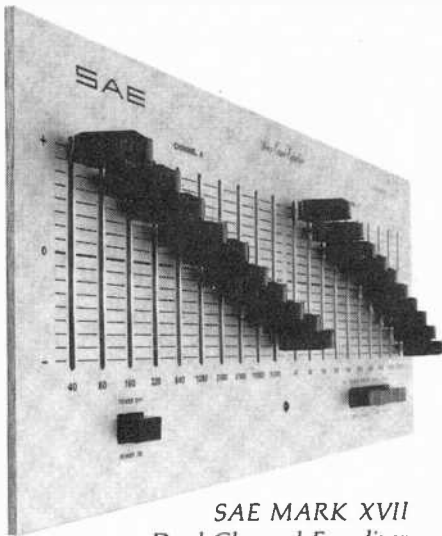

SAE MARK XVII
Dual-Channel Equalizer

Your tone controls are just not designed to compensate for

- Room acoustics
- Speaker placement
- Old or bad recordings

We built the Mark XVII Equalizer to solve these problems and more.

These are some of the ways:

- Individual Octave Control for each channel
- Long throw, oil-damped linear slide pots for greater accuracy
- Dual range operation (controls operate over either $\pm 8\text{dB}$ or $\pm 16\text{dB}$)

Plus

- Capable of driving any system
- Low distortion—less than 0.03% THD and IM
- Low noise—greater than 90dB
- 5-year parts and labor service contract
- SAE's reputation as the finest manufacturer in the audio field

You'd have to look a long time to find an EQ that delivers this much value. SAE innovation has done it.

Components for the connoisseur.



Scientific Audio Electronics, Inc. PE-1-76
P.O. Box 60271, Terminal Annex
Los Angeles, California 90060
Please send me the reasons (including available literature) why the SAE MARK XVII Dual-Channel Equalizer is the "\$300 Alternative."

NAME _____
ADDRESS _____
CITY _____ STATE _____ ZIP _____

CIRCLE NO. 48 ON FREE INFORMATION CARD

Hobby Scene



By John McVeigh

WINDSHIELD-WASHER ALARM

Q. Is there a circuit which will let me know when the windshield washer fluid in my car is running low?

—R. Claudet, Tannersville, NY

A. This circuit will do the job. Insert the two metal probes (pin plugs, stiff bare wire, etc.) into the washer fluid

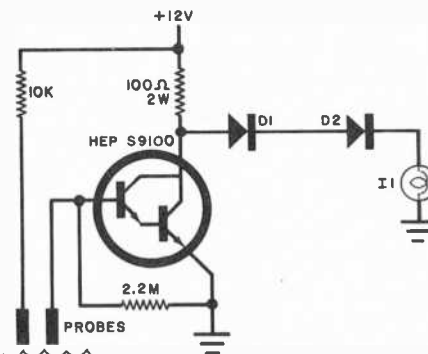

reservoir, leaving tips about 1 inch (2.5 cm) above the bottom. Install indicator *I1* (which can be a 53 pilot bulb, a Sonalert or a buzzer) at a convenient viewing angle. When the fluid level drops below the probe tips, the lamp will light. Diodes *D1* and *D2* can be common 1-A power supply rectifiers. The alarm will work with water and most detergent solutions.

DOUBLE-SIDED PC BOARD BLANKS

Q. I have been unable to find a source for double-sided pc board blanks. Any ideas?

—David Greenwood, Allison Park, PA

A. There are a number of sources which cater to the hobbyist. Two that we know of offhand are:

Techniques, Inc.
235 Jackson St.
Englewood, NJ 07631

GC Electronics (Calectro)
400 S. Wyman St.
Rockford, IL 61101
(or through local Calectro dealers).

This is by no means an exhaustive list. Check with electronics stores in your area, and scan the ads in Electronics Market Place each month in this magazine.

Planning to move?

Let us know 8 weeks in advance so that you won't miss a single issue of POPULAR ELECTRONICS.

Attach old label where indicated and print new address in space provided. Also include your mailing label whenever you write concerning your subscription. It helps us serve you promptly.

Write to: P.O. Box 2774, Boulder, CO 80302, giving the following information:

- Change address only.
- Extend subscription. Enter new subscription.
- 1 year \$6.98
- Payment enclosed (1 extra BONUS issue)
- Bill me later

← AFFIX LABEL →

If you have no label handy, print OLD address here.

name	please print	zip-code
address		
city		
state		

name	0180
address	
city	
state	
zip code	

Add'l postage per year: Add \$1 for Canada; \$2 for all other countries outside the U.S.

WHAT'S HAPPENING TONIGHT?



~~\$179.95~~ now \$132.50

The BEARCAT IV. The ultimate scanning monitor. Hear any eight channels of action, excitement and information from the nation's four public service frequency bands!

Please send me _____ Bearcat IVs @ \$132.50 ea.

Please send me _____ Crystal Certificates @ \$3.25 ea.

(Minimum order \$10.00.)
Send check or money order to:

BETA ELECTRONICS
P.O. BOX 5869
PITTSBURGH, PA 15209

Name _____
Address _____
City _____ State _____ Zip _____

POPULAR ELECTRONICS

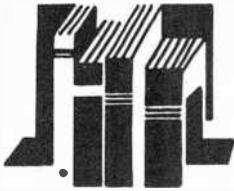

Electronics Library

BASICS OF ELECTRICITY AND ELECTRONICS

by Matthew Mandl

This revised work (formerly *Fundamentals of Electric and Electronic Circuits*) provides updated coverage of electronic theory, related equations, symbols, abbreviations, and associated data. Chapters are devoted to atoms and electrons; basic electrical units; series and parallel circuits; principles of magnetism; dc and ac measurements; RLC (simple and complex) circuits; resonance; transformers and coupling; polyphase ac and pulse-shaping circuits; and an introduction to tube and solid-state electronics. Many illustrations, examples, and problems are included.

Published by Prentice-Hall, Inc., Englewood Cliffs, NJ 07632. 388 pages. \$15.95 hard cover.

TELEVISION TROUBLESHOOTING

by Clyde N. Herrick

State-of-the-art television servicing is presented here for those with a basic knowledge of radio theory and basic servicing procedures. General principles of circuit function (and malfunction) are stressed throughout. In the area of chassis analysis, component identification, and circuit tracing, the illustrations supplementing the text facilitate an understanding of the subject matter. Specifics of circuit behavior, with examples from commercial products, illustrate the practical troubleshooting methods required. Test and measurement techniques are explained and illustrated for each subdivision of troubleshooting methodology.

Published by Reston Publishing Co., Box 547, Reston, VA 22090. 230 pages. \$14.95 hard cover.

NORTH AMERICAN RADIO-TV STATION GUIDE (TENTH EDITION)

by Vane Jones

Nearly 10,000 stations (all the active radio and TV broadcasters in the US, Canada, Mexico, and the West Indies, according to the publisher) are listed in this volume. Stations are listed in three ways—by geographical location, frequency (or channel), and call letters. Important statistics, such as power (day and night for AM stations), antenna heights (for FM stations) and time-sharing with other stations are given. Network affiliations are noted, as well as educational and FM stereo stations.

Published by Howard W. Sams & Co., 4300 W. 62nd St., Indianapolis, Ind. 46206. 192 pages. \$4.95 soft cover.

JANUARY 1976

INTRODUCING HALL EFFECT AUTOMOTIVE ELECTRONIC IGNITION

Transmits maximum available voltage no matter how weak the battery.

Every electronic ignition system today claims advantages over the traditional Kettering contact point set for firing spark plugs. The Voltronix System has been proven in over 750,000 road and test track miles. There is no mechanical or electrical wear; gasoline mileage is increased because the ignition system stays constantly in tune; spark plug life is extended up to 50,000 miles; the ignition system becomes virtually maintenance-free. Most electronic ignition systems are "rate-sensitive", that is, during starting, they must attain a high rate of RPM before sufficient voltage reaches the spark plugs. Therefore, a weak battery poses starting problems. Not so with the new Voltronix Hall Effect system,

the fifth and newest, generation in electronic ignition. A solid-state Hall Device, replacing the point set and condenser, fires at less than 1 RPM no matter how weak the battery. Only four major components make up the system, and the entire conversion can be made in less than 30 minutes: (1) Control Unit, (2) Fully terminated quick-connect Wire Harness, (3) Metal Signal Chopper, (4) Hall Device firing signal generator.

The signal generator mounts in place of the point set. It consists of a permanent magnet and the Hall Device. Each time a metal Signal Chopper blade passes the magnet, the Hall Device senses a change in the magnetic field, electronically triggering release of the spark.

Technical Specifications:

- 40° to + 300°F	Negative ground
0-100% humidity	Full reverse polarity protection
1 RPM to 7,000 + RPM	Permanent dwell setting
4.5 to 16 volts input	No tach adaptor required
27,000 volts output w/stock coil	Compatible with all test equipment

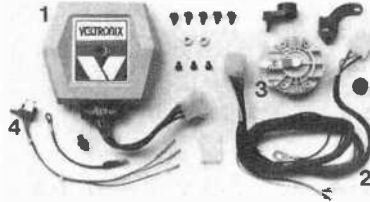

Voltronix Electronic Ignition conversion. For those knowledgeable in electronics who demand the finest. Fully guaranteed for 1 year. Fits most 1959-74 cars. Use your Master Charge, American Express, check or money order. Specify year, make and cubic inch displacement. **ONLY \$49.95**

VOLTRONIX, Box 116, Syracuse, New York 13205.

SHIP TO:

Name: _____
 Address: _____
 City: _____ State: _____ Zip: _____
 Year: _____ Make: _____ Cubic Inch Displacement: _____

Payment enclosed Check Money Order \$49.95 each (includes postage)
 N.Y. State Residents add Sales Tax
 Master Charge # _____ Expiration date: _____
 American Express # _____ Expiration date: _____

CIRCLE NO. 62 ON FREE INFORMATION CARD

NOW - ALL IN ONE

TACHOMETER / CALCULATOR / FREQUENCY COUNTER

- ★ RESOLUTION to 1 RPM
- ★ CALCULATOR + MEMORY
- ★ 1 - 120 KHz COUNTER (½ second gate time)
- ★ OPTICAL INPUT (Airlanes, boats)
- ★ ELECTRICAL INPUT (Automobiles, audio)

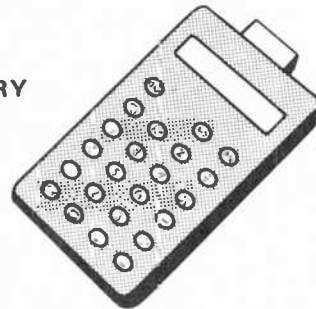

Model 26A

139⁹⁵

TACHOMETER: 60-7,200,000 RPM. Resolution to 1 RPM, .01%. Reads correct RPM for any number of pulses per revolution.

CALCULATOR: 5 functions + memory 8 digits

COUNTER: Sample time of less than ½ second to display 8 digits from 1 Hz to 120,000 Hz. Crystal controlled accuracy of .01%.

INPUT: Optical probe — Included
 Electrical probe— Optional

POWER: Internal battery pack or external AC charger/adaptor. Battery not included.

ACCESSORIES:

Electrical probe — \$20
 4' probe extension — \$ 8
 AC charger/adaptor— \$15

CALTACH PRODUCTS Div.
 American Video Corporation
 P.O.Box 3008
 Tucson, Az. 85702
 (602) 885-4261

Price includes postage and insurance. Include check or money order with your order.

We also accept BankAmericard or Master Charge.

Charge customers include your account number, expiration date, and sign your order.

Please allow 6-8 weeks for delivery.

CIRCLE NO. 7 ON FREE INFORMATION CARD

99

THE ALPHA PROFITMETER

AUTO ZERO/POLARITY 3½ DIGIT MULTIMETER KIT



ON THE SERVICE BENCH



IN THE FIELD

WITH BRIGHT RED LED DISPLAY

WHEREVER AND WHATEVER THE JOB, YOU'LL NEED ITS BATTERY OPERATED PORTABILITY AND ITS HIGH ACCURACY: .1% DCV & OHMS, 1% CURRENT AND ACV.

\$ **79.95** +2.95 P&H
Less test leads & batteries



ALPHA ELECTRONICS
DEPT 1 PO BOX 1005
MERRITT ISLAND, FLA. 32952
TO ORDER OR FOR INFORMATION
CALL TOLL FREE
800 - 327 - 2084

Operation Assist

If you need information on outdated or rare equipment—a schematic, parts list, etc.—another reader might be able to assist. Simply send a postcard to Operation Assist. POPULAR ELECTRONICS, 1 Park Ave., New York, NY 10016. For those who can help readers, please respond directly to them. They'll appreciate it. (Only those items regarding equipment not available from normal sources are published.)

Wurlitzer Model 1015 Juke Box, Serial 2344, made in Canada in 1930. Schematic diagram and/or operating manual. Bob Found, 12-12 9115-92 Avenue, Fort Saskatchewan, Alberta, Canada T8L 1A6.

E.H. Scott Model SLR-F 5-band receiver covering 80-550 kHz and 1.9-24.0 MHz. Serial 12238. Schematic and/or service manual. Raymond Scott, 422 Grafton Ave., San Francisco, CA 94112.

Operadio Model NB1325 Battle Announcing Equipment (1945). Schematics or any other information. Bob Macias, 4401 NE 15th Way, Ft. Lauderdale, FL 33334.

Wurlitzer Model 140B Electric Piano. Schematic. Richard Brush, 1965 E. 3375 St., Salt Lake City, UT 84106.

Stromberg-Carlson Model 1121, Series 12 receiver. Schematic and speaker coil impedances, and any other information. Edward Heimbach, RD 5, Box 169, Stroudsburg, PA 18360.

De Vry Tech. Inst. Scope/VTVM in same cabinet, model no. unknown. Need schematic, parts list, and power transformer. Alan Getz, 148 Camden Ave., S. Plainfield, NJ 07080.

De Vry Projector Model 439. Manual and parts. Fabian Bourge, Box 626, Vinton, LA 70668.

Lafayette Model HA-230 four-band receiver. Schematic and alignment information. Jim Wilkins, 6215 Lone Oak Dr., Bethesda, MD 20034.

Superior Instruments Model 450 Tube Tester. Schematic. S.W. Hawkinson, 6106 Lillywood Ln., Knoxville, TN 37921.

Weston Tubechecker Model 798 Type 5B. Schematic. Tracy LaVere, 13902 La Pat #16, Westminster, CA 92668.

Hammarlund HQ 145A receiver. Schematic. John Nelms, 521 Parkview, Richardson, TX 75080.

General Electric Model W300B portable intercom. Schematic. Gary Jackson, 1514 So. Ferdinand, Seattle, WA 98108.

Ameco Model SNLT noise limiter and squelch unit. Schematic. Charles Cerami, 66 Olympic Terrace, Irvington, NJ 07111.

Zenith Model 5808 cabinet "Long Distance Radio" Serial No. S576805. RCA Model K 80 cabinet radio. Schematics and any helpful information. Dave Faverty, 177 Haven Road, Elmhurst, IL 60126.

Sun Model SS-1 Auto Timing Unit. Service manual. Don Brown, 216 West Vally Parkway, Escondido, CA 92025.

Precise Development Corp. Model 300 Oscilloscope. Schematic, operations, and calibration data. Bert Goodrich, 886 Juniper Ave., Sherwood Park, Alberta, Canada T8A 2C7.

Chicago Tube and Set Tester Model 532 by Chicago Industrial Instruments Co. Instruction manual. Terrie Frane, Box 111, Owen, WI 54460.

Friden Flexwriter Model F10. Schematic and/or remote control jack connections. J. Marcomm, Box 82, Brice, OH 43109.

National Model NC 77X general coverage receiver with chassis marks 64 4838 and 64 0946. Schematic and/or service information. Richard H. James, Box 5289 T.E., Bradenton, FL 33507.

Montgomery Ward Airline receiver, TRF circuit, tubes: 3 No. 24A 1 No. 27A, 2 No. 45, 1 No. 80. Need schematic and model no. Charles D. Prater, Edna, KY 41419.

Collins Model 17L-8A aircraft transmitter, serial no. 2344. Maintenance and operations manual. David Moody, 4305 South St., Terre Haute, IN 47802.

AIWA tape recorder Model TP-730. Need motor or source for same. John Holvec, 301 W. Lead St., Bessemer, MI 49911.

SPECIAL OFFER: "PROFIT" AND SAVE \$40.00
NOW, BUY THE PROFITMETER AND GET OUR RALLY IV STOPWATCH KIT FOR \$29.95 OR OUR LED-1 OR DD12/24 (HR/MN/SEC/DATE) DIGITAL WRISTWATCH KIT FOR ONLY \$9.95 WITH THIS AD.

FREE catalog
over 2000
unique tools,
handy kits,
precision
instruments,
technical
supplies.

Our 23rd year of service to the World's finest craftsmen and technicians.

A carefully selected and tested assortment of unique, hard-to-find tools, clever gadgets, precision instruments, bargain kits. One-stop shopping for the technician, craftsman, hobbyist, lab specialist, production supervisor. Many tools and measuring instruments available nowhere else. One of the most unusual and complete tool catalogs anywhere. Get your copy of the NC FLASHER today.

National Camera
2000 West Union Ave., Dept. GGA
Englewood, Colorado 80110
(303) 789-1893

CIRCLE NO. 36 ON FREE INFORMATION CARD

A Major Advance...

- 500µs Restrike Rate
- High Energy >1000mJ
- Programmable Duration
- High Output Arc Current
- Fast Rise

- *INSURES PROPER COMBUSTION
- *EASIER STARTING
- *LONGER POINTS and PLUG LIFE
- *INCREASE MILEAGE up to 40%
- *EASY INSTALLATION (12v neg. grd.)

Labtronics' Multiple Restrike (M-R) Ignition produces a high energy repetitive spark on each power stroke to effectively ignite the air/fuel mixture. M-R statistically insures more complete combustion - resulting in greater energy and increased efficiency. Send for Labtronics' free literature on the M-R system. Better yet, experience M-R and enjoy the pleasure and the economy of a well-performing engine.

- Model VI \$79.95 • 1 Year Warranty •
- Model VI-B \$59.95
- Brochure 30 Day Money Back Guarantee
- P.P.D. in U.S.A.
- Send Check or Money Order to:

Labtronics, Incorporated
3635 Hillside, Ypsilanti, Michigan 48197

DEDICATED TO EFFICIENCY
CIRCLE NO. 30 ON FREE INFORMATION CARD

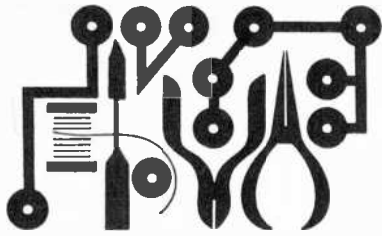

Experimenter's Corner

By Forrest M. Mims

USING AN OPTOISOLATOR

OPTOISOLATORS are ideal for solving many noise and high-voltage isolation problems in electronic circuits. Until fairly recently, their prices have been rather high for experimenter use. But now some real bargains are available from a number of electronic parts dealers, such as those who advertise in the back of this magazine.

An optoisolator is a relatively simple device, consisting of a light source and a light sensor housed in a light-tight package in such a manner that their active elements face each other. While the source is always electrically isolated from the sensor (in the low kilovolt range), the two are optically coupled in such a manner that a signal activating the source will trigger the sensor.

Most optoisolators use a gallium-arsenide (GaAs) infrared emitter for

the light source and a silicon detector. The latter can be a photodiode, light-activated SCR (LASCR), photosensitive FET, photo-Darlington, or, most commonly, a phototransistor. The housing for the two elements that make up the optoisolator is usually a semiconductor package, with the common IC DIP configuration predominating.

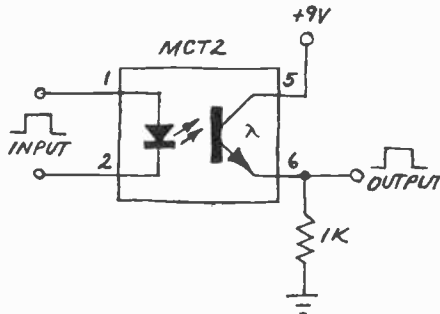

Fig. 1. An arrangement for coupling one signal to another with an optoisolator is shown at right above. The scope photo at right is typical of input and output pulses for the circuit.

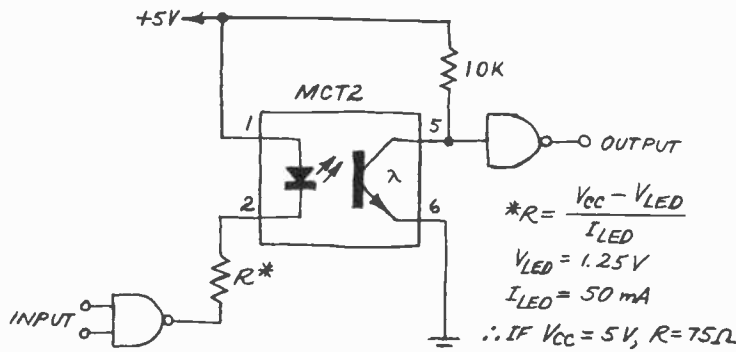
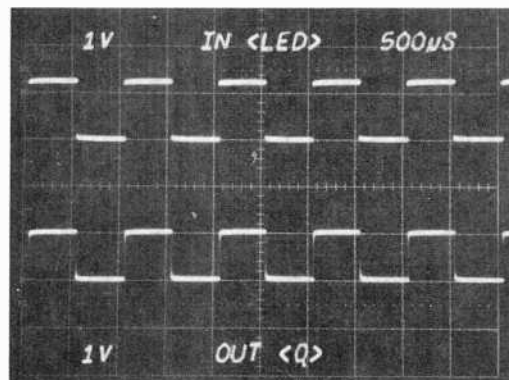

Fig. 2. One way of coupling circuits with an optoisolator.

TAKE YOUR CHOICE



Mini-Scan™
is the pocket
scanner that
works a week
on just 4
penlight cells.



A breakthrough we call "mini-miser circuitry" makes it possible ... and it's actually 2½ to 5 times more efficient than any other pocket scanner we tested!* Just 4 alkaline penlight cells power it for a full week, 8 hours a day, on a tough 50-50 duty cycle (50% full volume, 50% squelched). And its performance is bred from our experience in public safety two-way radio ... so it also gives you the crispest, clearest messages possible. Just \$119.95 with built-in ferrite antenna (batteries, crystals and optional flexible antenna extra.)

*Test results gladly supplied on request.



Johnson MINI-SCAN™

... the professional pocket scanner

E. F. JOHNSON CO., WASECA, MINNESOTA 56093
IN CANADA: A. C. SIMMONDS & SONS, LTD.

CIRCLE NO. 33 ON FREE INFORMATION CARD 101

Olson[®]

electronics wants

CB

DEALERS

DISTRIBUTORS

and Truck Stops

WE ADVERTISE AND CARRY FAMOUS BRANDS



Broyce
BREAKER

((P)) PACE

TURNER Olson

Regency

PEARCE-SIMPSON

ASTATIC

INCREASE YOUR SALES AND PROFITS! SEND FOR OUR CB CATALOG—IT'S YOURS FREE

Find out about the newest area of consumer electronics. Find out the qualifications for a CB Dealership. All products in this special catalog will be available at Dealer-Distributor prices.

FREE 7 Olson Catalogs

FREE Olson CB Catalog

NEXT 7 ISSUES SENT TO YOU FREE

WITH DEALERS PRICE LIST

Olson Electronics, 260 S. Forge St., Dept. HF, Akron, Ohio 44327

Please send me Olson catalog CB catalog Both

NAME _____

ADDRESS _____

CITY _____

STATE _____ ZIP _____

CIRCLE NO. 38 ON FREE INFORMATION CARD

Simple Couplers. A simple arrangement you can use to isolate an analog or pulsed signal to be coupled from one circuit to another is shown in Fig. 1. The circuit can use any photo-transistor optoisolator. (I used a Motorola MCT2, but any similar device can be substituted.) The photograph in Fig. 1 illustrates a pair of typical input and output pulses for the circuit. I calibrated the 4-volt, 1-kHz square-wave output from the scope to pulse the LED in the optoisolator and monitored both sides of the MCT2 to obtain this photo. Notice that the base of the transistor is not used. This is the case with most phototransistor optoisolator circuits, even though manufacturers usually make the base available for special applications such as external biasing.

There are dozens of ways to couple optoisolators to RTL and TTL circuits. A typical circuit for this is shown in Fig. 2. The various manufacturers who make optoisolators (Texas Instruments, Monsanto, Litronix, Fairchild, etc.) all include this and many other basic hookup schemes in their spec sheets, so there's no need to go into details here. Just remember to include a current-limiting resistor between the drive circuit and LED side of the optoisolator. If you omit this resistor, excessive current might be pumped through the LED, causing damage.

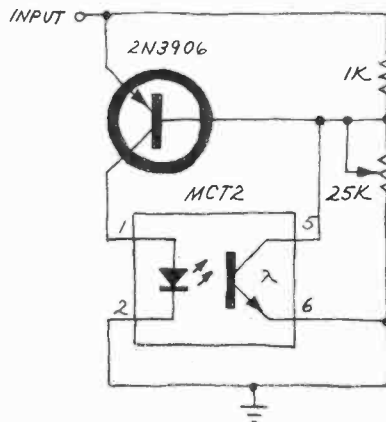

Fig. 3. This optoisolator circuit exhibits negative resistance.

Negative-Resistance Circuit. A circuit you won't find in anyone's spec sheet is the unusual optoisolator negative-resistance configuration shown in Fig. 3. This novel circuit was dreamed up by Japanese engineers Haruo Takahashi and Yasuo Kitahama and first published in the April 1974 *IEEE Journal of Solid State Circuits* ("An Optronic Negative Resistance

SAVE!

MONEY • TIME • FREIGHT

- ♪ QUALITY STEREO EQUIPMENT AT LOWEST PRICES.
- ♪ YOUR REQUEST FOR QUOTATION RETURNED SAME DAY.
- ♪ FACTORY SEALED CARTONS—GUARANTEED AND INSURED.
- ♪ SAVE ON NAME BRANDS LIKE:

A.D.C.	KLH
A.R.	SHURE
DYNACO	KOSS
SONY	FISHER

PIONEER
AND MORE THAN 50 OTHERS
BUY THE MODERN WAY
BY MAIL—FROM

illinois audio

Department 217S
12 East Delaware
Chicago, Illinois 60611
312-664-0020

CIRCLE NO. 26 ON FREE INFORMATION CARD

BE A LOCKSMITH



You'll EARN MORE, LIVE BETTER Than Ever Before in Your Life

"I have already master keyed my Elks Lodge and 38 apartments... so you see my locksmith course is practically paid for!"
Adelindo Orsi, Jr.
Azusa, Calif.

You'll enjoy your work as a Locksmith because it is more fascinating than a hobby—and highly paid besides! You'll go on enjoying the fascinating work, year after year, in good times or bad because you'll be the man in demand in an evergrowing field offering big pay jobs, big profits as your own boss. What more could you ask!

Train at Home—Earn Extra \$\$\$\$ Right Away! All this can be yours FAST regardless of age, education, minor physical handicaps. Job enjoyment and earnings begin AT ONCE as you quickly, easily learn to CASH IN on all kinds of locksmithing jobs. All keys, locks, parts, picks, special tools and equipment come with the course at no extra charge. Licensed experts guide you to success.

KEY MACHINE locks, picks, tools supplied with course.



Illustrated Book, Sample Lesson Pages FREE Locksmithing Institute graduates now earning, enjoying life more everywhere. You, can, too. Coupon brings exciting facts from the school licensed by N. J. State Department of Ed., Accredited Member, Natl. Home Study Council. Approved for Veterans Training.

LOCKSMITHING INSTITUTE
Div. Technical Home Study Schools
Dept. 1473-016 Little Falls, N. J. 07424

LOCKSMITHING INSTITUTE, Dept. 1473-016
Div. Technical Home Study Schools
Little Falls, New Jersey 07424 Est. 1948

Please send FREE illustrated Book—"Your Big Opportunities in Locksmithing," complete Equipment folder and sample lesson pages—FREE of all obligation—(no salesman will call).

Name _____ (Please Print)

Address _____

City/State/Zip _____

Check here if Eligible for Veteran Training

CIRCLE NO. 31 ON FREE INFORMATION CARD

POPULAR ELECTRONICS

Circuit"). Here's how it works. The transistor in the isolator is normally cut off, but an applied voltage causes a small current to flow through the outboard transistor and the LED. As the input voltage increases, the LED turns on and triggers the isolator's transistor into conduction. The circuit exhibits negative resistance because it begins to conduct only above a certain voltage threshold at the input.

Relaxation Oscillator. If you've ever built a neon-lamp flasher circuit, you already know that you can make a

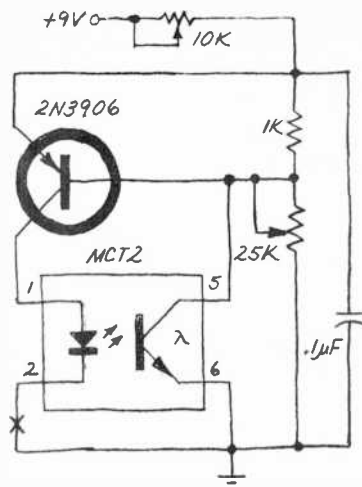

Fig. 4. Relaxation oscillator.

simple relaxation oscillator by connecting a resistor and capacitor to a negative-resistance component. The circuit in Fig. 4 shows how this is done with the optoelectronic negative-resistance circuit. Operation begins with the capacitor charging through the 10 k resistor until the negative-resistance circuit switches on. At this point, the capacitor discharges through the circuit and the system resets to the off state to repeat the cycle.

For best results, start with the component values specified in Fig. 4. After you get the circuit working, you can experiment with different capacitor values to change the oscillation range of the circuit. With the values shown, I measured a frequency range of about 3 to 8 kHz with the potentiometer adjusted for a resistance of about 5 k. Changing the capacitor's value to 1 µF caused the frequency range to drop to between 120 Hz and 1.8 kHz.

You can monitor the operation of this circuit with a scope connected across the LED and/or a 1 k resistor inserted between the emitter of the isolator's transistor and ground. The waveforms I obtained are shown in Fig. 5. Alternatively, you can connect a

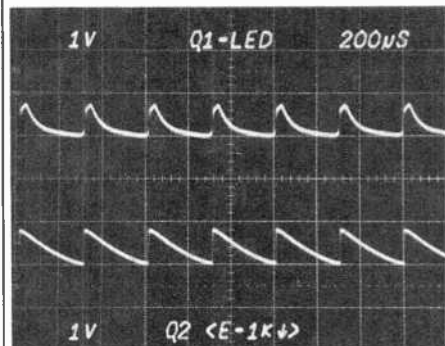

Fig. 5. Waveforms for Fig. 4.

miniature 8-ohm speaker at point "X" to make the oscillator's tone audible.

Parting Comment. So far, we've examined only one particular optoisolator, but there is a wide range of other useful gadgets that include electrically isolated emitters and detectors. These source-sensor pairs, as they are usually called, can be used for limit switches, object detectors, position sensors, reflectance sensors, and many other applications. I haven't seen any of these source-sensor pairs on the surplus/hobby market yet. ♦

STATEMENT OF OWNERSHIP, MANAGEMENT AND CIRCULATION (Act of August 12, 1970: Section 3685, Title 39, United States Code). 1. Title of Publication: Popular Electronics, 2. Date of filing: October 1, 1975. 3. Frequency of issue: Monthly. 3a. Annual subscription price: \$6.98. 4. Location of known office of publication: One Park Avenue, New York, New York 10016. 5. Location of the Headquarters or General Business Offices of the publishers: One Park Avenue, New York, New York 10016. 6. Names and addresses of publisher, editor, and managing editor: Publisher, Edgar W. Hopper, One Park Avenue, New York, New York, 10016; Editor, Arthur P. Salsberg, One Park Avenue, New York, New York, 10016; Managing Editor, John R. Riggs, One Park Avenue, New York, New York 10016. 7. Owner: Ziff-Davis Publishing Company, One Park Avenue, New York, N.Y. 10016; Ziff Corporation, One Park Avenue, New York, N.Y. 10016. 8. Known bondholders, mortgagees, and other security holders owning or holding 1 percent or more of total amount of bonds, mortgages or other securities: None. 9. For optional completion by publishers mailing at the regular rates (Section 132.121, Postal Service Manual). 39 U.S.C. 3626 provides in pertinent part: "No person who would have been entitled to mail matter under former section 4359 of this title shall mail such matter at the rates provided under this subsection unless he files annually with the Postal Service a written request for permission to mail matter at such rates." In accordance with the provisions of this statute, I hereby request permission to mail the publication named in Item 1 at the reduced postage rates presently authorized by 39 U.S.C. 3626.

William L. Phillips, Assistant Treasurer

11. Extent and nature of circulation	Average no. copies each issue during preceding 12 months	Actual no. of copies of single issue published nearest to filing date
A. Total No. Copies Printed (Net Press Run)	427,144	428,637
B. Paid Circulation		
1. Sales through Dealers and Carriers, Street Vendors and Counter Sales	60,534	58,400
2. Mail Subscriptions	295,644	298,927
C. Total Paid Circulation	356,178	357,327
D. Free Distribution by Mail, Carrier or Other Means		
Samples, Complimentary, and Other Free Copies	6,158	6,465
E. Total Distribution (Sum of C and D)	362,336	363,792
F. Copies not distributed		
1. Office use, Left Over, Unaccounted, Spoiled After Printing	2,465	2,045
2. Returns from News Agents	62,343	62,800
G. Total (Sum of E & F—should equal net press run shown in A)	427,144	428,637

I certify that the statements made by me above are correct and complete.

WILLIAM L. PHILLIPS, Assistant Treasurer

ACE OF THE MONTH SPECIALS



DUAL POWER SUPPLY KIT

Dual adjustment ± 10 to ± 16 volts, regulated, 250 ma. Each supply, short circuit protected. Board size 3" X 6". Ideal for OP AMP and CMOS projects. This kit is complete, all parts are included.

Complete Kit \$24.95
(includes instructions and schematics)
Wired & Tested \$29.95



ASCII COMPUTER KEYBOARDS

These keyboards were manufactured for use on Texas Instrument's line of Silent 700 series data terminals. They are fully encoded with TTL large scale integrated circuits (T.I. TMS-5000 in 28 pin socket). Additional IC's provide a parallel 7 bit, without parity, code plus a strobe signal indicating "valid" data and six other independent outputs for those special keys which are not encoded. The keys are reed type with a format similar to typewriter. Internal circuitry provides for two key rollover and de-bounce. Output is on standard 10 pin double readout connector for data and power input. And 8 pin double readout connector for six special switch functions.

KB-7 - Clare/Pendar 720731-1 New \$49.95

ACOUSTIC COUPLER

This coupler was manufactured by Novation, Inc. Tarzana, California for use in Texas Instrument's model 725 Electronic Data Terminal. It is compatible with Bell 103 and 113 data sets or equivalent. The coupler operates asynchronously to a maximum speed of 450 baud in the full-or-half-duplex mode coupled to a standard telephone handset. Transmit freq. is 1270hz for mark and 1070hz for space. Receive frequency is 2225hz for mark and 2025hz for space. Unit required ± 12 VOLTS and + 5 VOLTS for operation. Complete with schematic & all pertinent information, fully reconditioned, calibrated, and guaranteed - \$59.95.



MEMORY CHIP

SN74S201N 256-BIT RAM with 3 state output. Plug in replacement for SN74-200 & SN74S200.

\$3.95 ea. 10 for \$25.00
NEW GUARANTEED

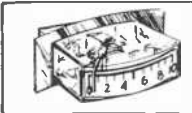

METER

EMICO Model 13 0-1 ma edgewise meter Scale is marked 0-10 relative output. Mounts in a 3/4 X 1 7/8 rectangular hole with a press on clip supplied with the meter. New \$1.95 each 10 for \$15.00

TERMS: We pay postage, unless otherwise specified. Include check or money order, no COD Texas residents add 5% sales tax.



ELECTRONIC PARTS

3303 Mangum Road
Houston, Texas 77018

ELECTRONICS MARKET PLACE

NON-DISPLAY CLASSIFIED: COMMERCIAL RATE: For firms or individuals offering commercial products or services, \$2.00 per word (including name and address). Minimum order \$30.00. Payment must accompany copy except when ads are placed by accredited advertising agencies. Frequency discount; 5% for 6 months; 10% for 12 months paid in advance. **READER RATE:** For individuals with a personal item to buy or sell, \$1.20 per word (including name and address.) No minimum! Payment must accompany copy. **DISPLAY CLASSIFIED:** 1" by 1 column (2-1/4" wide), \$230.00. 2" by 1 column, \$460.00. 3" by 1 column, \$690.00. Advertiser to supply film positives. For frequency rates, please inquire.

GENERAL INFORMATION: First word in all ads set in caps at no extra charge. All copy subject to publisher's approval. All advertisers using Post Office Boxes in their addresses **MUST** supply publisher with permanent address and telephone number before ad can be run. Advertisements will not be published which advertise or promote the use of devices for the surreptitious interception of communications. Ads are not acknowledged. They will appear in first issue to go to press after closing date. Closing Date: 1st of the 2nd month preceding cover date (for example, March issue closes January 1st. Send order and remittance to **POPULAR ELECTRONICS**, One Park Avenue, New York, New York 10016, Attention: Hal Cymes.

FOR SALE

FREE! Bargain Catalog—I.C.'s, LED's, readouts, fiber optics, calculators parts & kits, semiconductors, parts. Poly Paks, Box 942PE, Lynnfield, Mass. 01940.

GOVERNMENT Surplus Receivers, Transmitters, Snooperscopes, Radios, Parts, Picture Catalog 25 cents. Meshna, Nahant, Mass. 01908.

LOWEST Prices Electronic Parts. Confidential Catalog Free. KNAPP, 3174 8th Ave. S.W., Largo, Fla. 33540.

ELECTRONIC PARTS, semiconductors, kits. FREE FLYER. Large catalog \$1.00 deposit. BIGELOW ELECTRONICS, Bluffton, Ohio 45817.

RADIO—T.V. Tubes—36 cents each. Send for free catalog. Cornell, 4213 University, San Diego, Calif. 92105.

AMATEUR SCIENTISTS, Electronics Experimenters, Science Fair Students Construction plans—Complete, including drawings, schematics, parts list with prices and sources Robot Man — Psychedelic shows — Lasers — Emotion/Lie Detector — Touch Tone Dial — Quadraphonic Adapter — Transistorized Ignition — Burglar Alarm — Sound Meter over 60 items. Send 50 cents coin (no stamps) for complete catalog. Technical Writers Group, Box 5994, University Station, Raleigh, N.C. 27607.

METERS—Surplus, new used, panel or portable. Send for list. Hanchett, Box 5577, Riverside, CA 92507.

MECHANICAL. ELECTRONIC devices catalog 10 cents. Greatest Values — Lowest Prices. Fertik's, 5249 "D", Philadelphia, Pa. 19120.

SOUND SYNTHESIZER KITS—Surf \$12.95, Wind \$12.95, Wind Chimes \$17.95, Electronic Songbird \$6.95, Musical Accessories, many more. Catalog free. PAIA Electronics, Box J14359, Oklahoma City, OK 73114.

BUGGED??? New locator finds them fast. Write, Clifton, 11500-L N.W. 7th Avenue, Miami, Florida 33168.

DISCOUNT PRICES

B&K, SENCORE, LEAEO, RCA
EICO, FLUKE, HICKOK, SIMPSON

Test Equipment

ICC/ServiceMaster, RCA and Raytheon Tubes

Complete line of electronic supplies

Free Catalog

FORDHAM RADIO SUPPLY CO., INC.

558 Morris Ave., Bronx, N.Y. 10451 (212) 585-0330

YOU WILL SAVE BIG MONEY! Surplus, Clearouts, Bankruptcy, Inventory, Deals. Catalog \$1 (redeemable). ETCOA Electronics, Box 741, Montreal, H3C 2V2, U.S. Inquiries.

HEAR POLICE/FIRE Dispatchers! Catalog shows exclusive directories of "confidential" channels, receivers. Send 10 cent stamp. Communications, Box 56-PE, Commack, N.Y. 11725.

CONVERT any television to sensitive, big-screen oscilloscope. Only minor changes required. No electronic experience necessary. Illustrated plans, \$2.00. Sanders, Dept. A-33, Box 92102, Houston, Texas 77010.

CD IGNITIONS, VHF/UHF monitors, crystals, CB radios. Southland, Box 3591-B, Baytown, Texas 77520.

ALPHA/THETA BRAINWAVE biofeedback instruments. Analog instruments from \$125; digital processing systems from \$225. BioScan, Box 14168-E, Houston, Texas 77021.

SURPRISE! Build inexpensively, the most Unusual Test Instruments, Futuristic Gadgets using Numerical Readouts! Catalogue Free! GBS, Box 100A, Green Bank, West Virginia 24944.

LEARN DESIGN TECHNIQUES. Electronics Design Newsletter. Digital, linear construction projects, design theory and procedures. Annual subscription \$6.00, sample copy \$1.00. Valley West, Box 2119-B, Sunnyvale, California 94087.

TELEPHONES UNLIMITED, equipment, supplies. Catalog 50 cents. Box 1654E, Costa Mesa, Calif. 92626.

DIGITAL ELECTRONICS! Highly effective course brings immediate results, \$10.00. Satisfaction or \$11.00 refunded! Plans, Projects. Free Literature. DYNASIGN, Box 60A7, Wayland, Mass. 01778.

UNSCRAMBLERS: Fits any scanner or monitor, easily adjusts to all scrambled frequencies. Only 4" square \$29.95, fully guaranteed. Dealer inquiries welcomed, PDQ Electronics, Box 841, North Little Rock, Arkansas 72115.

SURPRISE! SURPRISE! Digital Piano Tuning Device tunes musical instruments Accurately! Perfectly! Inexpensively! Construction-Instruction-Plans Complete \$12.95 Airmail Postpaid! Moonlighting quickly repays \$40 electronics investment! GBS, Box 100P, Green Bank, West Virginia 24944.

PYROTECHNICAL chemicals, casings, fuse, tools, literature, supplies. Catalog-\$1.00, with samples — \$2.00. Westech, Logan, Utah 84321.

RECONDITIONED Test Equipment, \$0.50 for catalog. Walter, 2697 Nickel, San Pablo, CA 94806.

FREE giant bargain electronic catalog listing thousands of components, tubes, transistors, IC's, kits, test equipment. EDLIE'S, 2700-PK Hempstead Tpke., Levittown, N.Y. 11756.

ALPHA BRAINWAVE MONITOR—New from EICO. Model BW300 Kit, \$34.95; Wired, \$59.95 Postpaid. Send check or money order. M&K Electronic Corp., 135-33 Northern Blvd., Flushing, N.Y. 11354.

AUDIO PROGRAM CONTROL CENTER



\$14.95 PPD. USA

10 inputs, 4 outputs. Switch TV, Short-Wave, Ham, FM to Stereo Amplifier & Recorder. Listen & Record.

POWERCOM CORPORATION

Box 454 Dept 4 Troy, N. Y. USA 12181

FOR A New Electronic Experience, learn to control your brainwaves. Aquarius Electronics, Box 962E, Albion, CA 95410.

TEST EQUIPMENT—DISCOUNT PRICES: B&K, Sencore, Leader, EICO, Lectrotech, M&K Electronic Corp., 135-33 Northern Blvd., Flushing, N. Y. 11354.

wanted P-1
Citizens Band

DEALER-DISTRIBUTORS

Send this ad with Letterhead to:

PAL ELECTRONICS CO.

2962 W. WELDON - PHOENIX, ARIZ. 85017

BUILT THAT ELECTRONIC ORGAN YOU ALWAYS WANTED AT A PRICE YOU CAN AFFORD Third edition of "Organ Builder's Guide," pictured product kit line, circuits, block diagrams, design rationale using IC divider and independent generators with diode keying. \$3.00 postpaid. Also, free brochure on keyboards. DEVTRO-IX ORGAN PRODUCTS, Dept. C, 5872 Amapola Dr., San Jose, CA 95129.



WORLD'S SMALLEST ELECTRONIC CALCULATOR...\$19.95!

Does Everything Big Ones Do

Small but mighty! 8-digit, 4-function electronic calculator even has automatic % key... for only \$19.95. Take it anywhere. Carry it in your pocket or purse — it's 2/3 the size of a pack of cigarettes. This 3 1/2-ounce dynamo features floating decimal, constant key, lead zero depression, clear entry, more! At Edmund's low price, the unit comes with a Ni-Cad rechargeable battery pack that can plug into any AC outlet. No need for special recharging adapters. Calculator overall is just 2 x 3 1/2 x 1/8" with plenty of room for most fingers. Another Edmund first with advanced technology. **\$19.95** ppd.

STOCK NO. 1945 AVC Only **\$19.95** ppd.

GIANT FREE CATALOG!

NEW, 164 Pages Over 4,500 Unusual Bargains for Hobbyists, Schools, Industry.



JUST CHECK COUPON!

EDMUND SCIENTIFIC CO.
300 EDCORP BUILDING
Barrington, N. J. 08007

America's Greatest
Science • Optics • Hobby Mart

COMPLETE AND MAIL COUPON NOW

EDMUND SCIENTIFIC CO. 300 Edscorp Bldg., Barrington, N. J. 08007

SEND FREE Charge my BankAmericard Charge my MasterCard Charge my Master Charge

164 PAGE CATALOG "AVC" @ \$19.95 ea. (No. 1945 AVC) \$_____

Service and handling charge \$_____ 50

Enclosed is check, m.o. in amount of \$_____

Interbank No. _____ Signature _____

Card No. _____ Name _____ Please print

Expiration Date _____ Address _____

30-DAY MONEY-BACK GUARANTEE. You must be satisfied or return any purchase in 30 days for full refund.

City _____ State _____ Zip _____

S. D. SALES CO.

6 Digit Digital Clock Kit

We wanted our word to mean something to you. When we first introduced our clock we used such words as "impossible", "unbelievable bargain", "prime quality", and "unconditional money back guarantee." We anticipated selling several hundred kits. Your response to our clock has been fantastic. Now several thousand kits later, we hear such comments as "outstanding value", "exceptional service", "I can't believe it", etc. One enthusiastic customer even wrote saying it was "the best thing since bottled beer."

Here's What The Kit Includes:

- 1 - MM5314 National Clock Chip with socket
 - 6 - Common Cathode Led Readouts (.25 in. char.)
 - 13 - NPN and PNP Driver Transistors
 - 2 - Push Button Switches for time set
 - 1 - Switch for Time Hold
 - 1 - Filter Cap
 - 4 - IN4001 Rectifiers
 - 1 - IN914 Diode
 - 2 - .01 Disc. Caps
 - 9 - Carbon Resistors
- \$9.95 (KIT)**
WITH SPECS. POSTPAID
Transformer
\$1.50
P.C. BOARD FOR ABOVE
\$3.00 each

INTEL 1702A 2K ERASEABLE PROM'S \$6.95

We tell it like it is. We could have said these were factory new, but here is the straight scoop. We bought a load of new computer gear that contained a quantity of 1702A's in sockets. We carefully removed the parts, verified their quality, and are offering them on one heck of a deal. First come, first served. Satisfaction guaranteed.

PROFESSIONAL QUALITY STEREO HEADPHONES

Here is the kind of super deal that S. D. is famous for. Treat your ears to a super sound at a super price. Soft padded ear cushions, lightweight, fully adjustable headband, long coiled cord, wide response. **\$6 Post Paid - NEW IN ORIGINAL FACTORY BOXES**

SALE ON CUT LEAD SEMICONDUCTORS

Leads were cut for PCB insertion. Still very useable. IN4148 Diode - 40/\$1 2N3904 (House #Transistor) - 25/\$1

INSTRUMENT KNOBS

Black with brushed aluminum insert. Medium size, very attractive style. **SPECIAL 5 FOR \$1**

SIGNETICS 1K P-ROM

82S129. 256 X 4. Bipolar, much faster than MOS devices. 50 NS. Tri-state outputs. TTL compatible. Field programmable, and features on chip address decoding. Perfect for microprogramming applications. 16 pin DIP. With specs. \$2.95 ea.

TEXAS INSTRUMENTS 8 DIGIT CALCULATOR CHIP TMS0 103NC

Four function. Same style as used in TI pocket calculators. Factory new units, with specs. 99c each.

1AMP 1000 PIV SILICON RECTIFIERS
 IN4007. Factory prime devices. 10 for \$1.00

741C OP AMPS

Prime, factory tested and marked. Full spec on all parameters. Not re-tested, functional only, units as sold by others.
 741 CH -TO-5 8 Lead Metal Can . . . 3/\$1
 741CV - 8 Lead Mini Dip 4/\$1

DL747 JUMBO LED READOUTS

By Litronix. .65 inch character. Common anode. Outperforms SLA-3, perfect for giant digital clocks. Only 20 MA. per segment. Special - \$2.50 ea. (Not Class II)

SUBMINIATURE TRIMMER CAPS

Ultra stable. Range: 3.5 to 18 PF. 2 for \$1

FILTER CAPS

Dual section, 2000 MFD and 1500 MFD at 30 WVDC Twist Lock. 79c ea. 3 For \$2

NATIONAL VOLTAGE REGULATOR

Like 7805 5VDC - 1 AMP output. Has TO-220 plastic power tab - 99c

IN4148 COMPUTER DIODES

Same as IN914. Factory prime. 20 for \$1

FULL WAVE BRIDGE

By G. I. 1.5 AMP 800PIV - 75c

2N706A 400MHZ. TRANSISTORS

Silicon NPN. 1 WATT. TO-18 Case. 5 For \$1

LARGE SIZE LED LAMPS

Similar to MV5024. Prime factory tested units. We include plastic mounting clips which are very hard to come by. **Special 5 for \$1**

MOTOROLA NEG. VOLTAGE REG

MC1469R. TO-66 9 Lead package. For 3 TO 30V Outputs. Provides 600 MA direct output or more by using an external power transistor. Reg. catalog \$4 ea. With specs. \$1.95 ea.

VERNIER DIAL

From a close out of metal detector manufacturer. 1/2 Turn, 8 to 1 ratio. Internal stops easily removed to make unit multi-turn.

LIMITED QUANTITY - \$.99 EACH

DO YOU NEED A LARGE COMMON ANODE READOUT AT A FANTASTIC PRICE!



S. D. presents the MAN-64 by Monsanto - .40 inch character. All LED construction - not reflective bar type, fits 14 pin DIP. Brand new and factory prime. Left D.P.

\$1.59 ea. 6 for \$7.50

FAIRCHILD LED READOUTS - 69c
 FND-70. Common cathode. Right hand decimal point. .25 inch character. Prime new units. Perfect for clocks, frequency counters, etc. 69c 10 For \$6
 Best Readout Buy in USA!

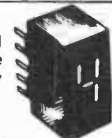

DRIVER TRANSISTORS
 2N3904 - NPN
 2N3906 - PNP
 8 for \$1

2102 1K RAM's - 8 FOR \$12.95

New units by National. We bought a load on a super deal, hence this fantastic price. Units tested for 500NS Speed.

FET'S BY TEXAS INSTRUMENTS

#TIS-75 but with an internal house number. TO-92 plastic case. N Channel, Junction type FET.

SPECIAL 5 FOR \$1

FAIRCHILD BIG LED READOUTS

A big .50 inch easy to read character. Now available in either common anode or common cathode. Take your pick. Super low current drain, only 5 MA per segment typical.

FND - 510 Common Anode
 FND - 503 Common Cathode

YOUR CHOICE
\$2 ea.

H.P. IS BACK!

No Rejects or Reworks here - You Want Quality? You have it with this popular 0.3" L.E.D. by Hewlett Packard. Fits Standard I.C. Socket. Right hand DP.

5082-7740 - Common Cathode \$1.25
 5082-7730 - Common Anode \$1.25
6 for \$6.00



HEAVY DUTY TRANSFORMER

36 VAC, 3.5 AMPS. 115VAC 60 HZ. PRI. For power supplies or audio power amps. Best quality, fully enclosed. \$4.95

8T97B

Signetics, TRI-State Hex Buffer. MOS and TTL interface to TRI-State Logic. Special: \$1.49.

936 DTL EY ITT

Prime, house numbered. Hex Inverter 10 For \$1

LM324 - QUAD 741 OP AMP - 99c
 NE555 - Timers - 49c
 709CH - OP AMPS - 4 For \$1
GE SCR C106B1
 4 AMP 200PIV. Sensitive Gate. 59c

MOTOROLA POWER DARLINGTON

\$1.99

MJ3001 - NPN - 80 Volts - 10 Amps - HFE 6000 typ. To-3 Case. Ideal for power supplies, etc. We include a free 723 regulator w/schematic for power supply with purchase of the MJ3001. You get the two key parts for a DC supply for only \$1.99. Regular catalog price for the MJ3001 is \$3.82

MOTOROLA NEGATIVE VOLTAGE REG

MC1463R - Like our 1469R, except for negative voltage. Reg. catalog \$5. Our price \$1.95.

We do not sell junk. Money back guarantee on every item. **WE PAY POSTAGE.** Orders under \$10 add 75c handling. No C.O.D. Texas Res. add 5% tax.

S. D. SALES CO.

P.O. BOX 28810
 DALLAS, TEXAS 75228

MERRY CHRISTMAS AND A HAPPY NEW YEAR

CIRCLE NO. 49 ON FREE INFORMATION CARD

TELEPHONE "BUGGED"? Countermeasures Brochure \$1.00, Negeye, Drawer 547, Pennsboro, W. VA 26415.

SAVE ELECTRIC POWER!

Save up to 80% electrical power with this unique, inexpensive, portable, permanent and legal method applicable for shops, homes, factories, businesses, farms, sites. 100% Refund Guaranteed if not scientifically sound or if it employs gimmicks.
Information \$1.00

CONSUMERTRONICS CO.

P.O. Box 1399 Alamogordo, N.M. 88310

POLICE, Fire monitors, scanners, crystals discount priced. New crystal-less scanners. Box 19224, Denver, CO 80219.

TELETYPE EQUIPMENT for sale for beginners and experienced computer enthusiast. Teletype machines, parts, supplies. Catalogue \$1.00 to: ATLANTIC SALES, 3730 Nautilus Ave., Brooklyn, NY 11224. Tel: (212) 372-0349.

ALTAIR 8800 EXPERIMENTERS — Wirewrap board plugs directly into Altair computer. Includes regulator, heatsink, filtering, decoupling, gold edge contacts. Capacity of over 70 wirewrap sockets (not included). Postpaid \$50. Cromemco, 26655 Laurel, Los Altos, CA 94022.



WAREHOUSE DISCOUNTS ON

NATIONALLY ADVERTISED

- C.B. RADIOS
- MONITOR SCANNERS FIRE POLICE

IN FACTORY SEALED CARTONS

BUSINESS - RECREATION - PERSONAL SATISFACTION GUARANTEED

WRITE FOR QUOTE

ELECTRONICS WAREHOUSE, INC.
6234 LITTLE RIVER TURNPIKE (DEPT. 5)
ALEXANDRIA, VA. 22312
OR PHONE: (703) 256-1300

SOLID STATE & HOBBY CIRCUITS MANUAL

\$1.95 postpaid to your door. The new manual offers over 400 pages of circuits for the hobbyist, engineer, experimenter and do-it-yourself kit builder. HURRY—Supply limited. Free catalog. Frazer & Associates, Dept. PE, 1888 Century Park East Suite 10, Century City, Calif. 90067.

JAPANESE TRANSISTORS. All transistors original factory made. Free catalog. West Pacific Electronics, P.O. Box 25837, W. Los Angeles, CA 90025.

\$ BREAKTHROUGH \$

8080A CPU → \$58

SPECIAL purchase of NEW, PRIME, FACTORY TESTED units, with data. Send Check or Money Order to: AMTEK, Calif. residents add P.O. Box 503 Campbell, Ca. 95008 \$t for the gov.

PC2406A MODU-CLOCK LED Clock Kit. Six Digit. 12/24 hour, XTAL Timebase, Includes Drilled, Plated PC Board and Instructions. Thousands sold nationally! Satisfaction Guaranteed! Order Now. 48 Hour Shipping! Only \$7.95. REL ELECTRONICS, 3511 Lynette Dr., Amarillo, Texas 79109.

DESCRAMBLERS: Several Professional Models that work with all Scanners. Tone Encoders/Decoders. Scanmate. AAPP. Radar Detectors. Big Ears. Alarms. Books. Kits. parts. Catalog 25 cents: KRYSTAL KITS. Box 445, Bentonville, Ark. 72712.

4K 8080 COMPUTER. 3 I/O Ports \$395 assembled. Kits from \$35. Details \$2.00 (refundable). VACOMP. Box 4733, Arlington, Virginia 22204.

UNIVERSAL TTL/DTL/CMOS IC TESTER. Tests 16/14 Pin Digital ICs! Set Programming Switches. Plug In, Press To Test; Errors Displayed. 151.072 Test Operations/Second. (All ICs TTL; costs less than \$20.00). Circuit is easy to understand and build. Illustrated Plans: \$20.00; NORTH-STAR ENGINEERING, 3617 North Crede Drive, Charleston, WV 25302.

INTEGRATED CIRCUIT TESTER. Easy assembly, under \$20.00. Tests Two Input Gates, Inverters In 7400 series. Complete Instructions, Part List. Send \$1.00. G.A.L. Electronics, 32001 Schoenher, Warren, Mich. 48093.

MICROPROCESSOR C8080A/8080A Factory Prime. \$65.00, post paid, Altair 8800 Cassette Interface Kit, \$100.00, post paid. Sargent's Distributing, 10268 Rosecrans, Bellflower, CA 90706.

T.V. GAMES LSI CHIP: Plays 8 exciting games with sound and score. One to four players. Plugs straight into your T.V. Antenna socket. Full constructional Data included. Cost, including Postage: 1 to 10 Chips, \$40 each; 11 to 50 Chips, \$30; 51 plus on application. Orders with Money Order or Cash to Television Sports, Ltd., 6 Half Moon Street, Mayfair, London, W1Y 7RA, England.

CARBON FILM RESISTORS. Brand new as low as 1.7 cents discounts of 20%. Prompt delivery. FREE samples/specifications. COMPONENTS CENTER, Box 134P, N.Y., N.Y. 10038.

SONAR VHF FM Business Radio. Pagers. Scanners. Amateur, Marine, L.C. McCann Co., Oley, PA 19547.

TEKTRONIX and Hewlett-Packard oscilloscopes and test equipment. Free information. American Calibration Services, Box 8104, Athens, Georgia 30601.

TV-GAMES. More than a Pong game. 5 game plan set—\$5.00. Big 12 game plan set—\$12.00. Full description and specs—\$1.00 (refundable). Advanced Electronics, P.O. Box 1128, Cupertino, Calif. 95014.

CBer's Compander increases talk Power. Superdesigned Sweep/Function/FSK generator. More! Miniltron, Box 184, Anoka, Minn. 55303.

OPTICAL SCANNER for bar coder. \$15. postpaid. Creed teletype with 8008 or 8080 (ALTAIR) Interface and manuals. \$150. Wilcox Enterprises, 25W178 39th Street, Naperville, Ill. 60540.

MEMORY 21L02A Static Rams \$2.75. brand new. Wm. Witherspoon, 3558 Stony Point Road, Grand Island, N.Y. 14072.

FLAT PANEL LOUDSPEAKERS. Super fidelity and also revolutionary communications loudspeakers that can double your receiving range. Lifetime guarantee. Mlgnon Products, 352 Old Country Road, Fairfield, N.J. 07006.

CARTRIVISION—Color video tape recorders. TV cameras, face plates, heads, blank tapes, spare electronics. Send S\$AE for price list. Phoenix Services, Dept. P2, P.O. Box 6509, San Jose, CA 95150.

JANUARY SPECIALS

DIGITAL

7447	\$.69
7483	.59
7490	.45
74151	.59
74153	.79
74180	.79
74193	.99
9602	.69
74C00	.12

CLOCK CHIPS

5311	\$3.95
5312	2.95
5314	3.95
5316	4.15
7001	6.95

CALCULATOR CHIPS

5005	\$1.69
------	--------

LINEAR

301 mDIP	.25
339 DIP	1.29
320 TO-220	1.39
320 TO-220	1.39
340 TO-220	1.39
340 TO-220	1.39

MEMORIES

2102	\$2.65
2101-1	2.75
2102-2	2.75
82523	3.25
F93410	2.19

FUNCTION GENERATOR

8038	\$3.95
------	--------

DVM

5330	\$14.95
------	---------

PULTRON V.I.P. QUARTZ REGULATED LED WATCH

MEN's 5 function — hours, minutes, month, day and seconds.
Latest slim-line design (prox. 1/8" thick)
Four year calendar — requires setting only on February 29th.
One year warranty against all defects in material and workmanship.
Built-in phototransistor adjusts intensity of display.
Gold tone — with adjustable mesh strap.



\$99.50
+\$1.50 Shipping & Handling
Usual 10% Discount Applies

5% OFF ON ORDERS OVER \$50.00
10% OFF ON ORDERS OVER \$100.00
15% OFF ON ORDERS OVER \$250.00

LINEAR CIRCUITS

300	Pos V Reg (super 723)	TO-5	\$.71
301	Hi perf op amp	mDIP	.28
307	Op AMP (super 741)	mDIP	.26
308	Micro Pwr Op Amp	mDIP	.89
309K	5V 1A regulator	TO-3	1.35
310	V Follower Op Amp	mDIP	1.07
311	Hi perf V Comp	mDIP	.95
319	Hi Speed Dual Comp	DIP	1.13
320	Neg Reg 5.2, 12, 15	TO-3	1.04
324	Quad Op Amp	DIP	1.52
339	Quad Comparator	DIP	1.58
340K	Pos. V reg. (5V, 6V, 8V, 12V, 15V, 18V, 24V)	TO-3	1.69
340T	Pos. V reg. (5V, 6V, 8V, 12V, 15V, 18V, 24V)	TO-220	1.49
370	AGC/Squelch AMPL	DIP	.71
372	AF-IF Strip detector	DIP	2.93
373	AM/FM/SSB Strip	DIP	.53
376	Pos. V. Reg	mDIP	2.42
380	2w Audio Amp	DIP	1.13
380-B	6w Audio Amp	mDIP	1.52
381	Lo Noise Dual preamp	DIP	1.52
550	Prcc V Reg	DIP	.89
555	Timer	mDIP	.89
556A	Dual 555 Timer	DIP	1.49
560	Phase Locked Loop	DIP	2.48
562	Phase Locked Loop	DIP	2.48
565	Phase Locked Loop	DIP	2.38
566	Function Gen	mDIP	2.25
567	Tone Decoder	mDIP	2.66
709	Operational AMPL	DIP	.26
710	Hi Speed Volt Comp	DIP	.35
723	V Reg	DIP	.62
739	Dual Hi Perf Op Amp	DIP	1.07
741	Comp Op Amp	mDIP	3.32
747	Dual 741 Op Amp	DIP	.71
748	Freq Adj 741	mDIP	.35
1304	FM Mulps Stereo Demod	DIP	1.07
1307	FM Mulps Stereo Demod	DIP	.74
1458	Dual Comp Op Amp	mDIP	.62
1800	Stereo multiplexer	DIP	2.48
3900	Quad Amplifier	DIP	.35
8038	V contr. osc	DIP	4.95
8864	9 DIG Led Cath Dvr	DIP	2.25
75150	Dual Line Driver	DIP	1.95
75451	Dual Peripheral Driver	mDIP	.35
75452	Dual Peripheral Driver	mDIP	.35
75453	(351) Dual Periph. Driver	mDIP	.35
75491	Quad Seg Driver for LED	DIP	.71
75492	Hix Digit Driver	DIP	.80

MEMORIES

1101	256 bit RAM MOS	\$ 1.50
1103	1024 bit RAM MOS	\$.95
2102	1024 bit static RAM	5.55
5203	2048 bit UV eras PROM	17.95
5260	1024 bit RAM	2.49
5261	1024 bit RAM	2.69
5262	2048 bit RAM	5.95
7489	64 bit ROM TTL	2.48
8223	Programmable ROM	3.69
74200	256 bit RAM tri-state	5.90

CALCULATOR & CLOCK CHIPS

5001	12 DIG 4 funct fix dec	\$3.45
5002	Same as 5001 exc btry pwr	3.95
5005	12 DIG 4 funct w/mem	4.95
MM5725	8 DIG 4 funct chain & dec	1.98
MM5736	18 pin 6 DIG 4 funct	4.45
MM5738	8 DIG 5 funct K & mem	5.35
MM5739	9 DIG 4 funct (htry sur)	5.35
MM5311	28 pin BCD 6 dig mux	3.45
MM5312	24 pin 1 pps BCD 4 dig mux	4.95
MM5313	28 pin 1 pps BCD 6 dig mux	4.45
MM5314	24 pin 6 dig mux	4.45
MM5316	40 pin alarm 4 dig	5.39

LED'S

MV10B	Red TO 18	\$.22
MV50	Axial leads	.18
MV5020	Jumbo Vis. Red (Red Dome)	.22
	Jumbo Vis. Red (Clear Dome)	.22
ME4	Infra red diff. dome	.54
MAN1	Red 7 seq. .270"	2.19
MAN2	Red alpha num .32"	4.39
MAN4	Red 7 seq. .190"	1.95
MAN5	Green 7 seq. .270"	3.45
MAN6	.7" high solid seq.	1.25
MAN7	Red 7 seq. .270"	4.19
MAN8	Yellow 7 seq. .270"	3.45
MAN64	.4" high solid seq.	2.95
MAN66	.6" high spaced seq.	3.75
MC12	Opto-iso translsr	.61

CMOS

4015A	1.49	4049A	.59
4016A	.56	4064A	.59
4001A	.25	4020A	1.49
4002A	.25	4021A	1.39
4006A	1.35	4022A	1.10
4007A	.26	4023A	.25
4008A	1.79	4024A	.89
4009A	.57	4025A	.25
4010A	.54	4027A	.59
4011A	.29	4028A	.98
4012A	.25	4030A	.44
4013A	.45	4035A	1.27
4014A	1.49	4042A	1.47
		4585A	2.10

Satisfaction guaranteed. Shipment will be made via first class mail within 3 days from receipt of order. Add \$.50 to cover shipping and handling for orders under \$25.00. Minimum order \$5.00. California residents add sales tax.

INTERNATIONAL ELECTRONICS UNLIMITED
P.O. BOX 1708/ MONTEREY, CA. 93940 USA
PHONE (408) 659-3171

Altaj Electronic Bargains

PRICES SLASHED! WE WANT YOUR BUSINESS. SATISFACTION GUARANTEED ON EVERY ITEM



LM309K
TO-3 Case, 1 AMP 5 VDC Voltage Regulator. Brand New By National \$1.19

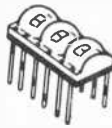

3 DIGIT LED READOUT ARRAY
Like Litronix DL-33 3 MAN-3 style readouts in one package. Factory new units Designed for calculators. Special — \$1.39 (3 Digits)



LITRONIX DL707 READOUTS
.30 IN. CHAR. Common Anode. SPECIAL — \$1.19

CALCULATOR CHIP BONANZA PRICES SLASHED!

The newest and easiest to use chips available today. Made by famous US mfg. All are 28 pin DIP. Features: direct LED segment drive, low power consumption, internal keyboard debounce, internal clock oscillator, single supply voltage, internal keyboard encoding, and floating decimal point. Does not require many external components as do older types like CT5001, 5002, 5005, etc. We offer the most sophisticated functions for the lowest price anywhere. Chip #1 — 8 Digit, Constat, Six Function (+, -, x, +, %,) — \$2.49

MOTOROLA MJE 3055
Plastic version of 2N3055. NPN Silicon. 90 Watts 15 Amps. SPECIAL — 69c

8008 MICROPROCESSOR
Computer on a chip. 8 Bit Parallel CPU. Can address 16k x 8 bits of memory. With specs. Factory tested units. \$24.95

2102-1K RAM's for above — \$4.95 or 8 For \$30

TTL SUPER SPECIAL
74121 — ONE SHOT 4/\$1

LINEAR IC SPECIALS
555V-75c 567V-\$1.95 723CH-59c
741CV-25c LM324 by National — Quad
741C in one DIP — \$1.19

12VDC REED RELAY
Coil is 500 OHM. SPST-No. \$1.49 Sub-Mini.

PRIME TTL DIP IC'S

7400-16c	7448-89c	74151-75c
7402-16c	7453-16c	74153-89c
7404-16c	7473-37c	74154-95c
7406-24c	7474-37c	74157-99c
7808-16c	7475-65c	74161-99c
7410-16c	7476-39c	74163-1.19
7413-49c	7483-85c	74164-1.89
7420-16c	7490-69c	74165-1.49
7427-24c	7492-75c	74174-1.29
7430-16c	7493-75c	74175-1.39
7437-39c	7495-75c	74181-2.75
7438-35c	7496-75c	74192-1.25
7440-16c	74121-38c	74193-1.25
7442-69c	74123-75c	74195-79c
7447-89c	74150-70c	74197-79c

COMPUTER BOARD BONANZA
We bought over 4 tons of assorted boards. Contains TTL, diodes, transistors, etc. 5 board assmt. with 150 to 250 IC's — \$3.95.

DIGITAL ALARM CLOCK IC

The newest and easiest to use alarm chip on the market today. Features:
1. Single supply voltage.
2. LED intensity control
3. Simple time set.
4. 4 or 6 Digit LED Display
5. AM-PM Indication
6. 24 Hr. Alarm.
7. 10 minute snooze.
8. Outperforms MM5316
Order #70250 — \$4.99

MM5314 NATIONAL CLOCK CHIP
The most popular clock chip around. We made a huge special purchase of factory fresh, prime units. Lowest price in USA. 24 Pin DIP. 4 or 6 Digits. With Specs. \$3.95

DOUBLE DIGIT JUMBO READOUTS
New. Litronix 727. Dual. Perfect for giant clocks, etc. \$3.95 each (2 DIGITS)

JUMBO LED READOUT
Twice the size of regular readouts. .65 inches. Like Litronix DL747. Outperforms and easier to read than SLA-3, only 20 MA per segment. Our best readout for digital clocks. \$2.95 ea. (6 FOR \$15) Common Anode

FILTER CAPS
1000 MFD 16VDC upright style. 4 FOR \$1

8038 FUNCTION GENERATOR
Brand new. Voltage controlled oscillator. Has sine, square wave, and triangular outputs. \$4.95 each.

IN4148 DIODES
Brand New Units. Same as IN914. Full Leads. 25 For \$1

MONSANTO COLORED READOUTS
.27 IN. Character. Common Anode. MAN5 — GREEN — \$1.29
MAN 8 — YELLOW — \$1.29

PHASE LOCKED LOOP
565A by Signetics. Extremely stable. High linearity, wide frequency range. TTL compatible. Perfect for tone decoders, FSK, SCA receivers, frequency multiplication and division — 99c WITH SPECS

FLOURESCENT READOUT TUBES

7 Segments. Blue-Green in color. Mfg. by ISE. #DG8F. The most popular display used in many imported clocks and calculators. Perfect for use with MM5316 clock chips. SUPER SPECIAL 69c ea. 12 For \$5.95

GE TRANSISTOR ASSORTMENT
One of the best mixed transistor lots we have seen. TO-98 Plastic cased. Includes Darlingtons, SCR's, PNP, NPN, etc. Untested sample test shows very high yield. Satisfaction assured. 50 for 99c SPECIAL: 6 BAGS FOR \$5.

COLOR ORGAN CONTROL MODULE
Completely self-contained. Has SCR circuitry, AC line cord, etc. From a close out by a mfg. of color organs. New, unused. \$1.49

MOTOROLA SCR
2N4443 8 Amp 400PN, Plastic Power Case. 69c

GE POWER DARLINGTON
NPN, Plastic Power Tab Case. VCEO-30 HFE-30,000 TYP. Brand new units, but leads are slightly trimmed for P.C.B. #D40C1 — SPECIAL 4 For \$1

RCA PHOTO DETECTOR — POWER AMP. IC
RCA CA3062 for photoelectric applications. The IC with a window. Contains photosensitive section, amplifier, and high current output pair of transistors. Has 100 MA output. Useful for intrusion alarms, counter, position sensors, etc. with complete spec sheets. Reg. \$4.84. SPECIAL — \$1.99

LOOK MOS 4 DIGIT COUNTER
An ALTJ exclusive. These are the latest state of the art, MOS chips. By a famous US mfg. Contains a complete 4 digit counter, including 4 decade counters, latches, multiplexing circuits, display decoders, etc. Features: 5VDC operation, 25 MW power consumption, both 7 segment and BCD outputs. Perfect for making DVM's frequency meters, tachometers, stopwatches, or any other device requiring 4 or more digits. Complete with specs 28 PIN DIP. QTY Limited. SPECIAL — \$12.50 BACK IN STOCK!

LED DRIVER IC'S
75491 Quad segment dr. — 29c
75492 Hex digit dr. — 39c

RCA CA3043 — FM IC
Used in FM stereos. Contains IF Amp, Limiter, FM Detector, and an Audio Preamp and Driver all in one 12 lead TO-5 package. With Spec Sheets. A \$3.00 Value — 99c

4 DIGIT ALARM CLOCK KIT
Features the only LED direct drive clock chip on the market. Kit includes all parts (except X fmr) for a 4 Digit alarm clock kit. Uses .25 inch LED readouts. SPECIAL: \$15.95 (with PC Board)

6 DIGIT LED READOUTS

Brand new arrays by T. I. Common cathode, properly multiplexed. Six digits plus a negative sign. Perfect for calculators, mini-clocks, stop watches, etc. SUPER SPECIAL \$1.29 ea 3 for \$3

U.V. ERASEABLE PROMS
New Prime units by National MM5203 2K \$14.95
MM5204 4K \$19.95

TRANSISTOR BAKER'S DOZEN SALE!
2 million pieces bought for this sale. New house numbered units by T.I. All prime first quality at a give-away price. NPN 2N3904-13 For \$1
PNP 2N3906-13 For \$1

In4004 RECTIFIERS
1 AMP 400PIV SPECIAL 15/\$1

7805 STYLE REGULATORS
TO-220 Plastic Case 5VDC Regulator. Brand New by National — 99c

FACTORY NEW LED'S
Jumbo Red-Like MV5024-8/\$1
Jumbo Green-Like MV5222-5/\$1
Jumbo Yellow-51/\$1
Mini Red-Like MV50-10!/\$1

FORD SOLID STATE MODULES
Mfg. by Contralab for Ford car radios. Each module contains 2 transistors plus other components. These modules were used as audio pre amps. We include specs. — 4 For \$1

TTL IC ASSORTMENT
Various types. Most are marked. Our best selling assortment. Untested but includes many useable devices. 200 PCS FOR \$3.95

FM TRANSFORMERS
We bought a load of coils and transformers that were used in Ford AM-FM car radios. Includes 19KHZ, 38KHZ, OSC. Coils, etc. All New. Perfect for experimenters or repairmen. 10 Pc Asst. — 99c

TANTALUM CAPS
By Sprague. 4.7 MFD 10 VDC. Axial Leads. Perfect for timers. 10 For \$1

TRANSFORMER SPECIAL #1
Miniature size. Primary 115V AC Secondary 11V AC No Load. 8V AC with 400 MA Load. Perfect for clocks or calculators or small power supply. 99c

Altaj Electronics
P.O. Box 38544
Dallas, Texas 75238

TERMS: Check or money order. No COD. Add 10% Pstg. and Hdq. Tex Res. add 5%.

C-MOS

CD400024	CD4015 1.19	CD4026 1.49	CD4044 . . .59
CD400124	CD4016 . . .59	CD4027 . . .59	CD4047 . . .59
CD400224	CD4017 1.29	CD4028 . . .99	CD4049 . . .59
CD40061.49	CD4018 1.49	CD4029 1.39	CD4050 . . .59
CD400724	CD4019 . . .59	CD4030 . . .49	CD4066 . . .99
CD40081.15	CD4020 1.59	CD4032 . . .24	CD4077 . . .39
CD400959	CD4021 1.49	CD4033 1.49	74C02 . . .29
CD401124	CD4022 1.19	CD4035 1.39	74C04 . . .29
CD401224	CD4023 . . .24	CD4040 1.59	74C107 1.29
CD401359	CD4024 . . .99	CD4041 . . .89	
CD40141.49	CD4025 . . .24	CD4042 . . .79	

7400N TTL

SN7400N	13	SN7451N	27	SN74151N	1.25
SN7401N	16	SN7453N	27	SN74153N	1.25
SN7402N	21	SN7454N	41	SN74154N	1.25
SN7403N	16	SN7455A	25	SN74155N	1.21
SN7404N	16	SN7456N	22	SN74156N	1.30
SN7405N	24	SN7470N	45	SN74157N	1.30
SN7406N	45	SN7472N	39	SN74158N	1.75
SN7407N	25	SN7473N	37	SN74159N	1.45
SN7408N	25	SN7474N	33	SN74160N	1.35
SN7409N	25	SN7475N	39	SN74161N	1.35
SN7410N	16	SN7476N	32	SN74162N	1.65
SN7411N	30	SN7480N	50	SN74165N	1.75
SN7412N	42	SN7482N	1.75	SN74167N	5.50
SN7413N	85	SN7483N	1.12	SN74170N	3.00
SN7414N	70	SN7485N	1.12	SN74172N	1.80
SN7416N	43	SN7486N	45	SN74173N	1.70
SN7417N	43	SN7488N	3.50	SN74174N	1.95
SN7418N	25	SN7489N	3.00	SN74175N	1.95
SN7419N	21	SN7490N	49	SN74176N	3.40
SN7421N	39	SN7491N	1.20	SN74177N	90
SN7423N	37	SN7492N	82	SN74180N	1.05
SN7425N	43	SN7493N	57	SN74181N	3.55
SN7426N	31	SN7494N	91	SN74182N	95
SN7427N	37	SN7495N	31	SN74184N	2.30
SN7429N	42	SN7496N	91	SN74185N	2.20
SN7430N	26	SN74100N	1.00	SN74187N	6.00
SN7432N	31	SN74107N	49	SN74189N	1.50
SN7437N	47	SN74121M	45	SN74191N	1.50
SN7438N	40	SN74122N	49	SN74192N	1.19
SN7439N	25	SN74123N	70	SN74193N	99
SN7440N	21	SN74125N	60	SN74194N	1.45
SN7441N	1.10	SN74126N	81	SN74195N	1.00
SN7442N	1.98	SN74127N	3.00	SN74196N	1.25
SN7443N	1.05	SN74141N	1.15	SN74197N	1.25
SN7444N	1.10	SN74142N	4.00	SN74198N	2.25
SN7445N	1.10	SN74143N	4.50	SN74199N	2.25
SN7446N	1.15	SN74144N	4.50	SN74200N	7.00
SN7447N	78	SN74151N	1.15	SN74251N	2.50
SN7448N	99	SN74149N	2.50	SN74284N	2.50
SN7450N	26	SN74150N	1.10	SN74285N	6.00

MANY OTHERS AVAILABLE ON REQUEST
20% Discount for 100 Counts of 7400's

CMOS

CD4001	25	74C10N	65
CD4002	25	74C20N	65
CD4006	2.50	74C40N	65
CD4007	25	74C42N	2.15
CD4009	59	74C43N	1.50
CD4010	59	74C47A	1.15
CD4011	25	74C48N	3.00
CD4012	25	74C49N	1.25
CD4013	47	74C51N	2.90
CD4016	58	74C52N	1.15
CD4017	1.35	74C53N	2.98
CD4019	55	74C54N	2.15
CD4020	1.49	74C55N	3.25
CD4022	1.25	74C56N	3.25
CD4023	69	74C57N	3.00
CD4024	1.50	74C58N	2.60
CD4025	25	74C59N	2.75
CD4027	69	74C60N	35
CD4028	1.65	74C62N	55
CD4029	2.90	74C64N	75

LINEAR

LM100H	15.00	LM1310N	2.95
LM105H	2.50	LM1351N	1.65
LM171H	7.75	LM1414N	1.75
LM212H	7.00	LM1458N	65
LM300H	80	LM1496N	95
LM301H	3/10	LM1580N	1.95
LM301CA	3/10	LM2111N	1.35
LM302H	7.75	LM2901N	1.85
LM303H	1.00	LM3055N	65
LM303H	1.00	LM3900N	55
LM303CA	35	LM3905N	60
LM303CA	1.00	LM3905N	1.85
LM3080N	1.00	MC5558V	1.00
LM309H	1.10	LM7525N	90
LM309H	1.25	LM7529N	2.20
LM3100N	1.15	LM7534N	2.50
LM311H	90	LM7535N	1.25
LM311N	90	8038B	4.95
LM3180N	1.50	LM75450	49
LM319N	1.30	754510N	39
LM319D	9.00	754520N	39
LM320K-1	1.35	754530N	39
LM320K-2	1.35	754540N	39
LM320K-3	1.35	754540N	39
LM320K-4	1.35	754540N	39
LM320K-5	1.35	754540N	39
LM320K-6	1.35	754540N	39
LM320K-7	1.35	754540N	39
LM320K-8	1.35	754540N	39
LM320K-9	1.35	754540N	39
LM320K-10	1.35	754540N	39
LM320K-11	1.35	754540N	39
LM320K-12	1.35	754540N	39
LM320K-13	1.35	754540N	39
LM320K-14	1.35	754540N	39
LM320K-15	1.35	754540N	39
LM320K-16	1.35	754540N	39
LM320K-17	1.35	754540N	39
LM320K-18	1.35	754540N	39
LM320K-19	1.35	754540N	39
LM320K-20	1.35	754540N	39
LM320K-21	1.35	754540N	39
LM320K-22	1.35	754540N	39
LM320K-23	1.35	754540N	39
LM320K-24	1.35	754540N	39
LM320K-25	1.35	754540N	39
LM320K-26	1.35	754540N	39
LM320K-27	1.35	754540N	39
LM320K-28	1.35	754540N	39
LM320K-29	1.35	754540N	39
LM320K-30	1.35	754540N	39
LM320K-31	1.35	754540N	39
LM320K-32	1.35	754540N	39
LM320K-33	1.35	754540N	39
LM320K-34	1.35	754540N	39
LM320K-35	1.35	754540N	39
LM320K-36	1.35	754540N	39
LM320K-37	1.35	754540N	39
LM320K-38	1.35	754540N	39
LM320K-39	1.35	754540N	39
LM320K-40	1.35	754540N	39
LM320K-41	1.35	754540N	39
LM320K-42	1.35	754540N	39
LM320K-43	1.35	754540N	39
LM320K-44	1.35	754540N	39
LM320K-45	1.35	754540N	39
LM320K-46	1.35	754540N	39
LM320K-47	1.35	754540N	39
LM320K-48	1.35	754540N	39
LM320K-49	1.35	754540N	39
LM320K-50	1.35	754540N	39
LM320K-51	1.35	754540N	39
LM320K-52	1.35	754540N	39
LM320K-53	1.35	754540N	39
LM320K-54	1.35	754540N	39
LM320K-55	1.35	754540N	39
LM320K-56	1.35	754540N	39
LM320K-57	1.35	754540N	39
LM320K-58	1.35	754540N	39
LM320K-59	1.35	754540N	39
LM320K-60	1.35	754540N	39
LM320K-61	1.35	754540N	39
LM320K-62	1.35	754540N	39
LM320K-63	1.35	754540N	39
LM320K-64	1.35	754540N	39
LM320K-65	1.35	754540N	39
LM320K-66	1.35	754540N	39
LM320K-67	1.35	754540N	39
LM320K-68	1.35	754540N	39
LM320K-69	1.35	754540N	39
LM320K-70	1.35	754540N	39
LM320K-71	1.35	754540N	39
LM320K-72	1.35	754540N	39
LM320K-73	1.35	754540N	39
LM320K-74	1.35	754540N	39
LM320K-75	1.35	754540N	39
LM320K-76	1.35	754540N	39
LM320K-77	1.35	754540N	39
LM320K-78	1.35	754540N	39
LM320K-79	1.35	754540N	39
LM320K-80	1.35	754540N	39
LM320K-81	1.35	754540N	39
LM320K-82	1.35	754540N	39
LM320K-83	1.35	754540N	39
LM320K-84	1.35	754540N	39
LM320K-85	1.35	754540N	39
LM320K-86	1.35	754540N	39
LM320K-87	1.35	754540N	39
LM320K-88	1.35	754540N	39
LM320K-89	1.35	754540N	39
LM320K-90	1.35	754540N	39
LM320K-91	1.35	754540N	39
LM320K-92	1.35	754540N	39
LM320K-93	1.35	754540N	39
LM320K-94	1.35	754540N	39
LM320K-95	1.35	754540N	39
LM320K-96	1.35	754540N	39
LM320K-97	1.35	754540N	39
LM320K-98	1.35	754540N	39
LM320K-99	1.35	754540N	39
LM320K-100	1.35	754540N	39

KITS EXAR ICS

XR-2206KA	SPECIAL \$17.95
XR-2206KB	SPECIAL \$27.95
XR-2206KC	SPECIAL \$27.95
XR-2206KD	SPECIAL \$27.95
XR-2206KE	SPECIAL \$27.95
XR-2206KF	SPECIAL \$27.95
XR-2206KG	SPECIAL \$27.95
XR-2206KH	SPECIAL \$27.95
XR-2206KI	SPECIAL \$27.95
XR-2206KJ	SPECIAL \$27.95
XR-2206KK	SPECIAL \$27.95
XR-2206KL	SPECIAL \$27.95
XR-2206KM	SPECIAL \$27.95
XR-2206KN	SPECIAL \$27.95
XR-2206KO	SPECIAL \$27.95
XR-2206KP	SPECIAL \$27.95
XR-2206KQ	SPECIAL \$27.95
XR-2206KR	SPECIAL \$27.95
XR-2206KS	SPECIAL \$27.95
XR-2206KT	SPECIAL \$27.95
XR-2206KU	SPECIAL \$27.95
XR-2206KV	SPECIAL \$27.95
XR-2206KW	SPECIAL \$27.95
XR-2206KX	SPECIAL \$27.95
XR-2206KY	SPECIAL \$27.95
XR-2206KZ	SPECIAL \$27.95

DATA HANDBOOKS

7400	Pin-out & Description of 5400/7400 ICS	\$2.95
CMOS	Pin-out & Description of 4000 Series ICS	\$2.95
LINEAR	Pin-out & Functional Description	\$2.95
ALL THREE HANDBOOKS \$6.95		

* JAMES JANUARY SPECIALS *

Astrisk Denotes Items On Special For This Month

Special Requested Items

RC4194	Dual Track V Reg	\$ 5.95	N8197	\$ 3.00	MC4040	4.50
RC4195	15V Track Reg	3.25	4024P	2.25	LM3909	2.25
F9388	Decoder	3.95	2513	11.00	MM5370	19.95
LD110/111	DVM Chip Set	28.00	2518	7.00	8258	1.15
CA3130	Super CMOS Op Amp	1.49	2321	3.50	8826	3.00
MC1408L7	AFO	9.95	2525	6.00	8890	1.35
F3341	VID	8.95	2527	5.00	7477	5.00

WE'LL BE HAPPY TO QUOTE ON YOUR SPECIAL PARTS —

XCITON OPTO ELECTRONICS

LITRONIX MONSANTO DISCRETE LEDES

R - RED
G - GREEN
Y - YELLOW
O - ORANGE

XC209R	5/81	XC526R	5/81	XC111R	4/51
XC209G	4/51	XC526G	4/51	XC111G	4/51
XC209Y	4/51	XC526Y	4/51	XC111Y	4/51
XC209O	4/51	XC526O	4/51	XC111O	4/51

.125" dia. .185" dia. .190" dia.

XC220R	5/81	XC556R	5/81	MV50	6/51
XC220G	4/51	XC556G	4/51	.085" dia. Micro red led	
XC220Y	4/51	XC556Y	4/51		
XC220O	4/51	XC556O	4/51		

.200" dia. .200" dia. .085" dia.

DISPLAY LEDES

FND70 DL707 MAN2 MAN3 MAN7 DL338 DL747

TYPE	POLARITY	HT	TYPE	POLARITY	HT
MAN 1	COMMON ANODE	270 \$1.95	MAN 74	COMMON CATHODE	300 \$1.50
MAN 2	5 x 7 DOT MATRIX	300 3.95	DL707	COMMON ANODE	300 \$1.50
MAN 3	COMMON CATHODE	125 3.90	DL747	COMMON ANODE	600 1.95
MAN 4	COMMON CATHODE	187 1.95	DL750	COMMON CATHODE	600 2.49
MAN 7	COMMON ANODE	300 1.50	DL338	COMMON CATHODE	110 1.95
MAN 7G	COMMON ANODE-GREEN	300 2.50	FND70	COMMON CATHODE	250 5.00
MAN 7Y	COMMON ANODE-YELLOW	300 2.50	FND503	COMMON CATHODE	500 1.75
MAN 7Z	COMMON ANODE	300 1.50	FND507	COMMON ANODE	500 1.75

IC SOLDERTAIL — LOW PROFILE (TIN) SOCKETS

8 pin	1-24	25-49	50-100	1-24	25-49	50-100
14 pin	1-17	18	19	24 pin	1-38	37
16 pin	20	19	18	28 pin	45	44
18 pin	22	21	20	36 pin	60	58
18 pin	29	28	27	40 pin	63	61
22 pin	37	36	35			

SOLDERTAIL STANDARD (TIN)

14 pin

CONTINENTAL SPECIALTIES \$15.95

PROTO BOARD 6
The PB-6 lets the user test and build circuits without soldering or patch cords. All interconnections between components are made with common #22 AWG hook-up wire. This quality breadboarding kit includes 630 component tie points at less than 2.5c each. It measures 6" long by 4" wide. Designed specially to Breadboard Microprocessor Circuits. **\$15.95**

PROTO BOARD 100
A low cost, big 10 IC capacity breadboard kit with all the quality of DT sockets and the best of the Proto Board series... complete down to the last nut, bolt and screw. Includes 2 OT-35S Sockets, 1 OT-35B Bus Strip, 25-way binding posts, 4 rubber feet, screws, nuts, bolts, and easy assembly instructions. **\$19.95**

Bring IC leads from pc board for fast signal tracing and troubleshooting. Inject signals. Wire unused circuits into boards. Scope probes and test leads lock onto Dynaprog bases (see circuit) for hands-off testing. Plastic construction eliminates springs, pivots. Non-corrosive nickel/silver contacts for simultaneous low resistance connections.
PC-14, 14-pin Proto Clip, \$4.50 ea.
PC-16, 16-pin Proto Clip, \$4.75 ea.
PC-24, 24-pin Proto Clips, \$8.50 ea.

CALCULATOR CHIPS AND DRIVERS

MMS725	8 DIGIT 4 FUNCTION	\$1.98
DM75491	SEGMENT DRIVER	.79
MMS736	6 DIGIT 4 FUNCTION DRIVER FOR 5736	1.95
DM75492	DRIVER FOR 5736	.89
MMS738	8 DIGIT 5 FUNCTION DRIVER TYPE 1	2.00
DM8864	DRIVER TYPE 2	2.00
DM8865	DRIVER TYPE 2	1.00

CLOCK CHIPS

MMS311	6 DIGIT WBCD	\$4.95
MMS312	4 DIGIT WBCD	4.95
MMS313	6 DIGIT WBCD	4.95
MMS314	8 DIGIT CLOCK	3.95
MMS316	ALARM CLOCK	4.95
CT7001	CALCLOCK CHIP	5.95

DIGITAL WATCH READOUT

FOR USE WITH WATCHES, DVMS, COUNTERS, ETC. **\$1.95**

HP-5082-7300

HP 5082-7300
3" Dnt Matrix type numeric readouts with decoders/driver/latch built on the chip. Only 8 pins (BCD IN, OR Latch +5v, ground).
HP 5082 7300 **\$5.95**

HP 5082 7300

HP 5082 7300
+1 version of 7300 **4.95**

1 1/4" x 1 1/2" XFEMERS

That were designed for clock type applications. 110 Vac primary @ 60 Hz. Secondaries: 9-10 Vac @ 300 mA-200 mA. 50 Vac @ 30 mA-50 mA. Excellent for miniature power supplies & gas discharge displays. **\$1.99**

P.C. Mount



1/16 VECTOR BOARD

Part No.	Material	0.1" Hole Spacing	Pattern	Length	Width	Price
PHENOLIC	64P44 062XXXP	4.50	6.50	11.72	1.54	
	169P44 02XXXP	4.50	17.00	3.69	3.32	
EPOXY GLASS	64P44 062	4.50	6.50	2.07	1.86	
	169P44 062	4.50	8.50	2.56	2.31	
	169P44 062	8.50	17.00	3.24	4.53	
	169P44 062	8.50	17.00	3.23	8.26	
	169P44 062C1	4.50	17.00	6.80	6.12	

VECTOR WRITING PENCIL

Vector Writing Pencil P173 consists of a hand held featherweight (under one ounce) tool which is used to guide and wrap insulated wire, feed off a self-contained replaceable bobbin, onto component leads or terminals installed on pre-punched "IP" Pattern Vectorboards™. Connections between the wrapped wire and component leads, pads or terminals are made by soldering. Complete with 250 FT of red wire. **\$9.50 ea.**

REPLACEMENT WIRE — BOBBING FOR WIRING PENCIL

W36-3-A-Pkg. 3 (Green)	\$2.40
W36-3-B-Pkg. 3 (Red)	\$2.40
W36-3-C-Pkg. 3 (Clear)	\$2.40
W36-3-D-Pkg. 3 (Blue)	\$2.40

9V BATTERY CLIP

STANDARD CLIP FOR USE WITH 9V TRANSISTOR BATTERIES WITH 4" LEADS **9/95 ea.**

TERMINAL STRIPS

THREE TERMINAL STRIPS, WITH CENTER TERMINAL USED FOR MOUNTING **15/\$1.00**

AMP TERMINAL PINS

TERMINAL PINS FOR MOUNTING COMPONENTS ALSO PERFECT FOR USE WITH BOARD CONNECTORS AND SUBASSEMBLIES **\$1.00/100 PCS.**

MICROPROCESSOR COMPONENTS

JAMES ELECTRONICS IS PROUD TO ANNOUNCE, FOR THE FIRST TIME EVER, TO THE ELECTRONIC HOBBIST... FROM AMERICAN MICRO DEVICES.

8080A \$39.95

8080 AND 8088 SUPPORT COMPONENTS

8224 CLOCK GENERATOR USED TO GENERATE TWO PHASE 8224 CLOCK NEEDED BY THE 8080 **\$12.95**
8228 SYSTEM CONTROLLER GENERATES A SYSTEM DATA BUS AND CONTROL SIGNALS FOR MEMORY **\$21.25**
74LS139 DECODER PERFECT FOR DECODING THE THREE 8088 STATE LINES INTO 8 USEABLE LINES FOR ADDRESS LATCHING **\$3.98**
8212 8 BIT INPUT OUTPUT PORT DIRECTLY INTERFACES WITH THE 8080 TO PROVIDE I/O INTERFACE **\$5.75**

	CPU'S		RAM'S		
8008	8 BIT CPU	\$19.95	1101	256K1	STATIC \$2.25
8080	SUPER 8008	39.25	1103	1024K1	DYNAMIC 6.95
4040	4 BIT 8080	39.25	2101	256K1	STATIC 6.95
	SR'S		2102	1024K1	STATIC 2.95
2504	1024 DYNAMIC	\$9.00	2107	4096K1	DYNAMIC 19.95
2518	HEX 40 BIT	7.00	2111	256K4	STATIC 7.55
2519	HEX 80 BIT	4.00	7010	1024K1	MNDS 29.95
2524	512 DYNAMIC	3.50	7489	16K4	STATIC 2.49
2525	1024 DYNAMIC	6.00	8101	256K4	STATIC 7.95
2527	DUAL 736 BIT	3.95	8111	232K4	STATIC 7.95
2529	DUAL 512 BIT	4.00	8599	16K4	STATIC 3.49
2532	QUAD 80 BIT	3.95	91102	1024K1	STATIC 2.95
2533	1024 STATIC	7.95	74200	1024K1	STATIC 6.95
3341	FIFO	6.95	93410	256K1	STATIC 1.75
74LS5670	16K4 REG.	3.95	5262	2048K1	DYNAMIC 2.95
	UART'S			PROMS	
AV-5-1013	20K BAUD	\$6.95	1702A	2048	FAMOS 15.95
	ROM'S		5203	2048	FAMOS 14.95
2513	CHAR. GEN.	11.00	8223	32K8	BIPOLAR 3.00
7488	RANDOM BITS	3.50	74S287	1024	STATIC 7.95

JOLT 159.95

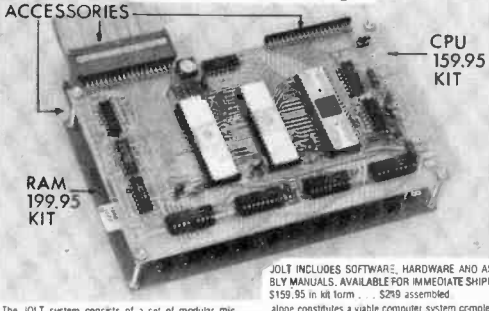

The JOLT system consists of a set of modular microcomputer boards which can be used singly or tied together to produce any desired microcomputer system configuration. The minimum system is one CPU board, which

JOLT SYSTEM DESCRIPTION
JOLT RAM Card — Fully static 4,096 bytes of RAM with 1 microsecond access time and on-board decoding. Hardware and assembly manuals included. AVAILABLE FOR IMMEDIATE SHIPMENT. \$199.95 kit... \$263 assembled.
JOLT Power Supply — Operates at +5, +12 and -10 voltages. Supports JOLT CPU, 4k bytes of RAM and JOLT I/O card — or, CPU and 8 I/O cards. Manuals included. AVAILABLE FOR IMMEDIATE SHIPMENT. \$99.95 kit, \$145 assembled.
JOLT Accessory Bag — Contains enough hardware to connect one JOLT card to another. Such necessary items as flat cable, connectors, cord spacers, hardware, etc. AVAILABLE FOR IMMEDIATE SHIPMENT \$39.95.

MULTIPURPOSE KEYBOARDS

MULTIPURPOSE KEYBOARDS
28 Keys — Touch Tone
No schematic needed. Calculator use or re-arrange (page 97) key tops. (See touch tone or any computer application). This unit may be cut apart for smaller units. **\$2.95**

WIRE WRAP WIRE

AWG	COLOR	25 FT. MIN.	50 FT.	100 FT.	1000 FT.
30 AWG	WHITE	\$2.10	\$2.75	\$3.50	\$24.00
30 AWG	YELLOW	2.10	2.75	3.50	24.00
30 AWG	RED	2.10	2.75	3.50	24.00
30 AWG	GREEN	2.10	2.75	3.50	24.00
30 AWG	BLUE	2.10	2.75	3.50	24.00
30 AWG	BLACK	2.10	2.75	3.50	24.00

STANDARD WIRE

AWG	COLOR	25 FT MIN	50 FT	AWG	COLOR	25 FT MIN	50 FT
16	RED	\$3.20	\$5.05	24	RED	\$1.55	\$2.05
18	GREEN	\$3.25	\$4.30	26	GREEN	\$1.45	\$1.90
20	WHITE	\$7.55	\$3.40	28	WHITE	\$1.25	\$1.65
22	BLACK	\$1.90	\$2.55	30	BLACK	\$1.25	\$1.65

6' 2 CONDUCTOR POWER CORDS 125V @ 5A 3/1\$

NUMBER	LENGTH	AWG	O.D.	RATING	COLOR	PRICE
17236	6	18(41X34)	265	1250W 10A-125V	BLACK Special	.99 ea.
17237	6	18(41X35)	253	1250W 10A-125V	GREY	1.25
17238	6	18(41X34)	265	1250W 10A-125V	BLACK Special	.99 ea.
17239	8	18(41X34)	253	1250W 10A-125V	GREY	1.30
17000	4	18(41X34)	253	1250W 10A-125V	BLACK	.59

Satisfaction Guaranteed. \$5.00 Min. Order. U.S. Funds. California Residents — Add 6% Sales Tax. Write for FREE 1976 Catalog — Data Sheets. 25¢ each

JAMES

P.O. BOX 822, BELMONT, CA. 94002
PHONE ORDERS — (415) 592-8097

JE SERIES KITS

JE801 DVM

The JE801 is a three and one half digit, auto polarity digital voltmeter. In a kit form. It features several options not available in any commercial digital voltmeter. Its low cost is perhaps the most important feature, which is achieved by offering it in a kit form. A kit allows the unit to be used by small OEM's where cost effectiveness is an important factor, and by the hobbyist who has to be concerned with cost. The unit also features on card regulators, allowing it to be operated off a single plus and minus fifteen volt, unregulated power supply. The unit has a small size of three inches width, three and three quarters of an inch length, and one and a quarter inch height.

\$39.95 Per Kit printed circuit board

JE803 PROBE

The Logic Probe is a unit which is for the most part indispensable in trouble shooting logic families TTL, DTL, RTL, CMOS. It derives the power it needs to operate directly off of the circuit under test, drawing a scant 10 mA max. It uses a MAN3 regulator to indicate any of the following states by these symbols: (H) 1 (LOW) 0 (PULSE) P The Probe can detect high frequency pulses to 45 MHz. It can't be used at MOS levels or on circuit damage will result.

\$9.95 Per Kit printed circuit board

JE804, JE805 SUPPLIES

THE JE804 AND JE805 ARE POWER SUPPLIES MOUNTED ON A 1 1/4 x 3" PC BOARD. THEY ARE AVAILABLE IN: ±5 @ 300 mA, ±6 @ 250 mA, ±12 @ 100 mA. SPECIFY VOLTAGE WHEN ORDERING.

\$9.95 per kit

JE700 CLOCK

The JE700 is a low cost digital clock, but is a very high quality unit. The unit features a simulated walnut case with dimensions of 6" x 2 1/2" x 1". It utilizes a MAN72 high brightness readout, and the MMS14 clock chip. **\$19.95**

12 or 24 Hour
115 VAC—
\$19.95 per kit.

WALL OR TV DIGITAL CLOCK

12 or 24 Hour 115 Vac 25" VIEWING DISTANCE
6 Digit LED DISPLAY (4) DEAF (2) MAN-7
KIT-All Comp. & Case **\$34.95**
Wired & Assembled **\$39.95**

JE010 CALC.

5 Functions
8-digit — business logic
Flattening decimal or fixed two-place add mode output (selectable)
Automatic mark up/down on percentage calculation
Automatic constant calculations
General calculations
Chain calculations
Repeat operations
Truss credit balance
Addressable Memory

OPTIONS:
115 VAC Transformer \$4.95 each
6 each "N" Alkaline Batteries \$2.50 lot

ELECTRONIC ROULETTE

Complete kit with all components case and transformer.
8" x 8" x 1"
A 56 page book on the facts of Roulette included. **\$29.95 Per Kit**

ELECTRONIC CRAPS

Complete kit with all components case and transformer.
6 1/2" x 3 1/2" x 1"
A 56 page book on the facts of Craps included. **\$19.95 Per Kit**

QUALITY ELECTRONIC COMPONENTS
— SAME DAY SERVICE —

NEW DISCOUNT SCHEDULE SAVES YOU EVEN MORE!

8080A \$69.50
MICROPROCESSOR
0-70°C 480 ns Clock Period

2102 \$3.50
1024 Bit Random Access Memory
500 ns Typical, 1000 ns Max Access Time

INTEGRATED CIRCUITS — TTL, CMOS, LINEAR & MOS

7400	24c	7451	22c	74155	77c	4018	\$1.44	4518	\$1.28
7401	24c	7452	22c	74156	77c	4019	\$1.44	4520	\$1.28
7402	24c	7453	22c	74157	77c	4020	\$1.44	4522	\$1.28
7403	24c	7460	22c	74160	\$1.19	4021	\$1.42	4528	90c
7404	24c	7470	34c	74161	\$1.11	4022	\$1.18	NES361	\$3.25
7405	24c	7472	34c	74162	\$1.19	4023	24c	NES40L	\$2.04
7406	24c	7473	31c	74163	\$1.19	4024	24c	NES50L	\$1.87
7407	24c	7474	31c	74164	\$1.28	4025	24c	NES54L	\$1.87
7408	24c	7475	51c	74174	\$1.09	4026	\$1.67	NES55V	48c
7409	24c	7476	34c	74175	\$1.02	4027	\$1.67	NES56A	88c
7410	24c	7480	68c	74176	77c	4028	\$1.04	NES57L	\$2.83
7411	24c	7482	68c	74181	\$2.13	4029	\$1.36	NES61B	\$3.83
7412	24c	7483	68c	74182	85c	4030	50c	NES62B	\$3.83
7413	24c	7485	\$1.11	74180	\$1.45	4033	\$1.67	NES65A	1.45
7414	\$1.02	7486	31c	4034	\$1.45	4034	24c	NES67L	\$1.28
7416	24c	74589	\$2.13	74192	\$1.19	4035	\$1.38	NES67V	\$1.36
7417	24c	7490	48c	74193	\$1.11	4040	\$1.60	uA709CA	43c
7420	24c	7491	77c	74194	\$1.11	4042	90c	uA709CV	43c
7421	24c	7492	48c	74195	\$1.11	4049	82c	uA711CA	37c
7425	65c	7493	48c	74279	56c	4043	67c	uA712CA	60c
7426	24c	7494	77c	8197	95c	4044	67c	uA712CA	60c
7428	43c	7495	85c	75150	\$1.40	4045	\$2.35	uA713CV	43c
7430	24c	7496	77c	4046	24c	4049	52c	uA748CV	68c
7432	43c	74100	\$1.24	4001	24c	4050	52c	uA748CV	41c
7433	31c	74107	31c	4002	24c	4051	\$1.44	MC1456V	\$1.00
7437	24c	74121	36c	4006	\$1.50	4052	\$1.44	MC1458V	\$1.00
7438	24c	74122	43c	4007	24c	4053	\$1.44	MC1300V	\$1.56
7440	24c	74123	78c	4008	\$1.17	4060	\$1.67	LM309K	\$1.28
7441	\$1.11	74125	39c	4009	64c	4066	90c	LM324N	\$1.80
7442	61c	74126	39c	4010	64c	4071	26c	uA780CU	\$1.25
7443	61c	74127	73c	4011	64c	4072	26c	uA780CU	\$1.25
7444	61c	74141	94c	4012	24c	4073	26c	uA780CU	\$1.25
7445	61c	74145	\$1.16	4013	50c	4075	26c	uA781CU	\$1.25
7446	77c	74150	\$1.36	501	\$1.58	4081	26c	uA781CU	\$1.25
7447	77c	74151	85c	4015	\$1.17	4082	26c	uA781CU	\$1.25
7448	85c	74153	77c	4016	50c	4502	\$1.26	uA782CU	\$1.25
7450	22c	74154	\$1.36	4017	\$1.26	4511	\$1.60	2102B	\$3.50

LED DISPLAYS

Your Choice of RED, GREEN or YELLOW

0.3" High... \$1.90 ea.	0.6" High... \$3.50 ea.
XAN72 RED C.A.	XAN672 RED C.A.
XAN52 GREEN C.C.	XAN652 GREEN C.C.
XAN82 YELLOW C.A.	XAN682 YELLOW C.C.
XAN74 RED C.C.	XAN674 RED C.C.
XAN54 GREEN C.C.	XAN654 GREEN C.C.
XAN84 YELLOW C.C.	XAN684 YELLOW C.C.

SILICON TRANSISTORS

2N1018	21c	\$17.85/C	MP3363BA	16c	\$13.60/C	PM8888	16c	\$13.60/C
2N1019	16c	\$13.60/C	2N3640	21c	\$17.85/C	2N5089	16c	\$13.60/C
MP32222A	16c	\$13.60/C	MP33641	16c	\$13.60/C	2N5129	21c	\$17.85/C
MP32259A	16c	\$13.60/C	MP33643	16c	\$13.60/C	2N5133	21c	\$17.85/C
MP32272	16c	\$13.60/C	2N3645	16c	\$17.85/C	2N5134	21c	\$17.85/C
MP32907A	16c	\$13.60/C	MP33646	16c	\$13.60/C	2N5137	21c	\$17.85/C
2N3055	99c	\$85.00/C	2N3904	16c	\$13.60/C	2N5138	21c	\$17.85/C
MP33392	16c	\$13.60/C	2N3906	16c	\$13.60/C	2N5139	21c	\$17.85/C
MP33393	16c	\$13.60/C	2N4124	16c	\$13.60/C	2N5210	16c	\$12.60/C
MP33394	16c	\$13.60/C	2N4126	16c	\$13.60/C	2N5457	52c	\$44.20/C
MP33395	16c	\$13.60/C	2N4401	16c	\$13.60/C	MP1062	16c	\$13.60/C
2N3563	21c	\$17.85/C	2N4403	16c	\$13.60/C	MP1072	48c	\$40.80/C
MP33565	16c	\$13.60/C	2N4410	16c	\$13.60/C	BM5113	40c	\$34.00/C
MP33638	16c	\$13.60/C				CI0618	55c	\$50.00/C

ELECTROLYTIC CAPACITORS

Radial Lead		Axial Lead		Axial Lead				
1uF/50v	8c	\$ 5.40/C	1uF/50v	11c	\$ 7.70/C	47uF/25v	17c	\$11.20/C
2.2uF/50v	8c	\$ 5.40/C	3.3uF/50v	12c	\$ 7.90/C	100uF/16v	17c	\$11.20/C
3.3uF/50v	8c	\$ 5.40/C	3.3uF/50v	12c	\$ 7.90/C	100uF/25v	20c	\$13.30/C
4.7uF/50v	8c	\$ 5.40/C	4.7uF/50v	12c	\$ 7.90/C	220uF/16v	29c	\$19.70/C
10uF/25v	8c	\$ 5.70/C	10uF/16v	11c	\$ 7.70/C	220uF/25v	29c	\$20.00/C
10uF/50v	10c	\$ 6.60/C	10uF/25v	12c	\$ 8.30/C	330uF/16v	29c	\$20.00/C
22uF/25v	9c	\$ 6.10/C	10uF/50v	14c	\$ 9.60/C	330uF/25v	32c	\$21.60/C
22uF/50v	12c	\$ 8.50/C	22uF/16v	13c	\$ 8.30/C	470uF/16v	36c	\$23.50/C
100uF/16v	9c	\$ 6.30/C	22uF/25v	13c	\$ 8.70/C	470uF/25v	37c	\$25.40/C
100uF/16v	11c	\$ 7.30/C	33uF/16v	12c	\$ 8.50/C	1000uF/16v	39c	\$26.60/C
100uF/25v	13c	\$ 9.20/C	33uF/25v	14c	\$ 9.60/C	1000uF/25v	58c	\$38.20/C
			47uF/16v	14c	\$ 9.60/C	2200uF/16v	62c	\$42.00/C

DISC CAPS

2200p/500v	4c	\$ 6.09/2C	01uF/500v	6c	\$ 8.59/2C
1000p/300v	4c	\$ 6.09/2C	01uF/50v	3c	\$ 4.05/2C
4700p/500v	4c	\$ 6.09/2C	022uF/25v	3c	\$ 7.73/2C
1000p/500v	4c	\$ 6.22/2C	047uF/25v	5c	\$ 4.73/2C
4700p/500v	4c	\$ 5.41/2C	1uF/25v	6c	\$10.57/2C

SILICON DIODES

1N4148	40/10	\$3.50/C	1N4004	70/10	\$5.95/C
1N4001	64/10	\$5.50/C	1N4005	87/10	\$7.05/C
1N4002	66/10	\$5.61/C	1N4006	90/10	\$7.33/C
1N4003	68/10	\$5.76/C	1N4007	99/10	\$8.59/C

1/2 WATT ZENER DIODES

1N5226B	3.3v	15c	\$11/C	1N5236B	7.5v	15c	\$11/C
1N5227B	3.6v	15c	\$11/C	1N5237B	8.2v	15c	\$11/C
1N5228B	3.9v	15c	\$11/C	1N5238B	9.1v	15c	\$11/C
1N5229B	4.3v	15c	\$11/C	1N5239B	9.1v	15c	\$11/C
1N5230B	4.7v	15c	\$11/C	1N5240B	10v	15c	\$11/C
1N5231B	5.1v	15c	\$11/C	1N5241B	11v	15c	\$11/C
1N5232B	5.6v	15c	\$11/C	1N5242B	12v	15c	\$11/C
1N5233B	6.0v	15c	\$11/C	1N5243B	13v	15c	\$11/C
1N5234B	6.2v	15c	\$11/C	1N5244B	14v	15c	\$11/C
1N5235B	6.8v	15c	\$11/C	1N5245B	15v	15c	\$11/C

REED RELAYS

6 AMP SPST N.O. CONTACTS	
5 V. Coil... \$1.70	\$125/C
6 V. Coil... \$3.70	\$125/C
12 V. Coil... \$1.70	\$125/C
24V. Coil... \$1.70	\$125/C

HARDWARE

2-56 1/4 Screw	99c	\$7.20/M
2-56 1/2 Screw	99c	\$7.65/M
4-40 1/4 Screw	55c	\$3.60/M
4-40 1/2 Screw	60c	\$4.05/M
6-32 1/8 Screw	65c	\$4.40/M
6-32 1/2 Screw	75c	\$4.85/M
8-32 3/8 Screw	90c	\$5.85/M
2-56 Hex Nut	55c	\$3.60/M
4-40 Hex Nut	55c	\$3.75/M
6-32 Hex Nut	60c	\$4.00/M
8-32 Hex Nut	60c	\$4.15/M
No. 2 Lockwasher	85c	\$5.75/M
No. 4 Lockwasher	85c	\$5.75/M
No. 6 Lockwasher	85c	\$5.75/M
No. 8 Lockwasher	85c	\$5.75/M

I.C. SOCKETS

8 Pin Solder Tab	17c
14 Pin Solder Tab	20c
16 Pin Solder Tab	22c
18 Pin Solder Tab	29c
24 Pin Solder Tab	38c
26 Pin Solder Tab	45c
40 Pin Solder Tab	63c
8 Pin Wire-Wrap	34c
14 Pin Wire-Wrap	52c
16 Pin Wire-Wrap	58c
18 Pin Wire-Wrap	60c
24 Pin Wire-Wrap	76c
28 Pin Wire-Wrap	82c
40 Pin Wire-Wrap	91c

M 6800 \$85

KIT-6800, 2-6810, 2-6820, 6830, 6850, APPLICATIONS & PROGRAM MANUALS—\$175

R-K ASSOCIATES Box 440
11900 CARLTON R. CLE., OH. 44106

INTEL 8080 users. Get pocket reference card similar to IBM S/370 yellow card. \$1.25 or 5 for \$5.00. 8080 CARD, 29 Hoyt St., Stamford, CT. 06905.

COMPUTER, 8 bit serial, complete. \$225. Scope display generator, 128 characters, parallel input. \$85. Brochure 10 cents. RAECO, Box 14, Readville, Mass. 02137.

PRECISION, Adjustable, solid state power supply. ±15VDC at 1-1/2amps, regulated simultaneously with 10VDC at 3amps unregulated, plus over 900 parts worth \$400.00. 120 transistors. Semiconductor characteristics, circuit diagrams included. New Cartrivision VTR electronic units. \$19.95 plus \$1.50 shipping. 50 cents for brochure. Madison Electronics Company, Inc., Box 369, D55, Madison, Alabama 35758.

PAIA ELECTRONICS, INC.

The GNOME Micro-Synthesizer Kit

- *VCO *VCA
- *VCF *NOISE
- *2 Function Generators
- *Ribbon Controller
- *32pg. Using Manual
- *in a hand-held battery powered package

\$48.95 plus shipping and insurance 6 lbs.

The Perfect LOW COST INTRODUCTION TO ELECTRONIC MUSIC SYNTHESIZERS

send for our FREE catalog
PAIA Electronics, Inc.
Box C-14359 Oklahoma City, Ok. 73114

COMPUTER, PERIPHERAL, TECHNICAL Reports; Project Supplies; Kits. Catalog 751A, 50 cents. E/S Lab, Box 738, College Park, Maryland 20740.

CB RADIO, Scanners, Antennas. The best for less. Free List. Capitol Sound, Box 3523, Des Moines, Iowa 50322.

YOU WANT TO BUILD IT: WE WANT TO HELP. WE SELL CONSTRUCTION PLANS with an Engineering Service. TELEPHONE: Answering Machines, Speakerphones, Carphones, PhoneVIsion, Touch Button Dialers. TELEVISION: VTR, 1" Color TV Set, PONG, \$25.00 Camera, COLOR PROJECTION TV. HOBBYIST: Electron Microscope, \$75 software programmable computer. BROADCAST: Special Effects Generator, Chroma Key, Audio Board, D.A. COURSES: Telephone Engineering \$52.00, Detective Electronics \$29.50, IC Engineering \$65.00. PLUS MUCH MORE. New Super Hobby Catalog PLUS year's subscription to Electronic News Letter AIR MAILED \$1.00. Don Britton Enterprises, 6200 Wilshire Blvd., Los Angeles, Calif. 90048.

FREE CATALOG. Ultrasonic Devices, LEDs, Transistors, IC's, Keyboards, Digital Thermometers, Unique Components. Chaney's, Box 15431, Lakewood, Colo. 80215.

SEMICONDUCTOR AND PARTS Catalogue from the semiconductor specialists. J & J Electronics, Box 1437, Winnipeg, Manitoba, Canada, U.S. inquiries.

ELECTRONIC ignition: Pointless, Transistor, Capacitor, Vapor inductors, Auburn Sparkplugs. Information 10 cents Anderson Engineering, Epsom, N.H. 03234.

TV PING PONG game. Plays through your set's antenna terminals: Plans \$3.25. ARS SYSTEMS, Box 1922, Sunnyvale, CA 94088.

6 MHZ CRYSTALS including schematic and info to generate 60 hz-12VAC to make your digital clock run on batteries. \$10.50 pp in U.S. Eastern Sales, Box 510, Raleigh, N.C. 27602.

FREE CATALOG. Kits and components. ELS Electronics, Box 581, Westbury, N.Y. 11590.

SAVE—TYPE AA NICKEL CADMIUM BATTERIES. Stock up now on these fully guaranteed, rechargeable nickel cadmium AA Batteries. Ideal for calculators and other electronic devices. American made. Available at \$1.35 apiece as unit cells or \$1.50 apiece assembled into battery packs. Large quantity discounts and distributors inquiries invited. Order Today! Telecommunication Devices, Inc., 111 E. Chicago Ave., Westmont, Ill. 60559. (312) 971-3460.

INTRODUCING THE SOURCE NOISE SUPPRESSOR—AND SILENCE. Silence is as much a part of music as sound. If instead of silence you hear hiss, you need the Source Noise Suppressor. Quiets any audio source (even 78's) up to 20db without muffling highs. Stereo in walnut cabinet with shipping prepaid \$250. Source Engineering, Box 506, Wilmington, Mass. 01887.

Olson Electronics Parts and Accessories

Standard Personal ALARMS Heavy Duty Professional

• Belt Or Shoulder Attachment **\$7**

• Loud Screaming Siren **\$9**

• Extra Loud Trumpet Speaker **\$11**

Complete personal protection. Push-button Alarm. XM-482. Wt. 1 lb.

Louder and longer sound. Leatherette case. XM-483. Wt. 2 lbs.

Approximately 135.5 decibels. XM-484. Wt. 2 lbs.

DUAL IN-LINE IC'S

Made in U.S. These IC's are guaranteed against defects. With diagram. Shpg. wt. 1/4 lb.

LOW AS 29c

Type 7400 Quad 2-Input Pos. NAND Gate. High speed, diode-clamped inputs. **29c**

Type 7401 Quad 2-Input Pos. NOR Gate. Low-noise. Propagation delay. 12 ns. **29c**

Type 7402 Quad 2-Input Pos. NOR Gate. Low-noise. Propagation delay. 12 ns. **29c**

Type 7403 Hex Inverter. Low noise, low power dissipation. **29c**

Type 7410 Triple 3-Input Pos. NAND Gate. Low output impedance. diode-clamped inputs. **29c**

Type 7431 Dual J-K Master / Slave Flip-Flop. **59c**

Type 7473 Dual J-K Master / Slave Flip-Flop. **39c**

Type 7474 Dual D-Type Edge Triggered Flip-Flop. **39c**

Type 7475 4-Bit Latch. Temp. stores binary coded info. **79c**

Type 7490 Decade Counter. Binary coded decimal counter with symmetrical divide. **79c**

BIG 5 LB. Surprise Kit

Resistors, capacitors — most wanted parts and hardware. **\$1**

XX-196. 5 lbs.

BIG 1 LB. Resistor Kit

Over 400 pieces of 1/4, 1/2, 1 watt sizes. All color coded. 2 1/2 lbs. **99c**

RS-239. 99c

NEW PRODUCTS

PROTO BOARDS

Build & test circuits as fast as you think!

PB100	10 IC cap breadboard kit, 4.5 x 6.0 x 1.35"	\$19.95
PB101	10 14-DIP cap, 4-way post, 940 solderless tie points, 5.8 x 4.5"	\$29.95
PB102	12 14-DIP cap, like PB101 with 2,240 tie points, 7.0 x 4.5"	\$39.95
PB103	24 14-DIP cap, 4 5-way posts, 1,250 tie points, 6.0 x 9.0"	\$59.95
PB104	32 14-DIP cap, 3060 solderless tie points, 8.0 x 9.76"	\$79.95

PROTO-CLIP
For power on/hands-off signal tracing. Bring IC leads up from PC board surface for fast troubleshooting.

LOGIC MONITOR
Simultaneously displays static and dynamic logic states of DTL, TTL, HTL or CMOS DIP ICs. Pocket size. \$84.95.

SOCKETS & BUS STRIPS

Plug-in, wire, test, modify or expand without patch cords or solder. Snap together to form breadboard needed.

PN/Description	L. Hole-to-Hole Term's	Price
QT595 Socket	6.5" 6.2"	118 \$12.50
QT598 Bus	6.5" 6.2"	20 2.50
QT475 Socket	5.3" 5.0"	94 10.00
QT365 Socket	2.3" 2.0"	16 2.25
QT355 Socket	4.1" 3.8"	70 8.50
QT358 Bus	4.1" 3.8"	12 2.00
QT185 Socket	2.4" 2.1"	36 4.75
QT125 Socket	1.8" 1.5"	24 3.75
QT85 Socket	1.4" 1.1"	16 3.25
QT75 Socket	1.3" 1.0"	14 3.00

7400N TTL

7400N	\$1.13	7443N	.95	74104N	1.20	74165N	1.30
7401N	.16	7444N	.72	74105N	.50	74166N	1.30
7402N	.14	7445N	.90	74107N	.30	74170N	2.50
7403N	.16	7446N	.90	74109N	.90	74171N	1.50
7404N	.19	7447N	.77	74110N	.72	74174N	1.10
7405N	.20	7448N	.80	74114N	.93	74175N	1.20
7406N	.29	7449N	.16	74118N	1.52	74176N	1.25
7407N	.21	7450N	.16	74121N	.45	74177N	1.40
7408N	.18	7453N	.16	74122N	.45	74180N	.73
7409N	.20	7454N	.16	74123N	.70	74181N	3.00
7410N	.18	7460N	.16	74125N	.50	74182N	.70
7411N	.26	7470N	.30	74126N	.50	74184N	2.00
7412N	.33	7472N	.32	74128N	.40	74193N	1.00
7413N	.58	7473N	.37	74132N	1.00	74188N	4.80
7414N	1.05	7474N	.32	74136N	.95	74190N	1.20
7415N	.28	7475N	.50	74141N	1.20	74191N	1.10
7416N	.33	7476N	.32	74145N	1.00	74192N	1.10
7417N	.21	7480N	.50	74147N	1.40	74193N	1.00
7418N	.33	7481N	1.18	74148N	1.80	74194N	1.15
7419N	.50	7482N	.89	74150N	1.00	74195N	.80
7420N	.50	7483N	.66	74151N	.80	74196N	1.70
7421N	.34	7484N	.30	74152N	1.40	74197N	.80
7422N	.25	7485N	1.20	74153N	1.00	74198N	1.75
7423N	.31	7486N	.35	74154N	1.40	74199N	1.40
7424N	.50	7489N	2.25	74155N	1.00	74200N	5.60
7425N	.20	7490N	.56	74156N	1.18	74221N	1.70
7426N	.33	7491N	.90	74157N	1.00	74222N	1.70
7427N	.35	7492N	.55	74158N	1.20	74278N	2.95
7428N	.33	7493N	.58	74160N	1.30	74279N	.90
7429N	.38	7494N	.80	74161N	1.20	74293N	1.00
7430N	.38	7495N	.78	74162N	.40	74298N	2.20
7431N	.60	7496N	.75	74163N	1.40		
7432N	.50	74100N	1.00	74164N	1.30		
7442N	.50						

HIGH SPEED TTL

74H00N	\$.33	74H20N	.33	74H53N	.36	74H73N	.90
74H01N	.25	74H24N	.33	74H54N	.36	74H74N	.87
74H02N	.30	74H22N	.33	74H55N	.36	74H75N	.90
74H03N	.33	74H30N	.33	74H56N	.36	74H101N	.80
74H05N	.33	74H40N	.36	74H61N	.36	74H102N	.80
74H08N	.40	74H60N	.36	74H62N	.36	74H103N	1.10
74H10N	.33	74H81N	.36	74H71N	.80	74H106N	.95
74H11N	.33	74H82N	.36	74H72N	.74		

LOW POWER TTL

74L00N	\$.31	74L10N	.33	74L51N	.34	74L90N	1.62
74L02N	.33	74L20N	.74	74L52N	.80	74L93N	.74
74L03N	.39	74L42N	1.49	74L74N	.90	74L95N	1.62
74L04N	.33						

74LS

74LS00	.46	74LS27	.50	74LS112	.58	74LS170	5.80
74LS01	.58	74LS30	.46	74LS113	.92	74LS174	2.20
74LS02	.46	74LS32	.50	74LS138	2.06	74LS175	2.42
74LS03	.50	74LS38	.46	74LS139	2.06	74LS181	7.00
74LS04	.50	74LS51	.60	74LS151	1.92	74LS194	2.40
74LS08	.46	74LS54	.48	74LS153	1.92	74LS195A	2.40
74LS09	.58	74LS55	.58	74LS157	1.68	74LS196	2.76
74LS10	.46	74LS73	.58	74LS159	1.68	74LS251	2.06
74LS11	.46	74LS74	.58	74LS160	3.06	74LS253	2.42
74LS15	.58	74LS76	.92	74LS161	3.06	74LS257	2.06
74LS20	.46	74LS78	.92	74LS162	3.06	74LS258	2.06
74LS21	.58	74LS107	.92	74LS163	2.90	74LS260	.58
74LS22	.58	74LS109	.92				

SCHOTTKY TTL

74S00N	\$.44	74S11N	.80	74S140N	.80	74S189N	4.40
74S02N	.60	74S64N	.80	74S151N	2.20	74S194N	3.30
74S03N	.75	74S74N	1.20	74S153N	3.40	74S195N	3.30
74S04N	.55	74S85N	6.10	74S157N	2.40	74S251N	2.20
74S08N	.80	74S86N	2.50	74S158N	2.20	74S253N	2.40
74S10N	.65	74S111N	1.00	74S160N	3.00	74S257N	2.40
74S11N	.65	74S113N	1.50	74S161N	4.70	74S258N	2.40
74S20N	.65	74S132N	3.60	74S174N	3.30	74S260N	1.20
74S30N	.80	74S133N	.80	74S175N	2.90	74S280N	5.70
74S32N	.80	74S138N	2.20	74S181N	8.40	74S289N	4.00
74S40N	.65	74S139N	.92				

9300 SERIES

9300PC	\$1.00	9318PC	2.30	9366PC	1.75	93L18	3.50
9301PC	1.20	9321PC	1.20	9301L	1.50	93L21	1.50
9304PC	1.50	9322PC	1.50	93L01	1.60	93L22	1.50
9306PC	6.90	9324PC	2.00	93L08	3.20	93L24	2.80
9308PC	2.50	9328PC	2.50	93L09	1.80	93L28	3.70
9309PC	1.60	9334PC	2.95	93L10	2.80	93L34	4.00
9310PC	1.50	9335PC	3.20	93L11	4.20	93L35	4.20
9311PC	2.30	9340PC	6.00	93L12	1.80	93L40	6.50
9312PC	1.20	9341PC	4.10	93L14	1.70	93L41	6.50
9314PC	1.30	9342PC	1.15	93L16	3.20	93L60	3.00
9316PC	1.50	9360PC	1.75	93L18	3.50	93L66	2.70

AUDIO AMPS

TYPE	V	W	Ω	PRICE
LM382	6-15	1.15	8	1.60
TAA611B12	6-15	1.15	8	1.60
TAA621A12	6-27	1.40	8	2.00
TAA641B11	6-18	2.20	8	2.00
TBA800	5-30	4.70	4	3.00
TBA810AS	4-20	2.50	4	3.00
TBA820	3-16	1.75	4	2.00
TCA830	5-20	2.00	4	2.00
TCA940	4-24	6.50	8	4.40

Prices effective through January 31, 1976. Minimum order: \$10.00. Add \$1.00 to cover postage and handling. California residents add 6% sales tax.

SEND CHECK OR MONEY ORDER TO:



Mail order: P.O. Box 2208P, Culver City, CA 90230. Phone order: (213) 641-4064. Visit our Electronic Shop: 11080 Jefferson Blvd., Culver City, CA (Studio Village Shopping Center). Prices may vary at over-the-counter locations.

H=TO-5	N=DIP	L=MINI-DIP	D=CER-DIP	K=TO-3	
LM114H	\$3.00	LM311D	.90	LM711CN	.90
LM300H	1.20	LM311M	1.75	LM711CN	.90
LM300L	1.20	LM312D	2.00	LM715CJ	3.50
LM301AH	.80	LM312H	2.50	LM715CJ	4.60
LM301AM	.80	LM318H	1.49	LM723CH	.60
LM301AN	1.10	LM318M	2.40	LM723CN	.65
LM301M	.90	LM324A	1.90	LM723CN	.70
LM301L	1.40	LM324B	2.20	LM727CH	2.00
LM302D	3.50	LM339N	2.90	LM726CJ	5.00
LM302N	1.30	LM320-5K	2.80	LM733CH	1.40
LM302H	1.40	LM320-5T	2.50	LM733CJ	3.50
LM304H	1.20	LM320-18K	2.80	LM733CN	3.30
LM304L	1.85	LM320-12T	2.50	LM741CJ	4.00
LM305AH	1.05	LM336K	2.40	LM741CJ	1.25
LM305N	1.00	LM340-05K	2.60	LM741CM	.39
LM306H	.95	LM340-06K	2.60	LM741CN	.70
LM307H	.60	LM340-08K	2.60	LM741CH	.70
LM307M	.95	LM340-10K	2.60	LM747CN	.90
LM307N	1.50	LM340-15K	2.60	LM747CD	2.50
LM308H	.85	LM340-18K	2.60	LM748CM	.55
LM308M	5.00	LM340-24K	2.60	LM748CN	.55
LM308N	2.00	LM355CM	.70	LM777CH	2.15
LM309H	1.20	LM556CM	1.30	LM777CM	2.10
LM309M	1.75	LM567CM	.70	LM3046CN	.95
LM309K	1.50	LM709CH	1.45	LM3054CN	1.50
LM310H	1.50	LM709CN	.45	SG4501T	2.40
LM310M	1.80	LM710CH	.90	SG4501N	2.40
LM311H	1.20	LM710CN	.90	LM500T	7.50

C-MOS		
1-9 10up	1-9 10up	1-9 10up
4000AE .26 .22	4023AE .26 .22	4053AE 1.34 1.33
4001AE .26 .22	4024AE .90 .88	4055AE 2.68 2.00
4002AE .26 .22	4025AE .26 .22	4055AE 2.43 1.86
4004AE 5.83 5.82	4026AE 3.72 3.70	4060AE 1.50 1.25
4006AE 1.35 1.34	4027AE .60 .50	4066AE .90 .72
4007AE .26 .22	4028AE .95 .90	4069AE .38 .34
4008AE 1.79		

SURPLUS. Receivers, Transmitters, Components, test equipment. Catalog free. E. French, 10 Alton, Aurora, Illinois 60538.

TV TECHNICIANS, SERVICEMEN, HOBBYISTS—Vista Model 740 Digital Crosshatch Generator. Compact crystal divider for lowest—priced ultra-stable 5x7 crosshatch or 56 dot patterns. AC powered, \$31.95 complete kit; \$41.95 assembled. Postpaid in USA, Canada. Information available free. Photolum Corporation, Dept. PE-16, 118 East 28th Street, New York, New York 10016.

CALCULATORS

TEXAS INSTRUMENTS CALCULATORS DISCOUNT HOT LINE Toll Free (800) 638-8906. Phone us long distance free for the low discount price on the Texas Instruments Calculator of your choice: SR-50A, SR-51A, SR-16, TI-2500 II, TI-1500, TI-2500, TI-2550, TI-5050. All of the great new Texas Instruments models. Capital Calculator Company, 701 East Gude Drive, Rockville, Maryland 20850. The discount super market for top brand name calculators. Mail and phone orders accepted. BankAmericard and Master Charge accepted.

PLANS AND KITS

NEW FROM EICO—Listen to official FCC-Licensed background music (SCA) on your FM radio without commercials. EC5000 Kit, \$12.95 Postpaid. M&K Electronic Corp., 135-33 Northern Blvd., Flushing, N. Y. 11354.

FREE CATALOGUE KITS, COMPONENTS. Audio equipment. Sinclair Kits, radio parts. Gladstone Electronics, 1736 Avenue RD., Toronto, Canada, M5M 3Y7. U.S. Inquiries.

NEW Capacitance Meter reads picofarads like ohmmeter reads ohms. Two I.C. battery circuit. Schematic, details \$2.00. C. Hall, Box 692, Addison, Texas 75001.

ELECTRONIC game kits. Creamed Chicken, ESP, LEDxce, others. Send Stamp. NBL-E, Box 1115, Richardson, Texas 75080.

SCIENCE kits for youngsters, information: Schubel & Son, Box 214848-Y, Sacramento, CA 95821.

TESLA COIL—40" SPARKS! Plans \$7.50. Information 75 cents. Huntington Electronics, Box 2009-P, Huntington, Conn. 06484.

ELECTRONIC ROULETTE: "Wheel of Fortune" shown in October's Popular Electronics. Complete kits, \$24.95 with same day shipments from Hostelt Electronics, 224 Opal Blvd., Steubenville, Ohio 43952.

AMAZING ELECTRONIC PRODUCTS

LASERS SUPER POWERED, RIFLE, PISTOL, POCKET SEE IN DARK - PYRO-TECHNICAL DE-BUGGING - UNCRACKERS - GIANT TESLA - STUNWAND - TV DISRUPTER - ENERGY PRODUCING, SCIENTIFIC DETECTION, ELECTRYFING, CHEMICAL ULTRASONIC, CB, AERO, AUTO AND MECH DEVICES, HUNDREDS MORE - ALL NEW PLUS INFO UNLTD PARTS SERVICE.

INFORMATION unlimited
Box 626 Lord Jeffery PZ. • Amherst, N. H. 03031

CATALOG \$1

BURGLAR ALARMS

BURGLAR ALARM dialing unit automatically calls police. \$29.95. Free literature. S&S Systems, 5619 St. John, Kansas City, MO 64123.

PRESSURE sensitive miniature cable for burglar alarm systems. Place under carpet in any contour for intrusion detection or secret switching. \$4.95 for twenty feet. Cable Switch Corp., Box 72-PE, West Long Branch, NJ 07764.

BURGLAR-FIRE alarm supplies and information. Free catalog. Protecto Alarm Sales, Box 357-G, Birch Run, Michigan 48415.

BURGLAR-FIRE ALARM Systems and information. Free Catalog. Vancor Security Systems, Box 438, Boston, Massachusetts 02144.

PROTECT your family against burglary-fire with a double duty alarm. Only \$8.95, guaranteed. Olivoco, 3737 Willett Ave., Bronx, N.Y. 10467.

HIGH FIDELITY

DIAMOND NEEDLES and Stereo Cartridges at Discount prices for Shure, Pickering, Stanton, Empire, Grado and ADC. Send for free catalog. LYLE CARTRIDGES, Dept. P, Box 69, Kensington Station, Brooklyn, New York 11218.

SAVE 50%. Build your own speaker systems featuring Norelco, Eminence and CTS. Famous brands from world's largest speaker factories at lowest wholesale prices. Write for free catalog of speakers and electronic accessories. McGee Radio & Electronic Corp., 1901 McGee Street, Kansas City, Missouri 64108.

SPEAKERS, build \$200 pair for \$40. Attractive fool-proof design. Plans \$2.00. Billman, 101 Valley View, Coquille, OR 97423.

WANTED

QUICKSILVER, Platinum, Silver, Gold, Ores Analyzed. Free Circular. Mercury Terminal, Norwood, Mass. 02062.

MICROTREK®

Microcomputer magazine pays well for microcomputer articles! Send standard self-addressed stamped envelope NOW for FREE AUTHOR'S KIT. Schneider Publications, 449 Elder Ln., N.W., Cedar Rapids, Iowa 52405.

TUBES

RADIO & T.V. Tubes—36 cents each. Send for free Catalog. Cornell, 4213 University, San Diego, Calif. 92105.

TUBES receiving, factory boxed, low prices, free price list. Transletronic, Inc., 1365 39th Street, Brooklyn, N.Y. 11218A, Telephone: 212-633-2800.

TUBES "Oldies", latest. Lists free. Steinmetz, 7519 Maplewood, Hammond, Indiana 46324.

CASH PAID FOR OLD TUBES AND AMPLIFIERS, RCA45, RCA50, WE300B, WE350B, MACINTOSH MC20, MC22, MC275, MARANTZ 7. Contact M. Takabe, Room 1816, 303 Fifth Ave., NYC 10016.

MUSICAL INSTRUMENTS

UP TO 60% DISCOUNT. Name brand instruments catalog. Freeport Music, 455N Route 110, Melville, N.Y. 11746.

WHOLESALE! Professional Guitars, PA Systems, Altec Speakers, 240W RMS Amplifiers. Free Catalog, Carvin, Escondido, Calif. 92028.

INTEL 8080 CPU\$89.00	TRANSISTOR SPECIALS		CMOS (DIODE CLAMPED)	
8080 BIT MICRO PROCESSING\$9.00	2N3585-NPN Si TO-66\$8.05	74C02--26 4012--24 4025--24	74C10--30 4013--45 4026--1.90	74C157--1.75 4015--1.24 4027--.55
CHIP (with Data Book)\$29.95	2N3772-NPN Si TO-3\$1.80	4001--24 4016--50 4028--.95	4002--24 4017--1.15 4030--.49	4006--1.35 4018--1.24 4035--1.50
2102-2 1024 BIT RAM\$2.95	2N490 PNP Si TO-3\$.85	4007--24 4019--50 4042--.75	4009--50 4022--1.24 4046--2.75	4010--50 4023--24 4047--3.50
5202A UV PROM\$12.50	2N6517 NPN Si TO-924/\$1.00	4011--24 4024--.95 4050--.49	4055--1.95	
MM5203 UV PROM\$12.50	2N5086 PNP Si TO-924/\$1.00	FCO 810 OPTO-ISOLATOR\$9.00		
5204-4R PROM\$24.95	2N4859 PNP TO-66\$.60	7 POLE SINGLE THROW TO-5		
1702A-UV PROM\$15.95	2N404 PNP GE TO-55/\$1.00	MINIATURE ROTARY SWITCH 5-30V,		
	2N3919 NPN Si TO-3 RF\$1.50	LOW CURRENT\$1.15		
MINIATURE TRIM POTS BOURNS 3009	MPSA13 NPN Si TO-923/\$1.00			
5K, 10K, 50K, 100K, 200K	2N3767 NPN Si TO-66\$.70			
100, 500	2N2222 NPN Si TO-185/\$1.00			
\$.75 ea. 3/\$2.00	2N3055 NPN Si TO-3\$.80			
MULTI-TURN TRIM POTS	2N3904 NPN Si TO-925/\$1.00			
Similar to Bourns 3010 style 3/16" x 1/8" x 1 1/4"; 50, 100, 2000, 10,000 ohms	2N3906 PNP Si TO-925/\$1.00			
	2N5296 NPN Si TO-220\$.50			
	2N6109 PNP Si TO-220\$.55			
	2N3866 NPN Si TO-5 Si RF\$.75			
	2N3638 NPN Si TO-55/\$1.00			
	2N2218A NPN Si TO-54/\$1.00			
LIGHT ACTIVATED SCR'S	CAPACITORS		DO-33-A 3 DIG. LED	
TO-18 200V 1A\$1.75	35V at 4.7 UF TANT 5/\$1.00	DO-33-A 3 DIG. LED	Full Wave Bridges	
PRINTED CIRCUIT BOARD	35V at 6.8 UF TANT 3/\$1.00	ARRAY READOUT\$1.35	PRV 2A 6A 25A	
4 1/2" x 6 1/2" single sided epoxy board, 1/16" thick, unetched	25V at 33 UF TANT\$.40	MAN-1 READOUT\$1.75	200 95 1.25 \$3.00	
\$.50 ea. 5/\$2.20	35V at .68 UF TANT 5/\$1.00	MAN-3 READOUT\$1.00	400 1.15 1.50 \$4.00	
VECTOR BOARD .1" SPACING	20V at 150 UF TANT\$.40	MAN-4 READOUT\$1.30	600 35 1.75 \$5.00	
4.5" x 6" SHEET\$1.50	5V 30 UF TANT\$.30	MAN-7 READOUT\$1.25		
	20V 4.7 UF ELECT\$.30	DL747\$3.50		
2N5460 P FET\$.45	FPA 711-7 LEVEL DIODE ARRAY		4 WATT IR LASER DIDDE\$7.95	
TIS 73 N FET\$.45	OPTICAL TAPE READERS\$5.95		CD 110 LINEAR 256 X1 BIT SELF SCANNING	
2N4891 UJT\$.45	CD201 100x100 CHARGED COUPLE DEVICES\$145.00		CHARGED COUPLED DEVIWE, WITH DATA\$125.00	
ER900 TRIGGER DIODES\$4/\$1.00	MM MOS SERIES		SANKEN AUDIO POWER AMPS	
2N6028 PROG. UJT\$.50	MM1402-3.75 MM5018-4.75 MM5060-4.95	MM1403-3.75 MM5050-3.75 MM5061-4.30	SI 1010 G 10 WATTS\$ 6.90	
	MM1404-3.75 MM5055-4.00 MM5059-2.95	MM5013-7.75 MM5056-4.00 MM5555-6.25	SI 1020 G 20 WATTS\$3.95	
	MM5016-3.50 MM5057-4.00 MM5556-6.25	MM5017-4.75 MM5058-4.95	SI 1050 G 50 WATTS\$24.95	
VERIPAX PC BOARD	TTL IC SERIES		LINEAR CIRCUITS	
This board is a 1/16" single sided paper epoxy board 4 1/2" x 6 1/2", DRILL LED and ETCHED which will hold up to 21 single 14 pin IC's or 8, 16 or LSI DIP IC's with buses for power supply connector.\$5.25	74100--26 7476--35	74101--14 7480--48	LM 309K 5V 1A REGULATOR\$1.35	
	7401--15 7482--75	7402--15 7485--1.05	723 240 .40V REGULATOR\$1.54	
	7403--15 7486--34	7404--18 7490--49	301/746 Hi Per Op Amp\$2.28	
	7405--18 7491--79	7406--35 7492--49	307 OP AMP\$2.28	
	7407--33 7493--49	7408--18 7495--74	CA 3047 - HI PERFORM OP AMP\$.95	
	7409--18 7496--79	7410--15 74107--34	CA 3088 FM IF SYSTEM\$3.25	
	7411--25 74121--38	7412--30 74123--74	LM 320T 12, 15 OR 24V NEG REGULATOR\$1.50	
	7413--45 74125--54	7414--15 74126--54	741A or 741C OP AMP\$.31	
	7415--33 74130--92	7416--33 74131--69	709C OPER AMP\$.25	
	7420--15 74153--79	7422--27 74154--1.05	340T-5, 8, 12, 15, 18, 24V POS REG. TO-220\$1.75	
	7425--24 74155--1.05	7426--24 74157--75	101 OPER. AMP, HI PERFORM\$.75	
	7427--15 74161--95	7428--27 74163--95	747--QUAL 741\$.65	
	7432--24 74164--1.10	7437--29 74165--1.10	558--QUAL TIMER\$1.30	
	7438--29 74167--1.10	7440--15 74173--35	540-70W POWER DRIVER\$2.50	
	7441--35 74175--95	7442--59 74177--75	LM 3900--QUAD OP AMP\$.49	
	7445--79 74181--2.30	7447--87 74192--1.10	LM 324--QUAD 741\$1.50	
	7446--87 74193--1.10	7448--85 74194--1.15	560--PHASE LOCK LOOP\$2.00	
	7449--78 74195--74	7472--28 74196--95	561--PHASE LOCK LOOP\$2.00	
	7473--34 74196--95	7474--35 75324--1.75	565--PHASE LOCK LOOP\$2.00	
	7475--49 75491--1.10		566 FUNCTION GEN\$2.00	
			567--TONE DECODER\$2.75	
			LM1310N STEREO DEMOD\$2.75	
			LM 370--AGC SQUELCH AMP\$.70	
			555--2 us - 2 HR. TIMER\$.53	
			553 QUAD TIMER\$3.50	
			1458 QUAD OP AMP\$.85	
			LM 380--2W AUDIO AMP\$1.10	
			LM 371--2W STEREO AUDIO AMP\$2.50	
			LM 381--STEREO PREAMP\$1.50	
			LM 382--QUAD AUDIO PREAMP\$1.50	
			LM 311--HI PER. COMPARATOR\$.95	
			LM 319--Dual Hi Speed Comp\$1.10	
			LM 339--QUAD COMPARETOR\$5.25	
			8038C IC VOLT CONT. OSC\$3.90	
		TRIACS	SCR'S	
		100 40 70 1.30 40 50 1.20	100 40 70 1.30 40 50 1.20	
		200 70 1.0 1.0 1.75 60 70 1.60	200 70 1.0 1.0 1.75 60 70 1.60	
		400 110 1.60 2.60 1.00 1.20 2.20	400 110 1.60 2.60 1.00 1.20 2.20	
		600 170 2.30 3.60 4.50 3.00	600 170 2.30 3.60 4.50 3.00	
		ALCO MINIATURE TOGGLE SWITCHES		
		MTA 106 SPDT\$1.50		
		MTA 206 DPDT\$2.25		

Terms: FOB Cambridge, Mass. Send Check or Money Order. Include Postage. Minimum Order \$5.00. COD's \$20.00.

SOLID STATE SALES WE SHIP OVER 95% OF OUR ORDERS THE DAY WE RECEIVE THEM

P.O. BOX 74A SOMERVILLE, MASS. 02143 TEL. (617) 547-4005

Poly Pak's

100'S OF BARRELS PURCHASED!

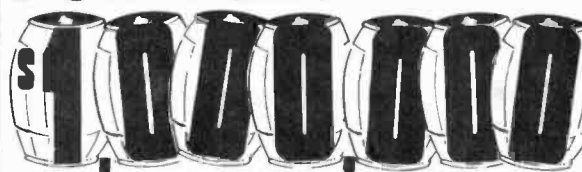

EXCLUSIVE 'BARREL'

THE BIGGEST INFLATION-FIGHTING VALUE EVER! TEST 'EM YOURSELF 'N SAVE!

Every kit carries money back guarantee.

Your choice of any kit
\$7.98

For the first time anywhere, Poly Pak merchandisers introduce a new way in buying the economical way. Raw stock from the "barrel". Remember the "good ole days"? They're back throughout the United States buy from various merchandisers... their own same. Therefore you are getting the same type of material as the RE-TESTERS DO!

BARREL KIT #1 SN7400 DIP IC'S 75 for \$1.98 Marked 14 and/or with 16 pin dips, may include gates, registers, flip flops, counters. Who knows! GUARANTEED SATISFACTION! Cat. No. 92CU2415	BARREL KIT #2 LINEAR OP AMPS, DIPS 75 for \$1.98 May include 709's, 741's, 703's, 680 series, 655 includes marked and unmarked. Cat. No. 92CU2416	BARREL KIT #3 1N4148/814 SWITCHING DIODES 100 for \$1.98 You never saw this before. Imagine famous switching diodes at this price! Cat. No. 92CU2418	BARREL KIT #4 "4000" RECTIFIERS 100 for \$1.98 These are the famous micro miniature rectifiers of the 1N4000 series. May include 25, 60, 100, 200, 400, 600, 800 and 1000 voltages. Cat. No. 92CU2417	BARREL KIT #5 SCRS, TRIACS, QUADRACS 40 for \$1.98 All the famous plastic power tab type. Raw factory stock! All the 10 amp types. Cat. No. 92CU2419	BARREL KIT #7 VOLUME CONTROL BONANZAI 40 for \$1.98 Singles, duals, variety of values, styles, big ones — small ones. 92CU2421	BARREL KIT #8 SUBMINIATURE IF TRANSFORMERS 60 for \$1.98 Amazing, includes 455kcs, ocs, antennas, who knows? From transistor radio manufacturers. No. 92CU2422			
BARREL KIT #10 ROMS-REGISTERS 50 for \$1.98 28 to 40 pin devices, marked. Internal factory numbers, etc. No. 92CU2424	BARREL KIT #11 POWER TAB TRANSISTORS 40 for \$1.98 NPN, plastic TO220 type. Assorted 2N numbers. Cat. No. 92CU2425	BARREL KIT #12 POWER TAB TRANSISTORS 40 for \$1.98 PNP, plastic TO220 type. Assorted 2N numbers. Cat. No. 92CU2426	BARREL KIT #13 RESISTOR NETWORKS 40 for \$1.98 By Corning Glass, in 14-pin dip packs. 92CU2427	BARREL KIT #14 PRECISION RESISTORS 200 for \$1.98 Marked and unmarked 1/2, 1/4, 2 watt. No. 92CU2428	BARREL KIT #15 MOSFET TRANSISTORS 60 for \$1.98 All 4 leaders TO-18 case, includes UHF transistors. Cat. No. 92CU2429	BARREL KIT #16 DISC CAPACITORS 200 for \$1.98 Marked and unmarked. Red case type ast. values. Cat. No. 92CU2430			
BARREL KIT #17 LINEAR & 7400 DIPS 100 for \$1.98 Marked and unmarked. Internal numbers of raw factory stock. No. 92CU2431	BARREL KIT #18 ZENER-RECTIFIER MIX 100 for \$1.98 Subminiature, DO7's, includes ast. zeners and rectifiers. It's mixed at the factory, we cannot separate. Cat. No. 92CU2432	BARREL KIT #19 DIPPED MYLARS 60 for \$1.98 Finest capacitors made, shiny finish, imagine factory sampling 'em in barrels. Cat. No. 92CU2597	BARREL KIT #20 LONG LEAD DISCS 100 for \$1.98 Factory distributor stock "action sale". Prime, marked only. Long leads. Cat. No. 92CU2598	BARREL KIT #23 "RTL" IC'S 75 for \$1.98 All in TO-5 cases, brand new. May include 908, 911, 912, 913, etc. 92CU2601	BARREL KIT #24 HIGH VOLTAGE RECTIFIERS 60 for \$1.98 Up to 12,000 volts, 4 mils. epoxy, axial leads. Cat. No. 92CU2602	BARREL KIT #25 METAL CAN TRANSISTORS 100 for \$1.98 Includes TO-5, TO-18, 18, etc., assorted 2N numbers, unmarked etc. Cat. No. 92CU2603			
BARREL KIT #26 PLASTIC TRANSISTORS 100 for \$1.98 Type TO-92 (TO-18), all manufacturers, variety of 2N's. Cat. No. 92CU2604	BARREL KIT #27 PREFORMED DISCS 100 for \$1.98 Hi-PI mica's shelf inventory but he dumped 'em in barrels. Preformed, for PC use. Mixed values too! Cat. No. 92CU2605	BARREL KIT #28 CERAMIC CAPACITORS 200 for \$1.98 Not only do the barrels contain dogbones, but factory dumped, Erie Central, moldings, types, too! Cat. No. 92CU2606	BARREL KIT #29 VITAMIN Q CAPS 100 for \$1.98 Every type of oil-impregnated caps, some worth \$2. But the "ole barrel" sale gives you the bargain-of-a-lifetime. 92CU2607	BARREL KIT #30 PREFORMED RESISTORS 200 for \$1.98 You've got barrels of 1/2 and 1/4 watters for pc use. You'll get even amount, 100's, 1/2, 100 1/2 watters. Cat. No. 92CU2608	BARREL KIT #31 METALLIC RESISTORS 100 for \$1.98 Made mostly by Corning, the finest resistor made. Mostly 1/2 watters, 1% to 5% tol. & a barrel of values. Cat. No. 92CU2609	BARREL KIT #32 TRANSISTORS WITH A HOLE IN IT 50 for \$1.98 Can't name factory but we bought barrels of 28 watters with mica hole in middle. PNP's and NPN's.			
BARREL KIT #34 TUBE SOCKETS 100 for \$1.98 Good ole tube sockets, still in demand! Barrels and barrels: 4's, 5's, 7's, 8, 9, even computer types. Cat. No. 92CU2612	BARREL KIT #35 NEON LAMPS 40 for \$1.98 Famous NE-2's. All prime, but factory made millions and barrels 'em. Your advantage. 92CU2613	BARREL KIT #36 GERMANIUM DIODES 200 for \$1.98 Famous maker, popular item. Never grows old. But this is the way the RE-TESTERS buy 'em from the factories. 92CU2614	BARREL KIT #37 1 AMP "BULLETT" RECTIFIERS 100 for \$1.98 Famous style, ast. voltages, silicon, axial includes all types of voltages to 3KV. Cat. No. 92CU2615	BARREL KIT #38 2 AMP RECTIFIERS 75 for \$1.98 "CYLINDER" type, silicon, Mallory, includes all voltages up to 1KV. Axial leads. Cat. No. 92CU2616	BARREL KIT #39 2N3055 HOBBY TRANSISTORS 15 for \$1.98 From factory to you, these fallouts of the famous 2N3055. We have 10 barrels. Cat. No. 92CU2617	BARREL KIT #40 PNP HIGH-POWER TRANSISTORS 20 for \$1.98 Popular germanium TO-3 case units, now available at "good ole barrel" prices. Cat. No. 92CU2618			
BARREL KIT #41 TO-98 SCRS 30 for \$1.98 IMAGINE! These popular TO-98 cases (mini TO-3), scrs, made up as barrel kit. Values to 600 volts. SILICON. Cat. No. 92CU2619	BARREL KIT #42 100 IIT "GLASS 4000" RECTIFIERS \$1.98 Just In! 1N4000 silicon rectifier in epoxy, now in glass encased at barrel prices \$0 to 100V. Cat. No. 92CU2620	BARREL KIT #46 G.E. 3.5 WATT AMPLIFIERS 25 for \$1.98 Hobby type, factory fallouts, we purchased them in barrels. These are unknowns. 92CU2624	BARREL KIT #48 744 MINI DIP "BONANZA" 50 for \$1.98 Barrels 'n barrels 'em. This is a buyer's market. How many can we get test ed? Cat. No. 92CU2626	BARREL KIT #49 QUADSI QUADS 50 for \$1.98 Imagine 4 mirror op amps in one package. Why the factory barreled these we don't know. 92CU2627	BARREL KIT #50 SIGNAL SILICON DIODES 200 for \$1.98 Includes many, many types of switching, signal silicon types, all axial leads. Some may be zeners. Cat. No. 92CU2628	BARREL KIT #51 HOBBY OPTO COUPLERS 30 for \$1.98 We bot 1,000's unknown both the sensor or transmit-ter may be good, or both. WE DON'T KNOW! We don't know the type, 150V isolation. Cat. No. 92CU2629			
BARREL KIT #53 DISCS! 500 for \$1.98 92CU2630 The bargain of a lifetime! First time ever offered by Poly Pak for the economy-minded bargain hunters.	BARREL KIT #53 JUMBO RESISTOR PAK 100-pc. \$1.98 No. 92CU2721 Assortment metal films, precision, carbons, metal oxide powers, from 1/2 watt to 7 watts. Color coded & marked. Worth \$10.	BARREL KIT #54 9 DIGIT READOUTS 10 for \$1.98 Bargain of a lifetime! All we got was 1 barrel — the "bicolor digit" types. Multi-plexed. Cat. No. 92CU2722	BARREL KIT #55 3 DIGIT READOUTS 15 for \$1.98 National cleaned its warehouse... now we have barrels of NSN-93 type readouts. Cat. No. 92CU2723	BARREL KIT #56 POWER! POWER! 100 for \$1.98 Large distributor cleaned power resistors 3 to 7 watts. Cat. No. 92CU2724	BARREL KIT #57 HI-POWER RECTIFIERS 15 for \$1.98 50-Amp studs: 6, 12, 24, 48V, 100% material, Factory rectifier "line" rejects. Cat. No. 92CU2725	BARREL KIT #58 SLIDE SWITCHES 30 for \$1.98 All shapes, sizes, apt. dpdt, momentaries, etc. Tremendous shop pak for 100's of switching projects. Cat. No. 92CU2726			
BARREL KIT #59 POWER TRANSISTORS 40 for \$1.98 18 watt Bendix B-5000 pellet transistors, non, all good, purchased from a pretester, have millions of 'em. Cat. No. 92CU2727	BARREL KIT #62 MIXED IC'S 100 for \$1.98 All shapes: 7400 Series, 8000, 9000, ROMS, RTL's, DTL's, linear of all kinds. What a mix! Have fun — Cat. No. 92CU2730	BARREL KIT #60 DTL'S IC'S 75 for \$1.98 This is prime barrel material. Who wants DTL's? 930, 935, 940's. Your gain is our loss. They're marked too. Cat. No. 92CU2728	BARREL KIT #61 POLYSTYRENE CAPS 100 for \$1.98 Finest caps made. As a grammar, we bought 10 barrels from factory, mixed values; all good. Cat. No. 92CU2729	BARREL KIT #64 6-DIGIT ARRAYS 20 for \$1.98 Here's a bargain! This is a National "dump"... inflation is stopped here! Cat. No. 92CU2732	BARREL KIT #65 MIXED READOUTS 30 for \$1.98 Factory returns — such numbers as MAN-5's, MAN-7's, MAN-3's, 11 barrels & no time to separate. Cat. No. 92CU2733	BARREL KIT #67 2-WATT AMPLIFIERS 50 for \$1.98 Buy from the barrel 'n save! LM-380 types in dip packs. Are they good? We don't know to find out. We got millions. Cat. No. 92CU2734			
BARREL KIT #68 2 WATERS 100 for \$1.98 Nobody seems to want 'em! So many suppliers don't count, but throw 'em in the barrel. It's a 1/2 mil size. All marked. 92CU2735	BARREL KIT #70 GIANT "LIGHT PIPE" \$1.98 Finished, with end-fittings. Polished, all perfect. Maker's overstock, 10-ft. long, 800 glass fibers in bundle. Jacket. Cat. No. 92CU2737	BARREL KIT #71 CAPACITOR SPECIAL 100 pcs. \$1.98 Empiled stockrooms into barrels of mylars, poly's, nicas, moideds, plastics, ceramics, diars, etc. Nifty shop supply. 92CU2738	BARREL KIT #72 TERMINALS, RECTIFIERS 150 for \$1.98 Maker of these dumped in to barrels. You get 2, 4, 6 strips & receptacles. What a buy! Cat. No. 92CU2739	BARREL KIT #73 ELECTROS ELECTROS 50 for \$1.98 It "bugs" us why the factories dump 'em in barrels. We don't wish to separate wide ast voltages & values up to 300 mf. 92CU2747	DOUBLE BARREL TWIN PAKS TWIN PAK #1 LED READOUTS 20 for \$1.98 10 Man-3's, 10 Man-7's. Cat. No. 92CU2626 TWIN PAK #4 ZENERS 100 for \$1.98 50 400-MW, 50 1-watt, 6, 8, 10, 12 to 16V. Cat. No. 92CU2629 TWIN PAK #9 8 & 9-DIGIT READOUTS 15 for \$1.98 10 6-digit, 15 for 6-digit. Cat. No. 92CU2834 TWIN PAK #10 POWER TABS 70 for \$1.98 40 Oxide 2-wattors, 30 Oxide 7-wattors. Cat. No. 92CU2835				
BARREL KIT #75 400MW ZENERS 100 for \$1.98 Factory out of big Amazing offer: 6, 8, 10, 12 to 15V. You test. Hermetically sealed glass pak. Double plug. Cat. No. 92CU2740	BARREL KIT #76 1-WATT ZENERS 100 for \$1.98 Factory same as 400-mw's. Never-to-use-gain offer, 6, 8, 10, 12, 15V, under 3 watt. Double plug. Cat. No. 92CU2741	BARREL KIT #77 "BROWN" BODY TRANSISTORS 40 for \$1.98 G-E 11-40 series: has voltage, Darlington's, hi-current, npn's. Factory line discontinued. Power tabs. Cat. No. 92CU2742	BARREL KIT #78 "RED" BODY TRANSISTORS 40 for \$1.98 D-42 series. You test — go into your own bin! High current, hi-V. NPN. Cat. No. 92CU2743	BARREL KIT #79 BROWN BODY POWER TABS 25 for \$1.98 Brown body, power tab Darlington's are mixed, raw factory stock. Why pay more? Cat. No. 92CU2744	BARREL KIT #80 HOBBY CAPS 200 for \$1.98 Production line stopped. Barrels of mylars, olla, tubulars, but unmarked with kinds of sizes, all good. You test. Cat. No. 92CU2745	BARREL KIT #81 SUBMINI RESISTORS 100 for \$1.98 PC, upright type, color coded, 1/2 watt. Ast values. Came to us in a barrel. Cat. No. 92CU2746	BARREL KIT #82 8000 SERIES IC'S 50 for \$1.98 By Navel. From factory to you. Assortment of popular series factory fallouts, overruns. Who knows? Cat. No. 92CU2834	BARREL KIT #83 LM-340T VOLT REGULATORS 15 for \$1.98 Factory rejected them for length of leads. May include 5, 6, 8, 12, 15, 18, 24 volts. Power tab. 92CU2835	BARREL KIT #84 MAN-3 25 for \$1.98 "THE CLAW", 5V 15 mils. 120 hobby of experimental use, for understanding the working of "mini" or calculator readouts. A argument may be missing. 92CU2876

DOUBLE BARREL TWIN PAKS

Terms: add postage. Rated: net 30.
Phone Orders: Wakefield, Mass. (617) 245-3829
Retail: 16-18 Del Carmine St., Wakefield, Mass.
(off Water Street) C.O.D.'S MAY BE PHONED

□ 20c CATALOG on Fiber Optics, IC's, Semi's, Parts
MINIMUM ORDER — \$4.00

POLY PAKS
P.O. BOX 642E, LYNNFIELD, MASS. 01940

HEAVY DUTY POWER SUPPLY

This power supply is surplus from a maker of computer peripherals. It has outputs of +5v @ 5 amps, -5v @ 500ma, +12v @ 2.5 amps, and -12v @ 200ma. All voltages are well filtered and regulated. Ideal for your micro or mini-computer. All are tested & working. 10 1/2" x 13 1/2" x 7" high, shipping weight 22 lbs. STOCK NO. P5312 \$34.95

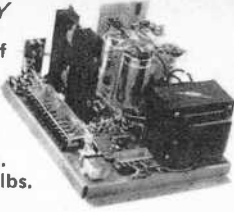

ALCO KNOBS FOR EVERY APPLICATION

Machined aluminum knobs with 2 setscrews. Clear anodized finish. Latest distributor price \$1.65 to 1.05 each.

ALCO NO	O.D. x HT.	DELTA NO.	PRICE
KS 500A	.500" x .625" w/skirt	P6176	.40 ea, 10/3.50
K 700A	.750" x .620"	P6177	.40 ea, 10/3.50
K 1250A	1.250" x .750"	P6178	.50 ea, 10/4.50



COMPLETE STEREO AMPLIFIER CHASSIS

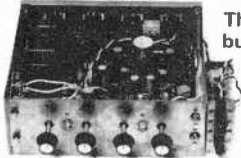

This complete stereo amplifier has 2 push button selected inputs, with indicator lights, and one has adjustable sensitivity. It has a transformer power supply, 15 watts per channel, and separate Volume, Bass, Treble, & Balance controls with knobs. Rugged steel chassis 11" wide, 8 1/2" deep, 3 1/2" high. Just needs 115v AC and speakers. Shipping weight 7 lbs. STOCK NO. P5286 Complete stereo amplifier \$19.95

MINIMUM ORDER \$5.00. Include sufficient postage, excess refunded. Send for new 88 page Catalog 15, bigger than ever.



BANKAMERICARD and MASTERCHARGE now accepted; minimum charge \$15.00. Please include all numbers. Phone orders accepted.



Enclose sufficient postage. Excess will be refunded. Send for our new catalog 14. 64 pages of electronic bargains.



DELTA ELECTRONICS CO.

BOX 1, LYNN, MASSACHUSETTS 01903
Phone (617) 388-4705

CIRCLE NO. 15 ON FREE INFORMATION CARD

ELECTRICAL SUPPLIES & EQUIPMENT

PLATING Equipment. Portable Platers. Supplies and "Know-How." Build your own tanks for nickel, chrome, etc. Easy-to-install PVC liners. Rectifier components—all sizes. Schematics, parts lists, formulas, operating instructions for all plating. Guaranteed to save you 25%-75%. Some good used units for sale. Write for details. Platers Service Company, 1511-PE Esperanza, Los Angeles, Calif. 90023.

TAPE AND RECORDERS

RENT 4-Track open reel tapes—all major labels—3,000 different — free brochure. Stereo-Parti, 55 St. James Drive, Santa Rosa, Ca. 95401

1930-1962 Radio Programs. Reels. \$1.00 Hour! Cassettes. \$1.00 Show! Mammoth Catalog. \$1.25. AM Treasures, Box 192PE, Babylon, N. Y. 11702.

RECORDS—TAPES! Discounts to 73%; all labels; no purchase obligations; newsletter, discount dividend certificates; 100% guarantees. Free details. Discount Music Club, 650 Main St., Dept 5-16, New Rochelle, New York, N. Y. 10801.

CLASSICAL CASSETTES! FREE CATALOG. Better quality. 50% less cost than records! CCC, Box 506PE, Saddle River, N. J. 07458.

PERSONALS

MAKE FRIENDS WORLDWIDE through international correspondence illustrated brochure free. Hermes, Berlin 11, Box 110660/ZD, Germany.

PH.D.'s. MASTER'S. BACHELOR'S — official nonresident College Degrees easily acquired through mailorder Universities. Revealing Directory — \$2. Counseling Connection, 5495 Claremont, No. BSG, Oakland, CA 94618.

MOVIE FILMS

8MM-SUPER 8-16MM MOVIES! Biggest Selection! Lowest Prices! Free Catalog! Cinema Eight, Box PE, Chester, Connecticut 06412.

For faster service

USE ZIP CODE

on all mail

CB SPECIALS—R.F. DRIVERS—R.F. POWER OUTPUTS—FETS

2SC481	1.85	2SC767	15.75	2SC866	5.85	2SC1449-1	1.60	40081	1.50
2SC482	1.75	2SC773	.85	2SC013	1.50	2SC475	1.50	40082	3.00
2SC495	1.10	2SC774	1.75	2SC1014	1.50	2SC1678	5.50	2SC608	7.90
2SC502	3.75	2SC775	2.75	2SC1017	1.50	2SC1679	4.75	SK3046	2.15
2SC517	4.75	2SC776	3.00	2SC1018	1.50	2SC1728	2.15	SK3047	3.75
2SC614	3.80	2SC777	4.75	2SC1173	1.25	2SC1760	2.15	SJ2095	3.50
2SC615	3.90	2SC778	3.25	2SC1226A	1.25	2SC1816	5.50	SK3048	3.25
2SC616	4.15	2SC797	2.50	2SC1237	4.50	2SC1908	.70	SK3054	1.25
2SC617	4.25	2SC798	3.10	2SC1239	3.50	2SC1957	1.50		
2SC699	4.75	2SC781	3.00	2SC1243	1.50	2SF8	3.00	2SK19	1.75
2SC710	.70	2SC789	1.00	2SC1306	4.75	HEP-S3001	3.25	2SK30	1.00
2SC711	.70	2SC796	3.15	2SC1306-1	4.90	2SD235	1.00	2SK33	1.20
2SC735	.70	2SC799	4.25	2SC1307	5.75	MRF8004	3.00		
2SC756	3.00	2SC802	3.75	2SC1307-1	6.00	4004	3.00	3SK40	2.75
2SC765	9.50	2SC803	4.00	2SC1377	5.50	4005	3.00	3SK45	2.75
2SC766	10.15	2SC839	.85	2SC1449	1.30	40080	1.25	3SK49	2.75

JAPANESE TRANSISTORS

2SA52	.60	2SB187	.60	2SC458	.70	2SC815	.75	2SC1569	1.25
2SA316	.75	2SB235	1.75	2SC460	.70	2SC828	.75	2SC1756	1.25
2SA473	.75	2SB303	.65	2SC478	.80	2SC829	.75		
2SA483	1.95	2SB324	1.00	2SC491	2.50	2SC830	1.60	2SD30	.95
2SA489	.80	2SB337	2.10	2SC497	1.60	2SC839	.85	2SD45	2.00
2SA490	.70	2SB367	1.60	2SC515	.80	2SC945	.65	2SD65	.75
2SA505	.70	2SB370	.65	2SC535	.75	2SC1010	.80	2SD68	.90
2SA564	.50	2SB405	.85	2SC536	.65	2SC1012	.80	2SD72	1.00
2SA628	.65	2SB407	1.65	2SC537	.70	2SC1051	2.50	2SD88	1.50
2SA643	.85	2SB415	.85	2SC563	2.50	2SC1061	1.65	2SD151	2.25
2SA647	2.75	2SB461	1.25	2SC605	1.00	2SC1079	3.75	2SD170	2.00
2SA673	.85	2SB463	1.65	2SC620	.80	2SC1096	1.20	2SD180	2.75
2SA679	3.75	2SB471	1.75	2SC627	1.75	2SC1098	1.15	2SD201	1.95
2SA682	.85	2SB474	1.50	2SC642	3.50	2SC1115	2.75	2SD218	4.75
2SA699	1.30	2SB476	1.25	2SC643	3.75	2SC1166	.70	2SD300	2.50
2SA699A	1.75	2SB481	2.10	2SC644	.70	2SC1170	4.00	2SD313	1.10
2SA705	.55	2SB492	1.25	2SC681	2.50	2SC1172B	4.25	2SD315	.75
2SA815	.85	2SB495	.95	2SC684	2.10	2SC1209	.55	2SD318	.95
2SA816	.85	2SB507	.90	2SC687	2.50	2SC1213	.75	2SD341	.95
		2SB511	.70	2SC696	2.35	2SC1226	1.25	2SD350	3.25
2SB22	.65			2SC712	.70	2SC1243	1.50	2SD352	.80
2SB54	.70	2SC206	1.00	2SC713	.70	2SC1293	.85	2SD380	5.70
2SB56	.70	2SC240	1.10	2SC732	.70	2SC1308	4.75	2SD389	.90
2SB77	.70	2SC261	.65	2SC733	.70	2SC1347	.80	2SD390	.75
2SB128	2.25	2SC291	.65	2SC739	.70	2SC1383	.75	2SD437	5.50
2SB135	.95	2SC320	2.00	2SC756	2.00	2SC1409	1.25		
2SB152	4.50	2SC352	.75	2SC762	1.90	2SC1410	1.25	C106B1	.50
2SB173	.55	2SC353	.75	2SC783	1.00	2SC1447	1.25		
2SB175	.55	2SC371	.70	2SC784	.70	2SC1448	1.25		
2SB178	1.00	2SC372	.70	2SC785	1.00	2SC1507	1.25		
2SB186	.60	2SC394	.70	2SC793	2.50	2SC1509	1.25		

POWER TRANSISTORS HIGH-VOLT. TV. TYPE

BU204	1300V	3.90	BU207	1300V	5.40	2SC1172B	1100V	4.25
BU205	1500V	4.70	BU208	1500V	6.25	2SC308	1100V	4.95
BU206	1700V	5.90	2SC1170	1100V	4.00	2SC1325	1100V	4.95

OEM SPECIALS

1N270	.10	2N960	.55	2N2219A	.30	2N2913	.75	2N3740	1.00	2N4401	.20
1N914	.10	2N962	.40	2N2221	.25	2N2914	1.20	2N3771	1.75	2N4402	.20
		2N967	.50	2N2221A	.30	2N2916A	3.65	2N3772	1.90	2N4403	.20
2N173	1.75	2N1136	1.35	2N2222	.25	2N3019	.50	2N3773	3.00	2N4409	.20
2N178	.90	2N1142	2.25	2N2222A	.30	2N3053	.30	2N3819	.32	2N4410	.25
2N327A	1.15	2N1302	.25	2N2270	.40	2N3054	.70	2N3823	.70	2N4416	.75
2N334	1.20	2N1305	.30	2N2322	1.00	2N3055	.75	2N3856	.20	2N4441	.85
2N336	.90	2N1377	.75	2N2323	1.00	2N3227	1.00	2N3866	.85	2N4442	.90
2N338A	1.05	2N1420	.20	2N2324	1.35	2N3247	3.40	2N3903	.20	2N4443	1.20
2N398B	.90	2N1483	.95	2N2325	2.00	2N3250	.50	2N3904	.20	2N4852	.55
2N404	.30	2N1540	.90	2N2326	2.85	2N3375	6.50	2N3905	.20	2N5061	.30
2N443	1.75	2N1543	2.70	2N2327	3.80	2N3393	.20	2N3906	.25	2N5064	.50
2N456	1.10	2N1544	.80	2N2328	4.20	2N3394	.17	2N3925	3.75	2N5130	.20
2N501A	3.00	2N1549	1.25	2N239	4.75	2N3414	.17	2N3954	3.50	2N5133	.15
2N508A	.45	2N1551	2.50	2N2368	.25	2N3415	.18	2N3954A	3.75	2N5138	.15
2N555	.85	2N1552	3.25	2N2369	.25	2N3416	.19	2N3955	2.45	2N5198	3.75
2N652A	.65	2N1554	1.25	2N2484	.32	2N3417	.20	2N3957	1.25	2N5294	.50
2N677C	6.00	2N557	.15	2N2712	.18	2N3442	1.85	2N3958	1.20	2N5296	.50
2N706	.25	2N1560	2.80	2N2894	.40	2N3553	1.50	2N4037	.60	2N5306	.20
2N706B	.40	2N1605	.35	2N2903	3.30	2N3563	.20	2N4093	.85	2N5354	.20
2N711	.50	2N1613	.30	2N2904	.25	2N3565	.20	2N4124	.20	2N5369	.20
2N711B	.60	2N1711	.30	2N2904A	.30	2N3638	.20	2N4126	.20	2N5400	.40
2N718	.25	2N1907	4.10	2N2905	.25	2N3642	.20	2N4141	.20	2N5401	.50
2N720A	.30	2N2060	1.85	2N2905A	.30	2N3643	.15	2N4142	.20	2N5457	.35
2N918	.35	2N2102	.40	2N2906	.25	2N3645	.15	2N4143	.20	2N5471	.25
2N930	.25	2N2218	.30	2N2906A	.30	2N3646	.14	2N4220A	.45	2N5474	.40
2N956	.30	2N2219A	.30	2N2907	.25	2N3730	1.50	2N4234	.95	2N5481	.50
		2N2219	.25	2N2907A	.30	2N3731	2.75	2N4400	.20	2N5482	.75

SILICON UNIJUNCTIONS

2N2646	.50
2N2647	.60
2N6027	.55
2N6028	.70
D5E37	.25

INTEGRATED CIRC.

UA703C	.40
709C OP. AMP.	.25
741C OP. AMP.	.25
7400	.15
7404AN	.18
7430N	.19
74100J	.35
74H55N	.35

RECTIFIERS

	10	100
IN4001	.60	5.00
IN4002	.70	6.00
IN4003	.80	7.00
IN4004	.90	8.00
IN4005	1.00	9.00
IN4006	1.10	10.00
IN4007	1.20	11.00



New-Tone Electronics
P.O. Box 1738 A
Bloomfield, N. J. 07003
Phone: (201) 762-9020

ALL PARTS GUARANTEED AND TESTED ON PREMISES.

N.J. residents add 5% sales tax. Minimum order \$5.00. All orders add \$1.00 postage. Dealers write or phone for discount prices.

FREE DATA SHEETS WITH EVERY ITEM 749 IC WITH EVERY \$10 ORDER*

- REDUCE YOUR PROJECT COSTS
- MONEY-BACK GUARANTEE
- 24-HOUR SHIPMENT
- ALL TESTED AND GUARANTEED

TRANSISTORS (NPN):

2N3563 TYPE RF Amp & Osc to 1 GHz (pl.2N918)	6/1.00
2N3565 TYPE Gen. Purpose High Gain (TO-92/106)	6/1.00
2N3567 TYPE High-Current Amplifier/Sw 500 mA	4/1.00
2N3866 TYPE RF Power Amp 1.5 W @ 450 MHz	1.50
2N3903 TYPE GP Amp & Sw to 100 mA and 30 MHz	6/1.00
2N3919 TYPE RF Power Amp 10-25 W @ 3-30 MHz	3.00
2N4274 TYPE Ultra-High Speed Switch 12 ns	4/1.00
MPS5515 TYPE High-Gain Amplifier hFE 250	3/1.00
Assort. NPN GP TYPES, e.g. 2N3694, 2N3903, etc. (15)	\$2.00
2N3638 TYPE (PNP) GP Amp & Sw to 300 mA	4/1.00
2N4249 TYPE (PNP) Low-Noise Amp 1µA to 50mA	4/1.00

FET's:

N-CHANNEL (LOW-NOISE)

2N4091 TYPE RF Amp & Switch (TO-18/106)	3/1.00
2N4416 TYPE RF Amplifier to 450 MHz (TO-72)	2/1.00
2N5163 TYPE GP. Purpose Amp & Sw (TO-106)	3/1.00
2N5486 TYPE RF Amp to 450 MHz (plastic 2N4416)	2/1.00
E100 TYPE Low-Cost Audio Amplifier	4/1.00
ITE4868 TYPE Ultra-Low Noise Audio Amp	2/1.00
TIS74 TYPE High-Speed Switch 4052	3/1.00
Assort. RF & GP FET's, e.g. 2N5163, MPF102, etc. (8)	\$2.00

P-CHANNEL:

2N4360 TYPE Gen. Purpose Amp & Sw (TO-106)	3/1.00
E175 TYPE High-speed Switch 12552 (TO-106)	3/1.00

JANUARY SPECIALS:

1N4154 DIODE 30 V/10mA-1N914 except 30 V	25/1.00
2N2222 NPN TRANSISTOR GP Amp & Switch	5/1.00
2N2907 PNP TRANSISTOR GP Amp & Switch	5/1.00
2N3553 RF Power Amp 5 W @ 150 MHz, 10 W @ 50 MHz	\$2.00
2N3904 NPN TRANSISTOR GP Amp & Switch	5/1.00
2N3906 PNP TRANSISTOR GP Amp & Switch	5/1.00
2N5108 RF Power Amp 2 W @ 450, 1 W @ 1 GHz	\$2.50
E101 N-CHANNEL FET Low Current, Low Vp Amp/Sw	3/1.00
MPF102 N-CHANNEL FET RF Amp-200 MHz	3/1.00
340 T 1 A VOLT. REG. Specify 5, 6, 12, 15 or 24 V-W/Ckts	\$1.75
556 OVAL 555 TIMER 1µsec to 1 hour (OIP)	\$1.00
8038 WAVE FORM GENERATOR ~ 1 A WAVE W/Ckts	\$4.50
MMS316 DIGITAL CLOCK Snooze/Alarm/Timer Hrs, Mins, Secs, 4 or 6 Digit-With Specs/Schematics	\$5.50

LINEAR IC's:

308 Micro-Power Op Amp (TO-5/MINI-OIP)	\$1.00
309 K Voltage Regulator 5 V @ 1 A (TO-3)	\$1.50
324 Quad 741 Op Amp, Compensated (OIP)	\$1.75
380 2.5 Watt Audio Amplifier 34 dB (OIP)	\$1.29
555 Timer 1µ-1 hr. NE555, LM555, etc. (MINI-OIP)	\$.65
709 Popular Op Amp (OIP/TO-5)	\$.29
723 Voltage Regulator 3-30 V @ 1-250mA (OIP/TO-5)	\$.58
739 Dual Low-Noise Audio Preamp/Op Amp (OIP)	\$1.00
1458 Dual 741 Op Amp (MINI-OIP)	\$.65
741 Freq. Comp. OP AMP (OIP/TO-5/MINI-OIP)	3/1.00

DIODES:

ZENERS—Specify Voltage 3.3, 3.9, 4.3, 5.1, 6.8, 8.2	400mW 4/1.00
9.1, 10, 12, 15, 18, 22, 24, 27 or 33V (±10%)	1 Watt 3/1.00
1N3600 TYPE Hi-Speed Sw 75 V/200 mA	6/1.00
1N3893 TYPE RECTIFIER Stud Mount 400 V/12 A	2/1.00
1N914 or 1N4148 TYPE Gen. Purp. 100V/10mA	15/1.00
05 VARACTOR 5-50 W Output @ 30-250 MHz, 7-70 pF	\$5.00
7F VARACTOR 1-3 W Output @ 100-500 MHz, 5-30 pF	\$1.00

*MAIL NOW! FREE DATA SHEETS supplied with every item from this ad. FREE ON REQUEST—749 Dual Op Amp (\$1.00 value) with every order of \$10 or more, postmarked prior to 1/30/76.

ORDER TODAY—All items subject to prior sale and prices subject to change without notice. All items are new surplus parts — 100% functionally tested.

WRITE FOR FREE CATALOG offering hundreds of semiconductors not listed here. Send 10¢ stamp.

TERMS: All orders must be prepaid. We pay postage, \$1.00 handling charge on orders under \$10. Calif. residents add 6% sales tax. Foreign orders — add postage. COD orders — add \$1.00 service charge.

ADVA ELECTRONICS
 BOX 4181 BE, WOODSIDE, CA 94062
 Tel. (415) 851-0455
 CIRCLE NO. 2 ON FREE INFORMATION CARD

LEARN TO BUILD AND TEST ELECTRONIC CIRCUITS FOR FUN AND PROFIT. Complete Details Free. Chapel Company, 1154 West 27th Street, Erie, Pennsylvania 16508.

LEARN Digital Troubleshooting, Clocks, Test Instruments, etc. Details Free. Educational Technologies, Box 224, Reynoldsburg, Ohio 43068.

GET INTO BROADCASTING: Pass FCC examinations, get jobs, start own station. Free literature. Broadcasting, Box 5516AA, Walnut Creek, CA 94596.

REAL ESTATE

NEW BIG SPRING '76 CATALOG Free! Over 2700 top values coast to coast! UNITED FARM AGENCY, 612-EP, West 47th, Kansas City, MO 64112.

DO-IT-YOURSELF

TELEPHONES, All Types, Equipment, Supplies, Keyed, Regular, Decorator, Catalog, 50 cents. Box 1654J, Costa Mesa, California 92626.

INVENTIONS WANTED

INVENTORS: Protect your ideas! Free "Recommended Procedure" Washington Inventors Service, 422T Washington Building, Washington, D.C. 20005.

Inventors Wanted
 RECOGNITION, FINANCIAL REWARD, OR CREDIT for "inventing it first" may be yours! We'll develop your idea, introduce it to industry, publicize it, negotiate for Cash Sale or Royalty Licensing.

Send for FREE INVENTORS KIT includes a Vital Information on Protection, Development, Marketing of your Invention • Important "Invention Record Form" • Directory of 500 Corporations Seeking New Products

RAYMOND LEE ORGANIZATION
 230 Park Ave. No., New York, NY 10017
 Please rush FREE INVENTORS KIT A-139

Name _____
 Address _____
 City _____ State _____ Zip _____

FREE PAMPHLET: "Tips on Marketing Your Invention." Write: United States Inventors Service Company, Dept. T, 1435 G Street NW, Washington, D.C. 20005.

INSTRUCTION

LEARN ELECTRONIC ORGAN SERVICING at home all makes including transistor. Experimental kit—trouble-shooting. Accredited NHSC. Free Booklet. NILES BRYANT SCHOOL, 3631 Stockton, Dept. A, Sacramento, Calif. 95820.

LEARN WHILE ASLEEP. Hypnotize! Strange catalog free. Auto-suggestion, Box 24-ZD, Olympia, Washington 98501.

DEGREE IN ELECTRONICS through correspondence. Free catalog. Grantham, 2000 Stoner Avenue, Los Angeles, California 90025.

INTENSIVE 5 week course for Broadcast Engineers. F.C.C. First Class license. Radio Engineering Incorporated, 61 N. Pineapple Ave., Sarasota, Florida 33577 and 2402 Tidewater Trail, Fredericksburg, VA 22401.

F.C.C. EXAM MANUAL

PASS FCC EXAMS! Memorize, study — "Test Answers" for FCC 1st and 2nd class Radio-telephone licenses. Newly revised multiple-choice questions and diagrams cover all areas tested in FCC exams plus "Self-Study Ability Test." \$9.95 postpaid. Money-back Guarantee.

WE PROGRAM FOR \$5 EACH

P.O. BOX 26348-P
 RADIO ENGINEERING DIVISION SAN FRANCISCO, CALIF. 94126

SCORE high on F.C.C. Exams Over 300 questions and answers. Covers 3rd, 2nd, 1st and even Radar, Third and Second Test, \$14.50; First Class Test, \$15.00. All tests, \$26.50. R.E.I., Inc., Box 806, Sarasota, Fla. 33577.

UNIVERSITY DEGREES BY MAIL! Bachelors, Masters, Ph.D's. Free revealing details. Counseling, Box 1162-PE1, Tustin, California 92680.

SELF-STUDY CB RADIO REPAIR COURSE. THERE'S MONEY TO BE MADE REPAIRING CB RADIOS. This easy-to-learn course can prepare you for a career in electronics enabling you to earn as much as \$16.00 an hour in your spare time. For more information write: CB RADIO REPAIR COURSE, Dept. PED16, 531 N. Ann Arbor, Oklahoma City, Okla 73127.

FREE Educational Electronics Catalog. Home study courses. Write to: Edukits Workshop, Department 713D, Hewlett N.Y. 11557.

UNLOCK your Future. Become professional Locksmith by spare time homestudy. \$13 in an hour possible. All tools, equipment included. Facts FREE. Send name. Locksmithing Institute (homestudy), Dept. 1373-016, Little Falls, N.J. 07424.

TELEVISION repair course. Learn how to service televisions from master technicians. Send \$6.00 for first lesson and details to: Guardian, 20 E. Main, Ramsey, N.J.

AMATEUR Radio: Complete no-textbook Code and Theory correspondence license courses. Ron Reed Electronics Institute, 12217 Santa Monica Blvd., Los Angeles, Calif. 90025.

NO FCC LICENSE? Tried every way but the right way? It's time for Genn Tech. Home Study. Free Catalog, 5540 Hollywood Blvd., Los Angeles, Calif. 90028.

FCC LICENSE STUDY GUIDE—new, 377 pages, includes 1465 FCC-type questions, with answers and discussions, covering third, second, and first class radiotelephone exams. \$8.95 postpaid. GSE, 2000 Stoner Avenue, Los Angeles, Calif. 90025.

POTTER BRUMFIELD
 Type KHP Relay
 4 PDT 3A Contacts
 24 VDC (650 coil) \$1.50 EA.
 120 VAC (10.5 MA coil) \$1.75 EA.

DIP SOCKETS

8 PIN PCB	\$.22
14 PIN PCB	\$.26
16 PIN PCB	\$.30
24 PIN PCB	\$.75
40 PIN PCB	1.25
14 PIN WRAP	\$.35

DIP TRIMMER

—12 turn trim pots which plug into a DIP socket
 —5K and 200K
 — $\frac{1}{4}$ " x $\frac{1}{8}$ " x $\frac{1}{4}$ "
 —4 leads spaced .3" x .2"

Each \$.65 10 for \$4.95

NPN TO3 POWER TRANSISTORS

Power transistor: PD-115H; VCE-60V; HFE-50; FT-30K; Case TO-3
 Each \$.90 10 for \$6.95

410 (RCA) 200V: 10A.
 Each \$1.75 10 for \$15.00

NATIONAL MOS TO-5

Dynamic shift registers TO-5

MM502 dual	50 Bit..	\$.75
MM506 dual	100 Bit..	1.75
MM5006 dual	100 Bit..	1.50
MM5013	1024 Bit..	2.25
MM5016	512 Bit..	1.00

Static shift registers

MM504 dual	16 Bit..	\$1.50
MM505 dual	32 Bit..	1.75
MM550 dual	differential analog switch	2.50

Memories

BRAND NEW—
 3410 — 256 X 4 RAM
 (256 WORD X 3 BIT) FULLY DECODED; HIGH SPEED (40 NS); OPEN COLLECTOR OUTPUT; 16 PIN DIP WITH DATA FROM FAIRCHILD
 ONLY \$2.25 10/\$18.95

1702 — 2048 BIT PROM
 2K STATIC UNITS, ULTRAVIOLET LIGHT ERASABLE. \$9.95 EACH

825129 — 1024 BIT ROM
 (256X4 PROM); 50 NS; POWER DISSIPATION .5 MW/BIT; TRI-STATE OUTPUT. \$5.00 EA. 8 — \$34.95

2102-2 MOS 1024 BIT MEMORY (DIP)

FULLY DECODED STATIC RANDOM ACCESS MEMORY DIRECTLY TTL COMPATIBLE INPUTS AND OUTPUT SINGLE 5V SUPPLY — NO CLOCKS OR REFRESH

\$3.00 EACH 10 FOR \$27.95

DIODE ARRAY

10 — 1N914 Silicon Signal Diodes in one package. 20 leads spaced .1"; no common connections. Each \$.25 10 for \$2.25

Numeric Display
 1/4" Single Digit GaAsP LED

COMMON CATHODE WITH RH DECIMAL

SUPER SPECIAL \$5.99
 TEN for \$4.95

Compact — 10 digits in 3" panel width
 Highly legible — bright red "4" character easily read within 10 feet over a wide viewing angle (140°)
 Low power — 125 mW per digit at typical brightness

ACTUAL SIZE

SPECIAL 8223 PROM

8 BIT
 32 WORD MEMORY
 \$3.00 EA.
 10 — \$29

WE PROGRAM FOR \$5 EACH

RECTIFIER SPECIAL! 1N4007 — 1 AMP — 1000 volt PRV
 \$.13 each 10 for \$1.00

All IC's are new and fully tested. Leads are plated with gold or solder. Due to increased costs, orders under \$7.00 add \$1.00 postage and handling. Residents of California add sales tax. TWX: 910-367-3521 \$10 minimum on C.O.D.'s. Phone (916) 334-2161 Mail orders to: P.O. Box 41778 Sacramento, CA 95841

SEND FOR FREE FLYER

BABYLON ELECTRONICS

CIRCLE NO. 10 ON FREE INFORMATION CARD

GOVERNMENT SURPLUS

GOVERNMENT Surplus. How and Where to Buy in Your Area. Send \$2.00. Surplus 30177-PE Headquarters Bldg., Washington, D.C. 20014.

MANUALS for Govt Surplus radios, test sets, scopes. List 20 cents (coin). Books, 7218 Roanne Drive, Washington, D.C. 20021.

SURPLUS ELECTRONIC EQUIPMENT, government and manufacturers' Grab Box Assortment—diverse, useful new and used parts, assemblies, etc. Carton packed: 50 lbs. \$6.00; 100 lbs. \$10.00. F.O.B. Lima. Send for BIG Free Catalog! Fair Radio, Box 1105-E, Lima, Ohio 45802.

SHORTWAVE LISTENING

"DXing I LOVE YOU" colorful Jacket Patches, \$1. Benefit Handicapped Aid Program. SWL Guide, Syracuse, NY 13219.

JANUARY 1976

CLASSIFIED ADVERTISING ORDER FORM

Please refer to heading on first page of this section for complete data concerning terms, frequency discounts, closing dates, etc.

1	2	3	4	5
6	7	8	9	10
11	12	13	14	15
16	17	18	19	20
21	22	23	24	25
26	27	28	29	30
31	32	33	34	35

WORD COUNT: Include name and address. Name of city (Des Moines) or of state (New York) counts as one word each. Zip Code numbers not counted. (Publisher reserves right to omit Zip Code if space does not permit.) Count each abbreviation, initial, single figure or group of figures or letters as a word. Symbols such as 35mm, COD, PO, AC, etc., count as one word. Hyphenated words count as two words. Telephone numbers count as two words; as three words with area code.

Words \$ 2.00 (Commercial Rate) \$ 1.20 (Reader Rate)

Payment of \$ _____ enclosed for _____ insertion(s).

CHARGE: American Express BankAmericard Master Charge Diners Club

for _____ insertion(s). You will be billed monthly.

Account # _____ Expiration Date _____

Master Charge Interbank # (4 digits above name) _____

SIGNATURE MUST BE PROVIDED BELOW

PRINT NAME _____

ADDRESS _____

CITY _____ STATE _____ ZIP _____

SIGNATURE _____ PE-176

EMPLOYMENT OPPORTUNITIES

ELECTRONICS/AVIONICS EMPLOYMENT OPPORTUNITIES. Report on jobs now open. Details FREE. Aviation Employment Information Service, Box 240E, Northport, New York 11768.

BUSINESS OPPORTUNITIES

I MADE \$40,000.00 Year by Mailorder! Helped others make money! Free Proof. Torrey, Box 318-NN, Ypsilanti, Michigan 48197.

FREE CATALOGS. Repair air conditioning, refrigeration. Tools, supplies, full instructions. Doolin, 2016 Canton, Dallas, Texas 75201.

MAILORDER MILLIONAIRE helps beginners make \$500 weekly. Free report reveals secret plan! Executive (*K1), 333 North Michigan, Chicago 60601.

PIANO TUNING LEARNED QUICKLY AT HOME! Musical knowledge unnecessary. Free information. Empire School, Box 450327, Miami 33145.

\$200.00 DAILY In Your Mailbox! Your opportunity to do what mail-order experts do. Free details. Associates, Box 136-J, Holland, Michigan 49423.

FREE BOOK "2042 unique proven enterprises." Work home! Hayling-B, Carlsbad, CA 92008.

IMSAI 8080

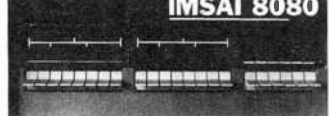

IMSAI 8080 . . . A COMPLETE MICRO-PROCESSOR SYSTEM . . . COMPATIBLE WITH THE ALTAIR BUT OFFERING

- A COMMERCIAL GRADE PRODUCT
- GOLD PLATED CONTACTS
- RELIABLE PADDOLE SWITCHES
- HEAVY DUTY POWER SUPPLY
- SUPER STURDY CARD CAGES
- 30 DAY DELIVERY

BASIC COMPUTER INCLUDES CPU, 1K RAM H.O. FRONT PANEL CONTROL BOARD WITH EXTRA 8 LED INDICATED OUTPUT PORT, ALL LIGHTS AND SWITCHES, H.O. POWER SUPPLY, EXPANDER BOARD & CASE.
KIT #439 ASSEMBLED \$621

ALPHANUMERIC PRINTER FOR IMSAI 8080 OR ALTAIR 8800

COMPUTERS AP-32 . . . \$139.00
32 CHARACTERS PER LINE!!
125 LINES PER MINUTE!!

INTERFACE KIT - EVERYTHING NECESSARY TO CONNECT AP-32 TO IMSAI 8080 OR ALTAIR 8800 - ALL PARTS INTERFACE BOARD, CABLE, & CONNECTORS
KIT #119 ASSEMBLED \$139

NEW!! PROTOBOARD FOR IMSAI 8080 AND ALTAIR FOR WIRE WRAP OR SOLDER JUMPERS, ROOM FOR THIRTY 14 OR 16 PIN CHIPS + TWO 40 PIN CHIPS OR THREE 24 PIN CHIPS

BOARD - HEAT SINK + 5 V. REGULATOR - ORDER KIT #PB-40 . . . \$37

"P.E." CASSETTE RECORDER INTERFACE (SEPT. ISSUE)

"P.E." CIRCUIT PLUS I/O CONTROL, I/O OTHER BOARD REQ'D
PART #CRI-1 \$29 KIT \$39 ASSEMBLED

THE INTEL DATA BOOK

CONTAINS COMPLETE SPECIFICATIONS AND DATA SHEETS ON INTEL 8080A AND ALL ASSOCIATED INTEL MEMORY AND PERIPHERAL CHIPS. ALSO INCLUDES PRELIMINARY SPECS ON "COMING" INTEL CHIPS.
187 pages \$5.00

THE TTL DATA BOOK

CONTAINS COMPLETE ELECTRICAL SPECIFICATIONS FOR ALL 7400 SERIES TTL. THIS IS THE TTL "BIBLE"
640 pages \$10.00

THE PINOUT HANDBOOK

COVERS ENTIRE 5400/7400 SERIES D.I.P. I.C.'S. PIN CONNECTIONS. FUNCTIONAL SPECS CROSS REFERENCE
\$3.95

IMS ASSOCIATES, INC. 1922 REPUBLIC AVE
SAN LEANDRO CALIF. 94577
TERMS: CHECK OR M.O., BANKAMERICARD, MASTERCHARGE
2% DEPOSIT ON C.O.D.

ADD 5% POSTAGE AND HANDLING. CALIF. RESIDENTS ADD 6.5% SALES TAX.

IMSAI PRICES SUBJECT TO CHANGE WITHOUT NOTICE

Wanted

P-2

Citizens Band DEALER-DISTRIBUTORS

Send this ad with Letterhead to:

PAL ELECTRONICS CO.

2962 W. WELDON - PHOENIX, ARIZ. 85017

GET RICH with Secret Law that smashes debts and brings you \$500 to \$5 Million cash. Free report! Credit 4K1, 333 North Michigan, Chicago 60601.

PROPRIETORSHIP-Partnership-Corporation Which is right for your new Business and how to go about forming it. \$5.00. ISSCO, Box 4009, Irving, Texas 75061.

HIGHLY PROFITABLE ONE-MAN ELECTRONIC FACTORY

Investment unnecessary, knowledge not required, sales handled by professionals. Postcard brings facts about this unusual opportunity. Write today! Barta-DA, Box 248, Walnut Creek, CA 94597.

MAKE durable building plastic easily. Waterproof, Free-proof. Economical. Bays Laboratory, Cedaredge, CO 81413.

RUBBER STAMPS

RUBBER ADDRESS STAMPS. Free Catalog. 45 type styles. Jackson's, Dept. K, Brownsville Rd., Mt. Vernon, Ill. 62864.

NEW

Wafers are meant to be inserted in a .063" maximum thickness board and have .043" diameter pins on .156" centers.

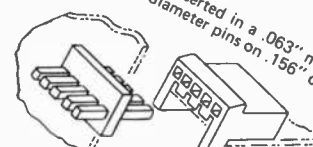

CATALOG NUMBER	DESCRIPTION	PRICES	
		1-10	11-99
13-0001	12 pos. rt. angle connector	.60	.55
13-0002	12 position wafer	.60	.55
13-0003	9 pos. rt. angle connector	.60	.55

MC14435 & MC1408L
A two piece 3 1/2 digit A/D converter system for panel meters and DVM's with schematics - \$30.00

8' POWER SUPPLY CORDS
Gray \$1.45 ea.

MM8314 NATIONAL CLOCK CHIP 4.75

LINEAR

ELECTROLYTIC CAPACITORS	NE501A	2.80
PLEASE ORDER IN MULTIPLES OF 5 PER ITEM	NE555A	.50
RADIAL LEADS	A710CA	.60
(uF) WORKING VOLTS DC \$	A741V	.40
10 \$16.35, 50 .16	A747CA	1.10
20 \$16.35, 50 .16	A748CV	.74
30 16 .16	A723CA	1.00
50 \$16.35 .22	MC1468L	3.90
100 \$16.35, 50 .25		
200 16 .22		
500 16 .34		
1000 16 .52		
2200 16 .80		
Specify ONE		

Red Led & Mtg. Hardware
T1-3/4
1-10 11-100
35 .29

MINIATURE FILM CAPACITORS

VALUE (uF)	PRICE TABLE		
	1-14	15-50	\$1-100
.001	.10	.10	.09
.0047	.10	.10	.09
.01	.10	.10	.09
.05	.19	.17	.15
1	.24	.21	.20
.22	.28	.26	.25

These units are made by International Components Corp. All units 100 V

FIXED POWER SUPPLY KITS

Specifications:	F0810	F1210	F1510	DIGITAL CIRCUITS
Input Voltage (50 500Hz)	105 125v	105-125v	110-125v	7400
Output Voltage	5v ± 5%	12v ± 5%	15v ± 5%	7402
Output Current (I _a = 25° C)	1.5A Max.	1.5A Max.	1.1A Max.	7404
PRICE	\$14.00	\$14.50	\$14.50	7410
INDEFINITE SHORT CIRCUIT PROTECTION Price includes Pre-drilled G10 Board All Parts and Transformer				7411
				7413
				7415
				7416
				7417
				7420
				7447
				7473
				7475
				7476
				7490
				7492
				7493
				74121
				74192
				7.70
				2.00

DISPLAY BEZELS

CATALOG NUMBER	FILTER COLOR	PRICE	DIMENSION	These bezels are heat resistant plastic with a black matte finish. Filters are circular polarized type.
1-24	C			
905 80	Red	\$2.50	1.37	7420
\$ 910 80	Red	2.55	2.00	7447
\$ 915 80	Red	2.65	3.00	7473
920 80	Red	2.70	4.00	7475
925 70	Amber	2.70	4.00	7476

\$ Per Green = .44
A 4 A
G 10
P 10
Part number

SOCKETS

LOW PROFILE
These sockets are from TI.

NUMBER OF PINS	5-99	100
8	.21	.18
14	.25	.20
16	.28	.24
24	.40	.35
28	.50	.48

TRANSISTORS

2N3638A	P	.5	TO-92	.25
2N2222A	N	.5	TO-18	.20
2N5133	N	.05	TO-18	.25
2N5494	N	7.00	TO-22	1.05
2N4401	N	.60	TO-92	.60
2N4403	P	.60	TO-92	.30
TIP32	P	3.00	TO-220	1.05

TRIMMER POTENTIOMETERS

These are 5/8" diameter thumbwheel trimmer potentiometers.



VALUES OHMS
100 500 1K 5K 10K 50K 100K 500K

PRICE TABLE	1-10	11-99	100
	\$0	\$0	\$0
	\$0	\$0	\$0

BAG OF 50 MOLEX PIN NESTERS

7 pin style \$2.00
8 pin \$2.25

MOLEX IC TERMINAL

100 for \$1.00	300 for \$2.00	500 for \$4.20
200 for \$1.50	400 for \$3.40	600 for \$5.00
700 for \$5.80		800 for \$7.40
900 for \$6.00		1,000 for \$6.20
Reel of 50,000 . . . \$279.00		

REGULATOR CIRCUITS

MC7805CP	5 volt regulator @ 1.5A max.	1.99
MC7812CP	12 volt regulator @ 1.5A max.	2.00
MC7815CP	15 volt regulator @ 1.5A max.	2.00

16 Page Catalog \$25

TERMS \$10.00 Min. Order.
Orders less than \$25.00 add \$1.00 postage & handling.
Master Charge & BankAmericard

DIODES

1N4001	. . .	8/51.00
1N4002	. . .	8/51.00
1N4148	. . .	10/51.00
1N5401	. . .	5/52.00
(3A, 100PVI)		
1N746-759A \$3.00		

TRACY DESIGN CORP.

15870 SCHAEFER • DETROIT, MI. 48227 • (313) 838-2501

CIRCLE NO. 24 ON FREE INFORMATION CARD

118

AmericanRadioHistory.Com

POPULAR ELECTRONICS

JANUARY 1976

ADVERTISERS INDEX

READER SERVICE NO.	ADVERTISER	PAGE NUMBER
1	A P Products Inc	81
25	Ace Electronic Parts	105
2	Adva Electronics	117
3	Allison Automotive Company	71
	Alpha Electronics	100
6	Alta Electronics	109
7	American Video Corporation	99
8	Ancrona Corp	113
9	B&K Precision, Product of Dynascan	1
10	Babylon Electronics	117
	Bell & Howell Schools	24, 25, 26, 27
	Beta Electronics	98
61	Breaker Corporation	29
	CREI Capital Radio Engineering Institute	30, 31, 32, 33
11	Cleveland Institute of Electronics	16
12	Cleveland Institute of Electronics	64, 65, 66, 67
	Cobra, Product of Dynascan	SECOND COVER
14	Continental Specialties Corporation	13
15	Delta Electronics Co	116
16	Delta Products, Inc.	52
17	Digi-Key Corporation	112
	Dixie-Hi-Fidelity	28
18	EICO	97
19	Edmund Scientific Co	106
20	Edmund Scientific Co	120
21	Electronics Technical Institute	74, 75, 76, 77
	Florida Institute of Technology	97
22	Handic USA Inc	6
5	Heath Company	5
24	IMS Associates, Inc	118
26	Illinois Audio	102
27	International Electronics Unlimited	108
28	James	110, 111
33	Johnson Co., E.F.	101
29	Lafayette Radio Electronics	34
30	Labtronics	100
31	Locksmithing Institute	102
32	McIntosh Laboratory Inc	45
34	MITS	2
35	Martin Research	89
	NRI Schools	8, 9, 10, 11
36	National Camera	100
	National Technical Schools	84, 85, 86, 87
37	New-Tone	116
38	Olson Electronics	102
	Olson Electronics	112
40	Parrott Precision Electronics	14
41	Pathcom Inc	15
63	Phase Linear	40
42	Pickering & Co	THIRD COVER
43	Pickering & Co	28
44	Poly Paks	115
45	Processor Technology	90
46	RCA Electronic Instruments	82
47	Radio Shack	17
48	SAE	98
49	S D Sales Co	107
50	Sencore	80
51	Shure Brothers Inc	73
52	Solid State Sales	114
53	Southwest Technical Products Corporation	7
54	Sphere Corporation	95
55	Stereo Discounters	28
56	Surplus Center	119
57	Systems Research, Inc	82
	TEAC Corporation	23
	Tracy Design Corporation	118
58	Tri-Star Corporation	45
59	Triplett	63
4	United Audio Products, Inc	FOURTH COVER
62	Voltronix	99

CLASSIFIED ADVERTISING

106, 108, 112, 114, 116, 117, 118, 119

PRO SPORTS ACTION FILMS

START A SPORTS FILMS COLLECTION IN 1976. Here's what you can buy for \$15.95 ppd per 200' reel of color film Standard or Super 8 your choice of the following Indy "500" official films: 1967 (A. J. Foyt); '68 (Bobby Unser); '69 (Mario Andretti); or 1970 (Al Unser). Standard 8 only can be shown on Standard 8 or Dual 8 projectors. B&W Golf films choice of Sam Snead "Cut Strokes" or 6 Tommy Armour films: "Grip", "Stands", "Swing", "Long Irons", "Short Irons", "Traps & Putting". Standard 8 or Super 8, \$5.95 ppd while they last. Castle, Columbia or Sportlite films catalogs, 30 cents each (coins or stamps, please). SPORT-LITE, Elect-1, Box 24-500, Speedway, Indiana 46224.

RECORDS

OLDIES. 45rpm. Free Catalog. Corny's Record Shop, Box 166TA, Mason, Ohio 45040.

FREE RECORD COLLECTION Reviewers wanted. Anyone qualifies. We ship you new records to review. You pay postage. Records are free. Applicants accepted "first come" basis. Write: Research PE, 6162 Washington Circle, Milwaukee, Wisconsin 53213.

BOOKS AND MAGAZINES

FREE Catalog. Aviation and Space books. Aero Publishers, 329PE West Aviation, Fallbrook, California 92028.

FREE book prophet Elijah coming before Christ. Wonderful bible evidence. Megiddo Mission, Dept. 64, 481 Thurston Rd., Rochester, N.Y. 14619.

LEARNING ABOUT SYNTHESIZERS. Covers complete field of Electronic Music. \$5.98. LINTON, Box 898P, N. Eastham, Mass. 02651.

POPULAR ELECTRONICS INDEXES. Detailed and complete subject indexes available to magazine years 1974, 1973, and 1972. Hundreds of subject references to help you quickly find that special project, article or product test. 1972, 1973 and 1974 editions \$1.50 each. All three editions only \$4.00. INDEX, Box 2228, Falls Church, Va. 22042.

HYPNOTISM

SLEEP learning. Hypnotic method. 92% effective. Details free. ASR Foundation, Box 23429EG, Fort Lauderdale, Florida 33307.

FREE Hypnotism. Self-Hypnosis. Sleep Learning Catalog! Drawer H400, Ruidoso, New Mexico 88345.

AMAZING self-hypnosis record releases fantastic mental power. Instant results! Free trial. Write: Forum (AA1), 333 North Michigan, Chicago 60601.

TREASURE FINDERS

FREE FACT-FILLED CATALOG! World's largest selection! Metal detectors starting at \$79.50. Two year guarantee! Three factories. U.S.-Canada. 1,200 dealers - Service Centers nationwide. Finest instruments at any price! Budget Terms. Dealer inquiries invited. Write: White's Electronics, Inc. Dept. PD60, 1011 Pleasant Valley Road, Sweet Home, Oregon 97386.

TREASURE FINDER locates buried gold, silver, coins, treasures. 6 powerful models. Instant financing available. Write or call for free catalog. Phone (713) 682-2728 day or night. Dealer inquiries invited. Relco, Dept. AA20, Box 10839, Houston, Texas 77018.

MAGNETS

MAGNETS. All types. Specials-20 disc. or 10 bar. or 2 stick. or 8 assorted magnets. \$1.00. Magnets, Box 192-H, Randallstown, Maryland 21133.

MISCELLANEOUS

WINEMAKERS: Free illustrated catalog yeasts, equipment. Semplex, Box 12276P, Minneapolis, Minn. 55412.

LEARN MORE ABOUT PSYCHOLOGY FREE...

Write for FREE information on the unique 8 quarter credit course in introductory Psychology developed by the University of California and PSYCHOLOGY TODAY magazine.

Write: STUDY PROGRAM, Dept. CL, Rm. 715, One Park Avenue, N.Y., N.Y. 10016.

ABOUT YOUR SUBSCRIPTION

Your subscription to POPULAR ELECTRONICS is maintained on one of the world's most modern, efficient computer systems, and if you're like 99% of our subscribers, you'll never have any reason to complain about your subscription service.

We have found that when complaints do arise, the majority of them occur because people have written their names or addresses differently at different times. For example, if your subscription were listed under "William Jones, Cedar Lane, Middletown, Arizona," and you were to renew it as "Bill Jones, Cedar Lane, Middletown, Arizona," our computer would think that two separate subscriptions were involved, and it would start sending you two copies of POPULAR ELECTRONICS each month. Other examples of combinations of names that would confuse the computer would include: John Henry Smith and Henry Smith; and Mrs. Joseph Jones and Mary Jones. Minor differences in addresses can also lead to difficulties. For example, to the computer, 100 Second St. is not the same as 100 2nd St.

So, please, when you write us about your subscription, be sure to enclose the mailing label from the cover of the magazine—or else copy your name and address exactly as they appear on the mailing label. This will greatly reduce any chance of error, and we will be able to service your request much more quickly.

GOV'T SURPLUS Electronic "Super-Buys"

115-VAC, 6-DIGIT COUNTER

• (ITEM #21-960) - Hundreds of uses. Counts 1 for each pulse. Capable of 600 pulses per minute. Use with any contactor. 115-volt, 60-cycle coil. 3-3/4" x 2-1/2" x 1-1/2". (2 lbs.)



\$4.97

24-VDC, 6-DIGIT COUNTER \$3.97 (8 oz.)

• (ITEM #21-1019) - Useful for some type applications as above unit, operates on 24-VDC. 3-1/8" x 1-5/8" x 1".

MOTOR DRIVEN COUNTING UNIT

• (ITEM #1-984) - Sophisticated control unit. Can be used to switch three ccts. in sequence, add action to electrical signs, can operate as a counter. Operates on 115-VAC. Has three 24-VDC solenoids, AC motor, number wheels, clutches, gears, contacts, etc. 7" x 7" x 4".

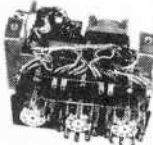

\$3.97 (5 lbs.)

HIGH VOLTAGE SPARK UNIT

• (ITEM #15-958) - Use for many spectacular experiments in electronics, physics, chemistry. 30,000 VAC output from 115-VAC. Fast, intense spark jumps 1/2" to 3/4". 6" x 4" x 3". (6 lbs.)



\$5.29

CHOPPED LIGHT, MICRO-PHOTOCELL DEVICE

• (ITEM #22-1030) - Reflective blades driven by 30 RPM, 115-VAC synch. motor post micro-photo cell 720 times per min. Chopped signal can be used to trigger other devices. Contains thermistor, 4" x 4" x 3".



\$4.71 (2 lbs.)

SOUND OPERATED SWITCHING MODULE

• (ITEM #11-1256) - Sound into crystal mike and amplifier triggers SCR (GEC106Q1) Make sound controlled relays to open doors, energize actuators, alarms, etc. Operates on 6-VDC. 3" x 1" x 1". (4 oz.) ALL ITEMS F.O.B. LINCOLN



\$1.49

SEND 25-CENTS (coin or stamps) FOR BARGAIN CATALOGS

SURPLUS CENTER PE-16 Lincoln, Nebraska Zip Code 68501

LIVE IN THE WORLD OF TOMORROW... TODAY!

And our FREE 164 PAGE CATALOG is packed with exciting and unusual values in electronic, hobby and science items — plus 4,500 finds for fun, study or profit... for every member of the family.

A BETTER LIFE STARTS HERE

FUEL MISER RECLAIMS HEAT

Save your 40% wasted heat to warm a basement, garage or rec room at no extra cost! Instead of going "up the chimney" it goes where you want it. Remove part of furnace exhaust pipe, slip Heat Exchanger in. At 125° fan automat. forces clean air through unit which heats to over 200°F., can be ducted to 20 ft. from unit. 110v AC. Instructions.



- No. 19,194V (5/8" OIA.) Shpg. 17 lb. \$106.00 FOB
- No. 19,195AV (6" OIA.) Shpg. 17 lb. \$106.00 FOB
- No. 19-198AV (7" OIA.) Shpg. 17 lb. \$106.00 FOB

SUPER POWER FOR ANY RADIO

New antenna assist turns a tiny transistor into a tiger, has pulled in stations up to 1000' miles away! Just set beside radio (no wires, clips, grounding) and fine-tune Select-A-Tenna's dial to same frequency — "gangbusters"! Great for clearing weak signals in radio depressed areas, off-coast islands, crowded frequency stations. Solid state—uses no electricity, batts., tubes.



- Stock No. 72,095AV \$15.95 Ppd.
- ULTRA SELECT-A-TENNA
- No. 72,147AV (*OVER 1000 MI.) \$22.95 Ppd.

50-150-300 POWER MICROSCOPE

Amazing Value—3 Achromatic Objective Lenses on Revolving Turret! Color-corrected, cemented achromatic lenses in objectives give far superior results to single lenses usually found in this microscope price range. Results are worth the difference! Fine rack and pinion focusing. Imported!



- Stock No. 70,008AV \$45.00 Ppd.
- MOUNTED 500 POWER OBJECTIVE:
- Threaded achromatic lenses, 3mm F.L.
- Stock No. 30,197AV \$9.75 Ppd.

SEE MUSIC IN PULSATING COLOR

New 3-Channel Color Organ adds to music listening pleasure, lets you modulate 3 independent strings of colored lamps with intensity of your music to create an audio "light show." They flash, vary in brightness related to music's rhythm, pitch, volume—pulsating lighting performance to music! Fully assembled & priced half that of others, the Edmund Sound To Light Control is a terrific value. Plug in, turn on!



- No. 42,309AV... (ASSEMBLED) \$17.95 Ppd.
- No. 42,336AV... (UNASSEMBLED) \$13.95 Ppd.

MAIL COUPON FOR GIANT FREE CATALOG!

164 PAGES • MORE THAN 4500 UNUSUAL BARGAINS

Completely new 1976 edition. New items, categories, illustrations. Dozens of electrical and electromagnetic parts, accessories. Enormous selection of Astronomical Telescopes. Unique lighting and ecological items. Microscopes, Binoculars, Magnifiers, Magnets, Lenses, Prisms. Hard-to-get-surplus bargains. Ingenious scientific tools. 1000's of components.

EDMUND SCIENTIFIC CO.
300 Edscorp Building, Barrington, N. J. 08007
Please rush Free Giant Catalog "AV"

Name _____
Address _____
City _____ State _____ Zip _____

COMPLETE & MAIL WITH CHECK OR M.O.

EDMUND SCIENTIFIC CO. 300 Edscorp Building, Barrington, N.J. 08007

How Many	Stock No.	Description	Price Each	Total
<input type="checkbox"/>		PLEASE SEND GIANT FREE CATALOG "AV"		
<input type="checkbox"/>		Charge my BankAmericard		
<input type="checkbox"/>		Charge my Master Charge		
Add Handling Chg.: \$1.00, Orders Under \$5.00, 50¢, Orders Over \$5.00				
Interbank No. _____				
My Card No. is _____			I enclose <input type="checkbox"/> check <input type="checkbox"/> money order for TOTAL \$ _____	
Card Expiration Date _____			Signature _____	
30-DAY MONEY-BACK GUARANTEE. You must be satisfied or return any purchase in 30 days for full refund. *\$15.00 minimum			Name _____ Address _____ City _____ State _____ Zip _____	

WHEN YOU COME TO PHILADELPHIA BE SURE TO SEE
FREE BICENTENNIAL LIGHT SHOW
IN BARRINGTON, N.J. ONLY 10 MINUTES AWAY AT
EDMUND FACTORY STORE

PLUG IN 200,000 CANDLEPOWER!



Powerful 12v emergency light projects big straight beam visible for 2 miles. Plugs into car's cigarette lighter; only 3 1/2 lbs. Great for motorists, outdoorsmen, emergency crews, security men, campers. Super bright 200,000 candlepower G.E. aircraft landing light in a

rugged weatherproof steel housing with baked enamel finish, steel lens grate, polished chrome-plated reflector, on/off switch. 15 ft. extension cord; 6 1/4 dia. x 11 1/2". Keep it handy!

- Stock No. 72,093 AV \$22.95 Ppd.

CAN'T SLEEP, RELAX? TRY THIS!

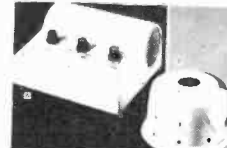

Electronic sound conditioner simulates 4 kinds of soothing sounds of ocean surf and rain. "White sound" helps mask unwanted noise, adds restful, intriguing background sound. Program the solid-state unit to your own need: 2 surf, 2 rain; or "white sound", proven by medical tests to have analgesic effects. Great for meditation, restlessness, sleeplessness psychology.

- (A)-No. 71,997AV... (7 1/2 x 7 x 3 1/2") 110V AC \$89.95 Ppd.
- (B)-AS ABOVE, BUT "WHITE SOUND" ONLY
- No. 71,980AV... (6" Rd. x 3 1/2" Hi) \$28.00 Ppd.

KNOW YOUR ALPHA FROM THETA!



For greater relaxation, concentration, listen to your Alpha-Theta brainwaves. Ultra-sensitive electrode headband slips on/off in seconds—eliminates need for messy creams, etc. Attach'd to amplifier, filters brainwaves, signals beep for ea. Alpha or Theta wave passed. Monitoring button stimulates Alpha sound; audio & visual

(L.E.D.) feedback. Reliable, easy-to-use unit comparable to costlier models. Completely safe. Comprehensive instruction booklet.

- No. 1635AV (8 x 3 x 4"); 24 oz.) \$149.50 Ppd.
- DELUXE "ON" TIME MONITOR—Measures and records %
- No. 1652AV... (15 x 10 x 6") \$299.50 Ppd.
- No. 71809AV LOW COST "STARTER" UNIT \$55.00 Ppd.
- 00-IT-YOURSELF KIT No. 61,069AV \$34.95 Ppd.

LOW COST 7X INFRA-RED VIEWER



For infra-red crime detection surveillance, security system alignment, I.R. detection, laser checking, nite wildlife study, any work req. I.R. detection & conv. to visible spectrum. Self control scope w/everything incl I.R. light source.

- 6v or 12v power, 6032 I.R. converter tube, f/4.5 objective lens, adjust. triplet eyepiece. Focuses from 10' to infinity.
- No. 1659AV (11 x 14 1/4 x 3") \$285.00 Ppd.
- WITHOUT LIGHT SOURCE
- No. 1663AV \$225.00 Ppd.

4 1/4" ASTRONOMICAL TELESCOPE



See moon craters, rings of Saturn, double stars. New equatorial mount. f/10, 1/4 wave mirror (Pyrex). Gives theoretical limit of resolution. Rack & pinion focusing. Aluminum tube, 6X finder. 1" F.L. 45X Kellner achromatic eyepiece and Barlow lens to double & triple power up to 135X. Free Star Chart plus 2 Books.

- Stock No. 85,105AV (Shipping Wt. 42 lbs.) \$159.50 FOB
- 4 1/4" WITH CLOCK DRIVE No. 85,107AV \$199.50 FOB
- 6" REFLECTOR TELESCOPE (48X to 360X) No. 85,187AV \$249.50 FOB
- 6" WITH CLOCK DRIVE No. 85,086AV \$285.00 FOB
- 3" DELUXE REFLECTOR (30X to 90X) No. 80,162AV \$ 89.95 Ppd.
- STANDARD 3" REFLECTOR No. 85,240AV \$ 59.95 Ppd.

We're #1—and the critics totally agree!

HIRSCH-HAUCK LABS . . . Stereo Review

“The Pickering XUV/4500-Q is obviously one of the best phono cartridges presently available.

There are few stereo cartridges that can outperform it in any of its individual characteristics, and we know of none that could be said to be a better stereo/CD-4 pick-up.”

B. V. PISHA . . . Audio Magazine

“The Pickering XUV/4500-Q ranks among the top cartridges for stereo, SQ, QS and CD-4. The sonic clarity is exceptionally good, with superb transient and applause response, and good definition, particularly in the low bass region.”

“To sum up, we can recommend the Pickering XUV/4500-Q cartridge without reservations, based upon our laboratory and listening tests.”

MAURICE HOLTHAM . . . Canadian Stereo Guide

“In fact the reproduction of all material . . . stereo, CD-4 and matrix . . . was absolutely superb. Good recordings were reproduced with outstanding fidelity and clarity, and tracking was secure at one gram with even the most heavily modulated bands. Solo instruments and voice were rendered with exciting realism; large orchestral and choral works came through in all their magnificence.”

Hi-Fi Stereo Buyers Guide

“In both stereo and CD-4 one of the most outstanding under any program conditions. Sound so clean and crisp it almost hurts.”

“This pickup is a perfect example of why measurements cannot truly express the sound quality from a transducer; though the measurements are good, the sound quality was rated by the entire listening panel as superb.”



The specifications of the XUV/4500-Q are so exciting that we hope you will write to Pickering and Company, Inc., Dept. PE, 101 Sunnyside Blvd., Plainview, New York 11803 for further information.



“for those who can hear the difference”

Reprinted by permission of Audio, Canadian Stereo Guide, Hi-Fi Stereo Buyers Guide and Stereo Review Magazines.

Dual precision starts automatically at \$139.95. And semi-automatically at \$199.95.

The least you should require of a turntable is assurance that its tonearm can track flawlessly with the most sensitive cartridges, and that its drive system will introduce no audible rumble, wow, or flutter. To accept less means risking damage to your expensive records and producing sounds from your system which were never recorded.

Happily, the lowest-priced Dual, the 1225, is the perfect example of Dual's basic design concept: to build every turntable with more precision than you are ever likely to need.

The 1225 is a fully automatic, single-play turntable with multi-play facility. Its vernier-adjustable, low-mass counterbalanced tonearm can track flawlessly at as low as one gram. Stylus pressure is applied exactly as in every Dual, around the vertical pivot and perpendicular to the groove, maintaining perfect balance in all planes. Anti-skating force is also applied exactly as in every Dual, with separate calibrations for conical, elliptical and CD-4 styli.

Other features the 1225 shares with all other Duals include pitch-control and cue-control damped in both directions. The hi-torque motor maintains speed within 0.1% even when line voltage varies as much as 20%, and the hefty 3½ lb., 10⅝" platter provides effective flywheel action to minimize the audible effect of any speed variation.

The newest Dual, the 510, is a single-play turntable with a unique semi-automated tonearm. A mechanical sensor indicates when the tonearm is positioned precisely over the lead-in groove of a 12" or 7" record. The tonearm remains suspended over the record until lowered by the cue-control; it cannot be dropped accidentally. At the end of play, the tonearm is automatically lifted by the cue-control and the motor shuts off.

In all other respects, the 510 is essentially the same as other full-sized Dual models. The 8¾" tonearm is mounted in a newly designed four-point gimbal suspension, and the dynamically-balanced cast platter is driven by an 8-pole synchronous motor via a precision-ground belt. Pitch is variable over a 6% range (a semitone) and can be conveniently set to exact speed by means of a built-in illuminated strobe, read directly off the rim of the platter.

Now all you need decide is which way you want Dual precision: automatically or semi-automatically. (And whether you will ever want to play two or more records in sequence.)



Dual 1225, less than \$140, less base. Dual 1226, similar but with cast platter and rotating single-play spindle. Less than \$170. Dual 1228 with gimballed tonearm, synchronous motor, illuminated strobe, variable tracking angle, less than \$200.

Dual 510, less than \$200, less base. Full-size belt-drive models include: Dual 601, fully-automatic, less than \$250. (Dual CS601, with base and cover, less than \$270.); Dual 1249, fully-automatic, single-play/multi-play, less than \$280.

United Audio Products, 120 So. Columbus Ave., Mt. Vernon, N.Y. 10553

CIRCLE NO. 4 ON FREE INFORMATION CARD

Exclusive U.S. Distribution Agency for Dual

