

# Popular Electronics®

WORLD'S LARGEST-SELLING ELECTRONICS MAGAZINE

AUGUST 1975/75c

**BUILD A GIANT-SIZE DIGITAL TIMER-SCOREBOARD FOR ATHLETIC EVENTS**

7

**Will Audio Go Digital?**

**Listen to Your Heart with Doppler Ultrasound**

**Imitating Musical Instruments with Synthesized Sound**

## LAB TEST REPORTS

- Sherwood S-7310 Stereo Receiver
- Stanton 8004-II Turntable/Cartridge
- McKay Dymek DA-3 Active AM Antenna
- Dynascan Cobra 29 CB Transceiver
- Exact 190 & 195 Function Generators

# Special Report on CB Transceivers

**\* BASE STATION EQUIPMENT DIRECTORY**

**\* USER'S BUYING GUIDE**

**\* CB COMMUNICATION RANGE**

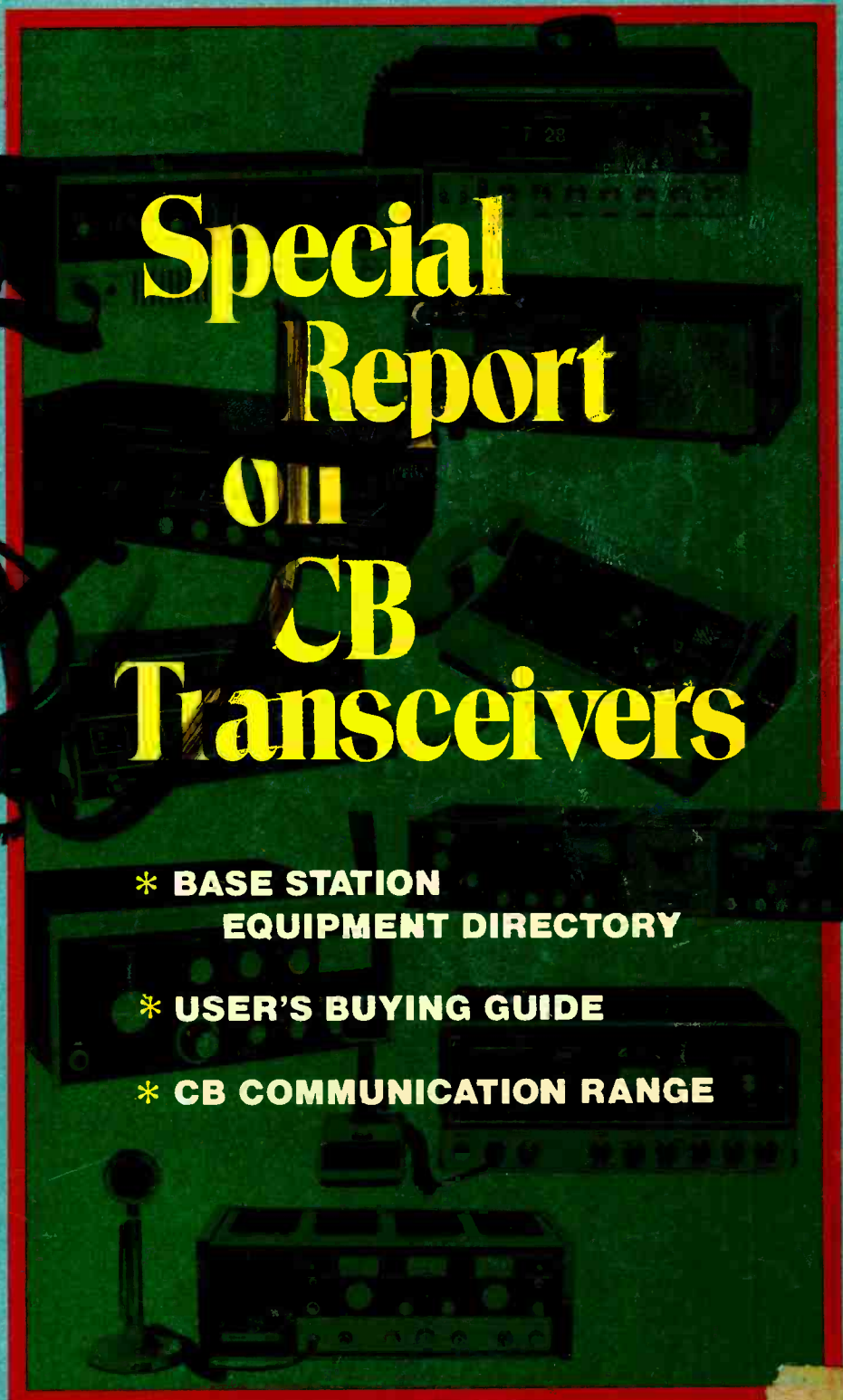

# YOU GET WHAT YOU PAY FOR.

Hy-Gain grew up in the west, where the going can be mighty tough. And we found out early it's important to give a man the best for his money.

So it is with our new Hy-Range CB radios. They have the same Hy-Gain

quality that's made our antennas the performance leader of the industry.

For years, we've been making CB radios and antenna systems for every installation, from the simplest to the most elaborate. Check with your

Hy-Gain distributor for details or write for our free CB catalog.

You wouldn't buy anything less than the best for your vehicle, don't settle for a second-rate radio. Buy Hy-Gain.

Hy-Gain Electronics Corporation, 8601 Northeast Highway Six, Lincoln, NE 68505; 402/464-9151; Telex 48-6424  
Branch Office and Warehouse: 6100 Sepulveda Blvd., #322, Van Nuys, CA 91401; 213/785-4532; Telex 65-1359  
Distributed in Canada by Lectron Radio Sales, Ltd., 211 Hunter Street West, Peterborough, Ontario

 **hy-gain**®



PICTURED: HY-RANGE III, A FULL FEATURE 23 CHANNEL MOBILE.



# World's Most Inexpensive BASIC Language System

## \$995

Limit: one per customer.  
OFFER expires September 15, 1975.



**Altair 8800 Computer Kit**

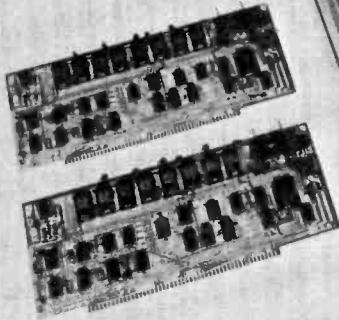

**Two 4,096 word Memory Boards (kit)**

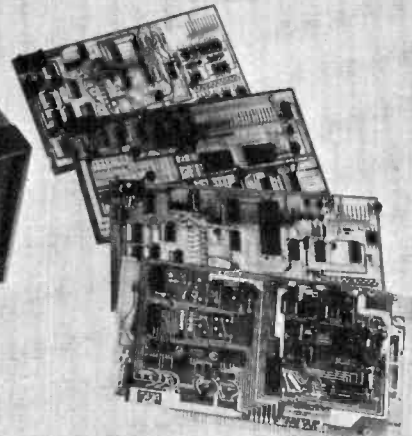

**Your choice of Interface Boards (kit)**

**Altair 8K BASIC Language**

**Altair 8K BASIC Language.** This language was chosen for the Altair Computer because of its versatility and power and because it is easy to use (comes with complete documentation). Altair 8K BASIC has many features not normally found in BASIC language including an OUT statement and corresponding INPut function that allows the user to control low speed devices (machine control without assembly language). Leaves 1750 words in 8K machine for programming and storage.

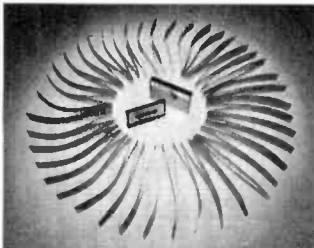

**NOTE:** Altair BASIC comes in either paper tape or cassette tape. Specify when ordering.

**Interface Board Options.** The *Parallel Interface Board* is used to connect the Altair 8800 to external devices that send and receive parallel signals. Many line printers require a Parallel Interface Board. The *RS232 Serial Board* is used to connect the Altair 8800 to external devices that send and receive RS232 serial signals. Most computer terminals require an RS232 Serial Interface Board. The *TTY Serial Interface Board* is used to connect the Altair 8800 to an ASR-33 or KSR-33 teletype (20 milliamp current loop). The *TTL Serial Interface Board* is for custom interfacing. The *Audio Cassette Interface Board* is used to connect the Altair 8800 to any cassette tape recorder. It works by changing the

electrical signals from the computer to audio tones. It can be used to store unlimited amounts of information coming out of the computer and it can be used to put information back into the computer.

**PRICES:**

Altair Computer kit with complete assembly instructions	\$439
Assembled and tested Altair Computer	\$621
1,024 Word Memory Board	\$176 kit and \$209 assembled
4,096 Word Memory Board	\$264 kit and \$338 assembled
Full Parallel Interface Board	\$92 kit and \$114 assembled
Serial Interface Board (RS232)	\$119 kit and \$138 assembled
Serial Interface Board (TTL or TTY—teletype)	\$124 kit and \$146 assembled
Audio Cassette Interface Board	\$128 kit and \$174 assembled
4K BASIC language (when purchased with Altair, 4,096 words of memory and Interface Board)	\$60
8K BASIC language (when purchased with Altair, two 4,096 word memory boards and Interface Board)	\$75
COMTER II	\$780 kit
Teletype ASR-33	\$1500 (assembled only)

**Input Output Devices.** The Comter II Computer Terminal has a full alpha-numeric keyboard and a highly-readable 32-character display. It has its own internal memory of 256 characters and complete cursor control. Also has its own built-in audio cassette interface that allows you to connect the COMTER II to any tape recorder for both storing data from the computer and feeding it into the computer. Requires an RS232 Interface board.

The Standard ASR-33 Teletype prints 10 characters per second. It has a built-in paper tape reader and punch. Has standard 120 day Teletype warranty. Requires a Serial TTY Interface board.

**NOTE:** The Altair 8800 can be connected to any number of input/output devices other than the ones listed above.

# MIT'S

"Creative Electronics"

6328 Linn, N.E., Albuquerque, NM 87108 505/265-7553

AUGUST 1975

CIRCLE NO. 34 ON READER SERVICE CARD

**MAIL THIS COUPON TODAY**

Enclosed is check for \$\_\_\_\_\_

BankAmericard # \_\_\_\_\_  or Master Charge # \_\_\_\_\_

\*  \$995 BASIC System Special with following Interface Board:  Parallel

Serial RS232  Serial TTY  Serial TTL  Audio Cassette

Altair 8800  Kit  Assembled  Options (list on separate sheet)

Include \$8 for postage and handling

Please send free Altair System Catalog

NAME \_\_\_\_\_

ADDRESS \_\_\_\_\_

CITY \_\_\_\_\_ STATE & ZIP \_\_\_\_\_

Credit Card Expiration date \_\_\_\_\_

MIT'S/6328 Linn, NE, Albuquerque, NM 87108 505/265-7553

Warranty: 90 days on parts for kits and 90 days on parts and labor for assembled units. Prices, specifications and delivery subject to change.

# New Mallory Ni-Cad Batteries. Rechargeable 1000 times.



Economical recharging —  
Mallory BC-1 Charger draws only two watts.

Team these long-life nickel-cadmium cells with an automatic Mallory Charger, and you can recharge them 1000 times, or more.

You'll be sure of having fresh D, C, and AA batteries, while saving money, time and trouble. Mallory Rechargeable Nickel-Cadmium Batteries keep on coming back for more in electronic calculators, tape recorders, radios, cameras, toys, other battery-powered products.

Keep a spare set of Mallory Ni-Cads on hand,

and you'll never run out of battery power again. They recharge to full strength, two or four at a time. And unlike ordinary dry cells that lose voltage during discharge, Mallory Ni-Cads with a full charge maintain operating voltage during the entire work cycle. You get maximum power, continuously, for top product performance.

For the long run, Mallory Rechargeable Ni-Cads . . . the 1000-time batteries. Get them now at your Mallory Distributor.

## MALLORY

### MALLORY DISTRIBUTOR PRODUCTS COMPANY

a division of P. R. MALLORY & CO. INC.

Box 1284, Indianapolis, Indiana 46206; Telephone: 317-856-3731

Batteries • Capacitors • Controls • Security Products • DURATAPE® • Resistors • Semiconductors • SONALERT® • Switches • Fastening Devices

DURATAPE® and SONALERT® are registered trademarks of P. R. Mallory & Co. Inc.

CIRCLE NO. 35 ON READER SERVICE CARD

# Popular Electronics®

WORLD'S LARGEST SELLING ELECTRONICS MAGAZINE

## FEATURE ARTICLES

<b>ELECTRONIC CROSSOVER NETWORKS FOR HI-FI</b> .....	Leonard Feldman	33
<i>What they are, how they work, and how you can design your own.</i>		
<b>IMITATING MUSICAL INSTRUMENTS WITH SYNTHESIZED SOUND</b> .....	Don Lancaster	37
<i>How the sounds of traditional instruments can be produced electronically.</i>		
<b>SPECIAL REPORT ON CB TRANSCEIVERS</b>		
<b>USER'S BUYING GUIDE TO CB BASE STATIONS</b> .....	John J. McVeigh	45
<i>What to look for in terms of performance.</i>		
<b>BASE STATION EQUIPMENT DIRECTORY</b> .....		48
<i>Specifications, features, and prices.</i>		
<b>CB COMMUNICATION RANGE</b> .....	Leo Sands	53
<i>The factors that affect the "talk power" of your CB station.</i>		

## CONSTRUCTION ARTICLES

<b>A DIGITAL TIMER-SCOREBOARD FOR ATHLETIC EVENTS</b> .....	Philip Harms	27
<i>Giant-sized readout for schools and amateur sports.</i>		
<b>LISTEN TO YOUR HEART WITH DOPPLER ULTRASOUND</b> .....	Joseph Jaffe	60
<i>Stethoscope lets you hear snapping of heart valves and blood-flow sounds.</i>		
<b>A SIMPLE ON-BOARD TESTER</b> .....	John T. Frye	70
<i>Checks many components with the aid of a scope.</i>		

## COLUMNS

<b>STEREO SCENE</b> .....	Ralph Hodges	16
<i>Will Audio Go Digital?</i>		
<b>SOLID STATE</b> .....	Lou Garner	78
<i>Audio Amplifiers for Hobbyists.</i>		
<b>HOBBY SCENE</b> .....	Editorial Staff	85

## PRODUCT TEST REPORTS

<b>SHERWOOD MODEL S-7310 AM/STEREO FM RECEIVER</b> .....	64
<b>STANTON MODEL 8004-II RECORD PLAYING SYSTEM</b> .....	66
<b>McKAY DYMEK MODEL DA-3 ACTIVE AM ANTENNA</b> .....	67
<b>DYNASCAN COBRA MODEL 29 MOBILE AM CB TRANSCEIVER</b> .....	68
<b>EXACT MODEL 190 FUNCTION AND MODEL 195 SWEEP/FUNCTION GENERATORS</b> .....	68

## DEPARTMENTS

<b>EDITORIAL</b> .....	Art Salsberg	4
<i>No Frowns in Distributor Land.</i>		
<b>LETTERS</b> .....		6
<b>NEW PRODUCTS</b> .....		12
<b>NEW LITERATURE</b> .....		14
<b>ELECTRONICS LIBRARY</b> .....		86
<b>ADVERTISERS' INDEX</b> .....		100

POPULAR ELECTRONICS, August 1975, Volume 8, Number 2. Published monthly at One Park Avenue, New York, NY 10016. One year subscription rate for U.S., \$6.98; U.S. Possessions and Canada, \$7.98, all other countries, \$8.98. Second Class postage paid at New York, NY and at additional mailing offices. Authorized as second class mail by the Post Office Department, Ottawa, Canada and for payment of postage in cash. Subscription service and Forms 3579, P.O. Box 2774, Boulder, CO 80302. POPULAR ELECTRONICS including ELECTRONICS WORLD, Trade Mark Registered. Indexed in the Reader's Guide to Periodical Literature. COPYRIGHT © 1975 BY ZIFF-DAVIS PUBLISHING COMPANY. ALL RIGHTS RESERVED

Ziff-Davis also publishes Boating, Car and Driver, Cycle, Flying, Modern Bride, Popular Photography, Skiing and Stereo Review. Editorial correspondence: POPULAR ELECTRONICS, 1 Park Ave., New York, NY 10016. Editorial contributions must be accompanied by return postage and will be handled with reasonable care; however, publisher assumes no responsibility for return or safety of manuscripts, art work, or models. Forms 3579 and all subscription correspondence: POPULAR ELECTRONICS, Circulation Dept., P.O. Box 2774, Boulder, CO 80302. Please allow at least eight weeks for change of address. Include your old address, enclosing, if possible, an address label from a recent issue.

**EDGAR W. HOPPER**  
Publisher

**ARTHUR P. SALSBERG**  
Editorial Director

**LESLIE SOLOMON**  
Technical Editor

**JOHN R. RIGGS**  
Managing Editor

**ALEXANDER W. BURAWA**  
Associate Editor

**EDWARD I. BUXBAUM**  
Art Director

**JOHN McVEIGH**  
Assistant Editor

**ANDRE DUZANT**  
Technical Illustrator

**HERBERT S. BRIER  
LEN BUCKWALTER  
LOU GARNER  
GLENN HAUSER  
JULIAN D. HIRSCH  
RALPH HODGES  
ART MARGOLIS  
WILFRED M. SCHERER**  
Contributing Editors

**JOSEPH E. HALLORAN**  
Advertising Director

**JOHN J. CORTON**  
Advertising Sales

**LINDA BLUM**  
Advertising Service Manager

**PEGI McENEANEY**  
Executive Assistant

**STANLEY NEUFELD**  
Associate Publisher

**FURMAN H. HEBB**  
Group VP, Electronics & Photo

**ZIFF-DAVIS PUBLISHING COMPANY**  
Popular Electronics

Editorial and Executive Offices  
One Park Avenue New York, New York 10016  
212-725-3500

Hershel B. Sarbin, President  
Furman Hebb, Executive Vice President  
Vincent Perry, Financial Vice President and Treasurer  
Phillip T. Heffernan, Senior Vice President, Marketing  
Edward D. Muhlfeld, Senior Vice President, Sports Division  
Philip Sine, Senior Vice President  
Frank Pomerantz, Vice President, Creative Services  
Arthur W. Butzow, Vice President, Production  
Lawrence Sporn, Vice President, Circulation  
George Morrissey, Vice President  
Sydney H. Rogers, Vice President  
Sidney Holtz, Vice President  
Charles B. Seton, Secretary  
Edgar W. Hopper, Vice President, Electronics Div

William Ziff, Chairman  
W. Bradford Briggs, Vice Chairman

Midwestern Office

The Patis Group, 4761 West Touhy Ave.,  
Lincolnwood, Illinois 60644, 312 679-1100  
GERALD E. WOLFE, THOMAS HOCKNEY

Western Office

9025 Wilshire Boulevard, Beverly Hills, CA 90211  
213 273-8050, BRadshaw 2-1161  
Western Advertising Manager, BUD DEAN

Japan: James Yagi  
Oji Palace Aoyama, 6-25, Minami Aoyama  
6 Chome, Minato-Ku, Tokyo 407-1930/6821,  
582-2851

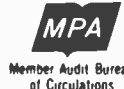

The publisher has no knowledge of any proprietary rights which will be violated by the making or using of any items disclosed in this issue



## Editorial

### NO FROWNS IN DISTRIBUTOR LAND

Electronic parts and equipment wholesalers registered sales of nearly \$5 billion in 1974—a record. And expectations are that the figure will be higher for 1975. So it's not surprising that we saw no frowns among exhibitors and attendees at the annual NEWCOM Show (the old distributor parts show) held recently.

The product star of the show was clearly CB radio gear—mobile and base stations, antennas and accessories. There was general agreement among CB suppliers that the best thing to happen to CB was its use by truckers during a strike about two years ago. Since then, with CB impressed on the public's consciousness, the no-test two-way radio system for just about anyone has exhibited a sales explosion. Manufacturers aren't sitting on their hands, though. Many exciting engineering innovations have been introduced to attract new buyers and to induce present CB'ers to upgrade their equipment. As an example, E.F. Johnson had a mobile unit at the show that employs LED readouts in place of the traditional analog S meter; Royce showed a mobile with channel readout incorporated into the microphone; Beltek features a unit especially designed for motorcycles and snowmobiles; Tram's base station had a two-speed vernier tuning arrangement; etc.

A wide array of mobile and base station antennas was displayed, too. An abundance of CB accessories, from mounting kits to CB antenna co-phasers, was shown; GC Electronics introduced a conical bit for drilling infinitely variable diameters when mounting antennas on automobiles. VHF-FM scanners for Public Safety Broadcasts were very much in evidence, as well. SBE's new 10-channel digital scanner employs 2¼" × 4¾" optical programming cards to give users fast, easy selection of about 16,000 frequencies.

CB did not fully dominate the show, however. There were plenty of other products exhibited: test instruments, TV and FM antennas and rotators, commercial sound systems, intercoms, garage door openers, electronic components, cabinets, cordless soldering irons, and so on.

Of special interest to us were products that we had never heard about. For example, Electrosonics exhibited its "Sound See-er", a battery-powered device that quickly indicates, through a red, yellow or green lamp indicator, whether a person using a public address system is producing a satisfactory sound level in the audience; RCA introduced an adapter for converting single-trace scopes to dual-trace; Para Dynamics featured a signal-searching TV color signal antenna rotor system; Datak showed a new photo-etch pc kit; Intra-Fab displayed a line of color-coordinated aluminum cabinets; Fanon boosted its wireless "babysitter" intercom; Sencore demonstrated a yoke and flyback tester; and making its U.S. debut was Italy's Amtron electronic kits.

Naturally there were many products we knew of but never handled: B&K's low-cost frequency counter, Panavise's bench tools, Eico's telephone electronic accessories, etc. So, in all, the show was a most worthwhile expenditure of time, considering the "hands on" opportunities presented under one roof. Further, it was made patently clear that the electronics distributor business is healthier than ever before.

*Art Salsberg*



# Cobra 85: Performance plus Simplicity

If you want the most performance with the easiest operation, you want Cobra 85.

Select any of 23 channels; adjust squelch and volume—the rest is automatic.

Like talk-range extending Dynabooast modulation circuitry that automatically gives you the most modulation the law allows and built-in automatic noise limiting that extends your listening range. The large illuminated meter tells you the strength of incoming signals and your relative power output. (You know that your radio and antenna

are good if the meter reads normally.)

Cobra 85 operates from either 117VAC or 12 VDC with detachable power cords, so you can use it as a mobile too.

You get big sound from the up front, carefully baffled speaker. You'll hear clearly in your living room or car.

Like every Cobra radio, Cobra 85 is backed by warranty service stations in all 50 states. See the advanced Cobra 85 styling at your dealer.

You'll like its small size and price as well as its superior performance.



 **Cobra 85**

PRODUCT OF DYNASCAN CORPORATION • 1801 W. Belmont • Chicago, Ill. 60613

## All New PROBE IV

CAT. NO.  
5104

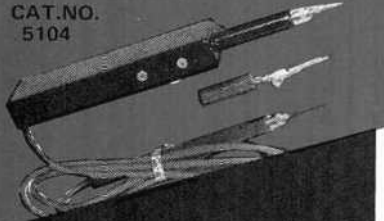

CHECK FOUR FUNCTIONS  
WITH ONE INSTRUMENT!

- Continuity
- Polarity
- Voltage
- Digital Logic

LIGHTWEIGHT - POCKET SIZE  
PROTECTIVE VINYL CARRYING  
POUCH. SEE YOUR FAVORITE  
ELECTRONICS DISTRIBUTOR.

## LIFT-IT!

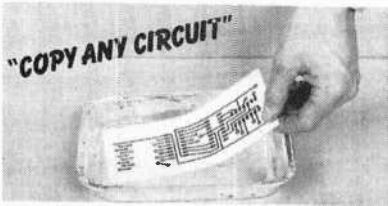

The All-New,  
Quick And Easy  
Way To Reproduce  
Printed Circuits.  
Get Your Kit From  
Your Favorite

CAT. NO.  
J4-828

 CALECTRO Electronics  
Distributor Today!

 **GC ELECTRONICS**  
DIVISION OF HYDROMETALS, INC.  
ROCKFORD, ILLINOIS 61101 U.S.A.

## Coming Up In The September Popular Electronics®

Hobbyist Computer Interchange  
Tape System

\$50 CD-4 Demodulator Kit

Add Functions to Calculators  
Direct-Reading Logic Probe



# Letters

### MANUFACTURER CHANGES TYPE NUMBER

In Mac's Service Shop "Lightning Damage Insurance Jobs" (January 1975), reference was made to the General Electric No. 9L15CCB007 home lighting protector. The number for this item has been changed to 9L15DCB002. This device is a 2-pole/3-conductor unit for 120/240-volt grounded metal service.

RICHARD W. BEHNKE  
Texas

### MANY USES FOR PE

POPULAR ELECTRONICS is a most exciting and easy-to-read magazine. I particularly appreciate the construction projects for CB'ers and SWL's. One needs only a minimum of tools and no specialized knowledge of electronics to build the projects. (My chief hobby interests are CB radio, which I use in Scouting, boating, and shortwave listening.)

It is also very gratifying to see that PE is now using the metric system of measures as well as the so-called British system. Keep up the good work.

JAN STIGELL  
Stockholm, Sweden

### LENS F NUMBERS

"Experimenting With Light-Beam Communications" (April 1975) appears to contain an error. Author Forrest Mims states that the term *f*/number is used to define the ratio of diameter to focal length and is expressed as *f*/*no*, which is equal to *d*/*fl*, where *d* is the lens diameter and *fl* is the focal length. This part of the text should read, "The term *f*-number (this is the proper designation—not *f*/*no*) is used to define the ratio of focal length to lens diameter and is expressed as *f*-no equal to *fl*/*d*."

DANIEL J. NETTO  
Los Angeles, Calif.

*You are correct. The f-no of a lens is equal to the focal length divided by the diameter of the lens. The formula d/fl is the divergence of the projected beam, or receiver field of view, in radians.* —Author

### NOTES ON HEAD ALIGNMENT

I would like to comment on the procedures outlined by Ralph Hodges for tape head alignment in his February 1975 "Stereo Scene." There are two important

points Mr. Hodges did not mention. The first is head rotation, which is very important on modern tape decks that do not have pressure pads. Rotation must be set so that the wear pattern is equal on both sides of the head gap and, more important, for maximum output at 15,000 Hz. I am certain that in most decks, any change in one alignment parameter will affect the other alignment parameters to some degree.

The second point, in azimuth alignment, is the importance on a multi-channel deck to check the phase relationships of the tracks to each other. It is possible to read maximum level at high frequencies and still be 180° out of phase.

In short, when it comes to a critical alignment procedure, the job is best left to a professional who has the knowledge and equipment to do the job correctly.

HOWARD M. LIEBERMAN  
Audio Concepts  
Spring Valley, N.Y.

*The column was not intended to be a formal discourse on head alignment. It was merely a loose discussion of a few cheap-and-dirty diagnostic tricks that might help one to keep tabs on a deck's variations in performance. I share any reservations Mr. Lieberman has about these procedures being good studio practice. I also agree on the subject of head rotation. However, the head gaps of many consumer decks cannot be seen with the unaided eye. As for adjusting rotation for maximum output at 15,000 Hz, I must confess that I have never tried it, but I agree that it can be worthwhile, particularly if thicker tapes are customarily used on the tape deck.*

*I realize that track phasing is important in certain professional applications (as when stereo material is mixed for mono broadcasting), but I do not understand why phasing should be of any practical consequence in consumer recorders where mixing is very rarely used.* —Author

## Out of Tune

In "Digital Marine/Auto Tachometer" (June 1975), the connection where the line coming from pin 5 crosses the line between pins 1 and 8 of IC2 in the schematic should be removed. Also, the IC's are sensitive to the r-f noise from the car's ignition system. To cope with this problem, it may be necessary to install r-f suppression-type spark plug cable in older cars and extensive capacitive bypass techniques in the circuit. Route the coaxial feed cable close to the metalwork on the bottom of the car and locate its grounding point experimentally. In most cases it will be on the car's body or frame, rather than on the engine.

In "How to Design Your Own Power Supplies" (June 1975), Fig. 10, page 39, the polarity of the zener diode should be reversed.

POPULAR ELECTRONICS



# Royce

## Construction-Range-Performance

New! Royce offers you a full line of professional antennas!



MODEL 2-202. MOBILE ANTENNA. 102" stainless steel whip. Stainless steel spring. 180° swivel mount. All hardware included.



\*MODEL 2-205. MOBILE ANTENNA. 46" high. Trunk lip/hole mount. Spring, tapered stainless whip, chrome plated brass cup. Includes hardware and 17-foot low loss coax assembly.



\*MODEL 2-208. MOBILE ANTENNA. Gutter clip type. Center loaded. Stainless steel spring, bar and whip, with 10-foot low loss coax assembly.



\*MODEL 2-222. MOBILE ANTENNA. High efficiency fiberglass. Trunk lip mount. 50" high. Chrome plated brass cup assembly and 17-foot low loss coax cable assembly.



\*MODEL 2-224. MOBILE ANTENNA. 48" high. Twin truck. Fiberglass shafts. Two West Coast mirror mounts, and a low loss coax phasing harness.

Antennas in the Royce tradition of quality. Specially designed to deliver maximum performance from your Royce (or any brand) transceiver.

MODEL 2-200. MOBILE ANTENNA. Stainless steel 102" whip. Spring and bumper strap.

\*MODEL 2-203. MOBILE ANTENNA. 44" high. Rooftop mount.  $\frac{3}{8}$ " snap in base. Stainless steel spring and whip. With low loss coax assembly.

\*MODEL 2-209. MOBILE ANTENNA. 20" high. Trunk lip reduced size antenna. Stainless steel whip bar and spring with low loss coax assembly.

\*MODEL 2-21C. PORTABLE ANTENNA. Screws in back of set for temporary or portable use.

\*MODEL 2-220. MOBILE ANTENNA. 48" high. Fiberglass shaft, top coil and stainless tuning tip.  $\frac{3}{8}$ "x24" stud.

\*MODEL 2-223. MOBILE ANTENNA. Same as Model 2-224, except single mirror mount antenna with low loss coax assembly.

MODEL 2-230. MARINE VHF ANTENNA. 6db gain. 8½-foot. Includes cyclocac tilt mount and coax cable.

MODEL 2-234. MARINE CB ANTENNA. Stationary base with 17-foot coaxial assembly. High efficiency center load coil.

MODEL 2-240. POPULAR GROUND PLANE BASE ANTENNA.

MODEL 2-245. SKY-MASTER I. ½ WAVE 3.75 db GAIN BASE ANTENNA.

MODEL 2-250. SKY-MASTER II. ¾ WAVE 5 db GAIN BASE ANTENNA.

\*ATTRACTIVELY PACKAGED ON 3-COLOR CARDS.

See the complete line of Mobile and Base Antennas at your Royce Dealer today!

## Royce electronics corporation

1142 Clay St., North Kansas City, Mo. 64116

CALL: (816) 842-0252 • TELEX: 426-145

# The real way to learn digital electronics!

## NRI is the only school to train you at home on a real digital computer.

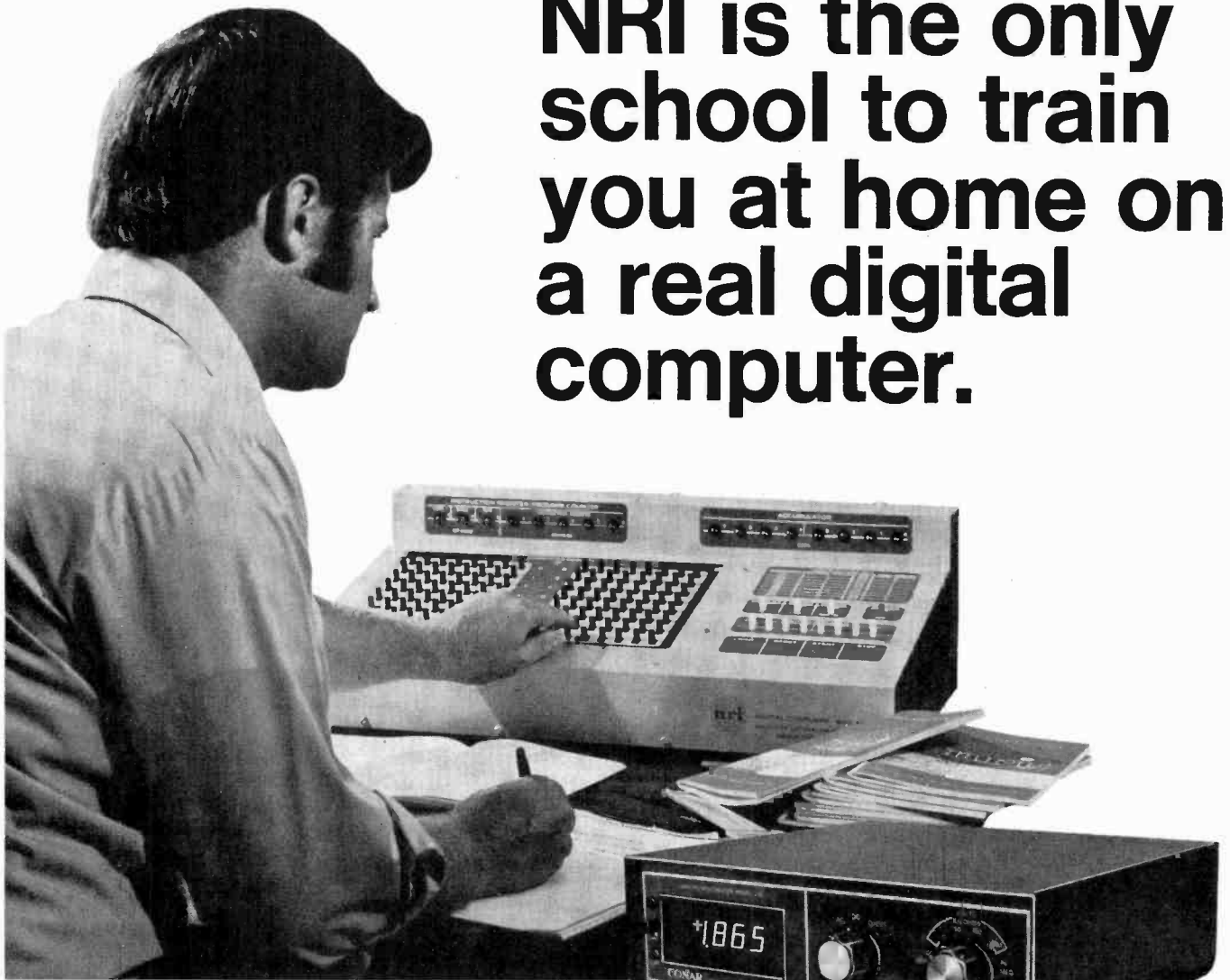

Learn computer design, construction, maintenance and programming techniques on your own digital computer using a professional digital multimeter!

Qualified technicians are urgently needed for careers in the exciting new field of digital and computer electronics . . . and the best way to learn digital logic and operations is now available to you in NRI's Complete Computer Electronics Course.

This exclusive course trains you at home on your own digital computer! This is no beginner's "logic trainer", but a complete programmable digital computer that contains a memory and is fully automatic. You build it yourself and use it to define and flow-chart a program, code your program, store your program and data in the memory bank. Press the start button and the computer solves your

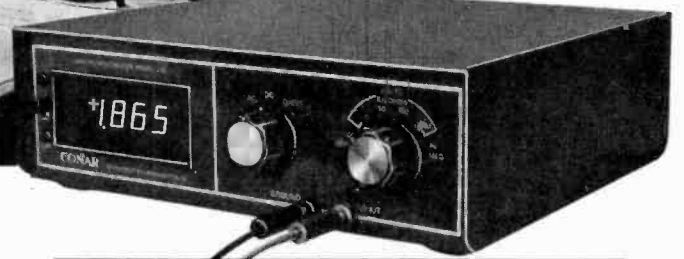

**NOW . . .  
YOUR OWN DIGITAL (3½ DIGITS)  
MULTIMETER INCLUDED  
AT NO EXTRA COST!**

The latest in digital testing equipment . . . along with valuable training experiments in digital techniques.

problem and displays the result instantly.

The NRI digital computer is one of 10 kits you receive in the NRI Complete Computer Electronics Course. You build and use your own 3½ digit digital multimeter . . . while you perform hundreds of experiments, building hundreds of circuits, learning organization, operation, troubleshooting and programming.

## Only NRI offers you five TV/Audio Servicing Courses



Color TV repair is another big opportunity field right now and NRI can train you at home to service and repair any color or black & white TV, hi-fi equipment, AM-FM radios, and sound systems.

You can choose from 5 courses, starting with a basic servicing course with 65 lessons . . . up to a Master Color TV course, complete with 25" diagonal solid state color TV in handsome woodgrain cabinet. No other school offers so many choices or so much value.

All courses are available with low down payment and convenient monthly payments to fit your budget. And all courses provide professional tools and equipment along with NRI-designed kits for hands-on training. With the Master Course, for instance, you receive your own 5" wide-band triggered sweep solid state oscilloscope, TV pattern generator, 3½ digit digital multimeter and a NRI 25" diagonal solid state television receiver expressly designed for color TV training.

### YOU PAY LESS WITH NRI TRAINING AND YOU GET MORE FOR YOUR MONEY.

NRI employs no salesmen, pays no commissions. We pass the savings on to you in reduced tuitions and extras in the way of professional equipment, testing instruments, etc. You can pay more, but you can't get better training.

## NRI's complete communication course includes your own CB Training Transceiver



NRI prepares you for a career in the rapidly expanding field of communications . . . a field destined to double in the next decade! NRI can train you at home for one of the thousands of service and

maintenance jobs opening in AM and FM Transmission and Reception, TV Broadcasting, Microwave Systems, Teletype, Radar, Marine Electronics, Mobile Communications and Aircraft Electronics. You train on your own 23-channel Johnson Transceiver and AC power supply; a digital multimeter, for digital experiments and precise testing; bite-size lessons leading to your FCC license and the communications field of your choice.

### NEARLY ONE MILLION STUDENTS IN 60 YEARS HAVE LEARNED AT HOME THE NRI WAY.

Mail the insert card and discover for yourself why NRI is the recognized leader in home study training. No salesman will call. Do it today and get started on that new career.

#### APPROVED UNDER GI BILL

For the career minded, we are approved for veterans benefits. Check box on card for details.

### MAIL THE INSERT CARD FOR YOUR FREE NRI CATALOG

No salesman will call



NRI SCHOOLS  
McGraw-Hill Continuing Education Center  
3939 Wisconsin Avenue,  
Washington, D.C. 20016



# NEW!

high  
reliability  
recording  
tape



from  
**Lafayette**  
the electronics  
shopping center

We're introducing a top-value line of Lafayette brand blank recording tape with formulations designed for every application. Cassette, cartridge, reel-to-reel—from our low-noise general purpose series to our Criterion XHE (Extra high energy) top-of-the-line—you'll find the tape you need at a price that's right. Visit the new tape centers at our stores, or read about it in our new 1976 catalog.

## FREE!



1976  
**Lafayette**  
Radio  
Electronics  
Catalog

Mail this card today, or reserve a copy through your Lafayette store.



Dept. 35085

**Lafayette Radio Electronics**  
111 Jericho Tpke., Syosset, New York 11791

**Send me your FREE 1976 Catalog**

Name .....

Address .....Apt. ....

City .....State .....

Zip

CIRCLE NO. 31 ON READER SERVICE CARD

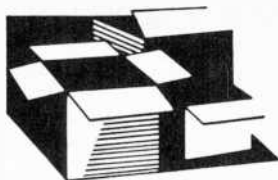

## New Products

*Additional information on new products covered in this section is available from the manufacturers. Either circle the item's code number on the Reader Service Card inside the back cover or write to the manufacturer at the address given.*

### TELEQUIPMENT DUAL-TRACE PORTABLE OSCILLOSCOPE

Tektronix's new Telequipment Model D32 oscilloscope is a 10-MHz, dual-trace unit. The scope has a vertical sensitivity ranging from 10 mV/div to 5 V/div in nine calibrated steps, nineteen sweep speeds ranging from 500 ns/div to 500 ms/div, a X5 horizontal magnifier, and flexible triggering. Automatic selection of chopped or alternate modes is incorporated, and the D32 can be run off line current or rechargeable batteries. Up to four hours of continuous operation is possible under battery power. Six rechargeable "D" cells, probes (2 each), and a front-panel protective cover are included as standard equipment. An optional carrying case is also available. The scope measures 11" D x 9" W x 4" H (27.9 x 22.9 x 10.2 cm). \$995.

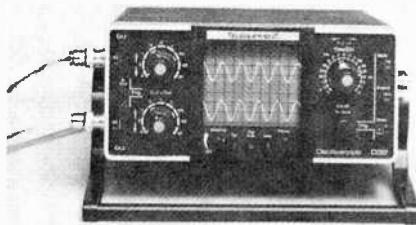

CIRCLE NO. 70 ON READER SERVICE CARD

### WALL-LENK SOLDERING PISTOL

Wall-Lenk's new Model 2116 is a lightweight, 30-watt pistol-grip soldering gun. It is UL listed and has a nylon handle that is said to stay cool even during prolonged use. The pistol is balanced for comfort, and its heating element reaches operating temperature in a few seconds, according to the manufacturer.

CIRCLE NO. 71 ON READER SERVICE CARD

### RCA PORTABLE SEMICONDUCTOR CHECKER

The new portable, battery-powered Transistor/Diode/FET Checker, Model WC-506B by RCA, permits quick checks of both in- and out-of-circuit devices. The instrument provides four ways to connect a device for relative gain or leakage tests of npn and pnp transistors, p- and n-channel

single- and dual-gate FET's, and relative front-to-back ratios of diodes. A conductive foam pad on the front panel is included to discharge FET leads. A special "square-law" meter makes possible one extended range for all tests. Relative gain readings are indicated on a single "good-bad" color-coded scale. Devices can be tested in the panel socket or with color-coded test leads. Extension leads are provided for in-circuit testing. The Checker measures 6 1/4" x 3 3/4" x 2" (15.9 x 9.5 x 5.2 cm) and weighs 14 ounces (397 g). \$33.

CIRCLE NO. 72 ON READER SERVICE CARD

### HIGH-VOLTAGE/CURRENT MEASURING PROBE

Eico's Model HVP-5 is a self-contained, direct-reading high-voltage and current measuring probe. It can read dc voltages up to 40,000 V and dc currents up to 200 mA. The two measuring circuits are independent of each other, and the meter is switched between them by a slide switch mounted on the probe body. The manufacturer claims that the HVP-5 cannot be damaged by placing the function switch in the mA position while measuring high voltage. \$29.95.

CIRCLE NO. 73 ON READER SERVICE CARD

### AUDIOANALYST "TOWER OF SOUND"

The Audioanalyst Tower of Sound is a stacked pair of A-100X three-way acoustic suspension loudspeakers. This is done to take advantage of the dispersion characteristics of the high-frequency drivers and mutual coupling between the two 10-inch woofers. It is said that the two low-frequency drivers behave as one 15-inch woofer without the beaming and breakup problems of a larger transducer. The two A-100X systems are wired in parallel, presenting a 4-ohm load to the power amplifier. The Tower of Sound stands about four ft. (1.2 m) tall and occupies a little more than a square foot of floor space.

CIRCLE NO. 74 ON READER SERVICE CARD

### CLARION UNDER-DASH CASSETTE PLAYER/RECORDER

The Clarion Model 812 car cassette player features record capability, a microphone with coiled cord and an on/off switch for



stop/start operation, and automatic reverse. Also included are fast forward/rewind and volume, tone, and balance controls, automatic or manual program switching, and program indicator lights.

CIRCLE NO. 75 ON READER SERVICE CARD

POPULAR ELECTRONICS

### KENWOOD LUXURY RECEIVER

The new KR-9400 stereo receiver boasts 120 watts rms/channel into 8 ohms between 20 and 20,000 Hz, with no more than 0.1% THD. The amplifier section uses direct-coupled output circuitry, and a pro-

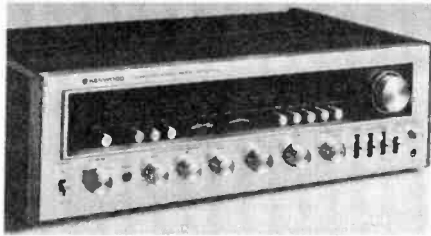

tection circuit combining electronic and relay switching. The KR-9400 tuner section uses a dual-gate MOSFET front end, a multi-function IC, and a phase-locked loop IC. Claimed sensitivity is 1.7  $\mu$ V, selectivity 80 dB, and capture ratio 1.3 dB. A triple-function meter performs as a signal-strength, multipath, and deviation indicator. Other features are three tone controls, a dual tape system for uninterrupted dubbing, and a new injection circuit which mixes the signal from any program source into the recorded signal, with front panel level control for proper blending.

CIRCLE NO. 76 ON READER SERVICE CARD

### AUDIO SWEEP GENERATOR/FREQ. METER

Production Devices' Model 140B is an audio oscillator, sweep generator, and frequency meter in one enclosure. As a sweep generator, it operates over two ranges—from 40 Hz to 1000 Hz, and from 1000 to 20,000 Hz. The frequency meter may be used independently. As an audio oscillator, it provides a sine wave with an adjustable output from 0 to 2.5  $V_{rms}$ , which is constant over the audio range ( $\pm 0.25$  dB). Distortion is said to be less than 1.5%. As a square-wave generator, the Model 140B can produce a fixed 8  $V_{rms}$  output. \$78.95.

CIRCLE NO. 77 ON READER SERVICE CARD

### ESP TESTER

Edmund Scientific's new solid-state portable ESP Tester has a guaranteed random



circuit for accurate testing. When the examiner pushes a button, a light appears

AUGUST 1975

# BUILD & TEST CIRCUITS AS FAST AS YOU THINK!

- POWER FOR THE PROFESSIONAL
- ECONOMY KITS FOR THE HOBBYIST
- A MODEL AND A PRICE FOR EVERYONE



### PROTO BOARD 203

Breadboard Prototyping with 5 Volt, 1 AMP Regulated Power Supply included! A total ready-to-use power breadboard prototyping device with a built-in regulated, short-proof power supply. Just plug-in and start building! 2 extra floating 5-way binding posts for external signals. Self-contained with power switch, indicator lamp and power fuse. 24-14 pin DIP capacity. Attractive two-tone quality case. All metal construction. 9 $\frac{3}{4}$ "L x 6 $\frac{1}{2}$ "W x 2 $\frac{3}{4}$ "H. 5 lbs. Order today!

**\$75**

Add \$2.50 shipping/handling

A modestly priced kit for the economy-minded experimenter . . .

### PROTO BOARD 100

A low cost, big 10 IC capacity breadboard kit with all the quality of QT sockets and the best of the Proto Board series . . . complete down to the last nut, bolt and screw. Includes 2 QT-35S Sockets; 1 QT-35B Bus Strip; 2 5-way binding posts; 4 rubber feet; screws, nuts, bolts; and easy assembly instructions.

**19<sup>95</sup>**

Add \$1.50 shipping/handling.

PROTO-CLIP  
for Power-On,  
Hands-Off Signal  
Tracing. No more  
shorting leads.  
Costs less than . . .

**\$5**

Bring IC leads from pc board for fast signal tracing and troubleshooting. Inject signals. Wire unused circuits into boards. Scope probes and test leads lock onto Dynagrip inset (see circle) for hands-off testing. Plastic construction eliminates springs, pivots. Non-corrosive nickel/silver contacts for simultaneous low resistance connections.

PC-14, 14-pin Proto Clip, \$4.50 ea.  
PC-16, 16-pin Proto Clip, \$4.75 ea.

Add 75¢ shipping/handling.

Order today off-the-shelf from CSC or local distributor. Charge: BAC, MC, AX. Write for free catalog. Free English/Metric Slide Rule with each order. Dealer inquiries invited.

Foreign orders add 15%.

Patents Pending Made in USA  
Prices subject to change

**CSC** Continental Specialties Corp.

Box 1942, New Haven, CT 06509 • 203/624-3103

W. Coast Off.: Box 7809, S. Francisco, CA 94119 • 415/383-4207  
Canada: Available thru Len Finkler Ltd., Ontario

CIRCLE NO. 19 ON READER SERVICE CARD

FOR  
"VOICE  
DIMENSION"  
IN  
CITIZENS  
BAND

... choose the engineering excellence of a Browning base station or mobile. Its outstanding depth of audio performance lets you go beyond casual fun to full CB enjoyment! Browning's unique "voice dimension" characteristics represent a skillful blending of audio power and fidelity — and are the result of over half a century of adherence to exacting production standards and time-consuming craftsmanship. You may spend a few more dollars — you may even have to wait for delivery — but if you're serious about CB, you'll choose Browning!

For your free full-color catalog, write . . .

**browning**  
Browning Laboratories, Inc.  
1269 Union Avenue  
Laconia, New Hampshire 03246  
Telephone (603) 524-5454

CIRCLE NO. 12 ON READER SERVICE CARD

above one of four symbols — a star, a square, a triangle, or a circle. If either the examiner or the subject has ESP, the number of correct guesses will average above that indicated by random chance (1 out of 4 or 25%). Four "D" cells are required for power. The ESP Tester (Cat. No. 72,090) comes with instructions and a 50-test experiment pad. Measures 6¼" × 3¾" × 2" (15.9 × 9.5 × 5.1 cm) \$29.95 Extra pads for 250 tests (Cat. No. 72,092) are available for \$3.50.

CIRCLE NO. 78 ON READER SERVICE CARD

#### SAE STEREO POWER AMPLIFIER

SAE is introducing its new stereo power amplifier, the Mark XXV. The manufacturer guarantees that the amplifier will deliver 300 W/channel, both channels driven into 8

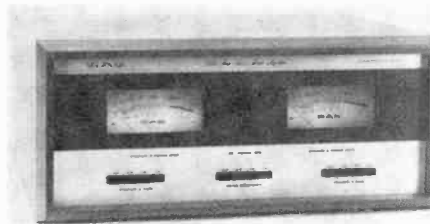

ohms, from 10 Hz to 30 kHz. Claimed IMD is 0.05% and THD is 0.1%, from 250 mW to rated output. Frequency response is said to be 10 Hz to 30 kHz ±0.25 dB, and S/N is 100 dB, both referenced to rated output. A newly developed PSO (Paralleled-Series-Output) circuit combines the inherent advantages of both parallel and series circuit designs. The Mark XXV is equipped with forced-air cooling, and has pushbuttons for channels A and B gain and output meter sensitivity. These discrete levels are calibrated in dB, and the two output meters are calibrated in both dB and watts for 8-ohm loads. \$1250.00

CIRCLE NO. 79 ON READER SERVICE CARD

#### KRICKET VOICE COMMUNICATIONS SPEAKER

The Model KC-35 Cricket voice communications speaker by Acoustic Fiber Sound Systems is housed in a fiberboard enclosure covered with U.S. Naugahyde,™ and comes with a mounting bracket which allows the speaker to be positioned at any convenient angle, including mobile applications. The speaker will be of interest to CB and ham operators, Business Band users, and boaters.

CIRCLE NO. 80 ON READER SERVICE CARD

#### CARBON-FILM RESISTOR SET

Energy Electronic Product's Resistor Set Model RS 10 contains over 2700 ¼-watt, 5% carbon film resistors. Included are 170 different values from 0.51 ohms up to 5.6 megohms. The quantity of each value has been chosen for its average frequency of applications in electronic design. \$126.00

CIRCLE NO. 81 ON READER SERVICE CARD

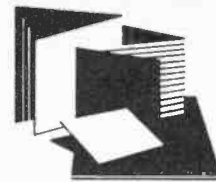

## New Literature

### ELECTRONIC IGNITION BOOKLET

"A Revolution in Ignition Systems," offered by the Tri-Star Corp, describes the physical operation, advantages, and disadvantages of the conventional (Kettering), transistorized, and capacitive-discharge (CDI) ignition systems. The illustrated publication includes comparative data on the three types of systems, and highlights the company's Tiger line of CDI modules. Also given are the results of a laboratory test comparing six of the most popular CDI products. Address: Tri-Star Corporation, Grand Junction, CO 81501.

### ELECTROSTATIC SPEAKER BROCHURE

An Electrostatic Research brochure describes its new ER-139 two- and three-way speaker systems, featuring dynamic bass and electrostatic tweeter drivers. The three-way system uses a dynamic mid-range driver. In both systems, a circular array of eight ES tweeters provides 360-degree horizontal dispersion. Energizing techniques (through either a separate voltage supply or self-energization) is discussed. Address: Electrostatic Research Co., Dept. P, 38 Cabot Street, Beverly, MA 01915.

### 3-D DISPLAY CATALOG

A new 8-page catalog is available from Optical Electronics, Inc., describing its three-dimensional display system modules for use with conventional XY CRT displays. The catalog illustrates the various capabilities of the 3-D system, including the generation of monocular and binocular images, image magnification, and various depth cues including local field, interposition, movement parallax and perspective. Also described are peripheral modules such as vector generators, background generators, and computer buffer/interfaces. Address: S. Day, Sales Dept., Optical Electronics, Inc., Box 11140, Tucson, AZ 85734.

### TRIPLETT TEST EQUIPMENT CATALOG

A new 16-page catalog of its line of test equipment is available from the Triplett Corp. The new 60-T catalog features two new VOM's, as well as Triplett's temperature testers, special feature testers, and general-purpose portable units. The catalog also contains a product selection guide for easy comparison of the manufacturer's various units. Address: Triplett Corporation, Dept. PR, Bluffton, OH 45817.

POPULAR ELECTRONICS



# Get the news before it's news... with a "behind-the-scenes" Scanner Radio from Radio Shack!

Pocket-size Realistic scanners seek and lock-in on exciting police, fire and emergency calls, even continuous weathercasts\*. There's one to cover the action in your area — 11 models in all.

## Radio Shack!

### PRO-6 — VHF-Hi and VHF-Low

Electronically scans up to 4 crystal-controlled channels on 148-174 or 30-50 MHz. Stops on each active channel until conversation ends, then resumes scanning. You don't miss a thing—it's like 4 radios in one. Lighted channel indicators, switches for bypassing any channels, scan/manual switch, variable volume and squelch, built-in antenna, earphone jack. With 4 "AA" cells. Requires up to 4 crystals. #20-171. **119<sup>95</sup>**

### PRO-4A — VHF-Hi Band

Like the PRO-6, but covers VHF-Hi only. #20-174. **99<sup>95</sup>**

### PRO-5 UHF "Metro" Band

Same as the PRO-4A, but covers 450-470 MHz used in many larger cities. #20-169. **119<sup>95</sup>**

Accessories Available. Plug-in antenna. 12VDC adapter, AC adapter/battery charger, rechargeable batteries.



POLICE



FIRE



VHF WEATHER



VHF MARINE

\*On VHF-Hi band in over 70 localities

**NEW PRO-16A — Super Scanner**  
for the ultimate at-home  
or mobile listening post



With  
Extended UHF  
Coverage

Scans up to 16 crystal-controlled channels, in any combination, on 30-50 and 148-174 MHz VHF and 450-512 MHz UHF. Like having 16 radios in one! Lockout buttons and indicator lights for each channel, manual selector, squelch, variable scan rate, scan-delay in/out button, 12VDC/120 VAC operation, mobile mounting bracket. Requires up to 16 crystals. U.L. listed. #20-165. **229<sup>95</sup>**

Police-frequency listening may be regulated by local authorities

## FREE New 1976 Radio Shack Catalog

OVER 2000 PRODUCTS  
EXCLUSIVES ON EVERY PAGE  
BEAUTIFUL FULL COLOR

Stereo • Quadraphonic • Phonographs  
TV Antennas • Radios • Citizens Band  
Kits • Recorders • Tape • Tools  
Auto Tune-Up • Electronic Parts  
Test Instruments • More!



164 pages of the finest in home and hobby electronics. Respected brand names like Realistic, Micronta, Archer, Science Fair — and they're available only at Radio Shack stores and dealers nationwide! See what's really new in electronics by getting this catalog now

SEND FOR YOURS TODAY!  
FILL OUT COUPON BELOW

1976 Mail to Radio Shack, P. O. Box 1052, Catalog Ft. Worth, Texas 76101. (Please print.) 540

Name \_\_\_\_\_ Apt. No. \_\_\_\_\_

Street \_\_\_\_\_

City \_\_\_\_\_

State \_\_\_\_\_ ZIP \_\_\_\_\_



Master Charge or  
Bank Americard at  
participating stores

**REALISTIC®**  
at  
**Radio Shack®**

A TANDY CORPORATION COMPANY  
OVER 3000 STORES • 50 STATES • 7 COUNTRIES  
Retail prices may vary at individual stores



# Stereo Scene

By Ralph Hodges

## WILL AUDIO GO DIGITAL?

“**W**HAT’S happening with digital audio?” is a question you hear from time to time. The answer is that it’s loping along nicely, with groups as diverse as Bell Telephone Laboratories and the British Broadcasting Company doing serious work on one project or another. Consumers cannot yet find digital tape recorders awaiting them at the local hi-fi emporium, but audio professionals can buy digital delay lines that can do a most effective job enhancing the naturalness of artificial reverberation, particularly when they are used with more conventional studio techniques. Digital techniques have been used to restore the fidelity of old recordings, and these efforts have met with unprecedented success. And, of course, in the area of synthesized music, digital techniques are becoming more established every day.

Digital applications for audio are being pursued in areas such as: signal processing (delay, filtering, etc.) and straight recording. Recording is simpler, at least in theory, except that it must generally be carried out in real time and committed to a medium (most often magnetic tape) which has serious storage-density limitations for this kind of work. Signal processing—or some types of it, anyway—can proceed chunk by chunk at the computer’s leisure, and permanent storage of the signal in digitized form may not be involved at all.

Earlier this year the Midwest Acoustics Conference, which takes place annually in Evanston, Illinois, devoted itself to an overview of digital audio, presenting a number of uniquely qualified speakers who explained where we are today and what’s coming next. I went there to get a feel for the viability of these techniques in the consumer sphere, and I came away mildly encouraged. Many of the experts foresee digital hardware making its way into the home in the not-too-distant future. (The exact timetable will involve mar-

keting considerations as much as technological advances, so it isn’t really worth speculating about right now.) Probably the most attractive product that could be offered the audiophile is a digital program source, especially if it—like a digital tape machine—could also produce digital recordings. For the rest of this column, I’ll focus on that sort of product, because it is of demonstrated interest and because its essential functions—conversion from analog to digital and back again—are basic to any digital processor.

**Music By Numbers.** You are perhaps familiar with the advantages of digital recording. They include virtual immunity to cumulative noise, distortion, and frequency-response degradation. Audible wow and flutter can be wiped out because the signal itself carries with it an unambiguous

timing notation, derived from a very stable and accurate electronic clock. This notation can drive a mechanical servo system that regulates the rate at which the recording is scanned (a simple servo-controlled capstan motor on a tape machine, for example). Another scheme might use a matrix of memory locations that “hold” data until they are scanned electronically to regenerate the digitized signal.

Digital comes by these benefits because it substitutes a numerical code for the thing itself, unlike our present-day analog recordings (discs and tapes) which really are the musical performance in a sense, frozen in time for our convenience. To construct a rough analogy: any oil painting would not fare too well if preserved for posterity by means of photocopies, whereas an instruction sheet for a paint-by-number kit, even if rendered just barely decipherable, would give rise to the same end product as an undamaged copy. Of course, few paint-by-number kits would fool anyone into believing he was in the presence of a Rembrandt original. But if the instructions were detailed enough—one hundred items per square centimeter of canvas, say—the unaided eye might very well find the reproduction indistinguishable from the original. This is the goal of a practical digital recording system: to provide adequate instructions for an au-



**ONE-TIME OFFER  
TO READERS OF  
POPULAR  
ELECTRONICS  
ONLY  
SAVE \$15  
Regular Price \$49.95**

# What does it take to build the world's smallest scientific calculator?

About three hours. And only \$34.95

Designing the Sinclair Scientific was no small feat of engineering. But you don't have to be an engineer to assemble it with our kit.

Now you can put together the world's thinnest, lightest scientific calculator from eight groups of components, using only a soldering iron and a pair of cutters.

(Complete instructions are included, of course. And our Service Department will help you with any questions that come up.)

For an incredible **SPECIAL PRICE OF ONLY \$34.95** (offer expires September 15, 1975), look what the Sinclair Scientific can do:

- sin and arcsin
- cos and arccos
- tan and arctan
- automatic squaring
- automatic doubling
- log and antilog (base 10)
- giving quick access to  $x^y$  (including square and other roots)
- four basic arithmetic functions
- plus scientific notation
- ( $10^{-99}$  to  $10^{+99}$ ).

To be a really valuable tool, a scientific calculator must provide all of the above.

A calculator without scientific notation severely limits the size of numbers with which you can work easily. And scientific notation without transcendental function is little more than window dressing on an arithmetic calculator.

Less than 3/4-inch thin and 3 3/4-ounces light, the British-made Sinclair Scientific isn't just portable. It's pocketable.

## ONE-YEAR GUARANTEE

All parts are tested before shipment—and we'll replace, **FREE OF CHARGE**, any defective part in any correctly assembled calculator for a full year from date of purchase (labor not included).



**AVAILABLE ASSEMBLED TOO**  
The Sinclair Scientific calculator is available in completely assembled form if you prefer. The **SPECIAL LOW PRICE** is only \$49.95—fully guaranteed. Defective calculators will be repaired or replaced within one year from date of purchase, **FREE OF CHARGE** (batteries not included).

## Kit Components

Coil  
LSI chip  
Interface chips  
Printed circuit board  
Keyboard panel  
Electronic components pack  
Batteries, battery assembly and on/off switch

Case mouldings, with buttons, windows and light-up display in position  
Soft carrying wallet  
Comprehensive instructions  
Assembly time is about 3 hours.

## Specifications

### Functions:

4 arithmetic  
2 logarithmic  
6 trigonometric

### Keyboard:

18 key format with 4 "triple-action" function keys

### Display:

5-digit mantissa  
2-digit exponent (both signable)

### Exponent:

200-decade range, from  $10^{-99}$  to  $10^{+99}$

### Logic:

Reverse Polish, with post-fixed operators

### Power Source:

Battery operated with 4 AAA batteries

**Size:** 4 3/8" high; 2" wide; 1 1/16" thick  
**Weight:** 3 3/4 oz.

**CHARGE YOUR ORDER TO YOUR AMERICAN EXPRESS, BANKAMERICARD, MASTER CHARGE OR DINERS CLUB ACCOUNT**

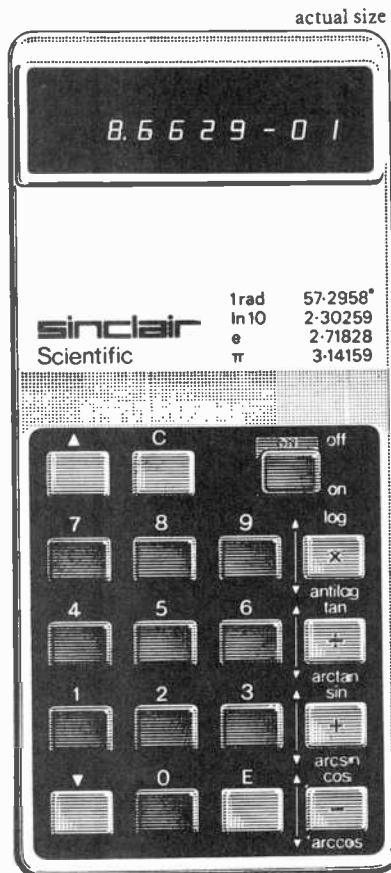

**CONSUMER SERVICE DIVISION, 595 Broadway, New York, N.Y. 10012**  
Please send the following:

- \_\_\_ Scientific Calculator Kit (s) @ \$34.95 plus \$2.00 ea. postage, handling & insurance
  - \_\_\_ Scientific Calculator (s) Assembled @ \$49.95 plus \$3.50 ea. postage, handling & insurance
- Residents of Calif., Colo., Fla., Ill., Mich., Mo., N.Y. State, D.C. and Tex., add applicable sales tax.
- Enclosed is \$\_\_\_\_\_ (Offer not valid outside U.S.A.)

- CHARGE:**
- American Express
  - BankAmericard
  - Master Charge
  - Diners Club

Account # \_\_\_\_\_  
Exp. Date \_\_\_\_\_  
Master Charge Interbank # \_\_\_\_\_  
(4 numbers above your name)  
Signature \_\_\_\_\_  
Print Name \_\_\_\_\_  
Address \_\_\_\_\_  
City \_\_\_\_\_  
State \_\_\_\_\_ Zip \_\_\_\_\_

PE-85



# Bell & Howell Schools invites you to **BREAK INTO 4-C**

Pick up new professional skills in this exciting field as you build Bell & Howell's new quadraphonic audio center. It's the very first learn-at-home program of its kind!



You've probably heard a lot about 4-channel sound by now. It's the most talked about and impressive technical advancement in sound in years. Separately recorded channels literally wrap a room in sound for a totally new listening experience.

And the excitement doesn't stop there. Thanks to Bell & Howell Schools' brand new learning program, now you can explore quad sound for yourself—from the inside out—and master the technology behind this important advancement right in your own home!

It's your opportunity to break away from the everyday routine and learn new occupational skills that could lead you in exciting new directions. Mail the attached card, postage free, to get the facts today!

### **Take hold of opportunity with both hands now!**

The world around you is changing every day. Forging ahead. The man who keeps pace is the man who continues to learn and grow. He's in the mainstream of life. Interested in what's going on. And he's much more interesting, too.

Bell & Howell Schools' new 4-channel audio program was designed to help you learn and grow. To put you in the mainstream of audio electronics technology. Where you can delve into fascinating electronics principles. Solve challenging problems and get actual hands-on, build-it-yourself experience.

And where you can acquire a sense of satisfaction and accomplishment you may not currently be getting.

### **Completely different from the typical kind of school you grew up with.**

Learning all about quad sound with Bell & Howell Schools is a lot more interesting and convenient than "school" used to be. First of all, we know you can't afford to quit your job. So we set up a program that lets you work at home in your spare time.

There are no classes to attend. No dry lectures to sit through. Everything comes to you in the mail. Lesson by lesson. Exciting package after package. And you work at a flexible pace in the relaxed atmosphere of your workshop—or wherever your favorite spot may be.

### **Sure, books are important. But they're only the beginning.**

With this fascinating learn-at-home program, you do a lot more than just read about electronics. You'll conduct dozens of experiments . . . build your own laboratory equipment for testing out electronics principles . . . and also as part of this program you put together a 4-channel amplifier and FM/FM stereo tuner as you delve into advanced audio technology.



We try to make learning so interesting you look forward to receiving each new lesson. And enthusiastically dive into each new project we send you.

### **We'll start you off on the right foot.**

You may be thinking, "I don't have any training in electronics . . . I might be getting in over my head."

Well, you can stop worrying about that. You don't need previous experience. You'll begin with the basics and acquire a thorough understanding of the fundamentals before moving on.

And remember, it's not just reading. With your very first lesson you get our LAB STARTER KIT, consisting of a simple voltmeter and electronics "breadboard" you can experiment with right away.

Of course, if you're already into electronics, you might be thinking, "I already know the basics . . . I want to get into the advanced stuff right away!"

For you there's an advanced standing program that lets you skip the beginning lessons.

### **Next you build the exclusive Electro-Lab® electronics training system.**

Once you've mastered the basics, we'll send you everything you need to put together these three important testing instruments:

**The design console.** You use it to set up and examine various kinds of circuits. It's completely modular . . . no soldering!

**The digital multimeter.** Use it to measure voltage, current and resistance. Displays data accurately in big, clear numbers—just like on a digital clock.

**The solid-state "triggered-sweep" oscilloscope.** Use it to analyze modern,



# HANNEL AUDIO!



state-of-the-art integrated circuits. Triggered-sweep feature locks in signals for easier observation.

These three superb testing instruments are the basis of your own home electronics laboratory. You'll use them throughout the program as you move into more advanced electronics principles and work into audio technology.

### **Bell & Howell's high performance 4-channel audio center you actually build and experiment with yourself!**

You need practical experience with high caliber equipment to develop professional skills and understand the ins and outs of today's audio technology.

So we came up with a system that Bell & Howell is proud to have its name on:

**First, there's the sophisticated outstanding 4-channel amplifier with SQ full-logic decoding and front to back separation.**

35 watts per channel—Min. RMS into 8 ohms at less than 0.25% total harmonic distortion from 20-20,000 Hz, all channels fully driven.

As you build and experiment with this remarkable piece of equipment, you'll learn about matrix 4-channel and discrete—including CD-4 when processed through an external demodulator.

And with it you'll have the advanced circuitry you need to get into signal tracing low level circuits . . . troubleshooting high power amplifier stages . . . and checking the operation of tone control circuits.

Next, the advanced FM-FM stereo tuner. As you build this superb stereo tuner, you'll come to fully understand how the advanced, "state-of-the-art" features lead to such high performance. You'll learn about all solid-state construction, FET front end for superior sensitivity, crystal IF filters for wide bandwidth and the superior multiplex circuit that produces such excellent stereo separation.

### **A wealth of knowledge in digestible chunks.**

O.K.! So now you might be thinking, "It sounds really interesting . . . but kind of complicated." And you're right. But that is why we use the "hands on" teaching approach.

We've taken all the material and broken it down into short, simple-to-grasp lessons, so you can master one thing at a time before moving on. And we take you through it step by step. From the basics to advanced theory to

applied audio technology. So you actually have an easier time with it.

### **Special learning opportunities give you extra help and attention.**

In case you do run into a problem or two, we're ready to give you more help and personal attention than you'd expect from most learn-at-home programs.

For example, many home study schools ask you to mail in your questions. Bell & Howell Schools gives you a toll-free number to call for answers you need right away.

Few home study schools offer personal contact with instructors. Bell & Howell Schools organizes "help sessions" in 50 major cities at various times during the year—where you can discuss problems with fellow students and instructors in person.

### **And when you're done, you'll know a lot more than just 4-channel sound!**

You'll have covered the complete spectrum of electronics principles, leading to a full understanding of audio technology.

And while no school can promise you a job or income opportunity, you will have occupational skills necessary to become a full-service technician. With the ability to work on the entire range of audio equipment. Such as tape recorders, cassette players, FM antennas and commercial sound systems. You'll know audio technology from the inside out. And you'll be proud of it.

Plus you will have the basic skills that apply to the entire electronics field, including television technology and repair.

### **For more details, mail card today!**

Here's your chance to break out of the mold. And break into 4-channel audio with Bell & Howell Schools. Why not look into it today. Mail the attached postage-paid card now.

Taken for vocational purposes, this program is approved by the state approval agency for Veterans' Benefits.

Wood cabinets available at extra cost.

"Electro-Lab®" is a registered trademark of the Bell & Howell Company

**If card has been removed, write:**

An Electronics Home Study School  
DeVRY INSTITUTE OF TECHNOLOGY 766 R2



ONE OF THE  
**BELL & HOWELL SCHOOLS**

4141 Belmont, Chicago, Illinois 60641



dibly perfect reproduction without blowing a simple instruction sheet up into a lengthy (and expensive) book.

How do you convert music to numbers? You could use any number of systems, as long as you're consistent. Figure 1 shows, for example, a musical waveform (such as a microphone output) of perhaps a millisecond's duration applied to a rectangular coordinate system; the  $t$  axis is time, and  $A$  is amplitude (voltage or current). Any point on the waveform can obviously be expressed in coordinate values of  $A$  and  $t$ , and that is how the waveform

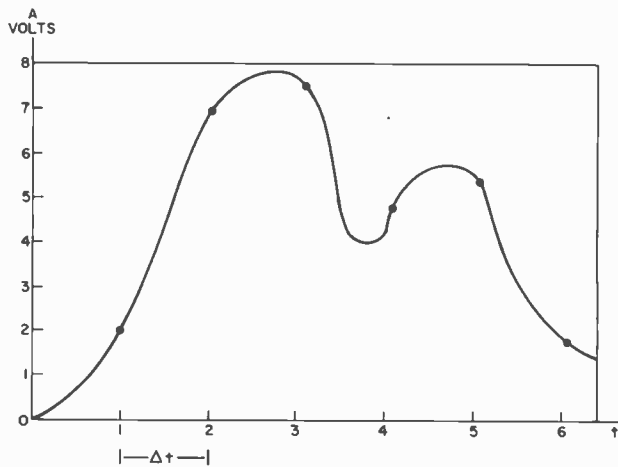

Fig. 1. A typical musical (analog) waveform. The smooth curve is sampled at small time intervals and the amplitudes are converted to digital information.

will be digitized. To establish the  $t$  values we'll move along the axis in small fixed increments. The size of the increments is determined by the sampling rate, which we'll have to get involved with later. For now, assuming our sampling rate is established, we'll just move along collecting our data: at  $t=1$ ,  $A=2$ ; at  $t=2$ ,  $A=7$ ; at  $t=3$ ,  $A=7.8$ , etc. We end up with the coordinate values for a series of points (Fig. 2). The numerical values are what we'll record on the tape, in digital form. What we'll get when the recorded tape is played back through a digital-to-analog converter is the points of Fig. 2, obviously not a good reproduction of the original curve. However, if the increments of time and amplitude are made small enough, very good results can be obtained.

**1, 2, 3 . . . Digitally.** Most computers can't make anything of such abstract symbols as "2," "5.5," and "9," even if they could be fed to them in that form. So, as many of you are

aware, computers have their own language for counting, based on the digits 0 and 1, generally corresponding to the open and closed conditions of the numerous switches that are among their principal contents. In this binary system, the digits are arranged in columns with the leftmost expressing the highest values, as in the decimal system. However, the columns are arranged in powers of the base 2 rather than the base 10 (Fig. 3). The first column on the right is the  $2^0$  column ( $2^0$  equals 1); the second is the  $2^1$  column (2), the third is  $2^2$  (4), the fourth is  $2^3$  (8), and so on. Thus the decimal number 9 is expressed 1001 in binary notation — one 1 plus no 2, no 4, and one 8. Each of the digits in 1001 is called a *bit*. A four-bit system like this can count up to 15 (1111, or 1 plus 2 plus 4 plus 8). To go higher (17, for example), we must add another bit to get 10001 (1 plus 0 plus 0 plus 0 plus 16). Note also that there's no way of expressing fractional parts of integers. We could arrange the system to

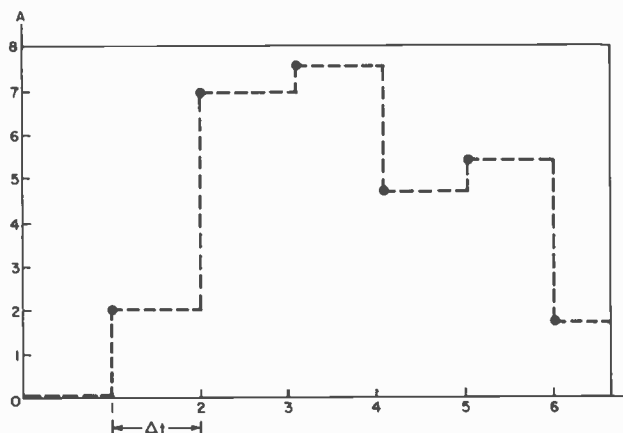

Fig. 2. Reconstructed waveform. In practice, much smaller time increments would be used to obtain a smoother, more detailed replication of waveform.

**The great new  
Super Scanner**

**The only "two-antennas" antenna. It scans 360° in milliseconds with 5.75 dB gain. Or beams an 8.75 dB gain signal where and when you want it—instantaneously. (And you'll wish you had a radio as handsome as the control box!)**

- New contemporary control console with blackout panel, simulated leather end panels.
- Compact size—radius just 3 feet. Wind rated in excess of 100 mph.
- Ideal for emergency teams—zero in on trouble spots instantly.



MODEL MS 119 Super Scanner electronic beam antenna with control console.



**the antenna specialists co.**

Division of ORION INDUSTRIES, INC.  
12435 Euclid Ave., Cleveland, Ohio 44106  
Export: 2200 Shames Dr.,  
Westbury, L.I., New York 11590  
Canada: A. C. Simmonds & Sons, Ltd.  
CIRCLE NO. 8 ON READER SERVICE CARD



do so but we would have to add more bits, just as we have to add columns to the right of the decimal point in our own number system.

The binary code described here lets us put the information we feed to the computer somewhat in a suitable form. Still, we're hard pressed to express the amplitude of the waveform at any instant with only the 15 numbers of a four-bit code. First of all, if the waveform should go below zero, merely to be able to express all the whole numbers will require an additional bit to distinguish between positive and negative values. (A 0, meaning positive, or a 1, meaning negative, preceding the four-bit digital "word" will readily accomplish that function).

Decimal	2 <sup>3</sup> (8)	2 <sup>2</sup> (4)	2 <sup>1</sup> (2)	2 <sup>0</sup> (1)
1	0	0	0	1
2	0	0	1	0
3	0	0	1	1
4	0	1	0	0
5	0	1	0	1
6	0	1	1	0
7	0	1	1	1
8	1	0	0	0
9	1	0	0	1
10	1	0	1	0
11	1	0	1	1
12	1	1	0	0

Fig. 3 Table for converting decimal to binary numbers.

But we'd also like to subdivide in order to express fractional values. This needs more bits; the question is, can we afford them? According to Dr. Barry Blesser of MIT, speaking at the Midwest Acoustics Conference, an 8-bit converter (analog-to-digital or digital-to-analog) can be bought for \$4 to \$8. A 12-bit converter might cost \$100 to \$500. An 18-bit converter is still blue sky. In short, equipment costs have a highly unfavorable exponential relationship to the number of bits in the system.

**Quantization Error.** But anyhow, we have our however-many-bit system and we're going to do the best we can. What should we watch out for? First, we should guard against signal levels that exceed the range of our number system because our converter won't be able to express them and will present us with nonsense at the output.

# New

## A P terminal & distribution strips

### solderless plug-in universal breadboarding elements



**for fast  
circuit buildup  
and checkout**

**10 new models  
starting at \$2**

**expanded capacity  
at lower cost**

All products are guaranteed  
to meet or exceed  
published specifications

accommodate  
all DIP sizes

●

easy hookup with  
22-ga. solid wire

●

free catalog



**A P PRODUCTS INCORPORATED**  
Box 110-H, Painesville, Ohio 44077  
(216) 354-2101 • Twx 810-425-2250

CIRCLE NO. 2 ON READER SERVICE CARD

# Why any cartridge (even ours) with an elliptical stylus must be considered just a bit old-fashioned.

As a premium stylus, elliptical designs have only one real advantage over a Shibata stylus: lower cost. Which is why we still offer them.

But when it comes to performance, a Shibata stylus is far, far better. It provides the small scanning radius needed to track highs (up to 45 Hz for CD-4), but without the penalty of requiring extremely low stylus force settings.

In fact, even tracking at up to 2

grams, a Shibata stylus is easier on your records than an elliptical stylus trying to track at 1/2-gram! New records last longer, old records sound better, and you can play every kind of two or four-channel record made.

All Audio-Technica top-of-the-line cartridges have genuine Shibata styli. Anything less would be false economy for you... and out-dated technology for us. Prove it to yourself today.



**audio-technica®**

AUDIO-TECHNICA U.S., INC., Dept. 85P, 33 Shilawsee Ave., Fairlawn, Ohio 44313  
Available in Canada from Superior Electronics, Inc.  
CIRCLE NO. 9 ON READER SERVICE CARD

Second, we must worry a lot about values that fall between the numbers we have available. The value 5.5, for example, cannot be expressed by our four-bit system; it will have to write 5 (0101) or 6 (0110) in its place. The difference between 5.5 and the 5 or 6 the converter gets from it is the *quantization error*, and it is something you have to put up with unless you can afford to divide up the values (with more bits) to achieve a closer approximation to the actual value. What quantization error *sounds* like is a subject we'll approach a little later.

If all has gone well up to now, we confront our third problem: the recording medium. Most existing digital systems use magnetic tape, laying down the 1's and 0's as dc pulses and non-pulses, or pulses of opposite polarity, or ac pulses with two discrete frequencies. But whatever the system of recording, tape has a notoriously limited packing density; you're allowed just so many bits per inch. More information per time unit can be recorded by increasing tape speed (sometimes to absurdity), or it is certainly possible to use several tape tracks for one audio channel. However, you're still at the mercy of those imperfections in the tape that cause dropouts. If the bit in the farthest-to-the-right column (the "least significant bit" or LSB) happens to get recorded on a tape dropout hole, the consequences are not likely to be too dire. But if it's the leftmost digit (MSB, or "most significant bit"), the performance of your electronics must be phenomenal if you don't get a distinctly audible pop or other sonic clunker as a result.

**Sampling Rate.** Leaving for the moment the problem of recording amplitude values, let's take a closer look at the time axis. Our "sampling" of the waveform is done at a uniform rate with samples separated by a more-or-less short space of time. How frequently should we sample? The rule is that the sampling frequency must be at least twice the highest sine wave of frequency of interest—40 kHz for a 20-kHz audio bandwidth, for example. And in fact, we must do everything possible to prevent a signal frequency higher than 20 kHz from reaching a 40-kHz sampler. The reason is simple. A signal frequency above 20 kHz cannot be adequately sampled. When this state of affairs crops up, the signal is modulated by the sampling

rate, giving rise to heterodyne (sum and difference) tones of the two frequencies. The difference tone is lower in frequency than either the signal or the sampling rate, and thus it tends to get heard. The sum tone is inaudible. The phenomenon is called *aliasing*. It is equivalent to gross intermodulation distortion.

In front of the input of any digital audio converter there will inevitably be a pretty sharp low-pass filter to forestall such nuisance. The skirt of the filter determines where the sampling rate must be placed to avoid trouble. But unfortunately, not-allowed high frequencies may be generated within the converter itself under certain circumstances, with the same unwholesome effects. This takes us back to quantization error and (again) to Dr. Blesser.

Quantization error results in distortion of the output waveform—distortion that does not strictly correspond to the spurious products we're used to from analog devices, but measurable by HD and IM analyzers nonetheless, and just as audible. In complex, high-level signals, quantization error sounds like hiss (white noise), although it doesn't come from the tape or from thermal noise in the electronics. It is simply (I would guess) the sum of highly randomized mistakes made by the recording system. However, for simpler, low-level signals, the audible character of quantization noise changes.

Consider a sine wave so low in level that its fluctuating value is expressed only by the least significant bit in the system. The device that quantizes the waveform can at best indicate only its maximum values in the positive and negative directions. There are no bits left to chronicle the rate of its rise and fall. To the quantizer, therefore, this sine wave is indistinguishable from a square wave, and a square wave, as we know, possesses an infinite series of odd-order higher harmonics. Some of these harmonics will fall above the highest frequency the sampler can handle, and up come the beat tones again. Of course, no typical audio signal is a simple sine wave, so the usual result is several beat tones, creating a dreadful, whining accompaniment to the music.

**The Fix Is In.** To diminish the beat tones, which are always much more annoying than the white-noise form of quantization error, there are a couple

of elegant ways to cheat on the analog-to-digital converter. One is the "dither" technique, in which a trace of random noise is fed to the converter along with the signal. The noise keeps the least significant bit occupied with things other than the low-level sine wave, so that the process won't produce a series of higher harmonics. The result, of course, is some noise in the output, but this is much more tolerable to most ears than the reedy whine.

Another technique, mentioned specifically by Dr. Blesser, involves little more than compression of the input signal, so that there are *no* low-level signals. The input to the converter is fed by several amplifiers of increasingly higher gain. The lowest-level input signals are switched through the highest-gain amplifier, and when the signal is recovered, there is a complementary amplifier array to undo the compression, controlled by information digitized along with the program. The approach is quite similar to that used by the nonlinear amplifiers in the Dolby system and other analog noise reducers. (In fact, nonlinear compander and coding schemes also turn up in digital systems.) It's most reminiscent of the Dynatrack noise-reduction technique that Mullin devised for 3M: recording high- and low-level signals on separate tape tracks, whilst employing high-gain electronics for the low-level track.

**Then Why Digital?** According to Blesser, none of the above will succeed in reducing quantization error, but it will convert the offensive noise into a form we can live with. Beyond that, the way to reduce error is to increase the number of bits available—an expensive remedy right now, but surely not for always. In terms of naked semiconductor hardware, a bit cost about 10 cents a few years ago; the price is now more like 1/10 of a cent (figures provided by Mahlon D. Burkhard at the Midwest Acoustics Conference).

Is it worth all the trouble and expense? Again, perhaps not immediately, but it certainly will be someday. Several of the speakers at the conference brought along tapes to demonstrate digital audio at its worst and best. It was obvious, even from a brief listening, that digital's best is very good indeed. So let it come if it will; I'll buy it, if I can afford it. ♦

# New 21<sub>(diag.)</sub>" Heathkit digital-design Color TV

Popular Electronics editors called the digital-design GR-2000 "the color TV of the future." Now you can enjoy the same technology and features in the new GR-2050 with the convenient, popular 21-inch picture tube.

**On-screen electronic digital channel numbers**—big, bright, bold, and easy to read, even from across the room. **On-screen electronic digital clock time**—low cost insurance against missed programs. In 12 or 24 hour format, 4 or 6 digits. **Silent, electronic, touch-tuning**, thanks to the combination VHF-UHF varactor tuner. No knobs to turn, nothing to wear out. Just touch to tune...on the front panel or the Remote. **Programmable digital counter/channel selector**—a computer-like programming board for you to pre-program any 16 stations, UHF or VHF, or both, in any order, even repeating if you wish. Touch the tune button and the counter silently sweeps up or down through all 16 channels, stopping when you release the button.

**Exclusive fixed ten-section LC bandpass filter**—does away with adjusted traps yet eliminates interference from adjacent channel, etc. And it never needs instrument alignment.

**100% solid-state**—with more ICs than any other set and a black negative matrix picture tube for brighter, more vivid pictures.

**Easy to build with modular circuits. Easy to service with built-in digital dot generator, check-out meter, and slide-out service drawer.** Build the GR-2050 TV of the future... Remote, \$89.95. Cabinets from \$119.95\*



**599.95** less cabinet



## New 2½-digit Heathkit DMM—only \$79.95

Full function capability. Four overlapping AC & DC voltage & current ranges plus five resistance ranges with accuracy of 1% on DCV, 1.5% on ACV, 1.5% on AC & DC current, and 2% on resistance. Ranges: (full scale) DCV, 2, 20, 200, 1000V; ACV, 2, 20, 200, 700V rms (25 Hz to 10 kHz); DC current, 2, 20, 200, 2000 mA; AC current, 2, 20, 200, 2000 mA (25 Hz to 10 kHz); Ohms, 200, 2k, 20k, 200k, 2000k ohms. Lighted panel indicators show overrange, positive and negative DC voltages and current at a glance. All solid-state design uses IC circuitry for a clear non-blinking display with up-date every 16 msec. One megohm input impedance with overload protection on all ranges; automatic decimal positioning; isolated floating ground; universal banana jack inputs; 120 or 240 VAC operation; one circuit board for easy assembly; blue & white heavy-duty metal case. Kit IM-1212, \$79.95; Assembled SM-1212, \$125\*.



**New Model Railroad Control Center/Power Supply** provides acceleration and braking of unsurpassed realism plus power for two HO or N-gauge engines and accessories. Throttle slide control plus 5-position Brake switch (Run, Release, Normal, Quick-Service, Emergency), and Mode switch (Momentum or Direct). Adjustable pulse width and frequency allow accurate control at low speeds, eliminate "jack rabbit" starts. Voltage control optimizes for each engine. One circuit board; builds in two evenings. Kit RP-1065, \$79.95\*.



**New Digital Tachometer** is faster than any meter-type tach. Numbers whirl by to show peak performance level your engine reaches. Great for monitoring best cruising RPM for your car, camper, boat (inboard or outboard), planes, cycles, mowers, tractors, even stationary engines. 2-digit electronic readout shows RPMs from 100 to 9900 in 100 RPM steps. For 4, 6, or 8 cyl., 4-cycle engines; 2, 3, or 4 cyl. 2-cycle engines; 2, 3, or 4-rotor Wankel engines; conventional, C-D, or factory electronic ignitions (12 v. neg. grd. only). Black die-cast case with bracket. Kit CI-1079, \$49.95\*.



**New Breakerless Ignition Adapter** develops timing signal electronically so your car is timed correctly at all speeds and stays correct for longer periods. For use with C-D ignition systems only, it replaces the points of all pre-1975 GM V-8 and V-6 engines, and all AMC V-8s with external dwell adjustment. Unit mounts under hood; sensor mounts in distributor without removing points (switch returns engine to point timing when you wish). Operates from -37.2°C to +85°C. Easy to build. Kit CP-1051, \$44.95\*.

**HEATHKIT ELECTRONIC CENTERS** — Units of Schlumberger Products Corporation Retail prices slightly higher.

ARIZ.: Phoenix; CALIF.: Anaheim, El Cerrito, Los Angeles, Pomona, Redwood City, San Diego (La Mesa), Woodland Hills; COLO.: Denver; CONN.: Hartford (Avon); FLA.: Miami (Hialeah), Tampa; GA.: Atlanta; ILL.: Chicago, Downers Grove; IND.: Indianapolis; KANSAS: Kansas City (Mission); KY.: Louisville; LA.: New Orleans (Kenner); MD.: Baltimore, Rockville; MASS.: Boston (Wellesley); MICH.: Detroit; MINN.: Minneapolis (Hopkins); MO.: St. Louis (Bridgeton); NEB.: Omaha; N.J.: Fair Lawn; N.Y.: Buffalo (Amherst), New York City, Jericho (L.I.), Rochester, White Plains; OHIO: Cincinnati (Woodlawn), Cleveland, Columbus, Toledo; PA.: Philadelphia, Pittsburgh; R.I.: Providence (Warwick); TEXAS: Dallas, Houston; VA.: Norfolk (Va. Beach); WASH.: Seattle; WIS.: Milwaukee.

Send for  
**FREE**  
Catalog



HEATH <b>Schlumberger</b>		Heath Company, Dept. 10-08 Benton Harbor, MI 49022
Please send my free 1975 Heathkit Catalog.		
NAME _____		
ADDRESS _____		
CITY _____	STATE _____	ZIP _____
*PRICES ARE FACTORY MAIL ORDER, FOB PRICES & SPECIFICATIONS SUBJECT TO CHANGE WITHOUT NOTICE.		
		CL-568



**"CLEAR" "Solid" ..**  
**"POWERFUL" ..**  
**"Crisp" .. "PENETRATING" ..**

Speech Compression is built-in every Johnson CB radio. State-of-the-art circuitry electronically selects voice frequencies that penetrate noise and interference... then boosts the level of modulation to give your signal that powerful "Johnson sound." It's one of many engineering advances - like receiver "steep skirt" filtering to cut interference and automatic threshold limiting to slice out noise - that gives U.S.-made Johnson CB that extra edge of performance. Performance that's backed by a full 1-year parts and labor warranty with over 700 authorized service centers nationwide.

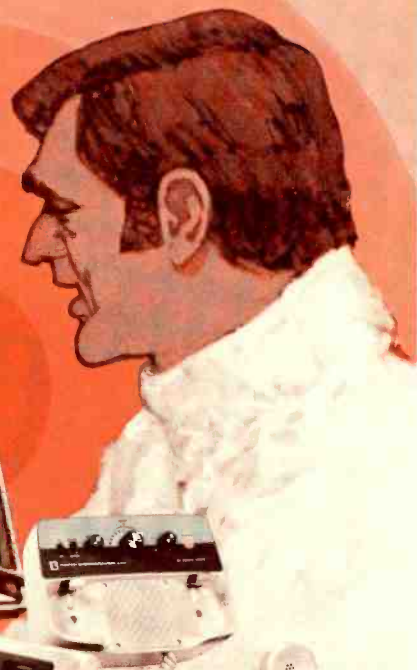

**Messenger 250**  
 100% solid-state base station



**Messenger 123A**  
 The most popular 23-channel  
 CB radio in America!



**Messenger 130 and 132**  
 "The radiotelephone CB System"  
 with private listening option



®

write for free catalog

**E.F. Johnson Co.**

Waseca, Minnesota 56093 • In Canada: A. C. Simmonds & Sons, Ltd.

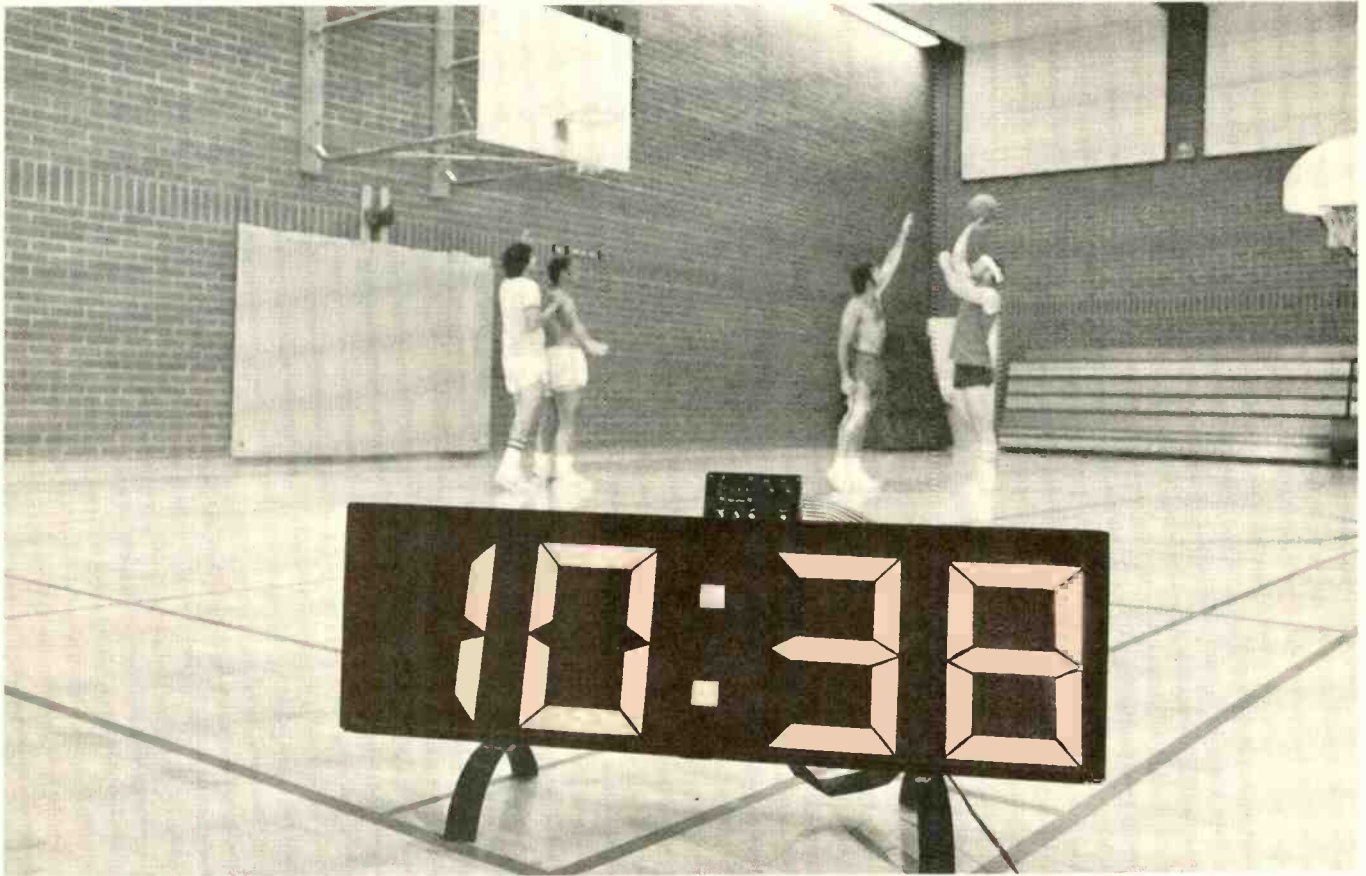

# A DIGITAL TIMER-SCOREBOARD FOR ATHLETIC EVENTS

*Gymnasium-sized digital readouts simultaneously time up or down and keep score. Ideal for schools and amateur sports groups.*

BY PHILIP HARMS

**E**LECTRONIC timers and scoreboards for athletic events are often too expensive for amateur organizations and small school groups. This is particularly true of a display that can be read across a gymnasium or stadium. The combination timer/scoreboard described here can be built with readily available components (TTL logic), many of which can be obtained from surplus dealers. Though variations on the display are possible, the prototype has four seven-segment digits, each one foot high. It can be built for about \$100.

The project has two independent modes of operation — timing and score displaying — both remotely controlled. Usually, the time is displayed, but while the score is being displayed, the internal electronic clock keeps operating so that the time display is always available. In addition, the timing can be made to run backward and the operator can start the timer at any selected time and run the time up or down from that point. If it is desired to stop the timing (for timeouts in basketball or football), this can also be done. The readouts will hold

the time and will start to operate (either up or down) when timing is resumed.

The four-digit readout can be set to indicate a preset score. When the time is displayed, a colon is lit between the two sets of digits. For a score, there is no colon. Provision is also made for an instant test of all the display lamps.

The electronic portion of the scoreboard control is easily assembled on printed circuit boards. Though some carpentry is involved in the construction of the display, it is not beyond the capability of a high-school

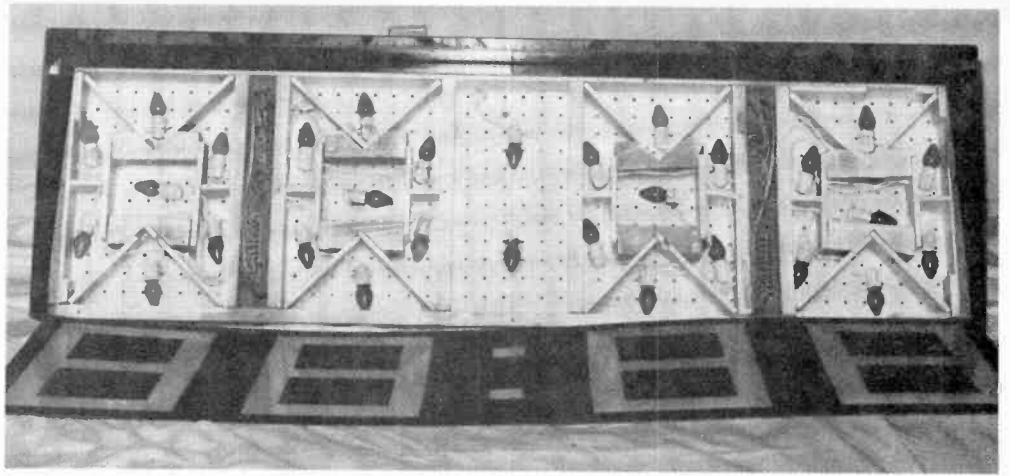

Photo of interior of prototype display board shows how lamps are placed in each segment and for colon. Note plastic front panel with all but figures painted flat black.

student. Ordinary 7½-watt lamps (Christmas-tree type) are used to illuminate the display. The remote control board and the display are connected by a multi-conductor cable.

**Circuit Operation.** An overall logic diagram is shown in Fig. 1. Portions of the circuit are shown in individual schematics and will be discussed separately.

**Control Box.** The control switches for the various functions are shown in Fig. 2. All of the circuits to which they are connected are terminated in resistors connected to the +5-volt line.

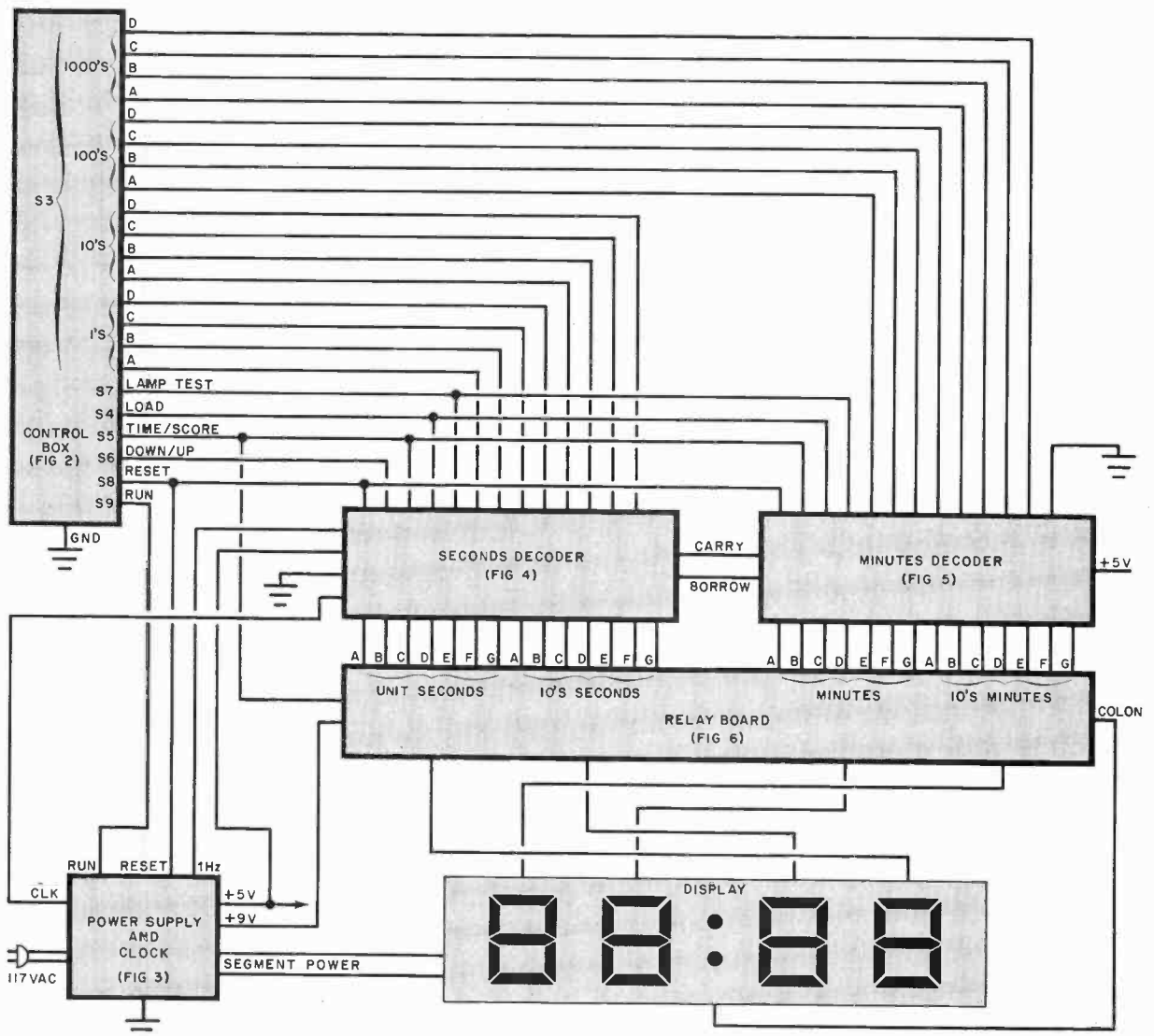
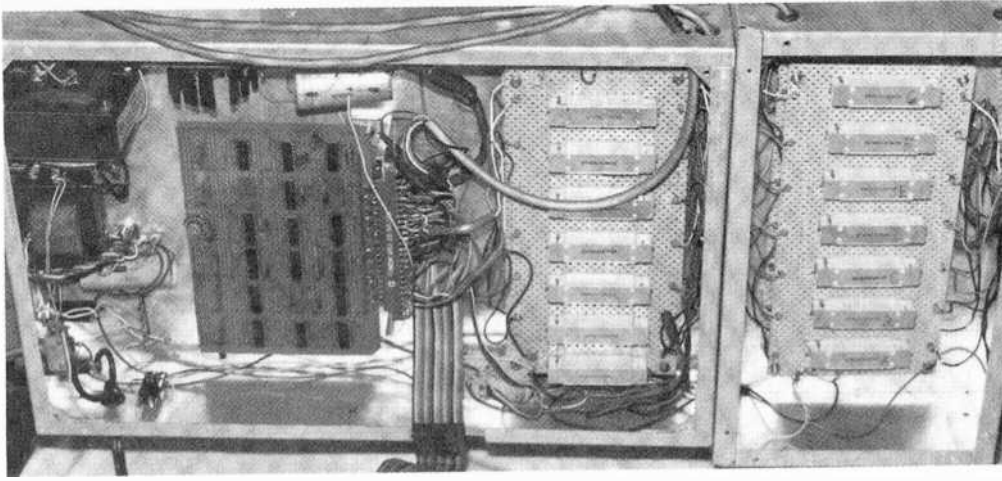

Fig. 1. Overall block diagram of the system. Schematics of individual sections are identified by figure number.





Interior of the two electronic chassis. The power supply, main electronic board, and relay board for two digits are in one chassis. Relay boards for other two digits are in second chassis.

Thus, when the switches are open, the lines indicate a logic 1 state.

The four sections of thumbwheel switch S3 have a complementary BCD output. Each section has a common wiper contact and four output lines. System ground is tied to each common line and the selected code is presented at the output terminals. The complementary BCD code is as follows: (C = closed contact; O = open contact)

Digit	D	C	B	A
0	C	C	C	C
1	C	C	C	O
2	C	C	O	C
3	C	C	O	O
4	C	O	C	C
5	C	O	C	O
6	C	O	O	C
7	C	O	O	O
8	O	C	C	C
9	O	C	C	O

**Power Supply and Clock.** The system requires two power supplies (Fig. 3). One, using a two-transistor regulator, provides +5 volts for the logic. The other is a simple rectifier (D4) and filter (C2) circuit to provide 9 volts for the segment relays.

The 117-volt ac supply is applied to the display lamps to light each segment. When S2 is closed, the full ac supply is applied to provide a bright display. With S2 open, diode D1 permits only the positive half cycles to be applied to the lamps, producing a dimmer display.

Integrated circuit IC8 is a one-shot multivibrator which provides a clean 60-Hz pulse from the ac supply so that any noise on the power line can't cause false timing. This pulse is then coupled to IC9 (a divide-by-six

counter). To prevent contact bounce from the RUN switch from producing false signals, the switch signal is conditioned by IC7. The latter operates IC10C (an AND gate) to allow the 60-Hz signal to pass to the countdown circuits.

**Seconds Decoder.** In this circuit (Fig. 4), IC12 is an up/down counter whose direction is controlled by S6 in the control box. Note that the 1-Hz signal is applied to IC12 through two sections of IC10. These gates control the up and down count lines. When the unit is set to time up, the 1-Hz clock is routed to pin 5. For count down, the input is to pin 4.

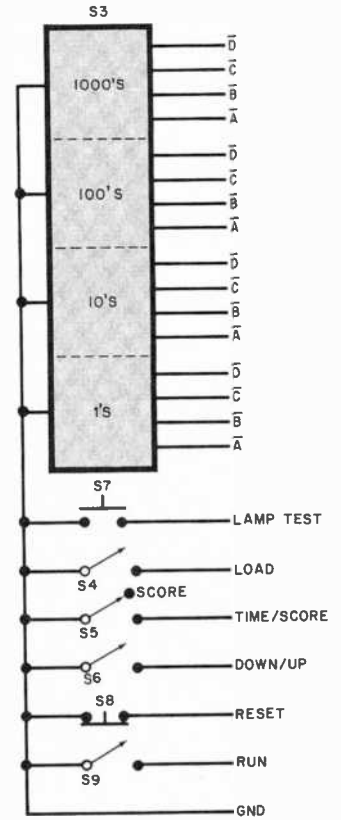

Fig. 2. Control box determines operation of the system. Connection to rest of system is through multiconductor cable.

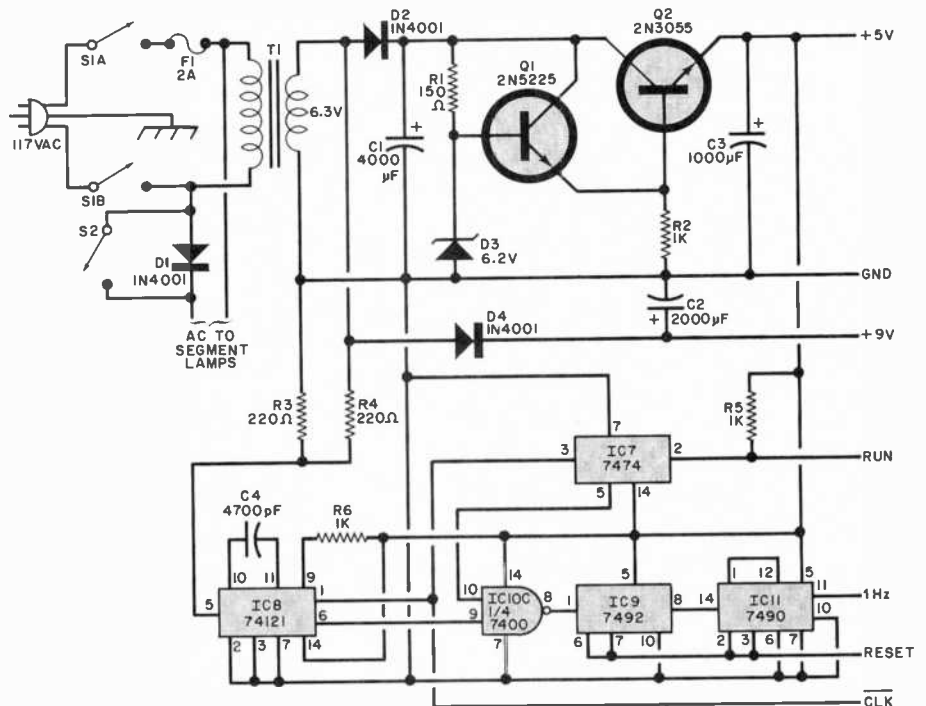

Fig. 3. Regulated 5-volt supply is used for TTL. The 60-Hz is counted down to produce 1-Hz clock pulse for timing.

## PARTS LIST

- C1—4000- $\mu$ F, 15-V tantalum capacitor  
 C2—2000- $\mu$ F, 15-V tantalum capacitor  
 C3—1000- $\mu$ F, 15-V tantalum capacitor  
 C4—4700-pF, 100-V ceramic capacitor  
 C5 to C10—0.1- $\mu$ F, 100-V ceramic capacitor  
 D1,D2,D4—Diode (1N4001 or similar)  
 D3—6.2-V zener diode  
 D5 to D33—1N914 diode  
 F1—2-A fuse and holder  
 I1 to I30—117-V, 7 $\frac{1}{2}$ -W incandescent lamp  
 IC1,IC2,IC12,IC17—74192 decade up/down counter  
 IC3,IC4,IC13,IC18—8233 quad 2-to-1 multiplexer  
 IC5,IC6,IC14,IC19—7447 BCD-to-7-segment decoder  
 IC7—7474 dual-D flip-flop  
 IC8—74121 monostable multivibrator  
 IC9—7492 divide-by-6/12 counter  
 IC10—7400 quad 2-input NAND gate  
 IC11—7490 decade counter  
 IC15,IC16—74153 dual 4-to-1 multiplexer  
 IC20—7404 hex inverter  
 IC21,IC22—74H21 dual 4-input AND gate  
 IC23—7473 dual JK flip-flop  
 IC24—7410 triple 3-input NAND gate  
 K1 to K29—12-V reed relay  
 Q1,Q3—2N5225 transistor  
 Q2—2N3055 transistor  
 R1—150-ohm,  $\frac{1}{2}$ -W resistor  
 R2,R5,R6,R11—1000-ohm,  $\frac{1}{2}$ -W resistor  
 R3,R4—220-ohm,  $\frac{1}{2}$ -W resistor  
 R7 to R10, R12 to R26—2200-ohm,  $\frac{1}{2}$ -W resistor  
 R27—4700-ohm,  $\frac{1}{2}$ -W resistor  
 S1—Dpst switch  
 S2,S4,S6,S9—Spst switch  
 S3—Four-decade thumbwheel switch (EECO 1776 or similar)  
 S5—Spst switch  
 S7—Normally open spst pushbutton switch  
 S8—Normally closed spst pushbutton switch  
 T1—6.3-V, 2-A filament transformer  
 Misc.—Heat sink kit for Q2; lamp sockets (30); hookup wire; 1" x 2" wood strips for display frame; pegboard for display back; translucent white plastic for display front, glossy white or silver paint; flat black paint; thin wood or metal strips for segment dividers; suitable metal chassis; multiconductor cable; press-on type; mounting hardware; line cord; perforated board; IC sockets (24); component mounting clips; etc.

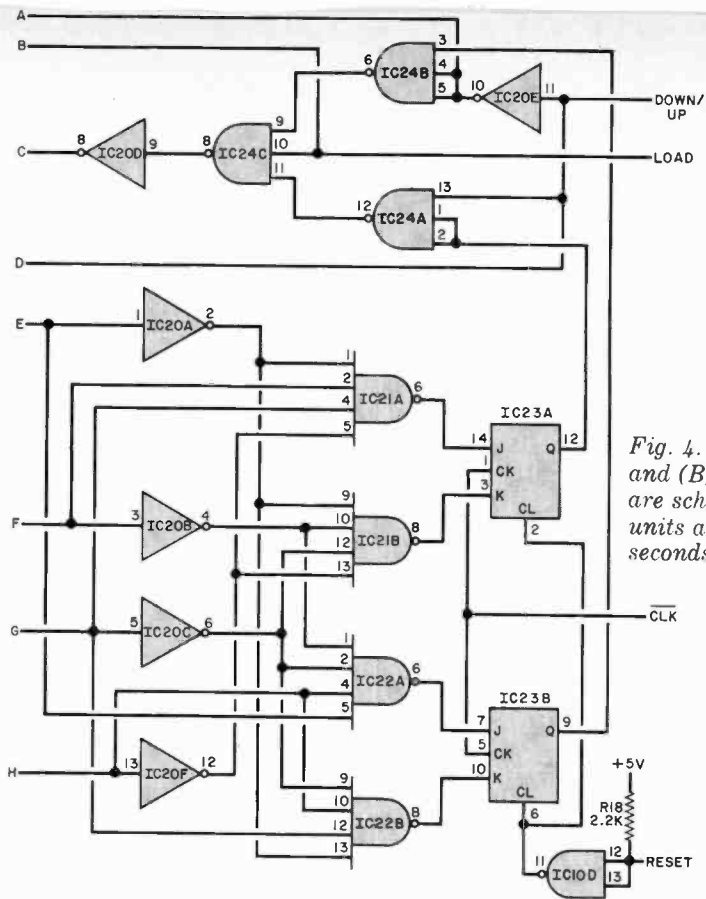
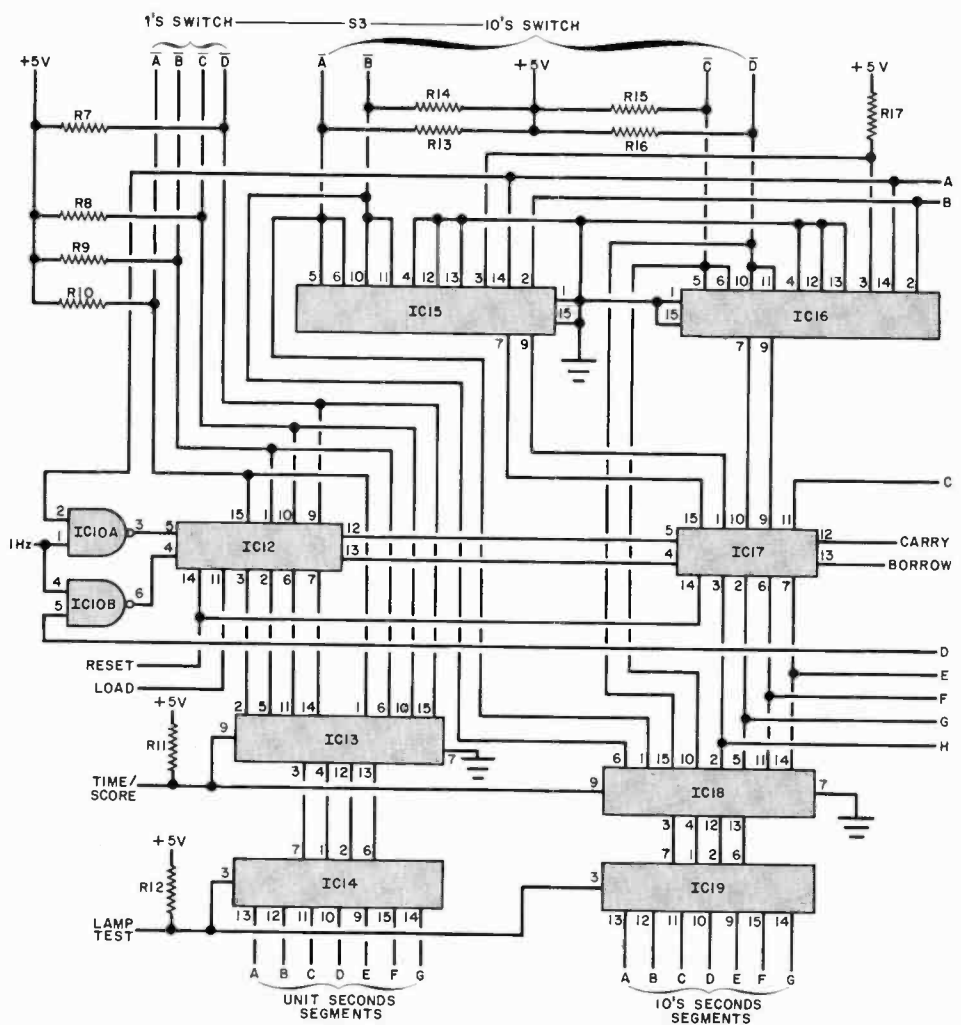

Fig. 4. (A), left, and (B), below, are schematics of units and tens of seconds stages.



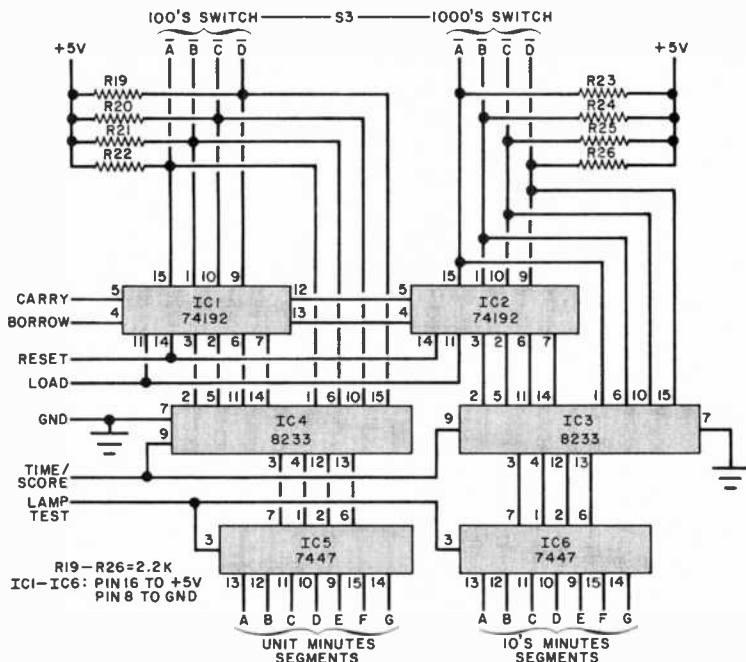

Fig. 5. Schematic of the units and tens of minutes stages. Part of circuit is also used to preset the score.

When pin 11 of IC12 is low, the BCD present on pins 15, 1, 10, and 9 is loaded into the counter; and when timing begins, it starts from this preset code. The preset code is generated in the applicable thumbwheel switch in the control box.

When the counter is being clocked (up or down), carry and borrow lines cascade IC12 to IC17, another decade up/down counter that forms the 10's of seconds counter. Each time IC12 reaches a zero on its up count, an output pulse increments IC17. Likewise, on a down count, a borrow pulse is generated for every zero transition. Integrated circuit IC13 acts as a four-pole, two-position switch! When pin 9 is low (indicating a score display), the BCD code from the thumbwheel switch is routed to IC14. When pin 9 is high, the BCD from counter IC12 is routed to IC13. Note that changing the display from TIME to SCORE does not affect the timing operation. The selected output from IC13 is decoded in IC14 and converted to seven-segment format with the standard segment (A through G) designations.

Decade counters can be cascaded for as many digits as required. However, since a minute consists of 60 seconds (not 100), external circuitry must be added to IC17 to make it a divide-by-six counter. This is not too much of a problem, except that both up and down counting are involved. For counting, up, the sequence must be 1-2-3-4-5-0-1-2 etc.; while for count-

ing down, the sequence is 5-4-3-2-1-0-5-4 etc.

The feedback to produce this logic is implemented as follows (for the up count; the down count logic is identical). When the counter cycles from 5 to 6, we want it to replace the 6 with a 0. The 6 count from IC17 is sensed by IC21A and the resulting high state presented to the J (pin 14) input of IC23A is stored. The high output of IC23A causes IC17 to enter a load condition; and, at the same time, IC14 and IC16 (arranged as a four-pole, four-position switch) force a count of 0 into the counter. When this 0 is detected by IC23A, the load command is removed and the counter continues to time from the 0 state. While the invalid 6 digit would be displayed, it is only for 1/60 of a second and will not be observed. IC15 is wired for a code of 0 (used during time up) and a code of 5 (used during time down), with the BCD

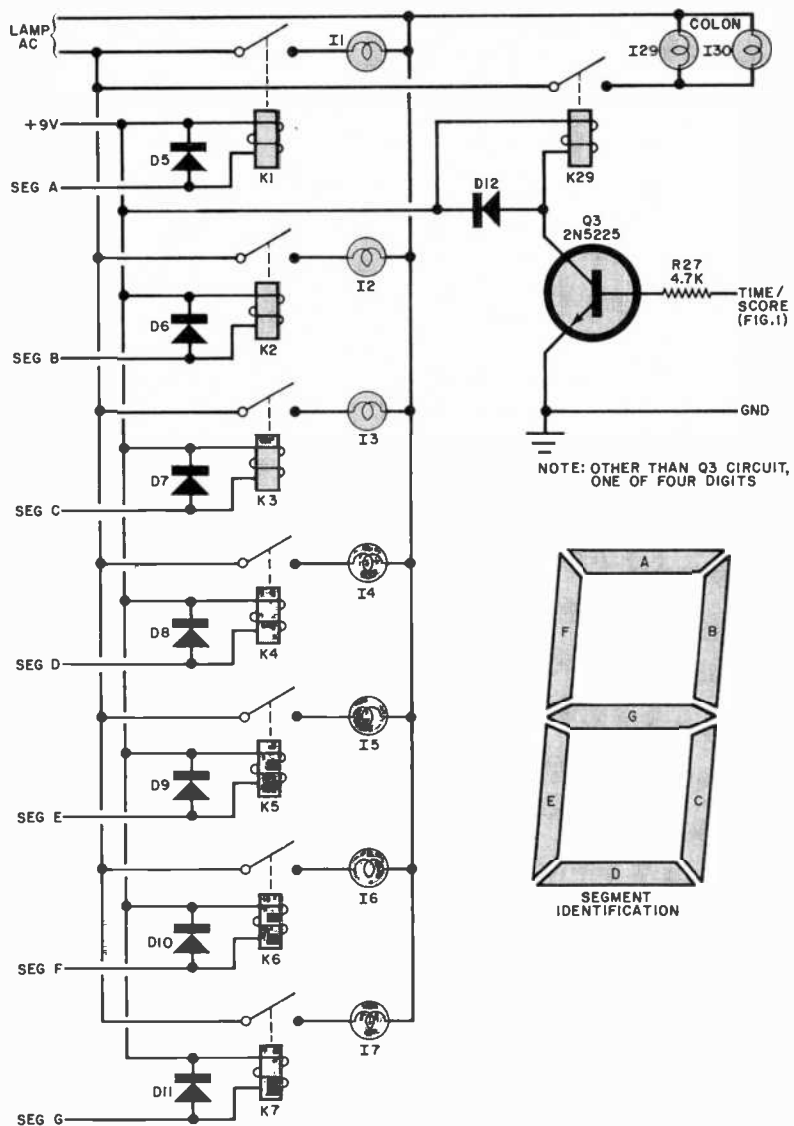

Fig. 6. There is one relay board for each digit in display. Relay circuit for colon display is on only one board.



code from the thumbwheel switch routed into the counter during the normal loading time.

The minutes and tens of minutes decoders are shown in Fig. 5. These are conventional circuits receiving their instructions from the control box.

**Relay Board.** The outputs of the BCD-to-seven-segment decoders (IC14, IC19, IC5, and IC6) are connected to their respective reed relay coils shown in Fig. 6. Other than the colon circuit, the reed-relay circuits are duplicated for each digit on the display. One side of each relay coil is connected to the nine-volt supply and the other to the decoder output. The diode across each coil eliminates the inductive spike that is generated when the segment drive voltage is removed. The switching is arranged so that each 117-volt segment lamp is placed in the circuit as its reed relay operates.

Transistor Q3 saturates when the TIME switch on the control box is operated. This energizes K29 and I29 and I30 to form the colon.

**Horn Option.** An additional circuit (not included in the prototype) can be used to sound a horn or buzzer at zero time (Fig. 7). The BCD code from each counter is routed to its own four-input NOR gate (7425). When all lines are at a zero level (zero time), the output of four-input NAND gate (7420) goes low causing the SR flip-flop composed of the two 7400 NAND gates to produce a high state. This state is retained until the RESET switch on the control box is operated. The output transistor is used to operate a relay whose switch contacts should have the capability of handling the current demand of the selected horn or buzzer. Any relay that can operate at 9 volts can be used and the transistor should have sufficient collector current (when saturated) to operate the relay coil.

**Construction.** The electronic circuits can be wired on perforated boards, using sockets for the IC's. No particular arrangement is required. The circuits can be grouped on boards as shown in the schematics, but separate boards will be required for each relay system (Fig. 6). (Only one colon circuit is needed.) In the prototype, most of the circuits, including two sets of segment lamp drivers, were assembled in one aluminum box (12" x 17" x 3") with the other two segment driver

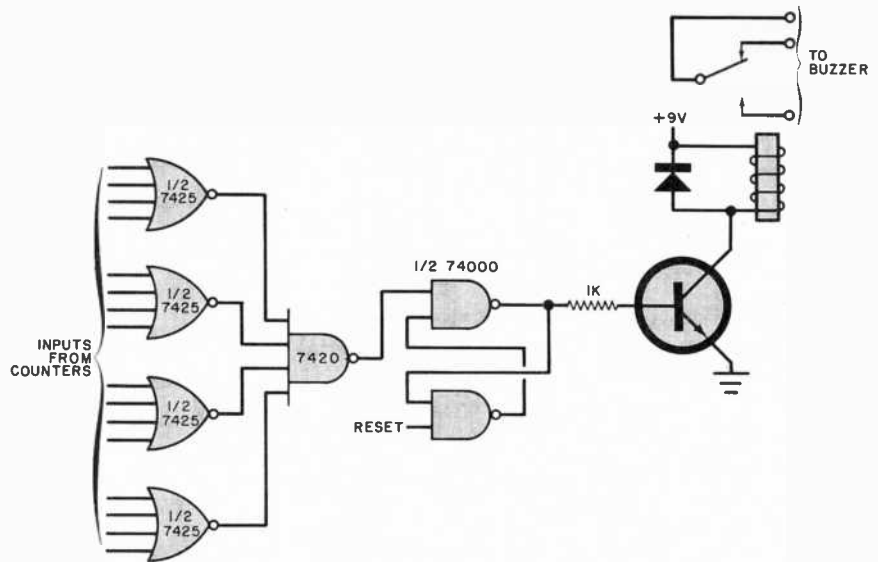

Fig. 7. This optional circuit can take the outputs from the counters and connect power to sound a horn accessory when the time is 00:00.

circuits in a smaller box (8" x 12" x 3"). Other, possibly smaller arrangements could be used; but if overall size is not important, the extra room facilitates wiring and maintenance.

Since the logic circuits operate at low frequencies, special layouts are not necessary. However, since there are current spikes flowing in the 5-volt and ground leads, it is a good idea to insert bypass capacitors (0.1  $\mu$ F) between each 5-volt line and ground. Decoupling all counter IC's is also a good idea.

The control box can be connected to the electronic circuits through a length of multiconductor cable, or the control box can be mounted on the larger package.

The display board can be constructed to fit your needs. The prototype was 48" long and 14" high. A wooden frame was constructed. The front face was made of translucent white plastic (available from most building supply stores) the same size as the frame. The face was prepared by masking out the four digits (seven segments each) and the colon on the back of the face. The back was then sprayed with flat black paint so that only digits and colon remained translucent.

Pegboard was used to mount the lights and provide ventilation. After cutting the board to size, it was painted glossy white (or silver) to add brightness to the lamps. A 7½-watt lamp socket was mounted at the center of each segment and wired as shown in Fig. 6. Pressboard or sheet aluminum was then used to separate

the lamps for each segment so that the light did not spill over. Black masking tape can also be used to avoid light spill.

The front face can be secured to the frame in any way that will provide a good overall appearance. Keep in mind that the front may have to be removed to replace lamps. A light shade can be added over the top of the front to make the digits more visible in bright ambient light. It has been found that yellow lamps in the display provide better definition. However, avoid lamps rated at more than 7½ watts, or the reed relays may be damaged. If brighter lamps are needed, an extra driving stage (with SCR's or triacs) will be necessary.

**Operation.** The controls are as follows:

**THUMBWHEEL SWITCH:** Used to set in the time and score.

**LAMP TEST:** Lights all segments of all digits for testing.

**LOAD:** Timer is forced to time set by thumbwheel switches.

**TIME/SCORE:** In the TIME position, the display indicates the preset time and the colon is lit. In SCORE, the colon is dark and the display indicates the score preset on the thumbwheel switches.

**DOWN:** Makes the timer count down from preset time. If switch is not closed, time counts up from preset time.

**RESET:** Returns timer to all zeroes.

**RUN:** Starts timer. When opened, the timer stops. (This switch is useful for time-out periods.)



# Electronic

# Crossover

*What they are, how they work,*

# and how you can design your own. Networks

# FOR HI-FI

BY LEONARD FELDMAN

**T**HE FIRST thing you're likely to learn about loudspeaker systems, whether through experience or by reading about them, is that different speakers are needed for different portions of the audio spectrum. You need a woofer to handle deep bass tones and a tweeter to handle the highs. Very often, one or more extra speakers are used to handle the mid-range, upper bass range, and the super highs.

The analogy is often made between a multi-driver (speaker) system and a human choral group in which basses, baritones, tenors, mezzo-sopranos, and coloraturas are all needed to cover the spectrum of songs created by composers. The analogy is valid only up to a point. The chorus is "powered" by as many human beings as there are voices, each supplying the acoustic "watts" for his or her range of frequencies. The multi-driver speaker system, on the other hand, is usually powered by a single amplifier, feeding all drivers simultaneously.

**The Crossover Network.** With a single source of power energizing all of the drivers in a multi-speaker system, a device is needed to direct the proper portions of the audio band to their respective speakers. This device is usually a passive capacitor/inductor network.

In a simple two-driver speaker system, the typical circuit of a crossover network would look like that shown in Fig. 1A. The lower part of the network would deliver to the woofer low frequencies up to some predetermined point based on the values of inductor  $L_1$  and capacitor  $C_1$ . Beyond the



*The Crown International Model VFX-2 two-channel crossover network has fixed 18-dB/octave rolloff.*

selected point, all higher frequencies would be attenuated, or "rolled off," at a rate of 12 dB/octave by the lower portion of the network.

The upper portion of the network would be designed to pass all frequencies beyond a certain point, determined by the values of  $C2$  and  $L2$ . All frequencies below that point would be attenuated at a rate of 12 dB/octave.

The response curves of both parts of the network are shown in Fig. 1B. The intersection of the curves is called the crossover point or frequency. Most crossover networks are designed so that the crossover point is 3 dB below (half) the levels of the frequencies within the pass band of each part of the network. Theoretically, if the crossover is at 600 Hz, the woofer and the tweeter will each produce sounds that are only half of that required at this frequency. The combined sound power would then equal that required by the original signal ( $\frac{1}{2} + \frac{1}{2} = 1$ ).

When the theory is put into practice, problems often develop. What is seldom mentioned concerning passive crossover networks is that even the best of them introduce time-delay distortion in the region of the crossover frequency. This occurs for a variety of reasons, including unequal phase delays between the two halves of the network, differences in response characteristics, differences in the velocity of the sound coming from the woofer and the tweeter, and many other variables.

Even if an ideal crossover network were designed, the manufacturer would still be faced with the problem of having to fabricate very large value inductances and buying low-loss,

low-distortion fixed capacitors of high value. For example, if the speakers to be driven are rated at 8 ohms,  $L1$  and  $L2$  would have to be about 2 mH in inductance. Since low-frequency audio current will be flowing through  $L1$  within the pass band, the inductor must be made from fairly heavy wires so that its dc resistance will be negligible and the power dissipated within it will be minimal. The values for  $C1$  and  $C2$  would be greater than 30  $\mu\text{F}$ , and complicating matters would be the fact that these capacitors would have to be nonpolarized.

**Power and Harmonics.** Modern recorded music has much more dynamic range than was contained in recordings of a few years ago. This means that audio amplifiers must be able to respond to sudden large transient peaks and deliver accurate replicas of high-amplitude signal waveforms without clipping or distorting. To make matters worse, most popular sealed-enclosure speaker systems require much more power for a given amount of sound output than did their large vented predecessors.

Suppose that during a given instant of music the amplifier is called upon to deliver a few cycles of 50-Hz tone at 20 volts rms. Assume that the amplifier will develop and deliver 50 watts of power to the speaker output terminals, to which an 8-ohm speaker system is connected. If the amplifier is rated at 50 watts/channel output power, the signal waveform might appear as shown in Fig. 2A.

Now, suppose that simultaneous with the 50-Hz tone a 1000-Hz burst, also at 20 volts rms, appears at the output of the amplifier. (Its waveform

is shown in Fig. 2B.) How much power would the amplifier now have to deliver to the speaker load? If you said 100 watts, you are wrong. The combined 50-Hz and 1000-Hz tone waveform would look like that shown in Fig. 2C. At 40 volts rms, its amplitude would be exactly twice that of either waveform by itself.

Since power varies as the *square* of the voltage ( $P = E^2/Z$ , where  $P$  is power in watts,  $E$  is voltage, and  $Z$  is the impedance of the speaker load), the amplifier would actually have to deliver 200 watts to the load. An amplifier rated at 50 watts would have clipped the waveform horribly.

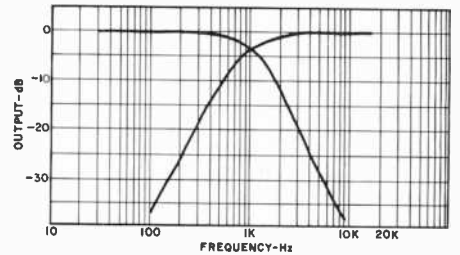
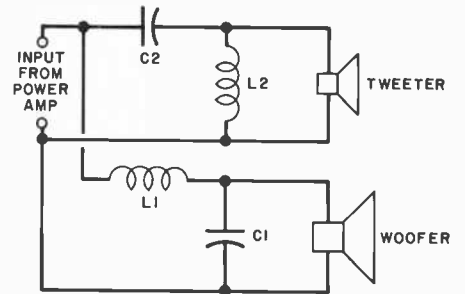
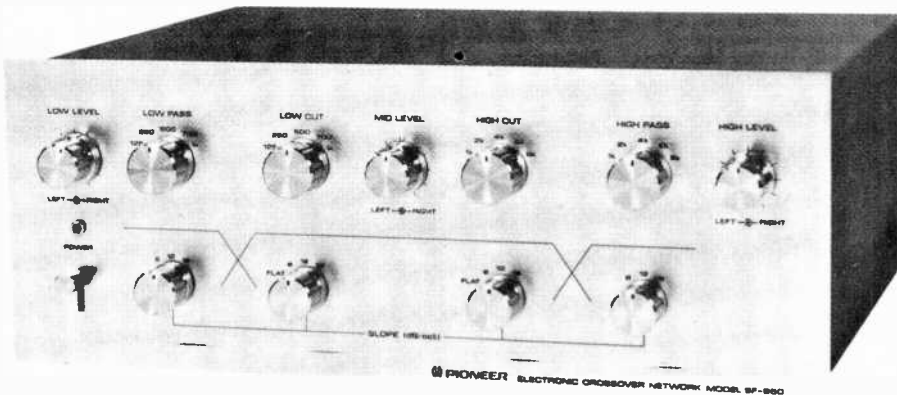

Fig. 1. (A) L/C crossover networks (12 dB/octave) and (B) response.

When an amplifier clips off the tops and bottoms of a musical waveform, it creates unwanted harmonics (multiples of the desired frequencies that were not in the original signal waveform). Worse still, since the harmonics might contain high-energy content and, being at higher and higher frequencies, some harmonics might pass right through the upper filter section of the crossover network and be fed to the tweeter. The network cannot discriminate between the high frequencies that are really part of the music and high frequencies generated by harmonic distortion, but the tweeter can. It is accustomed to accommodating *musical* high frequencies that usually contain much less energy than is ordinarily contained in the middle- and low-frequency registers. Faced with having to handle unnatural amounts of high-frequency energy, the tweeter either distorts badly or it burns out.



U.S. Pioneer Electronics Model SF-850 crossover network provides for selection of 6-, 12-, or 18-dB/octave slopes.



## CIRCUIT VALUES FOR LOW-LEVEL NETWORKS

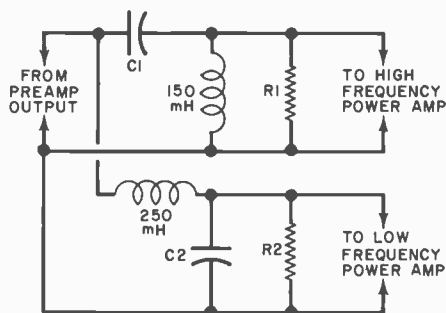

Frequency	C1 (μF)	R1 (ohms)	C2 (μF)	R2 (ohms)
1500 Hz	0.04	1500	0.06	1500
1200 Hz	0.062	1200	0.10	1200
1000 Hz	0.01	1000	0.15	1000
800 Hz	0.20	790	0.25	790
650 Hz	0.25	600	0.40	600

Clipping also causes a great deal of intermodulation (IM) distortion to appear at the output of the amplifier. IM distortion, consisting of the sum and difference between the two desired frequencies, is far more annoying to the average listener than simple harmonic distortion.

Suppose that instead of feeding both tones to the same amplifier we fed each tone to a separate amplifier and connected the woofer to one amplifier and the tweeter to the other amplifier. If each amplifier were rated at 50 watts or more output power, there would be no clipping. The woofer would receive pure 50-Hz energy, while the tweeter would receive the same amplitude 1000-Hz tone.

The sound power delivered to the listener would be exactly the same as if a single 200-watt amplifier, plus the conventional crossover network, had been used, and there would be no harmonic or IM distortion created at the output of either amplifier or driver element. This is the driving force be-

hind the current switch to bi-amplification and tri-amplification, a technique that has been used in professional studio monitoring and other professional sound applications for years. Hi-fi enthusiasts who have recognized the many advantages of multiple-amplifier/speaker systems have also made the switch, usually by fabricating their own low-level filter networks from scratch.

Making your own filter (crossover) network is not a formidable task. The low-level network is introduced ahead of the power amplifiers in a system, usually between preamplifier and power amplifiers, and is therefore fed from a low-impedance source and drives a high-impedance load. As a result, capacitor values become quite low, while inductances—though greater in value—are not required to handle appreciable power and can be quite small in size.

In passive crossover networks that are connected between the amplifier and speaker system, the terminating

impedance is the impedance of the speaker elements themselves. So, in such crossover networks, it is difficult to vary crossover frequency without changing the values of both the capacitors and inductors. In the case of low-level crossover networks working into the high-impedance input of an amplifier, an arbitrary resistance can be used to terminate the filter sections. It is, therefore, possible to work out a filter network for specific crossover frequencies using a fixed value of inductance and varying the values of the capacitors and terminating resistors.

Listed in the table are the component values for several popular crossover frequencies. These values apply to the crossover network shown. The resistances have been chosen to be low enough so that the parallel input impedance of the following power amplifiers will have little or no effect on the frequency response characteristic available at the woofer (low-frequency) and tweeter (high-frequency) outputs.

Low-level crossover networks have a further advantage in that the termination is purely resistive and unvarying. Part of the problem with passive networks introduced between the amplifier and speaker system is that they are presumed to terminate in a constant impedance when in fact the impedance of each driver coupled to the network varies widely with frequency. Consequently, the carefully chosen capacitor and inductor values seldom yield the optimized transfer characteristic shown in Fig. 1B. In fact, a typical curve might exhibit a somewhat random transfer characteristic as in Fig. 3.

The situation becomes even more complex when an attempt is made to design an 18-dB/octave passive crossover network such as shown in Fig. 4. The reason is that this filter con-

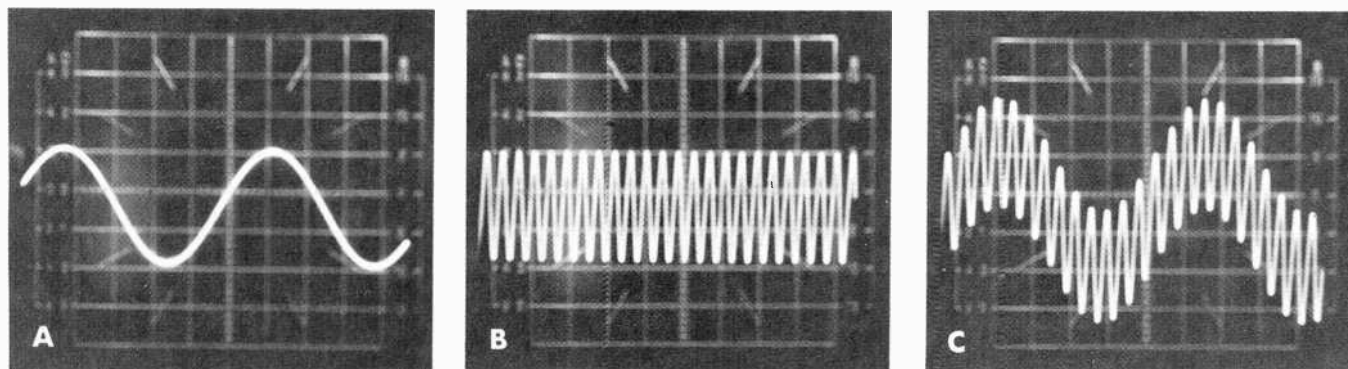

Fig. 2. At (A) is 50-Hz, 20-V amplifier output tone; (B) is 1000-Hz tone at same amplitude; (C) is (A) and (B) combined with twice the voltage and four times the power.

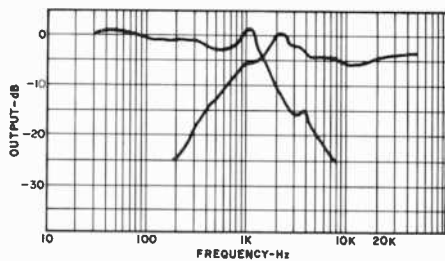

Fig. 3. Idealized response of Fig. 1 may actually be like this.

figuration is also based on the assumption that the termination is a constant-resistance load.

Attempting to make the crossover network variable to compensate for loudspeaker characteristics, listening environments, and listener preferences is an almost hopeless task. Many manufacturers resort to simple L-pad controls that provide a means for adjusting the level of the energy fed to the driver itself, after the crossover network. This further upsets the impedance relationships between the theoretically designed network components and their termination. It is also quite difficult to design a passive crossover network with one slope rate for attenuating the low-frequency signals and another slope rate for attenuating the high-frequency signals. But this is exactly the type of response that is often desirable with certain speaker combinations. For example, we might want to roll off the low frequencies fed to the woofer at an 18-dB/octave rate, while rolling off the middle or high frequencies fed to the midrange driver or tweeter at a more gradual 12-dB/octave rate.

**Setting Up a System.** It is more difficult to set up a multi-amplifier system than it is to set up a single-amplifier system. Getting the volume-control settings for the woofer, mid-range, and tweeter amplifiers just right for a smooth energy response from the lowest bass to the highest treble requires more care and a sound level meter. (Very few of us can judge absolute sound levels at all frequencies without the aid of some metering device.) Most SLM's sell for hundreds of dollars, but Radio Shack has one — the No. 33-1028 — that retails for only \$49.95.

Here is one way you might set up an active-crossover-network/tri-amplifier system using an FM tuner set between stations to serve as a wide-spectrum noise generator and an SLM. First, determine which are the proper cross-

over frequencies for the particular system and experiment with different slope rates for each of the two crossover points to determine which are the best.

With the other two level controls in the crossover system turned fully down in each case, adjust each level control in turn to obtain a random-noise level reading of about 80 dB on the SLM in each of the three bands. Carefully note the exact setting of each control as it is set.

Next, set all level controls to the noted positions, and play some music through the system. As you listen to the reproduced music, you might have to touch up the setting of one or two of the level controls to make the system response as flat and neutral sounding as possible. Differences in individual speaker efficiencies and gains in the three power amplifiers might require widely different control settings in each band, but this should be of no concern as long as the overall musical response is smooth and flat when you are finished.

Once the system is set up via the controls on the active crossover network, the volume control on the pre-amplifier then becomes the system's master volume control.

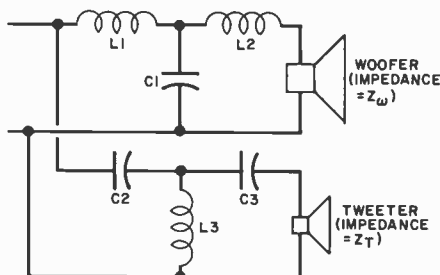

$$L1 = \frac{3Z_w}{4\pi f_c}$$

$$L2 = \frac{Z_w}{4\pi f_c}$$

$$C1 = \frac{2}{3\pi f_c Z_w}$$

$$C2 = \frac{1}{3\pi f_c Z_T}$$

$$C3 = \frac{1}{\pi f_c Z_T}$$

$$L3 = \frac{3Z_T}{8\pi f_c}$$

Fig. 4. An 18-dB/octave network; formulas for calculating values.

The differences between single- and multiple-amplifier systems begin to become very obvious as volume levels are increased. At the level where a single-amplifier system would begin to have audible distortion, the multiple-amplifier system will still sound clean and distortion-free. Further increases in volume will only make the distortion more intolerable in the single-amplifier system, while the multiple-amplifier system will still be going strong.

There is one precaution you should take if you embark on a multiple-amplifier project. Normally, when a manufacturer installs a passive crossover network inside his speaker enclosure, he takes pains to make sure that all drivers are connected in phase. (This is particularly important when connecting woofers and midrange drivers which, if accidentally hooked up out-of-phase, will cause their outputs to cancel.) In the case of an electronic crossover network and assorted power amplifiers, there is no guarantee that the various speakers in a system are wired in accordance with the phasing indicated at the terminals.

Unless you are using identical power amplifiers for each driver—a rather expensive approach since in most cases the tweeter does not need nearly as much power as do the mid-range speaker and woofer—different amplifiers might have different numbers of stages. Ordinarily, each stage produces a 180° phase shift of the waveform fed to it. So, you might well have one amplifier with an odd number of stages, with the result that the signals at their outputs will be 180° out-of-phase with each other.

Since you might not be able to interpret the number of stages merely by looking at the amplifier's schematic, the best way to solve the phasing problem is by trial and error. Even in a three-way system, there are only four possible ways to hook up the mid-range speaker and tweeter with respect to the woofer. So, establish a connection to the woofer and then try the four combinations of midrange and tweeter connections one by one.

Play only a single (mono) system at one time to avoid confusion, and listen for the combination of connections that gives the fullest, widest-range sound. You will be able to tell when the system is in-phase just by listening to ordinary musical program material.

**In Conclusion.** Multiple-amplifier systems are not for everyone. In general, the loudspeaker systems chosen for multiple-amplification applications should be relatively efficient, which would make them large and unsuited for bookshelf placement.

If your present speaker systems are of the small bookshelf variety, chances are good that they are also sealed-enclosure units. If they are sealed, you might not want to tear into them—especially if they are expensive and still under warranty. ♦

# IMITATING MUSICAL INSTRUMENTS



## WITH SYNTHESIZED SOUND

*How the sounds of traditional instruments  
can be produced electronically*

BY DON LANCASTER

**I**N A previous article ("Timbre and Voicing Circuits for Electronic Music," June 1975), we discussed techniques for altering the tonal quality of a basic waveform to produce the desired musical effects. Now, we can consider specific ways of synthesizing the sounds of given traditional musical instruments. Once we know how to accomplish this, we can go on to designing our own "voices" for the instruments. (Imitating an instrument is called "voicing." Proper voicing can make an electronic instrument, while improper voicing will break it.)

As a gross and crude approximation to classes of instruments, you can use sine waves with slight amounts of second-harmonic content to imitate flutes, piccolos, and bland tibia organ pipes. Sawtooth waveforms, with either additional high-pass filtering for brightening or low-pass filtering for softening or mellowing, produce string-like tones. The same sawtooth waveforms passed through a fixed resonant bandpass filter circuit or two will produce a horn-like resonance.

Square waves with some softening and perhaps some even-harmonic content added are useful as a source of "hollow" or "woody" tones, such as those produced by the clarinet and other woodwinds and some stopped organ pipes. Lower piano notes and

some organ pipes, or diapasons, have strong second harmonics, obtained by adding extra energy (usually more than is available in an unmodified sawtooth) at twice the fundamental frequency. Filtered noise forms the basis for many of the percussion instruments, particularly drums.

While any of these techniques is a good place to start and can produce a "clarinet-like" or a "trumpet-like" tone, they will all sound less than real. So, let us look at some basic voicing principles to find out what is needed in synthesized voices to make them sound more realistic.

**Principles of Voicing.** Successful voicing schemes must customize both the envelope and the timbre to the instrument. Having a fixed envelope shape and changing only the timbre is just as bad as having a fixed timbre and changing only the attack, sustain, and decay characteristics of the voice. Admittedly, some instrument limitations are somewhat tolerant of variations in envelope and timbre, but to do the job properly both envelope *and* timbre must be controlled, in addition to adding special effects.

Successful voicing cannot be accomplished with resistors and capacitors alone. Active electronic filters or inductors are usually needed.

The formant or fixed-filter method (or a voltage-controlled filter with a fixed input reference) is normally best for synthesizing traditional musical instrument sounds, although a tracking filter or vcf is useful for changing harmonic content during note decay and for sympathetic resonance effects.

Precise control of many harmonics, preferably the first 30 or so involved, is required for successful voicing. Synthesis techniques that use or build up only the first few harmonics are doomed to failure. Harmonics 30 dB and more down from the fundamental can have a significant effect on overall tone quality.

Voicing must be accomplished in register to be successful. If a trumpet has a certain acoustical range, the filtering to imitate that range should handle only those notes a trumpet would normally cover. Extensions out of register on the high or low end will sound too bright or too shallow to be realistic.

Voicing must not be spread too thin if it is to be successful. With modern low-cost operational-amplifier active filters, there is no reason to use only one active filter for an entire voice register. By customizing the filtering to one-third or one-half octave steps and using multiple filters, a much better

*continued on page 40*



# CHARACTERISTICS OF MUSICAL INSTRUMENTS

(Numbers in parentheses give the instrument's range, indicated by note and octave on the piano keyboard.)

**Bassoon** (A#1-D#5): Typical of the bassoon are its moderate Q resonances at 550 and 1150 Hz. Dropoff of higher harmonics is very rapid above the second peak. The blip-free attack lasts 50 ms and sustain is 60 ms in duration, followed by a gradual noise-free decay.

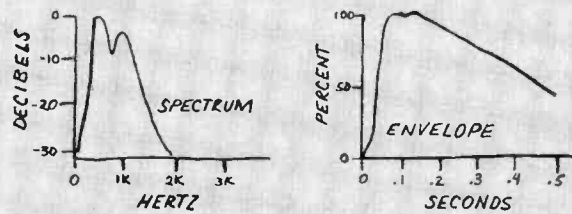

**Bass Violin** (E1-E3): Characteristic of the bass violin is its range through an almost pure sawtooth wave on the low end (50 Hz) through a steeply low-pass-filtered sawtooth on the high end (250 Hz). The rise and decay times are both 0.5 s in duration. A slight low-frequency noise modulation appears on the envelope.

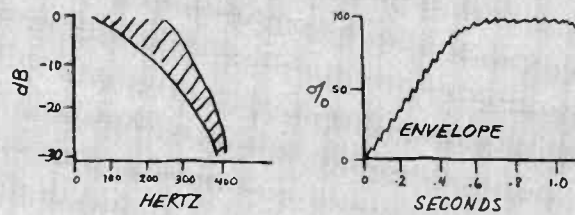

**Cello** (C2-E3): The sound from the cello is obtained by a predominantly sawtooth waveform that is moderately low-pass-filtered. Filter cut-off becomes steeper and must move up with increasing frequency. Very gradual attack and decay, with decay becoming more abrupt on the higher notes, characterizes the envelope.

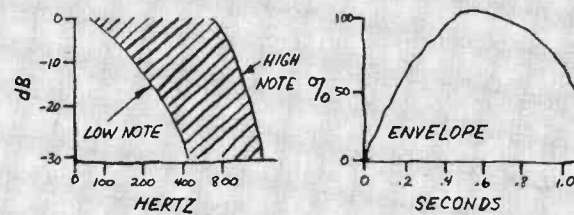

**Clarinet** (D3-F6): The sound of the clarinet consists predominantly of odd harmonics, although a low level of even-harmonic content must also be provided. Even harmonics are somewhat stronger for the upper notes. The rise time is about 50 ms, and a 10% modulation of low-frequency random noise adds to tone character.

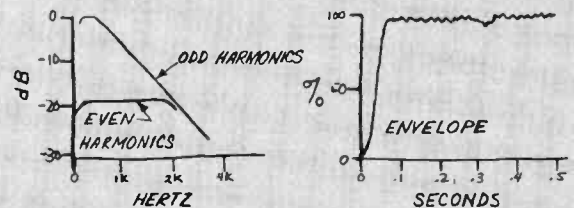

**English Horn** (G#3-C#6): A high, flat-topped resonance at 600 Hz and a narrower resonance at 1900 Hz are characteristic of the English horn. The dip between the two resonance peaks, located at 1300 Hz is some 26 dB down from the lower-frequency resonance peak. The two-step rise time is 5 ms to 60% amplitude and then more gradually to maximum at 400 ms. The final attack and sustain have a characteristic 10% random-noise amplitude modulation.

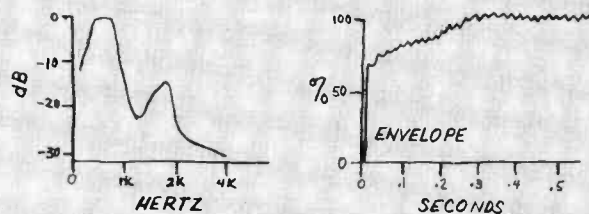

**Flute** (C4-C7): The flute is another double-resonance instrument with a minor resonance peak located at 300 Hz and a stronger peak at 600 Hz. Harmonics are very weak. The rise time is about 50 ms. A very pronounced (50-75% of maximum) tremolo of 5 to 7 Hz is present.

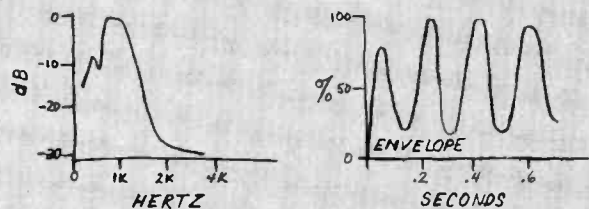

**French Horn (B1-F5):** Has a single resonance at 500 Hz and much narrower bandpass than the trombone. Rise-time varies between 100 and 20 ms, with an attack blip on lower notes.

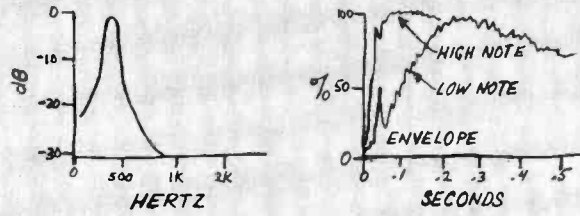

**Oboe (A3-G6):** A very complex spectrum structure is characteristic of the oboe. It has a 1050-Hz resonance peak, a 30-dB dip at 200 Hz, and a final high-pass resonance at 3000 Hz. Much more harmonic energy is in the oboe's sound than in other instruments. The rise time is 60 ms, sustain time is zero, and decay begins 100 ms after the start of the note. The envelope starts out relatively clean but then takes on a 10% noise modulation during the decay period.

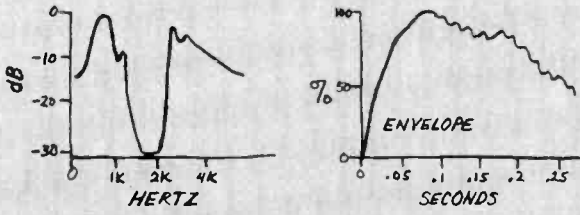

**Piano (A0-C8):** The absolute minimum needed to create a piano voice is three tone sources with non-harmonic over-

tones, combined with sympathetic-resonance buildups and interactions of harmonic overtones with time for

each note. The waveform structure for the piano note is too complex to be shown here.

**Trombone (E2-B4):** The trombone's frequency spectrum curve shows a single resonance peak at 475 Hz whose rise time is on the order of 60 ms. The envelope has a very pronounced double blip on the leading edge. Portamento or frequency modulation is needed for slide effects.

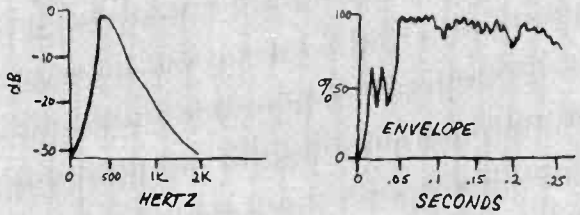

**Trumpet (E3-A#5):** The trumpet's single resonance peak falls at 1150 Hz. Its envelope displays a characteristic horn blip or impulse change in amplitude. The rise time is 50 ms.

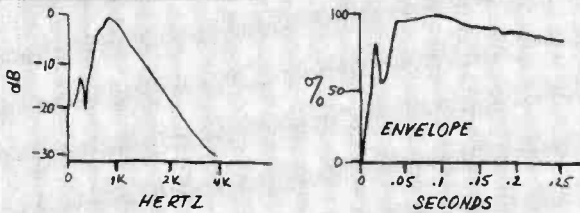

**Tuba (F1-F4):** The tuba's voice has a single resonance peak located at 275 Hz. A very pronounced horn blip is on the attack edge of the envelope. Rise time is 400 ms.

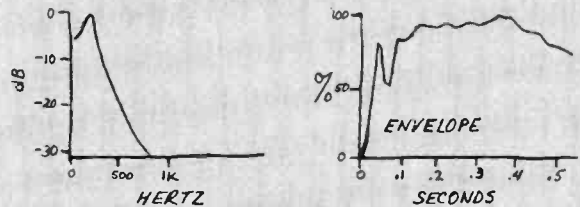

**Viola (C3-E4):** The voice of the viola ranges from a brightened, high-pass-emphasized sawtooth on the low end at 140 Hz through a slightly low-pass-filtered sawtooth on the high end at 750 Hz. The attack time is 150 ms, followed by a 150-to-300-ms decay time. The envelope exhibits some low-frequency noise modulation.

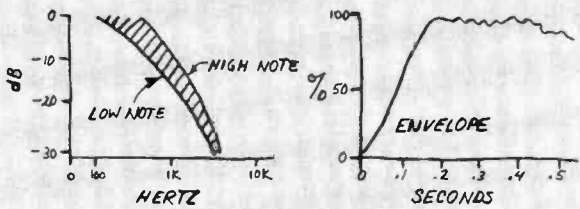

**Violin (G3-C6):** The violin's voice ranges from a brightened high-pass-emphasized sawtooth on the low end at 200 Hz through a slightly low-pass-filtered sawtooth on the high end at 1500 Hz. The attack time varies between 80 and 200 ms, and a 6- to 8-Hz frequency-modulation vibrato is optionally present.

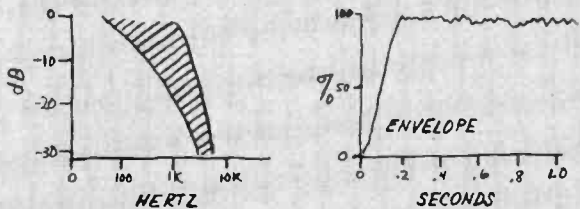

# The better the training the better you'll

Send for  
**FREE**  
illustrated  
career  
guide

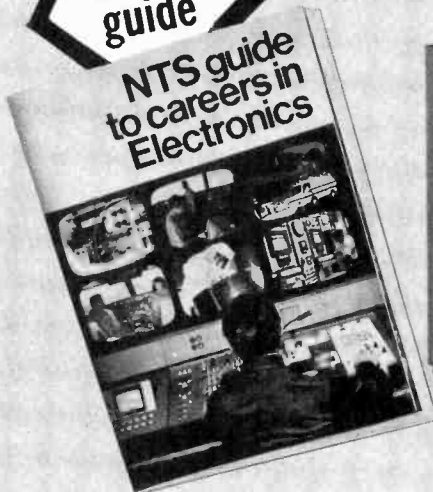

COMPU-TRAINER

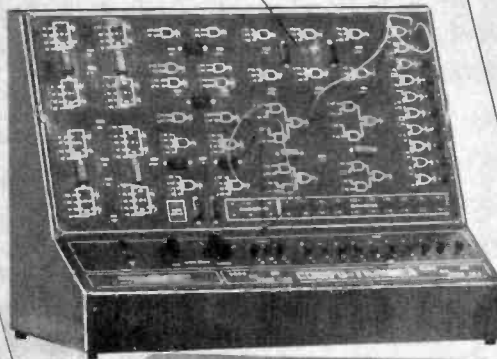

IN-CIRCUIT TRANSISTOR TESTER

TROUBLESHOOTER  
VOM

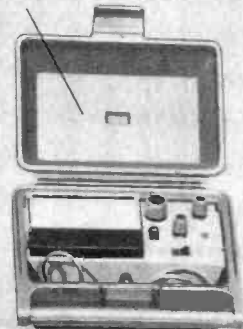

SOLID-STATE  
OSCILLOSCOPE

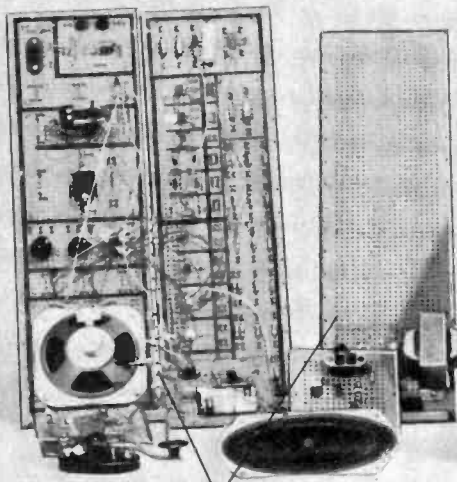

ELECTRO-LAB



(Simulated TV Reception)

As an NTS student you'll acquire the know-how that comes with first-hand training on NTS professional equipment. **Equipment you'll build and keep.** Our courses include equipment like the **NTS/Heath Digital GR-2000 Solid State color TV** with first-ever features like silent varactor diode tuning; digital channel selection, (with optional digital clock), and big 315 sq. in. ultra-rectangular screen.

Also pictured above are other units — 5" solid state oscilloscope, vector monitor scope, solid-state stereo AM-FM receiver with twin speakers, digital multimeter, and more. It's the kind of better equipment that gets you better equipped for the electronics industry.

This electronic gear is not only designed for training; it's field-type — like you'll meet on the job, or when you're making service calls. And with NTS easy-to-read, profusely illustrated lessons you learn the theory behind these tools of the trade.

**Choose from 12 NTS courses** covering a wide range of fields in electronics, each complete with equipment, lessons, and manuals to make your training more practical and interesting.

**Compare our training; compare our lower tuition.** We employ no salesmen, pay no commissions. You receive all home-study information by mail only. All Kits, lessons, and experiments are described in full color. Most liberal refund policy and cancella-



# and the equipment be equipped.

**COMPARE OUR  
KITS AND LESSONS.  
COMPARE OUR  
TUITION.**



**HIGH FIDELITY  
SPEAKERS**

**SOLID-STATE STEREO  
AM/FM/MULTIPLEX  
RECEIVER**

**COLOR BAR/DOT  
GENERATOR**

**TUBE & TRANSISTOR  
TESTER**

**FET-VOM**

**AM/FM/SW PORTABLE  
SOLID-STATE RECEIVER**

**VECTOR MONITOR  
SCOPE**

**SIGNAL  
GENERATOR**

**5" OSCILLOSCOPE**

**DIGITAL  
MULTIMETER**

**SOLID-STATE 2-METER FM  
TRANSCIVER & POWER SUPPLY**

**SOLID-STATE  
POCKET RADIO**



**74 sq. in.  
Solid-State  
B&W TV**

tion privileges spelled out. Make your own comparisons, your own decision. Mail card today, or clip coupon if card is missing.

**NO OBLIGATION. NO SALESMAN WILL CALL**  
APPROVED FOR VETERAN TRAINING  
Get facts on new 2-year extension

**NATIONAL TECHNICAL SCHOOLS**  
TECHNICAL-TRADE TRAINING SINCE 1905  
Resident and Home-Study Schools  
4000 So. Figueroa St., Los Angeles, Calif. 90037

**NATIONAL TECHNICAL SCHOOLS** Dept. 205-085  
4000 South Figueroa St., Los Angeles, Calif. 90037  
Please send FREE Color Catalog and Sample Lesson.  
NO OBLIGATION. NO SALESMAN WILL CALL.

<input type="checkbox"/> Color TV Servicing	<input type="checkbox"/> Electronics Technology
<input type="checkbox"/> B & W TV and Radio Servicing	<input type="checkbox"/> Computer Electronics
<input type="checkbox"/> Electronic Communications	<input type="checkbox"/> Basic Electronics
<input type="checkbox"/> FCC License Course	<input type="checkbox"/> Audio Electronics Servicing

NAME \_\_\_\_\_ AGE \_\_\_\_\_  
ADDRESS \_\_\_\_\_ APT # \_\_\_\_\_  
CITY \_\_\_\_\_ STATE \_\_\_\_\_

Please fill in Zip Code for fast service \_\_\_\_\_  
 Check if interested in G.I. Bill information.  
 Check if interested ONLY in classroom training in Los Angeles.

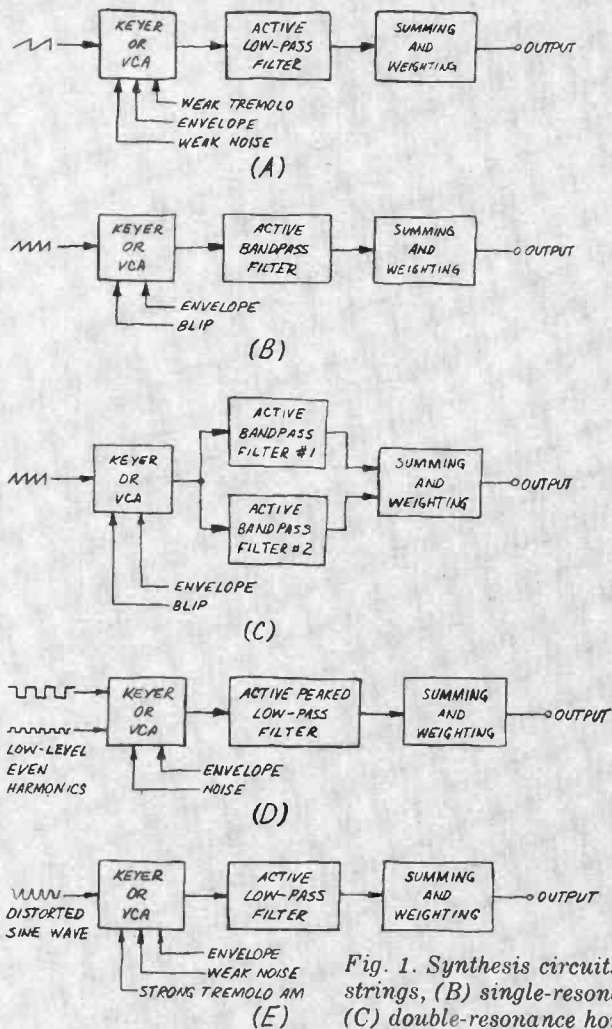

Fig. 1. Synthesis circuits: (A) strings, (B) single-resonance horn, (C) double-resonance horn, (D) woodwind, (E) flute or piccolo.

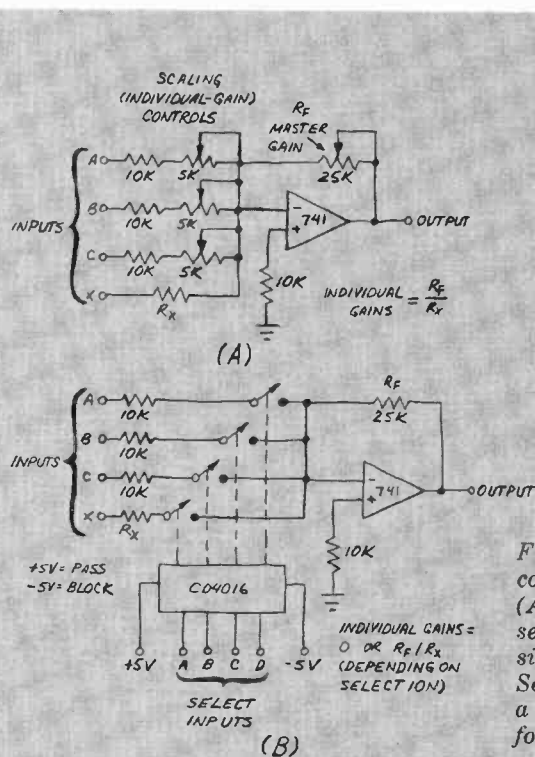

Fig. 2. Mixing and combining voice outputs: (A) Summing and scaling several sources to a single output. (B) Selecting voices with a CMOS analog switch for stops or presets.

job can be done at negligible additional cost. An alternate approach in monophonic instruments is to use a bank of vcf's and shift their parameters as needed to get the desired effect. Multiple or movable filters greatly ease the loudness balancing (scaling) problem from note to note.

One must recognize that instrument sounds are norms and not absolutes. A bass violin sounds quite different when played in a tiled room than it does in a concert hall. It sounds even more different in an anechoic, or acoustically "dead," room. Furthermore, the model and age of the instrument, its quality, the ambient temperature and humidity, mood of the performer, and context in which the instrument is used all combine to produce the final effect of the sound heard.

Finally, successful voicing cannot be accomplished by an engineer alone. Nor can the musician alone do the job properly. It must be done by both people contributing their best efforts.

**Instrument Sound Synthesis.** The accompanying box illustrates some of the characteristics essential to a number of popular traditional musical instruments. Bear in mind that the information given in the box is only a starting point in designing a system capable of realistic instrument voicing.

For most of the instruments listed, you can use a system setup like one of those shown in Fig. 1. In general, start with a sawtooth waveform and pass the signal through a suitable active filter or two. Use similar circuits for each octave or, better yet, each half- or third-octave increment. This permits each portion of the register to be weighted for optimum voicing and volume level. Where a clarinet voice is needed, a square wave or two sawtooths are used as an input. (A fundamental-frequency and minus one-half of the second harmonic-frequency sawtooths can be summed to obtain a square wave. Filtering then takes over.)

You can combine and mix various instrument voices, either in the preset form of the synthesizer or in the stop-tablet form of an electronic organ, with the aid of one of the circuits shown in Fig. 2. The CMOS analog switch in (B) is ideal for voice switching because it draws essentially zero control-line power.

to 2.5 kHz, and a greater negative dB number are desirable.)

A typical figure for an AM transceiver is -6 dB at 6 kHz ( $\pm 3$  kHz) and -40 dB at 20 kHz ( $\pm 10$  kHz). This means that a signal 3 kHz away from the frequency to which the receiver is tuned would have to be 4 times stronger than the desired signal to appear equally strong. At 10 kHz, the unwanted signal would have to be 100 times stronger than the desired one. SSB rigs usually have more selective receivers than AM units, since they must reject signals on the other sideband of the channel being used.

There is a whole group of specs related to selectivity, such as adjacent channel rejection, unwanted sideband suppression, image rejection, etc. Each tells how well the receiver can ignore unwanted signals at frequencies removed from the center of the channel.

A final specification of interest is the receiver audio output, expressed in watts at a given level of distortion. Anything up to 1 watt at 10% distortion will be adequate in most cases. Frequency response is limited to the voice band (500 to 3000 Hz) since that is all the range needed.

**Transmitter.** The primary spec that CB'ers use in judging a transceiver's transmitting section is its *r-f power output*, expressed in watts. Almost all base station transceivers have rated

outputs equal to the 4-watt legal limit. Don't look upon this as absolutely necessary to a good rig, though. You won't be able to hear the difference between two transceivers (other things being equal) if one puts out 3 or 3.5 watts and the other runs 4 watts.

Something that is just as important as the total output is what can be called *undesired products*. This refers to those parts of your transmitted signal at other frequencies than the desired one. They can take the shape of harmonics (high-frequency energies which can get you into trouble with the FCC and/or your neighbors—they are a prime cause of TVI) or in-band components. These signals cause interference to other CB'ers and rob you of usable output. All such undesired products, whether they are called splatter, intermodulation distortion products, harmonic distortion, unwanted sidebands or carrier, or harmonics, should be at least 25 to 50 dB below the level of the desired signal.

*Frequency stability* tells you how close your signal is to where it's supposed to be (the channel center). Almost all rigs are rated a percentage slightly better (lower) than the legal limit of 0.005%. *Modulation percentage* indicates how fully you are putting the carrier to work in conveying intelligence. The optimum figure is 100%, and most rigs will be rated between 90 and 100%. There is no dis-

cernable difference between the two figures. It's important not to go over 100%, however, since overmodulation causes splatter interference to other CB'ers, and even TVI!

**In Conclusion.** Here are some final purchasing considerations. Be sure that the CB rig you buy is *type accepted*. This means that the FCC has approved it for CB service. All transceivers licensed for the first time on or after November 22, 1974 must be type accepted. Those transceivers licensed before this date can be used until November 23, 1978, but must be taken off the air then.

Another area to look into before you buy a rig is its method of frequency generation. If it uses separate crystals for each transmit and receive channel, does it include them for all channels of interest? Sometimes they don't, and it's necessary to shell out roughly \$10 for each additional channel (\$5 for receive, \$5 for transmit crystals). If a frequency synthesizer is used in place of crystals, are all desired channels covered?

Finally, consider the total cost of the rig with all the operating features and conveniences you want—VOX, external speaker (if needed), desk mike, r-f wattmeter, etc. In some cases, these are available only as options, and will raise the final package price considerably. For some, extras are frills; for others, they are most desirable. ♦

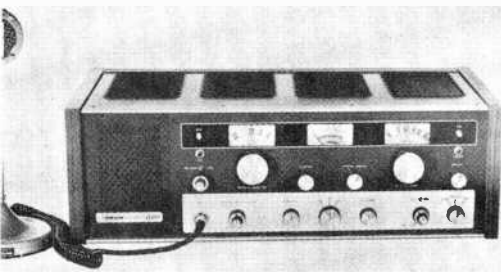

Tram Diamond D201 (AM/SSB)



Regency CR-142 (AM)



JC Penney Pinto 23B (AM)



Dynascan Cobra CAM-89 (AM)



Sonar FS-23 (AM)



SBE Trinidad (AM)



# BASE STATION EQUIPMENT DIRECTORY

Manufacturer and Model	Retail Price (\$)	Dimensions (in.) WxDxH	AM/SSB	Sensitivity ( $\mu$ V at $\frac{1}{2}$ dB S/N)		Selectivity (— dB at $\frac{1}{2}$ KHz)		Adj. Channel Rejection (—dB)	Image Response (—dB)	SSB Carrier Suppression (—dB)	Delta Tune Range ( $\pm$ KHz)	Special Features
				AM	SSB	AM	SSB					
Browning Golden Eagle Mark III SSB/AM	695.00	2 units, each 15.5 x 9.88 x 6.75	Both	0.3 @ 10	0.15 @ 10	70 @ 10	NA	70	56	70	0.7 Tr. 1.5 R.	Spkr. switch, anl, vfo, SWR meter, spot switch, incl. mike.
Dynascan Cobra CAM-89	240.00	13 3/8 x 12 5/8 x 5 3/4	AM	1 NA		6 @ 4 40 @ 20		80	30		1.5	Mike gain, anl, noise blanking, PA, mod. & r-f meters, incl. mike & crystals.
Cobra 135	450.00	13 7/8 x 12 x 5 7/8	Both	0.5 NA	0.25 NA	6 @ 5 50 @ 20		80	50	40	0.6	SWR meter, dig. clock, noise blanking, r-f gain cont., mike gain, incl. mike & crystals.
Cobra 139	395.00	13 3/8 x 12 5/8 x 5 3/4	Both	0.75 NA	0.25 NA	6 @ 4.2 60 @ 7.0		80	50	40	0.6	Sep. mod. & r-f meters, switchable nl, noise blanking, mike gain, r-f gain cont., incl. mike & crystals.
E.F. Johnson Messenger 250	229.95	11 x 9.8 x 5.4	AM	0.5 NA		6 @ 6		50	10			PA, speech compression, S/r-f meter, ext. spkr. provision.
Messenger 132	259.95	13 3/4 x 9 x 5 1/4	AM	0.5 NA		6 @ 6		50	10			Radiotelephone handset, PA, speech compression, S/r-f meter, ext. spkr. provision.
Messenger 124M	339.95	11 x 10 x 5.5	AM	0.5 @ 8		6 @ 7		50	50			Dual receiver for monitoring, 4-way meter, mike gain & nl controls, PA, speech comp.
Fanon/Courier Centurion SSB+	550.00	16 3/4 x 16 x 7 1/4	Both	0.25 @ 10	0.15 @ 10	6 @ 2.5	6 @ 2.1	80	55	55	0.6	S/r-f & VSWR meters, clarifier, dig. clock, PA, noise blanking incl. mike & crystals, ac/dc.
Conqueror II	260.00	15 1/2 x 10 1/4 x 5 1/2	AM	0.5 @ 10		6 @ 3		60	50		1.5	S/r-f meter, PA/CB, dig. clock, anl, incl. mike and crystals, ac/dc.
Caravelle II Fanfare 880	230.00	15 1/2 x 10 1/4 x 5 1/2	AM	0.5 @ 10		6 @ 3		60	50		1.5	S/r-f meter, PA/CB, anl, incl. mike & crystals, ac/dc.



Hy-Gain 623A (AM/SSB)



Lafayette Telsat 925 (AM)

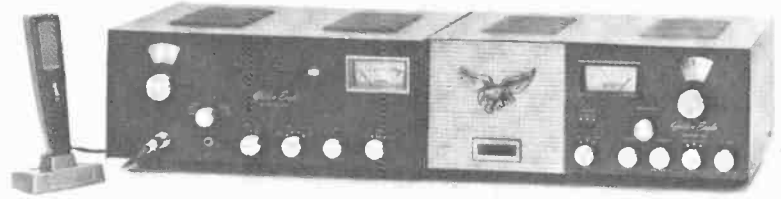

Browning Eagle Mark III (AM/SSB)



Teaberry T-Scout (AM)

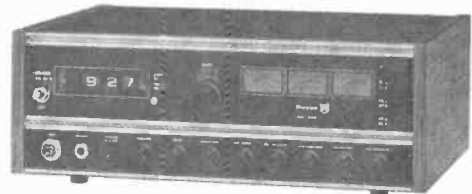

Royce 1-640 (AM/SSB)



Realistic TRC-57 (AM/SSB)



Pace 1000B (AM/SSB)



Pearce-Simpson Pussycat 23 (AM)



E. F. Johnson Messenger 132 (AM)



Kris 23+ (AM)



Fanon/Courier Conqueror II (AM)



Midland 13-887 (AM)



PAL Electronics Roadrunner 23 (AM)

# SPECIAL REPORT ON CB TRANSCEIVERS

Manufacturer and Model	Retail Price (\$)	Dimensions (in.) WxDxH	AM/SSB	Sensitivity ( $\mu$ V at $\mu$ S/N)		Selectivity ( $\mu$ dB at $\pm$ KHz)	Adj. Channel Rejection (-dB)	Image Response (-dB)	SSB Carrier Suppression (-dB)	Delta Tune Range ( $\pm$ KHz)	Special Features
				AM	SSB						
Hy-Gain 623A	595.00	11 13/16 x 11 1/4 x 5	Both	0.5 @ 10*	0.25 @ 10*	6 @ 3.5	60	60	45	0.75	SWR/power/S meter, a-f/r-f gain contrs., noise blanking, anl.
673A	239.95	13 1/4 x 11 x 5	AM	0.7 @ 10*		6 @ 6	50	50		1.5	Anl switch, mike preamp, TVI filter, incl. mike, var. tune.
JC Penney 981-6235	169.95	11 7/16 x 8 11/16 x 3 9/16	AM	0.5 @ 10*		NA	100	NA		1.0	R-f & S meters, anl, phone jack, PA & ext. spkr. jacks, ac/dc, synthesizer.
Pinto 23B	319.95	8 7/8 x 10 1/2 x 2 3/4	Both	0.5 @ 10*	0.1 @ 10*	60 @ 10	80	NA	NA	1.0	S/r-f & mod. meters, anl, PA & ext. spkr jacks, ac/dc, synthesizer.
Kris 23+	259.95	12 x 8 1/4 x 5	AM	0.8 @ 10		6 @ 6	60	75			NA
Ventura	219.95	12 x 8 x 4 1/2	AM	0.5 @ 10		6 @ 5	45	45		1.0	NA
Lafayette Telsat 925	269.95	16 x 9 1/16 x 5	AM	0.7 @ 10		6 @ 6	45	50		1.0	Dig. clock, ch. 9 monitor, headphone or ext. spkr. jack, S/P-r-f meter, incl. crystals & mike.
Telsat 1023	179.95	13 3/16 x 9 7/16 x 5	AM	1.0 @ 10		40 @ 10	40	55		1.0	Range-boost circ., S/P-r-f meter, anl, PA switch, headphone & spkr. jack, dc power jack, incl. crystals & mike.
Comstat-35	199.95	12 x 8 1/4 x 5	AM	0.8 @ 10		6 @ 6	45	50		1.0	Squelch/standby sw, CB/PA sw, headphone or ext. spkr. jack, range boost circ., ac/dc, incl. crystal & mike.
Com-Phone Mark II	229.95	10 1/4 x 10 x 3 1/2	AM	1.0 @ 10		40 @ 10	40	55			Range boost circ., anl, radio telephone handset, PA/CB switch, ext. spkr. jack, ac/dc.
Midland 13-87913	199.95	12 1/8 x 8 5/8 x 4 3/8	AM	0.5 @ 10		6 @ 6	50	NA			S/r-f meter, ext. spkr. jack, incl. crystals & mike, ac/dc.
13-863	244.95	12 1/8 x 8 9/16 x 4 5/16	AM	0.7 @ 10		6 @ 3.5	50	NA		1.0	PA & ext. spkr. jacks, anl, PA/CB switch, ac/dc, S/r-f meter, incl. crystals & mike.

13-887	296.95	16 x 10 x 5	AM	0.7 @ 10	6 @ 7	45	1.0	Dig. clock, S and power/SWR meters, ac/dc, anl, earphone, PA & recording output jacks, incl. crystals and PTT mike.
13-898B	489.95	15 x 10 x 5 1/4	Both	0.5 @ 10	6 @ 7	NA	35	Dig. clock, S and power/SWR meters, ac/dc, anl, PA, r-f gain, incl. crystals.
Pace 1000B	449.95	14 1/4 x 11 x 5	Both	0.5 NA	NA	90	40	PA, noise blanking, r-f gain cont., r-f/SWR/S meter, dig. clock, incl. mike.
CB76	219.95	13 3/4 x 9 x 3 3/4	AM	0.35 @ 10	NA	50	NA	Loc./dist. switch, ext. spkr. jack, S meter incl. mike.
DX2300B	249.95	13 3/4 x 9 x 3 3/4	AM	0.35 @ 10	NA	50	NA	Loc./dist./PA switch, PA & ext. spkr. jacks, S meter.
PAL Electronics Roadrunner 23	189.95	7 x 9 x 2 1/2	AM	1.0 @ 10	6 @ 5	55	45	PA, anl, ext. and PA spkr. jacks, S/power meter, incl. crystals & mike.
Pearce-Simpson Guardian	349.97	11 1/2 x 4 3/4 x 10 1/2	AM	0.4 @ 10*	6 @ 6 60 @ 21	60	70	Ext. spkr. jack, r-f gain & tone conts.
Pussycat 23	179.95	10 3/4 x 3 3/4 x 9 1/4	AM	0.7 @ 10*	6 @ 6	50	50	S/r-f meter, anl, PA & ext. spkr. jacks, ac/dc.
Lynx	209.95	11 5/8 x 4 3/8 x 8	AM	0.5 @ 10*	6 @ 5	50	50	S/r-f/mod. meter, ceramic filter, anl, ac/dc.
Bearcat 23C	319.95	14 7/8 x 5 x 11 1/4	AM	0.5 @ 10*	6 @ 5	50	50	Dig. clock, PA, S/r-f/mod. and SWR meters, noise blanking, ext. spkr., PA and headset jacks, ac/dc.
Super Lynx	269.95	13 3/8 x 5 1/4 x 10 3/4	AM	0.5 @ 10*	6 @ 5	50	50	Dig. clock, anl, ext. spkr., PA and headset jacks, ac/dc.
Bengal SSB	399.95	4 7/8 x 9 7/8 x 12 1/4	Both	0.5 @ 10*	6 @ 5 50 @ 20	50	40	Noise blanking, ext. spkr. and PA jacks, S/r-f/mod. meter, ac/dc.
Simba SSB	529.95	7 3/8 x 12 x 15	Both	0.5 @ 10*	6 @ 5 50 @ 20	50	40	Dig. clock, ext. spkr, PA & headphone jacks, S/r-f/mod. and SWR meters, ac/dc.
Realistic TRC-57	399.95	15 x 10 1/2 x 5 1/4	Both	0.5 @ 10	6 @ 4	60	40	Dig. clock, PLL freq. synth, PA, noise blanking, anl, SWR & r-f meters, PTT mike.
TRC-48	329.95	8 7/8 x 10 1/2 x 2 3/4	Both	0.5 @ 10	6 @ 5	80/100	40	Dual power supply, PA, S/r-f meter, freq. synth.
TRC-55	229.95	14 3/4 x 9 x 5	AM	0.5 @ 10	6 @ 6	55	NA	S/r-f & SWR meters, dig. clock, PA, anl, noise blanking, synthesizer, PTT mike.
TRC-30A	159.95	11 1/2 x 9 x 4	AM	0.5 @ 10	6 @ 6	55	NA	Dual power supply, S/r-f meter, PTT mike, ac/dc, synthesizer.
Regency CR-142	199.00	12 3/8 x 9 3/4 x 5 1/2	AM	0.5 @ 10	6 @ 5.5	50	NA	S/r-f meter, mike gain, anl, PA, ext. spkr. jack, ac/dc, incl. mike.



# SPECIAL REPORT ON CB TRANSCEIVERS

Manufacturer and Model	Retail Price (\$)	Dimensions (in.) WxDxH	AM/SSB	Sensitivity (µV at 1 dB S/N)		Selectivity (dB at ± kHz)		Adj. Channel Reflection (-dB)	Image Response (-dB)	SSB Carrier Suppression (-dB)	Delta Tune Range (± kHz)	Special Features
				AM	SSB	AM	SSB					
CR-123B	399.00	12 13/16 x 9 13/16 x 5 1/2	Both	0.5 @ 10	0.15 @ 10	6 @ 7	6 @ 2.2	50	NA	50	0.6	S/r-f meter, clarifier, mike gain, PA, ext. spkr. jack, ac/dc, incl. mike.
Royce 1-620	199.95	12 x 4 1/2 x 8	AM	0.5 @ 10		6 @ 5		45	40		1.5	S/r-f meter, on-the-air light, mod. light, anl. variable tone, dual powersupply, PA, tape rec. jack, incl. crystals & mike.
1-640	449.95	15 x 4 3/4 x 10 1/2	Both	0.5 @ 10	0.2 @ 10	6 @ 5	6 @ 2.2	70	50	40	0.6	Dig. clock, Tx. light, S/r-f meter, SWR meter, PA, noise blanker, r-f gain, dual power supply, headphone and tape rec. jacks, MOSFET r-f amp.
SBE Trinidad	239.95	17 3/4 x 8 3/4 x 5 3/4	AM	1.0 @ 10		6 @ 2.5 40 @ 10		NA	NA		1.0	S & r-f meters, anl, earphone jack.
Trinidad II	199.95	9 1/2 x 8 3/4 x 3 3/4	AM	1.0 @ 10		6 @ 2.5 40 @ 10		NA	NA			S & r-f meters, PA, ac/dc.
Console II	454.95	12 x 10 1/4 x 5	Both	1.0 @ 10	0.5 @ 15	6 @ 2.0 50 @ 5.5	6 @ 2.4	NA	NA	40		SWR/S & r-f meters, noise blanking.
Console IV	429.95	17 3/4 x 8 3/4 x 5 3/4	Both	1.0 @ 10	0.5 @ 15	6 @ 2.0 50 @ 5.5	6 @ 2.4	NA	NA	40		Clarifier, PA, noise blanking, r-f & SWR/S meters, ext. spkr. jack, anl.
Sonar FS-23	360.00	11 3/4 x 11 3/4 x 5 3/4	AM	0.5 @ 10		10 @ 4		60	50		1.75	Dual power supply, S meter, r-f gain, synthesizer, incl. crystals & mike, two power cords, ac/dc.
Teaberry T-Scout	119.95	7 1/2 x 5 3/4 x 2 1/4	AM	0.5 @ 10		40 @ 10		45	30			S meter, anl, mod. light.
Tram Diamond D201	798.00	29 9/16 x 13 1/2 x 8	Both	0.35 @ 10	0.1 @ 10	6 @ 6	6 @ 2.1	75	80	45	0.8	S/r-f meter, clarifier, tunable receiver, trans. & rec. tone contrs., r-f & mike gain contrs., SWR bridge, incl. crystals & Astatic crystal mike, VOX, noise blanker.

Notes: All have built-in speakers. Most have squelch and agc circuits. NA indicates information not supplied by manufacturer. Asterisk indicates (S+N)/N.

# CB COMMUNICATION RANGE

*Several factors affect the "talk power" you get from your station. Some are under your control, while others depend on surroundings*

BY LEO SANDS

**"H**OW far will I be able to talk?" is the question most often asked by a prospective CB'er, when shopping for equipment. The dealer will usually reply "it depends" since it does depend on a lot of factors he can't control. However, if he knows the neighborhood where you live and you tell him how high your house is, he should be able to make an educated guess.

The hedges regarding the base station include the altitude of your property, density and proximity to vegetation, type of structure on which the antenna can be mounted, and possible interference sources. With a mobile unit, it is the severity of electrical noise generated by the vehicle.

Range is determined by: (1) transmitter output power which is limited by the FCC to 4 watts on AM or 12 watts peak envelope power (pep) on SSB; (2) antenna system gain or loss; (3) effective antenna elevation (eae); (4) proximity to dense vegetation; (5) receiver sensitivity; and (6) noise level in vicinity of antenna.

Signals at 27-MHz travel outward and upward. The outward-going energy reaches somewhat farther than 1.2 times the distance from the antenna to the horizon with strong intensity and farther with reduced intensity. The upward-going energy is wasted except when "skip" conditions prevail. Then the energy is reflected by the ionosphere to points hundreds or thousands of miles away. The signals generated by a 4-watt (output) CB transceiver might be heard only 5 to 25 miles away under normal conditions and thousands of miles away when skip propagation conditions exist. The latter is prohibited by the FCC, limiting communication to 150 miles.

But, it is not the skip range that is important. It's the useful local range which is governed by erp, eae, effective receiver sensitivity (ers), and plane earth propagation loss, terrain loss, and diffraction loss.

**Propagation Losses.** Every radio transmitter sends power through space, but very little of the power reaches the receiver. At a distance of seven miles from the antenna of a 50,000-watt station, the power level at the terminals of a dipole antenna would be 0.5 microwatt. Thus if a CB antenna system radiates 4 watts of power, only 1/100-billionth of it is present at a receiving antenna seven miles away—but it is plenty, considering how sensitive most of the receivers are today.

The plane earth propagation losses for various distances are listed in Table 1 with respect to effective antenna elevation above the earth or surrounding terrain. It can be seen that, as distance is doubled, propagation losses increase 12 dB, which represents a power loss of 16 times. It can also be seen that, when effective antenna elevation is tripled from 30 feet to 90 feet, propagation losses decrease 10 dB. This indicates that power is ten times greater at the same

distances. And, if antenna elevation is increased nine times, from 30 feet to 270 feet, propagation losses decrease 20 db which means a 100 times increase in received power (Fig. 1).

When an antenna extends 20 feet above a 10-foot-high building, its elevation is 30 feet or when an antenna extends 20 feet above a 20-foot-high building on top of a 230-foot-high hill, the elevation is 270 feet.

The figures in Table 1 are approximate and subject to local variations. They include antenna height gain and 10 dB allowance for terrain loss. Table 2 lists the approximate signal levels at the receiving antenna from a station whose effective radiated power is 4 watts, which is equal to +36 dB above 1 milliwatt.

When the propagation losses are only 90 dB (a 1-billion times power loss), received power is down 54 dBm (0.025  $\mu$ W) and the signal voltage level at the terminals of a 50-ohm, unity-gain receiving antenna is 1400  $\mu$ V (all microvolt figures are rounded off). When propagation loss is 140 dB, received signal level is -104 dBm or approximately 1.4 microvolts.

If you are not familiar with decibels, remember 3 dB represents a power ratio of 2, a voltage ratio of 1.4; 10 dB, 10 and 3.16; and 20 dB, 100 and 10. To

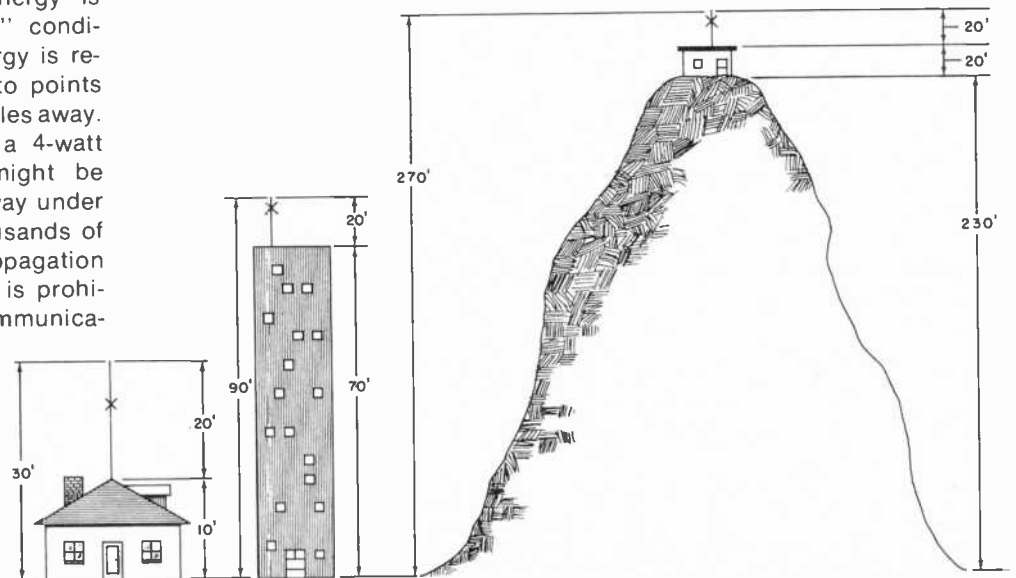

*Fig. 1. Examples of effective antenna elevation for a typical CB base station.*

# Have you ever asked yourself, "Can I make it in Electronics?"

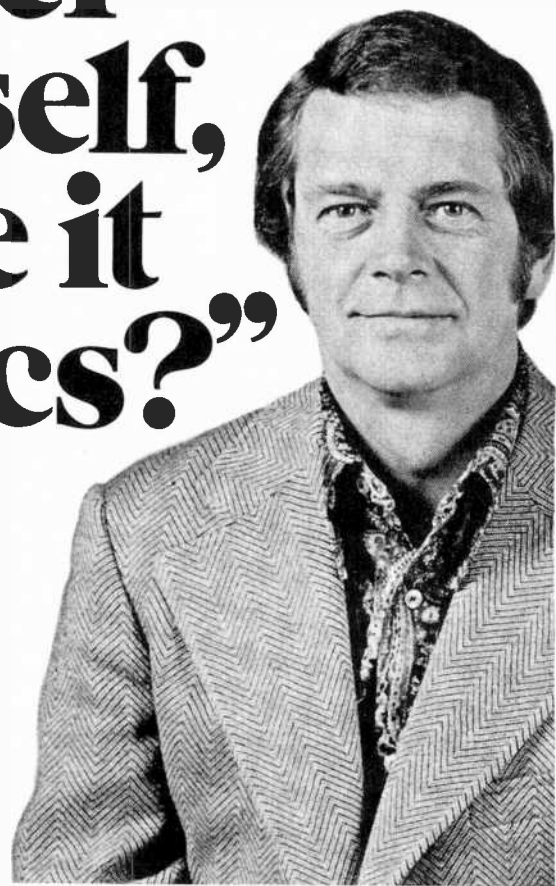

**CIE may be the answer if you have a technical aptitude and a serious desire to get ahead.**

Right now, you're reading a technical magazine with articles that require a certain amount of electronics know-how. And that says a couple of things about you.

First, you're involved in Electronics . . . on the job, or as a hobby.

Second, you obviously realize the importance of staying up-to-date on the latest technical applications and developments. Reading a technical magazine *helps*, but it takes more than that to get you where *you* want to be . . . if you're serious about Electronics.

## **How can you afford**

. . . *not* to continue with your electronics training?

You know the answer to that as well as we do.

To achieve continuing success, you have to keep building more knowledge into the Electronics background and experience you already have. You have to sharpen the tech skills you've already got and add new ones.

And one of the most logical ways for you to get what you need is to seriously consider an in-depth electronics training program that could help you achieve your ambitions in Electronics.

## **How can you afford**

. . . the time and trouble of going back to school?

An excellent and *convenient* way for you to develop and expand your electronics knowledge is to "let the *school* come to *you*."

CIE's independent education plan does just that. Because we can effectively train you with an "education by mail" electronics training program that makes sense. And it makes sense for these reasons:

You can master *career* Electronics without missing one day of work. Without sacrificing one paycheck! Because you study in your free time . . . setting the study pace that best fits your schedule. *You* decide when and where *you* want to study. So you can go right on enjoying your leisure time because there are no *rigid* classroom schedules to be met. *You're* in control!

## **How can you afford**

. . . the expense of the additional education you need?

A lot depends on which CIE course best fits your educational goals and background. We have a variety of electronics courses at beginner, intermediate, and advanced college-level. And there's a convenient payment plan available for every course. But, one way to evaluate your investment in CIE is this . . . you can *graduate* from CIE for about the cost of one year's tuition at some colleges or universities.

## **How can you afford**

. . . to learn Career Electronics from anyone other than an electronics *specialist*?

If you are *serious* about your career in Electronics, you owe it to yourself to investigate *the* home study school that devotes its entire curriculum and instructional efforts to Electronics. That's CIE — Cleveland Institute of Electronics.

We have *specialized exclusively* in Electronics education-by-mail for more than 40 years. Just Electronics. Nothing else. And, the courses we offer today are the result of these years of teaching experience and proven methods of training . . . all based on the expert guidance of our



specialized Electronics Instruction Staff. Our lessons reflect this specialized experience. No frills. No unnecessary fancy stuff. Instruction is thorough . . . designed to meet the demands of electronics employers.

Each CIE course is built on the principle that the best way for you to *learn* and *retain* what you've learned is to *explain*; then to *check* your understanding; then to *reinforce* your comprehension with practical applications. In some courses, you will perform experiments and tests with your CIE Experimental Electronics Laboratory using authentic electronic components and gear. And, if you select a course that includes Color TV technology, you will not only build and keep a big screen Color TV which features digital circuitry . . . you'll also learn how to troubleshoot your TV.

The course you select will be a complete educational program, designed by *experts* to give you the best in Electronics independent home-study education. It will not be a "snap" course. No easy exams. It will make you work . . . and think. So that when you've earned your CIE Diploma, you'll *really* know your stuff.

In education just like in the "real world" of Electronics, your success depends on you and the effort you make. That's a real plus in CIE independent home-study . . . you build a strong foundation of self-discipline. And *that* pays off!

### How can you afford . . . to stop now?

There is a lot more to CIE than this advertisement can tell you. And because you're looking for the *best*, we think it's well worth your while to find out what CIE is

all about. Detailed Courses of Study outlines. In-depth training programs in Electronics Technology, Broadcasting, Industrial, Color TV, Engineering, and 1st Class FCC License preparation. Special CIE Student Services.

All this information is available to you, **FREE**, when you mail the card or coupon to us. For your convenience, we'll try to have a school representative contact you to review the benefits of CIE training and assist in course selection. And as soon as we hear from you, we'll mail a complete package of information, including our school catalog, G. I. Bill details, special FCC License information. All the facts you need to start your Electronics career program with CIE.

**Send TODAY for CIE'S FREE information.**

**CIE** **Cleveland Institute of Electronics, Inc.**  
 1776 East 17th Street, Cleveland, Ohio 44114  
Accredited Member National Home Study Council

Yes, I want your **FREE** school catalog and career information package today. PE-85

I am especially interested in:

<input type="checkbox"/> Electronics Technology	<input type="checkbox"/> Industrial Electronics
<input type="checkbox"/> FCC License Preparation	<input type="checkbox"/> Electronics Engineering
<input type="checkbox"/> Color TV Maintenance	<input type="checkbox"/> Other _____
<input type="checkbox"/> Mobile Communications	_____

Print Name \_\_\_\_\_

Address \_\_\_\_\_ Apt. \_\_\_\_\_

City \_\_\_\_\_

State \_\_\_\_\_ Zip \_\_\_\_\_ Age \_\_\_\_\_

Check box for G.I. Bill information.  Veteran  On Active Duty



use dB, simply add them. For example, 26 dB represents a power ratio of 400 (20 dB = 100, 6 dB = 4,  $100 \times 4 = 400$ ), and a voltage ratio of 20 (20 dB = 10, 6 dB = 2,  $10 \times 2 = 20$ ).

**Antenna Gain.** An antenna can act as an amplifier when it provides "power gain." An omnidirectional antenna compresses the radiated energy toward the earth so that less escapes

satisfactory for runs of 50 feet (20% power loss) to 70 feet (30% power loss). For runs up to 150 feet, use RG-8/U cable and for longer runs, use foam-filled coax which has much lower losses.

### Propagation-Loss Calculations.

Although most CB transceivers have better than 0.5- $\mu$ V sensitivity ratings, noise usually makes it necessary to

sion can be obtained, as in Figure 2B. Low-loss coax should be used.

Many rural residents and farmers living in a valley in hilly country, as in Washington and Oregon, have complained about inadequate CB range. When a hill is within a few hundred feet of the house, the antenna can be mounted there, as shown in Figure 2C. If as much as 1200 feet of coax is required,  $\frac{7}{8}$ -inch foam cable should be

Fig. 2. Examples of base station antenna installations: ((A) directly on house; (B) on adjacent tall structure; (C) on nearby hill with cable supported by poles.

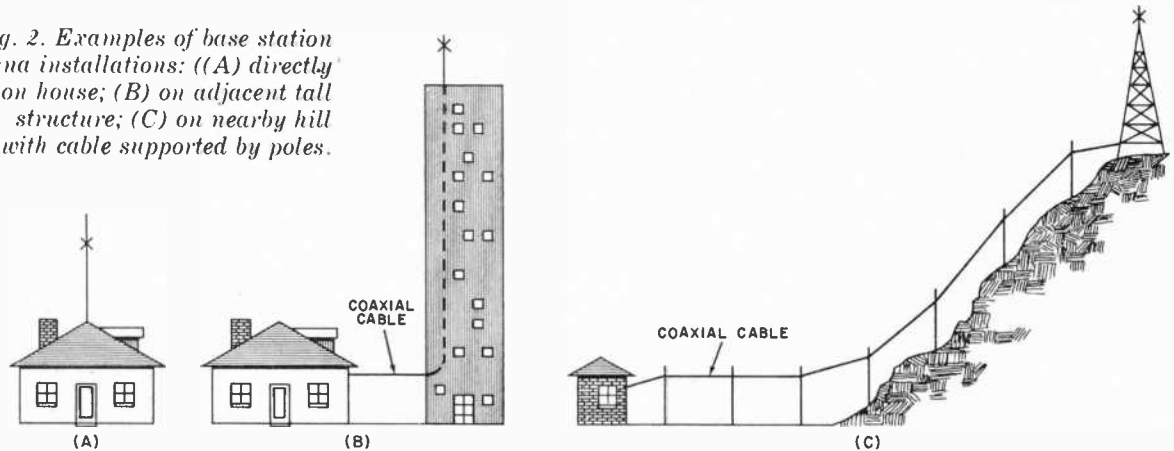

upward and is wasted; a unidirectional antenna compresses the energy in one horizontal direction; while a bi-directional antenna (such as a co-phased pair of omnidirectional antennas) radiates maximum energy toward the front and back or to the sides.

Antenna gain increases erp. If 3.2 watts of energy is applied to and radiated by a unity (0 dB) gain antenna, erp is 3.2 watts. But, if antenna gain is 4 dB, for example, erp is increased 2.5 times to 8 watts, and a 10-dB gain beam will increase erp to 32 watts—legally.

**Transmission Lines.** A CB antenna is fed through a 50-ohm coaxial-cable transmission line. Since coax introduces losses, the full output power of the transmitter does not reach the antenna. If you use 50 feet of RG-58A/U cable, 1 dB loss is caused by the cable. If transmitter output is 4 watts, 80% (3.2 watts) of the power reaches the antenna, a small part (about 4%) of which is reflected back to the transmitter by a well-matched antenna with an SWR rating of 1.5. The antenna absorbs about 3 watts. The coax cable loss can be offset by using a gain-type antenna.

Table 3 lists the losses for various types of coax and the maximum length that can be used in order to limit losses to 1 and 1.5 dB. Type RG-58A/U is

receive much stronger signals. An S9 indication (very strong signal) on an S meter usually indicates that received signal level is 50 or 100  $\mu$ V depending on the reference used by the designer.

Table 4 lists the loss calculations for base-to-base, base-to-mobile and mobile-to-mobile transmission over a distance of 14 miles. These calculations assume a 30-foot base antenna elevation, the use of 4-dB gain base antennas, and unity gain mobile antennas in typical terrain. It can be seen that received signal level is almost 22 times higher for base-to-base communication than for mobile-to-mobile. When a 3.3-microvolt signal is acceptable, it would appear that base-to-mobile range would be more than doubled and base-to-base range more than quadrupled. But, in most cases it wouldn't because at 28 miles and at 56 miles, beyond the radio horizon, absorption losses could be very high.

**Base Antenna Installation.** A base station antenna is usually installed in much the same way as a TV antenna, using the same types of mounting hardware. Most often, the base station antenna is mounted on top or at one end of a house, as shown in Fig. 2A. When a tall building, water tank, or other tall structure is adjacent to the house, the antenna could be mounted on top of the taller structure if permis-

used. It can be supported on wooden poles or buried if it has a polyethylene jacket. Since this cable comes in maximum lengths of 300 feet, splicing connectors must be used.

Although the 2.7-dB loss introduced by 1200 feet of  $\frac{7}{8}$ -inch foam cable will allow only 54% of the transmitter power to reach the antenna, the loss can be made up by using a gain-type antenna.

**Mobile Antennas.** A quarter-wave (approx. 104 inches) stainless steel antenna is an efficient radiator. But, when its mount is attached to the bumper, fender, or cowl of a car, its radiation pattern will be distorted. A much shorter, but less efficient base- or center-loaded whip or helical fiberglass antenna mounted in the center of the car roof will usually work better since the car body won't distort the radiation pattern.

**Noise Affects Range.** Communicating range can be seriously affected by ignition noise (a popping sound), even at base stations. The electrical noise generated by a car can often be picked up by a CB rig more than 100 feet away. If your home is close to a street, you can minimize ignition noise pickup by installing your antenna as far from the street as feasible—like on the garage at the back.

**TABLE 1—PROPAGATION LOSSES**

Distance (miles)	Effective Antenna Elevation		
	(30 ft)	(90 ft)	(270 ft)
7	110 dB	100 dB	90 dB
14	122 dB	112 dB	102 dB
28	134 dB	124 dB	114 dB

**TABLE 3—CABLE ATTENUATION LOSSES**

Cable Type	dB/100 ft
RG-58A/U	2.2
RG-58 foam	1.7
RG-8/A-AU	0.98
RG-8 foam	0.90

**TABLE 2—RECEIVED SIGNAL LEVELS  
(4-W ERP)**

Propagation (loss in dB)	Level at Receiving Antenna	
	(dBm)	(microvolts)
90	- 54	1400
100	- 64	440
110	- 74	140
120	- 84	44
130	- 94	14
140	-104	4

**TABLE 4—TYPICAL LOSS CALCULATIONS**

	Base-to-Base	Base-to-Mobile	Mobile-to-Mobile
Transmitter output (4 W)	+36 dBm	+36 dBm	+36 dBm
Coaxial cable loss	(- 1 dB)	(- 1 dB)	(- 0.4 dB)
Antenna gain	+4 dB	+4 dB	0
Eff. radiated power (8 W)	+39 dBm	+39 dBm	+35.6 dBm
Propagation loss (14 miles)	(- 122 dB)	(- 122 dB)	(- 122 dB)
Antenna height gain (30 ft)	+20 dB	+10 dB	0
Terrain factor loss	(- 10 dB)	(- 10 dB)	(- 10 dB)
Power at receiving antenna	- 73 dBm	- 83 dBm	- 96.4 dBm
Receiving antenna gain	+4 dB	0	0
Coaxial cable loss	(- 1 dB)	(- 0.4 dB)	(- 0.4 dB)
Power at receiver input	- 70 dBm	- 83.4 dBm	- 96.8 dBm
Voltage at receiver input	71.2 $\mu$ V	15.2 $\mu$ V	3.3 $\mu$ V

At a base station, interference can be caused by a nearby TV set, fluorescent lamps, sewing-machine motors, aquarium heaters, thermostats, and other electrical devices with moving contacts. To avoid radiated interference, place the transceiver as far as possible from appliances, particularly TV sets, and not under a fluorescent light fixture. Connect a powerline filter between the ac outlet and the offending appliance. To minimize feed-through from the power line to the transceiver, install a line filter in series with the power cord and to the nearest earth ground.

**Transmitter-Caused Interference.** If a nearby CB'er's transmis-

sions can be heard when your rig is not set to the channel on which he or she is transmitting, your antennas may be too close together. Move yours farther away and place it higher or lower than the other antenna. Although modern CB rigs are usually very selective, don't expect to escape channel bleedover when another CB'er pumps thousands of microvolts into your antenna.

When another CB'er or a ham can be heard on all channels, or your receiver is so desensitized that you can't use it, chances are that the CB'er (unlawfully) or ham (lawfully) is using a high-power linear amplifier. If it is the CB'er, the FCC should be happy to hear about it.

On the other hand, if your receiver is desensitized by a nearby FM or TV broadcast station or land-mobile system FM base station, install a low-pass filter between the antenna connector of the transceiver and the antenna transmission line.

**Summary.** Transmitting range depends on effective radiated power, effective antenna elevation, and modulation level. Receiving range depends on effective receiver sensitivity, which is affected by antenna gain and capture area, noise level, and nearness to other transmitters which might or might not desensitize the receiver. Range, either way, is affected by power-source voltage. ♦

# Listen to your Heart with Doppler Ultrasound

*Ultrasonic stethoscope lets you hear snapping  
of heart valves and blood-flow sounds.*

BY JOSEPH JAFFE

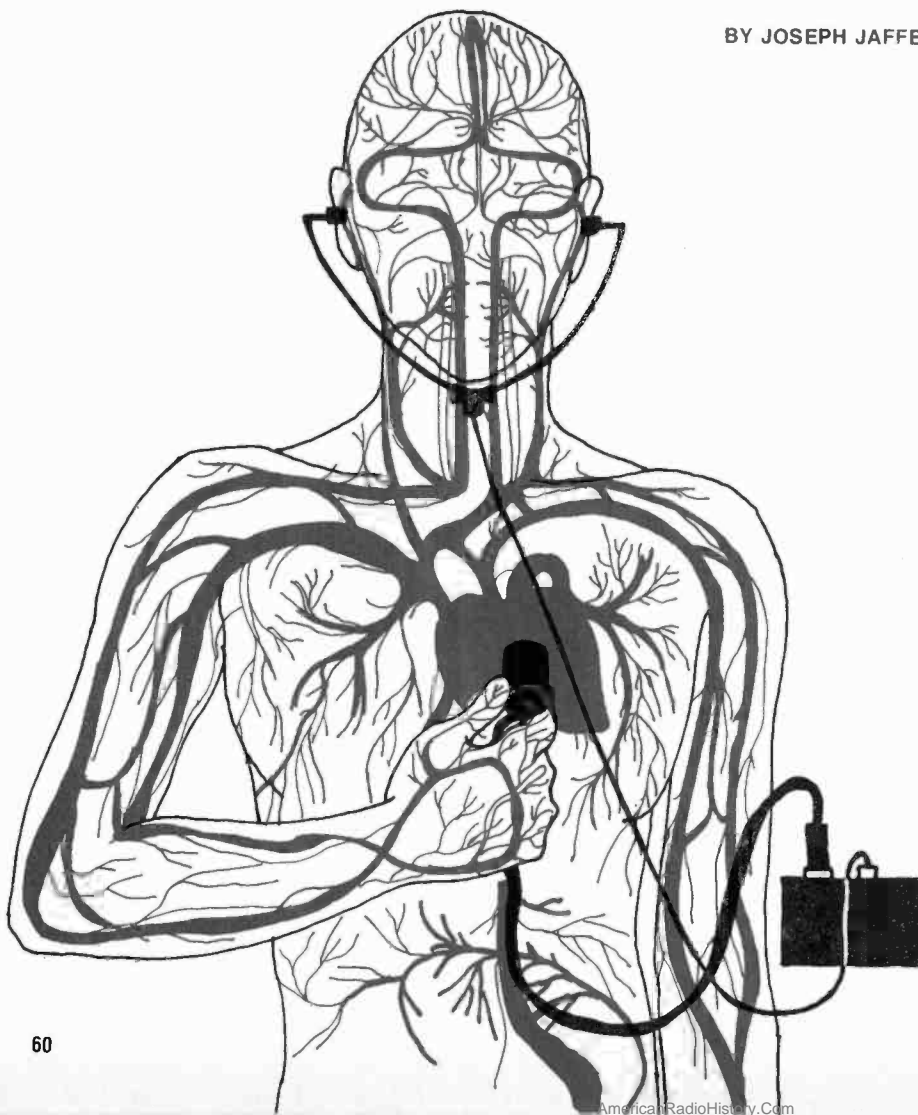

**A**BOUT 15 years ago, it was discovered that, when ultrasonic energy in the low-megahertz range is beamed into the body, the energy is reflected back to the surface by certain internal structures. If the structures move, the frequency of the reflected energy is changed in proportion to the velocity of the movement due to the Doppler effect. Development of this principle has given the medical profession a valuable and completely harmless tool for the noninvasive examination of movements inside the body—especially of the heart, its valves, and the flow of blood within the heart. All of the movements cause characteristic sounds which can be heard with the aid of an easily constructed ultrasonic stethoscope.

The basic elements in the stethoscope are two lead zirconate-lead titanate piezoelectric crystals. One of the crystals is energized by a signal from a 2-MHz oscillator so that it expands and contracts setting up pressure or sound waves that are transmitted into the body. When this wave (which is very directional) passes from one medium to another in the body, a portion is reflected back to the second crystal, which generates an electrical signal. If the reflecting surface is stationary, the signal generated in the receiving crystal is 2 MHz. If the reflecting surface is moving away from the transducer, the frequency is lower than the transmitted wave. Similarly, if the surface is moving toward the transducer, the reflected frequency is higher. By mixing a portion of the transmitted frequency with the received frequency and detecting the difference, we get a frequency in the audio range that is proportional to the velocity of the reflecting surface.

**Circuit Operation.** In the transmitter circuit (Fig. 1) *Q1* operates as a 2-MHz oscillator. Positive feedback is

**Editor's Note.** Experiments have shown that beaming high-frequency sound into the body is not harmful. The technique has even been used successfully in listening to the hearts of unborn babies in the mothers' wombs.

It should be remembered, however, that this project is for experimentation and entertainment. Do not attempt to interpret the sounds diagnostically for yourself or for others. Only a physician can do this by correlating the sounds with other medical information.

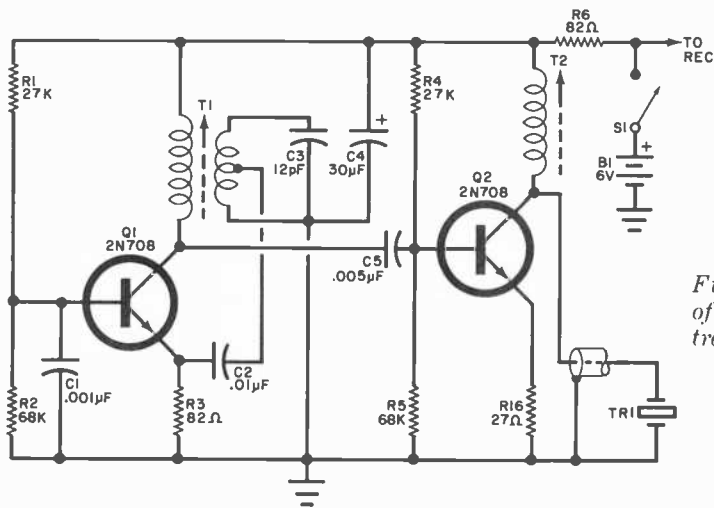

Fig. 1. Schematic of the stethoscope transmitter circuit.

### PARTS LIST

- B1—6-volt battery (4 AA cells)
  - C1—0.001- $\mu$ F polystyrene capacitor
  - C2, C6, C13, C14—0.01- $\mu$ F polystyrene capacitor
  - C3—12-pF ceramic disc capacitor
  - C4, C15—30- $\mu$ F, 15-V electrolytic capacitor
  - C5, C8—0.005- $\mu$ F polystyrene capacitor
  - C7, C9, C11—0.05- $\mu$ F polystyrene capacitor
  - C10—0.04- $\mu$ F polystyrene capacitor
  - C12—10- $\mu$ F, 15-V electrolytic capacitor
  - D1—Diode (1N295 or 1N4148)
  - IC1—Audio amplifier (RCA CA3020)
  - J1—Phone jack
  - Q1 to Q3—Transistor (2N708, 2N5134)
  - Unless otherwise noted, following are 1/4-watt, 10% resistors:
  - R1, R4—27,000 ohms
  - R2, R5—68,000 ohms
  - R3, R6, R9—82 ohms
  - R7—33,000 ohms
  - R8—10,000 ohms
  - R10—100,000 ohms
  - R11—680,000 ohms
  - R12 to R14—4700 ohms
  - R15—10,000-ohm potentiometer
  - R16—27 ohms
  - S1—Spst switch (on R15)
  - T1 to T4—Transformer (Lafayette #99-6300)
  - TR1, TR2—PZT-5 Vernitron Piezoelectric 16035 disc (see text and note)
  - Misc.—2-conductor individually spiral-shielded cable, plastic or metal tube (1/4" ID  $\times$  2"), cork or foam, epoxy, silver-bearing solder, Telex HMY-2 or #799 2000-ohm headset, knob, mounting hardware, etc.
- Note—The following are available from Products and Processes, P.O. Box 380066, Miami, FL 33138: PZT-5 disc at \$22, complete transducer and cable at \$49.50, pc board at \$4.50, cassette recorded with typical sounds at \$2.50. All prices postpaid. Florida residents please include 4% sales tax.

provided from the secondary of *T1* through *C2*. The frequency is determined by the value of *C3* and the tuning of *T1*. The oscillator is coupled through *C5* to *Q2*, an amplifier whose output is tuned by *T2*. The amplified signal is then coupled to the transmitter transducer *TR1* through a length of shielded cable. The transmitter generates about 25 milliwatts per square centimeter of transducer surface.

In the receiver (Fig 2), the voltage generated across *TR2* by the reflected ultrasonic signal is coupled to *Q3*, a tuned amplifier with a gain of approximately 300. The signal is detected by *D1*. Though it might appear that an FM detector would be used here, the AM detector provides better sensitivity and is simpler to construct. It also requires no alignment. Amplitude detection can be used because a portion of the transmitted pressure wave is directly coupled to the receiver transducer at the surface of the body. The mixing of the direct wave with the reflected wave causes amplitude modulation at a frequency determined by the Doppler effect.

The detected audio signal is amplified by *IC1*.

**Construction.** The circuits are assembled on a single pc board, using the foil pattern and component installation shown in Fig. 3. Since *IC1* is in a round, TO-type package, you must bend its leads to conform to the in-line pads on the board.

Construction of the transducer assembly is shown in Fig. 4. The two transducers are made by carefully cutting in half a 1-inch diameter PZT crystal (1/32" thick) to make two D-shaped devices. Fine wire, such as #36 or smaller, should be soldered to each side of the crystal using silver-bearing solder to avoid lifting the silver electrode. Use a low-power soldering iron (25 W or less) and a minimum of solder.

Maximum efficiency of power conversion is achieved when the transducers are "air-backed" so that most of the ultrasonic energy is radiated from the front of the crystal. Most of the ultrasonic energy reaching the air-backed surface is reflected to the front because of the poor acoustic matching. As shown in Fig. 4, a porous material such as cork or foam is suitable for mounting the crystals to achieve the air backing. The two crystals are secured to the backing material with small amounts of adhesive, with the two flat edges of the D shapes about 1/16" apart. The thin wires soldered to the crystals are threaded through the backing material.

A 4' or 5' length of two-conductor, individually shielded cable is soldered to the thin wires, making sure the solder joints don't touch any other connection or metal. The entire assembly is then encapsulated with epoxy. The active faces of the transducers should

Fig. 2. Receiver uses the same type of transducer as the transmitter.

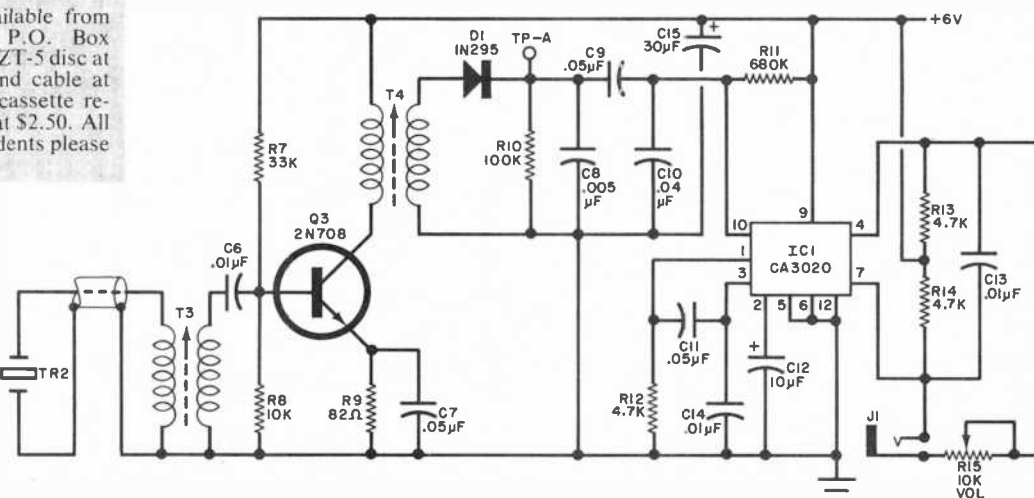



be slightly below the edge of the tube and covered with epoxy for insulation. Be sure there are no air bubbles in this coating.

Connect the transducer cable to the pc board as shown in Fig. 3, with each shield connected to ground.

The pc board and batteries, with S1, R15 and J1, can be mounted in any suitable enclosure.

When assembly is complete and the circuit is energized, you should hear a low-level hiss coming from the stethoscope. Connect a 20,000-ohms/volt meter across the diode load resistor (test point A to ground) and tune the oscillator transformer (T1) and amplifier transformer (T4) for maximum voltage. If you don't have a voltmeter, fill a water glass half full and immerse the transducer about one inch into the water. Keeping the face of the transducer under water, oscillate it rapidly up and down, listening for the Doppler effect as the sound is reflected from the bottom of the glass. Tune the transformers for maximum volume and best signal-to-noise ratio.

**Testing and Use.** To get good results, the acoustical impedance of the transducer must be matched to that of the body so that the pressure waves are transmitted into the body rather than reflected back at the skin surface. To obtain an impedance match, use a liquid or a liquid-gel between the transducer and the skin. Water, olive oil, or mineral oil will work; but better results will be obtained with a liquid-gel such as Aquasonic or Sonigel, which are specifically made for this purpose and are available in medical supply stores.

Apply a small amount of liquid or liquid-gel to the active transducer surface and place the transducer firmly against the bare chest several inches to the left of center and about 10 inches below the shoulder (Fig. 5). Place the transducer so that the ultrasonic beam passes between two ribs, for best transmission. You should be able to hear the movement of the heart. Remember that, as you change the direction in which the transducer faces (always keeping it firmly against the chest), the sounds you hear will change, depending on what surfaces are in the path of the beam. When you take a deep breath, the sound may disappear because the lung fills with air, covering a portion of the heart; and air is a poor conductor of high-frequency sound.

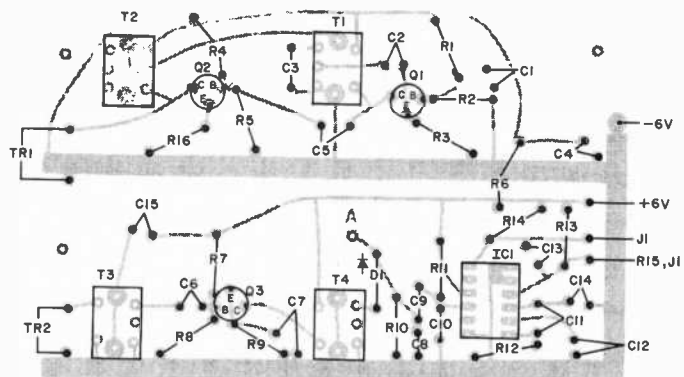
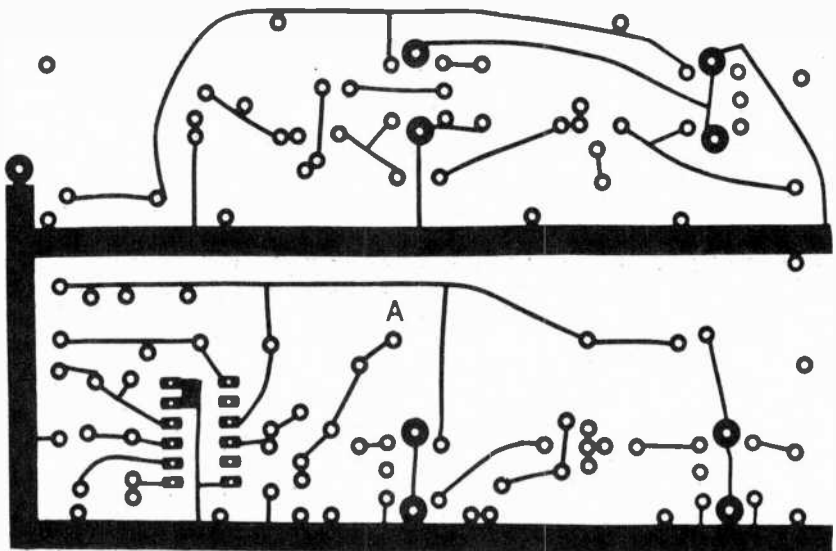

Fig. 3. Etching and drilling guide for printed circuit board is at top. Component layout below.

Typical sounds are the low-pitched "harrumph-oomph" of the heart wall, the snapping sounds of the heart valves, and the "shushing" of blood flow. These sounds occur briefly during each heart beat, and you will quickly learn to recognize the distinctive sounds. You will be able to study the effects of slow or fast breathing on your heart rate, as well as the effect of exercise.

If you are interested in biofeedback training, you may want to try to control your heart rate by meditation or other

means. You will be able to hear the changes if you are successful.

Because there is attenuation of the sound wave as it passes through the body, those with a heavy build may find it necessary to try alternate body positions to bring the heart closer to the chest wall and the transducer. Two suggested positions are lying on the left side or leaning forward in a sitting position.

After you have successfully heard the Doppler sounds in one area, you can move the transducer to other

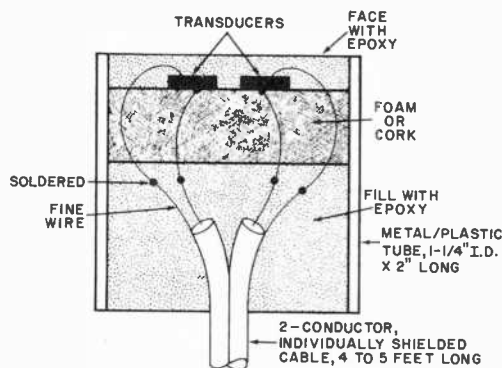

Fig. 4. Diagram shows how to assemble transducers for transmitter and receiver in stethoscope.



Fig. 5. To hear heart sounds, place the transducer about 10 inches below shoulder

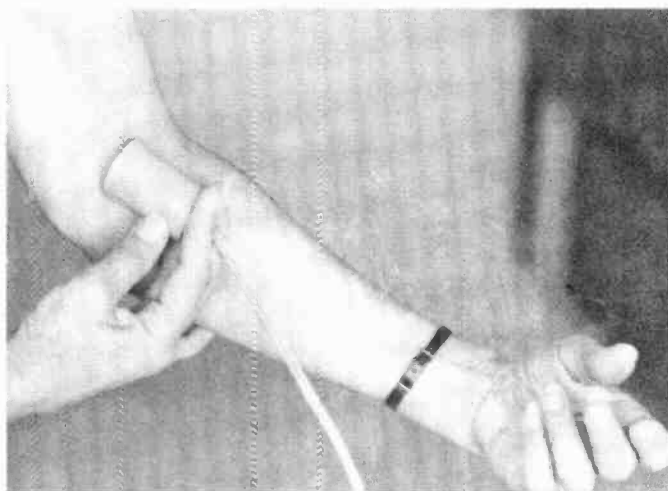

Fig. 6. To hear blood in arm vein, the transducer must point up toward shoulder.

areas to compare the sounds. Rocking the transducer back and forth in one position will also change the sound as the direction of the beam changes. This helps bring in the valve and blood-flow sounds. If loud scratchy sounds are heard when moving the transducer around, turn off the stethoscope while moving it.

It is sometimes possible to hear the flow of blood in the main (brachial) artery in the arm along the inside of the elbow (Fig. 6). In this case, the transducer is not placed flat against the arm but is oriented so that the beam points along the arm in the direction of the blood flow (toward the shoulder). The beam is then reflected

from the red blood cells; and when you have located the artery correctly, you will hear a short "pshhh" sound with each heart beat. For this experiment, use enough liquid-gel to fill the space between the tilted transducer face and the arm. It will also be necessary to use an external amplifier and speaker to get better sensitivity. ♦

## BUILD YOURSELF A SPEAKER SYSTEM AND SAVE!

You know specs, but you want speakers to speak for themselves. CTS speakers do; they sound just the way you like. For example, choose a CTS STARRSÖND™ system. Let CTS dealer/consultants tell you how to install it in an ideal enclosure. You'll know why many famous manufacturers use CTS speakers in their brand-name products! Write, send coupon or circle reader service number for our catalog on speakers for home, musical instruments, auto and other uses. Then visit your CTS dealer and hear them:

**The ones that speak for themselves.**  
**CTS OF PADUCAH, INC.**  
SUBSIDIARY OF CTS CORPORATION, ELKHART, INDIANA

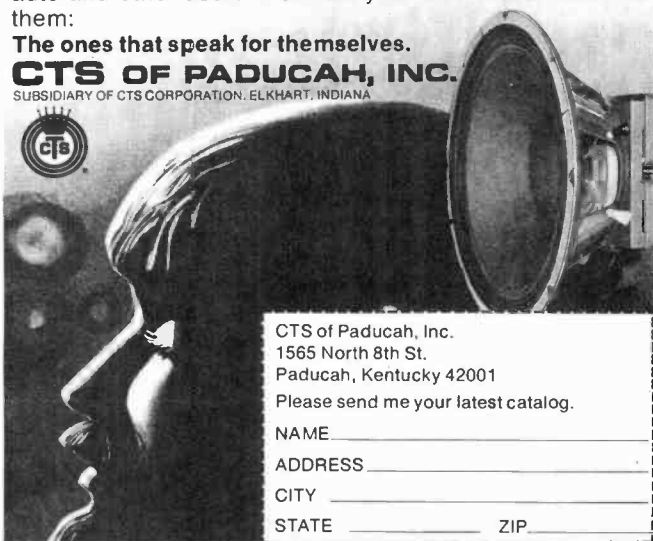

CTS of Paducah, Inc.  
 1565 North 8th St.  
 Paducah, Kentucky 42001  
 Please send me your latest catalog.  
 NAME \_\_\_\_\_  
 ADDRESS \_\_\_\_\_  
 CITY \_\_\_\_\_  
 STATE \_\_\_\_\_ ZIP \_\_\_\_\_

# FREE



## 1975

CATALOG  
 OF  
 CIRCUIT  
 DESIGN  
 AND  
 BREADBOARDING  
 EQUIPMENT

Send for your free copy of Circuit Design's new 1975 catalog. In it, you'll find lots of new ideas in solderless breadboarding aids and instrumentation (in kit form or assembled), as well as a host of hard to find components. If you are involved in any aspect of electronics, you can't do without it.

For your free copy, write to:

**CIRCUIT DESIGN, INC.**

Div. of E&L Instruments  
 P.O. Box 24 · Shelton Connecticut 06484



# Product Test Reports

## ABOUT THIS MONTH'S HI-FI REPORTS

*This month we are reporting on two products that provide top value for the buyer's money. Sherwood's S-7310 stereo receiver, for example, is a well-conceived, competently engineered unit where even the AM tuner section performs exceptionally well. It clearly offers better than average performance at a moderate price.*

*Another long-established company, Stanton Magnetics, has revived (with modifications) a unique single-play manual turntable and tonearm which they first introduced several years ago. Supplied with its excellent 681EEE calibrated cartridge, the new Stanton 8004 stereo record player (a four-channel version is also available) eliminates all the problems often associated with record player installations. The integrated system enables one to just plug it in and use it.*

—Julian D. Hirsch

## SHERWOOD MODEL S-7310 AM/STEREO FM RECEIVER

*High performance, medium power, has simulated 4-channel sound.*

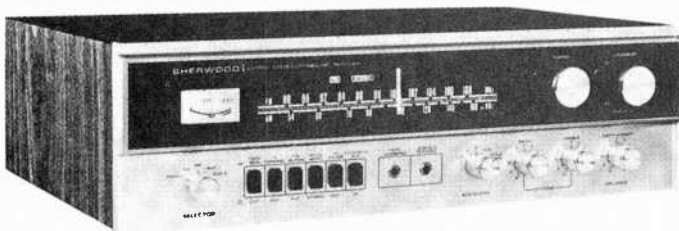

Some of today's better medium-priced stereo receivers offer a high level of

performance and operating flexibility. The Sherwood Model S-7310 is an excellent example of such a receiver. Its FM tuner section employs a state-of-the-art phase-locked-loop (PLL) integrated circuit for stereo demodulation with outstanding channel separation and low distortion. Another IC is used in the final i-f-amplifier/limiter section of the FM tuner. Four transistors and nine diodes are used in the interstation muting system to provide a smooth, noise-free transition between the system's on and off states.

Built into the AM/stereo FM receiver is a Dynaquad ambience-recovery system that derives the rear-channel signals from two-channel sources for a simulated 4-channel sound. There is

also a 4CH FM output jack on the receiver's rear apron for use with a discrete quadraphonic FM decoding system should the FCC approve this scheme in the future.

The receiver measures 17½"W × 13¼"D × 5¼"H (44.5 × 33.7 × 13.3 cm) and weighs 24 pounds (10.9 kg). It comes in a wooden walnut-finished cabinet and retails for \$369.95.

**General Description.** The receiver's direct-coupled audio amplifier system is rated at 38 watts/channel continuous output power into 8-ohm loads over a frequency range of 20 Hz to 20,000 Hz and with less than 0.5% harmonic and IM distortion. The preamplifier section has inputs for the receiver's AM and FM tuners, a magnetic phono cartridge, and two high-level Aux sources. There are also two sets of tape recording input/output jacks, with monitoring pro-

visions, although one set is labelled as 4 CHANNEL and is suggested for use with an external quadraphonic adapter if the system is to be converted to 4-channel operation.

The outputs of the power amplifiers can be switched to either of two pairs of speaker systems or to both pairs simultaneously, and can be shut off for private headphone listening. In the DYNAQUAD mode, the second pair of speaker systems (they should be located in the rear of the listening room) is connected into the system in the ambience-recovery scheme for simulated 4-channel sound reproduction with stereo program sources.

The tuning dial occupies the upper portion of the front panel, along with a single tuning meter and large TUNING and LOUDNESS control knobs. The window is faced with a filter that blacks out the logging scales and meters when the receiver is switched off or is on and neither tuner section is being used. The meter operates as a zero-center indicator for FM tuning and a peak indicator for AM tuning.

All remaining controls and switches are located along the lower portion of the front panel. Six pushbuttons are for switching in and out the TAPE MON, 4 CHANNEL (or second tape monitoring system), FM MUTING, MONO/STEREO mode, HI FILTER, and LOUDNESS compensation.

Two jacks on the front panel are labelled HEADPHONE and TAPE DUBBING. The latter jack duplicates the functions of the rear-apron tape recorder inputs and outputs.

All remaining inputs and outputs are located on the rear apron of the receiver. Also included is an external AM antenna input, as well as a hinged and pivoted ferrite-rod AM antenna.

**Laboratory Measurements.** The audio amplifiers in the receiver surpassed all of their published specifications by a wide margin. At the rated output of 38 watts/channel into 8 ohms, the THD was less than 0.1% from 20 to 20,000 Hz. Below 1000 Hz, where the THD measurements included small amounts of power supply ripple, our instrument readings were typically about 0.05% at full power, half power, and one-tenth power. When we used a filter in the distortion analyzer to remove the power frequency components, the THD above 1000 Hz measured between 0.01% and 0.02% up to about 10,000 Hz and 0.05% to 0.1% 10 to 20 kHz.

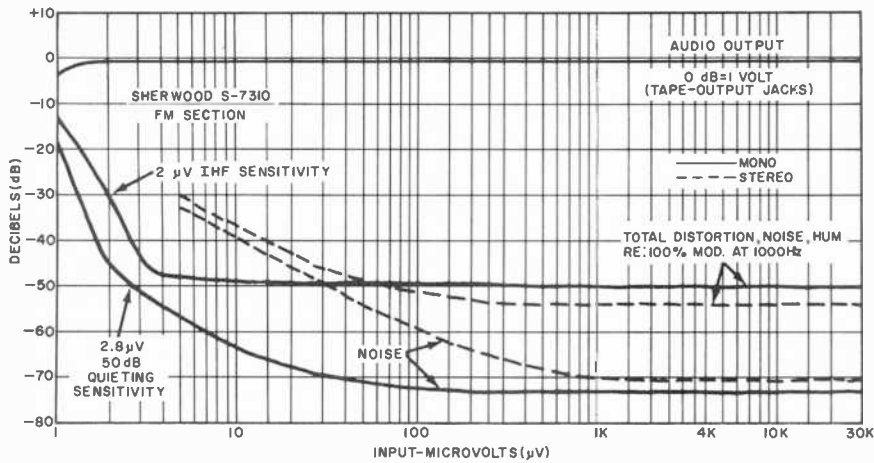

The 1000-Hz THD was below the receiver's noise level until the output power reached 10 watts, where it measured 0.01%. It was only 0.02% at 45 watts. (The output clipped at 46 watts.) The IM distortion was about 0.05% at 0.1 watt, decreased to 0.02% between 5 and 10 watts, and measured 0.06% at 50 watts.

Into 4- and 16-ohm loads, the 1000-Hz clipping power was 52.6 and 29.4 watts, respectively. The IM distortion at very low power levels remained less than 0.1% down to about 20 mW and rose to 0.47% at about 1.3 mW.

The amplifiers required an input of 76 mV on AUX and 0.9 mV on PHONO to produce a 10-watt reference output power. The respective noise levels measured -86 and -73.5 dB. The phono input overloaded at a very good 95 mV. The tone controls had an exceedingly wide range, considerably exceeding the rated  $\pm 10$  dB. At 30Hz, for example, a boost or cut exceeding 20 dB was available, while at 20,000 Hz, the range was  $\pm 15$  dB.

The loudness compensation circuit boosted only the low frequencies as the volume setting was reduced. The

HI FILTER had a 6-dB/octave slope, with the -3-dB point at 5000 Hz. The RIAA phono equalization was as accurate as our test instruments can measure, varying by less than 0.25 dB from 20 to 20,000 Hz. The equalization was virtually unaffected by cartridge inductance, with a response change of less

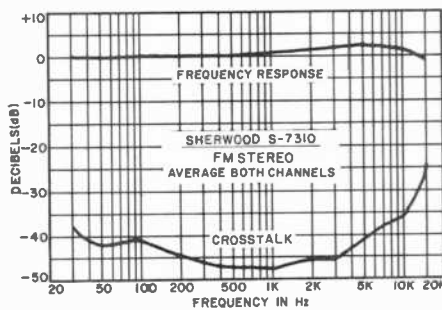

than 1 dB in the range between 10,000 and 20,000 Hz.

The FM tuner had an IHF usable sensitivity of 2.0  $\mu$ V in mono, with 50 dB of quieting achieved at a very low 2.8  $\mu$ V. The muting and automatic stereo switching thresholds were essentially the same at about 4.5  $\mu$ V. In stereo, the usable sensitivity was 5  $\mu$ V

and the 50-dB quieting sensitivity was 32  $\mu$ V. The ultimate quieting was very good in both modes, measuring 72.5 dB in mono and 70 dB in stereo. FM distortion was 0.32% in mono and, at 0.2%, was surprisingly lower in stereo.

The FM capture ratio was 1.8 dB at 1000  $\mu$ V. AM rejection was a very good 64 dB, and image rejection was 73 dB. The alternate-channel selectivity, which was essentially the same above and below the signal frequency (unlike most tuners), measured 68 dB. The 19-kHz pilot carrier leakage into the audio outputs was 59 dB below 100% modulation.

The stereo FM response was  $\pm 1.8$  dB from 30 to 15,000 Hz, with a slightly elevated output between 2000 and 10,000 Hz. Channel separation was better than 40 dB from 35 to 6000 Hz and was about 48 dB throughout much of the midrange. It reduced to 24.5 dB at 15,000 Hz. The AM frequency response was relatively flat throughout its useful range. It was down 6 dB at 30 and 4500 Hz.

**User Comment.** The performance of the audio section of this receiver speaks for itself. Except for greater output power, it is difficult to imagine how the audio section could be improved upon without a very large increase in price. Similarly, the FM tuner cannot be surpassed in most respects without a substantial increase in price.

The dial scales on this receiver, in spite of being calibrated at unusually wide 2-MHz intervals, are so linear and accurate that one has no difficulty in interpolating readings and pre-tuning to any desired channel.

The receiver's FM muting is completely free of noise bursts. Even the AM tuner, about which there's generally little to say because most man-

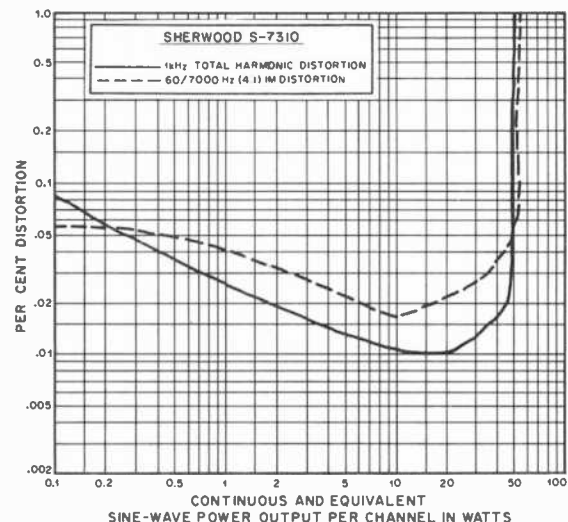
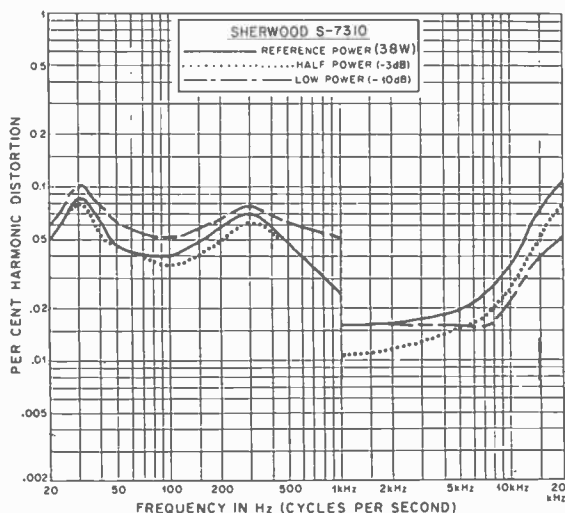



ufacturers skimp in this area, had a dead-silent background, low distortion, and excellent overall quality.

Finally, the Dynaquad feature gives as pleasing a 4-channel effect as any

quadraphonic receiver with a *basic* matrix decoder.

In conclusion, the Sherwood Model S-7310 is an excellent receiver that is demonstrably better than the vast ma-

majority of lower-priced receivers and, in many respects, the peer of a number of deluxe stereo units costing substantially more.

CIRCLE NO. 65 ON READER SERVICE CARD

## STANTON MODEL 8004-II RECORD PLAYING SYSTEM

*Single-play, belt-driven manual with arm and cartridge.*



The Stanton "Gyropoise", Model 8004 record playing system consists of a

two-speed belt-driven turntable, low-mass tonearm, and high-quality cartridge. The whole is set into a wood base that has a removable hinged plastic dust cover. The system comes completely assembled and ready for playing discs.

The Model 8004 record playing system is available in two forms. The Model 8004-II (which we tested) for stereo records is fitted with a Stanton TT681 cartridge, while the Model 8004-IV for discrete 4-channel records has a Stanton TT-780 cartridge.

The record playing system measures 14 $\frac{3}{4}$ "W x 13"D x 7"H (37.5 x 33 x 17.8 cm) with dust cover in place and weighs 10 $\frac{3}{4}$  pounds (4.9 kg). It retails for \$199.95 as the Model 8004-II and \$224.95 as the Model 8004-IV.

**General Description.** The turntable platter is driven by a low-speed (300-rpm), 24-pole synchronous motor. The operating speeds are 33 $\frac{1}{3}$  and 45 rpm, selected by a control that shifts the neoprene belt from a pulley of one diameter to a pulley of another diameter. The nonferrous cast platter, weighing 2 $\frac{3}{4}$  pounds (1.25 kg), is supported vertically by the magnetic repulsion that exists between two ring magnets, one of which is on the rotating platter and the other on the cast T bar that links the tonearm with the

turntable. The entire tonearm / turntable structure, in turn, "floats" on a soft suspension from the mounting plate, to which the motor is rigidly fastened for isolation.

The "Unipoise" tonearm is pivoted on a single point bearing. The cartridge plugs into a slim plastic shell that is fixed to the tonearm's tubular body. The finger lift extends upward from the cartridge shell instead of to the right side of the shell as is the case with most tonearm assemblies.

The tonearm is balanced by a counterweight. The desired tracking force is user set by sliding a small weight on the arm's tube. Tracking-force calibration marks are at 0.5-g intervals that cover a range of 0 to 4 grams. The anti-skating adjustment ring around the base of the tonearm support has separate scales for conical and elliptical styli.

The system is controlled by three sliding plastic plates located on the motorboard. At the left front is the speed selector. It should be operated only when the turntable is stationary. To the right of the platter are the on/off switch and the cueing lift control for the tonearm. Both the lift and the descent of the tonearm are viscous damped. There is no automatic arm lift or system shut-off. Hence, the tonearm must be returned to its rest post and the motor must be shut off manually at the end of play.

**Laboratory Measurements.** The calibration marks on the tracking

force scale were accurate to within 0.1 gram at all points. Unlike most anti-skating devices, the calibrations on this system's dial were exactly correct, with or without the brush installed. Except for a measurement of tonearm resonance, no tests were made of the cartridge's performance. (The TT681 cartridge is identical, except for the width of its mounting flange, to the 681EEE cartridge reported on in this column in April 1975.) The low-frequency tonearm/cartridge resonance was at about 8 to 9 Hz at a 5-dB amplitude peak.

The tonearm tracked warped records considerably better than most arms we have used, suggesting that its low mass and balanced symmetrical pivot design provide a direct benefit to the user. The total wiring and cable capacitance measured 90 pF/channel, which would be ideal for proper operation of the CD-4 version of the system. Although the capacitance is considerably lower than is normal for the 681 cartridge, it appeared to have no undesirable effects on cartridge performance. The lateral tracking error of the tonearm was less than 0.7°/in. over the entire record surface and was typically about 0.6°/in. of radius.

The turntable speeds were exact. They did not change with line-voltage variations of 95 to 135 volts. At both speeds, the wow was 0.1% and the flutter was 0.035% (unweighted rms). The unweighted rumble, including both lateral and vertical components, was 31 dB down. With RLL audibility weighting, this figure became 55 dB down, which is typical for a high-quality record playing system.

**User Comment.** This is a very compact record playing system, with a base that is barely larger than the 12" (30.5-cm) diameter of an LP disc and a weight that is far less than that of most contemporary turntables. It does a first-class job of playing records, and the cartridge has been effectively integrated into the 8004 system.

The controls could hardly be simpler or smoother to operate. The easy-to-use cueing system has no tendency to jar the pickup and no lateral drift during tonearm descent.

Once you become accustomed to the rather unusual tonearm finger lift, it is convenient to use. The design of the cartridge and the open face of the mounting shell give an unobstructed view of the stylus when cueing the pickup.

The lack of automatic tonearm pickup and return and shut-off is a minor inconvenience in a manual record playing system. Also minor is our one criticism. There is barely  $1/32$ " (0.79 mm) of clearance between the left side of the dust cover and a 12" disc on the

platter. If the dust cover is not lowered carefully while playing the disc, the edge of the record can rub against the dust cover and cause a momentary "wow." Other than this, the system performed flawlessly.

CIRCLE NO. 66 ON READER SERVICE CARD

## DYNASCAN COBRA MODEL 29 MOBILE AM CB TRANSCEIVER

*Has switches for automatic noise limiter and noise blanker.*



**M**ICROPHONE and r-f gain controls, a switchable automatic noise limiter (anl), and a separately switched noise blanker—all rarely found on mobile rigs—are among the features you'll find in the Dynascan Cobra Model 29 AM CB transceiver. This FCC type-accepted rig uses crystal synthesis for coverage of all 23 Class-D CB channels. Among the more or less standard features you'll find on most mobile rigs, are: adjustable squelch, delta tune, and PA circuits; external-speaker jacks; an S-unit/power-output meter; and transmitter-on and modulation lamps.

The transceiver is designed primarily for mobile service. It can be powered by any nominal 13.8-volt, positive or negative ground source through a doubly filtered, polarity-protected supply line. Zener diode regulation is built into the power supply for critical circuits.

The  $5\frac{1}{2}$ -pound (2.5-kg) transceiver measures  $8\frac{1}{2}$ "D  $\times$   $6\frac{7}{8}$ "W  $\times$   $2\frac{1}{4}$ "H (21.6  $\times$  17.2  $\times$  5.7 cm). It comes with a detachable push-to-talk dynamic microphone and mobile mounting hardware. It retails for \$185.

**The Receiver.** Double conversion is employed in the receiver section. The r-f input stage is protected by diodes. A diode-type variable attenuator at the antenna input serves as the r-f gain control.

The first conversion is made to an 11.275-MHz i-f by heterodyning the incoming signal with a signal in the range from 38.240 to 38.530 MHz, obtained from the crystal synthesizer.

The synthesizer produces the sum frequency of one of six crystals in the 23.290-to-23.540-MHz range and one of four crystals in the 14.950-to-14.990-MHz range. Heterodyning the resulting i-f at the second mixer with an 11.730-MHz crystal-controlled signal frequency brings the i-f down to 455 kHz. (A ceramic filter provides the selectivity.)

The rest of the receiver system consists of two i-f stages, diode detector, series-gate anl, and a three-stage audio section that ends in a push-pull output configuration. The noise blanker gate, located after the second mixer, is a balanced configuration that minimizes switching-transient noise during gating.

Our measurements revealed a receiver sensitivity of 0.6  $\mu$ V (better than the rated 1- $\mu$ V figure) for 10 dB (S + N)/N at 30% modulation and 1000 Hz. The image rejection measured 74 dB, while i-f-signal rejection was 52 dB and spurious responses were down a minimum of 40 dB.

Selectivity provided an adjacent-channel rejection and desensitization of 40 dB, with an overall nominal receiver response in the audio section of 450 to 3500 Hz for crisp voice quality. The agc held the audio output to within 12 dB with an 80-dB r-f signal change at 1 to 10,000  $\mu$ V. A 100- $\mu$ V signal was required to yield an S9 indication on the meter.

The squelch threshold range was 0.35 to 250  $\mu$ V. The maximum receiving output was 4 watts at 5% distortion with a 1000-Hz test signal, but on PA it dropped to 3 watts at 10% distortion, both into 8 ohms.

**The Transmitter.** On transmit, the output of the synthesizer is mixed with an 11.275-MHz crystal signal to generate the carrier. The driver and power output stages of the transmitter are conventionally collector modulated by the receiver's output stage. A sample of the modulating voltage is fed

back to a separate microphone amplifier stage, where it is used to provide automatic modulation control.

A multi-section network in the power amplifier stage provides matching to 50-ohm loads. A TVI trap and a filter in the transmitter mixer's output minimizes spurious responses. Receiver/transmitter switching is accomplished with an all-electronic system that employs diode switches.

Using a 13.8-volt dc power supply, we measured 3.5 watts of carrier output, with 100% sine-wave modulation at 1000 Hz at 2.4% distortion. With a 6-dB increase in audio level, the distortion rose to 8%, and some negative-peak crossover resulted. Under normal voice operation, however, adjacent-channel splatter at this point was 55 to 60 dB down. The audio response of the transmitter was nominally 500 to 2800 Hz at the 6-dB points. The radio-frequency tolerance fell between -65 and -775 Hz, depending on the channel in use.

**User Comment.** This is an attractive transceiver, with its satin-finished silver-colored front panel accented by a chromed bezel and chromed control knobs. The knobs themselves are rather small. The channel-selector knob, owing to its small size, could do with some knurling to improve its "grip."

Miniature toggle switches are provided for switching the PA/CB, ANL, and NB (noise blanker) functions. The delta control is detented at its center-of-rotation position for convenience. Although the transceiver uses an edgewise movement, the meter is larger and easier to read than is usually the case in mobile rigs.

The anl system is extremely effective on many types of low- and high-level noises. On the other hand, the noise blanker was not effective until impulse noise exceeded 1000  $\mu$ V.

The transmitter's output was a bit lower in power than is usually the case, amounting to a negligible 0.75 dB. What is more important is the fact that the transmitter easily maintained a clean, fully modulated signal.

As is common where a microphone gain control is furnished, this transceiver has no built-in means for accurately determining the proper gain

control setting for a given degree of modulation. However, most users would probably crank the gain up all the way anyway, which might not

cause undue overmodulation or splatter with this transceiver, as we noted in tests with a number of different voices.

CIRCLE NO. 67 ON READER SERVICE CARD

## McKAY DYMEK MODEL DA-3 ACTIVE AM ANTENNA

*Improves AM reception, captures hard-to-receive stations.*



**F**M HAS almost completely displaced AM as a serious listening medium for standard broadcast fare. There are certainly cogent reasons for this, but AM still has some attractive attributes: programs not broadcast on FM, some stations that maintain good-quality transmissions (to 10 kHz), and DX'ing opportunities.

The McKay Dymek Model DA-3 AM "active" antenna makes it possible for one to enjoy all of the foregoing by capturing more AM stations than normally received and by reducing interference from stations that are not desired.

**General Description.** The ac-powered DA-3 couples a shielded ferrite-rod directional antenna with a two-stage transistor preamplifier, which includes a FET front end. The user adjusts r-f tuned circuits by setting a frequency control to approximately the desired station frequency. The circular dial is calibrated in nine AM frequencies broadly spaced across the standard broadcast band range of 540 kHz to 1600 kHz. A front-panel sensitivity potentiometer allows the user to adjust desired preamplifi-

cation to his AM receiver. The non-electronic section, the ferrite rod, rests on a post above the base. It can be rotated and tilted for best reception, and it has a set knob to secure its position.

A power on-off switch and a power indicating lamp round out the front panel features, while the rear panel has a slow-blow fuse receptacle, an external antenna pin jack and an r-f output pin jack. (A 35" shielded cable with an RCA-type phono plug on one end and tinned, bare wire on the other is included.) Manufacturer's stated sensitivity is one microvolt.

Overall dimensions are 13 $\frac{3}{8}$ "W  $\times$  9 $\frac{1}{16}$ "D  $\times$  11"H (34.9  $\times$  23  $\times$  27.9 cm). Weight is 6 $\frac{1}{2}$  lb (2.9 kg), and the antenna is priced at \$155.00.

**User Comment.** Attaching the DA-3's output to the antenna terminals of an inexpensive transistor radio brought in a number of AM stations that were not previously received, including a few powerful distant ones. Sound quality of newly received stations was fair. Connecting the output to a hi-fi receiver's external AM antenna terminals produced feedback howls at some frequencies and interference at others. However, the DA-3's manufacturer notes that the antenna is designed for normal use with AM receivers not having a built-in antenna. This was verified by disconnecting the receiver's built-in loopstick. The result was a dramatic improvement in AM reception, which, with the original loopstick, was rather poor. In addition to capturing all the AM broadcasts that one expects, quality of sound was improved in many instances and a bevy of distant stations was brought in.

Our most interesting results were obtained by connecting the DA-3 to a communications receiver (Hammarlund HQ-180A). Here, a great number of distant AM stations, including some foreign ones, were brought in. Sound quality ranged from poor to fairly good. The latter is about the best the communications receiver can produce since audio is down 6 dB at 400 Hz and 8 kHz, while speaker quality is certainly not "hi-fi."

As an example of what we received with the DA-3 connected to this sensitive, highly selective receiver, the following stations were received with maximum clarity at midday at a Long Island, NY, location: WBZ (50 kW), Boston; WTOP (50 kW), Washington, DC; and WCAU (50 kW), Philadelphia, which was broadcasting an exhibition baseball game. We also got fairly good reception of WYAU (10 kW), Tampa, FL; and WBT (50 kW), Charlotte, NC. Additionally, a number of foreign broadcasts were picked up, though none in English at the daytime hours we were listening. (Foreign broadcasts are frequently not spaced 10 kHz apart, so one can often hear them, though weak, by tuning in on the dial "cracks" between 10-kHz divisions.)

Clearly, the DA-3 operates admirably. There was no problem in hitting an S9 on the receiver's S meter, though at busy times of the day, it's difficult on some frequencies to lift out a distant station.

The unit is handsomely designed with walnut wood endplates, high-quality escutcheon and smooth frequency tuning, ferrite-rod rotation, and tilt operation. It's suited for persons who want to DX the mediumwave band or substantially improve AM reception quality on a well-designed AM receiver. Since the DA-3 is an indoor antenna and strikingly attractive, it should have wide appeal.

CIRCLE NO. 68 ON READER SERVICE CARD

## EXACT MODEL 190 FUNCTION AND MODEL 195 SWEEP/FUNCTION GENERATORS

*Compact instruments provide sine, square, and triangle waveforms.*

**R**ECENTLY, we tested a pair of function generators from Exact Electronics, Inc. (a subsidiary of

Danalab). The Model 190 is a "deluxe" function generator that retails for \$245. The other instrument was the

lower-cost Model 195 sweep/function generator, priced at \$149.50. Both instruments weigh the same at 2 pounds (0.9 kg) and are housed in 8 $\frac{1}{2}$ "D  $\times$  7 $\frac{3}{8}$ "W  $\times$  2 $\frac{7}{8}$ "H (21.6  $\times$  20  $\times$  7.3 cm) enclosures, which makes them very lightweight and compact.

The two instruments share some

POPULAR ELECTRONICS



electrical similarities. Both offer the user sine, square, and triangle test waveforms, for example. They differ in frequency range (the Model 190 goes from 0.1 Hz to 1 MHz, whereas the Model 195 goes from 2 Hz to 200 kHz) and the types of test conditions they offer. Also, the Model 195 is battery-powered for portability (an optional battery eliminator is available), while the Model 190 is line powered. (The Model 190 is also available in a battery-powered version, Model 196 for \$350.)

**General Description.** The low-cost Model 195 is a special type of precision function generator that takes most of the work out of plotting frequency responses. The instrument has a built-in sweep generator that sweeps 1000:1 (three decades) on any of the three main frequency ranges. The sweep can be either linear or logarithmic, simply by pressing a pushbutton switch. There are also three fixed 1000:1 sweep rates to select from: SLOW (25 s), MED (250 ms) and FAST (2.5 ms). The sweep covers 20 Hz to 20 kHz in one range for fast audio-equipment response checks, and can be internally or externally controlled.

The generator can also be used at a fixed frequency anywhere within its range. Coarse frequency control is selected by three pushbutton switches labelled 2K, 20K, and 200K, while exact frequency control is via a calibrated control. Separate calibrations for both the linear and logarithmic mode are on this control. Frequency accuracy in the sweep mode is  $\pm 2\%$  of full range.

The output signal level at the HIGH and Low sine jacks is continuously

variable via a SINE AMPLITUDE control to 1 volt rms and 10 mV rms, respectively, open circuit. Output impedance is 600 ohms.

Arranged across the bottom of the front panel are six banana-type output jacks. Starting at the left, they deliver triangle, no-legend, square, LOW-sine, no-legend, and HIGH-sine waveforms. The jacks without legends are common to all of the legended jacks. This arrangement permits banana-jack-pair cables to be plugged directly into the instrument for any desired waveform without the need for an adapter.

The costlier Model 190 function generator does not have built-in sweep circuits. However, in addition to sine, square, and triangle waveforms, it also provides pulse and ramp waveforms. It has provisions for a voltage-control frequency input (VCF); dc offset control, and a TTL pulse output.

This is a high-performance function generator that has been designed to meet the demands of the audio, digital, and servo engineer. It offers continuously variable signal level outputs on all waveforms, variable time symmetry, and a floating output. The output is substantially higher than the 195's, being variable from zero to 20 volts peak-to-peak open circuit (10 volts peak-to-peak into 600 ohms). The TTL-compatible output has a fast 25-ns rise time and will sink 20 TTL loads.

Frequency selection is more precise than with the Model 195. Seven push-button switches provide the means for selecting the desired frequency range in decade steps from 1 Hz to 1 MHz full-range. Then the specific frequency can be dialed in via a calibrated rotary control.

Input and output connectors are five-way binding posts on plugpair centers that eliminate the need for special adapters. The ramp and pulse modes have their own separate amplitude control and can be instantly inverted simply by pushing a switch. Frequency accuracy of the Model 190 generator is  $\pm 5\%$  of full scale. The 10,000-ohm VCF input can accommodate a 0-to-10-volt input to produce a 1000:1 (three decade) ratio. The dc offset is variable from  $-10$  to  $+10$  volts open circuit ( $-5$  to  $+5$  volts into 600 ohms).

**Performance Results.** Both instruments met or exceeded (ex-

ceeded, mostly) all of their published specifications. We were not equipped to run a full battery of tests, but those we were able to perform convinced us that the results obtained would be repeated on those we couldn't perform.

To begin with, the frequency ranges we obtained were greater than specified, which was no surprise. The Model 195's output signal levels were exactly as specified for the fixed outputs at slightly less than +3 volts on the PULSE (square) waveform output and 1 volt peak-to-peak on the triangle output. The HIGH sine-wave output at maximum amplitude into 600 ohms measured closer to 1.3 volts than the published 1.0 volt. The sine-wave distortion was indeed less than 2%; in fact, it barely hit the 1% mark.

The Model 190's bench performance bore out the fact that this is a precision instrument. Its frequency accuracy was well within the 5% specified, and its response topped 1.1 MHz on the top end with the frequency dial beyond its calibrated markings. Sine-wave distortion was about 0.4% over most of the instrument's range.

**User Comment.** From performance test results and having used these instruments for several months, we feel that both instruments are good investments. We particularly liked the ease of operation provided by a well-designed panel control and jack arrangement. All controls operated flawlessly, and electrical performance was excellent.

With a price differential of almost \$100, how does one choose between these two excellent instruments? The low-cost Model 195 is ideal for service shops, particularly those concerned with general audio repair and maintenance. The built-in sweep generator is very handy for overall frequency response checks, while its battery power enables it to be moved easily around the shop. In conjunction with a good scope, the Model 195 would more than earn its keep.

The Model 190 (more expensive) should be useful in engineering and top-grade service shops. Its wider frequency span, plus its TTL-level function output enables its use in all kinds of analog and digital circuitry. Other features (such as the external vco capability) make this a very versatile instrument for original circuit design and critical repair of sophisticated equipment.

CIRCLE NO. 69 ON READER SERVICE CARD



... here Today!  
**"IGNITION OF THE FUTURE"**  
**ALLISON**  
**"OPTO-ELECTRIC"**

★ The BEST...the ULTIMATE...  
of ALL the Ignition Systems!

● (We challenge ANYONE  
to dispute this Fact).



● Never wears out or needs any Maintenance!



● Does more than Pay for itself in  
**GAS SAVINGS**

...it gives you Maximum Power  
with continuous **PEAK PERFORMANCE**

...while reducing Maintenance  
and Operating Costs!



● The Allison OPTO-ELECTRIC System eliminates the Points and Condenser, replacing them with an OPTO-ELECTRONIC TRIGGER, using a Light-Emitting Diode and Photo transistor. As there are NO moving parts in rubbing contact...Timing adjustments are PERMANENT. The only "TRUE" Electronic Ignition...that you can buy for under \$100.

● Gives 40-Times more Timing Accuracy than ANY system using "Mechanical" Breaker-Points! UNLIMITED RPM! "Electronically-Controlled" DWELL automatically supplies HIGHEST Performance at both Low and High speeds. Spark strength does not fall off at high RPM. POSITIVE SPARK helps eliminate "Misfire" for faster acceleration and improved Engine Performance! Smoother running (No timing fluctuation as with Magnetic Units). Easier Starting under any condition! Sparkplugs LAST 3 to 10-Times LONGER.

ALL SOLID-STATE Components. UNAFFECTED By Temperature, Moisture, or Vibration! Highest grade materials Guarantee you solid, Dependable Performance.

★ Perfect Timing and Dwell never change.

Pays for itself! Eliminates ignition Tune-Ups forever!  
"INFINITE LIFE"...Once installed...Never needs replacing.

● PERFECT TIMING INCREASES Engine Efficiency and Gas Mileage. SAVES Precious Fuel! Allison gives you MAXIMUM Engine Efficiency 100% of the time...and that's the name of the game for BETTER Gas Mileage and Economy.

★ **PROVEN RELIABILITY!**

Dyno Tested up to 15,000 RPM.  
Road and Race Proven.  
(Opto-Electric Systems won at  
INDY Two years in a row!)

● **QUICK AND EASY INSTALLATION**

★ If you want the BEST, and SAVE! This is IT!

● ORDER with CONFIDENCE...  
**SATISFACTION GUARANTEED!** Only \$49<sup>95</sup>  
**1-YEAR FACTORY WARRANTY.** COMPLETE.

● As you can see, you're not taking any chances at all...Send your Order Today.

State Make, Year, Engine Size. (Calif. Res. add Tax).  
(So New...it's Sold ONLY FROM FACTORY DIRECT).

● You may use your MASTER CHARGE or BANKAMERICARD. Send us (1) Your Number, (2) Interbank No., (3) Exp. Date.

● Before buying any other Type Ignition system...

Send Postcard for our FREE BROCHURE.

★ If you have already installed a C-D ignition system, Modernize and Increase its Efficiency...  
**CONVERT YOUR "C-D" UNIT TO BREAKERLESS!**  
Opto-Electric "TRIGGER UNIT"...Only \$34.95

● Our BEST Salesmen are the owners and users of our ALLISON System!



**ALLISON**  
**AUTOMOTIVE COMPANY**  
1269 - P, East EDNA PL., COVINA, CAL. 91722

CIRCLE NO. 4 ON READER SERVICE CARD



# MAC'S SERVICE SHOP

## A Simple On-Board Tester

By John T. Frye, W9EGV

"BARNEY," Mac called out the back door of the service shop to his assistant, who was blowing the dirt out of a TV chassis, "come in here a minute. I want to show you something."

"Con mucho gusto!" Barney answered, dropping the air hose with alacrity. "Wait till I wash my hands. Wherever did we get that cruddy set?"

"From Harry's Bar and Grill. The set's mounted behind the bar up near the ceiling where it gets all the smoke from the customers and the greasy fumes from the grill. But here's a little gadget I want to demonstrate. Your South American friends would call it a 'gray-bearded novelty' because of its actual age and its recent popularity. I first ran across it in John F. Rider's *The Cathode Ray Tube at Work*, published in 1935. In the past few months, it has been discussed in military and amateur publications. In Navy circles, it's called the 'Octopus.'

"The device (Fig. 1) can be used with any type of oscilloscope and consists of a 6.3-VCT filament transformer, three 1/2-watt resistors, and two test probes. Half the filament voltage is applied to a voltage divider consisting of  $R_1$  and  $R_2$ , yielding 1 volt ac at the top of  $R_3$ . This voltage can be applied to any component or combination of components across which the test leads are placed. The current is limited to 1 ampere by  $R_3$ . The voltage across the probes is applied to the horizontal input of a scope, while the voltage across  $R_3$  as a result of the current through it is applied to the vertical input. What we see on the scope is actually a display of the voltage across a component under test versus the current through that component."

"If you put the leads across a capacitor or an inductor, you actually have a phase-shifting network, huh?"

"Precisely. That's how Rider used the circuit. Now let's hook it to the scope. With an open circuit between the test leads, I adjust the horizontal gain for a 2" trace on the 5" tube (Fig. 2A). Under these open-circuit conditions, the full 1-volt ac appears across the horizontal input. Since no current is being drawn through  $R_3$ , no voltage appears across it or the vertical input.

Now I short the test leads together, and the trace flips to a vertical line (Fig. 2B). The vertical amplifier gain is adjusted to give a 2" trace. The shorted test leads short out the horizontal input and cause the full 1 volt of ac to appear across  $R_3$  and so across the vertical input. Now we're ready to do some testing.

"First let's hook a resistance substitution box across the test leads. With the resistance in the megohm range, the trace is that of an open circuit: a horizontal line. As the resistance value drops to about 50,000 ohms, the horizontal line starts rotating counterclockwise so that, with 10,000 ohms between the test leads, it is almost 10° from the horizontal; at 1000 ohms, it is 45°; and at 100 ohms, it is a little less than 10° from the vertical (Fig. 2C). When the ac voltage is increasing in a positive direction at the vertical input and deflecting the spot upward, it is increasing in a negative direction at the horizontal input and deflecting the spot to the right. (This particular scope deflects to the left with a positive voltage at the amplifier input.) The resultant of the two synchronized equal right-angle forces on the spot is the straight line lying halfway between the vertical and the horizontal. The angle of this line with respect to the horizontal is a function of the ratio of the resistance of  $R_3$  to the resistance being tested."

"Neat!" Barney approved. "With a little practice you could estimate at a glance the value of any resistance between 50 and 25,000 ohms—the values found most often in transistor work."

"Right. Now let's see what happens with a capacitance between the test

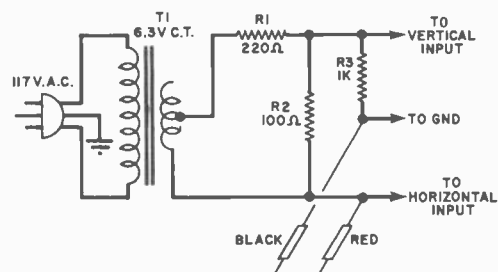

Fig. 1. Schematic of the testing device.

leads. With 0.1  $\mu\text{F}$ , the horizontal trace opens slightly to form a skinny horizontal ellipse (Fig. 2D); but with a combination of parallel capacitors that totals 2.6  $\mu\text{F}$ , we get a pretty fair circle (Fig. 2E). Finally, with 50  $\mu\text{F}$  across the probes we get a skinny vertical ellipse (Fig. 2F). Keep in mind that current leads voltage by 90° in a capacitor and that capacitive reactance goes down as capacitance goes up. The reactance of 2.6  $\mu\text{F}$  at 60 Hz is very close to the 1000 ohms of  $R_3$ ; so the voltages across the two are equal but 90° out of phase, a situation that produces the circular trace. Lower values of capacitance produce less current through  $R_3$  and flatten the circle. Higher values of capacitance result in more current through  $R_3$  and less voltage across the capacitor, with a resultant pulling in of the sides of the circle to form a vertical ellipse. Again, with a little practice, you can make a shrewd estimate of the value of any capacitor from 0.1 to 50  $\mu\text{F}$ ."

**Inductances.** "Wouldn't inductances do the same thing?"

"Yes. Unfortunately we have no calibrated inductor in the range we need for demonstrating, but we know that current lags voltage by 90° across an inductance and that the reactance value goes up with increasing inductance—just the opposite of the case with capacitance. When I place the primary of this transformer across the leads, we get a fairly fat ellipse slanted about 15-20° from the vertical (Fig. 2G). Watch what happens when I short the output of the transformer: the sides of the ellipse pull in, indicating that the shorted secondary has lowered the inductance of the primary. Inductances, unlike capacitors, have fairly low values of dc resistance, and this resistance accounts for the canting of the ellipse. When I open the secondary and put 4  $\mu\text{F}$  of capacitance in series with the transformer primary across the test leads, the ellipse collapses to a straight line still about 15 to 20° from the vertical (Fig. 2H). The reactance of the capacitor cancels the inductance of the transformer primary, leaving only the dc resistance of the winding, about 200 ohms, between the leads. If I short the secondary, I need 50  $\mu\text{F}$  of series capacitance to produce the straight line. This tells me the unshorted winding has a reactance at 60 Hz equal to that of 4  $\mu\text{F}$  of capacitance, or about 660 ohms. With the output shorted, this drops to the

now try the  
**A.C.E.**  
**ALL CIRCUIT  
EVALUATOR**  
from AP PRODUCTS

the newest  
solderless  
plug-in  
breadboard  
for quick  
circuit  
checkouts

**6 models**  
from \$20 to \$80...  
a size for every  
circuit layout

All products are guaranteed  
to meet or exceed  
published specifications

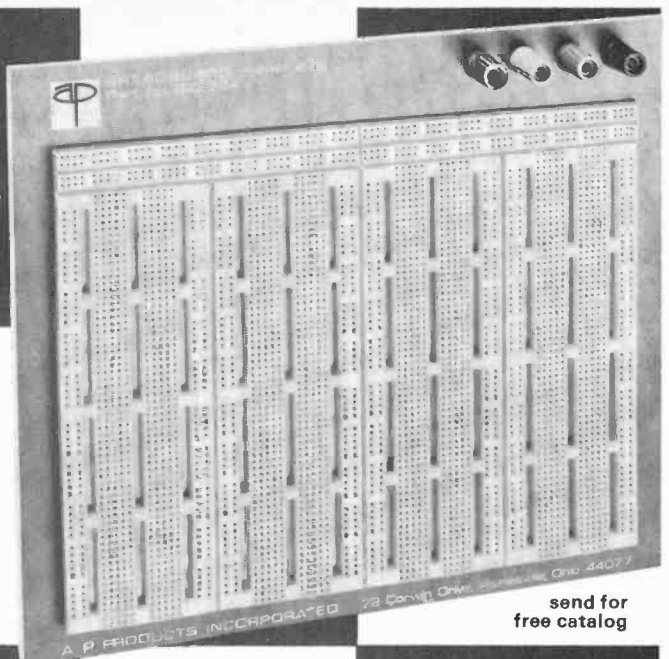

send for  
free catalog

model 232 shown: \$80  
32 DIP (14-pin) capacity

all models have plug-in  
power distribution system  
and circuit-building  
matrix or .10" centers

accepts all DIPs and  
components with leads up  
to .032" diameter

use ordinary solid wire  
jumpers to 22 gage

CIRCLE NO. 53 ON READER SERVICE CARD



A P PRODUCTS INCORPORATED  
Box 110-H, Painesville, Ohio 44077  
(216) 354-2101 • Twx 810-425-2250

### ALTAIR 8800 USERS !!

**FREE SOFTWARE!**... well, almost free. We will send octal & Assembly language listings to anyone sending \$3 per package for postage & handling. If you buy one of our modules, we'll send them FREE.

**Package 1:** Resident assembler, system monitor, and text editor for the Altair 8800. Really an OS for Assembly language! For example, you can store and call programs by name.

**Package 2:** BASIC language interpreter — this one should be ready by Oct. 75.

We are working very hard at putting the Monitor, Assembler into a fast 16K ROM module for delivery in Oct. 75. **SEND FOR OUR FREE SOFTWARE BROCHURE.**

#### OUR HARDWARE

Remember, if you don't continue to buy our neat modules we won't be able to provide FREE software. All our modules just plug into the 8800 bus. Check these:

**2KRO** — Erasable, reprogrammable PROM module. Kit, \$50; assembled, \$75.

**3P+S** — I/O module, 2 parallel I/O's plus a serial interface for TTY and RS232. Kit, \$125; assembled, \$165.

**4KRA** — 4096 word STATIC high speed memory. Kit, \$225; assembled, \$280.

**MB 1** — Mother board, 16 card slots, rugged. Kit, \$35.

**BT1** — Bus Terminator module. Kit, \$30.

**100PC** — 100 pin edge connector, \$8.50.

#### COMING SOON !!

**MMM-1** — The first in a series of Music Maker Modules will provide two computer controlled tones that go directly to an audio amplifier! Free driving software.

**PPM** — Smart PROM programmer. Let us know if you need to program 1702A's or 5203's or both. About \$150. 8800 Plug-in.

**TC+1** — Fully computer controlled cassette transport and controller/interface. This is a really nice one! About \$300 kit.

**TTK** — True Timekeeper Module, date and time down to .01 sec. Alarm and Real Time Interrupt too! About \$100.

**VTM** — Video Terminal Module, 16 or more, if we can do it, lines of 64 characters to a video monitor. Smart memory allocation & very fancy text editing software included. About \$125!

Send for our FREE flyer or order now from:  
**PROCESSOR TECHNOLOGY CO.**  
Dept. P, 2465 4th St., Berkeley, CA 94710  
(415) 549-0857

CIRCLE NO. 41 ON READER SERVICE CARD



**LISTEN!**

We're one of  
the country's  
largest Mail  
Order Houses  
of Stereo  
Equipment  
and Musical  
Instruments.

Our volume buying power enables us to pass the savings on to you. Listen to us ... You can't go wrong.

Fill out this coupon and mail to address below for our latest Free Catalogs.

Name \_\_\_\_\_

Address \_\_\_\_\_

City \_\_\_\_\_

State \_\_\_\_\_ Zip \_\_\_\_\_

AUDIO CATALOG

MUSICAL INSTRUMENT CATALOG

**STEREO  
DISCOUNTERS**

7A AYLESBURY ROAD □ TIMONIUM, MD. 21093

[301] 252-6880

CIRCLE NO. 50 ON READER SERVICE CARD

**Communications  
Engineering**

**Aeronautical  
& Navigational**

**Television  
Engineering**

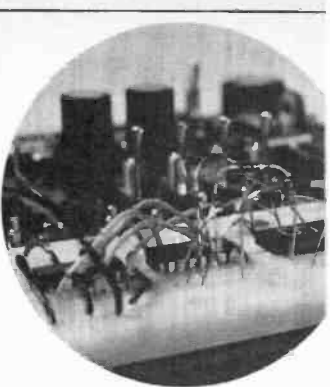

**Automatic  
Control  
Engineering**

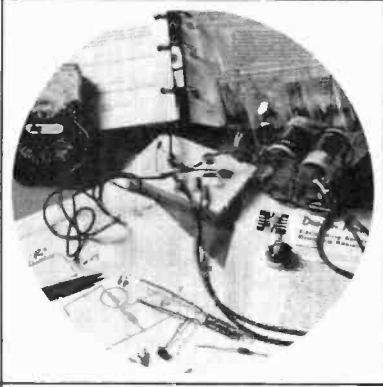

**Missile &  
Spacecraft  
Guidance**

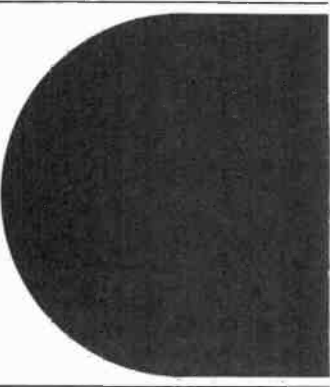

**Radar &  
Sonar  
Engineering**

**Digital  
Communications**

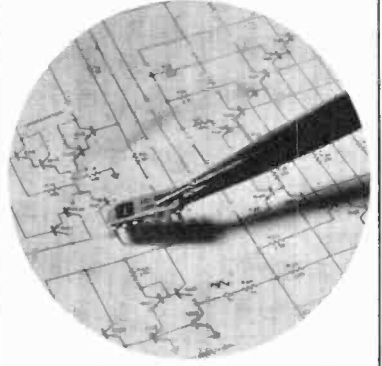

**Industrial  
Electronics**

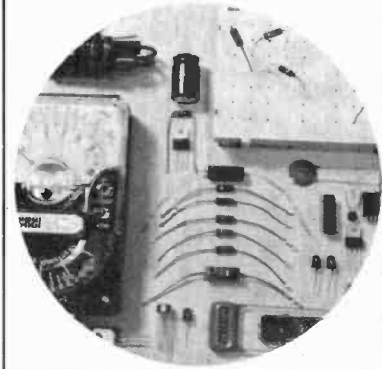

**Microwave  
Engineering**

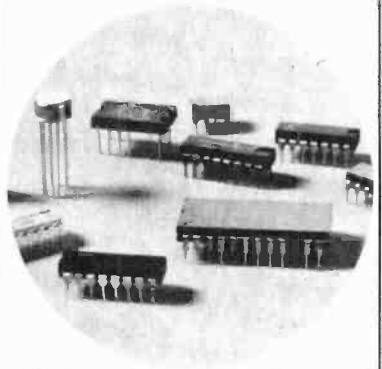

**Satellite  
Communications**

**Cable  
Television  
Engineering**

**Electronic  
Engineering  
Technology**

**Nuclear  
Instrumentation  
& Control**

**Special Programs  
for Electronic  
Engineers**

If you are too busy to go to college to learn advanced electronics, CREI brings college level training to you. CREI programs give you practical engineering training that you can apply in your work to move ahead to higher paying jobs. And CREI lets you specialize in exactly the area of electronics you want. You have a choice, depending on your qualifications, of 18 different programs.

Not only are CREI programs college-level but arrangements are available for you to earn college credit applicable to advanced degrees.

Computer  
Engineering

# Only CREI offers you a choice of 18 programs in advanced electronics

For over 45 years CREI programs have been recognized by leading technical organizations as effective home study training in advanced electronics.

### NEW OPTIONAL LAB PROGRAM



CREI now offers a supplementary ELECTRONIC DESIGN LABORATORY PROGRAM to make learning advanced electronics easier and to give you actual experience to use in your work. Only CREI offers this complete college type laboratory program. You learn to actually design electronic circuits. At the same time you get extensive experience in tests and measurements, breadboarding, prototype building and other areas important to your career.

**Qualifications to Enroll.** To qualify for enrollment in a CREI program, you must be a high school graduate (or equivalent). You should also be working in electronics or have previous training in this field.

**Send for FREE book.** If you are qualified, send for CREI's newly published book describing your career opportunities in advanced electronics. This full color book is filled with facts about career opportunities for you.



Accredited Member, National Home Study Council

CREI, Dept. E1208F  
3939 Wisconsin Avenue  
Washington, D. C. 20016

Rush me your FREE book describing my opportunities in advanced electronics. I am a high school graduate.

Name \_\_\_\_\_ Age \_\_\_\_\_

Address \_\_\_\_\_

City \_\_\_\_\_ State \_\_\_\_\_ ZIP \_\_\_\_\_

If you have previous training in electronics, check here

Employed by \_\_\_\_\_

Type of Present Work \_\_\_\_\_

Veterans and servicemen, check here for G. I. Bill information

**CREI**  
**CAPITOL**  
**RADIO**  
**ENGINEERING**  
**INSTITUTE**

A Division of McGraw-Hill  
Continuing Education Co.  
3939 Wisconsin Avenue,  
Washington, D. C. 20016

Electronic  
Systems  
Engineering

Nuclear  
Engineering  
Technology

Special Programs  
for  
Non Electronic  
Engineers



# SAVE!

**MONEY • TIME • FREIGHT**

- ♪ QUALITY STEREO EQUIPMENT AT LOWEST PRICES.
- ♪ YOUR REQUEST FOR QUOTATION RETURNED SAME DAY.
- ♪ FACTORY SEALED CARTONS—GUARANTEED AND INSURED.
- ♪ SAVE ON NAME BRANDS LIKE:
 

A.D.C.	KLH
A.R.	SHURE
DYNACO	KOSS
SONY	FISHER

AND MORE THAN 50 OTHERS  
BUY THE MODERN WAY  
BY MAIL—FROM

## ia illinois audio

Department 217S  
12 East Delaware  
Chicago, Illinois 60611  
312-664-0020

CIRCLE NO. 27 ON READER SERVICE CARD

# FREE catalog

over 2000



unique tools,  
handy kits,  
precision  
instruments,  
technical  
supplies.

Our 23rd year of service to the World's  
finest craftsmen and technicians.

A carefully selected and tested assortment of unique, hard-to-find tools, clever gadgets, precision instruments, bargain kits. One-stop shopping for the technician, craftsman, hobbyist, lab specialist, production supervisor. Many tools and measuring instruments available nowhere else. One of the most unusual and complete tool catalogs anywhere. Get your copy of the NC FLASHER today.

**National Camera**  
2000 West Union Ave., Dept. GGA  
Englewood, Colorado 80110  
(303) 789-1893

CIRCLE NO. 37 ON READER SERVICE CARD

reactance of the 50- $\mu$ F capacitor, or about 50 ohms."

"I'm beginning to grasp the possibilities of that thing," Barney said.

"There's more. Watch what happens when I put the leads across this germanium diode with the red lead connected to the cathode and the black to the anode. We get a right angle (Fig 2I). Reversing the test leads reverses the position of the angle (Fig. 2J). See the difference in similar tests with a silicon diode? In either case the horizontal portion is longer than the vertical portion (Fig. 2K and 2L). Can you guess why?"

"Sure. The vertical side of the angle represents the conducting portion of the cycle. A germanium diode conducts practically from zero voltage, but a silicon diode doesn't start to conduct until 0.4 to 0.7 volts in the forward direction appears across it."

"Right on! Now let's simulate a leaky diode by paralleling it with different values of resistance. Note decreasing resistance values cause the horizontal side of the right angle to move so as to open up the angle (Fig. 2M). At very low values of parallel resistance, we get the vertical line that indicates a direct short. Series resistance, on the other hand, causes the vertical side of the angle to pivot so as to open up the angle (Fig. 2N). At high values of series resistance, we have only the straight horizontal line\*of an open circuit."

"What happens if you put a

small capacitor across the diode?"

"Let's try it and see. With a 0.1- $\mu$ F capacitor across the germanium diode, the vertical portion stays the same but the horizontal line opens to form a fat 'foot' (Fig. 2O). Increasing the value of the capacitor causes this foot to get fatter and fatter. At 2  $\mu$ F, its influence dominates the pattern, leaving only a little vertical stub to show the diode is still getting in some feeble licks (Fig. 2P). At higher values of capacitance, the diode action is swamped out entirely."

**Transistors.** "How about transistors? Can it test them?"

"Yes. You treat a transistor junction as if it were a diode—which it really is. If you put the red lead on the base of a pnp transistor and the black lead on either the emitter or collector, you get the pattern in either Fig. 2I or 2K, depending on whether it is a germanium or a silicon transistor. The same tests with npn transistors produce Fig. 2J for a germanium transistor or Fig. 2L for a silicon transistor. A leaky transistor junction opens up the angle of the pattern just as with a leaky diode. Resistance or capacitance across a junction has exactly the same effect that it has across a diode."

"What if the transistor isn't marked and you don't know which is the base?"

"You touch the red lead to a transistor terminal and touch the black lead alternately to the other terminals.

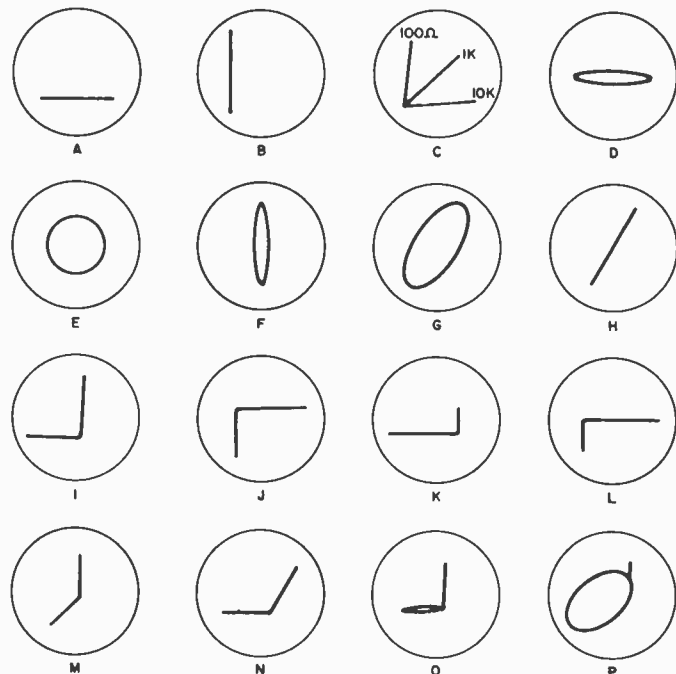

Fig. 2. Traces obtained on a scope using the testing device on various components.

Only when the red lead is on the base will you get almost identical traces when the black lead is touched to the other two."

"I think I see where you're heading. You've been showing me all these individual traces so I can recognize them when I'm probing combinations of components on a printed circuit board. Right?"

"Right. This little gadget which you can build for only a few dollars has the potential of being one of the fastest, most informative, most versatile, and most reliable troubleshooting instruments you ever used. Its uses are limited only by the imagination and technical savvy of the user. The one volt at a maximum of one mA that it puts out is completely safe to use on all transistors and low-voltage diodes and capacitors. You don't have to worry about bending meter pointers. You use it without any power applied to the equipment being tested, so there's no danger of a test prod slipping, shorting something out and blowing a transistor. Since it is a dynamic test, exposing the unit being tested to a continuously varying voltage, each readout yields a wealth of information that would require dozens of separate static tests to duplicate.

"Just consider what it will tell you: it indicates shorts, open circuits, approximate resistance and capacitance values, inductance, and the quality of diodes and transistor junctions. It separates germanium from silicon diodes, indicates the polarity of such diodes and separates germanium from silicon transistors and npn from pnp types. It will pick out the base of an unmarked transistor. It will reveal the presence of resistance or capacitance across a diode or transistor junction. You can also use it to phase transformer windings—but there's no point in my going on and on. The more familiar you become with the device, the more uses you will find for it.

"But make it a habit to understand thoroughly the *why* of every trace you see. Letter the peaks and zero-crossings of a sine wave and then letter each trace to correlate the spot positions with the instantaneous voltage and polarity of the applied 60 Hz sine wave. If you see a puzzling trace, try to duplicate it with a diode, a resistance or capacitance box, and possibly an inductance. Doing this will make an excellent teaching instrument of the little unit."

# NEW DELUXE CB RADIO

*Designed for the CB owner who wants top performance, class, ruggedness and functionality. PACE CB 145 is an all 23-channel transmit and receive CB Radio with two weather channels (WX-1 and WX-2) for monitoring weather information. Full legal transmit power.*



**NOTE THESE KEY FEATURES:**

Noise Blanker Switch • PA Control • Delta Tune • RF Gain Control • Illuminated S/RF Meter • Transmit and Receive Mode Indicator Lights • CB WX-1 and WX-2 Mode Indicator Lights • Plug-in Microphone.

Operates on 12V DC (+) or (-) ground. Suggested retail price \$199.95

*See your distributor today.*

**((P)) PACE COMMUNICATIONS**, Div. of Pathcom Inc., 24049 S. Frampton Ave., Harbor City, Ca. 90710. Available in Canada from Superior Electronics Ind. Export: 2200 Shames Dr., Westbury, N.Y. 11590. <sup>62</sup>

CIRCLE NO. 39 ON READER SERVICE CARD

**FREE**

## McIntosh CATALOG and FM DIRECTORY

Get all the newest and latest information on the new McIntosh Solid State equipment in the McIntosh catalog. In addition you will receive an FM station directory that covers all of North America.



### MX 113

FM/FM STEREO - AM TUNER AND PREAMPLIFIER

**SEND  
TODAY!**

McIntosh Laboratory, Inc.  
East Side Station P.O. Box 96  
Binghamton, N.Y. 13904  
Dept. PE

NAME \_\_\_\_\_

ADDRESS \_\_\_\_\_

CITY \_\_\_\_\_ STATE \_\_\_\_\_ ZIP \_\_\_\_\_

If you are in a hurry for your catalog please send the coupon to McIntosh. For non rush service send the *Reader Service Card* to the magazine.

CIRCLE NO. 32 ON READER SERVICE CARD

# AM Comes Alive



The McKay Dymek DA 3 shielded ferrite loop AM antenna has a solid state preamp with tuning and sensitivity controls.

Overcomes the two most common AM reception problems: strong local stations "hiding" weaker distant stations close on the dial, and interference from TV and electrical sources.

Improves inherent long range capabilities of AM—programs listenable from hundreds of miles.

Increases signal strength 4 to 8 times—really sharpens up AM performance in typical hi-fi receivers and tuners.

Factory direct—\$155.00, ten day money back guarantee. BankAmericard and Mastercharge welcome. For more information or to place your order, call toll free:

Nationwide 800/854-7769  
California 800/472-7782



McKay Dymek Co.  
675 North Park Ave.  
Pomona, Calif. 91766

CIRCLE NO. 33 ON READER SERVICE CARD

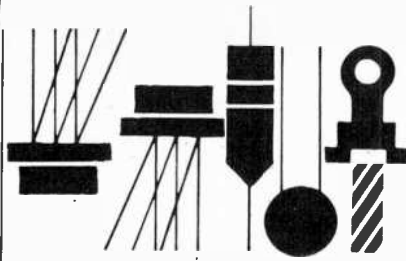

# Solid State

By Lou Garner

## AUDIO AMPLIFIERS FOR HOBBYISTS

WITHOUT question, audio amplifier projects, as a class, are the most popular of all among hobbyists. This is easy to understand, since amplifiers are used in a myriad of ways: headphone boosters, hearing aids, radio receivers, r-f transmitters (as modulators), TV receivers, electronic stethoscopes, portable phonographs, controls, tape recorders and playbacks, intercoms, PA systems, paging installations, and test instruments (such as signal tracers and metal detectors).

In contrast to the vacuum tube era, today's builder has a broad range of options. He can still use vacuum tubes, or he can choose an all-IC or an all-discrete solid-state design, or a combination of both discrete devices and IC's. A builder might select a circuit using an output transformer or one using any of a variety of OTL configurations, including direct single-ended drive, quasi-complementary, or full complementary-symmetry output stages. He can assemble a low-power amplifier smaller than a watch and with minimal battery drain or, at the other extreme, he can design an amplifier with sufficient power to shake the walls while running as cool as a cucumber.

Along with a broad range of circuit options, today's hobbyists can reasonably expect improved performance, high efficiency, and relatively modest costs. Old timers may remember the days when a "Hi-Fi" amplifier was one with a reasonably flat response from 50 Hz to, say, 15 kHz  $\pm 2$ dB, where a total harmonic distortion (THD) rating of 5% was considered acceptable, and an amplifier with a rated output of 25 watts was "high power." The parts to assemble, say, a 2-watt phonograph amplifier might have cost as much as ten or twelve dollars, even though average salaries hovered around \$60/week.

We've come a long way, baby! Today's hobbyist expects an amplifier intended for high-quality reproduction to have a frequency response of at least 20 Hz to 20 kHz  $\pm 1$  dB, while 10 Hz to 40 kHz  $\pm 0.5$  dB is not uncommon. And while THD might be tolerated in a general-purpose design, one would expect a THD of 1% or less in a high-fidelity instrument. Finally, despite inflation and an overall higher standard of living, the average experimenter would hesitate to pay much more than five or six dollars for the components to assemble a general-purpose, medium-power amplifier.

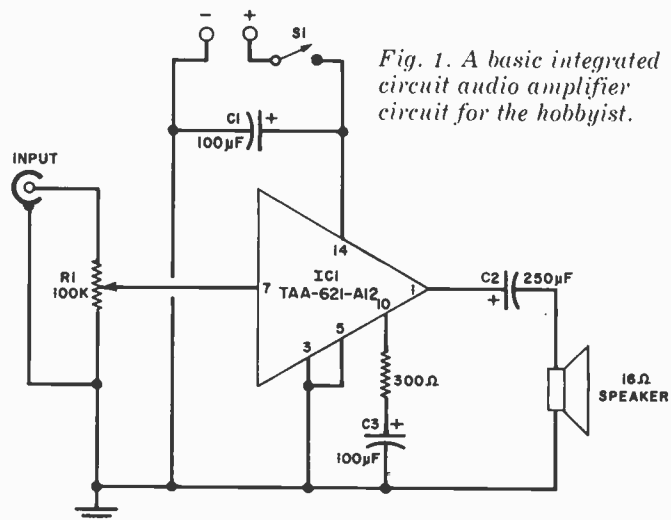

Fig. 1. A basic integrated circuit audio amplifier circuit for the hobbyist.

# CB

where the ACTION'S at

Millions of 2-way CB radios are in use—millions of new ones are being sold annually to new CBers and for replacing old units—what a market for repair service. It's the biggest thing in electronics since color TV. There's only one thing wrong with CB growth—the lack of technicians capable of servicing CB radios. That's why many TV shops are expanding into CB and why new CB shops are opening up all over the country. Going CB servicing rates run from \$12 to \$24 per hour.

To get into CB radio servicing, full-time or part-time, you need test equipment, an FCC operator license and to learn how. To learn how, you can buy the **CB RADIO REPAIR COURSE** for cash, on a monthly payment plan, or charge the cost to your BankAmericard or Master Charge account.

To make it easy to study, this 70-lesson course employs the **PROGRAMMED** teaching technique and sticks to the target—CB radio. Study at your own pace as you receive the self-examining lessons. We can't guarantee that you will become a CB expert since that depends on you. We promise nothing except information. To get the facts about this course, write a letter or card or mail the coupon below today. No salesman will call.

### CB RADIO REPAIR COURSE, INC.

Dept. P-8

531 N. Ann Arbor  
Oklahoma City, OK 73127

Please send information about your Course to:

Name \_\_\_\_\_  
Address \_\_\_\_\_  
City \_\_\_\_\_ State \_\_\_\_\_ Zip \_\_\_\_\_

CIRCLE NO. 13 ON READER SERVICE CARD

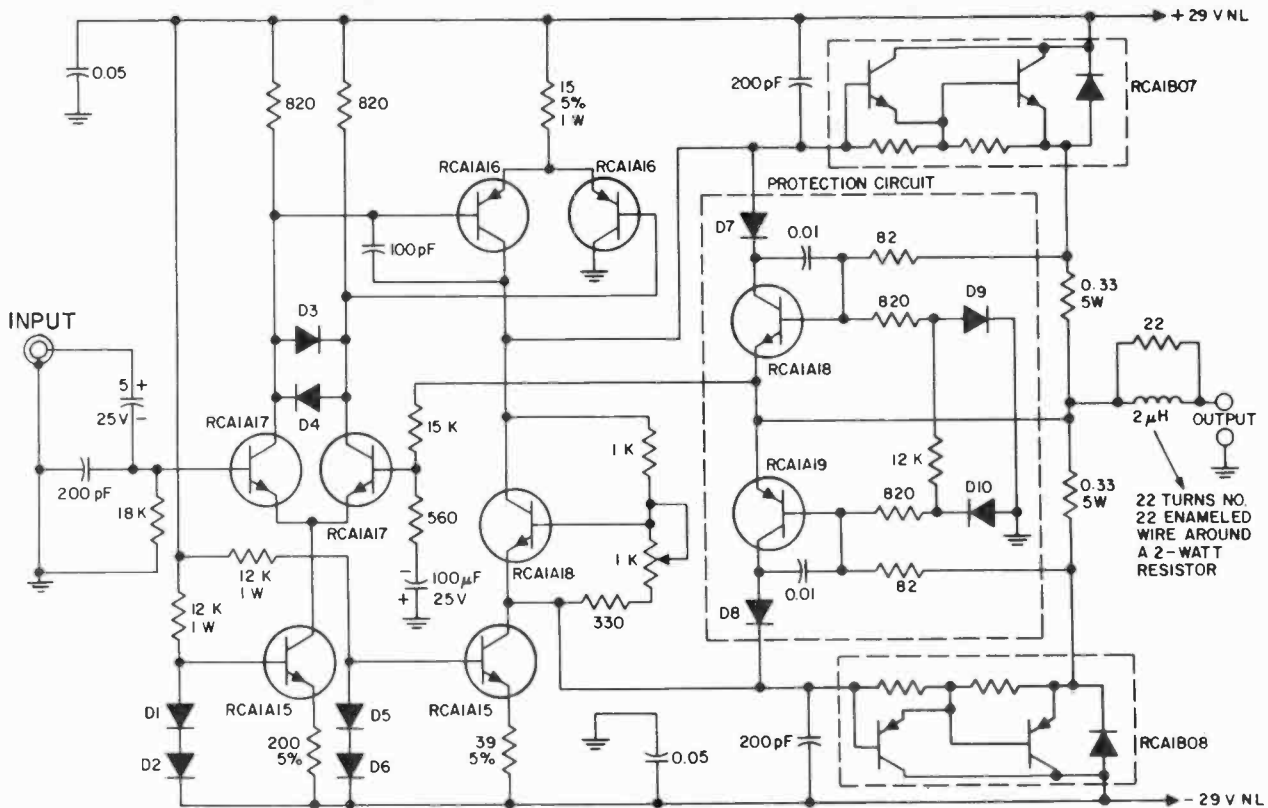
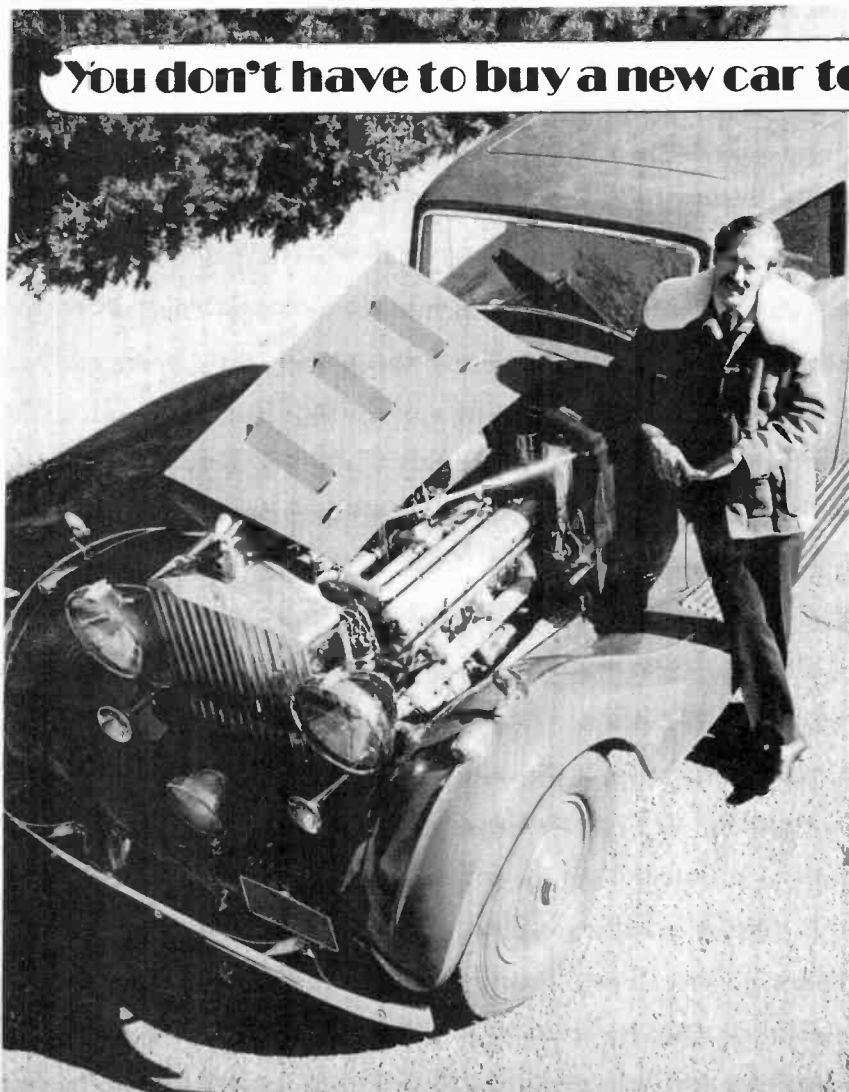

Fig. 2. RCA's 40-watt audio amplifier has full complementary-symmetry Darlington output.

92CM-24144

## You don't have to buy a new car to get an electronic ignition.



Let's face it. After 37 years, even a Phantom III can use a lift. That's why I put a Delta Mark Ten B Capacitive Discharge Ignition on my Phantom . . . to give her a spark I'd pit against any '75 model car. I went to Delta because they aren't Johnny-come-latelys. Delta's been making electronic ignition systems for over a decade.

Whatever kind of car you drive, you can give it the same great Delta performance I gave mine.

- Mark Ten B Capacitive Discharge Ignition Systems are manufactured by Delta Products, Inc., a company with a conscience, and with a proven record of reliability both in product and in customer relations.
- The Mark Ten B really does save money by eliminating the need for 2 out of 3 tune-ups. Figure it out for yourself. The first tune-up or two saved pays for the unit, the rest is money in your pocket. No bunk!
- Because the Mark Ten B keeps your car in better tune, you actually can save on expensive gasoline.
- With a Mark Ten B, spark plugs stay clean and last longer . . . fouling is virtually eliminated.



I want to know more about Mark Ten B CDI's. Send me complete no-nonsense information on how they can improve the performance of my car.

Name \_\_\_\_\_  
 Address \_\_\_\_\_  
 City \_\_\_\_\_ State \_\_\_\_\_ Zip \_\_\_\_\_



**DELTA PRODUCTS, INC.**

P.O. Box 1147, Dept. PE, Grand Junction, Colo. 81501  
 303-242-9000

Mark Ten B,		Standard Mark Ten,	
assembled	..... \$64.95 ppd	assembled	..... \$49.95 ppd
Mark Ten B, kit	..... \$49.95 ppd	Deltakit®	..... \$34.95 ppd

CIRCLE NO. 21 ON READER SERVICE CARD



**WE'LL  
SAVE YOU MONEY**  
ON FAMOUS BRAND  
NATIONALLY ADVERTISED  
**STEREO COMPONENTS,  
VIDEO & PROFESSIONAL  
PRODUCTS EQUIPMENT**  
WRITE TODAY FOR OUR QUOTE AND  
OUR COMPLETE PRICE CATALOG.  
FAST DELIVERY IN FACTORY SEALED CARTONS  
**FOR IMMEDIATE QUOTE**  
CALL (202) 723-6060  
THE COST OF YOUR CALL WILL BE DEDUCTED  
FROM ANY ORDER OVER \$200.00.

**A.D.R. VIDEO**  
6200 CHILLUM PLACE N.W.  
WASHINGTON, D.C. 20011

Master Charge / BankAmericard Honored on Mail Orders

CIRCLE NO. 1 ON READER SERVICE CARD



## 12 REASONS YOUR CAR NEEDS TIGER CDI

Instant starting in any weather - Eliminates tune-ups - Increases gas mileage - Increases horsepower 15% - Improves acceleration and performance - Spark plugs last up to 70,000 miles - Reduces engine maintenance expense - Amplifies spark plug voltage to 45,000 volts - Maintains spark plug voltage to 10,000 RPM - Reduces exhaust emissions - Dual ignition switch - An Unconditional LIFETIME GUARANTEE Installs in 10 minutes on any car with 12 volt negative ground - No rewiring - Most powerful, efficient and reliable Solid State Ignition made.

SATISFACTION GUARANTEED or money back

TIGER 500 assembled ..... \$53.95  
TIGER SST assembled ..... \$42.95  
Post Paid in U.S.A.

Send check or money order with order to:

**Tri-Star Corporation**  
P. O. Box 1727 C  
Grand Junction, Colorado 81501

DEALER INQUIRIES INVITED

CIRCLE NO. 51 ON READER SERVICE CARD

Except for single-transistor circuits used, typically, in headphone boosters, the simplest design today is one using a complete audio amplifier IC. Monolithic and hybrid devices are available furnishing outputs of from a fraction of a watt to a hundred or more watts and requiring a minimum of external components. A typical general-purpose audio amplifier featuring a single IC is illustrated in Fig. 1. One of several designs presented in a booklet published by the IC's manufacturer, SGS-ATES Semiconductor Corp. (435 Newtonville Ave., Newtonville, MA 02160), this circuit is suitable for a variety of projects ranging from a phonograph to a signal tracer. The rated power output is 2.2 W with an 18-volt dc power source and 4.0 W if a 24-volt source is used. The -3 dB bandwidth, exclusive of speaker, is 300 kHz and the voltage gain is 34 dB.

In operation, *R1* (audio taper) serves as the gain control and input bias return. Low frequency roll-off is determined by series resistor *R2* in conjunction with capacitor *C3*. The loudspeaker is coupled to the IC's output terminal through dc blocking capacitor *C2*. Circuit power is supplied by an external source, either batteries or a line-operated supply, controlled by *S1*, with additional filtering provided by *C1*.

Commercially available components are specified for the circuit. The IC is an SGS-ATES type TAA 621 A12, comprising seventeen transistors and seven integral resistors.

Priced at less than two dollars each, net, in unit quantities, the TAA 621 A12 is supplied in a 14-pin quad in-line (staggered terminal) package.

Turning from the simple to the sophisticated, the high-fidelity power amplifier circuit shown in Fig. 2 should appeal to more experienced hobbyists. Featuring discrete compo-

nents and a full complementary-symmetry output stage using a pair of high-gain npn (RCA 1B07) and pnp (RCA 1B08) Darlington transistors, the circuit was abstracted from RCA Technical Specification Bulletin 791. The amplifier is designed to deliver 40 watts to a 4-ohm loudspeaker or 30 watts to an 8-ohm load. With a sensitivity of 500 mV, it is suitable for use with virtually all standard preamps. According to RCA (Solid State Division, Somerville, NJ 08876), the amplifier has a THD specification of only 0.5%, an IM distortion level (at 10 dB below continuous power output at 60 Hz and 7 kHz, 4:1 ratio) of less than 0.2%, and an IHF power bandwidth at 3 dB below rated power of 5 Hz to 50 kHz. At a 1-W output, the bandwidth is 5 Hz to 100 kHz. Other performance specifications are an input impedance of 18,000 ohms, and a hum/noise rating 100 dB below the continuous power output with the input shorted.

A pair of npn transistors in conjunction with diodes *D3* and *D4* form an input differential amplifier, supplied by a third npn device which, in conjunction with *D1* and *D2*, forms a current source. The input amplifier is direct-coupled to a pair of pnp transistors serving as a class-A differential pre-driver. An npn multiplier balances the drive to the complementary-symmetry output stage, which consists of a pair of npn and pnp high-gain Darlington transistors. Another npn transistor, with *D5* and *D6*, serves as a current source for the multiplier and part of the pre-driver stage. Drive overload protection is provided by an npn and pnp complementary pair in conjunction with *D7* through *D10*. Feedback is applied to one side of the input differential amplifier stage through a frequency conscious network consisting of a 15,000-ohm resistor in series with a 560-ohm resistor and 100- $\mu$ F capacitor. Finally, the loudspeaker

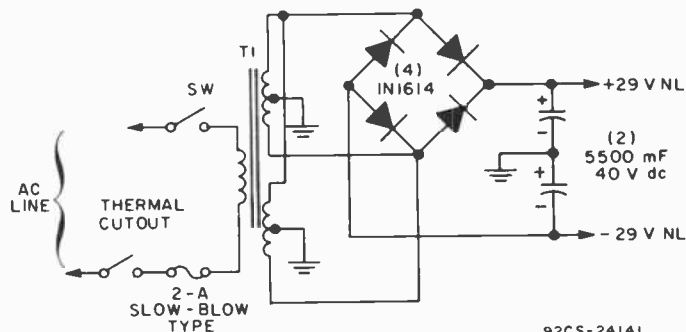

92CS-24141

Fig. 3. Suggested power supply for circuit in Fig. 2.

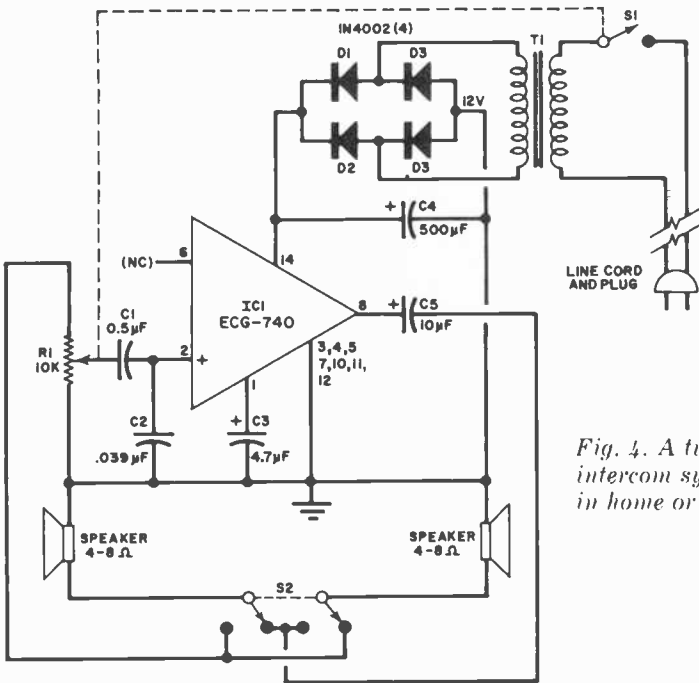
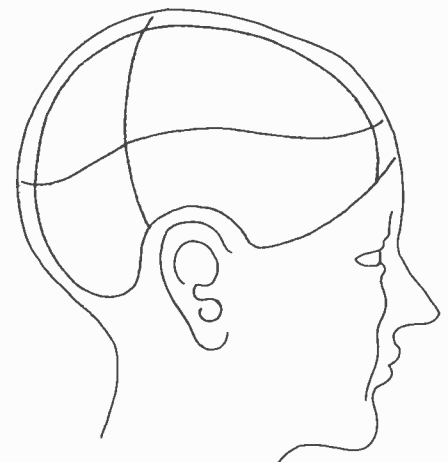

Fig. 4. A two-station intercom system for use in home or office.



# 'GET INTO YOURSELF'

## Discover your Alpha Brainwaves with this professional Biofeedback System.

### Lowest Cost Brainwave Monitor

EICO introduces a price breakthrough in the fantastic new field of brainwave biofeedback... a completely safe, battery operated, biofeedback system that offers features and sensitivity comparable to professional models costing much more.

### You Will Be Amazed At What You Hear

The BW-300 will detect your alpha brainwaves (which occur when you are totally relaxed) and produce a tone varying in frequency according to your mental state.

### 100% Solid State Circuitry

Reliable All Solid State IC Circuit Design features an active filter that isolates alpha brainwaves and a high-gain low-noise amplifier providing 5-microvolt sensitivity for easy alpha recognition. The BW-300 is supplied with stethoscopic earphones, electrodes headband, contact cream and instructions.

**KIT 3495**  
WIRED 59.95

## FREE EICO CATALOG

For latest EICO Catalog on Test Instruments, Automotive and Hobby Electronics, Eicocraft Project kits, Burglar-Fire Alarm Systems and name of nearest EICO Distributor, check reader service card or send 50¢ for fast first class mail service.

EICO—283 Malta Street, Brooklyn, N.Y. 11207

Leadership in creative electronics



CIRCLE NO. 23 ON READER SERVICE CARD

load is driven through a 22-ohm resistor shunted by a 2- $\mu$ H coil.

The Darlington output transistors featured in the amplifier are silicon devices packaged in type TO-3 cases. Both have a maximum  $V_{(BO)}$  rating of 80 volts, maximum collector current ratings of 10 amperes, and device dissipation ratings (up to 25°C) of 100 watts. Their dc beta (gain) values are specified at not less than 1000 nor more than 15,000.

A line-operated dc power supply circuit suitable for the amplifier is illustrated in Fig. 3.

RCA has specified standard components for the design. All resistors should be noninductive and, except where indicated, 1/2-watt, 10% tolerance types. Except for the power supply, where type 1N1614 is used, all diodes are type 1N5391. The thermal cutout should be rated to open at 90°C. The power supply transformer is a Signal Model 80-4 (Signal Transformer Co., 1 Junius St., Brooklyn, NY 11212).

Because of the power and gain levels involved, good audio layout and wiring practice should be observed. An adequate common heat sink should be provided for the Darlington output transistors.

**Reader's Circuit.** Mistakes can happen. A slip of a typewriter key, and Craig K. Sellen (48 Briarwood Road, Wayne, NJ 07470), who contributed the slow-sweep wiper control circuit featured in our April column, became Craig S. Kelleem. Apparently all is forgiven, however, for Craig has submitted

another circuit which, I feel, is especially appropriate to our discussion of audio amplifiers—the two station intercom illustrated in Fig. 4. Suitable for use in a home, small office or store, the project is inexpensive, requiring relatively few components, and could be assembled by most hobbyists in two or three evenings or on a weekend.

Small PM loudspeakers are used interchangeably as both microphones and output devices, while a single 2.5-watt IC serves as the complete amplifier. Potentiometer  $R1$  acts as the unit's gain (volume) control,  $C1$  as the input coupling capacitor,  $C5$  as the output dc blocking capacitor, and  $C2$  and  $C3$  as the input and amplifier bypass capacitors, respectively. A dpdt switch,  $S2$ , interchanges the loudspeaker input and output connections, providing a "talk-listen" capability. Operating power is furnished by a line-operated dc power supply, comprising power switch  $S1$ , step-down transformer  $T1$ , bridge rectifier  $D1$  through  $D4$ , and ripple filter capacitor  $C4$ .

Craig has specified readily available components for his project. The integrated circuit,  $IC1$ , is a Sylvania type ECG-740, while the gain control is an audio-taper potentiometer with an attached spst rotary switch,  $S1$ . Input capacitor  $C1$  and high-frequency bypass capacitor  $C2$  are small ceramic or plastic film types, while the remaining capacitors,  $C3$ ,  $C4$  and  $C5$ , are 20-volt electrolytics.

Layout and lead dress are not overly critical but good wiring practice

should be observed. One loud-speaker is mounted in the cabinet with the amplifier, power supply and controls, while the second is mounted in a separate cabinet for the remote location and connected to the amplifier using a length of two-conductor intercom wire or ordinary lamp cord.

**Device/Product News.** A unique device suitable for use in active filters, tone generators, selective audio amplifiers, medical electronic instruments and signal processing equipment has been introduced by Amperex Elec-

tronic Corp. (Solid State and Active Devices Division, Slatersville, RI 02876). Designated type ATF431, Amperex's new device is the industry's first practical audio frequency IC *gyrator*. In case you've forgotten, a gyrator is a circuit configuration which is inherently capable of inverting impedances. When terminated by a capacitive load, it presents a corresponding inductive input impedance. Thus, a gyrator may be used to obtain relatively high inductance values in comparatively small volumes. For example, the ATF-431 and a 0.1- $\mu$ F

capacitor combine to produce 5.625 H. Circuit Q's of over 500 can be realized in practice. A thin-film hybrid device consisting of dual monolithic wideband differential amplifiers and four 0.1% film resistors, the ATF431 is supplied in a 10-lead hermetically sealed TO-100 package.

Two new series of 8-ampere npn silicon Darlington transistors have been announced by RCA's Solid State Division. Consisting of eight devices, type numbers 2N6530-2N6533 and 2N6534-2N6537, these new units offer a choice of  $V_{CE0}$  ratings of 80, 100, or 120 volts and  $h_{FE}$  of 500 or 1000 min. at 3 or 5 amperes. Types 2N6530-2N6533 have device dissipation ratings of 65 watts and are supplied in the TO-220AB straight-lead version of the Versawatt package, while types 2N6534-2N6537 have dissipation ratings of 36 watts and are supplied in TO-66 hermetic packages.

The Fairchild Camera & Instrument Corporation (Integrated Circuits Group, 464 Ellis St., Mountain View, CA 94042) has added a new 7-segment LED decoder/driver to its 9300 TTL family. A BCD-to-7-segment decoder with constant-current sink outputs, the 9374 has low-power latched inputs which can be driven easily from all TTL as well as most MOS and CMOS devices. The unit's 15-mA constant-current outputs can drive virtually all common-anode (MAN-1 type) LED displays directly without the need for external resistors. The device's input latch and low input load currents permit simplified multiplexed display systems, while its constant-current output allows the LED anode supply voltage to be varied between 2.5 and 10 volts without affecting display brightness.

A new series of infrared LED's suitable for use in control systems, intrusion alarms, automatic door openers, interrupted beam counters, and similar projects has been announced by GE's Semiconductor Products Department (Electronics Park, Bldg. No. 7, Mail Drop 49, Syracuse, NY 13201). Identified as the LED55 and LED56 series, the new devices are gallium-arsenide diodes which emit non-coherent infrared energy with a peak wavelength of 940 nanometers and are ideally suited for use with silicon detectors. Packaged in hermetically sealed cases with either flat or lens cap configurations, the units may be used as replacements for the earlier SSL55 and SSL56 devices.  $\diamond$

## Expensive reasons.

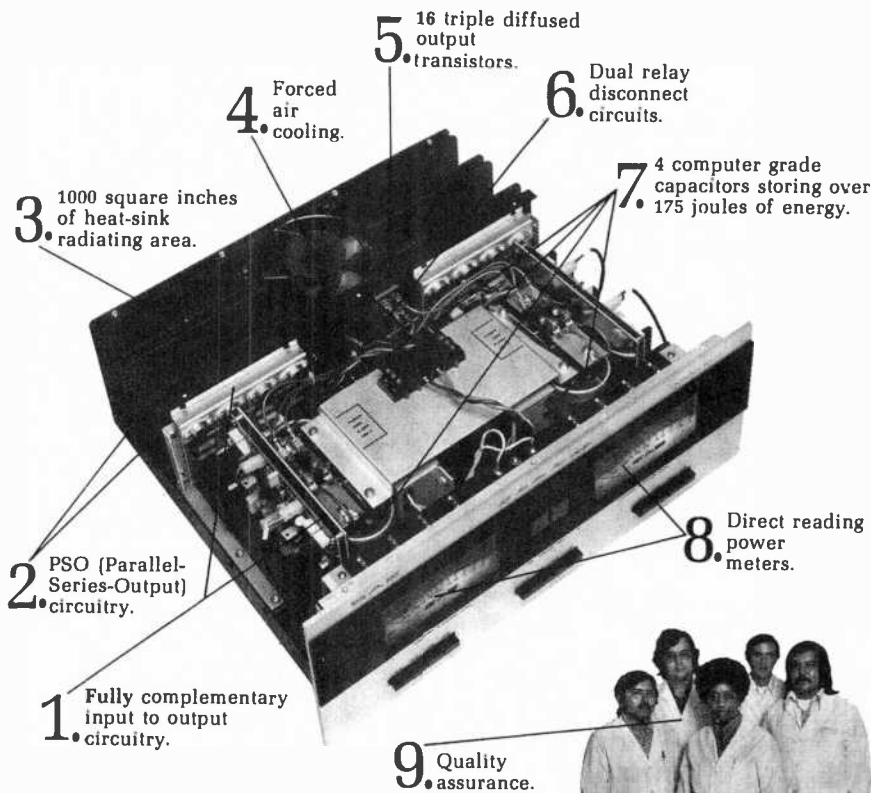

If you're going to invest \$1250 in a stereo power amplifier like our new Mark XXV there had better be good reasons.

We have built all of the above expensive reasons and more into our Mark XXV. So many, in fact, that this new amplifier

heralds a new era of amplifier design. Write us, and we'll send you all the good reasons why you'll

**get what you pay for.**

### Components for the Connoisseur



Scientific Audio Electronics, Inc.  
P.O. Box 60271 Terminal Annex, Los Angeles, California 90060

Please send some more good reasons for the Mark XXV.

Name \_\_\_\_\_

Address \_\_\_\_\_

City \_\_\_\_\_ State \_\_\_\_\_ Zip \_\_\_\_\_



Mark XXV



Model 2500 (Professional Version)

You can gain new skills as an electronics troubleshooter in a fascinating learn-at-home program from Bell & Howell Schools that includes building and experimenting with the new generation color TV.

# go exploring.



If you're like most men, deep down inside there's still a bit of the boy who loved to go exploring...and who'd love to go again.

Well, now you can.

Only this time you'll explore the expanding world of electronics...a world more fascinating than any you ever dreamed of as a boy.

Learn by exploring...Bell & Howell offers an exciting way for you to gain new occupational skills in electronics.

Everybody enjoys learning something new, but why learn it the old way? Classes to go to. Lectures to sit through. Teachers looking over your shoulder. And only a bunch of books to keep you interested.

Bell & Howell Schools' adventure in learning is a far cry from all that.

First of all, you'll be able to probe into electronics and learn exciting new skills right in your own home, in your spare time. On whatever days and whatever hours you choose. That means there'll be no conflicts with your other interests and, more importantly, no need to give up your present job and paycheck just because you'd like to learn new occupational skills. Secondly, we believe that when you're exploring a field as fascinating as electronics, reading about it is just not enough. That's why throughout this program you'll get lots of "hands on" experience with some of today's latest electronic training tools. And we, for one, think the best tools make the best teachers.

over please >

DETACH HERE AND MAIL TODAY

## FULL DETAILS!

Building Bell & Howell's 25" diagonal color TV—and the exclusive electronics lab—sounds like a great idea! I want complete information about this learn-at-home color TV program employing digital electronics. Taken for vocational purposes, this program is approved by the state approval agency for Veterans' Benefits. Check here for information

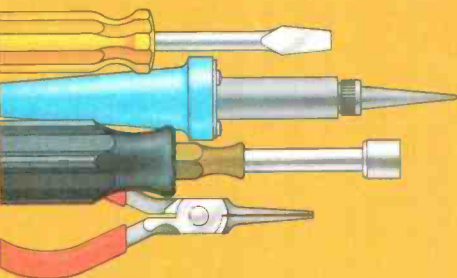

Name (please print)

Address

City State Zip

Telephone Age

Mail the postage-free card today for full details!

1-5A0135B

**Mail  
card  
today!**



You'll be stimulated for hours on end as you build, experiment, and learn while using the latest ideas and techniques in this fascinating field.

As part of the program you'll actually learn to build and work with your own electronics laboratory. Then you'll use the lab to put many of today's most dynamic electronic theories to the test.

You'll delve into the applications of electronic miniaturization, discovering how the development of tiny integrated circuits has made possible innovations such as an electronic calculator small enough to fit into a shirt pocket! Or digital display wrist-watches where you press a button and the time flashes on in digits.

You'll investigate the concept of "logic circuits." An idea that has been with us for centuries but only in recent years put to use as the "brain" behind all the new digital consumer appliances we see today.

But most important of all will be the new skills you'll develop all along the way... the kind of skills that could lead you in exciting new directions. While we cannot offer assurance of income opportunities, once you've completed the program you can use your training:

1. To seek out a job in the electronics industry.
2. To upgrade your current job.
3. As a foundation for advanced programs in electronics.

You build and perform many exciting experiments with Bell & Howell's Electro-Lab®, an exclusive electronics training system.

Using our successful step-by-step method, you'll build the following:

1. A design console, for setting up and examining circuits.
2. A digital multimeter for measuring voltage, resistance and current (it displays its findings in big, clear numbers like on a digital clock).
3. A solid-state "triggered sweep" oscilloscope—similar in principle to the kind used in hospital operating rooms to monitor heartbeats. You'll use it to monitor the "heartbeats" of tiny integrated circuits. The "triggered sweep" feature locks in signals for easier observation.

Step-by-step you'll build and work with Bell & Howell's new generation color TV—investigating digital features you've probably never seen before!

Here is one of the outstanding contributions of digital electronics to home entertainment. You'll build, experiment and learn from it.

This 25" diagonal color TV has digital features that are likely to appear on all TV's of the future. Features made possible by recent applications of digital electronics.

You'll probe into the technology behind all-electronic tuning. And into the digital circuitry of channel numbers that appear big and clear, right on the screen! You'll also build-in a remarkable on-the-screen digital clock, that will flash the time in hours, minutes and seconds. Your new skills will enable you to program a special automatic channel selector to skip over "dead" channels and go directly to the channels of your choice.

You'll also gain a better understanding of the exceptional color clarity of the Black Matrix picture tube, as well as a working knowledge of "state of the art" integrated circuitry and the 100% solid-state chassis.

And having actually built and experimented with this TV, you'll come away equipped with the kinds of skills that could put you ahead of the field in electronics know-how.

We try to give more personal attention than any other learn-at-home program.

1. Toll-free phone-in assistance. The program is designed so that you can proceed through it smoothly, step-by-step. However, should you ever run into a rough spot, we'll be there to help. Many schools make you mail in all your questions. We have a toll-free line you can call when you have a question that can't wait.
2. In-person "help sessions." These are held in 50 major cities at various times throughout the year where you can talk shop with your instructors and fellow students.

No electronics background needed.

What you really need is the thing you've never lost: a boy's love for exploring. Now you can go again, only this time learning new occupational skills all along the way. Mail the postage-paid card today for more details!



"Electro-Lab®" is a registered trademark of the Bell & Howell Company.

Simulated TV Test Pattern

700 R2

An Electronics Home Study School  
DEVRY INSTITUTE OF TECHNOLOGY



ONE OF THE  
**BELL & HOWELL SCHOOLS**

4141 Belmont, Chicago, Illinois 60641

First Class  
Permit No. 4148  
Chicago, Ill.

Business Reply Mail  
No Postage Stamp Necessary if Mailed in the United States

Postage will be paid by



DEVRY INSTITUTE OF TECHNOLOGY  
ONE OF THE

**BELL & HOWELL SCHOOLS**

4141 Belmont Avenue,  
Chicago, Illinois 60641



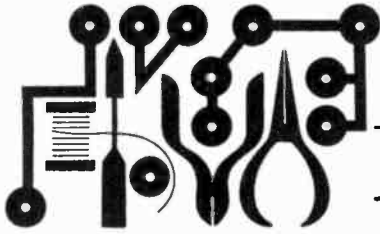

# Hobby Scene

## DARK-ON LIGHT

**Q.** I would like to have incandescent lights around my home which will turn on at dusk and off at dawn. Can you provide me with a circuit?

—E. Cassidy, Los Angeles, Calif.

**A.** The circuit shown will handle up to 1000 W of power. The selection of photocell PC is not critical, and any of the experimenter-type CdS cells should work. The light level at which the circuit changes states can be selected by varying the potentiometer. (Its value is not critical, and will depend on the photocell used. Check

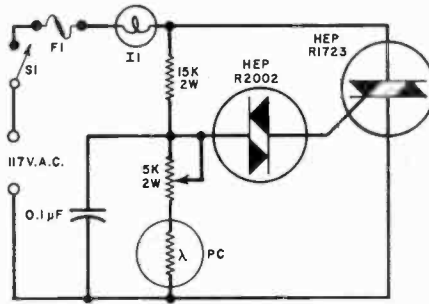

your junk box.) If more than one bulb (11) will be used, wire them in parallel. Choose the rating of the fuse to agree with the total load requirement. Be sure to adequately heat-sink the triac.

## OUTDOOR ANTENNA COUPLING

**Q.** How can I couple an outdoor antenna to a table-model transistor AM radio to increase its receiving range? —George Kalenchuk, Saskatchewan, Canada

**A.** The easiest way is by inductive means. At the receiver end of the lead-in, wind a husky coil of wire (ferrite

forms can be used) and position it close to the ferrite bar or air-core antenna on the back (or inside) of the set. If a directional external antenna is being used, make sure that the built-in antenna is facing the same direction, or you'll have to put the two coils inside a small shielded enclosure to avoid pickup from other directions.

## AUDIO-OPERATED RELAY

**Q.** Do you have a circuit for a simple voice- or sound-controlled relay?—J. Lengenfelder, Trenton, N.J.

**A.** The circuit shown here will perform this function. The Radio Shack 275-004 relay is used. Its contacts can handle 1 ampere at 125 V ac. The

diode across the coil protects the transistor from inductive surges. An SCR or triac can be used instead of the relay and the switching transistor if solid-state switching is more desirable. Also, an active filter (bandpass) could be inserted at the FET output if you want to activate the circuit with only one specific tone.

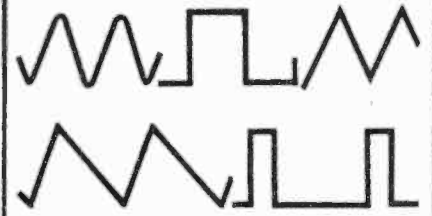
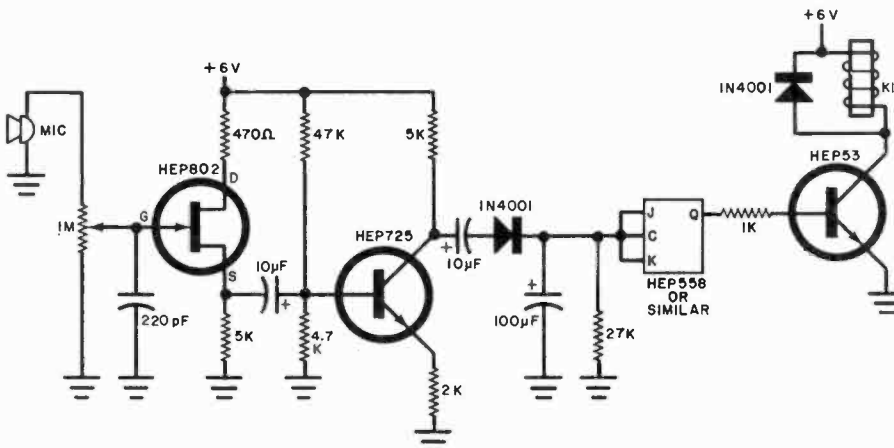

0.1 Hz. to 100 KHz.



For only \$39.95

Our new FG-2 Function Generator kit gives you all five of the most useful waveforms for design and testing at one fourth the cost of previous similar instruments. Thanks to improved IC's the FG-2 now features amplitude stability of  $\pm 1$  db over any range, Sine wave distortion of less than 1% from 20 Hz. to 20,000 Hz. and an output of 4.0 Volts peak-to-peak with adjustable offset. The offset selector lets you put the positive peak, negative peak, or the center of the waveform on DC ground. The DC coupled circuit keeps the waveforms in exactly the same position no matter what the level control setting.

Gray impact plastic case 5 1/4 x 6 3/4 x 2 1/2. 115 Volts 60 cycle power supply included.

FG-2 Function Generator Kit shipping weight 3.0 lbs.....\$39.95 PPd

GET OUR  
**NEW 1975  
CATALOG**

listing this and other unique kits

**"FREE"**

by simply circling our number on the reader service card.

 SOUTHWEST TECHNICAL PRODUCTS CORPORATION

DEPT. PE

219 W. Rhapsody  
San Antonio, Texas 78216

# MACHINE LANGUAGE PROGRAMMING

FOR THE 8008

(AND SIMILAR MICROCOMPUTERS)

Written to provide you with the detailed knowledge you need to know in order to successfully develop your own MACHINE LANGUAGE PROGRAMS! Coverage includes:

- DETAILED PRESENTATION OF THE '8008' INSTRUCTION SET ●
- FUNDAMENTAL PROGRAMMING TECHNIQUES ●
- ORGANIZING TABLES ●
- SEARCH AND SORT ROUTINES ●
- MATHEMATICAL OPERATIONS ●
- FLOATING POINT PACKAGE ●
- MAXIMIZING MEMORY UTILIZATION ●
- I/O PROGRAMMING ●
- REAL-TIME PROGRAMMING ●
- CREATIVE PROGRAMMING CONCEPTS

Virtually all techniques and routines illustrated also applicable to '8080' and similar types of micro/minicomputers, with appropriate machine code substitution. Orders now being accepted for immediate delivery at the LOW price of just \$19.95.\* Add \$3.00 if PRIORITY mailing service desired. (\*Domestic prices.) Order direct from -

**SCELBI COMPUTER CONSULTING, INC.**  
DEPT. PEA  
1322 Rear - Boston Post Road  
Milford, Connecticut 06460

MASTERCHARGE ACCEPTED. MASTERCHARGE customers must submit Card #, Bank #, Expiration Date, and card holder's personal signature.

**DON'T DELAY - ORDER TODAY!**  
CIRCLE NO. 45 ON READER SERVICE CARD

## Planning to move?

Let us know 8 weeks in advance so that you won't miss a single issue of **POPULAR ELECTRONICS**.

Attach old label where indicated and print new address in space provided. Also include your mailing label whenever you write concerning your subscription. It helps us serve you promptly. Write to: P.O. Box 2774, Boulder, CO 80302, giving the following information:

Change address only.

- Extend subscription.  Enter new subscription.  
 1 year \$6.98  
 Payment enclosed (1 extra BONUS issue)  
 Bill me later

AFFIX LABEL

If you have no label handy, print OLD address here.

name      please print  
address  
city      state      zip code

name      please print      0175  
address  
city      state      zip code

Add'l postage per year: Add \$1 for Canada; \$2 for all other countries outside the U.S.

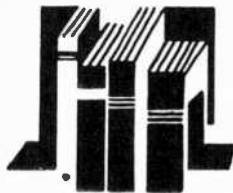

## Electronics Library

### A FLICK OF THE SWITCH 1930-1950

by Morgan E. McMahon

A words-and-picture tour of the "Golden Era of Radio." Aimed at both nostalgia fans and collectors, the book contains information on broadcasting fare, old radio receivers, early television sets, shipboard radios, and ham stations. Principal manufacturers are listed alphabetically, and products that show promise of becoming collector items are illustrated, described by year, price, number of tubes, type of circuitry, and many by the number of units made. Separate chapters are also devoted to WW2 military equipment, the radioman, collecting, and how it works. The text is well illustrated, and includes old advertisements.

Published by *Vintage Radio*, Box 2045, Palos Verdes Peninsula, CA 90274. 312 pages. \$9.95 hard cover, \$6.95 soft cover.

### INSTALLING TV & FM ANTENNAS

by Leo Sands

Here's a reference work for those who wish to learn not only how to fasten an antenna so it will stay upright, but also how to make the most of available signals. Basic propagation characteristics are discussed, as well as representative antenna configurations. Transmission lines, lightning protection, and types of hardware available are also treated. Installation procedures for maritime and mobile TV antennas are outlined, and urban and suburban installations are described.

Published by *Tab Books*, Blue Ridge Summit, Pa. 17214. 168 pages. \$7.95 hardcover, \$3.95 paperback.

### SOLID STATE COMPONENTS

by Rufus Turner

Solid-state devices have virtually taken over many functions previously performed by vacuum tubes. For those who want to know what these devices are, how they work, and what they can do, this book will be of interest. It covers not only semiconductor devices (transistors, diodes, and IC's) but also devices in which the significant action takes place in other solid materials, such as memorycores and piezoelectric crystals. Cross-references to related terms are included. Illustrations include pictorials of devices, circuit diagrams, and characteristic curves.

Published by *Howard W. Sams & Co.*, 4300 W. 62nd Street, Indianapolis, Ind. 46206. 96 pages. \$3.95 softbound.

### SERVICING ZENITH FDR 1974/1975 SERVICING RCA FOR 1975

by Stan Prentiss

These first volumes of a new series contain full servicing information on each company's entire line of consumer electronics products for the appropriate years. Based on manufacturer's information, these Audel manuals cover color and monochrome television receivers, stereo equipment, tape recorders, and small radios. Each includes fold-out schematics, parts lists, scope waveforms, troubleshooting guides, adjustment and alignment procedures, and chassis layouts. In the Zenith manual, operating theory of the FC45 color TV line is discussed, and a wide-ranging solid-state servicing section is partly based on Zenith's 20-week training course available to all technicians. Also, an entire chapter is devoted to the functional aspects of the oscilloscope, while much of another chapter covers new stereo circuitry (including FM) and four-channel decoding systems. The RCA manual follows the same format, and covers some of its 1974 line. Test instruments such as DMM's, function generators, and color-bar generators, are described in one chapter. Another chapter examines IC's (including complete circuit descriptions), modules and motherboards.

Published by *Theodore Audel & Co., Div. of Howard W. Sams & Co.*, 4300 W. 62nd St., Indianapolis, IN 46206. 527 pages (Zenith, not counting foldouts), 384 pages (RCA, not counting foldouts). \$12.95 each, soft cover.

### DIGITAL DESIGN WITH STANDARD MSI AND LSI

by Thomas Blakeslee

This book gives a thorough design approach to today's MSI and LSI circuits. It shows how to use standardized bargain components to handle many system requirements and how these building blocks can be traded off with other mechanical and electrical components for optimum results. Programmed logic and programming techniques are provided, with description of hardware and software for the Intel and National Semiconductor microprocessors.

Published by *John Wiley & Sons, Inc.*, 605 Third Ave., New York, NY 10016. 357 pages. \$19.95 hard cover.

### SYLVANIA ECG SEMICONDUCTOR GUIDE

GTE Sylvania's ECG<sup>®</sup> line of replacement semiconductors is presented in this catalog and cross-reference. The book provides replacement considerations, specifications, biasing, and outline drawings of the ECG products as well as a replacement directory which cross-references almost 106,000 JEDEC types and manufacturers' part numbers to the replacement devices.

Published by *GTE Sylvania Inc., Electronic Components Group*, 100 First Ave., Waltham, MA 02154. 214 pages. \$2.95 soft cover.



# The Monster



## The new BA 5000 Power Amplifier from Sansui

The most dramatic component in Sansui's new "DEFINITION" Series, the BA 5000 solid-state power amplifier is capable of 300 watts min rms per channel into 8 ohms, both channels driven, from 20 to 20,000 Hz, with no more than 0.1% harmonic distortion in the stereo mode. What's more, the BA 5000 can be strapped for mono operation to deliver 600 watts rms under the same conditions.

A true monster amplifier.

But that's not all. Unlike other solid-state amplifiers, the BA 5000 has a huge, laboratory-quality output transformer, enabling it to deliver rated power into 2, 4 or 8 ohms plus 25 volt line

output in stereo and 4, 8 or 16 ohms plus 70 volt line output in mono. A rating of 600 watts into a 16 ohm distortion, 20 to 20,000 Hz, is simply unprecedented in transistor equipment.

The "DEFINITION" series also includes the BA 3000, our Junior Monster, and the CA 3000 a very high quality, low distortion preamplifier.

For professionals, sophisticated audiophiles and monster lovers everywhere. See it and touch it if you wish at your nearest Sansui franchised dealer or write for complete literature.

### SANSUI ELECTRONICS CORP.

Woodside, New York 11377 • Gardena, California 90247  
SANSUI ELECTRIC CO. LTD. Tokyo, Japan • SANSUI AUDIO EUROPE S.A. Antwerp, Belgium  
ELECTRONIC DISTRIBUTORS (Canada) B.C.

CIRCLE NO. 52 ON READER SERVICE CARD



# LIVE IN THE WORLD OF TOMORROW... TODAY!

And our FREE 180 PAGE CATALOG is packed with exciting and unusual values in electronic, hobby and science items — plus 4,500 finds for fun, study or profit... for every member of the family.

## A BETTER LIFE STARTS HERE

### He-Ne LASERS FROM \$115.00

Edmund quality. TEMoo mode, cold cathode for long life. Completely self-contained units; solid state power supply; 110v AC. 0.3mW min — GREAT GENERAL PURPOSE LASER: 1.2mm beam dia., 2.0mRad beam Diverg.

- Stock No. 79,061AV ..... \$115.00 Ppd.  
1.0mW min — HI-PERFORMANCE LAB LASER: 1.2mm beam dia., 1.0mRad beam Diverg.
- Stock No. 79,050AV ..... \$180.00 Ppd.  
3.0mW min — PENDABLE HI-POWERED LASER: 1.0mm beam dia., 0.8mRad beam Diverg.
- Stock No. 79,052AV ..... \$350.00 Ppd.

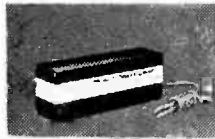

### The MOST POWERFUL SOLAR CELL!

World's biggest (3" dia.), strongest silicon cell delivers over 1 amp. @ .5v D.C. or 1/2W. 5 times more efficient per cost than ever before! Only 1 mil thick. Tab leads for any circuit, 100's of applications. Hook in series for more voltage; parallel—more current. Real breakthrough!

- No. 42,270AV ..... \$19.95 Ppd.  
2" DIA. 500 mA. @ .5v
- No. 42,145AV ..... \$9.95 Ppd.  
PIE-SHAPED 1/4 2" DIA. 100 mA. @ .5v
- No. 42,146AV ..... \$5.50 Ppd.

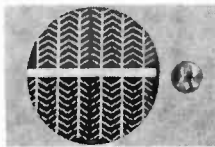

### PRO ELECTRONIC SOUND CATCHER

Parabolic mike w/ 18-3/4" reflecting shield & 2 I.C.'s in amplifier magnifies signals 100X that of omni-directional mikes. Catch a songbird 1/2 mile off; QB's huddle strategy; sounds never before heard. Super directivity gives highest signal to noise ratio poss. Safe: auto. cuts off ear damaging noises. Earphones, tape recorder output, tripod socket. Req. two 9v trans. batt. (not incl).

- No. 1649AV ... (5 1/2 LB.) ..... \$299.00 Ppd.
- BIG EAR "TOY" MODEL #80,176AV ..... \$32.25 Ppd.



### SUPER POWER FOR ANY AM RADIO

New antenna assist turns a tiny transistor into a tiger, has pulled in stations 1000 miles away! Just set it beside your radio (no wires, clips, grounding) and fine-tune Select-A-Tenna's dial to same frequency — "Gangbusters"! Terrific for sportsmen, vacationers. Great for clearing weak signals in radio-depressed area, off-coast islands, stations in crowded frequencies. Solid state—uses no electricity, batts., tubes. Works almost forever.

- Stock No. 72,095AV ..... \$15.95 Ppd.



WHEN YOU COME TO PHILADELPHIA BE SURE TO SEE  
**FREE BICENTENNIAL LIGHT SHOW**  
IN BARRINGTON, N.J. ONLY 10 MINUTES AWAY AT  
**EDMUND FACTORY STORE**

### "POP" YOUR OWN BUTTONS

Make customized badges in minutes! Create your own, reproduce photos with name affixed. Great anywhere, from kindergarten to business meetings, to school sports. Sell for profit! Ingenious badge machine makes permanent buttons; kit includes precision cast hand die press, matching color dies, starter asst. for 25 complete badges including plastic protectors. Sold nationally for several dollars each, yours will pay off fast. Step-by-step instrs.

- Stock No. 71,974AV ..... \$31.50 Ppd.
- 100 EXTRA BADGE PARTS  
Stock No. 71,976AV ..... \$13.50 Ppd.



### AN ALPHA MONITOR FOR \$34.95?

Yes, because you build it! Use your ability to tune in your brainwaves, an aid to relaxation, concentration. Kit incl. everything you need (except 9v trans. batt.) to own a portable self-cont. BIOFEEDBACK unit for a pitance: steth. earphones, electrode headband, solid-state circuitry; 5 microvolt sensitivity, more! Compl. assembly instructions & op. manual. With basic electronics knowledge, you can do it!

- No. 61,069AV ... (KIT) ..... \$34.95 Ppd.
- No. 71,809AV ... (FULLY ASSEMBLED) ..... \$55.00 Ppd.



### BUILD A SOLAR HOME AND SAVE!

Beat the energy crisis—build a modern 10 room solar heated & air conditioned home designed by famous ecological architect Malcolm B. Wells! Its 10-yr.-proven Thomason "Solaris System" can cut conventional heating costs as much as 2/3! Your builder can modify or use as-is the complete blueprints included with "Solar House Plans III" (by Edmund, Homan Thomason & Wells). Estimated \$40,000 building cost. 48-pg book shows all pro's and cons. Illustr.

- No. 9469AV ... (8 1/2 x 11" PPRBK) ..... \$24.95 Ppd.



### WHICH ARE YOUR CRITICAL DAYS?

Can Bio-rhythm tell you? We're not sure, but we're told that vast mood shifts are caused by your body's Internal Time Clock whose rhythms can be charted ahead to possibly warn you of "critical" days. Some are great, some blah. Maybe it's your physical, emotional & Intellectual rhythms converging at the right or wrong time. Compute your cycles with our Bio-rhythm kit and judge for yourself. Incl. Charting kit, metal Dialgraft Calc., instrs.

- Stock No. 71,949AV ..... \$11.50 Ppd.
- 1 YR. PERSONALIZED REPORT BY COMPUTER  
Stock No. 19,200AV ... (send Birthdate) ..... \$15.95 Ppd.



### CAN'T SLEEP, RELAX? TRY THIS!

Electronic sound conditioner simulates 4 kinds of soothing sounds of ocean surf and rain. "White sound" helps mask unwanted noise, adds restful, intriguing background sound. Program the solid-state unit to your own need: 2 surf, 2 rain; or "white sound", proven by medical tests to have analgesic effects. Great for meditation, restlessness, sleeplessness psychology.

- (A)-No. 71,997AV ... (7 1/2 x 7 x 3 1/2") 110V AC ..... \$79.95 Ppd.
- (B)-AS ABOVE, BUT "WHITE SOUND" ONLY  
No. 71,980AV ... (6" Rd. x 3 1/2" Hi) ..... \$28.00 Ppd.

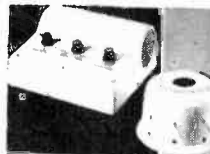

## MAIL COUPON FOR GIANT FREE CATALOG!

180 PAGES • MORE THAN 4500 UNUSUAL BARGAINS

Completely new 1975 edition. New items, categories, illustrations. Dozens of electrical and electromagnetic parts, accessories. Enormous selection of Astronomical Telescopes. Unique lighting and ecological items. Microscopes, Binoculars, Magnifiers, Magnets, Lenses, Prisms. Hard-to-get-surplus bargains. Ingenious scientific tools. 1000's of components.

**EDMUND SCIENTIFIC CO.**  
300 Edscorp Building, Barrington, N.J. 08007  
Please rush Free Giant Catalog "AV"

Name \_\_\_\_\_  
Address \_\_\_\_\_  
City \_\_\_\_\_ State \_\_\_\_\_ Zip \_\_\_\_\_

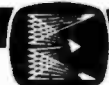

## COMPLETE & MAIL WITH CHECK OR M.O.

**EDMUND SCIENTIFIC CO.** 300 Edscorp Building, Barrington, N.J. 08007

How Many	Stock No.	Description	Price Each	Total
<input type="checkbox"/>		PLEASE SEND GIANT FREE CATALOG "AV"		
<input type="checkbox"/>		Charge my BankAmericard		
<input type="checkbox"/>		Charge my Master Charge		

Add Handling Chg.: \$1.00, Orders Under \$5.00, 50¢, Orders Over \$5.00  
Interbank No. \_\_\_\_\_  
My Card No. Is \_\_\_\_\_  
I enclose  check  money order for TOTAL \$ \_\_\_\_\_

Card Expiration Date \_\_\_\_\_ Signature \_\_\_\_\_

**30-DAY MONEY-BACK GUARANTEE.** You must be satisfied or return any purchase in 30 days for full refund. \*\$15.00 minimum  
Name \_\_\_\_\_  
Address \_\_\_\_\_  
City \_\_\_\_\_ State \_\_\_\_\_ Zip \_\_\_\_\_

# ELECTRONICS MARKET PLACE

**NON-DISPLAY CLASSIFIED: COMMERCIAL RATE:** For firms or individuals offering commercial products or services, \$1.80 per word (including name and address). Minimum order \$27.00. Payment must accompany copy except when ads are placed by accredited advertising agencies. Frequency discount; 5% for 6 months; 10% for 12 months paid in advance. **READER RATE:** For individuals with a personal item to buy or sell, \$1.10 per word (including name and address.) No minimum! Payment must accompany copy. **DISPLAY CLASSIFIED:** 1" by 1 column (2-1/4" wide), \$215.00. 2" by 1 column, \$430.00. 3" by 1 column, \$645.00. Advertiser to supply cuts. For frequency rates, please inquire.

**GENERAL INFORMATION:** First word in all ads set in bold caps at no extra charge. All copy subject to publisher's approval. All advertisers using Post Office Boxes in their addresses **MUST** supply publisher with permanent address and telephone number before ad can be run. Advertisements will not be published which advertise or promote the use of devices for the surreptitious interception of communications. Closing Date: 1st of the 2nd month preceding cover date (for example, March issue closes January 1st. Send order and remittance to **POPULAR ELECTRONICS**, One Park Avenue, New York, New York 10016, Attention: Hal Cymes.

## FOR SALE

**FREE!** Bargain Catalog—I.C.'s, LED's, readouts, fiber optics, calculators parts & kits, semiconductors, parts. Poly Paks, Box 942PE, Lynnfield, Mass. 01940.

**GOVERNMENT Surplus Receivers, Transmitters, Snooperscopes, Radios, Parts, Picture Catalog 25 cents.** Meshna, Nahant, Mass. 01908.

**LOWEST Prices Electronic Parts.** Confidential Catalog Free. KNAPP, 3174 8th Ave. S.W., Largo, Fla. 33540.

**ELECTRONIC PARTS.** semiconductors, kits. **FREE FLYER.** Large catalog \$1.00 deposit. **BIGELOW ELECTRONICS**, Bluffton, Ohio 45817.

**RADIO—T.V. Tubes—36 cents each.** Send for free catalog. Cornell, 4213 University, San Diego, Calif. 92105.

**AMATEUR SCIENTISTS, Electronics Experimenters, Science Fair Students... Construction plans—Complete, including drawings, schematics, parts list with prices and sources... Robot Man — Psychedelic shows — Lasers — Emotion/Lie Detector — Touch Tone Dial — Quadraphonic Adapter — Transistorized Ignition — Burglar Alarm — Sound Meter... over 60 items.** Send 50 cents coin (no stamps) for complete catalog. Technical Writers Group, Box 5994, University Station, Raleigh, N.C. 27607.

**METERS—Surplus, new used, panel or portable.** Send for list. Hanchett, Box 5577, Riverside, CA 92507.

**WE SELL CONSTRUCTION PLANS. TELEPHONE: Answering Machine, Speakerphone, Carphone, Phonevision, Auto Dialer, Touch Button Dialer, Central Dial System. TELEVISION: \$35.00 Color Converter, Video Tape Recorder. \$25.00 Camera. HOBBYIST: Electron Microscope, 96 Hour Tape Music System, Ultrasonic Dishwasher, Radar-Oven, Plans \$4.95 each. NEW ITEM: \$75. Electronic Pocket Calculator, \$7.50. COURSES: Telephone Engineering \$39.50. Detective Electronics \$22.50. Integrated Circuit Engineering, \$49.50. NEW SUPER HOBBY CATALOG plus year's subscription to Electronic News Letter AIRMAILED \$1.00. Don Britton Enterprises, 6200 Wilshire Blvd., Los Angeles, Calif. 90048.**

**MECHANICAL, ELECTRONIC devices catalog 10 cents.** Greatest Values — Lowest Prices. Fertik's, 5249 "D", Philadelphia, Pa. 19120.

**SOUND SYNTHESIZER KITS—Surf \$12.95, Wind \$12.95, Wind Chimes \$17.95, Electronic Songbird \$6.95, Musical Accessories, many more.** Catalog free. PAIA Electronics, Box J14359, Oklahoma City, OK 73114.

**BUGGED??? New locator finds them fast.** Write, Clifton, 11500-L N.W. 7th Avenue, Miami, Florida 33168.

## DISCOUNT PRICES

**B&K, SENECORE, LEADER, RCA**

**EICO, FLUKE and HICKOK**

**Test Equipment**

**ICC/ServiceMaster, RCA and Raytheon Tubes**

**Complete line of electronic supplies**

**Free Catalog**

**FORDHAM RADIO SUPPLY CO., INC.**

**558 Morris Ave. Bronx, N.Y. 10451**

**FREE CATALOG.** Parts, circuit boards for **POPULAR ELECTRONICS** projects. PAIA Electronics, Box C14359, Oklahoma City, OK 73114.

**TELEPHONE "BUGGED"?** Countermeasures Brochure \$1.00. Negeye, Drawer 547, Pennsboro, W. VA 26415.

**HEAR POLICE/FIRE Dispatchers!** Catalog shows exclusive directories of "confidential" channels, receivers. Send 10 cent stamp. Communications, Box 56-PE, Commack, N.Y. 11725.

**CONVERT any television to sensitive, big-screen oscilloscope.** Only minor changes required. No electronic experience necessary. Illustrated plans. \$2.00. Sanders, Dept. A-33, Box 92102, Houston, Texas 77010.

**CD IGNITIONS, VHF/UHF monitors, crystals, CB radios,** Southland, Box 3591-B, Baytown, Texas 77520.

**CRYSTALS, Scanners, \$3.88, include make and frequency.** G Enterprises, P.O. Box 461PC, Clearfield, UT 84105.

**ALPHA/THETA BRAINWAVE** biofeedback instruments. Analog instruments from \$125; digital processing systems from \$225. BioScan, Box 14168-E, Houston, Texas 77021.

**SURPRISE!** Build inexpensively, the most Unusual Test Instruments, Futuristic Gadgets using Numerical Readouts! Catalogue Free! GBS, Box 100A, Green Bank, West Virginia 24944.

**ELECTRONIC IGNITION:** Capacitor, transistor, pointless. Auburn sparkplugs. Information 10 cents. Anderson Engineering, Epsom, N.H. 03234.

**WHOLESALE Scanners, CB, Crystals, Directories, SSB/AM, Catalog 25 cents.** G—Enterprises, Box 461P, Clearfield, Utah 84105.

**LEARN DESIGN TECHNIQUES.** Electronics Design Newsletter. Digital, linear construction projects, design theory and procedures. Annual subscription \$6.00, sample copy \$1.00. Valley West, Box 2119-B, Sunnyvale, California 94087.

**TELEPHONES UNLIMITED,** equipment, supplies. Catalog 50 cents. Box 1654E, Costa Mesa, Calif. 92626.

**AUTHENTIC, INSTRUMENTED, FLYING ROCKETS** for casual or serious experimenters. Over 80 scale original, multi-stage or ready-to-fly models. Solid-propellant engines for safe, electric launch system liftoffs up to 2,500 feet. Measure altitude, temp. inversions, more. Real telemetry, electronic tracking, aerial still and movie photography with super-miniaturized equipment. New, detailed tech manual and full-color catalog. 25 cents from ESTES INDUSTRIES Dept. 18M, Penrose, Colo. 81240.

**DIGITAL ELECTRONICS!** Highly effective course brings immediate results, \$10.00. Satisfaction or \$11.00 refunded! Plans, Projects, Free Literature. DYNASIGN, Box 60A7, Wayland, Mass. 01778.

**UNSCRAMBLERS:** Fits any scanner or monitor, easily adjusts to all scrambled frequencies. Only 4" square \$29.95, fully guaranteed. Dealer inquiries welcomed. PDQ Electronics, Box 841, North Little Rock, Arkansas 72115.

**ELECTRONIC parts, low prices, free flyer:** DARTEK ELECTRONICS, Box 2460, Dartmouth, Nova Scotia, Canada. U.S. inquiries.

**SURPRISE! SURPRISE!** Digital Piano Tuning Device tunes musical instruments Accurately! Perfectly! Inexpensively! Construction-Instruction-Plans Complete \$12.95 Airmailed Postpaid! Moonlighting quickly repays \$40 electronics investment! GBS, Box 100P, Green Bank, West Virginia 24944.

**PYROTECHNICAL chemicals, casings, fuse, tools, literature, supplies.** Catalog-50 cents, with samples — \$2.00. Westech, Logan, Utah 84321.

**READ AND USE MICROCOMPUTER Hardware/Software** ideas in ECS monthly. Write for free catalog and subscription inf. MP Publishing Co. Box 378P, Belmont, Massachusetts 02178.

**RECONDITIONED Test Equipment.** \$0.50 for catalog. Walter, 2697 Nickel, San Pablo, CA 94806.

**7400 SERIES T.T.L. PINOUT HANDBOOK**

COVERS ENTIRE 5400/7400 SERIES D.L.R. I.C.'S

PIN CONNECTIONS — FUNCTIONAL SPECS

CROSS REFERENCE — ONLY \$2.95 FROM:

T.T.L. PINOUT HANDBOOK: IMS ASSOCIATES, INC.  
1298 E 14TH ST., SAN LEANDRO, CAL. 94577  
INCL. 30¢ POST. (CALIF. RES. ADD 20¢ SLS TAX)

**MONITOR RECEIVER, Preamp, Scanner, UHF Converter kits.** Hamtronics, 182 Belmont, Rochester, NY 14612.

**FREE giant bargain electronic catalog** listing thousands of components, tubes, transistors, IC's, kits, test equipment. EDLIE'S, 2700-PF Hempstead Tpke., Levittown, N.Y. 11756.

**CONSTRUCTION PROJECTS:** Laser, \$2.00. TV Camera, \$3.95. Catalog. Technologic, Box 5262, Orchard Lake, Michigan 48033.

**FREE Bargain Catalog.** Ultrasonic devices, LEDs, transistors, IC's, keyboards, Xtals, unique components. Chaney's, Box 15431, Lakewood, CO 80215.

**CARBON FILM RESISTORS.** Brand new as low as 2-1/4 cents. **FREE** samples and specifications. **COMPONENTS CENTER—PE**, Box 134, New York, NY 10038.

**CIRCUIT Collections:** 20 useful circuits you can build. Includes schematics, parts list, description, \$3.98. RJE Company, 28 Park Street, Jamestown, N.Y. 14701.

**FREE DATA SHEETS WITH EVERY ITEM 749 IC WITH EVERY \$10 ORDER\***

- REDUCE YOUR PROJECT COSTS
- MONEY-BACK GUARANTEE
- 24-HOUR SHIPMENT
- ALL TESTED AND GUARANTEED

**TRANSISTORS (NPN):**  
 2N3563 TYPE RF Amp & Osc to 1 GHz (pl.2N918) 6/\$1.00  
 2N3565 TYPE Gen. Purpose High Gain (TO-92/106) 6/\$1.00  
 2N3567 TYPE High-Current Amplifier/5w 500 mA 4/\$1.00  
 2N3866 TYPE RF Power Amp 1.5 W @ 450 MHz \$1.50  
 2N3903 TYPE GP Amp & Sw to 100 mA and 30 MHz 6/\$1.00  
 2N3919 TYPE RF Power Amp 10-25 W @ 3-30 MHz \$3.00  
 2N4274 TYPE Ultra-High Speed Switch 12 ns 4/\$1.00  
 MPS6515 TYPE High-Gain Amplifier hFE 250 3/\$1.00  
 Assort. NPN GP TYPES, e.g. 2N3694, 2N3903, etc. (15) \$2.00  
 2N3638 TYPE (PNP) GP Amp & Sw to 300 mA 4/\$1.00  
 2N4249 TYPE (PNP) Low-Noise Amp 1µA to 50mA 4/\$1.00

**FET's:**  
**N-CHANNEL (LOW-NOISE)**  
 2N4091 TYPE RF Amp & Switch (TO-18/106) 3/\$1.00  
 2N4416 TYPE RF Amplifier to 450 MHz (TO-72) 2/\$1.00  
 2N5163 TYPE Gen. Purpose Amp & Sw (TO-106) 3/\$1.00  
 2N5486 TYPE RF Amp to 450 MHz (plastic 2N4416) 3/\$1.00  
 E100 TYPE Low-Cost Audio Amplifier 4/\$1.00  
 ITE4868 TYPE Ultra-Low Noise Audio Amp 2/\$1.00  
 TIS74 TYPE High-Speed Switch 40µs 3/\$1.00  
 Assort. RF & GP FET's, e.g. 2N5163, MPF102, etc. (8) \$2.00

**P-CHANNEL:**  
 2N4360 TYPE Gen. Purpose Amp & Sw (TO-106) 3/\$1.00  
 E175 TYPE High-Speed Switch 125µs (TO-106) 3/\$1.00

## SUMMER SPECIALS:

1N4154 DIODE 30 V/10mA-1N914 exc. 30 V	20/\$1.00
2N3904 NPN TRANSISTOR GP Amp & Switch	5/\$1.00
2556 DUAL 555 TIMER 1 µsec to 1 hour (DIP)	\$1.00
2N2222 NPN TRANSISTOR GP Amp & Switch	5/\$1.00
2N2907 PNP TRANSISTOR GP Amp & Switch	5/\$1.00
2N3553 RF Power Amp 5 W @ 150 MHz, 10 W @ 50 MHz	\$2.00

## BUILD IN ONE HOUR!

**8-DIGIT MEMORY CALCULATOR KIT—Pocket size, 5 function (+ - x ÷ %), addressable memory with individual recall plus constant and floating decimal. Timed display turnoff (saves batteries). Easy to assemble. Everything you need—ICs, keyboard, LED array, handsome case, etc.; just add solder and batteries. \$19.95**

**LINEAR IC's:**  
 308 Micro-Power Op Amp (TO-5/MINI-DIP) \$1.00  
 309 K Voltage Regulator 5 V @ 1 A (TO-3) \$1.50  
 324 Quad 741 Op Amp, Compensated (DIP) \$1.75  
 380 2.5 Watt Audio Amplifier 34 dB (DIP) \$1.29  
 555X Timer 1 µs-1 hr. Dif. pinout from 555 (DIP) \$.85  
 709 Popular Op Amp (DIP/TO-5) \$.29  
 723 Voltage Regulator 3-30 V @ 1-250mA (DIP/TO-5) \$.58  
 739 Dual Low-Noise Audio Preamp/Op Amp (DIP) \$1.00  
 1458 Dual 741 Op Amp (MINI-DIP) \$.65  
 741 Freq. Comp. OP AMP (DIP/TO-5/MINI-DIP) 3/\$1.00

**DIODES:**  
 ZENERS—400mW, Specify Voltage 3.3, 3.9, 4.3, 5.1, 6.8, 8.2, 9.1, 10, 12, 15, 18, 22, 24, 27 or 33V (±10%) 4/\$1.00  
 1N3600 TYPE Hi-Speed Sw 75 V/200 mA 6/\$1.00  
 1N3893 TYPE RECTIFIER Stud Mount 400 V/1/2 A 2/\$1.00  
 1N914 or 1N4148 TYPE Gen. Purp. 100V/10mA 10/\$1.00  
 D5 VARACTOR 5-50 W Output @ 30-250 MHz, 7-70 pF \$5.00  
 F7 VARACTOR 1-3 W Output @ 100-500 MHz, 5-30 pF \$1.00

\*MAIL NOW! **FREE DATA SHEETS** supplied with every item from this ad. **FREE ON REQUEST—749 Dual Op Amp (\$1.00 value)** with every order of \$10 or more, postmarked prior to 9/30/75. **ORDER TODAY—All items subject to prior sale and prices subject to change without notice. All items are new surplus parts — 100% functionally tested. WRITE FOR FREE CATALOG** offering hundreds of semiconductors not listed here. Send 10¢ stamp.

**TERMS:** All orders must be prepaid. We pay postage. \$1.00 handling charge on orders under \$10. Calif. residents add 6% sales tax. Foreign orders — add postage. COD orders — add \$1.00 service charge.

**ADVA** ELECTRONICS  
 BOX 4181 AN, WOODSIDE, CA 94062  
 Tel. (415) 851-0455  
 CIRCLE NO. 3 ON READER SERVICE CARD

## BUILD YOUR OWN TV CAMERA!

— Ideal for home & business —



THE ECONOMICAL ANSWER TO HOME MONITORING OF NURSERIES, ENTRANCES, DRIVEWAYS, BUSINESS AND INDUSTRIAL SURVEILLANCE...TV...AMATEUR TV PLUS HUNDREDS OF OTHER APPLICATIONS. MODEL 371A, SERIES 10 - KIT FORM \$185 ASSEMBLED \$215. SOLID-STATE. WORKS ON ANY TV SET. OPTIONAL SOUND KIT \$28.95. PHONE OR WRITE for catalog. Dial 402-981-3171

1301 BROADWAY ATV Research DAKOTA CITY, NE. 68731

ALTAIR OWNERS—we have accessory boards, components, memories, etc. Boards, IC Kits for most popular minis. Mini Micro Mart, 1618 James, Syracuse, NY 13203.

500 MHZ PRESCALER assembled and tested complete with cabinet and power supply \$99.95. 200MHZ counter kit less cabinet \$139.95. Davis Electronics, 636 Sheridan Dr., Tonawanda, NY 14150. (716) 874-5848-9.

DIAGRAM Manuals, Radio—Television, useful. 14 volumes, normally \$44.00, only \$19.95 postpaid. Supreme Publications, 1760 Balsam, Highland Park, IL 60035.

DIGITAL multimeter, frequency counter, time modules and mainframe—assembled. Low cost—Free brochure. Farell' Research Corporation, P.O. Box 386, Elizabeth, PA 15037.

UNIVERSAL TTL/DTL/CMOS IC TESTER 100,000 test operations in 0.66 seconds. Will test 16/14 pin digital ICs. Circuit is easy to understand and build. ICs needed cost less than \$20.00; All are TTL. Plans \$1.40. NORTHSTAR ENGINEERING, 3617 North Crede Drive, Charleston, WV 25302.

MEMORY-2102-1K Static RAM, \$3.75. Quantity discount, computer components, digital clock kits. Send for free list. Digitex, 2603 West Davis, Dallas, Texas 75211.

AVOID electric shock device, Popular Electronics 4/74. GFI transformer \$11.50, toroid \$6.00. Lotronics, P.O. Box 975, El Cerrito, CA 94530.

BUILD THAT ELECTRONIC ORGAN YOU ALWAYS WANTED AT A PRICE YOU CAN AFFORD. Third edition of "Organ Builder's Guide," pictured product kit line, circuits, block diagrams, design rationale using IC divider and independent generators with diode keying. \$3.00 postpaid. Also, free brochure on keyboards. DEVTRONIX ORGAN PRODUCTS, Dept. C, 5872 Amopola Dr., San Jose, CA 95129.

NEARLY Invisible HAM or SWL Hertz Antenna. 130 foot long stranded stainless steel wire with miniature insulators, \$12.80. Wilcox Electronics, Box 1331, S.L.C., Utah 84110.

UNUSUAL digital plans for games, test equipment, others. FREE info. T. Wong, 103 E. Broadway, Dept. 4B, New York, NY 10002.

DISTRESS! Liquidation means lowest prices available 7400, 9300, 9000 series TTL. Send stamp for list. ANTEL, 216C Univ. Pk., Ithaca, NY 14850.

## 80 MHz COUNTER

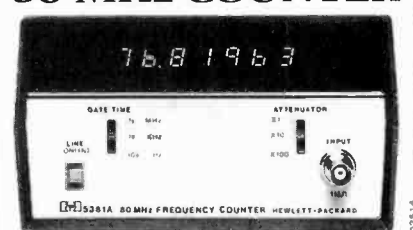

PROFESSIONAL QUALITY

Ideal for calibration \$275\* and frequency monitoring of Ham Rigs, CB sets, and other frequency dependent projects • The HP 5381A Counter covers 10 Hz to 80 MHz and combines economy with lab quality and performance. Sharp seven digit readout. High stability crystal. Time base. 25 mv sensitivity. Three position input attenuator. Rugged aluminum case • Other frequency counters at 225 MHz, 500 MHz, 1100 MHz. For information and catalogs write Larry Johnson, H.P., 5301 Stevens Creek Blvd., Santa Clara, CA 95050. \*Domestic USA price only.



I.C. POSTCARDS, microphotographs of actual integrated circuit chips. 4 for \$1.00. Send stamp for sample. Retelle, 146E Hazelhurst, Ferndale, Michigan 48220.

PHOTOGRAPHIC Timer, Digital Readout, Crystal time base, alarm footswitch, guaranteed. Cascade Labs, 5637 Bayview Ave., Richmond, California 94804.

KITS. Electronic games. Digital circuitry. From \$7.75. Information 10 cents. NBL-E, Box 1115, Richardson, Texas 75080.

TV CAMERAS with manual zoom lens, solid state. NEW (from Cartrivision bankruptcy sale) \$125 each. Bob Allen, 124 Lundy Lane, Palo Alto, CA 94306. Phone (415) 493-6146.

QUALITY military and industrial surplus electronic components. Free flyer. XTRONIX, Box 444, Baker, Oregon 97814.

SAVE TIME repairing counters, DMM's, Synthesizers, computers, calculators or anything digital with a logic probe from Chesapeake Digital Devices, Inc., Dept. H, Box 341, Havre De Grace, Maryland 21078. \$19.95 wired, \$14.95 kit, postpaid.

BLURB! Free, value-packed listing of electronic products and components. Midwest Design, Box 163, Stevensville, Michigan 49127.

TELEPHONES and ACCESSORIES. Wide color selection. Free Catalog. Flemco, 20272 37th Ave., N.E., Seattle, Wash. 98155.

### WAREHOUSE DISCOUNTS ON

NATIONALLY ADVERTISED

- C.B. RADIOS
- MONITOR SCANNERS FIRE POLICE

IN FACTORY SEALED CARTONS

BUSINESS - RECREATION - PERSONAL SATISFACTION GUARANTEED

WRITE FOR QUOTE

**ELECTRONICS WAREHOUSE, INC.**  
6234 LITTLE RIVER TURNPIKE (DEPT. 5)  
ALEXANDRIA, VA. 22312  
OR PHONE: (703) 256-1300

POLICE, Fire monitors, scanners, crystals discount priced. New crystal-less scanners. Box 19224, Denver, CO 80219.

## AUDIO PROGRAM CONTROL CENTER



\$14.95 PPD. USA  
10 inputs, 4 outputs. Switch TV, Short-Wave, Ham, FM to Stereo Amplifier & Recorder. Listen & Record.

POWERCOM CORPORATION  
Box 454 Dept 4 Troy, N. Y. USA 12181

<p>INTEL 8080 CPU .....\$169.00 8008 8 BIT MICRO PROCESSING CHIP (with data book) .....\$35.00 2102-2 1024 BIT RAM .....\$5.00 5202A UV PROM .....\$19.00 MM5203 UV PROM .....\$1.00</p> <p><b>MINIATURE TRIM POTS</b> 5K, 10K, 25K, 50K, 100K, 200K \$.75 ea. 3/\$2.00</p> <p><b>MULTI-TURN TRIM POTS</b> Similar to Bourns 3010 style 3/16" x 1/4" x 1/4". 50, 100, 2000, 5000 ohms. \$1.50</p> <p><b>LIGHT ACTIVATED SCR's</b> TO-18 200V 1A \$1.75</p> <p><b>PRINTED CIRCUIT BOARD</b> 4 1/2" x 6 1/2" single sided epoxy board, 1/16" thick, unetched \$5.00 ea. 5/\$2.20</p> <p>Conductive Elastometer low Profile Calculator keyboard .....\$6.00</p> <p>2N5460 P FET .....\$.45 TIS 73 N FET .....\$.45 2N4891 UJT .....\$.45 ER900 TRIGGER DIODES 4/1.00 2N6028 PROG. UJT .....\$.65</p> <p><b>VERIPAX PC BOARD</b> This board is a 1/16" single sided paper epoxy board, 4 1/2" x 6 1/2". DRILLED and ETCHED which will hold up to 21 single 14 pin IC's or 8, 16 or LSI DIP IC's with busses for power supply connector. \$5.25</p> <p>RED/GREEN BIPOLAR LED .....\$1.30 MT-2 PHOTO TRANS .....\$.60 GREEN OR YELLOW LED .....\$.30 RED GAP OSL-3 LED .....\$.20 14 PIN DIP SOCKETS .....\$.40 16 PIN DIP SOCKETS .....\$.50 MDLEX PINS .....100/\$1.00 1000/\$8.00</p> <p>8 PIN MINIDIP SOCKETS .....\$.32</p> <p>10 WATT ZENERS 3.9, 4.7 OR 18V .....\$.75 EA. 1. WATT ZENERS 5.6 10, 12, 15, 18, OR 22V .....\$.40 EA.</p> <p><b>Silicon Power Rectifiers</b></p> <table border="1" style="width: 100%; border-collapse: collapse;"> <tr><th>PRV</th><th>1A</th><th>3A</th><th>12A</th><th>50A</th></tr> <tr><td>100</td><td>.06</td><td>.14</td><td>.30</td><td>.80</td></tr> <tr><td>200</td><td>.07</td><td>.20</td><td>.35</td><td>1.15</td></tr> <tr><td>400</td><td>.09</td><td>.25</td><td>.50</td><td>1.40</td></tr> <tr><td>600</td><td>.11</td><td>.30</td><td>.70</td><td>1.80</td></tr> <tr><td>800</td><td>.15</td><td>.35</td><td>.90</td><td>2.20</td></tr> <tr><td>1000</td><td>.20</td><td>.45</td><td>1.10</td><td>2.75</td></tr> </table> <p><b>REGULATED MODULAR POWER SUPPLIES</b></p> <p>+ 15VDC AT 100ma 115VAC INPUT .....\$24.95 5VDC AT 1A, 115VAC INPUT \$19.95 12V 6A .....24.95</p> <p>IN 4148 (IN914) .....14/\$1.00</p> <p>1103 1024 bit RAM .....\$4.75 NEC 6003 2048 bit RAM .....\$9.50 1101 256 bit RAM .....\$1.75 8223 PROM .....\$4.75 7489 RAM .....\$2.45</p> <p>Terms: FOB Cambridge, Mass. Send Check or Money Order. Include Postage. Minimum Order \$5.00. COD \$20.00.</p>	PRV	1A	3A	12A	50A	100	.06	.14	.30	.80	200	.07	.20	.35	1.15	400	.09	.25	.50	1.40	600	.11	.30	.70	1.80	800	.15	.35	.90	2.20	1000	.20	.45	1.10	2.75	<p><b>TRANSISTOR SPECIALS</b></p> <p>2N6517 NPN Si TO-92 .....\$1.00 2N5086 PNP Si TO-92 .....4/\$1.00 2N4898 PNP TO-66 .....\$.60 2N404 PNP GE TO-5 .....5/\$1.00 2N3919 NPN Si TO-3 RF .....\$1.50 MPSA13 NPN Si TO-92 .....3/\$1.00 2N3767 NPN Si TO-66 .....\$.70 2N2222 NPN Si TO-18 .....5/\$1.00 2N3055 NPN Si TO-3 .....\$.80 2N2904 NPN Si TO-92 .....5/\$1.00 2N3906 PNP Si TO-92 .....5/\$1.00 2N5296 NPN Si TO-22 .....\$1.00 2N6109 PNP Si TO-220 .....\$.55 2N3866 NPN Si TO-5 Si RF .....\$.75 POWER .....\$.75 MJ2252 NPN Si TO-66 .....\$.90 2N3638 NPN Si TO-5 .....5/\$1.00 2N2218A NPN Si TO-5 .....4/\$1.00</p> <p><b>CAPACITORS</b></p> <p>35V at .47 UF TANT5/\$1.00 35V at 6.8 UF TANT3/\$1.00 20V at 150 UF TANT \$.40 6V 20 UF TANT .....5/\$1.00 12V 200 UF ELECT .....\$.30 200V 4.7 UF ELECT .....\$.30</p> <p><b>DO-33-A 3 DIG. LED ARRAY READOUT \$1.65</b></p> <p>MAN-1 READOUT .....\$1.75 MAN-3 READOUT .....\$1.00 MAN-4 READOUT .....\$1.30 MAN-7 READOUT \$1.25 SLA-3 .....\$4.50</p> <p><b>Full Wave Bridges</b></p> <table border="1" style="width: 100%; border-collapse: collapse;"> <tr><th>PRV</th><th>2A</th><th>6A</th><th>25A</th></tr> <tr><td>100</td><td>.05</td><td>1.25</td><td>\$3.00</td></tr> <tr><td>400</td><td>.15</td><td>1.50</td><td>\$4.00</td></tr> <tr><td>600</td><td>.35</td><td>1.75</td><td>\$5.00</td></tr> </table> <p>CD 201 100x100 IMAGE SENSOR CHARGED COUPLE DEVICES USED IN SOLID STATE CAMERAS, WITH APPLICATIONS. \$198.00</p> <p>FPA 711-7 LEVEL Diode Array Optical Tape Readers .....\$5.95</p> <p>Low cost digital volt meter kit contains integ. circuit schem., PC boards, LED displays, regulators. Outer case and battery not supplied, accurate to ± one count, has range of one mv to 1.999 VDC. Overall dimensions 1 1/2" x 3" x 5" \$62.00</p> <p><b>TTL IC SERIES</b></p> <table border="1" style="width: 100%; border-collapse: collapse;"> <tr><td>74L00</td><td>.30</td><td>7476</td><td>.45</td></tr> <tr><td>7400</td><td>.17</td><td>7480</td><td>.60</td></tr> <tr><td>7401</td><td>.17</td><td>7483</td><td>.99</td></tr> <tr><td>7402</td><td>.17</td><td>7485</td><td>1.10</td></tr> <tr><td>7403</td><td>.17</td><td>7486</td><td>.48</td></tr> <tr><td>7404</td><td>.17</td><td>7490</td><td>.60</td></tr> <tr><td>7405</td><td>.21</td><td>7491</td><td>1.00</td></tr> <tr><td>7406</td><td>.35</td><td>7492</td><td>.75</td></tr> <tr><td>7407</td><td>.37</td><td>7493</td><td>.60</td></tr> <tr><td>7408</td><td>.18</td><td>7495</td><td>.80</td></tr> <tr><td>7409</td><td>.18</td><td>7496</td><td>.85</td></tr> <tr><td>7410</td><td>.17</td><td>8267</td><td>1.95</td></tr> <tr><td>7411</td><td>.27</td><td>74107</td><td>.40</td></tr> <tr><td>7412</td><td>.45</td><td>74121</td><td>.50</td></tr> <tr><td>7413</td><td>.72</td><td>74123</td><td>.90</td></tr> <tr><td>7416</td><td>.37</td><td>74125</td><td>.60</td></tr> <tr><td>7417</td><td>.37</td><td>74126</td><td>.64</td></tr> <tr><td>7420</td><td>.17</td><td>74150</td><td>.99</td></tr> <tr><td>7425</td><td>.36</td><td>74151</td><td>.85</td></tr> <tr><td>7426</td><td>.27</td><td>74153</td><td>1.05</td></tr> <tr><td>7427</td><td>.31</td><td>74154</td><td>1.48</td></tr> <tr><td>7430</td><td>.17</td><td>74155</td><td>1.05</td></tr> <tr><td>7432</td><td>.27</td><td>74157</td><td>1.18</td></tr> <tr><td>7437</td><td>.36</td><td>74163</td><td>1.49</td></tr> <tr><td>7438</td><td>.35</td><td>74164</td><td>1.70</td></tr> <tr><td>7440</td><td>.17</td><td>74165</td><td>1.78</td></tr> <tr><td>7441</td><td>.95</td><td>74173</td><td>1.55</td></tr> <tr><td>7442</td><td>.90</td><td>74175</td><td>1.60</td></tr> <tr><td>7445</td><td>1.05</td><td>74177</td><td>1.50</td></tr> <tr><td>7446</td><td>1.10</td><td>74181</td><td>3.20</td></tr> <tr><td>7447</td><td>1.00</td><td>74192</td><td>1.40</td></tr> <tr><td>7448</td><td>1.00</td><td>74193</td><td>1.29</td></tr> <tr><td>7472</td><td>.33</td><td>74195</td><td>.80</td></tr> <tr><td>7473</td><td>.38</td><td>74196</td><td>1.90</td></tr> <tr><td>7474</td><td>.35</td><td>75324</td><td>1.75</td></tr> <tr><td>7475</td><td>.60</td><td>75491</td><td>1.10</td></tr> </table> <p>8038C IC VOLT CONT. OSC. \$4.40 5311, 5314 or 5316 CLOCK CHIPS .....\$5.00 ea. CT7001 Calendar Alarm CLOCK CHIP .....\$6.75</p>	PRV	2A	6A	25A	100	.05	1.25	\$3.00	400	.15	1.50	\$4.00	600	.35	1.75	\$5.00	74L00	.30	7476	.45	7400	.17	7480	.60	7401	.17	7483	.99	7402	.17	7485	1.10	7403	.17	7486	.48	7404	.17	7490	.60	7405	.21	7491	1.00	7406	.35	7492	.75	7407	.37	7493	.60	7408	.18	7495	.80	7409	.18	7496	.85	7410	.17	8267	1.95	7411	.27	74107	.40	7412	.45	74121	.50	7413	.72	74123	.90	7416	.37	74125	.60	7417	.37	74126	.64	7420	.17	74150	.99	7425	.36	74151	.85	7426	.27	74153	1.05	7427	.31	74154	1.48	7430	.17	74155	1.05	7432	.27	74157	1.18	7437	.36	74163	1.49	7438	.35	74164	1.70	7440	.17	74165	1.78	7441	.95	74173	1.55	7442	.90	74175	1.60	7445	1.05	74177	1.50	7446	1.10	74181	3.20	7447	1.00	74192	1.40	7448	1.00	74193	1.29	7472	.33	74195	.80	7473	.38	74196	1.90	7474	.35	75324	1.75	7475	.60	75491	1.10	<p><b>CMOS (DIODE COUNTER)</b></p> <p>74C02—\$.50 CD4019—\$.58 74C10—\$.50 CD4022—\$1.25 74C157—\$2.00 CD4023—\$.30 74C165—\$3.50 CD4024—\$1.00 CD4001—\$.30 CD4025—\$.30 CD4002—\$.30 CD4026—\$.67 CD4006—\$1.50 CD4027—\$1.20 CD4007—\$.30 CD4028—\$1.09 CD4009—\$.67 CD4029—\$1.42 CD4010—\$.67 CD4030—\$.30 CD4011—\$.30 CD4035—\$1.42 CD4012—\$.30 CD4042—\$.84 CD4013—\$.53 CD4046—\$2.55 CD4015—\$1.17 CD4047—\$3.10 CD4016—\$.63 CD4050—\$1.05 CD4017—\$1.34 CD4055—\$2.70</p> <p><b>4 WATT IR LASER DIODE .....\$7.95</b></p> <p>CD 110 LINEAR 256 X1 BIT SELF SCANNING CHARGED COUPLED DEVISE. WITH DATA .....\$150.00</p> <p><b>SANKEN AUDIO POWER AMPS</b></p> <p>Si 1010 G 10 WATTS .....\$ 6.90 Si 1020 G 20 WATTS .....\$13.95 Si 1050 G 50 WATTS .....\$24.95</p> <p><b>LINEAR CIRCUITS</b></p> <p>LM 309 5V 1A REGULATOR .....\$1.50 723 -40 +40V REGULATOR .....\$.58 301/748 -Hi Per. Op. Amp. .....\$1.75 LM 320 -5 or +15V REG. ....\$1.75 LM 376 -V to 37V POS REG. ....\$.58 741A or 741C OP. AMP. ....\$1.31 709C OPER. AMP. ....\$.25 340T-5, 12, 15, 18, 24V POS. REG. TO-220 .....\$1.75 101 OPER. AMP. HI PERFORM .....\$.75 LM 308 OPER. Amp. Low Power .....\$1.05 556 -DUAL TIMER .....\$1.30 556 -FUNCTION GEN. ....\$2.00 556 -TONE OSC/OEER .....\$2.00 703 -RF-IF AMP. ....\$.41 LM 370 -AGC SQUELCH AMP .....\$1.15 555 -2 us - 2 HR. TIMER .....\$.65 553 QUAD TIMER .....\$3.50 FCO 810 OPTO-ISOLATOR .....\$1.35 1456 OPER. AMP. ....\$.95 1458 DUAL OP AMP. ....\$.65 LM 380 -2W AUDIO AMP .....\$1.29 LM 377 -2W STEREO AUDIO AMP .....\$2.50 LM 381 -STEREO PREAMP .....\$1.69 LM 382 -DUAL AUDIO PREAMP .....\$1.88 LM 311 -HI PER. COMP/AMPLIF. ....\$1.95 LM 319 -Dual Hi Speed Comp. ....\$1.15 LM 339 -QUAD COMP/AMPLIF. ....\$1.25</p> <p><b>TRIACS</b></p> <table border="1" style="width: 100%; border-collapse: collapse;"> <tr><th>PRV</th><th>1A</th><th>10A</th><th>25A</th><th>1.5A</th><th>6A</th><th>35A</th></tr> <tr><td>100</td><td>.40</td><td>.70</td><td>1.30</td><td>.40</td><td>.50</td><td>1.20</td></tr> <tr><td>200</td><td>.70</td><td>1.10</td><td>1.75</td><td>.60</td><td>.70</td><td>1.60</td></tr> <tr><td>400</td><td>1.10</td><td>1.60</td><td>2.60</td><td>1.00</td><td>1.20</td><td>2.20</td></tr> <tr><td>600</td><td>1.70</td><td>2.30</td><td>3.00</td><td></td><td></td><td>3.00</td></tr> </table> <p><b>SCR'S</b></p>	PRV	1A	10A	25A	1.5A	6A	35A	100	.40	.70	1.30	.40	.50	1.20	200	.70	1.10	1.75	.60	.70	1.60	400	1.10	1.60	2.60	1.00	1.20	2.20	600	1.70	2.30	3.00			3.00
PRV	1A	3A	12A	50A																																																																																																																																																																																																																																				
100	.06	.14	.30	.80																																																																																																																																																																																																																																				
200	.07	.20	.35	1.15																																																																																																																																																																																																																																				
400	.09	.25	.50	1.40																																																																																																																																																																																																																																				
600	.11	.30	.70	1.80																																																																																																																																																																																																																																				
800	.15	.35	.90	2.20																																																																																																																																																																																																																																				
1000	.20	.45	1.10	2.75																																																																																																																																																																																																																																				
PRV	2A	6A	25A																																																																																																																																																																																																																																					
100	.05	1.25	\$3.00																																																																																																																																																																																																																																					
400	.15	1.50	\$4.00																																																																																																																																																																																																																																					
600	.35	1.75	\$5.00																																																																																																																																																																																																																																					
74L00	.30	7476	.45																																																																																																																																																																																																																																					
7400	.17	7480	.60																																																																																																																																																																																																																																					
7401	.17	7483	.99																																																																																																																																																																																																																																					
7402	.17	7485	1.10																																																																																																																																																																																																																																					
7403	.17	7486	.48																																																																																																																																																																																																																																					
7404	.17	7490	.60																																																																																																																																																																																																																																					
7405	.21	7491	1.00																																																																																																																																																																																																																																					
7406	.35	7492	.75																																																																																																																																																																																																																																					
7407	.37	7493	.60																																																																																																																																																																																																																																					
7408	.18	7495	.80																																																																																																																																																																																																																																					
7409	.18	7496	.85																																																																																																																																																																																																																																					
7410	.17	8267	1.95																																																																																																																																																																																																																																					
7411	.27	74107	.40																																																																																																																																																																																																																																					
7412	.45	74121	.50																																																																																																																																																																																																																																					
7413	.72	74123	.90																																																																																																																																																																																																																																					
7416	.37	74125	.60																																																																																																																																																																																																																																					
7417	.37	74126	.64																																																																																																																																																																																																																																					
7420	.17	74150	.99																																																																																																																																																																																																																																					
7425	.36	74151	.85																																																																																																																																																																																																																																					
7426	.27	74153	1.05																																																																																																																																																																																																																																					
7427	.31	74154	1.48																																																																																																																																																																																																																																					
7430	.17	74155	1.05																																																																																																																																																																																																																																					
7432	.27	74157	1.18																																																																																																																																																																																																																																					
7437	.36	74163	1.49																																																																																																																																																																																																																																					
7438	.35	74164	1.70																																																																																																																																																																																																																																					
7440	.17	74165	1.78																																																																																																																																																																																																																																					
7441	.95	74173	1.55																																																																																																																																																																																																																																					
7442	.90	74175	1.60																																																																																																																																																																																																																																					
7445	1.05	74177	1.50																																																																																																																																																																																																																																					
7446	1.10	74181	3.20																																																																																																																																																																																																																																					
7447	1.00	74192	1.40																																																																																																																																																																																																																																					
7448	1.00	74193	1.29																																																																																																																																																																																																																																					
7472	.33	74195	.80																																																																																																																																																																																																																																					
7473	.38	74196	1.90																																																																																																																																																																																																																																					
7474	.35	75324	1.75																																																																																																																																																																																																																																					
7475	.60	75491	1.10																																																																																																																																																																																																																																					
PRV	1A	10A	25A	1.5A	6A	35A																																																																																																																																																																																																																																		
100	.40	.70	1.30	.40	.50	1.20																																																																																																																																																																																																																																		
200	.70	1.10	1.75	.60	.70	1.60																																																																																																																																																																																																																																		
400	1.10	1.60	2.60	1.00	1.20	2.20																																																																																																																																																																																																																																		
600	1.70	2.30	3.00			3.00																																																																																																																																																																																																																																		

Send 20c for our catalog featuring Transistors and Rectifiers; 145 Hampshire St., Cambridge, Mass.



## SOLID STATE SALES

P.O. BOX 74A  
SOMERVILLE, MASS. 02143 TEL. (617) 547-4005

WE SHIP OVER 95%  
OF OUR ORDERS THE  
DAY WE RECEIVE THEM

# 7400N TTL

# \* JAMES AUGUST SPECIALS\*

SN7400N .16	SN7451N .27	SN74151N 1.25
SN7401N .16	SN7452N .27	SN74153N .60
SN7402N .21	SN7454N .41	SN74154N 1.25
SN7403N .16	SN7459A .25	SN74155N 1.21
SN7404N .21	SN7460N .22	SN74156N 1.30
SN7405N .24	SN7470N .45	SN74157N 1.35
SN7406N .45	SN7472N .39	SN74160N 1.70
SN7407N .45	SN7473N .45	SN74161N 1.45
SN7408N .25	SN7474N .45	SN74163N 1.65
SN7409N .25	SN7475N .80	SN74164A 1.65
SN7410N .20	SN7476N .47	SN74165N 1.65
SN7411N .30	SN7480N .50	SN74166N 1.70
SN7412N .42	SN7482N 1.75	SN74167N 2.50
SN7413N .85	SN7483N 1.15	SN74170N 3.00
SN7414N .70	SN7485N 1.12	SN74172N 1.80
SN7416N .43	SN7486N .45	SN74173N 1.90
SN7417N .43	SN7488N 1.50	SN74174N 1.75
SN7418N .25	SN7489N 3.00	SN74175N 1.90
SN7420N .21	SN7490N .59	SN74176N .95
SN7421N .39	SN7491N 1.20	SN74177N .90
SN7422N .37	SN7492N .82	SN74178N 1.05
SN7425N .43	SN7493N .82	SN74181N 3.55
SN7426N .31	SN7494N .91	SN74182N .35
SN7427N .37	SN7495N .91	SN74184A 2.30
SN7429N .42	SN7496N .91	SN74185N 2.00
SN7430N .26	SN74100N 1.25	SN74187N 6.00
SN7432N .31	SN74107N .40	SN74190N 1.50
SN7437N .47	SN74121N .55	SN74191N 1.50
SN7438N .40	SN74122N .49	SN74192N 1.50
SN7439A .25	SN74123N 1.05	SN74193A 1.40
SN7440N .21	SN74125N .60	SN74194N 1.45
SN7441N 1.10	SN74126N .81	SN74195N 1.00
SN7442N 1.08	SN74132N 3.00	SN74196N 1.25
SN7443N 1.05	SN74141N 1.15	SN74197N 1.00
SN7444N 1.10	SN74142N 6.50	SN74198N 2.25
SN7445N 1.10	SN74143N 7.00	SN74199N 2.25
SN7446N 1.15	SN74144N 7.00	SN74200N 7.00
SN7447N .89	SN74145N 1.15	SN74251N 2.50
SN7448N .99	SN74146N 2.50	SN74252N 6.00
SN7449N .26	SN74150N 1.10	SN74255N 6.00

DVM Chip Set  
LD110 Digital A/D Processor 16.00  
LD111 Analog A/D Processor 13.00 \$28.00 Set

UART -AY-5-1013A  
40K Baud Monolithic UART ..... \$7.95 each

LINEAR IC'S

LM301AN	DP AMP	4/51.00
LM307H	Super Op Amp	4/51.00
LM311 H	Hi. perf. V comp.	.75
LM311 H	Hi. perf. V comp.	.75
LM555V	Timer	.65
NE555T	Phase Lock Loop	1.75
NE557T	Tone Decoder	1.25
NE567T	Tone Decoder	1.75
LM723H	Volt. Reg.	2/51.00
LM723H	Volt. Reg.	2/51.00
8038	Function Generator	3.95

TTL Logic Probe Kit \$9.95 per kit  
Detects TTL levels, pulses, with man 3 readout

THE KIBOBYTE RAM CARD  
Complete 1K x 8 Memory  
\*Single 5V supply  
\*500ns Access Time  
\*High Noise Immunity Components  
\*Kit Includes Sockets & Board ..... \$99.95

DIGITAL COUNTER UNIT  
4 Each - Men7 Displays "Digit Latches"  
+ 10000 Counter "On Board Oscillator"  
\*Complete with Board ..... \$29.95 Kit

DIGITAL VOLTMETER KIT  
0-10 Volt, 3 1/2 digits (Man 7) DVM  
MDS - LSI Design  
Size: 3" x 3" x 1 1/2" \$39.95

# IC'S EXAR KITS

## FUNCTION GENERATOR KIT

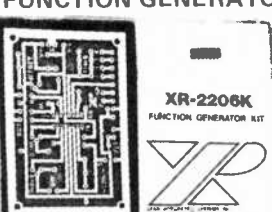

XR-2206K  
FUNCTION GENERATOR KIT

Features sine, triangle and square wave, THD 0.5% typ., AM/FM capability

4' POWER SUPPLY CORDS . . . . .  
Black .59¢ ea.

### THUMBWHEEL SWITCHES

Thumbwheel Switches  
Part # Description Price  
SW100 Single Pole 10 Positions \$2.00  
SW101 Single Pole 10 Positions \$2.00  
SW102 Single Pole 10 Positions \$2.00  
SW103 Single Pole 10 Positions \$2.00  
SW104 Single Pole 10 Positions \$2.00  
SW105 Single Pole 10 Positions \$2.00  
SW106 Single Pole 10 Positions \$2.00  
SW107 Single Pole 10 Positions \$2.00  
SW108 Single Pole 10 Positions \$2.00  
SW109 Single Pole 10 Positions \$2.00  
SW110 Single Pole 10 Positions \$2.00  
SW111 Single Pole 10 Positions \$2.00  
SW112 Single Pole 10 Positions \$2.00  
SW113 Single Pole 10 Positions \$2.00  
SW114 Single Pole 10 Positions \$2.00  
SW115 Single Pole 10 Positions \$2.00  
SW116 Single Pole 10 Positions \$2.00  
SW117 Single Pole 10 Positions \$2.00  
SW118 Single Pole 10 Positions \$2.00  
SW119 Single Pole 10 Positions \$2.00  
SW120 Single Pole 10 Positions \$2.00  
SW121 Single Pole 10 Positions \$2.00  
SW122 Single Pole 10 Positions \$2.00  
SW123 Single Pole 10 Positions \$2.00  
SW124 Single Pole 10 Positions \$2.00  
SW125 Single Pole 10 Positions \$2.00  
SW126 Single Pole 10 Positions \$2.00  
SW127 Single Pole 10 Positions \$2.00  
SW128 Single Pole 10 Positions \$2.00  
SW129 Single Pole 10 Positions \$2.00  
SW130 Single Pole 10 Positions \$2.00  
SW131 Single Pole 10 Positions \$2.00  
SW132 Single Pole 10 Positions \$2.00  
SW133 Single Pole 10 Positions \$2.00  
SW134 Single Pole 10 Positions \$2.00  
SW135 Single Pole 10 Positions \$2.00  
SW136 Single Pole 10 Positions \$2.00  
SW137 Single Pole 10 Positions \$2.00  
SW138 Single Pole 10 Positions \$2.00  
SW139 Single Pole 10 Positions \$2.00  
SW140 Single Pole 10 Positions \$2.00  
SW141 Single Pole 10 Positions \$2.00  
SW142 Single Pole 10 Positions \$2.00  
SW143 Single Pole 10 Positions \$2.00  
SW144 Single Pole 10 Positions \$2.00  
SW145 Single Pole 10 Positions \$2.00  
SW146 Single Pole 10 Positions \$2.00  
SW147 Single Pole 10 Positions \$2.00  
SW148 Single Pole 10 Positions \$2.00  
SW149 Single Pole 10 Positions \$2.00  
SW150 Single Pole 10 Positions \$2.00  
SW151 Single Pole 10 Positions \$2.00  
SW152 Single Pole 10 Positions \$2.00  
SW153 Single Pole 10 Positions \$2.00  
SW154 Single Pole 10 Positions \$2.00  
SW155 Single Pole 10 Positions \$2.00  
SW156 Single Pole 10 Positions \$2.00  
SW157 Single Pole 10 Positions \$2.00  
SW158 Single Pole 10 Positions \$2.00  
SW159 Single Pole 10 Positions \$2.00  
SW160 Single Pole 10 Positions \$2.00  
SW161 Single Pole 10 Positions \$2.00  
SW162 Single Pole 10 Positions \$2.00  
SW163 Single Pole 10 Positions \$2.00  
SW164 Single Pole 10 Positions \$2.00  
SW165 Single Pole 10 Positions \$2.00  
SW166 Single Pole 10 Positions \$2.00  
SW167 Single Pole 10 Positions \$2.00  
SW168 Single Pole 10 Positions \$2.00  
SW169 Single Pole 10 Positions \$2.00  
SW170 Single Pole 10 Positions \$2.00  
SW171 Single Pole 10 Positions \$2.00  
SW172 Single Pole 10 Positions \$2.00  
SW173 Single Pole 10 Positions \$2.00  
SW174 Single Pole 10 Positions \$2.00  
SW175 Single Pole 10 Positions \$2.00  
SW176 Single Pole 10 Positions \$2.00  
SW177 Single Pole 10 Positions \$2.00  
SW178 Single Pole 10 Positions \$2.00  
SW179 Single Pole 10 Positions \$2.00  
SW180 Single Pole 10 Positions \$2.00  
SW181 Single Pole 10 Positions \$2.00  
SW182 Single Pole 10 Positions \$2.00  
SW183 Single Pole 10 Positions \$2.00  
SW184 Single Pole 10 Positions \$2.00  
SW185 Single Pole 10 Positions \$2.00  
SW186 Single Pole 10 Positions \$2.00  
SW187 Single Pole 10 Positions \$2.00  
SW188 Single Pole 10 Positions \$2.00  
SW189 Single Pole 10 Positions \$2.00  
SW190 Single Pole 10 Positions \$2.00  
SW191 Single Pole 10 Positions \$2.00  
SW192 Single Pole 10 Positions \$2.00  
SW193 Single Pole 10 Positions \$2.00  
SW194 Single Pole 10 Positions \$2.00  
SW195 Single Pole 10 Positions \$2.00  
SW196 Single Pole 10 Positions \$2.00  
SW197 Single Pole 10 Positions \$2.00  
SW198 Single Pole 10 Positions \$2.00  
SW199 Single Pole 10 Positions \$2.00  
SW200 Single Pole 10 Positions \$2.00

POCKET CALCULATOR KIT  
5 function plus constant - address memory with individual recall - 8 digit display plus overflow - battery saver - uses standard or rechargeable batteries - all necessary parts in ready to assemble form - instructions included. 3" x 5" ..... \$17.50 each

115VAC Transformer ..... 4.95 each  
6 each "N" Alkaline Batteries ..... 2.50 lot

.394" DIAM. TRIMMER  
STANDARD RESISTANCE VALUES  
MODEL 10001 (500) 100  
700 100K 100K 100K  
100K 300K 100K

Model TR7  
1/16" VECTOR BOARD  
P-Pattern  
3" x 1 1/2" Size Spacing

MATERIAL	STOCK ON HAND	UNIT PRICE	MIN. ORDER
PCB	1000	1.75	100
FRONT PANEL	1000	1.75	100
REAR PANEL	1000	1.75	100
DRIVER TRANSISTOR	1000	1.75	100
RESISTORS	1000	1.75	100
DIODES	1000	1.75	100
IC'S	1000	1.75	100
WIRE	1000	1.75	100
SOCKET	1000	1.75	100
WELDED	1000	1.75	100

## NEW PROTO BOARD-100

Here's a low cost, big 10 IC capacity breadboard kit with all the quality of OT Sockets and the best of the Proto-Board series - complete down to the last nut, bolt and screw. Includes 7 OT 35S Sockets, 1 OT-35B Bus Strip; 2.5 way binding posts; 4 rubber feet; screws, nuts, bolts; and easy assembly instructions.

COMPLETE KIT ... \$19.95

### WALL or T.V. DIGITAL CLOCK

12 or 24 Hour  
25" VIEWING DISTANCE  
Walnut Case 6" x 3" x 1 1/2"  
Hr. & Min. 5" High  
Seconds "3" High  
KIT - All Comp. & Case  
Wired & Assembled 115 Vac \$39.95 \$44.95

XR-2206K \$19.95  
Includes monolithic function generator IC, PC board, and assembly instruction manual.

XR-2206KB \$29.95  
Same as XR-2206K above and includes external components for PC board.

TIMERS

XR-555CP	Monolithic Timer	\$ 1.10
XR-320P	Precision Timer	1.55
XR-556CP	Dual-555 Timer	1.85
XR-2556CP	Dual Timing Circuit	3.20
XR-2240CP	Programmable Counter/Timer	4.80

PHASE LOCKED LOOPS

XR-210	FSK Demodulator	5.20
XR-215	High Frequency PLL	6.60
XR-567CP	Tone Decoder (mini DIP)	1.95
XR-567CT	Tone Decoder (TO-5)	1.70

STEREO DECODERS

XR-1310P	PLL Stereo Decoder	3.20
XR-1310EP	PLL Stereo Decoder	3.20
XR-1800P	PLL Stereo Decoder	3.20

WAVEFORM GENERATORS

XR-205	Waveform Generator	8.40
XR-2206CP	Monolithic Function Generator	5.50
XR-2207CP	Voltage-Controlled Oscillator	3.85

OTHER EXAR IC'S

XR-1468CN	Dual +15V Tracking Regulator	3.85
XR-1488N	Quad Line Driver	5.80
XR-1489AN	Quad Line Receiver	4.80
XR-2206CP	Operational Multiplier	5.20
XR-2211 CP	FSK Demodulator/Tone Decoder	6.70
XR-2261	Monolithic Proportional Servo IC System w/4 ea. Driver Transistor	3.79

20% Discount for 100 Combined 7400's

HIGH SPEED	LOW POWER	SCHOTTKY
SN74400N .33	SN74L00N .33	SN74S00N .60
SN74401N .33	SN74L02N .33	SN74S02N .60
SN74404N .33	SN74L03N .33	SN74S04N .65
SN74405N .35	SN74L04N .33	SN74S05N .65
SN74408N .33	SN74L10N .33	SN74S10N .60
SN74410N .33	SN74L20N .33	SN74S11N .65
SN74411N .33	SN74L30N .33	SN74S15N .60
SN74420N .33	SN74L42N .33	SN74S20N .60
SN74421N .33	SN74L73N .69	SN74S22N .60
SN74422N .33	SN74L74N .69	SN74S40N .60
SN74430N .33	SN74L75N .79	SN74S64N .60
SN74440N .33	SN74L85N 1.15	SN74S65N .60
SN74450N .33	SN74L86N .69	SN74S112N 2.50
SN74451N .35	SN74L90N 1.60	

### CMOS

CD4000 .29	74C10N .65
CD4001 .29	74C20N .65
CD4002 .29	74C30N .65
CD4006 2.50	CD4035 1.85
CD4007 .29	CD4040 2.45
CD4008 .59	CD4047 1.90
CD4010 .59	CD4044 1.50
CD4011 .29	CD4046 2.51
CD4012 .59	CD4047 2.75
CD4013 .23	CD4049 2.75
CD4016 .69	CD4050 2.75
CD4017 1.35	CD4051 2.80
CD4019 .69	CD4052 2.98
CD4020 1.69	CD4060 3.25
CD4022 1.25	CD4066 1.75
CD4023 .29	CD4069 .45
CD4024 1.50	CD4071 .45
CD4025 .34	CD4072 .45
CD4027 .85	74C00N .39
CD4028 1.65	74C02N .55
CD4029 2.80	74C04N .75

### DISPLAY LEDS

CA	Common Anode	DC	Common Cathode
MAN 1	Com. Ano	270	\$1.95
MAN 3	Com. Cath.	125	59
MAN 4	Com. Cath.	187	1.95
MAN 7	Com. Ano.	30	1.95
DL 33	Com. Cath.	175	1.95
DL 747	Com. Ano.	625	2.50

### DISCRETE LEDS

MV 10	Red	5/51.00
MV 50	Red	6/51.00
MV 5024	Red	4/51.00
MV 5024	Green	4/51.00
MV 5024	Yellow	4/51.00
MV 5024	Orange	4/51.00

### IC SOLDER TAIL - LOW PROFILE (TIN) SOCKETS

Pin	1-24	25-49	50-100	1-24	25-49	50-100
8 pin	\$1.19	.18	.17	24 pin	\$ .68	.62
14 pin	.23	.22	.21	28 pin	.89	.81
16 pin	.27	.26	.24	36 pin	1.10	.99
18 pin	.46	.41	.37	40 pin	1.25	1.13
22 pin	.65	.59	.53			

### SOLDER TAIL STANDARD (TIN)

14 pin	\$3.20	28	.26	28 pin	\$ .99	.90	.81
16 pin	.33	.31	.29	36 pin	1.39	1.26	1.15
18 pin	.42	.39	.37	40 pin	1.59	1.45	1.30
24 pin	.59	.54	.49				

### SOLDER TAIL STANDARD (GOLD)

8 pin	\$3.20	27	.24	24 pin	\$ 1.70	.63	.57
14 pin	.35	.32	.29	28 pin	1.10	1.00	.90
16 pin	.38	.35	.32	36 pin	1.55	1.40	1.25
18 pin	.52	.47	.43	40 pin	1.75	1.59	1.45

### WIRE WRAP SOCKETS (GOLD) LEVEL #3

10 pin	\$4.45	.41	.37	24 pin	\$1.05	.95	.85
14 pin	.46	.42	.38	28 pin	1.40	1.25	1.10
16 pin	.55	.50	.45	36 pin	1.59	1.45	1.30
18 pin	.75	.68	.62	40 pin	1.75	1.55	1.40

## 50 PCS. RESISTOR ASSORTMENTS \$1.75 PER ASS'T.

ASST. 1	5 ea:	10 OHM - 12 OHM - 15 OHM - 18 OHM - 22 OHM - 27 OHM - 33 OHM - 39 OHM - 47 OHM - 56 OHM	1/4 WATT 5% - 50 PCS.
ASST. 2	5 ea:	68 OHM - 82 OHM - 100 OHM - 120 OHM - 150 OHM - 180 OHM - 220 OHM - 270 OHM - 330 OHM - 390 OHM	1/4 WATT 5% - 50 PCS.
ASST. 3	5 ea:	470 OHM - 560 OHM - 680 OHM - 820 OHM - 1K	1/4 WATT 5% - 50 PCS.
ASST. 4	5 ea:	1.2K - 1.5K - 1.8K - 2.2K - 2.7K	1/4 WATT 5% - 50 PCS.
ASST. 5	5 ea:	3.3K - 3.9K - 4.7K - 5.6K - 6.8K	1/4 WATT 5% - 50 PCS.
ASST. 6	5 ea:	8.2K - 10K - 12K - 15K - 18K	1/4 WATT 5% - 50 PCS.
ASST. 5	5 ea:	22K - 27K - 33K - 39K - 47K	1/4 WATT 5% - 50 PCS.
ASST. 6	5 ea:	56K - 68K - 82K - 100K - 120K	1/4 WATT 5% - 50 PCS.
ASST. 7	5 ea:	150K - 180K - 220K - 270K - 330K	1/4 WATT 5% - 50 PCS.
ASST. 7	5 ea:	390K - 470K - 560K - 680K - 820K	1/4 WATT 5% - 50 PCS.
ASST. 7	5 ea:	1M - 1.2M - 1.5M - 1.8M - 2.2M	1/4 WATT 5% - 50 PCS.
ASST. 7	5 ea:	2.7M - 3.3M - 3.9M - 4.7M - 5.6M	1/4 WATT 5% - 50 PCS.

### \*Special Requested Items\*

8008 Processor	\$29.95	8267	\$ 4.00	4024P*	\$2.25
1101 256 x 1 RAM	2.25	2513*	11.00	N8197	3.00
2102 6274 RAM	5.50	2518	7.00	MC1741	4.00
AYS-1413 UART	9.95	2519	4.00	MC4044	5.00
CA1918 TC	5.95	2524*	3.50	CA3130S	4.90
8101	18.00	2525	7.00	40A10	1.75
8263	7.00	2533	11.85	40673	1.75

### DIODES

TYPE	(Zener)	W	DIODE	TYPE	(Rectifier)	W	PRICE
IN746	3.3	400m	4/1.00	IN4003	200 PIV	1 AMP	.10
IN751A	5.1	400m	4/1.00	IN4004	400 PIV	1 AMP	.10
IN752	5.6	400m	4/1.00	IN3600	50 200m	6/1.00	
IN753	6.2	400m	4/1.00	IN4148	75 100m	15/1.00	
IN754	6.8	400m	4/1.00	IN4154	35 10m	12/1.00	
IN965B	15	400m	4/1.00	IN4734	5.5 1w	28	
IN1032	5.6	500m	.28	IN4735			



**wanted** Citizens Band  
DEALER-DISTRIBUTORS  
Send this ad with Letterhead to:  
**PAL ELECTRONICS CO.**  
2962 W. WELDON - PHOENIX, ARIZ. 85017

PHOTOELECTRIC SWITCH. 150W, Adjustable Sensitivity, Plastic Woodgrain Enclosure, \$14.99 Guaranteed. Labtronics, 3635P, Hillside, Ypsilanti, Michigan 48197.

VOICE DESCRAMBLERS, works with all scanners, several new models, priced from \$19.95. Krystal Kits, Box 445, Bentonville, Ark. 72712.

UNUSUAL ELECTRONIC PLANS, Projects, Security Equipment, etc. Catalog \$1.00. McCord Electronics, Box 276-PE, Sylvania, Ohio 43560.

TV TRANSMITTER, RCA TT-2AH. Excellent Condition. Reasonable. P.O. Box 4162, Pasadena, Calif. 91106.

GUARD Master Professional Wholesale Alarm Catalogue \$2. Mepco, Dept. A6, Box 28007, St. Louis, MO 63119.

**The PAIA pygmy Amp ...**  
Take it anywhere!



BATTERY POWERED  
• practice amp  
• headphone amp  
• distortion booster  
• stage monitor  
\$39.95 plus shipping  
6lbs. for the complete kit.  
Send for our FREE catalog

PAIA Electronics, Dept. "P",  
1020 W. Wilshire Blvd., Oklahoma City, OK 73116

TELETYPE EQUIPMENT for sale for beginners and experienced computer enthusiasts. Teletype machines, parts, supplies. Catalogue \$1.00 to: ATLANTIC SALES, 3730 Nautilus Ave., Brooklyn, NY 11224. Tel: (212) 372-0349.

1st PRIZE: 16 BIT MICROCOMPUTER CHIP!  
**CONTEST!!**  
2nd PRIZE: 8080 CPU  
3rd PRIZE: 8000 CPU

**GODBOUT**  
Bill Godbout Electronics

We were 1st to offer the 8008 to hobbyists over 16 months ago; now we're setting the pace again with a powerful new 16 bit microcomputer IC in a 40 pin DIP, made by **THE SECRET MICROCOMPUTER CO.**  
YOU MAY WIN ONE OF THESE CHIPS ... SIMPLY:  
1) Reveal the Secret Microcomputer Co.'s true identity  
2) Tell us in 25 words or less why you should receive a free chip  
If you can convince our jaded judges, in a form suitable for use in this magazine, you win.

★ **GOOD LUCK!** ★

FINE PRINT: ALL ENTRIES MUST BE POSTMARKED BY AUG 31 AND BE IN OUR HANDS BY SEP 7, 1975; ENTRIES BECOME PROPERTY OF BILL GODBOUT ELECTRONICS. ALL CONTESTANTS RECEIVE A DATA SHEET ABOUT OUR FIRST PRIZE. WINNER WILL BE NOTIFIED BY OCT 1, 1975. IF YOU DON'T WIN ANYTHING THIS TIME AROUND DON'T FEEL TOO BAD; ENTER OUR COMING CONTEST FOR A COMPLETE 16 BIT MICROCOMPUTER KIT. THESE CONTESTS SPOTLIGHT PRODUCTS WE'RE INTRODUCING FOR FALL '75. SEND ENTRIES TO "16 BIT CONTEST", BOX 2355, OAKLAND AIRPORT, CA 94614.

SURPLUS BARGAINS, Computer Accessories, Equipment, Energy Conservation, Technical Reports, Kits, Semiconductors, Specifications, 20% - 90% Discounts. Catalog 751, 50 cents. E/S Lab, Box 738, College Park, Maryland 20740.

**HYBRID AUDIO AMPLIFIER**  
EPITEK Model 1240  
12 WATTS RMS  
Distortion 0.6% at 12W  
Price: \$6.95 + 50 cents postage.  
(CA Residents add 6% tax)

**ROYER COMPONENTS**  
P.O. Box N  
Bellflower, CA 90706

Send Money Order or COD

PRESSURE sensitive miniature cable for burglar alarm systems. Place under carpet in any contour for intrusion detection or secret switching. \$4.95 for twenty feet. Cable Switch Corp., Box 72-PE, West Long Branch, NJ 07764.

SCHEMATICS Burglar Alarm Kit: 5 Alarms, 2 Souncers, Power Supply. Send \$5.00 to: DJW, 22541 Berg, Southfield, Mich. 48075.

**VIDEO PING PONG**  
PLANS - PC CARDS - KITS  
ATTACHES TO YOUR TV'S ANT.  
ONLY 14 IC'S MOSTLY 7400  
FAMILY. SEND \$5 FOR INFO.  
PACK - REFUNDED WITH FIRST PURCHASE

D. Duncan Electronics  
20650 Runnymede Canoga Park Ca 91306

FOR A New Electronic Experience, learn to control your brainwaves. Aquarius Electronics, Box 962E, Albion, CA 95410.

TEXAS INSTRUMENTS CALCULATORS DISCOUNT HOT LINE Toll Free (800) 638-8906. Phone us long distance free for the low discount price on the Texas Instruments Calculator of your choice: SR-50, SR-51, SR-16, TI-2500 II, TI-1500, TI-2500, TI-2550, TI-5050. All of the great new Texas Instruments models. Capital Calculator Company, 701 East Gude Drive, Rockville, Maryland 20850. The discount super market for top brand name calculators. Mail and phone orders accepted. BankAmericard and Master Charge accepted.

BURGLAR-FIRE alarm supplies and information. Free catalog. Protecto Alarm Sales, Box 357-G, Birch Run, Michigan 48415.

BURGLAR ALARM dialing unit automatically calls police. \$29.95. Free literature. S&S Systems, Box 12375C, North Kansas City, MO 64116.

**PLANS AND KITS**

ATTENTION AUDIO FREAKS!! ... Audio Processing Circuits ... designs, kits, unls. Laboratory tested designs for hobbyist through professional use—limiters, compressors, equalizers, phasers, mixers and more! Send now—\$1.00 (refundable) for complete catalog—CIRCUIT RESEARCH LABS, 3920 E. Indian School, Phoenix, AZ 85018.

DIGITAL CLOCK KIT \$22.50, Frequency Counter kit, PC boards only silk screened for component mounting double sided, no jumpers, full Instructions \$25.00. New 2N4424 or 2N4248 or 1N5391, mixed or not 7 for \$1.00. EAST COAST ELECTRONICS, 50 Scott, Hamburg, NY 14075.

**AUGUST SPECIALS**

- 5203  
2048 bit programmable ROM UV erasable \$14.95  
MAN3M LED DISPLAY  
RH dec comm cathode 12" character 12 for \$1.98  
9 DIGIT LED DISPLAY

On multiplexed substrate, comm. cathode compatible with all 8 digit calculator chips, 7 segment right hand decimal, red with clear magnifying lens, 12" character, 1 to 4 MA., 1.8V typ 2 1/2" x 1/4" x 1/16" high \$3.95

**CLOSEOUT ON CALCULATOR CHIPS**

These early model calculator chips have been superseded and are now offered at this lowest price ever. Complete with data.

- CTS001 12 digit display and calculate, 4 function, chain operation, fixed dec, 40 pin package \$1.95  
CTS005 12 digit display and calculate, 4 function plus memory 28 pin package \$3.49

**DIGITAL CIRCUITS (DIP PKG)**

- 7448 BCD - 7 seg Decoder/Driver (30V) \$ .89  
7474 Dual D flip-flop .29  
74107 Dual J-K flip-flop .33  
74123 Retrigger monostable multivib w/clr .69

**LINEAR CIRCUITS (DIP PKG)**

- 380 2 watt audio amplifier \$1.09  
3900 Quad amplifier .29

**POCKET CALCULATOR KIT**

5 function plus constant — addressable memory with individual recall — 8 digit display plus overflow — battery saver — uses standard or rechargeable batteries — all necessary parts in ready to assemble form — instructions included  
CALC KIT \$12.95  
ASSEMBLED 14.95  
SET OF ALKALINE BATT. 2.00



OUR 10% DISCOUNT HAS BEEN DEDUCTED FROM ALL PRICES REGARDLESS OF AMOUNT OF ORDER.

5% OFF ON ORDERS OVER \$50.00  
10% OFF ON ORDERS OVER \$100.00  
15% OFF ON ORDERS OVER \$250.00

**MEMORIES**

- 1101 256 bit RAM MOS \$ 1.50  
1103 1024 bit RAM MOS 3.95  
2102 1024 bit Static RAM 5.55  
5203 2048 bit UV eras PROM 17.95  
5260 1024 bit RAM 2.49  
5261 1024 bit RAM 2.69  
5262 2048 bit RAM 5.95  
7489 64 bit ROM TTL 2.48  
8223 Programmable ROM 3.69  
74200 256 bit RAM tri-state 5.90

**CALCULATOR & CLOCK CHIPS**

- 5001 12 DIG 4 funct fix dec \$3.45  
5002 Same as 5001 exc btry pwr 3.95  
5005 12 DIG 4 funct w/mem 4.95  
MM5725 8 DIG 4 funct chain & dec 1.98  
MM5736 18 pin 6 DIG 4 funct 4.45  
DIP 5.35  
MM5738 8 DIG 5 funct k & mem 5.35  
MM5739 9 DIG 4 funct (btry sur) 5.35  
MM5311 28 pin BCD 6 dig mux 4.45  
MM5313 24 pin 1 pps BCD 4 dig mux 3.95  
MM5314 24 pin 6 dig mux 4.45  
MM5316 40 pin alarm 4 dig 5.39  
CT7001 28 pin 6 DIG alarm, date 6.95

**LED'S**

- MV108 Red TO 18 \$ .22  
MV50 Axial leads .18  
MV5020 Jumbo Vis. Red (Red Dome) .22  
ME4 Infra red diff. dome .54  
MAN1 Red 7 seg. 270" 2.19  
MAN2 Red alpha num .32" 4.39  
MAN4 Red 7 seg. 190" 1.95  
MAN5 Green 7 seg. 270" 3.45  
MAN6 6" high solid seq. 4.25  
MAN7 Red 7 seg. 270" 1.19  
MAN8 Yellow 7 seg. 270" 3.45  
MAN64 3" high solid seq. 2.95  
MAN66 6" high spaced seq. 3.75  
MCT2 Opto-iso transistor .61

**CMOS**

- 4000A \$ .39 4019A \$ .69 4066A \$1.19  
4001A .39 4020A 1.98 4068A .49  
4002A .39 4021A 1.89 4069A .49  
4006A 1.95 4022A .39 4071A .40  
4007A .40 4024 1.45 4072A .40  
4008A 1.98 4025A .39 4073A .40  
4009A .69 4027A .98 4075A .40  
4010A .69 4028A 1.69 4078A .40  
4011A .39 4030A .79 4081A .40  
4013A .69 4035A 1.89 4082A .40  
4014A 1.98 4042A 1.89 4528A 1.60  
4015A 1.98 4049A .79 4585A 2.40  
4016A .69 4050A .79 4047A 2.71

**TTL**

7400	\$ .16	7485	\$1.10
7401	.17	7486	.40
7402	.17	7489	2.48
7403	.17	7490	.62
7404	.19	7491	.97
7404	.19	7492	.71
7405	.20	7493	.60
7406	.35	7494	.94
7407	.35	7495	.79
7408	.19	7496	.79
7409	.23	74105	.44
7410	.16	74107	.40
7411	.26	74121	.42
7413	.55	74122	.45
7415	.35	74123	.85
7416	.35	74125	.54
7417	.35	74126	.71
7420	.17	74141	1.04
7422	.26	74145	1.04
7423	.29	74150	.97
7425	.27	74151	.79
7426	.26	74153	.99
7427	.29	74155	1.25
7430	.20	74155	1.07
7432	.23	74156	1.07
7437	.35	74157	.99
7438	.35	74160	1.39
7440	.17	74161	1.25
7441	.98	74163	1.39
7442	.77	74164	1.59
7443	.87	74165	1.59
7444	.89	74166	1.49
7445	.89	74173	1.49
7446	.93	74175	1.39
7447	.80	74176	.89
7448	1.04	74177	.84
7450	.20	74180	.90
7453	.20	74181	2.98
7454	.17	74182	.79
7460	.17	74190	1.35
7464	.35	74192	1.25
7465	.35	74193	1.19
7472	.30	74194	1.25
7473	.35	74195	.89
7474	.35	74196	1.25
7475	.57	74197	.89
7476	.39	74198	1.79
7483	.99	74199	1.79

**LINEAR CIRCUITS**

300	Pos V Reg (super 723)	TO-5	\$ .71
307	Op AMP (super 741)	mDIP	.26
308	Micro Pwr Op Amp	mDIP	.89
309K	5V 1A regulator	TO-3	1.35
310	V Follower Op Amp	mDIP	1.07
311	Hi perf V Comp	mDIP	.95
319	Hi Speed Dual Comp	DIP	1.13
320	Neg Reg 5.2, 12, 15	TO-3	1.04
324	Quad Op Amp	DIP	1.52
339	Quad Comparator	DIP	1.58
340T	Pos Volt Reg (5V-6V 8V-12V-15V-18V-24V)	TO-220	1.04
370	AGC/Squelch AMPL	DIP	.71
372	AF-IF Strip detector	DIP	2.93
373	AM/FM/SSB Strip	DIP	.53
376	Pos. V. Reg	mDIP	2.42
377	2w Stereo amp	DIP	1.16
380	2w Audio Amp	DIP	1.13
380-B	.5w Audio Amp	mDIP	1.52
381	Lo Noise Dual preamp	DIP	1.52
550	Prec V Reg	DIP	.89
555	Timer	mDIP	.89
556A	Dual 555 Timer	DIP	1.49
560	Phase Locked Loop	DIP	2.48
563	Phase Locked Loop	DIP	2.48
565	Phase Locked Loop	DIP	2.38
566	Function Gen	mDIP	2.25
567	Tone Decoder	mDIP	2.66
709	Operational AMPL	DIP	.26
710	Hi Speed Volt Comp	DIP	.35
723	V Reg	DIP	.62
739	Dual Hi Perf Op Amp	DIP	1.07
741	Comp Op Amp	mDIP	.32
747	Dual 741 Op Amp	DIP	.71
748	Freq Adj 741	mDIP	.35
1304	FM Mulps Stereo Demod	DIP	1.07
1307	FM Mulps Stereo Demod	DIP	.74
1458	Dual Comp Op Amp	mDIP	.62
1800	Stereo multiplexer	DIP	2.48
3900	Quad Amplifier	DIP	.35
7524	Core Mem Sense AMPL	DIP	.71
7534	Core Mem Sense Amp	DIP	.71
8864	9 DIG Cath Dvr	DIP	2.25
75150	Dual Line Driver	DIP	1.95
75451	Dual Peripheral Driver	mDIP	.35
75452	Dual Peripheral Driver	mDIP	.35
75453	(3S1) Dual Periph. Driver	mDIP	.35
75491	Quad Seq Driver for LED	DIP	.71
75492	Hex Digit Driver	DIP	.80

Satisfaction guaranteed. Shipment will be made via first class mail within 3 days from receipt of order. Add \$5.00 to cover shipping and handling for orders under \$25.00. Minimum order \$5.00. California residents add sales tax.

**INTERNATIONAL ELECTRONICS UNLIMITED**  
P.O. BOX 1708/ MONTEREY, CA. 93940 USA  
PHONE (408) 659-3171





**QUALITY ELECTRONIC COMPONENTS**  
— SAME DAY SERVICE —

**NEW DISCOUNT SCHEDULE SAVES YOU EVEN MORE!**

**1024 BIT STATIC MOS RAM**  
**2102 . . . \$3.50**

**INTEGRATED CIRCUITS — TTL, CMOS, LINEAR & MOS**

7400N	24c	7413N	22c	74155N	77c	4019AE	86c	4518AE	\$1.28
7401N	24c	7414N	22c	74156N	77c	4020AE	86c	4519AE	\$1.28
7402N	24c	7406N	22c	74157N	77c	4021AE	86c	4520AE	\$1.28
7403N	24c	7417N	34c	74160N	\$1.19	4022AE	\$1.25	4521AE	96c
7404N	24c	7418N	34c	74161N	\$1.19	4023AE	\$1.25	4522AE	96c
7405N	24c	7419N	31c	74162N	\$1.19	4024AE	\$1.00	4523AE	\$1.87
7406N	24c	7420N	31c	74163N	\$1.19	4025AE	96c	4524AE	\$1.87
7407N	24c	7421N	51c	74164N	\$1.00	4026AE	\$1.87	4525AE	96c
7408N	24c	7422N	34c	74170N	\$1.00	4027AE	67c	4526AE	96c
7409N	24c	7423N	66c	74175N	\$1.00	4028AE	\$1.09	4527AE	\$3.83
7410N	24c	7424N	66c	74180N	77c	4029AE	\$1.42	4528AE	\$3.83
7411N	24c	7425N	66c	74181N	\$2.13	4030AE	\$1.42	4529AE	\$3.83
7412N	24c	7426N	\$1.11	74182N	95c	4031AE	\$1.42	4530AE	\$1.40
7413N	24c	7427N	\$1.11	74183N	\$1.45	4032AE	\$1.42	4531AE	\$1.28
7414N	\$1.02	7428N	\$2.13	74184N	\$1.45	4033AE	\$1.42	4532AE	\$1.28
7415N	24c	7429N	\$1.11	74185N	\$1.19	4034AE	96c	4533AE	42c
7416N	24c	7430N	77c	74186N	\$1.11	4035AE	96c	4534AE	42c
7417N	24c	7431N	46c	74187N	\$1.11	4036AE	67c	4535AE	42c
7418N	24c	7432N	46c	74188N	56c	4037AE	67c	4536AE	42c
7419N	63c	7433N	85c	74189N	29c	4038AE	67c	4537AE	42c
7420N	24c	7434N	85c	74190N	29c	4039AE	67c	4538AE	42c
7421N	24c	7435N	85c	74191N	29c	4040AE	67c	4539AE	42c
7422N	24c	7436N	85c	74192N	29c	4041AE	67c	4540AE	42c
7423N	31c	7437N	\$1.24	4002AE	29c	4042AE	67c	4541AE	42c
7424N	24c	7438N	31c	4006AE	\$1.50	4043AE	67c	4542AE	42c
7425N	24c	7439N	31c	4007AE	29c	4044AE	67c	4543AE	42c
7426N	24c	7440N	43c	4008AE	\$1.17	4045AE	\$1.00	4544AE	\$1.28
7427N	\$1.11	7441N	39c	4009AE	29c	4046AE	67c	4545AE	\$1.28
7428N	61c	7442N	39c	4010AE	29c	4047AE	67c	4546AE	\$1.28
7429N	61c	7443N	39c	4011AE	29c	4048AE	67c	4547AE	\$1.28
7430N	61c	7444N	39c	4012AE	29c	4049AE	67c	4548AE	\$1.28
7431N	61c	7445N	39c	4013AE	29c	4050AE	67c	4549AE	\$1.28
7432N	61c	7446N	39c	4014AE	29c	4051AE	67c	4550AE	\$1.28
7433N	61c	7447N	39c	4015AE	29c	4052AE	67c	4551AE	\$1.28
7434N	61c	7448N	39c	4016AE	29c	4053AE	67c	4552AE	\$1.28
7435N	61c	7449N	39c	4017AE	29c	4054AE	67c	4553AE	\$1.28
7436N	61c	7450N	39c	4018AE	29c	4055AE	67c	4554AE	\$1.28
7437N	61c	7451N	39c	4019AE	29c	4056AE	67c	4555AE	\$1.28
7438N	77c	7452N	\$1.16	4020AE	\$1.67	4057AE	67c	4556AE	\$1.28
7439N	77c	7453N	\$1.16	4021AE	\$1.67	4058AE	67c	4557AE	\$1.28
7440N	85c	7454N	\$1.16	4022AE	\$1.67	4059AE	67c	4558AE	\$1.28
7441N	85c	7455N	\$1.16	4023AE	\$1.67	4060AE	67c	4559AE	\$1.28
7442N	85c	7456N	\$1.16	4024AE	\$1.67	4061AE	67c	4560AE	\$1.28
7443N	85c	7457N	\$1.16	4025AE	\$1.67	4062AE	67c	4561AE	\$1.28
7444N	85c	7458N	\$1.16	4026AE	\$1.67	4063AE	67c	4562AE	\$1.28
7445N	85c	7459N	\$1.16	4027AE	\$1.67	4064AE	67c	4563AE	\$1.28
7446N	85c	7460N	\$1.16	4028AE	\$1.67	4065AE	67c	4564AE	\$1.28
7447N	85c	7461N	\$1.16	4029AE	\$1.67	4066AE	67c	4565AE	\$1.28
7448N	85c	7462N	\$1.16	4030AE	\$1.67	4067AE	67c	4566AE	\$1.28
7449N	85c	7463N	\$1.16	4031AE	\$1.67	4068AE	67c	4567AE	\$1.28
7450N	85c	7464N	\$1.16	4032AE	\$1.67	4069AE	67c	4568AE	\$1.28
7451N	85c	7465N	\$1.16	4033AE	\$1.67	4070AE	67c	4569AE	\$1.28

**SILICON TRANSISTORS**

BNP18	21c	10/52.00	1C/517.85	2N3640	21c	10/52.00	1C/517.85
BNV30	16c	10/51.55	1C/513.60	2N3641	16c	10/51.55	1C/513.60
MPS700	16c	10/51.55	1C/513.60	2N3642	16c	10/51.55	1C/513.60
BNZ222	16c	10/51.55	1C/513.60	MPS3643	16c	10/51.55	1C/513.60
MPS2222A	16c	10/51.55	1C/513.60	2N3645	21c	10/52.00	1C/517.85
2N2369A	16c	10/51.55	1C/513.60	2N3646	21c	10/52.00	1C/517.85
MPS2369A	16c	10/51.55	1C/513.60	2N3647	16c	10/51.55	1C/513.60
MPS2712	16c	10/51.55	1C/513.60	2N3906	16c	10/51.55	1C/513.60
2N2907	16c	10/51.55	1C/513.60	2N4124	16c	10/51.55	1C/513.60
2N3914	21c	10/52.00	1C/517.85	2N4126	16c	10/51.55	1C/513.60
2N3932	16c	10/51.55	1C/513.60	2N4128	16c	10/51.55	1C/513.60
MPS3932	16c	10/51.55	1C/513.60	2N4130	16c	10/51.55	1C/513.60
2N3939	16c	10/51.55	1C/513.60	2N4131	16c	10/51.55	1C/513.60
MPS3939	16c	10/51.55	1C/513.60	2N4132	16c	10/51.55	1C/513.60
2N3944	16c	10/51.55	1C/513.60	2N4133	16c	10/51.55	1C/513.60
MPS3944	16c	10/51.55	1C/513.60	2N4134	21c	10/52.00	1C/517.85
MPS3945	16c	10/51.55	1C/513.60	2N4135	21c	10/52.00	1C/517.85
2N3948	21c	10/52.00	1C/517.85	2N4136	21c	10/52.00	1C/517.85
MPS3948	21c	10/52.00	1C/517.85	2N4137	21c	10/52.00	1C/517.85
2N3949	16c	10/51.55	1C/513.60	2N4138	21c	10/52.00	1C/517.85
MPS3949	16c	10/51.55	1C/513.60	2N4139	21c	10/52.00	1C/517.85
2N3950	16c	10/51.55	1C/513.60	2N4140	16c	10/51.55	1C/513.60
MPS3950	16c	10/51.55	1C/513.60	2N4141	16c	10/51.55	1C/513.60
2N3951	16c	10/51.55	1C/513.60	2N4142	16c	10/51.55	1C/513.60
MPS3951	16c	10/51.55	1C/513.60	2N4143	16c	10/51.55	1C/513.60
2N3952	16c	10/51.55	1C/513.60	2N5087	16c	10/51.55	1C/513.60
MPS3952	16c	10/51.55	1C/513.60	2N5089	16c	10/51.55	1C/513.60
2N3953	16c	10/51.55	1C/513.60	2N5120	21c	10/52.00	1C/517.85
MPS3953	16c	10/51.55	1C/513.60	2N5121	21c	10/52.00	1C/517.85
2N3954	16c	10/51.55	1C/513.60	2N5122	21c	10/52.00	1C/517.85
MPS3954	16c	10/51.55	1C/513.60	2N5123	21c	10/52.00	1C/517.85
2N3955	16c	10/51.55	1C/513.60	2N5124	21c	10/52.00	1C/517.85
MPS3955	16c	10/51.55	1C/513.60	2N5125	21c	10/52.00	1C/517.85
2N3956	21c	10/52.00	1C/517.85	2N5126	21c	10/52.00	1C/517.85
MPS3956	21c	10/52.00	1C/517.85	2N5127	21c	10/52.00	1C/517.85
2N3957	16c	10/51.55	1C/513.60	2N5128	16c	10/51.55	1C/513.60
MPS3957	16c	10/51.55	1C/513.60	2N5129	16c	10/51.55	1C/513.60
2N3958	16c	10/51.55	1C/513.60	2N5130	16c	10/51.55	1C/513.60
MPS3958	16c	10/51.55	1C/513.60	2N5131	16c	10/51.55	1C/513.60
2N3959	16c	10/51.55	1C/513.60	2N5132	16c	10/51.55	1C/513.60
MPS3959	16c	10/51.55	1C/513.60	2N5133	16c	10/51.55	1C/513.60
2N3960	16c	10/51.55	1C/513.60	2N5134	16c	10/51.55	1C/513.60
MPS3960	16c	10/51.55	1C/513.60	2N5135	16c	10/51.55	1C/513.60
2N3961	16c	10/51.55	1C/513.60	2N5136	16c	10/51.55	1C/513.60
MPS3961	16c	10/51.55	1C/513.60	2N5137	16c	10/51.55	1C/513.60
2N3962	16c	10/51.55	1C/513.60	2N5138	16c	10/51.55	1C/513.60
MPS3962	16c	10/51.55	1C/513.60	2N5139	16c	10/51.55	1C/513.60
2N3963	16c	10/51.55	1C/513.60	2N5140	16c	10/51.55	1C/513.60
MPS3963	16c	10/51.55	1C/513.60	2N5141	16c	10/51.55	1C/513.60
2N3964	16c	10/51.55	1C/513.60	2N5142	16c	10/51.55	1C/513.60
MPS3964	16c	10/51.55	1C/513.60	2N5143	16c	10/51.55	1C/513.60
2N3965	16c	10/51.55	1C/513.60	2N5144	16c	10/51.55	1C/513.60
MPS3965	16c	10/51.55	1C/513.60	2N5145	16c	10/51.55	1C/513.60
2N3966	16c	10/51.55	1C/513.60	2N5146	16c	10/51.55	1C/513.60
MPS3966	16c	10/51.55	1C/513.60	2N5147	16c	10/51.55	1C/513.60
2N3967	16c	10/51.55	1C/513.60	2N5148	16c	10/51.55	1C/513.60
MPS3967	16c	10/51.55	1C/513.60	2N5149	16c	10/51.55	1C/513.60
2N3968	16c	10/51.55	1C/513.60	2N5150	16c	10/51.55	1C/513.60
MPS3968	16c	10/51.55	1C/513.60	2N5151	16c	10/51.55	1C/513.60
2N3969	16c	10/51.55	1C/513.60	2N5152	16c	10/51.55	1C/513.60
MPS3969	16c	10/51.55	1C/513.60	2N5153	16c	10/51.55	1C/513.60
2N3970	16c	10/51.55	1C/513.60	2N5154	16c	10/51.55	1C/513.60
MPS3970	16c	10/51.55	1C/513.60	2N5155	16c	10/51.55	1C/513.60
2N3971	16c	10/51.55	1C/513.60	2N5156	16c	10/51.55	1C/513.60
MPS3971	16c	10/51.55	1C/513.60	2N5157	16c	10/51.55	1C/513.60
2N3972	16c	10/51.55	1C/513.60	2N5158	16c	10/51.55	1C/513.60
MPS3972	16c	10/51.55	1C/513.60	2N5159	16c	10/51.55	1C/513.60
2N3973	16c	10/51.55	1C/513.60	2N5160	16c	10/51.55	1C/513.60
MPS39							

# Altaj Electronic Bargains

PRICES SLASHED! WE WANT YOUR BUSINESS. SATISFACTION GUARANTEED ON EVERY ITEM

<p><b>COMPUTER BOARD BONANZA</b> We bought over 4 tons of assorted boards. Contains TTL, diodes, transistors, etc. 5 board asmt. with 150 to 250 IC's — \$3.95.</p>	<p><b>\$2.95</b>  <b>BURROUGHS PANAPLEX II 12 DIGIT READOUT</b></p>	<p>#BR13251 Neon 7 segment readout. Latest design for calculators, etc. Requires 160 VDC. Right hand decimals. Brand new, factory fresh. We include mating socket FREE 2.95 NOTE: With purchase of above readout array we offer motorola 2N5401 PNP High Voltage driver transistor for 10c each.</p>	<p> <b>LM309K</b> TO-3 Case, 1 AMP 5 VDC Voltage Regulator. Brand New By National <b>\$1.19</b></p>
<p> <b>3 DIGIT LED READOUT ARRAY</b> Like Litronix DL-33 3 MAN-3 style readouts in one package. Factory new units. Designed for calculators. Special — <b>\$1.39 (3 Digits)</b></p>	<p><b>LITRONIX DL707 READOUTS</b> <b>.30 IN. CHAR. Common Anode.</b> <b>SPECIAL — \$1.19</b></p>	<p></p>	<p><b>MAN-3 LED READOUTS</b> Brand new, factory prime units. 12 in. character. Common cathode. Perfect for calculators 39c ea. Best Price Anywhere!</p>
<p><b>CALCULATOR CHIP BONANZA PRICES SLASHED!</b> The newest and easiest to use chips available today. Made by famous US mfg. All are 28 pin DIP. Features: direct LED segment drive, low power consumption, internal keyboard debounce, internal clock oscillator, single supply voltage, internal keyboard encoding, and floating decimal point. Does not require many external components as do older types like CT5001, 5002, 5005, etc. We offer the most sophisticated functions for the lowest price anywhere. Chip #1 — 8 Digit, Constant, Six Function (-, ., x, +, %, √) — <b>\$2.49</b></p>	<p><b>DIGITAL ALARM CLOCK IC</b> The newest and easiest to use alarm chip on the market today. Features: 1. Single supply voltage. 2. LED Intensity control 3. Simple time set. 4. 4 or 6 Digit LED Display 5. AM-PM Indication 6. 24 Hr. Alarm. 7. 10 minute snooze. 8. Outperforms MM5316 Order #70250 — <b>\$6.95 (2 FOR \$12)</b></p>	<p><b>CMOS</b> CD4001 - 33c CD4002 - 33c CD4009 - 69c CD4011 - 33c CD4012 - 33c CD4016 - 69c CD4017 - <b>\$1.39</b> CD4030 - 59c 74C02 - 39c 74C04 - 39c 74C107 - <b>\$1.49</b></p>	<p><b>1 AMP RECTIFIER RIOT!</b> We bought over 10 million pieces untested. 1N4000 series. Also a few 1 watt ZENERS mixed in. Sample tests show this lot contains many useable devices, some even up to 1 KV. Sold as is assorted, but you will be happy. 100 PCS — <b>\$1.29</b> 500 PCS — <b>\$4.95</b> Free 28 Pin Socket with purchase of any clock or calculator chip. <b>\$1 VALUE-FREE BONUS</b></p>
<p><b>MOTOROLA MJE 3055</b> Plastic version of 2N3055. NPN Silicon. 90 Watts 15 Amps. <b>SPECIAL — 69c</b></p>	<p><b>MM5314 NATIONAL CLOCK CHIP</b> The most popular clock chip around. We made a huge special purchase of factory fresh, prime units. Lowest price in USA. 24 Pin DIP. 4 or 6 Digits. With Specs. <b>\$3.95</b></p>	<p> <b>DIGITAL WRIST WATCH CRYSTAL</b> Brand new, mfg. by CTS-KNIGHT. 32.768 KHZ. Standard, most popular type. Special <b>\$1.95</b></p>	<p><b>POCKET CALCULATORS</b> 8 Digit. LED various styles. These are complete units, but are customer returns for various reasons. We got these from the mfg. and have not checked them out or culled through them. Includes 4, 5, and even 6 functions. No choice. A super value just for parts. <b>SPECIAL — \$7.95</b> Sorry — no Data Available — Sold as is —</p>
<p><b>8008 MICROPROCESSOR</b> Computer on a chip. 8 Bit Parallel CPU. Can address 16k x 8 bits of memory. With specs. Factory tested units. <b>\$24.95</b></p>	<p><b>CT7001 BY CAL-TEX</b> Digital alarm clock chip with calendar feature. 4 or 6 digits. Also has timing circuitry for radio ON-OFF control factory fresh. <b>\$6.95</b></p>	<p><b>COLOR ORGAN CONTROL MODULE</b> Completely self-contained. Has SCR circuitry, AC line cord, etc. From a close out by a mfg. of color organs. New, unused. <b>\$1.49</b></p>	<p><b>7805 STYLE REGULATORS</b> TO-220 Plastic Case 5VDC Regulator. Brand New by National — <b>99c</b></p>
<p>2102-1K RAM's for above — <b>\$4.95 or 8 For \$30</b></p>	<p><b>JUMBO LED READOUT</b> Twice the size of regular readouts. .65 inches. Like Litronix DL747. Outperforms and easier to read than SLA-3, only 20 MA per segment. Our best readout for digital clocks. \$2.95 ea (6 FOR \$15) Common Anode</p>	<p><b>MOTOROLA SCR</b> 2N4443 8 Amp 400PN, Plastic Power Case. 69c</p>	<p><b>FACTORY NEW LED'S</b> Jumbo Red-Like MV5024-8/\$1 Jumbo Green-Like MV5222-5/\$1 Jumbo Yellow-5/\$1 Mini Red-Like MV50-10/\$1</p>
<p><b>TTL SUPER SPECIAL</b> 74121 — ONE SHOT 4/\$1</p>	<p><b>LINEAR IC SPECIALS</b> 555V-75c 567V-\$1.95 723CH-59c 741CV-39c LM324 by National — Quad 741C in one DIP — <b>\$1.19</b></p>	<p><b>GE POWER DARLINGTON</b> NPN. Plastic Power Tab Case. VCEO-30 HFE-30,000 TYP. Brand new units, but leads are slightly trimmed for P.C.B. #D40C1 — <b>SPECIAL 39c 3 For \$1</b></p>	<p><b>FORD SOLID STATE MODULES</b> Mfg. by Centralab for Ford car radios. Each module contains 2 transistors plus other components. These modules were used as audio pre-amps. We include specs. — 4 For \$1</p>
<p><b>12VDC REED RELAY</b> Coil is 500 OHM. SPST-No. <b>\$1.49</b> Sub-Mini.</p>	<p><b>FILTER CAPS</b> 1000 MFD 16VDC upright style. <b>4 FOR \$1</b></p>	<p><b>1024 BIT SIGNETICS P-ROM</b> 82S1291-256X4 bipolar, field programmable ROM. Fully TTL compatible. 50 ns. max address access time. Much faster than MOS type units. Perfect for code conversions, microprogrammers, hard-wired algorithms, controllers, etc. With specs. Regular \$35 ea. <b>SPECIAL — 3.95</b> BEST MEMORY BUY IN USA!</p>	<p><b>TTL IC ASSORTMENT</b> Various types. Most are marked. Our best selling assortment. Untested but includes many useable devices. <b>200 PCS FOR \$3.95</b></p>
<p><b>PRIME TTL DIP IC'S</b> 7400-16c 7448-89c 74151-75c 7402-16c 7453-16c 74153-89c 7404-16c 7473-37c 74154-95c 7406-24c 7474-37c 74157-99c 7408-16c 7475-65c 74161-99c 7410-16c 7476-39c 74163-1.19 7413-49c 7483-85c 74164-1.29 7420-16c 7490-69c 74165-1.49 7427-24c 7492-75c 74174-1.29 7430-16c 7493-75c 74175-1.39 7437-39c 7495-75c 74181-2.75 7438-35c 7496-75c 74192-1.25 7440-16c 74121-38c 74193-1.25 7442-69c 74123-75c 74195-79c 7447-89c 74150-70c 74197-79c</p>	<p><b>8038 FUNCTION GENERATOR</b> Brand new Voltage controlled oscillator. Has sine, square wave, and triangular outputs. <b>\$4.50 each.</b></p>	<p><b>LOOK</b> <b>MOS 4 DIGIT COUNTER</b> An ALTJ exclusive. These are the latest state of the art, MOS chips. By a famous US mfg. Contains a complete 4 digit counter, including 4 decade counters, latches, multiplexing circuits, display decoders, etc. Features: 5 VDC operation, 25 MW power consumption, both 7 segment and BCD outputs. Perfect for making DVM's, frequency meters, tachometers, stopwatches, or any other device requiring 4 or more digits. Complete with specs. 28 PIN DIP. QTY Limited. <b>SPECIAL — \$12.50</b> <b>BACK IN STOCK!</b></p>	<p><b>FM TRANSFORMERS</b> We bought a load of coils and transformers that were used in Ford AM-FM car radios. Includes 19KHZ, 38KHZ, OSC. Coils, etc. All New. Perfect for experimenters or repairmen. 10 Pc Asst. — 99c</p>
<p><b>AUDIO AMP ASSEMBLY</b> From Audio Eqmt Mfg. Pc Board with 2 watt Ic Amp plus other components. <b>SPECIAL — \$1.49</b> Very Limited Qty.</p>	<p><b>IN4148 DIODES</b> Brand New Units. Same as IN914. Full Leads. 6c each</p>	<p><b>MONSANTO COLORED READOUTS</b> .27 IN. Character. Common Anode MAN 5 — GREEN — <b>\$1.29</b> MAN 8 — YELLOW — <b>\$1.29</b></p>	<p><b>ALTAJ ELECTRONICS</b> P.O. BOX 3854 DALLAS, TEXAS 75238</p>
<p><b>P &amp; B RELAYS</b> 4P.D.T Miniature Size 24VDC Coil — <b>1.49</b> 115VAC Coil — <b>1.79</b></p>	<p><b>PHASE LOCKED LOOP</b> 565A by Signetics. Extremely stable. High linearity, wide frequency range. TTL compatible. Perfect for tone decoders, FSK, SCA receivers, frequency multiplication and division — <b>\$1.75.</b> WITH SPECS</p>	<p><b>RCA CA3043 — FM IC</b> Used in FM stereos. Contains IF Amp, Limiter, FM Detector, and an Audio Preamp and Driver all in one 12 lead TO-5 package. With Spec Sheets. A \$3.00 Valve — 99c</p>	<p><b>TERMS:</b> Check or money order. No COD. Add 10% Pstg. and Hdg. Tex Res. add 5%.</p>



## AM/FM STEREO RECEIVER CHASSIS

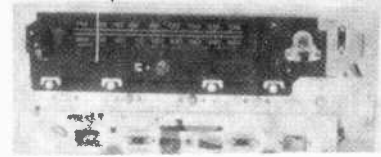

This receiver was designed to mount in an elaborate cabinet. Ideal for custom installation. Has inputs for phonograph and tape deck. Outputs for 2 sets of speakers, and headphone jack.

Has AFC switch, stereo indicator, 5 position function switch, bass treble and balance controls. We supply the external power transformer, but no speakers. Ready to go with your speakers. Data sheet included. 15"x10"x5 1/2". Wt. 7 lbs. Guaranteed.

STOCK NO. P5276 \$37.50 ea; 2/70.00

## LOADED COMPUTER PARTS BOARDS

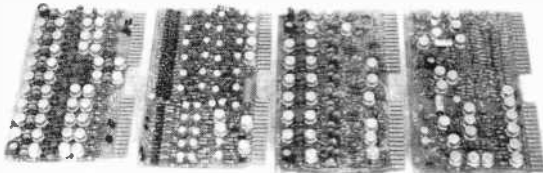

We have a group of boards that are loaded with highly desirable semi-conductors, 1/4 watt resistors and capacitors. A sample set of 4 boards yielded the following: 101 TO-5 transistors, 43 TO-18 transistors, 480 1/4 watt resistors, 238 small signal diodes, 113 small discaps, and much more. Enough parts for a lot of building and experimenting.

STOCK NO. P9160 4 different boards, 5.00. 9 different, 9.00.

### COMPUTER GRADE CAPACITORS

15 Volts	110,000 MFD.	P2352	3.50	3/9.00
50 Volts	4,000 MFD.	P2189	2.50	4/9.00
50 Volts	9,000 MFD.	P2350	3.25	4/12.00
75 Volts	3,750 MFD.	P2116	3.00	3/8.00

Enclose sufficient postage. Excess will be refunded. Send for our new catalog 14. 64 pages of electronic bargains.



# DELTA ELECTRONICS CO.

BOX 1, LYNN, MASSACHUSETTS 01903  
Phone (617) 388-4705

CIRCLE NO. 20 ON READER SERVICE CARD

## CB SPECIALS

2SC517	4.75	2SC781	3.25	2SC1237	2.00	2SC1678	5.75
2SC710	.70	2SC799	4.25	2SC1239	2.80	2SC1679	5.75
2SC711	.70	2SC1013	1.50	2SC1243	1.50	2SC1957	3.50
2SC735	.70	2SC1014	1.50	2SC1306	5.25	2SD235	1.00
2SC756	1.50	2SC1017	1.50	2SC1307	6.25	MRF8004	3.00
2SC773	.85	2SC1018	1.50	2SC1377	6.75	4004	3.00
2SC774	1.75	2SC1173	1.25	2SC1449	3.50	4005	3.00

## JAPANESE TRANSISTORS

2SA52	60	2SB370	110	2SC478	80	2SC829	75	2SC1509	125
2SA101	70	2SB379	65	2SC482	1.75	2SC833	70	2SC1569	125
2SA103	70	2SB380	70	2SC491	2.50	2SC838	70	2SC1756	125
2SA221	60	2SB405	100	2SC495	70	2SC839	85	2SD30	95
2SA473	85	2SB407	210	2SC497	1.60	2SC930	65	2SD45	2.00
2SA495	65	2SB415	105	2SC515	.80	2SC945	65	2SD64	75
2SA497	55	2SB461	125	2SC535	95	2SC1010	80	2SD65	75
2SA505	65	2SB463	165	2SC536	65	2SC1012	80	2SD68	70
2SA562	70	2SB471	175	2SC537	70	2SC1013	150	2SD72	1.00
2SA607	2.25	2SB474	175	2SC563	2.50	2SC1014	150	2SD88	1.50
2SA613	1.00	2SB481	210	2SC564	70	2SC1018	150	2SD120	85
2SA643	85	2SB492	125	2SC568	70	2SC1030	325	2SD130	1.50
2SA647	2.75	2SB495	95	2SC582	85	2SC1051	250	2SD141	2.25
2SA673	85	2SB605	2.00	2SC591	2.50	2SC1061	165	2SD151	2.50
2SA679	2.25	2SB606	1.00	2SC605	1.00	2SC1079	395	2SD170	2.00
2SA682	95	2SC15	65	2SC619	1.00	2SC1096	115	2SD198	2.50
2SA699	1.30	2SC24	65	2SC620	80	2SC1098	115	2SD180	3.00
2SA699A	2.00	2SC32	65	2SC627	1.75	2SC1115	275	2SD20	2.50
2SA705	55	2SC33	65	2SC644	70	2SC1166	70	2SD218	5.00
2SA714	2.50	2SC41	4.00	2SC645	85	2SC1170	4.00	2SD235	1.00
2SA720	70	2SC49	80	2SC681	2.50	2SC1172B	245	2SD261	80
2SA733	65	2SC56	95	2SC684	2.10	2SC1173	125	2SD291	85
2SB22	65	2SC143	3.50	2SC687	2.50	2SC1213	75	2SD292	85
2SB54	70	2SC154	3.75	2SC696	2.35	2SC1226	125	2SD300	2.50
2SB56	70	2SC162	3.75	2SC710	70	2SC1237	200	2SD313	1.20
2SB77	70	2SC163	4.50	2SC711	70	2SC1239	280	2SD315	.75
2SB128	2.50	2SC185	1.00	2SC712	.70	2SC1293	85	2SD318	.95
2SB135	95	2SC202	1.00	2SC713	.70	2SC1308	5.00	2SD341	.95
2SB152	4.50	2SC206	1.00	2SC732	.70	2SC1317	60	2SD350	3.50
2SB172	55	2SC240	1.10	2SC733	.70	2SC1325	5.00	2SD352	.80
2SB173	55	2SC261	65	2SC735	.70	2SC1347	90	2SD380	90
2SB175	55	2SC291	65	2SC739	.70	2SC1377	6.75	2SD389	6.00
2SB178	1.00	2SC320	75	2SC756	1.50	2SC1383	75	2SD390	.75
2SB186	60	2SC352	75	2SC774	1.75	2SC1393	60	2SD437	6.00
2SB187	60	2SC353	75	2SC775	2.00	2SC1409	2.75	2SD458	80
2SB235	1.95	2SC371	70	2SC778	3.00	2SC1410	2.75	2SD1111	3.50
2SB303	65	2SC372	70	2SC783	1.00	2SC1446	1.25	2SD1115	3.75
2SB324	1.00	2SC380	70	2SC784	.70	2SC1447	1.25	2SK19	2.25
2SB337	2.10	2SC387	70	2SC785	1.00	2SC1448	1.25	2SK30	1.25
2SB364	65	2SC394	70	2SC792	3.00	2SC1450	1.00	2SK40	1.60
2SB365	65	2SC458	70	2SC793	2.50	2SC1454	2.75	3SF11	3.14
2SB367	1.60	2SC460	70	2SC828	.75	2SC1507	1.25	SG609	4.95

20% off on Replacement orders of 25.00 or less. Above is partial list of current stock available at drastic reductions. Send for complete list!  
ALL PARTS GUARANTEED AND TESTED ON PREMISES.  
WRITE FOR FREE CATALOG AND LG. QUANTITY DISCOUNTS.

CIRCLE NO. 38 ON READER SERVICE CARD

AmericanRadioHistory.com

For  
faster  
service

USE  
ZIP  
CODE

on  
all  
mail

UNIVERSITY DEGREES BY MAIL! Bachelors, Masters, Ph.D's. Free revealing details. Counseling, Box 1162-PE8, Tustin, California 92680.

SELF-STUDY CB RADIO REPAIR COURSE. THERE'S MONEY TO BE MADE REPAIRING CB RADIOS. This easy-to-learn course can prepare you for a career in electronics enabling you to earn as much as \$16.00 an hour in your spare time. For more information write: CB RADIO REPAIR COURSE, Dept. PE085, 531 N. Ann Arbor, Oklahoma City, Okla. 73127.

EARN WHILE YOU LEARN Television Servicing. Simplified proven troubleshooting techniques. Profusely illustrated. Easily understood. Send \$2.00 for first lesson. Money refunded if not satisfied. Electronics Learning Center, 4501 Cedros, No. 245A, Sherman Oaks, California 91403.

UPDATE your electronics knowledge and add a FCC first class license. Home study. Free catalog. Genn Tech, 5540 Hollywood Bv., Los Angeles, CA 90028.

LEARN BROADCASTING: Become a disc jockey, get free tapes, records. Start own station. Complete details free. Broadcasting, Box 5516, Walnut Creek, CA 94596.

## MUSICAL INSTRUMENTS

UP TO 60% DISCOUNT. Name brand instruments catalog. Freeport Music, 455N Route 110, Melville, N.Y. 11746.

WHOLESALE! Professional Guitars, PA Systems, Altec Speakers, 240W RMS Amplifiers. Free Catalog, Carvin, Escondido, Calif. 92028.

FREE CATALOG! 30% ro 50% discount. Any model: guitar, amp, drum, banjo, dobro! Write: Warehouse, PE-2, Box 11449, Ft. Worth, TX 76109.

## TREASURE FINDERS

FREE FACT-FILLED CATALOG! World's largest selection! Metal detectors starting at \$79.50. Two year guarantee! Three factories, U.S.-Canada. 1,200 dealers - Service Centers nationwide. Finest instruments at any price! Budget Terms. Dealer inquiries invited. Write: White's Electronics, Inc. Dept. PD5V, 1011 Pleasant Valley Road, Sweet Home, Oregon 97386.

TREASURE FINDER locates buried gold, silver, coins, treasures. 6 powerful models. Instant financing available. Write or call for free catalog. Phone (713) 682-2728 day or night. Dealer inquiries invited. Relco, Dept. AA20, Box 10839, Houston, Texas 77018.

## OEM SPECIALS

1N270	06 2N630	310 2N1540	90 2N2325	210 2N3247	350 2N3856	20 2N4403	19
1N749.A	16 2N677C	500 2N1543	300 2N2326	300 2N3250	40 2N3866	90 2N4409	19
1N750.A	16 2N706	20 2N1544	80 2N2327	400 2N3375	495 2N3903	19 2N4410	19
1N751.A	16 2N706B	35 2N1549	105 2N2328	4 25 2N3383	19 2N3904	19 2N4416	75
1N914	06 2N711	35 2N1551	350 2N2329	600 2N3394	19 2N3905	19 2N4441	85
1N4148	06 2N711B	50 2N1552	350 2N2368	25 2N3414	22 2N3906	19 2N4442	90
1N4746	50 2N718	18 2N1554	175 2N2369	19 2N3415	25 2N3924	3.25 2N4443	1.25
1N4747	50 2N718A	.25 2N1557	150 2N2484	20 2N3416	28 2N3925	4.50 2N4852	60
1N4749	50 2N720A	1.35 2N1560	300 2N2712	25 2N3417	30 2N3954	4.50 2N5061	25
1N5355	75 2N759A	90 2N1605	35 2N2894	40 2N3442	190 2N3954A	4.90 2N5064	40
1N5357.A,B	75 2N760	40 2N1613	30 2N2903	3.50 2N3553	150 2N3955	2.50 2N5130	19
1N5358.A,B	75 2N877	2.25 2N1671	100 2N2904	19 2N3563	18 2N3955A	2.90 2N5133	15
1N5359.A,B	75 2N894	1.75 2N1711	30 2N2904A	25 2N3565	18 2N3957	1.30 2N5138	15
2N173	2.00 2N918	19 2N1907	4.25 2N2905	19 2N3638	18 2N3958	1.20 2N5154	6.25
2N178	90 2N930	19 2N2060	1.90 2N2905A	25 2N3642	19 2N4037	60 2N5157	8.95
2N327A	1.25 2N956	20 2N2102	.40 2N2906	19 2N3643	15 2N4093	90 2N5198	3.85
2N334	1.25 2N960	40 2N2218	20 2N2906A	20 2N3645	15 2N4124	18 2N5294	60
2N336	90 2N962	40 2N2218A	25 2N2907	19 2N3646	10 2N4126	23 2N5296	45
2N338A	1.10 2N967	40 2N2219	20 2N2907A	25 2N3730	1.25 2N4141	23 2N5306	20
2N398B	90 2N1136	1.25 2N2219A	25 2N2913	75 2N3731	1.65 2N4142	16 2N5354	25
2N404	20 2N1137A	1.65 2N2221	19 2N2914	1.25 2N3740	100 2N4143	15 2N5369	20
2N443	1.05 2N1142	1.95 2N2221A	19 2N2916A	3.75 2N3771	1.90 2N4220A	90 2N5400	50
2N456	1.15 2N1143	1.75 2N2222	19 2N3019	1.25 2N3772	200 2N4234	1.25 2N5401	50
2N501A	3.50 2N1302	25 2N2222A	19 2N3053	19 2N3773	2.10 2N4235	1.60 2N5457	35
2N506A	35 2N1305	30 2N2270	30 2N3054	70 2N3819	25 2N4300	1.90 2N5458	35
2N5112	250 2N1377	1.25 2N2322	150 2N3055	75 2N3823	60 2N4401	19 2N5467	28.00
2N555	45 2N1420	18 2N2323	160 2N3227	2.10 2N3843	25 2N4402	19 2N5468	45
2N652A	90 2N1483	1.00 2N2324	2.00				

### SILICON UNIJUNCTIONS

2N2646	To-18	.50
2N2647	To-18	.65
2N6027 PUT	To-92	.55
2N6028 PUT	To-92	.75
2N1671	To-5	1.00
D5E37	To-18	4/1.00

### INTEGRATED CIRC.

UA703C	.40
CA3066	4.00
CA3068	6.50
MC1305	1.50

### RECTIFIERS

	.10	1.00
1N4001	.60	5.00
1N4002	.70	6.00
1N4003	.80	7.00
1N4004	.90	8.00
1N4005	1.00	9.00
1N4006	1.10	10.00
1N4007	1.20	11.00

TRANSISTOR GRAB BAG—Germanium and Silicon small sigs and power transistors. Untested. 50/1.00 FAIRCHILD 9L00 IC's, prime units. 29 HOBBYIST'S 16 Pin Digital IC: Unt

# PRICES Slashed up to 50%

Take advantage of our new Volume Discount.

## SEMICONDUCTORS

Solid State Systems, Inc. has in stock a wide range of SEMICONDUCTORS including 7400 TTL, Linear IC's, Diodes, Transistors, and TRIAC's.

These items are ALL factory tested FIRST-RUN PRIME. All IC's are supplied in 18-, 14-, 16-, or 24-pin DIP plastic or ceramic package except for NE540 and SE540, which come in a TO-3 package.

Catalog Number	Description	Unit Prices
12-17501	NE501A Video Amplifier	2.50
12-27531	NE531V High Slew Rate OP Amp	2.60
12-37540	NE540L Power Driver	2.00
12-35540	SE540L Power Driver	4.00
12-17550	NE550A Precision Voltage Regulator	1.00
82-03554	SI-3554E, 5V 3 Amp Voltage Reg	7.50
12-27555	NE555V Timer	.80
12-25556	N5556V Operational Amp	1.50
12-25558	N5558V Dual Operational Amp	.68
12-17560	NE560B Phase Locked Loop	2.25
12-17561	NE561B Phase Locked Loop	2.25
12-17562	NE562B Phase Locked Loop	2.25
12-17565	NE565A Phase Locked Loop	2.25
12-27566	NE566V Function Generator	2.25
12-27567	NE567V Tone Decoder PLL	2.25
12-15595	N5595A Linear 4-Quad Multiplier	2.25
12-15596	N5596A Balanced Modulator-Demod	1.65
12-25709	709CV Operational Amp	.38
12-15710	710CA Voltage Comparator	.30
12-15711	711CA Dual Voltage Comparator	.32
12-15723	723CA Precision Voltage Reg	.85
12-15733	733CA Differential Video Amp	1.40
12-25741	741CV High Performance Op Amp	.45
12-15747	747CA Dual Operational Amp	.95
12-25748	748CV High Performance Op Amp	.35

### DIODES

21-10270	1N270 Germanium Switching Diode	.12
42-14001	1N4001, 1Amp, 50PRV, Rec Diode	.07
42-14002	1N4002, 1Amp, 100PRV, Rec Diode	.08
42-14003	1N4003, 1Amp, 200PRV, Rec Diode	.09
42-14004	1N4004, 1Amp, 400PRV, Rec Diode	.10
42-14005	1N4005, 1Amp, 600PRV, Rec Diode	.11
42-14006	1N4006, 1Amp, 800PRV, Rec Diode	.12
42-14007	1N4007, 1Amp, 1000PRV, Rec Diode	.13
42-14148	1N4148 Silicon Switching Diode	.08
73-10746	1N746A, 3.3V, 5%, 400MW, Zener Diode	.15
73-10747	1N747A, 3.6V, 5%, 400MW, Zener Diode	.15
73-10748	1N748A, 3.9V, 5%, 400MW, Zener Diode	.15
73-10749	1N749A, 4.3V, 5%, 400MW, Zener Diode	.15
73-10750	1N750A, 4.7V, 5%, 400MW, Zener Diode	.15
73-10751	1N751A, 5.1V, 5%, 400MW, Zener Diode	.15
73-10752	1N752A, 5.6V, 5%, 400MW, Zener Diode	.15
73-10753	1N753A, 6.2V, 5%, 400MW, Zener Diode	.15
73-10754	1N754A, 6.8V, 5%, 400MW, Zener Diode	.15
73-10755	1N755A, 7.5V, 5%, 400MW, Zener Diode	.15
73-10756	1N756A, 8.2V, 5%, 400MW, Zener Diode	.15
73-10757	1N757A, 9.1V, 5%, 400MW, Zener Diode	.15
73-10758	1N758A, 10V, 5%, 400MW, Zener Diode	.15
73-10759	1N759A, 12V, 5%, 400MW, Zener Diode	.15

### TRANSISTORS

54-23860	2N3860 NPN General Purpose Transistor	.21
----------	---------------------------------------	-----

### TRIACS

45-03003	3mA Gate 50V 3 Amp. TRIAC	1.31
45-03203	3mA Gate 200V 3 Amp. TRIAC	1.69
45-03403	3mA Gate 400V 3 Amp. TRIAC	2.11
45-10003	10mA Gate 50V 3 Amp. TRIAC	1.06
45-10203	10mA Gate 200V 3 Amp. TRIAC	1.36
45-10403	10mA Gate 400V 3 Amp. TRIAC	1.70
45-25003	25mA Gate 50V 3 Amp. TRIAC	.85
45-25203	25mA Gate 200V 3 Amp. TRIAC	1.19
45-25403	25mA Gate 400V 3 Amp. TRIAC	1.53
45-50010	50mA Gate 50V 10 Amp. TRIAC	.84
45-50015	50mA Gate 50V 15 Amp. TRIAC	1.31
45-50210	50mA Gate 200V 10 Amp. TRIAC	1.36
45-50215	50mA Gate 200V 15 Amp. TRIAC	2.33
45-50410	50mA Gate 400V 10 Amp. TRIAC	1.72
45-50415	50mA Gate 400V 15 Amp. TRIAC	2.95
46-50010	50mA Gate 50V 10 Amp. TRIAC	.75
46-50015	50mA Gate 50V 15 Amp. TRIAC	1.18
46-50215	50mA Gate 200V 15 Amp. TRIAC	2.10
46-50410	50mA Gate 400V 10 Amp. TRIAC	1.55
46-50415	50mA Gate 400V 15 Amp. TRIAC	2.60

## 7400 SERIES

Catalog Number	Unit Price	Catalog Number	Unit Price
7400	.20	7484	2.80
7401	.20	7485	1.40
7402	.20	7486	.45
7403	.20	7489	3.50
7404	.21	7490	.68
7405	.21	7491	1.00
7406	.40	7492	.68
7407	.40	7493	.68
7408	.22	7494	.98
7409	.22	7495	.98
7410	.20	7496	.98
7411	.21	74100	1.25
7413	.45	74104	.60
7416	.38	74105	.60
7417	.38	74107	.42
7418	.30	74121	.48
7420	.20	74122	.60
7421	.20	74123	1.00
7423	.40	74141	1.25
7425	.40	74145	1.21
7426	.26	74150	1.42
7430	.20	74151	1.00
7437	.44	74153	1.25
7438	.44	74154	1.95
7440	.20	75155	1.25
7441	1.00	74156	1.25
7442	1.00	74157	1.30
7443	1.00	74158	1.30
7444	1.00	74161	1.50
7445	1.20	74162	1.50
7446	1.00	74163	1.50
7447	.90	74164	1.50
7448	1.00	74165	1.50
7450	.20	74166	1.50
7451	.20	74170	2.75
7453	.20	74175	2.00
7454	.20	74176	1.75
7459	.20	74177	1.75
7460	.20	74180	1.00
7470	.32	74181	3.95
7472	.29	74182	.95
7473	.40	74192	1.25
7474	.40	74193	1.25
7475	.64	74196	1.95
7476	.42	74197	1.95
7480	.50	74198	2.65
7482	.93	74199	2.65
7483	1.30		

If your merchandise total is between:

#### STANDARD CHARGES

\$ 0.00 - \$ 4.99	..... add	..... \$2.00
\$ 5.00 - \$24.99	..... add	..... \$0.75
\$ 25.00 - \$49.99	..... add	..... \$0.50
\$ 50.00 - \$99.99	..... add	..... \$0.25
\$100.00 and up	.....	NO CHARGE

The above charges include shipping via First Class or UPS (your Choice), and insurance for all domestic shipments.

#### SPECIAL CHARGES

COD	..... \$1.00—additional
Air Mail	..... \$0.50—additional
Postal Insurance	..... \$0.25—additional
Special Delivery	..... \$0.75—additional

#### VOLUME DISCOUNT SCHEDULE

Merchandise Total	Discount
\$ 0.00 - \$ 9.99	..... NET
\$ 10.00 - \$ 24.99	..... Less 5%
\$ 25.00 - \$ 99.99	..... Less 10%
\$ 100.00 - \$499.99	..... Less 15%
\$ 500.00 - \$999.99	..... Less 20%
\$1000.00 and up	..... Less 25%

## SCHOTTKY TTL

SPECIAL CLOSEOUT SALE on 74S00 series Schottky TTL. This is a one-time offer, as we are discontinuing our line of this fast TTL. These items are offered at our cost, but only while they last. These items will NOT be backordered and credit will be issued for all items SOLD OUT. Get them while they are still in stock!

Catalog Number	Unit Price
74S01	.50
74S03	.50
74S04	.55
74S05	.55
74S09	.50
74S15	.50
74S20	.50
74S21	.50
74S22	.50
74S40	.55
74S50	.50
74S51	.50
74S60	.50
74S65	.50
74S74	.99
74S76	.99
74S78	.99
74S107	.99
74S112	.99
74S113	.99
74S114	.99

## CMOS

## 4000 SERIES

Catalog Number	Description	Unit Prices
4000	Dual 3-Input Positive NOR Gate Plus Inverter	.29
4001	Quad 2-Input Positive NOR Gate	.29
4002	Dual 4-Input Positive NOR Gate	.29
4006	18 Stage Static Shift Register	2.55
4007	Dual Complimentary Pair Plus Inverter	.29
4008	4-Bit Full Adder W/Parallel Carry Out	1.36
4009	Hex Buffer, Inverting Type	.74
4010	Hex Buffer, Non-Inverting Type	.74
4011	Quad 2-Input Positive NAND Gate	.29
4012	Dual 4-Input Positive NAND Gate	.29
4013	Dual D-Type Flip-Flop W/Set-Reset	.67
4014	8-Stage Static Shift Register	1.86
4015	Dual 4-Stage Static Register	1.79
4016	Quad Bilateral Switch	.67
4017	Decade Counter/Divider W/Decoded Outputs	1.69
4018	Presetable Divide-By-"N" Counter.	1.86
4019	Quad AND-OR "Select" Gate	.67
4020	14-Stage Ripple-Carry Binary Counter/Divider	1.86
4021	8-Stage Static Shift Register	1.79
4022	Divide-By-8 Counter W/8 decoded outputs	1.69
4023	Triple 3-Input Positive NAND Gate	.29
4024	7-Stage Binary Counter	1.43
4025	Triple 3-Input Positive NOR Gate	.29
4026	Decade Counter/7-Seg. Decoder, Oisp. Enable	2.89
4027	Dual J-K Master-Slave Flip-Flop W/Set & Reset	.84
4028	BCD-To-Decimal Decoder	1.43
4029	Presetable Up/Down Counter, Binary or BCD	2.11
4030	Quad Exclusive-OR Gate	.67
4033	Decade Counter/7-Seg. Decod. & Ripple Blank.	3.23
4035	4-Stage Shift Register (Parallel-In, Parallel Out)	1.86
4040	12-Stage Ripple-Carry Bin. Counter/Divider	1.86
4041	Quad True/Compliment Buffer	1.35
4042	Quad Clocked "D" Latch	1.28
4043	Quad NOR R/S Latch	1.26
4044	Quad NAND R/S Latch	1.26
4049	Hex Buffer/Converter, Inverting Type	.72
4050	Hex Buffer/Converter, Non-Inverting Type	.72
4051	Single 8-Channel Multiplexer	2.11
4052	Differential 4-Channel Multiplexer	2.11
4053	Triple 2-Channel Multiplexer	2.11
4060	14-Stage Ripple-Carry Bin. Count./Div. W/Osc.	2.55
4066	Quad Bilateral Switch	1.26
4071	Quad 2-Input OR Gate	.36
4072	Dual 4-Input OR Gate	.36
4081	Quad 2-Input AND Gate	.36
4082	Dual 4-Input AND Gate	.36
4502	Stobed Hex Inverter/Buffer	1.28
4510	BCD Up/Down Counter	1.96
4511	BCD-To-7 Seg. Latch/Decoder/Driver	1.96
4512	8-Channel Data Selector	2.13
4514	4-Bit Latch/4-16-Decoder(Hi)	2.47
4515	4-Bit Latch/4-16-Decoder(Lo)	2.47
4516	Binary Up/Down Counter	1.96
4518	Dual BCD Up Counter	2.04
4520	Dual Bin. Up/Down Counter	2.04
4528	Dual Monostable Multivibrator	1.69
4585	4-Bit Magnatude Comparator	2.13

SEND YOUR ORDER TO:

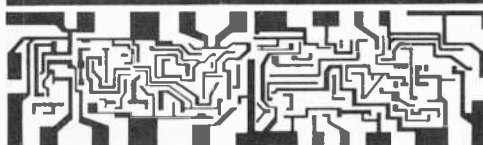

SOLID STATE SYSTEMS, INC.  
P. O. BOX 617  
COLUMBIA, MISSOURI 65201

OR CALL: 800-325-2981



AUGUST 1975

## ADVERTISERS INDEX

READER SERVICE NO.	ADVERTISER	PAGE NUMBER
1	A.D.R. Audio Video	80
2	A.P. Products Incorporated	23
53	A.P. Products Incorporated	71
3	Adva Electronics	89
4	Allison Automotive Company	70
6	Altaj Electronics	97
7	Anconra Corp.	101
8	Antenna Specialists Co., The	22
9	Audio Technica U.S., Inc	23
11	Babylon Electronics	100
	Bell & Howell Schools	18, 19, 20, 21, 83, 84
12	Browning Laboratories, Inc	14
13	CB Radio Repair Course, Inc	78
	CREI Capitol Radio Engineering Institute	72, 73, 74, 75
14	CTS of Paducah, Inc	63
15	Circuit Design, Inc	63
16	Cleveland Institute of Electronics, Inc.	54, 55, 56, 57
17	Cobra, Product of Dynascan Corporation	5
19	Continental Specialties Corp	13
20	Delta Electronics Co	98
21	Delta Products, Inc	79
22	Digi-Key Corporation	96
23	EICO	81
24	Edmund Scientific Co	88
25	Edmund Scientific Co	102
	G.C. Electronics	6
5	Heath Company	25
26	Hy-Gain Electronics Corporation	SECOND COVER
27	Illinois Audio	76
28	International Electronics Unlimited	92
29	James	91
30	Johnson Co., E.F.	26
31	Lafayette Radio Electronics	12
32	McIntosh Laboratory, Inc	77
33	McKay Dymek Co	78
34	MITS	1
35	Mallory & Co., Inc., P.R.	2
36	Midland International Communications Division	FOURTH COVER
	NRI Schools	8, 9, 10, 11
37	National Camera	76
	National Technical Schools	40, 41, 42, 43
38	New-Tone Electronics	98
39	Pace Communications	77
40	Poly Paks	95
41	Processor Technology Co	71
42	Radio Shack	15
43	Royce Electronics Corporation	7
44	SAE, Inc	82
52	Sansui Electronics Corp	87
45	Scelbi Computer Consulting, Inc	86
46	Solid State Sales	90
47	Solid State Systems, Inc	99
48	Southwest Technical Products Corporation	85
49	Stanton Magnetics	THIRD COVER
50	Stereo Discounters	71
51	Tri-Star Corporation	80
	CLASSIFIED ADVERTISING	89, 90, 92, 96, 98, 100

## PRO SPORTS FILMS

SUMMER FILM FESTIVAL—order Ali-Foreman heavy-weight championship; the '75 Super Bowl (Steelers-Vikings) in Super 8, Color, \$18.95 each PPD. You save \$1.50 on every print you buy. Sam Snead Cuts Strokes; '72 NBA Basketball, Super 8, 200' reel, B&W, \$5.95 each PPD. Or choose other interesting films (including Super 8 Sound) from Castle, Columbia and Sportlite catalogs (30 cents each, coins or stamps). PRO SPORTS FILMS, Elect. Dept.-8, Box 24-500, Speedway, Indiana 46224.

## DO-IT-YOURSELF

TELEPHONES, ALL TYPES. Equipment, Supplies, Keyed Regular, Decorator. Catalog 50 cents. Box 1654J, Costa Mesa, California 92626.

## BUSINESS OPPORTUNITIES

I MADE \$40,000.00 Year by Mailorder! Helped others make money! Free Proof. Torrey, Box 318-NN, Ypsilanti, Michigan 48197.

FREE CATALOGS. Repair air conditioning, refrigeration. Tools, supplies, full instructions. Doolin, 2016 Canton, Dallas, Texas 75201.

MAILORDER MILLIONAIRE helps beginners make \$500 weekly. Free report reveals secret plan! Executive (1K8), 333 North Michigan, Chicago 60601.

PIANO TUNING LEARNED QUICKLY AT HOME! Musical knowledge unnecessary. Free Information. Empire School, Box 450327, Miami 33145.

\$200.00 DAILY in Your Mailbox! Your opportunity to do what mail-order experts do. Free details. Associates, Box 136-J, Holland, Michigan 49423.

FREE BOOK "2042 unique proven enterprises." Work home! Hayling-B. Carlsbad, CA 92008.

ELECTRONIC Assembly Business. Big profits. Start home, spare time. Investment, knowledge, experience unnecessary. Free illustrated literature. Barta, Box 248CV, Walnut Creek, Calif. 94597.

*wanted* **Citizens Band** P-2

**DEALER-DISTRIBUTORS**

Send this ad with Letterhead to:

**PAL ELECTRONICS CO.**

2962 W. WELDON - PHOENIX, ARIZ. 85017

EXCEPTIONAL profits installing professional-grade, silent Police-Calling hold-up & burglary alarms. We teach you how—Fast. Write: Garrison Protective, B-550, 42-55 Colden, Flushing, New York 11351.

GET RICH with Secret Law that smashes debts and brings you \$500 to \$5 Million cash. Free report! Credit 4K8, 333 North Michigan, Chicago 60601.

MAKE durable building plastic easily. Waterproof, fire-proof, economical. Bays Laboratory, Cedaredge, Colo. 81413.

## RUBBER STAMPS

RUBBER address stamps. Free catalog. 45 type styles. Jackson's, Box 443G, Franklin Park, Ill. 60131.

## BOOKS AND MAGAZINES

FREE catalog aviation/electronic/space books. Aero Publishers, 329PE Aviation Road, Fallbrook, California 92028.

FREE book prophet Elijah coming before Christ. Wonderful bible evidence. Megiddo Mission, Dept. 64, 481 Thurston Rd., Rochester, N.Y. 14619.

## HYPNOTISM

SLEEP learning. Hypnotic method. 92% effective. Details free. ASR Foundation, Box 23429EG, Fort Lauderdale, Florida 33307.

FREE Hypnotism. Self-Hypnosis. Sleep Learning Catalog! Drawer H400, Ruidoso, New Mexico 88345.

AMAZING self-hypnosis record releases fantastic mental power. Instant results! Free trial. Write: Forum (AAB), 333 North Michigan, Chicago 60601.

## MISCELLANEOUS

WINEMAKERS: Free illustrated catalog yeasts, equipment. Semplex, Box 12276P, Minneapolis, Minn. 55412.



**POTTER BRUMFIELD**  
Type KHP Relay  
4 PDT 3A Contacts  
24 VDC (650 coil) \$1.50 EA.  
120 VAC (10.5 MA coil) \$1.75 EA.

<p><b>DIP SOCKETS</b></p> <ul style="list-style-type: none"> <li>8 PIN PCB .22</li> <li>14 PIN PCB .26</li> <li>16 PIN PCB .30</li> <li>24 PIN PCB .75</li> <li>40 PIN PCB 1.25</li> <li>14 PIN WIRE WRAP .35</li> </ul>	<p><b>TTL SPECIAL</b></p> <p>7400 DIP TTL Signetic/ House Numbered</p> <p>7404 OIP TTL Hex Inverter Signetic/House Numbered</p> <p>Each \$ .17 Ten for \$1.50</p>
--	---

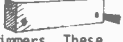
**FAIRCHILD "TRIMPOTS"** 

Brand new 20 turn precision trimmers. These are prime parts mostly individually packed in sealed envelopes. These values in stock:

50 OHM 1K	5K	25K
500 OHM 2K	10K	

Each only \$ .89 10 for \$7.50

**CARBON RESISTORS**

Carbon Resistors 1/4-Watt 5%-full prime All values in stock. 10 per value (minimum quantity). 10 for \$ .45

**2102-2 MOS 1024 BIT MEMORY (DIP)**

FULLY DECODED STATIC RANDOM ACCESS MEMORY DIRECTLY TTL COMPATIBLE INPUTS AND OUTPUT SINGLE 5V SUPPLY - NO CLOCKS OR REFRESH

**\$5.00 each 8 for \$34.95**

**DIODE ARRAY** 

10 - 1N914 Silicon Signal Diodes in one package. 20 leads spaced .1"; no common connections. Each \$ .25 10 for \$2.25

Numeric Display  
1/4" Single Digit  
GaAsP LED



COMMON CATHODE WITH RH DECIMAL  
SUPER SPECIAL \$ .59  
TEN for \$4.95

ACTUAL SIZE

SPECIAL  
8223  
PROM

8 BIT  
32 WORD  
MEMORY  
\$3.00 EA.  
10 - \$29  
WE PROGRAM  
FOR \$5 EACH

**RECTIFIER SPECIAL!** 1N4007 - 1 AMP - 1000 volt PRV  
\$ .13 each 10 for \$1.00

**SEND FOR FREE FLYER!**

C.O.D. PHONE ORDERS ACCEPTED—\$10 MINIMUM

All IC's new and fully tested, leads plated with gold or solder. Orders for \$5.00 or more are shipped prepaid, smaller orders—add 55c. California residents add Sales Tax.....IC's shipped within 24 hours. P.O. BOX 41727 SACRAMENTO, CA 95841

**BABYLON ELECTRONICS**  
916 334 2161

CIRCLE NO. 11 ON READER SERVICE CARD

## EMPLOYMENT OPPORTUNITIES

ELECTRONICS/AVIONICS EMPLOYMENT OPPORTUNITIES. Report on jobs now open. Details FREE. Aviation Employment Information Service, Box 240E, Northport, New York 11768.

## REAL ESTATE

BIG...NEW...FREE...FALL CATALOG! Over 2,600 top values coast to coast! UNITED FARM AGENCY, 612-EP, West 47th St., Kansas City, Mo. 64112.

## RECORDS

OLDIES, 45rpm. Free Catalog. Corny's Record Shop, Box 166TL, Mason, Ohio 45040.

FREE RECORD COLLECTION Reviewers wanted. Anyone qualifies. We ship you new records to review. You pay postage. Records are free. Applicants accepted "first come" basis. Write: Research PE, 6162 Washington Circle, Milwaukee, Wisconsin 53213.

**C-MOS**

1-9 10 up

4000AE	.26	.25
4001AE	.26	.25
4002AE	.26	.25
4004AE	5.88	8.22
4006AE	1.36	1.34
4007AE	.26	.25
4008AE	1.79	1.78
4009AE	.60	.59
4010AE	.59	.58
4011AE	.26	.25
4012AE	.26	.25
4013AE	.47	.46
4014AE	1.49	1.48
4015AE	1.26	1.25
4016AE	.56	.55
4017AE	1.20	1.19
4018AE	1.41	1.40
4019AE	.52	.51
4020AE	1.49	1.48
4021AE	1.34	1.33
4022AE	1.11	1.10
4023AE	.26	.25
4024AE	9.01	8.99
4025AE	.26	.25
4026AE	3.72	3.70
4027AE	.60	.59
4028AE	.98	.97
4029AE	1.27	1.26
4030AE	.44	.43
4031AE	3.01	3.00
4032AE	1.27	1.26
4033AE	1.49	1.48
4034AE	1.06	1.05
4035AE	.76	.74
4036AE	.60	.59
4037AE	3.54	3.53
4038AE	1.43	1.42
4039AE	.52	.51
4040AE	.52	.51
4041AE	1.34	1.33
4042AE	1.34	1.33
4043AE	1.34	1.33
4044AE	2.68	2.58
4045AE	3.43	3.39
4046AE	1.50	1.49
4047AE	.90	.89
4048AE	.78	.68
4049AE	.27	.25
4050AE	1.68	1.48
4051AE	.26	.25
4052AE	2.30	2.20
4053AE	1.98	1.78
4054AE	2.30	2.20
4055AE	3.28	2.98
4056AE	1.88	1.68
4057AE	2.30	2.20
4058AE	.43	.36
4059AE	.43	.36



**7400N TTL**

7400N	\$.14	7444N	\$1.05	7496N	\$.85	74161N	1.28
7401N	.17	7445N	.93	74100N	1.30	74162N	1.60
7402N	.14	7446N	1.10	74104N	1.25	74163N	1.48
7403N	.17	7447N	.88	74105N	.45	74164N	1.22
7404N	.20	7448N	1.00	74107N	.40	74165N	1.78
7405N	.20	7449N	.15	74109N	.75	74166N	1.50
7406N	.30	7451N	.20	74110N	.72	74170N	2.60
7407N	.20	7453N	.20	74111N	.92	74171N	1.55
7408N	.18	7454N	.26	74114N	.92	74174N	1.20
7409N	.22	7455N	.37	74115N	.92	74175N	1.60
7410N	.18	7460N	.25	74118N	1.51	74176N	1.30
7411N	.27	7462N	.37	74121N	.37	74177N	1.50
7412N	.52	7464N	.37	74122N	.37	74180N	.73
7413N	.65	7465N	.37	74123N	.90	74181N	3.20
7414N	1.80	7470N	.30	74125N	.48	74182N	.75
7415N	.37	7471N	.49	74126N	.64	74184N	2.90
7416N	.22	7472N	.32	74128N	.94	74185N	2.29
7417N	.34	7473N	.38	74132N	1.74	74188N	4.90
7417N	.34	7473N	.38	74136N	.92	74191N	1.49
7418N	.60	7475N	.63	74140N	2.50	74191N	1.20
7419N	.27	7476N	.33	74141N	1.19	74192N	1.40
7420N	.48	7478N	.55	74145N	1.08	74193N	1.00
7421N	.34	7480N	.60	74147N	2.35	74194N	1.35
7422N	.25	7481N	1.19	74148N	2.20	74195N	.80
7423N	.31	7482N	.90	74150N	.99	74196N	1.90
7424N	.52	7483N	.65	74151N	.75	74197N	.80
7425N	.20	7484N	3.02	74152N	1.50	74198N	2.00
7426N	.25	7485N	2.50	74153N	.06	74199N	2.00
7427N	.62	7486N	.36	74154N	1.48	74200N	6.90
7428N	.36	7488N	2.40	74155N	1.08	74221N	1.75
7429N	.35	7490N	.54	74156N	1.18	74251N	1.75
7430N	.39	7491N	1.00	74157N	1.18	74278N	2.95
7431N	.16	7492N	.60	74158N	1.44	74279N	4.90
7432N	.98	7493N	.60	74160N	1.50	74293N	.25
7433N	.69	7494N	1.20			74298N	2.95
7434N	.95	7495N	.80				

**WAVEFORM GENERATOR**

**XR205K KIT** Only \$25.00  
Here's a highly versatile lab instrument at a fraction of the cost of conventional unit. Kit includes two XR205 IC's, data & applications, PCB board (etched & drilled, ready for assembly) & detailed instructions.

**DUAL LOW NOISE OP AMP**

**LM331N:**  
V<sub>io</sub> = 6mV  
I<sub>ie</sub> = 2000 nA  
I<sub>is</sub> = 2000 nA  
Noise = 1.5dB  
\$2.20

**DISPLAYS**

OPCOA	
SLA1 Red	2.25
SLA11 Green	3.50
SLA21 Yellow	3.50
SLA7 Red	1.60
LITRONIX	
DL80 Red	6.00
DL81 Red	6.00
DL10 Red	6.00
CL10A Red	4.00
DL704 Red	2.25
DL57 Red	9.90
DL61 Red	12.00
DL33 Red	4.00
DL44 Red	6.00
DL402 Red	4.00
DL701 Red	3.40
DL702 Red	2.25
DL707 Red	2.35
DL747 Red	2.50
XCITON	
XAN72 Red	2.00
XAN52 Green	2.00

**CALCULATORS**

**1024-BIT N-Channel RAM**  
\$19.00



**2601-1** 11.40  
**2601-21** 11.40  
**2602-8** 8.00  
**2602-18** 8.00  
**2602-28** 8.00  
**MK4102P** 11.40  
**7552-1CPE** 8.00  
**7552-2CPE** 8.00

**74LS**

74LS00	.58	74LS76	.92
74LS01	.58	74LS78	.92
74LS02	.58	74LS107	.92
74LS03	.58	74LS109	.92
74LS04	.63	74LS112	.92
74LS05	.63	74LS113	.92
74LS08	.58	74LS114	.92
74LS09	.58	74LS138	2.38
74LS11	.58	74LS139	2.38
74LS15	.58	74LS151	2.10
74LS15	.58	74LS152	3.38
74LS20	.58	74LS157	2.10
74LS21	.58	74LS158	2.40
74LS22	.58	74LS160	2.70
74LS27	.64	74LS161	2.70
74LS30	.58	74LS174	3.02
74LS32	.64	74LS174	3.02
74LS38	.65	74LS175	2.90
74LS51	.58	74LS181	3.72
74LS54	.58	74LS251	2.55
74LS55	.58	74LS253	2.85
74LS73	.92	74LS260	.58
74LS74	.92		

**LEDs**

1.25" dia.	
209 Red	\$.25
209 Yellow	.35
209 Green	.35
1.60" dia.	
216 Red	.25
216 Yellow	.30
216 Green	.30
2.00" dia.	
220 Red	.25
220 Yellow	.30
220 Green	.30
LOW PROFILE	
226 Red	\$.25
226 Yellow	.30
226 Green	.30
226 Orange	.30
5053 Red	.35
5053 Yellow	.40
5053 Green	.40
5053 Orange	.40

**OPTOISOLATORS**

MONSANTO	
MCT2 1.35	
LITRONIX	
IL1 1.30	
IL12 1.40	
IL16 1.80	
IL74 1.35	
ILD74 1.75	
ILQ74 3.40	

**9300 SERIES**

9300PC 1.00	
9301PC 1.20	
9304PC 1.50	
9306PC 6.90	
9308PC 2.50	
9309PC 1.60	
9310PC 1.50	
9311PC 2.30	
9312PC 1.20	
9314PC 1.30	
9316PC 1.50	
9318PC 2.30	
9322PC 1.20	
9324PC 2.00	
9328PC 2.50	
9334PC 2.95	
9338PC 3.30	
9340PC 5.00	
9341PC 4.10	
9342PC 1.15	
9346PC 1.75	
9366PC 1.75	

**1-AMP RECTIFIERS**

10	100	1000
IN4001 1.00	70.00	60.00
IN4002 1.10	70.00	70.00
IN4003 1.20	90.00	80.00
IN4004 1.30	90.00	90.00
IN4005 1.40	110.00	100.00
IN4006 1.50	120.00	110.00
IN4007 1.60	130.00	120.00

**PHASE-LOCKED LOOPS**

LM567CM Mini-dip .80

**DECODED READ/WRITE RAM**

P1103 \$6.20

**PREMIUM QUALITY COMPONENTS**

We've been buying and selling top quality components for nearly ten years. Our annual volume exceeds \$3 million. We handle only original parts, from the world's leading manufacturers and our customers include some of the largest and most quality-conscious companies. Now you can take advantage of our component buying skills and power and select from a broad range of advanced circuits.



**INTERFACE MODULES**

CY1010	Instr. Amp., Bipolar Input	29.00
CY1011A	Instr. Amp., Bipolar Input	49.00
CY1020	Instr. Amp., FET Input	34.00
CY1021	Instr. Amp., FET Input	49.00
CY1021A	Instr. Amp., FET Input	59.00
CY137	DAC, 10 Bit, Low Drift	39.00
CY2218	DAC, 12 Bit, 2 Quad Multiplying	149.00
CY2237	DAC, 12 Bit, Low Drift	69.00
CY2735	DAC, 4 Digit BCD, Low Cost	79.00
CY3035	ADC, 8 Bit, Sect. Counting, Low Cost	89.00
CY3635	ADC, 3 Digit BCD, Sect. Count, Low Cost	119.00

**LINEAR ICs**

H-T05	N-DIP	M-MINI-DIP	D-CER-DIP	K-T03	
LM114H	3.00	LM311H	4.70	LM711CN	.90
LM300H	1.20	LM311D	1.90	LM715CH	4.30
LM300N	1.20	LM311M	1.75	LM715CD	4.60
LM301AH	.90	LM311N	2.00	LM723CH	.90
LM301AM	.80	LM312H	2.70	LM723CN	.75
LM301AN	1.10	LM318H	2.60	LM725CH	5.00
LM301H	.90	LM324N	1.90	LM725CD	5.20
LM302D	3.50	LM331N	2.20	LM733CH	1.40
LM302N	1.30	LM339N	3.20	LM733CD	3.50
LM302H	1.50	LM320-5K	2.90	LM733CN	1.30
LM304H	1.50	LM320-5T	2.70	LM741CH	.45
LM305H	1.05	LM320-12K	2.90	LM741CD	1.25
LM305AH	1.05	LM320-12T	2.50	LM741CM	.44
LM305N	1.00	LM340-05K	2.60	LM741CN	.70
LM306H	.95	LM340-05G	2.60	LM747CH	1.70
LM307H	.75	LM340-09K	2.60	LM747CN	.90
LM307M	.95	LM340-15K	2.60	LM747CD	2.50
LM307N	1.50	LM340-15G	2.60	LM748CM	.55
LM308H	1.20	LM340-18K	2.60	LM748CN	.55
LM308AH	5.00	LM340-24K	2.60	LM777CH	2.10
LM308D	2.00	LM340-24G	2.60	LM777CN	1.50
LM308M	1.20	LM340-28K	2.60	LM3054CN	1.50
LM309H	1.75	LM340-28G	2.60	SG4501T	2.20
LM309K	1.95	LM340-32K	2.60	SG4501N	2.20
LM310H	1.60	LM340-32G	2.60	LM5000K	.75
LM310M	1.80	LM340-36K	.90		

**IC POWER REGULATORS**

LM335K:	5V, 600mA	2.40
LM336K:	12V, 500mA	2.90
LM337K:	15V, 450mA	2.90

**HYBRID POWER AMPLIFIERS**

SI-1010G	10W	\$6.90
SI-1020G	20W	9.90
SI-1030G	30W	18.70
SI-1050G	50W	25.90

**POWER TRANSISTORS**

BU204 3A	1300V	\$4.14
BU205 3A	1500V	4.95
BU206 3A	1700V	5.95
BU207 6A	1300V	5.85
BU208 6A	1500V	6.95
BU209 6A	1700V	8.64

**COM2601 USRT**



# LIVE IN THE WORLD OF TOMORROW... TODAY!

And our FREE 180 PAGE CATALOG is packed with exciting and unusual values in electronic, hobby and science items — plus 4,500 finds for fun, study or profit... for every member of the family.

**A BETTER LIFE STARTS HERE**

## TOTAL KIRLIAN PHOTOGRAPHY SET

Explore "aura" photography w/ superb new self-contained Kirlian Electrophotography Research Unit. Terrific value — introduced at \$99.95 (\$140 in Sept.!) Has everything but vinyl photo changing bag. Ideal for color or b&w 35mm. sheet or Polaroid film for photos up to 5x7" all without camera or lens. Variable voltage 12v to 32kv. Ultimate safety design—fully encased in plastic; patented electronics. Instrs. No. 72, 104AV... (3x5 7/8x7 7/8") ..... \$99.95 Ppd. No. 42, 240AV... (CHANGING BAG) ..... \$ 6.50 Ppd.

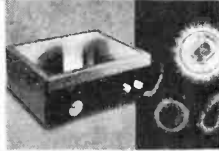

## ELECTRONIC DIGITAL STOPWATCH: \$69.95

A price breakthrough! New pocket size 4 oz. timer acc. to ±2% of last digit (1/100 sec. increments). Compares with others twice the price! Instant error-free readouts to 9999.99 sec. (over 2 3/4 hr). Starts, stops re-starts (accumulates). Mechanical pushbutton & electrical remote on/off's w/any 3.5-150v AC/DC source. Plug-in jack. Incls. 9v batt. Solid state.



No. 1943 AV (2 1/4x4 1/4x7/8") ..... \$69.95 Ppd.  
DELUXE 2 EVENT STOPWATCH (±0.01% OF LAST DIGIT)  
No. 1653 AV (PRICE UP IN SEPT.!) ..... \$120.00 Ppd.

## FUEL MISER RECLAIMS HEAT

Save your 40% wasted heat to warm a basement, garage or rec room at no extra cost! Instead of going "up the chimney" it goes where you want it. Remove part of furnace exhaust pipe, slip Heat Exchanger in. At 125° fan automat. forces clean air through unit which heats to over 200°F., can be ducted to 20 ft. from unit. 110v AC. Inst.



No. 19, 194AV (5" DIA.) Shpg. 17 lb. .... \$99.00 FOB  
No. 19, 195AV (6" DIA.) Shpg. 17 lb. .... \$99.00 FOB  
No. 19, 198AV (7" DIA.) Shpg. 17 lb. .... \$99.00 FOB

## LOW COST 7X INFRA-RED VIEWER

For infra-red crime detection surveillance, security system alignment, I.R. detection, laser checking, nite wildlife study, any work req. I.R. detection & conv. to visible spectrum. Self cont. scope w/everything incl I.R. light source. 6v or 12v power, 6032 I.R. converter tube, f/4.5 objective lens, adjust. triplet eyepiece. Focuses from 10' to infinity.



No. 1659AV (11" x 14 1/4" x 3") ..... \$275.00 Ppd.  
WITHOUT LIGHT SOURCE ..... \$225.00 Ppd.  
No. 1648AV ..... \$225.00 Ppd.

WHEN YOU COME TO PHILADELPHIA BE SURE TO SEE  
**FREE BICENTENNIAL LIGHT SHOW**  
IN BARRINGTON, N.J. ONLY 10 MINUTES AWAY AT  
**EDMUND FACTORY STORE**

## 3-CHANNEL COLOR ORGAN KIT



Easy to build low-cost kit needs no technical knowledge. Completed unit has 3 bands of audio frequencies to modulate 3 independent strings of colored lamps (i.e. "lows"-reds, "middles"-greens, "highs"-blues. Just connect hi-fi, radio, power lamp etc. & plug ea. lamp string into own channel (max. 300w ea.). Kit features 3 neon indicators, color intensity controls, controlled individ SCR circuits; isolation transformer; custom plastic housing; instr.

Stock No. 41,831AV ..... \$18.95 Ppd

## AM RADIO FITS IN/ON YOUR EAR!



Wear it inconspicuously *everywhere*, listen as you work (lawn, yard, office), watch (game, beach) or wait. Instant music, news, sports. No gimmick-6/10 oz. technological wonder w/integrated circuit, 11 transistors, patented ferrite antenna/tuner/volume dial. Works best outdoors. Uses hearing aid batt. (incl.)-up to 100 hrs. playing. New batt. to slip in avail. at drug stores (about 50¢). No lengthy wires, bulky cases, or power-packed!

Stock No. 42,275AV ..... \$14.95 Ppd.

## KNOW YOUR ALPHA FROM THETA!



For greater relaxation, concentration, listen to your Alpha-Theta brainwaves. Ultra-sensitive electrode headband slips on/off in seconds—eliminates need for messy creams, etc. Atch'd to amplifier, filters brainwaves, signals beep for ea. Alpha or Theta wave passed. Monitoring button stimulates Alpha sound; audio & visual (L.E.D.) feedback. Reliable, easy-to-use unit comparable to costlier models. Completely safe. Comprehensive instruction booklet.

No. 1635AV (8" x 3" x 4"; 24 oz.) ..... \$134.50 Ppd.  
DELUXE "ON" TIME MONITOR—Measures and records % LOW COST "STARTER" UNIT  
No. 1652AV ..... (15" x 10" x 6") ..... \$349.50 Ppd.  
No. 71809AV ..... \$55.00 Ppd.  
DO-IT-YOURSELF KIT ..... No. 61,069AV ..... \$34.95 Ppd.

## QUALITY DETECTOR UNDER \$40



New Edmund-developed, fully transistorized BFO unit capable of locating quarter at 18" — powerful 6-trans. oscillator-amplifier circuit. Easily compares to others priced 50% higher! Aluminum pole and housing—not plastic! 6" waterproof search coil (Faraday shielded to elim. outside interference); long 50-hr. battery (9V) life; powerful 2" speaker; 1-knob on-off tune control. Perfect balance; lightweight (2 lbs.). Great buy!

Stock No. 80,222AV ..... \$39.95 Ppd.  
DELUXE UNIT W/EAR PHONES, METER  
No. 80,134AV ..... (11" coil) ..... \$169.00 Ppd.

## 4 1/4" ASTRONOMICAL TELESCOPE

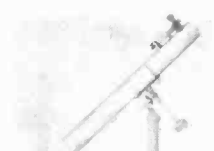

See moon craters, rings of Saturn, double stars. New equatorial mount, f/10, 1/4 wave mirror (Pyrex.) Gives theoretical limit of resolution. Rack & pinion focusing. Aluminum tube, 6X finder, 1" F.L. 45X Kellner achromatic eyepiece and Barlow lens to double & triple power up to 135X. Free Star Chart plus 2 Books.

Stock No. 85,105AV (Shipping Wt. 42 lbs.) ..... \$149.50 FOB  
4 1/4" WITH CLOCK DRIVE ..... No. 85,107AV ..... \$189.50 FOB  
6" REFLECTOR TELESCOPE (48X to 360X) ..... No. 85,187AV ..... \$249.50 FOB  
6" WITH CLOCK DRIVE ..... No. 85,086AV ..... \$285.00 FOB  
3" DELUXE REFLECTOR (30X to 90X) ..... No. 80,162AV ..... \$ 79.95 Ppd.  
STANDARD 3" REFLECTOR ..... No. 85,240AV ..... \$ 49.95 Ppd.



## MAIL COUPON FOR GIANT FREE CATALOG!

180 PAGES • MORE THAN 4500 UNUSUAL BARGAINS

Completely new 1975 edition. New items, categories, illustrations. Dozens of electrical and electromagnetic parts, accessories. Enormous selection of Astronomical Telescopes. Unique lighting and ecological items. Microscopes, Binoculars, Magnifiers, Magnets, Lenses, Prisms. Hard-to-get-surplus bargains. Ingenious scientific tools. 1000's of components.

EDMUND SCIENTIFIC CO.  
300 Edscorp Building, Barrington, N.J. 08007  
Please rush Free Giant Catalog "AV"

Name \_\_\_\_\_  
Address \_\_\_\_\_  
City \_\_\_\_\_ State \_\_\_\_\_ Zip \_\_\_\_\_

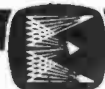

## COMPLETE & MAIL WITH CHECK OR M.O.

EDMUND SCIENTIFIC CO. 300 Edscorp Building, Barrington, N.J. 08007

How Many	Stock No.	Description	Price Each	Total
<input type="checkbox"/>		PLEASE SEND GIANT FREE CATALOG "AV"		
<input type="checkbox"/>		Charge my BankAmericard		
<input type="checkbox"/>		Charge my Master Charge		

Add Handling Chg.: \$1.00, Orders Under \$5.00, 50¢, Orders Over \$5.00

Interbank No.

My Card No. Is

Card Expiration Date

30-DAY MONEY-BACK GUARANTEE. You must be satisfied or return any purchase in 30 days for full refund. \*\$15.00 minimum

Name   
Address   
City  State  Zip

I enclose  check  money order for TOTAL \$

Signature



## Creation of the new Calibration Standard filled a need... the acceptance of Stanton's 681 TRIPLE-E is unprecedented!

It was no accident!

The Recording Industry needed a new calibration standard because it had been cutting discs with higher accuracy to achieve greater definition and sound quality.

So, the engineers turned to Stanton for a cartridge of excellence to serve as a primary calibration standard in recording system check-outs.

The result: the *new* calibration standard, The Stanton 681 TRIPLE-E.

The rest is history!

Major recording studios adopted it . . . as did many of the smaller producers. Radio stations across the world put the 681 TRIPLE-E on all of their turntables, both for on-the-air broadcasting and for disc-to-tape transfer.

And, audiophiles by their purchases have voted it the outstanding stereo cartridge available.

The Stanton 681 TRIPLE-E offers improved tracking

at all frequencies. It achieves perfectly flat frequency response beyond 20 kHz. Its ultra miniaturized stylus assembly has substantially less mass than previously, yet it possesses even greater durability than had been previously thought possible to achieve.

Each 681 TRIPLE-E is guaranteed to meet its specifications within exacting limits and each one boasts the most meaningful warranty possible. An individually calibrated test result is packed with each unit.

As Julian D. Hirsch of Hirsch-Houck Labs wrote in Popular Electronics Magazine in April, 1975: "When we used the cartridge to play the best records we had through the best speaker systems at our disposal, the results were spectacular".

Whether your usage involves recording, broadcasting, or home entertainment, your choice should be the choice of the professionals . . . the STANTON 681 TRIPLE-E.



Write today for further information to Stanton Magnetics, Terminal Drive, Plainview, New York 11803





# CB: What's stopping you?

For less than 50 bucks, you can be into serious Citizens Band radio. Not in big, maybe, but in. Because the great thing about Midland CB is that you can get into it, go as pro as you want, and still be assured of the same unquestioned quality and reliability that you'd expect from a company consistently ranking among the top CB names in the world. You've come to demand quality in electronics. Demand it in Citizens Band radio as well.

Whatever you want, whenever you're ready, Midland has it in CB. Specifically: 18 professional walkie-talkies, 14 base and mobile transceivers, plus more than 40 helpful CB accessories. So, if you've even thought about getting into CB within the last year, your best bet is to start by checking out what Midland has to offer.

Ask for your **FREE 1975 Midland CB brochure**. Simply contact your nearest Midland CB dealer or write to Midland Communications Division, Dept. A, Post Office Box 19032, Kansas City, Missouri, 64141. Or circle the number below on the Reader Service Card.

**MIDLAND**  
INTERNATIONAL®

Communications Division

*Communications is Our Middle Name: In CB, Amateur, Scanners, Marine, Intercoms.*

CIRCLE NO. 36 ON READER SERVICE CARD

[AmericanRadioHistory.com](http://AmericanRadioHistory.com)