

Popular Electronics

MAY 1974/FIFTY CENTS

Build a **9-BAND STEREO EQUALIZER**

Overcomes
room
acoustic
problems

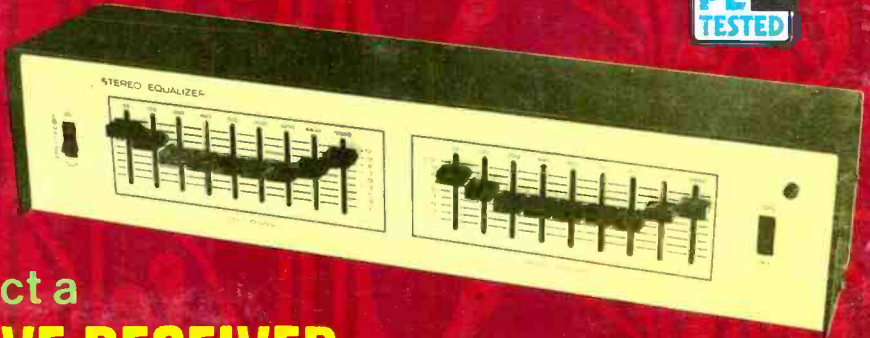

How to Select a **SHORTWAVE RECEIVER** plus English-Language Broadcast Directory

HOW TO BUILD:

- Home Freezer Temperature Alarm
- FLIP- A New CMOS Game
- Micropower Audible Continuity Tester

TEST REPORTS:

- Concord CR-400 4-Channel Receiver
- Koss HV-1 Stereo Headphones
- Pace CB-1023 SSB/AM CB Transceiver
- RCA WR-525 TV Si
- Helpmate CD-5 Aut

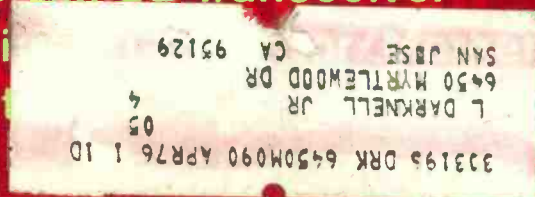

ener

CREI—the only home-study college-level training

and now

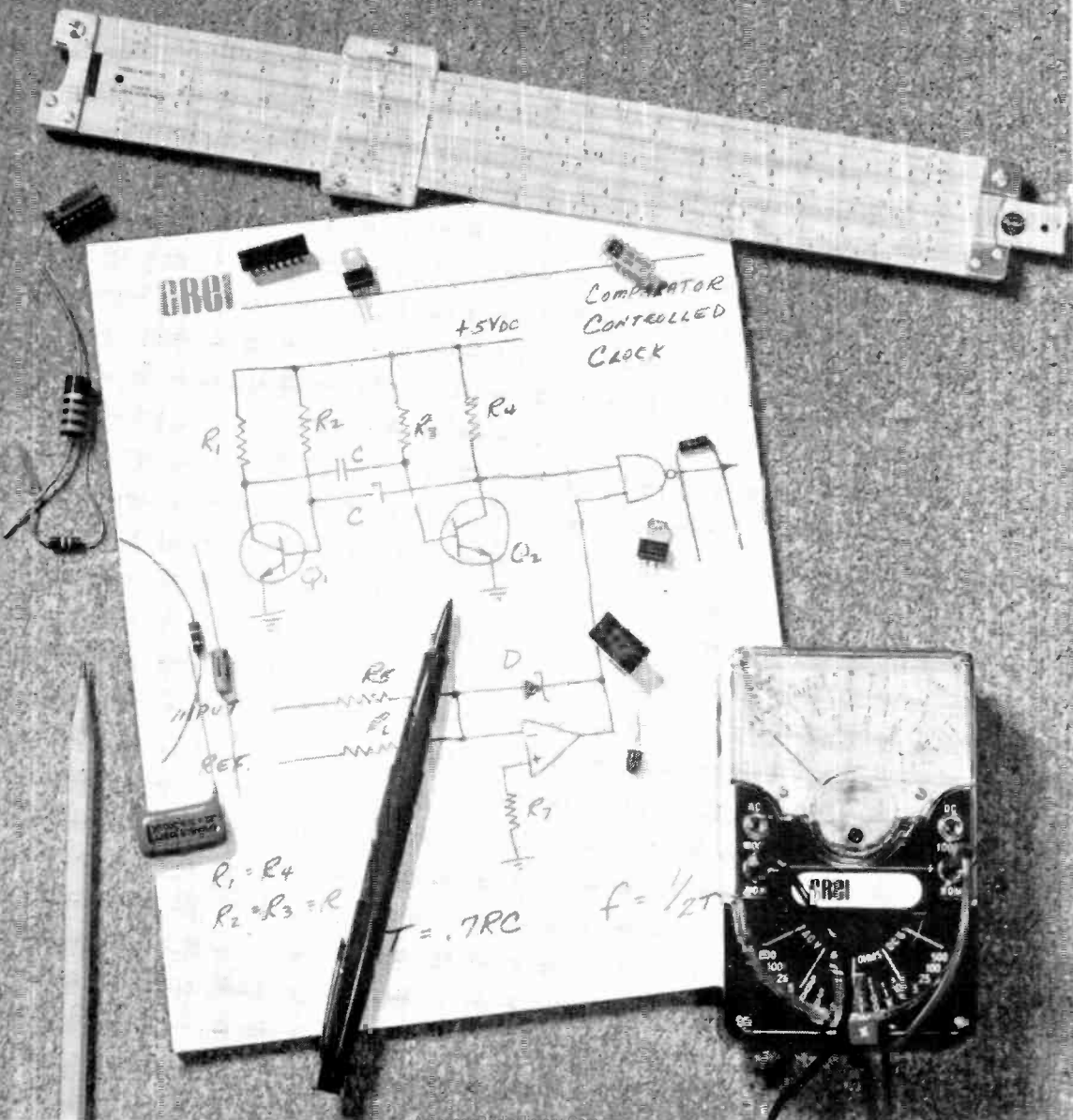

program which gives you in electronic circuit design

only CREI offers you a complete college-level Electronic Design Laboratory to speed your learning

Electronic circuit design—source of all new development in the application of electronics to new products and services. Without this skill, we would be unable to monitor the heartbeat of men in space. Without it, the computer revolution would never have occurred. And we would have yet to see our first TV show. Yet, *only CREI teaches electronic circuit design at home.*

This free book can change your life. Send for it.
If you are a high-school graduate (or equivalent) and have previous training or experience in electronics, then you are qualified to enroll in a CREI program to move you ahead in advanced electronics.



ELECTRONIC CIRCUIT DESIGN
A key skill which paces our nation's progress in countless fields—from pollution control to satellite tracking to modern medicine to exploring the ocean's depths. And beyond. A skill which *you* must have to move to the top in advanced electronics.

Send now for our full-color, eighty page book on careers in advanced electronics. In it, you will find full facts on the exciting kinds of work which CREI programs open up to you. And full facts on the comprehensive courses of instruction, the strong *personal* help, and the professional laboratory equipment which CREI makes available to you. All at a surprisingly low tuition cost.

CREI programs open up new worlds of opportunity for you.
In addition to electronic circuit design, CREI provides you with a full advanced electronics education in any of thirteen fields of specialization you choose. Communications, computers, space operations, television, nuclear power, industrial electronics—to mention just a few of the career fields for which CREI training is qualifying. With such preparation, you will have the background for a career which can take you to the frontiers of the nation's most exciting new developments. And around the world.

And when you have it, talk with your employer about it.
Tell him you're considering enrolling with CREI. He'll undoubtedly be happy to know you are planning to increase your value to him. *And he may offer to pay all or part of your tuition cost.* Hundreds of employers and government agencies do. Large and small. Including some of the giants in electronics. *If they are willing to pay for CREI training for their employees, you know it must be good.*

Send for Advanced Electronics today. You'll be glad you did.

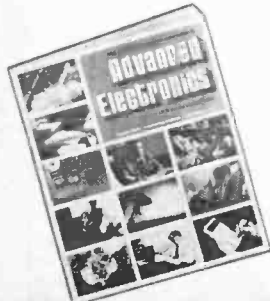

CREI Dept. EI205E
3939 Wisconsin Avenue
Washington, D.C. 20016

Rush me your FREE book describing my opportunities in advanced electronics. I am a high school graduate.

Name _____ Age _____
Address _____
City _____ State _____ ZIP _____

If you have previous training in electronics, check here

Employed by _____
Type of Present Work _____

Veterans and servicemen, check here for G. I. Bill Information
AmericanRadioHistory.Com

CREI
**CAPITOL
RADIO
ENGINEERING
INSTITUTE**
WASHINGTON, D.C. 20016

Popular Electronics

WORLD'S LARGEST-SELLING ELECTRONICS MAGAZINE

FEATURE ARTICLES

- 33 WHAT TO LOOK FOR IN A SHORTWAVE RECEIVER** *Richard W. Wood*
Evaluating broadcast coverage, technical and operating needs.
- 41 ENGLISH-LANGUAGE SHORTWAVE BROADCASTS** *Roger Legge*
Frequencies and times for May through August.
- 43 HOW RADIO-CONTROL SYSTEMS WORK** *Fred Marks*
Types of systems used to operate model planes, cars, and boats.
- 62 BUYING AND USING A POCKET CALCULATOR** *John T. Frye*
- 76 WHAT'S NEW IN ELECTRONIC MUSIC SYNTHESIZERS?** *Craig Anderton*
Digital techniques, new controllers, and module construction.

CONSTRUCTION STORIES

- 27 BUILD THIS NINE-CHANNEL STEREO EQUALIZER** *Gary Kay*
Low distortion, no ringing, ± 12 dB control.
- 47 MICROPOWER AUDIBLE CONTINUITY TESTER** *William D. Kraengel, Jr.*
Tests semiconductor junctions safely.
- 48 BUILD A HALL-EFFECT MAGNETOMETER** *L. George Lawrence*
Good Science Fair project. Probes magnetic field strengths.
- 58 BUILD FLIP: A CMOS GAME COMPUTER** *Joseph A. Weisbecker*
Challenge a handful of IC chips to a game of logic.
- 81 HOME-FREEZER THAW ALARM** *Franklin C. Willoughby*
Protects food investment.

ZIFF-DAVIS PUBLISHING COMPANY

Popular Electronics
Editorial and Executive Offices
One Park Avenue, New York, New York 10016
212-725-3500

William Ziff, President
W. Bradford Briggs, Executive Vice President
Hershel B. Sarbin, Senior Vice President, Secretary, and Treasurer
Philip Sine, Senior Vice President
Phillip T. Heffernan, Vice President, Marketing
Frank Pomerantz, Vice President, Creative Services
Arthur W. Butzow, Vice President, Production
Edward D. Muhlfeld, Vice President, Aviation Division
Irwin Robinson, Vice President, Travel Division
George Morrissey, Vice President
Sydney H. Rogers, Vice President
Sidney Holtz, Vice President
Lawrence Sporn, Vice President, Circulation

POPULAR ELECTRONICS, May 1974, Volume 5, Number 5. Published monthly at One Park Ave., New York, NY 10016. One year subscription rate for U.S., U.S. Possessions and Canada, \$6.00; all other countries, \$8.00. Second class postage paid at New York, N.Y. and at additional mailing offices. Authorized as second class mail by the Post Office Department, Ottawa, Canada and for payment of postage in cash. Subscription service and Forms 3579: P.O. Box 2774, Boulder, CO 80302. Editorial offices for manuscript contributions, reader inquiries, etc.: One Park Ave., New York, NY 10016.

POPULAR ELECTRONICS Including ELECTRONICS WORLD, Trade Mark Registered. Indexed in the Reader's Guide to Periodical Literature.

Copyright © 1974 by ZIFF-DAVIS PUBLISHING COMPANY. All rights reserved.

EDGAR W. HOPPER
Publisher
ARTHUR P. SALSBERG
Editorial Director
MILTON S. SNITZER
Editor
LESLIE SOLOMON
Technical Editor
JOHN R. RIGGS
Managing Editor
EDWARD I. BUXBAUM
Art Director

ALEXANDER W. BURAWA
Associate Editor
ANDRE DUZANT
Technical Illustrator
ELLEN S. FINKELSTEIN
Editorial Assistant
LEN BUCKWALTER
Editorial Assistant
LOU GARNER
JULIAN D. HIRSCH
RALPH HODGES
WALTER G. JUNG
Contributing Editors

JOSEPH E. HALLORAN
Advertising Director
JOHN J. CORTON
Advertising Sales
MADELEINE LITTMAN
Advertising Service Manager
PEGI MCENEANEY
Executive Assistant
STANLEY NEUFELD
Associate Publisher
FURMAN H. HEBB
Group VP, Electronics & Photo

THE SCENES

- 10 STEREO SCENE *Ralph Hodges*
- 24 HOBBY SCENE
- 82 SOLID STATE *Lou Garner*
- 86 CB SCENE *Len Buckwalter*
- 88 TEST EQUIPMENT *Leslie Solomon*

PRODUCT TEST REPORTS

- 65 CONCORD MODEL CR-400 AM/STEREO FM 4-CHANNEL RECEIVER
- 67 KOSS MODEL HV-1 STEREO HEADPHONES
- 68 RCA MODEL WR-525A TV MARKER/SIGNALYST
- 69 PACE SIDETALK MODEL CB-1023 AM/SSB CB TRANSCEIVER
- 70 HELPMATE MODEL CD-5 AUTOMATIC GARAGE DOOR OPENER

DEPARTMENTS

- 6 EDITORIAL *Milton S. Snitzer*
Qualifying TV Service Technicians
- 8 LETTERS
- 22 NEWS HIGHLIGHTS
- 94 NEW PRODUCTS
- 97 NEW LITERATURE
- 98 ELECTRONICS LIBRARY

COMING NEXT MONTH
The Cassette Recording Medium
How to Make Double-Sided PC Boards
Build a Single-IC Weather Receiver
CMOS Microlab for Digital Bread-Boarding

Midwestern Office
The Pattis Group, 4761 West Touhy Ave.,
Lincolnwood, Illinois 60644, 312 679-1100
GERALD E. WOLFE, GEORGE B. MANNION

Western Office
9025 Wilshire Boulevard, Beverly Hills, California 90211
213 273-8050; BRadshaw 2-1161
Western Advertising Manager, BUD DEAN

Japan: James Yagi
Oji Palace Aoyama; 6-25, Minami Aoyama
6 Chome, Minato-Ku, Tokyo 407-1930/6821

Ziff-Davis also publishes Boating, Car and Driver, Cycle, Flying, Modern Bride, Popular Photography, Skiing, and Stereo Review.

Forms 3579 and all subscription correspondence should be addressed to POPULAR ELECTRONICS, Circulation Department, P.O. Box 2774, Boulder, CO 80302, Please allow at least eight weeks for change of address. Include your old address, as well as new—enclosing, if possible, an address label from a recent issue.

Editorial contributions must be accompanied by return postage and will be handled with reasonable care; however, publisher assumes no responsibility for return or safety of art work, photographs, models, or manuscripts.

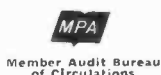



Editorial

By Milton S. Snitzer, Editor

QUALIFYING TV SERVICE TECHNICIANS

The pros and cons of licensing television service technicians have been advanced over and over for years. Proponents emphasize the importance of building up the "professionalism" of the business and establishing a better public image by setting minimum technical qualifications. (A byproduct of this would be the squeezing out of "moonlighters" who, with a low overhead, can charge less than regular shops.)

On the contrary side, there are those who are against licensing because (they say) it would merely create a bureaucratic system and tap the technician's income.

There are various forms of licensing, of course. State examinations can be established for qualifying technicians; electronics service associations can certify their own members; and states or cities can institute "registration" programs, relying on the mere establishment of a service business as the criterion for granting a license.

After all these years, however, little progress has been made. For example, only a few states boast technician license laws. New York is now in the process of establishing regulations for technicians who operate in any area of electronics repair—from TV to phonos. Details of the bill before committee (F1630) have not been made available. We understand, though, that technical competence will not be one of the prerequisites since it is said that only an "interview" procedure will be used in the licensing procedure. Such a system will hardly assure better service for the consumer.

The International Society of Certified Electronics Technicians (ISCET), a subsidiary of a national service dealers association, has registered about 7000 technicians. Requirements for the registration are four or more years of experience and/or schooling and the passing of a written exam. Since there are 204,000 technicians and 74,400 dealers (according to NESDA), the number registered by ISCET is relatively small; but the program is respected within the field. Being registered by ISCET should certainly aid a technician looking for a job. (For more information on the quarterly exams, write ISCET, 1715 Expo Lane, Indianapolis, IN 46224.)

The ISCET program and the regulations enacted by some state and local governments are good starts, of course, but much remains to be done to develop more public confidence.

Another introductory offer to new members of the ELECTRONICS AND CONTROL ENGINEERS' BOOK CLUB

	404/445 ELECTRONIC CIRCUITS MANUAL by J. Markus Pub. price, \$22.00 Club price, \$15.75		286/515 INTEGRATED CIRCUITS: A Basic Course for Engineers and Technicians by R. G. Hibberd Pub. price, \$10.25 Club price, \$8.45	
	637/458 DESIGNING WITH TTL INTEGRATED CIRCUITS by Texas Instruments Inc. Pub. price, \$19.50 Club price, \$13.50		100/810 MOS/LSI DESIGN AND APPLICATION by Carr & Mize Pub. price, \$18.50 Club price, \$13.50	
	404/437 SOURCEBOOK OF ELECTRONIC CIRCUITS by J. Markus Pub. price, \$21.50 Club price, \$17.50		313/059 HANDBOOK OF SEMI-CONDUCTOR ELECTRONICS, 3/e by P. Hunter Pub. price, \$29.85 Club price, \$21.50	
	484/368 COMMUNICATION SYSTEMS DESIGN by P. F. Panter Pub. price, \$19.50 Club price, \$13.50		287/341 STANDARD HANDBOOK OF ENGINEERING CALCULATIONS by T. G. Hicks Pub. price, \$19.50 Club price, \$14.25	
	491/364 THE DESIGN OF DIGITAL SYSTEMS by J. B. Peatman Pub. price, \$15.50 Club price, \$11.75		124/035 HANDBOOK OF PHYSICS, 2/e by Condon and Odishaw Pub. price, \$37.45 Club price, \$14.95	
			773/777 NOMOGRAPHS FOR ELECTRONICS by R. L. Peters Pub. price, \$27.50 Club price, \$19.95	
			649/170 OPERATIONAL AMPLIFIERS by Tobey, Graeme & Huelsman Pub. price, \$15.00 Club price, \$11.50	
			353/387 MINICOMPUTERS FOR ENGINEERS & SCIENTISTS by Korn & Korn Pub. price, \$17.75 Club price, \$10.50	
			209/731 STANDARD HANDBOOK FOR ELECTRICAL ENGINEERS, 10/e by Fink and Carroll Pub. price, \$34.85 Club price, \$24.95	

Save time and money by joining the
Electronics and Control Engineers' Book Club



MAIL THIS COUPON TODAY

HERE is a professional club designed specifically to meet your day-to-day engineering needs by providing practical books in your field on a regular basis at below publisher prices.

How the Club operates: Basic to the Club's service is its publication, the *Electronics and Control Engineers' Book Club Bulletin*, which brings you news of books in your field. Sent to members without cost, it announces and describes in detail the Club's featured book of the month as well as alternate selections which are available at special members' prices.

When you want to examine the Club's feature of the month, you do nothing. The book will be mailed to you as a regular part of your Club service. If you prefer one of the alternate selections—or if you want no book at all for that month—you notify the Club by returning the convenient card enclosed with each *Bulletin*.

As a Club member, you agree only to the purchase of four books over a two-year period. Considering the many books published annually in your field, there will surely be at least four that you would want to own anyway. By joining the Club, you save both money and the trouble of searching for the best books.

ELECTRONICS AND CONTROL ENGINEERS' BOOK CLUB
582 Princeton Road, Hightstown, N.J. 08520

Please enroll me as a member of the Electronics and Control Engineers' Book Club and send me the two books indicated below. I am to receive the bonus for just \$1.00, and my first selection at the special Club price shown. These books are to be shipped on approval, and I may return them both without cost or further obligation. If I decide to keep the books, I agree to purchase as few as four books during the next two years at special Club prices (at least 15% below list).

Write Code No. of
bonus book
here

Write Code No. of
first selection
here

Name _____

Address _____

City _____

State _____ Zip _____

E33255

CIRCLE NO. 15 ON READER SERVICE CARD

New—Low Distortion COMPRESSOR expander

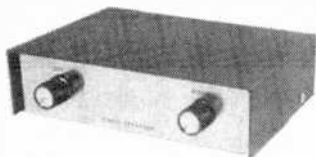

Restore the original dynamic range of your music— increase your stereo separation, OR make your own background music with our new compressor-expander kit. Our circuit uses an electronic gain control integrated circuit for fast attack, slow release type operation with none of the lags and distortion found in the old photocell lamp controlled circuits. Expansion beginning level and compression beginning signal levels are adjustable. Up to 20 db of expansion and 40 db of compression are available with less than 1.0% THD under worst case conditions. Typically less than .05% under most operating conditions. Frequency response of 2 Hz to 100,000 Hz. Self contained power supply. Connects to preamp output, or to "Tape Monitor" jacks if available.

EX-1 Kit. 3.0 lbs. \$29.95

REVERB ADAPTOR



Put more life into your music with this self powered stereo reverb adaptor system. The reverb circuit electronically simulates the longer reverberation time of a large hall, giving your music more life and realism. Separate spring units and controls for each channel may be used with any stereo system by connecting the adaptor between the amplifier and pre-amp.

No. 239 Reverb Adapter Kit with two spring units
Shipping Weight 5½ lbs. \$38.50

Circle the reader service card number below for a FREE copy of our latest catalog.



**SOUTHWEST TECHNICAL
PRODUCTS CORPORATION**
DEPT. PE

219 W. Rhapsody, San Antonio, Texas 78216

CIRCLE NO. 30 ON READER SERVICE CARD



Letters

ADDS MEMORY CIRCUIT TO LOGIC PROBE

After a few weeks of using the logic probe ("Assemble a Low-Cost Logic Probe," September 1973) it became apparent that the device needed a "memory" circuit to make it complete. The simple addition of a JK flip-flop, diode, LED, resistor, and normally closed switch pro-

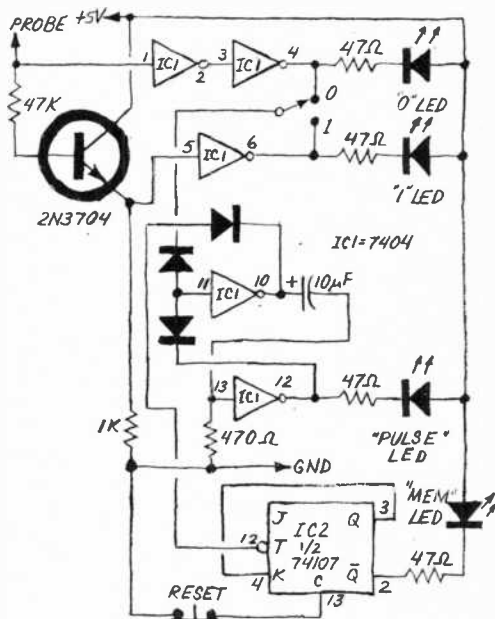

vides the probe with the memory function that really comes in handy for "trapping" very fast pulse indications. The parts are added to the probe's circuit as shown in the drawing.

KEITH D. WENTZEL
Charlotte, N.C.

Many thanks for passing on to our readers your practical modification that will almost double the versatility of the probe.

ABOUT CYBERNETICS AND R/C MODELING

How does one get into cybernetics? My main interest as a university student majoring in

electrical engineering is artificial intelligence, with a secondary interest in industrial robots. Incidentally, "How To Get Started In R/C Modeling" (February 1974) was great. However, you failed to list in the table one of the largest manufacturers of R/C gear: Kraft Systems, Inc., 450 West California Ave., Vista, CA 92083.

TOM PADEN
KVA 0821 (Class C); KGN 5865 (Class D)
New Castle, Pa.

If your interest is in cybernetics, look into computer programming and engineering. Mix together elements of electronic telemetry and control, mechanical engineering, hydraulic (or pneumatic) science, and cybernetics, and you have a good foundation for robotics. You should be able to obtain more information on these topics at your university.

We apologize for failing to mention Kraft Systems in the R/C story.

WHY DID THE AUTHOR USE. . . ?

I enjoyed reading "Luxury Features to Add to Digital Clocks" (December 1973). But why did the author use three 7485 IC's when only two were needed? Each IC contains four com-

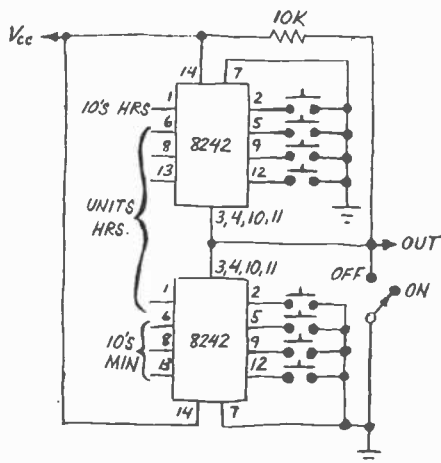

parators; so, the one used for the tens of minutes could also be used for the tens of hours. For even lower package count, the circuit shown can be used.

MICHAEL SCOTT
Kiron, Iowa

Why an author chooses to use one arrangement or IC when another would provide the same results depends on a number of variables. For example, he might have to use what was available in his locale. But whatever the reason, the object is to obtain a properly functioning circuit.

CAN YOU QUALIFY

NOT FOR BEGINNERS

for a High Paying and Secure position as a **CIRCUIT DESIGNER?**

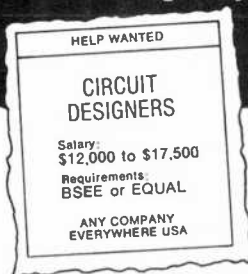

CHANCES ARE YOU CAN... Quickly & Easily!



DEGREE REQUIREMENT WAIVED! The need for Circuit Designers is so great that employers will put aside the degree requirement to move up or hire men with these skills. In every industry, there are men holding these prestigious positions who do not have a degree in engineering. **WHY NOT YOU?**

UP-TO-DATE INTENSIVE TRAINING! Our programs are not a rehash of the electronics you already know, but intensive training in the electronics you don't know. They offer you "hands-on" learning of how to design circuits using the latest devices. Included are: Transistors, IC's, FET's, IC power supply regulators; UJT's... plus more. **ARE YOU READY FOR TODAY'S ELECTRONICS?**

LOW COST HIGHLY SPECIALIZED COURSES! Because these courses are highly specialized, you can choose a curriculum which best suits your needs. And most important, you can learn at a price you can best afford. **CAN YOU AFFORD TO WAIT ANOTHER DAY?**

FREE Send for proof on how you can qualify for training as a circuit designer!

Gentlemen, please send me complete details on your **CIRCUIT DESIGN** courses.

Name _____ Age _____

Address _____

City _____ State _____ Zip _____

It is understood that there is no obligation on my part and that no salesman will call.

"a wholly owned subsidiary of Kurz-Kasch, Inc."



Phone: 513/296-1020
2876 CULVER AVENUE
DAYTON, OHIO 45429

CIRCLE NO. 6 ON READER SERVICE CARD

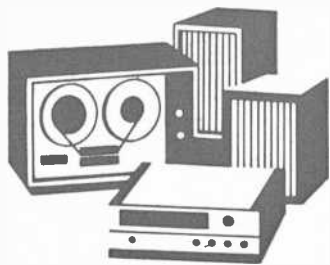

Stereo Scene

By Ralph Hodges

Here are some statements we have read with remarkable regularity in audio magazines in the last few months: "You must have several hundred watts in reserve to approach the levels of live music in the home . . . Nothing can compare with the unstrained ease that a super-power amplifier brings to the reproduction of large orchestral fortissimos. . . We wonder if 700 watts is enough!"

Surprisingly (unless, of course, you understand the acquisitive nature of the true audiophile), statements such as these are driving some sound buffs into a veritable frenzy of buying. The major manufacturers of super-power amplifiers report that demand continues to outstrip supply. —

Those of you who were not remembered in your rich uncle's will (and hence remain "super-powerless") or who are actually satisfied with 60 watts for each speaker are probably beginning to wonder what all the excitement is about.

Two Plus Two Isn't Four. Obviously, one thing a super-power amplifier can do is play recordings louder. One question is: How much louder? As it happens, a 600-watt amplifier is not ten times as loud as a 60-watt amplifier. At best, it can play approximately twice as loud—for reasons having to do with the nonlinear behavior of the human hearing mechanism.

The unit of loudness level is the *phon*. Largely through statistical studies of human test subjects, a phon scale has been created. It relates the loudness sensations perceived by the "average" ear to actual sound

intensity in decibels (dB) as measured by electronic instruments. For sounds of about 1000 Hz, the phon and dB scales correspond. Thus, at that frequency, a level of 0 phon (or dB) is roughly the threshold of hearing for most people, while 120 phons or dB approaches the point at which the ear's normal operation begins to break down under sensory overload.

The relationship between sound intensity, perceived loudness, and amplifier power can be explained as follows. An increase of 10 dB or 10 phons results in an approximate doubling of perceived loudness. (From here on, we assume that phons and dB's are equivalent for the important musical frequencies.) This requires a ten-fold increase in amplifier power ($60 \times 10 = 600$ watts = twice as loud). A 3-dB increase, which yields an incremental, but significant rise in loudness, requires twice as much power. Figure 1 shows these various relationships in graphical form.

Most sounds in nature—excepting such rare cataclysms as the explosion of Krakatoa—are safely below the level of 100 phons. But, as in so many other things, man's ingenuity has outdone nature. I suspect that many factory personnel endure levels of 100 phons or more throughout the working day (a situation actually prohibited by law). The pneumatic jackhammer so familiar on city streets does a good deal better than that. Sound-level meters have indicated that the output of a symphony orchestra can exceed 105 dB on climaxes; jet aircraft engines (and a few electronic bands during the height of the acid-rock era) top 120 dB at close range.

At mid-frequencies, let's say that a particular speaker system achieves an output of about 90 dB at a distance of 3 feet when driven with 1 watt of random noise. Accordingly, 10 watts of drive should produce a 100-dB level; 100 watts should give 110 dB; and, if the speaker could survive

Do You Need Super-power?

THE RIGHT PICKERING CARTRIDGE FOR YOUR EQUIPMENT IS THE BEST CARTRIDGE MONEY CAN BUY.

They feature low frequency tracking and high frequency tracing ability!*

DISCRETE 4 CHANNEL

UV-15 2400 Q
DCF 2400

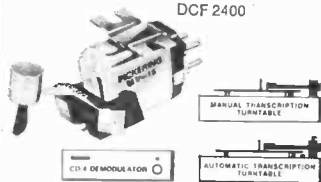

UV-15 2000 Q
DCF 2000

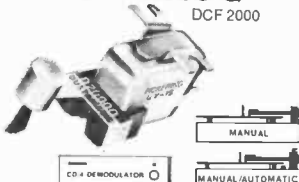

STEREO AND MATRIX

XV-15 1200E
DCF 1200

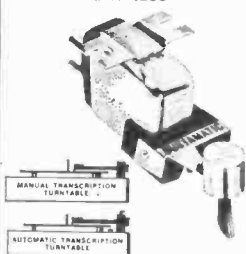

XV-15 750E
DCF 750

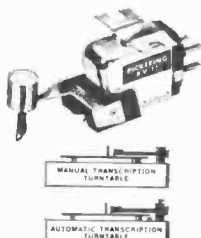

XV-15 400E
DCF 400



XV-15 350
DCF 350

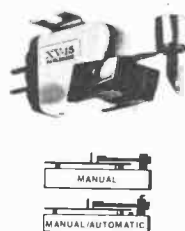

XV-15 200E
DCF 200

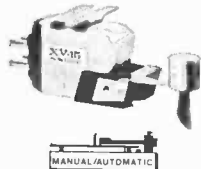

XV-15 150
DCF 150



XV-15 140E
DCF 140



XV-15 100
DCF 100

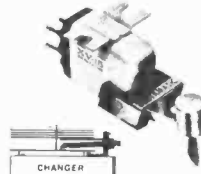

Pickering offers you "The Best of Both Worlds" in DISCRETE 4-channel and in STEREO cartridges. These cartridges have been specifically designed and engineered not only to peak specifications and performance characteristics, but also to achieve total compatibility with your music system to help you get the most out of it.

Only Pickering has developed a way for you to be absolutely certain you select the "right" cartridge for your music system. We did it first for STEREO by developing our Dynamic Coupling Factor rating system—DCF for short—which identifies pick-up performance in terms of a quantitative measurement. The value of a DCF rating lies not only in its merit to define low frequency tracking ability but also in its measure as an index of high frequency (8 to 50 kHz) tracing ability. Pickering's DCF-rated pick-ups have exceptional high frequency tracing characteristics, vital for both STEREO and DISCRETE 4-channel performance. The Pickering cartridge exactly

"right" for maximum performance with your equipment is simple to select because of this rating method.

Now, Pickering is also applying application engineering techniques and DCF ratings to its DISCRETE cartridges. They fulfill the stringent requirements necessitated by the sophisticated nature of discrete discs.

So, whether STEREO or DISCRETE is your preference, choose from "The Best of Both Worlds" the Pickering cartridge exactly right for your equipment.

For further information write to Pickering & Co., Inc., Dept. E 101 Sunnyside Blvd., Plainview, New York 11803
*TraceAbility—T.M.



"for those who can hear the difference"

CIRCLE NO. 25 ON READER SERVICE CARD

it, 120 dB should be available from 1000 watts. On the basis of these figures, a 100-watt amplifier could produce only four times as much sound as a 1-watt amplifier; and a 1000-watt amplifier only eight times as much. So, it is obvious that the law of diminishing returns catches up with the super-power set pretty quickly. Furthermore, if we compute the maximum acoustic outputs attainable from our typical speaker when used with a 40-watt amplifier (for example), the result is 106 dB. With a 200-watt amplifier, we get 113 dB. Unquestionably, the latter is louder; but a level of 106 dB in an average listening room is more than enough for most people. So what is the point of the additional 160 watts? Obviously, it is more than simply an order of loudness.

Music Isn't Steady State. So far, we have talked about power and dB levels as if we experience them as fixed values. However, music levels are anything but constant. On a millisecond-to-millisecond basis, the vari-

ations in level are liable to be much greater than the car can appreciate.

A good sound-level meter is designed to respond to acoustic phenomena in a "human" fashion. As such, it gives a fair indication of the *average* levels at any one time. But experience has taught us to expect frequent short-term peaks in music that the meter is too slow to follow. To predict how much these peaks exceed the average level at any moment is impossible; but knowledgeable people have suggested that 10-dB spikes are rather routine, so we will use that figure for the purpose of discussion. Providing 10 dB of headroom before an amplifier starts clipping means that average levels will have to be cut back by that amount. Thus they will be down to 96 dB for our hypothetical 40-watt amplifier, and 103 dB for the 200-watt unit. With these reductions, we begin to get into listening levels that, while still loud, are not extraordinarily loud for the serious listener.

Some Psychoacoustic Factors. It would appear then, based on these figures, that the super-power amplifier does have something going for it. However it is difficult to reconcile the numbers with the actual experience of listening to music. Several years ago, few would have suggested that levels exceeding 110 dB (even for brief instants) were necessary to realistic music reproduction. If 60 watts per channel was once considered an ample rating, why is it necessary now to have 150 watts per channel? How much better can all of that power actually sound?

Perhaps these basic questions can be answered by dealing with some specific problems in a logical progression:

(1) *Why don't these brief peaks at an intensely high level seem unbearably loud, forcing one to turn down the volume and thereby reduce the amplifier power requirements?*²

For brief sounds, the sensation of loudness depends on duration as well as intensity. According to an article in the *Hewlett-Packard Journal* (November 1967) by Wolfgang E. Ohme, any sound lasting less than about 100 milliseconds (0.1 second) will sound softer than a steady sound of equal intensity. A 10-millisecond sound must be at least 10 dB stronger than a steady sound of equal intensity in order to seem as loud (see Fig. 2).

Now 100 milliseconds may seem short to

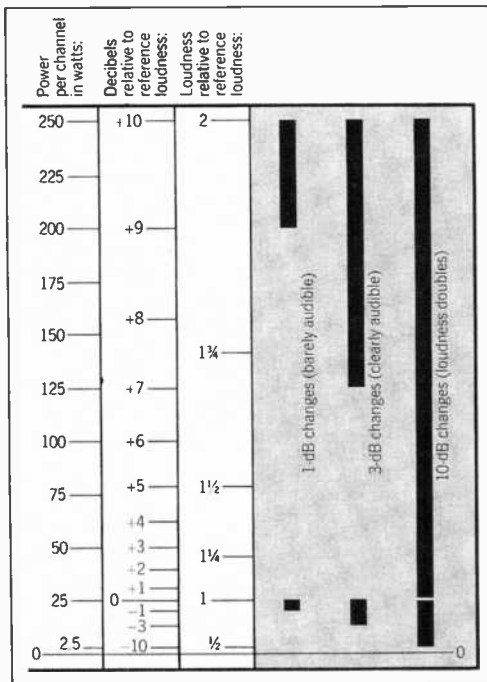

Fig. 1. Sound-pressure-level changes related to amplifier power requirements and perceived loudness changes. Base is 25 watts (0 dB).

Replacing semiconductors takes guidance.

And here it is.

Our new Semiconductor Product Guide.

It's *the* cross-reference for entertainment replacement semiconductors.

Transistors, zener diodes, diodes, high-voltage rectifiers, light emitting diodes, color crystals, integrated circuits, field-effect transistors . . . they're all here. With one of ours you can replace 265 on the average.

And with every one of ours you get Mallory performance and reliability.

Get your Semiconductor Product Guide at your Mallory distributor's today. With a guide like this you can't go wrong.



MALLORY

MALLORY DISTRIBUTOR PRODUCTS COMPANY

a division of P. R. MALLORY & CO. INC.

Box 1284, Indianapolis, Indiana 46206; Telephone: 317-636-5363

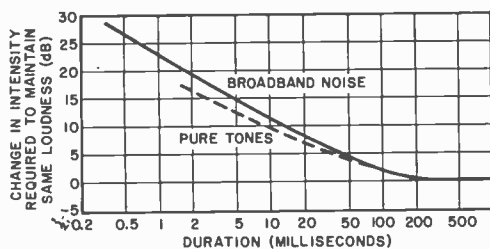

Fig. 2. Below 100 ms, short sounds must be more intense to seem as loud as longer sounds. (Courtesy Hewlett-Packard Journal)

the human auditory mechanism, but to an amplifier it is 100 cycles at 1000 Hz (or 10 cycles at 100 Hz). This is more than enough time for any music-power capabilities to be exhausted and for amplifier clipping to set in. So the peaks, though they may not sound so loud, require substantial power capability.

(2) *If the ear discriminates against very short sounds anyway, why would it notice if the amplifier clips (and distorts) them?*

We are not sure; but apparently it does under some circumstances. Distortion and its audibility are subjects of much argument. The main objection to distortion seems to be that it is somehow out of tune with the rest of the music. If the ear senses distortion in the same way that it senses the harmonic values of sound (pitch), then, according to Harry F. Olson's *Music, Physics and Engineering*, 13 milliseconds is sufficient time for distortion to be heard. The conclusion to be drawn (purely speculatively) is that the ear is almost ten times quicker in responding to distortion than to intensity. In short, an amplifier's ability to cope with severe peaks may not be heard, but its inability to do so can be heard.

(3) *Then why doesn't music reproduced by "inadequate" 60-watt amplifiers sound intolerably distorted?*

Obviously some kinds of music present lesser peak demands than others. Also, many recordings are electronically compressed as they are made, which greatly reduces or eliminates the peaks. But I suspect that much distortion goes unnoticed because of the psychoacoustic phenomenon of "masking."

Masking is the aural mechanism by which a loud sound can render a softer one partially or completely inaudible. It is dependent on the intensities and frequencies of both the

masking and masked sounds. Lower (in frequency) sounds can mask higher sounds, but the reverse seems not to be true. Also the closer together the two sounds are in frequency, the more effective the masking.

Although it is a familiar phenomenon, masking is hard to grasp intuitively because it is largely beyond our control. A fully masked sound cannot be heard, even by straining or concentrating. The best way to unmask it is to get closer to the source, thereby making it louder. This is difficult to do when many sources are coming through just two speakers, unless the masked sound has one of the speakers all to itself.

Like any sound, distortion can be masked. Theoretically, at moderate listening levels, comparatively large amounts of distortion (1 percent or more) can go unheard because they are softer than the ambient noise level of the room. But at 100-dB listening levels, 1-percent distortion achieves a 60-dB level, which is certainly loud enough to be audible. Evidently, it is sometimes masked by the music itself.

Making Some Tests. Concocting theories is certainly more fun than dealing with cold reality; but to make sure that the theories were not too far from the truth, I made some listening tests. Using speakers of typical acoustic-suspension efficiency and amplifiers rated at 60 and 200 watts per channel, I tried to determine if there was anything really objectionable about the smaller amplifier.

The first program source was a disc with a wide dynamic range (an advance copy of the latest in the Lincoln Mayorga/Mastering Labs series), produced by the direct-disc cutting technique. The music consists of big-band pop arrangements of familiar tunes, with bright, clear brass and a variety of outrageous percussion transients. Despite the dynamic demands of this material, getting the 60-watt amplifier into trouble involved some rather high volume-control settings. Hiss from the preamplifier filled the room and the speaker fuses were blown twice when the tonearm was set down on the record. Finally, at an *average* level of 101 dB on a Realistic Sound Level Meter, the "strained" sound of clipping occurred on drums and percussion. At 102 dB, the amplifier was into hard clipping.

With a total of 120 watts (2 times 60) and not considering room factors, this is the point at which one would expect clipping to

THERE'S A BETTER WAY TO GO.



Energy shortages tell us we have to change our driving style. Now! It doesn't mean we have to go back to horse and buggy days. But it does mean we have to make every drop of gas give us the most go for our money. Anyone with horse sense knows that a well-tuned car gets better mileage, and in times of fuel shortages, better mileage means a lot.

The Mark Ten B Capacitive Discharge System keeps your car in better tune so it burns less gas. Using Mark Ten B is more than horse sense. It's the smart move under the hood, helping a nation survive an energy crisis and keeping you on the road. Delta Mark Ten. The best way to go.



DELTA PRODUCTS, INC.
 P.O. Box 1147, Dept. PE
 Grand Junction, Colo. 81501
 (303) 242-9000

Please send me free literature.
 Enclosed is \$ _____ Ship ppd. Ship C.O.D.
 Please send: _____ Mark Ten B assembled @ \$59.95 ppd. _____ Mark Ten B Kit @ \$44.95 ppd. (12 volt negative ground only) _____ Standard Mark Ten assembled, @ \$44.95 ppd. _____ 6 Volt: Neg. Ground Only _____ 12 Volt: Specify _____ Pos. Ground _____ Neg. Ground _____ Standard Mark Ten Deltakit* @ \$29.95 ppd. (12 Volt Positive or Negative Ground Only)

Car Year _____ Make _____

Name _____

Address _____

City/State _____ Zip _____

CIRCLE NO. 10 ON READER SERVICE CARD

WORTH
LOOKING
FOR!

Lenk

**SOLDERING
IRONS - GUNS**

BY THE WORLD'S LARGEST
MANUFACTURER OF SOLDERING IRONS

Get the right soldering tool for
your jobs. You'll find the
right product at the
right price in the
Lenk line - at
better hardware
and supply
stores.



**PENCIL
TYPE
IRONS**

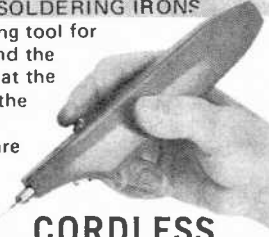

CORDLESS
Battery Powered
COMPLETE WITH
RECHARGER

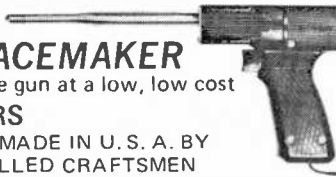

PACEMAKER

Instant type gun at a low, low cost

AND OTHERS

ALL MADE IN U. S. A. BY
SKILLED CRAFTSMEN

If your dealer does not have the Lenk line,
please send us his name and address.

SINCE
1864

WALL-LENK MANUFACTURING COMPANY
BOX 3349 KINSTON, N. C. 28501

CIRCLE NO. 35 ON READER SERVICE CARD

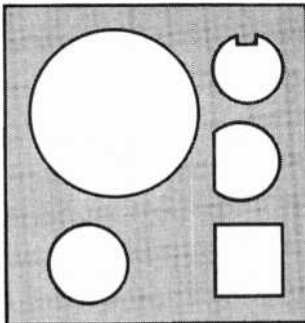

**Put more
punch in your work.**

With a Greenlee Chassis Punch you can punch
clean, true holes in seconds. Round, square,
key or D. In 16-ga. metal, hard rubber, plastic
or epoxy. Available at radio and electronics
parts dealers. Write for catalog E-730.
Greenlee Tool Co, 1764 Columbia Ave., Rock-
ford, Ill. 61101.

GREENLEE TOOL CO

A Unit of Ex-Cell-O Corporation 

CIRCLE NO. 17 ON READER SERVICE CARD

start on 10-dB peaks. However, since the clipping was clearly audible, the highest peaks were in all probability much more severe.

Switching to the 200-watt amplifier (which sounded much cleaner at these levels), we noted peaks on the meter of +4 dB (that is, 106 dB) on single beats of a kettledrum and +8 or more on continuous rolls. The bass, with an obvious assist from room conditions, convulsed the meter to +10 and above on certain notes. The meter was too slow to register most of the "snap" transients (wood block, chimes, etc.), but I was surprised to see it peg solidly on a relatively mild-sounding piano run.

The brass sounds were almost unbearably loud, yet registered a mere 105 dB during ear-splitting climaxes. So the relation between amplifier power and loudness is deceptive. According to the acoustic measurements, the 60-watt amplifier could have provided much more of the brass than I could take. But it couldn't manage the accompanying transient signals, which were subjectively much less overwhelming.

Then I tried a selection fairly typical of the Beatles' hard-rock creations, "Helter Skelter." A few seconds of this at 102 dB was all I wanted, but I was able to confirm that the sound was excessively (and equally) dirty from both amplifiers. Listening at a slightly reduced level, it was obvious that the recording was absolutely bereft of any dynamic range. Vocals, guitar, and drums were all compressed to an almost uniform level. Except for an occasional twitch due to the electric bass, the meter hovered steadily at about 99 dB.

So hard-core Beatles fans can save their money. It is unlikely that anyone could stay in the same room with "Helter Skelter" playing at a level that would clip a 60-watt amplifier. But for those buying new records with high dynamic ranges (such as classical recordings that capture the low fundamentals of pipe organs), super-power is an asset. Also, there are some new air-suspension speaker systems with massive woofers that demand very high power. One manufacturer of such a speaker system states that 200 watts per channel is required, and that severe clipping occurs with an amplifier rated for 100 watts per channel. Other considerations are the size of the listening room, the furnishings, and the number of speakers. Adding it all up, you may find that you need more power than you ever imagined. ♦

Partners in Scientific Calculations



MITS 7440

Desk-Top Scientific Calculator -

The 7440 Scientific Calculator does the basic arithmetic functions plus ten transcendental functions. Algebraic problem entry with two deep nesting parentheses makes it possible to enter a problem just the way you would write it. Either floating decimal mode or scientific notation. A separate memory register can be used for storage of an intermediate result or of a constant. Trigonometric functions can be performed using either degree or radian entry. There is also a radian mode indication. A separate π key, and factor reversal ($x \rightarrow y$) are also featured.

The 14-digit LED display provides ten-digit precision for mantissa and two-digit precision for exponent. There is full sign change capability for both mantissa and exponent, and full chain calculation with any sequence of functions desired. Also featured are automatic error indications for overflow, underflow, and forbidden operations. The 36-key keyboard has separate clear and clear entry keys to prevent having to clear the whole problem in the event of an erroneous entry. The calculation range is 10^{99} to 10^{-99} .

KEYBOARD FUNCTIONS:

Sine • Arcsine • Cosine • Arccosine • Tangent
 • Arctangent • e^x • \ln^x • \log_{10}^x • x^y • \sqrt{x} • $1/x$
 • Addition • Subtraction • Multiplication • Division

SIZE: 8 1/2" x 12" x 3 1/2"

PRICE: Kit \$199.95 Assembled \$299.95

Warranty: Full two-year warranty on assembled units, ninety days on kits.

Prices subject to change without notice.

Available from your local Olson Electronics Dealer.

MITS 7440 Programmer

Desk-Top Computer -

The programmer can program the 7440 to do extremely long or often used calculator operations. Instead of repeatedly entering into the calculator a formula in which only certain variables change, a formula can be entered once into the programmer and then be stored and run at will.

The programmer automatically executes all steps of the program until it sees a location within the formula where a variable is to be entered. It then halts execution, but once the variable is entered into the calculator, the continue key is pressed again and all remaining steps of the formula are executed until the programmer sees another variable entry or an "End of Program" command.

FEATURES:

256 programming steps with option of expandability to 512 steps • Program code for each function key on the calculator • Constant power to the RAM's precludes destruction of stored programs • Sixteen-key array to enter the address or instruction in hexadecimal • Six annunciator lights to give clear identification of programmed pauses; two to indicate a halt or end of program • Two RUN modes of operation: Continuous or step • S-Key to halt execution anywhere in the program.

Kit: Programmer . . . \$199.95 - Expansion . . . \$79.95
 Assembled: Programmer . . \$299.95 - Expansion . . \$129.95

MITS INC.

"Creative Electronics"

6328 Linn, N.E., Albuquerque, New Mexico 87108
 505/265-7553 Telex Number 660401

Enclosed is a Check for \$ _____
 or BankAmericard # _____
 or Master Charge # _____
 Credit Card Expiration Date _____ Kit
 Include \$5.00 for Postage and Handling Assembled
 Model 7440 7440 Programmer Expansion
 Please Send Information on Entire MITS Line.

NAME _____
 ADDRESS _____
 CITY _____
 STATE & ZIP _____
MITS/ 6328 Linn, N.E., Albuquerque, New Mexico 87108 505/265-7553 Telex # 660401

PE-574

CIRCLE NO. 22 ON READER SERVICE CARD

The better the the better you!

And
you can
get started
for just
\$10.

COMPU-TRAINER

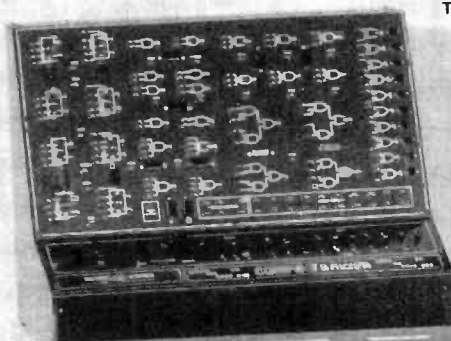

TUBE & TRANSISTOR
TESTER



SOLID STATE
OSCILLOSCOPE

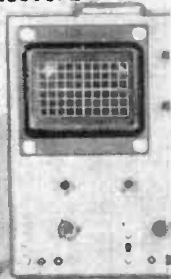

DIGITAL
MULTIMETER

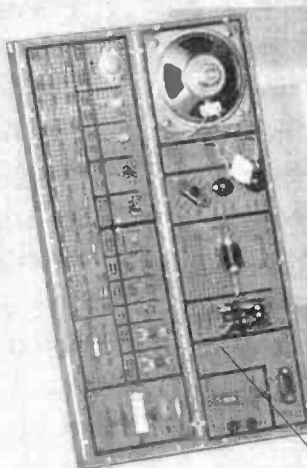

ELECTRO - LAB



NTS DIGITAL GR-2000 SOLID STATE
COLOR TV WITH 315 SQ. IN. PICTURE
AND VARACTOR DIGITAL TUNING

TROJELESHOOTER
VOM

Only \$10 down gets you into any NTS Home-Study Courses in Electronics.* Just \$10 that can lead to a top-dollar job, a big, bright career in electronics.

As an NTS student, you'll acquire the experience and know-how that comes with first hand training on NTS "pro" equipment. Equipment you'll build and keep. Our courses include equipment like the 5" solid-state oscilloscope, a transistor and tube-tester, a vector monitor scope, 74 sq. in. B&W TV, or a solid-state stereo AM-FM receiver. The unique

new NTS Digital GR-2000 Color TV with first-ever features like silent varactor diode tuning; digital channel selection, digital clock, an option at additional cost; and big 315 sq. in. ultra rectangular screen. This is just a sampling of the kind of better equipment that gets you better equipped for the electronics industry.

By following the easy-to-read NTS lessons, you learn the theory behind these tools of the trade. You'll learn and develop skill and confidence fast.

*Not including Advanced Color TV Servicing

equipment will be equipped.

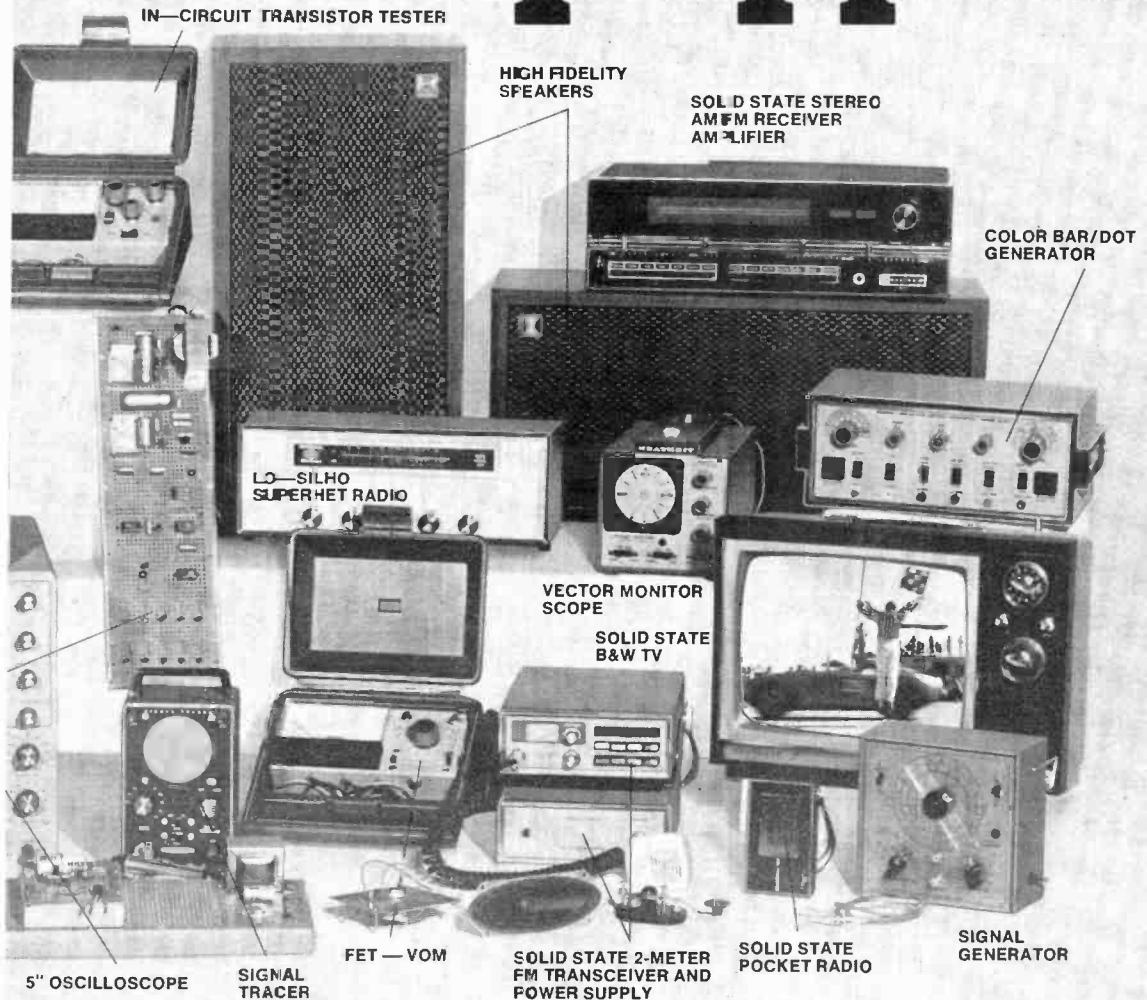

Choose from 12 NTS Electronics Courses, including Color TV and B&W TV Servicing, Electronics and Computer Technology, Electronics Communications & FCC, and Industrial & Automation Electronics. All courses can provide you excellent opportunities to expand your career in the exciting world of electronics! So get started right now by checking the coupon and mailing it today.

Classroom Training at Los Angeles. You can take classroom training at Los Angeles in sunny Southern California. NTS occupies a city block with over

a million dollars in facilities devoted exclusively to technical training. Check box in coupon.

Approved for Veteran Training. Accredited Member: National Association of Trade & Technical Schools; National Home Study Council

NATIONAL TECHNICAL SCHOOLS

TECHNICAL-TRADE TRAINING SINCE 1905
Resident & Home Study Schools

4000 South Figueroa St., Los Angeles, Calif. 90037



News Highlights

CBS Labs VP Receives Patent for SQ Quadraphonic Disc

Benjamin B. Bauer, Vice President for Acoustics and Magnetics of CBS Labs has been awarded patent number 3,770,901 covering his invention of the SQ™ stereo-compatible quadraphonic disc. Together with companion patents issued and pending, it provides broad coverage of the invention of the SQ quadraphonic record system. Mr. Bauer has made numerous contributions to theoretical and applied acoustics, including the invention of the phase-shift type of cardioid microphone which is universally used, as well as methods and apparatus for measurements of sound and vibration. He introduced several innovations in transducer designs, developed a 1-gram moving-magnet phono pickup (precursor of the modern high-fidelity reproducer), and made significant improvements in modern stereophonic disc technology.

Chip Shortage Slows Watch Makers

Digital electronic watch makers have been plagued with one shortage after another. First it was the quartz crystals that are used to establish the operating frequency, now it is another important ingredient—the CMOS chip that does the dividing and timing. Semiconductor makers seem to have given priority to other MOS products that they can deliver more readily and to those on which the yields are higher. In the meantime, the digital watch makers are chafing at the bit in an effort to get going into a market that still promises to reach over \$50 million by 1976.

IEEE Releases Manpower Report

The Manpower Committee of the IEEE has released its manpower report for 1973, "Career Outlook in Engineering (USA)." The report states that generally "career opportunities in electronics will continue to grow (however) . . . it will be necessary to remain flexible and ever ready to transfer to another area as activity changes in focus and grows in turn to meet market demands." The report urges engineers to keep abreast of new developments and avoid over-specialization in their education. The 225-page report is available to IEEE members at \$10 and to nonmembers at \$15 from the Institute of Electrical and Electronics Engineers, Inc., 345 East 47th St., N.Y., N.Y. 10017.

Hearing Aid Battery Recharged by the Sun

The Ultima in-the-car hearing aid is powered by a sealed nickel-cadmium rechargeable battery that operates the aid for 24 to 36 hours. To recharge the battery, the aid is inserted into a recharger overnight. The recharger contains a rechargeable high-capacity alkaline battery which has 2 to 3 months of recharging power. To keep the recharging battery fully charged, a six-cell silicon solar battery is built atop the recharging unit. By exposing the solar cell to about 10 hours of sunshine, about 1 month's recharging power is applied to the alkaline battery which can then be used to recharge the tiny nickel-cadmium cell built into the hearing aid. Covered by a 5-year guarantee with no batteries to buy, the entire system sells for just under \$400.

There's a wealth of enjoyment and information in Sams books for the hobbyist.

One or more of the eight shown here could be right down your alley.

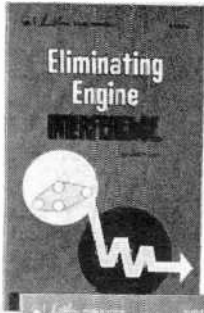

ELIMINATING ENGINE INTERFERENCE, 2nd Edition

By John D. Lenk
Explains how to eliminate or reduce troublesome interference caused by auto, boat or other engines in mobile communications receivers. Covers solid-state circuits and includes wiring diagrams for major autos. Analyzes and discusses squelch and noise-limiter circuits, commercial suppression kits, shielding kits, and electronic circuits that can be added to the receiver. 128 pages, softbound. No. 21004 \$4.50

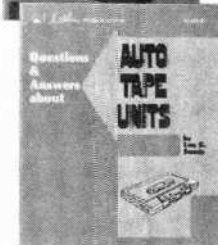

QUESTIONS AND ANSWERS ABOUT AUTO TAPE UNITS

2nd Edition
By Leo G. Sands
A handy, easy-to-follow guide to understanding the operation of auto tape units. Using a question-and-answer format, it provides information on the circuitry, installation, troubleshooting, and maintenance of auto tape players, cartridges, and cassettes. 96 pages, softbound. No. 21002 \$3.50

TAPE RECORDING FOR THE HOBBYIST, 3rd Edition

By Arthur Zuckerman
Everything you need to know to get the most from your tape recorder. The book discusses the advantages, disadvantages, maintenance, and repair of the different types of machines and microphones available. It also covers their many uses, ranging from recorded letters to sound effects and video tape recording. 192 pages, softbound. No. 21016 \$4.95



ELECTROSTATICS HANDBOOK

By Charles Green
An introduction to one of the great natural forces — electrostatic electricity. You learn its fundamentals firsthand by building educational and entertaining demonstration projects. Each chapter in the book includes groups of projects that cover different aspects of electrostatic electricity generation, detection, and use. 128 pages, softbound. No. 21023 \$4.25

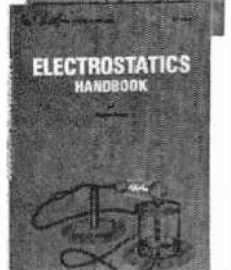

5-MINUTE ELECTRONIC PROJECTS

By Len Buckwalter
While each project can be created in just minutes, in total the book provides many hours of pleasure. It presents, in complete detail, dozens of projects that can be made with simple tools and inexpensive components. The projects start with simple demonstrations and grow progressively more complex, enabling you to learn by building. 96 pages, softbound. No. 20968 \$3.95

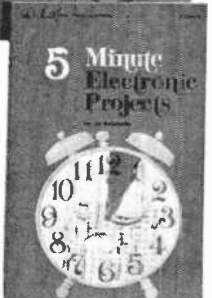

LED CIRCUITS & PROJECTS

By Forrest M. Mims III
The recently developed and fast-growing field of uses for light emitting diodes (LED) is graphically presented in this highly readable book. Following an introduction to the theory of LEDs, the book covers the many varied LED circuits and applications. Chapters cover installation, operating hints, multiple-color LEDs, diode laser theory, and much more. 176 pages, softbound. No. 21006 \$4.95

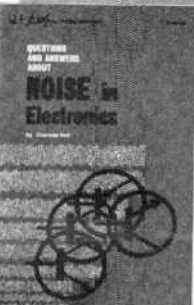
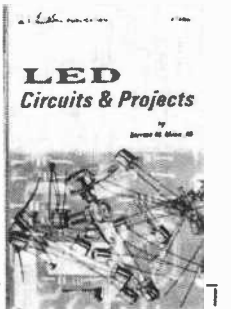

QUESTIONS AND ANSWERS ABOUT NOISE IN ELECTRONICS

By Courtney Hall
Explains, in easy Q & A format, the situations that cause noise in electronics. Provides a clear understanding of noise characteristics and the measurement peculiarities associated with them. Examples and tables of solutions save time and effort for the reader. 96 pages, softbound. No. 21022 \$3.95

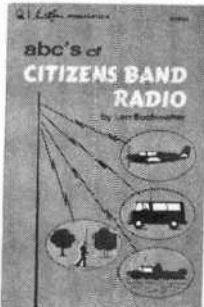

ABC'S OF CITIZENS BAND RADIO

3rd Edition
By Len Buckwalter
This easy-to-understand text covers the principles of operation, regulations, setup, and operating of CB radio equipment. Illustrations and schematics show how to obtain an FCC license, and set up and operate the equipment with efficiency. 128 pages, softbound. No. 21021 \$3.95



HOWARD W. SAMS & CO., INC.
4300 W. 62nd St., Indianapolis, Ind. 46206

Order from your Electronics Parts Distributor, or mail to Howard W. Sams & Co., Inc.

Send books checked at right. \$ enclosed. Please include sales tax where applicable. Canadian prices slightly higher.

Send FREE 1974 Sams Book Catalog.

- 21004
- 21002
- 21022
- 21021
- 21016
- 21023
- 20968
- 21006

Name _____

Address _____

City _____ State _____ Zip _____

PE-054

CIRCLE NO. 27 ON READER SERVICE CARD

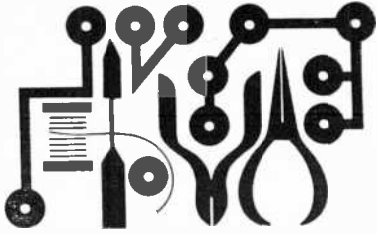

Hobby Scene

High-Voltage Geiger Supply

Q. I am experimenting with an old Geiger counter. Unfortunately, I can no longer buy the high-voltage batteries that the unit requires. Is there a simple 300-volt converter that could be powered from the internal battery?

A. The circuit shown at the right will generate about 300 volts dc—at a very low current, but enough for your Geiger tube.

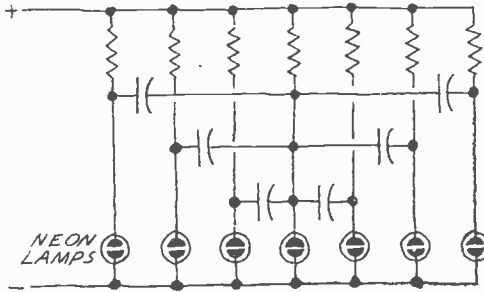
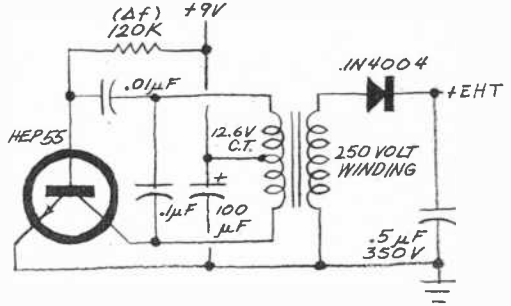

A Do-Nothing Box

Q. I want to duplicate a Do-Nothing box that a friend of mine has, but it is potted in plastic so I can't see the circuit. The seven neon lamps just blink in a random fashion. How is this done?

A. Use the circuit at the left. Capacitors should be between 0.1 and 1 µF (low leakage); resistors between 220 k and 2.2 megohms. Use a pair of series-connected 67½- or 90-volt dry batteries.

Needs an Audio Amplifier

Q. I like to experiment with crystal sets, but I don't like to wear earphones all the time. I need a small, low-cost audio amplifier that I can build from junk-box or other readily available parts.

A. All you need for this amplifier is a couple of transistors, two capacitors, a fixed resistor, and a volume control (plus a speaker of course). To extend battery life, or to add a little smoothing if an ac supply is used, connect a capacitance of 200 microfarads between the 9-volt supply and ground. If you don't have a 16 ohm speaker, try using the output transformer and speaker from an old transistor radio.

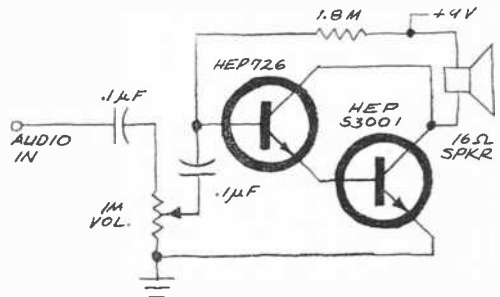

Have a problem or question on circuitry, components, parts availability, etc.? Send it to the Hobby Scene Editor, POPULAR ELECTRONICS, One Park Ave., New York, NY 10016. Though all letters can't be answered individually, those with wide interest will be published.

There are some things you'll appreciate about a Dual right away. Others will take years.

You can appreciate some things about a Dual turntable right in your dealer's showroom: its clean functional appearance, the precision of its tonearm adjustments and its smooth, quiet operation.

The exceptional engineering and manufacturing care that go into every Dual turntable may take years to appreciate. Only then will you actually experience, play after play, Dual's precision and reliability. And how year after year, Dual protects your precious records; probably your biggest investment in musical enjoyment.

It takes more than features.

If you know someone who has owned a Dual for several years, you've probably heard all this from him. But you may also wish to know what makes a Dual so different from other automatic turntables which seem to offer many of the same features. For example, such Dual innovations as: gimbal tonearm suspensions, separate anti-skating scales for conical and elliptical styli, and rotating single play spindles.

It's one thing to copy a Dual feature; it's quite another thing to match the precision with which Duals are built.

The gimbal, for example.

A case in point is the tonearm suspension. Dual was the first manufacturer of automatics to offer a true twin-ring gimbal suspension. More importantly, every Dual gimbal is hand assembled and individually tested with precision instruments especially developed by Dual. The vertical bearing friction of this gimbal is specified at 0.007 gram, and quality control procedures assure that every unit will meet this

specification. Only by maintaining this kind of tolerance can tonearm calibrations for stylus pressure and anti-skating be set with perfect accuracy.

Other Dual features are built with similar precision. The rotor of every Dual motor is dynamically balanced in all planes of motion. Additionally, each motor pulley and drive wheel is individually examined with special instruments to assure perfect concentricity.

The Dual guarantee.

Despite all this precision and refinement, Dual turntables are ruggedly built, and need not be babied. Which accounts for Dual's unparalleled record of reliability, an achievement no other manufacturer can copy. Your Dual includes a full year parts and labor guarantee; up to four times the guarantee that other automatic turntables offer.

If you'd like to read what several independent testing laboratories have said about Dual turntables, we'll be pleased to send you reprints of their impartial reports. To appreciate Dual performance first hand, we suggest you visit your franchised United Audio dealer.

But your full appreciation of Dual precision won't really begin until a Dual is in your system and you hear the difference it will make on your own records. Play after play. Year after year.



Dual[®]

United Audio Products, Inc., 120 So. Columbus Ave., Mt. Vernon, N.Y. 10553

Exclusive U.S. Distribution Agency for Dual.

CIRCLE NO. 4 ON READER SERVICE CARD

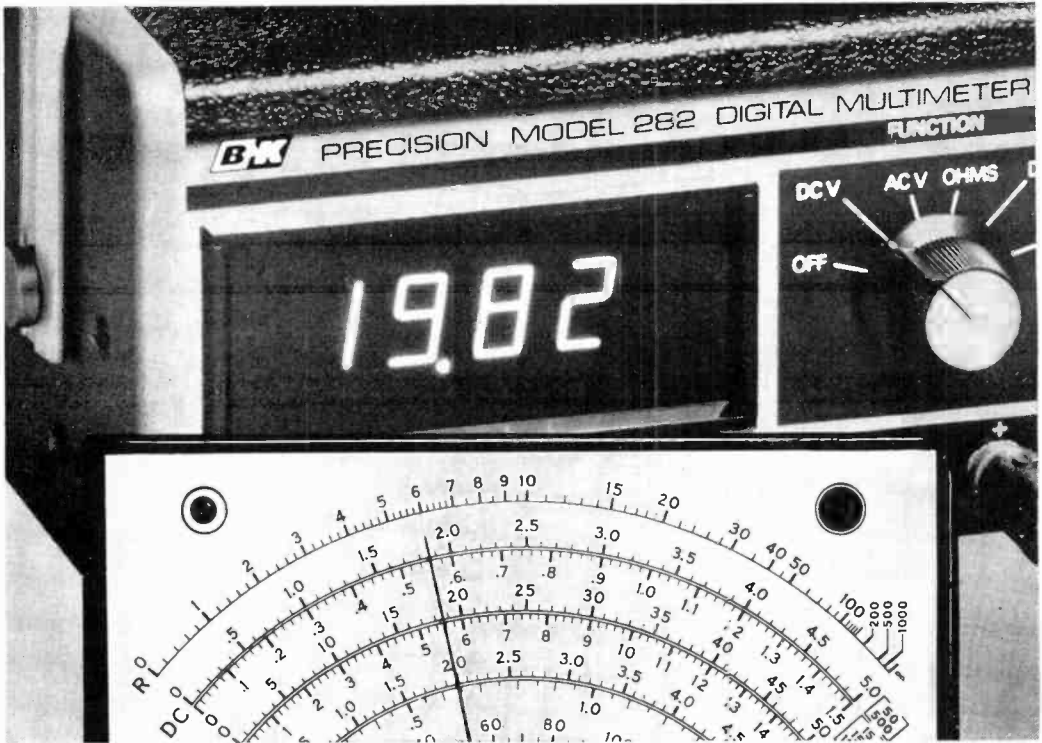

What's the Difference?

3-1/2 digit multimeter with 6 to 13 times the accuracy of a typical analog meter

The industry's most popular bench-type VOM, compared above to our Model 282 Digital Multimeter, has 3% full scale DC accuracy. On the 50-volt scale, that's an accuracy of ± 1.5 volts, or an accuracy of reading of 7.5% at about 20 volts. The 282's accuracy of reading is $0.5\% \pm 1$ least significant digit, or ± 0.11 volt. Divide those two figures—1.5 by 0.11—and you find that the 282 has 13.6 times the accuracy at that reading.

Even at readings close to 50 volts, where the analog multimeter is most accurate, Model 282 remains more than six times as accurate as the analog multimeter.

As for ease of reading . . . the picture above shows Model 282 and the analog meter to scale. Put it where you'd normally set up your multimeter and see for yourself how much more easily you can read the 282's bright digital display.

And there's more—automatic polarity, clear out-of-range indication, automatically positioned decimal point, 100% overrange capability, complete overload protection, 10 megohms input impedance and a three-position handle that doubles as a stand for tilt-up viewing. Plus a Model PR-21 probe with switchable 100K ohm isolation resistor to prevent capacitive loading while measuring DC in RF circuits.

And all for almost an analog price! Now in stock at your local distributor or write Dynascan.



MODEL 282 \$200

B&K PRODUCTS OF
DYNASCAN

1801 W. Belle Plaine Ave. • Chicago, IL 60613 • Phone (312) 327-7270

CIRCLE NO. 3 ON READER SERVICE CARD

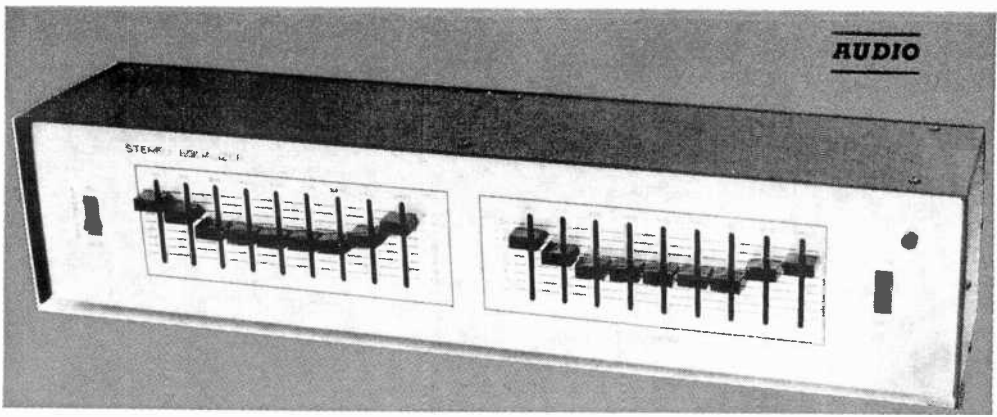

BUILD THIS

NINE-CHANNEL STEREO EQUALIZER



Active op-amp filters produce very low distortion, no ringing. Eighteen independent control positions offer full flexibility.

BY GARY KAY

AN INCREASING number of audiophiles are adding equalizers to their hi-fi/ stereo equipment. These auxiliary devices permit adjusting the response of the system in relatively small frequency increments to achieve a desired effect—whether it be to compensate for room acoustics or speaker deficiencies, or just to please their own personal tastes.

If you are contemplating adding an equalizer to your system, but are concerned about the cost of a commercial unit with enough flexibility, you will want to consider building the unit described here. Designed for a stereo system, it has nine 1-octave adjustments in each channel. Using integrated circuit (op amp) active filters, the equalizer has an internal ac power supply. Boost and cut limits are ± 12 dB; voltage handling limit is 2 V rms; and the total harmonic distortion is a low 0.05 percent.

The frequency response of the equalizer

is from 20 to 20,000 Hz (3 dB), hum and noise is 65 dB below 1 volt rms, input impedance is 100,000 ohms, and output impedance is less than 10,000 ohms. Connection to an operating audio system can be made between the preamp-out/power-amp-input jacks or between the tape-out/tape-monitor input jacks.

The nine gain controls are centered at 50, 100, 200, 400, 800, 1600, 3200, 6400, and 12,800 Hz. Although the lowest and highest frequency filters are bandpass types, their use in a feedback loop gives them a low-pass/high-pass response. The enclosure of the entire array of active bandpass filters in a feedback loop also provides low noise and distortion.

The arrangement of the potentiometer knobs for both channels on the front of the equalizer provides a true graphic representation of the tonal compensation. The equalizer can also be used in an electronic musical instrument system by connecting it

MAY 1974

27

boards are used: one each for left channel, right channel, and power supply (see Fig. 2). By mounting all of the switches and controls on the circuit boards, wiring is kept to a minimum.

When mounting the components on the boards, be sure to orient the diodes, integrated circuits, and electrolytic capacitors properly. See the component layout diagrams in Fig. 2.

MAY 1974

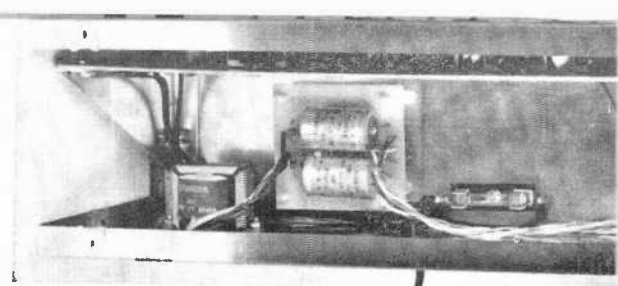

29

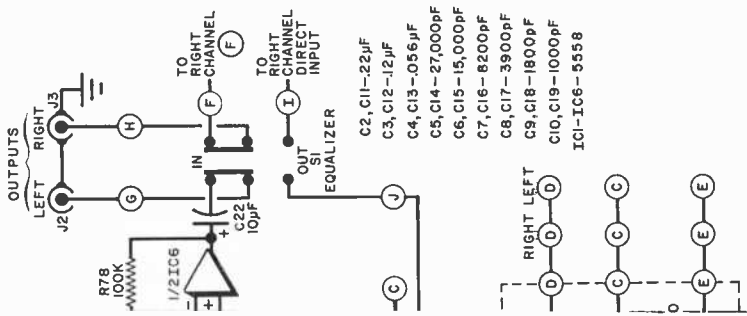

PROJECT EVALUATION (A Hirsch-Houck Labs Report)

The equalizer lives up to its specifications very easily—usually with a good margin of safety. All of the octave controls have ranges of at least 12 dB and most are about 14 dB. The frequency response is “dead flat” with the equalizer switched out (± 0.5 dB, 20 Hz to 20,000 Hz) and has a few bumps when it is switched in with the controls set to indicated center points. Even so, it is within ± 0.75 dB, which is not bad at all.

The center points of the equalizer controls are a little off, usually by 10 to 20%, which, of course, is of no practical importance. Needless to say, almost any sort of curve can be generated, depending only on the user’s talent and patience. The frequency response with controls centered rises outside the audio band at both ends, but is within 3 dB of the 1000-Hz level (unity gain) from 20 Hz to 190 kHz.

The 2-volt signal limit is evidently based on the input level, allowing for all or many of the octave controls to be at full boost. This is ultra-conservative, but it seems to be the only explanation for a 2-volt rating on a unit which has virtually no distortion up to the 10-volt maximum of our audio signal generator. Up to an output of about 4 volts (1000 Hz, all controls centered), the THD is entirely noise and hum, as indicated by the 6-dB/octave negative slope of the distortion-vs-level curve. At an output of about 7 volts, we begin to have distortion overcoming noise, with a reading

of 0.0075%. At the maximum test limit of 10 volts, the total harmonic distortion was all of 0.0095%!

The unweighted noise level in the output was 66 dB below 1 volt (just a little below the specified rating). When the measurement bandwidth was restricted to 250 to 20,000 Hz, to exclude hum and ultrasonic random noise, the measurement was 74 dB below 1 volt.

The physical packaging of the equalizer is unconventional, since it is too wide to sit on top of a receiver or any other component. The controls operate very smoothly, and have a nice “feel.” On the assumption that it will be connected into a tape monitoring circuit, it would have been nice to have included tape input and output jacks and a monitor switch, to replace those used on the amplifier or receiver (standard practice on most such accessories). On the other hand, the equalizer can just as well be placed between preamp and power amplifier, since it can handle any signal levels there and will not add to audible noise.

Square-wave tests showed virtually no distortion other than that introduced by the frequency shaping. No ringing was visible with the controls centered.

In quality of performance, this equalizer is comparable to commercial units costing twice as much. This one boasts separate adjustments for the two channels and nine bands per channel instead of five.

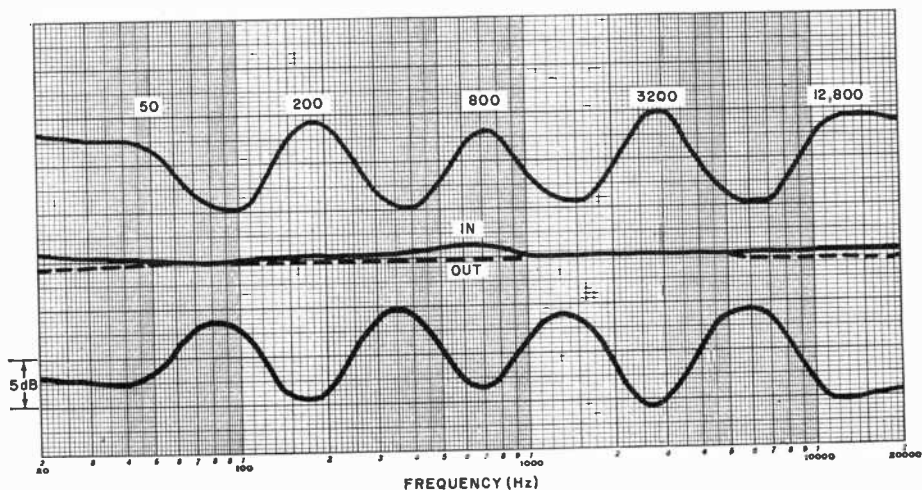

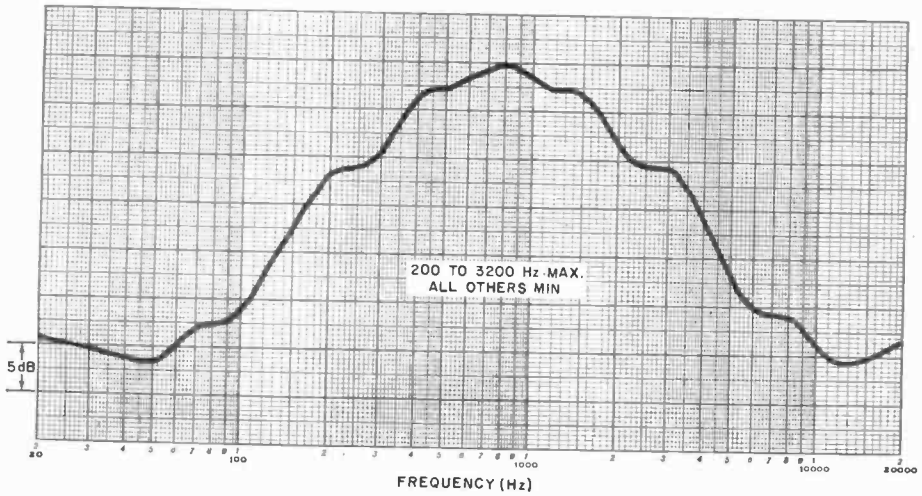
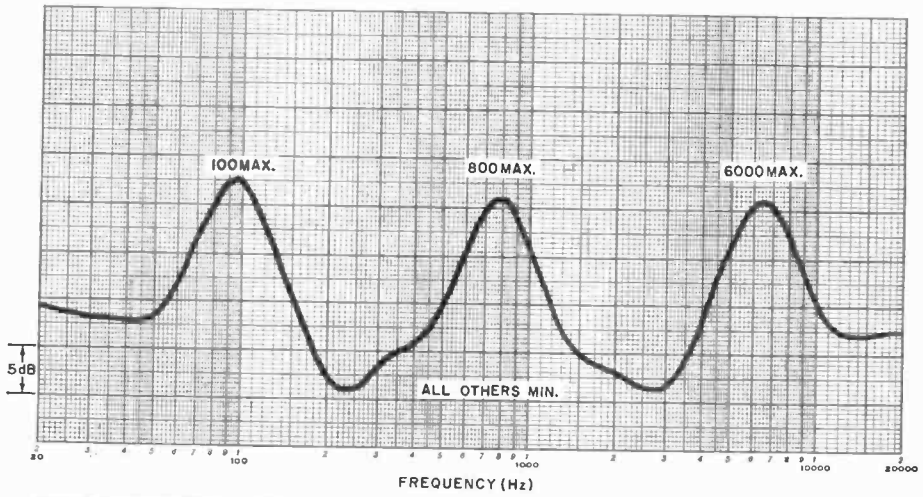
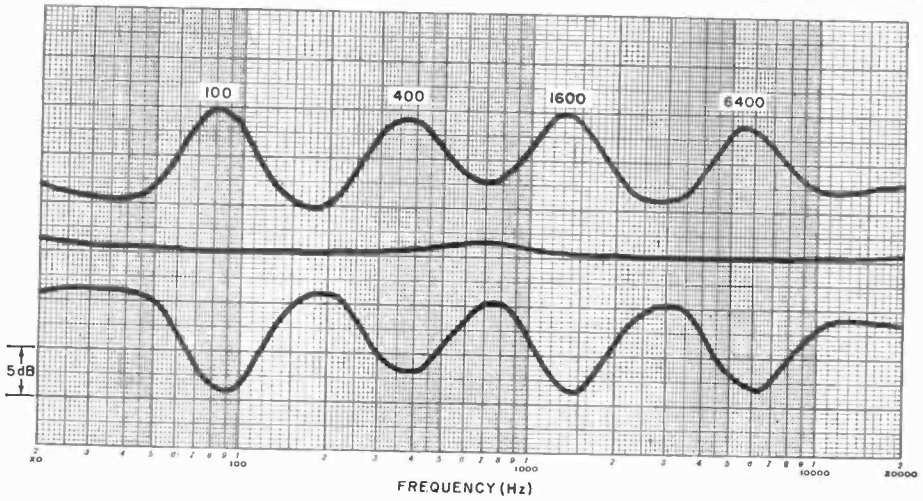

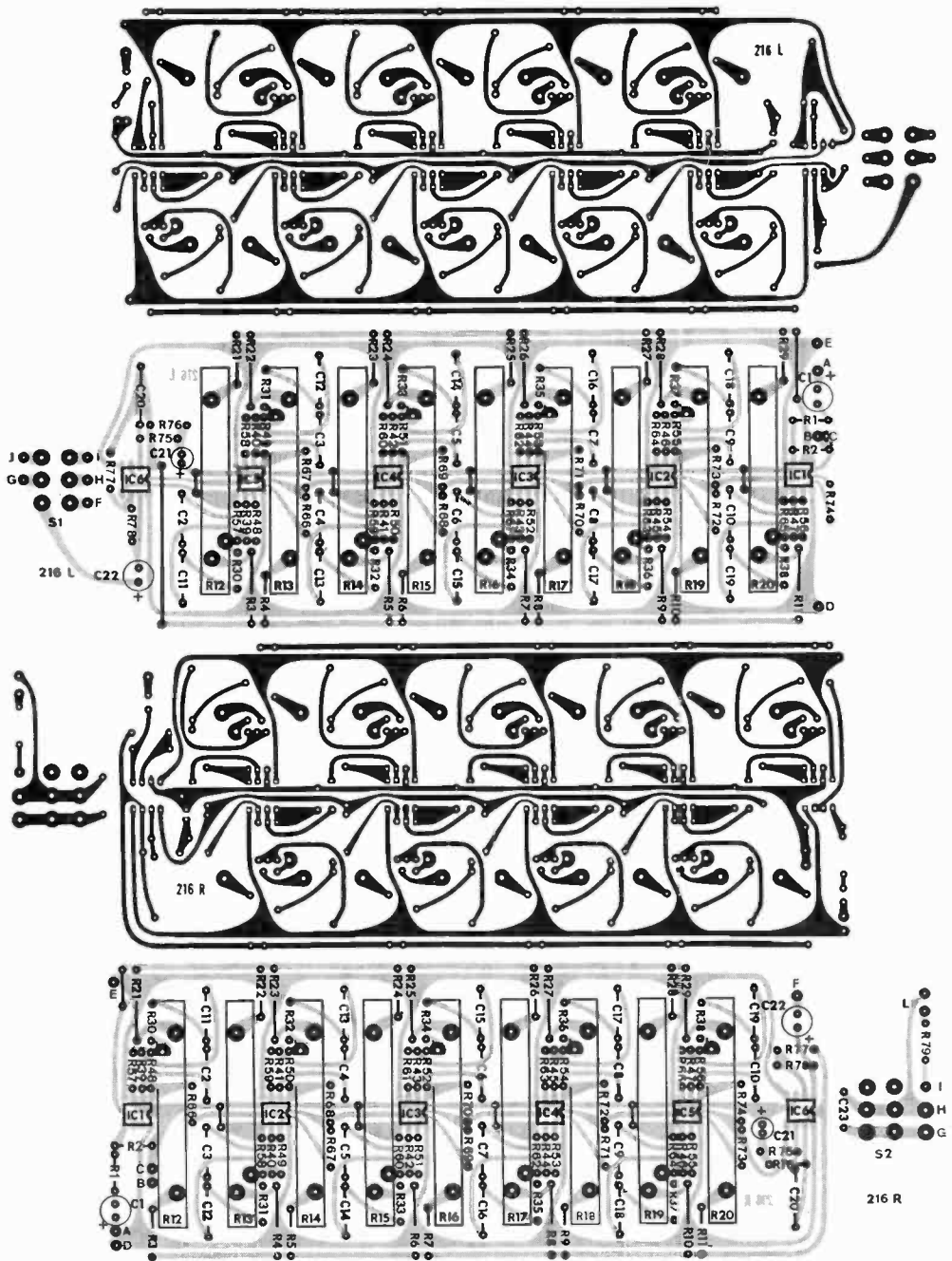

Fig. 2. Foil patterns and component layouts (left at top) are shown half-size. A foil pattern for the power supply is not shown, but one can be made easily.

ment where the preamp feeds the power amplifier. In any case, the input level to the equalizer should not exceed 2 volts rms.

After installation, set the audio system tone control for flat response. Using just the equalizer's controls for tone compensa-

tion will provide a better graphic representation of the equalization preferred.

Compensating for room acoustics is a bit tricky, but it can be accomplished by using a sound pressure level meter and test record. ♦

What to look for in a SHORTWAVE RECEIVER

*Evaluating your broadcast coverage,
technical and operating needs.*

BY RICHARD E. WOOD

VARIOUS types of receivers are commonly used by shortwave listeners. They range from multiband radios to professional communications receivers (not to be confused with less-sophisticated communications-type receivers). Budget permitting, the serious SW listener will opt for the communications receiver since it pulls in more stations (especially distant ones) and provides clearer reception on otherwise marginal stations. Shortwave communications receivers are both *general-coverage* (i.e., covering a specified range of frequency continuously, without a gap) or cover certain designated, limited *bands*.

What Coverage to Look For. If shortwave broadcast listening is your thing, then the bands you are interested in fall between 2.3 and 26.1 MHz (megahertz, the old megacycles-per-second or Mc/s). But they are not continuous throughout this range; in fact, only about a tenth of that spectrum is used by broadcasting stations officially, with a few more (in countries as varied as Britain, China, Israel, Egypt, and Spain) spilling over beyond the designated shortwave broadcast bands in happy defiance of

International Telecommunications Union regulations. Unlike the amateur bands, which are in a harmonic relationship to each other, on 3.5, 7, 14 MHz, and so on, the international broadcast bands have no regular frequency relationship. Thus, receiver design based upon harmonic principles is not possible.

The frequencies you will need include the international bands: 75, 49, 41, 31, 25, 19, 16, 13, and 11 meters, as they are popularly known. Of these, the 75- and 41-meter bands are not supposed to be used for broadcasts to the Americas, where they are an integral part of the 80- and 40-meter ham bands, respectively. But you will still want them, either to listen to the amateurs there, or to tune in to the broadcasts which are directed to North America, in some cases under the pretext of being intended for the "Atlantic Islands."

In any case, Radio Tirana, the voice of China's European ally, Albania, is there on 7300 kHz all year round, while Radio Moscow's North American service relies chiefly upon the 41-meter band during the North American winter, the main frequencies being 7150 and 7205 kHz, often supplemented by half a dozen others. At the high-frequency end, be sure that your receiver covers 13 meters, as it gives pristine reception of Europe during the day and Australia in the evening, plus many other areas. A receiver without 13 meters—particularly in areas away from the East Coast—may not give much good listening during the hours of daylight. So unless you're strictly a night owl, don't forget 13 meters (21.45-21.75

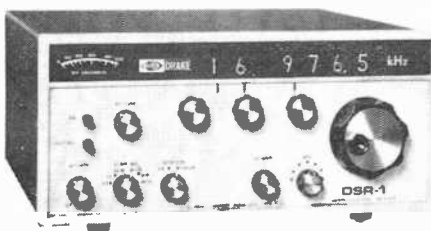

Drake's DSR-1 communications receiver.

MHz). Going higher, the 11-meter band, while not obligatory at the present stage in the sunspot cycle, when it is really too high for effective use over normal paths on the earth, is a useful band to have. For those days of good conditions it may bring local-quality reception of Britain, Norway, or South Africa (almost the only foreign countries which are using it now) during the otherwise downswing midday hours.

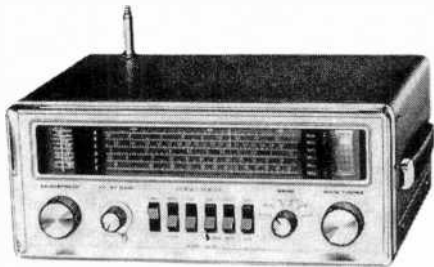

Heath's GR-78 SW receiver sold as a kit.

For the sounds of cumbias from Colombia, merengues from the Dominican Republic, vals from Venezuela, the tropical bands are not to be missed. And, while you're not likely to find the BBC, Radio Nederland, or other popular major broadcasters on them, they are best for real shortwave broadcast DX. The number of rare countries which can be heard only on the tropical bands is staggering: Belize, Gambia, Nepal, Cook Islands, and Reunion, to name just five. And, because of the greater interference on the international bands, or other reasons, many countries which operate on, say, 25, 31, or 49 meters are actually much easier to hear on 60, 90, or 120 meters: Honduras, Venezuela, Colombia, Bolivia, and almost all the African republics such as Upper Volta, Togo, Sierra Leone, Kenya, and Senegal. Thus, be sure you have coverage of 2.3-2.5 MHz (120 meters), 3.2-3.4 MHz (90 meters) where you'll also hear the very handy CHU

time signal from Ottawa, Canada), and 4.75-5.06 MHz (60 meters with WWV located at 5 MHz).

Other Receiver Considerations. Besides the above-specified *frequency coverage*, an SWL receiver should have the best possible characteristics of *sensitivity* and *selectivity*. Sensitivity is the ability to receive weak signals and raise them up, as the saying goes, "out of the mud;" to raise them above the background noise level, caused mainly by static (the effects of thunderstorms near and far), man-made noise, and internal receiver noise. Most genuine communications receivers today have no lack of sensitivity. It is worth checking each band, however, to make sure that sensitivity does not slump at either end of the tuning range, while peaking in the middle. Weaker signals are likely to be encountered at the high-frequency end of the shortwave spectrum, so check your reception in the 13-meter band and on 11, when open (carefully).

As more and more stations come onto the unexpanded shortwave broadcast bands, *selectivity* becomes more and more important. Check to see whether you have a choice of bandwidths: and if you do, check to see how intelligible (readable) amplitude modulated signals are at each bandwidth setting. The human voice should not be so clipped as to be incomprehensible. Getting rid of heterodynes (piercing whistles caused by stations too close, generally within 1 or 2 kHz of each other) can be performed by a *notch-filter*. It enables one to take a "slice" out of a range of frequencies, as narrow as possible, in order not to destroy the still-wanted frequencies. Check also whether you can change to a narrower bandwidth *without* switching in the BFO (beat-frequency oscillator). You will need the BFO for CW (Morse code) signals, but not for broadcasting stations using audio modulation.

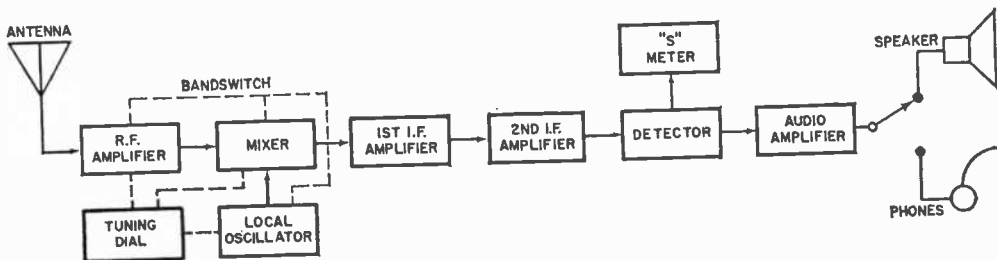

Typical shortwave receiver will have the circuits and features shown here.

Do I Need a Preamplifier? A preamplifier adds sensitivity, not selectivity. If your problem is weak signals, then perhaps a pre-amp is what you need. A good preamp will raise the signals without significantly raising the noise level. The bugaboo of preamplifiers is the production of images. A properly tuned preamp should not produce spurious radiations or images of powerful stations on frequencies where they are not supposed to be. It is wise to ground the preamp and receiver together with a braided metal strap. As we have said, lack of sensitivity is the least of the problems in a contemporary receiver, at least with the major shortwave broadcasters with their average transmitter power of 250 kW!

What About Grounding? A good ground doesn't look fancy. In fact, most of it is buried and you don't see it at all. But it makes a big difference. The best practical ground is a copper rod driven into moist earth. One reason why Alaskan AM stations are not easy to hear in the "Lower 48" is because of the permafrost which prevents the digging of a good grounding system. Anyway, unless you live directly on top of permafrost or in a wasteland of solid concrete, hammer that ground rod in deep and clamp a heavy-gauge wire from it (copper again, preferably) to the "G" (sometimes "E" for the British "Earth") connection of your receiver. Some SWL's keep the ground moist in dry weather by positioning their copper rod directly under the drip of an air conditioning unit. This is a good technique, as long as the air conditioner does not produce r-f noise. A substitute ground can be rigged by running a wire to a cold water pipe or any connection leading to ground.

How Do I Pinpoint Frequency? Shortwave receiver design has progressed recently in

the field of calibration. Exact frequency read-out to within the nearest assigned shortwave broadcast channel, i.e., to within 5 kHz, is now available on moderately priced SW receivers. This is a real breakthrough, taking much guesswork out of tuning and letting you dial your favorite station every time. Some SWL's won't settle today for less than that when purchasing new equipment, although many still enjoy the older-style equipment which requires the compilation of a logging scale or the use of an external calibrator. The internal calibrator in many receivers, with tones marking every megahertz, or every 500 and 100 kHz, is still as useful as ever and featured on many of the latest models of shortwave communications receivers.

The most sophisticated form of calibration is the *electronic digital display* of a frequency of great accuracy, say, one tenth of a kilohertz. Such displays represent the state-of-the-art and are found on receivers in the \$2000 price bracket. However, the same effect, a direct read-off of figures making up the exact frequency to which you are tuned, is achieved by the *digital dial*, now found on reasonably priced equipment. A regular *tuning scale* with *pointer* remains the most common method and, if accurate, can give good results.

A bandspeed scale is another desirable tuning-accuracy feature. Keep in mind, also, that frequency calibration can be checked by tuning to WWV time signals.

What About Crystals? Yes, if you have a favorite frequency to which you wish to tune regularly and are using a crystal-controlled set, you can insert a compatible crystal for just that frequency. An FM station in Washington, D.C., for example, which regularly relays the BBC news, has a crystal for 9510 kHz (which makes it a double relay, since BBC 9510 kHz beamed

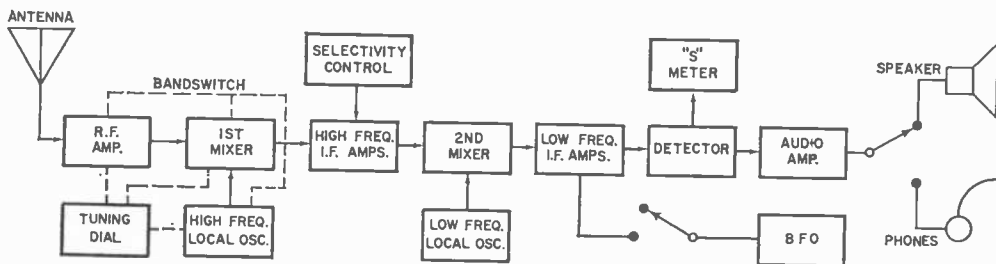

More sophisticated receivers use dual-conversion with two oscillators/i-f amps.

Discover the ease and excitement of learning Electronics with programmed equipment

NRI Sends you

When you train at home with NRI, you train with your hands as well as your head. You learn the WHY of Electronics, Communications, TV-Radio the NRI pioneering "3-Dimensional" way. NRI training is the result of more than half a century of simplifying, organizing, dramatizing subject matter, and providing personal services unique for a home study school. You get the kind of technical training that gives you priceless confidence as you gain experience equal to many, many months of training on the job.



NRI—The Leader in Electronics Training for more than Fifty Years

APPROVED UNDER NEW GI BILL

If you served since January 31, 1955, or are in service, check GI line in postage-free card.



*Earn \$5 to \$7 an hour
spare or full time in*

TV-RADIO SERVICING

Color television sales are soaring. And so is the demand for trained repairmen. If you can service TV sets, portable radios, tape recorders, hi-fi sets, phonographs and auto radios, you'll always be in demand. It's one of your best routes to spare-time earnings, a good paying job or a business of your own. NRI trains you quickly and expertly, showing you how to get started in servicing soon after you enroll, earning as you learn. NRI trains you in today's method of installing and repairing all electronic equipment for the home—including solid state Color TV. You even build, experiment with and keep to enjoy your own solid-state radio plus your choice of black-and-white or the new 25" diagonal solid state Color TV receiver NRI developed from the chassis up for training. Like thousands of others, you can soon be earning good money in your spare time . . . the easy NRI way.

*There's money and
success awaiting you in*

COMMUNICATIONS MOBILE RADIO & BROADCASTING

NRI training in Complete Communications equals as much as two years of training on the job. With NRI, you can train for a choice of careers ranging from mobile, marine and aviation radio to TV broadcasting and space communications. You learn how to install, maintain and operate today's remarkable transmitting and receiving equipment by actually *doing* it. You build and experiment with test equipment, like a TVOM you keep. You build and operate amplifier circuits, transmission line and antenna systems, even build and use a phone-cw transmitter suitable for transmission on the 80-meter amateur band. Whichever of these five intensely practical NRI Communications courses you choose, you prepare for your FCC License exams, and *you must pass your FCC exams or NRI refunds your tuition in full.*

*Move ahead in America's
fast growing industry as*

COMPUTER TECHNICIAN

Ours is rapidly becoming the age of the computer . . . and NRI can train you to cash in on the opportunities in this field. Only NRI trains you at home on a real computer—not a simple logic trainer, but a complete, stored program digital computer using over 50 integrated circuits. As you build the NRI Computer, you explore all fundamental logic circuits, then how to combine them in a complete, stored program computer. You observe the "heart" of a real computer. You solve typical problems and learn how to locate faults with diagnostic programs. Bite-size texts make studying easier. Prove to yourself what nearly a million NRI students could tell you—that you get more for your money from NRI. Check the card and mail it today for your free NRI Color Catalog. **NO SALESMAN WILL CALL.** NRI Training, 3939 Wisconsin Ave., Washington, D.C. 20016.

YOU GET MORE FOR YOUR MONEY FROM NRI



NRI Kits and Equipment

Dollar for dollar, you get more value from NRI training kits, because they are designed as educational tools. In the TV-Radio Servicing Course, for instance, the end product is a superb 25" diagonal color TV your whole family will enjoy. The set is designed so that, while building it, you can introduce and correct defects . . . for trouble-shooting and hands-on experience in circuitry and servicing. The kits include, at no additional cost, a wide-band service type oscilloscope and color cross-hatch generator, and other valuable equipment that will let you start earning money in your spare time making repairs . . . even before the course is completed.



Panasonic's RF-5000A portable SW receiver.

to North America comes via the Atlantic Relay Station on Ascension Island). Radio Japan sent some of its regular monitors a little hand-held portable with crystals for three leading NIK frequencies, 9505, 15105, and 17825 kHz. For receivers which come equipped with a certain range of frequencies and which are programmed to accept additional crystals, sets of crystals for the tropical bands, the aeronautical bands, the amateur bands, etc., may be bought and inserted.

Now—the Antenna. Strictly speaking, your antenna *is* your receiver. It seizes the incoming signals, then your receiver amplifies and converts them. But the antenna's role is the basic one. The most common SWL antenna is the *dipole*. To make a dipole, take any reasonably sturdy gauge of wire, shielded or unshielded, and measure it out. A *half-wave* dipole will measure half the wavelength at the center of the band for which the dipole antenna is being cut, minus one twentieth (5%). If you make all your measurements in meters, this should be easy to work out and it will give you practice with the metric system, which we will be using all the time eventually. Take the 19-meter band, one of the most popular. A wavelength toward the middle of that band is 19.6 meters; a half-wave, then would be 9.8 meters; a twentieth of that would be roughly half a meter. So your half-wave dipole should be 9.3 meters long. Fold it and cut it precisely in the middle. There, insert an insulator or, better still, a *balun*. That is the point where your transmission line or lead-in to the receiver is inserted. This can be ordinary twin-lead, but

it's better to spend a little money and use RG-58/U coaxial cable. If you hang the dipole between two trees or buildings, or between a mast or a house, or in any other hanging position, the balun and transmission line junction will be the vulnerable stress-point. So check it thoroughly for physical strength and give the coax connection a good weatherproofing either by encasing it in a watertight box or by greasing it thoroughly. Don't forget lightning arresters for shortwave or any other antenna that is installed outdoors.

The *Vee* antenna is essentially a folded dipole whose mid-point feeds directly down to the receiver via the transmission line, as above, while the two ends, rather than following a straight line, form a "V" shape encompassing an angle of, say, 30 or 40 degrees, as desired.

The *L* antenna looks, of course, like the letter L. It runs vertically, say, up a pole or the side of a house, then bends at right angles and from there horizontally into the receiver. There are many other kinds of antennas which can be built with simple wire, and antenna experimenting is part of the fun of SWL-ing. Antenna kits and pre-built SWL antennas, including a *multi-band dipole* and a *vertical*, may be bought commercially. ♦



"What I don't understand is why it only shorts out on Mondays."

ENGLISH-LANGUAGE SHORTWAVE BROADCASTS

MAY—AUGUST

By Roger Legge

TO EASTERN NORTH AMERICA

TIME—EDT	TIME—GMT	STATION	FREQUENCIES, MHz
7:15—8:30 a.m.	1115—1230	Melbourne, Australia	9.58, 11.71
7:30—8:00 a.m.	1130—1200	Jerusalem, Israel	15.13, 17.71
8:00—8:55 a.m.	1200—1255	Montreal, Canada	5.97, 11.825, 15.315
8:00—9:00 a.m.	1200—1300	Peking, China	11.685, 15.095
4:00—4.45 p.m.	2000—2045	Jerusalem, Israel	9.445, 9.785, 15,100
6:00—9:00 p.m.	2200—0100	London, England	5.975, 9.51, 9.58, 11.78
6:30—8:30 p.m.	2230—0030	Johannesburg, S. Africa	5.98, 9.585, 9.695, 11.97
7:00—7:30 p.m.	2300—2330	Helsinki, Finland	15.185
7:00—8:30 p.m.	2300—0030	Moscow, U.S.S.R.	7.15, 9.685, 11.87, 11.90, 15.21
7:45—8:45 p.m.	2345—0045	Tokyo, Japan	15.27, 15.445
8:00—8:30 p.m.	0000—0030	Tirana, Albania	7.065, 9.78
8:00—9:00 p.m.	0000—0100	Peking, China	15.06, 17.673
		Sofia, Bulgaria	9.70
8:30—9:00 p.m.	0030—0100	Stockholm, Sweden	11.895
8:30—10:45 p.m.	0030—0245	Johannesburg, S. Africa	5.98, 9.585, 9.695, 11.97
8:30 p.m.—3:00 a.m.	0030—0700	HCJB, Quito, Ecuador	9.56, 11.915, 15.115
8:40—9:00 p.m.	0040—0100	Brussels, Belgium	9.55
9:00—9:15 p.m.	0100—0115	Vatican City	5.995, 9.605, 11.845
9:00—9:20 p.m.	0100—0120	Rome, Italy	9.575, 11.81
9:00—9:30 p.m.	0100—0130	Budapest, Hungary	9.833, 11.91, 15.155



A little Traveling Music, Please

Daily frustrations make a person want to get away from it all. And, the UTAH MP-3000 Speaker will take you there better, faster than any comparable unit. With the MP-3000, you know you are in Tahiti, Paris or even Kentucky. Your day becomes more pleasant, too, as the MP-3000 conquers the sound barriers.

MP-3000 combines the rare attributes of sound and styling. Clean, undistorted sound comes from this 4-speaker, 3-way speaker system. The oiled and hand-rubbed walnut veneer cabinets, and unique grille of sculptured foam are both acoustically and geometrically beautiful. The system contains a 15" high compliance woofer with a 2" voice coil, as well as two horn-loaded-dome-tweeters. It's a distinguished combination of well-defined, distortion-free sound reproduction. Size: 27" x 20½" x 14" deep, excluding base. Shipping weight: 70#.

Come travel with us. Get complete information about the exciting MP-3000 Speaker System.



UTAH ELECTRONICS
Huntington, Ind. 46750

CIRCLE NO. 34 ON READER SERVICE CARD

9:00—9:45 p.m.	0100—0145	Berlin, E. Germany	9.73, 11.89
		Madrid, Spain	6.065, 11.925
9:00—9:55 p.m.	0100—0155	Montreal, Canada	6.085, 11.835
9:00—10:00 p.m.	0100—0200	Peking, China	7.12, 9.78, 15.06, 17.855
		Prague, Czechoslovakia	7.345, 9.74, 11.99
9:00—11:00 p.m.	0100—0300	Melbourne, Australia	15.32, 17.795, 21.74
9:00—11:30 p.m.	0100—0330	London, England	5.975, 9.58, 11.78, 11.82
9:00 p.m.—1:00 a.m.	0100—0500	Havana, Cuba	11.93
9:00 p.m.—1:00 a.m.	0100—0500	Moscow, U.S.S.R.	7.15, 9.665, 9.685, 11.735, 11.90
9:30—10:30 p.m.	0130—0230	Bucharest, Romania	5.99, 9.57, 11.94
9:30—10:50 p.m.	0130—0250	Cologne, W. Germany	6.04, 9.545, 9.69
9:45—10:15 p.m.	0145—0215	Berne, Switzerland	6.12, 9.535, 11.715, 15.305
10:00—10:30 p.m.	0200—0230	Stockholm, Sweden	11.955
10:00—10:45 p.m.	0200—0245	Lisbon, Portugal	6.025, 11.935
10:00—11:20 p.m.	0200—0320	Hilversum, Holland	11.73 (via Bonaire)
10:00—11:30 p.m.	0200—0330	Cairo, Egypt	9.475
10:00 p.m.—12 mdt	0200—0400	Peking, China	15.06, 15.51, 17.855
10:30—11:00 p.m.	0230—0300	Beirut, Lebanon	11.79
10:30—11:15 p.m.	0230—0315	Berlin, E. Germany	9.73, 11.89
11:00—11:30 p.m.	0300—0330	Bucharest, Romania	9.57, 11.94, 15.25
		Budapest, Hungary	9.833, 11.91, 15.155
11:00 p.m.—12:00 mdt	0300—0400	Buenos Aires, Argentina	9.69 (Mon.-Fri.)
		Prague, Czechoslovakia	5.93, 7.345, 9.74, 11.99

TO WESTERN NORTH AMERICA

TIME—PDT	TIME—GMT	STATION	FREQUENCIES, MHz
7:00—7:15 a.m.	1400—1415	Tokyo, Japan	9.505
8:00—8:15 a.m.	1500—1515	Tokyo, Japan	9.505
4:00—5:30 p.m.	2300—0030	London, England	9.74 (via Canada)
5:00—7:00 p.m.	0000—0200	London, England	9.51, 11.78, 11.82
5:30 p.m.—12 mdt	0030—0700	HCJB, Quito, Ecuador	9.56, 11.915, 15.115
6:00—8:00 p.m.	0100—0300	Melbourne, Australia	15.32, 17.795, 21.74
		Moscow, U.S.S.R.	17.775, 17.865 (via Khabarovsk)
		Peking, China	15.06, 15.51, 17.855
6:30—7:30 p.m.	0130—0230	Tokyo, Japan	15.235, 15.445, 17.825
6:30—7:45 p.m.	0130—0245	Johannesburg, S. Africa	5.98, 9.585, 9.695, 11.97
7:00—8:20 p.m.	0200—0320	Hilversum, Holland	11.73 (via Bonaire)
7:00—8:30 p.m.	0200—0330	Cairo, Egypt	9.475
7:00—8:50 p.m.	0200—0350	Taipei, Taiwan	15.345, 17.72, 17.89
7:00—9:15 p.m.	0200—0415	London, England	9.51, 11.82 (via Ascension Is.)
8:00—8:30 p.m.	0300—0330	Seoul, Korea	15.335
8:00—8:45 p.m.	0300—0345	Madrid, Spain	6.065, 11.925
8:00—9:00 p.m.	0300—0400	Buenos Aires, Argentina	9.69 (Mon.-Fri.)
		Prague, Czechoslovakia	5.93, 7.345, 9.74, 11.99
8:00—10:00 p.m.	0300—0500	Peking, China	15.06, 17.735, 17.855
8:30—9:00 p.m.	0330—0400	Stockholm, Sweden	11.705
		Tirana, Albania	6.20, 7.30
8:30—9:15 p.m.	0330—0415	Berlin, E. Germany	9.65, 11.825, 11.97
8:30—11:00 p.m.	0330—0600	Havana, Cuba	11.76, 11.93
8:30 p.m.—12:30 a.m.	0330—0730	Moscow, U.S.S.R.	15.18, 17.72, 17.865
9:00—9:15 p.m.	0400—0415	Tokyo, Japan	15.105
9:00—9:30 p.m.	0400—0430	Sofia, Bulgaria	9.70
9:00—9:45 p.m.	0400—0445	Lisbon, Portugal	6.025, 11.935
9:00—9:55 p.m.	0400—0455	Montreal, Canada	6.135, 9.655
9:15—9:45 p.m.	0415—0445	Budapest, Hungary	9.833, 11.91, 15.155
9:30—10:00 p.m.	0430—0500	Berne, Switzerland	5.98, 9.725, 11.715
		Bucharest, Romania	5.99, 9.57, 11.94
9:35—10:55 p.m.	0435—0555	Cologne, W. Germany	6.085, 9.605 (via Canada)
10:00—10:55 p.m.	0500—0555	Montreal, Canada	6.135, 9.655
10:00—11:20 p.m.	0500—0620	Hilversum, Holland	9.715, 11.73 (via Bonaire)
11:00—11:15 p.m.	0600—0615	Tokyo, Japan	15.105
11:00 p.m.—12 mdt.	0600—0700	Buenos Aires, Argentina	9.69 (Mon.-Fri.)
11:30 p.m. 1:00 a.m.	0630—0800	Havana, Cuba	9.525

HOW RADIO-CONTROL SYSTEMS WORK

TYPES OF
REMOTE R/C
SYSTEMS USED TO
OPERATE MODEL PLANES,
CARS, AND BOATS

BY FRED MARKS

A GROWING number of hobbyists has been attracted to radio-control modeling due to new solid-state designs and exam-free CB licensing. The electronic gear in today's modeling provides wide response flexibility and high reliability in extremely compact, lightweight packages. (See also "Radio Control For Hobbyists," February 1974.)

There are two commonly used basic schemes in R/C equipment. The simplest is a refined version of single-channel, pulse-proportional control. The other, a digital system, is a sophisticated feedback proportional control that utilizes pulse-position modulation.

Pulse-Proportional Systems. The only tone-modulated, pulse-proportional system we know of on the market today is made by Ace R/C. Its major advantages are minimal weight and low cost. It is used primarily in situations where multi-channel flexibility is not required.

In the Ace R/C system, a 600-Hz tone is pulsed on and off at the transmitter to drive an actuator in the receiver. The receiver demodulates the received pulsed tone and produces a square-wave output that reproduces the pulses originally sent to the transmitter's tone modulator.

The switching outputs of the receiver

connect one end of the actuator or the other (depending on the command initiated at the transmitter) to the positive voltage supply. This type of system is limited to one proportional function. The repetition rate is from 6 to 8 pulses per second. The model under control does not respond to individual pulses. Instead, it follows the average position.

Digital-Proportional Systems. Digital systems all use the same pulse-position modulation scheme, with the r-f envelope amplitude-modulated by a series of pulses at a specific interval (frame length) of from 10 to 15 milliseconds. Each pulse is separated from the others by a nominal 1.5 milliseconds. This separation is independently and continuously variable by ± 0.5 millisecond (maximum) for control. The decoded output to a digital feedback servo is a pulse that duplicates the original control input to an accuracy of 99.75 percent.

The block diagram of a typical digital-proportional transmit/receive system is shown in Fig. 1. The wavetrain illustrated is for a five-channel system.

The objective of digital encoding and decoding is to obtain a specific width-control pulse for each servo in the system. The length of the pulse must be variable over the desired control range. Timing and syn-

Fig. 1. Block diagram of contemporary five-channel digital-proportional transmit and receive system is complete as shown except for servos. The decoder system, shown on facing page, uses typical IC's.

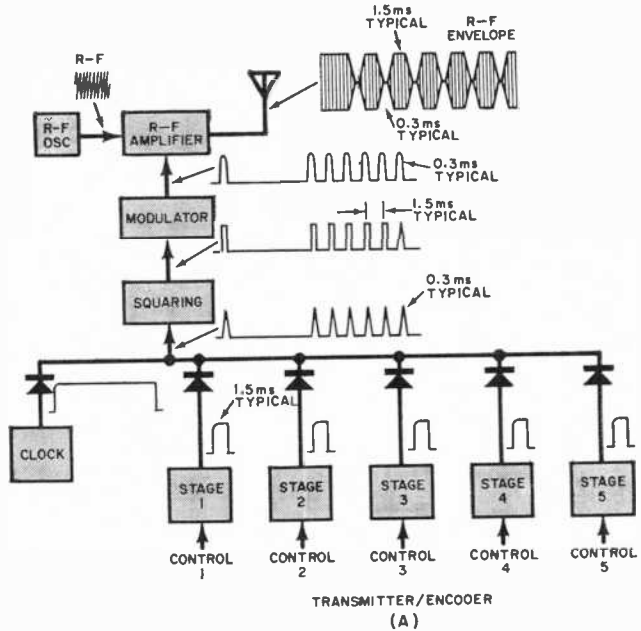

chronization of the scheme is shown in Fig. 2. The times indicated are approximate and are representative of those used in current systems.

A typical encode/decode process takes place as follows. The clock oscillator in Fig. 1A establishes the repetition rate of the system, which is usually 10 to 16 milliseconds or 60 to 100 Hz. The trailing edge of the frame pulse triggers the first stage. Upon being triggered, the first stage changes state for a period of time determined by the control potentiometer.

The output of each stage is gated by a diode to an RC differentiator, and a small spike at the input to the squaring block occurs at the trailing edge of the stage's output pulse. This spike is also coupled to the next stage for triggering. Stage two stays on for its commanded period (t_2 in Fig. 2). Stages three through five follow in like manner. Then 3 to 8 milliseconds are permitted to elapse to allow the decoder to reset. The clock, having completed its 15-millisecond period, changes state to re-start the cycle.

The gated output spikes appear at the input to the squaring amplifier in the first frame of pulses. The squaring stage converts each spike to a well-defined pulse with a 0.3-millisecond nominal width for control of the modulator.

The position of each pulse relative to the preceding pulse is the transmitted information—hence, pulse-position modulation. The rise and fall times of the pulsed r-f envelope must be carefully controlled to obtain an acceptable sideband spectrum.

The receiver attempts to reproduce the encoded envelope with the best possible fidelity for presentation to the decoder.

Digital-Decoder. The decoder, shown in block diagram form in Fig. 1B and schematically in Fig. 3, is typical of modern IC decoders. The output of the receiver is a train of two (for one channel) to nine (for eight channels) pulses per frame. The inverters switch between a 4.8-volt high level to almost zero for the low level. Transistor Q1 serves primarily as an inverter for the incoming signal, although it also provides a slight amount of amplification.

The pulse train that comes off the collector of Q1 proceeds to two stages. The stage consisting of inverters 4 and 5 generates the "set" pulse, while the one made up of inverters 2 and 3 shapes the pulse train to form the clock or "shift" pulses.

The shift-pulse shaper accepts the pulse train, squares it, and slightly stretches it by feedback through C3. The low output from inverter 2 is shifted high by inverter 6 to provide the proper output. The shaped

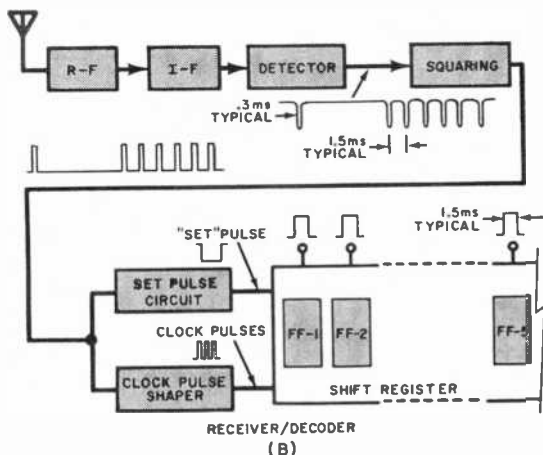

clock pulses are then passed to an eight-bit shift register.

Upon receipt of the sync pulse, the diode and *C4* act as a "sample-and-hold" circuit or pulse stretcher. Discharging through inverter 4, *C4* places the inverter in a high state. At this point, the pulse is stretched across the entire pulse train. The output from inverter 5 is square and low during the period when the pulse train is present.

The shift register is set by having the output of the inverter high at the instant the first clock pulse is received. The set is immediately driven low until after the last pulse is received. Flip-flop *FF1* in the register is inhibited from shifting to high at its Q output until the next frame of information is received. (see Fig. 1B).

The two control functions are entered at the set (S) input of *FF1* and at the clock inputs. When there is no information present during the sync (set) pause period, the *FF1* through *FF8* Q outputs are low. As soon as the first clock pulse is received, *FF1*'s Q output goes high. Unless it "sees" a high input at SA and SB, which it does at the instant the first clock pulse is received, *FF1* (at its Q output) cannot shift. It remains high until the second clock pulse is received, at which time it goes low.

If the S input of *FF1* were to remain high at all times, *FF1* would simply shift high

alternately at its Q and not-Q outputs every time a clock pulse is received. Now, *FF1* cannot shift again as long as the output of inverter 5 is low. This is why the pause between frames is called the sync or "set" pause.

Bear in mind that the Q output of *FF2* cannot shift high until the S input is high. It sees a high level only when the Q output of *FF1* is high. As soon as *FF1*'s Q output is driven high, *FF2* is set to shift high at its Q output when the second pulse, which

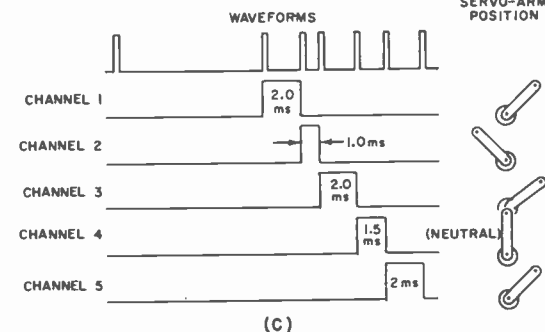
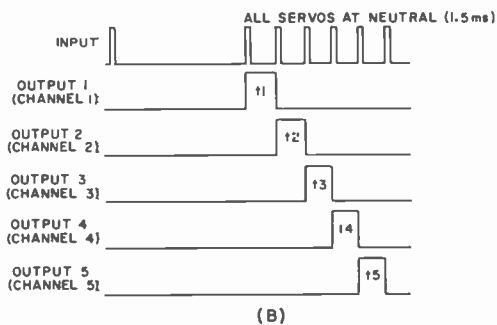
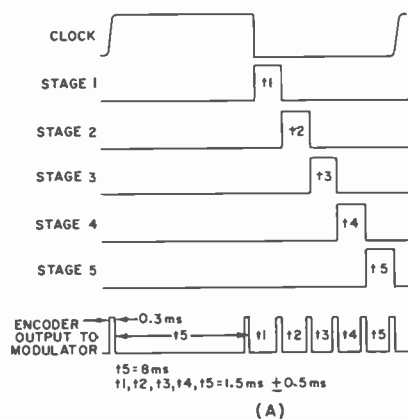

Fig. 2. Waveforms show timing and synchronization of digital signals. Those at (A) are for one frame of encoder; (B) is for decoder; and (C) shows control variations.

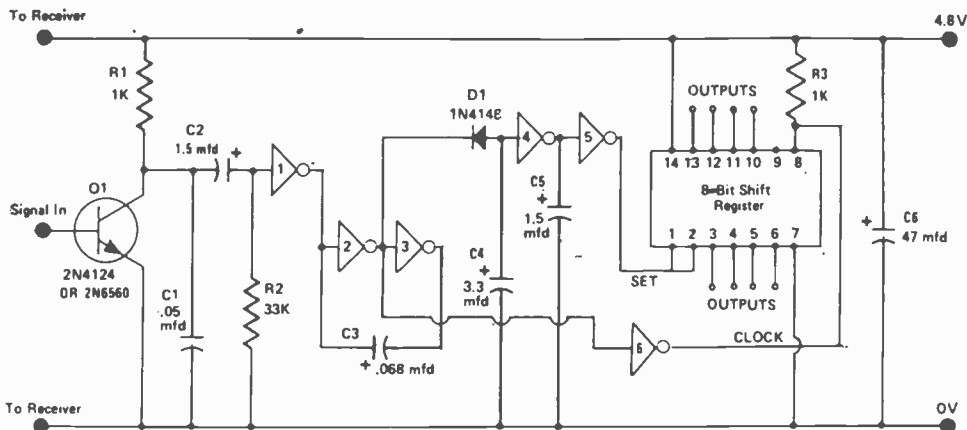

Fig. 3. Schematic diagram of the decoder shows how the 8-bit shift register in IC is used to simplify the circuit. Transistor Q1 is inverter and amplifier for input.

sets the Q output of FF1 to low, is received. The Q output of FF2 remains high until the third pulse is received to drive it low and the Q output of FF3 high, and so on down the line through FF5. As soon as C5 and C6 have discharged after the last pulse, the output of inverter 5 returns to high, setting FF1 for the next frame.

The Servo. Figure 4 is a block diagram of a digital feedback servo. Almost all servo amplifiers now consist of a specially designed IC that contains all the control functions shown in the diagram. The only external components needed are used for dead-band, travel, and feedback sensitivity trimming. The servo functions as follows.

First, a reference pulse is generated, its width determined by the feedback element as positioned by the servo output arm. The incoming signal may be wider or narrower than the reference pulse. The comparator,

usually a diode-resistor network, determines the relative width of the pulses (see Fig. 5).

The pulse stretcher and trigger convert the error pulse, measured in microseconds, to a longer pulse suitable for turning on the servo driver. The driver then applies B+ power to the servo motor, providing full power at any position.

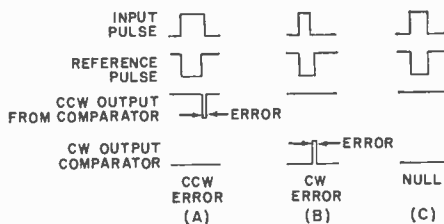

Fig. 5. Diode-resistor comparator determines relative width of pulses in digital servo.

As the motor and servo arm are driven, the feedback element is repositioning to yield a pulse that is exactly equal in width to the input pulse. The repositioning can take several frames to occur because full servo travel requires 0.5 to 1.0 second, depending on such factors as gearing and battery voltage.

Summing Up. Radio control for modeling has come a long way since the 1950's. With today's equipment, containing the sophisticated electronics described here, the modeler has at his command a control system that responds in a manner very similar to the systems used in full-size aircraft, racing and standard cars, and boats. ♦

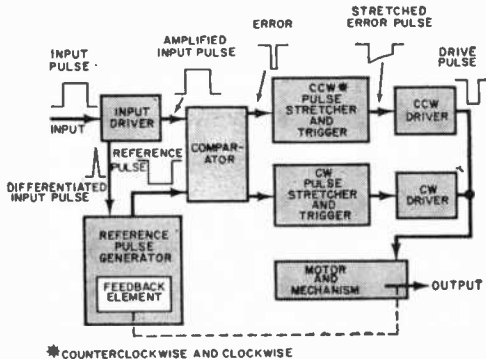

Fig. 4. Most of the functions in digital servo are included in a single IC device.

Micropower Audible Continuity Tester

SEMICONDUCTOR JUNCTION TESTER USES 55- μ A TO SOUND ALARM

BY WILLIAM D. KRAENGEL, JR.

THESE are many low-power ohmmeters whose test voltages are such that they will not cause semiconductor junctions to break down and give erroneous readings. (They are also low enough that they will not destroy a semiconductor junction.) These instruments are very useful when measuring resistance in a semiconductor circuit; but, as is true of all meter-type instruments, they require the user to look at the meter in order to determine the results. In continuity checking this can be a decided disadvantage.

For several reasons it is desirable that a continuity tester be small, portable and audible. Not all continuity checking is done on the workbench. Quite often, it is necessary to hold the probes in place while standing on a ladder, working in the dark (at least where the points to be checked can't be seen), or squeezing into a small space.

To avoid some of these problems, the micropower audible continuity tester described here can be a real boon to the technician and experimenter. The tester applies 0.3 volt at about 55 μ A to the circuit under test. It can be used without regard to polarity on circuits containing diodes, transistors or IC's since the tester interprets their presence as an open circuit. It will, however, indicate continuity through any resistance of less than approximately 1500 ohms. The tester can be carried in a pocket, with just the two test leads carried in the hands.

About the Circuit. The circuit is shown in Fig. 1. In operation, Q1 is biased just below conduction by voltage divider R2 and R3. Potentiometer R1 controls the test voltage and hence the sensitivity of the tester. Normally, a test voltage of about 0.3 volt is available between J1 and J2. When there is 1500 ohms or less between J1 and J2, the small additional voltage from R1 biases Q2 into conduction causing the audible alarm to sound. Potentiometer R1 can be adjusted to maintain a fixed test voltage as the battery ages.

Construction. The circuit can be assembled on a small piece of perf board, with the entire unit, including the battery, housed in a small plastic case. Mount the alarm, the switch, and the two connectors on the front cover. Power can be obtained from either a conventional 9-volt transistor radio battery or six AA cells in series.

A Note of Caution. One might be tempted to make the tester even more sensitive than it is but there is a practical limit to the maximum sensitivity that can be used. There is a definite leakage that is inherent to all semiconductor devices. Power semiconductors can have a leakage much greater than that normally associated with signal semiconductors. If the sensitivity of the continuity tester is made too great, it will interpret this leakage as continuity and give a false indication. ♦

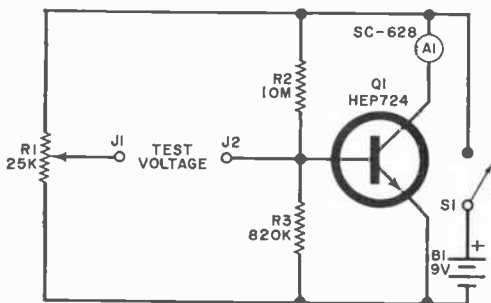

PARTS LIST

- A1—SC-628 Mallory Sonalert (or similar)
- B1—9-volt battery or six AA cells
- J1, J2—Banana jack
- Q1—Transistor (HEP724 or similar)
- R1—25,000-ohm trimmer potentiometer
- R2—10-megohm, 1/4-watt resistor
- R3—820,000-ohm, 1/4-watt resistor
- S1—Spst switch
- Misc.—Battery clips, suitable plastic case, test leads, etc.

Fig. 1. Transistor is biased just below operational point. When resistance between J1 and J2 is less than 1500 ohms, Q1 turns on and alarm goes off.

BUILD A

HALL • EFFECT MAGNETOMETER

*Probe magnetic fields with this
home-built instrument*

BY L. GEORGE LAWRENCE

IN 1879, E.H. Hall published a paper in which he described how a magnetic field, when passing through a current flowing in a thin piece of metal, produced a voltage between the edges of the metal. The same effect was also observed to greater degree in semiconductor materials such as germanium, silicon, and various indium compounds.

Hall-effect devices can sense magnetic forces without making physical contact. Such devices made from semiconductors are used to measure magnetic forces in almost every phase of applied electronics and power generation, including such diverse applications as the manufacture of razor blades, satellites, and large tractor tires.

In this article, we will tell how to construct a versatile Hall-effect magnetometer. It will not only demonstrate the principles of the Hall-effect operation, but will also make an educational Science Fair project. A commonly available IC, a transistor and conventional components are used in the project.

How a Magnetometer Works. The Hall generator can be a very thin strip of conductor through which a current is passed from *A* to *B* as shown in Fig. 1. If a galvanometer is connected to directly opposite points at the sides of the strip (*a* and *b*),

the potential between the points will be the same, and the galvanometer will not register a deflection. However, Hall discovered that if a very strong magnetic field (+*B*) is then applied at right angles to the strip's plane, the state of electrical balance is disturbed. The meter then indicates a potential difference between points *a* and *b*.

By holding control current I_c constant, Hall voltage V_H depends directly on +*B* (the magnetic flux density). If both I_c and +*B* are variable, the output (V_H) is proportional to the product of the two terms. Also, with the magnetic flux and control current held constant, V_H becomes a function of the angle between +*B* and the Hall generator's active area.

Today, Hall-effect devices are widely used in measuring current, usually by magnetic-field induction. Since the magnitude of a magnetic field at a given point is proportional to the current creating the field, the Hall voltage is proportional to the current level. Amplification is needed to make the small Hall voltage readable on a meter.

In Fig. 2 are shown various types of Hall-effect sensor applications. The simplest configuration (Fig. 2A) involves nothing more than a Hall generator mounted near a current-carrying conductor. This application works exceptionally well where very high direct currents—such as those re-

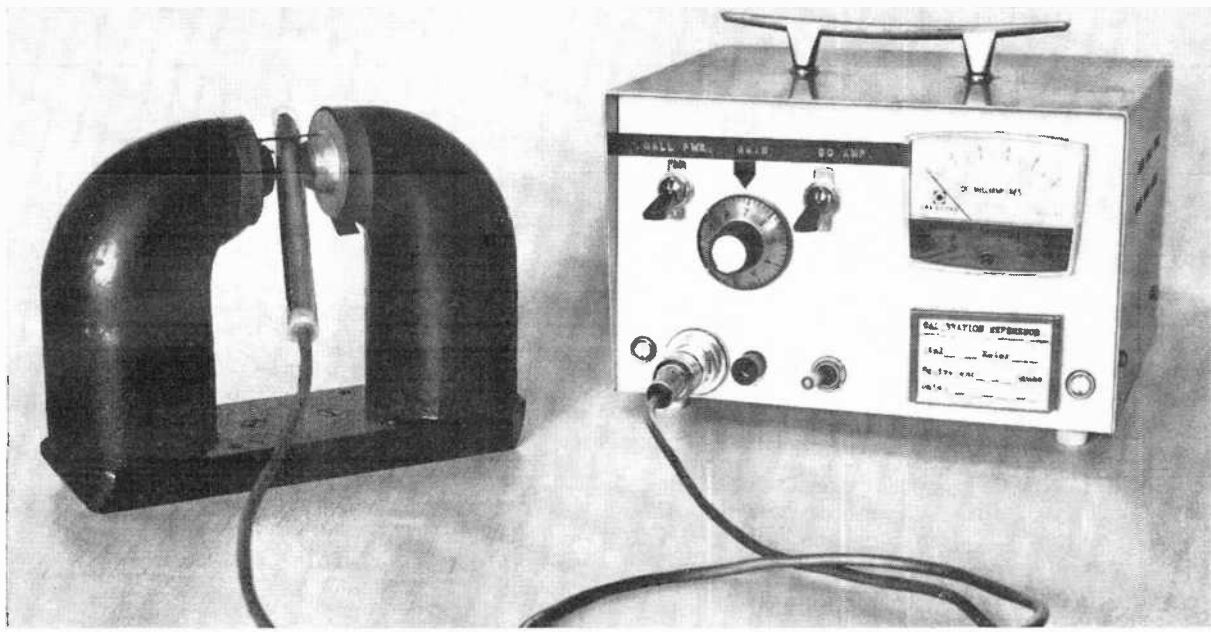

quired by automobile starters—must be measured without making contact. The magnetometer of which the Hall generator is a part is calibrated against a high-current source of known value.

Hall generators with flux-ring concentrators (Fig. 2B) provide increased sensitivity. The smaller the width of the gap in the concentrator (such as in an Arnold Engineering "Silectron" core), the higher the system's sensitivity.

Another flux-field concentrator arrangement is shown in Fig. 2C. Here a $\frac{1}{8}$ -in. diameter rod of ferrite or high-permeability steel, such as molypermalloy, makes a good concentrator. About 500 ampere-turns of field strength is the bottom measurable limit with this arrangement.

In Fig. 3 is shown another concentrator. Note how concentrator length L improves the magnetic sensitivity of the Hall generator (such as the F.V. Bell Type BH-702).

Fig. 1. Hall generator is a thin strip of conductor with a current flowing through it. With a magnetic field applied at right angles to the current, a potential difference occurs.

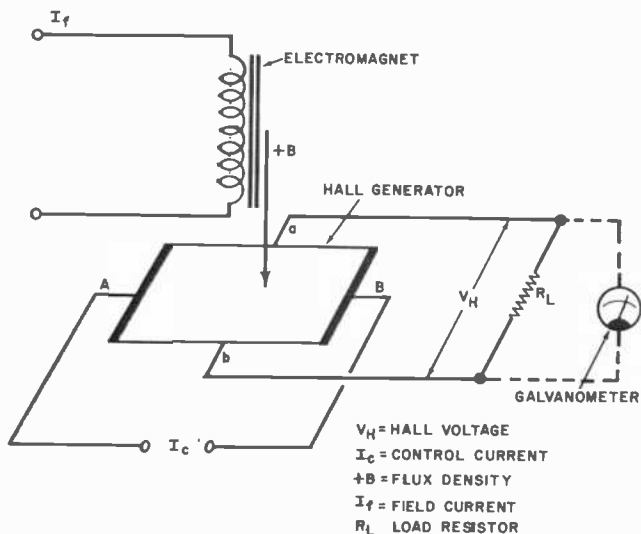

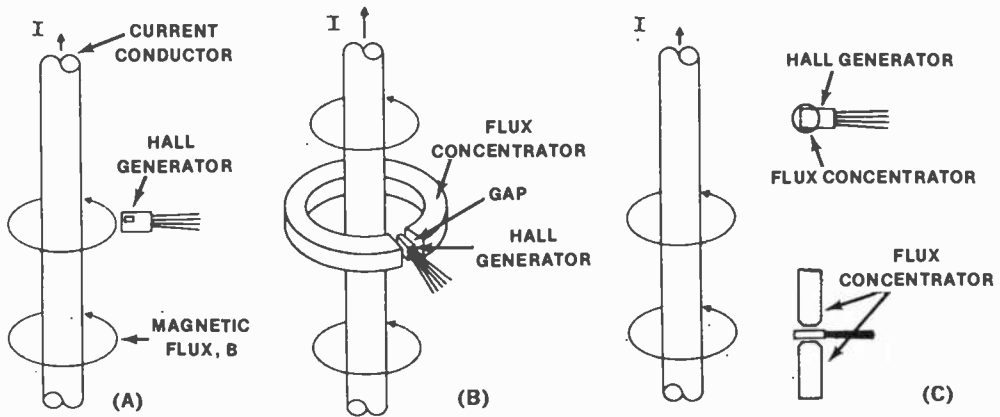

Fig. 2. A simple current sensor is shown at (A). In (B), the Hall generator has a flux concentrator ring. A Moly permalloy strip concentrator is shown in (C).

Molypermalloy strip concentrators measuring 0.014 in. by 0.25 in. are simply bonded to the Hall generator's main body and suitably secured in epoxy to avoid mechanical damage to the Hall device due to accidental bending.

A Home-Built Magnetometer. The magnetometer shown schematically in Fig. 4 can be built in a home workshop. Its highly flexible design can accommodate different types of Hall generators and their excitation currents. It has special provisions for use with the 741 IC amplifier, and the meter is easily calibrated.

The Hall generator specified is a Bell Type BH-702 that requires a control current of 200 mA so that, when suspended in a 100-gauss magnetic field, the open-circuit Hall voltage is about 10 mV. The generator has an operating temperature range of -40°C to $+100^{\circ}\text{C}$ (boiling point of water), which is typical of many similar Hall-effect devices.

The generator's control current is regulated by $Q1$, whose operating bias is set by $B1$ and $R8$. A simple adjustment of $R8$ will permit the system to accommodate other Hall generators that require different control currents. (You simply connect a dc ammeter in the collector circuit of $Q1$ and adjust $R8$ to set the required current.)

The Hall generator's output is fed into a high-gain operational amplifier ($IC1$) whose gain is set by $R3$. Null adjustment $R5$ is vital for zeroing the amplifier under quiescent conditions (Hall generator energized but without a magnetic field applied). Calibration control $R7$ permits proper full-scale settings of the meter.

Construction. The electronic components can be easily mounted on perforated phenolic board as shown in Fig. 5. The four batteries should be held in place with pipe clamps and holders for 1.5-volt D-size cells.

The three switches, meter, connector, and potentiometer $R3$ mount on the front panel of the chassis case. Use a 0-to-10 dial scale for $R3$, and make up a "Calibration Reference" card. Affix the latter to the case's front panel.

Constructing the main unit is not critical. However, special consideration must be

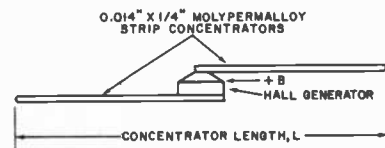
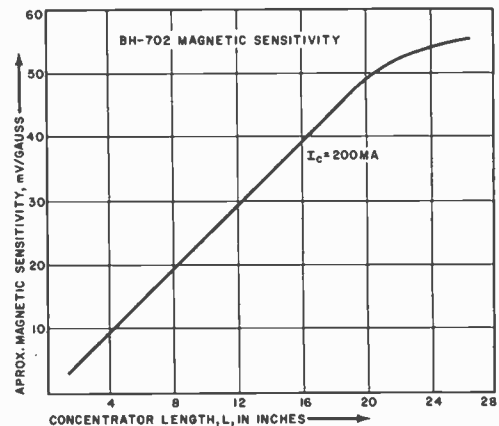

Fig. 3. Graph at top shows how length of concentrators improves magnetic sensitivity.

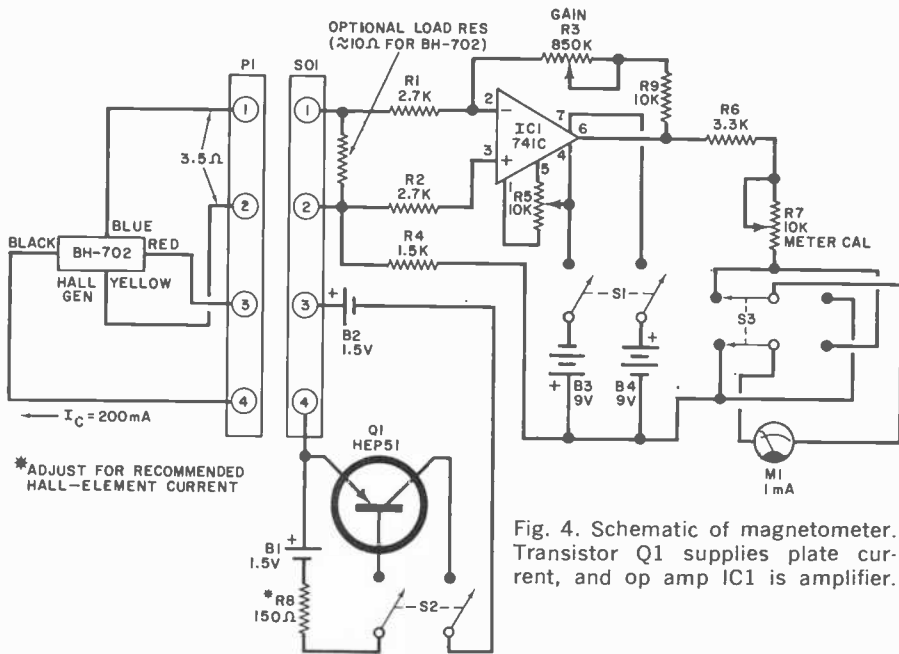

Fig. 4. Schematic of magnetometer. Transistor Q1 supplies plate current, and op amp IC1 is amplifier.

PARTS LIST

B1,B2—1.5-volt D cell
 B3,B4—9-volt battery
 Hall Generator—BH-702 (F. W. Bell)*
 IC1—741C op amp
 M1—1-mA meter (Calectro D1-912 or similar)
 P1—4-pin plug with attached color-coded leads (see text)
 Q1—HEP-51 transistor
 R1,R2—2700-ohm, ½-watt resistor
 R3—850,000-ohm linear potentiometer
 R4—1500-ohm, 1-watt resistor
 R5,R7—10,000-ohm linear potentiometer
 R6—3300-ohm, ½-watt resistor
 R8—150-ohm, 1-watt resistor (adjusted for recommended Hall-element current)

R9—10,000-ohm, ½-watt resistor
 S1,S2—Dpst switch
 S3—Dpdt switch
 SO1—4-pin socket to match P1
 Misc.—D-cell holder (2), pipe clamps (2) for 9-volt battery, battery connectors (2), suitable chassis, calibrated dial for R3, probe holder, cement, wire, mounting hardware, etc.
 *Hall generators of different sensitivity ranges and prices are available from (among others) F. W. Bell, Inc., 4949 Freeway Drive East, Columbus, Ohio 43229; and Ohio Semitronics, Inc., 1205 Chesapeake Ave., Columbus, Ohio, 43212.

taken when assembling the probe for the Hall generator (see Fig. 6). First, remember that Hall generators are very fragile and cannot be handled like most miniature electronic components. Their aluminum-oxide substrates are brittle. So, use *only the leads* to move and locate the generator. Avoid putting tension on the leads and bending them close to the substrate. Bends must be at least ¼ in. away from the substrate.

The Hall generator can be housed in a small plastic tube containing a paper filler to provide mechanical support. The Hall plate, being small, can be bonded to a glass or non-magnetic mount with epoxy cement to form a fillet and protect the

leads from breakage. Position the Hall plate inside the tube so that the "active" (+B) side faces the tube's wall. Mark this position with red paint or some other means of identification; it is the Hall generator's most sensitive area. Typically, the ceramic substrate—onto which the actual Hall plate is bonded—will face away from the probe's wall. Watch for special markings, since different manufacturers use different indicators.

Final assembly of the probe involves cutting the generator's four leads to a suitable length and connecting them to the magnetometer's 4-conductor, color-coded feeder cable. In the prototype, a 4-contact Amphenol No. 91-MC4M-385 plug and No.

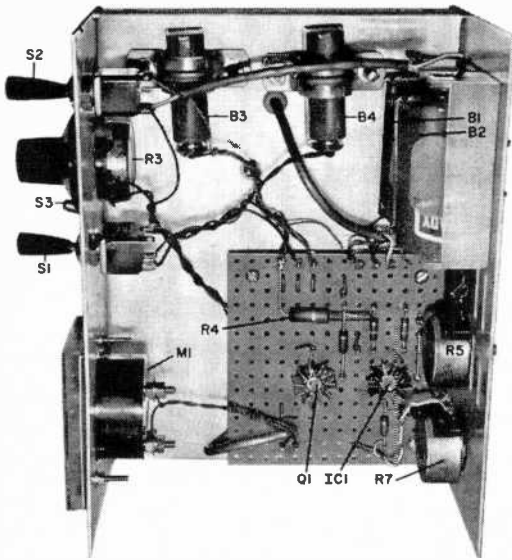

Fig. 5. Photo shows interior of prototype.

91-PC4F-385 receptacle were used to make the connection. A 5- or 4-ft-long cable will suffice for most applications. Be sure to insulate the solder connections.

Calibration. Prior to calibrating the magnetometer, remember that most Hall generators are high-current devices that heat up very rapidly unless some form of heat sinking is provided. Therefore, activate the probe for only a few seconds at a time, turning it off immediately after measurements are completed.

Precise calibration depends on whether the Hall generator is of the high- or low-sensitivity type. Calibrations can be made by using either magnets of known field strength or a conductor through which a known magnitude of current is passed.

With the Hall probe connected to the

input, start the nulling procedure by turning on S1 and S2. Set R3 for maximum gain. If the meter's pointer deflects with no external field present, adjust the setting of R5 until the pointer drops to zero.

To calibrate the magnetometer in given values of direct current, use a high-current battery charger or a fully charged battery as the current source. Connect the current source, with a rheostat, switch, and ammeter, in series with a length of cable. With the magnetometer activated, hold the Hall probe adjacent to the energized cable and set the R3 gain control for a given indication on the meter (say a scalar value of 0.5 for a current of 10 amperes). Touch up calibration control R7 to assure pointer deflection above and below that range.

The value on the dial of R3, together with the meter indication, provide your calibration reference. Enter this on the card on the front of the magnetometer. Calibration with reference magnets is accomplished in a similar manner, but the meter indications are referred to magnetic field strength (gauss) instead of current.

Applications for the Hall-effect magnetometer are limited only by your imagination. It is very useful, for example, in servicing automotive or marine electrical systems. The electrical system of the vehicle can be "mapped" (while energized); and then when trouble occurs, you can use the map to locate areas where abnormal conditions indicate the trouble.

Excellent frequency response and high speed make Hall-effect generators most valuable for physics experiments. If, for example, an oscilloscope is connected across the meter in the magnetometer, high-energy discharge of capacitors can be observed. It is also possible to duplicate Hall's original discovery by using strip conductors. ♦

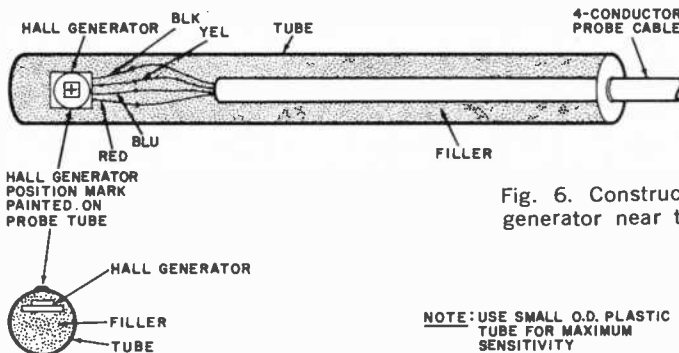
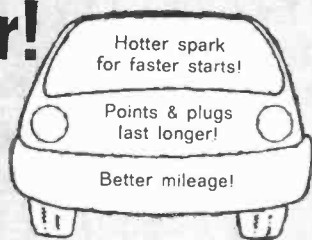

Fig. 6. Construction of probe. Position Hall generator near tube wall for best sensitivity.

Build yourself a better car! Build an Archerkit™ from Radio Shack



"After an hour or so of driving . . . we noted that the engine was acting the way it did two years and 20,000 miles ago . . . a definite improvement in performance. Acceleration, specifically, was much improved." Popular Electronics, May, '73

Radio Shack's Deluxe Capacitive Discharge Ignition puts more "Go" in every gallon! It delivers 50% more spark power for faster acceleration and more complete combustion. That means you get better gas mileage, and your points and plugs will last 3 to 10 times longer. An in/out button lets you make instant performance comparisons with your old ignition. And it makes tuneups easier. The thorough step-by-step manual makes it easy for even a first-time kit builder to assemble and install—no wires to cut. Improves any 12-volt negative ground vehicle. #28-3203.

Deluxe, High-Intensity Timing Light Kit



Tune-up aid for any engine. For full power & economy. Bright flash is visible even in daylight! #28-4016.

1995 With All Cables

Retail prices may vary at individual stores.



FREE '74 CATALOG 397
AT YOUR NEARBY STORE OR
MAIL THIS COUPON

180 Pages . . . Full Color! Hi-Fi, CB, Kits,
Recorders, Antennas, Parts, More!

PLEASE PRINT CLEARLY

Name _____ Apt. # _____

Street _____

City _____ State _____ ZIP

ArcherKit

by

Radio Shack®

A TANDY CORPORATION COMPANY
P. O. Box 1052, Fort Worth, Texas 76107

CIRCLE NO. 37 ON READER SERVICE CARD

READ WHAT THE THE NEW HEATHKIT



Major electronic magazines have reviewed the Heathkit GR-2000 Digital Color TV. The consensus is it's the most advanced design they've ever seen... far ahead of any other set

EXPERTS SAY ABOUT DIGITAL COLOR TV

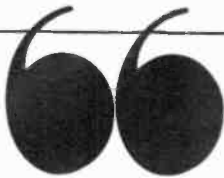

The editors of **RADIO-TV REPAIR** said, "with manufacturers only now beginning to get the color excellence Heath has featured for years, it was time for Heathkit to once again move ahead of the industry, and move they did..." According to **RADIO-ELECTRONICS**, the Heathkit GR-2000 Digital Color TV "uses so much digital design and so many integrated circuits... it sets new standards for state-of-the-art in color TV".

The **RADIO-ELECTRONICS** editors said the Heathkit Digital TV has "features that are not to be found in any other production color TV being sold in the U.S.:

"On-screen electronic digital channel readout... numbers appear each time you switch channels or touch the RECALL button... On-screen electronic digital clock... an optional low cost feature... will display in 12- or 24-hour format... Silent all-electronic tuning. It's done with uhf and vhf varactor diode tuners... Touch-to-tune, reprogrammable, digital channel selection... up to 16 channels, uhf or vhf... in whatever order you wish... there's no need to ever tune to an unused channel. LC IF amplifier with fixed ten-section LC IF bandpass filter in the IF strip... eliminates the need for critically adjusted traps for eliminating adjacent-channel and in-channel carrier beats. No IF alignment is needed ever. Touch volume control... when the remote control is used... touch switches raise or lower the volume in small steps."

POPULAR ELECTRONICS took a look at the 25-in. (diagonal) picture and said it "can only be described as superb. The Black (Negative) Maxtrix CRT, the tuner and IF strip, and the video amplifier provide a picture equal to that of many studio monitors..."

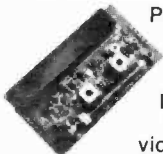
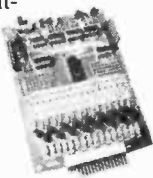
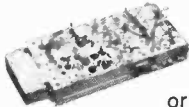

Furthermore, the Heathkit GR-2000 is an easier kit-form TV to build. **POPULAR ELECTRONICS** pointed out that "Each semiconductor has its own socket and there are 12 factory-fabricated interconnecting cables... The complete color adjustments can be performed in less than an hour."

And here's what **RADIO-TV REPAIR** said about service: "...virtually every function of the TV receiver has been broken down to a miniature plug-in circuit assembly... if trouble develops you simply pop out the correct board and check it yourself... Heath provides free technical consultation, and if you do need factory service, as we said, the costs are low, well below that for (conventional color TV) insurance protection."

To sum up, **POPULAR ELECTRONICS** concluded its study by stating, "In our view, the color TV of the future is here — and Heath's GR-2000 is it!"

Why not see what the experts have seen? The Heathkit Digital Color TV — without question the most remarkable TV available today.

Mail order price for chassis and tube, \$649.95. Remote Control, \$79.95 mail order. Clock, \$29.95 mail order. Cabinets start at \$139.95.

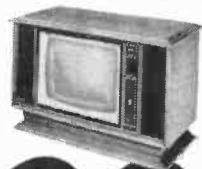

Send for your **FREE '74 Heathkit Catalog** describing the amazing new Heathkit Digital Color TV in detail. If post paid card has been removed, write: Heath Company, Dept. 10-5, Benton Harbor, Mich. 49022.



HEATHKIT ELECTRONIC CENTERS Units of Schlumberger Products Corporation
Retail prices slightly higher
ARIZ.: Phoenix; CALIF.: Anaheim, El Cerrito, Los Angeles, Pomona, Redwood City, San Diego (La Mesa), Woodland Hills; COLO.: Denver; CONN.: Hartford (Avon); FLA.: Miami (Hialeah), Tampa; GA.: Atlanta, ATL.; CHICAGO: Downers Grove, IND.: Indianapolis; KANSAS: Kansas City (Mission), KY.: Louisville; LA.: New Orleans (Kenner); MD.: Baltimore, Rockville; MASS.: Boston (Wellesley); MICH.: Detroit; MINN.: Minneapolis (Hopkins); MO.: St. Louis; NEB.: Omaha; N.J.: Fair Lawn; N.Y.: Buffalo (Amherst), New York City, Jericho, L.I., Rochester, White Plains, OHIO: Cincinnati (Woodlawn), Cleveland, Columbus; PA.: Philadelphia, Pittsburgh, R.I.: Providence (Warwick); TEXAS: Dallas, Houston; WASH.: Seattle; WIS.: Milwaukee.

CL-512

CIRCLE NO. 5 ON READER SERVICE CARD

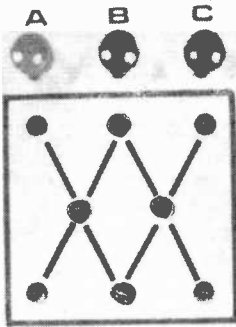

ON RES

FLIP

BUILD

FLIP

A CMOS GAME COMPUTER



Do you dare challenge a handful of CMOS chips to a game of logic?

BY JOSEPH A. WEISBECKER

HERE IS a fascinating new electronic game based on digital logic. Called "Flip," it will introduce you to some basic computer concepts, pose a number of interesting mathematical questions, and provide a set of challenging puzzles. The puzzles are easily solved, however, when the proper logic sequence is understood.* Using low-cost CMOS logic and LED readouts, construction of Flip is simplified.

Circuit Operation. There are 8 flip-flops (A through H) connected as shown in Fig. 1. Eight LED indicators on the front panel show the state of each flip-flop (Fig. 2). A trigger pulse applied to a flip-flop reverses its state. Momentary-contact switches S1, S2, and S3 provide trigger pulses for flip-flops A, B, and C. For example, pressing switch S1 will trigger flip-flop A so that, if LED1 was on, it will go off, and vice versa. The transition from off to on also supplies a pulse to trigger flip-flop D. The reversal of D then supplies a trigger pulse to F or G.

The circuits in Fig. 1 actually form a number of 2- and 3-bit interacting counters. For example, flip-flops C, E, and G form a 3-bit binary counter that is triggered each time S3 is pressed. Figure 3 shows how this counter works. Pressing the reset switch, S4, sets the C, E, and G lights as shown in the top row. Now, repeated pressing of S3 causes the lights to go on and off in the 3-bit binary sequence shown in Fig. 3. The combinations of flip-flops BEH, BDF, ADF, etc. also form 3-bit binary counters.

The circuit in Fig. 1 also contains 8 "memory" cells which remember an 8-bit pattern. This pattern (or state) can be

modified by the input switches and is displayed by the LED's. A wired-in "program" controls the change-in-state of the device as a function of the previous state and an input switch. Pressing a single input switch 8 times always returns the device to its initial state, thereby demonstrating its ability to count input switch depressions.

In Fig. 1, IC5 and IC6 are quad 2-input NAND gates connected to form three set/reset flip-flops for debounce of the switches. Eight D-type flip-flops are provided by IC1 through IC4, which are triggered by a positive-going edge. Flip-flops A, B, and C are triggered directly by the three debounce flip-flops. Flip-flops D, E, F, G, and H are each triggered by transitions of other flip-flops. The capacitance-resistance combinations differentiate the outputs of these flip-flops to form positive pulses. For example, C1-R1 and C7-R7 differentiate the positive-going not-Q outputs of A and D to feed an OR gate formed by D1 and D7 and trigger flip-flop F. Trigger pulses for D, E, G, and H are derived in a similar manner.

Integrated circuits IC7 and IC8 are hex-inverting buffers used to drive the displays. Resistors R22 through R29 were chosen to limit the LED current to about 7 mA. Any LED that provides reasonable brightness for this current can be substituted—possibly reducing the cost. Resistors R22-R29 can also be reduced in value to increase the brightness of the LED's; but this loads

*Flip is an electronic version of a plastic computer game called "Think-A-Dot" made by Edu-Cards Corp. An article entitled "Mathematical Theory of Think-A-Dot" in the Sept.-Oct. 1967, issue of Mathematics Magazine provided a detailed analysis of the game. The original Think-A-Dot instruction book also provided an extensive discussion of the device, with methods for demonstrating counting, adding, and subtracting of 8-bit binary numbers.

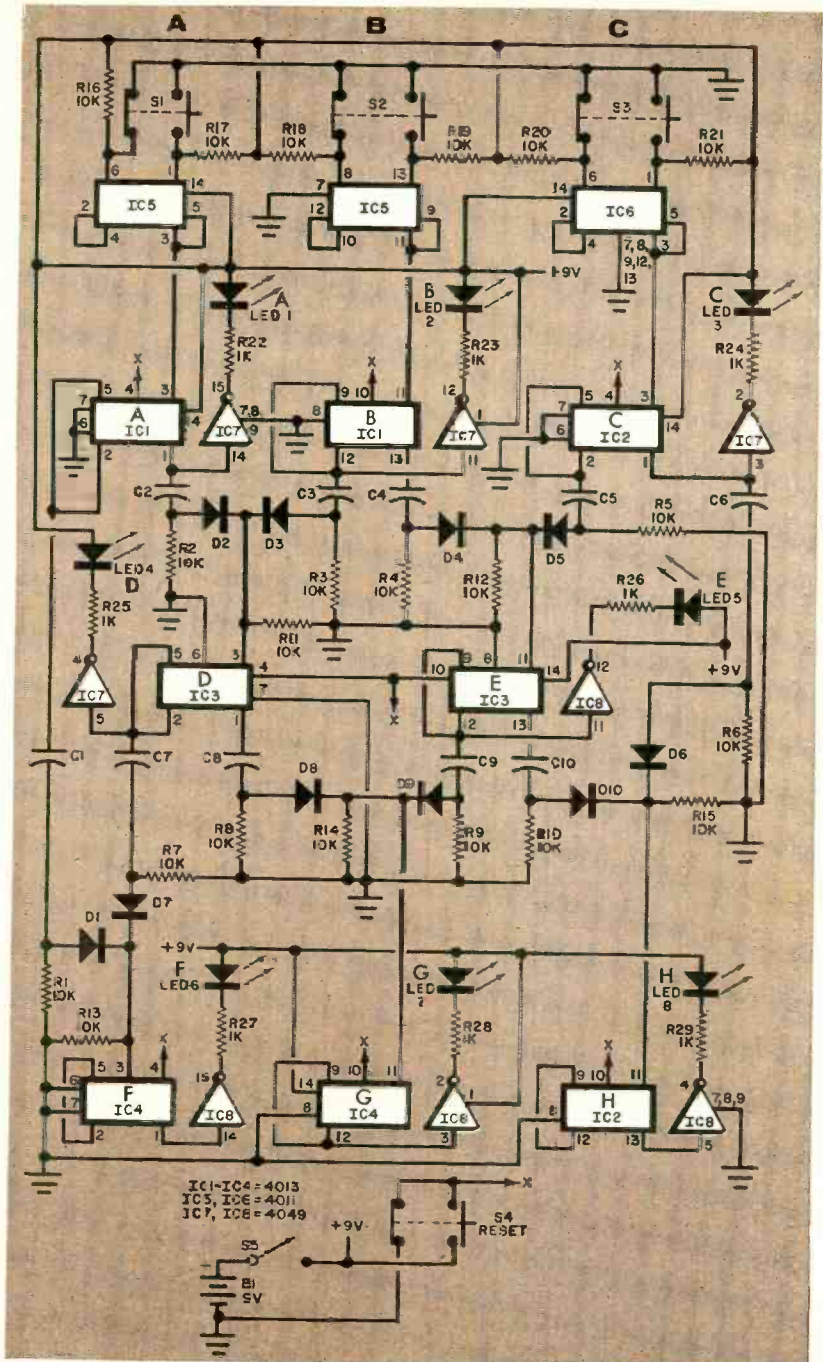

Fig. 1

PARTS LIST

- B1—9-volt alkaline/mercury battery
- C1-C10—0.033- μ F disc capacitor (low voltage)
- D1-D10—Silicon diode (1N914 or similar)
- IC1-IC4—CD4013 integrated circuit
- IC5, IC6—CD4011 integrated circuit
- IC7, IC8—CD4049 integrated circuit

- LED1-LED8—Any light-emitting diode
- R1-R21—10,000-ohm, $\frac{1}{4}$ -watt resistor
- R22-R29—1000-ohm, $\frac{1}{4}$ -watt resistor
- S1-S4—Spdt switch, momentary closed (Alco MSP-105F or similar)
- S5—Spst switch
- Misc.—Battery connector, suitable cabinet, "dry-transfer" type, adhesive tape, etc.

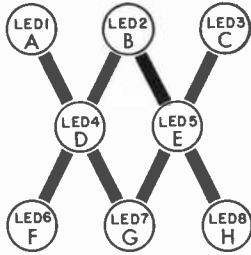

Fig. 2. Arrangement of LED's on the front panel of Flip.

IC7 and IC8 above rated values and will also decrease battery life.

Construction. The Flip circuit uses CMOS logic circuits since they require low power, have good noise immunity and can be operated with unregulated voltage between 3 and 15 V. However, in using CMOS, some precautions must be kept in mind. All unused gates must have their inputs tied to the plus or minus supply voltage to prevent potential chip burn-out. Care must also be taken in installing the devices. Avoid any possibility of static charges on the inputs. Keep them in the insulation in

which they are shipped until ready to solder and use a grounded soldering iron. Low-temperature solder and a low-power iron should be used.

Diodes D1 through D10 are not critical; low-current switching types (silicon) were used in the prototype.

The circuit can be assembled on a perf board or on a pc board as shown in Fig. 4. To avoid complexity on the pc board, some short cuts have been taken. Note that C1 through C10, D1 through D10, and R1 through R10 are attached together as shown in the insert in Fig. 4 before inserting the loose ends in the pc board. Note that the capacitor end is called out as A, the diode end as B and the resistor end as C on the overall component layout.

There are 19 jumpers that must be made of thin insulated wire and connected between similarly numbered points in Fig. 4 (point 1 to point 1, etc. up to point 16 to point 16). The last three jumpers are from point 17 on IC1, IC2 and IC3 to point X, the reset circuit.

The eight LED's and the three switches are mounted on the front panel as shown in Fig. 2 and the photo. Also mount the

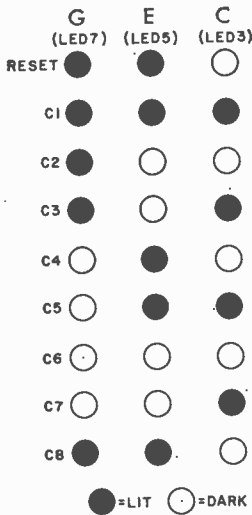
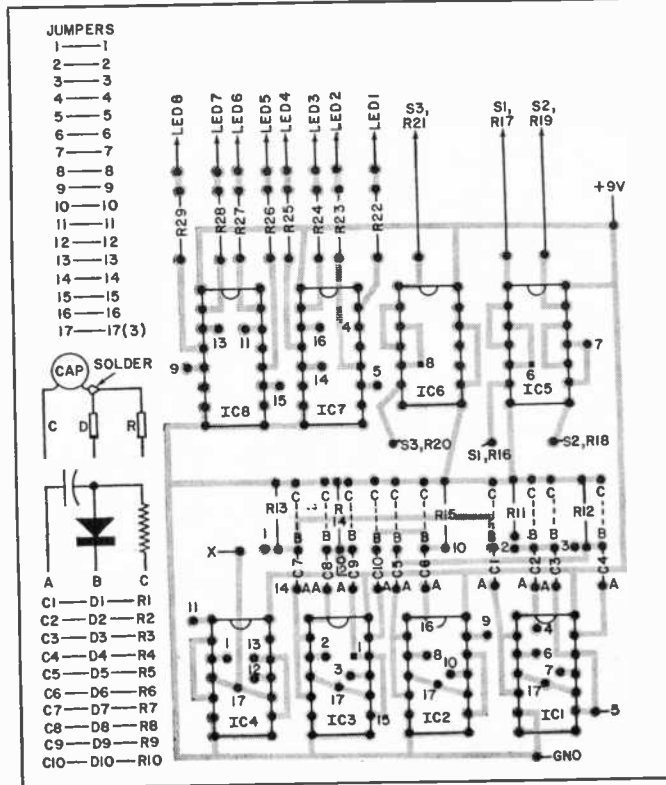

Fig. 3. It takes eight operations of a pushbutton to make the cycle. This shows which LED's come on in sequence.



reset and on/off switches on the front panel. The lines connecting the lights on the front panel can be added in any way desired.

Testing. Turning on the power switch should cause a random pattern to appear on the LED display. Pressing the reset switch should result in the P1 pattern of Fig. 5. If it doesn't, check the reset wiring and voltage connections. After obtaining the P1 pattern, press switches A, B, and C one at a time to verify that all flip-flops are being triggered properly as indicated in Fig. 3. Check signals and wiring for any that fail to operate properly. If the signals to a flip-flop are correct but it still fails to trigger, replace the chip.

Use. Figure 5 shows how Flip is used to solve puzzles. Pressing reset switch S4 provides the pattern of lights shown at P1. As a sample problem, try to get from pattern P1 to pattern P2 by pressing one or the other of the input switches just 7 times. The other patterns in Fig. 5 can be obtained with the indicated number of switch operations.

An interesting game that can be played

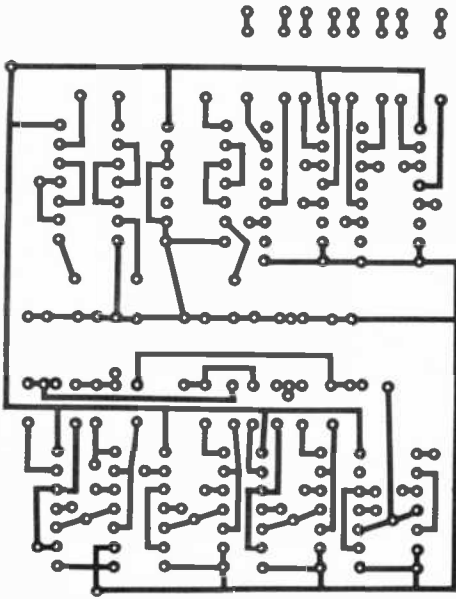

Fig. 4. Either a perf board or printed circuit board can be used for the circuit. Note how the C-D-R assembly is made. Be sure to install the jumpers.

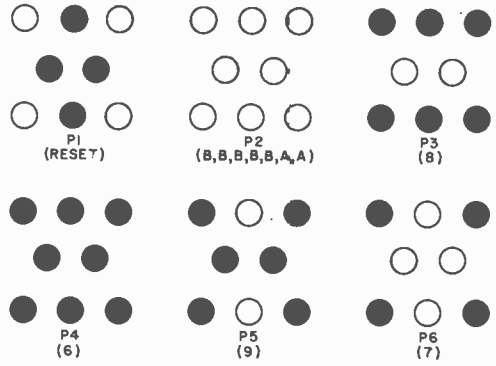

Fig. 5. Pattern after reset is P1. To get P2, press switches as shown. Other patterns take indicated number of switch operations.

is to try to generate specific patterns, with players taking turns pressing just one switch at a time. Starting with the reset switch operated to set the original pattern, the goal is to obtain a pattern consisting of a triangle of lights (either ACDEG or BDEFH). It doesn't matter if additional lights are on as long as one of the two winning triangles appears. Of course, other patterns, easier or harder, can be chosen as the winning pattern. Since it is possible to predict what pattern is going to appear next, considerable skill can be developed.

Flip provides some insight into why bugs occur in large computers after months or even years of use. These machines have thousands of possible states, many of which remain untested until someone happens to write a program that causes one of these states to occur. Flip, with only 8 flip-flops, has relatively few possible states, but it is still nontrivial in a mathematical sense. For example, how many of the potential 256 states (or patterns) can be obtained starting from the reset state? Can you develop an algorithm (set of rules) for finding the shortest sequence of switch depressions to transform one pattern to another?

Here is another interesting property of Flip. If the sum of the lights that are on in the top and bottom rows is even, then pressing A, B, and C any number of times will leave this sum even. In other words, the parity of these 6 bits (lights) can't be changed by the input switches. This concept of parity is used for error checking in computers. For example, a switch input can only change the parity of the 6 bits of the top and bottom rows if a circuit malfunction occurs. This condition could easily be detected and used to turn on an error light. ♦



Buying and Using A Pocket Calculator

By John T. Frye, W9EGV, KHD4167

"**A**RE YOU buying *another* pocket calculator?" Barney incredulously asked his employer as he discovered the latter poring over several calculator brochures spread out on the service bench.

"No, I'm just getting ready to tell other people how to buy and use one," Mac replied. "Every week more and more people ask me what kind of a calculator to buy. Knowing math is my avocation and electronics is my vocation, they figure these two interests should come together and make me a real authority on the subject of electronic pocket calculators—which, of course, is not true. But I have been fascinated by these devices ever since Sharp put one of the first ones on the market; and I never miss a chance to play with a new one. I decided that before I started dishing out advice on what to buy, I'd better get it all together, because new calculators with new features are coming on the market every week or so."

"Good!" Barney exclaimed. "I've been thinking about investing; so you can lay your advice on me. Not that I'll take it, but I like to hear you talk—especially since, when you're lecturing me, you can't expect me to be slaving away at the bench."

"If anyone ever catches you 'slaving away' anywhere, I hope they send me a telegram," Mac retorted; "but my spiel goes something like this."

What to Consider. "The important points to consider are: (1) why you think you need a pocket calculator; (2) how old you are; (3) how much math you've had or plan to take; (4) where you will be using the calculator; (5) who else will share its use; and (6) how much you want to pay."

"With most people, that last point comes first," Barney observed.

"It shouldn't, because a good calculator, like a good slide rule or a good camera,

should be a long-time investment whose usefulness and power increase with familiarity. That doesn't mean you should buy the most expensive, but other considerations should come before price."

"What's age got to do with it?"

"Probably some modern educators will disagree, but I don't think you should give a kid a calculator until he is at least out of the eighth grade. Up till then, he should be learning the basics of mathematical computation with a pencil and paper. I'm amazed at how many high school youngsters today seem to have a very shaky acquaintance with the multiplication tables. I'd want a kid of mine to know there's *another* way to do long division besides pushing buttons on a calculator in the proper sequence.

"At the other end of the scale, there's not much point in an elderly person's buying a calculator that has functions beyond his present grasp of mathematics because it's unlikely that his understanding will be expanded. Addition, subtraction, multiplication, and division comprise all the math many people know or need. An inexpensive but reliable four-function calculator will make their necessary daily computations easier, more accurate, and more pleasant. They don't need transcendental functions to balance their check book.

"But if you're buying a calculator for a junior or senior high school student who plans to go on to college and take an engineering course, give him one he will not outgrow, one that represents a challenge and a powerful aid in his school work. What he needs is an 'electronic slide rule' type of calculator that has pre-programmed full trigonometric and inverse functions with decimal angle conversion to either degrees/minutes/seconds or radians. It should also be capable of performing common and natural logarithmic functions, exponential func-

tions, square roots, squares, reciprocals, polar ordinate conversion, statistical accumulation with mean and standard deviation calculations, pi, U.S./metric conversion of length, weight, and volume units, fixed-point or scientific display modes, addressable memory registers (the more the better), register review, polar arithmetic, factorial function, a dynamic range from 10^{-99} to 10^{99} ...

"Whoa!" Barney interrupted. "Do you mean there is such an animal still called a 'pocket calculator'? It would have to be as big as a bread box and weigh at least twenty pounds.

"Not true," Mac denied, shaking his head vigorously. "Hewlett Packard's HP-45, the Cadillac of the pocket calculators at \$395, measures 5.8" by 3.2" by 0.7-1.3"; yet it has all the features I mentioned and more. It weighs just 9 ounces and wedges snugly into a man's shirt pocket or slips easily into his coat pocket. For that matter, the HP-35, the first scientific pocket calculator that came on the market only two scant years ago and is still going strong at \$295, has the great majority of the functions mentioned and is the same size and weight.

"But you don't need to go that high to get a multifunction calculator. Unicom's Model 202SR sells for \$195 and has twenty keys and thirty functions. Bowmar's Model MX-100-1 'Scientific' Bomar Brain sells for \$179.95 and has twenty functions, thirteen of which are termed 'scientific.' Texas Instruments' SR-10 Electronic Slide Rule features scientific notation, reciprocals, squares, square roots, change-sign, and nearly a 200-decade range. It sells for just under \$100. Sharp has introduced the PC-1801 'pocket computer' that performs twelve different scientific functions and sells for under \$200. MITS Inc. has a whole line of desktop and pocket calculators including an interesting Model 941, a handheld metric converter available in kit (\$130) or assembled form (\$150)."

"I'd think the power source for the calculator would be an important consideration," Barney hazarded.

"It is. That's where your use for the calculator comes in. If you plan to use it only at home or in the office, a straight ac model will suffice. Some of the calculators are powered by alkaline flashlight batteries to achieve low-cost portability, which is fine if you plan to use the instrument only occasionally and for short periods of time. But

let me warn you that using a calculator grows on you. I find myself reaching for mine a dozen times a day—almost a reflex whenever I think about numbers. The best arrangement for use in the home, the classroom, and the field is to have the calculator powered by self-contained nickel-cadmium rechargeable batteries with an external plug-in charger for use when ac is available. When plugged in, the calculator operates from the line with the batteries 'floating' across the charging voltage."

"You said you were going to advise people on how to buy and use pocket calculators. Wouldn't the user's manual tell you how to use the thing?"

Improving the Four-Banger. "Not in the way I mean. The manual tells you how to add, subtract, multiply, and divide on a four-function calculator; but I want to make that four-banger do a lot more than that. After all, we can't all afford HP-45's, but we still have at least an occasional need to make some of the calculations the HP-45 does with a single key-stroke. I want to get the same answer on my four-function job, and I'm willing to punch a few more keys and use a pencil-and-paper 'memory' to do it. Suppose, for example, we want to extract the square root of a number such as 539 with this basic Sharp Model EL-8 here on the bench. We shall use the formula $T = (N/A + A)/2$ where N equals the number whose square root we're seeking—in this case 539—A is a trial root, and T is the second trial root or the answer.

"Let's take 20 as the first trial root, although it obviously is way off. When we try this in the formula, we get 23.475. Squaring this yields 551.07562, which is not close enough. We plug 23.475 into the formula as A and come up with 23.217798. This squared is 539.06614, which probably is close enough for all practical purposes; but just for the heck of it let's plug 23.217798 into the formula at A. Now we get 23.216373, and that squared is 538.99997. That's much closer than near beer; so let's quit. Unless you start with a trial root that is ridiculously far off, you only need two or three operations of the formula to come up with a root that is plenty close enough for all practical purposes."

"Yeah, but how about extracting other roots, or raising a number to certain power? Can you do that on your four-speed job?"

"Why not? All I have to do is get myself

The Ultimate in Ignition Systems!
★ ELIMINATES BREAKER POINTS. ★
Perfect Timing and Dwell never change!

- Never wears out or needs any Maintenance.
- Eliminates Tune-ups.



● The Most Advanced OPTO-ELECTRIC SYSTEM

● The Allison Breakerless System eliminates the Points and Condenser, replacing them with an Opto-Electronic Trigger, using a Light-Emitting Diode and Phototransistor. The only "TRUE" Electronic Ignition! Gives 40 times more Timing Accuracy than ANY system using mechanical Breaker-Points! Unlimited RPM. Smoother running... (No timing fluctuation as with Magnetic units). Unaffected by Temperature, Moisture, or Vibration! All Solid-State Components. Easier Starting under any condition. Increased Horsepower. Sparkplugs last longer. Perfect timing increases engine Efficiency and Gas Mileage up to 30%!

Quick and Easy Installation! Tested and Proven reliability.

- Only \$49.95
- SATISFACTION GUARANTEED!
- 1-YEAR FACTORY WARRANTY!

(State Make, Year, Engine Size). (Calif. Res. add Tax).

● CONVERT YOUR "C-D" UNIT TO BREAKERLESS!

"TRIGGER-UNIT" ONLY \$34.95

- Send Postcard for FREE BROCHURE Today.

ALLISON AUTOMOTIVE CO.

P. O. Box 881-P, TEMPLE CITY, CAL. 91780

CIRCLE NO. 1 ON READER SERVICE CARD

SAVE!

MONEY • TIME • FREIGHT

QUALITY STEREO EQUIPMENT AT LOWEST PRICES.

YOUR REQUEST FOR QUOTATION RETURNED SAME DAY.

FACTORY SEALED CARTONS—GUARANTEED AND INSURED.

SAVE ON NAME BRANDS LIKE A.D.C.



DYNACO

A.R.

FISHER

KLH

SHURE

KOSS

SONY

AND MORE THAN 50 OTHERS

BUY THE MODERN WAY
BY MAIL—FROM

illinois audio

12 E. Delaware Place
Chicago, Illinois 60611
312-664-0020

CIRCLE NO. 18 ON READER SERVICE CARD

a set of log tables. Four-place tables would be fine for most practical problems, though I use six-place tables. If a person doesn't remember how to use logarithms, he can bone up on the subject in one evening. With logarithms, extracting any root of a number is a matter of simple division. Suppose we want to extract the 11th root of 48,828,125. We look up the logarithm of this number and find it is 7.688669. Dividing this by 11 on the calculator, we get 0.698970. The tables reveal the antilog of this to be 5. The process is reversible. We could have multiplied the logarithm of 5 by 11 and got the antilog of 48,828,125.

"Using scientific notation and the calculator is an easy way to multiply and divide very large or very small numbers. To write a number in scientific notation, you move the decimal point right or left until you have only one integer to the left of the decimal. Then you indicate this number is multiplied by 10 raised to a power equal to the number of places you moved the decimal, giving the exponent a negative sign if you moved the decimal to the right. For example, the distance to the sun is 93,005,000 miles. We can write this as 9.3005×10^7 . The mass of an electron can be written as 9.1091×10^{-28} g, instead of the awkward 0.000,000,000,000,000,000,000,000,910,91 g. With numbers in this form, you can multiply and divide them by doing the computation on the significant figures with the calculator and adjusting the exponent of 10 in the answer according to the law of exponents. For instance, 3.141×10^{-12} multiplied by 3.00×10^{10} yields 9.423×10^{-2} .

"Here's one final little trick. If you want pi to greater accuracy than 22/7, write 113355, which you notice consists of doubling the first three odd integers. Now divide the last three digits, 355, by the first three, 113, on the calculator. That 3.14159-29 you see showing is accurate to 8.47 millionths of 1%.

"To sum it all up, a calculator should match the owner's mathematical ability—just as a generator delivers the most power when the impedance of the load matches the internal impedance of the generator. A student, however, will want to buy the best "electronic slide-rule" calculator he can afford because he's matching it to what he eventually expects to know. On the other hand, if all you have is a four-banger, keep in mind that there are many ways of enhancing the power of a simple calculator." ♦



Product Test Reports

CONCORD MODEL CR-400 AM/STEREO FM 4-CHANNEL RECEIVER (A Hirsch-Houck Labs Report)

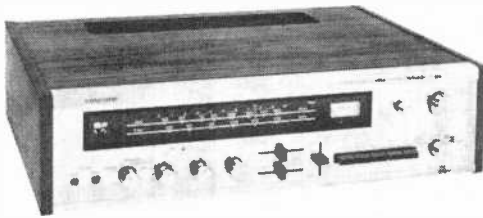

AT A SUGGESTED retail price of \$300, the Concord Model CR-400 is one of the lowest priced 4-channel receivers on the market. The CR-400 contains an AM/stereo FM tuner and four amplifiers, each of which is specified at 12 watts continuous output power with less than 1 percent distortion. In addition, the AUX inputs can be used with an external CD-4 demodulator for playing discrete 4-channel discs.

General Description. The tape outputs and monitoring inputs of the CR-400 receiver are intended for use with a 2-channel recorder, but a second 4-channel tape input is available for playing prerecorded 4-channel open-reel and 8-track cartridge tapes. The receiver has an FM DET output ahead of its multiplexing and de-emphasis circuits to drive an external demodulator should the FCC approve a discrete 4-channel FM broadcasting system.

For deriving rear channels from 2-channel programs, a SYNTHETIC operating mode drives the rear speakers from the difference (L - R) component of the stereo program. Similar in principle to the well-known "Dynaquad" system, the SYNTHETIC feature in the receiver uses the rear-channel amplifiers to provide greater flexibility in balancing front and rear channels.

The FM tuner has an FET r-f amplifier and ceramic filters in its i-f section, while a

single IC serves as the i-f amplifier on AM and FM. IC's are also used for the FM's multiplex demodulator and the SQ matrix decoder.

Four lights on the front panel are used for balancing purposes, with their brightness levels being proportional to the output level from each channel. The light array also provides instant identification of mono, stereo, and 4-channel programs. The tuning dial's pointer is illuminated in white, changing to red when a stereo FM broadcast is received.

The output stages of the amplifier are electronically protected against overloads and short circuit by an SCR that cuts off the supply voltage to the amplifier and lights a RESET legend above the dial scales in the event a problem arises. Shutting off the receiver for a few seconds resets the system, which can be turned on again if the fault has been remedied.

An FM FINE TUNING control supplements the main TUNING knob. A DUAL POWER switch located on the receiver's rear apron can be set to provide increased output power when the front-channel amplifiers are operated in the 2-channel mode.

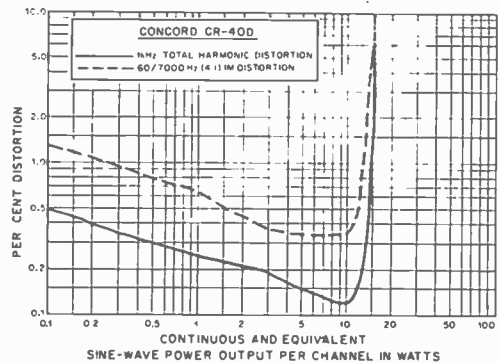

Laboratory Measurements. The amplifier outputs of the CR-400 receiver clipped at 12.3 watts/channel (all four channels driven into 8-ohm loads at 1000 Hz) during our tests. All subsequent measurements were made with only two channels driven, yielding outputs of 13 watts/channel into 8 ohms, 17.7 watts into 4 ohms, and 7.5 watts into 16 ohms. In the DUAL POWER mode, the maximum available power rose to 15.1 watts/channel into 8 ohms and 23.5 watts/channel into 4 ohms.

The 1000-Hz THD was 0.5 percent at a 0.1-watt output, dropping to 0.12 percent

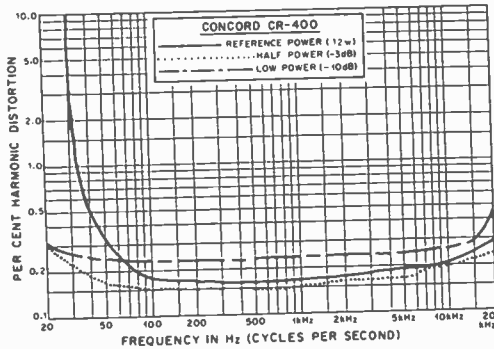

at 10 watts and remaining at close to this figure at 12 watts, which was just below the clipping point. IM distortion was 1.35 percent at 0.1 watt and 3.9 percent at 1.2 mW. But it was less than 0.5 percent at outputs between 1.5 and 14 watts.

At full power (12 watts/channel), THD was less than 0.3 percent from 55 to 20,000 Hz (typically about 0.17 percent). Full power could not be maintained at very low

frequencies, and distortion rose below 35 Hz. At half power, however, THD was less than 0.3 percent from 20 to 20,000 Hz, and at one-tenth power, it exceeded 0.3 percent only at frequencies greater than 15,000 Hz.

Through the AUX inputs, 120 mV drove the amplifiers to an output of 10 watts; 30 mV was required at the PHONO inputs. The noise levels were low, respectively -73 and -70.7 dB in AUX and PHONO. Phono overload occurred at 45 mV, an acceptable level for most cartridges. The AUX inputs could also be overloaded, but this required an input signal level of 5.7 volts and can be disregarded as a potential source of distortion.

The RIAA phono equalization was within ± 0.8 dB from 20 Hz to 20,000 Hz. Cartridge inductance had less effect on the high-frequency response than with most amplifiers we have tested.

In general, the FM tuner met or surpassed its specifications. The IHF usable sensitivity was $3.3 \mu\text{V}$ in mono and $9.0 \mu\text{V}$ in stereo. The 50-dB quieting sensitivity was $3.7 \mu\text{V}$ in mono (very good), but was $60 \mu\text{V}$ in stereo. Distortion at the 50-dB quieting level was about 0.3 percent in mono and 1.6 percent in stereo. At $1000 \mu\text{V}$ input, the S/N ratio was 63 dB in mono and 59 dB in stereo.

Image rejection was 50 dB and capture ratio was 2.6 dB. Alternate-channel selectivity was 39.5 dB below the set frequency and 74 dB above it. In stereo, channel separation was an excellent 30 to 35 dB from 30 to 15,000 Hz. The 19-kHz pilot carrier leakage was an unusually low -73.5 dB. AM rejection was 52 dB, and the automatic stereo switching threshold was $6 \mu\text{V}$.

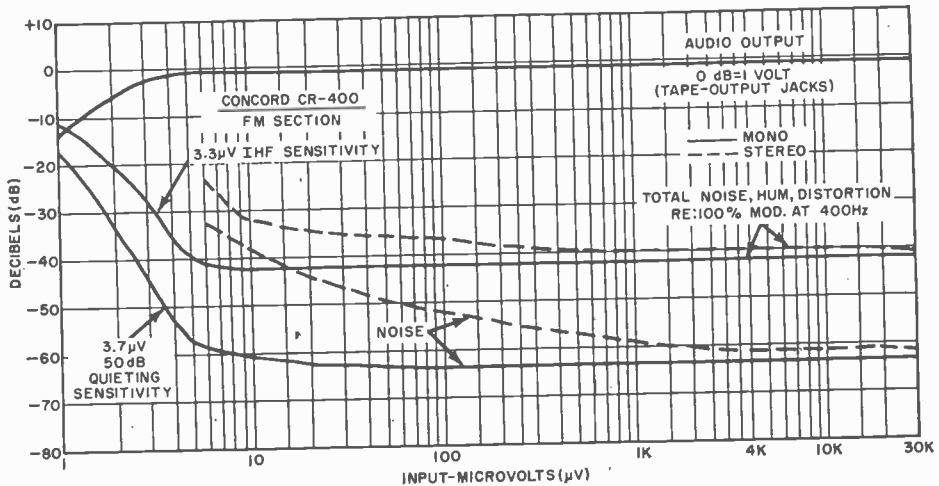

User Comment. Obviously a \$300 4-channel receiver cannot be expected to match the performance of a comparably priced 2-channel receiver or a 4-channel receiver selling at a much higher price. The budget-priced Concord Model CR-400 delivers budget performance, but it is honestly rated and does what is claimed of it.

During our use test, we found that the FM FINE TUNING control had a range of a little more than one channel width. In reality, the tuner was about as easy to tune with its MAIN TUNING control as any other receiver. The FM FINE TUNING control simply adds extra convenience.

An A-B comparison test against another receiver costing about twice as much revealed that the major difference between it and the CR-400 was the latter's slightly higher background hiss.

With SQ-encoded discs, the 4-channel performance of the CR-400 was typical of

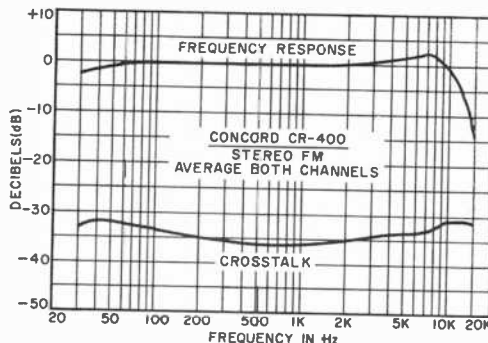

that obtained with any simple matrix decoder. In this respect, the receiver matches some of the highest priced 4-channel gear. The SYNTHETIC mode generates some degree of "ambience" in the rear channels from out-of-phase material in a stereo program. While it did not offer an improvement over using the SQ matrix, its inclusion could hardly be considered an extravagance since it required only one extra switch position.

Circle No. 65 on Reader Service Card

KOSS MODEL HV-1 STEREO HEADPHONES (A Hirsch-Houck Labs Report)



THE Koss Model HV-1 (the "HV" stands for High Velocity) stereo headphones are lightweight, weighing in at only 9½ ounces, exclusive of cord. Unlike most phones that depend on a tight seal around the ear for best bass performance, the HV-1 rests on porous foam pads that provide no isolation from ambient sound; one can hear external sounds as well with the phones on as with them off. By the same token, the phone sounds can be heard clearly in the room, especially when listening at high levels. In fact, the phones are designed to provide

excellent sound quality and low distortion at high listening levels.

The HV-1 phones are comfortable to wear for extended periods of listening. Each earcup contains a 2-in. diaphragm made from 1-mil Mylar. The diaphragms are driven by a 1-in. diameter voice coil. The outside of the earcup is vented, and the compliant diaphragm suspension resonates at about 200 Hz—roughly an octave lower than the resonance of the stiff suspensions used in sealed phones. The resonance is damped by the acoustic resistance of the ear cushion and the internal structure of the earcup. The useful frequency response of the phones extends far below the resonance point.

The phones are relatively efficient, producing a 95-dB sound pressure level in the wearer's ear with only 0.6 volt applied drive. They are capable of very high undistorted output, on the order of 132 dB in the 200-Hz region, where much musical energy is concentrated, without damage or serious distortion—to the phones, that is.

The Koss HV-1 phones are fitted with an integrated coiled cord that extends to 10 ft. They are designed to operate from any amplifier with an output impedance of from 3.2 ohms to 600 ohms. They retail for \$40.

Laboratory Measurements. The measured frequency response of a headphone is critically dependent upon the dimensions and design of the coupler or "artificial ear" used to match the headset to the microphone. We tested the HV-1 phones in a Koss coupler, a slightly modified ANSI headphone coupler.

The response curve for the phones had a broad maximum centered at 200 Hz but spanning several octaves. There were the usual midrange irregularities, found in virtually all phones, but the overall frequency response was a very good ± 7 dB from 20 Hz to beyond the 15,000-Hz upper limit of our microphone calibration.

With a 1-volt signal applied, the acoustic output of the phones varied between 95 and 109 dB over the full frequency range. This level, which would be uncomfortably loud for many listeners, can easily be achieved when driving the phones from any amplifier known to us. At 1000 Hz, the distortion was only 2.6 percent at a 120-dB sound pressure level. At 200 Hz, the distortion was less than 2 percent for any output up to 132 dB SPL, at which point, we began to hear some buzzing. Of course 132 dB would be an ear-splitting level to even the most dedicated rock-music enthusiast.

The electrical impedance of the HV-1 phones was a uniform 150 to 200 ohms from 20 Hz to 20,000 Hz.

User Comments. The Koss phones had an open, airy quality which most people find to their liking. Subjectively, this effect comes closer to that of loudspeaker listening than that of tightly sealed headphones.

The overall sound quality was so good that we compared it to the expensive Koss Model ESP-9 electrostatic phones which were the best we had previously tested and which are considered by some people to be a standard of headphone sound quality. Although the HV-1's did not match the sound provided by the ESP-9's, the differences were not great. The HV-1 had a fuller, warmer sound, easily explained by their response curve which emphasized the lower midrange and had somewhat less output at both extremes of the audio range. The HV-1's sound smooth and free from obvious coloration. For good sound, we feel that the HV-1's offer strong competition to far more expensive stereo headphones. On the whole, they rank at or near the top of all phones we have tested for output level capabilities.

Circle No. 66 on Reader Service Card

RCA MODEL WR-525A TV MARKER/SIGNALYST



THE SERVICE technician has at his disposal a great variety of test instruments, each for a specific job in testing and/or measuring. Most such instruments can be classified as voltage/current/resistance measuring devices, display instruments (oscilloscopes, vectorscopes, etc.), signal-generating equipment, or component-value checkers.

After looking over and working with RCA's Model WR-525A Marker/Signalyst (\$46.50 at RCA distributors), we found

it difficult to classify this instrument in a single category. Essentially, it is a battery-powered r-f signal generator that is tunable across all 12 vhf TV channels. This makes it ideal for use as a signal marker generator when using an r-f sweeper. Unlike most other r-f generators, the WR-525A can be externally modulated by an audio or video signal of up to 4.5 MHz in frequency, making this small (4½ in. × 3½ in. × 3 in.) instrument a good substitute TV transmitter when needed.

Our standard bench-type sweep generator has excellent crystal-controlled markers built into it; so, we were at a loss as to just how to use the WR-525A. We subsequently learned that there were potential applications for this compact instrument from RCA in the modulation mode. This mode enabled us to check TV receivers on any vhf channel supplying the WR-525A with the video output of a color-bar/dot generator, or by supplying the unit with the video extracted from our bench TV receiver. Employed this way, we were able to use the WR-525A to

check each channel of a TV tuner. If there were any noticeable differences between channels, it meant that the tuner had to be checked out.

We could also check TV receivers being used on the local CATV line where all 12 channels are active. While the TV receiver was tuned to an on-the-air channel, the modulated WR-525A was tuned to either adjacent channel (one side at a time) to check for adjacent-channel interference.

CATV service technicians will find the WR-525A a handy device to have around.

Circle No. 67 on Reader Service Card

PACE SIDETALK MODEL CB-1023 AM/SSB CB TRANSCEIVER

THE Pace Sidetalk Model CB-1023 is designed to provide the punch power of single-sideband operation while maintaining compatibility with the AM transceivers still in widespread use. The rig is a mobile unit, which operates from a nominal 12-volt dc source. It uses a negative- or positive-ground system (for which reverse-polarity protection is provided). It functions at the full legal input of 15 watts PEP on SSB and 5 watts on AM on any of the 23 class-D CB channels.

The transceiver measures 9 $\frac{1}{2}$ in. by 7 $\frac{1}{4}$ in. by 2 $\frac{1}{4}$ in. and weighs only 4 $\frac{1}{2}$ pounds. Complete with detachable push-to-talk dynamic microphone and mobile mounting hardware the CB-1023 retails for \$330.

Receiver Section. Employing single conversion to a 7.8-MHz i-f, the receiving section has excellent sensitivity. We measured it at 0.15 μ V on SSB and 0.3 μ V on AM with 400 or 1000 Hz modulation for 10 dB (S + N)/N. (The manufacturer's ratings are 0.5 and 1.0 μ V, respectively.) Image and other spurious-signal rejection was a minimum of 60 dB down—10 dB better than specified. This performance is obtained with a front-end consisting of a bipolar transistor r-f amplifier and a dual-gate FET mixer.

High sensitivity is usually obtained at the expense of good signal-handling capability. This can be the result of overload, intermodulation products, cross-modulation, and desensitization by an adjacent-channel signal. To prevent this in the CB-1023, there is an r-f gain control that allows the user to reduce sensitivity.

The same i-f section is used for both SSB and AM with separate detectors for each

It can be used to "ring out" suspect coaxial cables, using it to simulate any of the desired commercial TV broadcast channels available.

We also found another use for the instrument. It appears that some department stores in the New York area are using CCTV systems with each camera operating on a different vhf channel, but all on a single, although complex, coaxial cable setup. Using the WR-525A supplied with video from a battery-powered TV receiver, we have successfully checked out a complete r-f coax system of this type.



mode of operation. Selectivity and sideband selection are obtained with a common crystal filter preceding the i-f chain. The filter has a 6-dB bandwidth that is rated at ± 2100 Hz (4200 Hz overall).

For SSB, the heterodyning frequency from the synthesizer is placed so that the resulting i-f is at one skirt of the filter, producing an overall SSB a-f response of 300 to 3100 Hz at 6 dB. The unwanted-sideband suppression at 1000 Hz was 45 dB.

For AM reception, the heterodyning frequency is shifted so that the frequency of the i-f falls at the center of the filter pass-band. This results in a double-sideband signal for which the overall a-f response was found to be 450 to 3200 Hz at 6 dB. Adjacent-channel rejection was nominally 40 dB.

A common age is used for both operational modes, holding the a-f output to within 3 dB with a change of 80 dB (1-10,000 μ V) in the r-f input signal. Approximately 30 μ V of input signal was needed to register S-9 on the meter. (The meter doubles as an r-f output indicator on transmit, at which time a red lamp also comes on.)

A variable squelch for both AM and SSB can be adjusted over a threshold-sensitivity range of 0.3 to 5000 μ V. A slight delay at squelch release holds the receiver open between words during SSB use.

A noise blanker can be switched into or

out of the circuit (with an a-f noise limiter when used on AM). The overall effectiveness between in and out appears to be greater on AM than on SSB, since the noise is inherently less on SSB. With impulse-noise peaks of 10 μ V or more, the overall noise attenuation with the blanker on was at least 20 dB.

External speaker jacks are furnished for the receiver and for PA work. At the rated 3 watts a-f output, the distortion at 1000 Hz was 5 percent. But 8 watts into an 8-ohm speaker could still be obtained before clipping set in.

Frequency Synthesizer. The frequency synthesizer employs ten crystals and provides heterodyning frequencies in the 19-MHz range. Only one crystal is used at the bfo. Sidebands are switched by placing the heterodyning signal at the low side of the CB signal for LSB and at the high side for USB work. The latter is accomplished by remixing the synthesizer output with the second harmonic of the bfo.

This setup eliminates the need for up to five additional crystals, keeps the signal at the best side of the sideband filter, and maintains the operating frequency with

operation on either one of the sidebands.

A CLARIFIER control provides for on-frequency operation. At its midpoint, each channel was within 50 Hz of the assigned frequency, and the CLARIFIER's range was nominally \pm 900 Hz.

Transmitter Section. Transmissions are set up in the conventional manner, using a balanced modulator and the sideband filter for SSB. For AM, the receiver's a-f system collector-modulates the r-f driver and power-output amplifier. The latter is designed to work into a 50-ohm (nominal) load from a multi-element output-matching and filtering network.

Operating from the standard EIA test potential of 13.8 volts dc, the SSB output was 8.5 watts PEP with third and fifth-order distortion products at onset of maximum output down 19 and 28 dB, respectively, below maximum single-tone output. Unwanted-sideband and carrier suppression were 45 dB (at 1000 Hz) and 55 dB, respectively. Overall 6-dB response was 200 to 4500 Hz.

With AM, the carrier output was 3.5 watts with a good waveform. The overall 6-dB response was 450 to 3200 Hz.

Circle No. 68 on Reader Service Card

HELPMATE MODEL CD-5 AUTOMATIC GARAGE DOOR OPENER

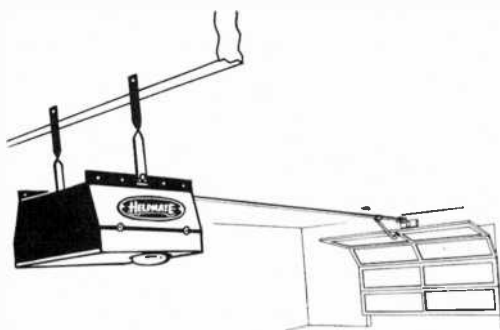

BASICALLY, an automatic garage door opener consists of a power head with an electric motor; a trolley and rail assembly; a mechanical drive system; a radio control transmitter and separate receiver; mounting brackets; and a manually operated switch. All of these items—and a variety of improvements—are included in the Helpmate Model CD-5 automatic garage door opener that sells for \$140.

General Description. The CD-5 is a heavy-duty residential system designed for easy owner installation. It employs a hefty $\frac{1}{2}$ -hp motor rather than a $\frac{1}{4}$ -hp unit. Hence, the system can open and close light and heavy doors ranging in size up to 20 ft wide. The system works equally well with one-piece or sectional and track or trackless doors.

The radio control transmit/receiver system can be chosen to operate on the 225-260-MHz high vhf band, 350-400-MHz uhf band, or 410-450-MHz uhf band. A pulsed-tone scheme keys a given transmitter to a specific receiver. (Extra remote-control transmitters are available for families with two or more cars at \$20 each.) Maximum range is about 150 ft.

The power-head motor is an instant-reverse, capacitor-start type with thermal overload protection. It is activated manually by depressing a wall-mounted switch or remotely by keying the transmitter. The 800-rpm speed of the motor is reduced by a large pulley that, in turn, drives a roller

chain attached to a trolley. The door arm assembly links the trolley to the garage door. As a safety feature, the door's travel reverses in the event the door encounters an obstacle while closing.

A 75-watt lamp comes on when the system is activated and remains on for approximately two minutes, after which it extinguishes automatically. This gives ample time to close the door and leave the garage.

Accessories are available for special problems. For example, an extension kit can be obtained for using the CD-5 with garage doors exceeding 7 ft in height. There are also kits for reinforcing light metal and fiberglass doors.

User Comments. Installing the garage door opener is not a particularly difficult task. Rather, it is a time-consuming one, especially if you haven't done this sort of work before. The completely assembled power head is housed in an attractive enclosure (nothing is exposed) that is easily hung from rafters or the ceiling.

The rail consists of four sections of 1½-in. tubing that butt into each other. The trolley rides on this with the chain assembly attached to each side and in sprockets at each end of the rail. Traveling at 6.5 in./second, doors open and close at a smoothly controlled speed. The door is automatically locked by the mechanism; so, there is no need for a lock and key.

A thoughtful feature in the CD-5 system is a quick-release hitch pin that uncouples the door arm from the trolley in seconds to permit manual opening and closing should electrical service be interrupted. In these days of power failures and brown-outs, the idea of power interruption is not a far-fetched possibility.

When the door is coming down, not much is required to cause it to reverse automatically. Therefore, you will never have to worry about a child becoming accidentally pinned under the door. The fact that the door reverses itself is a particularly nice feature since most door openers simply stop and require a command to start to reverse.

After the CD-5 system was installed, we checked its radio-control setup. The battery-powered transmitter opened the door at distances well beyond 50 ft. We did not attempt to verify the maximum range of the radio control link, but we have no doubt that the 150-ft specification is valid.

Circle No. 69 on Reader Service Card



NEW FREE CATALOG OF CIRCUIT DESIGN & BREADBOARDING EQUIPMENT!

NOW . . . TEST NEW CIRCUIT IDEAS, I.C.'S,

DISCRETE COMPONENTS WITH NO SOLDERING!

Circuit Design's new catalog has everything you need to take you from circuit concept to working hardware in minutes. Featured items include the great SK-10 socket for solderless circuit design and testing, the NEW SK-20 socket (only \$2.75) for smaller circuits, the versatile Digi Designer (in kit form or assembled), a new Op-Amp Designer, plus power supplies, pulse generators, digital logic courses, plug-in socket boards, and much more.

Write today for your free copy.

CIRCUIT DESIGNS, INC.

P.O. Box 24, Shelton, Conn. 06484

Exclusive mail order dist. for E&L Instruments.

CIRCLE NO. 7 ON READER SERVICE CARD



Free!

New 14th Edition of the Midwest Hifi Catalog!

Save on stereo! Buy direct from us and you save money with our high-volume prices on more than 100 name brands. Order from the branch nearest you.

Midwest Hifi Wholesale & MAIL ORDER DIVISION

2455b Wisconsin Ave., Downers Grove, Ill 60515 3309 E. J W Carpenter Frwy, Irving, Tex 75062

PL

NAME

ADDRESS

CITY/STATE

ZIP

CIRCLE NO. 24 ON READER SERVICE CARD

One of our most successful students wrote this ad!

Harry Remmert decided he needed more electronics training to get ahead. He carefully "shopped around" for the best training he could find. His detailed report on why he chose CIE and how it worked out makes a better "ad" than anything we could tell you. Here's his story, as he wrote it to us in his own words.



Harry Remmert gives his CIE Electronics course much of the credit for starting him on a rewarding career. He tells his own story on these pages.

By Harry Remmert

AFTER SEVEN YEARS in my present position, I was made painfully aware of the fact that I had gotten just about all the on-the-job training available. When I asked my supervisor for an increase in pay, he said, "In what way are you a more valuable employee now than when you received your last raise?" Fortunately, I did receive the raise that time, but I realized that my pay was approaching the maximum for a person with my limited training.

"Education was the obvious answer, but I had enrolled in three different night school courses over the years and had not completed any of them. I'd be tired, or want to do something else on class night, and would miss so many classes that I'd fall behind, lose interest, and drop out.

The Advantages of Home Study

"Therefore, it was easy to decide that home study was the answer for someone like me, who doesn't want to be tied down. With home study there is no schedule. I am the boss and I set the pace. There is no cramming for exams because I decide when I am ready, and only then do I take the exam. I never miss a point in the lecture because it is right there in print for as many re-readings as I find

necessary. If I feel tired, stay late at work, or just feel lazy, I can skip school for a night or two and never fall behind. The total absence of all pressure helps me to learn more than I'd be able to grasp if I were just cramming it in to meet an exam deadline schedule. For me, these points give home study courses an overwhelming advantage over scheduled classroom instruction.

"Having decided on home study, why did I choose CIE? I had catalogs from six different schools offering home study courses. The CIE catalog arrived in less than one week (four days before I received any of the other catalogs). This indicated (correctly) that from CIE I could expect fast service on grades, questions, etc. I eliminated those schools which were slow in sending catalogs.

FCC License Warranty Important

"The First Class FCC Warranty* was also an attractive point. I had seen "Q" and "A" manuals for the FCC exams, and the material had always seemed just a little beyond my grasp. Score another point for CIE.

*CIE backs its courses with this famous Money-Back Warranty: when you complete a CIE license preparation course, you'll be able to pass your FCC exam or be entitled to a full refund of all tuition paid. Warranty is valid during completion time allowed for your course.

"Another thing is that CIE offered a complete package: FCC License and technical school diploma. Completion time was reasonably short, and I could attain something definite without dragging it out over an interminable number of years. Here I eliminated those schools which gave college credits instead of graduation diplomas. I work in the R and D department of a large company and it's been my observation that technical school graduates generally hold better positions than men with a few college credits. A college degree is one thing, but I'm 32 years old, and 10 or 15 years of part-time college just isn't for me. No, I wanted to *graduate* in a year or two, not just *start*.

"When a school offers both resident and correspondence training, it's my feeling that the correspondence men are sort of on the outside of things. I wanted to be a full-fledged student instead of just a tag-a-long, so CIE's exclusive home-study program naturally attracted me.

"Then, too, it's the men who know their theory who are moving ahead where I work. They can read schematics and understand circuit operation. I want to be a good theory man.

"From the foregoing, you can see I did not select CIE in any haphazard fashion. I knew what I was looking for, and only CIE had all the things I wanted.

Two Pay Raises in Less Than a Year

"Only eleven months after I enrolled with CIE, I passed the FCC exams for First Class Radiotelephone License with Radar Endorsement. I had a pay increase even before I got my license and *another* only ten months later.

"These are the tangible results. But just as important are the things I've learned. I am smarter now than I had ever thought I would be. It feels good to know that I know what I know now. Schematics that used to confuse me completely are now easy for me to read and interpret. Yes, it is nice to be smarter, and that's probably the most satisfying result of my CIE experience.

Praise for Student Service

"In closing, I'd like to get in a compliment for my Correspondent Counselor who has faithfully seen to it that my supervisor knows I'm studying. I think the monthly reports to my supervisor and generally flattering commentary have been in large part responsible for my pay increases. My Counselor has given me much more student service than "the contract calls for," and I certainly owe him a sincere debt of gratitude.

"And finally, there is Mr. Tom Duffy, my instructor. I don't believe I've ever had the individual attention in any classroom that I've received from Mr. Duffy. He is clear, authoritative, and spared no time or effort to answer my every question. In Mr. Duffy, I've received everything I could have expected from a full-time private tutor.

"I'm very, very satisfied with the whole CIE experience. Every penny I spent for my course was returned many

times over, both in increased wages and in personal satisfaction."

Perhaps you too, like Harry Remmert, have realized that to get ahead in Electronics today, you need to know much more than the "screwdriver mechanics." They're limited to "thinking with their hands" . . . learning by taking things apart and putting them back together . . . soldering connections, testing circuits, and replacing components. Understandably, their pay is limited—and their future, too.

But for men like Harry Remmert, who have gotten the training they need in the fundamentals of Electronics, there are no such limitations. He was recently promoted, with a good increase in income, to the salaried position of Senior Engineering Assistant working in the design of systems to silence submarines. For trained technicians, the future is bright. Thousands of men will be needed in virtually every field of Electronics from two-way mobile radio to computer testing and troubleshooting.

Send for Complete Information — FREE

Many men who are advancing their Electronics career started by reading our illustrated school catalog, "Succeed in Electronics." It tells of the many electronics careers open to men with the proper training. And it tells which courses of study best prepare you for the work you want.

If you're "shopping around" for the training you need to move up in Electronics, this interesting book may have the answers you want. We'll send it to you FREE. With it, we'll also include our other helpful book, "How To Get A Commercial FCC License."

To get both FREE books, just fill out and mail the reply card. For your convenience, we will try to have a representative call. If card is missing, use coupon below.

APPROVED UNDER G.I. BILL

All CIE career courses are approved for educational benefits under the G.I. Bill. If you are a Veteran or in service now, check box for G.I. Bill information.

CIE Cleveland Institute of Electronics, Inc.

1776 East 17th Street, Cleveland, Ohio 44114
Accredited Member National Home Study Council

Cleveland Institute of Electronics, Inc.

1776 East 17th Street, Cleveland, Ohio 44114

Please send me your two FREE books:

1. Your school catalog, "Succeed in Electronics."
2. Your book on "How To Get A Commercial FCC License."

I am especially interested in:

- | | |
|---|--|
| <input type="checkbox"/> Electronics Technology | <input type="checkbox"/> Electronic Communications |
| <input type="checkbox"/> Broadcast Engineering | <input type="checkbox"/> Industrial Electronics |
| <input type="checkbox"/> First Class FCC License | <input type="checkbox"/> Electronics Engineering |
| <input type="checkbox"/> Electronics Technology with Laboratory | |

Name _____ (Please Print)

Address _____

City _____

State _____ Zip _____ Age _____

Veterans & Servicemen: Check here for G. I. Bill information

PE-58

For men with prior electronics training . . . Electronics Engineering Course

. . . Covers steady-state and transient network theory, solid-state physics and circuitry, pulse techniques, computer logic and mathematics through calculus. A college-level course for men already working in Electronics.

CIRCLE NO. 8 ON READER SERVICE CARD

THE ELECTRONIC music synthesizer is here to stay. You can hear the result of this union of art and technology in many TV commercials. Synthesizers are also well represented in pop music disc and tape recordings and on the sound tracks of modern motion pictures. And now they are showing up in a variety of forms in private homes and schools!

Why this sudden acceptance? One rea-

son is that synthesized music provides an exciting and "different" medium of expression. Another is that consumer demand has spurred diversity and pushed prices down as synthesizer systems went into mass production. Perhaps the most important reason is that no prior musical knowledge or training is needed to produce music on a synthesizer.

Controllers. The most popular synthesizer controller is the organ-type keyboard, even though it limits the synthesizer in which it

WHAT'S NEW IN ELECTRONIC MUSIC

son is that synthesized music provides an exciting and "different" medium of expression. Another is that consumer demand has spurred diversity and pushed prices down as synthesizer systems went into mass production. Perhaps the most important reason is that no prior musical knowledge or training is needed to produce music on a synthesizer.

Since synthesizer technology is still in its infancy, many changes are taking place. Here is an overview of new ideas and devices in the synthesizer field. This includes alternatives to the conventional organ-type keyboard, applications of digital techniques to a primarily analog field, and the attempts being made to solve the cumbersome inter-connection problems of the traditional

is used to those who are familiar with the keyboard technique. Other disadvantages are complexity and high cost.

Robert Moog, a prominent electronic music equipment inventor, recognized these problems. To overcome this deficiency, he developed the ribbon controller, a device similar to a one-string fretless guitar. Moving a finger up and down the "string" produces control voltage changes in pitch, (something more unusual) amplitude, or filter resonance. In Fig. 1, a resistance wire, fed by a constant-current source that provides a uniform voltage drop, runs the length of the instrument body. Suspended above this wire is a steel ribbon that, when pressed, picks off a voltage from the wire.

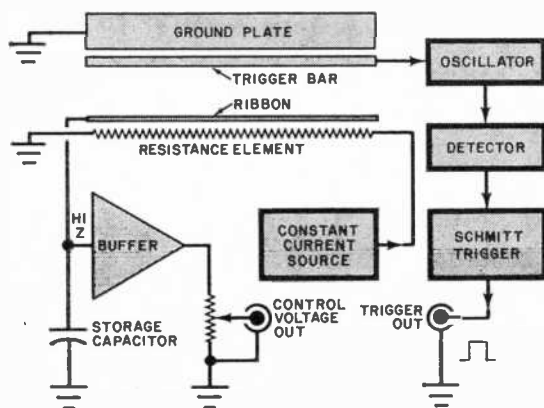

Fig. 1. Ribbon controller for synthesizer, developed by Moog.

The magnitude of the voltage depends upon where the contact is made. This voltage goes to a storage capacitor and high-impedance buffer that "remembers" the voltage until a change occurs in the system.

Adjacent to the ribbon/wire assembly are two parallel metal plates that act as a capacitance in a high-frequency oscillator. Pressing on the ribbon closes the gap between the plates, squelching the oscillator and causing a trigger voltage to appear at the output of a Schmitt trigger. The advantage of a rib-

of discrete adjustable control voltages, traditionally done by clocking a "bucket-brigade" counter in which each clock pulse advances a voltage down the counter, stage by stage. At the output of each stage is a control for varying the voltage level.

Synthetic Sound Labs has developed a different "touch-controlled expression" approach. In it is a printed circuit board with two adjacent insulated conductive pads. Lying flat on this board is a piece of conductive foam. The copper pads on the board nor-

SYNTHESIZERS ?

Applications of computer techniques to the music field, alternatives to the conventional keyboard, and use of electronic music modules

BY CRAIG ANDERTON

bon controller is that very subtle glides from note to note and dramatic multi-octave sweeps are possible.

Another Moog innovation is the percussion controller that resembles a drum but is actually a drumstick-activated controller. Striking the drum head produces a sharp pulse at the output of a transducer (see Fig. 2). A peak stretcher conditions this pulse, which is then sampled by a sample-and-hold circuit to produce a control voltage output. Simultaneously, a Schmitt trigger delivers a trigger output for use with envelope generators and other triggerable synthesizer modules.

Another type of controller called a sequencer (Fig. 3), illustrates a musical use of digital logic. Basically, it produces a series

mally have a high resistance between them. But pressing down on the foam causes the resistance to decrease. This variable resistance is then converted to a variable voltage by an interface amplifier. A low-pass filter keeps transients and noise out of the interface amplifier.

E μ Systems has devised a modular digital sequencer. A complete sequencer includes such modules as a voltage-controlled clock; two 8-position address generators that provide eight (expandable to 64) decoded outputs; two 256-word memory modules that can be programmed via keyboard, analog voltage source, or binary code; and other modules, such as a potentiometer matrix, analog switch, inverter OR gate, one-shot multivibrator, and latch. Taken together,

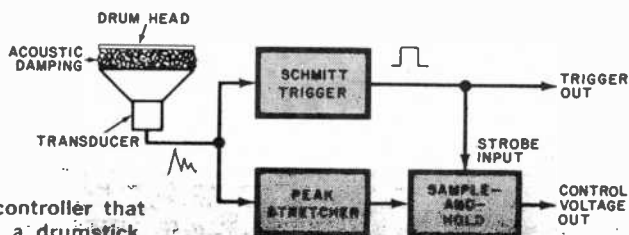

Fig. 2. A percussion controller that is actuated by a drumstick.

these modules provide a very capable sequencing system.

EMS (of London) Ltd. has attacked the problem in a different way with its 256-word "KS" memory keyboard. As a melody is played, the keyboard information enters the memory at every clock pulse (limited to one note at a time). With a finite memory, programming a 20-second sequence of 256 events with good resolution is possible. Setting the clock speed slower provides more playing time but decreases definition. Conversely, increasing the clock speed increases definition, but cuts down on playing time.

The KS system has such interesting features as a meter whose percent of full-scale deflection indicates how much memory has been used; transposition pads for raising the entire sequence a third, a fifth, a semitone, or anything else up to an octave; a trigger output; and a real-time (not stored) output. A block diagram is shown in Fig. 4.

The organ-type keyboard controller has also undergone changes. Many companies are working on adding extra notes and voices to augment the basic monotonic (one-note-at-a-time) synthesizer sound. Methods currently used to obtain more than one-note-at-a-time include digital multiplexing systems, constant-current schemes that compare the voltages present at the low and high ends of the keyboard's resistor string; and building a separate oscillator, vca (voltage-controlled amplifier), and vcf (voltage-controlled filter) for each note required. Most synthesizers now offer two simultaneous notes or voices—with certain limitations.

On smaller synthesizers, another feature that adds keyboard versatility is a "bend" control. Operated with the left hand, it allows the player to slide the pitch of a note played on the keyboard up or down several semitones. Also, touch-sensitive keyboards are becoming more popular, with their advantages of no moving parts and greater resistance to wear and tear.

Mini-Synthesizers. The synthesizer was originally conceived as a studio device. To produce synthesized music, a multi-track tape recorder was needed because synthesizers, for all their complexity, could play only one note at a time. Complex timbres or harmonics had to be constructed, layer by layer, on tape. And because sounds were created in a building-block manner by connecting the various modules together with patch cords, synthesizers were virtually useless for live performances. If that were not enough, they were large, fickle, and susceptible to drift and other bugs.

Now, many types of low-priced mini-synthesizers are on the market. They have stable oscillators and require no patching (switches and potentiometers route the signals). Some minis even have patching facilities for studio use, giving the operator extra options. These instruments use regular synthesizer function blocks in a non-modular, predetermined order. A typical synthesizer block diagram is shown in Fig. 5. Connections between modules are normally closed. Inserting a patch cord opens them and routes the signal to a different module.

The mini offers a variety of features; how many depends on how much money you are prepared to invest. The ElectroComp Model 101 (\$1500) includes a ring modulator, vca, multi-mode filter, noise source, sample-and-hold provisions, two-voice keyboard, four oscillators, mixers, two envelope generators, and a microphone preamplifier. Most inputs and outputs are available at a patch bay for the operator who wants to create custom signal paths.

Less expensive minis, like the ARP "Pro Soloist," usually sacrifice the patch bay, an oscillator or two, and the more esoteric effects, such as ring modulation. On the other hand, they are smaller, lighter, and contain fewer things that can go wrong. PAIA Electronics even offers a complete mini-synthesizer kit for those who would rather build their own.

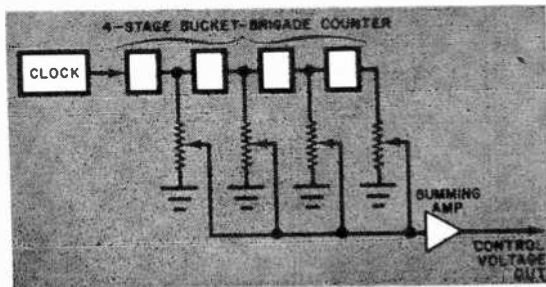

Fig. 3. This type of controller, called a sequencer, uses simple digital counter circuit.

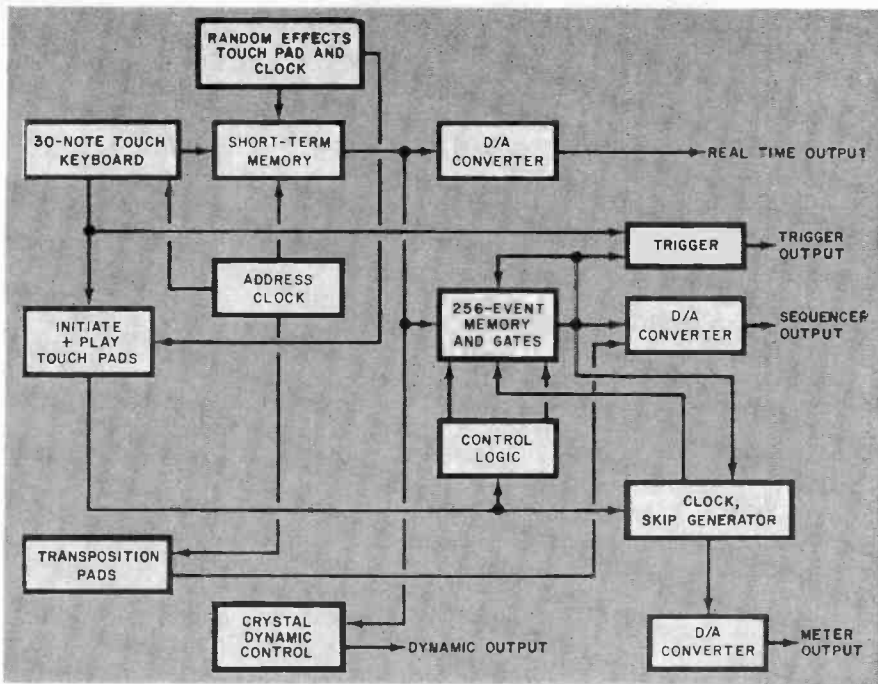

Fig. 4. Block diagram of KS memory keyboard by EMS Ltd. using 256-word memory.

Modifiers. Like any other new idea, synthesizers have taken a little while to catch on. This is due mainly to such factors as high cost, the use of organ controller keyboards, and the fact that people are just plain scared of all those dials. As a result, a large number of devices now exist, using synthesizer modules, to add synthesizer effects to conventional musical instruments. One of the first of these was the Oberheim "Music Modulator" shown in block diagram

form in Fig. 6. Note how simple it is compared to keyboard systems.

Filters are popular, starting with the simple bandpass filter (waa-waa effect) and going up to the state-variable filter, set in the notch position, to yield imitation "phasing" effects. Another powerful building block for instrument modifiers is the envelope-follower module. It consists of a precision dc rectifier that detects the amplitude envelope of an input signal and transforms it into a dc

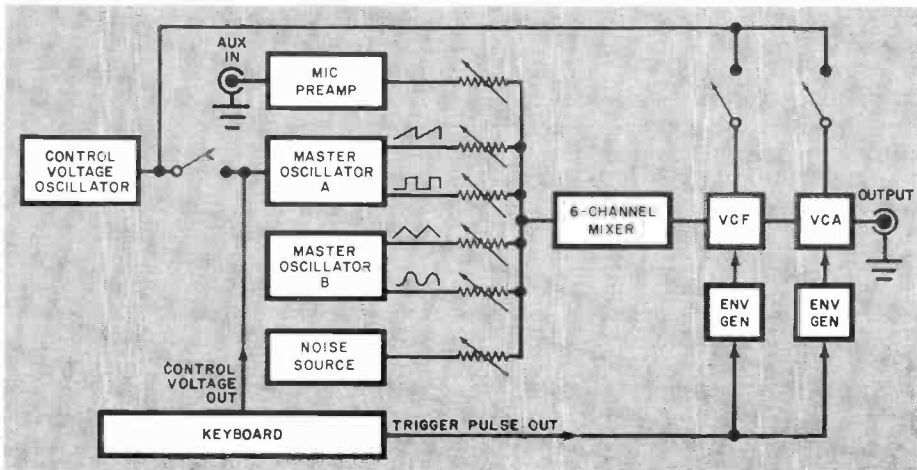

Fig. 5. Typical mini-synthesizer block diagram. Function order is usually predetermined.

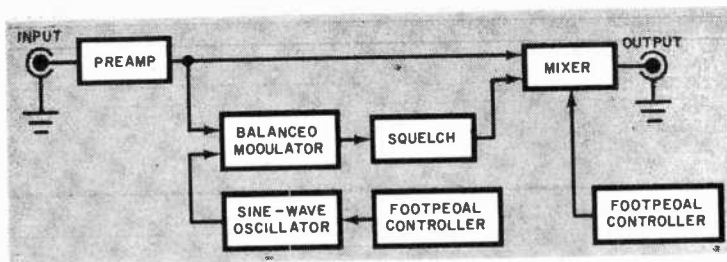

Fig. 6. Oberheim Music Modulator is used with conventional instruments.

voltage that can vary parameters of other modules (as in the Seamount "Funk Machine" in which an envelope follower and a bandpass filter give an automatic waa-waa effect).

An interesting refinement of the voltage-follower concept is the EMS pitch-to-voltage converter (P-VC) that provides a connection between traditional instruments and voltage-controlled instruments. Although its major function is to convert an audio input into a dc control voltage that is precisely proportional to the pitch, the P-VC also contains an envelope follower that provides either a duplicate of the original envelope, a new envelope shape, or an inverted (backwards tape effect) envelope. There is also a built-in sawtooth oscillator that can track the input signal.

An interesting feature of the P-VC is that it can track instruments with a high harmonic content. Thanks to special filtering in the P-VC, a fundamental comprising 10 percent or more of the total signal insures proper tracking.

EMS also makes a modifier called the "Hi-Flt." It has a batch of synthesizer modules, including a ring modulator, filter, envelope generator, mixer, fuzz (harmonic generator), and foot-pedal controllers.

IC's For The Experimenter. A lot of help for the experimenter is coming from semiconductor companies that are designing IC's suitable for use in electronic music applications. Signetics, for example, offers the 556 vco that is tunable over a 10:1 range with triangle and square-wave outputs; the 555 timer that can be used as an oscillator or an envelope generator; and the 565 phase-locked loop that is good for pitch-to-voltage conversion.

Intersil makes the 8038 function generator, a vco that has a tuning range of 1000:1 and generates sine, triangle, square, and other waveforms. The Exar XR-205 is a function generator; XR-S200 is a multi-

function IC with a vco, four-quadrant analog multiplier, and op amp on the same chip; XR-2240 timer has a built-in binary counter. Motorola's offerings include the MFC4040 toggle flip-flop designed for octave division, MFC6020 (dual MFC4040), and MFC6040 vca.

A variety of analog-multiplier IC's is also available, the 5595 being the least expensive but requiring considerable outboard circuitry. For about three times the price, Intersil's 8013 is far simpler to use.

Other IC's useful in electronic music are the low-noise 739 dual op amp for filters and preamps; the CD4046 micropower phase-locked loop; the 74C154 CMOS version of the 74154 for making a 16-step sequencer, a digital wave-form generator or an envelope generator; and the CD4016 quad analog switch that is used as a voltage-controlled switch.

Looking to the Future. The trend towards integrated packages of synthesizer modules, rather than modular systems (started by the mini-synthesizers) will continue. This will result in electronic instruments with simpler operation, lower prices, and extreme portability for live performances. Modular synthesizers, on the other hand, will become more sophisticated, mixing digital and analog techniques. A patching system using analog switch matrices and programmed patches will probably show up soon; and to simplify transportation, synthesizers will aim for higher and higher densities.

You can also expect refinements, such as touch-sensitive keyboards, to become commonplace, thanks to chips like comparators. It is also the opinion of this author that more and more voltage-controlled parameters will be put under the control of the musician. This may mean less "spectacular" synthesizer effects, but a more "human" and subtle sound. As musicians learn to tame this new medium, synthesizers will complement pre-electronic instruments. ♦

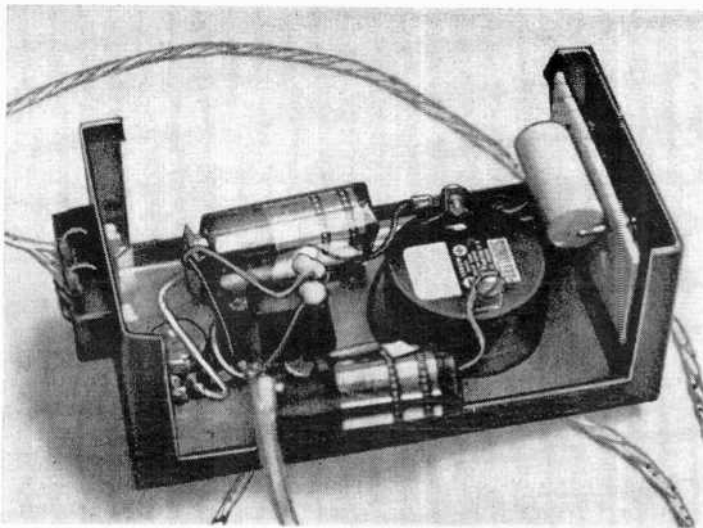

*Sounds alarm
when freezer
temperature
rises above
safe, preset
value*

HOME-FREEZER THAW ALARM

Protects Food Investment

BY FRANKLIN C. WILLOUGHBY

IF YOU have a home freezer unit, you probably have a sizable investment in stored food. All that food can be lost if, for some reason, the temperature inside the freezer rises to the thaw point. For about \$10, you can build a thaw alarm to warn you of rising temperature long before the thaw point is reached.

The thaw alarm is adjustable over a temperature range of 0° F to room temperature. By adjusting it to trip at 10° F, the freezer can be opened to put in or take out food without triggering a false alarm.

The alarm's circuit (see schematic) is simple. Thermistor probe *TH1* (Solid State Devices No. GB42P2, available from Allied Electronics as stock No. 791-0441, at \$3.60 each) goes into the freezer and serves as the temperature sensor. The temperature

at which the alarm trips is governed by the setting of *R1*. Resistor *R2* is a gate current limiter for *SCR1* (the tripping device), while capacitor *C1* prevents transients from tripping the SCR when reset switch *SI* is operated. A Mallory No. SC628 Sonalert® is the "beeper."

Power for the circuit is provided by an ordinary 9-volt battery (*B1*). Since current drain when the alarm is on standby is only 30 μ A, *B1*'s service life should be essentially the same as its shelf life. Even when the alarm trips, current consumption is still only 4 mA. To provide continuous, reliable protection, however, it is recommended that *B1* be replaced every six months or so.

Temperature adjustment, via *R1*, is made only after the probe, *TH1*, has been in the freezer for a half hour or so. Rotate *R1*'s knob slowly just to the point at which the Sonalert starts to beep. Then back off just a bit until the alarm no longer sounds when *SI* is depressed and let go.

When you build the thaw alarm, carefully solder thin wires to *TH1*. Make these wires long enough to reach the circuit proper, located atop or somewhere near the freezer. After first insulating the soldered connections at *TH1*, slip a length of insulating tubing over the probe assembly. Pack both ends of the tubing with silicone rubber caulking compound. When the caulk sets, place the probe assembly in the freezer. ♦

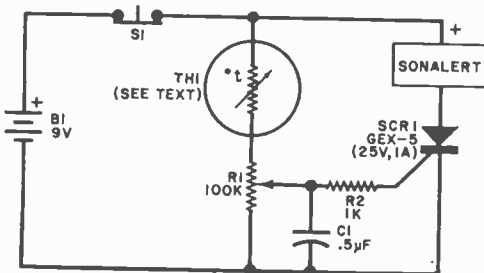

Thermistor probe, inside freezer, changes resistance with temperature to trigger SCR.



Solid State

By Lou Garner

IF YOU have ever blown an expensive power transistor, don't feel bad—you're in good company. Although there are no firm statistics, there's a good chance that nearly everyone who has done much work with transistors has had the misfortune of having one blow out at one time or another. If you haven't—by sheer luck—enjoyed the unrewarding experience as yet, you've something to look forward to in the future.

Power transistors may be damaged by any one of several conditions—incorrect parameters or bias, open or shorted components, simple wiring errors, accidental shorts, overloads, higher than rated voltages, or extreme ambient temperatures. Quite often, damage results from a condition known as *thermal runaway*. For one reason or another (such as a change in bias, extreme loading, or whatever), the transistor starts drawing excessive current. This leads to internal heating, reducing the transistor's effective internal resistance and leading to a further increase in current and even higher temperature. Once started, the alternating conditions of temperature increase and current increase keep building until the transistor is destroyed unless the current is limited by external means. This may be done by using a series resistor, a current-limited power supply, a circuit breaker, or a fuse.

For those of us who have blown more than our share of power transistors, there is, as a famous radio commentator used to say, "good news tonight." The National Semiconductor Corporation (2900 Semiconductor Drive, Santa Clara, CA 95051) has recently introduced a power "transistor" that protects itself and anything connected to it from short circuits and overload conditions. Designated the LM195, the device is actually a three-terminal bi-polar monolithic IC that simulates a 40-watt transistor with a high switching speed.

The LM195 contains some 50 compon-

ents in a circuit that both drives and protects a large multi-emitter npn power transistor, rendering the unit virtually blowout-proof at output current levels of up to 2 amperes and at input and output voltage levels of 40 V. The current-limiting and thermal-shutdown circuits built into the device cut off the output stage if the output current exceeds the 2-A level or if the chip temperature exceeds 165°C. About the only way the device can be harmed is by applying an excessive voltage. If this happens, the LM195, unlike conventional power transistors, fails safe. It becomes an open circuit, disconnecting the load.

Electrically, the LM195 looks like a pnp transistor driving an npn Darlington with an overall gain of over 1 million. Two versions are available, the LM195, designed for operation from -55 to 150°C and a lower priced unit, the LM395, intended for use over the 0-to-125°C range.

Circuit Potpourri. In his recent articles "The IC Time Machine" (November 1973) and "Applications for the IC Time Machine" (January 1974), our co-editor, Walter G. Jung, discussed the type 555 IC timer in detail, mentioning that several manufacturers were offering dual versions of this versatile and interesting device, including Signetics

Blow-Out- Proof Transistor

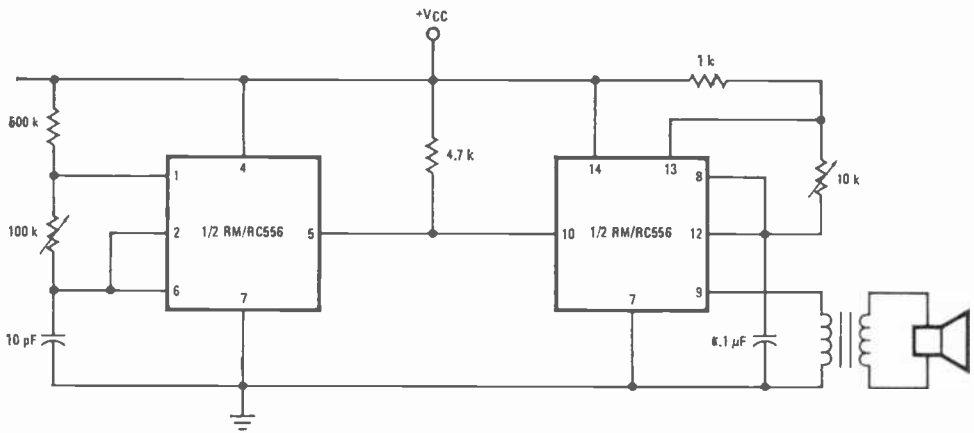

Fig. 1. Tone-burst generator uses dual timer, has pitch and interval controls.

(type NE556A), Exar (type XR-2556CP), and Lithic Systems (type LS555-2). Another firm may now be added to the roster of producers of the 555 and its dual version, the 556. This is Raytheon's Semiconductor Division (350 Ellis Street, Mountain View, CA 94042). Raytheon has kicked off its introduction of these IC timers by producing a 16-page booklet featuring both device specifications and a variety of practical circuit applications. Three valuable circuits abstracted from that booklet are shown in Figs. 1, 2 and 3; all use the type 556 dual device.

You can use the tone-burst generator in Fig. 1 as an attention-getting alarm, incorporate it in musical rhythm equipment,

utilize it for special sound effects, or employ it in any similar application. In operation, one timer section serves as a slow-speed astable multivibrator to gate the second timer (an audio-frequency oscillator) at preset intervals. The gate control signal is applied to the second timer's "reset" terminal (pin 10). Separate controls are provided for adjusting both the audio pitch and the burst interval.

The auto burglar alarm control circuit given in Fig. 2 utilizes one timer section (A) to provide a time delay, thus permitting the driver to enter, exit, or disarm the alarm. This eliminates the need for an easily defeated external "disarm" switch. Note that a

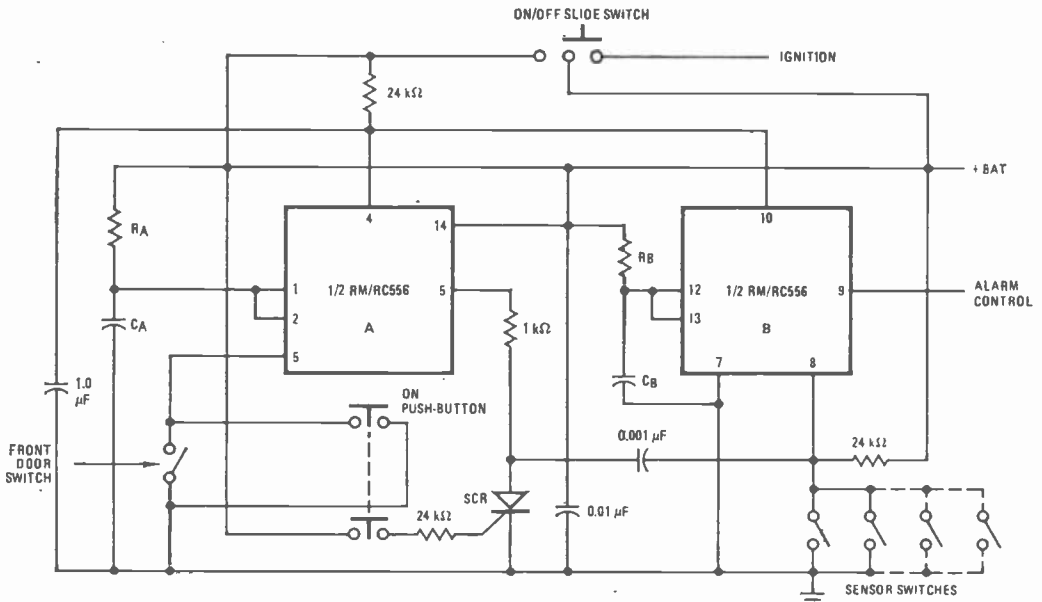

Fig. 2. Auto burglar alarm control circuit uses one timer to provide a delay.

separate sensor switch is provided on the front door *only* to control the delay circuit. All other sensor switches (rear door, luggage compartment, hood, etc.) are connected in parallel. The control circuit's output signal is used to switch an external alarm system.

Suitable for use as either a frequency or speed alarm control, the circuit shown in Fig. 3 employs one timer section to compare the input signal frequency to a preset RC time constant. If the signal frequency exceeds the allowable value, the timer's output remains in a high state, causing the second timer's output to shift to a low state and activate the separate alarm.

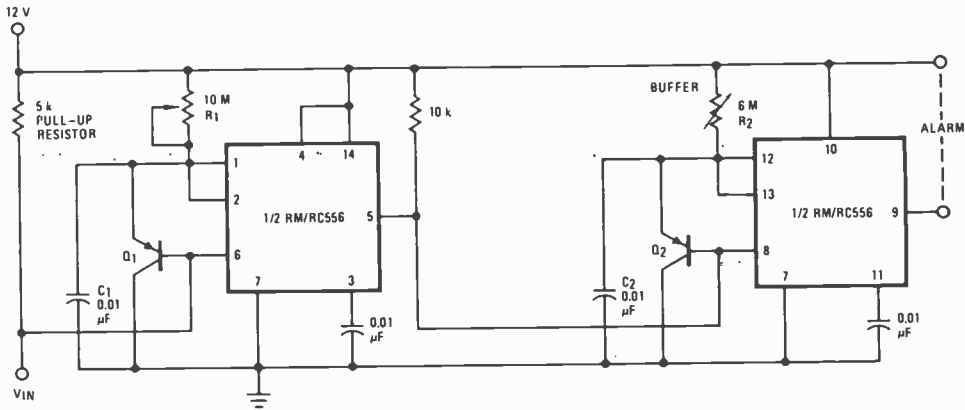

Fig. 3. For frequency or speed alarm control, timer compares input to preset constant.

Books, Brochures, et al. Unlike the slow-grinding Mill of the Gods, the printing presses of our semiconductor manufacturers are almost setting new records in turning out useful and valuable literature. Among the recent offerings:

Amperex High Power RF Transistors. Published by the Amperex Electronic Corporation (230 Duffy Ave., Hicksville, NY 11802), this 640-page book, contains 24 application reports which cover subjects ranging from single-sideband drivers and amplifiers to vhf and uhf FM power amplifiers. Among the circuits described are a single-stage power amplifier for 40 watts output in the 470-MHz band and a wide-band (1.6 to 28 MHz) linear power amplifier for 165 watts PEP. Suitable for advanced experimenters, serious hams, technicians and engineers, the book is priced at \$15.00 per copy, including a 2-year subscription to future reports.

Silicon Rectifier Handbook, 2nd Edition. Published by Motorola Semiconductor Products, Inc. (P.O. Box 20924, Phoenix, AZ

85036), this 216-page volume covers all phases of rectifier use, from basics through applications. Included are tables, graphs, circuits and specifications. A useful addition to any technical bookshelf, it is priced at \$2.50/copy.

Linear Integrated Circuits Data Book, 3rd Edition. Another Motorola publication, this massive 800-page book contains device listings, data sheets, package outlines, pinouts, schematic diagrams, an interchangeability guide and a listing of available Application Notes. "Quick Selector Guides" are provided for each device category to facilitate the location of specific data. The volume is \$3.00.

Linear IC Direct-Replacement Guide, publication CRG-110A. Available on request, this useful guide is printed on heavy card stock pre-punched for loose-leaf binding. Published by RCA's Solid State Division (Box 3200, Somerville, NJ 08876), the guide cross-references the products of 13 industry manufacturers. It should be extremely handy in locating a device for a project or for replacement.

Application Note AN-76. Available on written request from the National Semiconductor Corporation (2900 Semiconductor Drive, Santa Clara, CA 95051), this publication covers the practical aspects of using modern clock drivers in MOS memory systems and includes application information on driving various types of shift registers and RAM's using logic control.

Application Note AN-79. Also available from National Semiconductor, this paper covers the complete circuit and operating description of the LM121 IC preamplifier, discusses the techniques for achieving low drift, and includes circuit applications.

Device/Product News. Converting an existing piece of electronic test equipment from vacuum-tube to solid-state operation is not considered a feasible procedure under most conditions. It requires a complete re-design of the circuit, replacement of virtually every component, and a complete re-wiring job. But the conversion can be a cinch if it is accomplished by replacing vacuum tubes with FETRONS, hybrid JFET devices with characteristics (except for a filament) closely duplicating those of the vacuum tubes they are designed to replace.

Recognizing that many users would like to convert their older test instruments to solid-state operation, Teledyne Semiconductor (1300 Terra Bella Ave., Mountain View, CA 94043) has introduced the first two of a planned series of kits for replacing vacuum tubes with FETRONS. One is designed to replace the meter tubes in the Hewlett Packard HP400 VTVM, while the other kit replaces all tubes in the Tektronix CA oscilloscope plug-in module. The HP400 kit contains five FETRONS and sells for \$48.00, while the 15 FETRON CA kit is priced at \$110.00.

Featuring medium-power TTL drive capability, low power dissipation, high noise immunity, and good temperature stability, RCA's new 3-state COS/MOS gate (CD-4048A) has three binary control inputs which permit the selection of 1 of 8 output functions of eight input variables. The eight output functions are OR, NOR, AND, NAND, OR/AND, OR/NAND, AND/OR, and AND/NOR. An "expand" input permits cascading of several CD4048A's to obtain functions of 16, 24, or more variables. The device is available in 16-lead ceramic or plastic DIP's, in a 16-lead flat pack, and in chip form.

Working with r-f? Then you will be interested in Motorola's new r-f transistors designed for 28-volt dc transmitter applications—types MRF5174, MRF5175 and MRF5176. Of these, the MRF5174 is rated at 2 watts output and 12 dB gain at 400 MHz, the MRF5175 at 5 watts output and 11 dB gain at the same frequency, and the MRF5176 at 15 watts output and 10 dB gain. All three devices are for 200-to-600-MHz operation and are supplied in SOE (Strip-line Opposed Emitter) ceramic stud packages. Unit prices range from \$6.00 for the MRF5174 to \$17.00 for the MRF5176. ♦

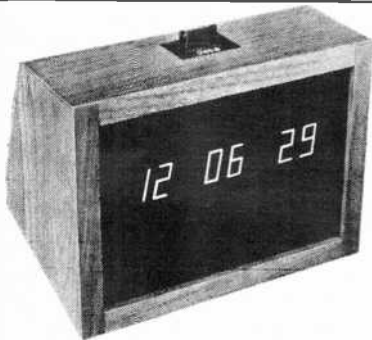

CHOICE OF DISPLAY MODES

You can decide to display time only, date only, or a continuous 10-second cycle in which time alternates with date. You can operate on a 12-hour or 24-hour international time sequence. And you can change all display modes instantly—anytime you wish—by flicking simple controls.

The highest quality digital clock/calendar you can build or buy!

This new Digital Concepts electronic digital clock and calendar indicates the hours, minutes and seconds . . . or the month and the day . . . or alternates between time and date at 10 second intervals. Glowing orange digital readout (a continuous character .55 inch high) is visible from almost any viewing angle, no matter how light or dark the room.

Operation is totally silent, with accuracy to within seconds a month; life expectancy is an incredible 100,000 hours.

Beautifully easy to assemble in just one evening—The contemporary hand rubbed oiled walnut cabinet is ideal for home, office or place of business. And a very memorable gift. All components of the kit mount on two interlocking printed circuit boards, for easy assembly in one evening, using only a soldering iron and a pair of diagonal cutters. The only wire in the kit is the line cord. The kit comes complete with one MOS/LSI integrated circuit, full 6-digit planar gas-discharge readout, and all other highest quality components you'll need. The Digital clock and calendar is also available factory assembled.

Enclosed please find my check or money order for \$ _____
or charge my MasterCard or BankAmericard account
number _____

Expiration date _____ to cover the following order:

_____ kit(s) of electronics only,
Model CK-100 @ \$68.00 each.
_____ cabinet(s) with face and mounting hardware,
Model C-31 @ \$18.00 each.
_____ factory assembled calendar/clock(s),
Model EC-102 @ \$108.00 each.

Add \$3.00 to cover costs of postage and handling.

digital concepts

247 Route 46, Saddle Brook, New Jersey 07662

Order now for immediate delivery—Send this coupon with your check or money order for fast delivery anywhere in the world. Money back guarantee if not fully satisfied.

Name _____

Address _____

City _____ State _____ Zip _____

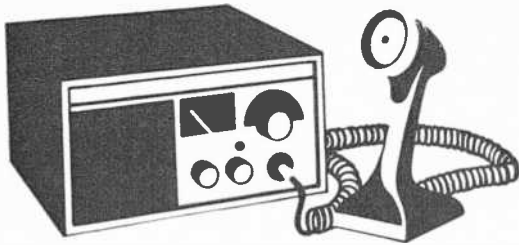

CB Scene

By Len Buckwalter, KQA5012

WE GET our CB from a speaker barking away somewhere under the dashboard. But the chairman of the board of Transylvania Oil probably listens over a telephone handset. The captain of a Boeing jumbo jet monitors with phones clamped to his head. Thanks to a couple of novel designs now reaching the CB marketplace, these deluxe features are no longer limited to transceivers that cost more than a Volkswagen.

The most unusual rig in many months was recently brought out by E. F. Johnson in



New E. F. Johnson rig has telephone handset.

what the company calls a "radiotelephone configuration." Translated, that means there is a telephone handset that looks exactly like the one on a home phone. Instead of listening through a loudspeaker and speaking over a mike, you simply remove the handset from its cradle and start communicating. A push-to-talk bar near the middle of the handset is for sending. The resemblance to a true radiotelephone is hardly an accident since Johnson purchases the housings from the same company that supplies radiotelephone manufacturers.

There are a couple of advantages to be gained from CB'ing with a handset. Since the receiver is held directly to the ear, noisy conditions of road and car are cut down. Also, weak signals are more easily under-

stood over headphones than through a loudspeaker. (The rig, incidentally, has a loudspeaker to alert the operator to an incoming call when the handset is in the cradle.) Yet another benefit is the privacy of listening—if that should be an important factor. Last, but certainly not least, is the prestige of using a handset instead of an old-fashioned mike.

The Boom Mike. Another novel item for "hollering and hearing" is from Telex, the headphone people. They are preparing to introduce a "boom mike headset" for the CB'er. It is designed to replace, or supplement, any rig's existing mike and speaker. A headphone, as mentioned earlier, has the advantage of excluding traffic and other noises that might be heard in the cab of a truck or the pilot house of a boat cleaving through the water. Telex, though, is using just one headphone because it is against the law in some states to drive with both ears covered up.

Even more interesting is the "boom mike" part of the new product. As shown in the photo on next page, the boom is attached to the back of the headphone and curves around the wearer's cheek. It positions the microphone squarely in front of the mouth for close talking and allows virtually hands-free operation. Boom mikes are especially popular among professional pilots because

Hearing & Speaking Accessories

POPULAR ELECTRONICS



Telex headset has earphone, boom mike.

they eliminate fumbling and cord-fouling in the cockpit. It is still necessary, however, to have some sort of press-to-talk switch, which Telex supplies as a part of the cord itself.

It should be possible to modify just about any existing CB rig to use a boom mike headset. Although Telex is still putting the finishing touches on the product, it will probably include a ceramic mike rated at 2000 ohms. Since there are so many connector styles for CB inputs, the mike cord will be supplied unterminated so that any plug can be attached.

Even if you don't buy a boom mike, you can still modify almost any CB receiver to be used with a headphone. Many receivers have a provision for the use of an external speaker. This jack can be used for an earphone by making one small addition. Since an earphone is far more sensitive than a speaker, the signal must be attenuated. Of course, this can be done by adjusting the front-panel volume control; but the knob, for a comfortable listening level, may be only slightly cracked open and, thus, diffi-

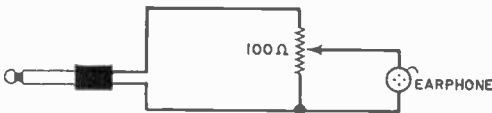

Fig. 1. Adding a jack for external speaker.

cult to adjust. One way to avoid the problem is to install a 100-ohm potentiometer, as shown in Fig. 1, and use it to reduce the audio power delivered to the earphone.

If the receiver has no external speaker

outputs, an earphone jack can be added to the speaker circuit as shown in Fig. 2. The CB audio circuit is a typical one, with one side of the speaker connected to chassis ground. Note that a wire from the audio output transformer was originally connected to the hot side of the speaker. This wire is broken, as indicated by the "X" in Fig. 2, and reconnected to the center of a closed-circuit jack. Mount the jack at some convenient point on the front or rear panel. With this arrangement, the speaker is automatically disabled when the earphone is plugged in. If the earphone is too loud, simply add the 100-ohm potentiometer as in Fig. 1 to serve as a coarse volume adjustment. Set the potentiometer for normal earphone level with the CB set's volume control about one-quarter open. Then leave the potentiometer at that setting. Day-to-day adjustments are usually more convenient to make at the set's regular volume control.

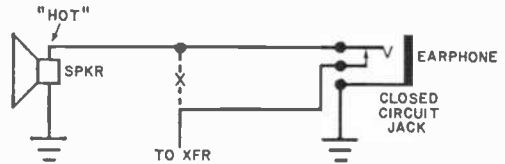

Fig. 2. Circuit for adding headphone jack.

External Speakers. That external speaker jack mentioned earlier is one of the more valuable additions that can be made to a CB receiver. There are many instances when the set's built-in speaker simply won't deliver the audio to the right place. If the transceiver is in a bedroom, for instance, it's pretty hard to monitor it when you are puttering around in the basement workshop or polishing the car. If you are using CB in one of the trades—construction, plumbing, etc.—you may not hear calls from a truck set while you're on the job. And the distance between a campsite and a parked automobile may put the mobile rig out of earshot.

The external speaker solves these problems. To add a speaker, start by installing the closed-circuit jack shown in Fig. 2. Since you'll be listening at a remote point, it is also handy to add a volume control at the second speaker. A 100-ohm wirewound potentiometer can be installed in series with one leg of the speaker circuit. This permits you to decrease the sound at the remote speaker. If the potentiometer is set at full volume, and there is insufficient signal, turn the set's volume control to a higher setting. ♦



Test Equipment Scene

By Leslie Solomon, Technical Editor

SEVERAL times, in previous columns, we have mentioned that the triangle waveform is the ideal signal to use in checking audio systems. The idea has generated quite a bit of mail—some pro and some con. A number of readers have also asked for a suggestion for a low-cost circuit of a triangle waveform generator that could be used in audio testing. Ever eager to please, this month we present such a circuit.

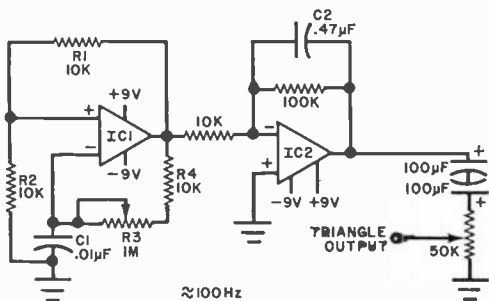

For the op amps, a pair of 741's can be used; but, in the long run, it will cost less to use a single 747, which is a dual op amp. It is also possible to use the 709 type of op amp, but then it is necessary to use compensation elements to prevent oscillation from throwing everything out of kilter.

The first part of the circuit is a simple variable-frequency square-wave generator (*IC1*). The second part is an integrator that converts the square waves to triangles. If you already have a square-wave generator, it can be used to drive the integrator directly. Circuit operation of the square-wave generator is as follows. When the output of *IC1* is at maximum positive, the noninverting input (marked +) is held to $\frac{1}{2}V_{cc}$ by the voltage divider made up of *R1* and *R2*. At the same time, capacitor *C1* is charged up through the series combination of *R4* and potentiometer *R3* (frequency control). As soon as the charge on *C1* reaches $\frac{1}{2}V_{cc}$, its

action on the inverting (-) input of *IC1* causes the op amp to switch to its maximum negative output.

The noninverting input is now clamped at $-\frac{1}{2}V_{cc}$ and *C1* starts to discharge to maximum negative. When the capacitor voltage slightly exceeds $-\frac{1}{2}V_{cc}$, the op amp switches again to its maximum positive output and the cycle repeats.

The output of this op amp is a square wave whose frequency is determined by the setting of *R3*. The values of *C1* and *R3* can be varied to provide other frequency values of interest. However, with the 741, the upper frequency limit is not very high, and the output waveform will not be a good square wave. The frequency used for triangle waveform testing is about 100 Hz (using the component values shown here).

The second op amp is connected as a conventional integrator with a capacitor in the feedback network. When a constant voltage (such as the top and bottom flat portions of a square wave) is applied to the integrator, capacitor *C2* starts to receive a charge at a constant rate and the voltage across the capacitor increases in a linear fashion. The capacitor is charged in one direction on the positive portion of the input square wave to produce one side of the triangle. On the negative portion of the square wave, the capacitor is rapidly

A Triangle Waveform Generator

switched to provide the other side of the triangle.

If you are in the mood to experiment, try various values for the feedback capacitor and square waves of different frequencies. You can learn a lot about op amp operation in this way.

The output goes through a nonpolarized capacitor coupling and a level control which determines the amplitude being fed to the test circuit.

Cosmetics. Many people build test equipment based on circuits and ideas given in this, and other, magazines. Unfortunately, the builder doesn't always realize that a project is not really complete when the electronic portion has been put together. Some seem to feel that finding and finishing a decent cabinet, using proper front-panel lettering, and having decent test leads and access connectors are merely frills that don't really count. They don't realize that, considering the amount of time and money they have put into a project, they should take enough pride in it to make it look presentable. It shouldn't have to be hidden away—unfortunately, we have seen some that deserve just that fate.

That's why we say that, if you are going to build a project (in this case, a piece of useful test equipment), give at least some thought to the cabinet and how it looks.

How do you do this? Start by getting catalogs from suppliers. (Many are advertised in this magazine.) Take a look at all of the cabinets, pilot lamp housings, switches, knobs, and other items that go on the outside of a project. Don't forget rubber feet. They not only dress up a project; they also keep it from slipping off the workbench. A little paint or some self-adhering patterned plastic also goes a long way toward making a project look like a fairy princess instead of an ugly duckling. There are all sorts of self-adhering trims too—gold or silver metal stripping, for instance.

You can always make a fancy front panel by cutting out a piece of stiff cardboard that will just fit the panel size. Paint it, add some lettering, and cement it onto the front of the chassis. Or, you can use the mounting hardware of the controls on the front to keep the facing in place. Don't forget to keep some "stick-on" lettering on hand to make the labeling look professional.

In finishing a chassis, you can use one of the various metallic sprays. ◆

2 Hz to 200 kHz frequency range
Sine, square, and triangle outputs
Linear and logarithmic sweep
Battery powered for maximum portability

All of the above in the function generator below

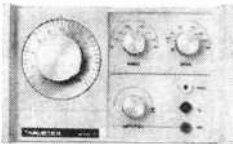

for only \$149.95.

Well, Wavetek's done it again—another function generator first. For under 150 bucks, you can get a complete audio signal source with the capability of generators costing several times as much. With our new Model 30, you can generate sine, square, and triangle waveforms over a frequency range of 2 Hz to 200 kHz. You can also sweep the frequency

in either the linear or logarithmic mode. The battery-powered Model 30 operates anywhere with complete line isolation. And for unlimited line operation, you can get an optional rechargeable power supply kit. At \$149.95, the Model 30 has performance and versatility that everyone can afford. So don't just sit there. Order one.

WAVETEK®

P.O. Box 651, San Diego, Calif. 92112; TWX 910-335-2007, Tel. (714) 279-2200

CIRCLE NO. 36 ON READER SERVICE CARD

DIGITAL COLO

Bell & Howell Schools announces an exciting new at-home learning program that includes this advanced color TV with digital features... you build it yourself!

You learn valuable skills in electronics through experiments and testing as you build a color television that's ahead of its time!

You've seen TV's that swivel, TV's with radios built in. TV's small enough to stuff in a suitcase and TV's that have remote control.

But now comes a color television with features you've *never* seen before. Features now possible as a result of the new applications of digital electronics --- features that make Bell & Howell's new 25-inch diagonal color TV ahead of its time! You learn about...

Channel numbers that flash big and clear right on the screen. An on-screen digital clock that flashes the time in hours, minutes and seconds with just the push of a button. An automatic channel selector that you pre-set to skip over "dead" channels and go directly to the channels of your choice.

And to insure highest quality performance, this new TV has silent, all-



electronic tuning, "state-of-the-art" integrated circuitry, Black Matrix picture tube for a brighter, sharper picture and 100% solid-state chassis for longer life and dependability.

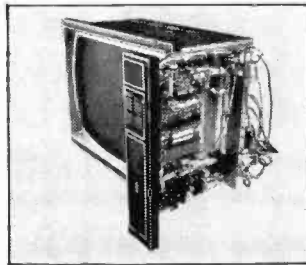

Perform fascinating experiments with the exclusive Electro-Lab® electronics training system. It's yours to build and keep!

Designed exclusively for our students, this Bell & Howell Electro-Lab®

Simulated TV picture.

You build and keep this revolutionary new Bell & Howell 25" diagonal color TV with amazing digital features!

Mail the postage-free card today for complete details, free!

gives you up-to-date "tools of the trade," including instruments you can use professionally after you finish the program.

A digital multimeter that measures voltage, current and resistance and displays its findings in big, clear numbers. Far more accurate and readable than conventional "needle pointer" meters



meters that require guesswork and interpretation.

The solid-state "triggered sweep" oscilloscope is a "must" for accurate analysis of digital circuitry. Includes DC wide-band vertical amplifier and "triggered sweep" feature to lock in signals for easier observation.

The design console is a valuable device for setting up and examining circuits without soldering! Features patented modular connectors, AC power supply and transistorized dual range DC power supply.

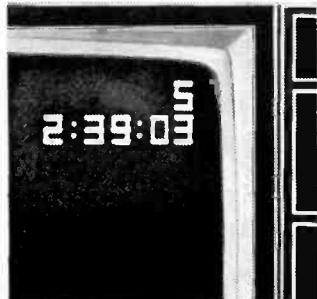

R TV IS HERE!

Build it yourself... the perfect way to discover the exciting field of digital electronics!

It's part of a complete learn-at-home program!

Imagine spending your spare time actually building your own 25-inch diagonal color TV! It's a project you can work on right in your home. You'll enjoy the challenge...exploring the new systems of digital circuitry and performing experiments to test what you learn.

There's no travelling to classes, no lectures to attend, and you don't have to give up your job or paycheck just because you want to get ahead. When you finish this new Bell & Howell Schools program you'll have learned new skills, plus you'll have a great color TV to keep and enjoy for years!

You need no prior electronics background!

We start you off with the basics.

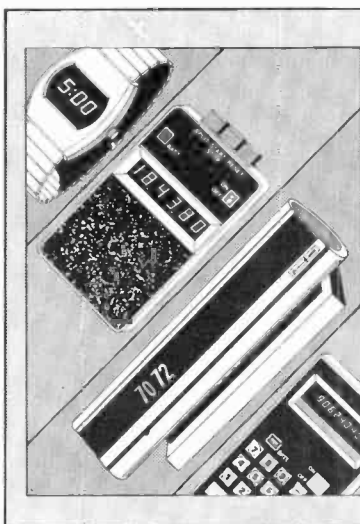

Digital electronics is changing our lives!

There's a lot more to digital electronics than just the numbers! True, that's what you see on more and more products like digital calculators, clocks and watches. But behind the numbers lies a fantastic technology that's creating higher standards of accuracy and dependability. The versatility of digital electronics has begun another industrial revolution. Its growth and applications are giving us new and better ways of doing things and spectacular products like this new Bell & Howell color TV with digital features!

You'll receive a special Lab Starter Kit with your first lesson so that you can get immediate "hands on" experience to help you better understand newly-learned electronics principles. Later, you'll use your new knowledge and learn valuable skills as you build the color TV. You can take advantage of our toll-free phone-in assistance service throughout the program and also our in person "help sessions" held in major cities throughout the year where you can "talk shop" with your instructors and fellow students.

Pick up valuable skills in electronics that could lead to extra income, full or part time... perhaps a business of your own!

Once you complete this new learn-at-home program from Bell & Howell Schools, you'll have the specialized skills to service color TV's plus the knowledge that you can apply to repair a variety of home electronics equipment. No better or more practical at-home training in electronics is available anywhere!

These skills could open up new income opportunities for you full or part time. While many of our students do not ask for employment assistance, it is available. Of course, no assurance of income opportunities can be offered. Get the complete story on this exciting, learn-at-home program... the world's first color TV course employing digital electronics technology!

Mail card today for full details, free!

If card has been removed, write:
An Electronics Home Study School
DEVRY INSTITUTE OF TECHNOLOGY

ONE OF THE
BELL & HOWELL SCHOOLS

4141 Belmont, Chicago, Illinois 60641

Electro-Lab is a registered trademark of the Bell & Howell Company.

597R4



New Products

Additional information on new products covered in this section is available from the manufacturers. Either circle the item's code number on the Reader Service Card inside the back cover or write to the manufacturer at the address given.

SANSUI FIVE-DRIVER SPEAKER SYSTEM

Sansui's Model SP-2500 three-way speaker system has a 12-in. woofer, two 5-in. midrange drivers, and two 2-in. horn-type tweeters. The midrange drivers are angled toward each other to provide a crossfire of sound. They have concave aluminum radiators mounted on the voice coil bobbins to yield smooth transition to the tweeters with little phase disruption. The newly



developed woofer is designed to assure smooth response even at low frequencies and allows the amplifier signal to be fed into it, bypassing the crossover network. The sound diffuser adjacent

to the tweeters creates an acoustic lens effect. Frequency range of the system is 30 Hz to 20,000 Hz, and power-handling capacity is 80 watts. (Price is \$209.95.)

Circle No. 70 on Reader Service Card

SENCORE FET MULTIMETER

The first thing one notices different about Sencore's Model FE27 Big Henry FET multimeter is the total absence of the traditional range/function switch. In its place are 16 push-button switches arranged in two rows of eight

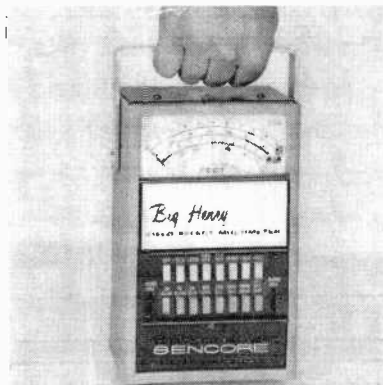

each. The upper row controls power to the instrument and the test functions, while the lower controls the range to be used. The user simply presses one button in each row. The only other controls on the front panel are thumb-operated zero-adjust and ohms-adjust potentiometers. (Price is \$150.)

Circle No. 71 on Reader Service Card

REGENCY 10-CHANNEL SCANNING MONITOR

The Regency Electronics, Inc., Model ACT-R 10/H/L/U is a 10-channel scanning monitor radio that can be programmed for any combination of frequencies in the uhf, high vhf, and low vhf bands. It can be used to monitor police, fire, civil defense, marine, weather, and business radio. It features pushbutton program control for each channel and for both automatic and

FREE McIntosh CATALOG and FM DIRECTORY

McIntosh Laboratory, Inc.
East Side Station P.O. Box 96
Binghamton, N.Y. 13904
Dept. 16-5

**SEND
TODAY!**

NAME _____

ADDRESS _____

CITY _____ STATE _____ ZIP _____

CIRCLE NO. 21 ON READER SERVICE CARD

Get all the news and latest information on the new McIntosh Solid State equipment in the McIntosh catalog. In addition you will receive an FM station directory that covers all of North America.



MX 113

AM FM/FM STEREO TUNER PREAMPLIFIER

POPULAR ELECTRONICS

manual operation. The receiver scans at a rate of approximately 15 channels per second while searching for an active signal. It automatically stops to permit monitoring any transmission it detects, then automatically resumes scanning. (Price is \$169 plus crystals.)

Circle No. 72 on Reader Service Card

NU-CONCEPT DESOLDERING TOOL

A desoldering tool that provides a simple solution to 14- and 16-pin dual in-line integrated circuit removal is being marketed by Nu-Concept Computer Systems Inc. Designated the PAK-X-TRAC™, it enables the user to remove soldered-in IC's from printed circuit boards in seconds. In use, it is a one-handed tool that weighs less than 8 ounces.

Circle No. 73 on Reader Service Card

NEW-TRONICS 2-METER COLINEAR ANTENNA

The Hustler 2-meter colinear Model G6-144-A antenna is expressly designed for repeater or fixed-station operation. FCC accepted for repeater application, the antenna is conservatively rated at 6 dB gain, based on EIA Standard RS-329 (gain over a half-wave dipole). Special features are built into the 117-in. antenna, including high-power capability, shunt feed with dc grounding, easily accessible SO-239, four radials, heavy-duty construction, and U-bolt mounting. (Price is \$49.95.)

Circle No. 74 on Reader Service Card

HEATHKIT HIGH-RESOLUTION FREQUENCY COUNTER KIT

The new Heathkit Model IB-1103 frequency counter responds out to 180 MHz with high resolution through the use of a phase-locked



frequency multiplier. Pushbutton switch selection permits multiplication by 1, 10, 100, or 1000. A temperature-compensated crystal oscillator generates the time base, and three push-buttons provide 1-ms, 100-ms, and 1-s gate times. Input sensitivity is 50 mV to 120 MHz and 100 mV from 120 MHz to 180 MHz. A rear-panel switch permits bypassing the internal oscillator to permit the use of any external time base (up to 3 V). The display consists of an 8½-digit cold-cathode neon indicator array. Indicators

MAY 1974

DELUXE
MAGAZINE CASES

Designed Exclusively for
POPULAR ELECTRONICS

- The ideal way to save your valuable copies, keep them well protected and make it easy for you to refer to any issue at any time. Both decorative and attractive enough to enhance the decor of any room, each case holds a full year's copies. Constructed of reinforced fiberboard, these durable cases are covered in a rich-textured leatherette. The gold embossed back adds to its elegance and makes each case a welcome addition to your bookshelf or cabinet.

Magazine cases are available for any of your favorite magazines. They're only \$4.50 each, 3 for \$12.50, in any combination of titles ordered. Add 50¢ per case for postage and handling. Outside U.S.A. add \$1.00 per case ordered.



**CHARGE YOUR AMERICAN EXPRESS
OR BANKAMERICARD ACCOUNT**



Ziff-Davis Pub. Co., Dept. 23, 1 Park Avenue, New York 10016

My remittance in the amount of \$_____ is enclosed. Please send magazine cases for the titles indicated below.

CHARGE: American Express BankAmericard

Account # _____

Signature _____

TITLE	PE-574	QUANTITY

Check One: All Black Maroon Back, Black Sides

Print Name _____

Address _____

City _____ State _____ Zip _____

PAYMENT MUST ACCOMPANY ORDER

Planning to move?

Let us know 6 to 8 weeks in advance so that you won't miss a single issue of **POPULAR ELECTRONICS INCLUDING ELECTRONICS WORLD**

Attach old label where indicated and print new address in space provided. Also include your mailing label whenever you write concerning your subscription. It helps us serve you promptly.

Write to: P.O. Box 2774, Boulder, Colo., 80302 giving the following information.

If you have no label handy, print OLD address here.

name	please print
address	
city	
state	zip-code

AFFIX LABEL

- Extend subscription.** **Change address only.**
- Enter new subscription.**
- 5 yrs. \$21 3 yrs. \$15. 1 year \$6
- Payment enclosed (1 extra issue per yr. as a BONUS)**
- Bill me later.** 0882

name _____ please print

address _____

city _____ state _____ zip _____

Add postage: \$2 per year outside U.S., its possessions & Canada.

are provided for gate, overrange, unlocked operating conditions, and for MHz, kHz, and Hz. (Price is \$379.95.)

Circle No. 75 on Reader Service Card

PHASE LINEAR STEREO PREAMPLIFIER

The new Phase Linear Model 4000 preamplifier is designed to eliminate the inherent noise produced during the recording process and to restore dynamic range. It features the "Auto

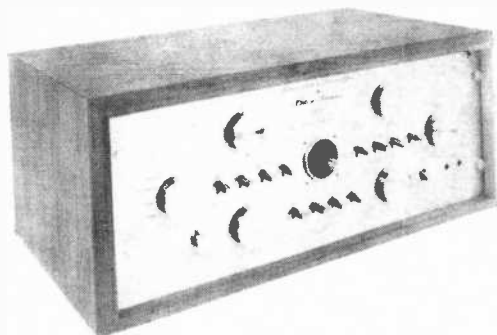

Correlator" noise reduction system that makes record/tape hiss and FM broadcast noise virtually vanish without affecting musical content. Music altering recording techniques, such as "peak unlimiting" and "gain riding", used to put the full range of musical sound on tape or disc, are compensated for by the preamp. The preamp's "Peak Unlimiter" and "Downward Expander" sense whether these techniques have been used and automatically corrects them. (Price is \$599.)

Circle No. 76 on Reader Service Card

MIT'S 8-DIGIT CALCULATOR WITH MEMORY

An 8-digit/8-function hand-held calculator with built-in memory function is available factory-wired and in kit form from MITS, Inc. The Model 908M calculator performs the usual four arithmetic functions, square, square root, reciprocal, and percent. The memory feature can be used as a constant, temporary storage register, or an accumulator. The user can choose between fixed and floating decimal. Other features include raised, positive-touch keys; true credit balance sign display; algebraic mode of entry;

leading and trailing zero suppression; overflow indication; automatic display cutoff; and low-battery indication. (Price is \$99.95 in kit form, \$129.95 factory wired.)

Circle No. 77 on Reader Service Card

TURNER NOISE-CANCELLING MICROPHONE

Turner's Model ND350DM microphone was designed specifically for use in mobile communications applications where traffic, equipment, motor, or any other unwanted background noise presents a problem. The mike has a frequency range of 100 to 8000 Hz and an impedance of 2000 ohms to complement all solid-state equipment in which the input impedance is between 600 and 5000 ohms. It has an output level of -60 dB (0 dB = 1mV/10 microbars). It is wired for relay switching, but it can be easily converted for electronic switching.

Circle No. 78 on Reader Service Card

AUDIOTEX STEREO MICROPHONE MIXER

You can increase the number of microphone inputs to your tape recorder or amplifier with the new stereo mike mixer (Cat. No. 30-2320) from GC Electronics, Audiotex Division. The mixer feeds up to four high-impedance signals to a single high-impedance input. It has provisions for increasing or decreasing the volume of any channel while feeding or holding the other channels at a constant level.

Circle No. 79 on Reader Service Card

TEAC DELUXE 3-MOTOR/3-HEAD TAPE DECK

Teac's Model 3300S-2T looks and is designed to handle like a professional mastering tape deck. It has three motors and three heads, a two-track/2-channel format, 15 and 7½-ips speeds, 10½-in. tape reel capacity, remote control capability, and total pushbutton transport control with logic circuitry. Separate bias and equalization switches are provided for standard and high-energy tapes. A reel size selector automatically presets motor torque and holdback tension. A precision narrow-gap tape head design is said to offer the highest possible frequency response and a signal-to-noise ratio of 60 dB. (Price is \$679.50.)

Circle No. 80 on Reader Service Card

SBE

SCANNERS

HF/FM • VHF/FM • UHF/FM •

SBE "Sentinel", high performance, full-feature scanning receiver. VHF, UHF and HI-Lo models.

- 8 xtal controlled channels • Automatic or manual scanning • Lockout of any channel • Priority Channel! Provides instant shift to pre-selected channel when priority signal appears —by-passes other channels • 12VDC and 115VAC operation for car or home use • Big audio —¾ watts • Telescoping antenna, mounting bracket, 2 power cords • Compact

Write for full line scanner brochure

LINEAR SYSTEMS, INC. 220 Airport Blvd., Watsonville, CA 95076



CIRCLE NO. 20 ON READER SERVICE CARD

POPULAR ELECTRONICS

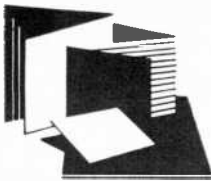

New Literature

MOTOROLA CMOS DATA BOOK

More than 300 pages of CMOS product data, basic technology and applications information, and product selector guides are in Motorola's "McMOS Integrated Circuits Data Book." Data is included on 68 separate functions, some of the more useful of which are: an Arithmetic Logic Unit, Look Ahead Carry Block, 64-bit RAM, 1024-bit ROM, and Successive Approximation Register (for A/D applications). The Data Book is \$2.50 from Motorola Semiconductor Products, Inc., Technical Information Center, P.O. Box 20924, Phoenix, AZ 85036.

RADIO SHACK ELECTRONIC PARTS CATALOG

Radio Shack has added more than 2000 hard-to-find electronics items to its parts and test equipment line, all of which are listed and described in the "Qwik-Fill" 1974 Electronic Parts Catalog (No. AE-74). The 52-page catalog lists a variety of special-purpose tubes, transistors, readouts, PC and IC equipment, relays, resistors, capacitors, potentiometers, transformers, test instruments, and more. Address: Radio Shack, 2617 W. Seventh St., Fort Worth, TX 76107.

EDMUND SCIENTIFIC CATALOG

Hundreds of new items have been added to the latest edition (No. 742) of the Edmund Scientific catalog. In its 180 illustrated pages are listed and described more than 4500 items. Coverage includes toys and games, electronic and light effects gadgets, scientific materials, astronomy and optics equipment, and much more. Among the electronic items to be found are the Bio-Rhythm Charting and Analysis kit, lasers, solar-powered radio kit, electronic calculator/digital clock combination, and a handheld metal locator. Address: Edmund Scientific Co., 380 Edscorp Bldg., Barrington, NJ 08007.

CALECTRO FET CIRCUIT BOOK

For 25¢, you can get the "FET Circuit Book" (Cat. No. FR-172) from Calectro Division of GC Electronics. It gives a basic introduction to the technical details of the field-effect transistor and provides schematics for nine different circuits. Address: GC Electronics, Division of Hydrometals, Inc., 400 S. Wyman St., Rockford, IL 61101.



FREE

1974 LAFAYETTE CATALOG 740

Ready Now!

Your Complete Electronics Buying Guide

- Stereo/Hi-Fi Components • CB Transceivers & Walkie-talkies • PA Systems • Tools & Test Equipment
- Police/Fire Monitor Receivers • Antennas • Photography Equipment • Ham Gear • Books, Parts, and More!

Send Today!

Lafayette Radio Electronics
P.O. Box 10, Dept. 35054
Syosset, L.I., N.Y. 11791

NAME _____ 35054

ADDRESS _____

CITY _____

STATE _____ ZIP _____

CIRCLE NO. 19 ON READER SERVICE CARD

ABOUT YOUR SUBSCRIPTION

Your subscription to POPULAR ELECTRONICS is maintained on one of the world's most modern, efficient computer systems, and if you're like 99% of our subscribers, you'll never have any reason to complain about your subscription service.

We have found that when complaints do arise, the majority of them occur because people have written their names or addresses differently at different times. For example, if your subscription were listed under "William Jones, Cedar Lane, Middletown, Arizona," and you were to renew it as "Bill Jones, Cedar Lane, Middletown, Arizona," our computer would think that two separate subscriptions were involved, and it would start sending you two copies of POPULAR ELECTRONICS each month. Other examples of combinations of names that would confuse the computer would include: John Henry Smith and Henry Smith; and Mrs. Joseph Jones and Mary Jones. Minor differences in addresses can also lead to difficulties. For example, to the computer, 100 Second St. is not the same as 100 2nd St.

So, please, when you write us about your subscription, be sure to enclose the mailing label from the cover of the magazine—or else copy your name and address exactly as they appear on the mailing label. This will greatly reduce any chance of error, and we will be able to service your request much more quickly.

BE CHOOSEY. YOU CAN AFFORD TO WITH EICO

The more you know about electronics, the more you'll appreciate EICO. We have a wide range of products for you to choose from, each designed to provide you with the most pleasure and quality performance for your money. If you prefer, you can "Build-it-Yourself" and save up to 50% with our famous electronic kits.

For latest EICO Catalog on Test Instruments, Automotive and Hobby Electronics, Burglar-Fire Alarm Systems and name of nearest EICO distributor, check reader service card or send 25¢ for fast first class mail service.



CIRCLE NO. 13 ON READER SERVICE CARD

**EVERYTHING YOU
WANTED TO KNOW
ABOUT CD IGNITION
SYSTEMS BUT DIDN'T
KNOW WHOM TO ASK.**

Send for FREE Tiger booklet (20 pages) which answers all your questions.

Name _____

Address _____

City _____

State _____ Zip _____

CLIP OUT THIS AD AND SEND TO—

TRI-STAR CORP.

P. O. Box 1727 Dept. E
Grand Junction, Colo. 81501

CIRCLE NO. 33 ON READER SERVICE CARD

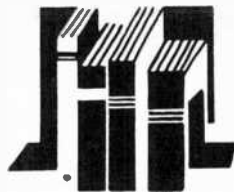

Electronics Library

ELECTRONICS SHOP PRACTICES, EQUIPMENT, AND MATERIALS

by Clyde N. Herrick

As its title implies, this book is primarily an exposition on the proper fabrication techniques to use when assembling original electronic equipment. While it is written for the technician-in-training, the material covered is invaluable to hobbyists and experimenters who make their own gear from basic parts. Among the topics are safety rules and tools, parts identification and codes and symbols, basic hardware, soldering, cabling and harness making, drawings and blueprints, and much more.

Published by Prentice-Hall, Inc., Englewood Cliffs, NJ 07632. Hard cover. 340 pages. \$14.95.

CASSETTE TAPE RECORDERS: HOW THEY WORK—CARE & REPAIR

by Walter G. Salm

This book is an up-to-date guide to cassette recorder alignment, adjustment, maintenance, and repair for the technician, hobbyist, audiophile, or anyone who wants to develop a well-rounded understanding of cassette recorders. The text explains how cassette recorders work, how various systems differ, and why the cassette is now challenging open-reel tapes as the record/playback system most suitable for serious hi-fi applications. Much useful data on recording techniques involving microphones, mike mixers, and volume levels is included.

Published by Tab Books, Blue Ridge Summit, PA 17214. 204 pages. \$7.95 hard cover; \$4.95 soft cover.

WORLD RADIO & TV HANDBOOK 1974

When a specialized handbook like this has gone into its 28th edition, there is very little in it that can be considered "new and exciting." Be that as it may, this is a comprehensive compilation on radio and TV broadcasting throughout the world. Updated during the latter part of 1973 for use in 1974, it contains all the information needed by the serious listener, including stations, call signs, frequencies, schedules, languages, power, etc.

Distributed by Gilfer Associates, Inc., Box 239, Park Ridge, NJ 07656. Soft cover. 408 pages. \$7.50.

ELECTRONICS MARKET PLACE

NON-DISPLAY CLASSIFIED; COMMERCIAL RATE: For firms or individuals offering commercial products or services, \$1.60 per word (including name and address). Minimum order \$16.00. Payment must accompany copy except when ads are placed by accredited advertising agencies. Frequency discount: 5% for 6 months; 10% for 12 months paid in advance. **READER RATE:** For individuals with a personal item to buy or sell, \$1.00 per word (including name and address.) No minimum! Payment must accompany copy. **DISPLAY CLASSIFIED:** 1" by 1 column (2 3/4" wide), \$200.00. 2" by 1 column, \$400.00. 3" by 1 column, \$600.00. Advertiser to supply cuts. For frequency rates, please inquire.

GENERAL INFORMATION: First word in all ads set in bold caps at no extra charge. All copy subject to publisher's approval. All advertisers using Post Office Boxes in their addresses **MUST** supply publisher with permanent address and telephone number before ad can be run. Advertisements will not be published which advertise or promote the use of devices for the surreptitious interception of communications. Closing Date: 1st of the 2nd month preceding cover date (for example, March issue closes January 1st. Send order and remittance to **POPULAR ELECTRONICS**, One Park Avenue, New York, New York 10016, Attention: Hal Cymes.

FOR SALE

FREE! bargain catalog. Fiber optics, LED's, transistors, diodes, rectifiers, SCR's, triacs, parts. Poly Paks, Box 942, Lynnfield, Mass. 01940.

GOVERNMENT Surplus Receivers, Transmitters, Snooperscopes, Radios, Parts, Picture Catalog 25¢. Meshna, Nahant, Mass. 01908.

LOWEST Prices Electronic Parts. Confidential Catalog Free. **KNAPP**, 3174 8TH Ave. S.W., Largo, Fla. 33540.

ELECTRONIC PARTS, semiconductors, kits. **FREE FLYER**. Large catalog \$1.00 deposit. **BIGELOW ELECTRONICS**, Bluffton, Ohio 45817.

RADIO—T.V. Tubes—36¢ each. Send for free catalog. Cornell, 4213 University, San Diego, Calif. 92105.

AMATEUR SCIENTISTS, Electronics Experimenters, Science Fair Students . . . Construction Plans—Complete, including drawings, schematics, parts list with prices and sources . . . Robot Man — Psychedelic shows — Lasers — Emotion/Lie Detector — Touch Tone Dial—Quadrasonic Adapter—Transistorized Ignition — Burglar Alarm—Sound Meter . . . over 60 items. Send 25¢ coin (no stamps) for complete catalog. Technical Writers Group, Box 5994, University Station, Raleigh, N.C. 27607.

METERS—Surplus, new, used, panel or portable. Send for list. **Hanchett**, Box 5577, Riverside, CA 92507.

PYROTECHNICAL chemicals, casings, tools, supplies, fuse, literature. Giant, illustrated catalogue/handbook includes formulas, instructions—50¢, with samples—\$1.00. **Westech**, Box 593, Logan, Utah 84321.

WE SELL CONSTRUCTION PLANS. TELEPHONE: Answering Machine, Speakerphone, Carphone, Phonevision, Auto Dialer, Touch Button Dialer, Central Dial System. **TELEVISION:** \$35.00 Color Converter, Video Tape Recorder. \$25.00 Camera. **HOBBYIST:** Electron Microscope, 96 Hour Tape Music System, Ultrasonic Dishwasher, Radar-Oven. Plans \$4.95 each. **NEW ITEM:** \$75. Electronic Pocket Calculator, \$7.50. **COURSES:** Telephone Engineering \$39.50. Detective Electronics \$22.50. Integrated Circuit Engineering, \$49.50. **NEW SUPER HOBBY CATALOG** plus year's subscription to Electronic New Letter **AIRMAILED \$1.00**. Don Britton Enterprises, 6200 Wilshire Blvd., Los Angeles, Calif. 90048.

JAPAN HONG KONG DIRECTORY. World products information. \$1.00 today. World Trade Inquiries, Hillyard, Washington 99207.

SCOPES, meters, test equipment, military and industrial surplus. Write for free "Bargain Bulletins". Lawrence Instruments, P.O. Box 744, Sunbury, Pa. 17801.

TEST EQUIPMENT, Aerospace-Laboratory Grade. Request your needs; will mail appropriate catalogs (we have 24 catalog categories). Only for Engineers, Businessmen, Schools and advanced Technicians. Goodheart, Box 1220PE, Beverly Hills, Calif. 90213.

WAVEFORM GENERATOR KIT 8038 Function Generator IC Producing Sine, Square, Triangular Waveforms, \$10.00. Write for catalog. Photolum Corporation, 118 East 28th Street, New York, N.Y. 10016.

LOOKING FOR A NEW CHALLENGE?

... then build a TV camera!



ONLY SOLID-STATE CAMERA AVAILABLE IN KIT FORM OR FACTORY ASSEMBLED. COMPLETE KIT WITH VIDICON TUBE ONLY \$120.00. POSTPAID DELIVERY ANYWHERE IN USA, CANADA and MEXICO. OPTIONAL AUDIO SUBCARRIER \$18.95. WRITE OR PHONE NOW FOR COMPLETE CATALOG OF KITS, PARTS and PLANS. DIAL 402-987-3771.

1301 BROADWAY **ATV Research** DAKOTA CITY, NEBR. 68731

DIGITAL ELECTRONICS: Complete schematics, parts lists, theories —Discrete Component Digital Clock, \$3.00—Sound Sensitive Switch, \$1.50. Increase technical competence, hobby skills—Complete Course in Digital Electronics is highly effective, \$10.00. Free literature. **DYNASIGN**, Box 60A7, Wayland, Mass. 01778.

SOUND SYNTHESIZER KITS—Surf \$11.95, Wind \$11.95, Wind Chimes \$16.95, Electronic Songbird \$6.95, Musical Accessories, many more. Catalog free. **PAIA Electronics**, Box 114359, Oklahoma City, OK 73114.

Digi-Key

Quality Electronic Components

DIGI-KEY CORPORATION

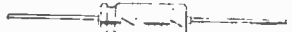

MINIATURE ALUMINUM ELECTROLYTIC CAPACITORS

Temp. range: -40°C +85°C Tolerance: -10 +50% for more than 4.7 ufd, -10 +75% for 4.7 ufd or less

Value	1	10-99*	100-240*	Value	1	10-99*	100-240*
1 ufd/50V	14c	12c	11c	100 ufd/16 V	19c	15c	14c
2.2 ufd/50 V	14c	12c	11c	100 ufd/25V	24c	18c	17c
3.3 ufd/35V	14c	12c	11c	220 ufd/16 V	24c	18c	17c
4.7 ufd/35 V	14c	12c	11c	220 ufd/25 V	35c	25c	24c
10 ufd/16 V	13c	10c	9c	330 ufd/16 V	35c	25c	24c
10 ufd/25 V	14c	11c	10c	330 ufd/25 V	44c	35c	32c
22 ufd/16 V	14c	11c	10c	470 ufd/16 V	37c	30c	27c
22 ufd/25 V	15c	13c	12c	470 ufd/25 V	49c	39c	35c
33 ufd/16 V	15c	12c	11c	1000 ufd/16 V	49c	39c	35c
33 ufd/25 V	17c	13c	12c	1000 ufd/25 V	75c	60c	55c
47 ufd/16 V	17c	14c	13c	2200 ufd/16 V	75c	60c	55c
47 ufd/25 V	19c	15c	14c				

*10 pcs per capacitance value

1/2 & 1/4 WATT CARBON COMP. RESISTORS

5 each of the 85 standard 10% values (2.2-220M) 1/2 W Resistors (425 pcs)
Sorted by value \$12/set 2-4 are \$11/set 5-9 are \$10/set.

5 each of the 70 standard 10% values (10-5.0M) 1/4 W Resistors (350 pcs)
Sorted by value \$12/set 2-4 are \$11/set 5-9 are \$10/set.

Also available are TTL & Linear IC's, Silicon Rectifiers, Molex Pins, LED Readouts & Lamps, Transistors, IC Sockets, Slide Switches, Reed Relays and more!



Send for FREE CATALOG or Mail Readers Service Card
C.O.D. ORDERS ACCEPTED FOR SAME DAY SHIPMENT
CALL 218-681-6674



Orders Less Than \$10.00 Add 25c — Others Postpaid

DIGI-KEY

Box 126 Thief River Falls, MN 56701
CIRCLE NO. 11 ON READER SERVICE CARD

FREE 1974 CATALOG!!

NEW .3" Char. Height YELLOW MAN 81 and red MAN 74 LEDs. 3-4 only \$5.00 each.
 Also available with 7490, 7447, 7475 latch and G-10 epoxy board for 2, 4, or 6 digits.

POWER SUPPLY KITS!
 5, 12, 15 vDC @ 1 Amp. $\pm 15\% \pm .1$ or 1 amp. Short Circuit, thermal overload protection. All models include space for transformer on the circuit board. 5v kit for only \$8.95 (less transformer). Instructions included.

RESISTORS - 5% 1/2 watt CARBON FILM
 Superior to composition in everyway, but at the same low price 12c each. Quantity Discounts.

CAPACITORS for bypassing, coupling, etc. Sub-miniature case. .001-.22uF, 100 vDC .001 15c each. Quantity Discounts.

ALUMINUM ELECTROLYTICS 1-2200 uF from 16-50 vDC. These are high quality ICC units at a very low price.

OTHER 7400 SERIES PARTS AVAILABLE as well as op amps, transistors, display bezels, and cases for your projects. **MANY OTHER KITS** also. All products guaranteed. **NAME BRANDS ONLY.** Mastercharge and Bank Americard accepted.

Tracy Design Corporation

15870 Schaefer Detroit, Mich. 48227

CIRCLE NO. 31 ON READER SERVICE CARD

MECHANICAL, ELECTRONIC devices catalog 10¢. Greatest Values—Lowest Prices. Fertik's, 5249 "D", Philadelphia, Pa. 19120.

SURPLUS electronic parts and pieces. Monthly picture flyer free. Startronics, Box 17127, Portland, Oregon 97217.

BURGLAR-FIRE alarm components, hardware. Free catalog—information. Silmar, 133 S.W. 57 Ave., Miami, Florida 33144.

DISCOUNT PRICES

B & K, SENCORE, LEADER Test Equipment
 RAYTHEON, ICC/MULLARD Tubes
 TELEOMATIC Test Jigs

Free Catalog

FORDHAM RADIO SUPPLY CO. INC.
 558 Morris Ave., Bronx, N.Y. 10451

FREE CATALOG. Parts, circuit boards for **POPULAR ELECTRONICS** projects. PAIA Electronics, Box C14359, Oklahoma City, OK 73114.

YOU SAVE BIG MONEY! Surplus, Clearouts, Bankruptcy, Inventory, Deals. Catalog \$1 (redeemable). ETCOA Electronics, Box 741, Montreal, H3C 2V2. U.S. Inquiries.

ELECTRONIC Parts wholesale. Catalog 10¢. Donlyn Electronics, P.O. Box 15421, Phoenix, Arizona 85060.

FREE Catalog lists resistors, tubes, transistors, rectifiers, condensers, tools, tuners, etc. Hytron Hudson, Dept. PE, 2818 Kennedy Blvd., Union City, N.J. 07087.

BURGLAR-FIRE alarm supplies and information. Free catalog. Protecto Alarm Sales, Box 357-G, Birch Run, Michigan 48415.

FREE CATALOG. IC's, Puts, Transducers, Thermocouples, Led's, Transistors, Circuit Boards, parts. Chaney's, Box 15431, Lakewood, Colo. 80215.

LASER parts catalog, 60¢. Moynihan, 107 North Brighton, Atlantic City, New Jersey 08401.

AUTHENTIC, INSTRUMENTED, FLYING ROCKETS for casual or serious experimenters. Over 80 scale original, multi-stage or ready-to-fly models. Solid-propellant engines for safe, electric launch system liftoffs up to 2,500 feet. Measure altitude, temp. inversions, more. Real telemetry, electronic tracking, aerial still and movie photography with super-miniaturized equipment. New, detailed tech manual and full-color catalog. 25¢ from **ESTES INDUSTRIES** Dept. 18W, Penrose, Colo. 81240.

PAIA SYNTHESIZER KITS



- Models
 priced from
 \$139 -

**LIKETOHEARIT?
 NEED TOKNOWMORE?**
 10 minutes of far out sounds
 created with the PAIA Synthesizer
 now on a demo record...75¢ - Catalog free

PAIA ELECTRONICS, INC.

BOX P14359, OKLAHOMA CITY, OK 73114

ELECTRONIC ORGAN KITS, KEYBOARDS and many components. Independent and divider tone generators. All diode keying. I.C. circuitry. Supplement your Artisan Organ. 35¢ for catalog. **DEVTRONIX ORGAN PRODUCTS**, Dept. C, 5872 Amapola Drive, San Jose, Calif. 95129.

CALCULATOR OWNERS: Use your $+ - \times \div$ calculator to compute square roots, cube roots, $\sin(x)$, $\cos(x)$, $\tan(x)$, $\arcsin(x)$, $\arccos(x)$, $\arctan(x)$, logarithms, exponentials, and more! **Quickly, Accurately, Easily!** Send today for the **IMPROVED AND EXPANDED EDITION** of the first and best calculator manual—now in use throughout the world... only \$2.00. Unconditional money-back guarantee—and **FAST** service! Mallmann Optics and Electronics, Dept. 15A, 836 South 113, West Allis, Wisconsin 53214.

BUGGED??? New locator finds them fast. Write, Clifton, 11500-L N.W. 7th Avenue, Miami, Florida 33168.

TELEPHONE "BUGGED"? Countermeasures Brochure \$1.00. Negeye, Drawer 547, Pennsboro, W. VA 26415.

JAPANESE TRANSISTORS, Wholesale Prices, Free Catalog. West Pacific Electronics, Box 25837, W. Los Angeles, CA 90025.

ELECTROSLEEP, acupuncture. Catalog of 200 more projects free. Cimarron Labs, G-13060 Center Rd., Clio, Michigan 48420.

WE SELL MONEY MAKING CONSTRUCTION MANUALS!—Reclaim refined **GOLD** and **SILVER** for **EXCELLENT** full time or part time money!—Color Catalog 25¢—Airmailed 50¢. Creative Products, Dept. PE-574, 8415 Lofland, Houston, Texas 77055.

HEAR POLICE/FIRE Dispatchers! Catalog shows exclusive directories of "confidential" channels, receivers. Send 10¢ stamp. Communications, Box 56-PE, Commack, N.Y. 11725.

FIREWORKS NEWS—Magazine Covering Commercial—Display Fireworks, Sources, Construction, Pyrotechnical Supplies, Fuse, Literature. Free Catalogs/Book'ist With Subscription! Calendar Year \$9.00 "1974" Fireworks Buyers' Guide" \$5.95. Pyro Press, Box 12010N, Lexington, Kentucky 40511.

DRAKE and Swan Receivers, Transmitters, Transceivers, Accessories. New Boxed 1974 models, trade-in's taken. Slep Electronics, P.O. Box 100, Otto, North Carolina 28763.

1/2 WATT Resistors all values 2¢. Minimum \$2.00. Lectronix, Box 1067, Southgate, Michigan 48195.

LOW NOISE RESISTORS—carbon film. Brand new as low as \$2.25 each. Components Center-PE, Box 134, N.Y., N.Y. 10038.

LIGHT EMITTING DIODES		TRANSISTORS SPECIALS		5311—Clock Chip featuring BCD, hold count and output \$11.50		C MDS (Diode Clamped)	
MRD 14B Photo \$.75	2N1137B PNP TO-3 GE \$.95	5314—Clock Chip 6 digit read-out hold count \$9.50	5316—Alarm Clock Chip \$13.95
MT2 Photo Transistor \$.80	2N2222 NPN Si TO-92 \$1.00	ASCII Encoder \$60.00	Terminal Keyboards \$60.00
WCT-2 Opto. Isolator \$.90	2N3137 PNP Si TO-5 \$1.00	14 Pin IC Sockets \$.40	Printed circuit board 4 1/2" x 6 1/2" double sided fiber glass board 1/16" thick, unetched. \$2.50 ea. \$52.50
OSL-3 GaP VIS. LED \$.50	2N1605 NPN GE TO-5 \$1.00	Miniature Trim Pots \$2.00	5K, 10K, 20K, 25K, 50K, 100K \$1.75 3/\$2.00
WCD-2 Opto. Isolator \$.90	MPS3393 PNP Si TO-106 \$1.00	FULL WAVE BRIDGES \$1.25	200 95 1.25	400 1.15 1.50
ME4 IR LED's \$.50	2N2218T NPN Si TO-5 4 \$1.00	PRV 2A 6A \$1.25	600 1.35 1.75	
GREEN GaP OSL-16 LED \$.90	2N3767 PNP Si TO-66 \$.75	2A 6A \$1.25		
7400 \$.28	2N3772 NPN Si TO-3 \$1.25	200 95 1.25 \$1.25		
7401 \$.28	2N3856 NPN Si TO-5 \$.75	400 1.15 1.50 \$1.25		
7402 \$.28	2N6109 PNP Si TO-220 \$.55	600 1.35 1.75 \$1.25		
7403 \$.28	2N5296 NPN Si TO-220 \$.55				
7404 \$.33	2N4898 PNP Si TO-66 \$.60				
7405 \$.30	MJ2522 NPN Si TO-66 \$.90				
7407 \$.50	2N3055 PNP Si TO-3 \$1.00				
7408 \$.32	SLA-3 7 Segment LED Readout 77" Num- \$7.50				
7410 \$.28	INJECTION LASER—A SINGLE DIODE 6W, 25A GAS UNIT SIMILAR TO RCA 40859 \$7.50				
7411 \$.32	MAN-1, Red or Yellow READOUT \$3.25				
7412 \$.40	MAN-4 LED READOUT \$2.50				
7413 \$.85	MAN-3 LED READOUT \$1.75				
7416 \$.50	MAN-3 LED READOUT \$1.75				
7417 \$.50	MAN-3 LED READOUT \$1.75				
7420 \$.28	MAN-3 LED READOUT \$1.75				
7422 \$.32	MAN-3 LED READOUT \$1.75				
7426 \$.35	MAN-3 LED READOUT \$1.75				
7427 \$.55	MAN-3 LED READOUT \$1.75				
7430 \$.30	MAN-3 LED READOUT \$1.75				
7432 \$.30	MAN-3 LED READOUT \$1.75				
7437 \$.60	MAN-3 LED READOUT \$1.75				
7438 \$.50	MAN-3 LED READOUT \$1.75				
7440 \$.28	MAN-3 LED READOUT \$1.75				
7441 \$.150	MAN-3 LED READOUT \$1.75				
7442 \$.125	MAN-3 LED READOUT \$1.75				
7446 \$.150	MAN-3 LED READOUT \$1.75				
7447 \$.150	MAN-3 LED READOUT \$1.75				
7448 \$.150	MAN-3 LED READOUT \$1.75				
7449 \$.28	MAN-3 LED READOUT \$1.75				
7451 \$.30	MAN-3 LED READOUT \$1.75				
7470 \$.50	MAN-3 LED READOUT \$1.75				
7472 \$.50	MAN-3 LED READOUT \$1.75				
7473 \$.60	MAN-3 LED READOUT \$1.75				
7474 \$.50	MAN-3 LED READOUT \$1.75				
7475 \$.100	MAN-3 LED READOUT \$1.75				
7476 \$.75	MAN-3 LED READOUT \$1.75				

VERIPAX PC BOARD	
This board is a 1/16" single sided paper epoxy board 4 1/2" x 5 1/2" (standard veripax) drilled and etched, which will hold 21 single 14 pin IC's, or 8,16 or LSI DIP IC's with bussees for power supply connections. It is also etched for a 22 pin connector. \$5.25 3/\$14.50	

CAPACITORS	
6V 30 UF TANT \$ 51.00
20V 4.7 UF TANT \$ 51.00
12V 70 UF ELECT. \$ 51.00
50V 100 UF ELECT. \$.40
25V AT 30 UF \$1.00
1103 1024 BIT RAM \$ 7.25
NEC5009 2048 BIT RAM \$10.95
1101 256 BIT RAM \$ 3.25
8225 64 BIT MEMORY \$ 5.50
8260 1024 BIT RAM \$7.25
DUAL TAPERED CDS PHOTO CELL USED FOR OPTICAL ALIGNMENT WITH A SINGLE PLANE LENSE (Not Included) \$.95
SIMILAR TO 8038C IC VOLTAGE-CONTROLLED OSCILLATOR AS FEATURED IN P.E. OCT 73. THEY HAVE SINE, SQUARE AND TRIANGULAR OUTPUT GOOD TO 1 MHz \$5.95
NIXIE TUBE RAYTHEON 8650 WITH SOCKET AND DATA SHEET \$2.25 3/\$6.00

SILICON POWER RECTIFIERS	
PRV 1A	3A 12A 50A
100 .06 .11 .30 .85	
20C .07 .16 .35 1.25	
400 .09 .20 .45 1.50	
600 .11 .30 .70 2.00	
800 .15 .40 .85 2.30	
1000 .20 .55 1.10	

TRIACS		SCR'S	
PRV1 1A 10A 25A	1.5A 6A	1.5A 6A	
100 .40 .70 1.30	.40 .50		
200 .70 1.10 1.75	.60 .70		
400 1.10 1.60 2.60	1.00 1.20		
600 1.70 2.30 3.00			

TIS-73 N CHANNEL P.E.T.	
2N 4891 UJT \$.50
ER 900 TRIGGER DIODE 4/1.00 \$.50

Send Check or Money Order. Include Postage Minimum Order \$3.00. Rated Companies 30 Days Net Send \$2.00 for our latest catalog featuring transistors and rectifiers

SOLID STATE SALES

Post Office Box 74A Somerville, Mass. 02143 Tel. (617) 547-4005

CIRCLE NO. 28 ON READER SERVICE CARD

CONVERT any television to sensitive, big-screen oscilloscope. Only minor changes required. No electronic experience necessary. Illustrated plans. \$2.00. Sanders, Dept. A-33, Box 92120, Houston, Texas 77010.

BIOFEEDBACK. Professional instruments: Electroencephalophone, Galvanic Skin Response. J&J, 8102E, Bainbridge, WA 98110.

ALPHA WAVE Monitors—free brochure. MedLab, Box 31035, San Francisco, CA 94131.

PROFESSIONAL Record Cleaner eliminates dust and static. Only available from Canada. \$4.50 postpaid, Dept. P, P.O. Box 5207 Stn. B., Victoria, Canada. U.S. Inquiries.

DIGITAL IC Manual—Latest Edition—1500 types by types/diagram number, \$3.95. 32—function digital computer kit—IC, transistors, instructions. \$14.00. IC applications manual—numerous circuits—Analog/Digital, \$3.95. Electronics, P.O. Box 127, Hopedale, Mass. 01747.

NE555V: \$1.10; MOR10A: \$2.50; IC's: Digital, Linear; LED's. Catalog. 10¢. Electronic Discount Sales, 138 N. 81st Street, Mesa, Ariz. 85207.

CITIZENS BAND equipment discount prices. Free List. CRS Communications, 2271 Morris Avenue, New York, N.Y. 10453.

CITIZEN'S band radio, scanners, stereo, discounts. Free Catalog. Capitol Sound, Box 3523, Des Moines, Iowa 50322.

POWER SUPPLY PLANS, precision regulated 9 to 12vdc, 2 amps \$5.00. Airborne Systems, Box 1175, Hartford, Conn. 06101.

EXPERIMENTER MINICOMPUTERS! Write M.P. Engineering, Dept. 2, Box 378, Belmont, Massachusetts 02178.

FREE Professional Experimenters Catalog. Walton Electronics, Box 503E, Bethany, Oklahoma 73008.

TAPE RECORDER COMPUTER I/O, other plans. Free Catalog. M.P. Publishing Co., Box 378, Belmont, Massachusetts 02178.

THE CALCULATOR HANDBOOK 127 pages practical applications, short cuts, algorithms. \$1.25 plus .39 postage and handling. Techniplan, Box 51, Baldwin, New York 11510.

FREE! Diodes and catalog. BDI Electronics, 11 Revere, Tappan, New York 10983.

SCREW DRIVER with built in flashlight with four interchangeable parts, \$1.25. Write: Baez & Santana, 565 Academy St., N.Y., N.Y. 10034.

CD IGNITIONS, VHF/UHF monitors, crystals, CB radios. Southland, Box 3591-B, Baytown, Texas 77520.

CRYSTALS, Scanners, \$3.88, include make and frequency. G Enterprises, P.O. Box 461PC, Clearfield, UT 84015.

LINEAR IC's, most types available, send for free list. Semi-Lin Enterprises, P.O. Box 992, Santa Ana, Calif. 92702.

AUTOMATIC telephone recording and debugging equipment. Top quality. Lowest wholesale prices. Viking International, Box 632E, Newhall, California 91321.

RADIO-TELEVISION Diagram Manuals, essential 14 volumes, \$48.75 value, only \$19.95, postpaid. Publications, 1760 Balsam, Highland Park, Illinois 60035.

ELECTRONIC TEST INSTRUMENT CATALOG—160 illustrated pages list over 5,000 new, used and reconditioned test instruments—600 manufacturers. Send \$2.50 refundable with first purchase. Tucker Electronics, P.O.B. 1050, Garland, Texas 75040.

PRACTICAL APPLICATIONS of Digital IC's. 100's of tips, circuits, projects, on TTL. 443 pp. \$19.95. Money Back Guarantee, GEA, P.O. Box 285, Northfield, Ohio 44067.

PLANS AND KITS

RADAR DETECTOR KIT, alerts you to hidden radar "traps", transistorized, clips to visor, #1 seller worldwide over 12 years. Send check, charge or call. Bank Americard, Master Charge, \$29.95. Assembled, \$39.95, guaranteed. Kartronix PE, 4017 Coronado Place, Oklahoma City, Oklahoma 73122. (405) 842-1493.

ELECTRONIC Slot Machine type game. Plans \$5.00. KAB, 1923 Fern, Royal Oak, Michigan 48073.

CB MOBILE co-phase antenna harness. VSWR 1-1:1 match. Plans \$2.00. Enclose self-addressed stamped envelope. DUFFY'S, P.O. Box 808, Nevada City, Ca. 95959.

STRANGLE TV Commercials! Sound revives AUTOMATICALLY! Devilish plans \$2.00. Hobby Electronics, Box 2172E, Capistrano Beach, Calif. 92624.

TESLA COIL—40" SPARKS! Plans! \$7.50. Information 75¢. Huntington Electronics, Box 2009-P, Huntington, Conn. 06484.

FREE Semiconductors with purchase of detailed plans. Digital clock, stereo amplifier, Dwell Meter, and more. \$3.50. Box 245, Littleton, Mass. 01460.

MILES ELECTRONICS CO. has better kits for a lower price. Let us custom design a circuit to fit your needs. 100, 200, 400 watt RMS stereo power speakers. All you need is a preamp or tuner. Systems are studio quality. 4000 Old College Rd., Bryan, Texas 77801.

SIMPLE DIGITAL READOUT CONSTRUCTION PLANS: 10,000 rpm tach, 12V crystal clock, reaction timer, thermometer, portable stopwatch (manual and photocell), R/C checker, crystal time base (clock). \$2 each. Digi-Dec, 342 S.E. 32nd, Portland, OR 97214.

DIGITAL COMPUTER complete plans; Send \$7.00 to Walter, 58700 Bremen Highway, Mishawaka, Indiana 46544.

HIGH FIDELITY

DIAMOND NEEDLES and Stereo Cartridges at Discount prices for Shure, Pickering, Stanton, Empire, Grado and ADC. Send for free catalog. LYLE CARTRIDGES, Dept. P, Box 69, Kensington Station, Brooklyn, New York 11218.

DERIVE 4 channel sound from your present stereo without any expensive devices. Send \$1.00 for easy instructions to: Surround Sound, 96 Home St., Somerset, N.J. 08873.

WANTED

QUICKSILVER, Platinum, Silver, Gold, Ores Analyzed. Free Circular. Mercury Terminal, Norwood, Mass. 02062.

CAPACITORS WANTED: Computer-Grades, Tantalums, Mylars, Discs.—Cash Paid—National Electronics Supply, Dept. P1, 7231-B Garden Grove Blvd., Garden Grove, Calif. 92641.

MAIL ORDER CONCERN Seeks Security Oriented Products. Box 671, Westwood, New Jersey 07675.

TUBES

RADIO & T.V. Tubes—36¢ each. Send for free Catalog. Cornell, 4213 University, San Diego, Calif. 92105.

RECEIVING & INDUSTRIAL TUBES, TRANSISTORS. All Brands—Biggest Discounts, Technicians, Hobbyists, Experimenters—Request **FREE** Giant Catalog and **SAVE!** ZALYTRON, 469 Jericho Turnpike, Mineola, N.Y. 11501.

TUBES "Oldies", latest. Lists free. Steinmetz, 7519 Maplewood, Hammond, Indiana 46324.

SAVE money on parts and transmitting-receiving tubes, foreign-domestic. Send 25¢ for giant catalog. Refunded first order. United Radio Company, 56-P Perry Street, Newark, N.J. 07105.

TUBES receiving, factory boxed, low prices, free price list. Transleteronic, Inc., 1306 40th Street, Brooklyn, N.Y. 11218A, Telephone: 212-633-2800.

CASH Paid for obsolete receiving tubes WE300B, WE350B, WE252A, WE310A, WE274A, WE262B, WE284D, RCA45, RCA50, and Movie Theatre we amplifier models 91B, 86F. Contact: M. Takabe, 303 Fifth Avenue, N.Y.C. (212) 679-1970.

TAPE AND RECORDERS

RENT 4-Track open reel tapes—all major labels—3,000 different—free brochure. Stereo-Parti, 55 St. James Drive, Santa Rosa, Ca. 95401.

1930-1962 Radio Programs. Reels, \$1.00 Hour! Cassettes, \$2.00 Hour! . . . Mammoth Catalog, \$1.00. AM Treasures, Box 192F, Babylon, N.Y. 11702.

WHOLESALE PRICES CASSETTES

PLAIN WHITE CASSETTE LABELS, NORELCO CASSETTE CLEANERS, PAPER MAILER BOXES** HOLDS NORELCO-TYPE PLASTIC BOX, FAMOUS BRAND CASSETTES, "LIKE NEW" 10 1/2" METAL OR FIBERGLASS REELS. SEND FOR OPEN REEL AND CASSETTE DISCOUNT CATALOG. *QUANTITY 1-9 10-99 100 1000
CASSETTE LABELS (Multiples of 10) .65 .02 .15 .01
NORELCO CASSETTE CLEANER .50 .50 .55 .50
**NORELCO PAPER MAILER BOXES .03 .025 .022 .02
10 1/2" FIBERGLASS REELS, USED .50 .40 .35 .25
10 1/2" METAL NAB HOLE, USED 1.00 1.00 .80 .70
*PLUS POSTAGE BY WEIGHT AND ZONE MINIMUM ORDER. **N.W. 1776 COLUMBIA ROAD. WASHINGTON, D.C. 20004

SAXITONE TAPE SALES

OLD radio programs on tape. Thousands available. Six hours, \$8.00. Catalogue, 25¢. Nostalgic Radio, Box 29Q, Peoria, IL 61601.

16,000 OLD RADIO SHOWS on tape. Catalog \$2.00, supplement 50¢ (refundable). Hart Enterprises, 1329H George Washington, Richland, WA 99352.

PERSONALS

MAKE FRIENDS WORLDWIDE through international correspondence. Illustrated brochure free. Hermes, Berlin 11, Germany.

BUGGED??? . . . Detectors locate hidden transmitters. Literature 25¢. Security, Box 671, Westwood, N. J. 07675.

MOVIE FILMS

8MM-SUPER 8-16MM MOVIES! Biggest Selection! Lowest Prices! Free Catalog! Cinema Eight, Box PE, Chester, Connecticut 06412.

TOOLS

WRAP Tool \$1.00, Wire, Panels. Xycon, Box 9341, Phoenix, AZ. 85020.

ELECTRICAL SUPPLIES AND EQUIPMENT

PLATING Equipment, Portable Platers, Supplies and "Know-How." Build your own tanks for nickel, chrome, etc. Easy-to-install PVC liners. Rectifier components—all sizes. Schematics, parts lists, formulas, operating instructions for all plating. Guaranteed to save you 25%-75%. Some good units for sale. Write for details. Platers Service Company, 1511-PE Esperanza, Los Angeles, Calif. 90023.

GOVERNMENT SURPLUS

GOVERNMENT Surplus. How and Where to Buy in Your Area. Send \$2.00. Surplus Information, Headquarters Bldg., Box 30177-PE, Washington, D.C. 20014.

ELECTRONIC Equipment and Parts. Big 36 page Free Catalog. Send for your copy today! Fair Radio Sales, Box 1105-P, Lima, Ohio 45802.

MANUALS for Govt Surplus radios, test sets, scopes. List 50¢ (coin). Books, 7218 Roanne Drive, Washington, D.C. 20021.

ELECTRONIC gadgets and parts. Send for free bulletin. Aeroparts, International Airport, Box 1492, Del-Rio, Texas 78840.

LED 7-SEGMENT Readouts

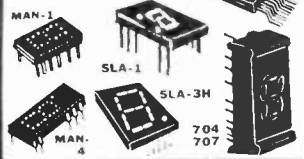

(All "LED" TYPES)

Type	Char.	Each	Special
MAN-1	.27	\$3.75	3 for \$9.
MAN-3	.12	1.49	3 for \$3.
MAN-4	.19	2.50	3 for \$6.

REFLECTIVE BAR TYPES

707*	.33	2.50	3 for \$6.
704**	.33	2.50	3 for \$6.
SLA-1**	.33	2.10	3 for \$5.
SLA-3**	.70	4.95	3 for \$13.
SLA-11**	.33†	3.50	3 for \$10.

* By Litronix. ** By Omron, equal to MAN-1 or MAN-4 specs. Color - RED. † Green.

8-TRACK CAR RADIO STEREO TAPE TRANSPORT

8-Track tape transport with complete stereo playback system, less audio amplifier. Operates on 12 VDC. Vibration & flutter proof. Use T39 preamp & ready to go. Uses 8-track tape, Wt. 3-lbs.

3 for \$24
\$8.88

LINEAR Op Amps

5 FACTORY GUARANTEED

531 Hi slew rate op-amp (TO-5)	\$2.50
532 Micro power 741 (TO-5)	2.50
533 Micro power 709 (TO-5)	2.50
536 FET input op amp (TO-5)	2.95
550 Precision 723 voltage reg. (DIP)	1.17
555 Timer 2 w Seconds to 1-hr. (A)	1.25
556 5 Times faster than 741C.	2.10
558 Dual 741 (A)	1.00
560 Phase lock loops (DIP)	2.95
561 Phase lock loops (DIP)	2.95
562 Phase lock loops (DIP)	2.95
565 Phase lock loops (A)	2.95
566 Function generator (TO-5)	2.95
567 Tone decoder (A)	1.75
702C Hi-grain, DC amp (TO-5)	.49
703C RF-IF amp, 14 ckt's (TO-5)	.69
704 TV sound IF system	1.50
709C Operational amp (A)	.39
710C Differential amp (A)	.47
711C Dual diff. comp (A)	.47
723C Voltage regulator (A)	.75
733 Diff. Video Amp	1.75
741C Frequency compensator 709 (A)	.44
741CV Freq. comp 709 (Mini DIP)	.49
747C Dual 741C (A)	.89
748C Freq. adj; 741C (A)	.69
753 Gain Block	1.75
739-739 Dual stereo preamp	1.98
741-741 Dual 741C (TO-5)	.89
PA265 5-Watt voltage regulator	1.50
ULN2300M Op amp with SCR	1.50
CA3065 Video Audio system	1.05
4250 Programmable Op Amp	2.50
4136 Quad 74's (DIP)	1.95
75451 Dual peripheral driver	.44
75453 Dual peripheral driver	.44
75491 Quad seg driver for LED readouts	1.65
75492 Hex driver w/col. out 250 ma.	1.85

For LED readouts: BUY ANY 3
(A) TO-5 or DIP dual in line pak TAKE 10%

SANKEN HYBRID AUDIO POWER AMPS

Mfg'r's Type Watts Sale

Si-1010Y	10	\$ 8.88
Si-1025E	25	18.88
Si-1050E	50	29.95

Used extensively in hi-fi systems, tape decks, FM tuners, record players, stereo components, musical instruments, P.A., etc. All amplifiers, that within 1/2 db from hz to 100,000. Each unit properly heat-sinked, with heavy-duty connecting tie lug connections. Single-ended pushpull output. Power supply required 240VAC. Output to 8 ohms.

Order by Stock No.

BRAND NEW LOWEST PRICES

GENERAL ELECTRIC 3-WATT AUDIO AMP 3 for \$6.00 **\$2.50**

Delivers 3 watts continuous, 10 watts peak. With heat sink; micro-mini size: 3 1/2" x 2 1/2" x .9" to 30V supply. High sensitivity: 10 to 16 ohms. For mono and stereo thubns. tape, FM, AM, TV, stereo.

Brand New

OVER 1,000,000-PC INVENTORY

"DIP" Packages OFFERED!

POLY PAKS SMASHES IC PRICES

Factory Marked Order by type number! Spare sheets on request "ONLY"

Type Sale	SN7400 \$0.24	SN7432 .35	SN7471 .55	SN74108 .95	Buy 100 — Take 20%
SN7401 .24	SN7437 .49	SN7472 .41	SN74109 .95	SN74161 1.59	
SN7402 .24	SN7440 .52	SN7473 .49	SN74112 .95	SN74163 1.75	
SN7403 .24	SN7440 .24	SN7474 .49	SN74113 .95	SN74164 2.10	
SN7404 .26	SN7441 1.19	SN7475 .85	SN74114 .95	SN74165 2.10	
SN7405 .26	SN7442 1.12	SN7476 .53	SN74121 .69	SN74166 1.85	
SN7406 .49	SN7443 .12	SN7478 .85	SN74122 .69	SN74173 1.85	
SN7407 .45	SN7444 1.25	SN7480 .65	SN74123 1.05	SN74174 2.20	
SN7408 .27	SN7445 1.19	SN7481 1.25	SN74125 1.45	SN74175 2.50	
SN7409 .28	SN7447 1.29	SN7482 .99	SN74126 1.45	SN74176 1.85	
SN7410 .24	SN7448 1.35	SN7483 1.15	SN74129 1.25	SN74177 1.85	
SN7411 .31	SN7450 .27	SN7485 1.15	SN74139 1.25	SN74179 1.85	
SN7413 .89	SN7451 .31	SN7486 .49	SN74145 1.19	SN74180 1.10	
SN7415 .39	SN7453 .43	SN7489 3.10	SN74148 4.50	SN74181 4.10	
SN7416 .39	SN7454 .43	SN7490 .85	SN74150 1.19	SN74182 1.05	
SN7417 .49	SN7455 .31	SN7491 1.35	SN74151 1.00	SN74185 2.50	
SN7420 .24	SN7460 .27	SN7492 .85	SN74152 4.95	SN74193 1.55	
SN7421 .55	SN7461 .27	SN7493 .85	SN74153 1.39	SN74194 1.55	
SN7422 .31	SN7462 .35	SN7494 1.05	SN74154 1.69	SN74195 1.10	
SN7425 .50	SN7464 .43	SN7495 1.00	SN74155 1.25	SN74196 1.25	
SN7426 .33	SN7465 .43	SN7496 1.00	SN74156 1.45	SN74197 1.10	
SN7430 .24	SN7470 .36	SN74106 .85	SN74157 1.45	SN74198 2.35	
		SN74107 .51	SN74160 1.85	SN74200 9.95	

IC'S FOR EXPERIMENTERS

Money Back Guarantee! Factory Marked! **\$1.00**

SN7400	20 for \$1.	SN7476	10 for \$1.
SN7404	20 for \$1.	SN7490	5 for \$1.
SN7441	5 for \$1.	SN74107	10 for \$1.
SN7442	5 for \$1.	SN74121	10 for \$1.
SN7444	5 for \$1.	SN74123	5 for \$1.
SN7447	5 for \$1.	SN74154	10 for \$1.
SN7448	5 for \$1.	SN74181	3 for \$1.
SN7473	5 for \$1.	SN74192	5 for \$1.
SN7475	10 for \$1.	SN7492	5 for \$1.

Includes factory-80 rejects & defects, who knows at these prices!

CLOCK CHIPS ON A "DIP"

ANY CHIP \$8.88

MM5311	6-digit 28-Pin	8.88
MM5312	4-digit 24-Pin	8.88
MM5313	6-digit 28-Pin	8.88
MM5314	6-digit 24-Pin	8.88
MM5316	4-digit 40-Pin	13.50

Alarm

1-MM5316, DIGITAL ALARM FACTORY FALLOUT — \$1.49

60-WATT STEREO AM-FM-MULTIPLEX HIGH FIDELITY AMP

• Tape, Record Player, PA & Musical Instruments! • Wall "Slim-Line" Type!

The most amazing audio offer for the hi-fivers, PA men, and an ideal unit for the family den, or any room in the house, office, etc. Comes complete with hookup, enclosure, and knobs, 5 separate controls: LOUDNESS, BALANCE, TREBLE, BASS, circuits switch for MIONO, TUNING, TAPE, MIKE, AUX, 3 switches for SCRATCH FILTER, RUMBLE FILTER, and POWER "ON-OFF" with built-in tie 4-output transistors, each 30 watt. Separate accessory mounting panel for 4 speaker attachment, mike and musical instrument jack, tone, tuner, and power jacks, 6-ft. cord set for 15VAC, 60 cycles. Measures only 14 x 7 x 3 1/2" Wt. 3 lbs. With all active multi-color enclosure. Made by leading US maker of quality amplifiers.

• 20-20,000 Cycles Resp • 4-Channel Spkr. Systems!

Only **\$6.95** "THE PRO" DYNAMIC PENCIL MIKE

Sold elsewhere for over \$10. All metal construction, with stand, 6-ft. cord, and standard mike plug. Its General Electric. NO IMPORT! Highly polished with chrome trim, Omni-directional, 20,000 ohm load, 60 to 100kHz freq resp. 4 db, ultra-sensitive, high quality, hi-fidelity. Ideal for PA, CB, and all Hi-Fi equipment. May be hand-held too! Mike 5 1/2" long 1 1/2" dia., with taper. Heavy-duty grey metal stand, 2 1/2 x 2 1/4 x 1 1/2", ideal for our 60w stereo amp, wt. 1-lb.

4-FUNCTION MEMORY "CALCULATOR KIT"

59.95

Packet type, the lowest price 4-function memory with all arithmetic. Complete with all parts, instruction booklet.

CALCULATOR CHIPS ON A "DIP"

Similar to Mostek 5001. Outperforms Texas 8-digit TMS1802. A 40-pin DIP. Adds, multiplies, subtracts, and divides. Use with 7-segment readouts, Nixies, and LEDs.

CT5001	12-digits 40-Pin	\$6.95
CT5002	9 Volt version of 5001	8.88
CT5005	12-digits 28-Pin	9.95

with 3-function memory.

POCKET CALCULATOR KEYBOARD

For hand-held units, properly multiplexed for chip CT-5001, 2, 12 or Mostek 5010-12, 18 feather-touch keys, by PLEX-KEY.

Only **\$6.95** 3 for \$18.

Terms: add postage Rated: net 30

Phone Orders: Wakefield, Mass. (617) 245-3829

Retail: 16-18 Del Carmine St., Wakefield, Mass. (off Water Street) C.O.D.'S MAY BE PHONED

POLY PAKS

P.O. BOX 942 E Lynnfield, Mass. 01940

CIRCLE NO. 26 ON READER SERVICE CARD

LOGIC NEWSLETTER

SAMPLE COPY \$ 1.00
LOGIC NEWSLETTER
POB 252
WALDWICK,N.J. 07463

LED READOUT BONANZA!

Compare prices and you will buy from us.

MAN-1 type readout. 27 inch character size. Left decimal point. Uses 7447 driver. 14 pin style — \$2.50 ea.

MAN-3A type readout. 12 inch character size. Right decimal point. Uses 7448 driver — \$ 99

Three digit readout. In one dip. Has 3 MAN-3 type readouts. Internally multiplexed. Designed for calculators, etc. Right decimal point. Like DL-33 — (3 digits) \$2.95.

OPCOA SLA-1 readout. Electrically like MAN-1 except has larger digit size. 33 inch character. 14 pin style. Uses 7447 driver. Segments consist of bar rather than dots. Much easier to read. Left decimal — \$1.75 ea.

LOOK! OPCOA SLA-17 readout. Same as SLA-1 but Green! Like MAN-5. Uses 7447 A Driver. Left decimal point — \$2.50 ea.

OPCOA SLA-1C. Color readout for use in digital clocks. Has either left or right decimal — \$2.50 ea

Jumbo red led lamps. Large like MV5024 5 for \$1.00
Jumbo green led lamps. Like MV5222 3 for \$1.00

Prime TTL DIP IC'S

7400 - \$.25	7438 - \$.49	7483 - \$.89	74157 - \$1.25
7402 - \$.25	7439 - \$.99	7486 - \$.39	74164 - \$1.95
7404 - \$.25	7442 - \$.89	7490 - \$.95	74166 - \$1.50
7407 - \$.30	7445 - \$.89	7491 - \$.95	74174 - \$1.95
7408 - \$.25	7447 - \$.95	7492 - \$.95	74175 - \$1.95
7409 - \$.30	7448 - \$.95	74109 - \$.90	74181 - \$3.50
7410 - \$.25	7472 - \$.39	74121 - \$.49	74182 - \$.95
7427 - \$.35	7474 - \$.49	74150 - \$1.80	74192 - \$1.39
7430 - \$.25	7483 - \$.89	74151 - \$.89	74193 - \$1.39
	74H73 - \$.49	74154 - \$1.95	74197 - \$1.50

Buy any three, take 10% off.

Prime TTL DIP IC'S

Clock Chip — C77001 — has alarm and calendar — \$12.95

LM309-K 5V regulator — \$1.75 + 741C mini dip — \$.49

Phase lock loop. NE 567V mini dip — \$1.95

TTL and Linear Assortment. Contains 1/2 pound (Approximately 200 pieces) mixed TTL and Linear IC's untested. Includes logic gates. Flip flops, counter FM detectors chroma demod IC's, etc. Marked and unmarked, with some spec sheets — \$3.95.

Plastic transistor assortment manufactured by T.I. contains NPN and PNP silicon. TO-92 case. many useable units. We have more than 1000 can test. 100 piece assortment — \$1.49

New for 74 4 bags for \$5.00.

SPECIAL OFFER

On every \$15.00 order, choose \$1.00 worth of free merchandise.

ALTAJ ELECTRONICS

P. O. Box 28592

Dallas, Texas 75228

Terms: Check or Money Order. No COD. Add 10% of order to postage and handling. Bargain flyer \$1.00 free with order. Cashiers check — 4% off. Any order will speed up delivery.

CIRCLE NO. 2 ON READER SERVICE CARD

INSTRUCTION

LEARN ELECTRONIC ORGAN SERVICING at home all makes including transistor. Experimental kit—trouble-shooting. Accredited NHSC, Free Booklet. NILES BRYANT SCHOOL, 3631 Stockton, Dept. A, Sacramento, Calif. 95820.

LEARN WHILE ASLEEP, Hypnotize! Strange catalog free. Auto-suggestion, Box 24-ZD, Olympia, Washington 98501.

DEGREE IN ELECTRONICS through correspondence. Free catalog. Grantham, 2000 Stoner Avenue, Los Angeles, California 90025.

INTENSIVE 5 week course for Broadcast Engineers. F.C.C. First Class license. Radio Engineering Incorporated, 52 S. Palm Ave., Sarasota, Florida 33577.

SHORTCUTS To Success! Highly Effective, Profitable Short Courses. (75 Choices). Study At Home. Diploma Awarded. Our 27th Year. Free Literature. CIEE-D, Box 10634, Jackson, Miss. 39209.

F.C.C. EXAM MANUAL

PASS FCC EXAMS! Memorize, study — "Tests-Answers" for FCC 1st and 2nd class Radio-telephone licenses. Newly revised multiple-choice questions and diagrams cover all areas tested in FCC exams.—plus—"Self-Study Ability Test." \$9.95 postpaid. Moneyback Guarantee.

Tests-Answers for
FCC First and
Second Class
Commercial
License

**COMMAND PRODUCTIONS P.O. BOX 26348-P
RADIO ENGINEERING DIVISION SAN FRANCISCO, CALIF. 94126**

DEGREE Program in Electronics Engineering. Our 27th Year! Free literature. Cook's Institute, Dept. 13, Box 10634, Jackson, Miss. 39209.

EARN College Degrees at home. Many subjects. Florida State Christian University, P.O. Box 1674, Fort Lauderdale, Florida 33302.

SCORE high on F.C.C. Exams . . . Over 300 questions and answers. Covers 3rd, 2nd, 1st and even Radar. Third and Second Test, \$14.50; First Class Test, \$15.00. All tests, \$26.50. R.E.I., Inc, Box 806, Sarasota, Fla. 33577.

ELECTRONICS career training at home. College level communications, FCC license, Broadcast Engineering, Satellite Communications. Free Catalog. Genn Tech., 5540 Hollywood Blvd., Los Angeles, Calif. 90028.

INVENTIONS WANTED

CASH-ROYALTIES for patented, unpatented inventions. Global Marketing Service, 2420-P 77th, Oakland, California 94605.

INVENTORS: Protect your ideas! Free "Recommended Procedure". Washington Inventors Service, 422T Washington Building, Washington, D.C. 20005.

PATENT Searches including Maximum speed, full airmail report and closest patent copies. Quality searches expertly administered. Complete secrecy guaranteed. Free Invention Protection forms and "Patent Information," Write Dept. 9, Washington Patent Office Search Bureau, Benjamin Franklin Substation, P.O. Box 7167, Washington, D.C. 20044.

FREE PAMPHLET: "Tips on Safeguarding Your Invention." Write: United States Inventors Service Company, 708-T Carry Building, Washington, D.C. 20005.

INVENTORS! Either we will sell your invention before you or anyone else does, or we will pay you a cash bonus. Get Free Invention Evaluation and information: Write Gilbert Adams Organization, Invention Brokerage, Dept. 20, 80 Wall St., New York, NY 10005.

FILE your own patent application. Complete information and materials. Write: Inventor's Guide, 468-R, Goodspeed Road, Virginia Beach, Virginia 23451.

FREE "DIRECTORY OF 500 CORPORATIONS Seeking New Products." For information regarding Development, Sale, Licensing of your patented/unpatented invention, write for FREE "INVENTOR'S KIT NO. A-73, RAYMOND LEE ORGANIZATION, 230 Park Avenue, New York, N.Y. 10017.

MUSICAL INSTRUMENTS

30% DISCOUNT name brand musical instruments. Free Catalog. Freeport Music, 455N, Route 110, Melville, N.Y. 11746.

WHOLESALE! Professional Guitars, PA Systems, Altec Speakers, 240W RMS Amplifiers. Free Catalog, Carvin, Escondido, Calif. 92028.

30% + DISCOUNT. Name Brand Musical Instruments. Free Catalog. Continental Music, Dept. H, P.O. Box 3001, Garden City, New York 11530.

REAL ESTATE

FREE . . . NEW . . . BIG . . . SUMMER CATALOG! Describes and pictures hundreds of farms, ranches, town and country homes, businesses coast to coast! Specify type property and location preferred. UNITED FARM AGENCY, 612-EP, West 47th St., Kansas City, Mo. 64112.

SOLID STATE SYSTEMS, INC. now has a wider selection of LED displays, lower prices. Now available are:

- ★ 7-segment numeric displays in 3 colors
- ★ Resistor packages for each display
- ★ 9-digit calculator displays

Catalog Number	Description	Character Height	Color	Price Each					Grouping code
				1-49	50-99	100-499	500-999	1000-up	
21-00001	OPCOA SLA-1, 7-Segment, 15mA, left decimal	0.33"	Red	2.00	1.85	1.70	1.55	1.40	10
11-48001	Pkg of 8 current limiting resistors for SLA-136	.32	.28	.24	.20	16
21-10001	OPCOA SLA-11, 7-Segment, 40mA, left decimal	0.33"	Green	2.00	1.85	1.70	1.55	1.40	10
21-20001	OPCOA SLA-21, 7-Segment, 40mA, left decimal	0.33"	Yellow	2.00	1.85	1.70	1.55	1.40	10
11-58001	Pkg. of 8 current limiting resistors for SLA-11 & -2136	.32	.28	.24	.20	16
24-00002	OPCOA SLA-2, ±1, 15mA	0.33"	Red	2.00	1.85	1.70	1.55	1.40	10
11-44002	Pkg. of 4 current limiting resistors for SLA-220	.17	.14	.12	.10	16
24-10001	OPCOA SLA-12, ±1, 40mA	0.33"	Green	2.00	1.85	1.70	1.55	1.40	10
24-20001	OPCOA SLA-22, ±1, 40mA	0.33"	Yellow	2.00	1.85	1.70	1.55	1.40	10
11-54002	Pkg. of 4 current limiting resistors for SLA-12 & -2220	.17	.14	.12	.10	16
23-00011	OPCOA SLA-1C, 7-Segment with Colon, 15mA	0.33"	Red	2.30	2.15	2.00	1.85	1.70	10
11-49011	Pkg. of 9 current limiting resistors for SLA-1C40	.36	.32	.28	.24	16
23-10011	OPCOA SLA-11C, 7-segment with Colon, 40mA	0.33"	Green	2.30	2.15	2.00	1.85	1.70	10
23-20011	OPCOA SLA-21C, 7-Segment with Colon, 40mA	0.33"	Yellow	2.30	2.15	2.00	1.85	1.70	10
11-59011	Pkg. of 9 current limiting resist. for SLA-11C & -21C40	.36	.32	.28	.24	16
21-00007	OPCOA SLA-7, 7-segment, 20mA, left decimal	0.33"	Red	1.50	1.40	1.30	1.20	1.10	10
11-48007	Pkg. of 8 current limiting resistors for SLA-736	.32	.28	.24	.20	16
24-00009	OPCOA SLA-9, ±1, 20mA	0.33"	Red	1.50	1.40	1.30	1.20	1.10	10
11-44009	Pkg. of 4 current limiting resistors for SLA-920	.17	.14	.12	.10	16
21-00008	OPCOA SLA-8, 7-segment, 20mA, left decimal	0.33"	Red	1.50	1.40	1.30	1.20	1.10	10
11-48008	Pkg. of 8 current limiting resistors for SLA-836	.32	.28	.24	.20	16
24-00010	OPCOA SLA-10, ±1, 20mA	0.33"	Red	1.50	1.40	1.30	1.20	1.10	10
11-44009	Pkg. of 4 current limiting resistors for SLA-1020	.17	.14	.12	.10	16
21-10008	OPCOA SLA-18, 7-segment, 40mA, left decimal	0.33"	Green	1.50	1.40	1.30	1.20	1.10	10
11-58008	Pkg. of 8 current limiting resistors for SLA-1836	.32	.28	.24	.20	16
24-10010	OPCOA SLA-20, ±1, 40mA	0.33"	Green	1.50	1.40	1.30	1.20	1.10	10
11-54010	Pkg. of 4 current limiting resistors for SLA-2020	.17	.14	.12	.10	16
21-20008	OPCOA SLA-28, 7-segment, 40mA, left decimal	0.33"	Yellow	1.50	1.40	1.30	1.20	1.10	10
11-58008	Pkg. of 8 current limiting resistors for SLA-2836	.32	.28	.24	.20	16
24-20010	OPCOA SLA-30, ±1, 40mA	0.33"	Yellow	1.50	1.40	1.30	1.20	1.10	10
11-54010	Pkg. of 4 current limiting resistors for SLA-3020	.17	.14	.12	.10	16
21-00003	OPCOA SLA-3H, 7-segment, 30mA, right decimal	0.77"	Red	5.50	5.10	4.70	4.30	3.90	10
11-48003	Pkg. of 8 current limiting resistors for SLA-3H36	.32	.28	.24	.20	16
21-20003	OPCOA SLA-23H, 7-segment, 30mA, right decimal	0.77"	Yellow	5.50	5.10	4.70	4.30	3.90	10
11-58003	Pkg. of 8 current limiting resistors for SLA-23H36	.32	.28	.24	.20	16
24-00004	OPCOA SLA-4H, ±1, 30mA, right decimal	0.77"	Red	5.50	5.10	4.70	4.30	3.90	10
11-45004	Pkg. of 5 current limiting resistors for SLA-4H24	.21	.18	.15	.12	16
24-20004	OPCOA SLA-24H, ±1, 30mA, right decimal	0.77"	Yellow	5.50	5.10	4.70	4.30	3.90	10
11-55004	Pkg. of 5 current limiting resistors for SLA-24H24	.21	.18	.15	.12	16
29-00125	OPCOA 9B125, 9-digit calculator display	0.125"	Red	10.00	9.25	8.50	7.75	7.00	10
29-10125	OPCOA 69B125, 9-digit calculator display	0.125"	Green	10.00	9.25	8.50	7.75	7.00	10

All resistors in packages are supplied for operation with 5V TTL supply.
All items with the same grouping code may be combined for quantity pricing.

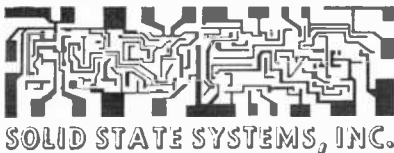

WRITE: SOLID STATE SYSTEMS, INC.
P. O. BOX 617
COLUMBIA, MISSOURI 65201

PHONE (TOLL FREE)
800-325-2595 & 800-325-2981



CIRCLE NO. 29 ON READER SERVICE CARD

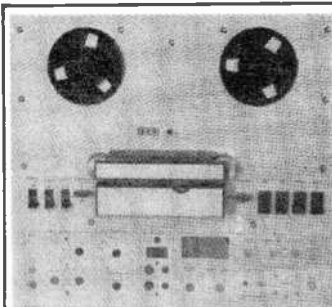

KLH TAPE DECK

New in factory cartons. 3 head, 3 motor or solenoid operated. Part of their \$699 unit. No electronics, but panel cut for all controls. Walnut case

Included. Controls include Automatic Rewind, Search, Pause, Fast forward, Reverse, Play, and speed control, (3.75 & 7.5"). Tape counter. Wt. 37 lbs. 14 1/2" x 15 3/4". Ideal for custom installation.
STOCK NO. F5180 \$79.00

3 1/2" LIQUID CRYSTAL WRIST WATCH DISPLAY



The AE0129 Liquid Crystal Display specified in Jan. '74 POPULAR ELECTRONICS article! Build This Electronic Digital Wristwatch.

We supply reprint of article, and data sheets.

STOCK NO. B 5192 With Socket \$19.75

MINIMUM ORDER \$5.00. Include sufficient postage; excess refunded. Send for latest 56 page catalog with exciting values.



DELTA ELECTRONICS CO.

BOX 1, LYNN, MASSACHUSETTS 01903

CIRCLE NO. 9 ON READER SERVICE CARD

BUSINESS OPPORTUNITIES

I MADE \$40,000.00 Year by Mailorder! Helped others make money! Start with \$15.00—Free Proof. Torrey, Box 318-N, Ypsilanti, Michigan 48197.

FREE CATALOGS. Repair air conditioning, refrigeration. Tools, supplies, full instructions. Doolin, 2016 Canton, Dallas, Texas 75201.

MAILORDER MILLIONAIRE helps beginners make \$500 weekly. Free report reveals secret plan! Executive (1K5), 333 North Michigan, Chicago 60601.

PIANO TUNING LEARNED QUICKLY AT HOME! Tremendous field! Musical knowledge unnecessary. GI approved. Information free. Empire School, Box 450327, Miami 33145.

\$2000.00 MONTHLY selling information by mail. Ropchan, Box 161X, Saginaw, Oregon 97472.

FREE Secret Book "2042 Unique Proven Enterprises." Fabulous "Little Knowns." Work home! Haylings-BH, Carlsbad, California 92008.

DO SIMPLE ADDRESSING—Mailing. Receive \$12.95 orders. Keep \$8.00 profit. Details Free. Quality, Box 9-ZD, East Rockaway, N.Y. 11518.

START SMALL, highly profitable electronic production in your basement. Investment, knowledge unnecessary. Postcard brings facts. Barta-CE, Box 248, Walnut Creek, California 94597.

\$200.00 DAILY In Your Mailbox! Your opportunity to do what mail-order experts do. Free details. Associates, Box 136-J, Holland, Michigan 49423.

EARN \$15,000 annually plus. Full year trial plan Import-Mailorder business. Postcard brings details: Northeast Imports, Box 121PE5, Fremont, N.H. 03044.

HIGHLY PROFITABLE ONE-MAN ELECTRONIC FACTORY

Investment unnecessary, knowledge not required, sales handled by professionals. Postcard brings facts about this unusual opportunity. Write today! Barta-DE, Box 248, Walnut Creek, CA 94597.

EMERGENCY Highway kit boldly says you need help. 4 large self-stick eye-catching, pliable plastic posters. \$3.00. Chun Lam, Box 5662, LA, CA 90055.

TELEPHONE answering machine manufacturer is looking for dealers. Our high-fidelity unit takes 90 messages. It can even ask questions from callers! Retail value \$225. For limited time anyone can buy one sample at factory cost for only \$78. Telephonic, 4880 49th Street North, St. Petersburg, Florida 33709.

wanted Citizens Band

DEALER-DISTRIBUTORS

SEND THIS AD TO:

PAL ELECTRONICS CO.

P. O. BOX 778 • WESTMINSTER, CA. 92683

MAKE \$1,500 per month from your home. Timothy Hamlin, Route 5, Box 500, Ashland, Kentucky 41101.

\$178.00 WEEKLY. Work one hour daily. Free brochure. FAS, Box 13703-A, San Antonio TX, 78213.

EMPLOYMENT OPPORTUNITIES

ELECTRONICS/AVIONICS EMPLOYMENT OPPORTUNITIES. Report on jobs now open. Details FREE. Aviation Employment Information Service, Box 240E, Northport, New York 11768.

AGENTS WANTED—Can you sell a Telephone Answering Machine for \$49.50??? If you can, you can make **BIG MONEY** representing us! Free details! Palomar, Box 17384E, Jacksonville, Florida 32216.

EMPLOYMENT INFORMATION

EXCITING Overseas jobs. Directory \$1.00. Research Associates, Box 1167-E, Kailua, Hawaii 96734.

BETTER RESUMES (satisfaction guaranteed). Free starter Resume Package: **JOB CAMPAIGN**, 91 Market Street, Annapolis, Maryland 21401.

TREASURE FINDERS

FREE—Valuable Treasure Finder catalog sent by return mail. Find Coins, Rings, Gold, Silver, Metals, Relics. Write today. JETCO. Dept. CPE, Box 26669, El Paso, Texas 79926.

FREE FACT-FILLED CATALOG. World's largest line of metal detectors. Models as low as \$49.50 and up. Two year Guarantee. Three factory locations, U.S. and Canada, plus over 1,000 dealers and 35 Service Centers from coast to coast. No finer instruments made at any price. Budget terms. Write: White's Electronics, Inc., Rm# 391, 1011 Pleasant Valley Road, Sweet Home, Oregon 97386.

FAMILY FUN! OUTDOOR ADVENTURE! Find valuable coins and treasure with world famous metal detectors. Free illustrated booklet. Detectron, Dept. PE, Box 243, San Gabriel, Calif. 91778.

RUBBER STAMPS

RUBBER address stamps. Free catalog. 45 type styles. Jackson's, Box 443G, Franklin Park, Ill. 60131.

Popular Electronics

MAY 1974

ADVERTISERS INDEX

READER SERVICE NO.	ADVERTISER	PAGE NO.	READER SERVICE No.	ADVERTISER	PAGE NO.
1	Allison Automotive Co.	64	20	Linear Systems, Inc.	96
2	Altaj Electronics	104	21	McIntosh Laboratory, Inc.	94
3	B&K Products of Dynascan	26	22	MITS Inc.	17
	Bell & Howell Schools	90, 91, 92, 93		Mallory Distributor Products Company	13
	CREI Capitol Radio Engineering Institute	SECOND COVER, 1, 2, 3	24	Midwest Hifi Wholesale & Mail Order Division	71
6	Center for Technical Development Inc., The	9		NRI Training	36, 37, 38, 39
7	Circuit Designs, Inc.	71		National Technical Schools	18, 19, 20, 21
8	Cleveland Institute of Electronics	72, 73, 74, 75	25	Pickering & Co., Inc.	11
9	Delta Electronics Co.	106	26	Poly Paks	103
10	Delta Products, Inc.	15	37	Radio Shack	53
11	Digi-Key	99	27	Sams & Co., Inc., Howard W.	23
	Digital Concepts	85	32	Shure Brothers Inc.	FOURTH COVER
13	EICO	98	28	Solid State Sales	101
14	Edmund Scientific Co.	108	29	Solid State Systems, Inc.	105
15	Electronic and Control Engineers' Book Club	7	30	Southwest Technical Products Corporation	8
16	GTE Sylvania	109, 110	31	Tracy Design Corporation	100
17	Greenlee Tool Co.	16	33	Tri-Star Corp.	98
5	Heath Company	54, 55, 56, 57	4	United Audio Products, Inc.	25
18	Illinois Audio	64	34	Utah Electronics	41
	CLASSIFIED ADVERTISING		35	Wall-Lenk Manufacturing Company	16
			36	Wavetek	8
					.99, 100, 101, 102, 104, 106, 107

SPORTS ACTION FILMS

SAVE ENERGY—ORDER BY MAIL! 1974 Catalogs ready for immediate delivery. Make your selection from Columbia, Castle or Sportlite Films Catalogs at 25¢ each (coin or stamps). **MAY SPECIAL:** Ali-Frazier #2, 2-reeler, B&W, \$16.95 PPD; Eastman Color, \$33.95 delivered. **SPORTLITE**, Elect-5 Dept., Box 500, Speedway, Indiana 46224.

PLASTICS

CASTOLITE pours like water, hardens like glass without heat. Crystal clear, colors. Embed flowers, seashells, momentos, anything. Make fine gifts. Form flexible molds over any pattern, size. Reproduce your own designs in plastics, candle wax, metal, plaster, cement. Profitable. Illustrated Manual and Catalog Only 50¢. **CASTOLITE**, Dept. 74E/PE, Woodstock, Ill. 60098.

RESORTS AND TRAVEL

BERTH & Partnership in 155 ft. 3-masted Barquentine for \$10,700. Join in Europe, assist conversion then help sail on 2-year Adventure & Business World Voyage. Write: R. Bruderer, IYC, Box 149 Broadway, NSW Australia 2007.

HYPNOTISM

SLEEP learning. Hypnotic method. 92% effective. Details free. ASR Foundation, Box 7566EG, Fort Lauderdale, Florida 33304.

FREE Hypnotism. Self-Hypnosis. Sleep Learning Catalog! Drawer H400, Ruidoso, New Mexico 88345.

AMAZING self-hypnosis record re-eases fantastic mental power. instant results! Free trial. Write: Forum (AA5), 333 North Michigan, Chicago 60601.

BOOKS

FREE catalog aviation/electronic/space books. Aero Publishers, 329PE Aviation Road, Fallbrook, California 92028.

FREE book prophet Elijah coming before Christ. Wonderful bible evidence. Megiddo Mission, Dept. 64, 481 Thurston Rd., Rochester, N.Y. 14619.

BOOKS—thousands titles, bargains. Catalog Free. Cassiano, 92-27 New York Blvd., Jamaica, New York 11433.

736 PAGES of the good old days, 1908 Sears Catalogue. \$2.89 pp. Return in 10 days if not delighted. No C.O.D.'s. Jay, Box 103, St Mary's City, Md. 20686.

REPAIRS AND SERVICES

TECHNICAL services—Engineers will answer or give opinion on technical questions. \$5.00 fee with request. Will custom design, modify or construct circuits, kits or equipment. Quotation: EECO, Box 64622, Baton Rouge, La 70806.

ETCHED CIRCUIT BOARDS from your toil patterns, same size or reduced, phenolic or glass, silver plated, fast service. Write for price list. Box 302, Cote-St-Luc, Quebec, Canada. U. S. Inquiries.

MAGNETS

MAGNETS. All types. Specials-20 disc, or 10 bar, or 2 stick, or 8 assorted magnets, \$1.00 Magnets, Box 192-H, Randallstown, Maryland 21133.

MISCELLANEOUS

WINEMAKERS: Free illustrated catalog yeasts, equipment. Semple, Box 12276P, Minneapolis, Minn. 55412.

CATALOGS! Receive many! Catalog Directory \$1.00. Box 33098, District Heights, Md. 20028.

LIVE IN THE WORLD OF TOMORROW...TODAY!

(And our FREE CATALOG is packed with exciting and unusual ecological & physical science items—plus 4,500 finds for fun, study or profit . . . for every member of the family.)

A BETTER LIFE STARTS HERE

HE-NE LASERS... \$99.50 UP!

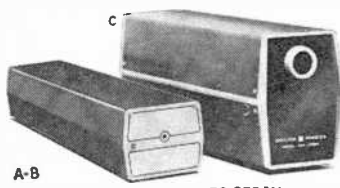

- A-B (B) 1.0mW... (as above) = \$79.073AV
 (C) 4.0mW... 0.8 Beam Dia, 1.1 mRad Diverg. = \$79.079AV (3.9x5.5x15.6") = \$465.00 Ppd.

Top quality Spectra Physics lasers feature TEM₀₀ mode, internal mirror, plasma tubes w/ 10,000 hr life, self-starting cold aluminum cathodes, low noise & ripple, guaranteed output power stability and more for demanding lab work. 18-mo. mfr. wty. 115V AC (A) 0.5mW... 0.88 Beam Dia... 1mRad Diverg. = \$79.070AV (2.6x8.5x14.8") = \$99.50 Ppd. = \$125.00 Ppd.

KNOW YOUR ALPHA FROM THETA!

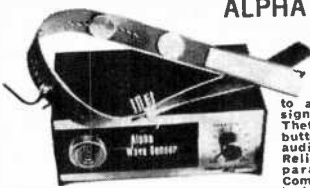

For greater relaxation, concentration, listen to your Alpha-Theta brainwaves. Ultra-sensitive electrode headband slips on/off in seconds—eliminates need for messy creams, etc. Aitch'd to amplifier, filters brainwaves, signals beep for ea. Alpha or Theta wave passes monitoring button stimulates Alpha sound; audio & visual (L.E.D.) feedback. Reliable, easy-to-use unit—comparable to costlier models. Completely safe. Comprehensive instruction booklet.

- No. 1635AV... (8x3x4"; 24 oz.) = \$128.00 Ppd.
 No. 71.809AV... (LOW COST "STARTER" UNIT)... \$49.95 Ppd.

3-CHANNEL COLOR ORGAN KIT

Easy to build low-cost kit needs no technical knowledge. Completed unit has 3 bands of audio frequencies to modulate 3 independent strings of colored lamps (i.e. "lows"—reds, "middles"—greens, "highs"—blues. Just connect hi-fi, radio, power lamp etc. & plug ea. lamp string into own channel (max. 300w ea.). Kit features 3 neon indicators, color intensity controls, controlled individ SCR circuits; isolation transformer; custom plastic housing; instr.



Stock No. 41,831AV \$17.50 Ppd.

"FISH" WITH A GIANT MAGNET

Fascinating fun, and sometimes very profitable! Tie a line to our 3 1/2-pound Magnet—drop it overboard in bay, river, lake or ocean. Trawl it along the bottom. Your "treasured" haul can be outboard motors, anchors, other metal valuables. Five-pound Magnet is war surplus—Alnico V Type that cost the Government twice our price. It lifts over 40 pounds on land—much greater weights under water!

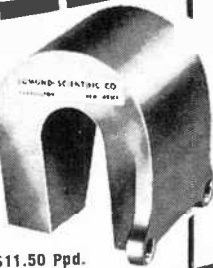

- Stock No. 70,570AV 3 1/2 lbs. \$11.50 Ppd.
 Stock No. 60,215AV 1 1/2 lbs. \$ 6.50 Ppd.

HOW TO BEAT THE ENERGY CRISIS



Shop Solar Headquarters USA—that's us! Our "Solar House Plans" book gives det. on bldg 5 homes; hi-output Silicon Solar Cell can power a boat, toy car; Conversion Kit shows how sun's energy becomes electricity to run small motors, etc. Solar Cooker cooks great; Furnace Kit goes to 2000°!

- No. 9440AV... (SOLAR HOME PLANS)..... \$10.00 Ppd.
 No. 30,538AV... (SILICON CELL)..... \$11.95 Ppd.
 No. 60,505AV... (CONVERSION KIT)..... \$18.00 Ppd.
 No. 71,653AV... (PORT. SOLAR COOKER)..... \$10.75 Ppd.
 No. 70,533AV... (SOLAR FURNACE KIT)..... \$ 4.00 Ppd.

SUPER 6" SPACE CONQUEROR



Superb Astro-Optical Reflector reveals faint stars of nearly 13th magnitude, w/ 11 double stars separated by less than 1 sec. of arc. Features aluminumized overcoated 6" f/8 ground polished Pyrex® parabolic mirror accurate to 1/4 wave, 45° f/8.5X astronomical finder, 3 eyepieces—1.8X Kellner, 1.6" 36X, 1/4" 129X (transdms., & a Barlow to double or triple power)—rack & pinion focusing mount. 47 1/2" aluminum tube, electric clock drive w/ manual slow motion control. Setting circles. Heavy-duty equatorial mount. Pedestal base.

- No. 85,086AV... (Shp. Wt. 68 lbs.) = \$259.50 F.O.B.
 6" W/OUT CLOCK DRIVE
 No. 85,187AV... \$222.50 F.O.B.
 No. 85,105AV... \$115.00 F.O.B.
 4 1/2" REFLECTOR (48X to 275X)
 No. 85,107AV... \$149.95 F.O.B.
 3" REFLECTOR (60X to 180X)
 No. 85,050AV... \$ 36.95 Ppd.



MAIL COUPON FOR GIANT FREE CATALOG!

180 PAGES • MORE THAN 4,500 UNUSUAL BARGAINS!

Completely new '74 Catalog. Packed with huge selection of telescopes, microscopes, binoculars, magnets, magnifiers, prisms, photo components, ecology and Unique Lighting items, parts, kits, accessories—many hard-to-get surplus bargains. 100's of charts, illustration. For hobbyists, experimenters, schools, industry.

EDMUND SCIENTIFIC CO.
 300 Edscorp Building, Barrington, N. J. 08007
 Please rush Free Giant Catalog "AV"

Name _____
 Address _____
 City _____ State _____ Zip _____

COMPLETE & MAIL WITH CHECK OR M.O.

EDMUND SCIENTIFIC CO.

300 Edscorp Building, Barrington, N.J. 08007

How Many	Stock No.	Description	Price Each	Total

PLEASE SEND GIANT FREE CATALOG "AV" MERCHANDISE Total
 ADD HANDLING CHARGE: \$1.00 ON ORDERS UNDER \$5.00; 50c ON ORDERS OVER \$5.00



I enclose check money order for \$ _____
 TOTAL \$ _____
 NAME _____
 ADDRESS _____
 CITY _____ STATE _____ ZIP _____

CIRCLE NO. 14 ON READER SERVICE CARD
 Printed in U.S.A.

CIRCLE NO. 16 ON READER SERVICE CARD

Why a Sylvania home training program may be your best investment for a rewarding career in electronics.

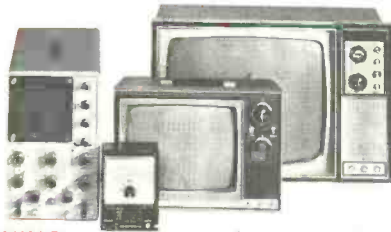

In the Master TV/Radio Servicing Program, you build and keep the all solid-state black and white TV set, the color TV set, the oscilloscope and multimeter shown.

1. LEADER IN ELECTRONICS TRAINING

Over the years, Sylvania Resident Schools have trained thousands of students for key positions in electronics. Now, through Sylvania Home Training, you can receive the same high-quality career training at home.

2. AUTOTEXT TEACHES YOU ELECTRONICS RAPIDLY, EASILY.

AUTOTEXT, offered exclusively by Sylvania, is the proven step-by-step method of home training that can help you learn electronics quickly and easily.

3. CASSETTE SYSTEM

This innovative learning-by-hearing approach is a special option that is almost like having an instructor in your own home. On cassette tapes, an instructor guides you through your AUTOTEXT lessons, explaining the material as you read it.

4. SPECIALIZED ADVANCED TRAINING

With our advanced courses, you can start on a higher level and skip work you know.

5. PERSONAL SUPERVISION THROUGHOUT

All during your program, your exams are

reviewed and your questions are answered by Sylvania instructors who become personally involved in your efforts and help you over any "rough spots" that may develop.

6. HANDS-ON TRAINING

Many programs come with valuable kits to give practical application to your studies. In our Master TV Radio Servicing Program, for example, you actually build and keep an all solid-state black and white TV set, a color TV set, an oscilloscope, and a multimeter.

7. FCC LICENSE TRAINING — MONEY BACK AGREEMENT

Take Sylvania's Communications Career Program — or enter with advanced standing and prepare immediately for your 1st, 2nd, or 3rd class FCC Radio Telephone License examinations. Our money-back agreement assures you of your money back if you take, and fail to pass, the FCC examination taken within 6 months after completing the course.

8. CONVENIENT PAYMENT PLANS

You get a selection of tuition plans. And, there are never any interest charges.

LET SYLVANIA TRAIN YOU FOR A BIG FUTURE CAREER IN ELECTRONICS

Send for your FREE CATALOG right now!

Please rush me Free Illustrated Career CATALOG and more information about Sylvania's CASSETTE SYSTEM. I understand that I am under no obligation and that no salesman will call. I am interested in:

HOME STUDY

- | | |
|---|--|
| <input type="checkbox"/> Television & Radio Servicing (including Color TV and CATV lessons) | <input type="checkbox"/> Fundamental Electronics |
| <input type="checkbox"/> Communications (including CATV lessons) | <input type="checkbox"/> Electronics Technology |
| <input type="checkbox"/> FCC License Preparation | <input type="checkbox"/> Solid State Electronics |
| | <input type="checkbox"/> Digital Technology |
| | <input type="checkbox"/> Industrial Electronics |
| | <input type="checkbox"/> Instrumentation |
| | <input type="checkbox"/> Drafting |

CLASSROOM TRAINING

- Boston New York Philadelphia

694-405 0

Name _____ Age _____

Address _____

City _____ State _____ Zip _____

Veterans & Servicemen: Check here for GI Bill information
Sylvania Technical Systems, Inc.

GTE SYLVANIA

The Sylvania Cassette System

An exciting concept -
new in electronics
home training



It's almost like having an instructor in your own home.

This innovative learning-by-hearing approach is designed to get you started more quickly and easily towards an electronics career. The CASSETTE SYSTEM adds an extra dimension to AUTOTEXT, the step-by-step planned instruction which simplifies the mechanics of learning. As you play the cassette tapes, you'll have an instructor guiding you through your AUTOTEXT lessons. Explaining the material as you read it. And now the CASSETTE SYSTEM is available as an optional extra to all students enrolling in basic, fundamental, and career programs.

"HANDS-ON" TRAINING

In addition, you get the all-important "Hands-On" training. You perform experiments and build a number of pieces of electronics test equipment that are yours to keep. In the Master TV/Radio Servicing

program you build and keep an all solid-state black & white TV set and a color TV set, oscilloscope and multimeter.

CHOOSE FROM EXCITING CAREERS

Whether your career goal is radio/TV servicing, digital technology, communications or industrial electronics, Sylvania Home Study gets you started towards that career with the training you might have thought was too expensive, too drawn-out, or too hard to learn.

NO SALESMAN WILL CALL

If you want an exciting, rewarding career in electronics, discover which Sylvania course or program is for you. Send the attached card today.

GTE SYLVANIA

BUSINESS REPLY MAIL

No Postage Stamp Necessary if Mailed in U.S.A.

FIRST CLASS
PERMIT NO
48975
NEW YORK, N.Y.

Postage will be paid by —

SYLVANIA TECHNICAL SCHOOL
Home Study Division
909 Third Avenue
New York, N.Y. 10022

**FOR FREE
ILLUSTRATED
CAREER
CATALOG**

and more
information about
Sylvania's
CASSETTE SYSTEM
send postage paid
reply card
TODAY!

Sylvania Technical
Systems, Inc.

Popular Electronics

READER SERVICE

Here's an easy and convenient way for you to get additional information about products advertised or mentioned editorially (if it has a reader service number) in this issue. Just follow the directions below... and the material will be sent to you promptly and free of charge.

1

On the attached postage-free card, print or type your name and address on the lines indicated.

2

Circle the number(s) that corresponds to the key number(s) at the bottom or next to the advertisement or editorial mention that is of interest to you. (Key numbers for advertised products also appear in the Advertisers' Index.)

3

Simply cut out the card and mail. No postage required.

FREE INFORMATION

1974 ELECTRONIC EXPERIMENTER'S HANDBOOK Spring Edition

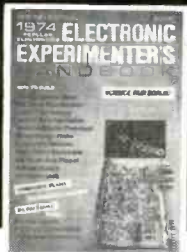

Helps you get it together... with a score of build-it-yourself projects.

You can count on ELECTRONIC EXPERIMENTER'S HANDBOOK. It's by the editors of Popular Electronics—with features and articles and complete lab-tested instructions that guarantee successful hours and months of mind-absorbing projects for fun and practicality.

How about BOUNCING, BOUNCING, BOUNCING—a fascinating analog computer programmed to solve an intriguing problem. Then there's the MEMO-O-PROBE LOGIC LEVEL INDICATOR—a probe that not only reveals high and low TTL or DTL logic states but captures low-duty-cycle pulses that even a scope might miss. Or a TC SWITCH FOR REMOTE CON-

TROL—a handy device with which you can turn off the TV without getting out of bed, start the morning coffee perking or turn on house lights when you have both hands full. You can build the 2-TONE "WAVERLY" ALARM—it can be used as a panic button, novelty audio device, an electronic doorbell, a selective call, a burglar alarm, and more. There's an Issue full of other brain teasers including HEADS 'n' TAILS—the electronic coin flipper • DIGI-VIEWER—the handy digital IC tester that can be built for under \$20 • CRYPTO-LOCK—the electronically activated, small in size, burglar-proof lock • SIGNAL-DIFFERENCE STEREO BALANCE METER • AN ELECTRONIC CLINICAL THERMOMETER • SOUND ACTIVATED PHOTOFLASH ATTACHMENT • CONSTRUCTING PC BOARDS—a useful technique for making professional-looking-printed circuit boards • PLUS other challenging and stimulating build-it-yourself projects.

HERE'S HOW TO ORDER

Send your order to Ziff-Davis Service Division, Dept. EEH, 595 Broadway, New York, N. Y. 10012. Print your name and address clearly, specify "1974 ELECTRONIC EXPERIMENTER'S HANDBOOK—Spring Edition," enclose \$1.25 plus 35c for postage and handling. (Outside U.S.A. copies are \$2.50 each, postpaid.)

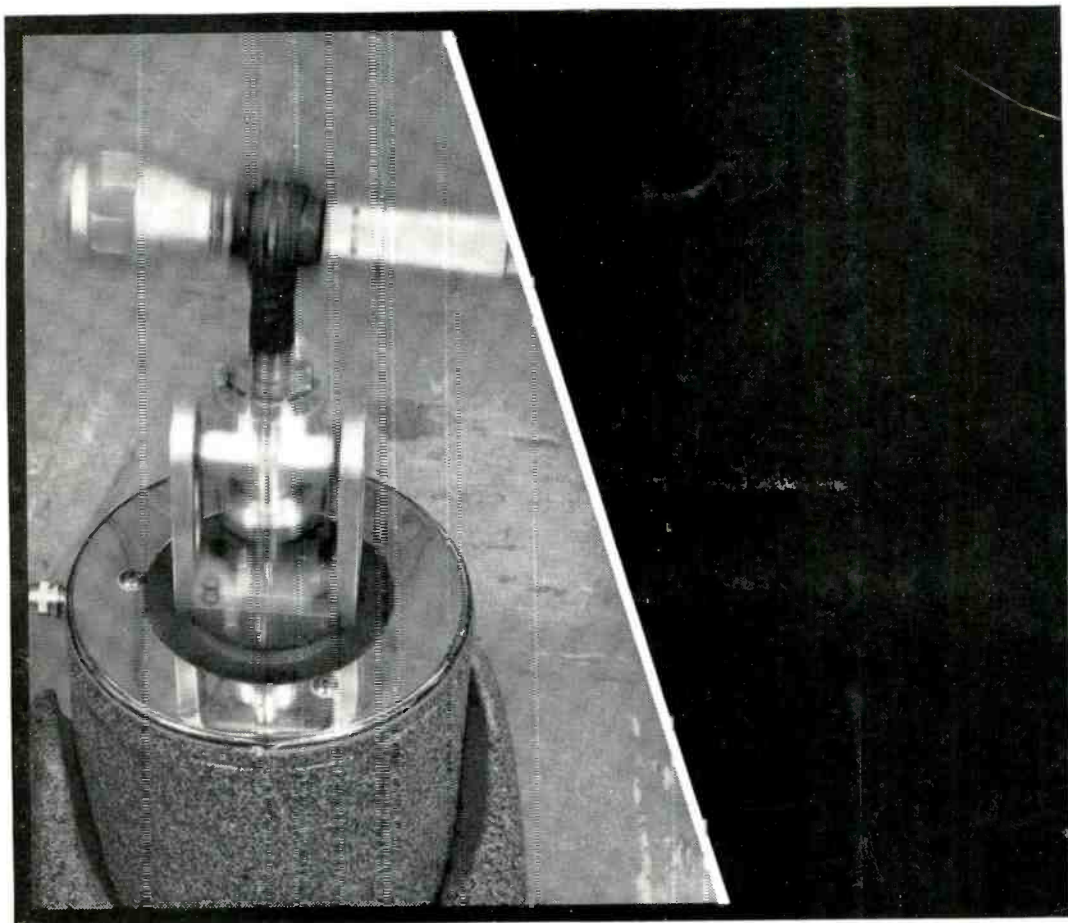

shake. rattle & roll.



Welcome to our chamber of horrors. Inside the Shure Quality Control laboratory, some of the most brutal product tests ever devised are administered to Shure microphones. The illustration above shows a "shaking" machine at work on a Shure microphone and noise-isolation mount. It's only one in a battery of torturous tests that shake, rattle, roll, drop, heat, chill, dampen, bend, twist, and generally commit mechanical, electrical and acoustical mayhem on off-the-production-line samples of all Shure microphones. It's a treatment that could cause lesser microphones to become inoperative in minutes. This kind of continuing quality control makes ordinary "spot checks" pale by comparison. The point is that if Shure microphones can survive our chamber of horrors, they can survive the roughest in-the-field treatment you can give them! For your catalog, write:

Shure Brothers Inc.
222 Hartrey Ave., Evanston, Ill. 60204
In Canada, A. C. Simmonds & Sons Ltd.



CIRCLE NO. 32 ON READER SERVICE CARD