

A GUIDE TO "CMOS" OPERATION

# Popular Electronics

MARCH 1974/FIFTY CENTS

## FOR HI-FI BUFFS

- Testing with Audio Sweep Generators
- Are Your Speakers in Phase?

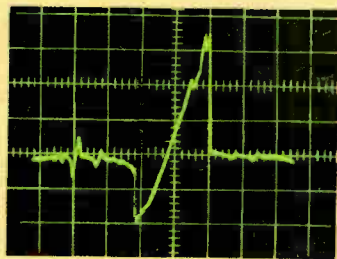
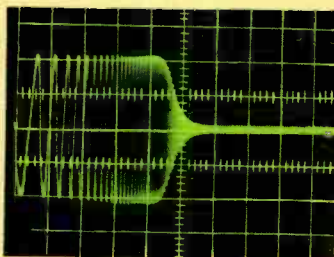
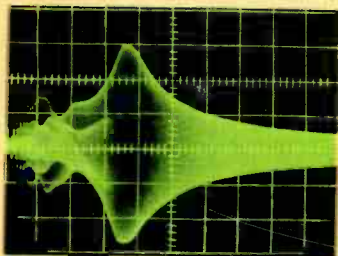

## FOR RADIO COMMUNICATION FANS

- Antenna Switching Methods
- "Whistlers" and Other Strange Radio-Frequency Noises

## PROJECTS FOR EXPERIMENTERS

- Build an Op Amp "Lab in a Box"
- A Single-LED Light-Beam Voice Communicator



## TEST REPORTS

- Sony NR-115 Noise-Reduction A
- E-V Interface: A Speaker System
- Tram Diamond-60 SSB/AM CB
- Leader LBO-302 Dual-Channel

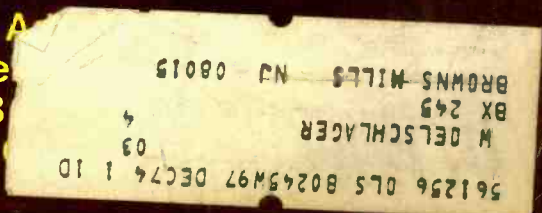



# firsts

make learning  
**Electronics at home**  
**fast and fascinating—**  
**give you priceless**  
**confidence.**

Some NRI **firsts** in training equipment



**first** to give solid state 25" diagonal color TV, 5" wide band oscilloscope, color bar generator and other professional equipment engineered specifically for education. You work directly on the receiver as you build it, discovering the practical aspects of TV servicing as you create a handsome new color console. Only NRI includes an attractive woodgrain cabinet without extra charge.



**first** to give you a unique, exciting digital computer *with memory* built especially for home training. You learn organization, troubleshooting, operation, programming as you build and use it. Performs the same functions as commercial computers. Lessons stress computer repair. You conduct a hundred experiments, build hundreds of circuits. A solid-state TVOM is included among ten training kits.



## NRI's "discovery" method is the result of over half a century of leadership simplifying and dramatizing training at home

The FIRSTS described below are typical of NRI's half century of leadership in Electronics home training. When you enroll as an NRI student, you can be sure of gaining the in-demand technical knowledge and the priceless confidence of "hands-on" experience sought by employers in Communications, Television-Radio Servicing and Industrial and Military Electronics. Everything about NRI training is designed for your education . . . from the much-copied, educator-acclaimed Achievement Kit sent the day you enroll, to "bite-size" well-illustrated, easy to read texts programmed with designed-for-learning training equipment.

### YOU GET YOUR FCC LICENSE OR YOUR MONEY BACK

There is no end of opportunity for the trained man in Electronics. You can earn \$6 or more an hour in spare time, have a business of your own or qualify quickly for career positions in business, industry, government. And if you enroll for any of five NRI courses in Communications, NRI prepares you for your FCC License exams. *You must pass* or NRI refunds your tuition in full. No school offers a more liberal money-back agreement. The full story about NRI leadership in Electronics training is in the new NRI Catalog. Mail postage-free card today. No salesman is going to call.  
NATIONAL RADIO INSTITUTE, Washington, D.C. 20016 (In Canada write: NRI Rep., 330 Progress Ave., Scarborough, Ont.)

**APPROVED UNDER NEW GI BILL** If you have served since January 31, 1955, or are in service, check GI line on postage-free card.

## designed from chassis up for your education



**first** to give you true-to-life experiences as a communications technician. Every fascinating step you take in NRI Communications training, including circuit analysis of your own 15-watt, phone/cw transmitter, is engineered to help you prove theory and later apply it on the job. Studio equipment operation and troubleshooting become a matter of easily remembered logic.



**first** to give you completely specialized training kits engineered for business, industrial and military Electronics. Shown above is your own training center in solid state motor control and analog computer servo-mechanisms. Telemetry circuits, solid-state multi-vibrators, and problem-solving digital computer circuits are also included in your course.

# Popular Electronics

WORLD'S LARGEST-SELLING ELECTRONICS MAGAZINE

## FEATURE ARTICLES

- 27 A GUIDE TO CMOS OPERATION**, *Part 1.* Walter G. Jung  
*How and why these IC's are becoming so popular.*
- 41 ARE YOUR SPEAKERS IN PHASE?** David B. Weems  
*Using a scope and mike to get proper connections.*
- 44 HOW AUDIO SWEEP GENERATORS SAVE TIME & INCREASE ACCURACY** Jon D. Paul  
*Tests for amplifiers, speakers, noise reduction units, etc.*
- 50 PITCH GENERATORS FOR ELECTRONIC MUSIC** Don Lancaster  
*Part 2. Digital dividers and phase-locked loops.*
- 58 RANDOM TONE GENERATOR**
- 89 ELECTRONICS PHYSICS QUIZ** Robert P. Balin
- 94 GENERAL ELECTRIC COLOR TV SETS** John T. Frye
- 97 WHISTLERS AND OTHER STRANGE R-F NOISES** D. J. Holford
- 99 ANTENNA SWITCHING METHODS** W. R. Moody

## CONSTRUCTION STORIES

- 33 IC DIGITAL LOGIC MEMORY PROBE** Richard P. May
- 40 BUILD A TREMOLO ADAPTER** Deane A. Gardner
- 59 BUILD THE OP AMP DESIGNER** Jack Cazes  
*Experiment with op amps the easy way.*
- 64 BUILD THE LOW-COST OSCILLOSCOPE TESTER** John F. Hollabaugh  
*Makes audio, r-f tests and identifies type.*
- 66 SINGLE-LED TRANSCIVER** Forrest M. Mims  
*Communicates over light beams.*

### ZIFF-DAVIS PUBLISHING COMPANY

Popular Electronics  
Editorial and Executive Offices  
One Park Avenue, New York, New York 10016  
212-725-7405

William Ziff, President  
W. Bradford Briggs, Executive Vice President  
Hershel B. Sarbin, Senior Vice President, Secretary, and Treasurer  
Philip Sine, Senior Vice President  
Phillip T. Heffernan, Vice President, Marketing  
Frank Pomerantz, Vice President, Creative Services  
Arthur W. Butzow, Vice President, Production  
Edward D. Muhlfeld, Vice President, Aviation Division  
Irwin Robinson, Vice President, Travel Division  
George Morrissey, Vice President  
Sydney H. Rogers, Vice President  
Sidney Holtz, Vice President  
Lawrence Sporn, Vice President, Circulation

POPULAR ELECTRONICS, March 1974, Volume 5, Number 3. Published monthly at One Park Ave., New York, NY 10016. One year subscription rate for U.S., U.S. Possessions and Canada, \$6.00; all other countries, \$7.00. Second class postage paid at New York, N.Y. and at additional mailing offices. Authorized as second class mail by the Post Office Department, Ottawa, Canada and for payment of postage in cash. Subscription service and Forms 3579: P.O. Box 2774, Boulder, CO 80302. Editorial offices for manuscript contributions, reader inquiries, etc.: One Park Ave., New York, NY 10016.

POPULAR ELECTRONICS Including ELECTRONICS WORLD, Trade Mark Registered. Indexed in the Reader's Guide to Periodical Literature.

Copyright © 1974 by ZIFF-DAVIS PUBLISHING COMPANY. All rights reserved.



**EDGAR W. HOPPER**  
*Publisher*  
**ARTHUR P. SALSBERG**  
*Editorial Director*  
**MILTON S. SNITZER**  
*Editor*  
**LESLIE SOLOMON**  
*Technical Editor*  
**JOHN R. RIGGS**  
*Managing Editor*  
**EDWARD I. BUXBAUM**  
*Art Director*

**ALEXANDER W. BURAWA**  
*Associate Editor*  
**ANDRE DUZANT**  
*Technical Illustrator*  
**ELLEN S. FINKELSTEIN**  
*Editorial Assistant*  
**LEN BUCKWALTER**  
**JOHN T. FRYE**  
**LOU GARNER**  
**RALPH HODGES**  
**WALTER G. JUNG**  
*Contributing Editors*

**JOSEPH E. HALLORAN**  
*Advertising Director*  
**JOHN J. CORTON**  
*Advertising Sales*  
**MADELEINE LITTMAN**  
*Advertising Service Manager*  
**PEGI McENEANEY**  
*Executive Assistant*  
**STANLEY NEUFELD**  
*Associate Publisher*  
**FURMAN H. HEBB**  
*Group VP, Electronics & Photo*

## THE SCENES

- 12** STEREO SCENE *Ralph Hodges*
- 24** HOBBY SCENE
- 84** SOLID-STATE *Lou Garner*
- 101** CB SCENE *Len Buckwalter*
- 104** TEST EQUIPMENT SCENE *Les Solomon*

## PRODUCT TEST REPORTS

- 76** ELECTRO-VOICE INTERFACE: A SPEAKER SYSTEM
- 78** SONY MODEL NR-115 NOISE REDUCTION ADAPTOR
- 80** LEADER MODEL LBO-302 DUAL-CHANNEL OSCILLOSCOPE
- 81** TRAM DIAMOND-60 AM/SSB TRANSCEIVER
- 83** CALECTRO MINI MOUNTS

## DEPARTMENTS

- 6** EDITORIAL *Milton S. Snitzer*  
*The Energy Crisis and Electronics*
- 8** LETTERS
- 22** NEWS HIGHLIGHTS
- 106** TIPS & TECHNIQUES
- 107** NEW LITERATURE
- 112** NEW PRODUCTS
- 115** ELECTRONICS LIBRARY

**COMING NEXT MONTH**  
*Build a Low-Cost Professional  
Alphanumeric Keyboard  
Walkie-Talkies for Everyone  
Electronics and the Modern Sound  
Studio  
Construct a GFI Anti-Electrocution  
Device*

Midwestern Office  
The Patis Group, 4761 West Touhy Ave.,  
Lincolnwood, Illinois 60644, 312 679-1100  
GERALD E. WOLFE, GEORGE B. MANNION

Western Office  
9025 Wilshire Boulevard, Beverly Hills, California 90211  
213 273-8050; BRADSHAW 2-1161  
Western Advertising Manager, BUD DEAN

Japan: James Yagi  
Oji Palace Aoyama: 6-25, Minami Aoyama  
6 Chome, Minato-Ku, Tokyo 407-1930/6821

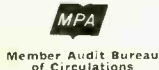

Ziff-Davis also publishes Boating, Car and Driver, Cycle, Flying, Modern Bride, Popular Photography, Skiing, and Stereo Review.

Forms 3579 and all subscription correspondence should be addressed to POPULAR ELECTRONICS, Circulation Department, P.O. Box 2774, Boulder, CO 80302. Please allow at least eight weeks for change of address. Include your old address, as well as new—enclosing, if possible, an address label from a recent issue.

Editorial contributions must be accompanied by return postage and will be handled with reasonable care; however, publisher assumes no responsibility for return or safety of art work, photographs, models, or manuscripts.



# Editorial

By Milton S. Snitzer, Editor

## THE ENERGY CRISIS AND ELECTRONICS

Bureaucratic decisions can be frustrating—whether they place a freeze on sales prices for a specific month (damaging to companies whose prices for that month were at a seasonal low) or institute power consumption cutbacks based on usage the previous year (catastrophic to companies enjoying a production boom, with large capital expenditures made in anticipation of increased demands). The latter is especially discouraging to electronics buffs, who might be faced with increasing parts shortages if power reductions based on previous usage become mandatory.

For example, West Coast semiconductor manufacturers were asked to cut power consumption 10 percent below the November 1972 level! We all know how semiconductor sales have mushroomed in the past year (more than doubling the output). If the power cutbacks were effected, the expanding semiconductor industry would be in jeopardy—a serious situation for an industry in which the U. S. is a world leader. The results would be manifested in losses in production and engineering jobs, not to mention the broadbased losses due to a decrease in construction of new facilities.

Restricting power or unannounced temporary cutoffs (rolling blackouts) could play havoc with the semiconductor producers, the on-line computer industry, and the suppliers of plastic parts to the electronic industry. One plastics manufacturer points out that rolling blackouts could wipe out processing equipment because the plastics solidify and it would take a jackhammer to pull apart the machines. This would mean no plastic cases for calculators or IC chip carriers. (One semiconductor manufacturer already requires that customers return plastic chip carriers.) Note, too, that diffusion furnaces for semiconductor devices operate around the clock; and a power interruption of more than 30 minutes could destroy the expensive quartz linings in the furnace.

Interestingly, it has been reported that semiconductor firms in the United Kingdom are expected to be rated as continuous industrial process users, enabling them to continue operations despite the power cutbacks ordered by their government. Perhaps similar easements are appropriate in the U. S. also. Since the energy crisis will apparently be with us for some time, we hope that the sensitive requirements of the electronics industry will be considered by government bureaus and utility companies if energy priorities are initiated at some future time.

*Other signs of the energy-shortage times: A major U. S. semiconductor manufacturer plans to build a large wafer fabrication plant in Poland. . . . Low-power CMOS could replace TTL in many applications, reducing power consumption by as much as a factor of 100.*

# Are you playing your records or ruining them?

If you're like most music listeners, you never think about your records after putting them on your record player.

You just sit back and enjoy the music.

Chances are you'd be less relaxed if you knew that your records might be losing something with every play.

Like the high notes.

It's something to think about. Especially when you consider how many hundreds or even thousands of dollars you have invested in your record collection. And will be investing in the future.

## What happens during play.

Even the cheapest record changer can bring its tonearm to the record and lift it off again. But what happens during the twenty minutes or so of playing time is something else.

The stylus is responding with incredible speed to the roller-coaster contour of the stereo grooves. This action recreates all the music you hear, whether it's the driving energy of a rock band or the richness of a symphony orchestra.

The higher the frequency of the music, the more rapidly the contours change, and the sharper the peaks the stylus has to trace. If the stylus bears down too heavily, it won't go around those soft vinyl peaks. Instead, it will lop them off. The record will look unchanged, but your piccolos will never sound quite the same. Nor will Jascha Heifitz.

## It's all up to the tonearm.

What does it take for the stylus to travel

the obstacle course of the stereo groove without a trace that it's been there? It takes a precision tonearm. One that can allow today's finest cartridges to track optimally at low pressures of one gram or less. For flawless tracking, the tonearm should be perfectly balanced with the weight of the cartridge, and must maintain the stylus pressure equally on each side wall of the stereo groove. And in order to maintain this equal pressure during play, the tonearm must not introduce any drag. This requires extremely low friction pivot bearings.

There is much more to the design and engineering of tonearms and turntables. But this should be sufficient to give you the idea.

## Dual: the music lovers' preference.

By now you probably understand why serious music lovers won't play their precious records on anything but a precision turntable. And the most serious of these people, the readers of the leading music magazines, buy more Duals than any other make of quality turntable.

If you would like to know more about Dual turntables, we'll send you lots of interesting literature, including an article on how to buy a turntable, and reports by independent test labs. Or better yet, just visit your franchised United Audio dealer and ask for a Dual demonstration. You will never have to worry about your records again.



Dual 1218, \$189.95

Dual 1216, \$154.95

Dual 1229, \$259.95



United Audio Products, Inc., 120 So. Columbus Ave., Mt. Vernon, N.Y. 10553

Exclusive U.S. Distribution Agency for Dual

**CIRCLE NO. 4 ON READER SERVICE CARD**



# FAR OUT

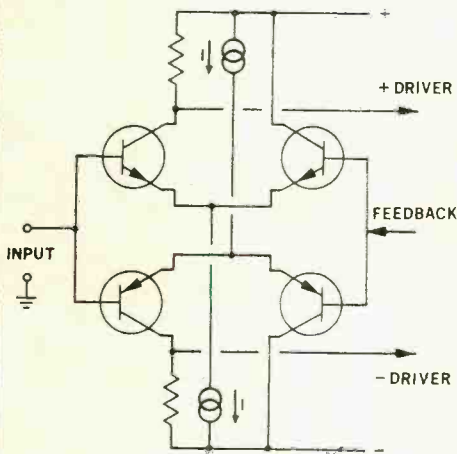

Yes the circuits used in our power amplifiers and preamp kits are rather unique and unusual. They probably are as good, or better than anything else available too. We don't however charge you a large premium for the engineering that has gone into these outstanding products. Get a copy of our new catalog and compare prices and specifications.

Where else are you going to buy a 60 watt amplifier kit that has less than 0.01% IM distortion all the way up to full rated RMS output for \$75.00? In addition to the unmatched performance you get bronze anodized chassis and cover and even an output level meter on the front panel—like we said "far out".

GET OUR  
**NEW 1974  
CATALOG**

listing this and other unique kits

**FREE**

by simply circling our number  
on the reader service card.



**SOUTHWEST TECHNICAL  
PRODUCTS CORPORATION**

DEPT. PE

219 W. Rhapsody, San Antonio, Texas 78216

**CIRCLE NO. 33 ON READER SERVICE CARD**

# Letters

## EASIER COMBINATION CHANGES

In "Simple Electronic Combination Lock" (November 1973), the positions of the switches must be changed to alter the combination, decreasing versatility if the switches are located remotely. By wiring the switches to a connector assembly such as the Amphenol RAC 17 series, combination changes can be greatly simplified. All wires between the switches and circuitry would go to separate pins on the female connector, with bridging conductors to complete the circuit wired to the male connector. Different bridging schemes wired to extra males would provide different combinations. (Don't forget to print the appropriate combinations on the males.) To change combinations, you simply change males.

WILLIAM H. GREENHALGH, W2NCN  
Neshanic Station, N.J.

*Good idea, but where switch locations make position changes convenient, your connector idea simply adds expense to the overall cost of the project.*

## ELECTRONIC MUSIC DEALER IN CANADA

I was happy to see Don Lancaster's article ("Introduction to Electronic Music") in the October 1973 issue of PE. Noting that the manufacturer/supplier list given contained only U.S. addresses, I thought that it might be worthwhile to point out that Electronic Music Studio Supplies is the Canadian distributor for EMS (London) Ltd.

OTTO JOACHIM  
Electronic Music Studio Supplies  
5832 Westminister Ave.  
Montreal HW4 2J8, Quebec, Canada

## AUTHOR SOLVES PROBLEM

I appear to have made an error in my "Picture-Tube Tester and Rejuvenator" (October 1973). I stated that a 50-mA meter movement was needed when it should have been 5 mA. This would account for any arcing that occurs without S3 being depressed. The value of R3 should be ten times the conducting resistance of the CRT, an impossible demand placed upon a

scheme using a 50-mA movement. By using a 5-mA or lower movement, the problem of burning up the resistors, which might also occur when the arcing problem exists, will be eliminated.

WILLIAM R. SHIPPEE  
Frazee, Minn.

### TIMELY PIX TUBE TESTER/REJUVENATOR

"Picture Tube Tester and Rejuvenator" came just in time. It saved me the cost of a new color tube; all I had to do was rejuvenate my bad red gun.

I would like to make a suggestion to other readers who are interested in building this project. Coletronics Service Inc. (1744 Rockaway Ave., Hewlett, NY 11557) sells a Model MH-3 CRT multi-head adapter that works with both color and monochrome picture tubes. I used an

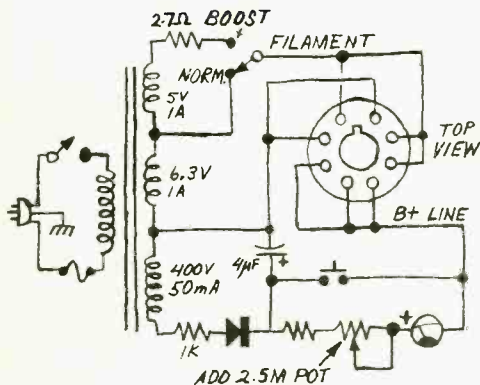

eight-pin socket on the rejuvenator to match the adapter, connecting it as shown in the drawing. I hope other builders will find my modification useful.

THOMAS F. LA CHE  
Milwaukee, Wisc.

*Many thanks for passing on your idea.*

### NON-PEEP SIREN

I recently constructed the "Electronic Siren" (December 1973). So far, I haven't been able to get a "peep" out of it.

RICHARD H. LIVINGSTON  
Springfield, Pa.

The diagram in the article showed only the logic connections to IC1. The author (or somebody) just assumed that the power connections would be made also. Connect +3.6 volts to pin 11 and ground to pin 4. Actually the 9-volt supply is not absolutely necessary; 3.6 volts can be used throughout if it is more convenient.

With the battery connected, the circuit will operate as described.

MARCH 1974

## If You Work In Electronics:

# GRANTHAM OFFERS YOU College-Level Training

and a college degree.

**Electronic Circuit Design, Engineering Analysis (including mathematics thru calculus), Classical and Solid-State Physics, Engineering Design, etc., etc., are all part of the Grantham home-study degree program in Electronics Engineering.**

*(Regardless of what you may have read in another school's ad, Grantham does teach college-level circuit design by home study.)*

By adding college-level home training and a college degree to your experience, you can move up to greater opportunities in electronics.

Grantham offers the A.S.E.T. degree by correspondence. After earning this degree, you may continue with additional correspondence plus a one-week residential seminar and certain transfer credits to earn the B.S.E.T. degree. Then, the B.S.E.E. is available through further residential attendance.

## GRANTHAM SCHOOL OF ENGINEERING

2000 Stoner Ave., Los Angeles, CA 90025

● Telephone (213) 462-1411 ●

Established in 1951 — G.I. Bill approved.  
Mail the coupon below for free bulletin.

**Grantham School of Engineering** PE-3-74  
2000 Stoner Ave., Los Angeles, CA 90025

I have been in electronics for \_\_\_\_\_ years. Please mail me your free bulletin which gives details concerning your electronics degree programs.

Name \_\_\_\_\_ Age \_\_\_\_\_

Address \_\_\_\_\_

City \_\_\_\_\_ State \_\_\_\_\_ Zip \_\_\_\_\_

**CIRCLE NO. 17 ON READER SERVICE CARD**

# The MITS 7440

## Desk-Top Scientific Calculator



### Your Assistant for Expert Results.

The 7440 Scientific Calculator does the basic arithmetic functions plus ten transcendental functions. Algebraic problem entry with two deep nesting parentheses make it possible to enter a problem just the way you would write it. Either floating decimal mode or scientific notation may be used and the results will be displayed in the correct manner result or of a constant. A separate memory register can be used for storage of an intermediate radian entry. There is also a radian mode indication. Two convenience functions ( $\sqrt{x}$ ,  $1/x$ ), a separate  $\pi$  key, and factor reversal ( $x \leftrightarrow y$ ) are also featured.

The fourteen digit LED display provides ten digit precision for mantissa and two digit precision for exponent. There is full sign change capability for both mantissa and exponent, and full chain calculation with any sequence of functions desired. Also featured are automatic error indications for overflow, underflow, and forbidden operations. The thirty-six key keyboard has separate clear and clear entry keys to prevent having to clear the whole problem in the event of an erroneous entry. The calculation range is 10<sup>99</sup> to 10<sup>-99</sup>.

**KEYBOARD FUNCTIONS:**

- Arc tangent
- $e^x$
- $\ln^x$
- Multiplication
- Division
- Sine
- Arcsine
- $\log_{10}x$
- $x^y$
- Cosine
- $\sqrt{x}$ ,  $1/x$
- Arc cosine
- Addition
- Tangent
- Subtraction

**SPECIAL FEATURE:** The 7440 interfaces with the MITS programmer.

**WARRANTY:** Full two-year warranty on assembled units, ninety days on kits.

**SIZE:** 8½" x 12" x 3½"

**\*PRICE:** Kit . . . . . \$199.95  
Assembled . . . . . \$299.95

● MITS makes a full line of Electronic Calculators and Test Equipment.  
\*Prices subject to change without notice.

# MITS INC.

"Creative Electronics"

6328 Linn. N.E. Albuquerque, New Mexico 87108  
505/265-7553 Telex Number 660401



# The MITS 7440 Programmer

## Desk-Top Computer - At Your Command With Instant Recall.

The programmer can program the 7440 to do extremely long or often used calculator operations. Instead of repeatedly entering into the calculator a formula in which only certain variables change, a formula can be entered once into the programmer and then be stored and run at will.

The programmer automatically executes all steps of the program until it sees a location within the formula where a variable is to be entered. It then halts execution, but once the variable is entered into the calculator, the continue key is pressed again and all remaining steps of the formula are executed until the programmer sees another variable entry or an "End of Program" command.

Each key of the calculator (7440) is represented by a special alphanumeric programmer code. The code is entered into the programmer by depressing the appropriate programmer keys associated with each code. Once a complete program has been entered, the user can return to the beginning address and either run the program from start to finish or "step" through each instruction, executing them one at a time.

### FEATURES:

- 256 programming steps with option of expandability to 512 steps
- Program code for each function key on the calculator
- Precludes destruction of stored programs or instruction in hexadecimal
- Six annunciator lights to give clear identification of programmed pauses; two to indicate a halt or end of program
- "IF" instruction which allows branching to the beginning of any line in the program
- "GO TO" instruction which allows transfer of program control to any other line in the program
- "RE-TURN" iterative looping or sub-routines
- "REMEMBER" instruction which allows branching with no instruction with no previous information: Continuous operation: Controlled by "R" and "X" keys
- "S" Key to halt execution anywhere in the program. Execution can be restarted in either of the above RUN modes
- The ability to look at any instruction in memory and/or its execution
- Sperry gas discharge display shows the user where the program execution point is and the current contents of that location.



### \*PRICES:

- Kit: Programmer . . . \$199.95
- Expansion . . . \$79.95
- Assembled: Programmer . . . \$299.95
- Expansion . . . \$129.95

\*Prices subject to change without notice.  
 (Also models available to interface with MITS 816, 1440, and 908DM desk-top calculator.)

Enclosed is a Check for \$ \_\_\_\_\_

or  BankAmericard # \_\_\_\_\_

or  Master Charge # \_\_\_\_\_

Credit Card Expiration Date \_\_\_\_\_

Include \$5.00 for Postage and Handling

Model 7440     Programmer     Expansion

Please Send Information on Entire MITS Line.

NAME \_\_\_\_\_

ADDRESS \_\_\_\_\_

CITY \_\_\_\_\_

STATE & ZIP \_\_\_\_\_

MITS/ 6728 Linn. N.E., Albuquerque, New Mexico 87108 505/265-7553 Telex # 660401

Kit  
 Assembled

CIRCLE NO. 22 ON READER SERVICE CARD

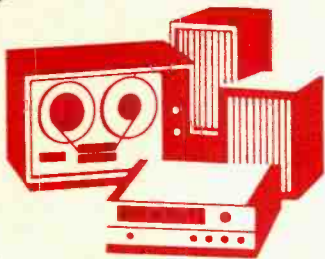

# Stereo Scene

By Ralph Hodges

ON THE West Coast it's popularly called "the Hiss Thing." In the East it's in such short supply that it's still relatively unknown. Its developers at the Phase Linear Corp., with their penchant for functional jargon, refer to it as the "Autocorrelator." What it's intended to do is reduce continuous random noise (hiss) on *existing* phonograph records by about 10 dB without touching the content of the recorded program. The phrase "existing records" means that the device doesn't require the signal preprocessing of compression-expansion systems like the Dolby. It doesn't, in other words, keep noise from being added while the recording is made; it takes noise that exists in the final recording and removes it.

The Autocorrelator is said to work by taking into account what is typical and predictable about noise and music signals (recorded level, frequency distribution, variations with time, etc.) and capitalizing on the difference between them. While I wouldn't attempt to explain the electrical operation of the device in this small space, even if I understood it, Phase Linear offers a nice conceptual model for its action that can be summarized rather easily.

Imagine a set of narrow-band, slightly overlapping filters or "windows," extending from 2000 Hz up to inaudibility. Under no-signal conditions all the filters are "in," and whatever hiss might be present to contaminate the silence is reduced. Then along comes a musical tone, perhaps with a funda-

mental frequency of about 800 Hz. The Autocorrelator senses the fundamental and knows that it is music because it's loud—much louder than the background noise at that frequency. It also knows that the fundamental, being music, probably carries with it a predictable set of harmonically related overtones (1,600 Hz, 2,400 Hz, 3,200 Hz, etc.). Quick as a flash (within one millisecond) the Autocorrelator flips open the windows corresponding to those overtone frequencies. All the rest of the windows remain shut, so that the only noise to get through is the small amount near each of the "pass" frequencies, and this is of course masked by the program.

Ingenuous? Yes, but not quite perfect. There are, after all, a number of recorded sounds people listen to that have little or no overtone content. To keep the Autocorrelator from opening the windows on nothing (except noise), an electronic override had to be added. This keeps track of the overtone range to make sure there's something up there worth hearing. Also there are, according to the manufacturer, a few rare types of recorded signal (low-level applause, for example) that the Autocorrelator can mistake for noise and exclude. In other words, there are a few audible errors to which the device is prone, and eliminating these as much as possible took Phase Linear a reported two years from first working prototype to production model.

**Ticks, Pops, Rumbles, Etc.** While it is fair to call the Autocorrelator a record-noise reducer (after all, what else is there besides the much maligned scratch filter that will remove disc noise?), it is really a *hiss* reducer, and should work very nicely with tape, FM, or any noisy program source. But to suggest that disc records hiss is a slur on the fair name of vinylite (vinyl for

## Noise on Records

THE BEST OF  
BOTH  
WORLDS

STEREO  
and MATRIX\*  
XV-15/1200 E

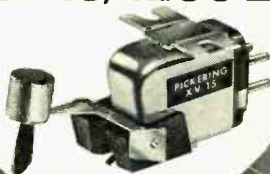

\*DERIVED 4-CHANNEL

DISCRETE  
4-CHANNEL  
UV-15/SERIES



PICKERING'S  
STATE-OF-THE-ART  
CARTRIDGES...

For the world of STEREO—  
XV-15/1200E

Designed for use with all stereo and four-channel derived compatible systems.

"PRECISION" is the one word that best characterizes the extraordinary quality of the new Pickering XV-15/1200E cartridge. We sincerely feel that the 1200E is the furthest advance achievable today—and perhaps in the foreseeable future—in stereo cartridge design and performance. Its exceptional ability to pick up *all* the material recorded at the lightest possible tracking forces make it totally unique and superior.

And all of Pickering's exhaustive testing shows that the 1200E is superior in the flatness of its frequency response and channel separation in comparison to competitive cartridges.

SPECIFICATIONS:

Frequency Response	10 Hz to 30 kHz
Channel Separation, Nominal	35 dB
Tracking Force	¾ gram, + ½ gram, — ¼ gram
Nominal Output	4.4 mv
Stylus Tip	0.0002" x 0.0007"

For the world of DISCRETE 4-CHANNEL—  
UV-15/2400-Q

Designed and engineered specifically for playback of discrete recordings.



QUADRAREDRAL™

The discrete 4-channel system requires a completely new cartridge that could not only faithfully reproduce the 20 Hz to 20 kHz AM signals, but also the 30 kHz FM modulated signals. The result is the Pickering UV-15/2400-Q. It consists of a completely redesigned cartridge and a new high performance stylus assembly, the Quadraredral™, specially developed for this application. The UV-15/2400-Q performs in a superior manner by every test, and is capable of satisfying all technical and aesthetic requirements for playback of both discrete and stereo disks. Moreover, its stylus is designed to reduce record wear.

SPECIFICATIONS:

Frequency Response <sup>1</sup>	10-50,000 Hz
Channel Separation	35 dB
Tracking Force <sup>2</sup>	1-3 grams
Output <sup>3</sup>	3.6 mv ± 2 dB
Stylus	Quadraredral

Notes: 1 Recommended by manufacturer for optimum performance. 2 When the cartridge is terminated in the recommended load of 100K ohms and 100 PF. 3 Output with reference to 5.5 cm/sec record velocity.



**PICKERING**

The right Pickering cartridge for your equipment is the best cartridge money can buy.

"for those who can hear the difference"

For further information write Pickering & Co., Inc., Dept. E, 101 Sunnyside Boulevard, Plainview, New York 11803

CIRCLE NO. 26 ON READER SERVICE CARD



short). They don't. Unadulterated, unblemished vinyl is actually the quietest recording medium we have. CBS Labs gives its potential signal-to-noise ratio as better than 54 dB under "worst case" conditions; typically it approaches 70 dB or more with RIAA equalization. So when you hear hiss from an LP, the source is probably what it's always been—tape noise from the master recording.

However, records do make other noises—not noises that are inherent in the medium, but noises often introduced because there has been sabotage of some sort during manufacture. To briefly list a few of them:

*Pops, ticks, spits, spatters, and the like.* If these aren't the result of surface contamination from your environment (dust, dirt, etc.), they may come from similar con-

tamination at the record plant, where dirt can sometimes adhere to the parts destined to mold the record and mar the groove detail. Otherwise, molding errors can occur (ripping noises, sometimes severe, and once-around swishes are examples), and other defects of the molding parts, but I believe these have diminished in recent years.

*Mold grain.* This is an old friend, sometimes called "orange peel" in the trade. It produces a nondescript noise, fairly low in frequency but not so low as rumble. Since all records have a trace of it, you can usually hear it by advancing the volume control during a quiet or silent passage (ideally it is completely inaudible at any volume-control settings you might use).

Mold grain is caused, I am told, by the irregular "pebbly" surfaces of the *backs* of

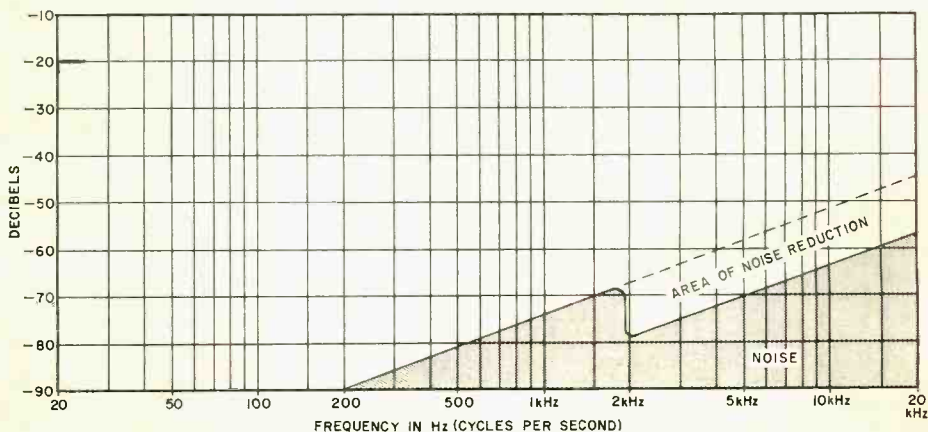
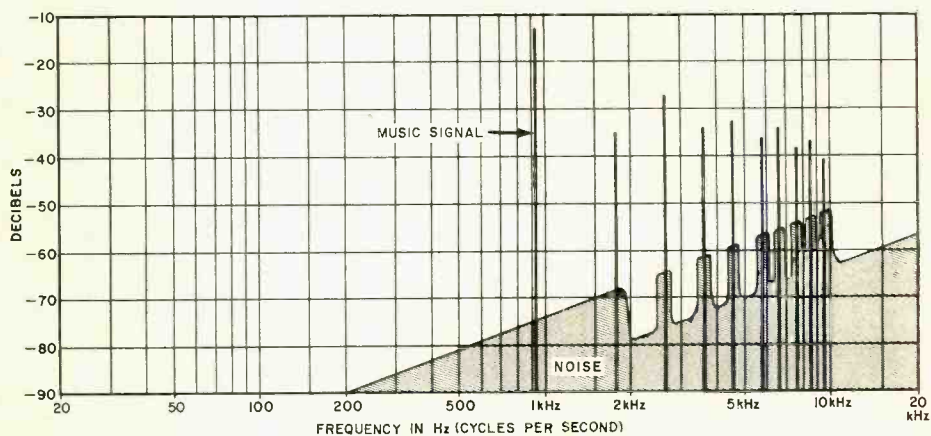

Theoretical operation of the Autocorrelator. Lower diagram shows no-signal condition; full 10 dB of noise reduction above 2000 Hz. In upper diagram, presence of loud musical fundamental causes windows corresponding to higher harmonic frequencies, passing entire music signal and small amounts of noise. Full reduction at other frequencies.

# Take a leaf from the Mallory Money Tree and save on famous Mallobins.<sup>®</sup>

Our Mallobin benchtop organizers are worth many times their modest cost in keeping electronic components neatly sorted, labeled, protected and ready for use. Now, you can save on buying them, too. For

instance, this PTC semiconductor Mallobin organizer can be purchased at a special discount at your Mallory Distributor. Just present the Mallory Money Tree coupon below.



**MALLORY**

**MALLORY DISTRIBUTOR PRODUCTS COMPANY**

a division of P. R. MALLORY & CO. INC.  
Box 1284, Indianapolis, Indiana 46206; Telephone: 317-636-5353

Batteries • Capacitors • Controls • Security Products • DURATAPE<sup>®</sup> • Recorders • Resistors • SEMICONDUCTORS • SONALERT<sup>®</sup> • Switches • Timers



DURATAPE<sup>®</sup> and SONALERT<sup>®</sup> are registered trademarks of P. R. Mallory & Co. Inc.

## Money Tree Coupon

This coupon valid through Sept. 1, 1974. Only one coupon valid on each purchase. This coupon not valid where prohibited or taxed by law. Coupon does not apply to sales tax, if applicable.

### TO MALLORY DISTRIBUTOR

This coupon redeemable for \$1.00 credit towards the purchase of any Mallory products or \$1.00 in cash provided it is tendered to Mallory Distributor Products Company, a division of P. R. Mallory & Company Inc., Indianapolis, Indiana prior to Oct. 1, 1974. Invoices showing purchase of Mallobin organizers sufficient to cover coupon must be shown on request.

Worth  
**\$100 OFF**  
on any purchase of any Mallory Mallobin organizer at a Mallory Distributor.

PE 34

**CIRCLE NO. 23 ON READER SERVICE CARD**

the metal parts ("stampers") used to mold the discs. The pressure of the molding process evidently forces the imprint of this knobby texture right through the relatively thin nickel stamper and onto the vinyl. This is the one noise that seems to be basic in the record-producing process. Mold grain can be seen by holding a record so that the almost ungrooved portion near the label catches the light and reflects some object in the room. The grain then appears as a wavy distortion of the object's outline.

As mentioned, noise caused by mold grain should be inaudible at any listening level. When it isn't, it usually means that the backs of the stampers have not been

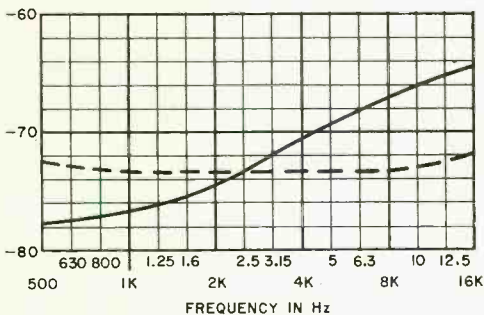

Comparative noise levels for a fourth-generation 15-ips master tape (solid line) and a 33 $\frac{1}{3}$ -rpm vinyl disc. Both media measured with their appropriate playback equalizations (NAB and RIAA, respectively), in  $\frac{1}{3}$ -octave bands. Data according to CBS Labs.

properly ground smooth by the record producer.

**Rumble.** This fluttery, very-low-frequency noise, often indistinguishable from turntable rumble but present only on certain records, does not have any one clear cause that I've been able to discover. Informed sources tell me that record-cutting turntables definitely do not vibrate at any frequency likely to be reproducible by even the best of today's speakers.

I can recall, some years ago, encountering a really intolerable case of rumble on a newly acquired record; its intrusion made the music virtually unlistenable. And then, suddenly, about three quarters of the way through the side it stopped! "Why?" I asked one of the record company's engineers on the phone next day. "Because that's the moment someone thought to turn off the

air-conditioning system in the recording studio," he replied.

**Thumps.** These are almost always caused by warps, pure and simple. If you hear thumps from any of your records, squat down beside the turntable so that the record's edge is at eye level and observe. Most likely you'll see the record—and your phono cartridge's stylus—go up and down.

That's the roster, as far as I know, of noises prevalent on disc recordings. Note that there is nothing presently available, except for simple filters, that can do much to eliminate most of them. But also note that the majority arise from shabby treatment of the merchandise before it reaches the consumer. That could certainly be rectified, but I don't know if it's economically feasible. Care and quality are synonymous with money these days. Over the past years, the record companies have done a remarkable job keeping the price of their product stabilized, and since their costs, like everybody's, have gone up steadily, there just can't be much left over to implement significant improvements, or even to hold the line. Therefore, the burden of technical mediocrity may weigh increasingly on the shoulders of the consumer in times to come. If so, to unburden himself he'll have to resort to devices like the Autocorrelator and its future variants. What form are these likely to take?

For a long time there's been talk of a Dolby system for LP's. Indeed, the present Dolby B system built into so many cassette decks would undoubtedly do a fine job on record hiss (i.e., tape hiss). It would be less successful with ticks and pops, since they are much louder than hiss and the 10 dB of noise reduction offered by Dolby B will not be able to bring them down to inaudibility.

Where the Dolby would really fall down, however, is in low-frequency noise reduction. The Dolby system works by seeing to it that all the program input is recorded at a very high level—as much as possible above the noise level that creeps in even with the best recording equipment. The Dolby de-processor in the listener's home then sorts out all this high-level material, making the quiet musical passages quiet again, and so forth. The end result is that the listener constantly hears something close to the best signal-to-noise ratio the medium can afford, even when the signal coming through his speakers is very small.

The trouble is that, for the system to



work, the frequencies at which noise reduction is to be achieved must be recorded at a louder than normal average level. Loud low frequencies take up a lot of space on phonograph records; the groove wiggles from side to side more, and therefore more space must be allowed between grooves if they're not to overlap. This means that there will be fewer grooves per record side, and therefore less playing time per record—less and less as the amount of noise reduction available gets greater and greater. Record companies are just not interested in anything that cuts down on the amount of music they can get on a disc and a Dolby system capable of eliminating the worst cases of mold grain would probably do that drastically. In fact, just now they're in search of something that will accomplish the opposite.

Could the correlator approach help with mold grain? Possibly, but I'm told that a device sophisticated enough to be both effective and inaudible in its action at those frequencies would have to be prohibitively priced. But when it comes to ticks and pops, the outlook is a little brighter. These noises are of very brief duration, and it might be possible to, in effect, turn the amplifier off for the split second they last, and then back on again before the listener could hear what happened. Assuming the brief "off" period would be too short to be audible, it wouldn't matter if the noise-reducing device occasionally mistook a bit of music for a tick and removed it. But if ticks proved to be of longer duration than expected, it might be necessary to "teach" the noise reducer to recognize them, so that they could be treated by some appropriate process—perhaps a limiter that would reduce them to the average level of the program.

Recognition is the problem, but even this is not impossible. EMI (Electrical & Musical Industries) in England has a "tick counter" to keep track of record quality. It operates on the assumption that all musical sounds have a relatively slow decay time; the sound takes a certain amount of time to die down, if only because of the reverberation from the recording environment. Ticks, on the other hand, are minute little notches—or minute little specks of dust—on the groove surface. Their sound goes away as quickly as it comes. The EMI contraption is simply a record player that plays the record backward, from inside to out. Thus every musical sound starts at a low level and builds up; but ticks, whether played backward or forward, reach their maximum level within an instant. So every time the EMI backward-playing device encounters a steep wavefront it registers it as a tick.

The tick eliminator of the future for a forward-playing turntable (and it should work well as a scratch eliminator also) might contain a delay line to give the circuit a chance to examine the end of a short-term waveform before you heard the beginning of it. If it saw a precipitous drop-off in level it would simply reduce or eliminate that particular input, as inaudibly as possible, before it ever got to the speakers.

The technology for such a processor already exists, and there is a market among record companies eager to restore ancient phono discs and cylinders to pristine condition. Unfortunately, I suspect I'll never be able to afford one within my lifetime, so I look forward more eagerly to simpler improvements in the disc medium—improvements that can be realized cheaply. A discussion of these will have to wait for a later column. ♦

## FREE McIntosh CATALOG and FM DIRECTORY

McIntosh Laboratory, Inc.  
East Side Station P.O. Box 96  
Binghamton, N.Y. 13904  
Dept. 16-5

**SEND  
TODAY!**

NAME \_\_\_\_\_  
ADDRESS \_\_\_\_\_  
CITY \_\_\_\_\_ STATE \_\_\_\_\_ ZIP \_\_\_\_\_

Get all the news and latest information on the new McIntosh Solid State equipment in the McIntosh catalog. In addition you will receive an FM station directory that covers all of North America.



**MX 113**

AM FM/FM STEREO TUNER PREAMPLIFIER

**CIRCLE NO. 21 ON READER SERVICE CARD**

# DIGITAL COLOR

**Bell & Howell Schools introduces an amazing new color TV featuring channel numbers and digital clock that flash on the screen and automatic channel selector!**

**Now you can build and keep a color television that's ahead of its time!**

You've seen TV's that swivel, TV's with radios built in, TV's small enough to stuff in a suitcase and TV's that have remote control.

But now comes a color television with features you've *never* seen before. Features now possible as a result of the new technology of digital electronics... features that make Bell & Howell's new 25-inch diagonal digital color TV ahead of its time! Like...

Channel numbers that flash big and clear right on the screen. An on-screen digital clock that flashes the time in hours, minutes and seconds with just the push of a button. An automatic channel selector that you pre-set to skip over "dead" channels and go directly to the channels of your choice.

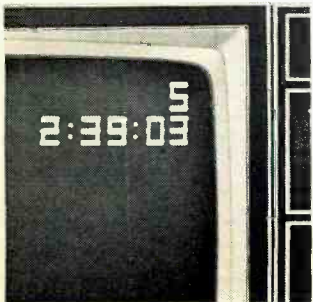

And, to insure highest quality performance, this new TV has all-electronic tuning, reliable integrated circuitry, and 100% solid-state chassis for a brighter, sharper picture with long life and dependability.

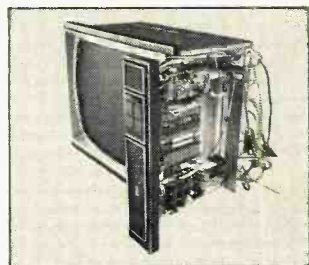

**Perform fascinating experiments... test your new TV as you build it... with the exclusive Electro-Lab<sup>®</sup> electronics training system. It's yours to build and keep!**

Designed exclusively for our students, this new Bell & Howell Electro-Lab<sup>®</sup> features the most sophisticated and up-to-date "tools of the trade". In-

Simulated TV picture

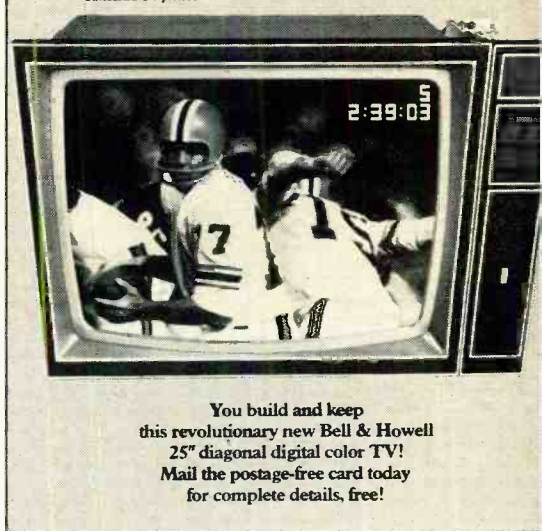

**You build and keep this revolutionary new Bell & Howell 25" diagonal digital color TV! Mail the postage-free card today for complete details, free!**

struments you can use professionally after you finish the program.

A new digital multimeter that measures voltage, current and resistance and displays its findings in big, clear numbers. Far more accurate and readable than conventional "needle pointer" meters that require guesswork and interpretation.



The solid-state "triggered sweep" oscilloscope is a "must" for accurate analysis of digital circuitry. With it you are able to make measurements of circuits in much the same way that heartbeats are measured on an electrocardiograph. Includes DC wide-band vertical amplifier and "triggered sweep" feature to lock in signals for easier observation.

The design console is a valuable device for setting up and examining circuits without soldering! Features patented modular connectors, AC power supply and transistorized dual range DC power supply.



# R TV IS HERE!

**Build it yourself... the perfect way to learn all about the exciting new field of digital electronics!**

**It's a fascinating spare-time project you can enjoy at home!**

Imagine spending your spare time actually building your own 25-inch diagonal digital color TV! It's a project you can enjoy working on right in your home. And you'll be amazed at the electronics knowledge you'll pick up in a relatively short period of time!

There's no travelling to classes, no lectures to attend, and you don't have to give up your job or paycheck just because you want to get ahead. When you finish this new Bell & Howell Schools program, you'll have the skills you need plus a great color TV to keep and enjoy for years!



**Digital electronics is changing our lives!**

There's a lot more to digital electronics than just the numbers! True, that's what you see on more and more products like digital calculators, clocks and watches. But behind the numbers lies a fantastic new technology that's creating higher standards of accuracy and dependability. The versatility of digital electronics has begun another industrial revolution. Its growth and applications are limitless, giving us new and better ways of doing things and spectacular products like this new Bell & Howell digital color TV!

**You don't have to be an electronics expert to build it... we help you every step of the way.**

One of the beauties of this TV is that you don't need previous electronics experience to build it! With a few simple household tools, our step-by-step instructions and the exclusive Electro-Lab™, you've got all the basics you need. Should you ever hit a 'snag', you're just a toll-free call away from one of our expert instructors who can help you solve it. You can also take advantage of our in-person "help

sessions" held in major cities throughout the year where you can enjoy "talking shop" with instructors and fellow students.

**Pick up valuable skills in digital electronics that could lead to extra income full or part time... or a business of your own!**

Once you have your new TV, cash in on all that you learned from building it! This new Bell & Howell program employing digital electronics will help you gain valuable new skills that could easily lead to extra income, part time. A service or repair business of your own? Why not! We even show you how to get started with a complete volume on the basics of setting up a TV servicing business. Get the complete story on this exciting, learn-at-home program... the world's first color TV course employing digital electronics technology!

**Mail card today for full details, free!**

Electro-Lab is a registered trademark of the Bell & Howell Company.

**If card has been removed, write:**

An Electronics Home Study School  
DEVRY INSTITUTE OF TECHNOLOGY

ONE OF THE

**BELL & HOWELL SCHOOLS**

4141 Belmont Chicago, Illinois 60641







# News Highlights

## IC for Discrete Four-Channel Hi-Fi Systems

An integrated circuit that decodes four channels of sound from a discrete CD-4 phono disc has been developed by Signetics Corp. in conjunction with JVC, the Victor Company of Japan, Ltd. The new IC, which uses phase-locked loop circuits, permits CD-4 equipment to be made smaller and less expensive. In the JVC system, two of the IC's will be used, one for the two channels on the right and one for the left-hand channels. Signetics will make the chip, the CD4-392, available to other firms shortly at a price of \$1.54 each for large volume orders.

## WWV/WWVH Time Designation Change

At the beginning of this year, the familiar announcements of WWV and WWVH in Greenwich Mean Time changed to Coordinated Universal Time. Because both GMT and UTC are identical times, the change should in no way affect anyone using the time services. UTC, more precisely, designates the reference time scale maintained and disseminated by NBS since 1958. By international agreement, UTC was redefined January 1, 1972 as atomic time (based on the oscillations of the cesium atom) corrected as necessary by whole (leap) seconds to agree within 0.7 second with navigator's time. As a compromise time scale, UTC combines the constant rate of atomic time with the time of the rotating earth used for celestial navigation and astronomy. To prevent our clocks from getting badly out of step with the sun, scientists invented the leap second.

## New Packaging Concept Developed for Batteries

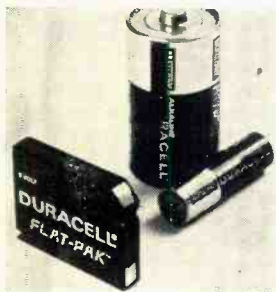

A thin, rectangular, 6-volt battery that will permit some interesting new ideas to be used in the design of battery-powered products has been developed by the Mallory Battery Company. Called the Flat-Pak™, and to be sold under the Duracell® label, the new energy package is less than 1/8 in. thick, 1 1/2 in. long and 1 1/2 in. wide. It contains four alkaline cells in series and has a terminal design to insure that it is connected properly. An expected early use is in pocket-size calculators. Suggested retail price is \$1.95.

## Panasonic Unveils New Color Picture Tube

Panasonic has announced the introduction of its new Quintrix picture tube developed for the firm's new color-TV line. The tube's outstanding features include an additional pentode pre-focus lens for sharper picture detail and a negative guard band black matrix for improved contrast. The receiver employs a new high-voltage chassis for increased picture brightness.



# *In Quest of Perfection...*

"Jonathan Livingston Seagull" is a story about striving, struggling, soaring in quest of perfection.

In the film adaptation of the best selling book, "Jonathan Livingston Seagull," the spirit of the quest is captured in a moving original music score composed and performed by Neil Diamond.\*

Transforming the celebrated book into a unique motion picture was a monumental task that demanded the finest cinematography and music reproduction modern technology could produce. So Neil Diamond selected BOSE 901<sup>®</sup> Speakers to reproduce his music for the press premières of "Seagull," commenting: "After auditioning what were reputed to be the best high fidelity speakers on the market today, I chose BOSE 901 Speakers because they offer the ultimate in theatre music reproduction." This is no surprise to thousands of 901 owners around the world who believe they enjoy the ultimate in music reproduction in their homes.

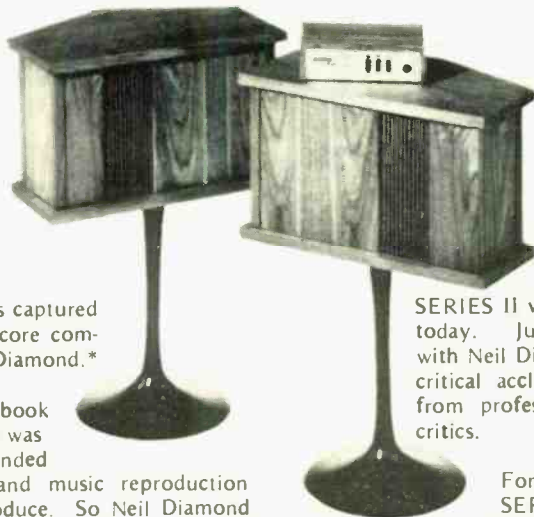

In our ever-continuing quest of audible perfection, we developed the new BOSE 901 SERIES II Speakers -- a product of over 15 years of research in musical acoustics.† We invite you to compare the BOSE 901

SERIES II with any speaker on the market today. Judge for yourself if you agree with Neil Diamond's selection and with the critical acclaim the original 901 received from professional music and equipment critics.

For information on the BOSE 901 SERIES II, complimentary copies of the rave reviews on the original 901, and a report on the theatre sound system competition, circle your reader service card or write Dept. K1.

\*Original motion picture soundtrack recording available on Columbia records and tapes.

†This research is presented in the article "Sound Recording and Reproduction" published in TECHNOLOGY REVIEW (MIT), Vol. 75, No. 7, June '73. Reprints are available from BOSE for fifty cents a copy.

**BOSE**

The Mountain, Framingham, Mass. 01701

CIRCLE NO. 6 ON READER SERVICE CARD

www.americanradiohistory.com

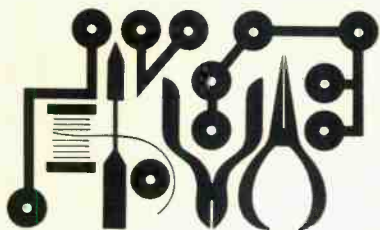

# Hobby Scene

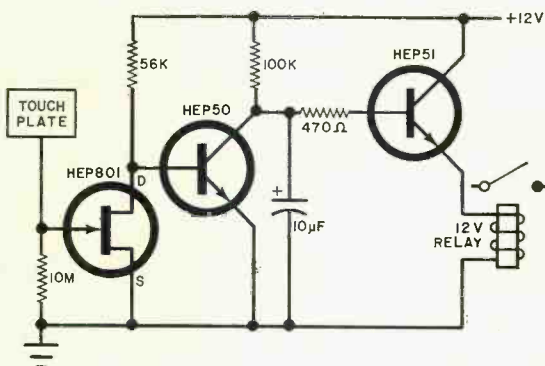

## Touch Alarm Circuit

**Q.** Do you have a circuit for a simple touch alarm to activate a relay when a small metal plate is touched?

**A.** This circuit should do the job. If you have any troubles with the operation, try using an ac power supply (delivering dc to the circuit, of course) and reversing the line plug to get proper operation.

## UJT Oscillator Stabilization

**Q.** Is there any way to stabilize a UJT oscillator?

**A.** Not many people know it, but you can control a UJT oscillator with a crystal as shown in the sketch. Use a low-frequency (100 kHz as a good start) crystal instead of the usual timing capacitor and adjust the potentiometer in the B2 leg for the desired waveform at the emitter. You can parallel the crystal with some low-value capacitor to change the frequency.

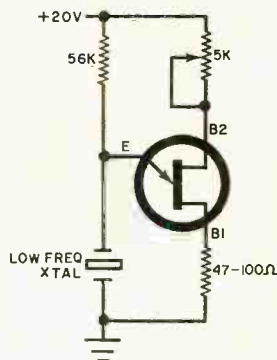

## Circuit for Action Photography

**Q.** I would like to have a circuit for use with a flash camera so I can take action shots such as a balloon breaking, etc. This type of photography interests me.

**A.** Such a circuit was published in the December 1972 issue of this magazine. Essentially, it consists of a conventional audio amplifier that turns on an SCR when a certain sound level is picked up by the microphone. The SCR acts as the remote turn-on switch for the strobe.

The exact instant of "freezing" the picture

depends on the distance from the sound source to the microphone. The shorter the distance, the sooner the strobe flash after the event. Increasing the distance between the sound source and microphone will produce a "later" picture. It is in this way that you can select just what part of the event you want to photograph.

Have a problem or question on circuitry, components, parts availability, etc.? Send it to the Hobby Scene Editor, POPULAR ELECTRONICS, One Park Ave., New York, NY 10016. Though all letters can't be answered individually, those with wide interest will be published.



# THERE'S A BETTER WAY TO GO.



Energy shortages tell us we have to change our driving style. Now! It doesn't mean we have to go back to horse and buggy days. But it does mean we have to make every drop of gas give us the most go for our money. Anyone with horse sense knows that a well-tuned car gets better mileage, and in times of fuel shortages, better mileage means a lot.

The Mark Ten B Capacitive Discharge System keeps your car in better tune so it burns less gas. Using Mark Ten B is more than horse sense. It's the smart move under the hood, helping a nation survive an energy crisis and keeping you on the road. Delta Mark Ten. The best way to go.



CIRCLE NO. 11 ON READER SERVICE CARD



## DELTA PRODUCTS, INC.

P.O. Box 1147, Dept. PE  
Grand Junction, Colo. 81501  
(303) 242-9000

Please send me free literature.  
Enclosed is \$ \_\_\_\_\_  Ship ppd.  Ship C.O.D.  
Please send: \_\_\_\_\_ Mark Ten B assembled @ \$59.95 ppd. \_\_\_\_\_ Mark Ten B Kit @ \$44.95 ppd. (12 volt negative ground only) \_\_\_\_\_ Standard Mark Ten assembled, @ \$44.95 ppd. \_\_\_\_\_ 6 Volt: Neg. Ground Only \_\_\_\_\_ 12 Volt: Specify \_\_\_\_\_ Pos. Ground \_\_\_\_\_ Neg. Ground \_\_\_\_\_ Standard Mark Ten Deltakit\* @ \$29.95 ppd. (12 Volt Positive or Negative Ground Only)

Car Year \_\_\_\_\_ Make \_\_\_\_\_

Name \_\_\_\_\_

Address \_\_\_\_\_

City/State \_\_\_\_\_ Zip \_\_\_\_\_

# 10Mhz 3" Triggered Sweep Scope ... 1/3 the size of comparably performing scopes

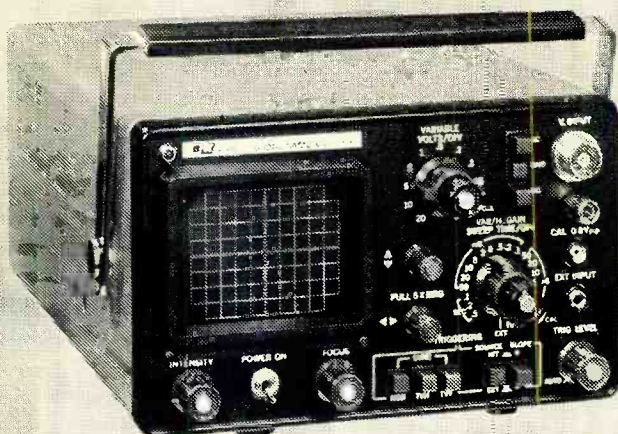

Model  
1431

**\$400<sup>00</sup>**

only 4<sup>3</sup>/<sub>4</sub>"  
high

It's a lightweight 13 pounds in your hand with heavy-weight wideband scope performance on your bench or jobsite. Only 35 nanosecond rise time, 10 millivolts / division sensitivity and 19 calibrated auto or triggered sweep speeds from 0.5 usec/cm to 0.5 sec/cm with 5X magnification. Pushbutton selected sync modes include internal, external, pos and neg slope, and TV horizontal and TV vertical with exclusive TV sync separator. If you've been waiting to buy a portable scope until you could get all the features you'll ever need at a price you want to pay, you've been waiting for the B&K Precision Model 1431. See your distributor or write Dynascan Corporation.

**B&K** PRODUCTS OF  
**DYNASCAN**

1801 W. Belle Plaine Ave.  
Chicago, IL 60613 • (312) 327-7270

CIRCLE NO. 31 ON READER SERVICE CARD



# A GUIDE TO CMOS OPERATION

**PART 1**

*Photomicrograph of COS/MOS chip courtesy RCA Corp.*

*Complementary-Symmetry Metal-Oxide-Semiconductor IC's are revolutionizing circuit design concepts. Here's how and why they are fast replacing TTL in applications from electronic timepieces to frequency synthesizers.*

**BY WALTER G. JUNG, Contributing Editor**

**A**RE you confused by CMOS IC's? For instance—what do they do? How do they do it? How are they different from other types? And, how are they the same (if at all)? Well, chances are we've all wondered at one time or another about some aspect of the CMOS puzzle. Maybe now is the time to sort out the pieces, one at a time.

The CMOS is not like any other form of IC, even if we were to restrict the discussion to the digital form of CMOS. Don't try to make comparisons or analogies to DTL, TTL, or, for that matter, any other logic. Not only is CMOS a unique type of IC logic; it is also usable in linear applications.



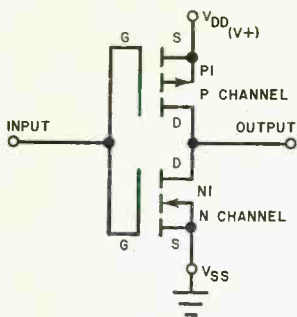

Fig. 1. Basic CMOS stage consists of an n-channel and a p-channel MOSFET. Input impedance is high; while the output impedance is low.

**The Basic CMOS Structure.** Any kind of IC, no matter whether it is digital or linear, must contain some type of amplifier because it is the amplification that does the useful work. When you get right down to it, the type of amplifier used in CMOS really provides its uniqueness.

There are a few things that most circuit designers want in an ideal amplifier: high input impedance (so as not to load down the input signal); low output impedance (to drive many other stages); and high voltage swings (about 100% of the power supply for CMOS). Then, why should we waste voltage drops in biasing? In fact, why not eliminate biasing? Also, why not have an amplifier that does not consume any standby power? The only power used should be in the load. Finally, the amplifier should be as simple as possible (with only one or two components, for instance).

By now, you are probably saying all this sounds ridiculous; but hang on for a moment, and see how closely we can come to this ideal amplifier.

Most of us know that a MOSFET (metal oxide semiconductor field effect transistor) has an extremely high input resistance, usually a million megohms or more. MOSFET's are voltage-operated devices, responding to an input voltage rather than current. The voltage applied to the gate controls the drain-to-source resistance. Therefore, a MOSFET can be looked upon as a voltage-controlled resistor. The range of control varies from a few hundred ohms when on, to several thousand megohms when off. MOSFET's come in two types: p channel and n channel. A p-channel MOSFET conducts when its gate goes negative and an n-channel unit conducts when its gate is positive. Thus it can be seen that p- and n-channel MOSFET's complement one another; and, in fact, using matched p- and n-channel MOSFET's gives complementary MOS or CMOS.

A CMOS amplifier stage is shown in Fig. 1. This is the most basic form of CMOS circuit and is functional as shown. Using just two transistors as an amplifier seems unusual; but, in fact, this circuit will serve in a variety of digital and linear applications, as we shall see later.

In Fig. 1, *PI* is the p-channel device, and *NI* is the n-channel part. This is an inverting amplifier with both units operating in the common-source mode so *PI*'s source goes to the supply, while *NI*'s source goes to ground. In MOS language,  $V_{DD}$  is the positive supply and  $V_{SS}$  the negative supply voltage. These are simply new terms—one for what we have previously known as  $V+$  and the other for the normal ground.

In spite of all its simplicity, there is a key to what enables the circuit to work, and this is the matched and complementary characteristics of the p and n units. If, for

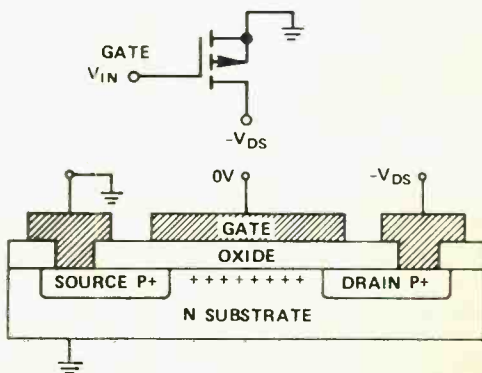
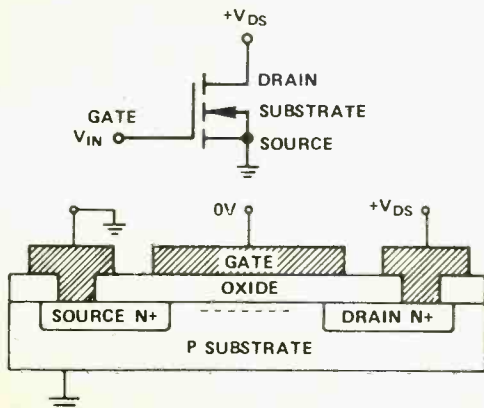

Operation of n-channel (left) and p-channels MOSFET's, as depicted by Solid-State Scientific.

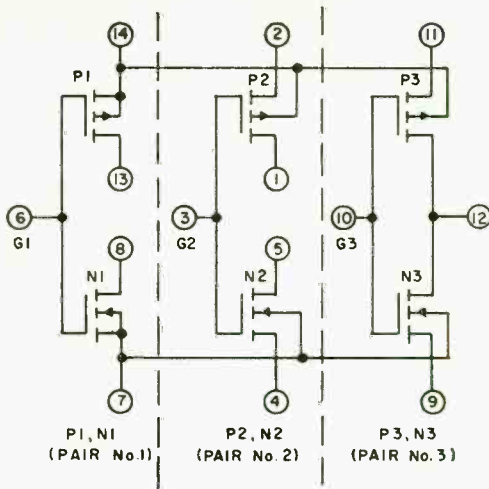

Fig. 2. Schematic shows the RCA COS/MOS CD4007AE and CA3600E three-section arrays.

instance, a voltage of exactly half of  $V_{DD}$  is applied to the input, both the p and n units will have an equal amount of voltage from gate to source; and both will conduct equally. If both are conducting equally, they may be likened to a matched pair of equal-value resistors, so that the output is  $\frac{1}{2}V_{DD}$ , precisely balanced. Surely, a stage couldn't be biased more simply than this.

The stage also has an appreciable voltage gain, since a common-source amplifier is, in this regard, similar to a common-emitter stage, noted for its high gain. Gain will vary with supply voltage, but we will have more to say on that later, also.

Suppose there is an increase in the input voltage—approaching  $V_{DD}$ . This produces less bias on  $P1$  and more on  $N1$ . Consequently,  $N1$  is turned on more (lower resistance) and  $P1$  less (more resistance). More resistance in  $P1$  and less in  $N1$  changes the balance of this "voltage divider" and the output goes lower, approaching ground. As you can see, a negative-going input reverses the order, sending the output to a higher level. The complementary units,  $P1$  and  $N1$ , act as an electronic "see saw" adjusting their respective resistances in response to the change in relative input voltage. They can, in fact, be viewed as an electronic voltage divider whose common point can be moved from ground to  $V_{DD}$ , controlled by the input voltage.

Typical CMOS stages achieve input resistances of  $10^{12}$  ohms and an input current of only 10 pA, and that is high Z. Output

impedance is a few hundred ohms, varying slightly from one type to another; but the point is that one of these stages can certainly drive a great number of similar ones. In addition, they can be operated over a wide power-supply range since the p and n units are designed to match over a range of 3 to 15 volts. Since either the p or n transistor can be turned on while its mate is completely off, the output swing is high in either direction.

Moving from generalities to hardware, consider some representative CMOS units. The CD4007AE and CA3600E (Fig. 2) are both made by RCA, which first introduced CMOS in its COS/MOS series. These two units are chosen as examples because they can be used to set up a wide variety of different experiments and are readily available. They also illustrate both the digital and linear aspects of CMOS.

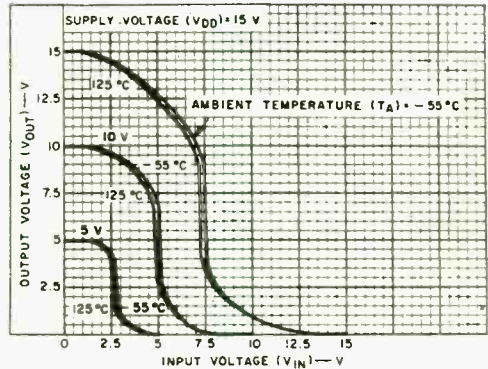

Fig. 3. Transfer characteristics of typical COS/MOS stage show input threshold stability for variations in the supply or temperature.

The CD4007AE and CA3600E are identical with regard to pin arrangement and they are interchangeable in many circuits. The main difference between the two is that the CA3600E has characteristics controlled for linear service, which (in general) is tighter.

**CMOS in Digital Applications.** Digital use of an amplifier implies operation in a switching mode, an ideal application for CMOS. In the inverter of Fig. 1 for example, if the input is low or near ground,  $N1$  will be completely off and  $P1$  completely on. So  $P1$ 's resistance is at its lowest point of about 500 ohms, and  $N1$  is effectively an open circuit. Under these conditions, the output pulls up to  $V_{DD}$ , since it simply looks like a 500-ohm resistor to  $V_{DD}$ . So the high logic

level of CMOS is essentially equal to  $V_{DD}$ . By essentially, we mean within a few millivolts. If the state of the input is reversed and a high level is applied, the output state reverses, and  $N1$ 's low resistance pulls the output to ground. Since, in this state, the output looks like 500 ohms to ground, a CMOS logic low looks essentially like ground (also within a few millivolts). If no current is flowing from the output, which is usually the case when driving other CMOS stages, there will really be no measurable difference between the high and low output levels compared to  $V_{DD}$  and ground, respectively. This is logical, because if no current flows through the 500-ohm resistance, there is no voltage drop.

This brings up another interesting point—in either the digital high or low state, one of the two transistors is always off. This means that there is no static power drain in a CMOS digital stage because one of the two switched devices is always in a high-resistance state. The only current that flows is due to leakage and is far down in the sub-microampere range—about 5 nanoamperes for the CD4007AE. That is why CMOS provides low-power logic: one of the two series switches is always off.

**Logic Threshold.** So far, we have discussed the effects of a high- or low-level digital input voltage. But this is hardly the whole story. There are the “in-betweens” but they present no problem. A CMOS

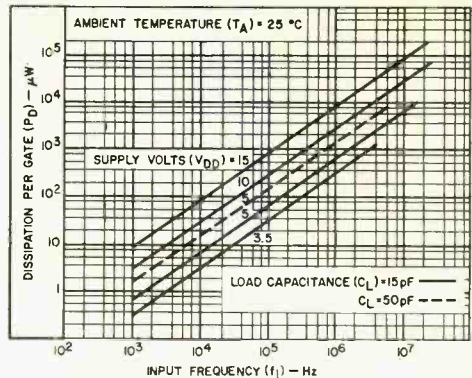

Fig. 4. Curves show how dissipation of an RCA COS/MOS logic stage increases according to frequency, supply and load capacitance.

stage's output is balanced when the input is  $\frac{1}{2}V_{DD}$  and for digital use, this means that above or below the balance point, the output will go toward its low or high state. Since the stage has a fairly high gain, it is not necessary to go very far from the input voltage's center point to flip the output completely high or low. To simplify matters even more, this  $\frac{1}{2}V_{DD}$  switching threshold very nicely stays constant over wide temperature ranges—even over the operating range of supply voltage.

A graph of this effect is called a “transfer characteristic” and a family of these is shown in Fig. 3. What these curves show is how the output responds as the input changes. The important thing to note is that, for any supply voltage (5, 10, or 15 V), the output changes (dropping in this case) at a point where the input equals  $\frac{1}{2}V_{DD}$  (2.5, 5 or 7.5 V). A more subtle point is that each set of curves also shows variations of the thresholds for temperatures from  $-55^{\circ}$  to  $125^{\circ}\text{C}$ . This means that temperature effects at room temperature operations are negligible.

The important thing to remember about CMOS logic is that its input switching threshold is  $\frac{1}{2}$  the supply voltage for any value of supply (within rating of course). This is not true of any other form of logic.

**Power Dissipation and Frequency Effects.**

As long as one of the series n or p units of a CMOS amplifier is off, there is no great power drain (with dc operation). However, because of the duration of time that they are both on, they look like a pair of resistors in series across the power supply. And, they draw a pulse of current for the time they

**CMOS MANUFACTURERS**

RCA Solid State Division  
Box 3200  
Somerville, NJ 08876

Motorola Semiconductor Products  
Box 20912  
Phoenix, AZ 85036

National Semiconductor  
2900 Semiconductor Dr.  
Santa Clara, CA 95051

Harris Semiconductor  
Box 883  
Melbourne, FL 32901

Fairchild Semiconductor  
313 Fairchild Dr.  
Mountainview, CA 94040

Solid State Scientific Inc.  
Montgomeryville, PA 18936



are on. The level of this current pulse increases with the supply voltage, reaching about 10 mA at  $V_{DD} = 15$  V. What this means is that CMOS power drain increases with frequency since every time the stage switches, it draws current.

This effect is summarized in Fig. 4, a graph of power versus speed. Although this curve is from a CD4007A data sheet, there is similar information for other CMOS units. The curves show the power dissipated in a single gate as the operating frequency is increased.

As an example, note that, at  $V_{DD} = 15$  V and with a frequency of 1 MHz, the dissipation of an individual gate is  $10^1$  microwatts or 10 mW, which is not really very low. On the other hand, at frequencies of 100 Hz or lower, the power drops to 10 microwatts or less per gate, depending on supply voltage. In practical terms, this means that, if a CMOS system has a timing cycle of seconds, the ac power dissipation effects can be disregarded. For a CD4007A, the dissipation is typically 0.05 microwatt per gate with a 10-volt supply. This means that, for battery operation, the power drain will hardly affect the battery more than if it were sitting on the shelf.

Load capacitance also affects power dissipation since it takes higher average current to charge a high capacitance. This effect is shown in Fig. 4 (dashed line). To summarize, lowest power results from lowest supply voltage, lowest load capacitance, and lowest clock frequency.

**Speed Capability.** While it is true that the biggest advantage of CMOS is at low-speed operation, the devices can be used at speeds up to several MHz and propagation times in the 50-to-100-ns range. Of course, that is not "super" fast, so if speed is a main consideration, other devices should be used. There are, however, some general rules that can be used to improve the speed in CMOS circuits.

First, speed capability increases with supply voltage. This is because, as supply voltage increases, the resistances of the n and p units drop during the conducting state. This allows shorter RC time constants. The time constant is determined essentially by the output impedance of the CMOS and the load capacitance. If either is lowered, the speed is increased. The CD4007AE propagation time at 5 volts (for instance) is about 35 ns; but at 10 volts, it is 20 ns. Looking at it from the capacitance angle, increasing the load capacitance to 80 pF from 15 pF, while operating at 10 volts will increase the propagation time from 20 to 50 ns.

Gates, inverters, buffers, and simple logic elements are measured in terms of propagation delay. Flip-flops and registers are rated in terms of toggle speed; and the lower the propagation delay, the faster the toggle speed. Some typical numbers for CMOS flip-flops are 4 MHz at 5 V, 10 MHz at 10 V, and 13 MHz at 15 V.

The important thing to remember is that CMOS is not really fast, and operation at even a few MHz means a sacrifice in power.

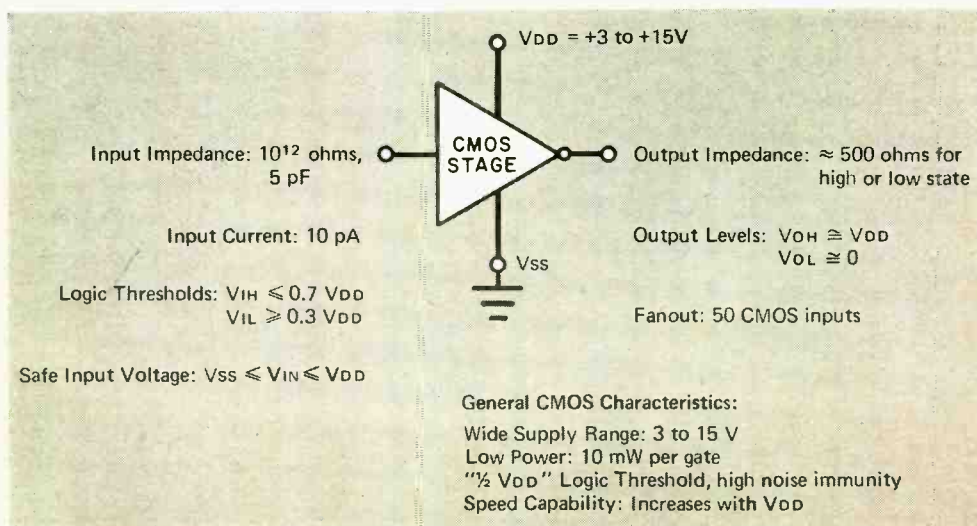
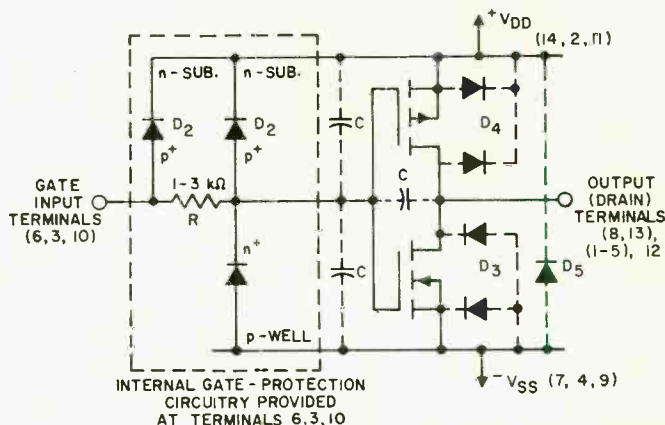

Fig. 5. Capsule summary of CMOS logic stage.

However, if appreciably higher speeds are necessary, CMOS units can be mixed with a faster type of logic (such as TTL) which can handle higher speeds. Interfacing the two types will be discussed later. Higher speeds can of course be obtained by reducing the load capacitance and using additional drive. This can be accomplished by using a high-power CMOS buffer stage, and paralleling stages.

**CMOS Fanout.** Problems of limited current drive in a CMOS system are not likely to be encountered since a single output can drive virtually any number of inputs. Remember the gate input current is only 10 picoamperes. However, it must also be remembered that each gate represents about 5 pF and enough 5-pF capacitances in parallel (with some stray capacitance) increase the propagation time as we mentioned before. So the ac effects are the real limiting factor in CMOS fanout. To be conservative and minimize speed degradation, most CMOS manufacturers say the fanout is 50 CMOS inputs for one CMOS output.

Fig. 6. Internal voltage clamping diodes protect terminals of RCA COSMOS.



**Summary of Characteristics.** Before getting into other logic functions and the CMOS family, it is a good idea to note again the characteristic highlights. This is done in Fig. 5.

**CMOS Handling—The Facts of Life.** Like many MOS devices, CMOS transistors are subject to damage when abused. This means they can be easily destroyed if not properly handled. This should not prevent them from being used, however, if some simple do's and don't's are observed:

(1) Keep unused devices in conductive foam (in which most of them are packed) or

somehow short the leads until ready for use to prevent static build-up. Never put them in styrofoam or "snow."

(2) Use grounded soldering tips and grounded test fixtures.

(3) Never insert or remove a CMOS device with the power on. In breadboarding, use sockets; and make circuit changes with the chip out.

(4) Observe the input voltage limits faithfully. This means that the input voltage must be less than or equal to  $V_{DD}$  and greater than or equal to  $V_{SS}$  (normally ground). If either limit is exceeded, internal diodes will conduct and, if the current is not limited, the chip will be destroyed. These diodes are shown in Fig. 6. They are used at each gate terminal of CMOS IC's. There are also diodes between the output pins and each supply line. These should never be forward biased unless the current is limited to about 100 microamperes or less. All of this means that an input signal can be applied only with the power on, unless some series input resistance is used to limit current flow.

(5) Don't allow unused inputs to float. Tie them high or low according to their function (AND high, OR low), or tie them in parallel with a like input from the same gate. Input leads which go off the board should not be left hanging since, when the board is removed, they will be floating. A simple 1-megohm resistor to ground will solve this problem. In the CD4007AE and CA3600E units, connect unused p and n sources to  $V_{DD}$  and  $V_{SS}$ , respectively (for example, 2 and 11 to 14 or 4 and 9 to 7).

In part 2 of this article, we will have more details about CMOS operation and applications. ♦

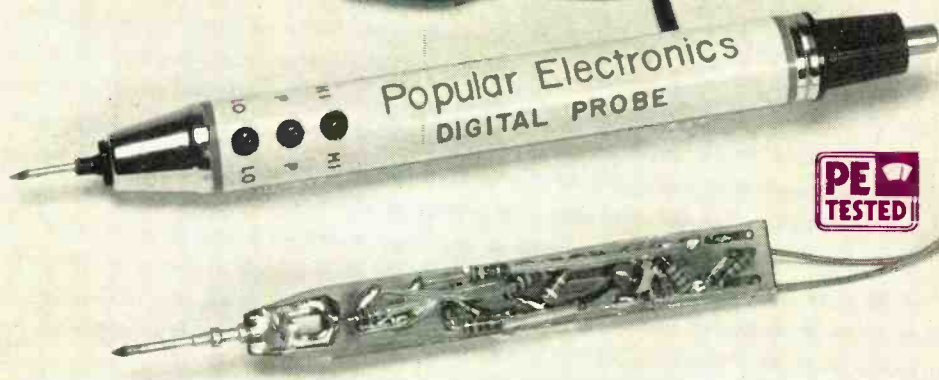

## IC DIGITAL LOGIC MEMORY PROBE

INDICATES LOGIC STATE OF CIRCUIT AND DETECTS PULSES AS SHORT AS 50 NS

BY RICHARD P. MAY

ONE of the more vexing problems facing today's experimenter is finding a way to check the 5-volt logic devices that dominate the hobby construction scene. Lacking a high-speed triggered-sweep oscilloscope, the experimenter is left defenseless in coping with the frequent 50-ns pulses that are more than long enough to trigger IC logic devices. To cope with the problem without a scope, however, you can build the digital logic memory probe described here. It is designed to indicate the logic state of a circuit, providing detection capabilities for pulse durations as short as 50 ns.

The circuitry of the probe is housed in a penlight tube and derives its power from the 5-volt line and signal ground of the circuit under test. The indicator system consists of three light-emitting diodes (LED's) mounted in-line at the end of the probe tube. The top LED lights up for a logic 1, while the bottom LED illuminates for a logic 0 (2.4 or more volts and less than 0.8 volts, respectively). The center LED comes on to indicate a positive- or negative-going transition as short in duration as 50 ns and remains on for 200 ms without regard to the time duration of the pulse being observed. This stretching feature provides ample time to observe a short-duration pulse that would otherwise not be seen on the 1 and 0 LED's.

To expand the stretching feature, a switch on the probe can be used to activate a mem-

ory mode that causes the stretch LED to remain on permanently after a positive or negative pulse occurs. The memory mode can aid in establishing the presence of unwanted pulses (such as noise). To reset the memory, the switch is simply returned to the stretch mode.

The memory mode can also be used to detect a power failure that might cause a sequence scrambling in the system under test. To accomplish this, the power input leads of the probe are connected to the 5-volt supply line and the switch is set to the memory mode. If the power should fail and self-restore, it will leave the stretch LED illuminated, indicating that a power interruption has occurred.

**Construction.** To keep the project as compact as possible so that its simple circuit (see Fig. 1) will fit into the penlight body, printed circuit construction is highly recommended. An actual-size etching and drilling guide is shown in Fig. 2. Also shown are two component placement guides, since the components mount on both sides of the board.

Before you begin assembly, remove from IC1 (7404) pins 5, 6, 8, 9, 12, and 13 and from IC2 (9601) pins 5, 8, 9, 10, and 12. This will permit maximum utilization of the available board space. Then mount and solder in place all components as shown.

Mount the probe tip in the board's end slot as follows: First, place the tip in the slot



and secure it with a couple of turns of bare solid hookup wire, passing the wire through the four holes provided. Heat sink the cathode end of *D1*. Then liberally apply solder along both sides of the tip where it joins the foil pattern.

Prepare the ends of two 5-in. lengths of stranded hookup wire. Solder these wires to the holes shown. Then prepare one end of the coaxial cable and solder the inner conductor to the + hole on the board and the shield to the - hole.

Carefully spot on the body of the penlight flashlight the three holes for the LED's, using the board assembly to guide you. The exit hole for the coaxial cable does not require critical location so long as it is clear of the board and does not interfere with switch operation. Label the LED holes LO, P, and HI from tip end toward the switch

end of the body. Then fit small rubber grommets into the tip and cable exit holes.

Slip over the free ends of the memory switch wires 1/2-in. lengths of small-diameter, heat-shrinkable tubing. Solder the leads to the switch lugs and shrink the tubing over the connections.

Over the free end of the coaxial cable, slip a 4-in. length of shrinkable tubing. Push it all the way down toward the board and shrink it. Pass the free end of the cable through its grommet-lined hole from the inside of the body and slip over it another 4-in. length of shrinkable tubing. Strip away 5 in. of outer insulation and remove and discard 4 1/2 in. of the braided shield. Being careful to avoid heat damage to the cable's inner insulation, pre-tin the braid on one side with

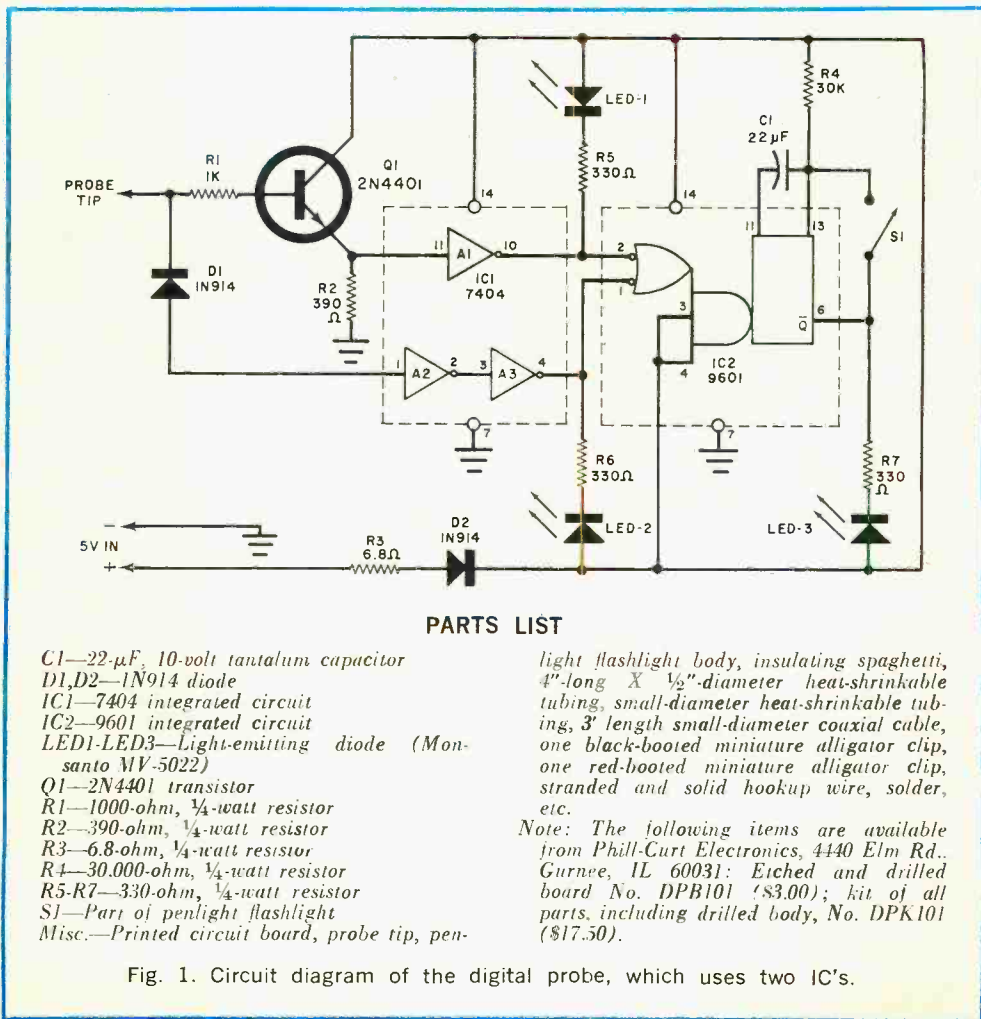

solder. Strip  $\frac{3}{8}$  in. of insulation from a 5-in. length of stranded hookup wire and pre-tin the exposed wires. Then carefully tack-solder the wire to the shield stub. Slip the tubing down over the connection, overlapping it by  $\frac{1}{2}$  in., and shrink it.

Strip away  $\frac{1}{4}$  in. of insulation from the free ends of the inner conductor of the coax and the stranded wire. Solder a red-booted miniature alligator clip to the inner conductor and a black-booted clip to the stranded wire.

Next, make a  $\frac{1}{2}$ -in. slit, lengthwise, in one end of a 4-in. length of  $\frac{1}{2}$ -in.-diameter shrinkable tubing. Slip the tubing over the board, slotted end toward the tip located on the foil side of the board. Locate and mark the positions of the LED lenses. Remove the tubing and punch or drill  $\frac{1}{8}$ -in. holes in the marked locations. (Note: This tubing will not be shrunk during final assembly.)

To assemble the probe, slip the tubing into the probe body and line up the two sets of holes. Slide the board assembly, probe end first, into the body and push it home,

### HOW IT WORKS

The memory probe (Fig. 1) is powered by the circuit under test. Diode *D2* protects the probe should the wrong hookup be made to the power line. The combination of *D1* and *R1* provides over-voltage protection. Diode *D1* buffers *IC1* from excessively high inputs and insures a high input impedance (better than 75,000 ohms with a high input).

Transistor *Q1* provides a high input impedance and serves as a buffer for the input of *A1* in *IC1*. When the probe tip is not terminated, pin 11 of *IC1* is low and pin 1 goes high. Inverting through *A3* and double inverting through *A1* and *A2*, *LED1* and *LED2* extinguish. With a low input (0.8 volt or less), pin 1 of *A1* goes low. Then by double inversion through *A1* and *A2*, *LED2* turns on. All the while, *Q1* is cut off and *LED1* remains extinguished. A high input causes *LED2* to turn off and sends *Q1* into conduction, resulting in *LED1* turning on.

The on time of *IC2* (a triggerable one-shot multivibrator) is determined by the time constant of *C1* and *R4*, which is 200 ms with the component values specified. The IC is triggered by a negative-going transition at pin 1 or pin 2. Any level change at the probe tip will cause this condition, triggering *IC2* and turning on *LED3* for 200 ms.

To prevent *IC2* from timing out after being triggered, memory switch *S1* must be closed. When pin 6 of *IC2* goes low at the moment of triggering, the signal is applied to the junction of *C1* and *R4*. This prevents *C1* from charging, and *IC2* remains in the triggered state. Opening *S1* permits normal timing to resume.

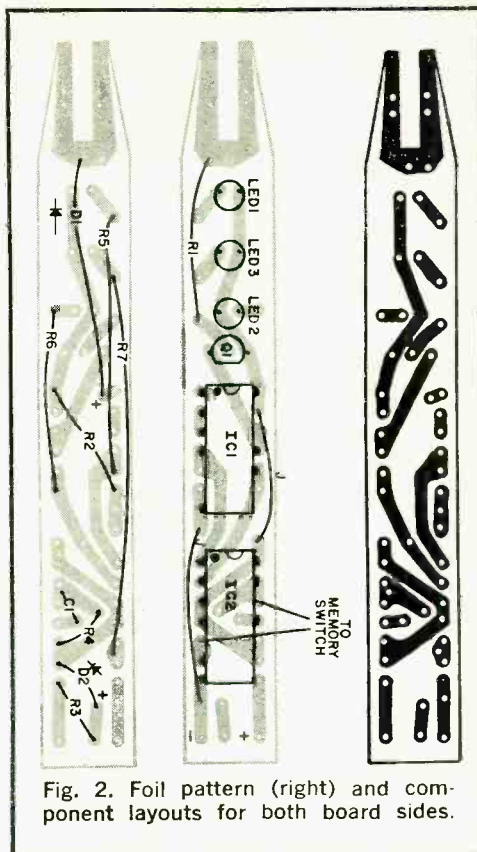

Fig. 2. Foil pattern (right) and component layouts for both board sides.

orienting the LED lenses under their respective holes. Gently pull on the coaxial cable to take up the slack. Then screw on the switch cap.

**Testing The Probe.** Observing polarity, connect the alligator clips to a variable dc source. With *S1* set to the stretch mode, slowly advance from 0 to 5 volts. At 2.8 volts, the memory (P) LED should flash on then off as the potential is increased through 4.1 volts. This condition can be used to check for low voltages.

With the supply set to 5 volts, touch the probe tip to the common lead. The LO LED should light while the P LED comes on for 200 ms. When the common is removed from the probe tip, the LO LED should extinguish and the P LED should again light for 200 ms.

When +5 volts is applied to the probe tip, the same thing should be observed on the 1 LED. To check for memory action, place *S1* in the memory mode and touch the probe tip to either common or +5 volts. LED P should come on and remain on until *S1* is returned to the stretch mode. ♦



# CREI—the only home-study college-level training

## and now

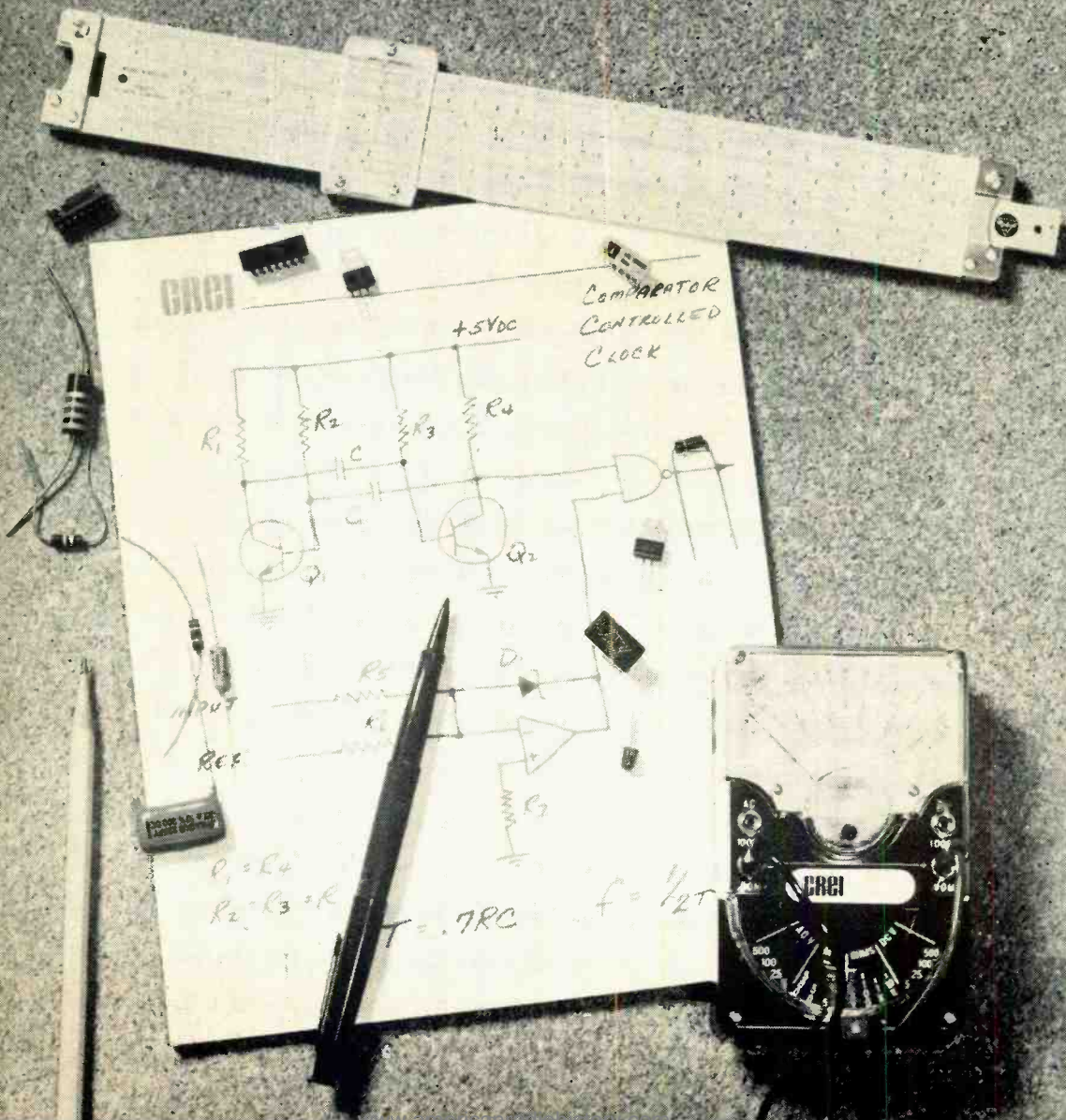



# program which gives you in electronic circuit design

# only CREI offers you a complete college-level Electronic Design Laboratory to speed your learning

**Electronic circuit design**—source of all new development in the application of electronics to new products and services. Without this skill, we would be unable to monitor the heartbeat of men in space. Without it, the computer revolution would never have occurred. And we would have yet to see our first TV show. *Yet, only CREI teaches electronic circuit design at home.*

## ELECTRONIC CIRCUIT DESIGN

A key skill which paces our nation's progress in countless fields—from pollution control to satellite tracking to modern medicine to exploring the ocean's depths. And beyond. A skill which you must have to move to the top in advanced electronics.

## CREI programs open up new worlds of opportunity for you.

In addition to electronic circuit design, CREI provides you with a full advanced electronics education in any of thirteen fields of specialization you choose. Communications, computers, space operations, television, nuclear power, industrial electronics—to mention just a few of the career fields for which CREI training is qualifying. With such preparation, you will have the background for a career which can take you to the frontiers of the nation's most exciting new developments. And around the world.

## This free book can change your life. Send for it.

If you are a high-school graduate (or equivalent) and have previous training or experience in electronics, then you are qualified to enroll in a CREI program to move you ahead in advanced electronics.



Send now for our full-color, eighty page book on careers in advanced electronics. In it, you will find full facts on the exciting kinds of work which CREI programs open up to you. And full facts on the comprehensive courses of instruction, the strong *personal* help, and the professional laboratory equipment which CREI makes available to you. All at a surprisingly low tuition cost.

## And when you have it, talk with your employer about it.

Tell him you're considering enrolling with CREI. He'll undoubtedly be happy to know you are planning to increase your value to him. *And he may offer to pay all or part of your tuition cost.* Hundreds of employers and government agencies do. Large and small. Including some of the giants in electronics. *If they are willing to pay for CREI training for their employees, you know it must be good.*

Send for Advanced Electronics today. You'll be glad you did.

CREI Dept. E1203E  
3939 Wisconsin Avenue  
Washington, D.C. 20016

Rush me your FREE book describing my opportunities in advanced electronics. I am a high school graduate.

Name \_\_\_\_\_ Age \_\_\_\_\_

Address \_\_\_\_\_

City \_\_\_\_\_ State \_\_\_\_\_ ZIP \_\_\_\_\_

If you have previous training in electronics, check here

Employed by \_\_\_\_\_

Type of Present Work \_\_\_\_\_

Veterans and servicemen, check here for G. I. Bill information

**CREI**  
**CAPITOL  
RADIO  
ENGINEERING  
INSTITUTE**

WASHINGTON, D.C. 20016

# TREMOLO ADAPTER

ADD TREMOLO TO YOUR ELECTRIC GUITAR  
OR OTHER ELECTRONIC INSTRUMENT

BY DEANE A. GARDNER

**T**REMOLO devices are quite popular for adding interesting effects to different types of electronic musical instruments. In fact, they are often built into expensive systems. For systems that lack the tremolo feature, an inexpensive tremolo adapter is easily added.

The ideal tremolo would be a low-frequency (6 to 10 Hz) sine-wave oscillator driving a non-distorting, voltage-controlled amplifier (vca). Some circuits employ triangle-wave modulation or a nonlinear vca, which can cause undesirable clicks or distortion. The tremolo adapter described avoids these problems by using a sine-wave modulation signal to control the channel resistance of a field effect transistor. The FET vca has much less distortion than bipolar transistor or diode techniques.

As shown in the schematic diagram, IC1 and its associated components form a phase-shift oscillator. The output of this oscillator is attenuated by R4 and R5 and is then

fed to Q1 via S1. You can change the value of R5, which affects the modulation depth, to suit the gain of the FET used. A lower resistance increases the depth, but avoid going below 30,000 ohms or the FET will become reverse biased.

The oscillator output adds or subtracts from the bias level set by R6 and R7. The voltage on the inverting input of IC2 will always be very close to ground level. Therefore, the gate-source voltage of Q1 is dependent only upon gate voltage relative to ground, resulting in a low-distortion modulation of the signal on the drain terminal. The output of IC2 is attenuated by R9.

With a 1-volt peak-to-peak drive, the frequency range of the tremolo adapter is 40 to 50,000 Hz. Extended low-frequency response can be obtained by increasing the capacitance of C4 and C5. Higher gain can be obtained by increasing the value of R8.

Use of a printed circuit board or perforated phenolic board and solder clips for assembling the adapter is strongly recommended. Also, use only a low-wattage soldering iron to solder into place the components. (Switch S1 can be a footswitch if desired, but it must be sturdily mounted. A commercial footswitch, selling for as little as \$3, is ideal for this application.)

When assembly is complete, plug the instrument to be used with the adapter into J1 and a power amplifier into J2. If any clipping circuits, such as a fuzzbox, are to be used, they must be placed between the instrument and the tremolo adapter. Flip S2 to power the adapter. (Note: It may take a few seconds before the tremolo oscillator reaches full output.) Place S1 in the OUT position and adjust level control R9 as desired. Set S1 to IN and adjust R4 for the desired depth of tremolo. That is all there is to it. ♦

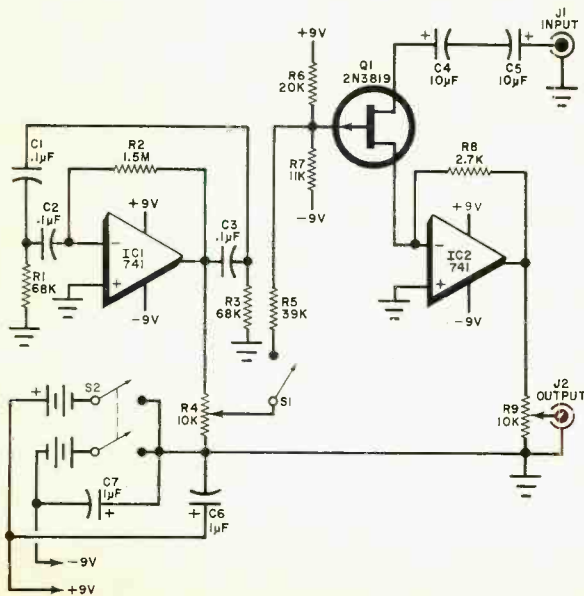





# ARE YOUR SPEAKERS IN PHASE ?

USING A SIMPLE SCOPE-MICROPHONE METHOD  
TO GET PROPER CONNECTIONS.

BY DAVID B. WEEMS

**WE** HEAR and read much about the necessity of properly phasing the speakers in a stereo system. The usual method prescribed is that of simply trying one hook-up and then its reverse, settling on the speaker connection that produces the better bass response. This takes only a few

seconds. Even so, many stereo speaker systems are hooked up with reversed polarity. Some "hi-fi" shops proudly demonstrate equipment that is operating out-of-phase.

If you do not trust your ears, there is a visual test that leaves no doubt about phasing. It can be used as a final phase

**This photo shows checking phase difference in crossover network. Audio generator is set at crossover frequency. Tweeter is raised above benchtop level so that its cone is on plane with woofer. In photo above, two mikes are used to phase stereo speakers. Speakers are fed a low-frequency signal from the stereo amplifier set for mono.**

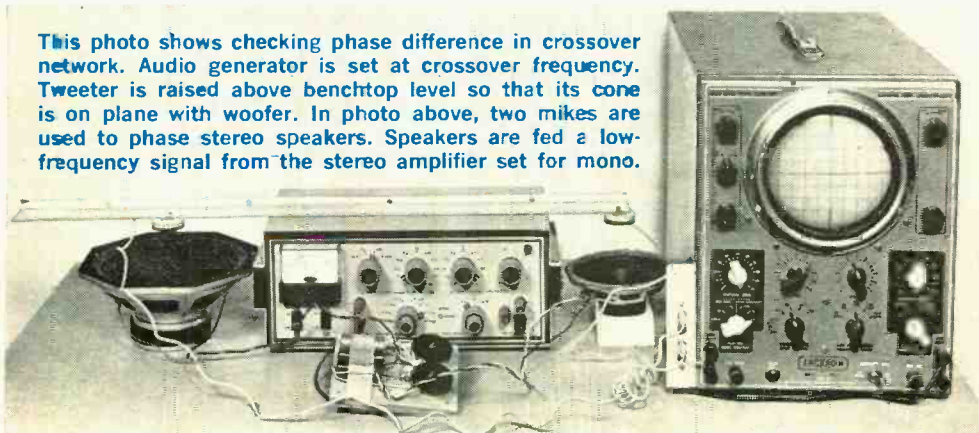



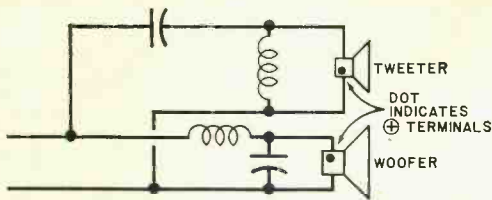

Fig. 1. Typical 12-dB/octave 2-way crossover network. Phase difference between the two legs of the circuit is 180 degrees so speakers must be wired out-of-phase as shown.

check on stereo speaker systems, but it is even more useful in determining the proper polarity of woofer and tweeter or woofer and midrange driver in a two- or a three-way speaker system. (It should be noted that hookup errors in multi-unit speaker systems are common occurrences.)

**Test Setup.** Most loudspeakers have coded terminals—usually a red dot but sometimes a “+” sign stamped near or a red fiber washer under the positive terminal. The difficulty with most faulty speaker systems involves the 12-dB/octave crossover networks they employ. This type of network, containing two filter components in each leg (see Fig. 1), is popular because it offers a compromise between the gentle frequency-response slope of the 6-dB/octave and the sharp cut-off 18-dB/octave types of networks. The 6-dB/octave network provides too little separation for some speaker

systems, while the 18-dB/octave crossover can cause transient distortion.

In wiring together a 12-dB/octave network, the problem is that it produces 180° phase differences between legs. Hence, to make the woofer and tweeter work in phase, the two should be wired out-of-phase. In a three-way system, the midrange driver should be wired out-of-phase with both the tweeter and the woofer.

You can probably draw the schematic diagram of a crossover network that is not sealed in a can and figure out the proper connections for each driver simply by tracing out the circuit. However, if you have an oscilloscope, you can avoid this time-consuming step. In addition to the scope, you will also need two crystal microphones of the type used as “lapel mikes” with most inexpensive tape recorders. Connect one mike to the horizontal and the other to the vertical input of the scope.

Now, place the mikes at equal distances from a single-cone loudspeaker while you feed a low-frequency signal to the speaker. Adjust the scope’s vertical and horizontal gain controls to obtain a line, inclined at 45° to the right or left of the vertical axis, on the CRT screen.

If the mikes are in-phase with each other and the scope is properly phased, the line will incline to the right (solid line in Fig. 2), while an out-of-phase condition will yield a line inclined to the left (dashed

Put two inexpensive microphones equal distance from single speaker which is fed by a low-frequency signal from generator to get a phase reference curve on the scope.

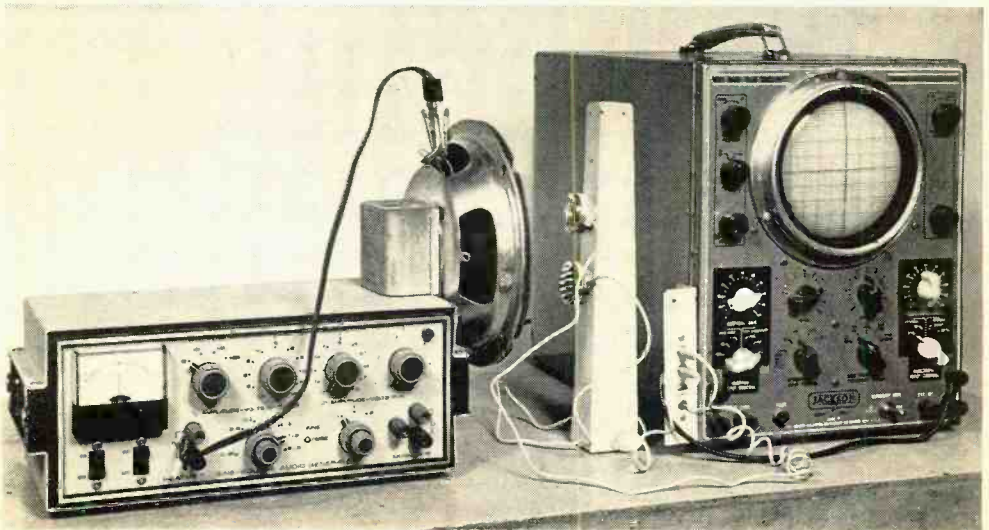

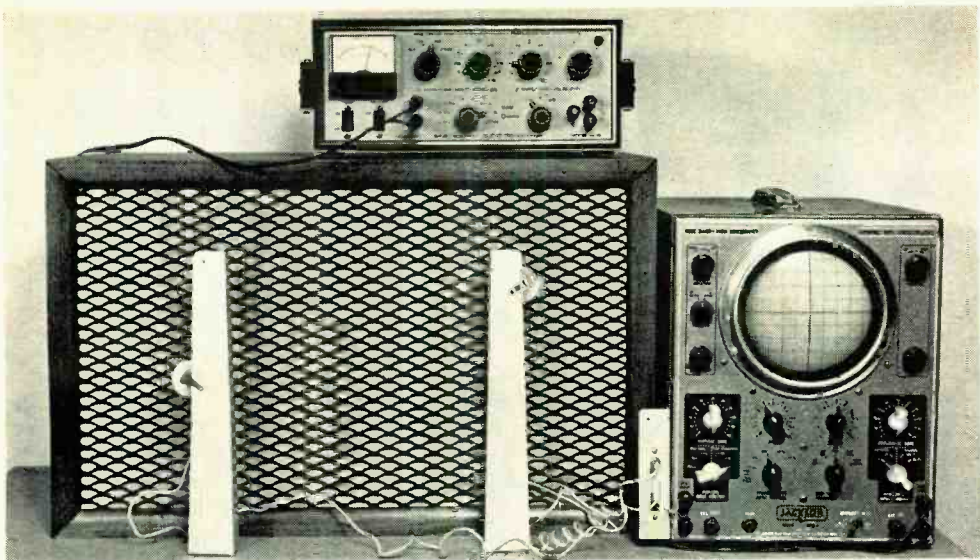

This test setup is used to determine phase difference between the woofer and the tweeter units in a completed speaker system.

line). Whether the mikes are in-phase or out-of-phase is unimportant; what is important is the slope of the line when the mikes are placed before a single speaker. Make a note of the slope either on the graticule or on a card pasted to the side of the scope.

With the above described setup, you can test any pair of speakers for proper polarity, positioning one mike before each speaker and using a preferably low-frequency signal to drive the speakers. The mikes should be placed at equal distances from their respective speakers. Thus set up, the speakers are operating in-phase when the trace on the CRT screen is the same as that produced by a single speaker.

**Multi-Driver Systems.** When testing speakers in a two- or a three-way system,

Fig. 2. Setup for phasing speakers with scope.

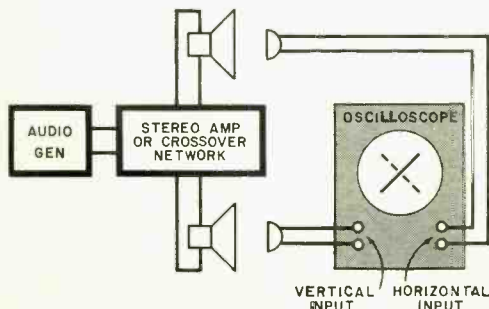

set the test signal at the crossover frequency so that the woofer and tweeter receive equal power. In three-way systems, always test the phasing between the woofer and midrange driver(s). At high frequencies, the shorter wavelengths make positioning of the mikes too critical for reliable results. Just remember to make the polarity of the tweeter the same as that of the woofer.

If during your tests you obtain a scope pattern of a circle instead of a line, the speakers under test are out-of-phase by  $90^\circ$  or  $270^\circ$ , indicating a crossover network with either a 6-dB/octave or, less likely, an 18-dB/octave slope. In either case, the speakers should be wired in-phase. Theoretically, you should correct this situation by moving the plane of the tweeters at the crossover frequency one-quarter wavelength to the front or the rear of the plane of the woofer. Unless the crossover frequency is rather low, however, this is unnecessary because the difference in depth between the woofer and tweeter cones automatically injects a compensating factor by putting the tweeter's cone ahead of that of the woofer.

The oscilloscope test can quickly settle any arguments or indecision about the phasing of your speakers. And, if you are like most audio buffs, knowing that your speakers are wired correctly will also make them sound better. ♦

# HOW AUDIO SWEEP GENERATORS SAVE TIME & INCREASE ACCURACY

*Tests Amplifiers, Speakers,  
Noise Reduction Units, Phase-Locked Loops*

BY JON D. PAUL

**WORKING** with audio equipment and circuits need not involve old-fashioned point-to-point response plotting. Audio sweep generators make the job easy and accurate.

**Linear and Log Sweeps.** With a linear sweep, the frequency (horizontal) scale, as displayed on an oscilloscope is calibrated in so many Hz or kHz per division. This is fine for indicating exact frequencies, but for audio work, a logarithmic scale is necessary, because the ear reacts to ratios of frequencies rather than to numerical values. (See the "Super Sweeper" in the October 1973 POPULAR ELECTRONICS.)

The audible sound spectrum has been

roughly divided into three ranges, each spanning about three octaves or one decade (10:1 ratio). These are popularly called bass (20 to 200 Hz), midrange (200 Hz to 2 kHz), and treble (2 kHz to 20 kHz). A linear scale spanning the 0-to-20-kHz range (Fig. 1A) compresses the entire bass range into the first 1/100 of its length and the midrange is in the first 1/10. However, a logarithmic scale (Fig. 1B) gives equal area to each part of the audio spectrum.

As a practical application, note the response of a low-pass filter to a linear sweep using two different sweep ranges, as shown in Fig. 2A. The shape of the response changes when the sweep rate is changed. With a log sweep, however, the essential shape of the response stays the same, as shown in Fig. 2B.

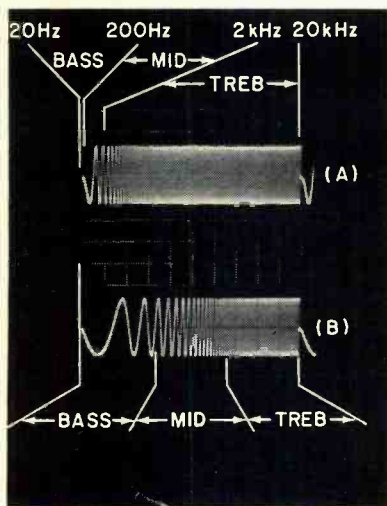

Fig. 1. Basic sweeps from 20 Hz to 20 kHz. Linear sweep at (A), log at (B).

**Using a Sweep Generator.** The basic arrangement for using a sweep generator is shown in Fig. 3, with the sawtooth output of the sweeper driving the horizontal axis of the scope and the audio sweep connected to the unit being tested. The output of the tested unit (properly terminated) goes to the scope's vertical input. At slow sweep rates (longer than 100 ms), the scope should have dc coupling at the horizontal input. If an ac-coupled horizontal input is used, the sawtooth waveform will be distorted. A sweep rate that is too low will be evidenced by the uneven motion of the horizontal trace. It will be fast at first and then slow up as the sweep progresses to the right.

An alternate mode of operation is to use the time base of the scope. The external sync or trigger of the scope is connected to the sweeper's sync output, and the scope's time base is reset each time the sweeper's



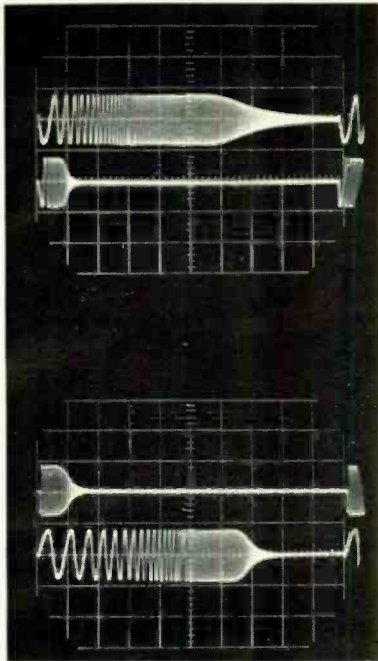

Fig. 2. Low-pass filter response for 2 different ranges of linear sweep (top). Below are log sweeps for two ranges of response for the same low-pass filter.

speed is changed. This setup is useful if the scope does not have a dc-coupled horizontal amplifier.

The scope's vertical amplifier will also affect the accuracy of an audio sweep display. Dc coupling is desirable when slow speeds are used with a generator that does not begin each sweep with a zero dc offset. If the generator has an initial-condition reset circuit so that the output has no dc component, either ac or dc coupling can be used.

To make a permanent recording of a sweep, it is only necessary to feed the sawtooth output of the sweeper to a graphic recorder's horizontal input, use a detector to convert the ac output of the circuit under

test to dc, and apply this to the recorder's vertical input. The setup is similar to that shown in Fig. 3. Very slow sweeps (ten to 100 seconds) should be used to prevent the relatively slow response time of the recorder from distorting the shape of the plot.

The logarithmic mode of a sweep generator should be used for wideband analysis, and the linear mode for narrow-band (high-Q) systems—or to read exact frequencies directly off of the scope trace. For example, note the audio amplifier's overall response pattern with log and linear sweeps as shown in Fig. 4. The overall response is best seen in Fig. 4A, while the exact -3-dB point is more easily identified on the linear sweep in Fig. 4B. This assumes, of course, that zero is on the left and the 100-kHz point is on the right, with each horizontal division representing 10 kHz.

In sweep generators having a fixed starting frequency, the frequency is usually 0 to 1/1000 of the full sweep frequency in the linear mode and 1/100 to 1/1000 of the sweep in the log mode. There is one other method of frequency control that may be encountered. This occurs in an r-f sweep-type generator where a start-frequency control determines the beginning of the sweep and a sweep-width control sets the frequency deviation.

The sweep-rate control on a generator determines the time that it takes a sweep to occur. There are two opposing factors involved in this setting, which means a trade-off is necessary. Slow sweeps (long sweep time and slow sweep rate) cause flicker in the CRT display which may make observation difficult. If the rate is too fast, a smearing effect occurs.

These conditions are illustrated in Fig. 5 for a low-pass filter. In Fig. 5A, the slow sweep produces a clear trace and the result is accurately depicted. In Fig. 5B, the sweep rate is too fast and a hard-to-read display results. The best way to set the sweep rate is to start off with a slow setting and watch

Fig. 3. Test setup used in conducting tests described.

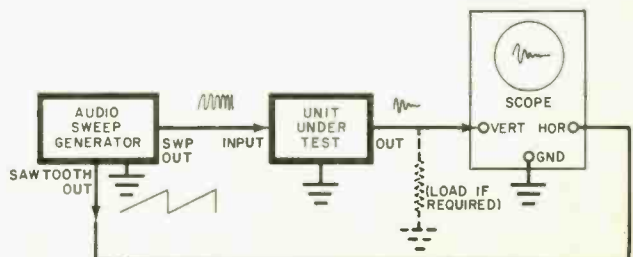

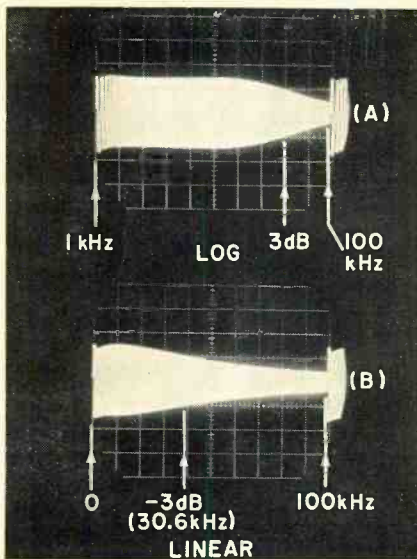

Fig. 4. Log sweep from 1 to 100 kHz of an audio amplifier (top). Below is the linear sweep from 0 to 100 kHz of same.

the display while increasing the sweep speed until smearing occurs. Then back off on the speed control until the trace is clean. The sweep rate at which distortion starts depends on the bandwidth of the equipment under test and on the width of the sweep.

**Sweeper Applications.** There are a number of basic tests that can be performed using a sweep generator—with a scope as the readout device. We will list them by the units on which the tests are performed.

**Amplifiers.** There are precautions that must be observed when using a sweeper to check a power amplifier. They are: keep the output voltage low enough to prevent overloading the circuit being tested; take the response at various output levels; use a carbon resistor of the correct power-handling capability as the load—not a speaker or a wirewound resistor since its impedance varies with frequency.

The results of an amplifier test are shown in Fig. 6. The 15-watt transistorized amplifier's response with a 1-watt output is shown at the top and with a 15-watt output below. Note the reduction in high-frequency response at the rated power. Remember that some transistor power amplifiers should not be tested for prolonged periods at full power. Also, make sure that the power line has the correct voltage.

**Preamplifiers.** Keep in mind that the vari-

ous inputs to a preamplifier are designed for specific voltage levels and source impedances. Consult the preamplifier's specifications before hooking up the sweeper. Check the phono inputs for conformity to the RIAA compensation curve. The tape output(s) should be observed first since they usually bypass the volume and tone controls. The effects of these controls can be checked by making a response test from a "flat" input (usually auxiliary) to the main (power amplifier) output.

**Tape Decks.** Response of a tape unit depends on tape speed, bias, recording level, head alignment (especially azimuth), and, finally, the tape itself. The output of a three-head deck is delayed with respect to the input. Two-head decks, especially cassette and cartridge recorders, provide no output at all during recording. These factors complicate testing. Two techniques are available for getting around these problems. The first, which can be used only on three-head decks, is to set the sweep time to a submultiple of the delay time (head spacing/tape speed). This rate can be set by observing the swept output of the deck and adjusting the sweep rate until one complete

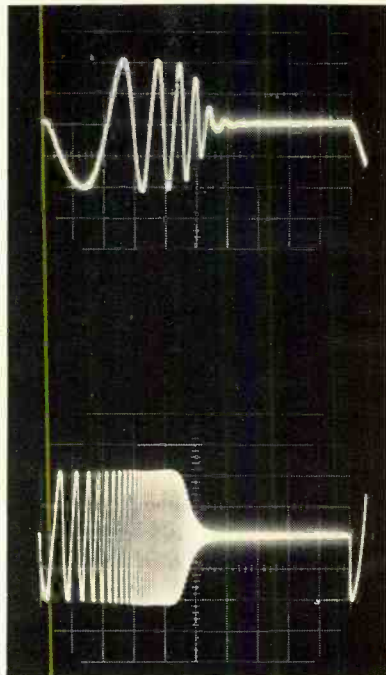

Fig. 5. Effect of sweep rates on low-pass filter response curves. Below is slow sweep, which is clear. At top is fast sweep, which is not as readable.

sweep is displayed, with the starting point properly positioned and with no movement. Set scope for int. sweep and ext. sync.

An alternate method, suitable for two- or three-head machines is to record a test tape of sweeps and play them back, displaying the output of the deck on a scope. The scope's internal time base is used with internal sync, and the end of each audio sweep will serve as a trigger for the scope. The scope time/cm (horizontal sweep) and triggering controls should be set for a stable display of one complete sweep. The level of the sweeper's output must be carefully adjusted so that it does not exceed the dynamic range of the deck. Although zero on the VU meter would appear to be the best level at which to run tests, many tape-deck manufacturers recommend a level that is -20-dB lower. At this level, bias and low-frequency noise may appear to be excessive, but these signals can be ignored since only the frequency response is important. If desired, a bias trap and low-frequency cutoff filter can be used at the deck's output.

Once these techniques are mastered, frequency response can be checked at various

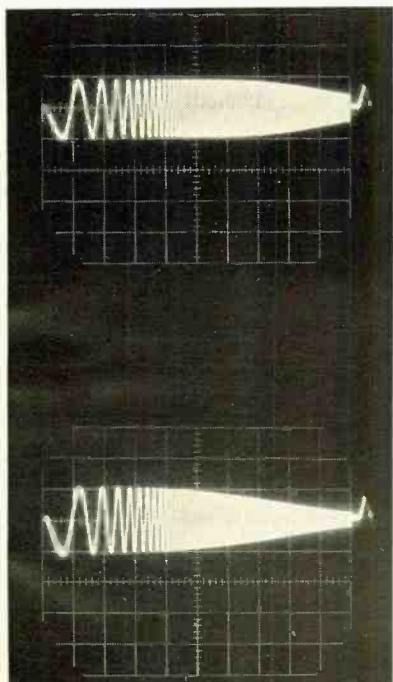

Fig. 6. Amplifier response from 1 to 100 kHz at 1-watt level (top) and 15-watt level (bottom). Note response changes with power and how 3-dB point lowers.

tape speeds and with different types of tapes. The channels of a stereo deck should be checked separately first and then compared for a balanced result. If the response doesn't meet the specified ratings, demagnetize and re-align the deck's bias, head

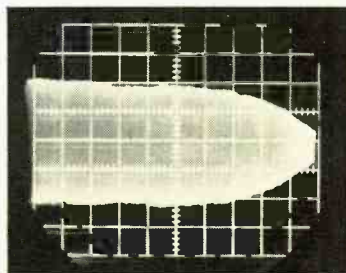

Fig. 7. Overbiased tape response curve.

azimuth, and equalization according to the manufacturer's instructions. Use the type of tape recommended. This is the coarse alignment.

The sweep generator can now be used to make the fine alignment. Vary the bias level so that the output level is maximum with the frequency response as flat as possible (or as flat as it was after the coarse alignment). A low bias will cause a high-frequency boost while over biasing will cut the highs. With the bias set, the response can be trimmed to get the best flatness using the equalization controls. All controls should require only small changes from the settings arrived at in the coarse alignment. Note that the head azimuth can cause a loss in high-frequency response if it was not set up properly during coarse alignment.

With the deck properly set up, a calibration sweep tape can be recorded. To check playback equalization and azimuth in the future, play the tape back and observe the scope display. The effect of using a different type of tape can now be tested. The procedure above should be repeated to test response at lower speeds on multi-speed machines, but the equalization can only be adjusted for low speed. Bias and azimuth settings are the same for all speeds. Figure 7 shows the effects of over-biasing.

**Filters.** There are many applications for filters in audio equipment: speaker cross-overs, multiplex FM, 4-chan. decoders, tone controls, scratch and rumble filters, etc. The ham uses filters in SSB transmission, code reception, SSTV, and RTTY. In testing filters, it is necessary to detach their inputs from the unit in which they are used



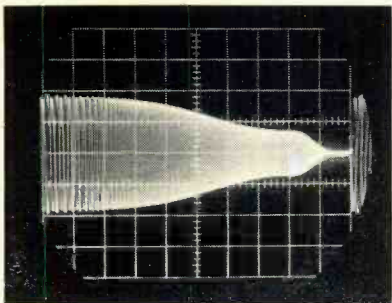

Fig. 8. FM multiplex filter response using a 300-Hz-to-30-kHz logarithmic sweep.

and determine the source impedance of the driving circuit. Then use the sweep generator to drive the filter through a resistor equal to the source impedance. Observe the filter's output with a scope probe that will not load the filter. Figure 8 shows the response of a multiplex filter used in a high-quality tuner.

**Speakers.** The response of a speaker is checked by applying the sweep generator signal through a power amplifier to drive the speaker. A calibrated microphone (a low-cost electret condenser unit is good) is set up a few feet in front of the speaker. The microphone's output is displayed on the scope directly (or through a preamp if necessary). The resonant point at low frequency, the midrange flatness, and the high-frequency rolloff should be noted. The enclosure, the amplifier's damping ratio and the room acoustics all affect the response, so take all of these factors into consideration.

**Microphones.** In testing a microphone, the technique is identical to that used on a speaker except that a mike with calibrated response is used as a reference for comparison purposes. Then the mike to be tested is substituted for the reference mike.

After making a test with the sweep generator, the reference response is compared to the new response and the difference represents the new mike's response. If the reference response can be made flat (over the band of interest) by using filters, equalizers, etc., then the second test will provide the test mike's curve.

**Noise Reduction Units.** Dolby, DBX and similar noise reduction systems often create overall responses that are dependent on the input level. A flat response is desired, but a full system sweep test can be done only if a coder and decoder are connected together. If, for example, a cassette deck containing only a Dolby decoder is under test, then the Dolby decoder's family of response curves vs level must be consulted. Comparison of the swept response with these curves will verify proper operation. The noise reduction circuit should be isolated from the surrounding circuits to avoid bias or equalization from confusing the results.

**Operational Amplifiers.** The setup shown in Fig. 9 can be used in testing the open-loop frequency response of an op amp. Due to the high gain and the dc input offset of the op amp, attenuation of the sweep generator and biasing of the op amp are necessary. The open-loop gain may be flat to a maximum of only 10 to 1000 Hz. Then, a 6-dB per octave rolloff will start. At the frequency at which the gain becomes unity, the 6-dB per octave slope must be maintained for closed-loop stability (freedom from oscillation). Maximum external compensation (for unity closed-loop gain) should be used if the op amp is not internally compensated.

The closed-loop response will depend on the feedback. Generally, the gain and offset problems encountered in open-loop measurements will not arise and the closed-loop test will not require the setup in Fig. 9.

**Power Supplies.** Figure 10 shows a sim-

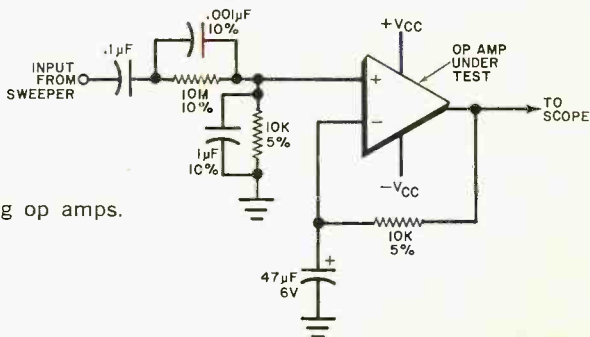

Fig. 9. Test setup for checking op amps.

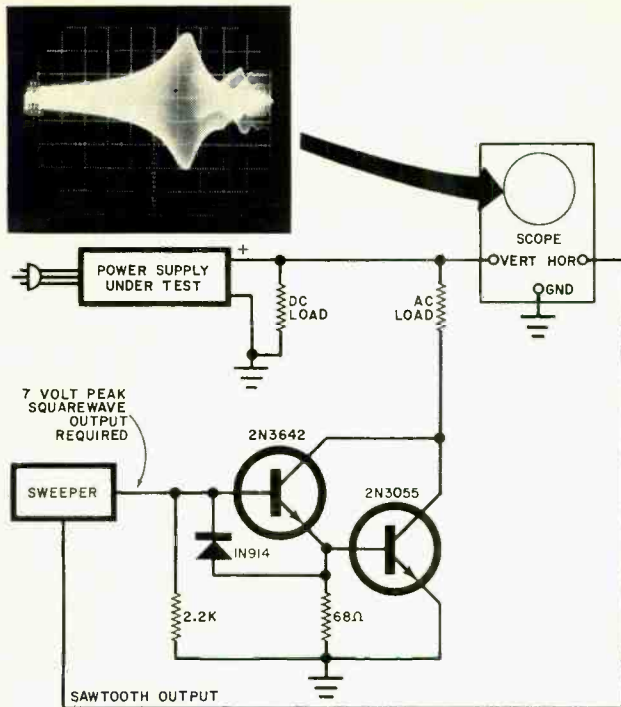

Fig. 10. Test for output impedance versus frequency of a power supply can be made by using this setup. A typical scope display is upper left.

ple circuit that can be used to check output impedance vs the frequency of a power supply. The sweeper switches the Darlington pair from cutoff to saturation, inserting and removing a known load resistance in the supply output at the sweep generator's frequency. The ac component in the output of the supply is displayed on the scope. This gives a direct reading of output impedance vs frequency. Power supply oscil-

lation problems can be debugged using the sweep generator by opening the loop and checking the open-loop response of the regulator at the opened point.

**Phase-Locked Loops.** Since PLL's are basically low-frequency FM detectors, the swept response will be in the shape of a Z as shown in Fig. 11. The lock and capture range of the loop and its center frequency can be measured and adjusted by viewing this display. The input level should be varied since the parameters may be functions of input voltage. A slow sweep rate is often required since some PLL circuits have a slow response to reduce noise.

**Ultrasonic Transducers.** In testing ultrasonic transducers, the manufacturer's drive and receiver circuits should be consulted since external inductors and/or capacitors are sometimes used for tuning and narrowbanding purposes. The power used in testing should be low. (50 mW is a typical maximum CW power.) The beamwidth of the transducers is often of interest. Move one element off axis in a face-to-face setup. Maintain a 5-foot radius and swing the element in an arc. Measure the angles from on-axis to the point where the peak of the sweep display falls to 0.707 of its maximum. The beamwidth is twice this angle. ♦

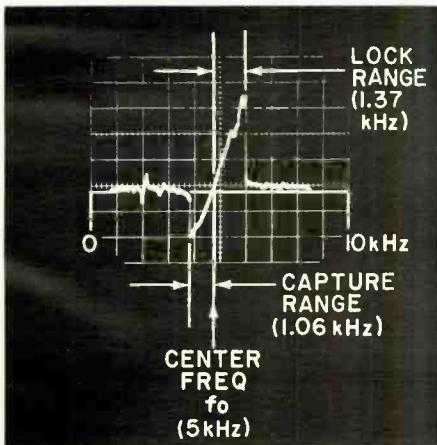
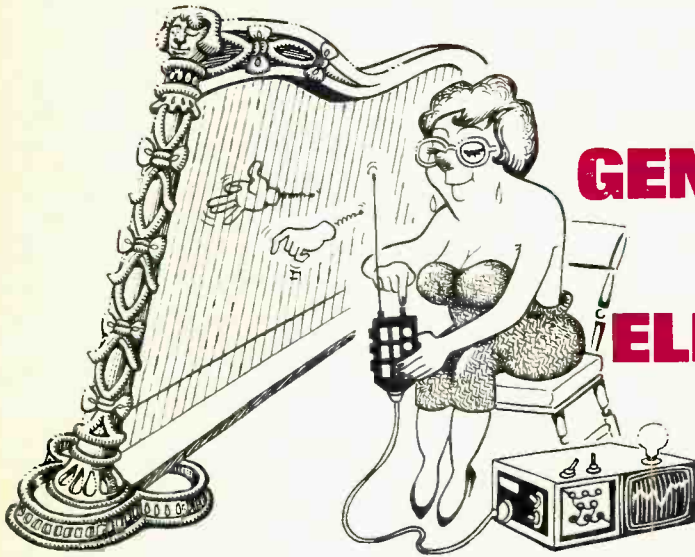

Fig. 11. Phase-locked loop response. FM output versus frequency. Note "Z" shape.

# PITCH GENERATORS FOR ELECTRONIC MUSIC



## PART 2. DIGITAL DIVIDERS AND PHASE-LOCKED LOOPS

BY DON LANCASTER

**L**AST month, the first part of this article covered pitch generation using simple separate voicing or vco with sample-hold. Here are two additional techniques.

**Digital Dividers.** A digital divider generates a tone by dividing down, by some factor, a high-frequency reference. The factor ( $N$ ) used in the division is chosen so that the result approximates as accurately as possible the desired frequency. By changing  $N$ , a group of different notes is generated. The optimum 8-bit series is 116-123-130-138-146-155-164-176-184-195-207-219-232, while an optimum 9-bit series ranges from 239 through 438. Some of these frequencies result in asymmetrical output waveforms. By doubling everything and adding a binary divider to get the final output frequency, a square-wave output for each value of  $N$  can be achieved.

Successive binary division from the top octave generates all the lower octaves. With a single  $N$  divider, the system is monophonic; with 12 dividers in parallel, the system is fully polyphonic, the number of notes depending on how far down the frequency is divided.

Figure 1 shows a single-voiced divider which can be built using TTL logic IC's and diodes. The original crystal oscillator frequency of 1942.040 kHz is divided by the  $N$

ratios to get a frequency equal to twice the top octave. Successive binary division generates the top octave and successive lower ones. Tuning is permanently related to crystal stability. A note is chosen by providing a ground to generate  $N$ , and the proper octave is selected by a switch or an electronic data selector. The 8281 IC's are made by Signetics and are also available from Motorola Semiconductor distributors.

By taking several octaves at once and adding them resistively, a linear sawtooth output can be obtained (Fig. 2). In timbre and voicing circuits, square waves are useful for clarinet and certain stopped pipe tones, but the linear sawtooth with all harmonics present is a better choice for most other voices. It simulates a string directly; and, with suitable bandpass filtering, it provides horn voicing.

A variable oscillator can be used instead of the crystal oscillator to allow tuning to another instrument or to introduce vibrato or short glides. An even better method is to use a phase-locked tracking oscillator that uses the crystal reference in the absence of a vibrato or glide command.

The equivalent of a sample-hold can be added by placing digital latches between the keyboard and the tone generator, a good application for the 74174 TTL hex latch. Unlike analog sample-hold circuits, digital



sample-holds are nearly instantaneous in their action and are free of droop.

Another interesting possibility is to run

the note generator 16 or 32 times faster than the note desired and then sample some sort of memory device, such as an RAM (random

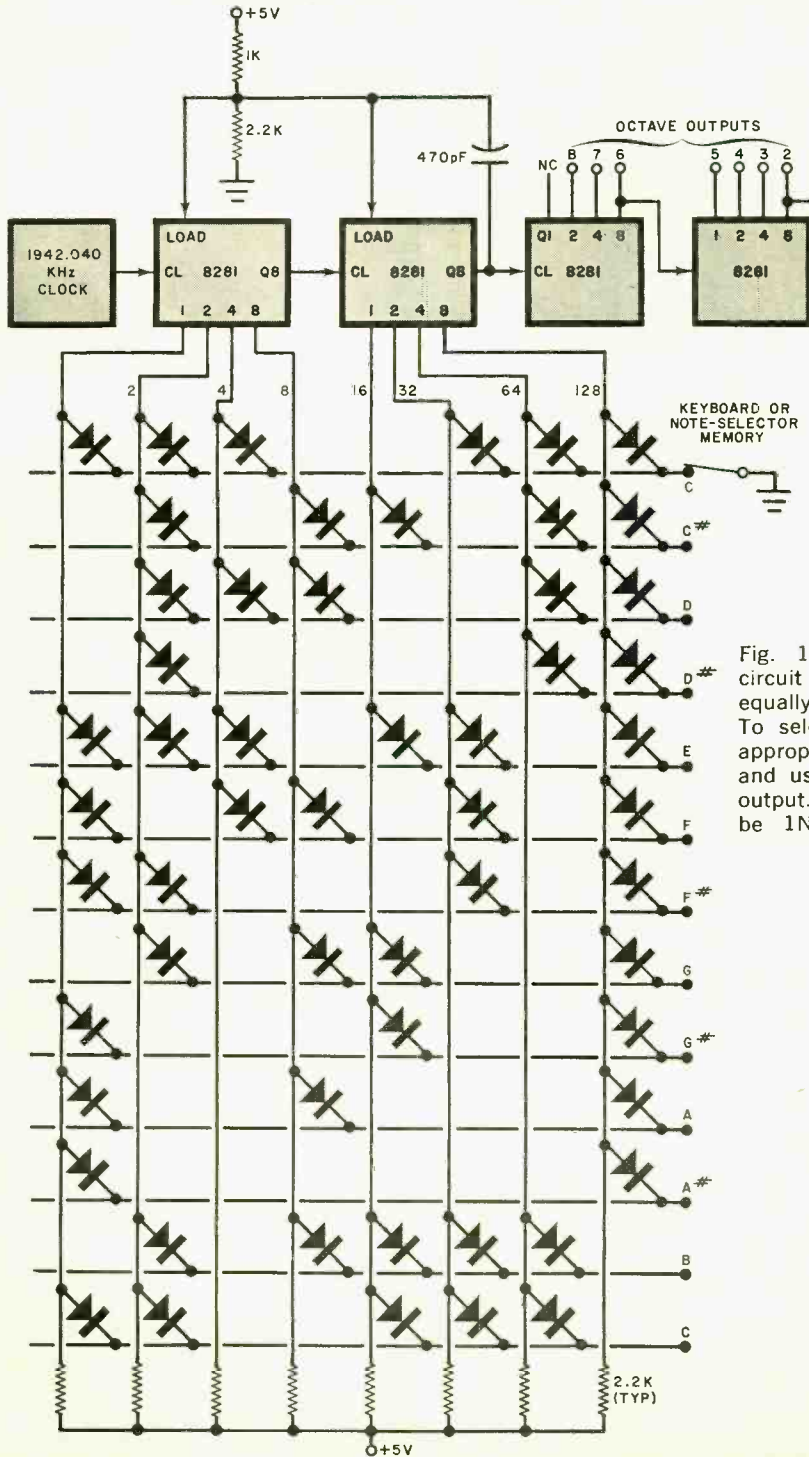
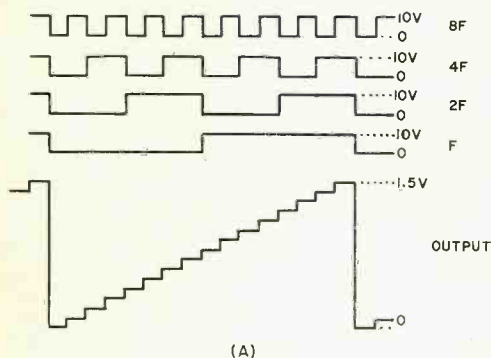

Fig. 1. Digital divider circuit generates any equally tempered note. To select note, ground appropriate diode line and use chosen octave output. Diodes used can be 1N914 or similar.

access memory), an ROM (read only memory), a program card, or a group of slide potentiometers. This makes a 16-bit or 32-bit sample of the waveform; and it is a powerful voicing technique that directly generates any tonal color without further filtering or summing circuits.

**Polyphonic Digital Dividers.** The obvious thing to do is build twelve dividers, one for each note of the upper octave, followed by as many dividers as are needed for the range of the instrument to be built. This provides a single pitch adjustment for the entire instrument or the possibility of fixed crystal control. In fact, this is such a good idea that commercial organ manufacturers now have a wide variety of top-octave generators and frequency dividers. Many of the top-octave generators imitate the obsolete GEM555 and GEM556.

One recent single-chip top-octave system uses the Mostek MK5024P (Fig. 3). While a good selection of custom, for-music-only



(A)

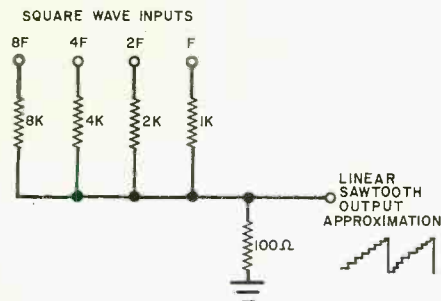

(B)

Fig. 2. Square waves from binary dividers contain only odd harmonics. All harmonics can be obtained by converting the wave to a staircase linear sawtooth approximation as shown. All harmonics except 16, 32, and 48 are present.



The "Performer" by Ionic Industries has synthesizer and modulator with 4-octave keyboard.

binary dividers is available, ordinary TTL IC's work just as well and are much cheaper. The CMOS IC's are even better since the supply current is low, the output voltage is high, and the cost soon will be competitive with TTL. The CD4024 (RCA) and MC14024 (Motorola) are particularly good choices for dividers.

Note that any time the supply is being used to generate a musical waveform directly, the supply must be tightly regulated and properly bypassed. If not, interaction and noise modulation can become serious problems.

These methods are moderate in cost and provide multiple voicing. They are used in most commercial organs. The "locked-in" nature of the octave harmonics is a definite advantage in imitating single-voiced instruments by formant filtering circuits. For pipe-organ imitation, certain "warming" techniques are easily added to imitate effectively the sound of a second pipe. This is done by altering the phase or frequency of the second harmonic slightly with a mechanical device, an analog shift register, a controllable phase shifter, or a phase-locked loop tracker.

**Phase-Locked Loop.** The phase-locked loop (PLL) tracker offers an interesting way of adding "synthesizer sound" to the digital divider techniques. It is a nominally single-voiced add-on for a polyphonic, fixed-keyboard instrument. It does everything a vco does without any need for precision resistors, log converters, or extremely linear vco's. A block diagram is shown in Fig. 4.

Basically, a phase-locked loop is used to track whatever frequency is applied by depressing a key. The PLL generates an internal square wave which is compared to the input signal and an error signal is generated. The latter is filtered to force the internal square wave to the same frequency as the input.

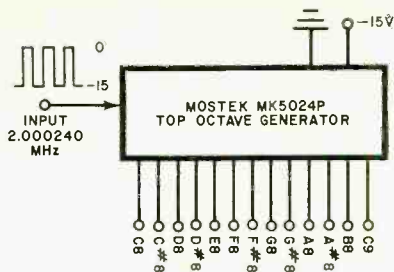

Fig. 3. A single-IC top-octave generator circuit. Binary dividers can be added to the outputs or the input to generate notes in other octaves.

To work properly, the PLL needs a 1000:1 (or greater) frequency range and must not be sensitive to harmonics. While this leaves out the vast majority of today's PLL chips, it does not prevent the use of the CD4046 (RCA, Motorola, Solitron, and others), which costs around \$5 and, to date, is the only one available for the job.

But why bother to generate a note that is identical to another? For one thing, it is possible to control how fast the circuit locks onto a new note so that one can control, on a keyboard instrument, glides, portamento, siren sweeps, trombones, etc. In addition, some vibrato can be inserted easily into the loop filter, for the notes where this effect is desired. Other disturbances inserted on the loop filter can generate really wild effects.

It is also possible to control how smoothly the note changes frequency. If the damping of the loop filter is high enough (controlled by the resistor in series with the loop capacitor), the transition is very smooth, and its speed is determined by the capacitor. On the other hand, if this resistor is made smaller or eliminated, the note bounces and overshoots, creating different kinds of interesting vibrato and bounce effects. With a small capacitor, a new note can be locked onto

in a time far less than usually required by an envelope generator to start its attack cycle.

All sorts of tricks can be pulled by adding a divider between the vco and the phase detector. One thing to do is use a divide-by-sixteen circuit to allow resistive summing for a sawtooth. A divide-by-two circuit provides a warmed second harmonic tone. With combination dividers, a fifth above or below an input can be followed for automatic chording and accompaniment.

The only restriction on this technique is that the input waveform can only have one zero crossing per cycle. Thus, sine, square, triangle, or sawtooth waves work well, but a microphone pickup of a real instrument may need some filtering to insure that the fundamental is much stronger than any of the input harmonics. There should also be only one note at a time on the inputs. One easy way is to add a computer chip called a parity generator to the keyboard outputs. This provides a signal if one key is pressed, but no signal if zero or two keys are pressed.

Usually, precision frequencies are much easier to generate (to arbitrary accuracy) with digital techniques than analog voltages. This is the big advantage of a PLL tracker over conventional vco systems.

Several PLL trackers can be used in one electronic music system, but the usual question of which loop goes with what key has to be resolved. This can be done by a priority hierarchy, restricting certain notes to a given tracker or using a separate "solo" keyboard for each tracker. As an alternate, several trackers can go after the same note at the same time to produce chorus or warmth effects, harmonics, or chords.

Remember that the four generation techniques described in the two parts of this article provide only the note's frequency. It is still necessary to provide keying, envelope shaping, and voicing to get a final musical output. ♦

Fig. 4. Phase-locked loop tracker allows generation of portamento, glides, and trombone effects on instruments equipped with keyboards.

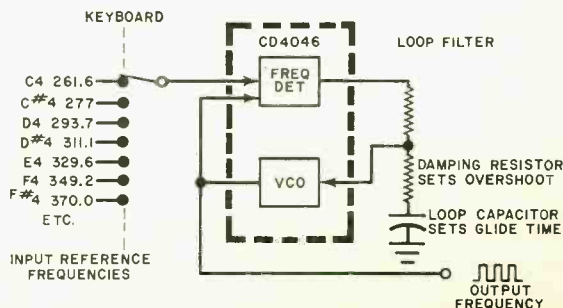



# Train at home on NTS equipment like this:

## NTS Audio Electronics Servicing

Know tweeters, woofers and baffles—sound distortion, amplification and control—public address and music systems. Kits you build and keep include Heath 60-watt stereo receiver, twin speakers, Volt-Ohmmeter, digital meter, in-circuit transistor tester, solid-state pocket radio.

### AM-FM Solid-State 60-Watt Stereo Receiver and Twin Speakers

Digital Multimeter

## NTS color and b&w tv servicing

Build the largest and most advanced solid-state color TV. A 315 sq. in. ultra-rectangular matrix picture tube, Varactor Diode Tuner, Electronic Character Generator and more. Or build B&W TV with cabinet. Both TV's feature "instant on" Automatic Fine Tuning, solid-state design, and more. Other kits you build and keep: Solid-State Pocket Radio, Troubleshooter, AM/SW Radio, Volt-Ohmmeter, Color Bar/Dot Generator, Electronic Tube and Transistor Tester, TV Vector Monitor Scope and 5-inch Oscilloscope. Send card or coupon for all new color catalog and full details today.



NTS/GR2000  
solid-state color TV  
315 sq. in. picture

Solid-state  
B&W TV  
74 sq. in.  
picture

Electronic Tube  
and Transistor Tester

Signal  
Generator

Color Bar  
Generator

TV Vector  
Monitor Scope

FET  
Volt-Ohmmeter

Solid-State  
Oscilloscope

Transceiver  
and  
Power Supply

Compu-Trainer

## NTS Automation and Computer Electronics

Master computer servicing technology as you build this solid-state Compu-Trainer—an NTS exclusive! Duplicates circuit technology of giant computers in industry, do your own wiring, patch-cording, assembly. Other kits you build and keep: 5-inch wide-band solid-state oscilloscope, FET Volt-Ohmmeter, Electro-Lab.

## NTS Electronic Communications

Earn your FCC First-Class Radio-Telephone License. Prepare for the test by building your own amateur phone 2-Meter FM Transceiver. NTS gives you the exact skills the FCC requires. Other kits you build and keep: fully transistorized Volt-Ohmmeter and regulated power supply.

## Project Method Training — "heart" of the NTS system.

NTS Project Method Training is a better way to learn electronics. With easy-to-follow lessons, comprehensive kit manuals, large fold-out charts and more, you'll build advanced equipment while you learn electronics principles and applications. You'll learn how components work, why they work, what to do when they don't work. In short, you'll use your mind *and* your hands to develop ability and confidence. This is why the NTS Project Method is such an invaluable part of your program.

## NTS gives you confidence-building extras!

- Job Getting Manual
- Advice On Starting A Business
- Answers To On-The-Job Questions
- Illustrated Electronics Dictionary
- Mechanics & Science Bulletins

**NATIONAL TECHNICAL SCHOOLS**

Technical-Trade Training Since 1905  
Resident & Home Study Schools

4000 SOUTH FIGUEROA ST., LOS ANGELES, CA. 90037

# Feel at home on jobs like these:

NTS builds your confidence with more solid training in Solid-State

NTS Training on professional solid-state equipment prepares you for many careers — in many consumer, commercial and industrial fields. If television is your chosen field, you could join a first class TV repair center, start a shop of your own, or specialize in industrial applications of television such as security system installation. And other electronic fields are continuing to grow, revolutionizing industry and communications, even reshaping our own lives. Opportunities are opening in home entertainment areas, commercial audio systems, mobile communications,

computer servicing, industrial controls and many other service technician areas. Yes, this is truly "The Age of Electronics." Your NTS training and the equipment you receive prepare you for these exciting careers wherever electronic technicians are needed. Start now! Build your confidence along with new skills in electronics. You may start earning extra money even before you graduate! Check your course on the card or coupon and mail today! No obligation. No salesman will call.



Master Technician: Communications Electronics



Master Technician:  
Home Entertainment Electronics



Master Technician:  
Industrial Electronics

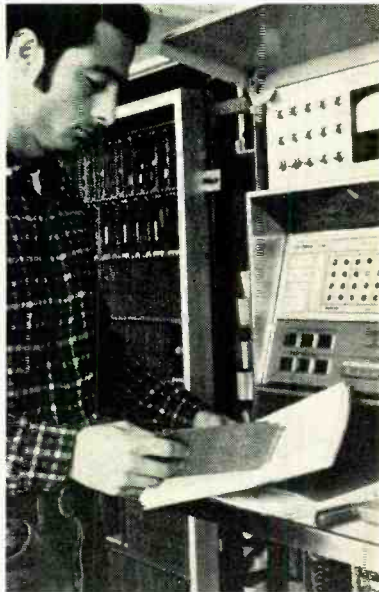

Master Technician:  
Computer Electronics

## Classroom training at Los Angeles

You can take classroom training at Los Angeles in sunny Southern California. NTS occupies a city block with over a million dollars in facilities devoted exclusively to technical training. Check box in coupon.

## Approved for Veteran Training

Accredited Member: National Association of Trade and Technical Schools; National Home Study Council.

Please rush Free Color NTS Guide To Careers In Electronics and Sample Lessons, plus information on course checked below. No obligation. No salesman will call.

**National Technical Schools**  
Technical-Trade Training Since 1905  
Resident & Home Study Schools  
4000 So. Figueroa St.  
Los Angeles, Ca. 90037

NTS guide to careers in Electronics



- Master Course in Color TV Servicing
- Color TV Servicing (For Qualified Technicians)
- Master Course in B&W TV & Radio Servicing
- Master Course in Electronic Communications
- Practical Radio Servicing
- FCC License Course
- Master Course in Electronics Technology
- Automation & Industrial Electronics
- Computer Electronics
- Basic Electronics
- Audio Electronics Servicing
- Audio Technology for Qualified Technicians

Dept. 205-034

NAME \_\_\_\_\_ AGE \_\_\_\_\_

ADDRESS \_\_\_\_\_

CITY \_\_\_\_\_

STATE \_\_\_\_\_ ZIP \_\_\_\_\_

- Check if interested in Veteran Training under new G.I. bill.
- Check if interested ONLY in Classroom Training at Los Angeles.



# RANDOM TONE GENERATOR

BY LESLIE SOLOMON, Technical Editor

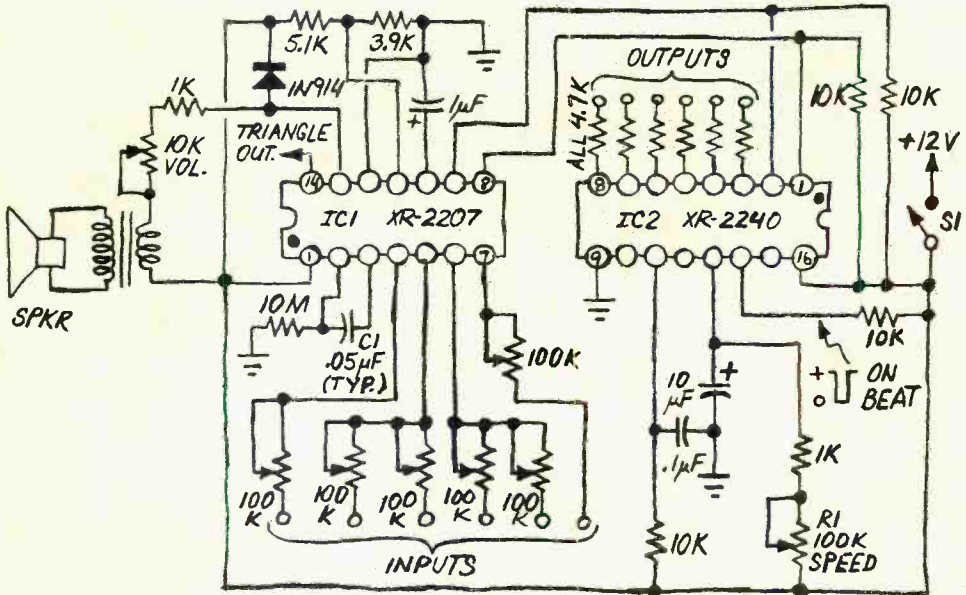

THE latest in random-tone generators can be assembled easily using two chips made by Exar—Integrated Systems, Inc. One is the new XR-2240, a programmable timer, and the other is XR-2207, a current-controlled oscillator. The two can be connected together as shown in the diagram to provide 256 separate tones (all in the same key) in a pseudo-random sequence which recycles automatically at the end of each sequence. Each tone has its own frequency control so that even more sounds can be produced as each of the six potentiometers is adjusted (at any time in the sequence). The addition of one more IC (not shown) will provide a generator capable of running for months without repeating a tone sequence.

In the circuit shown, the range of the basic frequency of IC1 is determined by C1. For the value shown, the frequency is in the middle bass range. If the value is reduced, the basic frequency goes up, and vice versa. Switched capacitors can be used to get a wide range.

The oscillator output is varied by applying different signal levels to pins 4 through 9 of IC1. Pin 13 is an uncommitted output tran-

sistor collector, for which some sort of load is required. A speaker transformer can be used with a volume control arrangement as shown here, or a simple load resistor can be placed between pin 13 and the positive supply, with pin 3 attached to an external audio system. A "softer" triangle waveform output can be obtained by coupling an audio amplifier directly to pin 14.

The amount of current delivered to pins 4 through 7 of IC1 is determined by the setting of the potentiometers in series with the pins. The potentiometers also control the pitch, permitting even more tones. If desired, any combination of the potentiometers can be grounded for further variations.

The timing chip, IC2, is similar to a 555 timer, internally coupled to and 8-stage countdown with 256 "beats" available in binary form.

The IC1 inputs and IC2 outputs can be patched together in any desired order. Use S1 to reset the sequence.

The chips are available from any Exar representative or distributor. The 2207 is presently priced at \$12, and the 2240 runs \$8.60, for orders of one. ♦



The Op Amp Designer was developed to eliminate many of the problems involved in designing and breadboarding circuits using these versatile IC's. It provides the necessary power supplies, a waveform generator for test inputs, a null detector with LED readout, and a mounting socket on which any number of different circuits can be set up.

In a case measuring 7" by 8½" by 3", the Op Amp Designer contains a regulated +5-volt, 500-mA short-circuit-proof power supply, a regulated ±15-volt, 200-mA supply (also short-circuit proof); and a generator of sine, square, and triangle waveforms whose frequency can be changed. The breadboard socket contains 128 sets of five electrically connected solderless terminals arranged in vertical columns with eight sets of 25 terminals arranged in rows above and below the main column. When an IC or other component is inserted in the socket, four other solderless connections can be made to it. Groups of circuits are interconnected by lengths of #22 solid wire.

Five-way binding posts are used for external connections. The various voltage points, the outputs of the function generator, and the inputs to the null detector are made with miniature insulated pins that feed through the front panel.

With these provisions, almost any circuit can be breadboarded by inserting the components and interconnecting with jumpers. No soldering is required.

**About the Circuits.** The +5-volt supply (Fig. 1) is a conventional bridge rectifier (*RECT1*) and filter (*C1,C2*) with a regulator (*REG1*) whose output is filtered by *C3* and *C4*. Line and load regulation are typically less than 0.5% with less than 20 mV ripple. The regulator automatically shuts down with any short or overheating.

The 15-volt supply has two bridge rectifiers with filters and two feed-pass transistors (*Q1* and *Q2*). Control for these two supplies is provided by *REG2*. Each side of the supply delivers 15 volts at 200 mA with better than 20-mV line and 30-mV load regulation. Ripple is less than 20 mV.

The waveform generator (Fig. 2) has an 8038 function-generator IC, with sine, square, and triangle outputs. The basic oscillation frequency is determined by switching (through *S3*). Capacitor *C12* is used for 500 Hz or an external capacitor can be used for another frequency. Large values

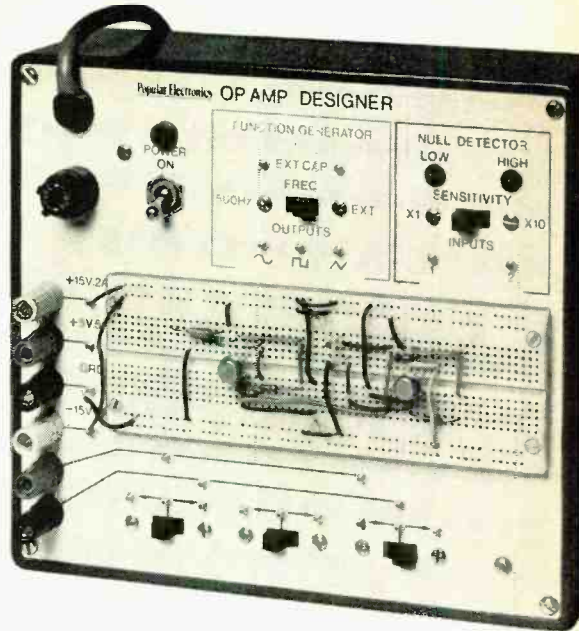

**BUILD THE**  
**OP AMP**  
**DESIGNER**

*Experiment with  
 op amp circuits  
 the easy way.  
 Built-in power supplies,  
 function generator,  
 and  
 null detector.*

**BY JACK CAZES**

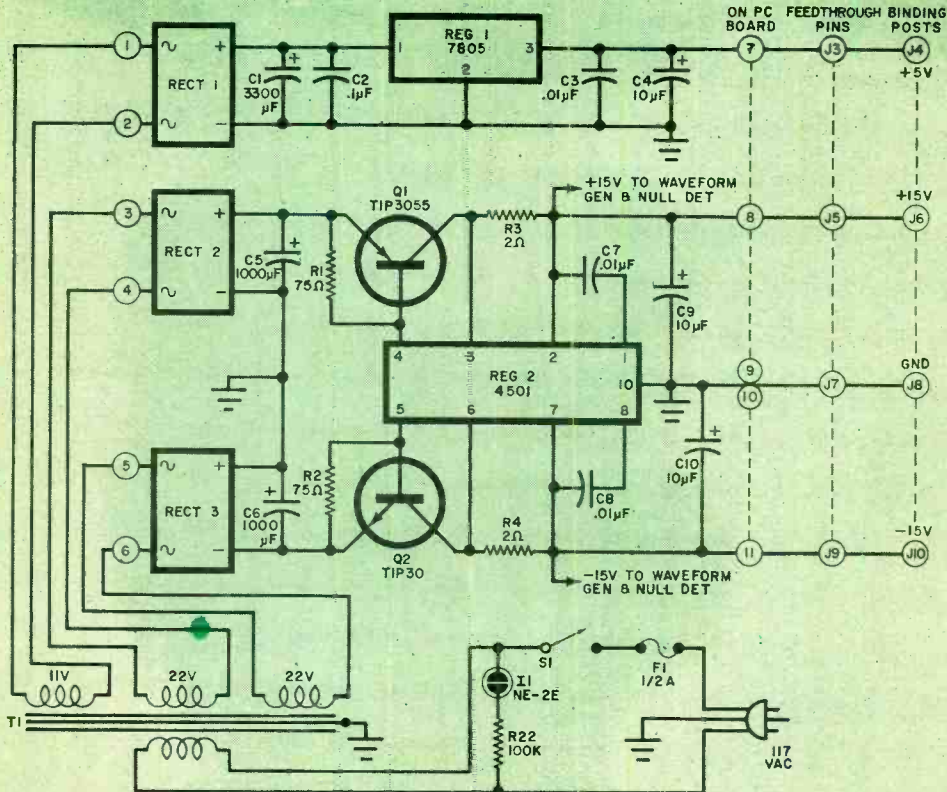

Fig. 1. The power supplies use IC regulator chips for accurate and stable output.

### PARTS LIST

C1—3300- $\mu$ F, 16-volt electrolytic capacitor  
 C2,C11,C12—0.1- $\mu$ F, 50-volt disc capacitor  
 C3,C7,C8—0.01- $\mu$ F, 25-volt disc capacitor  
 C4,C9,C10—10- $\mu$ F, 30-volt electrolytic capacitor  
 C5,C6—1000- $\mu$ F, 30-v electrolytic capacitor  
 D1—1N914 or 1N4148 diode  
 F1—0.5-A fuse and panel-mounted holder  
 I1—NE-2E neon lamp and holder  
 IC1—8038 waveform generator  
 IC2,IC3—741C op amp  
 J1-J3,J5,J7,J9,J11-J26,J28,J29—BP-22 feed-through breadboard pins  
 J4,J6,J8,J10,J27,J30—Five-way binding posts  
 LED1,LED2—Light-emitting diode (MV-5026)  
 Q1—TIP-3055 transistor (2N3055 may be used if leads are inserted properly)  
 Q2—TIP-30 or HEPS-3027 transistor  
 All following resistors  $\frac{1}{4}$  watt unless otherwise specified  
 R1,R2—75-ohm  
 R3,R4—2-ohm,  $\frac{1}{2}$ -watt  
 R5,R6—56,000-ohm  
 R7,R21—270,000-ohm  
 R8,R11—10,000-ohm, PC-type potentiometer  
 R9—1000-ohm  
 R10—100-ohm  
 R12,R15,R17—4700-ohm  
 R13—22,000-ohm  
 R14—15-megohm  
 R16—1000-ohm, PC-type potentiometer

R18—15,000-ohm  
 R19,R20—100,000-ohm, PC-type potentiometer  
 R22—100,000-ohm  
 RECT1-RECT3—50-volt, 1-ampere bridge rectifier  
 REG1—7805 regulator (5 volts)  
 REG2—4501 regulator (15 volts, dual)  
 S1—Spst switch  
 S2-S6—Spdt slide switch  
 T1—Transformer; secondaries: 11 V, 22 V, 22 V  
 Misc.—Breadboarding socket (EL SK-10), suitable case with aluminum front panel, slide-on heat sink for REG2, line cord with strain relief, rubber grommets (2).  
 Note: The following are available from E&L Instruments, Inc., 61 First St., Derby, CT 06418: transformer T1 at \$9.90; PC board at \$7.80; breadboarding pins (BP-22) at 25 for \$5.95; breadboarding socket SK-10) at \$17.75; case at \$2.25; front panel punched and marked at \$11.00; complete kit of parts including case and front panel (OA-2K) at \$89.95. Add \$1.00 postage for parts other than complete kit, which is postpaid.  
 Note 2: The following are available from Electronics Co., Inc., P.O. Box 278, Cranbury, NJ 08512: 8038 waveform generator at \$8.40, postpaid.

of external capacitance produce lower frequencies, and vice versa.

The waveforms, symmetrical about ground, are available at the *IC1* outputs, with the sine wave constructed from the triangle wave by an 8-point breaking network within the IC. Potentiometers *R19* and *R20* are used to adjust the sine-wave symmetry. Sine-wave distortion is typically near 2%, but it can be refined by using the two potentiometers.

The null detector (Fig. 3) is essentially a sensitive voltage comparator with two compensated op amps. The gain is selected by *S2* with *R9* and *R10* chosen for either *X1* or *X10* gain. The two LED's are connected with opposing polarities in the feedback loop of *IC3*. When the input voltage to *IC3* is zero, neither LED will glow. With an input greater than zero, *LED2* conducts, and when the input drops below zero, *LED1* conducts. Potentiometers *R8* and *R11* remove any offset within the op amps.

**Construction.** The circuits can be assembled on a PC board, whose foil pattern is shown in Fig. 4, with component layout as shown. Be sure to observe the polarity of the components and use a low-power soldering iron and fine solder. Don't forget the two jumpers. Note that external connections are

made through numbered pads on the board, which correspond to those shown in the schematics.

Any type of chassis can be used as long as it will accommodate all the necessary controls. Use rubber grommets to mount the two LED's. The large socket is held in place with six flat-head screws: A #29 drill is used to make the small holes necessary to mount the insulated breadboarding pins. These pins are installed by pushing them into their holes on the panel and then pushing the metal posts into the insulator as far as they will go. Use the flat side of heavy pliers for this as the posts make a hard fit.

The transformer is mounted on the rear of the front panel next to the three slide switches, using countersunk flat-head screws since one of the transformer mounting holes may be under the large socket.

Mount the PC board on small metal brackets at right angles to the front panel with the foil side toward the three slide switches. Connect the PC board to the other components according to the schematics. Use a slide-on heat sink for *REG2*.

Note that, in the case of the function generator and null detector, connections are made through feedthrough pins, while the power supplies are terminated in the parallel connection of the board to both feedthrough

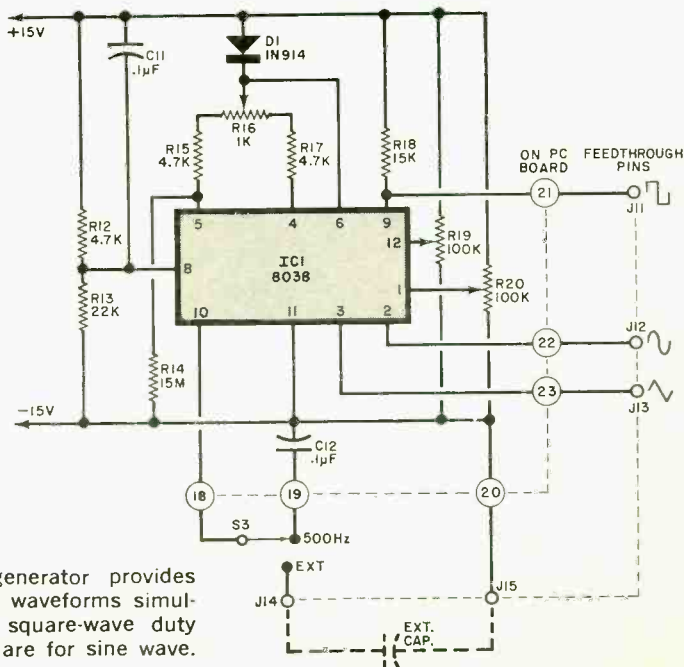

Fig. 2. The waveform generator provides sine, square, and triangle waveforms simultaneously. *R16* sets the square-wave duty cycle while *R19* and *R20* are for sine wave.



pins and binding posts. Also note that there are two binding posts, interconnected with two feedthrough pins that can be used for interconnecting to external circuits. The three slide switches also terminate in feedthrough pins.

**Testing.** With the Designer plugged into the power line, turn on the ac power and note that neon indicator *II* glows. Measure the voltage between the +5-volt binding posts (and feedthrough pin) and ground. This assures that *REG1* is operating. Then check for the 15-volt supplies at their pins. If any voltage is missing, or is far from its proper values, turn the device off and check component installation, polarities, solder bridges, etc.

Connect a scope to the square-wave output and be sure that it has a frequency of approximately 500 Hz with an amplitude about 0.9 times the generator's measured supply voltage. Adjust *R16* to obtain a 50% duty cycle (tops and bottoms of square waves have equal durations). Move the scope to the sine-wave output pin and note that this is about 0.2 times the supply voltage. Adjust both *R19* and *R20* for minimum sine-wave distortion. One control will affect the top of the sine wave; the other, the

bottom. There is some interaction between the two controls. Recheck the square-wave duty cycle and adjust *R16* to obtain the equal widths. Then recheck the sine wave. The triangle wave will be about 0.3 times the supply voltage. The generator can deliver up to approximately 20 mA to experimental circuits.

If you have a frequency counter, measure and record the frequencies in the function generator with different capacitors attached to the external pins. Use standard values of capacitors, ranging from 0.0001  $\mu\text{F}$  (which gave about 225 kHz in the prototype) to 100  $\mu\text{F}$  (less than 1 Hz). Keep the capacitors separate and make a record of the actual frequencies.

To test the null detector, ground inputs 1 and 2 and note that both LED's are off. If you see a faint glow in either LED, potentiometers *R8* and *R11* must be adjusted until the glow disappears.

Leave input 1 connected to ground and connect input 2 to the +5-volt line. The high LED2 should glow and LED1 (low) should remain off. Reversing the input by connecting input 2 to ground and input 1 to the +5-volt line should show LED1 on and LED2 off. The sensitivity of the null detector can be determined by using a low

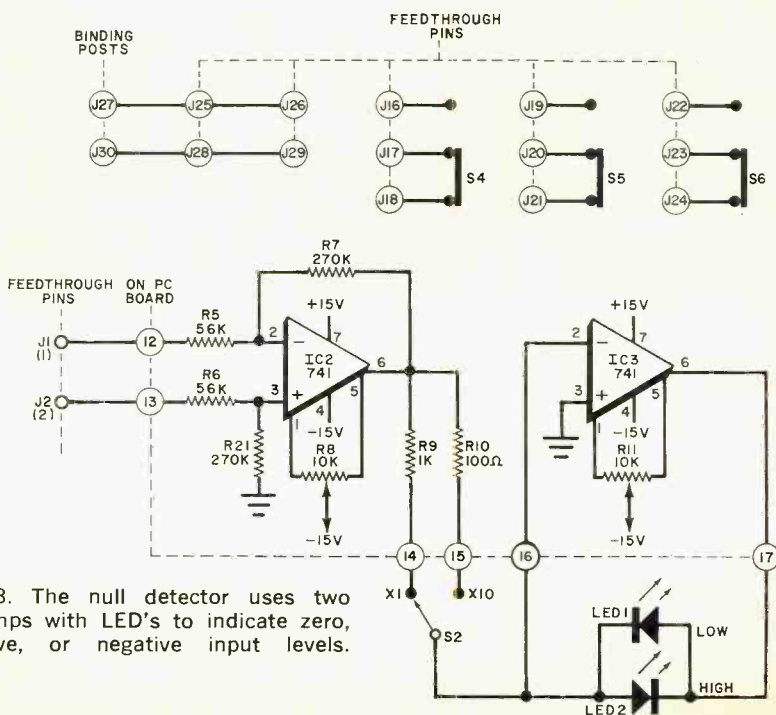

Fig. 3. The null detector uses two op amps with LED's to indicate zero, positive, or negative input levels.

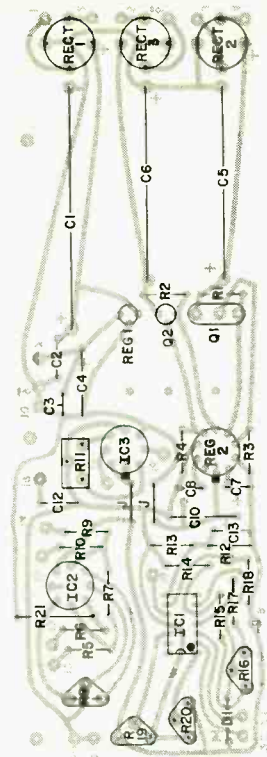
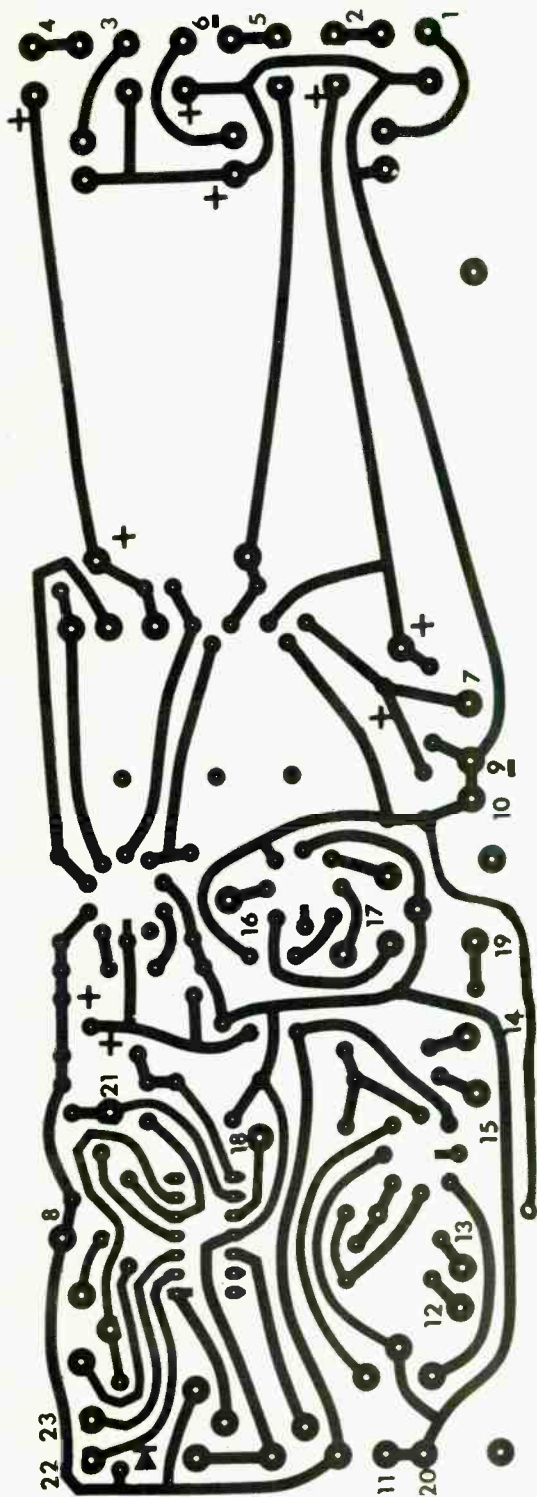

Fig. 4. Actual-size foil pattern and component installation for the Op Amp Designer.

variable-dc voltage as the input. Note the smallest input voltage that will produce a visible output from either LED. This should be about 2 to 10 mV for the X10 setting of S2.

**Using the Designer.** Select one of the upper horizontal rows of pins as the +15-volt line. If necessary interconnect the right and left rows using short lengths of wire. Use another of the top or bottom rows for the -15-volt line and another for ground. The fourth row can be used for the +5-volt line if needed.

Note that there is a wide horizontal gap between the two halves of the large socket. Install IC's so that they straddle the gap. This leaves four pins at each lead to be connected with wires to any other point on the board, or through either of the two unused binding posts to external sources.

Standard components can be "plugged" directly into the socket with lengths of #22 solid wire (with stripped ends) used for interconnections. ♦

# Build the low-cost TRANSISTOR OSCI-TESTER

*A-f & r-f tests, checks junctions, identifies type*

BY JOHN F. HOLLABAUGH

**T**HE Transistor Osci-Tester is more than just a simple go-no-go checker. Of course, it does indicate whether the junctions of a transistor are good, but it also determines if the transistor will oscillate at about 5 kHz for audio functions and whether it will provide gain at about 3 MHz for r-f applications. The latter test eliminates the measurement of gain, junction capacitance, and leakage. If the transistor will oscillate at r-f, it must be in good shape. The tester also shows whether the transistor is npn or pnp and silicon or germanium.

**Circuit Operation.** The a-f test is made by including the unknown transistor in a blocking oscillator circuit consisting of *T1*, *C1*, *R1*, and *R2*. Resistors *R1* and *R2* determine the operating bias of the unknown to give a partial indication of the operating frequency.

The oscillator output is passed through *C2* to drive a dc voltmeter consisting of *D4*, *Q1*, *Q2*, and *M1*. The quiescent (zero) current of *Q1* is balanced by the channel resistance of *Q2*, which has zero bias and matches the zero bias of *Q1*. Diode *D4* rectifies the oscillator output, producing the negative voltage required to drive *Q1*. The setting of potentiometer *R5* balances the relative quiescent voltage drops across the channels of *Q1* and *Q2*.

The r-f test is made by connecting the

unknown transistor in a Pierce oscillator consisting of a crystal (channel 5 used in prototype), *R5*, *R3*, *R4*, and *C3*. In this circuit, the base of the unknown transistor is driven by the collector output through the crystal. This produces positive feedback at the crystal frequency. If you want to check the harmonics of the crystal frequency, loosely couple the r-f oscillator output to the receiver antenna.

In some cases, increasing *R3* to 560,000 ohms will improve r-f oscillation.

The third portion of the tester converts it into a one-volt dc meter, which is used to measure the forward voltage drop (barrier voltage) across the forward biased base-emitter junction of the unknown transistor. Voltage of the correct polarity is determined by the setting of *S2* which applies this current through *R7*. The meter then indicates the approximate 0.3-volt drop of a germanium junction or the approximate 0.7-volt drop of a silicon junction. Diodes *D1* and *D2* are a silicon and a germanium connected in series to limit the open-circuit voltage to about 1 volt when the transistor under test is disconnected.

**Construction.** The circuit can be assembled in any way. The prototype was built on a piece of perf board and put in a small plastic case. The meter and necessary switches were installed on the front panel.



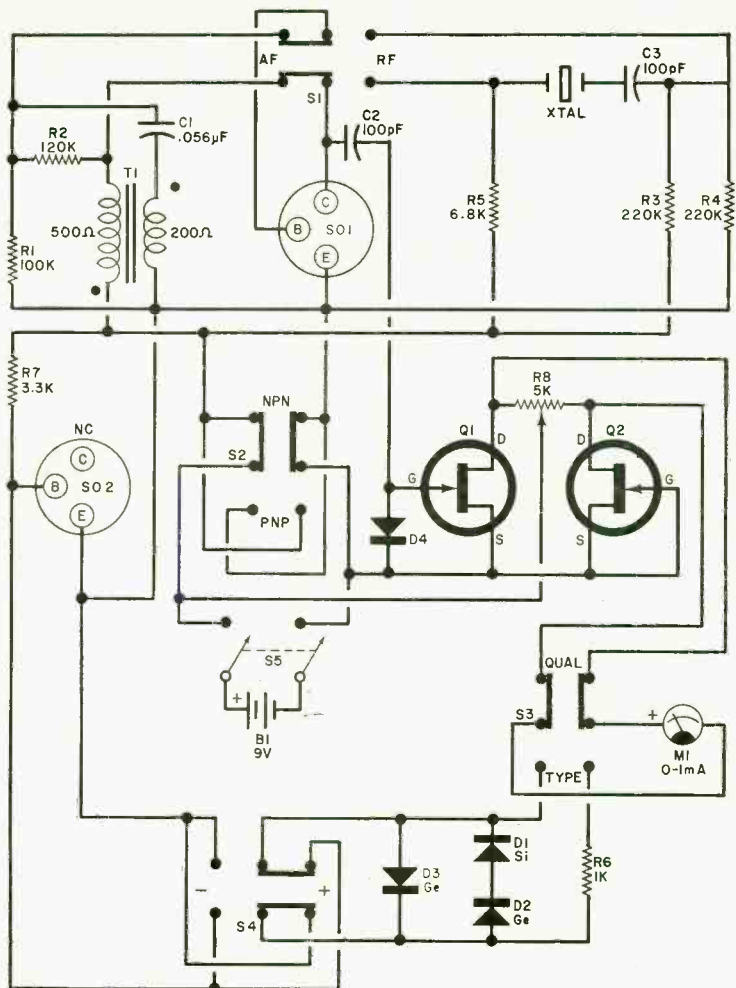

### PARTS LIST

B1—9-volt battery  
 C1—0.056- $\mu$ F capacitor  
 C2, C3—100-pF capacitor  
 D1—Silicon diode  
 D2, D4—Germanium diode  
 M1—0-1-mA meter  
 Q1, Q2—HEP801 transistor  
 R1—100,000-ohm resistor  
 R2—120,000-ohm resistor  
 R3, R4—220,000-ohm resistor

R5—6800-ohm resistor  
 R6—1000-ohm resistor  
 R7—3300-ohm resistor  
 R8—5000-ohm potentiometer  
 S1, S4—Dpdt switch  
 S5—Dpst switch  
 T1—500:200-ohm transistor driver transformer (Radio Shack 273-1581 or similar)  
 XTAL—CB crystal (channel 5 used in prototype)  
 Misc.—Battery holder and connector, mounting hardware, etc.

Tester circuit consists of blocking oscillator, r-f oscillator and dc voltmeter.

**Operation.** Connect the unknown transistor to SO1. Place S1 in the AF position, S3 in the QUAL position, and turn on the power. Operate S2 for a meter indication. The position of S2 will indicate the transistor type. If you get a meter indication, the transistor will oscillate at audio. Switch-

ing S1 to RF will show whether the transistor will operate at r-f.

With the transistor in SO2 and S3 in the TYPE position, operating S4 will show either a low-scale indication for germanium types or a high-scale indication for silicon types of transistors. ♦

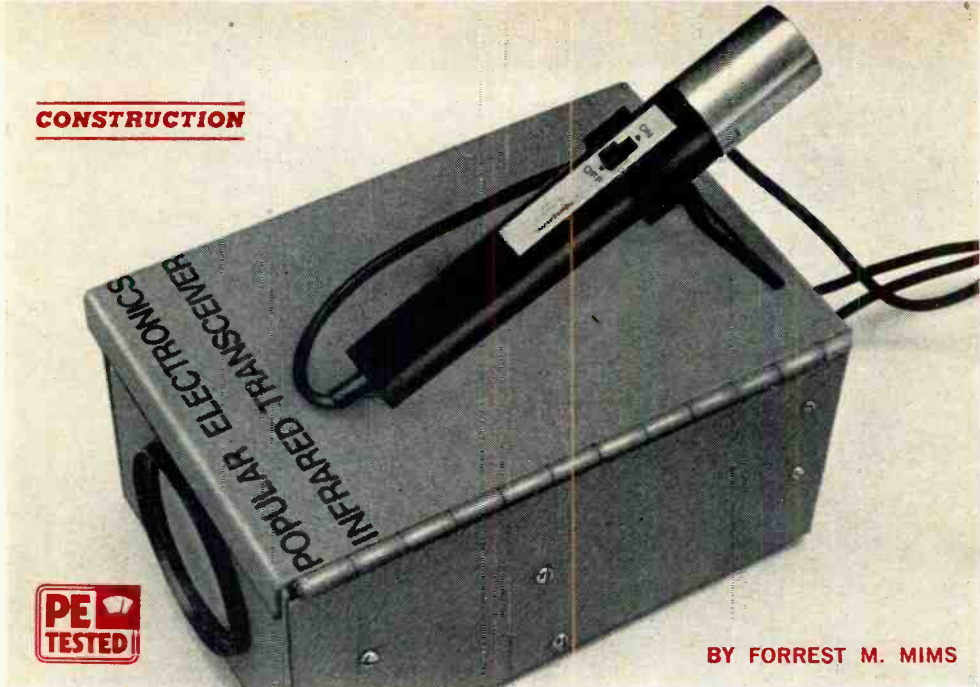

BY FORREST M. MIMS

# COMMUNICATE OVER LIGHT BEAMS with the FIRST SINGLE-LED Transceiver

REDUCES COST AND SIMPLIFIES CONSTRUCTION

**T**HE EVOLUTION of the new light-beam communicators has opened a whole new vista in modern optoelectronics. So far, all previous light-beam communicators have required separate light sources and detectors for proper operation. Now, for the first time, it is possible to build an optical communicator that uses a single semiconductor diode as both source *and* detector of near infrared radiation.

The semiconductor source/detector is an ordinary light-emitting diode (LED), a semiconductor device designed for the efficient generation of visible or infrared light. What has not been bruited about is that LED's, just as most semiconductor diodes, can be made to detect as well as generate light; so, LED's can be used as detector elements, too.

Using a single LED as both source and detector accrues certain important advantages. As can be seen in the accompanying photos, the POPULAR ELECTRONICS Infrared Transceiver employs only one lens, a feature not found on any other present light-beam communicator. Besides reducing the cost and simplifying the construction pro-

cedure of the project, a single lens greatly simplifies optical alignment between two infrared transceivers. Of even more significance is the fact that the entire front of the transceiver can be taken up by the lens. This results in narrower beam-widths and much higher light-collection efficiency than is obtained with conventional dual-lens systems installed in an identical space.

**Construction.** Assembling the infrared transceiver is a straightforward job. A 6" × 4" × 3" hinged steel chassis box is ideal for the project, but other similar size boxes will suffice. As shown in Fig. 2, begin fabrication by drilling the holes to accommodate the panel switches and jacks. The amplifier, modulator, speaker, and battery holder holes come next. (Note: Don't forget to drill holes to permit the sound from the speaker to escape.)

The hole for the lens is best cut with a 2" chassis punch. But if such a large punch is not available, you can drill a 2" circle of small holes, knock out the center, and use a file to smooth the edges of the opening.

When you mount the switches and jacks as shown in Fig. 3, make them only finger tight. It may be necessary to remove some of these parts during soldering to facilitate easy connection of hookup wire. When you install *R1*, be sure its lugs are easily accessible since connections will be made to all three.

Mount the modular amplifier with four 4-40 × ½" machine screws and nuts, sandwiching between the board and chassis box small rubber grommets at all four locations to serve as spacers. A Radio Shack No. 277-1240 four-transistor modular amplifier was used in the prototype, but any general-purpose audio amplifier can be used so long as impedance matching between the microphone and speaker is provided.

Use two sets of 4-40 × ¼" machine hardware to mount the dual AA-cell holder (see Fig. 2). The 9-volt battery that supplies power for the amplifier can be mounted between two 8-32 × 1" screws, being held in place by a metal or plastic retainer and two 8-32 nuts.

The LED modulator is so simple that a perforated phenolic board can be used as the assembly medium, using Fig. 4 as a guide to parts layout. Note how potentiometer *R5* is mounted with its adjustment screw facing upward for easy access. Mount the LED to one side of the board, at the midpoint of the cabinet's vertical dimension. Then use a pair of L brackets and some 4-40 machine hardware to attach the modulator assembly. Be sure the mounting holes orient the LED at the horizontal midpoint of the cabinet. (Before the mounting holes are drilled, measure the focal length of the lens so that the LED can be placed approximately at the focal point.)

The lens used in the prototype is made of red plastic to filter out unwanted light when the devices are in the RECEIVE mode. Its 2" diameter and 4" focal length give an f-number of 2, which is very inefficient in the TRANSMIT mode since only about 20 percent of the infrared radiation from the LED is collected by it. Somewhat more radiation can be collected by a lens with a

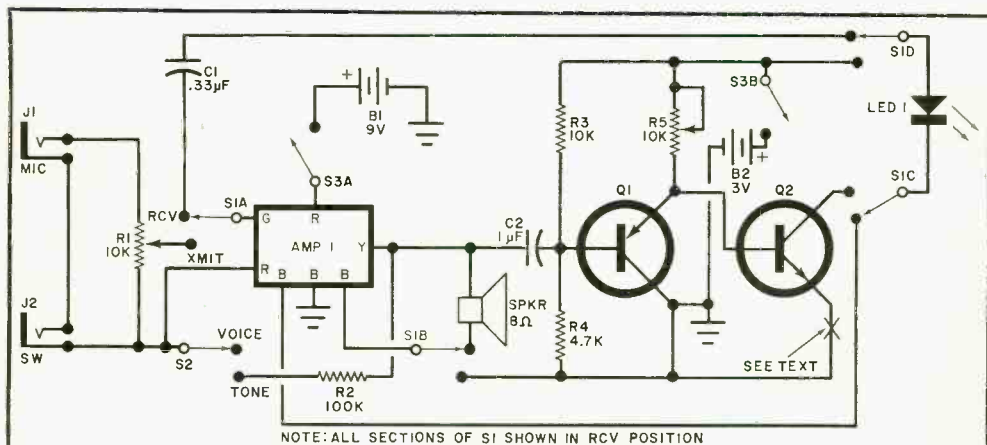

#### PARTS LIST

*AMP1*—Audio amplifier module (see text)  
*B1*—9-volt battery  
*B2*—Two 1.5-volt AA cells  
*C1*—0.33- $\mu$ F, 10-volt capacitor  
*C2*—1- $\mu$ F, 10-volt unpolarized capacitor  
*J1*—½" miniature phone jack  
*J2*—¾" subminiature phone jack  
*LED1*—Light-emitting diode (see text)  
*Q1*—2N2907 transistor  
*Q2*—TIP33 power transistor  
*R1, R5*—10,000-ohm miniature trimmer potentiometer

*R2*—100,000-ohm, ¼-watt resistor  
*R3*—10,000-ohm, ¼-watt resistor  
*R4*—4700-ohm, ¼-watt resistor  
*S1*—4pdt rotary switch  
*S2*—Spdt switch  
*S3*—Dpdt switch  
*Misc.*—Chassis box (see text); lens (see text); battery holders; speaker (miniature 8-ohm); low-impedance microphone with built-in switch; perforated phenolic board; grommets; hookup wire; solder; etc.

Fig. 1. A single LED is used for both transmitting and receiving. A two-transistor current modulator and a commercial audio amplifier complete the circuit.



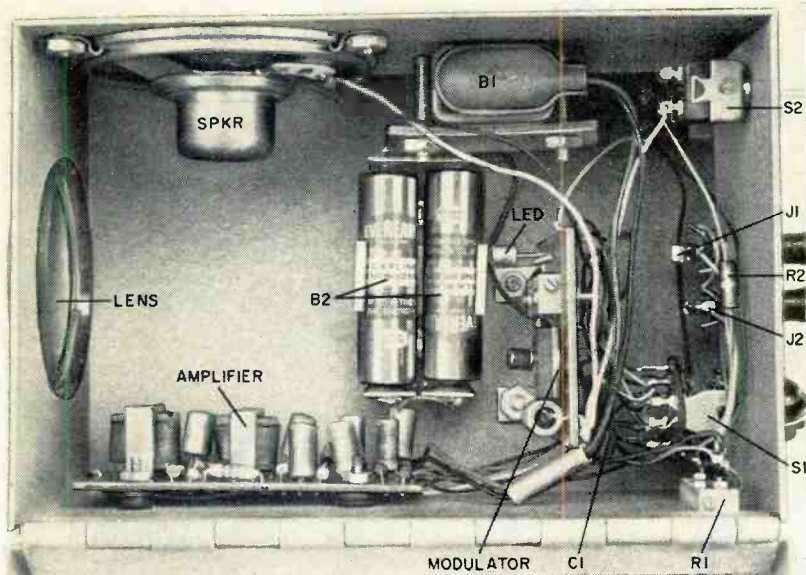

Fig. 2. Make sure that none of the components get in the way of the light path between the LED and the lens. The photo is of prototype.

focal length similar to its diameter. (A great variety of lenses is available from Edmund Scientific Co., 300 Edscorp Bldg., Barrington, NJ 08007. You might write for a catalog to find out what they have.) Do not mount the lens at this time.

Mount the speaker with three sets of 4-40  $\times$   $\frac{1}{2}$ " screws and nuts. You will have to make three small tabs from 1/16"-thick aluminum stock.

Complete internal assembly by soldering all connections, referring to Fig. 1 as you proceed. Use particular care when soldering to S1 since an error will cause the transceiver to malfunction. Note that R2 is soldered directly between S2 and C2, and CI is soldered directly to S1. It may be necessary to extend some of the leads from the amplifier module.

Assembly of the project is completed with the mounting of the lens and labelling of the controls. You can use GE Silastic<sup>®</sup> silicone cement to mount the lens. Ideally, the lens should be cemented to the inside of the chassis box for best external appearance. Use dry-transfer letters to label the controls.

**LED Selection.** Any LED will operate as both a source and a detector in the finished transceiver, even visible red, yellow, and green units. For best results, however, use a silicon compensated near-infrared LED

made from gallium arsenide (GaAs). These LED's are by far the most efficient available. Note that all LED's emitting 930 to 940 nanometers (9300-9400 Angstroms) are silicon compensated. For the prototype, a General Electric SSL-55C was used. This is one of the most efficient LED's commercially available.

Current compensation may be required for the LED. As designed and shown in Fig. 1, the circuit will operate with LED's capable of handling 100 mA continuously without a heat sink. Most metal-glass-packaged LED's are rated at this current level. If a low-current LED is used, a current-limiting resistor must be installed at point X in Fig. 1. Determine the value needed for the resistor by temporarily installing a 100- or 500-ohm potentiometer at X and a 0-100-mA meter movement in series with the pot. Set R5 at about mid-point to allow for circuit adjustment and adjust the potentiometer until the milliammeter indicates the maximum allowable LED current. Without disturbing its setting, disconnect the potentiometer and measure its resistance. Solder an equivalent fixed resistor into the circuit at point X.

**Transceiver Operation.** Unless you have a conventional amplitude-modulated LED communicator such as the Opticom (November 1970), it will be necessary to build

### HOW IT WORKS

In spite of its novel detection scheme, operation of the infrared transceiver (Fig. 1) is straightforward. In the XMIT mode, a commercial solid-state amplifier (AMP1) is connected to a two-transistor (Q1 and Q2) current modulator via XMIT/RCV switch S1. Audio signals from the amplifier are fed into the modulator via C2, and Q1 and Q2 provide linear modulation over a range greater than 75 percent.

LED's are current-sensitive devices. The peak current through LED1 is normally determined by the setting of R5. Since a variety of LED's can be used in the circuit, additional current control may be necessary to prevent exceeding device specifications.

To simplify the alignment of two transceivers, the transmitter circuitry is provided with R2, which causes feedback oscillation when connected from the output to the input of the amplifier via TONE/VOICE switch S2. With S2 set to TONE, the transmitter generates a tone whose frequency can be changed from a low to a high pitch by disconnecting the microphone at J1 from the circuit with its self-contained switch plugged into J2.

In the rcv mode, the same LED used to transmit the optical signal is switched to the input of the modular amplifier via S1. Capacitor C1 blocks undesirable dc signals from LED1 from getting to AMP1. In the rcv mode, the modulator circuit is disconnected from the power source to conserve battery power.

Incoming optical radiation striking the sensitive surface of LED1 generates a photocurrent that is proportional to the amplitude of the signal modulations. The photocurrent is amplified by AMP1 and passed to a miniature 8-ohm speaker.

two transceivers to test the circuit. Plug in a low-impedance microphone and set S1 to XMIT and S2 to TONE. An audio tone should be heard from a second transceiver pointed toward the first when S1 is set to RCV. If no tone is heard, check all battery connections and the batteries themselves to assure that they are fresh. Then check the wiring, paying particular attention to the connections made to S1. When the transceivers are operating properly, reverse both S1's and check RCV/XMIT operation.

When two-way operation has been verified, check voice operation by repeating the above procedure with S2 in the VOICE position. If the receiver seems to be overmodulated, try slightly misaligning the two units to reduce the amount of IR radiation falling on the LED in the detector mode. If volume is too low, try adjusting R1 in the transceiver set to the XMIT mode. Reverse S1 in both units and repeat the test.

The initial tests should be followed by a check of LED current to avoid possible overheating of the LED in the xmit mode. This is easily done by temporarily inserting a 0-150-mA meter in series with the LED at point X. Alternatively, connect the meter in series with one of the batteries by removing one cell and using clip leads to connect cell and meter to the holder; be careful to avoid a short circuit.

The current reading should not exceed the peak allowable current through the LED if a heatsink is not used. If the current is too high, adjust R5 to reduce it; if well below the peak allowable value, again adjust R5 to bring it up. A quick test for excess current can be made by touching the LED. If it is hot, immediately turn off the power and adjust R5 to reduce the current. It may be necessary to insert a permanent limiting resistor at point X as described above.

**Range Testing.** Place one transceiver on a steady support and point it along a path unimpeded by obstacles for several hundred feet. Set S1 of this transceiver to XMIT and S2 to TONE. Set S1 in a second transceiver to RCV. Now, walk about 15' away from the first transceiver, pointing the second one toward the first until a tone is heard. Due to the very narrow field of view of the receiver and the tight beam of the transmitter, alignment will be difficult at first. This highly directional nature of reception illustrates the significance of optical communications—totally private, jamproof transmissions.

Complete the testing by walking away from the transceiver with the receiver while listening to the tone. Daylight range will be shorter than night range due to the in-

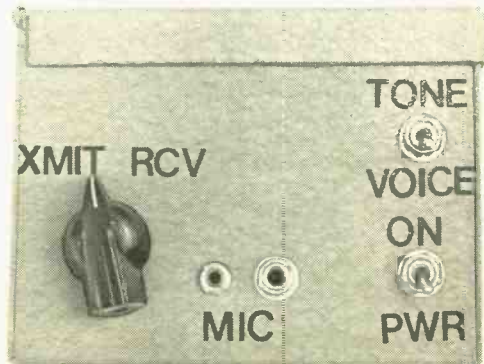

Fig. 3. Suggested front-panel arrangement.

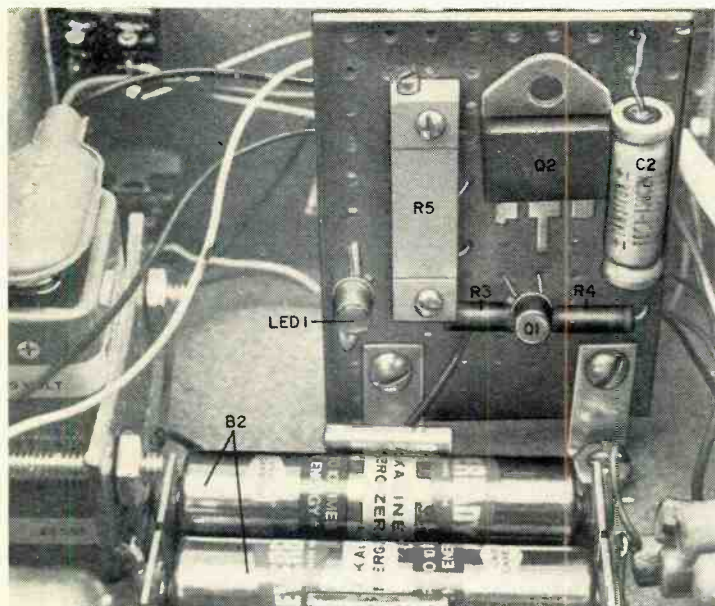

Fig. 4. Current modulator is built on perf board. LED must align with lens and adjustment R5 must be available after mounting board.

crease in detector noise caused by ambient light.

**Modifications.** Although the Infrared transceiver can be used as is, it lends itself to several interesting modifications. First, for permanent field installations, mount each unit on a tripod. This will greatly ease optical alignment and make possible continuous transmissions with few realignment problems.

For more range, increase the size of the lens. The light-collecting area of a lens is proportional to the square of its diameter; so a small increase in diameter yields a significant increase in receiving area. A lens 3" in diameter has more than twice the collecting area of a 2" lens. A diverging beam of light follows the inverse square law. Therefore, doubling the lens collection area will, in theory, double the range. But due to variations in atmospheric absorption and ambient light, doubling lens area will not necessarily double the range.

The most interesting modification of all is to connect two transceivers together with a single fiber-optic link. A transceiver can be converted for both atmospheric and fiber-optic operation by mounting the LED to the modulator board with a miniature

phone plug and jack. For fiber-optic operation only, the LED's become an integral part of a single fiber optic assembly.

A hole bored through a vacant corner of the front of the transceiver will facilitate installation of the optical fiber link. Use a rubber grommet to line the hole to protect the fiber from damage. For best results, choose a length of large-diameter (40-mil) fiber. Remove the caps from the LED's and place a layer of optically clear epoxy over the chip and cement the fiber as close as possible to the chips with the epoxy. Secure the assembly in a fixed position until the epoxy has fully set. Exercise care during the epoxying operation to avoid damaging the delicate LED chip and electrodes. Solder the leads of each LED to a miniature phone plug and pack the connections with more epoxy to make a rigid, durable assembly.

The fiber-optic mode of operation is a precursor of what telephone systems of the future are likely to resemble. For this reason, the Infrared Transceiver is an entertaining, educational, and highly functional project. ♦

*(Editor's Note: The author is pursuing patent protection for concepts described in this article. However, readers may build the project for personal use.)*



# 1974 ELECTRONIC EXPERIMENTER'S HANDBOOK

## SPRING EDITION

**Helps you get it together...  
with a score of  
build-it-yourself projects.**

You can count on Electronic Experimenter's Handbook. It's by the editors of Popular Electronics Including Electronics World. With features and articles and complete lab-tested instructions that guarantee successful hours and months of mind-absorbing projects for fun and practicality.

*Be sure you don't miss the all-new 1974 Spring Edition scheduled to go on sale nationally Mar. 19, 1974.*

**YOU CAN RESERVE YOUR COPY  
NOW AT  
THE SPECIAL MONEY-SAVING  
PRE-PUBLICATION PRICE OF  
ONLY \$1.00, POSTPAID.**

This offer is being made to readers of POPULAR ELECTRONICS Magazine only. Regular price is \$1.25; mail order price \$1.60. You can reserve your copy now at this special pre-publication price of only \$1 by completing the Reservation Form and returning it promptly along with your remittance. The 1974 Spring ELECTRONIC EXPERIMENTER'S HANDBOOK will be mailed to you on or before publication date from first-off-the-press copies.

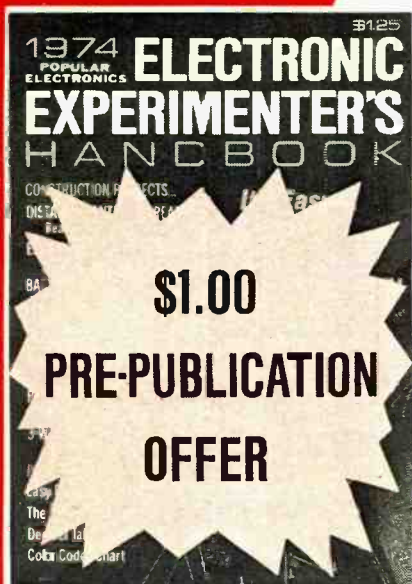

### PRE-PUBLICATION RESERVATION FORM

ZIFF-DAVIS SERVICE DIVISION • DEPT. EEH  
595 BROADWAY • NEW YORK, N.Y. 10012

Enclosed is \$\_\_\_\_\_. Please reserve \_\_\_\_\_ copies of the 1974 Spring ELECTRONIC EXPERIMENTER'S HANDBOOK at the special pre-publication price of only \$1.00 per copy, postpaid, to be mailed to me from first-off-the-press copies on or before March 19, 1974.

Print Name \_\_\_\_\_

Address \_\_\_\_\_

City \_\_\_\_\_

State \_\_\_\_\_ Zip \_\_\_\_\_

**PLEASE ENCLOSE PAYMENT WITH ORDER.**

PE-374

# CIE graduate builds two-way radio service business into \$1,000,000 electronics company!

**How about YOU? Growth of two-way transmitters creates demand for new servicemen, field and system troubleshooters. Licensed experts can make big money. Be your own boss, build your own company. And you don't need a college education.**

Two-way radio is booming. There are already nearly seven million two-way transmitters for police cars, fire department vehicles, taxis, trucks, boats, planes, etc., and Citizens Band uses. And the number keeps growing by the thousands every month. Who is going to service them? You can — if you've got the know-how!

## Why You'll Earn Top Pay

One reason is that the United States Government doesn't permit anyone to service two-way radio systems unless he's *licensed* by the FCC (Federal Communications Commission).

Another reason is that when two-way radio men are needed, they're *really* needed! A two-way radio *user* must keep those transmitters operating at all times. And, they *must* have their frequency modulation and plate power input checked at regular intervals by licensed personnel to meet FCC requirements.

As a licensed man, working by the hour, you would usually charge at least \$5.00 per hour, \$7.50 on evenings and Sundays, plus travel expenses.

Or you could set up a regular monthly retainer fee with each customer. Your fixed charge might be \$20 a month for the base station and \$7.50 for each mobile station. Studies show that one man can easily maintain at least 135 stations — averaging 15 base stations with 120 mobiles! This would add up to at least \$12,000 a year.



Edward J. Dulaney, Scottsbluff, Nebraska, (above and at right) earned his CIE Diploma in 1961, got his FCC License and moved from TV repairman to lab technician to radio station Chief Engineer. He then founded his own two-way radio business. Now, Mr. Dulaney is also President of D & A Manufacturing, Inc., a \$1,000,000 company building and distributing two-way radio equipment of his own design. Several of his 25 employees are taking CIE courses. He says: "While studying with CIE, I learned the electronics theories that made my present business possible."

## Be Your Own Boss

There are other advantages, too. You can become your own boss — work entirely by yourself or gradually build your own fully staffed service company. Of course, we can't promise that you will be as successful as Ed Dulaney, or guarantee that you'll establish a successful two-way radio business of your own, but the opportunities for success are available to qualified, licensed men in this expanding field.

## How To Get Started

How do you break in? This is probably the best way:

1. Without quitting your present job, learn enough about electronics fundamentals to pass the Government FCC exam and get your Commercial FCC License.
2. Then get a job in a two-way radio service shop and "learn the ropes" of the business.
3. As soon as you've earned a reputation as an expert, there are several ways you can go. You can move out and start signing up and servicing your own customers. You might become a franchised service representative of a big manufacturer and then start getting into two-way radio sales.

Cleveland Institute of Electronics has been successfully teaching Electronics for over 37 years. Right at home, in your spare time, you learn Electronics step by step.



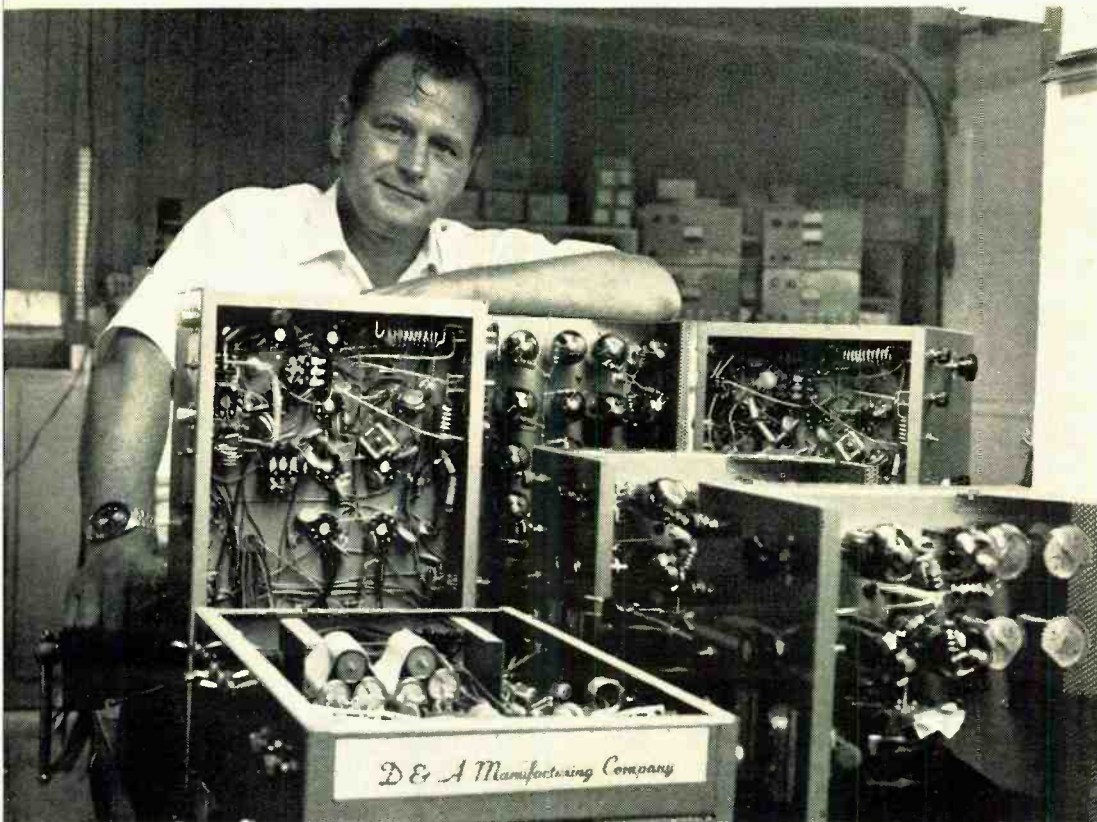

CIE's AUTO-PROGRAMMED® Lessons remove the roadblocks by using simple, concise examples. You learn in small, compact steps — each one building on the other!

You'll learn not only the fundamentals that apply to all electronics design and servicing, but also the specific procedures for installing, troubleshooting, and maintaining two-way mobile equipment.

#### You Get Your FCC License ... or Your Money Back!

By the time you've finished your CIE course, you'll be able to pass the FCC License exam. A recent survey of 787 CIE graduates reveals that better than 9 out of 10 CIE grads passed the FCC License exam. That's why we can offer our famous Money-Back Warranty: when you complete any CIE licensing course, you'll be able to pass your FCC exam or be entitled to a full refund of all tuition paid. This warranty is valid during the completion time allowed for your course. You get your FCC License — or your money back!

#### It's Up To You

Mail the reply card for two FREE books, "Succeed in Electronics" and "How To Get A Commercial FCC License." For your convenience, we will try to have a representative call. If card has been removed, mail coupon or write: Cleveland Institute of Electronics, Inc., 1776 E. 17th St., Cleveland, Ohio 44114.

#### APPROVED UNDER G. I. BILL

All CIE career courses are approved for educational benefits under the G.I. Bill. If you are a Veteran or in service now, check box for G.I. Bill information.

## CIE Cleveland Institute of Electronics, Inc.

1776 East 17th Street, Cleveland, Ohio 44114  
Accredited Member National Home Study Council

Please send me your two FREE books:

1. Your book on "How To Get A Commercial FCC License."
2. Your school catalog, "Succeed in Electronics."

I am especially interested in:

- |   |  |
|---|--|
| <input type="checkbox"/> Electronics Technology                 | <input type="checkbox"/> Electronic Communications |
| <input type="checkbox"/> Broadcast Engineering                  | <input type="checkbox"/> Industrial Electronics    |
| <input type="checkbox"/> First Class FCC License                | <input type="checkbox"/> Electronics Engineering   |
| <input type="checkbox"/> Electronics Technology with Laboratory |  |

Name \_\_\_\_\_ (Please Print)

Address \_\_\_\_\_

City \_\_\_\_\_

State \_\_\_\_\_ Zip \_\_\_\_\_ Age \_\_\_\_\_

Veterans & Servicemen: Check here for G. I. Bill information

PE-56

**CIRCLE NO. 9 ON READER SERVICE CARD**



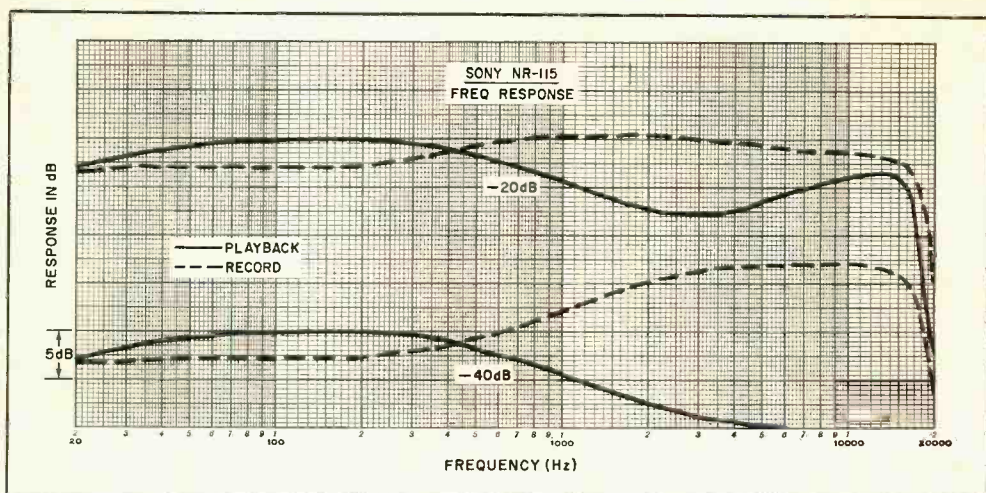

TAPE IN going to the TAPE MON jacks of an amplifier.

Although in this mode of operation the unit cannot be used with a tape recorder, it offers a relatively inexpensive way to hear Dolby-encoded FM broadcasts with the proper frequency balance and reduced noise

level. To calibrate the PB gains, it is desirable to use the standard level Dolby test tones transmitted by the FM stations. However, in the absence of these tones, adjusting the adaptor's PB CAL controls so that maximum program levels indicate 0 dB or slightly less will provide satisfactory results.

Circle No. 66 on Reader Service Card

## LEADER MODEL LBO-302 DUAL-CHANNEL OSCILLOSCOPE



**O**SCILLOSCOPES are the "eyes" of the electronics field. Without scopes, those of us engaged in hobby and professional electronics would be lost in some areas and severely handicapped in many others. It therefore behooves us to obtain as good a "vision" as possible for our money and needs.

During the past two years, we have used quite a few excellent scopes. Most have been priced higher than we would have liked, but the great majority had a host of features that made the extra expense

palatable. For example, bandwidths now run from dc to 10 MHz or more, rise times are currently measured in nanoseconds, broad ranges of triggered sweeps are becoming common, and sensitivities have been greatly improved. Add to this the fact that solid-state electronics has been responsible for reducing size, weight, and power requirements of the instrument. In the past, a scope with several or all of these features might have been considered a luxury to anyone who did not absolutely need them; but with high-speed circuitry invading the consumer equipment scene, such a scope is no longer a luxury—rather, it is a necessity.

The latest Leader Instruments Corp. 3-in. dual-channel oscilloscope, the Model LBO-302, is one of the new breed of high-performance instruments that represents state-of-the-art for service lab and experiment requirements. The \$700 scope has some impressive specifications: dc to 10 MHz vertical bandwidth, 44-ns rise time, 1 megohm shunted by 40 pF input impedance (becoming 10 megohms and 15 pF when a 10:1 probe is used), and 10 mV to 5 V/division sensitivity in nine calibrated steps.

The display can be selected to be channel 1 alone, channel 2 alone, channels 1 and 2 alternately, and channel 1 + channel 2 (added algebraically). There is also a vector-scope mode for color TV servicing. The horizontal amplifier has a range of 2 Hz to 200 kHz and has a 200-mV sensitivity/division with an input impedance of 1 megohm shunted by 40 pF.

The triggered-sweep time base ranges from 1  $\mu$ s/div. to 0.2 s/div. in 17 steps. Special steps for TV vertical (33 ms/div.) and horizontal (127  $\mu$ s/div.) are available to those who need them. The sweep also features a  $\times 5$  magnifier facility and full selection of the types of triggering required. Provision is also made for intensity, or Z-axis, modulation.

Should the user lose track of which trace is which during two-channel operation, a pushbutton switch on the front panel of the scope can be pressed to invert channel 2 to provide instantaneous identification.

**Mechanical Considerations.** The LBO-302 is physically small. It measures a mere 12 in. deep by 8 in. wide by 4 $\frac{3}{4}$  in. high. Its weight is only 10 lb. To reduce front-panel area, the three input connectors (two BNC connectors for channels 1 and 2 and a common-ground binding post) are located at the top-right of the scope, just behind the front panel's bezel. This unusual arrangement is not as awkward as it first appears to be, and

it keeps the test leads out of the way of the controls.

The scope is equipped with a tilt carrying handle which can be used as a bench stand if desired. Because the instrument is so small, we removed the handle, a simple process that requires the removal of only two finger-tight lugs, and slipped the scope into a small space on the shelf just above our workbench where it was in easy view. By this simple expedient, we were able to move to our work area a critical piece of test equipment without using up a single square inch of bench-top surface. Our other scope, a surplus giant on a wheeled dolly, always had to be rolled up to the side of the workbench in an awkward position.

Some comparisons were inevitably made between our surplus laboratory-type scope and the LBO-302. The latter performed quite well in similar tests conducted with both scopes. However, the LBO-302 proved to be the handier instrument owing to its two-channel capability. We cannot over-emphasize the advantages of two channels in a single instrument—it is the only way to see cause-and-effect on waveforms. And being able to see simultaneously the input signal and what the intervening stage or stages does to it certainly simplifies the troubleshooting procedure.

The LBO-302 oscilloscope comes with two direct low-capacitance probes, two terminal adapters, and a set of test leads.

Circle No. 67 on Reader Service Card

## TRAM DIAMOND-60 AM/SSB TRANSCEIVER

**J**OINING the ranks of the AM/SSB transceivers already on the market is the Tram Diamond-60. This \$350 solid-state mobile rig provides the top-notch performance of a base station and has a few features not usually found in a mobile unit. These include fail-safe circuitry for the transmitter, a microphone gain control, different clarifier ranges for AM and SSB, an SWR indicator, and a theft discouragement system.

Other customary features include a 15-watt PEP input on either sideband and 5 watts on AM; all-channel operation via a crystal frequency synthesizer; alc on SSB and compression on AM; and operation from a 13.8-volt dc positive- or negative-ground source with polarity protection. Add to these a transmitter-on lamp, receiver r-f gain control, adjustable squelch, switchable noise



blanker, three-way meter (S units, transmitter output, and SWR), external speaker jacks for receiver or PA operation, and electronic voltage regulation for the critical circuits.

Single conversion to a 7.8-MHz i-f is used for SSB, while dual conversion to 7.8 MHz and 455 kHz is used on AM. A crystal filter

is used in the SSB i-f strip, two ceramic filters in the AM i-f strip. Separate detectors are used for each mode.

SSB transmissions are generated with a conventional balanced modulator and the receiver's filter. AM is produced by a carrier modulated at the power amplifier and driver by the receiver's audio output stage.

**Special Features.** The output transistor of a CB transceiver can be permanently damaged when operated into an improper load. To avoid this, the Diamond-60 utilizes a fail-safe feature. If an excessive SWR is present (resulting from a bad load mismatch or shorted or open transmission line), there will be a high SWR and a reflected potential from the SWR-sensing unit. This is detected and used to deactivate a low-power r-f stage, causing the transmitter drive to be cut off. In turn, the meter does not indicate an output and the transmitter-on lamp extinguishes to give visual indications of the abnormal condition. Drive and power output cannot be restored until the SWR is brought back within safe operating limits.

During transmit in both modes, the clarifier range is nominally  $\pm 800$  Hz (midpoint was within 100 Hz on any channel), but during AM reception, a variation of about 2250 Hz can be obtained. Why this much larger-than-usual shift is provided is not quite clear, inasmuch as we have yet to find a CB transmitter frequency this far out of tolerance or out of the receiver's AM pass-band.

**The Synthesizer.** The synthesizer system is different from the norm. Ten crystals (six near 16 MHz and four near 6 MHz) are used in pairs to provide a nominal 22-MHz output. This signal is mixed with a nominal 12.8-MHz crystal signal to yield a heterodyning signal in the 34.8-MHz range. With a 27-MHz CB signal, this then yields the required 7.8-MHz i-f.

Sidebands are changed by switching between two crystals at the bfo to place the signal at the required edge of the sideband filter for LSB or USB operation. This requires that the heterodyning signal also be shifted by the same difference for the receiver to remain exactly on the same frequency in either case. This is handled by simultaneously shifting the 12.8-MHz oscillator by "tweaking" the crystal with a variable-capacitance diode through which the

frequency can also be varied by the clarifier control.

**How It Performed.** The receiver, with its FET r-f amplifier, had a sensitivity of 0.1  $\mu\text{V}$  on SSB and 0.3  $\mu\text{V}$  on AM for 10 dB  $(S + N)/N$ , at which levels at least 1 watt of a-f output was obtained. A dual agc system held the a-f output to within 7 dB with a signal change of 80 dB (1-10,000  $\mu\text{V}$ ). The agc threshold, however, was somewhat below 1  $\mu\text{V}$  with the result that in the absence of a signal, the residual background noise was relatively higher than usual—unless the squelch was brought into play. On the other hand, good quieting occurred in the presence of a signal.

The squelch threshold was adjustable from 0.3 to 450  $\mu\text{V}$  on AM and 0.2 to 1000  $\mu\text{V}$  on SSB. The meter registered S9 with a 35- $\mu\text{V}$  input signal.

On AM, adjacent-channel rejection was 60 dB minimum. On SSB, it was greater than 80 dB, with a 64-dB unwanted-sideband suppression at 1000 Hz. Image and other spurious-signal rejection was at least 70 dB. The receiver was also found to be less subject to overload problems than usual, making the use of the r-f gain control seldom necessary.

The noise blanker was highly effective with impulse-noise peaks greater than 10  $\mu\text{V}$ . The a-f output during receive or with PA operation was 5 watts with 11 percent distortion at start of clipping (1000 Hz into 8 ohms).

Operating from a 13.8-volt dc source, the transmitter output on SSB was almost 9 watts PEP during voice modulation, with good control by the alc system at the threshold of which the third- and fifth-order distortion products were 22 and 37 dB, respectively, below maximum output. Carrier suppression was a minimum of 50 dB. On AM, carrier output was 4 watts, with a good modulated waveform to a maximum degree just short of 100-percent modulation. The compression setup functioned much better than usually, preventing overmodulation, clipping, or carrier breakup on negative peaks—even with a 20-dB input signal rise above that needed for full modulation. With this degree of compression, the distortion at 1000 Hz was only 7 percent, and splatter at the adjacent channel was at least 70 dB down, indicating an exceptionally clean signal.



## CALECTRO MINI MOUNTS

**T**HERE are many ways to breadboard a circuit, the choice being left to the builder. But when you have finalized your circuit design and are satisfied that it works properly, you have another decision to make—how to go about assembling the finished project. If the first thing that comes to mind is a printed circuit board or perforated phenolic board, you are a good candidate for Calectro's Mini Mount PC assembly devices.

The Mini Mounts combine printed-circuit type construction with perf-board simplicity. In the first place, they are etched conductor patterns on insulated bases. The assemblies have pressure-sensitive adhesive backings: so, all you do is place them on a chassis, arranging them in the most convenient configurations. You do not have to etch or drill the Mini Mounts. Just mount and solder the components to the conductor pads and interconnect the assemblies.

Mini Mounts provide the convenience of perf-board assembly in that they can be arranged in any convenient pattern. You simply interconnect the assemblies with bridging components or hookup wire as required.

There are currently six Mini Mounts in Calectro's inventory. These include the No. J4-782 eight-lead TO-5 configuration, No. J4-783 ten-lead TO-5 configuration, No. J4-784 14/16-pin DIP configuration; No. J4-785 column/row component mounting configuration, No. J4-786 narrow solid bus bar, and No. J4-787 narrow segmented component mounting strip. Each configuration is packaged in pairs, and each package of two retails for \$1.19. Availability is through Calectro distributors.

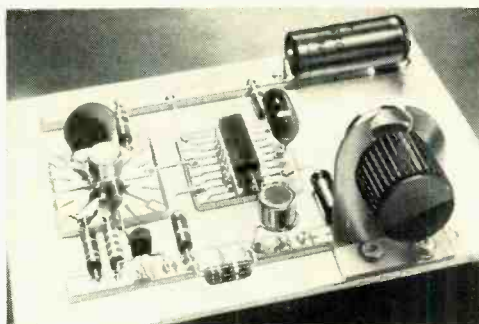

Use of the novel Mini Mounts is simple. Before peeling away their protective backings to place them on the "chassis" (wood, glass, plastic, or composition plastic), it is necessary to rough out the component placement diagram. If you have already breadboarded the circuit, you will have a good idea of how to lay out the Mini Mounts.

Next, lay out the Mini Mounts on the chassis, spacing them to accommodate the dimensions of the bridging components. To mount the components, you simply tack their leads to the solder pads.

The major advantage of the Mini Mount method of assembly is that the entire circuit, including conductor pattern, is always in view on the same side of the board. This minimizes the chances of wiring errors even more than is usual with PC boards where components are mounted "blind" (unless, of course, the board is silk screened).

After building one project of medium complexity and several add-on devices for existing equipment in our lab, we can emphatically state that we have found a third alternative for board-type construction.

Circle No. 69 on Reader Service Card

# SBE

# SCANNERS

HF/FM • VHF/FM • UHF/FM •

SBE "Sentinel", high performance, full-feature scanning receiver. VHF, UHF and Hi-Lo models.

- 8 xtal controlled channels • Automatic or manual scanning • Lockout of any channel • *Priority Channel!* Provides instant shift to pre-selected channel when priority signal appears —by-passes other channels • 12VDC and 115VAC operation for car or home use • Big audio — ¾ watts • Telescoping antenna, mounting bracket, 2 power cords • Compact

Write for full line scanner brochure



**LINEAR SYSTEMS, INC.** 220 Airport Blvd., Watsonville, CA 95076

CIRCLE NO. 20 ON READER SERVICE CARD



# Solid-State

By Lou Garner

It was a medical application—the hearing aid—that led to the introduction of the original low-cost experimenter's transistor, the famous, though obsolete, CK722.

In the early 1950's, the Raytheon Manufacturing Company, a prominent supplier of sub-miniature vacuum tubes, started producing high-quality, low-noise pnp junction transistors for hearing aids. A certain percentage of the transistors manufactured, while meeting basic performance standards, were not suitable for critical hearing aid designs. Rather than scrap these useful devices, Raytheon sorted them into high- and low-gain types and offered them to the hobbyist market as the CK722 and its higher gain "cousin," the CK721. The first CK722's were priced at an amazingly low (for the time) \$7.60 each! The CK722 soon became the standard device for experimenter and hobbyist projects and, for a while, Raytheon sold more transistors than any other manufacturer.

During the past two decades, electronic design engineers have continued to work hand-in-glove with medical professionals in developing ever more exotic applications for solid-state devices. Today, for example, the hearing aid, once the size of a package of cigarettes, has shrunk until some designs are no larger than the earpieces used in the first models. IC's, rather than transistors, are used in most units.

## Semi-conductors in Medicine

Solid-state devices are used extensively in heart pacemakers—electronic instruments which supply tiny electrical pulses to maintain the heart's rhythm. Some of these are so small that they can be implanted surgically within the patient's body.

More recently, a medical team in Boston, headed by Dr. K. W. Chang, has been working to develop an implantable instrument to help diabetics. Intended to serve as a substitute for a patient's malfunctioning beta cells in the pancreas, the proposed instrument may one day comprise a miniature glucose sensor, an integral power source, a small IC computer, an insulin reservoir, and a pump to deliver the insulin. The insulin reservoir would be refilled periodically by hypodermic injection. In operation, the device, when perfected, would sense body glucose levels, compute the amount of insulin needed to restore normal balance, and automatically release the insulin into the blood stream.

Many research teams are working on electronic aids for the blind, including reading devices suitable for standard printed matter as well as portable instruments to enable totally blind persons to sense, identify and avoid obstacles as they walk. Although an easily used and inexpensive, but completely reliable, instrument has not been developed for general use as yet, work is continuing with such techniques as echo ranging, light sensing using injection diode lasers and phototransistors, and even modified radar systems.

One of the newest solid-state instruments for the blind is a unit developed from NASA technology as a by-product of space research. Enabling a blind person to identify paper money by its "sound signature," the instrument gives that old cliché "money talks" a literal meaning. In operation, a bill is passed under a light source (Fig. 1) while a phototransistor measures changes in

the bill's light patterns. These changes are converted into audible signals by an oscillator, producing sounds much like the beeping tones heard when making a long-distance telephone call. Since the design of various denominations of paper money differs, each bill develops its own distinctive tone pattern. Using the instrument, the average blind person can learn to distinguish the sound patterns of different bill denominations with as little as three hours of practice.

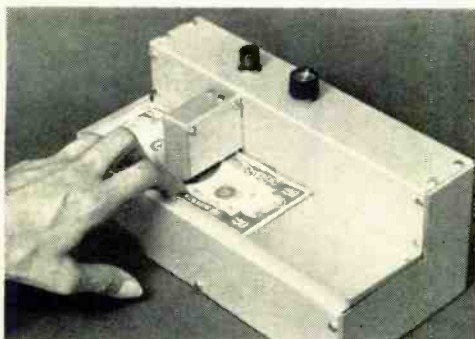

Fig. 1. The Marchak "money talker" interprets bill denominations into sound signals.

The "money talker" is being produced by the Marchak Engineering and Manufacturing Co., 6609 North Lamar Blvd., Austin, TX 78757, and marketed by Applied Rehabilitation Systems, 3902 Idlewild, Austin, TX 78731. The unit is currently priced at \$149.50.

The progress in medical/electronic technology to date, although often bordering on the miraculous, is but a token of what the future may bring as new and even more exotic solid-state devices are developed in the world's research laboratories.

**An Electronic Stopwatch.** Suitable for use in a variety of exciting hobbyist projects, including digital timers, electronic stopwatches, and 24-hour clocks, the ICM7045, Fig. 2, is a complementary MOS LSI precision timer. Manufactured by Intersil, Inc. (10900 North Tantau Ave., Cupertino, CA 95014), the device comprises a crystal-controlled oscillator, a high-frequency binary divider, an intermediate-frequency counter, latch circuits, a multiplexer, a decoder, a control circuit, and segment and digit output buffers. It is designed to operate on a nominal source of 3.6 volts (three rechargeable NiCd cells in series) and will

### 3-15 VOLT 0.1% REGULATORS ON A CIRCUIT BOARD



Board contains 3 15 volt regulators. 2 rated at 3 amps & 1 @ 6 amps, all @ 0.1%. At 5 & 10 amps, reg. is 0.5%. Comes with common +, easily isolated or changed to common -. Ideal for circuits requiring + & - 15 volts. Board contains 5 2N5878 150 watt silicon NPN transistors. 4 used in regulators & 1 spare.

2 regulators have electronic crowbar over voltage control, and all are short circuit protected. Precision resistors and capacitors used thruout. Best regulators we've seen, all for less than the price of the power transistors. With data sheet and circuit diagram. 6" x 6" STOCK NO. F5169 \$11.95 ea. 2/21.00.

### TRANSFORMERS

(Ideal for above regulators)

14 V. 3 A.	3 lbs	F9793	2.75	2/5.00
34 V ct 5A.	5 lbs	F9448	4.75	2/9.00
32 Vct 2 A.	3 lbs	F9743	4.00	3/11.00

### COMPUTER GRADE CAPACITORS

MFD.	VOLTS	STOCK	PRICE
8500	55	F2221	1.50 6/8.00
4000	50	F2189	1.50 6/8.00
3750	75	F2116	1.75 6/9.00

MINIMUM ORDER \$5.00. Include sufficient postage; excess refunded. Send for latest 56 page catalog with exciting values.



**DELTA ELECTRONICS CO.**

BOX 1, LYNN, MASSACHUSETTS 01903

CIRCLE NO. 10 ON READER SERVICE CARD

**EVERYTHING YOU WANTED TO KNOW ABOUT CD IGNITION SYSTEMS BUT DIDN'T KNOW WHOM TO ASK.**

Send for *FREE Tiger booklet* (20 pages) which answers all your questions.

Name \_\_\_\_\_

Address \_\_\_\_\_

City \_\_\_\_\_

State \_\_\_\_\_ Zip \_\_\_\_\_

CLIP OUT THIS AD AND SEND TO—

**TRI-STAR CORP.**

P. O. Box 1727 Dept. E  
Grand Junction, Colo. 81501

CIRCLE NO. 30 ON READER SERVICE CARD



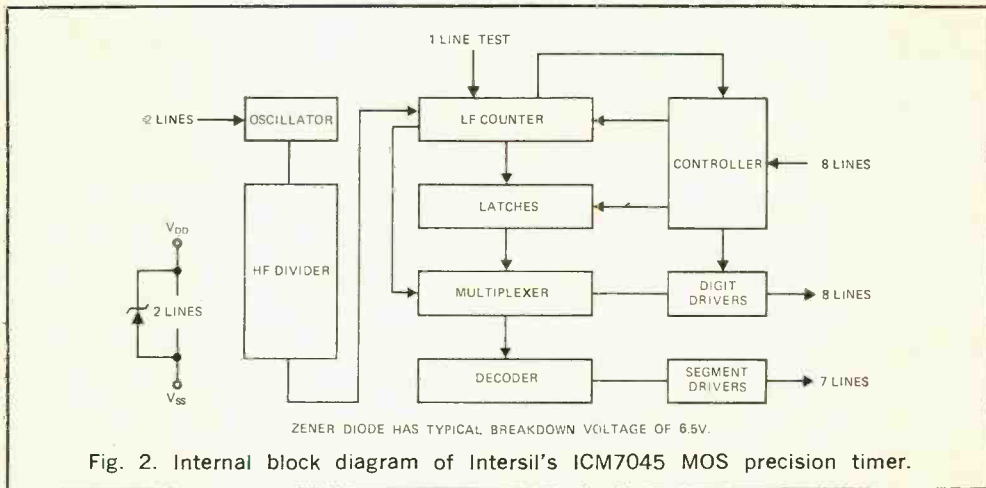

interface directly with a fully multiplexed seven-segment/eight-digit, common-cathode LED display. Supplied in a 28-pin DIP, the ICM7045 sells for \$63.80 each in unit quantities.

In operation, the oscillator signal is divided in sixteen binary stages to 100 Hz. Some of the divider outputs are used to generate multiplex waveforms at a 12.5% duty cycle/800-Hz rate. The 100-Hz signal is processed through the counters into the latch circuits which, in turn, are multiplexed into the decoder. The counter section spans the range from 1/100 second to 24 hours, which can be simultaneously displayed on an eight-digit readout. The digit drivers (cathodes) are connected to the multiplex lines through zero suppression logic, while the segment drivers (anodes) are connected directly to the decoder outputs.

A versatile four-mode electronic stopwatch circuit featuring the ICM7045 is illustrated in Fig. 3. Abstracted from the 8-page technical bulletin for the device published by Intersil, the design requires a minimum of components in addition to the IC itself—a quartz crystal, a trimmer capacitor, a suitable LED readout, a 3.6-volt battery power pack, and four switches. The quartz crystal used should have a nominal frequency of 6.5536 MHz when tuned by a total parallel capacitance of 12 pF or less, and an  $R_s$  of about 40 ohms. The instrument may be assembled on either an etched circuit board or breadboard, as preferred, but good layout and wiring practice should be observed during construction. In addition, for optimum results, prospective

builders should obtain and study a copy of the Intersil bulletin before starting circuit assembly.

With the 8-digit display specified, the instrument's readout is expressed in intervals of 1/100 second, 1/10 second, seconds, 10 seconds, minutes, 10 minutes, hours, and 10 hours, from a minimum of 1/100 of a second to a maximum of 24 hours.

**Readers' Circuits??** Have you designed an interesting circuit, modified a published circuit to improve performance, redesigned an older circuit to adapt it for special applications? If you've done any of these things, perhaps you'd like to share your efforts with your fellow readers. We'd like to hear the details for, from time to time, we'll be featuring selected readers' circuits in these pages.

All types of solid-state circuits will be considered for publication, from simple two or three transistor designs to complex projects employing several IC's. The basic requirements are simple:

- (a) the circuit should be useful;
- (b) it should be an original design or modification;
- (c) it should be a *tested* circuit—one actually assembled and checked, not a theoretical design.

To submit your circuits for review and possible publication, send the complete schematic diagram, specify all component values and device type numbers, and include a letter describing the circuit and its application, and outlining any special construction hints as well as alignment or ad-

justment procedures. Include your name and full mailing address. If you have a photograph of an assembled model, fine, but a photo is not required. If you've adapted or modified a previously published circuit, *be sure to mention the original source*. No payments will be made, except for your satisfaction in being able to demonstrate your own ability to your fellow hobbyists.

Mail your circuits to:

Lou Garner  
 SOLID-STATE  
 POPULAR ELECTRONICS  
 One Park Avenue  
 New York, NY 10016

**Booklets, Brochures and Bulletins.**

**QUADZILLA** a booklet published by the National Semiconductor Corporation (2900 Semiconductor Drive, Santa Clara, CA 95051), may well become a collector's item because of its unique cover—a color cartoon of a four-eyed, multi-legged monster

crushing its way down a city street against the opposition of planes and tanks in a scene reminiscent of the low-budget Japanese science-fiction films. First issued late last year in conjunction with an engineer's circuit-design contest, the booklet is a 40-page collection of useful linear circuit applications featuring National Semiconductor's devices.

National Semiconductor, of course, is not the only major firm which has published useful data in recent months. Here are a few other publications you may wish to add to your technical library.

From the General Electric Company, Semiconductor Products Dept., Electronics Park, Bldg. #7, Mail Drop 49, Syracuse, NY 13201: *Interchangeability & Cross Reference Guide*, a 44-page booklet listing over 6,000 semiconductor types, including 1N, 2N, 3N and popular industry house types, together with cross reference to either an exact GE type or a suggested replacement.

Also from GE: *Semiconductor Data*

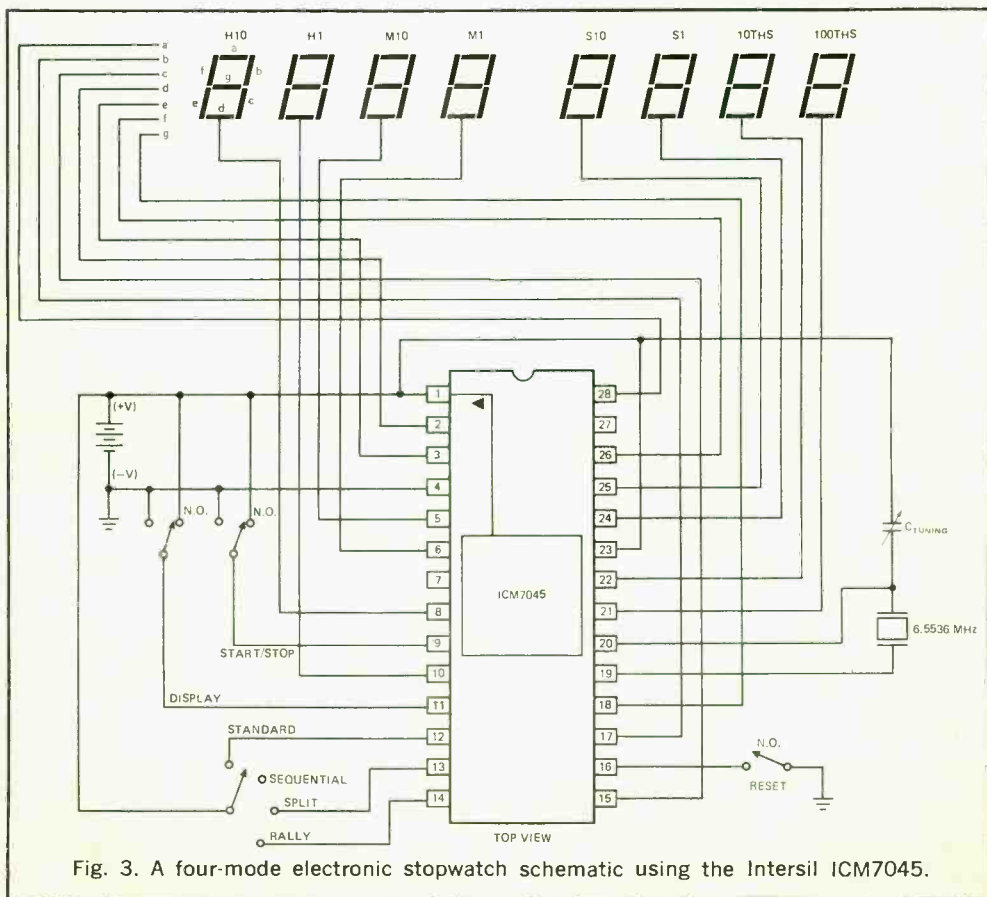

Fig. 3. A four-mode electronic stopwatch schematic using the Intersil ICM7045.

*Handbook* (2nd Edition), 1484 pages of useful data, including an index and interchangeability guide, product selector guides, and detailed product specification sheets covering all GE semiconductor devices. This thick volume is priced at \$4.95 per copy (plus applicable sales tax).

From RCA's Solid State Division, Box 3200, Somerville, NJ 08876: *Applications of the CA3085 Series Monolithic IC Voltage Regulators*, Application Note ICAN-6157, a 12-page brochure which describes the basic circuits of the CA3085 series devices and discusses typical applications, including high-current regulators, constant-current regulators, a switching regulator, high-voltage regulators, a dual-voltage tracking regulator, methods of providing current limiting, and the use of the CA3085 as a general-purpose amplifier.

RCA's *Power Switching Using Solid-State Relay*. Application Note AN-6141 is a 6-page folder describing the triac as a power switching element. The fabrication of a triac and its advantages and disadvantages over the electro-mechanical relay are discussed in general terms. Basic parameters and the various modes of triac gating are examined in detail. The publication also includes a selection of practical circuit designs for on/off control, zero-voltage switching and line-voltage isolation.

Finally from RCA, *Microwave Power Transistors*. Publication No. MPT-700A, a 16-page booklet should be of real interest to advanced experimenters and hams. Covering the use of power transistors at microwave frequencies, the publication discusses transistor construction, basic design techniques, design examples, and performance data for practical transistor power amplifier and oscillator circuits at GHz frequencies.

**Device/Product News.** Working with digital logic circuits? Then you may find applications for the MC10127L, a new dual IC device recently introduced by Motorola Semiconductor Products, Inc. (P.O. Box 20924, Phoenix, AZ 85036) for interfacing ECL to MOS logic. Each translator section has a differential input and an output capable of driving NMOS, CMOS, and PMOS logic. Designed for operation on 10-to-20-volt dc power sources, the MC10127L, is supplied in a 16-pin ceramic DIP.

Also announced by Motorola, a new series of modular voltage-tripler rectifier assemblies. Identified as types MDA3551/2

and MDA3661/2, the new devices, Fig. 4, provide approximately 50% lower leakage compared to earlier designs and can supply average forward output currents of 3 mA at 25 kV with excellent voltage regulation under changing load current conditions. The new devices are intended for use in TV and CRT display applications.

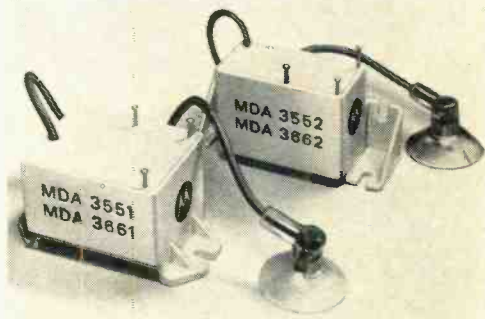

Fig. 4. Motorola high-voltage rectifier units.

The Fairchild Camera and Instrument Corporation (Semiconductor Components, 464 Ellis Street, Mountain View, CA 94042) has introduced a line of six Darlingtons power transistors. Three of the new units are packaged in TO-3 metal cans and three electrically equivalent devices are offered in TO-220 plastic power packages. The metal can units, designated types SE9300, SE9301 and SE9302 can dissipate up to 100 watts, while the equivalent plastic package types SE9303, SE9304 and SE9305 are rated at 70 watts. All six devices are npn types capable of handling currents of up to 10 amperes and have high gain characteristics. (Typical beta is 1,000 at 4 A.)

Several new LED's are now available from Litronix, Inc. (19000 Homestead Road, Cupertino, CA 95014), including a pair of constant-brightness devices and a series of orange lamps. The new constant-brightness units combine a current-regulating IC and a red LED in a single package. Identified as types RLC-200 and RLC-210, the new devices can be used over a voltage range of 4.5 to 12.5 volts, thus eliminating the need for different drive resistors in equipment with varying voltages in its circuit design. Unit prices are 90 cents for the RLC-200 and \$1.00 for the RLC-210. The new orange LED's, types OL-30 and OL-31, are GaAsP devices priced the same as their equivalent red types, RL-4403 and RL-209, respectively. ♦



# ELECTRONICS PHYSICS QUIZ

BY ROBERT P. BALIN

The scientific principles behind today's electronic devices were discovered when experimenters first observed certain strange occurrences. In time, these effects were developed into practical components having many applications. For example, the Doppler effect, an apparent shift in the frequency of the sound from a moving source, is utilized in modern radar systems.

To test your knowledge of physics, see if you can match the following electronic effects (which are illustrated below) to the names (A to J) also given below.

1. When a nickel rod is magnetized, it becomes shorter in length.
2. When a bar of metal is heated at one end, a voltage is produced between the hot and cold ends.
3. When a dc current is sent through a semiconductor pn junction, the junction becomes hotter or cooler depending on the direction of the current.
4. When the junction of two dissimilar

metal strips is heated, a voltage is produced between the free ends

5. When the input signal to a vacuum tube is increased, the tube's input capacitance is also increased, thereby reducing the frequency response of the stage.

6. When a Rochelle salt crystal is twisted, a voltage is produced between its faces.

7. When two dissimilar metals are placed in close contact with each other, a voltage is produced between the free ends.

8. When the plate in a vacuum tube is made positive with respect to the filament, electrons flow through the vacuum from the filament to the plate.

9. When a current flows through a crystal of InAs held in a magnetic field, a voltage is produced between the edges of the crystal which lie parallel to direction of current.

10. When the reverse voltage applied to a crystal diode reaches a critical value, the current increases very rapidly, indicating a sharp drop in reverse resistance.

- A. Edison effect
- B. Hall effect
- C. Joule effect or magnetostriction
- D. Miller effect
- E. Peltier effect

- F. Piezoelectric effect
- G. Seebeck effect
- H. Thomson effect
- I. Volta effect or contact potential
- J. Zener effect

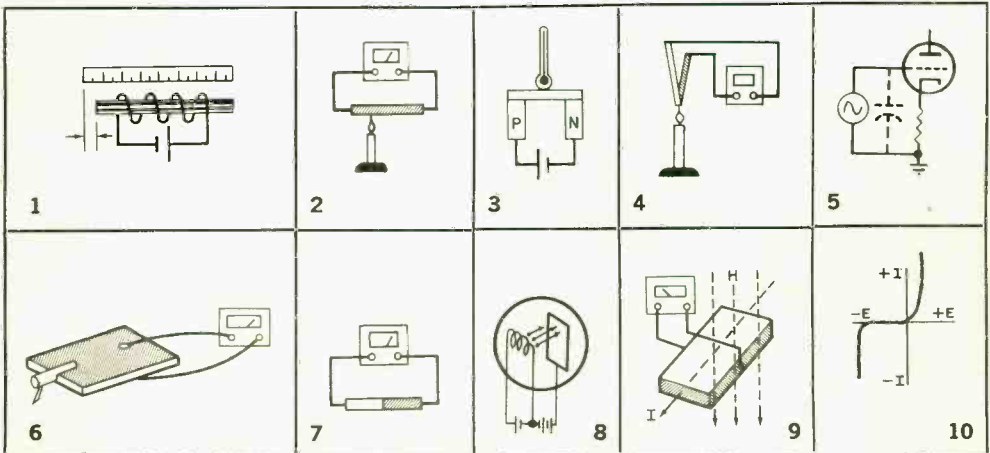

10—J  
9—B

8—A  
7—I

6—F  
5—D

4—G  
3—E

2—H  
1—C

ANSWERS

# The all-new digital-design

It offers you these important advances in technology, quality, and performance:

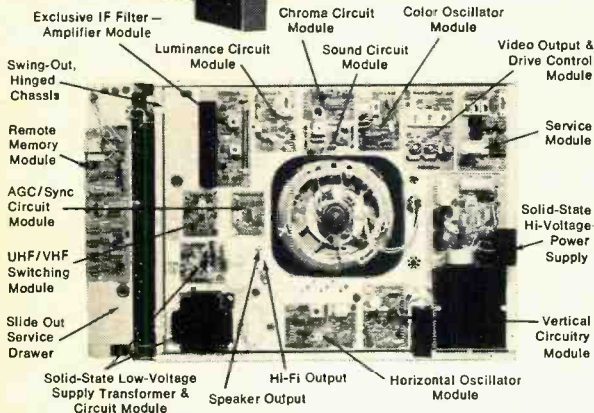
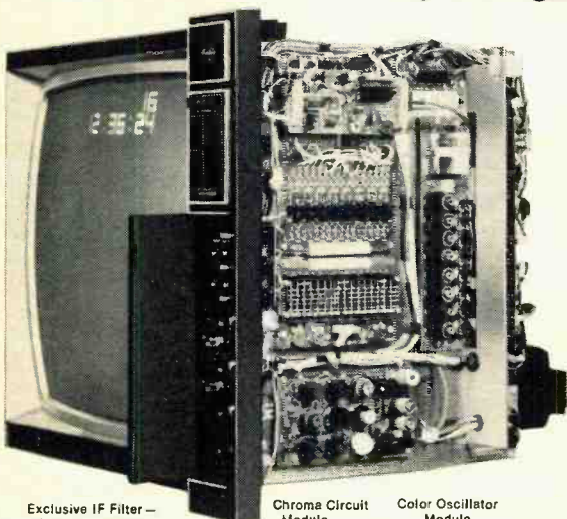

Programmable Channel Selection through digital up-down counter with computer-like programming board.

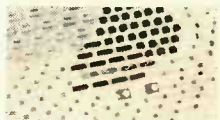

100% Solid-State Design — the picture is the only tube-type device.



Silent All Electronic Tuning with new combination UHF/VHF Varactor Tuner located inside the chassis — completely shielded.



Touch Tuning at front panel (or remote) — touch to change channels up or down — hold in to sweep all channels.



On-Screen Channel Readout — big, bright 1½" numerals for both UHF and VHF.



On-Screen Clock Readout gives time in 4 or 6-digit format, 12 or 24 hour time.



Fixed Filter IF totally eliminates instrument IF alignment forever.



19 Integrated Circuits simplify kit building and permit ultra-sophisticated technology with long-term reliability.



Solid-State Hi-Voltage Supply in triple configuration for efficiency and long life.

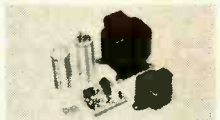

Solid-State Low-Voltage Supply has short-circuit proof integrated circuit regulators.



New Deluxe Black (Negative) Matrix Picture Tube — fully illuminated color dots with black background matrix for greater brightness and contrast — new, etched, face plate reduces glare.



New Vertical Sweep Design gives better picture interlace, improved picture detail; complementary power transformers eliminate output transformers for better linearity.



True Digital Design Dot Generator makes picture convergence easier and more precise.



Twelve Wiring Harnesses — pre-fabricated, connectors installed, pre-stripped, ready to solder — this TV is easier to build.

## Eleven-Function Touch-Tune Remote Control for the Heathkit GR-2000... 79.95\*

This all solid-state ultrasonic system utilizes 13 integrated circuits, 28 transistors to give you wireless armchair control of on and off, volume, VHF/UHF channel selection, up or down color intensity, and tint. Plus, a touch of the volume button automatically recalls the digital readout to the screen. Kit includes receiver for in-chassis mounting and hand-held transmitter. Operates from 20-feet away from set.

Kit GRA-2000-6, 4 lbs. .... 79.95\*

## Optional Digital Clock for your GR-2000

In just a couple hours' time you can build the GRA-2000-1 Digital Clock Accessory. Everything mounts on one small board that plugs into the readout board in the GR-2000 service drawer. That's all there is to it. Clock circuit board has slow, fast and hold pushbuttons for setting time, jumper wire for selecting 12 or 24-hour format. You set your on-screen display for hours and minutes, or hours, minutes and seconds using the programming circuitry on the channel readout board. Order with your GR-2000, or add it on later, if you prefer.

Kit GRA-2000-1, Digital Clock Accessory, 1 lb. .... 29.95\*



# Heathkit GR-2000 Color TV

Three years ago, in response to your requests, we set out to design a truly unique color TV. We have. It uses digital design techniques unusual to TV technology. The result is spectacular.

The 100% solid-state GR-2000 25V color TV — it silently selects channels with digital-logic accuracy — it displays the channel digits on the screen — it displays the time digits on the screen — it uses a fixed filter IF that never needs alignment — it uses more integrated circuitry than any other set. Yet the kit-building process is now easier than ever.

**Silent, All-Electronic Touch-Tuning** — no knobs to turn, no noisy turrets, no humming motors and no mechanical contacts to clean. Now you just touch a button on the front panel or optional remote control transmitter and the new programmable Digital Counter silently sweeps up or down through any 16 preselected stations. Release the button and the new UHF/VHF Varactor Tuner is precisely locked-in on the channel of your choice.

You program up to 16 channels into the Touch-Tune System located in the convenient slide-out service drawer. You can program any channels in any sequence, interspersing UHF with VHF, even programming the same channel to appear more than once if you like.

After you have programmed a channel-selection sequence, Automatic Fine Tuning keeps picture and color consistent from station to station. The UHF/VHF Varactor Tuner is positioned inside the chassis, away from the control panel. This helps keep the picture free of spurious signals that find their way into front-mounted tuners.

**The channel number is seen on the screen** — The Heath-designed On-Screen Electronic Digital Channel Readout has bright white numerals that are easy to see — from across the room, from any viewing angle. Each time you change channels, using the Touch-Tune button either on the set or on the remote control, illuminated digits (adjustable brightness) identify the UHF and VHF stations as you cycle through the channels. After stopping at a desired program, the readout remains on for as long as you want, up to 1½ minutes, or stays on all the time...the choice is yours. You pre-program the Digital Channel Readout to your requirements with a computer-like programming board located in the service drawer. When the readout is timed to shut off after a few moments, it can always be recalled by changing channels or by tapping the volume "down" button. What's more, you can position the readout anywhere you want it on the 25V screen and adjust its brightness for optimum contrast with the overall picture. The digital readout generator uses a custom designed MOS large scale integrated circuit containing the equivalent of over 2000 transistors, plus diodes, and resistors.

The new Heath Electronic Digital Channel Readout completely eliminates the confusion often found with mechanical tuning devices — especially when trying to find an elusive UHF station. And it makes across-the-room remote control tuning easier than ever.

**We even changed the way you adjust the sound** — With the GR-2000 a touch of either of two buttons automatically raises or lowers the sound in a series of small steps. Just hold the button down until the sound level is right where you want it. This also controls the volume of the Hi-Fi Sound Output (to your separate amplifier) so you can control it with your remote transmitter.

**Build-in an optional Electronic Clock with Digital On-screen Readout** — true digital circuitry gives you the time in four-digit, six-digit, 12-hour or 24-hour format. A programming board in the slide-out service drawer lets you set your clock to display time the way you want to see it. The on-screen display appears directly below the channel numeral in same-size 1½" digits. And when you add the clock option, it becomes an integral part of the channel display, responding to the same controls. It can be positioned anywhere on the screen with the channel digits, remains on for the same pre-set length of time, or remains on constantly. For setting the time, Hold, Fast and Slow pushbuttons are located in the service drawer. And once set, the electronic clock continues to run even when the set is off, unless the set's Master Switch has been turned off. In normal operation, whenever the set is turned on and the on-screen display is activated, the time is right to the second.

**A Heath-designed IF Filter sets this TV apart from all others** — You wanted truly superior color reception, particularly in urban areas where multiple transmitters are located or where multi-channel cable service is available. So we designed a fixed LC-type filter with an IC IF amplifier...a "first" in the television industry, and you can

have it now with the Heathkit GR-2000. This unique circuitry produces an ideally shaped bandpass that greatly reduces adjacent-channel interference. And, this totally new approach to IF design gives the GR-2000 another equally important plus — a consistently excellent color picture, year after year with no need for periodic instrumental alignment. The GR-2000 IF system eliminates the highly critical traps that go out of adjustment because of normal component value changes through aging. In short, the Heathkit GR-2000 will maintain its best picture longer than any set with ordinary IF design.

**Add Total Touch-Tune Remote Control** — it's an all solid-state ultrasonic system that lets you select UHF/VHF channels, control volume, color tint and intensity, on and off. And you do so from as far as 20 feet from the set. The channel selector and volume buttons on the remote also may be used to return the channel and clock readouts to the picture screen whenever you wish.

**The easiest-to-build color TV we've ever offered** — We said 100% solid-state. And for the GR-2000 that means 19 integrated circuits (33 including the remote and clock), 71 transistors, all of which mount in sockets; 20 glass-epoxy circuit boards; and 12 cables. Imposing? Perhaps, but actual assembly operations for this kit have been greatly simplified. The GR-2000 has fewer point-to-point connections, more ICs, more modular circuit boards, more prefabricated wiring harnesses and cables, and fewer chassis-mounted parts to make it easier to build.

Here's what all those solid-state components do for you to produce truly exceptional color entertainment. To start off, there is DC controlled contrast for less picture interference. An IC color amplifier for truer colors. An IC color oscillator and automatic phase control for more precise and reliable tints. An IC automatic gain control for improved sensitivity, stability and noise immunity. Improved picture interlace for remarkable image definition and crispness. A new solid-state high voltage rectifier. Short-circuit-proof IC regulators eliminate component damage through accidental shorts. Dual VHF antenna inputs, 300 ohm balun for your twin-lead antenna, true 75-ohm for proper cable TV and coax hook-up. Exclusive Heath Magna-Shield Chassis to keep stray magnetic fields from interfering with picture quality.

**New, latest-design picture tube** — a deluxe Black (Negative) Matrix 25V picture tube now with fully illuminated dots with black "surround" and new, etched, face plate...it all adds up to brighter, more vivid pictures with reduced glare and reflections and greater contrast.

**New exclusive Heath self-service features** — no other manufacturer offers them to you at any price. Built-in service facilities such as a new digital-design true dot generator, purity and convergence adjustments; test meter; new vertical and horizontal centering circuits; new Top-Bottom-Sides punch cushioning corrections; new "Service" circuit board puts everything in an easy-to-find place.

We set out to design the most advanced and unique color TV available today...we believe the performance of the set will speak for itself. The new digital-design Heathkit GR-2000...it will change your mind about color TV.

**Kit GR-2000, 147 lbs. . . . . 649.95\***

Four new cabinet designs from \$139.95\*, see catalog.

**Send for FREE Heathkit catalog.**

## HEATHKIT ELECTRONIC CENTERS

Units of  
Schlumberger Products Corporation  
ARIZ.: Phoenix, CALIF.: Anaheim, El Cerrito, Los Angeles, Pomona, Redwood City, San Diego (La Mesa), Woodland Hills; COLO.: Denver; CONN.: Hartford (Avon); FLA.: Miami (Hialeah), Tampa; GA.: Atlanta; ILL.: Chicago, Downers Grove; IND.: Indianapolis; KANSAS: Kansas City (Mission); KY.: Louisville; LA.: New Orleans (Kenner); MD.: Baltimore; ROCKVILLE; MASS.: Boston (Wellesley); MICH.: Detroit; MINN.: Minneapolis (Hopkins); MO.: St. Louis; NEB.: Omaha; N.J.: Fair Lawn; N.Y.: Buffalo (Amherst), New York City, Jencho, L.I., Rochester, White Plains; OHIO: Cincinnati (Woodlawn), Cleveland, Columbus; PA.: Philadelphia, Pittsburgh; R.I.: Providence (Warwick); TEXAS: Dallas, Houston; WASH.: Seattle; WIS.: Milwaukee.

HEATH Schlumberger	
<b>HEATH COMPANY,</b>	
Dept. 10-3	
Benton Harbor, Michigan 49022	
<input type="checkbox"/> Please send FREE Heathkit Catalog	
<input type="checkbox"/> Please send model(s) _____	
Enclosed is \$ _____	
plus shipping.	
Name _____	
Address _____	
City _____	
State _____ Zip _____	
* Mail order prices; F.O.B. factory. CL494R	

**CIRCLE NO. 5 ON READER SERVICE CARD**





# General Electric Color TV Sets

By John T. Frye, W9EGV, KHD4167

MAC grunted a brusque good morning to Barney, his assistant, who had just come into the service shop out of a windy, wet March morning. Shrugging out of his bright yellow slicker and hanging it on the coat rack, where it immediately started a big puddle, Barney glanced over Mac's shoulder. "By the looks of that stuff on the workbench," he remarked, "you must be working on the color line of another TV manufacturer. Whose sets are you going to tell me all about today?"

"General Electric's 1974 Color TV Line," Mac answered, moving over to the bench that was loaded with pictures, press releases, and other printed material. "Starting at the bottom, GE offers five 10" Porta Color sets. Three are hybrid; two are solid-state. Weighing 25 pounds, they feature, among them, such things as automatic degaussing, an earphone jack for private listening, a home-replaceable, built-in, fold-down telescoping antenna—we both know how hard teenage users are on antennas—a detachable swivel base, and GE's 'OneTouch' color system that activates automatic fine tuning, automatic chroma-control, and automatic color and tint range lock at the touch of a single button.

"All use GE's In-Line Porta Color tube. GE, you know, was the first to employ the in-line tube in this country when they came out with the first truly portable color TV set in 1965. During the ensuing years they have produced over a million of these tubes and have made many improvements in the system, including a change from 70- to 90-degree deflection. They now have under way development work which they say will extend this Porta Color system into screen sizes up to 25" and to deflection angles up to 110 degrees, but right now the four simple set-up adjustments on this in-line tube

and the fact that its convergence is little affected by the earth's magnetism or by stray magnetic fields make it ideal for portable use.

"That's why GE also offers three 16" portables using this system. One is a hybrid and two are solid-state. The 16" in-line tube is a black-matrix type for sharper pictures. These sets also feature GE's 'Plus-70' click-



"Going by the book," service technician is using GE's STC manual to make initial checks.

tuning of ulf and have a 'sharpness control' to adjust the crispness of the picture to the user's taste. These portables weigh 44 pounds.

"Of eight 19" models offered, five are hybrid and three are solid-state. One is a small furniture console, and seven are 'table models.' These sets use the conventional triad-dot type of tube. Three feature GE's Spectra-Brite® picture tube, while five employ the Black Matrix Advanced Spectra-Brite IV picture tube. These models weigh around 60 pounds.

"That brings us to the twenty 25" con-

soles that top out the line, all of which have 100% modular solid-state chassis. This MA/MB chassis employs ten plug-in modules as follows: i-f, video low level, RGB, audio, chroma, vertical, power supply, signal conditioner, horiz. buffer, and high voltage regulation. Several of these cool-running modules employ plug-in IC's and are designed to be repaired in the field or in the shop. Four consoles feature the Spectra-Brite tube, while 16 use the Spectra-Brite IV Black Matrix type. All use 28,250 volts—which I believe is one of the highest in the industry—on the picture tube for brighter, crisper pictures.

**Serviceability.** "But now let's get down to the nitty-gritty—as far as we are concerned—of the serviceability of these GE color receivers. I have already mentioned the easily replaceable antennas on the portables and the designed-to-be-repaired modules, but there's much more. For example, the consoles have what is called the GE Service-Quick Back. Move four latches, take out two screws, and the back is off almost while you're reaching for your cheater cord. This may sound like a small item to anyone but a practicing technician who knows how much time he can waste removing, keeping track of, and replacing a dozen or so small wood screws. But the real *piece de resistance* of this service program that GE has cooked up for the technicians is contained in what they call their new 'STC' program."

"As your straight man, I guess I'm supposed to ask what 'STC' stands for." Barney said after a long pause.

"Thought you'd never ask! The 'S' stands for this little blue and black Symptom Repair Manual that is the heart of the program. Every GE technician is supposed to carry this 47-page book with him on the job and use it to identify quickly most causes of GE TV breakdowns. Field testing has shown that STC can minimize repair time on 95% of GE TV service calls. Other than GE technicians can order the manual for a buck from the General Electric Company, TV Product Service, College Blvd., Portsmouth, Virginia 23705.

"If you look through the book, you will find it lists a variety of symptoms for individual GE TV chassis—both monochrome and color—and outlines what to check and in what order. These symptoms and repairs were developed from computerized data supplied from actual service technician

**Eliminates Breaker Points, Eliminates Tune-ups. Never wears out or needs any maintenance. Timing and Dwell never change.**

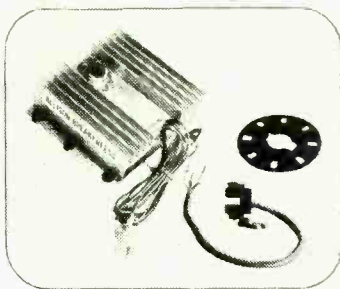

**The ultimate in ignition systems — The Infrared Breakerless Electronic Ignition System by Allison Engineering.**

The Allison Breakerless Ignition system eliminates the points and condenser, replacing them with an optical trigger, using a light emitting diode and phototransistor. Only a system which eliminates breaker points can eliminate tune-up causing wiper arm (contact point rubbing block) wear and give the performance, economy and reliability of true electronic ignition. This is why GM and Chrysler use only breakerless electronic ignition in their new car models.

This is the only true electronic ignition that you can install on your car for under \$100.00. The system gives ignition timing 40 times more accurate than systems using breaker points. Actually increase engine efficiency and gas mileage up to 30%. Will not misfire under any conditions. Installs in 20 minutes using existing distributor and coil, no rewiring. Ten times as much energy available for plug firing. Spark plug last 3 to 10 times longer. Unlimited R.P.M. capability. Tests prove dramatic increase in power and performance. Precision timing means instant starts in any weather and noticeably smoother running. An average 30% reduction in emissions.

Installing the Allison Breakerless Ignition in your car converts the present inefficient trouble prone system to the most advanced electronic ignition system available. Remember if it is not breakerless then it is not true Electronic Ignition.

Units available for all engines. To order: state make, year & engine size. \$49.95 PPD or \$15.00 bal. C.O.D. Calif. res. 5% tax. CONVERT YOUR C-D UNIT TO BREAKERLESS! Trigger unit only, \$34.95 PPD \$15.00 C.O.D. Allison Automotive Co., P.O. Box 973, Temple City, CA. 91780. FREE LITERATURE!

**CIRCLE NO. 1 ON READER SERVICE CARD**

**Now... the most enjoyable, do-it-yourself project of your life—a Schober Electronic Organ!**



You'll never reap greater reward, more fun and proud accomplishment, more benefit for the whole family than by assembling your own Schober Electronic Organ.

You need no knowledge of electronics, woodwork or music. Schober's complete kits and crystal-clear instructions show you — whoever you are, whatever your skill (or lack of it) — how to turn the hundreds of quality parts into one of the world's most beautiful, most musical organs, worth up to twice the cost of the kit.

Five superb models, with kit prices from \$500 to around \$2,000, each an authentic musical instrument actually superior to most you see in stores.

Get the full story FREE by mailing the coupon TODAY for the big Schober color catalog, with all the fascinating details!

The Schober Organ Corp., Dept. PE-54  
43 West 61st Street, New York, N. Y. 10023

- Please send me Schober Organ Catalog.
- Enclosed please find \$1.00 for 12-inch L.P. record of Schober Organ music.

NAME \_\_\_\_\_  
ADDRESS \_\_\_\_\_  
CITY \_\_\_\_\_ STATE \_\_\_\_\_ ZIP \_\_\_\_\_

**CIRCLE NO. 28 ON READER SERVICE CARD**

repair invoices. In other words, the manual presents, in highly usable form, the accumulated experience of hundreds of service technicians. Naturally, GE does not contend that all possible combinations of symptoms are covered, but the majority are.

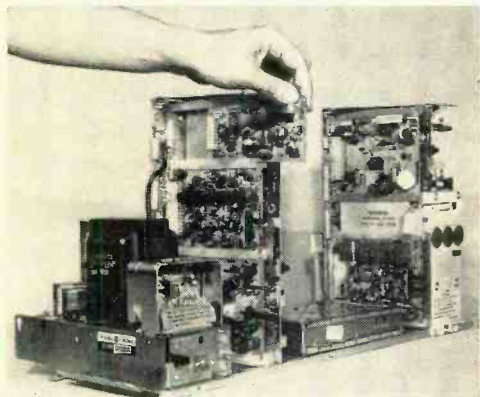

GE's modular solid-state color TV chassis.

"The approach is highly logical. First the symptom is connected with a most likely cause; then there's a description of the probable faulty or maladjusted component; and this is followed by the catalogue number of the module or component to be replaced. Another section is devoted to repairing individual modules, giving the most likely cause of module failure and suggesting repairs. Finally, there's a section on fast moving parts. This contains three kits for the most popular chassis, plus a listing of the most frequently used parts and receiving tubes. The quantity of each item to be stocked is indicated.

"Now we come to the 'T' of STC. This refers to the Troubleshooting Flow Charts that are included in factory technical publications. If a particular problem cannot be identified using the Symptom Repair Manual, the Troubleshooting Flow Charts guide the technician through a logical series of checks to locate the fault. Take a look at the beginning page of this one on the MA Chassis used in the 25" consoles. Note you begin with the symptom of no raster and no sound and move step by step, asking yourself questions that can be answered 'Yes' or 'No' at each check point, while the direction your further inquiry takes is dictated by the answers you get. If your quarry isn't cornered on one page, you simply follow the arrow at the bottom of one page to the top of a following page. Basic symptoms

are taken up one at a time, as are combinations of symptoms."

"That still leaves the letter 'C,'" Barney pointed out.

"C" stands for Circuit Analysis, which is the third, most elaborate, and most time consuming of the diagnostic procedures. That's the one we ordinarily use when we puzzle out the circuit diagram and try to relate the symptoms we see to a possible component failure in that circuit and then devise our own techniques for proving or disproving this possibility. This approach, to be fully effective, requires that the technician have a sound grasp of theory and a lot of practical experience."

"But using the Symptom Repair Manual and the Troubleshooting Flow Charts requires less" Barney interrupted. "An intelligent technician could be taught to use these two aids to locate and repair the trouble in a high percentage of sets in the customers' homes with dispatch, especially if he confined himself to replacing entire modules or easily replaced components on these modules, such as transistors or IC's. Changing the module would put the set back in operation, and then the module could be repaired back in the shop and returned, or an exchange arrangement could be worked out." ♦



"Just tell him W6XQ437 is here to see him. He'll know who it is."



BY D. J. HOLFORD

# WHISTLERS AND OTHER STRANGE R-F NOISES

THEIR ORIGIN IS OBSCURE, BUT YOU CAN HEAR THEM ON YOUR RECEIVER



**I**N 1886 Austrian long-distance telephone operators complained of hearing strange whistling noises on the line. Six years later, British operators reported hearing similar noises—especially when the aurora borealis was active. These were the first recorded reports of “whistlers,” intriguing phenomena which, although still not completely understood, have become a valuable tool in upper atmosphere research.

Whistlers and similar strange noises occur at the very bottom of the radio spectrum (below 30 kHz) in the vlf range. While most

long-range radio signals are propagated by reflection from the ionosphere, strange things can happen at vlf. Some signals get trapped by the earth’s magnetic field and make a long-distance trip far above the ionosphere before returning to the surface. When this happens, the signal is not only delayed because of the distance, but signals of different frequencies travel at different speeds. What starts out as a simple pulse returns stretched out, with high frequencies arriving first and progressively lower ones following. The result is a slowly falling tone (hence, the term whistler).

## TYPES OF WHISTLERS

**One-hop:** Originates in opposite hemisphere and has made only one trip into space.

**Two-hop:** Originates in same hemisphere, probably from a local thunderstorm, and has made a round trip to the opposite hemisphere and back.

**Echo train:** Series of whistlers all caused by the same event. Each is more drawn out than the previous one since it has made an additional round trip. Up to seven have been heard.

**Multiples:** Several whistlers, frequently overlapping. May be due to multiple lightning strokes or a single flash but propagated over slightly different paths.

**Nose Whistler:** Starts at a medium frequency and has both rising and falling characteristics.

**Where Do They Come From?** Lightning discharges radiate vast amounts of electromagnetic energy over the whole spectrum. When some of this energy is trapped in a magnetic duct, or natural waveguide, whistlers may be generated. However, this does not always happen; and that is one of the great mysteries still surrounding whistlers. Why do some lightning strokes trigger whistlers; and others—seemingly similar—produce no such effects?

While whistlers were first detected almost ninety years ago, it was not until the 1950’s that instruments were available to measure and analyze them. By 1953, researchers at Cambridge University (England) had positively identified lightning as the cause of most of these strange noises.

In 1954, an experiment was conducted

## OTHER VLF NOISES

**Hiss:** May vary in amplitude over periods of about one second or may remain stable for several hours. Frequently associated with auroral displays.

**Chorus:** Series of closely spaced fast-rising tones, usually from 1 to 5 kHz. Frequently heard near dawn (Dawn Chorus).

**Discrete:** Any short-term signal. May be rising or falling tones or hooks (falling tones which reverse direction and rise again).

**Periodic:** Any sequence of related or similar signals.

between Stanford University and the USS Atka, which was at sea south of Australia. When monitors at Stanford detected a whistler, the Atka reported lightning in her area. Since the two sites were at opposite ends of the same magnetic line of force—conjugate points—this was the first firm proof that the earth's magnetic field was involved in whistler generation.

Whistlers have since been monitored by several satellites, providing proof that they do indeed penetrate far out into space.

By 1957 and 1958, during the International Geophysical Year, whistlers had become so intriguing that a major international monitoring program was set up. It provided much new information, including the fact that high-power vlf radio transmitters, operated by the U.S. Navy on frequencies between 10 and 30 kHz, could also generate whistlers under certain conditions.

Although many of the IGY monitoring stations no longer exist, several nations still operate an international whistler research program.

**Why Listen to These Noises?** Mainly because they are an ideal tool for learning more about the structure and composition of the upper atmosphere and the far magnetic field. By careful analysis of whistler signals, it is possible to determine what elements and particles were in their path—information that would be very difficult to obtain in any other way. For example, satellites and balloons can give us detailed information on certain levels, but whistlers reveal an overall picture from the surface, out to several thousand miles.

This has led to the establishment of the world's largest plasma laboratory. (Plasma

is the ionized conductive gases which make up the far fringe of the atmosphere.) Stanford University, which has been a leader in whistler research for over twenty-five years, has set up a transmitter at Siple Station, less than a thousand miles from the South Pole. A receiving station at Roberval, Quebec, monitors the signals, which are transmitted from a 13-mile-long antenna. (The two stations are at conjugate points.)

The signals are short pulses transmitted on frequencies between 4.5 and 30 kHz, at powers up to 100 kW. The pulse length is increased until whistlers are generated; then the power is decreased until they stop.

This experiment will reveal much previously unknown information about the composition of the atmosphere and ionosphere and the shape and variations of the magnetic field.

If all of this intrigues you, why not try listening for whistlers yourself? Occasionally, sensitive vlf receivers are available from surplus houses. Also you might try building your own vlf preamplifier to be connected to a sensitive audio amplifier. The antenna could consist of 200 turns of #25 enamelled copper wire on a 4-ft. diameter wooden frame, tuned by a fixed 0.02- $\mu$ F low-voltage disc capacitor. This could be coupled to a 2-stage transistor amplifier using interstage coupling capacitors in the order of 10 to 35  $\mu$ F. Be sure to position the antenna for minimum 60-Hz power line hum.

If you don't hear anything other than clicks, pops, and hiss for a couple of days, don't be disappointed. There are frequently periods of several days with very few whistlers. They also vary on both daily and seasonal bases. Peak activity is between midnight and dawn, and the best time of year is winter. At peak periods, up to 10 whistlers per minute may be heard.

You may also come across some of the other strange inhabitants of the vlf band—hisses, chirps, and a peculiar sound called the dawn chorus. This sounds like a flock of birds chirping and though it is frequently heard around dawn, it can occur at any time.

There is still a great deal of mystery surrounding many of these noises; and if enough serious experimenters were to set up monitoring stations, they might be able to contribute some really valuable information, which can't be gathered by the small number of official stations presently in operation. ♦

# ANTENNA SWITCHING METHODS

SOME SIMPLE METHODS OF SWITCHING AN ANTENNA FROM RECEIVER TO TRANSMITTER

BY W. R. MOODY, WA3NFW

IT IS almost universal practice to use the same antenna for receiving and transmitting, the theory being that if the antenna transmits well, the reception will also be good. In most cases, this is true. Hence, what you usually have is a transmit-to-receive (and vice versa) antenna switching system.

**A Simple Case.** In a very basic system, you might have something like the setup

shown in Fig. 1, where the spdt switch is of the knife type. In practice, to transmit, you would first disable the receiver by cutting off power to the plates of the tubes in the r-f, mixer, and i-f sections (usually with a switch on the front panel), or the equivalent circuits in a solid-state receiver. Then you would throw the switch to position T. Next, the plate power to the final amplifier of the transmitter would be switched on so that keying or modulation could take place.

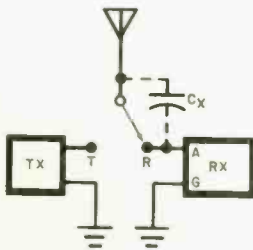

Fig. 1. Simple knife switch may have stray coupling.

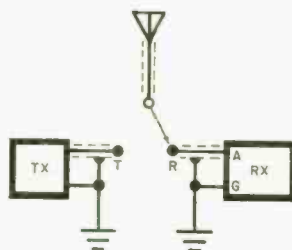

Fig. 2. High-grade rotary switch with coaxial cable.

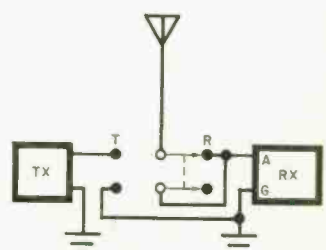

Fig. 3. Dpdt switch shorts receiver input on transmit.



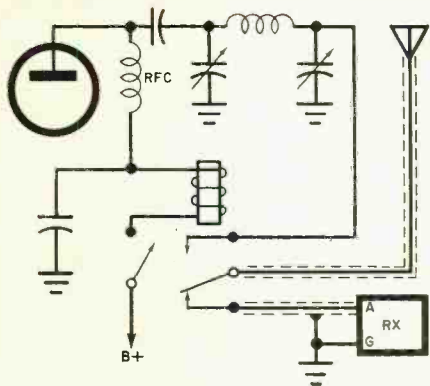

Fig. 4. Using relay for antenna switching.

In low-power setups, the switch is not critical. But above a couple of hundred watts, the power handling capacity becomes a serious consideration. Such a system is also cumbersome and slow. An internal switch in a transceiver is one thing, but an external knife switch is pretty old fashioned; though it does have the quality of being reliable and it permits you to see what is happening.

Another disadvantage of an external switch system is that there may be leakage between the armature of the switch and the input circuit of the receiver ( $C_x$ ) which induces a signal of sufficient strength to cause physical damage in the receiver during transmit. A knife switch in a metal box is no answer, but a more sophisticated, higher grade rotary switch and coaxial connectors (to link up the switch and cables) will fill the bill (Fig. 2). Such a switch can also be built into a transceiver. But even this shielding may not be enough to eliminate stray coupling and a surge in the receiver's input. Even diode limiters in a receiver's input circuit fall short of solving the problem since the diodes might cause signal rectification and spurious responses.

**Taking Further Steps.** If you replace the spdt switch with a dpdt switch as shown in Fig. 3, and keep the leads to the receiver's input short, the switch shorts out the receiver's input circuit during transmit to limit induced signals. On transmit, the antenna is connected to the transmitter's output, while on receive, the transmitter's output is disconnected from the antenna. If you inadvertently fed the output of the transmitter into an open circuit, the final amplifier might go up in smoke.

Some provision must be made for automatically switching off power to the final during receive. This usually takes the form of an automatic switch (relay) as shown in Fig. 4. When the plate contact of the relay is open, the antenna goes to the receiver and no power is delivered to the final. Closing the plate contact of the relay applies power to the final, disconnects the antenna from the receiver, and connects the antenna to the transmitter output. The design must be such that the capacitance between the relay's armature and receiver contacts is very small to limit signal transfer during transmit.

Some relays are fitted with coaxial connectors to permit high-frequency use without impairing the SWR to any noticeable degree. The coaxial relay is handy and convenient when the installation is in a separate receiver and transmitter setup. When separate units are used, a single antenna system requires some form of switching, or a double antenna system must be used, with provision for limiting receiver input during transmit.

One method of limiting takes advantage of cross-polarization—a vertical transmitting element for nondirectional radiation and high power with a light, horizontal beam (such as the lazy H) rotatable for reception. Horizontal wire antennas can also be switched, using a coaxial switch in re-

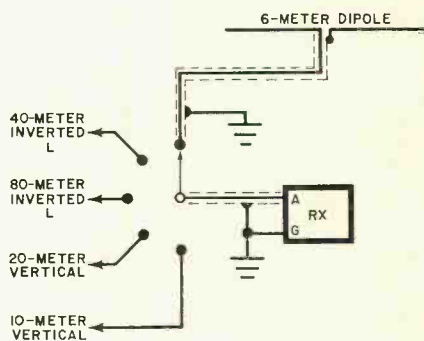
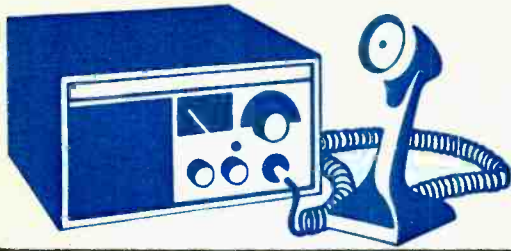

Fig. 5. Multiple-antenna receiver setup.

ceiving. The installation might then look like the circuit in Fig. 5. Naturally, the antennas should be well separated to avoid mutual coupling.

By adjusting each antenna for optimum performance on its band, some rather surprising improvements in signal-to-noise ratio can be made. Another advantage of redundancy is that catastrophic failure of one antenna does not put the station off the air. ♦



# CB Scene

By Len Buckwalter, KQA5012

**A** SWEEPING change in CB rules was recently written into law, and we will feel its first effects a few months from now. Having to do with what is called "type acceptance," the change will have an important impact on CB manufacturers, operators, and equipment. In about a dozen pages of amendments, the FCC is putting sharper teeth into laws intended to keep the airwaves clear of shoddy equipment and man-made interference.

Type acceptance has been a part of CB rules for many years, but it was treated in a simple, voluntary fashion. It merely meant that a manufacturer could certify in writing to the FCC that his equipment met the required technical standards with regard to things such as r-f power, frequency tolerance, and modulation. The Commission didn't have to inspect an actual unit to grant type acceptance but relied on the manufacturer's measurements. This was far less stringent than the requirements of "type approval," in which FCC engineers torture-test a new radio to see if it lives up to legal specifications. The gentler type of acceptance meant that CB equipment did not require the expensive test procedures applied to equipment for other services such as aircraft or commercial two-way radio.

Until now, type acceptance hasn't been a critical factor in the marketplace. About the only reason a manufacturer would take the extra pains was to win the right to tag the gear "FCC Type Accepted." This assured a prospective customer that the equipment "smacked" of quality. Yet many producers of superb equipment never bothered with type acceptance because it never mattered much. Others, who made inferior rigs, could push them onto the market and not run any risk of an official crackdown. For years, the law held the operator, not the

manufacturer, liable for drifting oscillators, mushy modulation, or some other designed-in deficiency.

In 1970, the responsibility for poor equipment shifted so that it protected the consumer. In a completely separate section of the Rules (Sec. 2.805) there appeared something called "Marketing of RF Devices." It didn't include type acceptance and it had surprisingly little impact; but, in a general way, it prohibited anyone from selling transmitting equipment unless it met the appropriate technical standards. This was obviously levelled at the producers of junk equipment. But the failure of that vague law is no longer important because type acceptance will compel all manufacturers to submit data on new models according to the precise instructions written into CB's Part 95. The earlier type acceptance rule has been beefed up with a number of new additions. Let's look at the important ones and see how they will affect CB hardware and operation in the coming years.

Besides the existing technical factors with regard to power, frequency stability, and type of modulation, a new rig will have to meet these additional requirements:

*Modulation Limiter* to prevent audio on the carrier from exceeding 100 percent. Also,

## Type Acceptance

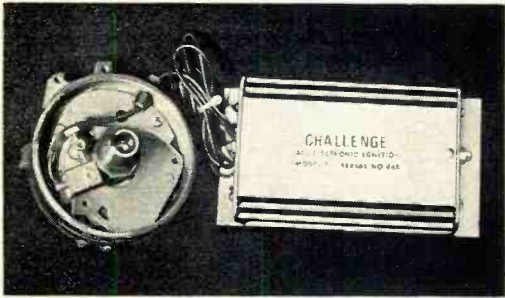

**POSITIVELY THE ULTIMATE IGNITION SYSTEM! LONG-TERM FIELD-TEST PROOF! SAVE GAS—INCREASE PERFORMANCE—CUT MAINTENANCE**

Popular Challenge capacitor discharge ignition system, with no breaker points, provides instant all-weather starting — a much hotter spark AT ALL SPEEDS and peak-performance reliability. This is due to our modern, pointless, CDI system design. The same basic Chrysler pointless system, BUT with added vitally beneficial refinements! Our system fits all neg. gnd. distributors and may be easily changed from car-to-car. Can be installed in just minutes. Install a Challenge superb quality CDI system now! Get longer spark plug life, peak performance at all speeds, SAVE GAS and reduce exhaust emissions. SAVE MONEY AND VALUABLE TIME! Made in U.S.A. Satisfaction guaranteed or money back. Only \$49.50 ppd. Free literature available. Send check or M.O. today, or order C.O.D.

**CHALLENGE ELECTRONICS**

Dept. M, P.O. Box 3345, Whittier, Ca. 90605

**CIRCLE NO. 8 ON READER SERVICE CARD**



**Free!**

*New 14th Edition of the Midwest Hifi Catalog!*

Save on stereo! Buy direct from us and you save money with our high-volume prices on more than 100 name brands. Order from the branch nearest you.

**Midwest Hifi Wholesale & MAIL ORDER DIVISION**

2455b Wisconsin Ave. 3309 E. J W Carpenter Frwy,  
Downers Grove, Ill 60515 Irving, Tex 75062

PE

NAME

ADDRESS

CITY/STATE

ZIP

**CIRCLE NO. 24 ON READER SERVICE CARD**

audio can rise in frequency no higher than 3000 Hz.

Crystals must be located internally and not be readily accessible from the exterior of the cabinet.

Power Output Devices (final tube or transistor) can not be capable of dissipating more than 10 watts. By introducing the term "dissipate," it is hoped that a manufacturer will be discouraged from installing (for instance) a 100-watt transistor in the final stage, driving it only to the 5-watt limit to meet type acceptance. Such an arrangement could too easily be altered to boost the power output.

No connection or addition of any part or accessory can be made if it was not included by the manufacturer for his type acceptance. This restriction, however, does not apply to antennas and transmission lines, antenna switches, passive networks (such as matching units) or replacement microphones.

Maximum Single-Sideband Power is 12 watts PEP (peak envelope power). Sideband power was never clearly defined, and this figure is intended to bring SSB onto an equal basis with conventional (double sideband) output. In conventional transmitters, a 4-watt maximum r-f output still applies. Another SSB rule is that all sideband transmitters must be capable of transmitting at least on the upper sideband. Lower sideband is optional, but the rule assures compatibility between sideband sets of different manufacturers. Further, sideband transceivers must be fitted with a circuit which automatically limits output power to the transmitter's maximum rating.

Multi-Frequency Transmitters will be permitted, mostly as an accommodation to the Civil Air Patrol, which uses frequencies just outside the CB band. Such sets, though, may not have more than a total of 23 channels and must have a single-knob frequency selector.

External Controls and Connections for the transmitter will be limited to: mike, r-f output, audio output (PA, for example), sideband selector, carrier level for SSB, frequency selector, transmit-receive switch, transmitter meter, r-f output indicator, instruction book, and warnings. Note that the receiver section and its controls are not covered by the type acceptance rules. A manufacturer may request additional transmitter controls if he feels that those listed above are too restrictive.



Kits are being considered for type acceptance, but a final ruling is still pending.

**Significance of Changes.** The new rules should not catch most major manufacturers unawares. If they already have type acceptance on certain models, they will not have to make any changes, even if the rig does not meet every detail of the new law. If equipment is not type accepted, the change-over isn't expected to cause major price increases in the lines of reputable manufacturers. One company, Browning Labs, told us that it is studying the possibility of protecting its customers who purchased older models by *retroactive* type acceptance. The company hopes to submit data to the FCC to show that sets marketed three years ago can meet the standards. This will benefit the customer who hopes to keep his radio more than another four years. After that, it will be illegal to operate any Class D set that has not been type accepted.

The timetable for implementation of type acceptance rules is shown in the box. What it boils down to is this. If you now operate a type-accepted rig, you can use it until it disintegrates. The new rules won't apply.

If you now own a rig that is not type accepted, you can use it until the ultimate cut-off date of November 23, 1978. Beyond that time, you must scrap it because no such equipment can be put on the air. This "grandfather clause" is intended to protect most people's investment by giving it time to wear out.

If you plan to invest in CB equipment, be aware that non-accepted gear may be in the marketplace until November 22, 1974. But there should be little such gear available by then because manufacturers are supposed to stop producing them May 24, 1974. If you do pick up a new rig after Nov. 22, 1974,

### TIMETABLE FOR TYPE ACCEPTANCE

**Prior to May 24, 1974:** Transmitters that received type acceptance before May 23, 1974, will continue to be acceptable under new law.

**May 24, 1974, and thereafter:** Transmitters manufactured after this date must be type accepted under new law.

**November 22, 1974:** All transmitters first licensed for use on or after this date will be required to have type acceptance. (Until that date, manufacturers can market nonaccepted equipment.)

**November 23, 1978:** All transmitters will be required to have type acceptance.

your application form will bounce because the FCC won't license it unless it is type accepted.

These new regulations have ramifications which go beyond the technical. They are expected to give the FCC a stronger grip on one of CB's greatest transgressions: the high-power linear amplifier. When a CB'er fills out an application form, he will probably have to indicate an intention to operate at his station with approved equipment. In effect, he takes an oath not to use illegal add-ons. Some people in the industry believe this may change the linear-amplifier offense from a civil to a criminal act, compelling many people to think twice about the consequences. Time will tell whether or not they are right. In the meantime, type acceptance should be a boon to circuits and consumer alike. ♦

## Planning to move?

Let us know **6 to 8 weeks in advance** so that you won't miss a single issue of **POPULAR ELECTRONICS INCLUDING ELECTRONICS WORLD**

Attach old label where indicated and print new address in space provided. Also include your mailing label whenever you write concerning your subscription. It helps us serve you promptly.

Write to: P.O. Box 2774, Boulder, Colo., 80302, giving the following information.

Change address only.

Extend subscription.  Enter new subscription.

(1)  5 yrs. \$21 (2)  3 yrs. \$15 (3)  1 year \$6

Payment enclosed (1 extra issue per yr. as a BONUS)

Bill me later.

If you have no label handy, print OLD address here.

name please print

---

address

---

city

---

state zip-code

AFFIX LABEL

name please print 0880

address

city state zip

Add'l postage: \$1 per year outside U.S., its possessions & Canada



# Test Equipment Scene

By Leslie Solomon, Technical Editor

**T**HERE are probably many technicians and hobbyists who think a digital frequency counter is a pretty "special" (even unnecessary) piece of equipment. They would argue that they don't really need to know exact frequencies in a circuit—a ballpark figure will suffice. We have heard this opinion many times; but when we succeed in persuading someone to try a counter for a while, he usually changes his tune.

In amateur radio, the digital counter has worked wonders in the design of filters. Tuning SSTV and RTTY filters (among others) is a snap with a counter; and it is amazing how much better reception is when all filters are properly tuned. If you stick a 175-MHz front-end scalar on your counter, you find out just what frequency you are on. Using a digital counter, the CB'er will also find out why a lot of units now have "clarifier" controls.

In the service shop, with a counter, it is possible to align FM multiplex filters and the chroma circuits of color TV. The counter makes it possible to know exactly what all the frequencies really are in audio and r-f signal generators. (The dials on many of the latter leave a lot to be desired.) We have also found that in working with crossover networks and high- and low-pass filters, the counter is of great value. Troubleshooting digital countdowns is made easier since we can follow a frequency from the original oscillator down through

the last stage; and, at each point, we can be sure that the countdown is correct, with no mysterious "glitches" causing erratic counts.

Having used a frequency counter (with front-end scalar) for the past few years, we have found it to be a valuable instrument for both servicing and hobby work—especially since it now seems that the whole world is going digital.

**What the Specifications Mean.** First, let's clear up the mystery of the "half digit" which is included in the specs of some instruments (either counters or DMM's) that are said to have  $2\frac{1}{2}$ ,  $3\frac{1}{2}$ ,  $4\frac{1}{2}$ , etc., digits. How can you have half a digit? This means, simply, that if a readout consists of a few complete digits, the "1" at the beginning is the half digit. If, for example, you have a counter consisting of two decade units that can total up to 99, all you need is a 1 indicator that accepts the carry signal from the last decade to make the two-digit counter indicate up to 199. This is then called a  $2\frac{1}{2}$ -digit readout. If you have three complete decades, then adding the 1 in front, makes this a  $3\frac{1}{2}$ -digit counter. Of course, if a counter is specified as having 3, 4, or 5 digits (for example), then it will indicate to 999, 9999, or 99999, respectively.

Now the question is, "How many digits do you need?" The answer to this depends on how much accuracy you want. Obviously, the more readouts, the better the accuracy, depending on the accuracy and stability of the gating source.

This brings up another point. Since a digital frequency counter is an instrument that compares an unknown frequency with a known time interval (called the gate), the counter's accuracy depends strongly on how accurate the gate interval is. There are two basic gate timing approaches: the commercial power line whose frequency is kept pretty close (about 0.1%) or a crystal-

## Digital Frequency Counters

controlled time base whose accuracy depends on the crystal and usually is about 0.001 to 0.005%. The power-line time base is usually used in instruments measuring up to 3½ digits and a crystal time base for 3½ and up. Obviously, as the measured frequency goes up, more and more input waves have to be crowded into a small fixed time interval; and the more accurate the time interval, the more accurate the readout. In general, for relatively low frequencies (in the audio range), the power-line approach is fine. It is also lower in cost.

You will note in some specifications, that a counter has an accuracy of X% plus or minus 1 count. This means that the timing gate is not synchronized with the input signal so the counter may either add or miss one count, depending on the instantaneous relationship between the event to be counted and the gate opening and closing.

The second source of accuracy (or inaccuracy) is called time base stability. Obviously, if the crystal that controls the gate timing is exactly on frequency, the gate is accurate; and, if the crystal drifts, so does the accuracy. This should not trouble the experimenter or service technician—only those who are concerned with super accuracy. Most crystal-controlled counters have crystal-tuning provisions for setting the crystal to WWV or some similar standard. This eliminates the need for a crystal oven—which some rather expensive counters have.

Trigger error, which causes miscounts, can come from noise on the input signal (the glitches). The counter can't differentiate between the actual signal and the noise pulses, so it adds the unwanted glitches to the count. Another source of this error is noise in the time gate itself. This can cause the gate to open and/or close in the wrong time slot, thus affecting counting accuracy. Proper power line filtering, shielding, and good circuit and mechanical design can reduce this error to a minimum. This type of error also points up the fact that the same glitches that cause false counter indications also "run around" in other elements connected to the same power line. That is why any work bench should have complete noise suppression devices coupled to the power line feed.

**What About the User?** The biggest error of all concerned with digital counters is probably made by the user. He takes any

old length of wire (usually some insulated test lead) to make the connections between the counter and the source of the input. This wire (and possibly its companion ground wire) acts like an antenna feeding a high-input-impedance circuit. In a situation like this, just about any indication on the counter is liable to be wrong. This may explain why some people get readings that are off many kHz when measuring simple audio circuits. Properly shielded wire must be used—just as in testing with an oscilloscope. Most counters are equipped with the proper cable and connections.

A major problem to be solved in buying a counter is whether to get one with an upper limit of 15 to 30 MHz (if most of the use will be in that area) or a more expensive one that has a range up to a couple of hundred MHz (for the occasional times when it might be needed). The answer here is to buy the best counter covering the frequency range you use most and then get a front-end scalar. Scalars are available from a number of sources—some in kit form.

Some people, especially hams, may still be using older heterodyne converters to determine a high-frequency signal value. These were fine in the past since they were the best (and only) way to measure frequency. However, with the advent of fast logic such as ECL, which can have a frequency of about 350 MHz and higher, digital frequency counters with their unambiguous readout are the best. Prices are dropping rapidly, and more and more models are appearing on the market.

**Period Measurements.** Period is the inverse of frequency, and period measurements are made with the time base and input reversed. (That is, the circuit is switched so that the time base pulses are the input and the normal input signal starts and stops the time base.) This approach is very useful when measuring low frequencies because the longer period of the low frequency allows more counts to be accumulated in the period measurement, improving both resolution and accuracy. For example, if you make a frequency measurement of 100 Hz on an 8-digit counter having a gate time of 10 seconds, the display will show 0000.1000 kHz. A period measurement of the same 100 Hz, using 100 MHz as the clock frequency, will display 010000.00  $\mu$ s, so the resolution is increased by a factor of 1000 and measurement time is decreased by 100. ♦



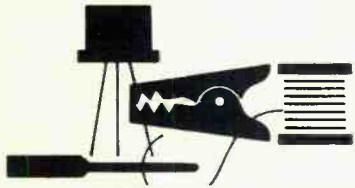

# Tips & Techniques

## DIODE AND SWITCH BOX MAKES SOLDERING IRON DOUBLY USEFUL

Most medium-power soldering irons in the 25- to 40-watt range can be used safely for delicate jobs where soldering heat must be carefully controlled to prevent thermal damage to solid-state components. All you need to make such an iron safe is a small box just large enough to accommodate an spst switch, a diode, and a

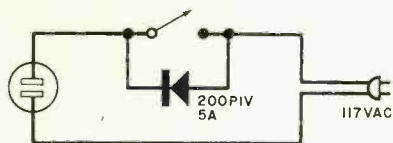

chassis-mounting ac receptacle. Mount the switch and receptacle on the cover of the box and wire the circuit shown. The soldering iron plugs into the receptacle, while the line cord plugs into any convenient 117-volt ac socket. Now, when you tackle most jobs, leave the switch in the open position. When you have to solder to a diode, transistor, or IC terminal, close the switch and wait 15 seconds and continue soldering.

—John Manning

## VISUAL BEAT INDICATOR FOR A RHYTHM BOX

A rhythm box is basically a metronome with drum and cymbal sounds. Most metronomes have a light that flashes in time with the beat.

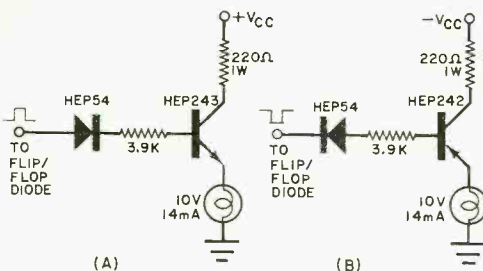

Rhythm boxes however have either no light at all or a light that flashes only on the down-beat. This circuit can produce either a downbeat light or a full-beat light. First locate the flip-

flop chain in the rhythm box. Then determine if its output pulses are positive or negative. You can use either a scope or VOM to determine the polarity. Next, construct either circuit (A) or (B) for positive-going or negative-going output pulses. Components and values are not critical except for the lamp which should be a low-current type (such as Allied Radio #749-C0504).

—James E. Rothen

## HOW TO SPLICE AUDIO COAX OR SHIELDED CABLE

Here's a tip that may help those who have been reluctant to repair severed coax cable. The method is very easy and can be applied to audio molded cable which must be lengthened. Cut both ends of the cable as shown in the figure. Cut an extra piece of coax braid about 1½" long and gently compress it lengthwise until it expands sufficiently in diameter to slip over the jacket. Cut two pieces of shrink tubing to the

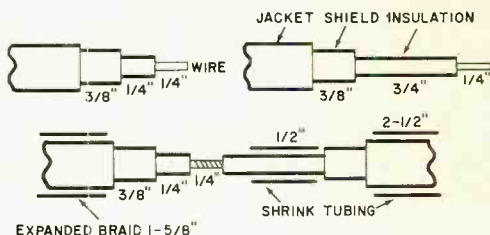

dimensions in the figure. Tubing diameters should be slightly larger than the cable parts they are to slip over. Install shrink tubing and expanded braid as shown. Twist or butt solder the inner connectors together and solder quickly. (Pretinning each conductor before installing the shrink tubing helps.) Push shrink tubing on inner conductor over the splice and shrink with heat. Push the expanded braid over the two exposed ends of the shield of both cables and stretch slightly to return the braid to its smaller diameter; then completely solder each end. Push output shrink tubing over the braid splice and shrink with heat.

—Robert Marchant

## PLASTIC PILL CONTAINER MAKES HANDY BULK SOLDER DISPENSER

Buying solder by the pound is a real money saver, but those large spools on which it comes are awkward to use. However, if you have an empty plastic pill container handy, you can convert awkwardness to finesse. First, drill a ⅛" hole through the bottom of the container, locating the hole near the edge. Several feet of solder can now be wound into a convenient load on the handle of a soldering aid or around a pen or pencil. In loading the dispenser, the working end of the solder is fed down the center of the coil and out through the hole in the bottom of the pill container.

—John McNamery

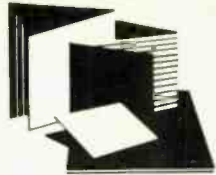

## New Literature

### AUDIO RESEARCH BROCHURE

"High Definition Music Reproduction" is the title of a new full-color brochure from Audio Research. The four-page brochure describes the principal features of the SP-3 preamplifier; Dual 51 and Dual 75 power amplifiers, and the Magneplanar Tympani loudspeakers. Also included are discussions of the design approach used by the company to achieve high-definition sound reproduction and an explanation of their manufacturing techniques. Address: Audio Research Corp., 2843 26 Ave. S., Minneapolis, MN 55406.

### SANSUI 4-CHANNEL BOOKLET

A new booklet, titled "A Non-Technical Guide to QS 4-Channel Sound," available from Sansui will prove of interest to all non-technical quadraphonic sound equipment users. It describes the various 4-channel sound formats, their advantages, disadvantages, and availability of material. The booklet is available from Sansui dealers or by writing to: Sansui Electronics Corp., 55-11 Queens Blvd., Woodside NY 11377.

### CALECTRO DIGITAL PROJECTS HANDBOOK

Basic fundamentals of the digital integrated circuit with charts, schematics, and eight easy-to-build digital projects are featured in the Digital Projects Handbook (Cat. No. FR-169) from Calectro. The catalog contains easily understood instructions on how to build such interesting and practical projects as a digital dice game, digital clock, digital burglar alarm, and other applications for the company's digital components. Address: GC Electronics, Div. of Hydrometals, Inc., 400 S. Wyman St., Rockford, IL 61101.

### FORDHAM CATALOG

An illustrated 32-page discount mail-order catalog is available from Fordham Radio. It has been specifically designed as a quick reference ordering guide for use by radio/TV servicemen, technicians, and hobbyists. Listed are tools, service and repair kits, vacuum tubes, test equipment, phono cartridges and styli, speakers and microphones, antennas, and other servicing aids made by major manufacturers. Address: Fordham Radio Supply Co., 558 Morris Ave., Bronx, NY 10451.

MARCH 1974



## NEW ...for the sound buff HYBRID<sup>POWER</sup> AMPLIFIERS

With the addition of a few off-the-shelf components, you can easily build your own quality amplifier for record player, tape deck, tuner, P.A. (musical instruments) or intercom system.

### USED BY LEADING MANUFACTURERS

Harmonic Distortion: < .05%, Bandwidth: 20 Hz - 100K Hz, Flat Response within 1/2 dB, Input Sensitivity: 500 mV - Available in 3 Models:

POWER	RMS	IHF	Price
SI-1010Y	10W	25W	\$ 6.40
SI-1025E	25W	65W	18.00
SI-1050E	50W	120W	25.40



Technical data free with order or may be ordered separately for \$1.

**ANCRONA CORP.**  
P.O. BOX 2208, CULVER CITY, CA. 90230



# FREE

## 1974 LAFAYETTE CATALOG 740

Ready Now!

### Your Complete Electronics Buying Guide

- Stereo/Hi-Fi Components • CB Transceivers & Walkie-talkies • PA Systems • Tools & Test Equipment
- Police/Fire Monitor Receivers • Antennas • Photography Equipment • Ham Gear • Books, Parts, and More!

Send Today!

Lafayette Radio Electronics  
P.O. Box 10, Dept. 35034  
Syosset, L.I., N.Y. 11791

35034

NAME \_\_\_\_\_

ADDRESS \_\_\_\_\_

CITY \_\_\_\_\_

STATE \_\_\_\_\_ ZIP \_\_\_\_\_

CIRCLE NO. 19 ON READER SERVICE CARD

Why a Sylvania home training program may be

# your best investment for a rewarding career in electronics

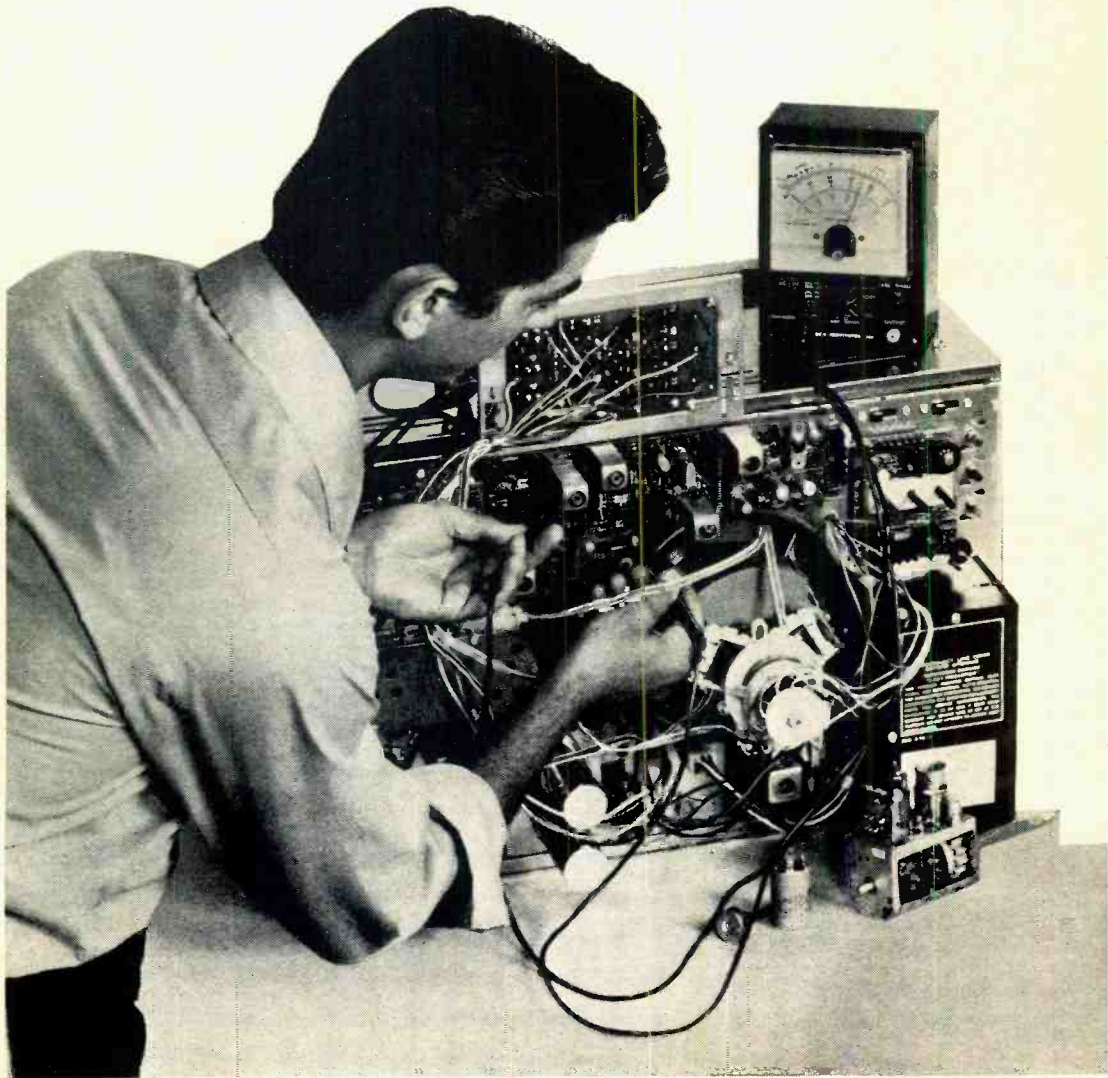



## 1 LEADER IN ELECTRONICS TRAINING

Over the years, Sylvania Resident Schools have trained thousands of men and women for key positions in the electronics field. Now, through Sylvania Home Training, you can receive the same high-quality career training at home. In your spare time. While you hold your present job. Remember, this training is designed with one purpose in mind — to give you the background you need to land the electronics job you really want!

## 2 AUTOTEXT TEACHES YOU ELECTRONICS RAPIDLY, EASILY.

AUTOTEXT, offered exclusively by Sylvania, is the proven step-by-step method of home training that can help you learn the basics of electronics quickly and easily.

## 3 CASSETTE SYSTEM

This innovative learning-by-hearing approach is a special option that adds an extra dimension to AUTOTEXT. It's almost like having an instructor in your own home. As you play the cassette tapes, you'll have an instructor guiding you through your AUTOTEXT lessons. Explaining the material as you read it. Going over schematics with you, reinforcing the basic electricity and electronics study materials with you. Everything you need to know to get you started towards a highly regarded position as an electronics technician — all in an easy-to-understand, conversational tone.

## 4 SPECIALIZED ADVANCED TRAINING

For those already working in electronics or with previous training, Sylvania offers advanced courses. You can start on a higher level without wasting time on work you already know.

## 5 PERSONAL SUPERVISION THROUGHOUT

All during your program of home study, your exams are reviewed and your questions are answered by Sylvania instructors who become personally involved in your efforts and help you over any "rough spots" that may develop.

## 6 HANDS-ON TRAINING

To give practical application to your studies, a variety of valuable kits are included in many programs. In Sylvania's Master TV/Radio Servicing Program, you will actually build and keep an all solid-state black and white TV set, and a color TV set. You also construct an oscilloscope which is yours to keep and use on the job.

## 7 FCC LICENSE TRAINING — MONEY BACK AGREEMENT

Take Sylvania's Communications Career Program — or enter with advanced standing and prepare immediately for your 1st, 2nd, or 3rd class FCC Radio Telephone License examinations. Our money-back agreement assures you of your money,

back if you take, and fail to pass, the FCC examination taken within 6 months after completing the course.

## 8 CONVENIENT PAYMENT PLANS

You get a selection of tuition plans. And, there are never any interest or finance charges.

**SEND ATTACHED POSTAGE PAID CARD TODAY! FREE DESCRIPTIVE BOOK YOURS WITHOUT OBLIGATION!**

If reply card is detached send this coupon

<b>SYLVANIA TECHNICAL SCHOOL</b>	
Home Study 809 Third Avenue New York, N.Y. 10022	
Please send me FREE illustrated career catalog. I understand that I am under no obligation.	
Name _____	
Address _____	
City _____	
State _____	Zip _____
Age _____	
Veterans: Check here <input type="checkbox"/>	

Sylvania Technical Systems, Inc.

**GTE SYLVANIA**

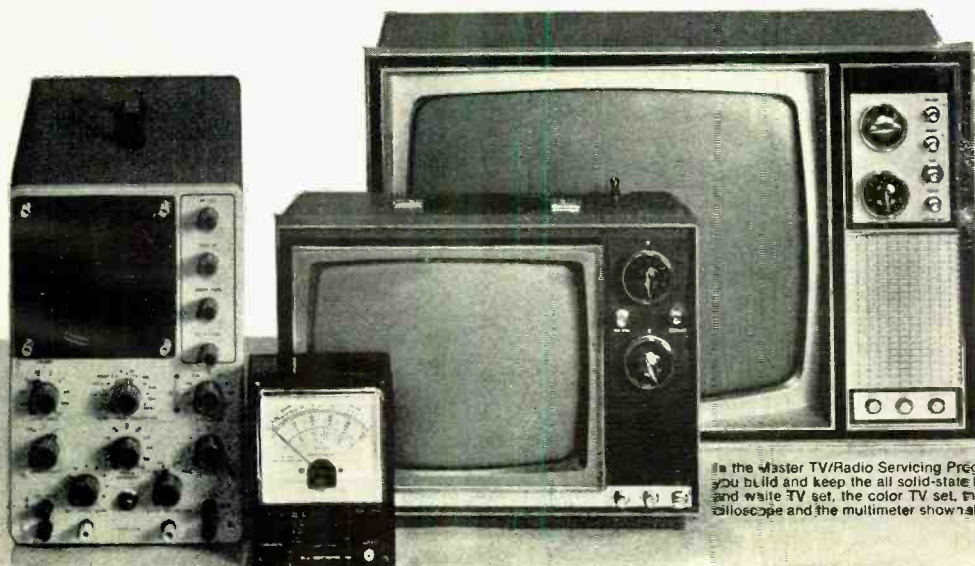

In the Master TV/Radio Servicing Program, you build and keep the all solid-state black and white TV set, the color TV set, the oscilloscope and the multimeter shown above.

CIRCLE NO. 16 ON READER SERVICE CARD

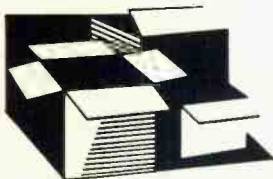

## New Products

Additional information on new products covered in this section is available from the manufacturers. Either circle the item's code number on the Reader Service Card inside the back cover or write to the manufacturer at the address given.

### HEATHKIT FET TESTER KIT

Transistors, diodes, FET's, SCR's, triacs, UJT's can be tested in or out of circuit with the new Heathkit Model IT-121. Five current ranges



measure leakage as low as 1  $\mu$ A and collector currents as high as 1 A. Gain, or dc Beta; transconductance ( $G_m$ ); and leakage values are read directly on the scales of a large meter movement. The instrument has color-coded, pushbutton range selection, battery testing circuitry, and 36-in. test leads. (\$49.95).

Circle No. 5 on Reader Service Card

### UTAH SPEAKER SYSTEM

Utah Electronics is marketing a new compact acoustic-suspension speaker system, the Model AS-2AX, that is said to have a flat impedance curve for uniform power output, smooth frequency response, and safe parallel hookups to solid-state amplifiers. The impedance peaks to 11 ohms at resonance and dips to 6.7 ohms at its lowest point. The bass response goes down to 45 Hz, the highs go beyond audibility, and the crossover is at 5000 Hz. The driver complement consists of an 8-in. woofer and a 3 $\frac{1}{2}$ -in. direct-radiator tweeter. Overall range is 45 to 17,000 Hz, and power-handling capacity is 24 watts peak. (\$49.95).

Circle No. 70 on Reader Service Card

### VECTOR BREADBOARDING/ASSEMBLY AIDS

"Klip-Bloks" from Vector Electronic Corp. facilitate breadboarding and final assembly of circuits using DIP IC's, transistors, and other components at low cost. The Klip-Bloks consist of four connected spring clips assembled in insulated columns of eight and 24 on 0.1-in. centers. Single-line Klips are available for power and common buses. Interconnections are made with ordinary solid hookup wire without soldering. Leads can be inserted into the top or bottom of the blocks. The Model T66-32 (\$1.06 each in quantities of 50) has terminals on 0.1-in. centers; the Model T66-96 (\$2.53 each in 50's) has 24 terminals. Each has mounting pins on centers compatible with 0.1-in. grid perforated board.

Circle No. 71 on Reader Service Card

### EICO METAL DETECTOR

Designed to detect both ferrous and non-ferrous metals Eico's Model TH-30 solid-state metal detector will locate plumbing beams and wall studs, coins and souvenirs. No meters or dials are used; instead, when metallic objects are sensed, a signal is emitted from a built-in speaker. The entire unit is ruggedized to prevent damage from shock and weather. It comes with a detachable 36-in. handle (measures 40 in. overall) and 9-volt transistor battery.

Circle No. 72 on Reader Service Card

### GLENBURN/McDONALD DELUXE RECORD CHANGER

The top-of-the-line Model 2130 automatic record changer from Glenburn/McDonald comes complete with base, magnetic phono cartridge with elliptical diamond stylus, and dust cover



for its retail price of \$95.90. It has a full-size 11-in. turntable platter with cushioned protective mat, bidirectional viscous-damped cue/pause control, adjustable anti-skate and stylus pressure controls (the latter with an indicator scale), and interchangeable manual and automatic spindles. The automatic locking tonearm rest is a built-in safety feature, engaging after the last disk in a stack is played.

Circle No. 73 on Reader Service Card

### DECIBEL PRODUCTS 150-174-MHZ ANTENNA

The Model DB-702 is a high-gain mobile antenna from Decibel Products, Inc., designed for mounting on the rooftop or trunk deck of a vehicle. With an operating range of 150-174 MHz, the antenna consists of a  $\frac{1}{2}$  wavelength radiator and a reactance matching unit (coil). Models are available to fit different types of mounting bases. Installation of the antenna is simple. The coil requires no tuning. The whip is cut to the desired frequency in the field. A whip cutting chart is included in the installation instructions supplied with the antenna. The DB-702 is said to be conservatively rated to provide in excess of 2.5 dB of gain over a  $\frac{1}{2}$ -wave whip mounted in the same location.

Circle No. 74 on Reader Service Card

### REALISTIC AM/STEREO FM RECEIVER

The Realistic Model STA-14A 25-watt AM/stereo FM receiver from Radio Shack has both magnetic and ceramic phono inputs for use with

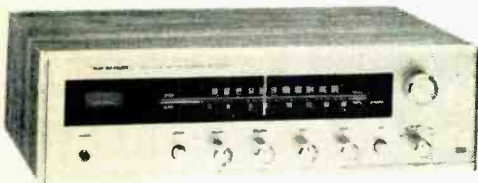

virtually any record changer or turntable. Other features include an FET FM front end, wide-band AM circuitry, switchable AFC to prevent drift on FM, separate bass and treble controls, headphone jack, tuning meter, and built-in AM and FM antennas. (\$109.95, including walnut case).

Circle No. 75 on Reader Service Card

### FANON ECONOMY CB TRANSCEIVER

A new low-cost, 23-channel mobile CB transceiver designated the Fanfare 100 is being marketed by Fanon. The rig comes equipped with crystals for all channels and includes a dynamic microphone, all mounting hardware, an external speaker switch, and a large illuminated channel selector. Featured are an illuminated S/r-f meter, highly sensitive and selective circuitry, and built-in automatic noise limiter. Power input at 13.8 volts dc is a full 5 watts. The Fanfare 100 can be used in vehicles with either a positive or a negative grounding electrical system.

Circle No. 76 on Reader Service Card

### COLE FLUX REMOVER/CLEANER

Designed for rapid removal of organic solder flux, the No. CD-290 aerosol cleaner from Cole Flex Corp. removes 100 percent of activated-resin solder fluxes used by the major solder manufacturers. In addition, it is highly compatible with most materials used in printed circuit boards and point-to-point wired chassis.

## NOW A PROFESSIONAL BURGLAR-FIRE ALARM SYSTEM YOU CAN INSTALL YOURSELF.



Save hundreds of dollars in alarm installation and monthly service charges. The EICO SS-500 "install-it-yourself" burglar-fire alarm system offers you the kind of professional protection you have been looking for, at a price you can afford. The SS-500 has been designed on the EICO "Expandability Concept" that enables you to "add-on" protection to meet your own special needs. As you purchase any security system, we suggest you read the EICO Security Handbook and see how easy EICO makes it to "Do-it-Yourself."

### FREE EICO CATALOG/SPECIAL OFFER!

Security handbook (Reg. \$2.95) only \$1.50 with this ad. Includes a catalog on EICO Security Systems. Test Instruments. Stereo, Hobby Kits and name of nearest distributor. For catalog only, check reader service card or send 25¢ for first class mail service.

EICO, 283 Malta Street, Brooklyn, N.Y. 11207



CIRCLE NO. 13 ON READER SERVICE CARD

## ABOUT YOUR SUBSCRIPTION

Your subscription to POPULAR ELECTRONICS is maintained on one of the world's most modern, efficient computer systems, and if you're like 99% of our subscribers, you'll never have any reason to complain about your subscription service.

We have found that when complaints do arise, the majority of them occur because people have written their names or addresses differently at different times. For example, if your subscription were listed under "William Jones, Cedar Lane, Middletown, Arizona," and you were to renew it as "Bill Jones, Cedar Lane, Middletown, Arizona," our computer would think that two separate subscriptions were involved, and it would start sending you two copies of POPULAR ELECTRONICS each month. Other examples of combinations of names that would confuse the computer would include: John Henry Smith and Henry Smith; and Mrs. Joseph Jones and Mary Jones. Minor differences in addresses can also lead to difficulties. For example, to the computer, 100 Second St. is not the same as 100 2nd St.

So, please, when you write us about your subscription, be sure to enclose the mailing label from the cover of the magazine—or else copy your name and address exactly as they appear on the mailing label. This will greatly reduce any chance of error, and we will be able to service your request much more quickly.



# AUTO AIDS

Do-It-Yourself—Save Time, Money, Gas.



**EICO 1064** Dual purpose Battery Eliminator and Charger incorporating an extra low ripple filter circuit. Ideal for servicing, and powering 6-12 volt auto and marine equipment. \$69.95 Kit \$89.95 Wired

**EICO 888** Portable Universal Engine Analyzer. Keeps your car or boat engine in tip-top shape. Complete with "How-to-Use" tune-up and troubleshooting manual. Kit \$59.95 Wired \$89.95

**EICO 1080** 200 watt Solid State Power Inverter and Battery Charger. Converts 12 volts DC to 117V, AC current. For use in cars, mobile homes and boats to operate recorders, appliances, etc. Kit \$49.95 Wired \$64.95

**EICO 889** Solid State C-D Ignition System adds power to any engine. Boosts gas mileage up to 20%. Points and spark plugs last up to 5 times longer, instant cold weather starting. Kit \$34.95 Wired \$44.95

## FREE 32 PAGE EICO CATALOG

For latest catalog on EICO Test Instruments, Stereo, EICOCRAFT Projects, Environmental Lighting, Burglar/Fire Alarm Systems, and name of nearest EICO Distributor, check Reader Service Card or send 25c for First Class mail service.

EICO, 283 Malta Street, Brooklyn, N.Y. 11207



CIRCLE NO. 13 ON READER SERVICE CARD

The solvent is not flammable and is said to have excellent wetting characteristics, high evaporation rate, and no open-cup flash point when tested. Low surface tension and high density permit the cleaner to penetrate recesses for quick removal of all dirt and flux. (\$2.85 in lots of 6 to 11).

Circle No. 77 on Reader Service Card

## TECHNICS STEREO CASSETTE DECK

A two-motor stereo transport is offered by Technics by Panasonic in their Model RS-276US cassette tape deck. The unit features the Dolby noise reduction system to eliminate tape hiss,



tape selector switch for chromium-dioxide tape formulations, photoelectric eye record indicator, two VU meters, pushbutton controls, microphone/line switch, headphone jack, slide controls for record/play volume, and a tape counter. (\$399.95).

Circle No. 78 on Reader Service Card

## SAE HIGH-POWER AMPLIFIER

Scientific Audio Electronics, Inc., has announced the introduction of their latest high-power amplifier, the Mark IIICM with rated output of 200 watts/channel into 8 ohms. It incorporates a relay protection circuit that disables the output in the event that dc or very low frequencies are detected. Unlike other amplifiers, the thermal cutout is connected to the relay circuit so

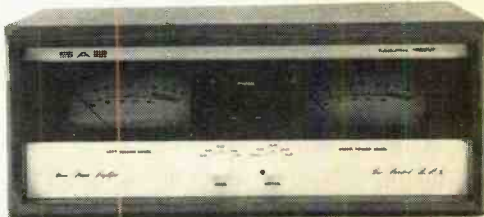

that, under high-temperature conditions, the amplifier will not shut off entirely; a very low sound level will be heard. The amplifier is designed to deliver full rated power into any resistive or reactive load. The Mark IIICM features an output level meter in each channel. (Another version, the Mark IIIC, is identical to the Mark IIICM except that it has no meters.)

Circle No. 79 on Reader Service Card

# free BA 1974 catalog



## 276 PAGE RADIO, TV & ELECTRONICS CATALOG

Your Buying Guide for Everything in Electronics... Stereo, Hi-Fi, TV's, Radios, Tape Recorders, CB, Kits, Tools, Books, and Electronic Parts.

WRITE FOR IT TODAY!

## burstein-applebee

DEPT. PE 3199 MERCIER ST. KANSAS CITY, MO. 64111

NAME \_\_\_\_\_

ADDRESS \_\_\_\_\_

CITY \_\_\_\_\_

STATE \_\_\_\_\_ ZIP \_\_\_\_\_

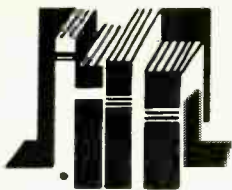

## Electronics Library

### CB RADIO CONSTRUCTION PROJECTS, Second Edition

by Len Buckwalter

This easy-to-read book is a CB'er's guide to building low-cost devices to use with today's Citizens Band radios. Chapters cover how to build an S meter, portable antenna, multi-purpose test oscillator, TVI trap, line filter, SWR meter and output-power indicator, CB oscilloscope adapter, auxiliary control unit, coaxial switch, and on-the-air sign. The text is supported with full schematic diagrams, complete parts lists, assembly drawings, and photos.

Published by Howard W. Sams & Co., Inc.,  
4300 West 62 St., Indianapolis, IN 46268. Soft  
cover. 128 pages. \$3.95.

### MOTOROLA SILICON RECTIFIER HANDBOOK

This is a true technical handbook rather than a catalog-type "data book." Its easily absorbed text is well illustrated and contains tables, graphs, and circuits on almost every page. Much of the material has never been published in a rectifier handbook before. Progressing from the basics through the latest rectifier applications, the book is well suited for self-study as well as technical reference use.

Published by Motorola Inc., P.O. Box 20924,  
Phoenix, AZ 85036. Soft cover. 216 pages. \$2.50.

### HOW TO BUY STEREO COMPONENTS

by Peter Johnson

This book offers a solution for all of those people who want to buy stereo component systems but are intimidated by high prices, fast-talking salespeople, and a multitude of items they simply do not understand. Written in a simple, sometimes technical style, the text discusses such basics as receivers, speaker systems, record players, and tape decks, and details the workings of each. In the process, some of the basic elements of sound are introduced. This explanation, however, is directed toward helping the consumer to understand stereo components.

Published by Halb Associates, 6601 Bay St.,  
Emeryville, CA 94608. Soft cover. 96 pages.  
\$1.75.

MARCH 1974

## 4 Money-saving reasons to buy EICO's Solid State Test Equipment.



**EICO 242 FET-TVOM.** Peak-to-peak measurements of AC volts and milliamps.  $6\frac{1}{2}''$  meter. 7 non-skip ranges. High input impedance. Low 1 volt scale. DC/AC Multi-Probe. AC or battery operated. Kit \$84.95. Wired \$119.95.

**EICO 330 RF Signal Generator.** 5 bands cover a range from 100 kHz to 54 MHz. Calibrated modulation adjustment control. 400 Hz audio output. Provision for modulating RF with internal or external signal source. Kit \$69.95. Wired \$109.95.

**EICO 379 Sine/Square Wave Generator.** Simultaneous sine and square wave outputs. Covers 20 Hz to MHz in five ranges. Low distortion sultzer feedback circuit. Square wave rise time better than 0.1 microseconds. Kit \$79.95. Wired \$119.95.

**EICO TR-410 Triggered Sweep Scope.** 100% solid state. DC to 10MHz bandwidth. Sweep synchronized gate output. Z Axis input. Use as vectorscope for color TV servicing. One probe for direct and 10:1 measurements. Wired \$429.95.

### FREE 32 PAGE EICO CATALOG

For latest catalog on Eico Solid State Test Equipment, Automotive and Hobby Electronics, Burglar-Fire Alarm Systems, Stereo, and name of nearest EICO Distributor, check reader service card or send 25¢ for fast first class mail service.

EICO, 283 Malta Street, Brooklyn, N.Y. 11207



CIRCLE NO. 13 ON READER SERVICE CARD

## SAVE!

### MONEY • TIME • FREIGHT



QUALITY STEREO EQUIPMENT AT LOWEST PRICES.

YOUR REQUEST FOR QUOTATION RETURNED SAME DAY.

FACTORY SEALED CARTONS—GUARANTEED AND INSURED.

SAVE ON NAME BRANDS LIKE

A.D.C.

A.R.

DYNACO

FISHER

KLH

SHURE

KOSS

SONY

AND MORE THAN 50 OTHERS

BUY THE MODERN WAY  
BY MAIL—FROM

# illinois audio

Department B  
12 E. Delaware Place  
Chicago, Illinois 60611  
312-664-0020

CIRCLE NO. 18 ON READER SERVICE CARD



# ELECTRONICS MARKET PLACE

**NON-DISPLAY CLASSIFIED: COMMERCIAL RATE:** For firms or individuals offering commercial products or services. \$1.60 per word (including name and address). Minimum order \$16.00. Payment must accompany copy except when ads are placed by accredited advertising agencies. Frequency discount: 5% for 6 months; 10% for 12 months paid in advance. **READER RATE:** For individuals with a personal item to buy or sell, \$1.00 per word (including name and address.) No minimum! Payment must accompany copy. **DISPLAY CLASSIFIED:** 1" by 1 column (25/8" wide), \$200.00. 2" by 1 column, \$400.00. 3" by 1 column, \$600.00. Advertiser to supply cuts. For frequency rates, please inquire.

**GENERAL INFORMATION:** First word in all ads set in bold caps at no extra charge. All copy subject to publisher's approval. All advertisers using Post Office Boxes in their addresses **MUST** supply publisher with permanent address and telephone number before ad can be run. Advertisements will not be published which advertise or promote the use of devices for the surreptitious interception of communications. Closing Date: 1st of the 2nd month preceding cover date (for example, March issue closes January 1st. Send order and remittance to Hal Cymes. **POPULAR ELECTRONICS**, One Park Avenue, New York, New York 10016.

## FOR SALE

**FREE!** bargain catalogs. Fiber optics. LED's, transistors, diodes, rectifiers, SCR's, triacs, parts. Poly Paks, Box 942, Lynnfield, Mass. 01940.

**GOVERNMENT** Surplus Receivers, Transmitters, Snooperscopes, Radios, Parts, Picture Catalog 25¢. Meshna, Nahant, Mass. 01908.

**LOWEST** Prices Electronic Parts. Confidential Catalog Free. **KNAPP**, 3174 8TH Ave. S.W., Largo, Fla. 33540.

**ELECTRONIC PARTS**, semiconductors, kits. **FREE FLYER**. Large catalog \$1.00 deposit. **BIGELOW ELECTRONICS**, Bluffton, Ohio 45817.

**CONVERT** any television to sensitive, big-screen oscilloscope. Only minor changes required. No electronic experience necessary. Illustrated plans. \$2.00. Reico-A33, Box 10563, Houston, Texas 77018.

**RADIO**—T.V. Tubes—36¢ each. Send for free catalog. Cornell, 4213 University, San Diego, Calif. 92105.

**AMATEUR SCIENTISTS**, Electronics Experimenters, Science Fair Students . . . Construction Plans—Complete, including drawings, schematics, parts list with prices and sources . . . Robot Man — Psychedelic shows — Lasers — Emotion/Lie Detector — Touch Tone Dial—Quadrasonic Adapter—Transistorized Ignition—Burglar Alarm—Sound Meter . . . over 60 items. Send 25¢ coin (no stamps) for complete catalog. Technical Writers Group, Box 5994, University Station, Raleigh, N.C. 27607.

**METERS**—Surplus, new, used, panel or portable. Send for list. Hanchett, Box 5577, Riverside, CA 92507.

**PYROTECHNICAL** chemicals, casings, tools, supplies, fuse, literature. Giant, illustrated catalogue/handbook includes formulas, instructions—50¢, with samples—\$1.00. Westech, Box 593, Logan, Utah 84321.

**WE SELL CONSTRUCTION PLANS. TELEPHONE:** Answering Machine, Speakerphone, Carphone, Phonevision, Auto Dialer, Touch Button Dialer, Central Dial System. **TELEVISION:** \$35.00 Color Converter, Video Tape Recorder. \$25.00 Camera. **HOBBYIST:** Electron Microscope, 96 Hour Tape Music System, Ultrasonic Dishwasher, Radar-Oven. Plans \$4.95 each. **NEW ITEM:** \$75. Electronic Pocket Calculator, \$7.50. **COURSES:** Telephone Engineering \$39.50. Detective Electronics \$22.50, Integrated Circuit Engineering, \$49.50. **NEW SUPER HOBBY CATALOG** plus year's subscription to Electronic New Letter **AIRMAILED \$1.00**. Don Britton Enterprises. 6200 Wilshire Blvd., Los Angeles, Calif. 90048.

**JAPAN HONG KONG DIRECTORY.** World products information. \$1.00 today. World Trade Inquiries, Hillyard, Washington 99207.

**SCOPES**, meters, test equipment, military and industrial surplus. Write for free "Bargain Bulletins". Lawrence Instruments, P.O. Box 744, Sunbury, Pa. 17801.

**TEST EQUIPMENT**, Aerospace-Laboratory Grade. Request your needs; will mail appropriate catalogs (we have 24 catalog categories). Only for Engineers, Businesses, Schools and advanced Technicians. Goodheart, Box 1220PE, Beverly Hills, Calif. 90213.

## BUILD YOUR OWN SPACE-AGE TV CAMERA



**ONLY KNOWN SOLIDSTATE CAMERA KIT!** Ideal for experimenters, home, education, industry, etc. \* High quality \* Backed by over six years of lab & field testing. \* Fully Guaranteed \* Connects to any TV set without modification. \* Step-by-step construction manual. \* Model XT-1A, Series D complete with vidicon \$129.50 postpaid anywhere in USA & Canada (less vidicon tube \$116.50)

PHONE or WRITE for CATALOG.

DIAL 402-262-7773

Many other kits, parts and plans available including starter kits, focus-colls, vidicon tubes, const. plans, audio subcarrier kit, etc.

1301 BROADWAY

**ATV Research**

DAKOTA CITY, NEBR. 68731

**DIGITAL ELECTRONICS:** Complete schematics, parts lists, theories—Discrete Component Digital Clock, \$3.00—Sound Sensitive Switch, \$1.50. Increase technical competence, hobby skills—Complete Course in Digital Electronics is highly effective. \$10.00. Free literature. DYNASIGN, Box 60A7, Wayland, Mass. 01778.

**MECHANICAL, ELECTRONIC** devices catalog 10¢. Greatest Values—Lowest Prices. Fertik's, 5249 "D", Philadelphia, Pa. 19120.

## Atlantic CB INVENTORY

# SALE

EXCLUSIVE 3-CHANNEL,  
6-WATT HAND-HELD  
SSB / AM CB  
TRANSCEIVER

MIDLAND MODEL 13-778  
ATLANTIC CB PRICE—

Original  
List Price  
\$230.95

**\$99<sup>95</sup>**

**FEATURES INCLUDE:** 6-Watts P.E.P., 3-Watts AM. Dual Circuitry Provides AM, SSB Transmission, DeLuxe Dual Conversion, Super-Heterodyne Receiver. Combination SSB Clarifier-AM Delta Tuning. Exclusive IF Noise Blanker Circuit. Separate Speaker and Microphone. Convenient Battery Condition Meter. 3 Integrated Circuits, plus 2 FETs. Operates on 3 Modes: Standard AM, Upper Sideband (USB) and Lower Sideband (LSB), on Three Pre-Selected DB Channels. Plug-In Transmit and Receive Crystals for Channels 5, 11 and 17 Factory installed. Provides 9 Possible Combinations. Can be used in Car or Home, with Optional Accessories.

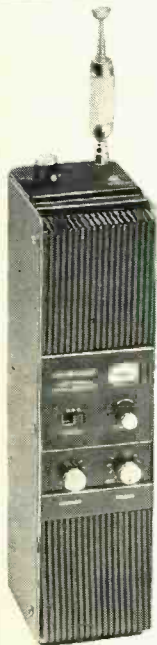

**U. S. ORDERS SEND  
CHECK OR MONEY OR-  
DER—WE WILL PAY ALL  
HANDLING CHARGES!  
CIRCLE NO. 3 ON READER SERVICE CARD**

## Atlantic CB

7748 CLEMENTS ROAD.  
WYNCOTE, PA 19099  
TEL: 455-5300 (215)



**FREE** Catalog lists resistors, tubes, transistors, rectifiers, condensers, tools, tuners, etc. Hytron Hudson, Dept. PE, 2818 Kennedy Blvd., Union City, N.J. 07087.

**SOUND SYNTHESIZER KITS**—Surf \$11.95, Wind \$11.95, Wind Chimes \$16.95, Electronic Songbird \$6.95, Musical Accessories, many more. Catalog free. PAIA Electronics, Box J14359, Oklahoma City, OK 73114.

**AUTHENTIC, INSTRUMENTED, FLYING ROCKETS** for casual or serious experimenters. Over 80 scale original, multi-stage or ready-to-fly models. Solid-propellant engines for safe, electric launch system liftoffs up to 2,500 feet. Measure altitude, temp. inversions, more. Real telemetry, electronic tracking, aerial still and movie photography with super-miniaturized equipment. New, detailed tech manual and full-color catalog. 25¢ from ESTES INDUSTRIES Dept. 18U, Penrose, Co. 81240.

## PAIA SYNTHESIZER KITS



- Models priced from \$139 -

**LIKE TO HEAR IT?  
NEED TO KNOW MORE?**

10 minutes of far out sounds  
created with the PAIA Synthesizer  
now on a demo record... 754 - , Catalog free

**PAIA ELECTRONICS, INC.**  
BOX P14359, OKLAHOMA CITY, OK 73114

**WHOLESALE** Scanners, CB., Crystals, Directories, SSB/AM, Catalog 25¢. G—ENTERPRISES, Box 461P, Clearfield, Ut. 84015.

**LOGIC** Probe \$9.95. Free bargain catalog. Electro, 4201 Irving Park, Chicago, Illinois 60641.

**CD IGNITIONS**, VHF/UHF monitors, crystals, CB radios. Wholesale. Southland, Box 3591-B, Baytown, Texas 77520.

**WAVEFORM GENERATOR KIT** 8038 Function Generator IC Producing Sine, Square, Triangular Waveforms, \$10.00. Write for catalog. Photolum Corporation, 118 East 28th Street, New York, N.Y. 10016.

**NEW FM Deviation Meters** \$75.00. Free Information. Write: ECM, 412A N. Winbach, Evansville, Indiana 47711.

**SURPLUS** electronic parts and pieces. Monthly picture flyer free. Startronics, Box 17127, Portland, Oregon 97217.

**BURGLAR-FIRE** alarm components, hardware. Free catalog—information. Silmar, 133 S.W. 57 Ave., Miami, Florida 33144.

### DISCOUNT PRICES

**B & K, SENCORE, LEADER Test Equipment**  
RAYTHEON, ICC/MULLARD Tubes  
TELEMATIC Test Jigs

## Free Catalog

**FORDHAM RADIO SUPPLY CO. INC.**  
558 Morris Ave., Bronx, N.Y. 10451

**FREE CATALOG.** Parts, circuit boards for POPULAR ELECTRONICS projects. PAIA Electronics, Box C14359, Oklahoma City, OK 73114.

**YOU SAVE BIG MONEY!** Surplus, Clearouts, Bankruptcy, Inventory, Deals. Catalog \$1 (redeemable). ETCOA Electronics, Box 741, Montreal, H3C 2V2. U.S. Inquiries.

**ELECTRONIC** Parts wholesale. Catalog 10¢. Donlyn Electronics, P.O. Box 15421, Phoenix, Arizona 85060.

MARCH 1974

## FREE 1974 CATALOG!!

**NEW .3" Char. Height YELLOW MAN 84 and red MAN 74 LEDs.** 3-4 only \$5.00 each. Also available with 7490, 7447, 7475 latch and G-10 epoxy board for 2, 4, or 6 digits.

**POWER SUPPLY KITS!**  
5, 12, 15 vDC @ 1 Amp. ± 12, 15 @ ± 300 ma. Short Circuit, thermal overload protection. All models include transformer mounted on the circuit board. 5v kit for only \$13.49. Instructions included.

**RESISTORS - 5% 1/2 watt CARBON FILM**  
Superior to composition in everyway, but at the same low price-12c each. Quantity Discounts.

**CAPACITORS** for bypassing, coupling, etc. Sub-miniature case. .001-22uF, 100 vDC .001 15c each. Quantity Discounts.

**ALUMINUM ELECTROLYTICS** 1-1000 uF from 16-50 vDC. These are high quality ICC units at a very low price.

**OTHER 7400 PARTS AVAILABLE** as well as op amps, transistors, display bezels, and cases for your projects. **MANY SURPLUS** items also. All products guaranteed - **NAME BRANDS ONLY.** Mastercharge and Bank Americard accepted.

## Tracy Design Corporation

**15870 Schaefer Detroit, Mich. 48227**

**CIRCLE NO. 29 ON READER SERVICE CARD**

**BURGLAR-FIRE** alarm supplies and information. Free catalog. Protecto Alarm Sales, Box 357-G, Birch Run, Michigan 48415.

**ELECTRONIC ORGAN KITS, KEYBOARDS** and many components. Independent and divider tone generators. All diode keying. I.C. circuitry. Build any type or size organ desired. Supplement your Artisan Organ. 35¢ for catalog. DEVTRONIX ORGAN PRODUCTS, Dept. C, 5872 Amapola Drive, San Jose, Calif. 95129.

**BRAIN WAVE MONITOR** Biosone BF-20 Alpha Biofeedback Instrument. \$34.95 complete. Not a kit. Fully Guaranteed. For information write: BIO-LOGIC DEVICES, INC., Dept. A, 888 Seventh Avenue, New York, New York 10019.

**LEDs**, sample pack of 10, includes green and yellow, \$3.25, postpaid U.S.A. East Coast Electronics, 50 Scott St., Hamburg, New York 14075.

**FREE!** Diodes and catalog. BDJ Electronics, 11 Revere, Tappan, New York 10983.

**FREE CATALOG.** IC's, Puts, Transducers, Thermocouples, Led's, Transistors, Circuit Boards, parts. Chaney's, Box 15431, Lakewood, Colo. 80215.

**CALCULATOR OWNERS:** Use your + - × ÷ calculator to compute square roots, cube roots, sin(x), cos(x), tan(x), arcsin(x), arccos(x), arctan(x), logarithms, exponentials, and more! Quickly, Accurately, Easily! Send today for the IMPROVED AND EXPANDED EDITION of the first and best calculator manual—now in use throughout the world... only \$2.00. Unconditional money-back guarantee—and FAST service! Mallmann Optics and Electronics, Dept. 12A, 836 South 113, West Allis, Wisconsin 53214.

**BUGGED???** New locator finds them fast. Write, Clifton, 11500-L N.W. 7th Avenue, Miami, Florida 33168.

**PROJECT TV** image life size! Construction plans: \$2.00. Macrovision, Box 14197, San Francisco, CA 94114.

**BIOFEEDBACK.** Professional instruments: Electroencephalophone, Galvanic Skin Response. J&J, 8102-E, Bainbridge, WA. 98110.

# DIGITAL TO ANALOG CONVERTERS

## DESCRIPTION

The SS-2000 series of Digital to Analog Converters feature a combination of linearity, temperature stability, and settling time compatible with moderate to severe environment operational requirements, at the lowest possible cost.

Use of stable thin film resistor networks, high quality reference devices and low drift operational amplifiers offers the user the most economical solution where reliability and long term stability are important requirements.

The SS2035, SS2135, and SS2235 are 8-, 10- and 12-bit binary D/A converters respectively; whereas SS2635 and SS2735 are 3 and 4 digit BCD D/A converters.

## FEATURES

- \* **LOW LINEARITY DRIFT** - 0.0005% per °C for binary and  $\pm 1/2$  LSB for BCD converters over full operational temperature range of 0°C to +70°C.
- \* **INTERNAL/EXTERNAL REFERENCE** - User selectable by jumper wire. Internal reference available for external use.
- \* **FULL SCALE AND ZERO OFFSET ADJUSTABLE** - externally fine-trimable for improved accuracy.
- \* **RUGGED CONSTRUCTION** - encapsulated module designed for DIP iC compatibility. High quality brass, gold plated pins, 0.1" centers.

## OPERATIONAL CHARACTERISTICS

SPECIFICATION	SS2035, SS2135, SS2235	SS2635	SS2735
Full Scale Output Voltage Range	0V to +10V, Straight Binary Code -5V to +5V, Offset Binary Code -10V to +10V, Offset Binary Code	0V to +9.99V, BCD Code	0V to +9.999V BCD Code
Output Impedance (DC)	< 0.1 ohm	< 0.1 ohm	< 0.1 ohm
Reference Output	+10.08V nominal at 5mA	+10.08V nominal at 5mA	-10.00V nominal at 5mA
Input Logic Levels	TTL/OTL Compatible $V_H = \text{Logical '1'}$ , +2.1V to +5.5V; $V_L = \text{Logical '0'}$ , 0V to +0.7V		
Data Loading	1 TTL Load/Line		
Temperature Range: Rated Specifications Operational Storage	0°C to +70°C -25°C to +85°C -55°C to +100°C		
Power Requirements	+15V $\pm 5\%$ at 30mA -15V $\pm 5\%$ at 20mA +5V $\pm 5\%$ at 80mA		
Dimensions L x W x H	2" x 2" x 0.54"	2" x 2" x 0.54"	3" x 2" x 0.54"

## SPECIFICATIONS ( $T_A = 25^\circ\text{C}$ UNLESS OTHERWISE NOTED )

SPECIFICATION	SS2035	SS2135	SS2235	SS2635	SS2735
Resolution	8 Binary Bits	10 Binary Bits	12 Binary Bits	3 Digit BCD	4 Digit BCD
Setting Time (to $\pm 0.05\%$ of full scale, 0 to +10V)	20 $\mu$ S	20 $\mu$ S	20 $\mu$ S	20 $\mu$ S	20 $\mu$ S
Linearity in percent of full scale (at 25°C) (at 0°C to +70°C)	0.2 0.25	0.05 0.075	0.0125 0.0375	0.05 0.075	0.01 0.035
Zero Offset in percent of full scale	0.2	0.05	0.05	0.05	0.05
Scale Factor (Gain) Error in percent of reading	0.2	0.1	0.1	0.1	0.1
Zero Drift in percent of full scale per °C from 0°C to +70°C	0.005	0.002	0.002	0.002	0.001
Scale Factor (Gain) Drift in percent of reading per °C from 0°C to +70°C with Internal Reference with External Reference	0.005 0.003	0.005 0.003	0.004 0.002	0.004 0.002	0.003 0.001
Output Load, rated specification (short circuit proof) $R_L$ in K $\Omega$ $C_L$ in pf	$\geq 2$ $\leq 1000$	$\geq 2$ $\leq 1000$	$\geq 2$ $\leq 1000$	$\geq 2$ $\leq 1000$	$\geq 2$ $\leq 1000$
Long Term Stability in percent of full scale per 1000 hours per year	0.1 0.3	0.05 0.1	0.05 0.1	0.05 0.1	0.025 0.05

## PRICE LISTING D/A CONVERTERS

Catalog Number	Description	1-4	5-9	10-24	25-up	Grouping Code
95-02035	Model SS2035 D/A Converter	20.75	19.75	18.75	17.75	28
95-02135	Model SS2135 D/A Converter	29.50	28.25	27.00	25.75	28
95-02235	Model SS2235 D/A Converter	45.00	43.00	41.00	39.00	28
95-02635	Model SS2635 D/A Converter	38.00	36.00	34.00	32.00	28
95-02735	Model SS2735 D/A Converter	65.00	62.00	59.00	56.00	28

# ANALOG TO DIGITAL CONVERTERS

## DESCRIPTION

The SS-3000 series of Analog to Digital Converters are highly versatile over a wide range of applications such as Digital Panel Meters, Data Acquisition Systems, Low or High Level Transducer Readouts, and others. The BCD coded outputs of these converters makes them ideal for use when a digital readout of the analog signal is required by simple addition of necessary decoder/driver and appropriate display.

Models SS3535 and SS3635 are unipolar 2- and 3-digit A/D converters utilizing "section counting" multiple comparator technique. Model SS3638A is a bipolar 3½ digit A/D converter with true differential input and an input impedance of 100MΩ! Separate overrange and overload bits provide for extreme simplicity in interfacing with any digital system. Models SS3735 and SS3735B are unipolar and bipolar 4-bit A/D's respectively. The principle of "section counting" is employed here again for precise conversion down to 1mV.

## OPERATIONAL CHARACTERISTICS

SPECIFICATION	SS3535	SS3635	SS3638A	SS3735	SS3735B
Inputs					
Analog, Full Range	0 to +9.9V	0 to +9.99V	±1.999V	0 to +9.999V	±9.999V
Digital, Convert Start	Pos. Edge	Pos. Edge	Pos. Edge	Pos. Edge	Pos. Edge
Input Impedance					
$R_{in}$	1MΩ	1MΩ	100MΩ	10KΩ	10KΩ
shunted by $C_{in}$	10pF	10pF	10pF	10pF	10pF
Internal Reference	10.08V (Nominal)				
Temperature Range:					
Rated Specification	0°C to +70°C				
Operational	-25°C to +85°C				
Storage	-55°C to +100°C				
Power Requirements	+15V ±5% at 60mA -15V ±5% at 24mA +5V ±5% at 200mA		+15V ±5% at 40mA -15V ±5% at 15mA +5V ±5% at 180mA	+15V ±5% at 45mA -15V ±5% at 45mA +5V ±5% at 350mA	
Dimensions L x W x H	4" x 2" x 0.54"		4" x 2" x 0.54"		3" x 2" x 0.54" (2 units)

## SPECIFICATIONS (T<sub>A</sub> = 25°C UNLESS OTHERWISE NOTED)

SPECIFICATION	SS3535	SS3635	SS3638A	SS3735	SS3735B
Resolution (Number of BCD Digits)	2	3	3 + Sign Bit + 100% Overrange	4	4 + Sign Bit
Coding	8-4-2-1	8-4-2-1	8-4-2-1	8-4-2-1	8-4-2-1
Conversion Time	50μSec	100μSec	10mS Full Scale 20mS Full Range	200μSec	200μSec
Linearity in percent of Full Scale (at 25°C)	0.5	0.05	0.03	0.01	0.01
(0°C to +70°C)	0.5	0.075	0.05	0.035	0.035
Zero Offset in percent of Full Scale	0.5	0.05	0.05	0.05	0.05
Scale Factor (Gain) Error in percent of reading	0.5	0.1	0.1	0.1	0.1
Quantizing Error in percent of reading	0.5	0.05	0.05	0.005	0.005
Zero Drift in percent of Full Scale per °C (0°C to +70°C)	0.005	0.002	0.002	0.001	0.001
Scale Factor (Gain) Drift in percent of reading per °C (0°C to +70°C)					
with internal reference	0.008	0.004	0.004	0.003	0.003
with external reference	0.005	0.002	0.002	0.001	0.001
Long Term Stability in percent of Full Scale: Per 1000 Hours	0.1	0.05	0.05	0.025	0.025
Per Year	0.3	0.1	0.1	0.05	0.05

## PRICE LISTING A/D CONVERTERS

Catalog Number	Description	1-4	5-9	10-24	25-up	Grouping Code
95-03535	Model SS3535 A/D Converter	55.00	52.00	49.00	46.00	28
95-03635	Model SS3635 A/D Converter	100.00	96.00	92.00	88.00	28
95-13638	Model SS3638A A/D Converter	80.00	76.00	72.00	68.00	28
95-03735	Model SS3735 A/D Converter	150.00	144.00	138.00	132.00	28
95-23735	Model SS3735B A/D Converter	190.00	180.00	170.00	160.00	28
60-01267	Complete set of data sheets for all A/D and D/A converters	.50	---	---	---	28

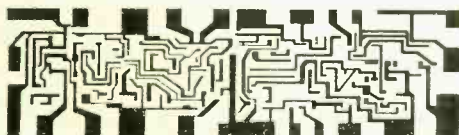

WRITE:

SOLID STATE SYSTEMS, INC.  
P. O. BOX 773  
COLUMBIA, MISSOURI 65201



**SOLID STATE SYSTEMS, INC.** PHONE TOLL FREE: 800-325-2595 & 800-325-2981

CIRCLE NO. 32 ON READER SERVICE CARD





### SEMICONDUCTOR SPECIAL

**MAN 1 Type Readouts**  
\$2.50 each  
Best Price In U.S.A.!

**Motorola HEP 170 rectifiers.** Rated a full 2½ amps at 1000 PIV. Miniature plastic 4 for \$1.00 — 10 for \$2.

**40 WATT Audio output pair.** Plastic TO-220 power transistors by G.E. PNP and NPN. \$3.95 pair

**Phase Lock Loop.** NE 567V mini dip — \$2.95.

**Full Wave Bridges.** Varo VS647. 2 amps, 600 PIV — \$95.

**LM309K.** 5V Regulator — \$1.95\* 741C mini dip — \$4.9.

**Reed Relay.** Subminiature Size SPST N.O. Coil 500 ohm. Operates at 5V. DC. 10 MA. compatible with TTL IC's — \$3.95.

**Filter Cap Special.** Dual section 1000 + 1000 MFD at 75 WVDC Twist Lock type — \$3.95.

#### FACTORY TESTED TTL DIP'S

7400 — \$25	7427 — \$35	7483 — \$89	74121 — \$49
7402 — \$25	7439 — \$65	7486 — \$40	74164 — \$195
7404 — \$25	7447 — \$95	7490 — \$95	74192 — \$140
7407 — \$30	7473 — \$40	7491 — \$95	74193 — \$140

#### SEMICONDUCTOR GRAB BAGS

We bought over 20 million various semis and IC's, direct from the factory. There are many usable devices. **BUT, we cannot test them all.** You can buy untested and save.

TTL and LINEAR IC assortment contains ½ pound (Approximately 200 pieces) mixed TTL and LINEAR IC's untested, includes logic gates, Flip flops, counter, FM detectors chroma demod IC's, etc. Marked and unmarked, with some spec sheets. — \$3.95.

**COMPUTER DIODE GRAB BAG** — IN914 and IN4148 type silicon diodes. Many good units ½ pound. (Approximately 1,400 pieces) — \$3.95 untested.

**GERMANIUM DIODE ASSORTMENT** ½ pound (Approximately 1,200 pieces). like IN270, etc. Many usable devices — \$3.95 untested.

**STEREO AUDIO AMPS, TWO** — 2 watt amps on one chip. We bought too many to test. Untested, but many usable units, with spec sheets. 3 for \$1.00.

**PLASTIC TRANSISTOR ASSORTMENT**, mfg. by T.I. contains NPN and PNP silicon. TO-92 case, many usable units. We have more than we can test. 100 piece assortment — \$1.49.  
New for 74! 4 bags for \$5.00.

#### SPECIAL OFFER

On every \$15.00 order, choose \$1.00 worth of free merchandise.

**ALTAJ ELECTRONICS**  
P. O. Box 28592  
Dallas, Texas 75228

Terms: Check or Money Order. No COD. Add 10% of order to help cover postage. Bargain flyer \$1.10, free with order.

### CIRCLE NO. 2 ON READER SERVICE CARD

**DIGITAL logic trainers.** Digital and analog modules. LED displays. Scientific Measurements, 2945 Central, Wilmette, Illinois 60091.

**WE SELL MONEY MAKING CONSTRUCTION MANUALS!**—Reclaim refined GOLD and SILVER for EXCELLENT full time or part time money!—Color Catalog .25¢—Airmailed .50¢. Creative Products, Dept. PE-374, 8415 Lofland, Houston, Texas 77055.

**FREE CATALOG**—Tremendous electronics bargains. Compukits, Box 4188L, Mountain View, California 94040.

**BUILD Numerical Readout Test Instruments and Futuristic Gadgets:** Free Information. GBS, Box 100P, Green Bank, West Virginia 24944.

**ELECTROSLEEP**, acupuncture. Catalog of 200 more projects free. Cimarron Labs, G-13060 Center Rd., Clio, Michigan 48420.

**DIGITAL/ANALOG PLANS FOR HOME AND LAB!!!** For free catalog write: MP Publishing Co., Box 378-P, Belmont, Massachusetts 02178.

**SEMICONDUCTORS**, parts, IC's. Price list free. Samples, \$1.00 box. Davis Associates, 16 Grove, Londonderry, N.H. 03053.

**ALPHA/THETA BRAINWAVE biofeedback instruments.** Analog instruments from \$125; digital processing systems from \$225. BioScan, Box 14168-E, Houston, Texas 77021.

**SOLAR ENERGY COMPANY** offering: Solar battery chargers for yachts, autos, radios, 12V 1200mW \$75.00; swimming pool heating systems; wind driven electric generators 12V 168W \$495.00; design manual for systems \$10.00. 810 18th Street, N.W., Washington, D.C. 20006.

**"EDWARD'S Bargain Catalog"** Send \$1.00 for post. and handling, deductible on first order to: Edward's 37 Lexington Ave., Methuen, Mass. 01844.

**TELEPHONE "BUGGED"?** Countermeasures Brochure \$1.00. Negeye, Drawer 547, Pennsboro, W. VA 26415.

**JAPANESE TRANSISTORS**, Wholesale Prices, Free Catalog. West Pacific Electronics, Box 25837, W. Los Angeles, CA 90025.

**LASER parts catalog**, 60¢. Moynihan, 107 North Brighton, Atlantic City, New Jersey 08401.

**DIAGRAMS**, Radio-Television individual material, mostly \$2. Beitman, 1760 Balsam, Highland Park, Illinois 60035.

**DISCOVER A NEW HOBBY!** Collect old-time radios for fun and challenge. Fastest-growing hobby. Is there a fortune in your attic? **VINTAGE RADIO pictorial reference**, 1,000 photos, 263 pages, \$4.95. **RADIO COLLECTOR'S GUIDE**, 50,000 facts, 264 pages, \$3.95. **1927 RADIO ENCYCLOPEDIA**, 175 pages, \$9.95. Vintage Radio, Dept. P, Box 2045, Palos Verdes Pnsia. CA 90274. Send a check today!

**AIRCRAFT TYPE HEADSET** with tube loaded mike for CB walkie-talkies only \$9.95, literature 25¢ refundable. Dept. E. Campbell & Company, Box 91654, L.A., Calif. 90009.

**TELEPHONE answering machines** sold directly by manufacturer. Only \$78. Takes 90 messages in high-fidelity. 1 year guarantee worth retail over \$225. TRDL, 4880 49 Street, North St. Petersburg, Florida 33709.

## PLANS AND KITS

**TESLA COIL**—40" SPARKS! Plans! \$7.50. Information 75¢. Huntington Electronics, Box 2009-P, Huntington, Conn. 06484.

**ELECTRONIC Slot Machine** type game. Plans \$5.00. KAB, 1923 Fern, Royal Oak, Michigan 48073.

**FIBEROPTICS:** Sample kit, instructions plus complete catalog of F.O., 50¢—Kits, Glass, Plastic Fibers; Light sources; Lowest factory outlet prices anywhere! Luxline, Box 211, Melrose, Mass. 02176.

**PLANS:** Logic tester, multimeter, electronic dice, power supplies; \$1.50 each. MCT, 4510 Stinson Blvd., Col. Hgts., MN 55421.

**NEW!**

**CONVERT TV TO 6 FT. WIDE SCREEN!**

**Easy Do-It-Yourself Kit**

Project a giant 5'x6' picture onto wall or screen. B&W/Color. Kit contains detailed plans, Inst., and Precision Lens System. Only \$15.95 ppd., or write for Free illustrated details. **The Macrocoma Co., Dept. DCE** Washington Crossing, PA 18977

**Guaranteed to Work!**



**FUN Kits** novel, entertaining, educational. Build electronic touch switch, audio a arm, digital clock, others. Send for free flyer. ADVENT ELECTRONICS, Dept. PE, P.O. Box 252, Lafayette Hill, PA 19444.

## HIGH FIDELITY

**DIAMOND NEEDLES** and Stereo Cartridges at Discount prices for Shure, Pickering, Stanton, Empire, Grado and ADC. Send for free catalog. All merchandise brand new and factory sealed. LYLE CARTRIDGES, Dept. P, Box 69, Kensington Station, Brooklyn, New York 11218.

**SAVE 50%.** Build your own speaker systems featuring Norelco, Eminence and CTS. Famous brands from world's largest speaker factories at lowest wholesale prices. Write for 176 page catalog for speakers and electronic accessories. McGee Radio Company, 1901 McGee Street, Kansas City, Missouri 64108.

## ELECTRICAL SUPPLIES AND EQUIPMENT

**PLATING** Equipment, Portable Platers. Supplies and "Know-How." Build your own tanks for nickel, chrome, etc. Easy-to-install PVC liners. Rectifier components—all sizes. Schematics, parts lists, formulas, operating instructions for all plating. Guaranteed to save you 25%-75%. Some good units for sale. Write for details. Platers Service Company, 1511-PE Esperanza, Los Angeles, Calif. 90023.

LIGHT EMITTING DIODES		TRANSISTORS SPECIALS		C MOS (DIODE CLAMPED)	
MRD 148 Photo	\$ .75	2N11378 PNP TO-3 GE	\$ .95	CD 4001	\$ .65
Darlington	\$ .80	2N2222 NPN Si TO-92 S	\$ 1.00	CD 4009	\$ 1.50
MT2 Photo Transistor	\$ .80	2N3137 PNP Si TO-5 4	\$ 1.00	CD 4010	\$ .65
MCT-2 Opto. Isolator	\$ .90	2N1605 NPN GE TO-5 5	\$ 1.00	CD 4011	\$ .65
OSL-3 GaP VIS. LED	\$ .59	MPS3393 PNP Si TO-18	\$ 1.00	CD 4013	\$ 1.60
MCD-2 Opto. Isolator	\$ .90			CD 4016	\$ 1.50
MCA-2-30 Photo Relay	\$ .90	2N2218T NPN Si TO-5 4	\$ 1.00	CD 4017	\$ .65
ME4 IR LED's	\$ .59	2N3767 PNP Si TO-66	\$ .70	CD 4030	\$ .65
GREEN GaP OSL-16 LED	\$ .90				
7400	28	7480	70	LM 309K SV	
7401	28	7483	1.25	1 Amp Regulator	\$ 2.25
7402	28	7486	.50	741 OPER. AMP	\$ .47
7403	28	7490	1.50	709 OPER. AMP	\$ .47
7404	33	7491	1.25	723 Regulator	\$ .75
7405	30	7492	1.30	703RF 1F Amp	\$ .80
7407	50	7493	1.30	565 Phase Lock Loop	\$ 2.95
7408	32	7494	1.30	567 Tone Decoder	\$ 2.95
7410	28	7495	1.30	560 Phase Lock Loop	\$ 2.95
7411	32	7496	1.10	561 Phase Lock Loop	\$ 2.95
7412	40	74107	.75	536 FET Input Oper Amp	\$ 2.95
7413	85	74121	.75	537 Precision 741	\$ 1.25
7416	50	74123	1.10	LM308 Oper Amp	\$ 1.95
7417	50	74129	1.50	101 Oper Amp	\$ .75
7420	28	74126	1.50	741A Oper Amp	\$ .47
7422	32	74149	1.00	320-SV Reg.	\$ 1.75
7426	35	74151	1.25	748 Oper Amp	\$ .90
7427	55	74154	1.95	LM370 AGC Squelch Op.	\$ 1.25
7430	28	74157	1.50	LM380 2 Watt Amp	\$ 1.75
7437	60	74164	2.20	2 Watt Stereo IC & Pin Dip	\$ 3.95
7438	55	74165	2.20	LM319 Dual HiSpeed	\$ 1.50
7440	28	74173	2.20	Comparator	\$ 1.50
7441	1.50	74176	1.95	LM382 Stereo Preamp	\$ 1.75
7442	1.50	74177	1.95		
7446	1.50	74192	1.75		
7447	1.50	74193	1.75		
7448	1.50	74195	1.75		
7450	28	75451	1.00		
7451	30	75452	1.00		
7470	50	74173	2.20		
7472	50	8211	1.50		
7473	60	8220	1.50		
7474	55	8217	1.75		
7475	1.00	936	1.50		
7476	75	LM351	1.00		

FULL WAVE BRIDGES		Silicon Power Rectifiers	
PRV	2A 6A	100	.06 .11 .30 .85
	200   .95   1.25	200	.07 .16 .35 1.25
	400   1.15   1.50	400	.09 .20 .45 1.50
	600   1.35   1.75	600	.11 .30 .70 2.00
		800	.15 .40 .85 2.30
		1000	.20 .55 1.10 2.75

TRIACS		SCR's	
PRV	1A 10A 25A	1.5A	6A
100	.40   .70   1.30	.40	.50
200	.70   1.10   1.75	.60	.70
400	1.10   1.60   2.60	1.00	1.20
600	1.70   2.30   3.00		

CAPACITORS	
6V 30 UF TANT	\$ 5/1.00
20V 4.7 UF TANT	\$ 5/1.00
12V 10 UF ELECT.	\$ 5/1.00
50V 100 UF ELECT.	\$ 4/.40
25V AT 30 UF	\$ 4/1.00

NIXIE TUBE	
RAYTHEON 8650 WITH SOCKET	\$ 2.25
AND DATA SHEET	\$ 2.25 3/\$8.00

SLA-3 7 Segment LED Readout 77" Num-	
bers 45 ma 1 Seg.	\$ 7.95

INJECTION LASER—A SINGLE DIODE GW	
25A GaAs UNIT SIMILAR TO RCA 40859	\$ 10.95

DATA LIT 707 READOUT	
S3.25	
MAN-4 LED READOUT	\$ 3.50
MAN-3 LED READOUT	\$ 2.95

5311—Clock Chip featuring BCD, hold count and Output Strobe	
\$11.50	

5314—Clock Chip, 6 Digit readout hold count and Output Strobe	
\$9.50	

ASCII Encoded Terminal Keyboards	
\$60.00	

14 Pin IC Sockets	
\$ .40	

Printed circuit board 4 1/2" x 6 1/2" double sided fiber glass board 1/16" thick, unetched.	
\$ .60 ea. 5/\$2.50	

Miniature Trim Pots	
SK, 10K, 20K, 25K, 50K, 100K	\$ .75 3/\$2.00

C MOS (DIODE CLAMPED)	
LM 309K SV	\$ 2.25
741 OPER. AMP	\$ .47
709 OPER. AMP	\$ .47
723 Regulator	\$ .75
703RF 1F Amp	\$ .80
565 Phase Lock Loop	\$ 2.95
567 Tone Decoder	\$ 2.95
560 Phase Lock Loop	\$ 2.95
561 Phase Lock Loop	\$ 2.95
536 FET Input Oper Amp	\$ 2.95
537 Precision 741	\$ 1.25
747 Dual 741	\$ 1.25
LM308 Oper Amp	\$ 1.95
101 Oper Amp	\$ .75
741A Oper Amp	\$ .47
320-SV Reg.	\$ 1.75
748 Oper Amp	\$ .90
LM370 AGC Squelch Op.	\$ 1.25
LM380 2 Watt Amp	\$ 1.75
2 Watt Stereo IC & Pin Dip	\$ 3.95
LM319 Dual HiSpeed	\$ 1.50
Comparator	\$ 1.50
LM382 Stereo Preamp	\$ 1.75

555-US-2 HR. TIMER	
\$1.40	

556-HIGHSPEED OP. AMP	
\$1.13	

558-DUAL OP. AMP.	
\$ .88	

7522-SENSE AMP.	
\$1.69	

501-VIDEO AMP.	
\$1.00	

711-DUAL COMPARTOR	
\$ .47	

LM300-REGULATOR	
\$1.25	

CONDUCTIVE ELASTOMETER LOW PROFILE CALCULATOR KEYBOARD	
\$6.50	

FLEX KEY, 19 SK-6 KEYBOARD	
\$6.50	

HAWKIN Q-9	
\$6.50	

K-C BUTTONS WITH OFF. ON SWITCH	
\$6.50	

Terms: FOB Cambridge, Mass. Minimum Order \$3.00. Rated Companies 30 Days Net	
Send \$2.00 for our latest catalog featuring transistors and rectifiers	

# SOLID STATE SALES

Post Office Box 74A Somerville, Mass. 02143 Tel. (617) 547-4005

CIRCLE NO. 31 ON READER SERVICE CARD

## WANTED

**QUICKSILVER**, Platinum, Silver, Gold, Ores Analyzed. Free Circular. Mercury Terminal, Norwood, Mass. 02062.

**CAPACITORS WANTED:** Computer-Grades, Tantalums, Mylars, Discs.—Cash Paid—National Electronics Supply, Dept. P1, 7231-B Garden Grove Blvd., Garden Grove, Calif. 92641.

**GENERATOR**, Wind Driven. McPhee, Topaz, CA 96133.

## TUBES

**RADIO & T.V. Tubes**—36¢ each. Send for free Catalog. Cornell, 4213 University, San Diego, Calif. 92105.

**RECEIVING & INDUSTRIAL TUBES. TRANSISTORS.** All Brands—Biggest Discounts. Technicians, Hobbyists, Experimenters—Request **FREE** Giant Catalog and **SAVE!** ZALYTRON, 469 Jericho Turnpike, Mineola, N.Y. 11501.

**TUBES "Oldies"**, latest. Lists free. Steinmetz, 7519 Maplewood, Hammond, Indiana 46324.

**SAVE** money on parts and transmitting-receiving tubes, foreign-domestic. Send 25¢ for giant catalog. Refunded first order. United Radio Company, 56-P Perry Street, Newark, N.J. 07105.

**TUBES** receiving, factory boxed, low prices, free price list. Transleteronic, Inc., 1306 40th Street, Brooklyn, N.Y. 11218A, Telephone: 212-633-2800.

**CASH** Paid for obsolete receiving tubes WE300B, WE350B, WE252A, WE310A, WE274A, WE262B, WE284D, RCA45, RCA50, and Movie Theatre we amplifier models 91B, 86F. Contact: M. Takabe, 303 Fifth Avenue, N.Y.C. (212) 679-1970.

## TAPE AND RECORDERS

**RENT 4-Track** open reel tapes—all major labels—3.000 different—free brochure. Stereo-Parti, 55 St. James Drive, Santa Rosa, Ca. 95401.

**USED SCOTCH MAGNETIC TAPE**

1800 FOOT, 7 INCH REEL, 1 MIL POLYESTER, 150. BULK ERASED (NO BOX), 99¢ PLUS 10% FOR SHIPPING & HANDLING & MINIMUM ORDER (10 REELS). "LIKE NEW" EMPTY 10 1/2 INCH REELS; FIBERGLASS, 3/4" CENTER HOLE, 50c. ALUMINUM, NAB 3" CENTER HOLE, \$1.00—BOTH CHEAPER IN LARGER QUANTITIES—ALL PLUS POSTAGE BY WEIGHT & ZONE (INCREDIBLE BARGAINS ON NEW, FAMOUS BRAND TAPES & CASSETTES).

**SAXITONE TAPE SALES**  
1776 Columbia Rd., N.W. Washington, D.C. 20009



**CATALOGS!** Receive many! Catalog Directory \$1.00. Box 3308R, District Heights, Md. 20028.

**SWL's HAMS "Short Wave Sounds"** is a 30 minute cassette with examples and explanations of all types of transmissions heard on the HF bands. \$5.95. J. E. Cunningham Associates, 1669 Bunts Road, Lakewood, Ohio 44107.

**1930-1962 Radio Programs.** Reels, \$1.00 hour! Cassettes, \$2.00 hour! . . . Mammoth catalog, \$1.00 . . . Six hour 4T sample reel, \$5.00!!! AM Treasures, Box 192F, Babylon, N.Y. 11702.

## PERSONALS

**MAKE FRIENDS WORLDWIDE** through international correspondence. Illustrated brochure free. Hermes, Berlin 11, Germany.

**BUGGED???** . . . Detectors locate hidden transmitters. Literature 25¢. Security, Box 671, Westwood, N. J. 07675.

## MOVIE FILMS

**8MM-SUPER 8-16MM MOVIES!** Biggest Selection! Lowest Prices! Free Catalog! Cinema Eight, Box PE, Chester, Connecticut 06412.

## INSTRUCTION

**LEARN ELECTRONIC ORGAN SERVICING** at home all makes including transistor. Experimental kit—trouble-shooting. Accredited NHSC, Free Booklet. **NILES BRYANT SCHOOL**, 3631 Stockton, Dept. A, Sacramento, Calif. 95820.

**LEARN WHILE ASLEEP**, Hypnotize! Strange catalog free. Auto-suggestion. Box 24-ZD, Olympia, Washington 98501.

**DEGREE IN ELECTRONICS** through correspondence. Free catalog. Grantham, 2000 Stoner Avenue, Los Angeles, California 90025.

**INTENSIVE 5 week course** for Broadcast Engineers. F.C.C. First Class license. Radio Engineering Incorporated, 52 S. Palm Ave., Sarasota, Florida 33577.

**SHORTCUTS To Success!** Highly Effective, Profitable Short Courses. (75 Choices). Study At Home. Diploma Awarded. Our 27th Year. Free Literature. CIEE-D. Box 10634, Jackson, Miss. 39209.

**F.C.C. EXAM MANUAL**  
PASS FCC EXAMS! Memorize, study Tests-Answers for FCC 1st and 2nd class Radio-telephone licenses. Newly revised multiple-choice questions and diagrams cover all areas tested in FCC exams—plus Self-Study Ability Test. \$9.95 postpaid. Moneyback Guarantee.  
COMMAND PRODUCTIONS RADIO ENGINEERING DIVISION P.O. BOX 26348-P SAN FRANCISCO, CALIF. 94126

**DEGREE Program in Electronics Engineering.** Our 27th Year! Free Literature. Cook's Institute, Dept. 13, Box 10634, Jackson, Miss. 39209.

**KNOW your electronics I.Q.#** Self scoring exam. Rush \$3.00 guaranteed! Omicron, Dept. 1012, Box 10219, Albuquerque, New Mexico 87114.

DIGITAL:THEORY,DESIGN,  
CONSTRUCTION

## LOGIC NEWSLETTER<sup>®</sup>

SAMPLE COPY \$1.00  
LOGIC NEWSLETTER  
POB 252  
WALDWICK,N.J. 07463

**SCORE high on F.C.C. Exams . . .** Over 300 questions and answers. Covers 3rd, 2nd, 1st and even Radar. Third and Second Test, \$14.50; First Class Test, \$15.00. All tests, \$26.50. R.E.I., Inc, Box 806, Sarasota, Fla. 33577.

**LICENSE-AID** formula chart. Formulas you should be able to work with before sitting for Second and First class FCC license exams. \$7.00 each. License-Aid, Box 1497, Moultrie, Georgia 31768.

**LEARN ELECTRONICS.** College level course. FCC license, Broadcast Engineering, Satellite Communications. Home Study. Free Brochure. GTI, 5540 Hollywood Bv., Hollywood, Ca. 90028.

## GOVERNMENT SURPLUS

**GOVERNMENT Surplus.** How and Where to Buy in Your Area. Send \$2.00. Surplus Information, Headquarters Bldg., Box 30177-PE, Washington, D.C. 20014.

**ELECTRONIC Equipment and Parts.** Big 36 page Free Catalog. Send for your copy today! Fair Radio Sales, Box 1105-P, Lima, Ohio 45802.

**JEeps, TRUCKS,** Cars From \$31.50 . . . Airplanes, Typewriters, Clothing, Multimeters, Transceivers, Oscilloscopes, Photographic Electronics Equipment . . . 100,000 Surplus Bid Bargains Direct From Government Nationwide Typically Low as 2¢ on Dollar! Complete Sales Directory and Surplus Catalog \$1.00 (Deductible First \$10 Order From Included Catalog). U.S. Surplus Disposal, 2200 Fuller 601B-PEL, Ann Arbor, Michigan 48105.

**MANUALS** for Govt Surplus radios, test sets, scopes. List 50¢ (coin). Books, 7218 Roanne Drive, Washington, D.C. 20021.

## INVENTIONS WANTED

**CASH-ROYALTIES** for patented, unpatented inventions. Global Marketing Service. 2420-P 77th, Oakland, California 94605.

**FREE "Directory of 500 Corporations Seeking New Products."** For information regarding development, sale, licensing of your patented/unpatented invention. Write: Raymond Lee Organization, 230-GR Park Avenue, New York City 10017.

**INVENTORS:** Protect your ideas! Free "Recommended Procedure". Washington Inventors Service, 422T Washington Building, Washington, D.C. 20005.

**PATENT Searches** including Maximum speed, full airmail report and closest patent copies. Quality searches expertly administered. Complete secrecy guaranteed. Free Invention Protection forms and "Patent Information," Write Dept. 9, Washington Patent Office Search Bureau, Benjamin Franklin Substation, P.O. Box 7167, Washington, D.C. 20044.

**FREE PAMPHLET:** "Tips on Safeguarding Your Invention." Write: United States Inventors Service Company, 708-T Carry Building, Washington, D.C. 20005.

**INVENTORS!** Either we will sell your Invention before you or anyone else does, or we will pay you a cash bonus. Get Free Invention Evaluation and information: Write Gilbert Adams Organization, Invention Brokerage, Dept. 20, 80 Wall St., New York, NY 10005.

**FILE your own Patent Application.** Complete information and materials for simplified method. Details Free. Inventor's Guide, 468-R Goodspeed Road, Virginia Beach, Virginia 23451.

## PLASTICS

**CASTOLITE** pours like water, hardens like glass without heat. Crystal clear, colors. Embed flowers, seashells, momentos, anything. Make fine gifts. Form flexible molds over any pattern, size. Reproduce your own designs in plastics, candle wax, metal, plaster, cement. Profitable. Illustrated Manual and Catalog Only 50¢. CASTOLITE, Dept. 74C/PE, Woodstock, Ill. 60098.

## RESORTS AND TRAVEL

**BERTH & Partnership** in 155 ft. 3-masted Barquentine for \$10,700. Join in Europe, assist conversion then help sail on 2-year Adventure & Business World Voyage. Write: R. Bruderer, IYC, Box 149 Broadway, NSW Australia 2007.

## BOOKS

**FREE catalog** aviation/electronic/space books. Aero Publishers, 329PE Aviation Road, Fallbrook, California 92028.

**FREE book** prophet Elijah coming before Christ. Wonderful bible evidence. Megiddo Mission, Dept. 64, 481 Thurston Rd., Rochester, N.Y. 14619.

**BOOKS,** Special Sale. Save up to 70%. Write for free catalog. Trauner Books, Inc., Box 4631 PE, Milwaukee, Wisc. 53215.

**JETT MARTIN COMEDY CLASSICS**—Free book! Enclose two 8¢ stamps. Talk-O-Graphic Books, Box 85, Totowa, New Jersey 07511.

**DIAGRAMS,** Radio-Television, 17 volumes, 2,880 pages, regular \$42.25, only \$14.95. Publications 1760 Balsam, Highland Park, Illinois 60035.



# 20-WATT AM-FM-Stereo- MULTIPLEX

The most unusual HI-FI stereo buy of 1974. A unit that has so many unique and different functions, makes it the finest system of its kind at the usual Poly Pak economy prices. Features: 4-speaker system, built-in FM antenna, record player jacks on separate panel. Another external panel consists of provisions for external FM and AM antenna, "satellite" speakers to provide 4-speaker sound, jacks for connecting a tape recorder to radio tuner or phono of systems to record. Lower inputs for connecting tape deck that will play back thru the internal amplifier for systems. AC jack for phono power connection. RED, GREEN and CLEAR indicators for Phono, AM, and FM respectively. Includes red indicator on front panel for STEREO indicator. Has separate input to plug into mike, guitar and other musical instruments as well as another jack for plugging in a pair of stereo headphones.

Has the following controls on front panel. PHONO-STEREO-AM-FM, MONO, FM STEREO, GUITAR, TAPE, MIKE master control switch, LOUDNESS, BALANCE, TREBLE, BASS controls, with power ON-OFF rocker switch, and AFC ON-OFF. Designed for all audio-phones to use as wall unit in DEN or FAMILY ROOM, or control unit by easy chair in family room, or for those who wish to design their own console or modular system. With 6 ft. 115 VAC cord and plug. Only 13 x 7 3/4" deep. No escutcheon, but we include template for one, plus diagram. Shpg. wt. 8 lbs. With knobs.

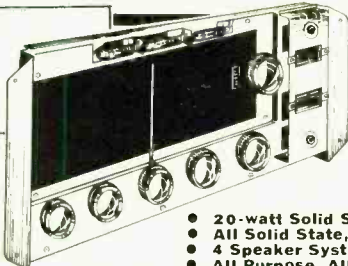

Only  
**39.95**  
IT'S NEW!

- 20-watt Solid State Amplifier!
- All Solid State, Printed Circuitry!
- 4 Speaker Systems! Slide Rule Dial!
- All Purpose, All Family System!



**SLIM-LINE  
WALL OR  
CABINET**

## LITRONIX-OPCOA-MAN "7-SEGMENT" LED Readouts

All fit 14-pin IC sockets. All 7-segments. MAN Series "all LED" and made by well-known West Coast mfr. Others Reflective Bar type made by OPCO and LITRONIX. The Reflective Bar types are low-cost versions of the MAN's except .33 character height! If one LED blows you lose a segment. MAN's you DO NOT! All readouts 0-10-9 numerals, plus letters and decimal. \*\*Opcoa and Litronix products pin-for-pin replacements for MAN-1 MAN-4. All 5V TTL compatible.

ALL LED READOUTS	TYPE	Character Size	Color Display	Decimal	Mils	Driver	Each	Special
<input type="checkbox"/> MAN-3 equal		.115	Red	Yes	10	SN7448	1.69	3 for \$4.50
<input type="checkbox"/> MAN-3 equal		.115	Red	***	10	SN7448	1.50	3 for \$4.
<input type="checkbox"/> MAN-3M equal*		.127	Red	Yes***	10	SN7448	1.50	3 for \$4.
<input type="checkbox"/> MAN-4 equal*		.190	Red	Yes	15	SN7448	2.50	3 for \$6.
<input type="checkbox"/> MAN-4 equal*		.190	Red	Yes***	15	SN7448	2.25	3 for \$5.

\* REFLECTIVE LITE BAR" (Segment LED Readouts)

<input type="checkbox"/> 707** (MAN-1)	.33	Red	Yes	20	SN7447	2.75	3 for \$6.
<input type="checkbox"/> 704** (MAN-4)	.33	Red	Yes	20	SN7448	2.75	3 for \$6.
<input type="checkbox"/> SLA-1** (MAN-1)	.33	Red	Yes	20	SN7447	2.75	3 for \$6.
<input type="checkbox"/> SLA-1** (MAN-1)	.33	Red	No	20	SN7447	2.25	3 for \$5.
<input type="checkbox"/> SLA-3H Giant	.70	Red	Yes	20	SN7447	6.50	3 for \$18.
<input type="checkbox"/> SLA-11C** (MAN-5.33)	.30	Green	Yes	40	SN7447	4.95	3 for \$13.

\* Red epoxy case, others clear. \*\* Litronix and Opcoa's pin-for-pin equals and electrical specs as MAN-1 or MAN-4. \*\*\* LED "dot" missing.

## Buy Any 3 — Take 10% LINEAR Op Amps

FACTORY GUARANTEED	FACTORY TESTED	FACTORY MARKED
<input type="checkbox"/> 532 Hi slow rate op-amp (TO-5)		\$2.50
<input type="checkbox"/> 533 Micro power 741 (TO-5)		2.50
<input type="checkbox"/> 536 FET input op amp (TO-5)		2.50
<input type="checkbox"/> 556 S Times faster than 741C		2.95
<input type="checkbox"/> 558 Dual 741 (TO-5)		2.10
<input type="checkbox"/> 560 Phase lock loops (DIP)		1.00
<input type="checkbox"/> 561 Phase lock loops (DIP)		2.95
<input type="checkbox"/> 562 Phase lock loops (DIP)		2.95
<input type="checkbox"/> 565 Phase lock loops (A)		2.95
<input type="checkbox"/> 566 Function generator (TO-5)		2.95
<input type="checkbox"/> 567 Tone decoder (A)		2.95
<input type="checkbox"/> 702C Hi-grain, DC amp (TO-5)		2.95
<input type="checkbox"/> 703C RF-IF amp, 14 ckt (TO-5)		.49
<input type="checkbox"/> 704 TV sound IF system		.69
<input type="checkbox"/> 709C Operational amp (A)		1.50
<input type="checkbox"/> 710C Op amp (mini DIP)		.47
<input type="checkbox"/> 710C Differential amp (A)		.47
<input type="checkbox"/> 711C Dual diff. comp		.47
<input type="checkbox"/> 723C Voltage regulator (A)		.47
<input type="checkbox"/> 733C Diff. Video Amp		.75
<input type="checkbox"/> 741C Freq. comp 709 (A)		1.75
<input type="checkbox"/> 747C Dual 741C (A)		.49
<input type="checkbox"/> 748C Freq. adj. 741C (A)		.49
<input type="checkbox"/> 709-709 Dual 709C (DIP)		1.75
<input type="checkbox"/> 739-739 Dual stereo preamp		1.00
<input type="checkbox"/> 741-741 Dual 741C (A)		1.98
<input type="checkbox"/> PA265 5-Watt voltage regulator		1.00
<input type="checkbox"/> ULN2300M Op amp with SCR		1.95
<input type="checkbox"/> CA3065 Video Audio system		1.50
<input type="checkbox"/> 75451 Dual peripheral driver		1.05
<input type="checkbox"/> 75491 Quad seg driver for LED readouts		.88
<input type="checkbox"/> 75492 Hex driver w/cou. out 250 mA		1.65

(A) TO-5 or DIP dual in line pak

## NATIONAL EQUALS ON "DIGITAL CLOCK ON A CHIP"

Mfrs #	Description	Price
<input type="checkbox"/> 5311	28-pin, ceramic, any readout, 8-digits: A-B-D	\$8.88
<input type="checkbox"/> 5312	24-pin, ceramic, any readout, 4-digits: C-D	\$8.88
<input type="checkbox"/> 5313	28-pin, ceramic, any readout, 8-digits: A-B	\$8.88
<input type="checkbox"/> 5314	24-pin, plastic, LED and incandescent readouts, 8-digits: A-B	\$8.88
<input type="checkbox"/> 5316	40-pin, normal alarm, snooze alarm, sleep timer, 4-digits:	\$14.95

Code: A—Hold Count, C—1 PPS Output, B—Output Strobe, D—BCD

## 1-MM5316, DIGITAL ALARM CLOCK FACTORY VALUE — \$1.49 EACH

## "CALCULATOR CHIP" 12-DIGIT \$6.95

Similar to Mostek 5001. Outperforms Texas 8-dig. TM1802. A 40-pin DIP. Adds, multiplies, subtracts, and divides. Use with 7-segment readouts. Nixies, and LEDs. We include schematics, instructions to build calculator.

CT5005—Same with MEMORY \$10.50

N-Track tape transport with complete stereo playback system less audio amplifier. Operates off 12 VDC. Wow & Rattle proof. Use 739 preamp & ready to go. Uses N-track tape.

## B-TRACK CAR RADIO STEREO 3 for \$24 TAPE TRANSPORT 8.88

Terms: add postage. Rated: net 30. Phone Orders: Wakefield, Mass. (617) 245-3829. Retail: 16-18 Del Carmine St., Wakefield, Mass. (off Water Street) C.O.D.'S MAY BE PHONED

**POLY PAKS**  
P.O. BOX 942 E  
Lynnfield, Mass. 01940

## Lowest Prices Largest Selection TTL IC's

Type	Sale	SN7437	.50	SN7472	.50	SN74112	.95	SN74163	1.75
<input type="checkbox"/> SN7400	\$0.30	SN7438	.50	SN7473	.55	SN74113	.95	SN74164	2.75
<input type="checkbox"/> SN7401	.30	SN7440	.30	SN7474	.49	SN74114	.95	SN74166	1.85
<input type="checkbox"/> SN7402	.30	SN7441	1.19	SN7475	1.00	SN74115	.95	SN74167	1.65
<input type="checkbox"/> SN7403	.35	SN7442	1.10	SN7476	.65	SN74122	.95	SN74173	1.65
<input type="checkbox"/> SN7404	.35	SN7443	1.19	SN7478	.95	SN74123	1.09	SN74174	3.20
<input type="checkbox"/> SN7405	.35	SN7444	1.25	SN7480	.65	SN74125	.71	SN74175	1.85
<input type="checkbox"/> SN7406	.45	SN7445	1.19	SN7481	1.25	SN74126	.71	SN74176	1.85
<input type="checkbox"/> SN7407	.55	SN7446	1.40	SN7482	.99	SN74139	1.25	SN74177	1.85
<input type="checkbox"/> SN7408	.35	SN7447	1.40	SN7483	1.19	SN74140	1.25	SN74179	2.10
<input type="checkbox"/> SN7410	.30	SN7448	1.45	SN7485	.50	SN74148	4.50	SN74181	4.25
<input type="checkbox"/> SN7411	.50	SN7450	.30	SN7486	.50	SN74150	1.19	SN74182	1.25
<input type="checkbox"/> SN7413	.85	SN7451	.30	SN7489	3.25	SN74151	1.02	SN74185	2.50
<input type="checkbox"/> SN7415	.55	SN7453	.30	SN7490	1.22	SN74152	1.02	SN74192	1.62
<input type="checkbox"/> SN7416	.49	SN7454	.30	SN7491	1.35	SN74153	1.39	SN74193	1.62
<input type="checkbox"/> SN7417	.49	SN7455	.55	SN7492	1.02	SN74154	1.65	SN74194	1.85
<input type="checkbox"/> SN7420	.30	SN7460	.30	SN7493	1.02	SN74155	1.29	SN74195	1.10
<input type="checkbox"/> SN7421	.55	SN7461	.35	SN7494	1.05	SN74156	1.45	SN74196	1.95
<input type="checkbox"/> SN7422	.32	SN7462	.32	SN7495	1.02	SN74157	1.45	SN74197	1.95
<input type="checkbox"/> SN7425	.50	SN7463	.30	SN7496	1.02	SN74158	1.55	SN74198	2.65
<input type="checkbox"/> SN7426	.36	SN7465	.50	SN74106	.95	SN74160	1.95		
<input type="checkbox"/> SN7430	.30	SN7470	.50	SN74107	.70	SN74161	1.55		
<input type="checkbox"/> SN7432	.35	SN7471	.55	SN74108	.95				

\* Factory Marked \* Money Back Guarantee Buy 100 — Take 20%

BRAND NEW LOWEST PRICES  
**GENERAL ELECTRIC 3-WATT \$2.50  
PHONE AMP 3 for \$6.00**  
Delivers 3 watts continuous, 10 watts peak. With heat sink, microphone, 3 x 1/2 x 3/4" 3 to 30 db supply. High sensitivity, 8 to 18 db. For mono and stereo phonos, tape, FM, AM, TV, servo.

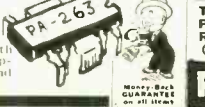

CIRCLE NO. 27 ON READER SERVICE CARD



## MINIATURE ALUMINUM ELECTROLYTIC CAPACITORS

Temp. range: -40°C to +85°C Tolerance: -10 to +50% for more than 4.7 ufd., -10 to +75% for 4.7 ufd or less

Value	1	10-99*	100-240*	Value	1	10-99*	100-240*
1 ufd/50V	14c	12c	11c	100 ufd/16 V	19c	15c	14c
2.2 ufd/50 V	14c	12c	11c	100 ufd/25V	24c	18c	17c
3.3 ufd/35V	14c	12c	11c	220 ufd/16 V	24c	18c	17c
4.7 ufd/35 V	14c	12c	11c	220 ufd/25 V	35c	25c	24c
10 ufd/16 V	13c	10c	9c	330 ufd/16 V	35c	25c	24c
10 ufd/25 V	14c	11c	10c	330 ufd/25 V	44c	35c	32c
22 ufd/16 V	14c	11c	10c	470 ufd/16 V	37c	30c	27c
22 ufd/25 V	15c	13c	12c	470 ufd/25 V	49c	39c	35c
33 ufd/16 V	15c	12c	11c	1000 ufd/16 V	49c	39c	35c
33 ufd/25 V	17c	13c	12c	1000 ufd/25 V	75c	60c	55c
47 ufd/16 V	17c	14c	13c	2200 ufd/16 V	75c	60c	55c
47 ufd/25 V	19c	15c	14c	*10 pcs per capacitance value			

### 1/2 & 1/4 WATT CARBON COMP. RESISTORS

5 each of the 85 standard 10% values (2.2-22M) 1/2 W Resistors (425 pcs)

Sorted by value \$12/set 2-4 are \$11/set 5-9 are \$10/set.

5 each of the 70 standard 10% values (10.5-6M) 1/4 W Resistors (350 pcs)

Sorted by value \$12/set 2-4 are \$11/set 5-9 are \$10/set.

Also available are TTL & Linear IC's, Silicon Rectifiers, Molex Pins, LED Readouts & Lamps, Transistors, IC Sockets, Slide Switches, Reed Relays and more!



Send for FREE CATALOG or Mail Readers Service Card

C.O.D. ORDERS ACCEPTED FOR SAME DAY SHIPMENT

CALL 218-681-6674



Orders Less Than \$10.00 Add 25c — Others Postpaid

# DIGI-KEY

Box 126

Thief River Falls, MN 56701

CIRCLE NO. 12 ON READER SERVICE CARD

## RUBBER STAMPS

**RUBBER** address stamps. Free catalog. 45 type styles. Jackson's, Box 443G, Franklin Park, Ill. 60131.

## HYPNOTISM

**SLER** learning. Hypnotic method. 92% effective. Details free. ASR Foundation, Box 7566EG, Fort Lauderdale, Florida 33304.

**FREE** Hypnotism. Self-Hypnosis. Sleep Learning Catalog! Drawer H400, Ruidoso, New Mexico 88345.

**AMAZING** self-hypnosis record releases fantastic mental power. Instant results! Free trial. Write: Forum (AA3), 333 North Michigan, Chicago 60601.

**AMAZING HYPNODISK** PULLS Subjects into Deep Hypnosis!! Instructions! Rushed!! Guaranteed! \$2.25. Hypnodisk, 508 Mourningdove, CM-3, Audubon, Pennsylvania 19407.

## BUSINESS OPPORTUNITIES

**I MADE \$40,000.00** Year by Mailorder! Helped others make money! Start with \$15.00—Free Proof. Torrey, Box 318-N, Ypsilanti, Michigan 48197.

**FREE CATALOGS.** Repair air conditioning, refrigeration. Tools, supplies, full instructions. Doolin, 2016 Canton, Dallas, Texas 75201.

**MAILORDER MILLIONAIRE** helps beginners make \$500 weekly. Free report reveals a secret plan! Executive (1K3), 333 North Michigan, Chicago 60601.

**PIANO TUNING LEARNED QUICKLY AT HOME!** Tremendous field! Musical knowledge unnecessary. GI approved. Information free. Empire School, Box 327, Miami 33145.

**\$2000.00 MONTHLY** selling information by mail. Ropchan, Box 161X, Saginaw, Oregon 97472.

**FREE** Secret Book "2042 Unique Proven Enterprises." Fabulous "Little Knowns." Work home! Haylings-BH, Carlsbad, California 92008.

## HIGHLY PROFITABLE ONE-MAN ELECTRONIC FACTORY

Investment unnecessary, knowledge not required, sales handled by professionals. Postcard brings facts about this unusual opportunity. Write today! Barta-DC, Box 248, Walnut Creek, CA 94597.

**START SMALL,** highly profitable electronic production in your basement. Investment, knowledge unnecessary. Postcard brings facts. Barta-CC, Box 248, Walnut Creek, California 94597.

**DO SIMPLE ADDRESSING**—Mailing. Receive \$12.95 orders. Keep \$8.00 profit. Details Free. Quality, Box 9-ZD, East Rockaway, N.Y. 11518

**IMPORT-MAILORDER OPPORTUNITY.** Risk free trial basis. Details: Northeast Imports, Box 111PE3, Fremont, New Hampshire 03044.

**\$940** equiv entitlement to Vet's. Details \$2.00; NOE, P.O. Box 749, Cypress, Calif. 90630.

**\$60,000.** In 12 weeks—I did it—So can you. Start with \$20.00, refundable. D. R. Supplies, Box 4504, Atlanta, GA 30302.

**200.00 DAILY** In Your Mailbox! Your opportunity to do what mail-order experts do. Free details. Associates, Box 136-J, Holland, Michigan 49423.

## TOOLS

**TOOLS,** Metal, Woodworking, Shop, Power, Hand, Atlas, Unimat, Maximat Lathes. Catalog \$1.00 refundable. Tools Unlimited, Inc. Box 7PE, Brentwood, New York 11717.

**WRAP** Tool \$1.00, Wire, Panels. Xycon, Box 9341, Phoenix, AZ 85020.

## TREASURE FINDERS

**FREE**—Valuable Treasure Finder catalog sent by return mail. Find Coins, Rings, Gold, Silver, Metals, Relics. Write today. JETCO. Dept. CPE, Box 26669, El Paso, Texas 79926.

**FREE FACT-FILLED CATALOG.** World's largest line of metal detectors. Models as low as \$49.50 and up. Two year Guarantee. Three factory locations, U.S. and Canada, plus over 1,000 dealers and 35 Service Centers from coast to coast. No finer instruments made at any price. Budget terms. Write: White's Electronics, Inc., Rm# 391, 1011 Pleasant Valley Road, Sweet Home, Oregon 97386.

**FAMILY FUN! OUTDOOR ADVENTURE!** Find valuable coins and treasure with world famous metal detectors. Free illustrated booklet. Detection, Dept. PE, Box 243, San Gabriel, Calif. 91778.

**TREASURE FINDER** locates buried gold, silver, coins, treasures. 5 powerful models. \$19.95 up. Instant financing available. Free catalog. Relco, Dept. A-33, Box 10839, Houston, Texas 77018.

## MUSICAL INSTRUMENTS

**30% DISCOUNT** name brand musical instruments. Free Catalog. Freeport Music, 455N, Route 110, Melville, N.Y. 11746.

**WHOLESALE!** Professional Guitars, PA Systems, Altec Speakers, 240W RMS Amplifiers. Free Catalog, Carvin, Escondido, Calif. 92028.

**30% + DISCOUNT.** Name Brand Musical Instruments. Free Catalog. Continental Music, Dept. H, P.O. Box 3001, Garden City, New York 11530.

# Popular Electronics

MARCH 1974

## ADVERTISERS INDEX

READER SERVICE No.	ADVERTISER	PAGE NO.
1	Allison Automotive Co.	95
2	Altaj Electronics	120
	Ancrona Corp	107
3	Atlantic CB	116
31	B&K Products of Dynscan	26
	Bell & Howell Schools	18, 19, 20, 21
6	Bose	23
	Burstein-Applebee	114
	CREI Capitol Radio Engineering Institute	36, 37, 38, 39
7	Center for Technical Development, Inc., The	79
8	Challenge Electronics	102
9	Cleveland Institute of Electronics	72, 73, 74, 75
10	Delta Electronics Co.	85
11	Delta Products, Inc.	25
12	Digi-Key	124
13	EICO	113, 114, 115
15	Edmund Scientific Co.	126
16	GTE Sylvania	108, 109, 110, 111
17	Grantham School of Engineering	9
5	Heath Company	90, 91, 92, 93
CLASSIFIED ADVERTISING		116, 117, 120, 121, 122, 124, 125

READER SERVICE No.	ADVERTISER	PAGE NO.
18	Illinois Audio	115
19	Lafayette Radio Electronics	107
20	Linear Systems, Inc.	83
21	McIntosh Laboratory, Inc.	17
22	MTS Inc.	10, 11
23	Mallory Distributor Products Company	15
24	Midwest Hifi Wholesale & Mail Order Division	102
	National Radio Institute	2nd COVER, 1, 2, 3
	National Technical Schools	54, 55, 56, 57
26	Pickering & Co., Inc.	13
27	Poly Paks	123
28	Schober Organ Corp., The	95
25	Shure Brothers Inc.	4th COVER
31	Solid State Sales	121
32	Solid State Systems	118, 119
33	Southwest Technical Products Corporation	8
29	Tracy Design Corporation	117
30	Tri-Star Corp.	85
4	United Audio Products, Inc.	7

### HOME ENTERTAINMENT FILMS

START AN EXCITING NEW HOBBY—BE A FILM COLLECTOR! Order the Castle, Columbia or Sportlite catalogs at 25¢ each. Complete selection from cartoons to major action sports events. 200 foot reels, \$7.95 each B&W; Color, \$15.95 each, Standard or Super 8. SPORTLITE FILMS, Elect. Dept., Box 500, Speedway, Indiana 46224.

### REAL ESTATE

FREE . . . BIG . . . 264-PAGE . . . SPRING CATALOG! Describes and pictures hundreds of farms, ranches, town and country homes, businesses coast to coast! Specify type property and location preferred. UNITED FARM AGENCY, 612-EP, West 47th St., Kansas City, Mo. 64112.

### EMPLOYMENT INFORMATION

EXCITING Overseas jobs. Directory \$1.00. Research Associates, Box 1167-E, Kailua, Hawaii 96734.

IMPROVE your job opportunity potential. Professionally written resumes. Samples, \$3.00. Dept. PE. Cullen Associates, 30 West Washington, Chicago, Ill. 60602.

### EMPLOYMENT OPPORTUNITIES

ELECTRONICS/AVIONICS EMPLOYMENT OPPORTUNITIES. Report on jobs now open. Details FREE. Aviation Employment Information Service, Box 240E, Northport, New York 11768.

WANTED: Ham Radio Oper./Instr. Boys resident Camp. Please write: Camp Winadu, 1 Patchin Place, N.Y., N.Y. 10011.

MARCH 1974

### MAGNETS

MAGNETS. All types. Specials-20 disc, or 10 bar, or 2 stick, or 8 assorted magnets, \$1.00 Magnets, Box 192-H, Randallstown, Maryland 21133.

### MISCELLANEOUS

WINEMAKERS: Free illustrated catalog yeasts, equipment. Semplex, Box 12276P, Minneapolis, Minn. 55412.

WIN AT DICE. Free details on scientific method I use while winning 87% of the time. Write Sanders, Dept. B-17, Box 92102, Houston, Texas 77018.

MENS TIES \$1.00 each. Sullivan, 790 President Street, Brooklyn, New York 11215.

MATHEMATICAL CARD TRICKS: complete, \$2.00. Institute of Recreational Mathematics, S-3 Draper's Meadow, Blacksburg, VA. 24060.

YOUR LOW COST Classified or Display Classified Ad in these columns will be seen, read and responded to regularly by America's largest audience of Electronics Professionals and Hobbyists. For \$1.60 per word (minimum \$16.00) your Classified ad will produce sales results far in excess of the small amount you'll spend on advertising. If your product or service deserves more prominent exposure to this audience, then Display Classified is for you . . . and it's available in units of 1", 2" or 3" by one column at rates of \$200.00, \$400.00 or \$600.00 per insertion (even less if you sign up for a 6 or 12-time contract.) For immediate action send copy and payment NOW to: Hal Cymes, Classified Advertising Manager, POPULAR ELECTRONICS, One Park Avenue, New York, New York 10016.

125



# LIVE IN THE WORLD OF TOMORROW... TODAY!

**A BETTER LIFE STARTS HERE**

## ASTRONOMICAL TELESCOPE KITS



Grind your own mirror for powerful telescopes. Kit contains fine annealed pyrex mirror blank, tool, abrasives, diagonal mirror, and eyepiece lenses. Instruments you build range in value from \$75.00 to hundreds of dollars.

- Stock No. 70.003AV 4 1/4" diam. 3/4" thick \$12.50 Ppd.
- Stock No. 70.004AV 6" diam. 1" thick \$19.50 Ppd.
- Stock No. 70.005AV 8" diam. 1 3/4" thick \$28.25 Ppd.
- Stock No. 70.006AV 10" diam. 1 3/4" thick \$33.25 FOB 30 lbs.
- Stock No. 70.007AV 12 1/2" diam. 2 1/8" thick \$89.50 FOB 46 lbs.

## "FISH" WITH A GIANT MAGNET

Fascinating fun, and sometimes very profitable! Tie a line to our 3 1/2-pound Magnet—drop it overboard in bay, river, lake or ocean. Troll it along the bottom. Your "treasured" haul can be outboard motors, anchors, other metal valuables. Five-pound Magnet is war surplus. Alnico V Type that cost the Government twice our price. It lifts over 40 pounds on land—much greater weights under water!



- Stock No. 70.570AV 3 1/2 lbs. \$11.50 Ppd.
- Stock No. 60.215AV 1 1/2 lbs. \$ 6.50 Ppd.



## 130 EXPERIMENTS IN OPTICS . . .

and photography! Optix® Experiments Kit is a complete optical & photography lab for 130 exciting experiments. Lets you recreate the periscope, telescope, microscope, kaleidoscope! Build a 35-mm reflex camera with interchangeable lens system! Make, develop photographic film! Enjoy the fun and fascination of having your own optics lab. Fully illustrated 112-pg manual, 8 1/2 x 11", clearly explains usage of this stimulating kit's 114 precision engineered components.

Stock No. 71.646AV . . . . . \$22.50 Ppd.

(And our FREE CATALOG is packed with exciting and unusual ecological & physical science items—plus 4,500 finds for fun, study or profit . . . for every member of the family.)

## KNOW YOUR ALPHA FROM THETA!

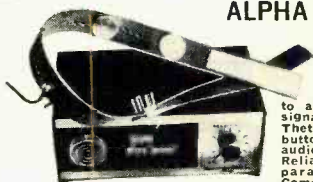

For greater relaxation, concentration, listen to your Alpha-Theta brainwaves. Ultra-sensitive electrode headband slips on/off in seconds—eliminates need for messy creams, etc. Atch'd amplifier, filters brainwaves, signals beep for ea. Alpha or Theta wave passed. Monitoring button simulates Alpha sound; audio & visual (L.E.D.) feedback. Reliable, easy-to-use unit—comparable to costlier models. Completely safe. Comprehensive instruction booklet.

- No. 1635AV . . . . . (8x3x4") 24 oz. . . . . \$124.50 Ppd.
- No. 71.809AV . . . . . (LOW COST "STARTER" UNIT) . . . . . \$49.95 Ppd.

## 3-CHANNEL COLOR ORGAN KIT

Easy to build low-cost kit needs no technical knowledge. Completed unit has 3 bands of audio frequencies to modulate 3 independent strings of colored lamps (i.e. "lows"—reds, "middles"—greens, "highs"—blues. Just connect hi-fi, radio, power lamp etc. & plug ea. lamp string into own channel (max. 300W ea.). Kit features 3 neon indicators, color intensity controls, controlled invidiv SCR circuits; isolation transformer; custom plastic housing; Instr.



Stock No. 41.831AV . . . . . \$17.50 Ppd.

SEE THE STARS. MOON, PLANETS CLOSE UP!



## 3" ASTRONOMICAL REFLECTING TELESCOPE

60 TO 180 Pwr. Famous Mt. Palomar Type See the rings of Saturn, the fascinating planet Mars. Seas and Craters of the Moon, Star Clusters in detail. New improved, aluminized and overcoated 3" diameter f/10 primary mirror, ventilated cell. Equatorial mount with locks on both axes. Equipped with 60X finder telescope, hardwood tripod. Included FREE: VALUABLE "HOW TO USE YOUR TELESCOPE" book; "STAR CHART"

- Deluxe 3" Reflector Telescope . . . . . \$66.50 Ppd.
- Stock No. 80.162AV \$66.50 Ppd.
- Stock No. 85.105AV \$115.00 FOB
- 6" Reflector Telescope Stock No. 85.187AV . . . . . \$222.50 FOB
- 6" Reflector W (Electric) Clock Drive No. 85.086AV . . . . . \$259.50 FOB



## MAIL COUPON FOR GIANT FREE CATALOG!

180 PAGES • MORE THAN 4,500 UNUSUAL BARGAINS!

Completely new '74 Catalog. Packed with huge selection of telescopes, microscopes, binoculars, magnets, magnifiers, prisms, photo components, ecology and Unique Lighting items, parts, kits, accessories—many hard-to-get surplus bargains. 100's of charts, illustration. For hobbyists, experimenters, schools, industry.

EDMUND SCIENTIFIC CO.  
300 Edscorp Building, Barrington, N. J. 08007

Please rush Free Giant Catalog "AV"

Name \_\_\_\_\_

Address \_\_\_\_\_

City \_\_\_\_\_ State \_\_\_\_\_ Zip \_\_\_\_\_

## COMPLETE & MAIL WITH CHECK OR M.O.

EDMUND SCIENTIFIC CO.  
300 Edscorp Building, Barrington, N.J. 08007

How Many Stock No.	Description	Price Each	Total

PLEASE SEND  GIANT FREE CATALOG "AV" MERCHANDISE Total

ADD HANDLING CHARGE: \$1.00 ON ORDERS UNDER \$5.00; 50c ON ORDERS OVE \$5.00

TOTAL \$ \_\_\_\_\_

I enclose  check  money order for \$ \_\_\_\_\_

NAME \_\_\_\_\_

ADDRESS \_\_\_\_\_

CITY \_\_\_\_\_ STATE \_\_\_\_\_ ZIP \_\_\_\_\_



CIRCLE NO. 15 ON READER SERVICE CARD  
Printed in U.S.A.

# Popular Electronics

## READER SERVICE

Here's an easy and convenient way for you to get additional information about products advertised or mentioned editorially (if it has a reader service number) in this issue. Just follow the directions below... and the material will be sent to you promptly and free of charge.

# 1

On the attached postage-free card, print or type your name and address on the lines indicated.

# 2

Circle the number (s) that corresponds to the key number (s) at the bottom or next to the advertisement or editorial mention that is of interest to you. (Key numbers for advertised products also appear in the Advertisers' Index.)

# 3

Simply cut out the card and mail. No postage required.

## FREE INFORMATION

### SPECIAL DISCOUNT OFFER

FOR READERS OF POPULAR ELECTRONICS

The 1974 *ELECTRONIC EXPERIMENTER'S HANDBOOK* — Spring edition, is scheduled to go on sale nationally March 19, 1974.

Here is the one publication that helps you get it together... with a score of build-it-yourself projects.

You can count on *ELECTRONIC EXPERIMENTER'S HANDBOOK*. It's by the editors of Popular Electronics. With features and articles and complete lab-tested instructions that are sure to guarantee successful hours and months of mind-absorbing projects for fun and practicality.

**YOU CAN RESERVE YOUR COPY NOW AT THE SPECIAL MONEY-SAVING PRE-PUBLICATION PRICE OF ONLY \$1 POSTPAID.**

This offer is being made to readers of Popular Electronics Magazine only. Regular price is \$1.25; mail order price \$1.60. You can reserve your copy now at this special pre-publication price of only \$1, postpaid —

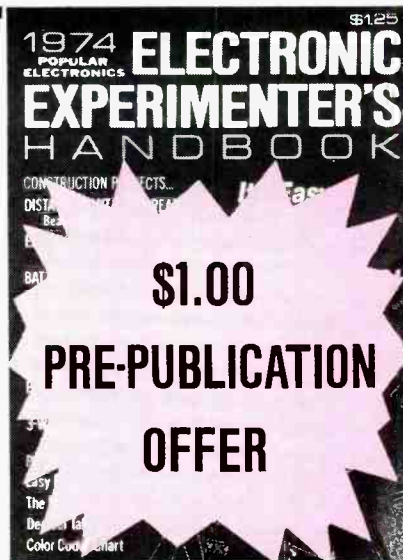

### HERE'S HOW TO ORDER

Send your order and remittance in the amount of \$1 to Electronic Experimenter's Handbook, Ziff-Davis Service Division, 595 Broadway, New York, N.Y. 10012. Print your name and address clearly and specify "1974 ELECTRONIC EXPERIMENTER'S HANDBOOK — SPRING EDITION." Your copy will be mailed to you on or before publication date from first-off-the-press copies.

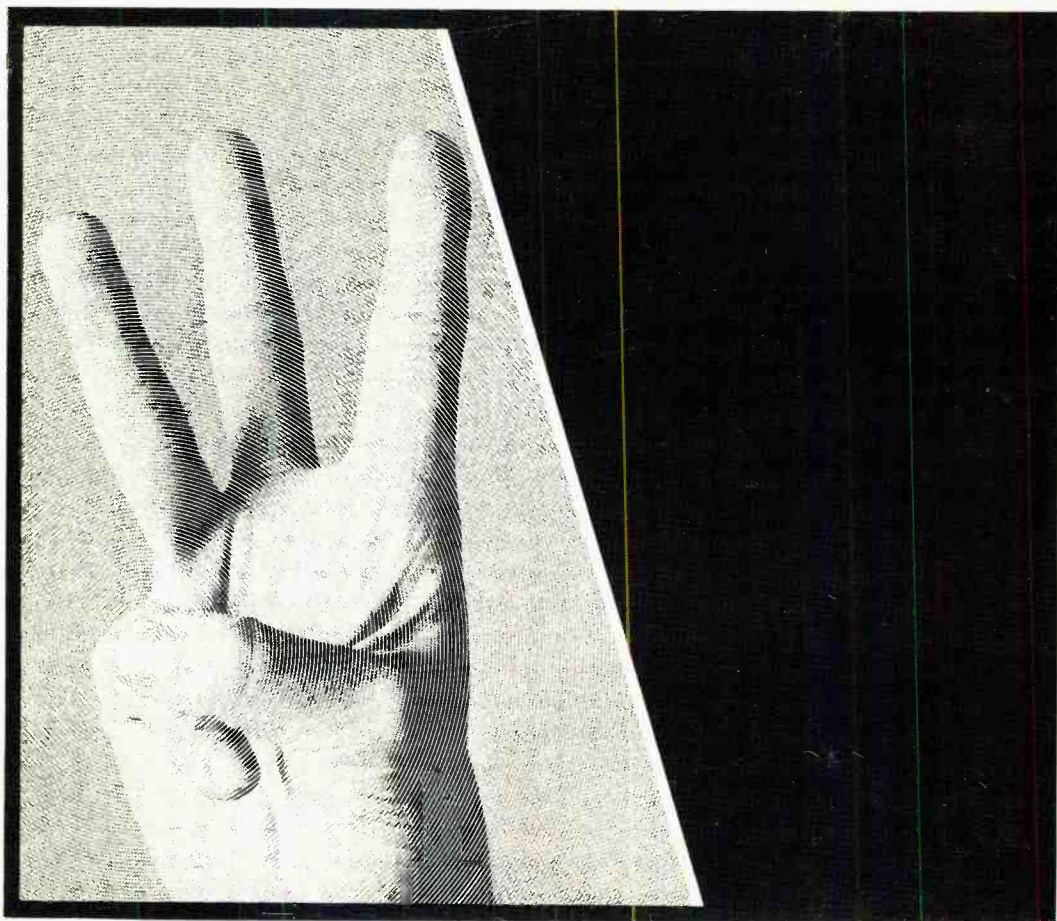

## Best. Best. Best.

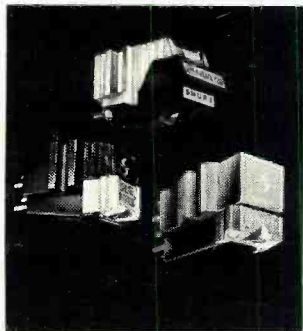

Permit us this momentary bit of self-indulgence, because our intentions are pure: to assist you in choosing the best phono cartridge for your hi-fi system, within the practical limitations of your audio budget. To begin, if you feel uncomfortable with anything less than state-of-the-art playback perfection, we heartily recommend the Shure V-15 Type III, a cartridge of such flawless performance it is the perfect companion to the finest turntables and tone arms available today — and those coming tomorrow. At a more moderate level of performance and price, we suggest the Shure M91ED, a superb performer second in trackability only to the Type III. Finally, for optimum performance under a budget austerity program, the yeoman Shure M44E is for you. All in all, these are three great ways to enjoy music with the kind of system you have decided is best for you.

Shure Brothers Inc.  
222 Hartrey Ave., Evanston, Ill. 60204  
In Canada: A. C. Simmonds & Sons Ltd.



**SHURE**®

CIRCLE NO. 25 ON READER SERVICE CARD