

BUILD ULTRASONIC ALARM/DETECTION SYSTEM

POPULAR ELECTRONICS

MARCH
1970

50
CENTS



**NEW—OPPORTUNITY/CAREER
DEPARTMENT**

**BEGINNER'S R. F.
SIGNAL GENERATOR**

NEW DIGITAL READOUT

MORE IC EXPERIMENTS

**D.C. TO D.C.
UPVERTER**

**BUILD TELEPHONE
SPEECH SCRAMBLER**

page 27

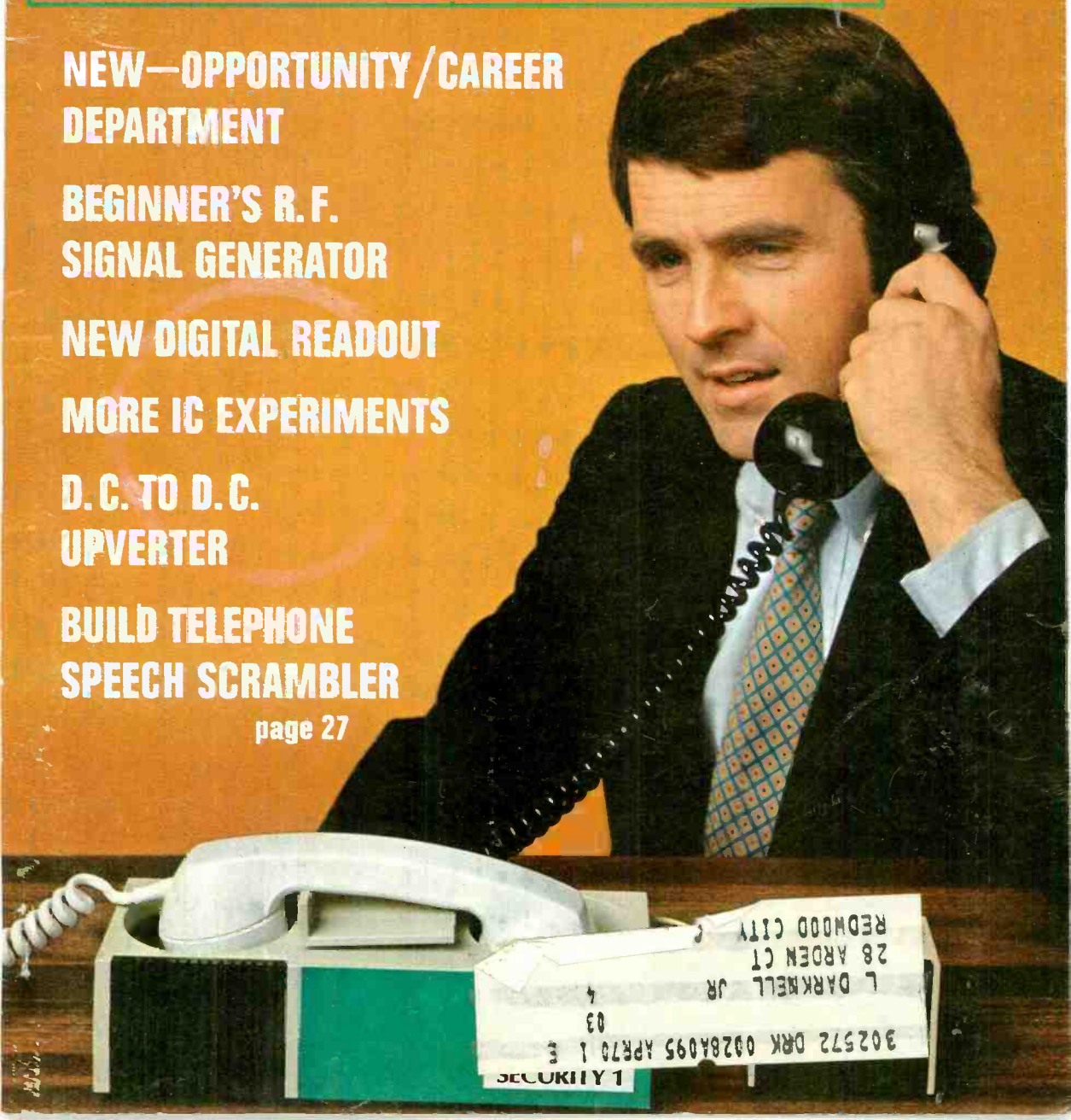



nri **firsts**

**make learning
Electronics at home
fast and fascinating —
give you priceless
confidence.**

Some NRI **firsts** in training equipment

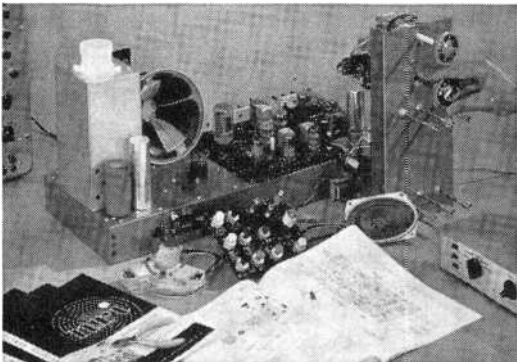

first to give you Color Television training equipment engineered specifically for education — built to fit NRI instructional material, *not* a do-it-yourself hobby kit. The end product is a superb Color TV receiver that will give you and your family years of pleasure. You "open up and explore" the functions of each color circuit as you build.

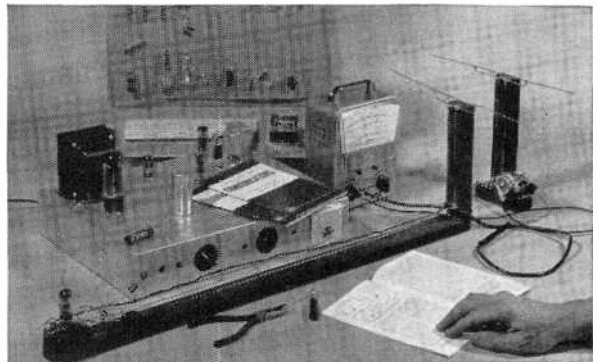

first to give you transmission lines and antenna systems that include experiments not otherwise attempted outside of college physics laboratories. The experience gained with this kind of Communications training equipment is matched only by months — sometimes years — of on-the-job experience.

NRI's "discovery" method is the result of over half a century of leadership simplifying and dramatizing training at home

The FIRSTS described below are typical of NRI's half century of leadership in Electronics home training. When you enroll as an NRI student, you can be sure of gaining the in-demand technical knowledge and the priceless confidence of "hands-on" experience sought by employers in Communications, Television-Radio Servicing and Industrial and Military Electronics. Everything about NRI training is designed for your education . . . from the much-copied, educator-acclaimed Achievement Kit sent the day you enroll, to "bite-size" well-illustrated, easy to read texts programmed with designed-for-learning training equipment.

YOU GET YOUR FCC LICENSE OR YOUR MONEY BACK

There is no end of opportunity for the trained man in Electronics. You can earn \$6 or more an hour in spare time, have a business of your own or qualify quickly for career positions in business, industry, government. And if you enroll for any of five NRI courses in Communications, NRI prepares you for your FCC License exams. *You must pass* or NRI refunds your tuition in full. No school offers a more liberal money-back agreement. The full story about NRI leadership in Electronics training is in the new NRI Catalog. Mail postage-free card today. No salesman is going to call. NATIONAL RADIO INSTITUTE, Washington, D.C. 20016

APPROVED UNDER NEW GI BILL If you have served since January 31, 1955, or are in service, check GI line on postage-free card.

designed from chassis up for your education

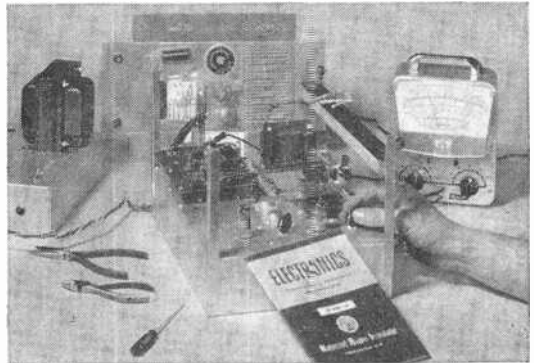
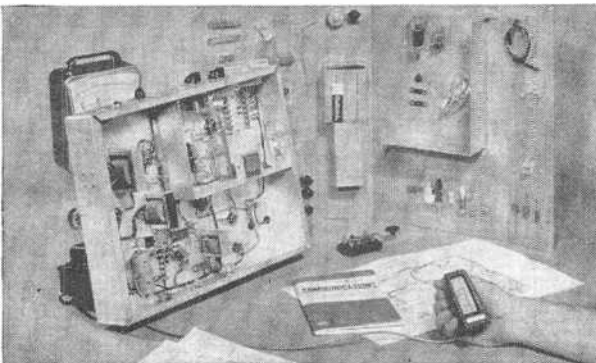

first to give you true-to-life experiences as a communications technician. Every fascinating step you take in NRI Communications training, including circuit analysis of your own 25-watt, phone/cw transmitter, is engineered to help you prove theory and later apply it on the job. Studio equipment operation and troubleshooting become a matter of easily remembered logic.

first to give you completely specialized training kits engineered for business, industrial and military Electronics. Shown above is your own training center in solid state motor control and analog computer servo-mechanisms. Telemetry circuits, solid-state multi-vibrators, and problem-solving digital computer circuits are also included in your course.

POPULAR ELECTRONICS

VOLUME 32 NUMBER 3

MARCH, 1970

WORLD'S
LARGEST-SELLING
ELECTRONICS
MAGAZINE

FEATURE ARTICLES

- | | | |
|---|-----------|-----------------------------|
| BUILD SECURITY 1 | 27 | <i>J. Pina</i> |
| <i>Speech scrambler for your telephone</i> | | |
| HOBNOBBING WITH HARBAUGH | 34 | |
| BUILD A D.C. TRANSFORMER | 35 | <i>Jon Colt</i> |
| <i>High voltage for non-semiconductors</i> | | |
| INTERFERENCE FROM LEFT FIELD | 44 | <i>Edward Arnold</i> |
| <i>RFI—what can we do about it?</i> | | |
| BEGINNER'S SIGNAL GENERATOR | 47 | <i>Frank H. Tooker</i> |
| BUILD THE NO-BOUNCE PUSHBUTTON | 51 | <i>Don Lancaster</i> |
| <i>Digital trigger source</i> | | |
| ELECTRONIC OVERLOAD PROTECTION | 54 | <i>John L. Keith</i> |
| ONE-STEP MOTION DETECTOR | 57 | <i>Daniel Meyer</i> |
| <i>Ultrasonic intruder alarm</i> | | |
| THE TOUCH-A-TONE | 66 | <i>Charles D. Rakes</i> |
| <i>Ultimate in electronic sounds</i> | | |
| NUMITRON READOUT | 73 | <i>Vincent Wood</i> |
| <i>Seven-segment display in one tube</i> | | |
| THE PRODUCT GALLERY | 76 | |
| <i>Digital Design Program</i> | | |
| <i>Regency Imperial II CB Transceiver</i> | | |
| <i>Hallicrafters Star Quest S-120A Receiver</i> | | |
| OPPORTUNITY MIRROR | 79 | <i>David L. Heiserman</i> |
| <i>Thoughtful reflections on your future</i> | | |
| THE STEREO SCENE | 82 | <i>Robert MacDonald</i> |
| <i>True hi-fi speaks for itself</i> | | |
| AMATEUR RADIO | 85 | <i>Herb S. Brier, W9EGQ</i> |
| ENGLISH LANGUAGE NEWS BROADCASTS TO N.A. | 92 | <i>Roger Legge</i> |
| TWO-WAY REACTIONS | 93 | <i>G. H. Reese, KCN6990</i> |
| SHORT-WAVE LISTENING | 95 | <i>Hank Bennett, W2PNA</i> |
| SOLID STATE | 97 | <i>Lou Gorner</i> |

DEPARTMENTS

- | | |
|--|----------------|
| LETTERS FROM OUR READERS | 8 |
| OUT OF TUNE | 14 |
| <i>Electronic Aquarium Heater (January 1970)</i> | |
| READER SERVICE PAGES | 15, 115 |
| NEW LITERATURE | 16 |
| NEW PRODUCTS | 22 |
| OPERATION ASSIST | 103 |
| ELECTRONICS LIBRARY | 116 |

POPULAR ELECTRONICS is indexed
in the Readers' Guide
in Periodical Literature

This month's cover photo by
Justin Kerr

Copyright © 1970 by ZIFF-DAVIS PUBLISHING COMPANY. All rights reserved.

POPULAR ELECTRONICS, March 1970, Volume 32, Number 3, Published monthly at One Park Ave., New York, N.Y. 10016. One year subscription rate for U.S., U.S. Possessions and Canada, \$6.00; all other countries, \$7.00. Second class postage paid at New York, N.Y. and at additional mailing offices. Authorized as second class mail by the Post Office Department, Ottawa, Canada and for payment of postage in cash. Subscription service and Forms 3579: Portland Place, Boulder, Colorado 80302. Editorial offices for manuscript contributions, reader inquiries, etc.: One Park Ave., New York, N.Y. 10016.

Solitron's microelectronic amplifier.

The little box with the big sound.

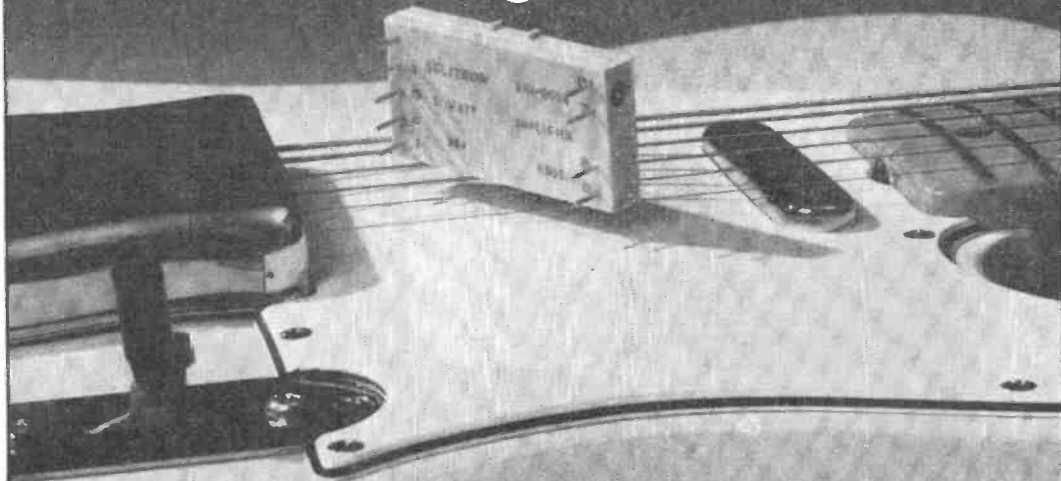

If you've been looking around for a top quality 2-watt class A, 5- or 15-watt class B audio amplifier, look no more. Solitron is into them. Has them in stock.

With Solitron microcircuit amplifiers, you can make an electric guitar amplifier or other instrument that makes it like a top make (they're the same amplifiers). Or use them in hi-fi or stereo amplifiers, record players, PA systems, intercoms. Whatever turns you on.

The 5 watt doesn't need a preamp. All need fewer than the usual external jazz. (4 or 5 inexpensive external components give you a completed unit.) And they're dependable. They're made with the latest thick film hybrid microcircuit construction; cermet chips on ceramic substrates. By the company known as the "high-reliability aerospace semiconductor house."

Get into the microelectronics action with Solitron. For complete specifications and instructions, contact Solitron at 256 Oak Tree Road, Tappan, New York 10983.

It's where it's at.

Solitron

CIRCLE NO. 23 ON READER SERVICE PAGE

"How an already superior product can be further improved by intelligent and imaginative design and engineering!"

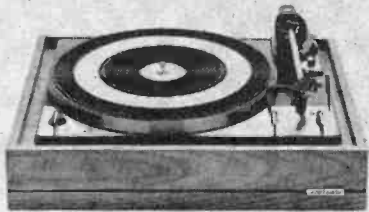

This comment by Hirsch-Houck Labs sums up their test report on the Dual 1219 automatic turntable, printed in Stereo Review, Dec. 1969.

We had anticipated such a warm reception for the 1219. After all, its predecessor was "widely regarded as one of the finest record players available." (As Hirsch-Houck also said.)

And it is "a joy to use and a fine instrument...with nearly every refinement one could imagine." (Said Audio.)

The 1219's tonearm is the longest on any automatic, for the lowest tracking distortion of any automatic.

The tonearm is mounted in a true ring-in-ring gimbal, with four identical low-friction needle bearings.

Another exclusive feature is the Mode Selector that shifts the tonearm base down for the single-play mode. This achieves the perfect 15° tracking angle.

Tonearm settings are also more precise. The counterweight has a click stop for every hundredth of a gram. And there are separately calibrated anti-skating scales for conical and elliptical styli, since each type skates differently.

The continuous-pole/synchronous motor combines high torque with absolute speed constancy. And a pitch control lets you "tune" any record over a semitone range.

These and other features of the \$175 Dual 1219 are fully described in our literature together with other Duals from \$89.50. Write for it today.

United Audio Products, Inc.,
120 So. Columbus Ave., Mount Vernon,
New York 10553.



CIRCLE NO. 28 ON READER SERVICE PAGE

POPULAR ELECTRONICS

LAWRENCE SPORN
Publisher

OLIVER P. FERRELL
Editor

LESLIE SOLOMON
Technical Editor

JOHN R. RIGGS
Managing Editor

EDWARD I. BUXBAUM
Art Director

ALEXANDER W. BURAWA
Associate Editor

ANDRE DUZANT
Technical Illustrator

PATTI MORGAN
Assistant Editor

JUDITH L. HOGAN
Editorial Assistant

H. BENNETT, W2PNA
H. S. BRIER, W9EGQ

L. E. GARNER, JR.
G. H. REESE, KC6990
Contributing Editors

RICHARD J. HALPERN
Advertising Manager

ROBERT UR
Marketing Manager

MARGARET DANIELLO
Advertising Service Manager

FURMAN H. HEBB
Group Vice President
Electronics and Photographic

ZIFF-DAVIS PUBLISHING COMPANY
Editorial and Executive Offices

One Park Avenue, New York, New York 10016
212 679-7200

Midwestern Office

307 North Michigan Avenue, Chicago, Illinois 60601
312 726-0892

Midwestern Advertising Manager, JAMES WEAKLEY

Western Office

9025 Wilshire Boulevard, Beverly Hills, California 90211

213 Crestview 4-0265; Bradshaw 2-1161
Western Advertising Manager, BUD DEAN

Japan: James Yagi

Ishikawa Mansion, #4, Sakuragaoka
Shibuya-ku, Tokyo, 462-2911-3

Circulation Office

Portland Place, Boulder, Colorado 80302

William Ziff, President

W. Bradford Briggs, Executive Vice President

Hershel B. Sarbin, Senior Vice President

Stanley R. Greenfield, Senior Vice President

Philip Sine, Financial Vice President

Walter S. Mills, Jr., Vice President, Circulation

Phillip T. Heffernan, Vice President, Marketing

Frank Pomerantz, Vice President, Creative Services

Arthur W. Butzwang, Vice President, Production

Edward D. Muhlfield, Vice President, Aviation Division

Irwin Robinson, Vice President, Travel Division

George Morrissey, Vice President

Sydney H. Rogers, Vice President

Ziff-Davis also publishes Airline Management and Marketing, Including American Aviation, Boating, Business & Commercial Aviation, Car and Driver, Cycle, Electronics World, Flying, Modern Bride, Popular Photography, Skiing, Skiing Area News, Skiing Trade News, Stereo Review, and Travel Weekly.

Forms 3579 and all subscription correspondence should be addressed to POPULAR ELECTRONICS, Circulation Department, Portland Place, Boulder, Colorado 80302. Please allow at least six weeks for change of address. Include your old address, as well as new—enclosing if possible an address label from a recent issue.

EDITORIAL CONTRIBUTIONS must be accompanied by return postage and will be handled with reasonable care; however, publisher assumes no responsibility for return or safety of art work, photographs or manuscripts.



Member Audit Bureau
of Circulations

A new concept **100% MUSIC POWER[®]**

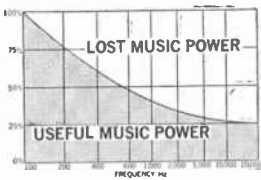

CARTRIDGE "C"
at 25% Music Power

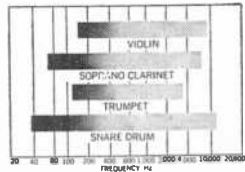

... a serious loss of definition occurs; because cartridge "C" has completely lost 75% of the Music Power at the higher frequencies.

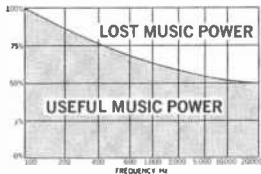

CARTRIDGE "B"
at 50% Music Power

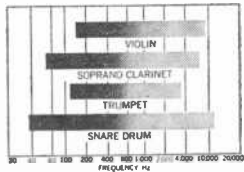

... in this case you lose definition of tone and instruments; because cartridge "B" loses as much as 50% at higher frequencies.

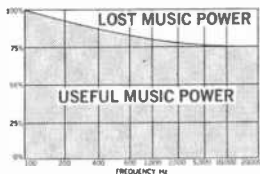

CARTRIDGE "A"
at 75% Music Power

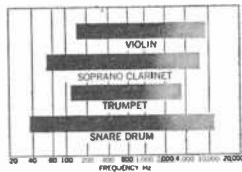

... the instruments seem a little faded in the upper frequencies; because cartridge "A" attenuates higher frequencies as much as 25%.

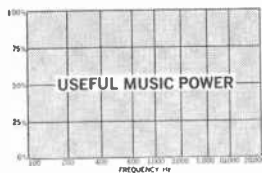

XV-15
at 100% Music Power

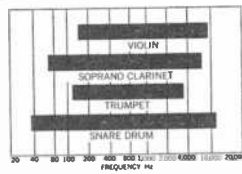

... the instruments, all of them, are distinct and clear throughout the entire fundamental frequency range.

With the Pickering XV-15 Cartridge You Get 100% Music Power — You Hear It All!

Only Pickering's XV-15 series of cartridges features 100% Music Power. With the Pickering, a harp sounds like a harp, a trumpet has the biting sound that you expect from a brass instrument, the flute has a rich romantic tone, the orchestra is the full-throated instrument the composer called for. So choose Pickering — and make the enjoyment of 100% Music Power a part of your life.

PICKERING

For those who can HEAR the difference



THE NEW PICKERING XV-15/750E, PREMIER MODEL OF THE XV-15 SERIES. TRACKS AT 1/2 TO 1 GRAM. DYNAMIC COUPLING FACTOR OF 750 FOR USE IN FINEST TONEARMS. \$60.00. OTHER XV-15 CARTRIDGES FROM \$29.95. PICKERING & CO., PLAINVIEW, L.I., N.Y.

CIRCLE NO. 31 ON READER SERVICE PAGE

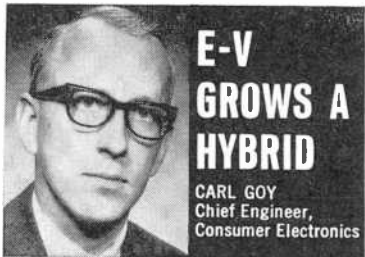

E-V GROWS A HYBRID

CARL GOJ
Chief Engineer,
Consumer Electronics

One of a
series of
brief
discussions
by
Electro-Voice
engineers

While the input section of an amplifier or receiver may get little more than passing notice from the consumer, low-level, high gain preamplifiers pose one of the more interesting and difficult challenges for the design engineer. Performance of the first stage is extremely critical if good signal/noise figures are to be achieved.

An unique thick-film hybrid circuit has been created for Electro-Voice receivers and amplifiers that makes a substantial contribution to stable, low-noise performance with uniform equalization characteristics.

A silk-screened circuit comprising the 9 resistors and 2 capacitors needed for a magnetic phono preamp is created on a ceramic slab or substrate, then fired at high temperature to fuse the circuit and substrate into a single element. Two silicon low-noise transistors are carefully soldered into the circuit and wire leads are attached. The entire assembly is then dipped in Durez to form a thick-film hybrid circuit that can be inserted into a PC board containing the bypass and coupling capacitors needed for the balance of the preamp.

Several advantages accrue from this technique. Extremely short internal leads insure minimum hum sensitivity, with measurably superior performance compared to discrete components. The circuit's small size (about 1½"x¾"x¼") permits a pair of thick-film hybrid assemblies to be located immediately adjacent to the input connectors of the receiver.

Unusually uniform equalization characteristics can be achieved, not only between channels of a single stereo system, but also from one unit to the next. And testing of a complete preamplifier assures that the entire circuit meets noise, gain, and equalization standards prior to assembly, a step difficult to achieve with conventional discrete component assemblies.

In addition to the use of these hybrid circuits, E-V takes another step to reduce noise by locating the preamplifiers and input switching at the rear of the chassis in a shielded enclosure. This location insures that only relatively high level signals need be routed to the front panel of the unit. The net effect is quiet performance with uniform, stable equalization and minimum sensitivity to external disturbances.

For reprints of other discussions in this series, or technical data on any E-V product, write: ELECTRO-VOICE, INC., Dept. 303P, 630 Cecil St., Buchanan, Michigan 49107

Electro-Voice®

A SUBSIDIARY OF GULTON INDUSTRIES, INC.

CIRCLE NO. 7 ON READER SERVICE PAGE

letters

FROM OUR READERS

QUADRASONIC EARPHONES?

The four-channel Quadrasonic story ("The Stereo Scene," January 1970, p 67) was very exciting and adeptly written. It left me with only one unanswered question. How will quadrasonics tackle the problem of us listeners who use earphones for private listening?

R. B. ZEH
Slingerlands, N.Y.



Obviously, most stereo listeners with a love of Quadrasonics must become mutants.

GRAVITY—ARE YOU OUT THERE?

The good Cdr. Appleby's "An Experiment with Gravity" (January 1970, p 66) is a difficult pill to swallow. I have the highest regard for Cdr. Appleby, but isn't he measuring the normal atmospheric activity and inherent receiver deficiencies?

D. T. WHITE
Russellville, Ky.

Tried the experiment and discovered some new aspects. Solved difficulty of signal pick-up with extra grounding, but in plotting the response graph, I got a dip at noon instead of a peak.

After pondering why, I came to the conclusion that maybe the physical orientation of the receiver (east-west vs north-south)

POPULAR ELECTRONICS



The New COBRA 24... Wild, but never Primitive!

Watch for It! The New 23- Channel Radio that brings order to the CB Jungle!

The COBRA 24 lurks no longer. It has struck with deadly effectiveness to prey on the weaknesses of others. With more power, more intelligence, more beauty than any other radio in its class.

- A full 5-watts of clear message with DYNABOOST speech compression, a Dynascan exclusive
- Selective, dual-conversion, superhet receiver with ceramic filter to give outstanding selectivity and gain
- Message gets through crisp and clear when others are garbled and unclear
- 23 crystal-controlled channels—no extra crystals needed
- Positive/negative ground operation without internal wiring changes needed—with reverse polarity protection
- All solid-state plus FET and integrated circuitry
- PA/CB switch with adjustable volume
- Illuminated channel selector and "S" meter for night transmission
- Includes push-to-talk microphone
- Meets FCC requirements—operates on 12 volts DC

There are other reasons for COBRA superiority. Get all the facts from DYNASCAN. Better yet, visit the COBRA dealer near you. He will show you through the CB jungle!

CoBra 24 Net \$169.95
Optional PAC 24 AC Power Supply—\$32.95

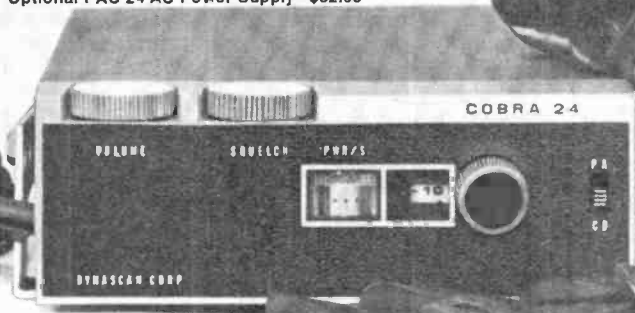

Product of DYNASCAN CORPORATION
1801 W. Belle Plaine, Chicago, Illinois 60613

CIRCLE NO. 2 ON READER SERVICE PAGE

THE CALECTRO



EVERYTHING IN ELECTRONICS!

Over 800 popular, new Calectro products for every household use!
Now at each location, hundreds and hundreds of items for everyone
hobbyist, enthusiast, amateur, executive, homeowner, do-it-yourselfer.
See the SELF-SERVICE G.C. Calectro display
at your Calectro SUPERMARKET TODAY.

VARIABLE BALANCE STEREO PHONE
Unique "Sound Level" control on each
earpiece permits adjustment.
Frequency range: 20 to 20,000 \pm cps.
6 $\frac{1}{2}$ " cord with stereo plug. Impedance
4 to 16 ohms.
Cat. No. Q4-132 \$17.95 Net



"C" (FLASHLIGHT) TYPE CELL HOLDER
Holds 4, 6 volt "C" cells; connect
with wires.
Cat. No. F3-064 \$ 6.92 Net



AUDIO ADAPTORS
"Y" Audio Adaptor has a phone pin
jack on one end and dual phone pin
plugs on the other.
Cat. No. Q4-708 \$ 9.99 Net



EXPERIMENTER'S CIRCUIT BOARD KIT
Contains a 3 $\frac{1}{2}$ " x 4 $\frac{1}{2}$ " perforated
board, 15 terminals (No. 14-636) and
4 mounting feet w/screws. Build
small circuits, hobby and science
projects, etc.
Cat. No. 14-660 \$ 6.94 Net



TWO STATION WIRELESS INTERCOM
Just plug into any electrical outlet.
Completely portable. Expand system
anytime with additional units. Two
unit system complete in display pack.
Cat. No. M4-110 \$34.95 Net



3 CONDUCTOR PHONE PLUG
Plug has black or red plastic handle
w/solder lug and clamp.
Cat. No. F2-016 (black) \$ 4.43 Net
Cat. No. F2-017 (red) \$ 4.43 Net

MINIATURE LAMPS



Type PR2 - 2.5 volt - 0.50 amp -
Cat. No. E2-430 - Pkg. of 2 \$ 2.29 Net
Type PR3 - 3.6 volt - 0.50 amp -
Cat. No. E2-431 - Pkg. of 2 \$ 2.29 Net



Type 12 - 6.3 volts - 0.15 amp -
Cat. No. E2-435* \$.39 ea. Net



Type 40 - 6.3 volt - 0.15 amp -
Cat. No. E2-437 - Pkg. of 2 \$ 2.29 Net
Type 46 - 6.3 volt - 0.25 amp -
Cat. No. E2-441 - Pkg. of 2 \$ 2.29 Net



TV WIRE STANDOFF HOLDERS
Wood screw type, 3 $\frac{1}{2}$ " long. Insulator
fits "flat-line," foam and co-ax cable.
Cat. No. 32-950 Pkg. of 4 \$ 4.42 Net
Same as above, but 2 $\frac{1}{2}$ " long
Cat. No. 32-954 Pkg. of 8 \$ 7.71 Net
Snap-on type, Fits on 1 $\frac{1}{2}$ " masts.
Universal insulation for all types of
cable.
Cat. No. 32-062 Pkg. of 2 \$ 5.94 Net

RESISTORS

Attractively packaged 2 per pack, showing
values, color codes and formulas.

Type	Rating	Available	Price	Units
Carbon	$\frac{1}{2}$ Watt	10 Ohm - -10% 10 Meg	\$.19	Pkg. of 2
Carbon	1 Watt	10 Ohm - -10% 1 Meg	.19	Ea.
Carbon	2 Watt	10 Ohm - -10% 100K	.25	Ea.
Wire	10 Watt	10 Ohm - -10%	.36	Ea.
Wound		15K		



STANDARD 1000 VOLT CAPACITOR
High quality, compact and reliable.
Minimum capacity change with
varying temperature. Rating: 1000
volts; tolerance: 20%.

Cat. No.	Description	Net	Unit
A1-060	220pF	\$.25	Pkg. of 2
A1-061	330pF	.25	Pkg. of 2
A1-062	470pF	.25	Pkg. of 2
A1-063	680pF	.25	Pkg. of 2
A1-064	0.001uF	.19	Ea.
A1-065	0.005uF	.19	Ea.
A1-066	0.01uF	.19	Ea.



SUPERMARKET

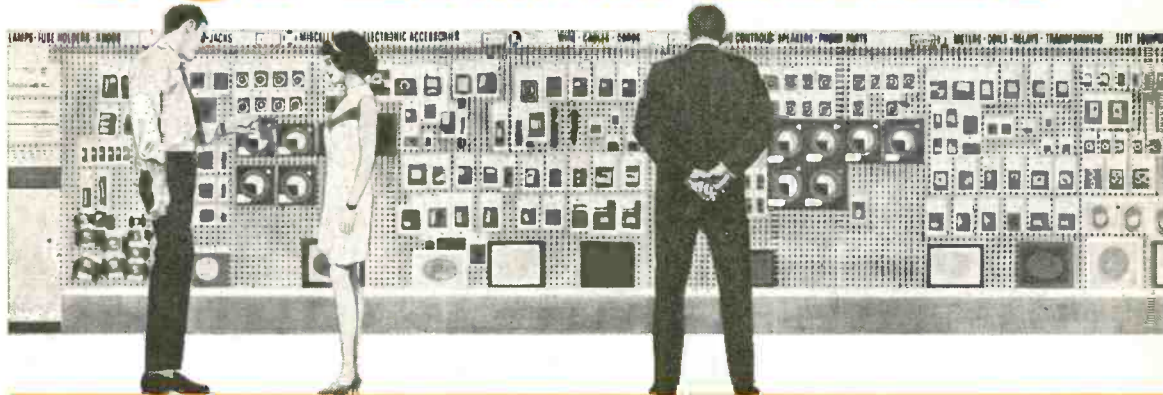

"HOBBY-PACK" SEMICONDUCTORS



PNP GEN. PURPOSE Audio/RF Silicon Transistor - TO-5 case - typ. gain 60 - max. operat. vol. 12 - freq. to 2MHz.
Cat. No. R4-501 - 1/2 g. of 3.99 Net



PNP-HI POWER Ceriumium Transistor - TO-3 case - typ. gain 50 - max. operat. vol. 15 - max. power 35W.
Cat. No. R4-520 - .99 Ea.



HOBBYIST'S SOLDERING AND TOOL KIT
Diagonals, long nose pliers, soldering iron and solder, solder aid foot, heat-sink, and screwdriver.
An ideal gift item.
Cat. No. R3-376 \$7.95 Net.

PRECISION PANEL METERS

Economical, high quality, dependable meters give 2% accuracy. Hand calibrated - Linear dial scales - D'Arsonval movement with jeweled bearings. Clear cover, DC Current Types... DC Volt Types... AC Volt Types... also available as VU Meter and "S" Meter.

See *Calectro Handbook* page 38 for prices and specifications.



TV PICTURE TUBE BRIGHTENERS
Restores brightness and contrast. Corrects low emission problems or internal shorts. Just plugs in in parallel or series circuits.

Cat. No.	Description	Net
R4-035	For 10" B/W Tubes	\$2.95
R4-036	For 9" B/W Tubes	2.85
R4-037	For Round Color Tubes	6.95
R4-038	For Rect. Color Tubes	7.75



TAPE RECORDER MICROPHONE

Outstanding performance on music and speech for the price. Low impedance matches late model solid state recorders. Removable desk stand, 48" cord with dual plugs that fit most models. Freq. Response: 100 Hz. Output: -77 dB. Impedance: 200 ohms.
Cat. No. Q4-144 \$4.95 Net



The "GC Calectro Hobbyist Handbook" is available at your nearest Calectro Electronic Supermarket. One is located near you. WRITE TODAY and we'll send you the name and address of your nearest Calectro Supermarket.

700 locations all over the country and Canada. See your electronic parts distributor and SAVE.

CALECTRO

G-C ELECTRONICS

400 SO. WYMAN ST. ROCKFORD, ILLINOIS 61101



CIGARETTE LIGHTER PLUG
Connects CB Sets, warning lights, bottle warmers, etc. to auto dash receptacle.
Cat. No. R4-029 \$2.75 Net

PHONE JACK

Chassis mount jack for open or closed circuit.
Cat. No. F2-142 \$2.75 Net



CIRCLE NO. 8 ON READER SERVICE PAGE



A DIVISION OF
HYDROMETALS, INC.



Be One of Those "SOME GUYS" Who Get All the Breaks

LEARN DRAFTING AT HOME IN SPARE TIME

The "breaks," today, can be in the exciting field of Drafting where good jobs come looking for you if you've had the right training. And now you can get just the training you need in your own home in your spare time. After an interesting and intensive course in Mechanical Drafting you can be the one who's on the "inside" in a fast-moving space industry or an electronics company. You can be the well-paid man who does fascinating work — and moves ahead rapidly.

Find out how you can turn spare time into new skills and qualify for one of these exciting jobs. Send for free booklet with all the details.

Approved for Veteran Training.

United Technical Institute

division of Career Academy

740 N. 2nd Street • Milwaukee, Wis. 53203

Dept. N87219

Please rush me your free 32 page booklet with all the details on your Drafting Course.

Name _____ Age _____

Address _____ Phone _____

City/State/Zip _____

Please send facts on the GI Bill, too.

I am interested in Home Study Resident Training

CIRCLE NO. 29 ON READER SERVICE PAGE

LETTERS

(Continued from page 8)

had something to do with this anomaly. After all, gravity is a vector force and the orientation of the receiver should be important.

K. E. STONE
Marlboro, N.J.

I almost fell out of my chair when Cdr. Appleby stated that variations in gravity could be detected by a ham-band receiver. Someone is pulling his leg.

DAVE COOK, WAØTTN
Boulder, Colo.

Is it possible that the article was originally intended for the April First issue?

TOM SMITH, K6OOJ
Science Dept.
Los Altos High School
Los Altos, Calif.

Commander Appleby tells us that, in our editing zeal, we omitted some important details, which make the experiment successful. Here they are:

"In the morning, set the CW receiver to either of these frequencies (3500 or 7000 kHz) and adjust the dial-set crystal-frequency to zero beat or, if you have a BFO, VFO, or crystal control, set either of these to zero beat the dial setting. Any frequency deviation within the receiver will then produce a beat signal. Preferably use the VFO.

"As gravity changes, an audible beat signal will be heard.

"The curve will change somewhat from day to day because the moon's orbit differs from that of the sun. Those who do not have a crystal, BFO or VFO in their receivers may use a separate BFO in connection with their receivers."

FOUR-CHANNEL STEREO CASSETTE

I would like to know a source of information on the Lumistor model LP-1 cassette stereo tape deck mentioned in "The Stereo Scene" in your January 1970 issue.

CURTIS MARSHALL, M.D.
Baltimore, Md.

The unit in question is marketed by Lumistor Products, Inc., an affiliate of S.C.A. Services Co., Inc. P.O. Box 601, Port Washington, N.Y. 11050. The reader should note that the model LP-1 has been designed to allow for future conversion to play and record simultaneous 4-track stereo cassettes when they are available. It will be necessary to purchase a converter pack for the cassette deck when such time arrives.

TOO, TOO LOUD

More and more studies are being conducted on the subject of noise in our environment. In certain American and Canadian nightclubs and discotheques, a volume level of 128 dB has been recorded—8 dB above

MIGHTY MOUTH

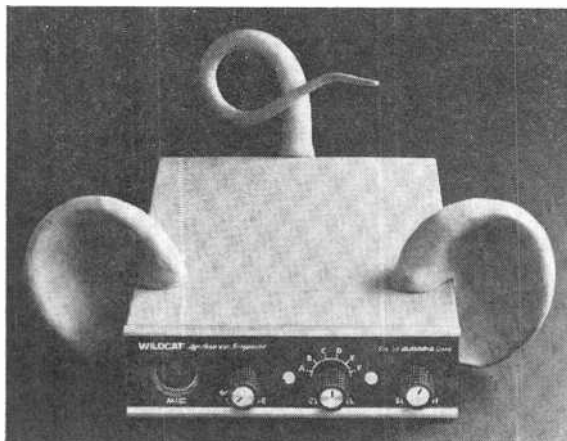

Sure it's small. It measures merely $1\frac{1}{8}$ inches high, $4\frac{1}{4}$ inches across, and $6\frac{1}{4}$ inches deep. It weighs less than two pounds. With all the extras.

In fact, it's the smallest mobile CB in the world.

Do not be deceived.

Its real name is Wildcat. And it lives up to the name.

The Wildcat gives you as much power as *any* CB...including the great big ones. It has six full channels. Including crystals for channel 9. It comes equipped with mounting bracket and quick power disconnect.

The Wildcat is all solid state. It's completely warranted by Pearce-Simpson, the finest name in marine radios, depth finders, hailers, and CB radios and antennas. And backed by Gladding Corporation, first in outdoor recreation since 1816.

It's even got a wood grain finish in the front.

And what a mouth. This little radio will fit inconspicuously into any car, but turn it on and you've got pure talk power.

And ears? Well, you can see for yourself. We've got the biggest in the business. So sensitive, they can pick up even the weakest signal.

Oh, yes. One other very small thing. The price. Only \$69.95.

So, please. See your Pearce-Simpson dealer. He'll introduce you to Mighty Mouth. And any of our other fine CB radios and antennas.

Or write for complete literature to Pearce-Simpson, P.O. Box 800, Biscayne Avenue Annex, Miami, Florida 33152.

Wildcat. By Pearce-Simpson. Good things come in small packages.

Pearce-Simpson  **GLADDING**

A Division of Gladding Corporation. First in outdoor recreation since 1816.

In 1948, University Sound made home high fidelity possible.

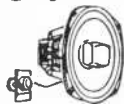

Now, 22 years and 38 patents later, we've made it perfect.

In 1948, University Sound unveiled the world's first popularly priced, full fidelity speaker — the 6201.

In 1970, University unveils the finest, fullest line of component speakers in the world — still popularly priced. Want an example?

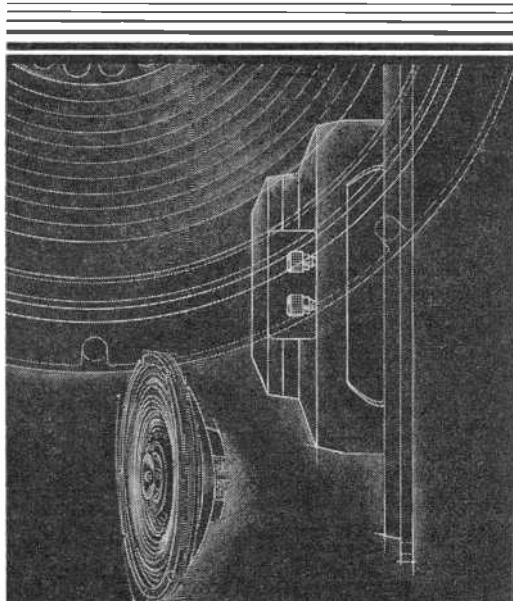

ONE, THERE'S MUSTANG/Modestly priced, high performance speakers for all high fidelity applications.

Slim profile. Ideal for wall and ceiling installations. Heavy duty die-cast aluminum baskets. Exclusive front or rear baffle mounting. Six models. Send for complete details on the Mustang Series, on the rest of University's component speaker line, and on PSE — University's Planned Speaker Expansion program (a brochure full of construction details, hints, specs, blueprints — simplified so anyone can build a fine speaker system.)

U University Sound— the world's leading manufacturer of electroacoustic products.

P.O. Box 26105, Oklahoma City, Okla. 73126
A quality company of LTV Ling Altec, Inc.

LETTERS *(Continued from page 12)*

the threshold of feeling and 12 dB below that of ear-splitting pain.

Anthony Leo's article ("Treble Boost for Your Guitar," December 1969, p 59) about blasting them with another 20 dB is certainly no help to the sound pollution problem.

It would seem to me that the civic responsibility of POPULAR ELECTRONICS would be to show some concern for the health and well-being of its readers.

J. R. GUTHRIE
Niagara Falls, N.Y.

OVERWHELMED!!

In your January 1968 issue, you very kindly published a letter of mine requesting assistance in obtaining solid-state components, relays, etc., for electronic experiments. I mentioned that parts were very difficult to obtain in Baghdad and that I would send in exchange Iraqi novelties and stamps.

I received more than 100 packages from friends all over the U.S.A. and this has created a problem for me—a college student with limited income.

Please assure all of your readers who were so kind to me that I haven't forgotten a single one of them and that I am attempting to repay each and every gift with appropriate items. Please understand that this has taken me a substantial period of time and I hope that no one has been offended by the delays encountered—the number of gifts received was just overwhelming.

RAAD SADIQ JALAL
Baghdad, Iraq

The above "explanation" is unfortunately typical of the mail we receive from readers in Europe, Asia, and Africa. Good intentions frequently create unusual problems for the recipients. Although many readers would like to help those less fortunate than themselves, may we recommend it be done purely and simply on a gift basis.

OUT OF TUNE

"Electronic Aquarium Heater" (January 1970). In Fig. 1 are shown 26 resistors when only 24 are specified in the Parts List for R7. The reason for this is that the author did not have handy the proper number of 300-ohm resistors and paralleled several higher value units to obtain the proper resistance of approximately 7 ohms. Anyone can do the same if necessary. Also, in Fig. 4, change R3 to R2, R5 to R4, R4 to R3 and R7 to R5.

POPULAR ELECTRONICS READER SERVICE PAGE

free information service:

Here's an easy and convenient way for you to get additional information about products advertised or mentioned editorially (if it has a "Reader Service Number") in this issue. Just follow the directions below... and the material will be sent to you promptly and free of charge.

1. On coupon below, circle the number(s) that corresponds to the key number(s) at the bottom or next to the advertisement or editorial mention that is of interest to you. (Key numbers for advertised products also appear in the Advertisers' Index.) Print or type your name and address on the lines indicated.

2. Cut out the coupon and mail it to: POPULAR ELECTRONICS, P.O. Box 8391, Philadelphia, PA 19101.

note: If you want to write to the editors of POPULAR ELECTRONICS about an article on any subject that does not have a key number, write to POPULAR ELECTRONICS, One Park Avenue, New York, N.Y. 10016. Inquiries concerning circulation and subscriptions should be sent to POPULAR ELECTRONICS, Portland Place, Boulder, Colo. 80302.

VOID AFTER APRIL 30, 1970

POPULAR ELECTRONICS

P.O. BOX 8391
PHILADELPHIA, PA. 19101

1 2 3 4 5 6 7 8 9 10 11 12 13 14 15 16 17 18 19 20
21 22 23 24 25 26 27 28 29 30 31 32 33 34 35 36 37 38 39 40
41 42 43 44 45 46 47 48 49 50 51 52 53 54 55 56 57 58 59 60
61 62 63 64 65 66 67 68 69 70 71 72 73 74 75 76 77 78 79 80
81 82 83 84 85 86 87 88 89 90 91 92 93 94 95 96 97 98 99 100

NAME (Print clearly) _____

ADDRESS _____

CITY _____ STATE _____ ZIP CODE _____

3 a

TAKE ONE



new literature

To obtain a copy of any of the catalogs or leaflets described below, simply fill in and mail the coupon on page 15 or 115.

A free six-page construction article that describes a monolithic integrated stereo FM decoder system is available from *J.W. Miller Company*. The project described is designed around a Motorola MC1304 IC, the circuit of which provides excellent channel separation across the entire audio range. Miller series 1359 coils are incorporated into the project to help assure optimum channel separation characteristics.

Circle No. 75 on Reader Service Page 15 or 115

A new short form "Tape Head Replacement and Conversion Guide," listing 218 manufacturers and more than 1200 tape recorder models, can be obtained from *Nortronics Co., Inc.* The information contained in the condensed

guide provides complete tape head replacement listings for most popular priced and professional recorders, both domestic and imported. Also included is a listing of Shure and Michigan Magnetics tape heads, cross-referenced to the Nortronics equivalent.

Circle No. 76 on Reader Service Page 15 or 115

"The World of SWL'ing," 1970 edition, is the title of a new mail-order-only catalog devoted to shortwave listening equipment and accessories. Available from *Gilfer Associates, Inc.*, the catalog lists special offers and bonuses for the Drake SPR-4, Eddystone EC-10, Squires-Sanders IBS receivers; antennas made by Murch and Mosley; and a complete listing of all SWL books. Some of the other items cataloged are world time and digital clocks, an antenna matcher, QSL card holder and album, and a great circle map. This catalog is quite literally a shortwave listener's dream listing.

Circle No. 77 on Reader Service Page 15 or 115

A 24-page, fully illustrated catalog offering several new and extremely useful, but hard-to-find, tools is available from *Brookstone Co.* Precise and detailed descriptions and applications of each tool listed in this unique collection are contained in the catalog. Among the items listed are tungsten carbide saw blades, miniature riffer files, torch lamp, stainless steel pliers, and hard-chromed needle files. Also included in the listing are woodworking,

(Continued on page 116)

Turner Improves On Turner



Turner +2
The Old Best

There never was a better base station microphone than the transistorized Turner +2. Until now. Now there is a new best. The +3 from Turner. A superior microphone with modern styling and several important features. Transistorized electronics. A volume control for greater range and signal strength. ModuGard™, the compression amplifier which prevents over modulation and ensures a loud, clear signal. Frequency range 300-3000 Hz. Output -23 db. Push-to-talk bar. Lock lever. List price \$75.00. At your dealer. The Turner Company. 909 17th Street N.E., Cedar Rapids, Iowa 52402.

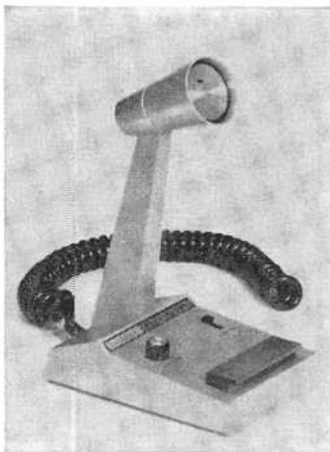

Turner +3
The New Best

CIRCLE NO. 27 ON READER SERVICE PAGE



S-1204
"Star Quest"



SX-133

S-214



SHORT-WAVE
General coverage and special frequency receivers. A range of models stretching across every known frequency used in communications and entertainment. Prices range from \$59.95



SX-122A



S-240

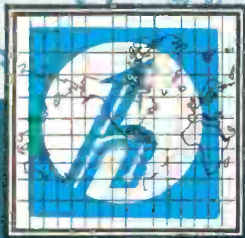

OUR SHORT-WAVE RADIOS COVER THE WORLD

AMATEUR
Transceivers and communications systems that give you the maximum in power, range, sensitivity, coverage—all around performance. Unrivalled advanced-engineering features in the price range that fits your needs. Prices to \$1545

CR-44A
"Ranger"



SR-2000



SR-400

CRX-101,
-106, -107



MONITORS
Table model and hard-headed tunable solid-state receivers. High-performance superheterodyne units of high sensitivity and selectivity for aviation, marine, and industry/public service coverage. Prices from \$39.95

ACCESSORIES
Power supplies, antennas, filters, keyers, remote VFO/VSWR console, speakers, learning and practice systems—all the key elements for top enjoyment, maximum professionalism, are yours at their best from your Hallicrafters distributor.



HA-1A



HA-20

MAP COURTESY OF
RADIO AMATEUR
CALL BOOKING.



CRX-103A -104, -105A



**THE NEW HALLICRAFTERS
WORLD TIME DIAL & FREQUENCY CHART**
Only \$1.00 each, postpaid, to readers of this publication.

Please send me dial/chart(s).
Enclosed is my check money order for \$___00
in full payment, including postage and handling.
PLEASE PRINT

Name _____
Address _____
City _____ State _____ Zip _____



hallicrafters
A Division of National Instruments

600 HICKS ROAD
BOLLING MEADOWS, ILLINOIS 60008

We pack your electronics course with kits to make your training fast. You'll enjoy every minute of it.

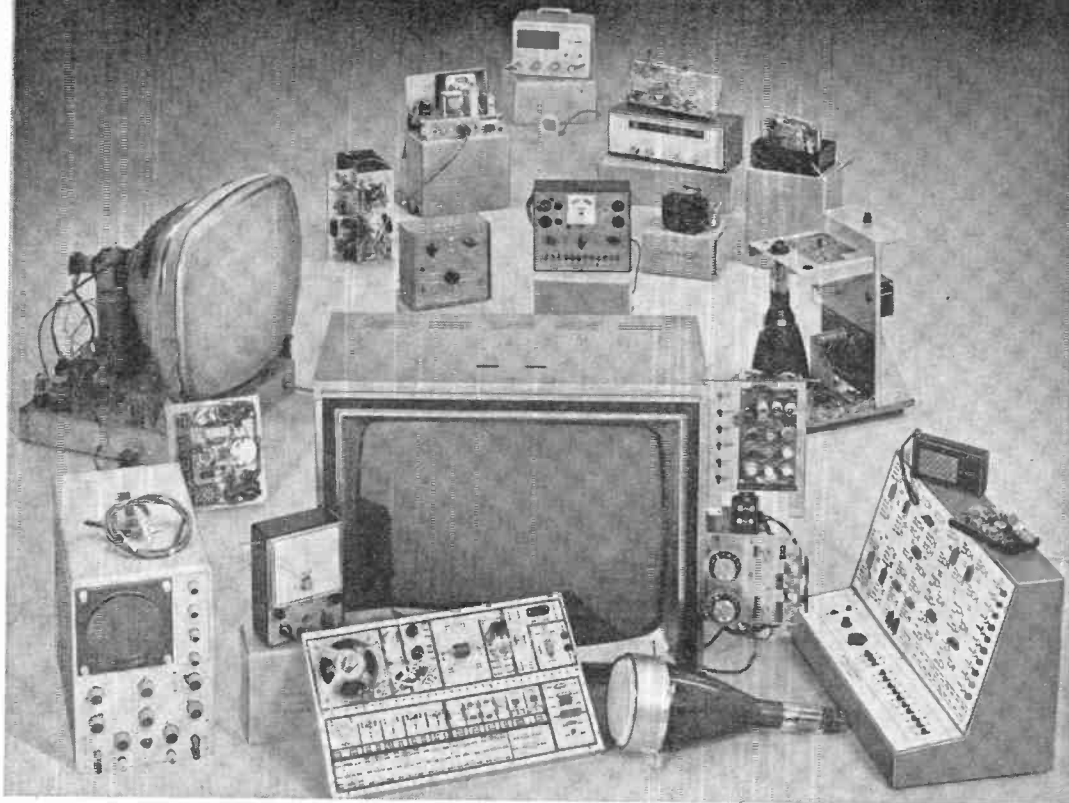

Your NTS success package

Choose a career in electronics: Computers, Color TV Servicing, Automation, Communications. Whatever the field, NTS has a complete home-study package to get you to the top *faster*. 10 thorough training courses. Each includes *everything* to give you the *working* knowledge required of successful technicians.

NTS Project-Method Training is the practical way to learn elec-

tronics. It's a proven combination of lessons and the best professional kit equipment available. NTS provides the *biggest selection of kits ever offered in home-study . . . all at no extra cost*. You'll construct these exciting kits to fully understand electronic circuits, components, and concepts. Our Project-Method lets you build skills by putting theory into practice . . . by working with your hands, as well as your head.

The NTS "learn and practice" approach makes training at home really easy. All it takes is a few hours a week . . . whether you're starting from scratch or in advanced courses. This is the all-inclusive success package that put thousands of men into the best paying jobs . . . or into their own business. If "just a living" isn't good enough for you, now is the time to get something better going for you!

NTS COMPUTER ELECTRONICS

This is the future. And it's happening now. The number of computers will *increase many times* in the next few years.

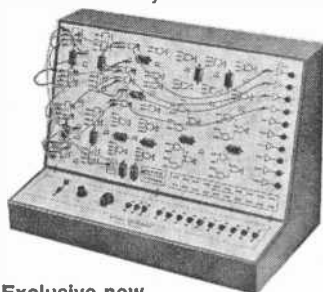

Exclusive new Compu-Trainer®

NTS offers a solid grounding in computer operation, wiring, data processing and programming. One of the 10 important kits included is our exclusive Compu-Trainer®. It's a fully operational computer logic trainer — loaded with integrated circuits — the first ever offered in home study. It introduces you quickly to how, what, when and why of computers . . . from theory to practical servicing techniques. This unit is capable of performing 50,000 operations per second. And it's sent at no extra cost.

NTS COLOR TV SERVICING

This is a broad, easily understood

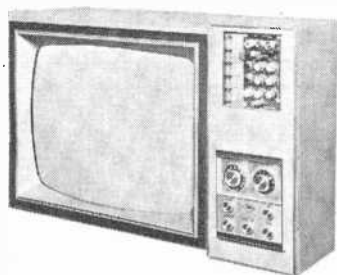

COLOR TV 295 SQ. IN. PICTURE

program designed to make you a complete home-entertainment service technician. Included, at no extra cost, is a color TV that has more features than any

set on the market. You also learn all about stereo, hi-fi, multiplex systems, and become a specialist in Color TV Servicing. Kits also include AM-SW radio, solid-state radio, field-effect transistor volt-ohmmeter, electronic tube tester.

NTS AUTOMATION/ INDUSTRIAL ELECTRONICS

You're trained in the "push-button" electronics that keep industry going and growing . . . from relay type controls to highly advanced systems essential to production. You receive 16 kits including a 5" wide band oscilloscope, and the new NTS electronics lab: a fascinating NTS exclusive experimental laboratory. A complete workshop which makes you familiar with solid-state, miniature, and integrated circuits.

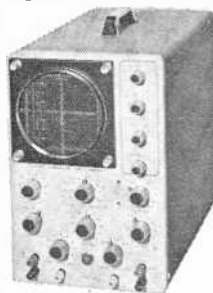

5" Oscilloscope

NTS ELECTRONIC COMMUNICATIONS

The use of 2-way radio systems in private and commercial applications is skyrocketing. NTS prepares you for the big-money opportunities in the field of transmitting and receiving equipment. *Your tuition will be refunded in full if you cannot pass the FCC exam for a 1st Class Commercial Radio-Telephone License within*

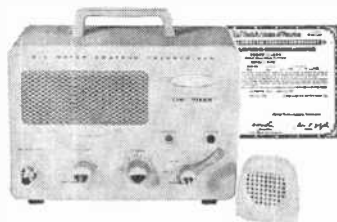

5 Watt AM Transmitter & Receiver

six months after successfully completing this course. You build valuable kits including Amateur-Phone 6 Meter VHF Transceiver, solid-state Radio, and a field-effect transistor volt-ohmmeter.

CLASSROOM TRAINING AT LOS ANGELES

You can take classroom training at Los Angeles in sunny Southern California. NTS occupies a city block with over a million dollars in facilities devoted exclusively to technical training. Check box in coupon.

NATIONAL TECHNICAL SCHOOLS

World-Wide Training Since 1905
4000 South Figueroa Street
Los Angeles, Calif. 90037, U.S.A.

APPROVED FOR VETERANS

Accredited Member: National Association of Trade and Technical Schools, National Home Study Council.

TODAY, MAIL
COUPON
FOR FREE
COLOR
CATALOG
AND SAMPLE
LESSON.



NATIONAL TECHNICAL SCHOOLS
4000 S. Figueroa St., Los Angeles, Calif. 90037

Please rush Free Color Catalog and Sample Lesson, plus information on field checked below. No obligation. No salesman will call.

- MASTER COURSE IN COLOR TV SERVICING
- COLOR TV SERVICING
- MASTER COURSE IN TV & RADIO SERVICING
- PRACTICAL TV & RADIO SERVICING
- MASTER COURSE IN ELECTRONIC COMMUNICATIONS
- FCC LICENSE COURSE
- MASTER COURSE IN ELECTRONICS TECHNOLOGY
- INDUSTRIAL AND AUTOMATION ELECTRONICS
- COMPUTER ELECTRONICS
- BASIC ELECTRONICS

Name _____ Age _____

Address _____

City _____ State _____ Zip _____

- Check if interested in Veteran Training under new G.I. Bill.
- Check if interested ONLY in Classroom Training at Los Angeles. Dept. 205-030

NEW PRODUCTS

Additional information on products covered in this section is available from the manufacturers. Each new product is identified by a code number. To obtain further details on any of them, simply fill in and mail the coupon on page 15 or 115.

DELUXE AM/STEREO FM RECEIVER

The availability of a deluxe solid-state stereo receiver kit was recently announced by the *Heath Company*. Designated the Heathkit Model AR-29, the new receiver borrows liberally from the technology of the company's famous Model AR-15 receiver. The AR-29 incorporates advanced FET and IC designs;

ultra-sensitive tuner; ultra-selective i.f. design; and some new advances of its own—such as modular plug-in circuit boards, built-in test circuitry, and the first use of computer designed, fixed-tuned LC i.f. filters. Technical specifications: 7-60,000 Hz -1 dB at 1-watt output; less than 0.25% harmonic and IM distortion; 50 watts into 8 ohms (IHF) output power/channel; 1.8- μ V FM tuner sensitivity.

Circle No. 79 on Reader Service Page 15 or 115



"VEHICULAR BASE" ANTENNA

Directional gain at 27 MHz and electronic beam control are two of the radical developments featured in *Antenna Specialists Company's* two-way "Mobile Scanner" CB antennas. The antennas comprise a matched pair of 50-ohm base-loaded whips interconnected through a dash-mounted control box. The radiated or received signal is fed through dividing circuitry, by means of a three-position switch, to produce a highly directional beam either to the front or back or simultaneously to both sides. Forward gain is 2 dB with attenuation of unwanted signals at 17 dB front-to-side. Rear gain is 2.5 dB, while side gain is 1 dB in each direction if whips are center mounted. The Mobile Scanner can be utilized as an instantaneous beam for scanning the horizon and then zeroed in on the desired signal.

Circle No. 80 on Reader Service Page 15 or 115

BASIC DIGITAL COMPUTER KITS

Science Workshop's new "Digi-Kit" series of basic digital computer kits provides a practical introduction to solid-state components and their application to computer circuitry.

The series is designed so that each assembled kit performs a complete function by itself, and combinations of kits can be used to build systems. The Digi-Kits offered are an astable multivibrator, bi-stable multivibrator, monostable multivibrator, inverter, flip-flop/counter, and an AND gate/OR gate. A salient feature of the kit series is slow-speed operation to allow monitoring of circuit operation. Lamps in the output circuits of each kit indicate the operating state, eliminating the need for test equipment or meters.

Circle No. 81 on Reader Service Page 15 or 115

EIGHT-CHANNEL AUTO-SCAN RECEIVER

A new receiver that automatically scans up to eight fixed-frequency channels, while presenting a continuous flashing light display is being made by *Electra Corp.* The receiver, known as the "Bearcat," is available in three models: Model BCL is for low-band (30-50 MHz) reception; Model BCH is for high-band (150-174 MHz) reception; and Model BCU is for UHF (450-470 MHz) reception of the emergency and business service transmissions. The receiver searches at a rate of 12 channels per second, locking onto the first active channel it encounters. When the transmission ends, the signal search continues, while a red light winks for each channel scanned. The light remains on during a transmission to identify the active channel. Sensitivity of the Bearcat is 1 μ V or better for 20 dB quieting. A squelch control eliminates noise. Miniature crystals are available for desired frequencies.

Circle No. 82 on Reader Service Page 15 or 115



PORTABLE RHYTHM INSTRUMENT

Lafayette Radio Electronics' "Rockbeat" supplies completely automatic percussion in six beats: swing trot, down beat, jazz rock, rock beat, four beat, and slow ballad. It features instant start/stop operation with footswitch provision; variable-tempo control for changing the beat and rhythm; and a separate pushbutton with footswitch provision that permits solo ad lib drum beat. Variations can be made by changing the time between each push of the solo button and by varying the time it is held down. A volume control changes the signal level supplied to the external power amplifier. The Rockbeat operates on a 9-volt battery or with an optional a.c. adapter.

Circle No. 83 on Reader Service Page 15 or 115



NEW "UNISPHERE" MICROPHONE

A unidirectional microphone, which combines professional features with low cost, has been introduced as the "Unisphere B" Model 588 by *Shure Brothers, Inc.* The 588 is for use



**The sensibly priced tape cassette
...from MALLORY.**

Just what you've been waiting for. The new Mallory DURATAPE[®] Cassette.

You get the quality and performance of expensive tape cassettes at a nice, lots-less price. But not the poor performance or the problems of the special-discount cheapies.

And since they're from Mallory — a company long known for quality electronic products—you can expect high fidelity, smooth operation, and long reliability. And get it . . . every time!

They'll fit any cassette recorder, player, cassette-radio. Even the new cassette changers. And you pick the recording time: 30, 60, 90, 120 minutes.

Our DURATAPE[®] Cassettes are tough but we put them in unbreakable, easy-to-stack containers just for extra protection. Like in the rain or through the mail.

And we make a head cleaner that's perfect for Cassette Recorders, too.

You'll find this great new thing in sound wherever Mallory products are sold.

MALLORY

MALLORY DISTRIBUTOR PRODUCTS COMPANY

a division of P. R. MALLORY & CO. INC.
Box 1558, Indianapolis, Indiana 46206; Telephone: 317-836-6363

Batteries • Capacitors • Cassette Tapes • Controls • Resistors • Semiconductors • Sonalert[®] • Switches • Timers • Vibrators • ICs

CIRCLE NO. 13 ON READER SERVICE PAGE

PRODUCTS (Continued from page 22)



with high-quality sound systems and tape recorders. It features a true cardioid pickup pattern that suppresses feedback and allows the user greater freedom of movement without unnatural coloration. The microphone cartridge is shock mounted to reduce handling noise, and a built-in filter reduces wind and breath noises. The new microphone is available in three models: 588SA (high impedance); 588SAC (high impedance with series "C" connector); and 588SB (low impedance). Technical specifications: 80-13,000-Hz frequency range; built-in locking on/off switch; 20' detachable cable with Cannon-type connector; swivel mounting adaptor.

Circle No. 84 on Reader Service Page 15 or 115

MINI-COLOR GENERATOR

The first color bar/dot generator small enough to fit into a tube caddy is now available from *Sencore*. The new generator, Model CG19, appropriately named the "Caddy Bar," is smaller than a box of cigars and weighs only 2 lb. It employs circuitry that reduces current drain, allowing full regulation of voltage on all circuits—not just the timer circuits. The timer range has been doubled over the company's earlier models, making it nearly impossible to have a timer jump. Standard RCA-licensed color bars, crosshatch, white dots, vertical lines, and horizontal lines are generated.

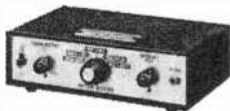

Circle No. 85 on Reader Service Page 15 or 115

ULTRA-MINIATURE MONITOR RECEIVER

The "Minicom" is an ultra-miniaturized, multi-purpose VHF/FM monitor receiver available from *Unimetrics, Inc.* In a 7¼" x 4½" x 1½" cabinet it has an all-solid-state circuit with one IC, 14 transistors, 9 diodes, and a FET. The Minicom has two crystal-controlled positions in addition to being completely tunable in a frequency range of 147.5 to 174.5 MHz. A built-in a.c./d.c. power supply permits 117-volt and 12-volt d.c. operation; and, with an optional power pack, the Minicom can be used as a portable monitor receiver.



Circle No. 86 on Reader Service Page 15 or 115

STEREO EQUALIZER

Altec Lansing has perfected a new process that enables audiophiles to have an entire room "tuned" for the ultimate in high fidelity. The "Acousta-Voicette" stereo equalizer

actually adjusts a stereophonic sound system to harmonize completely with the natural acoustics of the listening room. The Acousta-Voicette uses 24 filters, spaced at the one-third octave band centers from 63 to 12,500 Hz per channel. There are 48 critical band filters in all, plus a gain control on each channel for stereo balance. The system brings into equality special frequencies which the room and sound system tend to over-emphasize. As each exaggerated tone is brought into equality with the normal responding tones in the room, the sound quality is vastly improved. The result is perfect tonal balance at all frequencies, allowing the listener to hear the original environment of the recording studio.

Circle No. 87 on Reader Service Page 15 or 115

PROFESSIONAL VTVM

An advanced design VTVM, the Mercury Model 1700C, from *Singer Products Co., Inc.*, will meet the technician's most rigid requirements. The 1700C has a large 6" wide-view meter with anti-parallax mirrored scale, and uses highest quality components throughout. Other features include wide frequency response on a.c. voltage function for compatibility with color TV servicing; FM multiplex, troubleshooting, and general industrial applications; double-jeweled, triple-inspected D'Arsonval meter movement with individual side and tail weights.



Circle No. 88 on Reader Service Page 15 or 115

SOUND MIXER AND SPECIAL EFFECTS CHAMBER

The "Ultramix I," a solid-state preamplifier and sound mixer that accepts up to four separate inputs and permits the addition of tremolo and reverberation effects, has been introduced by *The Turner Company*. Inputs can be from microphones, tape recorders, or electrical instruments such as guitars and organs. Volume and gain controls are supplied for each input to permit proper blending and mixing of the multi-channel sound. The composite signal is then delivered to any existing power, guitar, or public address amplifier. The front panel controls are realistic and utilitarian, with one gain control for each channel, one reverberation and two tremolo controls (depth and rate), an a.g.c. on/off switch, and a master volume control.



Circle No. 89 on Reader Service Page 15 or 115

INSTANT WEATHER REPORTS

The "Weather Sentry" receiver made by *Hammarlund Mfg. Co.* features an exclusive pretuned band for reception of U.S. Government VHF weather report broadcasts around
(Continued on page 114)

*It took more than skill
to design the world's
smallest complete mobile
5-watt CB
transceiver*



Johnson Messenger 125

\$99⁹⁵

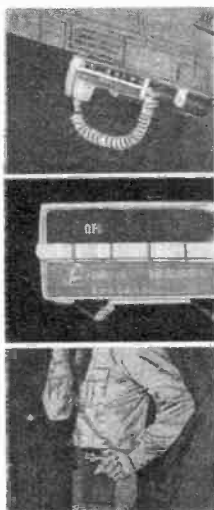

Only the famous Johnson "talk-power" is big as ever on Johnson's radically new Messenger 125! Virtually every vehicle on the road, including the 1969 and 1970 models, can easily accommodate this versatile new radio. Its far-ahead features make operation extremely simple and enjoyable. Best of all, we sliced the most out of the price!

Features

- 5 push button channels—no knobs ■ slide-lever vol. and squelch
- World's smallest panel configuration— $1\frac{1}{4}$ " by $4\frac{1}{32}$ ", just 7" deep
- 4 watts output at 13.8 VDC ■ Accessories for portable use



E. F. JOHNSON CO.

WASECA, MINNESOTA 56093

CIRCLE NO. 11 ON READER SERVICE PAGE

Clip the coupons!

Present one or more to your participating RCA Test Equipment Distributor for big discounts on these four instruments during RCA's big Spring Coupon Carnival. (Only one coupon will be accepted per instrument.) Do it today. Offer good only between February 15th and April 30th, 1970.

\$7.50 Toward Purchase
of RCA WT-501A
Transistor Tester



Mr. Distributor, please refer to RCA 1970 Carnival announcement. Void where prohibited, taxed, or restricted. Cash value 1/20¢. Offer expires April 30, 1970.

\$10.00 Toward Purchase
of RCA WT-509A
Picture Tube Tester



Mr. Distributor, please refer to RCA 1970 Carnival announcement. Void where prohibited, taxed, or restricted. Cash value 1/20¢. Offer expires April 30, 1970.

\$7.50 Toward Purchase
of RCA WV-98C
Senior VoltOhmyst



Mr. Distributor, please refer to RCA 1970 Carnival announcement. Void where prohibited, taxed, or restricted. Cash value 1/20¢. Offer expires April 30, 1970.

\$20.00 Toward Purchase
of RCA WR-99A
Crystal Calibrated
Marker Generator



Mr. Distributor, please refer to RCA 1970 Carnival announcement. Void where prohibited, taxed, or restricted. Cash value 1/20¢. Offer expires April 30, 1970.

RCA Electronic Components, Harrison, N. J. 07029

CIRCLE NO. 21 ON READER SERVICE PAGE

RCA

POPULAR ELECTRONICS

BUILD

COVER STORY

SECURITY 1

SPEECH SCRAMBLE YOUR TELEPHONE CONVERSATIONS

BY J. PINA

AT ONE TIME or another most of us have the need or desire to pass along information that we would just as soon not put in writing or otherwise broadcast to the whole world. To do so, we use the ordinary telephone; but there are few telephones these days that don't have extensions or some other means by which a conversation can be overheard—so keeping something truly 100% confidential gets to be pretty difficult.

If you really want to keep a phone conversation private, it is necessary to "scramble" your speech so that only the person for whom it is intended can understand it. The "Security-1" does just that. When two parties are using this scrambler system and talking in plain language, they can understand each other, but a third party listening in on an extension phone will hear a strange concoction of sounds that make no sense at all. It is impossible to decipher the conversation unless you have another



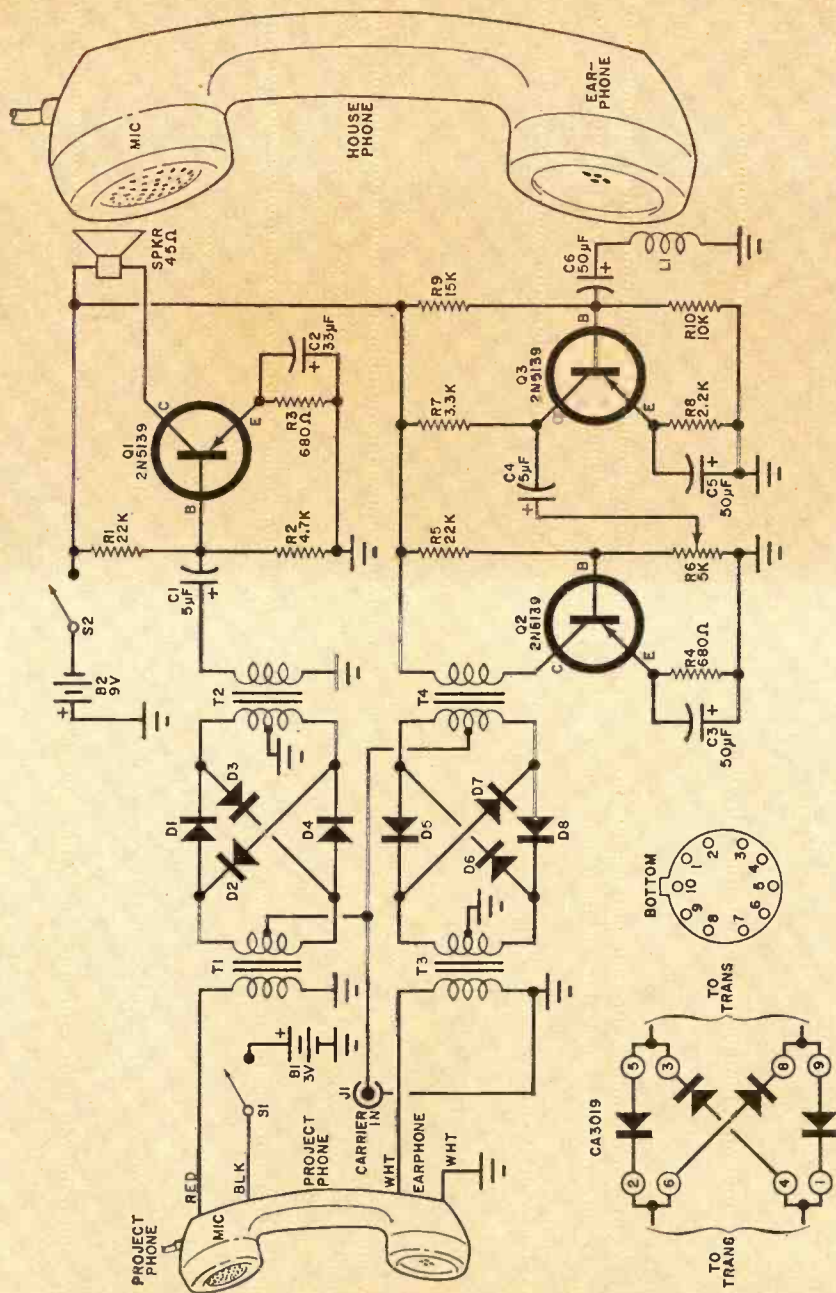

Fig. 1. An RCA CA3019 IC may be used in place of the diodes shown. The transistors and most of the components, including two transformers may be salvaged from the commercial telephone amplifier. L1 is built into the plastic container.

PARTS LIST

- B1—C or D cell (2)*
B2—9-volt transistor radio battery
C1,C4—5- μ F, 15-volt electrolytic capacitor
C2—33- μ F, 10-volt electrolytic capacitor
C3,C5,C6—50- μ F, 15-volt electrolytic capacitor
D1-D8—Small-signal silicon diode (1N34A or similar or use RCA CA3019 IC)
J1—Earphone jack
L1—Telephone induction coil pickup (Lafayette 99E10340 or similar)
Q1-Q3—Small-signal npn transistor (2N5139 or similar)
R1,R5—22,000-ohm
R2—4700-ohm
R3,R4—680-ohm
R7—3300-ohm
R8—2200-ohm
R9—15,000-ohm
R10—10,000-ohm
R6—500-ohm PC potentiometer
S1,S2—S.p.s.t. switch
T1-T4—500-ohm to 500-ohm center-tapped transformer (Lafayette Argonne AR162 or similar)
Misc.—Telephone amplifier (Radio Shack 43-230 or similar, optional), surplus telephone, battery holders, transistor radio earphone cable and connector, audio signal generator, radio, mounting hardware, etc.
Note—A printed circuit board, etched and drilled, is available from Southwest Technical Products Corp., 219 W. Rhapsody, San Antonio, Texas 78216 at \$4.50.

*All resistors
 1/4-watt*

scrambler and know the electronic key being used. The Security-1 requires no electrical connections to the telephone—all coupling between the scrambler and the telephone is made by magnetic induction and acoustic means.

Besides the scrambler devices, the users at each end of conversation must have conventional audio sine-wave generators capable of delivering about 1 volt, tunable between 1 and 3 kHz. These are used as the scrambler sources. If a scrambling scheme that is almost impossible to decode is desired, the audio output from a conventional transistor radio (through the headphone connector) may be used as the scrambler source. In this case, of course, both parties must be able to tune their receivers to the same broadcasting station.

The basic principle of the Security-1 employs what is known as a balanced ring demodulator—the same circuit being used for both coding and decoding. This particular circuit has been employed for

many years by the telephone company and radio amateurs for the generation of single-sideband suppressed carrier signals. Because of the strange sounds coming from the scrambler, the same basic circuit may also be used for experimenting with far-out music. One electronic instrument can be substituted for the speech input while an audio generator or another electronic instrument could be used for the scrambling source. Although not tested by the author, such a system should produce some really weird effects.

Each end of a scrambler system requires two telephone hand sets: the conventional house telephone (called the "house phone" here) and another handset (called the "project phone"). The project phone can be any surplus telephone handset that has a conventional carbon microphone and dynamic earphone with a connecting cable.

Construction. The mechanical construction of the scrambler involves making a mounting for the house phone so that a pickup coil and small loudspeaker can be placed in close proximity to the earpiece and microphone, respectively, of the house phone. It is best to prepare this mounting first and then construct the electronic portion of the scrambler and fit it into the support.

The prototype shown in the photos uses a commercially available plastic telephone amplifier for the cabinet. You can build any type of cabinet (preferably of wood) slightly longer than the telephone handset and a few inches deep. If you build your own cabinet, lay the house phone handset down on the upper surface and mark the locations of the microphone and earpiece. Cut out holes of the correct size so that the phone drops smoothly into place when it is in position.

Using appropriate mounting hardware and spacers, mount the small 45-ohm loudspeaker under the microphone hole so that it is about half an inch from the house phone microphone when the phone is placed on the support. Mount the induction pick-up coil in the usual fashion to the earpiece. Any of the low-cost telephone pickup induction coils, available at most electronic supply stores, can be used here.

If you decide to use the commercial

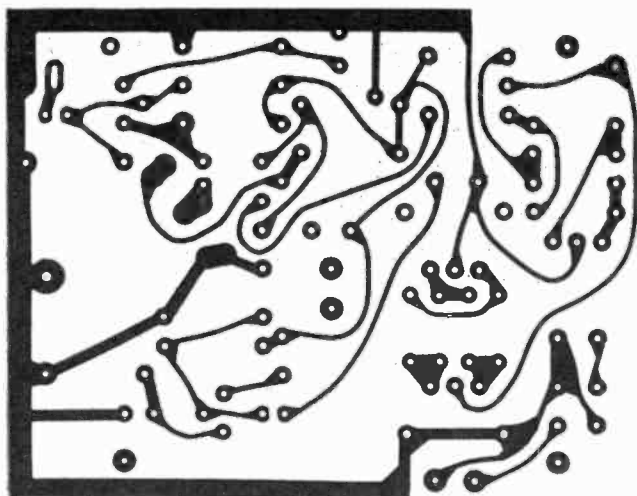
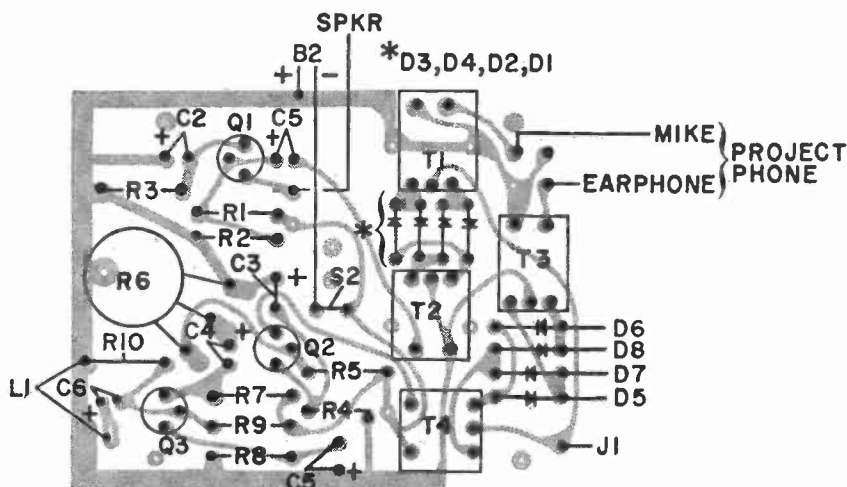

Fig. 2. Actual size foil pattern for the scrambler. This layout can be used only with subminiature transformers such as the Lafayette TR98 or similar types.

Fig. 3. Component installation on the board. The bulk of the components, including the transformers, can be salvaged from the printed circuit amplifier that comes with the commercial unit.



telephone amplifier set (see Parts List of Fig. 1) you will find all of these holes already made. You will also find an induction coil built into the earpiece hole. Remove the bottom cover of the cabinet, and remove the plastic insert from the microphone chamber. Then remove the built-in audio amplifier. Do not remove the induction coil. Also remove the small loudspeaker from its plastic cabinet. Using appropriate hardware and spacers, mount the loudspeaker in the microphone chamber as previously described. Although a 45-ohm speaker is specified in the Parts List, you can use the low-impedance speaker that comes with the built-in amplifier. In this case, also re-

move the speaker output transformer from the PC board and wire it to the speaker, using a pair of leads to run the primary back to the circuit.

In both the commercial and homemade cabinets, once the speaker has been mounted, use foam rubber to pad the perimeter of the microphone hole so that the house phone microphone fits snugly in place. You can also insert foam-rubber sound-deadening material under the speaker to keep the acoustic energy within the mike chamber. In the commercial unit, leave the earphone jack in place; in the homemade unit, mount an earphone jack on one wall.

The circuit for the scrambler is shown

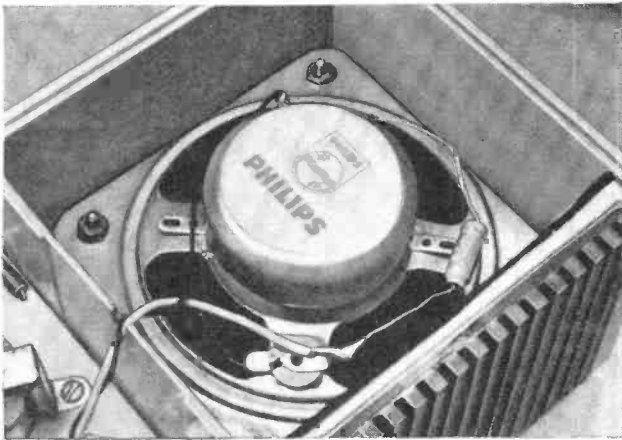
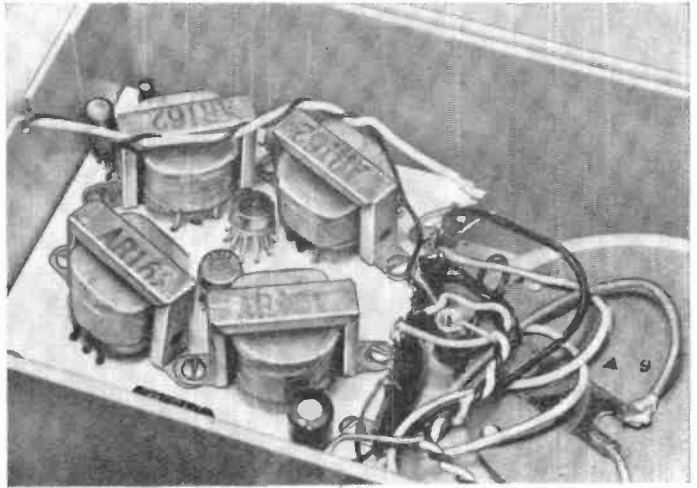

Three views of a non PC board prototype. The photo above shows the use of an IC for each diode bridge, and the larger-sized transformers. The speaker (left) is a 45-ohm type that is mounted on standoffs within the old microphone chamber. The batteries and power switch were contained in the old loudspeaker housing.

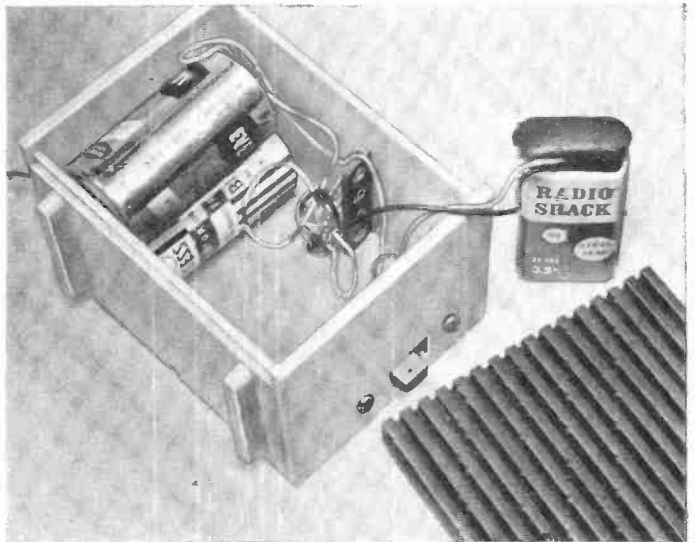

HOW IT WORKS

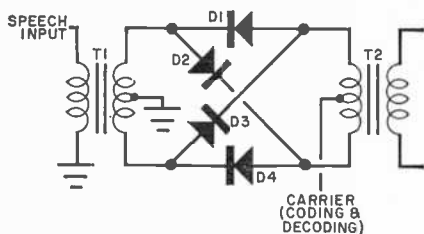

With no speech applied to the primary of T_1 , when the applied encoding carrier is positive going (with respect to ground), the currents in the primary of T_2 and the secondary of T_1 (through diodes D_1 and D_4) are out of phase so that no carrier signal is developed in the secondary of T_2 . When the encoding carrier is negative going, the same thing happens as the current flows through diodes D_2 and D_3 . Thus none of the encoding carrier gets through output transformer T_2 .

When speech is applied to the primary of T_1 , the audio voltage across the secondary of T_1 unbalances the diode modulator. The resulting signal across the secondary of T_2 consists of a series of pulses whose polarity and repetition rate are determined by the carrier voltage and whose amplitude is determined by the instantaneous amplitude of the speech signal. If this output is viewed on a spectrum analyzer, it is seen to contain only an upper and a lower sideband.

If the encoding carrier is assumed to be a 3000-Hz tone and the speech frequency is assumed to be a 100-Hz tone, then the output would contain both a 3100-Hz upper sideband and a 2900-Hz lower sideband. If a filter is used to cut off signals above 3000 Hz, then only the lower sideband remains. When the input speech frequency is changed to 200 Hz, the output will be 2800 Hz. Thus the modulator inverts the incoming speech frequency, making it completely unintelligible to the unwanted listener.

Decoding uses the same circuit as encoding, and the system works as long as the same carrier signal is used at both ends.

in Fig. 1. The four diodes in each half of the circuit may be either individual units or an RCA CA3019 integrated circuit.

The actual size foil pattern for the printed circuit is shown in Fig. 2 and component installation is shown in Fig. 3. If you are using the commercial telephone amplifier, most of the required components can be removed from the built-in amplifier including the transistors, volume control, and on-off switch, to be used in the scrambler. The driver

transformer for the push-pull output stage can also be salvaged and used as T_2 . If you do not choose to use the PC board, perf-board construction may be used, making sure that the overall board will fit within the enclosure.

The completed board is mounted on standoffs within the homemade cabinet or on the existing standoffs in the commercial unit. Once the board has been installed, drill a hole in the side of the enclosure large enough to pass the four-lead cable from the project phone. In most phones, the two white leads are from the earpiece, while the black and red leads are from the phone microphone.

The 9-volt battery is mounted as it comes in the commercial unit, while a pair of C-cell holders are placed within the microphone chamber. A small s.p.s.t. on-off switch is also mounted within the mike chamber. In the homemade version, mount the batteries where convenient.

Testing. The scrambler can be tested without using the house phone. Disconnect both leads supplying the project phone mike to input transformer T_1 . Connect the loudspeaker output from any radio to the input terminals of T_1 and tune the radio to an "all news" station—or one that has more speech than music. If you use a conventional radio, disconnect the speaker connections to the output transformer secondary and use the secondary to supply T_1 . If you are using a transistor radio, use the earphone jack that usually is provided. When the earphone connector is plugged into its jack, the internal speaker is automatically disconnected. Remove the earphone and connect the cable ends to the input of T_1 . Turn the radio volume down.

Connect a conventional audio sine-wave generator through a transistor radio earphone plug and cable to the coder input jack on the scrambler, making sure the feed is properly grounded. Set the audio generator to about 1 kHz, 1 volt. Turn on the scrambler power switch S_1 . Slowly turn up the radio volume. Garbled speech will be heard from the built-in speaker.

By adjusting the radio volume control or the signal generator output level control, the garbled speech can be heard at its best "quality." If you adjust the signal generator frequency to about 3 kHz,

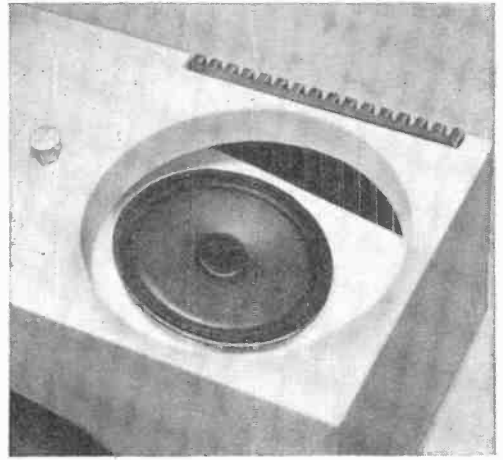
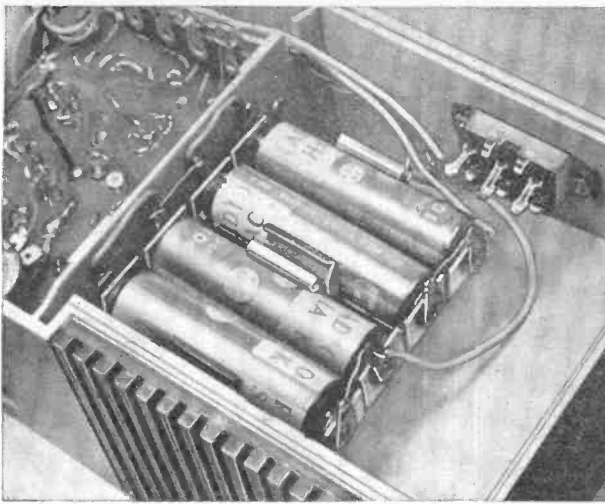

In the PC board version of the scrambler, four AA cells were used in place of the two C cells as microphone power. The speaker that came with the commercial unit (8-ohms) was used in conjunction with the output transformer that came with the built-in amplifier. The speaker is mounted on a piece of heavy cardboard at an angle to make good acoustical contact with the house phone microphone. The use of a PC board, and the smaller AA cells, enabled mounting all batteries within the plastic housing. The 9-volt battery is mounted in the same position as it was in the commercial unit, under the cover at the bottom.

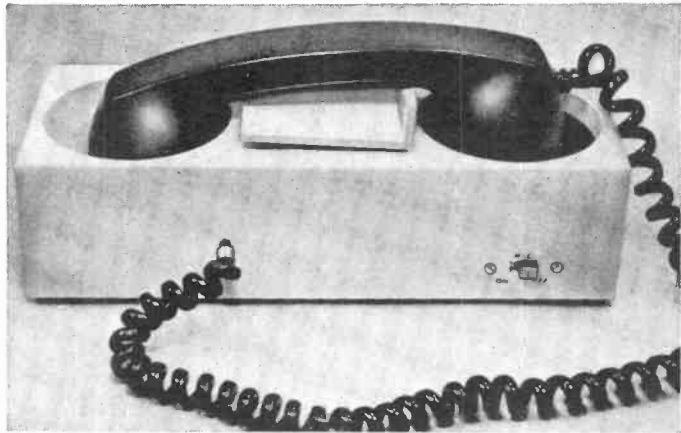

the garbled speech will change. As you will soon notice, the best scrambling for the human voice takes place at about 1 kHz.

To test the unscrambler, connect the radio to the project phone earpiece leads and a transistor radio earpiece to the secondary of *T3*. When the project phone is placed in its correct position with the earpiece in the proximity of (or attached to) *L1*, scrambled speech will be heard in the radio earpiece. If audio tone breakthrough is encountered, the value of capacitor *C3* may be changed to reduce the level of this unwanted signal.

Once both halves are working proper-

ly, connect the circuit up for operation as shown in Fig. 1.

Use. Obviously, to use the scrambler, two units must be made—one for each end of the conversation.

Using the house phone normally, dial the desired number and instruct the other end to "scramble." Make sure you have pre-arranged with him the audio frequency to be used on the signal generators. Each end then places the house phone on the housing with the holes correctly located. Either party can readjust his audio-generator frequency to clear up the speech at his end.

Hobnobbing
with
Harbaugh



Sorry, Nancy, I'm going steady with WPE6XPN.



I'd like you to marry me later.
Right now, DX conditions
on 21 MHz are too good.



No, but I had a
CB license once.



Madam!

BY JON COLT

BUILD
A

D.C. TRANSFORMER

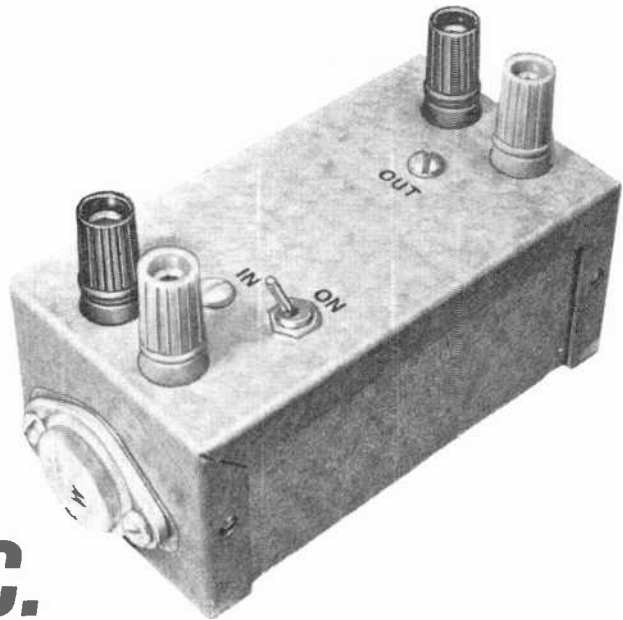

HIGH VOLTAGE FOR THE NON-SEMICONDUCTORS

WHILE IT IS TRUE that many 1970 electronic devices involve low-voltage circuits, there are still quite a few high-voltage circuits and components around. If you don't believe it, try to fire a neon lamp or a flashtube with a 9-volt battery. You might as well use a match—at least you will make the lamp or tube warm.

The next time you want to power a neon-lamp multivibrator or even rediscover vacuum tubes (they are fascinating, by the way), the d.c. "transformer" might be just what you need. It is called a transformer because it accepts a wide range of input voltages (3-15 volts d.c.) and delivers anywhere from 80 to 425 volts d.c. output with an efficiency of approximately 70% with higher loads. Best of all, the d.c. transformer uses stand-

ard, low-cost components—no expensive, hard-to-locate inverter transformer.

The d.c. transformer is so simple in design (see circuit in Fig. 1) that it can be assembled, checked out, and put to work in about four hours.

Construction. The prototype d.c. transformer in Fig. 2 is built in a 4" × 2" × 2" metal utilities box. All components are mounted on the top half of the box except for *R1*, *R2*, *C1*, and *RECT1*. Capacitor *C1* is supported by output binding posts *BP3* and *BP4*, while resistors *R1* and *R2*, because of their size, are made self-supporting via their connection points.

Integrated bridge rectifier assembly *RECT1* is mounted as follows: First press two layers of insulating vinyl tape onto

**“He’s a good worker.
I’d promote him
right now if he had
more education
in electronics.”**



Could they be talking about you?

You'll miss a lot of opportunities if you try to get along in the electronics industry without an advanced education. Many doors will be closed to you, and no amount of hard work will open them.

But you can build a rewarding career if you supplement your experience with specialized knowledge of one of the key areas of electronics. As a specialist, you will enjoy security, excellent pay, and the kind of future you want for yourself and your family.

Going back to school isn't easy for a man with a

full-time job and family obligations. But CREI Home Study Programs make it possible for you to get the additional education you need without attending classes. You study at home, at your own pace, on your own schedule. You study with the assurance that what you learn can be applied to the job immediately.

CREI Programs cover all important areas of electronics including communications, radar and sonar, even missile and spacecraft guidance. You're sure to find a program that fits your career objectives.



**IN-DEPTH
 COVERAGE OF
 SOLID STATE
 ELECTRONICS**
 ...including
 integrated circuits!

You're eligible for a CREI Program if you work in electronics and have a high school education. Our FREE book gives complete information. Mail postpaid card for your copy. If card is detached, use coupon at right or write: CREI, Dept. 1203A, 3224 16th St., N.W., Washington, D.C. 20010.

CREI, Home Study Division
McGraw-Hill Book Company
Dept. 1203A, 3224 Sixteenth Street, N.W.
Washington, D.C. 20010

Please mail me FREE book describing CREI Programs. I am employed in electronics and have a high school education.

NAME _____ AGE _____
 ADDRESS _____
 CITY _____ STATE _____ ZIP CODE _____
 EMPLOYED BY _____
 TYPE OF PRESENT WORK _____ G.I. BILL

I am interested in
 Electronic Engineering Technology Computers
 Space Electronics Nuclear Engineering Technology
 Industrial Automation NEW! Electronics Systems Engineering



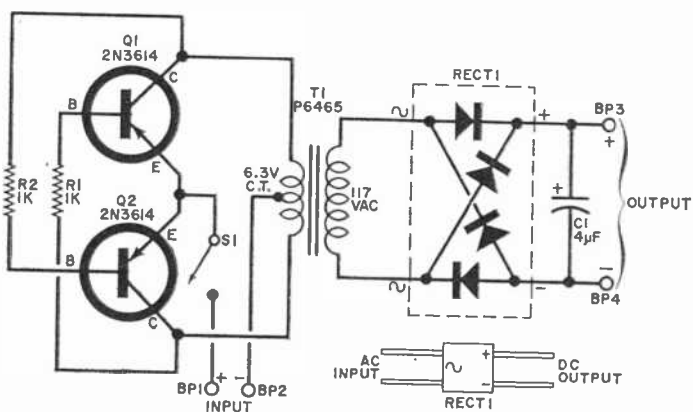

Fig. 1. Multivibrator circuit employs common filament transformer as saturable device. Output is rectified by RECT1, filtered by capacitor.

PARTS LIST

BP1-BP4—Five-way binding post
 C1—4- μ F, 500-volt electrolytic capacitor
 Q1, Q2—2N3614 or Motorola HEP-232 transistor
 R1, R2—1000-ohm, $\frac{1}{2}$ -watt resistor
 RECT1—Integrated bridge rectifier (Motorola No. MDA 920-7, or similar)
 S1—S.p.s.t. miniature toggle switch

T1—117-volt primary, 6.3-volt center-tapped secondary at 0.6 ampere filament transformer (Stancor No. P6465)
 1—4" x 2" x 2" metal utility box
 2 sets—TO-3 transistor insulating and mounting hardware
 Misc.—6-32 hardware for transformer mounting; #6 solder lugs (2); vinyl tape; epoxy cement; solder; etc.

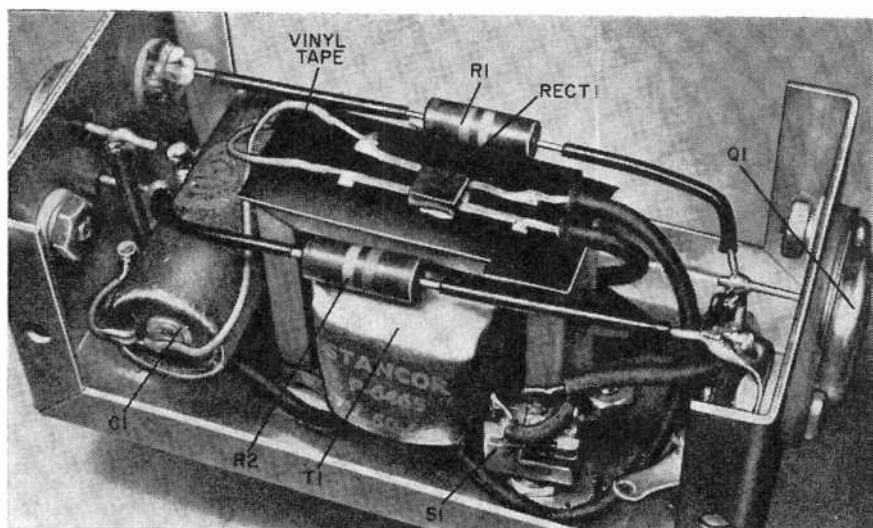

Fig. 2. Transistors are mounted on opposite ends of small utility box. Note that RECT1 is mounted on and insulated from transformer frame with daub of epoxy cement and vinyl tape.

the top of the transformer's frame. Then use epoxy to cement *RECT1* directly to this tape. Also, for insulation purposes, cut out Fig. 3 (or make a copy) and tape this to the inside of the bottom half of the utility box to prevent the rectifier as-

sembly from shorting out against the case. Besides providing insulation, the chart gives you a handy reference for the d.c. transformer's transfer characteristics.

Transistors *Q1* and *Q2* are then mounted at the ends of the case with insulating shoulder washers and TO-3 mica insulators. Put a solder lug on one of the hold-down screws on each transistor to provide collector connection points. Remember to provide adequate clearance when drilling the holes for the base and emitter pins, and heat-sink these pins when soldering to them.

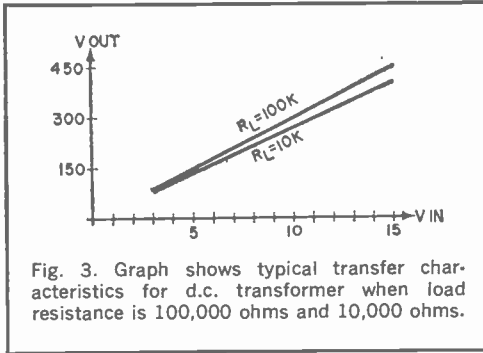

Fig. 3. Graph shows typical transfer characteristics for d.c. transformer when load resistance is 100,000 ohms and 10,000 ohms.

How To Use. As can be seen from Fig. 4, the output of the d.c. transformer starts to drop at any voltage with a

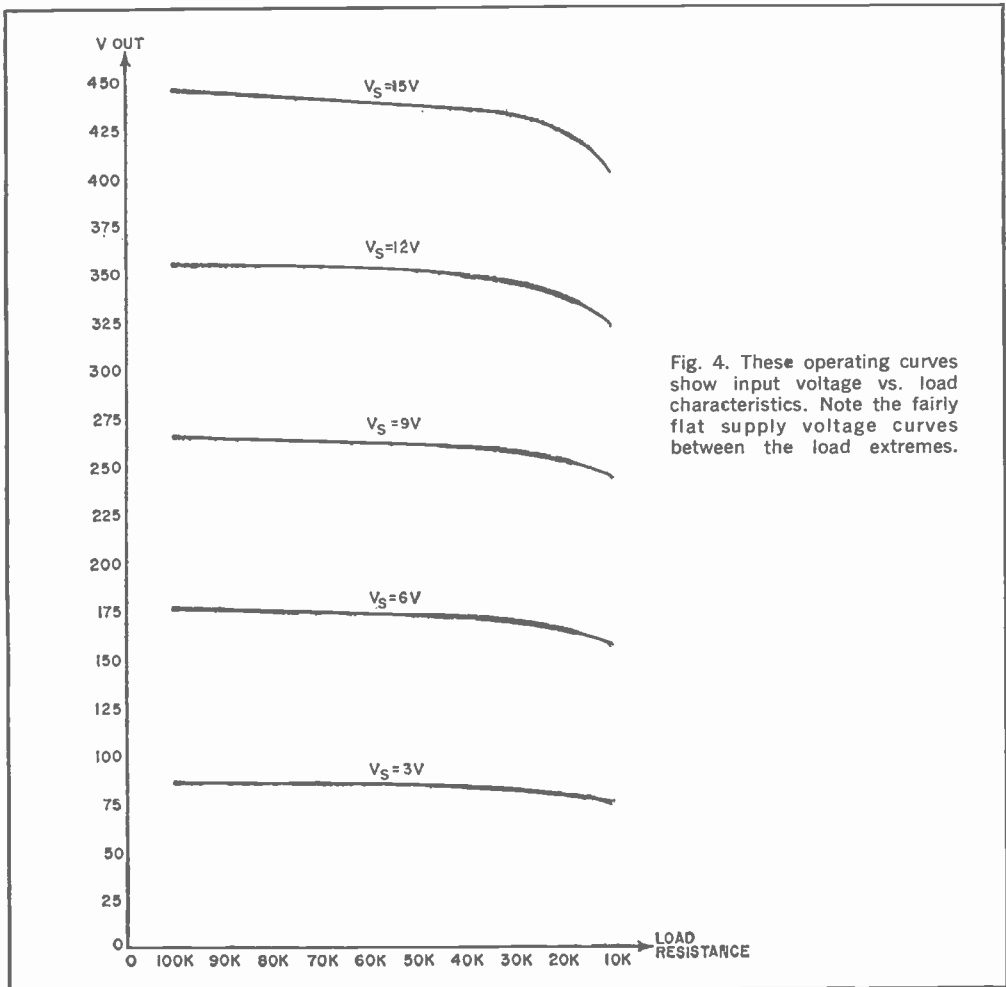
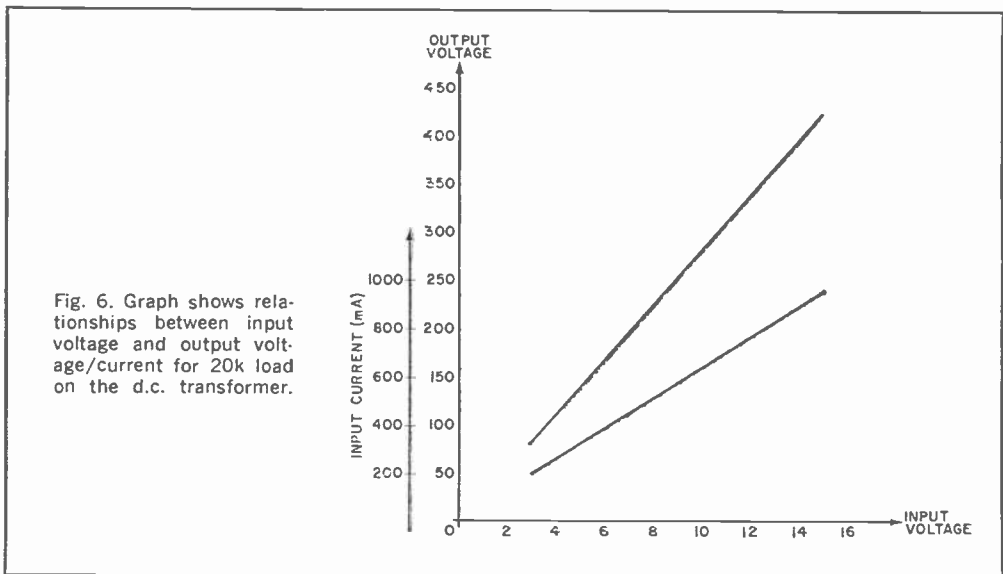
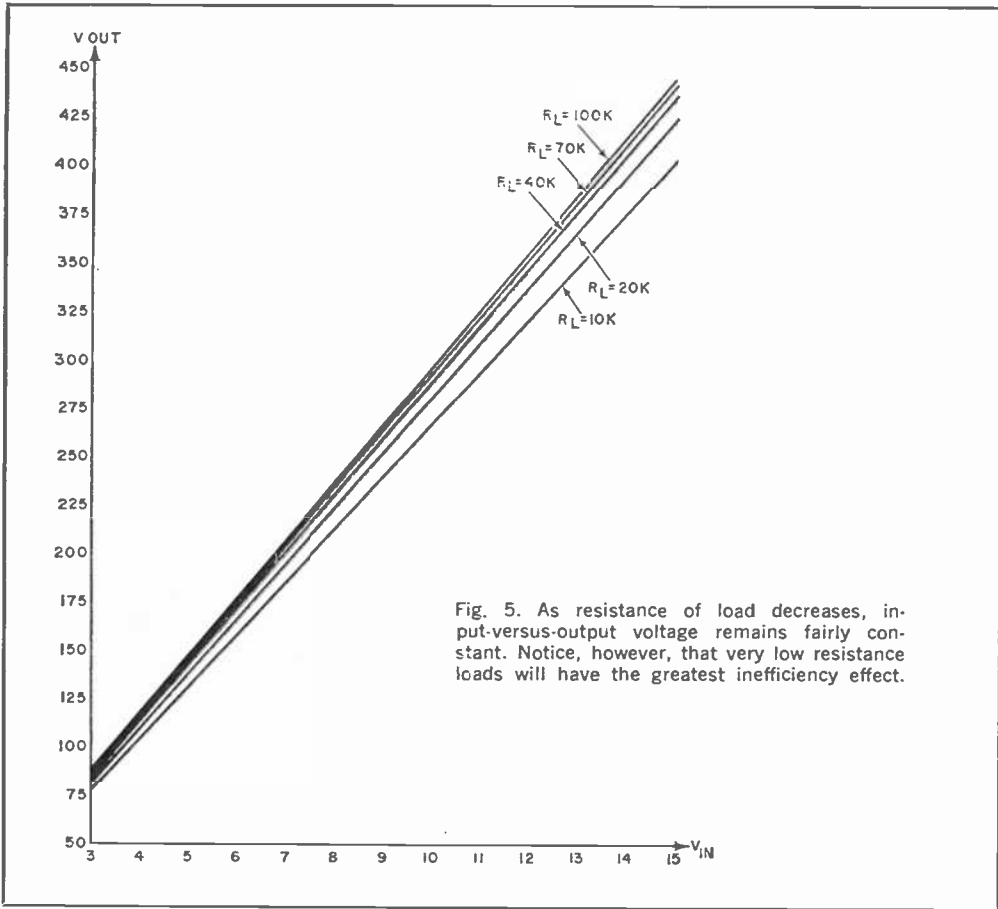
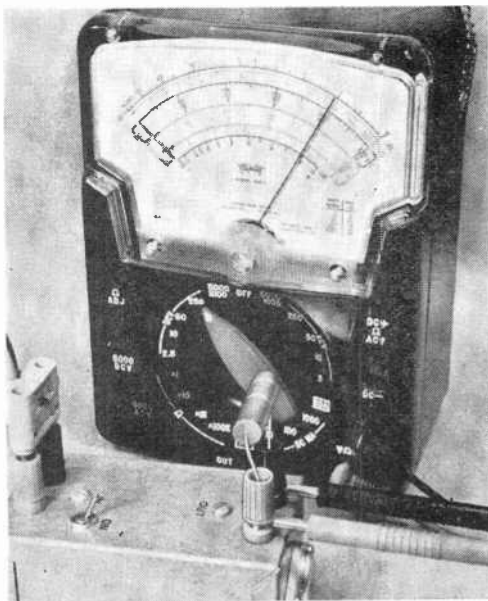

Fig. 4. These operating curves show input voltage vs. load characteristics. Note the fairly flat supply voltage curves between the load extremes.





Proper output voltage is obtained by measuring potential across equivalent output load resistor.

10,000-ohm load. The converter, in fact, will not start at all when a 5000-ohm load is connected to the output. A good rule to follow is: do not try to drive loads which are equivalent to less than 10,000 ohms. For example, from Fig. 5, you can see that the output will be about 135 volts for a 5-volt input to *BP1* and *BP2*.

According to the rule, you cannot draw more than 13.5 mA (135 volts/10,000

ohms, by Ohm's Law) from the supply. But don't be misled into thinking that the supply is not powerful. With 15 volts input and a 10,000-ohm load, output current is greater than 40 mA, representing a power output of 16.25 watts.

Because the converter's current drain, like its output voltage, varies linearly with respect to supply voltage (see Fig. 6), operation from a supply made up of ten D cells is not out of the question for short periods of time. A 6-volt d.c. input results in an output of 165 volts to a 20,000-ohm load, representing an 8.25-mA drain, while the converter draws about 380 mA from the supply.

The input voltage range was not chosen arbitrarily. For inputs lower than about 3 volts, the converter will not start. And for inputs higher than 15 volts, the voltage ratings of *RECT1* and *C1* become the limiting factors. Even if you decide to experiment with higher output voltages by replacing *RECT1* and *C1* with appropriately rated devices, the breakdown voltage of *Q1* and *Q2* will limit the maximum voltage applied to *BP1* and *BP2* to about 20-25 volts.

One more thing: don't let the converter's small package fool you. High voltage *does* come in small packages; and under the proper conditions can be just as dangerous. Treat high voltage with respect.

-30-

HOW IT WORKS

The d.c. "transformer" is built around a magnetically coupled astable multivibrator circuit (stages *Q1* and *Q2* in Fig. 1). What is different about this circuit is the use of a common filament transformer, rather than a special inverter transformer, as the saturating device.

Transformer *T1* is connected so that the low-voltage supply is across the 6.3-volt, center-tapped winding with high-voltage a.c. pulses across the 117-volt winding. The high-voltage pulses are then rectified by bridge rectifier *RECT1* and filtered by capacitor *C1*. Because the output of an inverter is essentially a square wave, much less filtering is needed than would be required for a rectified sine wave.

Inputs between 3 and 15 volts d.c. are applied between *BP1* and *BP2*, triggering the multivibrator circuit. Once rectified and filtered, the output d.c. voltage (with slight a.c. ripple superimposed on it), is available at *BP2* and *BP3*.



INTERFERENCE

from Left Field

BY EDWARD ARNOLD

IT'S EVERYWHERE—AND THERE'S NOT MUCH WE CAN DO ABOUT IT

IN A SOUTH Florida town recently, a newcomer to the community complained that all she got on the "local" TV channels was interference; yet she received distant stations—more than 100 miles away—without trouble.

Upon investigation, it was determined that a distribution amplifier for a local cable-TV (CATV) system was leaking signals right into the young lady's antenna. On the local channels, she received TV direct from the stations mixed with the signals from the amplifier. For distant stations on other channels, she received only the signals from the CATV amplifier and no local interference.

In this day of super-power transmitters and super-sensitive receivers, incidents such as this are becoming too common, unfortunately, to even be reported. But what is worse is that now we're getting interference in the oddest

and goofiest ways—you might call it interference from left field.

The problem is simply that devices that weren't intended to be transmitters are transmitting and devices that weren't intended to be receivers are receiving all sorts of signals.

Even Computers Are Culprits. Who would ever have suspected, for instance, that a computer could act as a receiver? Yet one radar installation kept having its core memory erased for no apparent reason until someone noticed that a radar antenna nearby was swinging its beam toward the computer just when the cores were erased.

And if a computer can act as a receiver, who's to say that it can't transmit also?

At one telemetry station a while back, the operators kept getting garbled out-

Who would have suspected
that a computer could
act as a receiver



puts until radio frequency interference (RFI) specialists determined that computer equipment at the station was radiating a signal that was being received by the station's huge telemetry dish!

In this computer-happy world, we probably are in for a lot of such computer-generated interference; the square-wave signals in digital circuits have a wide range of harmonics.

On the home side, of course, digital circuits are uncommon, but new devices like cable TV have their share of interference problems. CATV firms have found (the hard way) that 300-ohm twinlead in a customer's house can radiate the CATV signals so they now require use of coaxial cable exclusively.

That Old Bugaboo Corrosion. Whether on the home front, in industry, or in the military, we still get interference from an old enemy: corrosion in metal joints. The corrosion sometimes creates a nonlinear resistor which acts as a mixer of electromagnetic signals. When the signals are very strong, the joint may even re-radiate the mixed signals.

Typical of such occurrences is the case of the radio that would suddenly receive several stations at the same time when

anyone walked across the floor. It was found that metal heating ducts in the floor had poor joints which acted as mixers and re-radiators when sufficient pressure was applied from above.

Much the same thing happened to a Chicago engineer back in the days of trolley cars. As he was waiting in his car at a traffic light, a trolley car pulled up beside him; whereupon his car radio was overcome with cross-modulation. His theory was that the poor connection between the trolley wheels and the ground rail at that intersection created a nonlinear resistance.

While such events are normally humorous and of no particular consequence, when they happen on board some of the U.S. Navy's ships loaded with tons of high-power transmitters and very sensitive receivers, they can be almost as dangerous as they are exasperating.

Salt-water corrosion naturally is an everyday problem on ships, but if you have dozens of different antennas in a limited, crowded space, salt corrosion can create almost unbearable RFI. Although the re-radiated signals from the nonlinear joints or contacts may be too weak to be transmitted more than a few feet, on a ship it may take only a few



Site radars would be turned on only to direct missiles toward incoming warheads.

The military will have to discuss electronics with, of all people, the U.S. Forestry Service.



feet to get into somebody else's receiver.

Also, on ships, the abundant metal surfaces, chains, and doors sometimes are of a size or length that is related to the wavelength of high-power transmitters on board. More than one sailor has started to open a hatch only to find that the door is hot with RFI.

A different kind of RFI problem for the military is predicted when the Nike X anti-ballistic missile weapon system goes into use, according to a story in "Electronic News" (March 25, 1968). The site radars for this ABM system threaten to knock out virtually all other radio communications in the vicinity. Hopefully most of us would not complain about this RFI since the site radars would be turned on only to direct missiles toward incoming warheads. Surely the most impatient TV viewers can tolerate TVI for such a good cause.

To resolve RFI problems such as this, the Department of Defense has set up an Electromagnetic Compatibility Analysis Center. Its job is to tell the military specifically what types of interference they can expect if they change locations or shift frequencies.

Enter the Forest Ranger. If a military organization decides to run from its RFI problems and place its transmitter on a high mountain top on government land, it will have to discuss electronics with, of all people, the U.S. Forestry Service,

probably the last group in the world you would expect to have an interference problem.

The reason for their involvement, however, is quite simple: government land on mountains is often administered by the Service. Mountains obviously are just *the* place for line-of-sight microwave transmitters, etc. Put all those transmitters on a mountain top and you have a possible RFI problem!

Or should we say an "EMC" problem? In keeping with the times, some engineers are now referring to RFI problems as electromagnetic compatibility (EMC) problems to give recognition to the fact that not all emanations are at radio frequencies but can occur throughout most of the spectrum.

Regardless of the name, EMC problems do not often have easy (inexpensive, that is) solutions. To cure these problems requires proper circuit design as well as bonding, grounding, and shielding which can be expensive and often create their own problems. Bonding straps, for instance, may be resonant at certain frequencies and create their own RFI.

We are bound to have problems with electromagnetic smog as long as, in the words (in "IEEE Transactions on EMC," October 1964) of Rexford Daniels, president of Interference Consultants, "we try to fit a microvolt civilization into a millivolt world." -30-

BY
**FRANK H.
TOOKER**

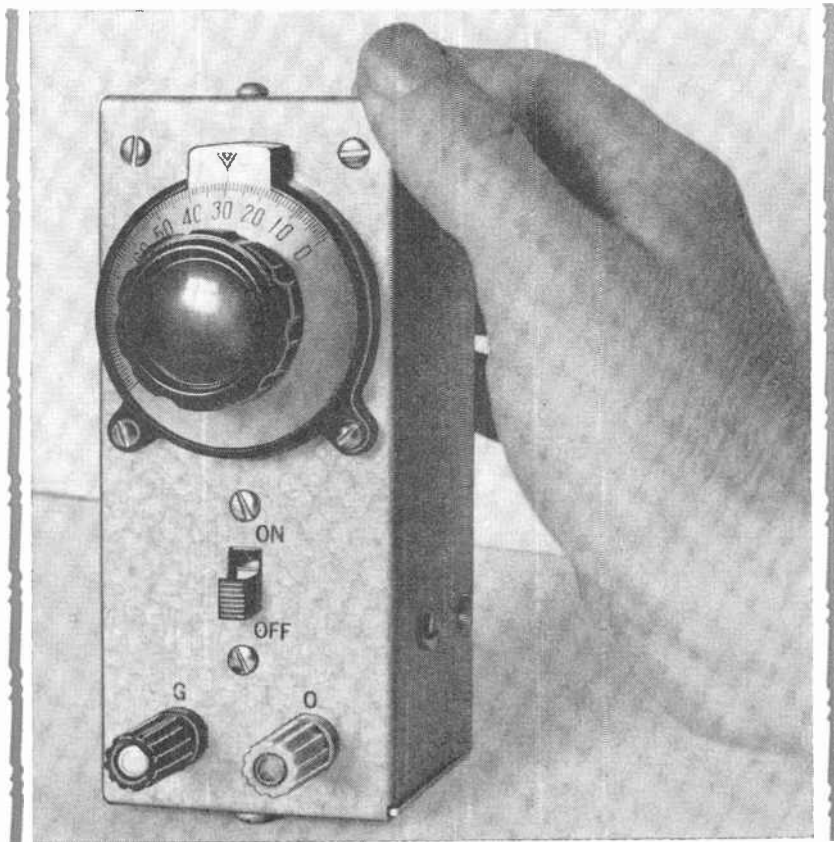

Beginner's Signal Generator

LOW-COST BCB OPERATION FOR A FIRST PROJECT

EVERY RECEIVER, whether simple or complex, requires some r.f. adjustment if it is to operate with maximum sensitivity and selectivity. In fact, the simple superhet receivers that are most often built by beginners usually require more attention than do complex communications receivers.

Unfortunately, most radio beginners lack the necessary test equipment to adjust their receivers properly. The biggest handicap is not having access to a signal generator that provides a signal source with modulation that is unvarying in both frequency and amplitude. There are many excellent signal generators available commercially; but, as the beginner soon learns, the investment required for

a generator can be many times the cost of the receiver.

Since most beginners build an AM receiver as their first radio project, the "Beginner's Signal Generator" described here is designed for low cost and BCB operation. While it does not have the elaborate adjustments and advantages of a conventional signal generator, it does provide a modulated signal that can be tuned to any spot in the AM broadcast band. The initial adjustment of the Beginner's Signal Generator is simpler than that of a regenerative receiver.

How It Works. The r.f. signal is generated in the tuned circuit consisting of capacitor *C2* and coil *L1* (see Fig. 1).

axis shown by the broken line. Use 4-40 hardware to fasten the bracket to the inner surface of the box front and to the frame of *C2*. Now check the mounted parts to make certain that the dial aligns accurately with the shaft of the capacitor and that the vernier dial, when temporarily slipped into place, does not bind against the front of the box. Then mount battery *B1* against the side of the box, using two $\frac{1}{2}$ " spacers, #6 hardware, and an aluminum bar (see Fig. 4).

While Fig. 4 shows *C1*, *L1*, *Q1*, and *R1* mounted on a printed circuit board, it is simpler and less expensive to mount and wire these parts together on a $1\frac{3}{4}$ " \times $1\frac{5}{16}$ " perforated phenolic board. To simplify wiring, use "flea" clips.

Layout on the circuit board is not critical. However, make sure that *L1* is located as far as possible from any metal when the board is mounted inside the box. Mount the circuit board to the side of the box with a pair of L brackets and machine hardware.

Referring back to Fig. 1, wire together the components, being particularly careful with the orientation of *Q1*'s leads and the polarity of *B1*. (Note: a tapped coil is best for *L1*, but if only an untapped coil is available, you can close-wind 8-12 turns of #28 enameled wire over the center of the untapped coil windings. Use as few turns as possible to prevent lowering the Q of the coil and producing too broad a signal, but as many turns as needed to provide an adequate signal level in a good-quality receiver. Now, connect one end of the new winding to the *B1* terminal of *Q1* and the other end to case ground.)

Finally, mount the vernier dial on the capacitor shaft. To do this, first completely mesh the capacitor plates. Remove but reserve the screws on the shaft collar of the vernier dial and slip the vernier onto the shaft of *C2*, orienting it as shown in the photo on the first page of this article. Set the vernier dial to its zero index.

With the vernier dial properly oriented, mark the two mounting hole locations on the front of the box. Remove the dial without disturbing its setting. Then drill the two #32 holes in the positions indicated by your markings. Replace the dial and anchor it down with 4-40 hardware. Finally, replace the shaft collar

setscrews, driving them through the hole at the bend of the capacitor L bracket. Then assemble the box.

Testing and Use. When the generator is completely assembled, make an output lead by connecting a banana plug to one end of a 24"-long piece of flexible test cable. Do not remove the insulation from the other end of this test cable since it must *never* be physically connected to any point in the receiver.

Plug the output lead into the yellow binding post (*BPI*) on the generator and lay the free end of the cable near the

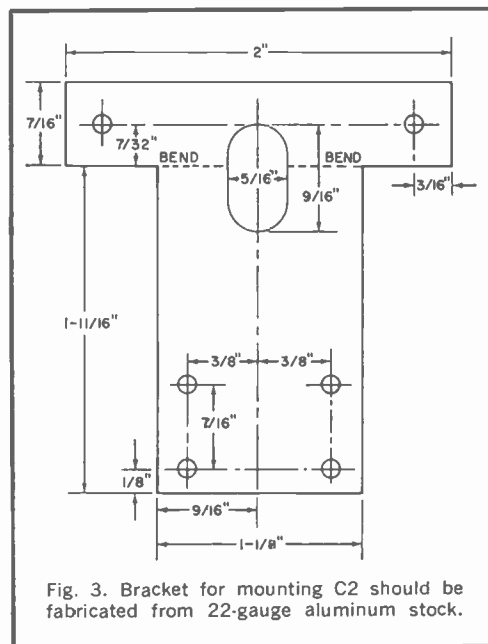

Fig. 3. Bracket for mounting *C2* should be fabricated from 22-gauge aluminum stock.

antenna coil of any available AM receiver. Make sure the vernier dial is set to the zero index. Set the receiver dial to the low end of the AM band or 535 kHz.

Turn on the power to the receiver, and set the volume control so that you hear a soft rushing sound coming from the receiver speaker. Now switch on the power to the signal generator and use a tuning tool to adjust the slug on *L1* (for this step you will have to temporarily remove the rear of the generator box), until you hear the 750-Hz audio tone in the speaker. If the tone tends to become very loud, do *not* readjust the receiver volume control setting. Instead, put some

distance between the generator's output cable and the receiver's antenna.

Continue to adjust the slug of *L1* for maximum signal strength, putting more distance between the receiver and generator as needed. Proper adjustment of *L1* must be made while the tone coming through the speaker is at a low level, since a loud signal tunes too broadly.

In use, regardless of what type of AM broadcast band receiver is under test, always set the volume control of the receiver for maximum and adjust the sound level by changing the distance between the receiver and generator.

In the event you are testing a low-gain receiver and can barely hear the audio tone even when the generator output cable is actually touching the receiver's antenna coil, connect another cable from receiver chassis ground to the black binding post on the generator. This will significantly increase the signal level. However, if the signal level is adequate without this connection, do not use the extra cable. Also, under no circumstances should an a.c./d.c. tube-type receiver be

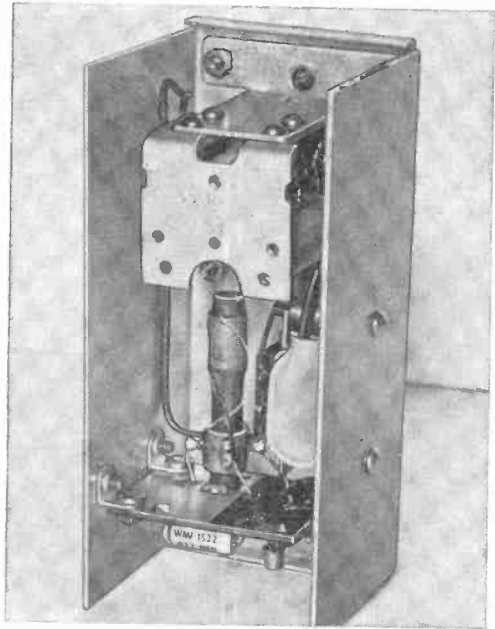

Orient C2 mounting bracket as shown at top, and use small L brackets for mounting circuit board.

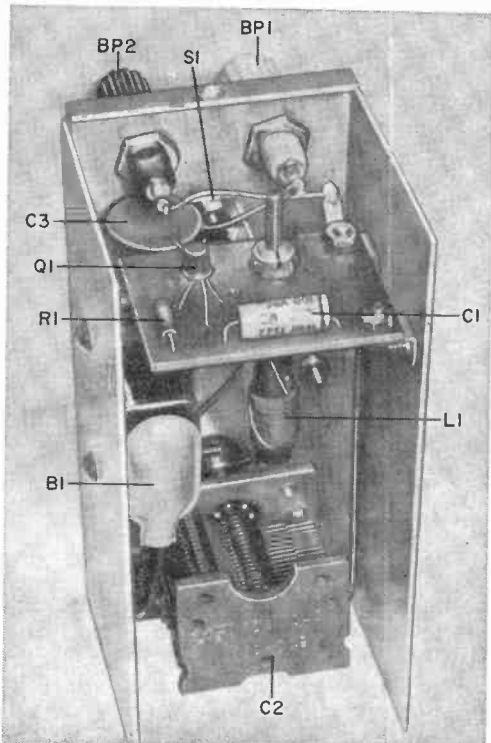
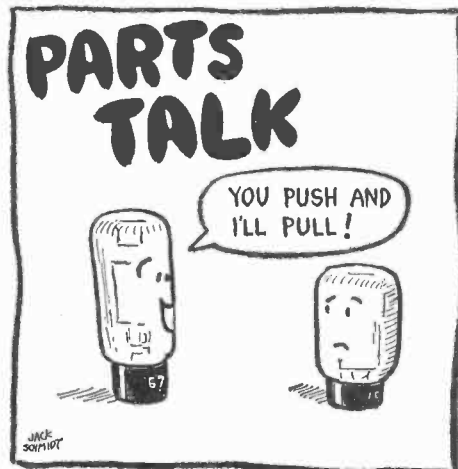

Fig. 4. Mount battery to side of box with length of aluminum stock, 1/2" spacers, and #6 hardware.

connected in this manner as the chassis of the receiver is likely to be 117 volts a.c. "hot."

Always make tests at low sound levels with minimum coupling between the generator's output cable and receiver's antenna coil. Otherwise, the output of the generator will tend to "swamp" the receiver and you will be unable to tune the R.F. (if any) and I.F. stage(s) on the nose. Result: a badly misaligned receiver and poor selectivity.

-30-



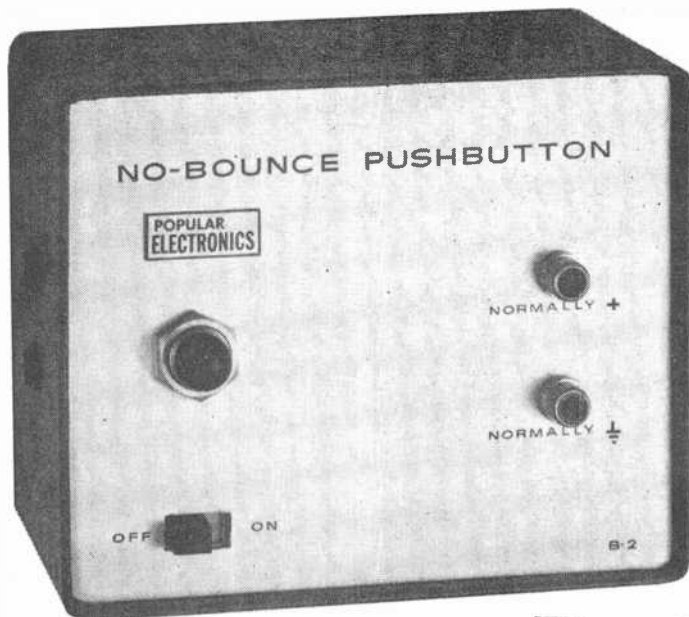

Build the No- Bounce Pushbutton

BY DON LANCASTER

INPUT TRIGGER SOURCE FOR DIGITAL CIRCUITS

RESISTOR-TRANSISTOR-LOGIC (RTL) circuits, such as those used in many projects in previous issues of POPULAR ELECTRONICS, are designed to "count" the input (trigger) signal each time it changes state. (In the case of a JK flip-flop, for example, the input is counted each time it goes from positive to negative.) When the input signal is derived from an electronic source, special signal conditioning circuits are usually included to "refine" any oddly shaped pulses so that they have sharp, rapid rise and fall times.

Sometimes, however, the input trigger is derived from a mechanical switch of one type or another (often a necessity if it is desired to trigger the system slowly to observe circuit operation); and here the shape of the pulse created by the switch can create problems.

Because of the spring action required in most mechanical switches, the contacts do not make just one closure for a single operation. Instead, they bounce one or more times before settling down. Unfortunately, the logic system is not aware that a mechanical switch is bouncing and it considers each bounce to be an input pulse. In such cases, something must be done to "clean up" the pulse; and the usual solution is to add a simple electronic circuit to the switch to provide a single, noise-free trigger pulse. This function is achieved neatly and inexpensively in the "No-Bounce Pushbutton." It consists (see Fig. 1) of a mechanical pushbutton switch, whose output is converted by a single integrated circuit to

IC
EXPERIMENTER'S
CORNER

NO. 2 of 5

March, 1970

51

PARTS LIST

- B1, B2—1.5-volt "D" cell*
C1—200- μ F, 6-volt electrolytic capacitor
C2—0.1- μ F, 10-volt disc capacitor
IC1—RTL dual two-input gate (Fairchild μ L914 or Motorola HEP584)
J1, J2—phono jack
S1—S.p.d.t. snap-action pushbutton switch
S2—S.p.s.t. slide or toggle switch
Misc.—Battery holder (Keystone 176 or similar), mounting hardware, etc.
Note—The following are available from Southwest Technical Products Corp., Box 16297, San Antonio, Texas 78216: etched and drilled PC board, \$1.00; complete kit of parts, including prepunched vinyl-clad case, less batteries, \$4.00; postpaid in continental USA.

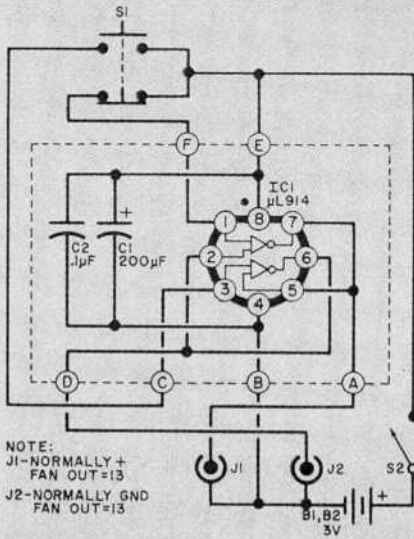

NOTE:
 J1—NORMALLY +
 FAN OUT=13
 J2—NORMALLY GND
 FAN OUT=13

Fig. 1. Essentially a bistable flip-flop, the circuit delivers a clean, single output pulse for each operation of the mechanical switch.

either a normally positive pulse which goes to ground when the switch is activated or a normally ground pulse which goes positive.

How It Works. The integrated circuit used here is a dual two-input gate with both gates connected back-to-back to form a bistable multivibrator or set-reset flip-flop. Pushbutton switch *S1* keeps the flip-flop in the set condition until the flip-flop in the set condition until the flip-flop is activated. When the normally open contact of *S1* is first closed (even if it is just a momentary contact) the multivibrator changes states and remains in the new state regardless of bounces or

noise from the mechanical switch. Capacitors *C1* and *C2* are used to lower the power supply impedance. When the pushbutton is released, the multivibrator returns to its original state.

Construction. While it is not essential, the use of a printed circuit board simplified the construction and provides support for the integrated circuit. You can buy a board (see Parts List) or make your own using the foil pattern shown in Fig. 2. In installing the components, also shown in Fig. 2, note that the IC has a flat or dot at pin 8 for orientation. The pins are numbered counterclockwise

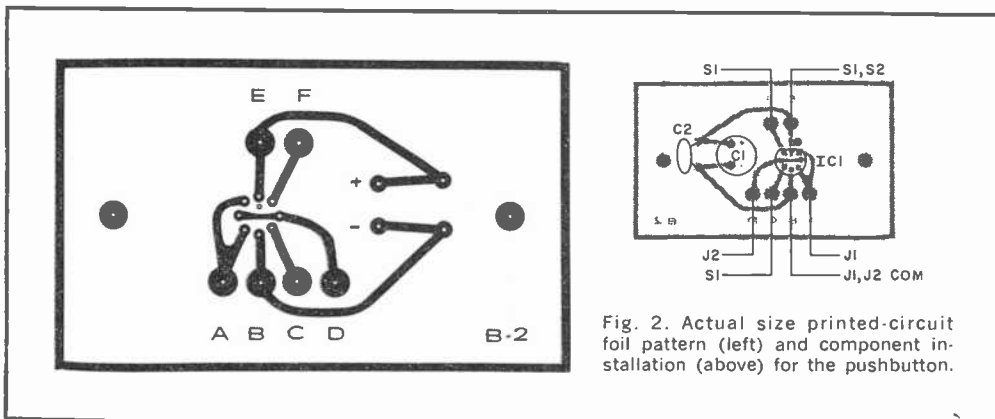
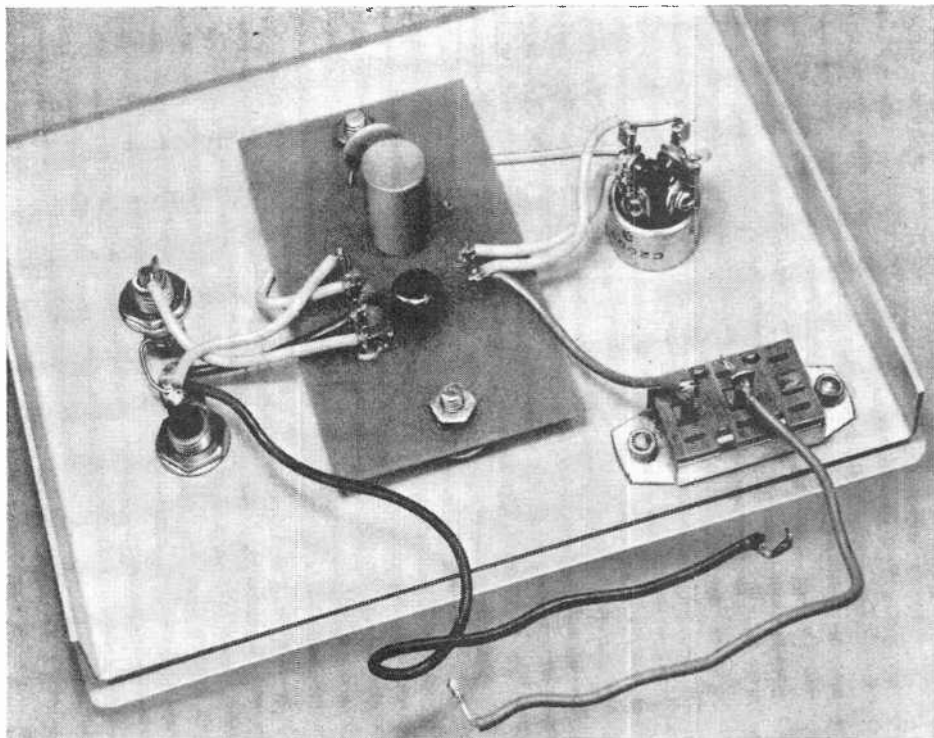

Fig. 2. Actual size printed-circuit foil pattern (left) and component installation (above) for the pushbutton.



Although any type of mounting may be used, the prototype was mounted on the metal front panel of a general-purpose utility box. The batteries can be mounted within the box in suitable holders.

viewed from the top. Use a low-power soldering iron and fine solder when installing the IC. Be sure to get the polarities of the batteries and *C1* correct also.

Almost any type of enclosure can be used to house the project. In the prototype, a 3" × 4" × 5" aluminum enclosure was used with the PC board on standoffs in the base and the batteries mounted in clips on the rear panel.

Operation. Depending on the type of logic circuit you are working with, you can use the output at either *J1* or *J2*. The output at *J1* is normally positive until the pushbutton is depressed, when it goes to ground. Output at *J2* is normally ground and goes positive when the pushbutton is depressed. The fanout of each output is 13.

Be sure that the No-Bounce Pushbutton's ground connection is made very close to the actual input point and, to reduce ground currents, do not use the test set ground return for any other piece of equipment.

If your logic circuits are not RTL, an additional transistor (with power supply) may be added to the circuit. -30-



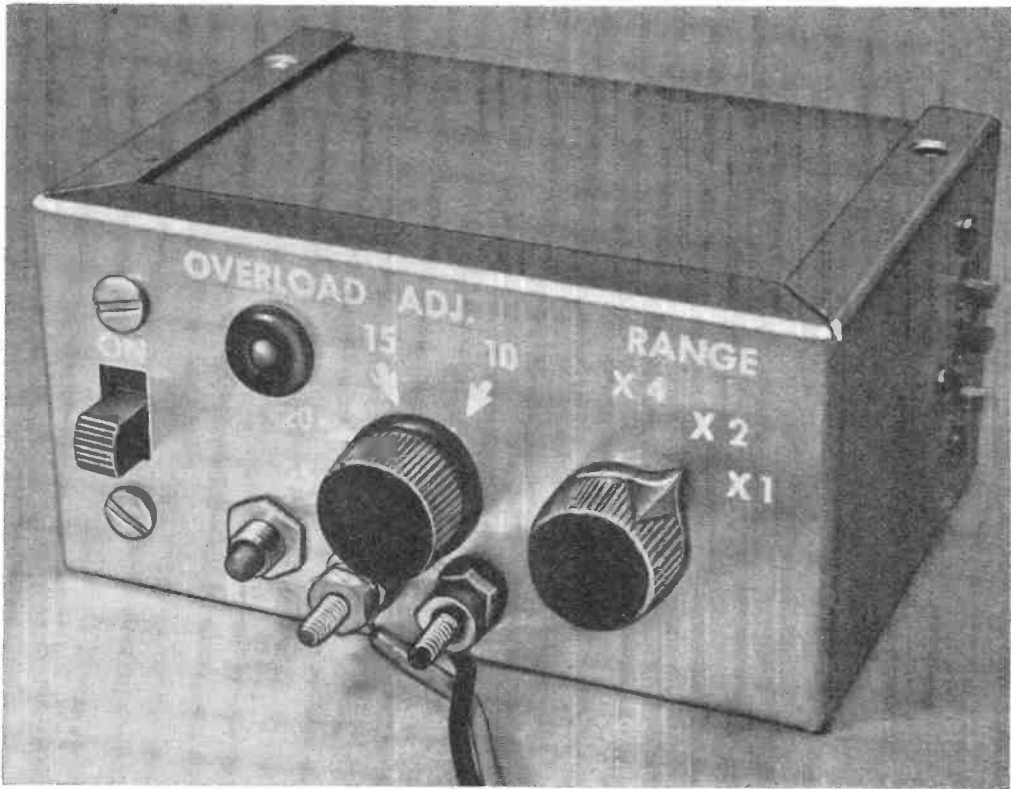

ELECTRONIC

Overload Protection

CURRENT LIMITER FOR YOUR SEMICONDUCTORS

BY JOHN L. KEITH

ELECTRONICS experimenters are finding more and more uses for the latest microminiature solid-state devices—and with good reason. These components simplify circuit design and construction, making it possible for the experimenter to build projects that were formerly too complex and expensive to duplicate. There is one great care the experimenter must exercise, however: most semiconductor devices are extremely current sensitive. Exceed the rating just a little bit, and the device may be permanently damaged. To prevent such occurrences, try the electronic overload protector described here.

When connected between the power

supply and the experimental circuit, the overload protector automatically limits the current drawn by the circuit to a value consistent with the known ratings of the semiconductor devices you are using.

The protector, whose circuit is shown in Fig. 1, operates on the principle of a shunt current meter. The load current must flow through one of the range resistors, *R8-R10*. The voltage drop across the resistor is then applied through potentiometer *R11* to the base of *Q1*. The use of *R11* makes each range continuously variable.

With no overload condition, *Q1* conducts slightly, allowing *Q2* to conduct

PARTS LIST

D1,D2—1N34A diode
 D3—1N2096 diode
 I1—#327R incandescent pilot lamp (28 volts at 40 mA)
 K1—S.p.d.t. relay, 5500-ohm at 2.9-mA winding
 Q1,Q2—2N508 transistor (see text)

R1—680-ohm
 R2—220-ohm
 R3,R5—220,000-ohm
 R4—82,000-ohm
 R6—9100-ohm
 R7—10,000-ohm (see text)
 R8—20-ohm
 R9—10-ohm
 R10—5-ohm
 R11—5000-ohm linear taper potentiometer
 S1—S.p.s.t. slide or toggle switch
 S2—Momentary-action, push-to-close switch
 S3—Three-position, non-shorting rotary switch
 7—Five-way binding posts or banana jacks for contacts 1 through 7
 1—metal utility box
 Misc.—Rubber grommet for I1; hardware; hook-up wire; solder; etc.

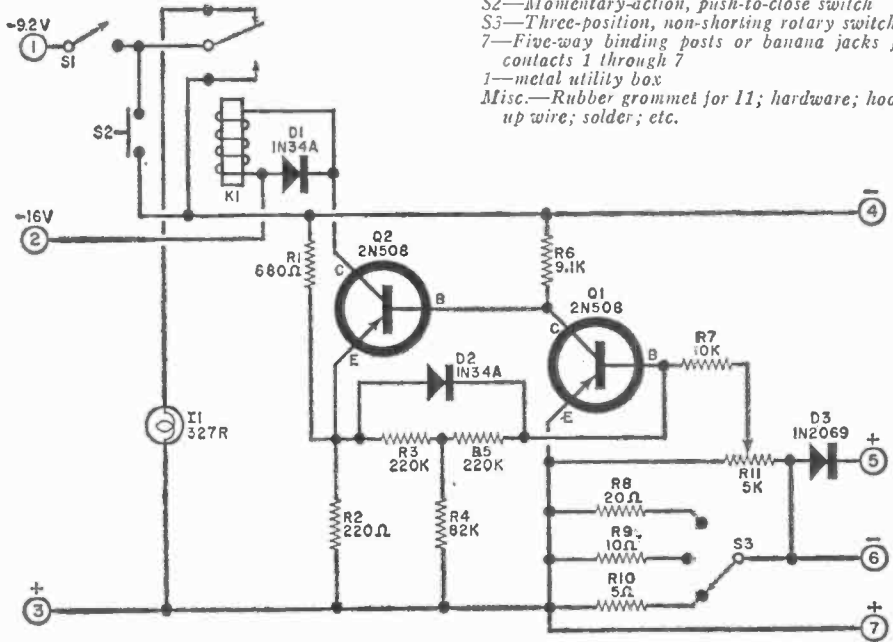
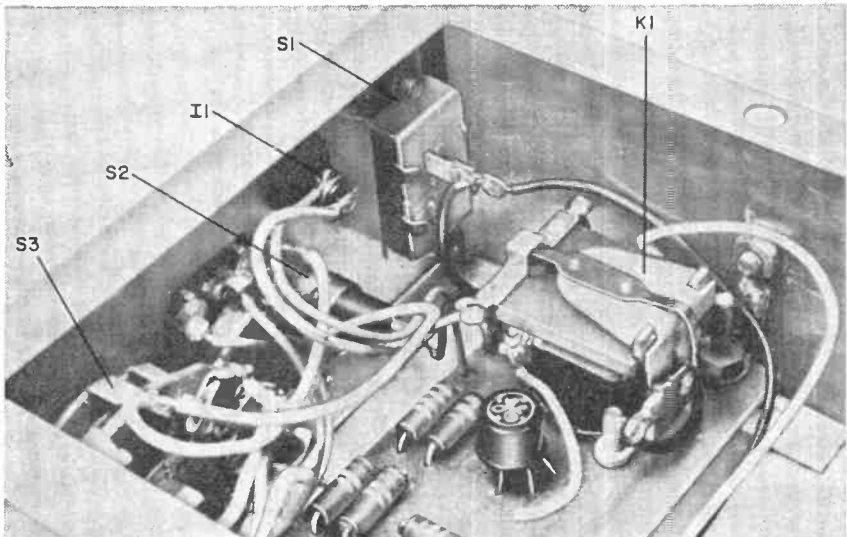

Fig. 1. Input power is applied via contacts 1 and 2; separate 16-volt supply for K1 via 2 and 3; load via 4 and 5. Load current is measured as voltage drop between 6 and 7 and converted to current with Ohm's Law.

Switches S1-S3, potentiometer R11, and indicator lamp I1 mount directly to front panel of utility box. Load connectors, also on front panel, can be five-way binding posts.



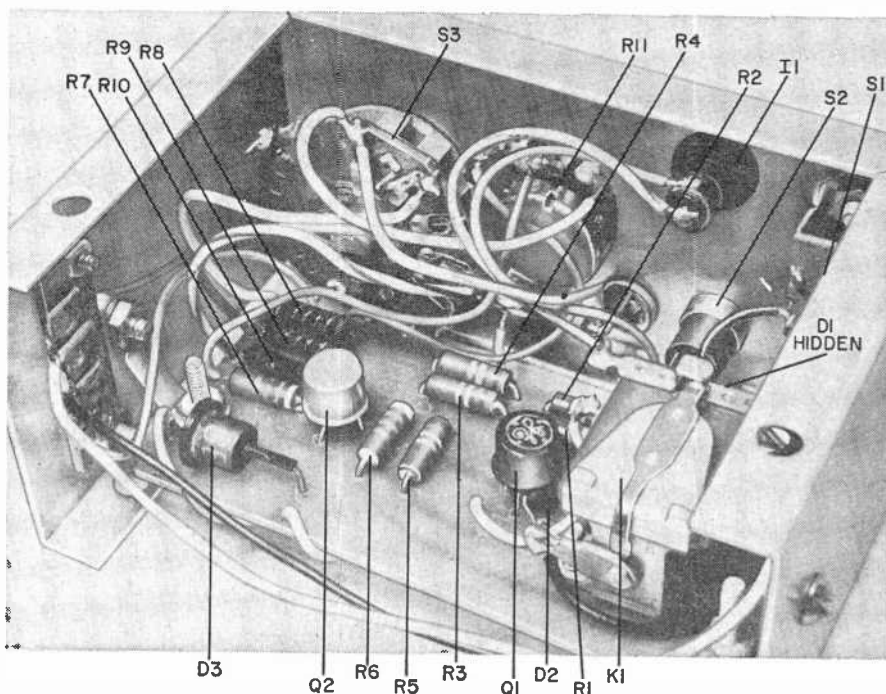

Fig. 2. Although printed circuit board construction is shown, circuit is simple enough to be assembled with point-to-point wiring. Terminal strip at left is for power inputs.

heavily and energize relay *K1*. Emitter-to-base negative feedback is used as temperature compensation.

When an overload occurs, *Q1* becomes forward biased, lowering the *Q2* bias and deenergizing *K1*. This action disables the output circuit. Then when reset switch *S2* is momentarily depressed, bias is restored to *Q1*, *Q2*, and the output. If the overload still exists, *Q2* will remain cut off, and *K1* will not energize. But if the overload is removed, *Q1* conducts and energizes *K1* when *S2* is depressed.

The three ranges chosen provide accurate current control in steps of 10-25 mA, 20-50 mA, and 40-100 mA at 9 volts d.c. Also provided are connections for measuring the voltage drop across the range resistors (contacts 6 and 7). This voltage can be converted, by Ohm's Law, to current and indicated on a graph.

Although designed for 9-volt operation, the overload protection circuit can be used with other input voltages to provide corresponding output voltages. Just be sure to take into account the change of current flowing through the range resistors with the new voltage.

The construction and layout of the electronic overload protection circuit are not critical. While the original prototype shown in Fig. 2 was assembled with the aid of a printed circuit board, the circuit is simple enough to permit point-to-point wiring. Almost any general-purpose transistor should work satisfactorily, provided that the one employed as the shunt amplifier has high enough gain, and the transistor for relay control has a V_{CBO} of 16 volts or more. If the transistor (*Q2*) gain is too low, the value of *R7* might have to be reduced to 4700 ohms.

For your convenience, the table gives the voltage-to-current specifications for the three settings of range switch *S3*. This table can be cut out or copied and pasted to the enclosure.

-30-

VOLTAGE TO CURRENT RELATIONSHIPS			
RANGE SWITCH POSITION			
VOLTS	A	B	C
0.2	10 mA	20 mA	40 mA
0.3	15 mA	30 mA	60 mA
0.4	20 mA	40 mA	80 mA
0.5	25 mA	50 mA	100 mA

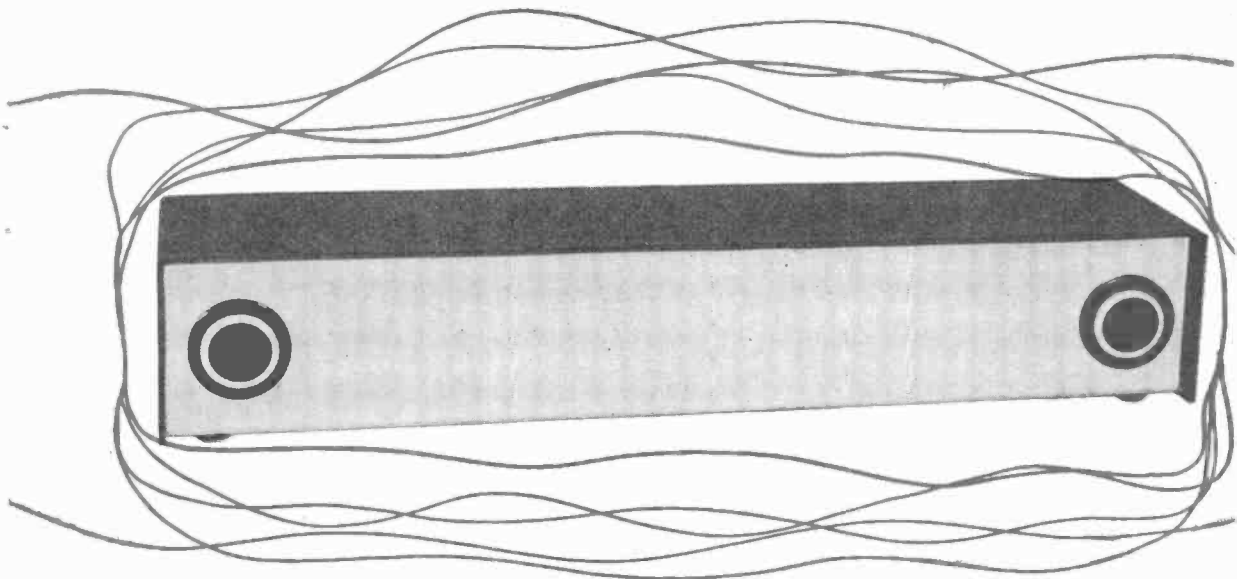

ONE-STEP

Motion Detector

Ne plus ultrasonic intruder alarm

BY DANIEL MEYER

IT WOULD TAKE all ten fingers—and maybe a couple of toes—to count the various types of intruder alarm systems that can be leased, purchased, or home-built. None, however, is better than an ultrasonic system of the type used in areas of tight military security. The “One-Step Motion Detector” described here is such a system. When you have the One-Step for protection, it is not necessary for the intruder to break a wire or tape or even touch anything to set off the alarm—and there are no visible or invisible light beams to be broken. All the intruder has to do is take one step into the protected area and his very presence disturbs the ultrasonic field to actuate the alarm circuit.

Built around integrated circuits to reduce cost and construction complexity, the One-Step generates a signal with a frequency of 40 kHz (far above the limit of human hearing) and aims it at the area to be protected. (The area covered is in the shape of a 50° cone fanning out

from the detector to a distance of about 15 feet.) The receiver portion of the detector uses the 40-kHz output as a reference and compares it with the frequency reflected from the protected area. If there is no movement in the area, there is no difference between the radiated frequency and the reflected frequency, and no alarm is given. If the two do not agree, the receiver actuates the alarm circuit.

Besides detecting intruders, the One-Step can be used for other alarm purposes. Since the air turbulence caused by flames is sufficient to create a Doppler shift, you can use One-Step as a fire detector. A wild-life photographer can use the device and let the alarm signal trip a camera shutter and photoflash. One-Step can also be used to activate a counter to indicate the passage of objects or to open a door as a person or object approaches. You can even use it to detect rodents or other small animals.

Any type electrical or electronic alarm

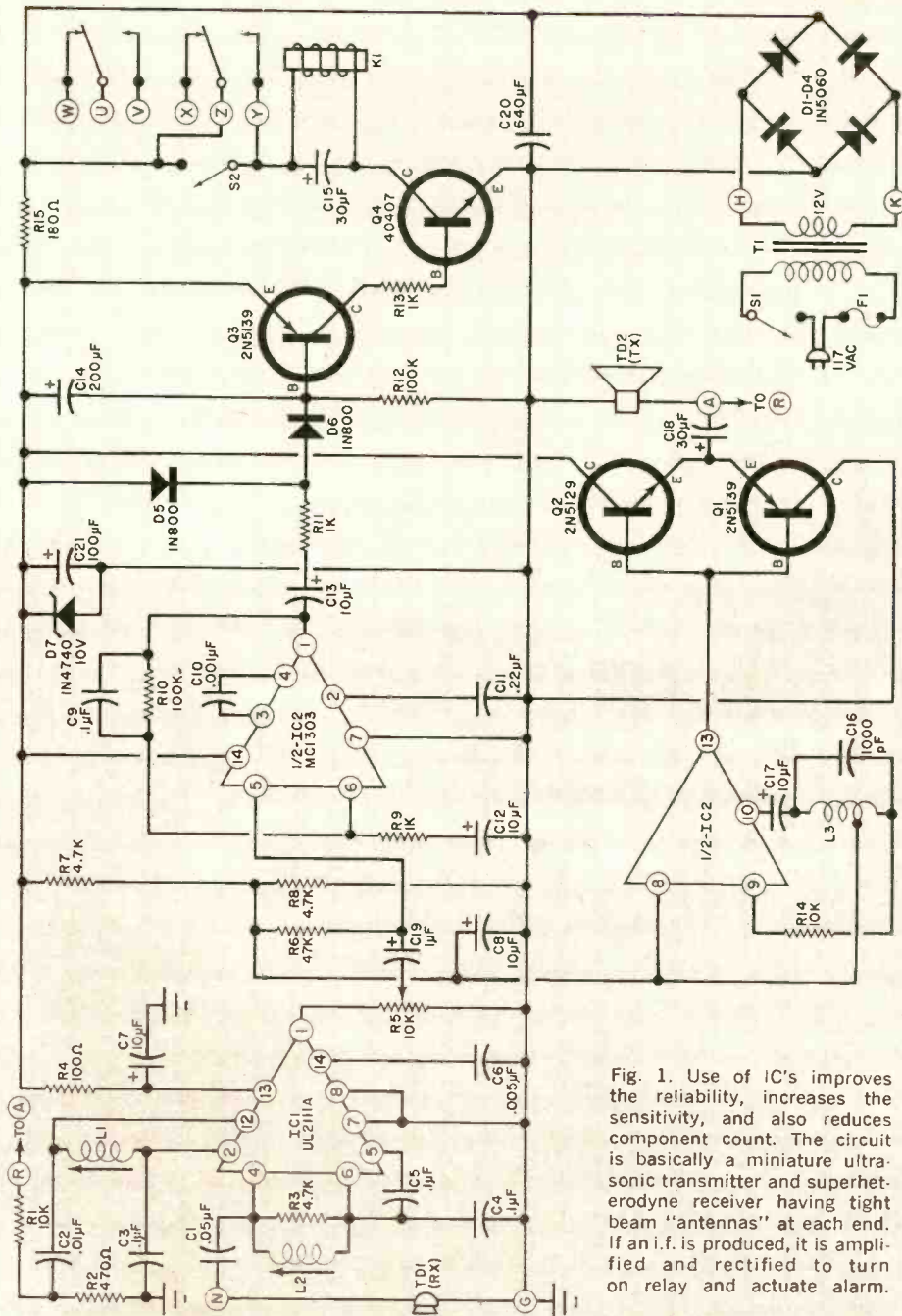

Fig. 1. Use of IC's improves the reliability, increases the sensitivity, and also reduces component count. The circuit is basically a miniature ultrasonic transmitter and superheterodyne receiver having tight beam "antennas" at each end. If an i.f. is produced, it is amplified and rectified to turn on relay and actuate alarm.

circuit can be used with One-Step. The external circuit is controlled by normally open or normally closed 1-ampere contacts on the relay in the detector.

Construction. Most of the circuitry of the One-Step (see Fig. 1) is contained in two integrated circuits so construction of the device is much simpler than if discrete components were used throughout. To further simplify construction, make or buy the printed circuit board whose foil pattern is shown in Fig. 2. Mount

ANIMALS AND ULTRASONICS

In most commercial installations of ultrasonic alarm systems, the ultrasonic generator is left on all the time and only the alarm circuit is de-activated when detection is not desired. This may not be such a good idea around the home or anywhere pets are considered. While humans cannot hear the 40-kHz signal, animals can; and, although it affects different animals in different ways, it's best to keep it turned off when not in use to avoid discomfort to them. Remember also that, when you are using the detector, it can be activated by animals, causing false alarms. In fact, they may be attracted to it.

PARTS LIST

- C1—0.05- μ F capacitor
 - C2—0.01- μ F capacitor
 - C3,C4,C5,C9—0.1- μ F capacitor
 - C6—0.005- μ F capacitor
 - C7,C8,C12,C13,C17—10- μ F, 15-volt electrolytic capacitor
 - C10—0.001- μ F capacitor
 - C11—0.22- μ F capacitor
 - C14—200- μ F, 6-volt electrolytic capacitor
 - C15,C18—30- μ F, 15-volt electrolytic capacitor
 - C16—1000-pF polystyrene capacitor
 - C19—1- μ F, 50-volt electrolytic capacitor
 - C20—640- μ F, 25-volt electrolytic capacitor
 - C21—100- μ F, 15-volt electrolytic capacitor
 - D1-D4—1N5060, 1-ampere diode
 - D5,D6—1N800, silicon diode (General Electric)*
 - D7—1N4740, 10-volt, 1-watt zener diode
 - F1—1-ampere fuse and holder
 - IC1—Integrated circuit (Sprague ULN2111A)*
 - IC2—Integrated circuit (Motorola MC1303)*
 - K1—D.p.d.t. relay, 12-volt, 300-ohm coil, 1-ampere contact rating (Price Electric 22E121-FF or similar)
 - L1-L3—15-20-mH coil (Wee Coil Inc. 387-2000 or similar)*
 - Q1,Q3—Transistor (National Semiconductor 2N5139)
 - Q2—Transistor (National Semiconductor 2N5129)
 - Q4—Transistor (RCA 40407)
 - R1,R14—10,000-ohm
 - R2—470-ohm
 - R3,R7,R8—4700-ohm
 - R4—100-ohm
 - R6—47,000-ohm
 - R9,R11,R13—1000-ohm
 - R10,R12—100,000-ohm
 - R15—180-ohm
 - R5—10,000-ohm printed-circuit potentiometer
 - S1,S2—S.p.s.t. switch (S2 optional)
 - T1—Filament transformer, secondary 12 volts 2 amperes (Stancor P-8130 or similar)
 - TD1,TD2—40-kHz transducer (Massa MK-109 or similar)
- Misc.—Spacers (4), transducer connectors (2), line cord, mounting hardware, etc.
- Note—An etched and drilled printed circuit board for \$3.50 and a complete kit of parts including punched chassis for \$37.25 are available from Southwest Technical Products Corp., 219 W. Rhapsody, San Antonio, TX 78216.
- *Also available from Southwest Technical Products are: D11D-800 diode (20¢); 15-20-mH coil (\$2); ULN2111A integrated circuit (\$2); MC1303 integrated circuit (\$5.25); 40-kHz transducer (\$4). These prices are for single units.

the components on the board as shown in Fig. 3. Use a 35-to-50-watt soldering iron, 60/40 alloy resin-flux solder, and take care in soldering.

The detector shown in the photos was built in a U-shaped metal enclosure 13" \times 2½" \times 2½", though any type of enclosure will do. Drill holes at each end of the channel for TD1 and TD2. With the transducers in place, mount transformer T1, fuseholder for F1 and an outlet for the connection to the external alarm circuit at one end of the chassis. Drill another hole for the power cord. Put a grommet in the hole before installing the cord.

Mount the printed circuit board on four insulated standoffs. Make a pair of transducer connectors by using twisted pairs with conventional phono plugs at the ends. Connect the board to the external components.

If you want to have a remote reset, connect a s.p.s.t. switch (S2) to terminals Y and Z. For automatic reset, connect a jumper between these two

WHAT IS DOPPLER SHIFT?

Doppler shift is a change in the observed frequency of a train of waves (acoustical or electromagnetic) caused by the relative motion of either the source, the medium through which the wavetrain passes, or the observer. The most common example of Doppler shift occurs when the sound of a train's whistle is higher in frequency as the train approaches and lower as it passes.

Doppler shift is the principle used in police radar systems to measure the speed of vehicles. It is also used to measure the relative velocity of stars and the rotational speed of planets or satellites. Certain types of military radar systems also operate on the Doppler principle.

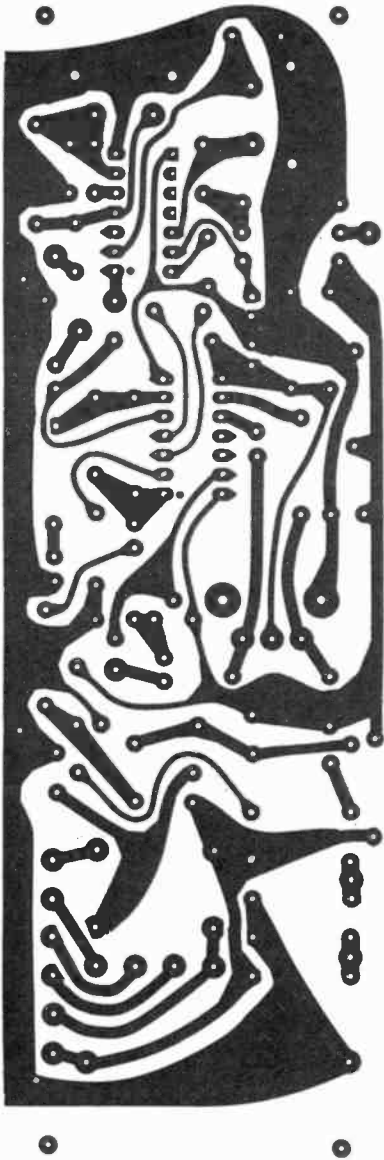

Fig. 2. Actual size printed circuit foil pattern for ultrasonic alarm. Due to circuit complexity, the use of a foil pattern prevents wiring errors.

OTHER ULTRASONIC ALARMS

Ultrasonic alarms are getting popular. Besides the several commercial versions, the Knight/James Kit KG-642 Sonic Intrusion Alarm (Allied Radio, \$69.95) is also available. The unit measures 2" x 2" x 12" and operates at a frequency of 40 kHz, covering an area of 100 square feet (10' x 10'). Using 10 discrete transistors and an SCR, the KG-642 has provisions for 12-volt operation and will switch on an external alarm of up to 117 volts at five amperes using its internal relay. The two transducers are positioned at each of the long front face while all operating controls and a switched power outlet are at the rear.



The kit goes together with relative ease (case is extruded aluminum) and operation is quite good within the protected area.

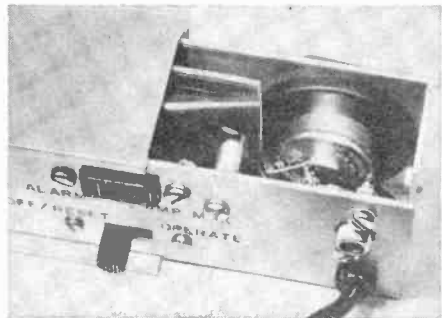

Still another ultrasonic alarm, the Delt-Alert (Delta Products, Inc.) will be described next month in The Product Gallery.

Fig. 3. When installing components, be sure that the diodes, IC's, and electrolytic capacitors are installed correctly.

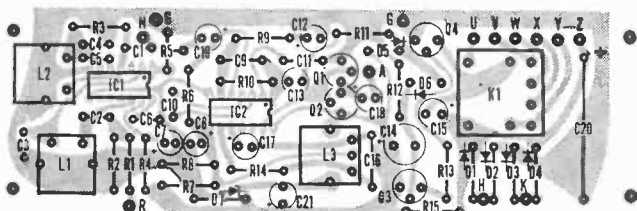

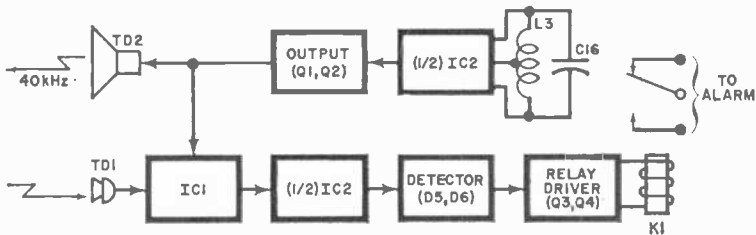

HOW IT WORKS

The transmitter portion (at the top of the diagram) consists of a 40-kHz ultrasonic oscillator, formed by half of *IC2* and tuned circuit *L3-C16*, and a complementary emitter follower, *Q1* and *Q2*. The output drives ultrasonic transducer *TD2*. The beam from *TD2* is cone-shaped, about 50 degrees wide.

The receiver portion of the One-Step has two inputs: one is the 40-kHz signal generated in the transmitter and the other is the observed frequency (Doppler shifted or not) existing in the area covered, and picked up by *TD1* (which also has a 50-degree pattern of coverage). In integrated circuit *IC1*, the detected (observed frequency) signal is amplified and mixed with the 40-kHz reference from the transmitter. As long as the two frequencies are identical, there is no output from *IC1*. However, if there is any motion within the protected area, the signal picked up by *TD1* is Doppler shifted from the reference. The difference produces a beat frequency which is a function of the rate of change of the target motion. The output of *IC1* is a low-frequency audio signal, usually between 10 and 50 Hz.

The output of *IC1* is applied to level control

potentiometer *R5* and then to the second half of *IC2*, where it is amplified. The gain of this amplifier is determined by the ratio between resistors *R9* and *R10* and its frequency response is determined by *C9*, *C10*, and *C12*.

The amplified low-frequency signal, present only when there is motion in the protected area, is rectified by *D5* and *D6*. Capacitor *C14* then integrates the signal, thus making it necessary for the motion to continue for a second or so before the signal is high enough to operate the relay driver circuit (*Q3* and *Q4*). This helps to suppress false signals due to line-voltage variations, or random air motion within the protected area. The relay is normally energized so that any attempt to disable the system by cutting the power will cause the alarm to sound. The second pole of the relay may be used to activate an external alarm. The load is restricted only by the current-carrying capacity of the relay contacts. The built-in power supply can handle one ampere at 12 volts d.c. to an external load. The power supply is a conventional full-wave bridge rectifier with capacitor-input filtering. Zener diode *D7* stabilizes the amplifier circuit and prevents supply loading and line-voltage variations from affecting circuit operation.

terminals. The isolated relay contacts (at board terminals U, V, and W) are connected to the external outlet. Make sure that a jumper is connected between terminals A and R to provide the receiver with the reference signal.

Place a metal cover, suitably painted or covered with contact material, over the completed chassis.

Installation. Since the transmit and receive transducers have 50-degree cones of usefulness, they must be "aimed" to achieve the best results. The sensitivity of the detector decreases with distance and air movement. Obviously, the larger the area to be included, the more important it is to avoid air currents from heat-
(Continued on page 104)

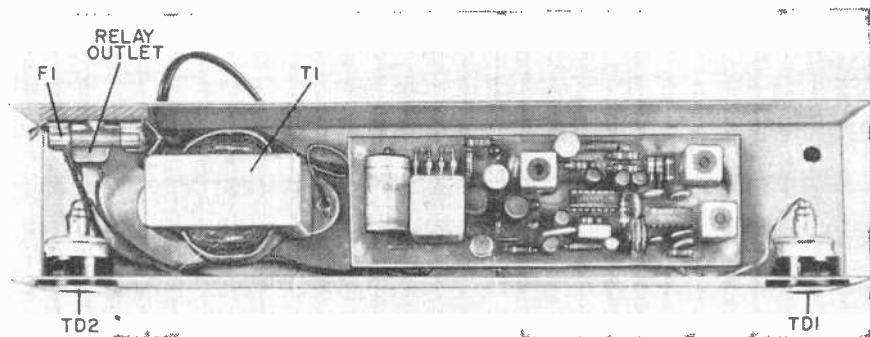

The prototype One-Step was constructed within a long slim metal cabinet. The transducers should be a foot or so apart and arranged so that the beams overlap to cover protected area.

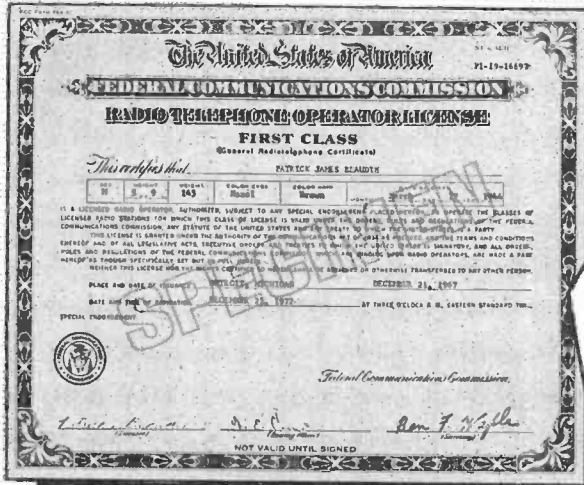

Better than
9 out of 10
CIE men wir
their "ticket"
the very first
time they try

(NATIONAL AVERAGE
IS ONLY 1 OUT OF 30)

Cleveland Institute of Electronics WARRANTY

of success in obtaining a Government FCC License

The Cleveland Institute of Electronics hereby warrants that upon completion of the Electronics Technology, Broadcast Engineering, or First-Class FCC License course, you will be able to pass the FCC examination for a First Class Commercial Radio Telephone License (with Radar Endorsement) ;

OR upon completion of the Electronic Communications course you will be able to pass the FCC examination for a Second Class Commercial Radio Telephone License ;

AND in the event that you are unable to pass the FCC test for the course you select, on the very first try, you will receive a FULL REFUND of all tuition payments.

This warranty is valid for the entire period of the completion time allowed for the course selected.

Dr. G. O. Allen
President

You can earn more money if you get an FCC License

...and here's our famous CIE warranty that you will get your license if you study with us at home

NOT SATISFIED with your present income? The most practical thing you can do about it is "bone up" on your electronics, pass the FCC exam, and get your Government license.

The demand for licensed men is enormous. Ten years ago there were about 100,000 licensed communications stations, including those for police and fire departments, airlines, the merchant marine, pipelines, telephone companies, taxicabs, railroads, trucking firms, delivery services, and so on.

Today there are over a million such stations on the air, and the number is growing constantly. And according to Federal law, no one is permitted to operate or service such equipment without a Commercial FCC License or without being under the direct supervision of a licensed operator.

This has resulted in a gold mine of new business for licensed service technicians. A typical mobile radio service contract pays an average of about \$100 a month. It's possible for one trained technician to maintain eight to ten such mobile systems. Some men cover as many as fifteen systems, each with perhaps a dozen units.

Coming Impact of UHF

This demand for licensed operators and service technicians will be boosted again in the next 5 years by the mushrooming of UHF television. To the 500 or so VHF television stations now in operation, several times that many UHF stations may be added by the licensing of UHF channels and the sale of 10 million all-channel sets per year.

Opportunities in Plants

And there are other exciting opportunities in aerospace industries, electronics manufacturers, telephone companies, and plants operated by electronic automation. Inside industrial plants like these, it's the licensed technician who is always considered first for promotion and in-plant training programs. The reason is simple. Passing the Federal government's FCC exam and getting your license is widely accepted proof that you know the fundamentals of electronics.

So why doesn't everybody who "tinkers" with electronic components get an FCC License and start cleaning up?

The answer: it's not that simple. The government's licensing exam is tough. In fact, an average of two out of every three men who take the FCC exam fail.

There is one way, however, of being pretty certain that you will pass the FCC exam. And that is to take one of the FCC home study courses offered by the Cleveland Institute of Electronics.

CIE courses are so effective that better than 9 out of every 10 CIE-trained graduates who take the exam pass it. That's why we can afford to back our courses with the iron-clad Warranty shown on the facing page: you get your FCC License or your money back.

There's a reason for this remarkable record. From the beginning, CIE has specialized in electronics courses designed for home study. We have developed techniques that make learning at home easy, even if you've had trouble studying before.

In a Class by Yourself

Your CIE instructor gives his undivided personal attention to the lessons and questions you send in. It's like being the only student in his "class." He not only grades your work, he analyzes it. Even your correct answers can reveal misunderstandings he will help you clear up. And he mails back his corrections and comments the same day he receives your assignment, so you can read his notations while everything is still fresh in your mind.

It Really Works

Our files are crammed with success stories of men whose CIE training has gained them their FCC "tickets" and admission to a higher income bracket.

Mark Newland of Santa Maria, Calif., boosted his earnings by \$120 a month after getting his FCC License. He says: "Of 11 different correspondence courses I've taken, CIE's was the best prepared, most interesting, and easiest to understand."

Once he could show his FCC License, CIE graduate Calvin Smith of Salinas, California, landed the mobile phone job he'd been after for over a year.

Mail Card for Two Free Books

Want to know more? The postpaid reply card bound-in here will bring you free copies of our school catalog describing opportunities in electronics, our teaching methods, and our courses, together with our special booklet, "How to Get a Commercial FCC License." If card has been removed, just mail the coupon at right.

THESE CIE MEN PASSED THE FCC LICENSE EXAM... NOW THEY HAVE GOOD JOBS

**Matt Stuczynski,
Senior Transmitter
Operator, Radio
Station WBOE**



"I give Cleveland Institute credit for my First Class Commercial FCC License. Even though I had only six weeks of high school algebra, CIE's AUTO-PROGRAMMED[®] lessons make electronics theory and fundamentals easy. I now have a good job in studio operation, transmitting, proof of performance, equipment servicing. Believe me, CIE lives up to its promises."

**Chuck Hawkins,
Chief Radio
Technician, Division
12, Ohio Dept.
of Highways**



"My CIE Course enabled me to pass both the 2nd and 1st Class License Exams on my first attempt...I had no prior electronics training either. I'm now in charge of Division Communications. We service 119 mobile units and six base stations. It's an interesting, challenging and rewarding job. And incidentally, I got it through CIE's Job Placement Service."

ENROLL UNDER NEW G.I. BILL: All CIE courses are available under the new G.I. Bill. If you served on active duty since January 31, 1955, OR are in service now, check box on reply card for G.I. Bill information.

Cleveland Institute of Electronics
1776 E. 17th St., Cleveland, O. 44114

Please send me without cost or obligation: Your 44-page book "How To Succeed In Electronics" describing the job opportunities in Electronics today, and how your courses can prepare me for them.

Your book on "How To Get A Commercial FCC License."

I am especially interested in:

- | | |
|--|--|
| <input type="checkbox"/> Electronics Technology | <input type="checkbox"/> Electronic Communications |
| <input type="checkbox"/> Broadcast Engineering | <input type="checkbox"/> Industrial Electronics |
| <input type="checkbox"/> First Class FCC License | <input type="checkbox"/> Electronics Engineering |

Name _____ (PLEASE PRINT)

Address _____

City _____

State _____ Zip _____ Age _____

Check here for G.I. Bill information

PE-94

2 NEW CIE CAREER COURSES

1. BROADCAST (Radio and TV) ENGINEERING... now includes Video Systems, Monitors, FM Stereo Multiplex, Color Transmitter Operation and CATV.

2. ELECTRONICS ENGINEERING... covers steady-state and transient network theory, solid state physics and circuitry, pulse techniques, computer logic and mathematics through calculus. A college-level course for men already working in Electronics.

CIE Cleveland Institute of Electronics
1776 East 17th Street, Cleveland, Ohio 44114

CIRCLE NO. 5 ON READER SERVICE PAGE

LOOKS LIKE A GUITAR . . .

SOUNDS LIKE A DREAM . . .



THE TOUCH-A-TONE

BY CHARLES D. RAKES

ONE OF THE biggest fads sweeping the rock music world is sound produced purely by electronic means. Electronic organs, drums, and castanets abound. The "Touch-A-Tone" electronic instrument described here is a different all-electronic musical instrument. It resembles a banjo and is held in much the same manner, but there all similarity ends.

Capable of producing a range of four full octaves (one below and three above middle C) in organ-like tones, the Touch-A-Tone has eight note contacts and an easy-to-reach octave selector switch. It has a built-in speaker and battery supply and a variable-rate tremolo control (6 to 36 beats per second) to add color to the music. Optional features that can be added are a variable-depth control for the tremolo circuit and a headphone jack for solitary listening.

Playing the Touch-A-Tone is very simple. With one hand, the player selects any of the eight note contacts and also touches a metal strip (located on the rear of the neck of the instrument). He then uses the thumb of his free hand to touch or "pick" a third contact located at the base of the neck.

Learning to play the Touch-A-Tone is simplicity itself—you can master "Yankee Doodle Dandy" in a matter of minutes.

About the Circuit. The tremolo circuit is comprised of $Q1$ and its associated components (see Fig. 1). This is a variable-rate, low-frequency generator, the output of which is coupled to the input of mixer-amplifier stage $Q3$. Potentiometer $R2$ adjusts the rate of the generated signal at the player's discretion, and $S1$ engages or disables the tremolo circuit.

Transistor *Q2* is the heart of the four-octave tone generator. Capacitors *C3-C6* and resistors *R43-R50* comprise the generator's frequency determining network. Switch *S3* selects the desired octave range, and the player simultaneously touches the touch bar and one of the note keys (1-8) to activate the proper transistor touch switch for the note he wishes to play. Then, with his free hand, the player also contacts the thumb touch knob.

The output of *Q2* now feeds into the input of mixer-amplifier *Q3* where it mixes with the tremolo beat (if the tremolo circuit is active) and is amplified. The output of *Q3* is taken off the wiper contact of *R11* and is coupled to audio amplifier *Q7* via *C9*.

Transistor stages *Q4-Q6* operate as a touch switch; until it is switched open by touching the thumb touch knob, the gate of *Q3* is clamped to ground, allowing no output from the mixer-amplifier.

The eight direct-coupled touch switch circuits select the proper resistive value for the tone generator. Each circuit consists of a pair of transistor stages: *Q8/Q9*, *Q10/11*, etc., through *Q22/Q23*. Diodes *D1* through *D8* provide isolation for the touch switch circuits.

The touch bar is used to supply B+ to the inputs of each touch switch as it is selected. This positive voltage is applied through the body resistance of the player!

Construction. Since the physical layout of the Touch-A-Tone is not dictated by strings or critical dimensions, you can build the circuit into almost any housing that suits your taste. Just make sure that all touch contacts are within easy reach.

Although the circuit can be assembled on a piece of perforated phenolic board with push-in terminals for soldering, the use of a printed circuit board is recommended (see etching guide and component placement in Fig. 2). The PC board reduces assembly time and minimizes the chances of wiring errors.

Mount the components on the board in the following order: fixed resistors, capacitors, output transformer *T1*, and diodes and transistors (before installing *Q3*, cut off the case lead). The last components to be mounted should be the eight trimmer-type potentiometers for *R43-R50*.

When mounting the transistors and diodes, heat sink all leads whenever heat is applied. Also, leave about 1/4" of space between the bottoms of the transistors and the top of the circuit board. Then carefully check the polarities of the electrolytic capacitors, diodes, and transistors, and the orientation of *T1*. Flip over the circuit board and make sure that all leads are properly soldered to the foil; resolder any connections that appear "grainy." After making sure that

PARTS LIST

- B1*—12-volt d.c. power source (eight 1.5 AA cells connected in series)
- C1*—1- μ F Mylar or paper capacitor
- C2*—0.03- μ F paper capacitor
- C3*—0.377- μ F paper capacitor (see text)
- C4*—0.19- μ F paper capacitor (see text)
- C5*—0.1- μ F paper capacitor (see text)
- C6*—0.057- μ F paper capacitor (see text)
- C7, C10-C13*—0.47- μ F paper or Mylar capacitor
- C8*—100- μ F, 15-volt electrolytic capacitor
- C9*—10- μ F, 15-volt electrolytic capacitor
- C19*—250-500- μ F, 15-volt electrolytic capacitor (see text)
- D1-D9*—1N4003 or 1N4004 diode
- Q1, Q2*—2N2646 unijunction transistor
- Q3*—Field effect transistor (Motorola HEP-801)
- Q4-Q6, Q9, Q11, Q13, Q15, Q17, Q19, Q21, Q23* — Bipolar transistor (Motorola HEP-725)
- Q7*—2N2102 bipolar transistor
- Q8, Q10, Q12, Q14, Q16, Q18, Q20, Q22* — Bipolar transistor (2N3638 or Motorola MPS3638)
- R1*—39,000-ohm
- R3, R8*—270-ohm
- R4*—22-ohm
- R5*—See text
- R6*—680,000-ohm
- R7*—1-megohm
- R9*—27-ohm
- R10*—1.5-megohm
- R12, R15, R16, R19, R21, R22, R24, R25, R27, R28, R30, R31, R33, R34, R36, R37, R39, R40, R42*—3300-ohm
- R13, R14, R20, R23, R26, R29, R32, R35, R38, R41*—10,000-ohm
- R17*—150,000-ohm
- R18*—4.7-ohm
- R2*—150,000-ohm potentiometer
- R11*—5000-Ohm potentiometer
- R43-R50*—PC-type miniature potentiometer (see text)
- S1, S2*—S.p.s.t. switch (for *R2* and *R11*)
- S3*—S.p.4t. rotary switch
- SPKR—3.2-ohm, 3" loudspeaker
- T1*—400:4-ohm, 300-mW output transformer (Allied Radio Corp. No. 54A2367, or similar)
- 1—1 1/2" diameter x 3 1/2" deep wood bowl
- 8—1" diameter chrome-plated drawer pulls
- 1—Spoon-shaped, chrome plated drawer pull
- 1—Chrome-plated lever knob
- Misc.—Control knobs (2); 32" x 4" x 3/4" piece of redwood; hardboard panel; dual AA-cell battery holders (4); 9" x 4 3/8" perforated phenolic board with push-in solder terminals (or see text for printed circuit board); rubber cement; #6 hardware and solder lugs; spacers; aluminum or brass stock for touch bar; speaker grille; phone jack (optional); color-coded hookup wire; solder; etc.

All resistors 1/2-watt

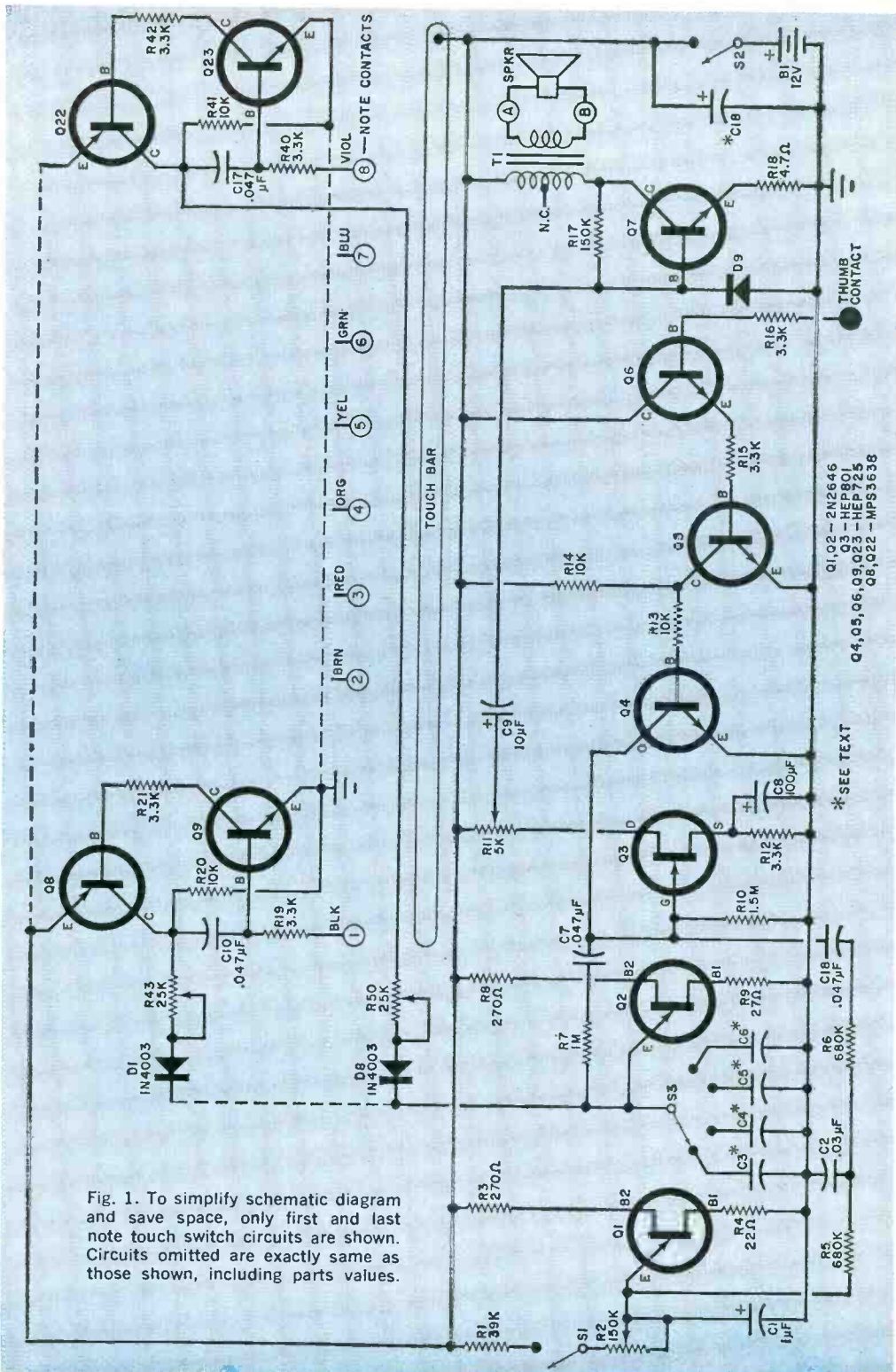

Fig. 1. To simplify schematic diagram and save space, only first and last note touch switch circuits are shown. Circuits omitted are exactly same as those shown, including parts values.

Q1, Q2 - 2N2646
 Q3 - HEP801
 Q4, Q5, Q6, Q7, Q8 - HEP725
 Q8, Q22 - MPS3638

*SEE TEXT

no solder bridges exist between closely spaced foil conductors, set the board aside.

Now lay a piece of hardboard wall paneling face down on a flat surface. Set the wood bowl rim down on top of the paneling and strike a pencil line on the paneling around the circumference of the bowl. Remove the bowl and set it aside. Then, working carefully with a sabre saw or router, cut out the circular piece and sand the rough edges. This piece will be the front panel of the instrument.

Now, referring to Fig. 3, finish fabricating the front panel according to the dimensions given. This done, set aside the front panel, and fashion the neck of the instrument from redwood or other decorative lumber. When the neck piece is cut to size with the desired outline, route out a $\frac{3}{16}$ "-deep by $\frac{3}{8}$ "-wide groove down the center of the rear to provide a channel for the touch contact wires.

Drill eight equally spaced $\frac{1}{8}$ " holes through the center of the groove in the neck piece. Then place a #6 solder lug on each of the eight screws provided with the drawer-pull "touch contacts," and mount a drawer pull at each hole location.

Solder a length of hookup wire to each of the solder lugs (measure these wires from the solder lug to the base of the neck and add 8" to each length). If possible, use color-coded wire for easy contact lead identification. A good code to use is black, brown, red, orange, yellow, green, blue, and violet for contacts 1 through 8, respectively.

Mount a $16\frac{3}{4}$ "-long by $\frac{3}{8}$ "-wide (almost any thickness between 22 gauge and $\frac{1}{4}$ ") strip of aluminum about $\frac{1}{4}$ " to one side of the center groove (see Fig. 4), using $\frac{3}{8}$ " woodscrews. Connect an 8" length of white hookup wire to the screw nearest the bowl end of the neck piece. Then carefully cut a shallow groove with a sharp knife between this last connection point to the center groove, and route the white wire through both grooves.

Anchor the neck to the front panel with three sets of 6-32 hardware. To do this, first center the spoon-shaped drawer pull at the base of the neck, and fasten it there with a screw equipped with a #6 solder lug to which a 6" length of gray hookup wire has been soldered.

Mount the speaker and grille, volume and tremolo controls, and octave selector

switch in their respective holes (and the optional headphone jack, if used), as shown in Fig. 4. Pass a $1\frac{1}{2}$ " oval-head machine screw through the center hole on the front panel, slide on a lockwasher, and screw all the way on a 1" threaded spacer. Slide on the circuit board, foil pattern down, follow with another lockwasher, and screw onto the threaded screw stub another $2\frac{1}{2}$ " length of threaded spacer. (Note: If you cannot obtain the second spacer in the required length, try sandwiching a few flat washers between the board and a shorter spacer to obtain the proper final length. In this case, substitute a 2" oval-head screw to start with.)

Now referring to Figs. 1 and 2, interconnect all components and assemblies. If you are using the optional headphone jack, reroute the wiring from the output of the transformer through the jack as shown in Fig. 5, then to the speaker.

When connecting the color-coded wires from the various touch contacts to the circuit board, leave about 1" of slack and clip away any excess. Then to finish initial assembly, wire the battery holders for a series hookup, and connect the loose ends of the wires from the positive and negative holder contacts to the appropriate points in the circuit.

Tuning. To make the method of playing the Touch-A-Tone similar to that of a guitar, the instrument must be tuned so that the high-frequency notes are played by touching the contacts nearest the

FREQUENCY IN HERTZ*				
	FIRST OCTAVE	SECOND OCTAVE	THIRD OCTAVE	FOURTH OCTAVE
R43	2093	1047	523	262
R44	1976	988	494	247
R45	1760	880	440	220
R46	1568	784	392	196
R47	1397	698	349	175
R48	1319	659	329	165
R49	1117	587	294	147
R50	1047	523	262	131

*As observed from oscilloscope patterns or read from frequency counter.

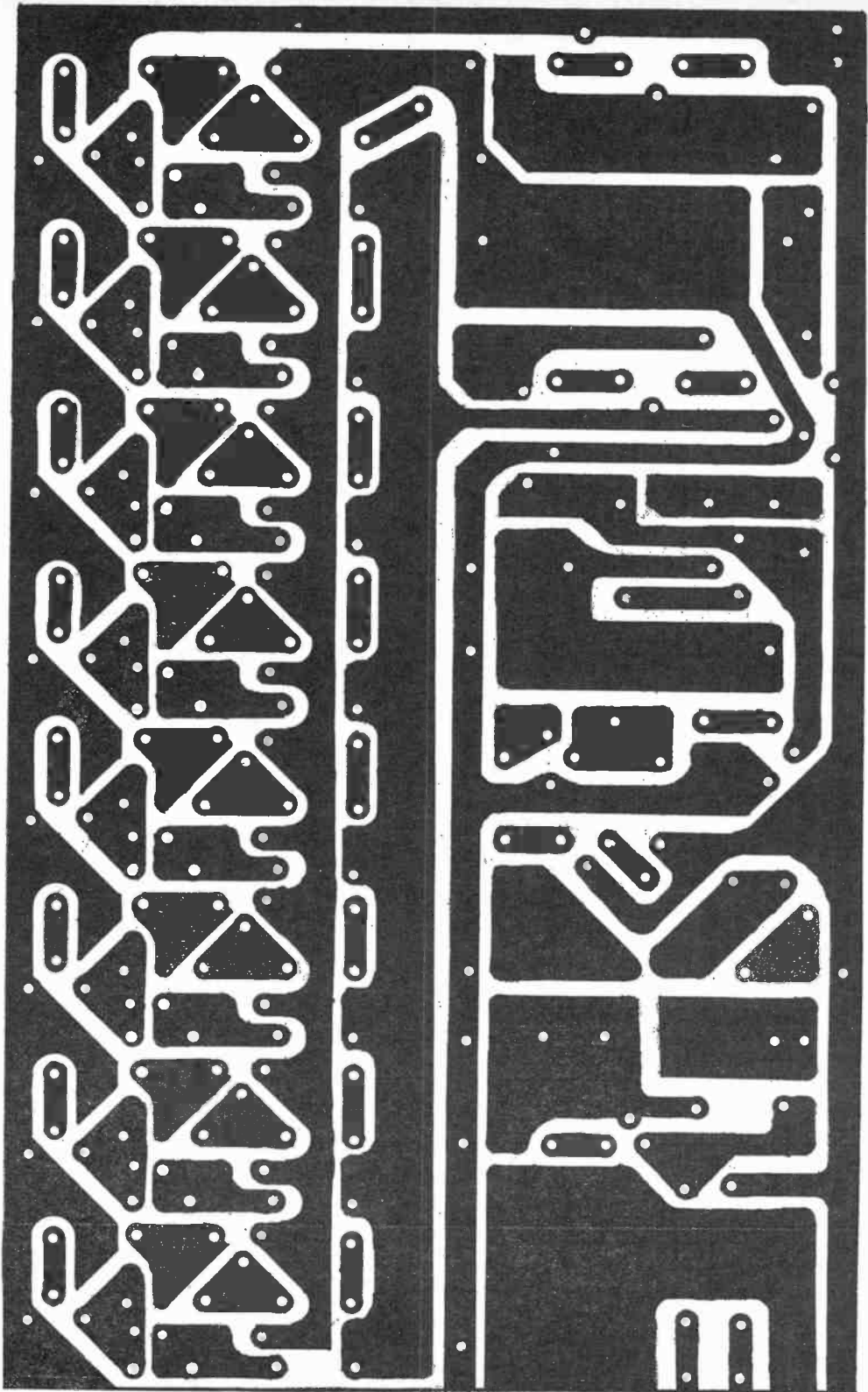

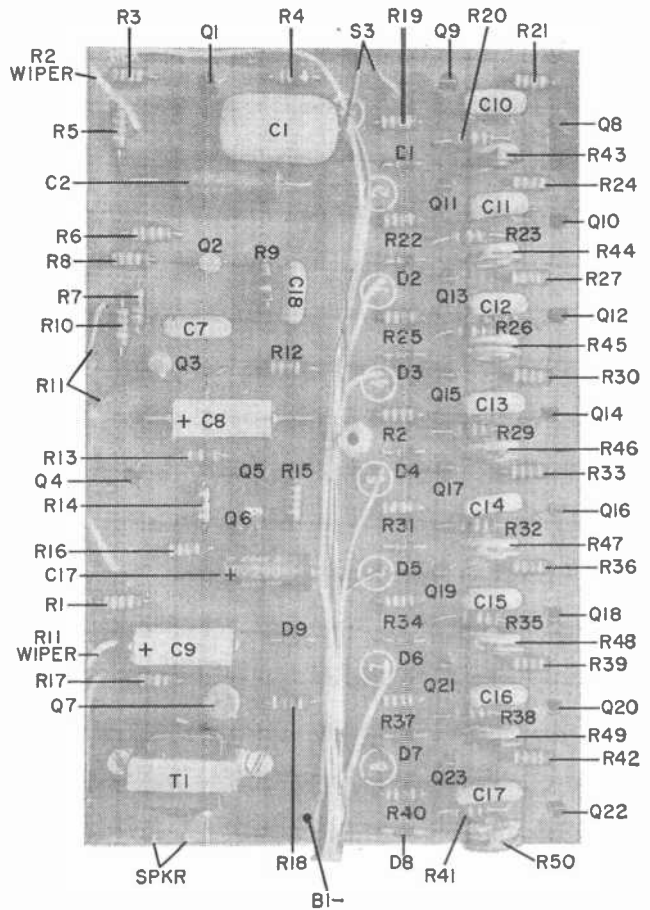

Fig. 2. Actual size printed circuit etching guide is shown on opposite page; component placement on board is shown at right. Refer to packages or cases for transistor lead identification.

bowl. Each successive contact away from the bowl should diminish the frequency of the note generated.

The simplest method of tuning the instrument is to use a frequency counter. However, if a frequency counter is not available, you can use an audio generator

and oscilloscope. In fact, if you are a musician and have a good ear for pitch and access to a properly tuned piano, you can even tune the instrument by ear.

To prepare for tuning by either of the electronic methods, make sure the tremolo is off. Take the output of the Touch-

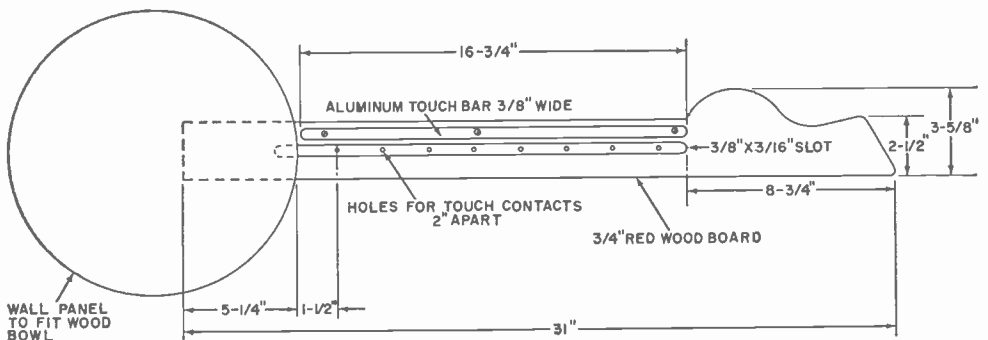

Fig. 3. Cut wall panel to fit outer circumference of bowl used. Locate holes for note touch contact mounting as shown, aluminum touch bar slightly above groove.

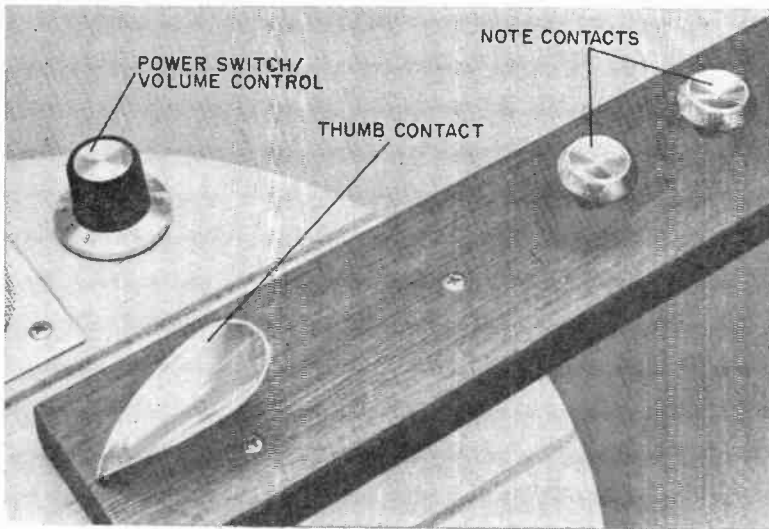

Fig. 4. Neck piece attaches to wall panel with three screws. Locate spoon-shaped drawer pull at base.

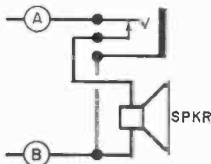

Fig. 5. Wire headphone jack as shown; connect to points A and B in schematic.

A-Tone from the speaker terminals. First, solder a 0.047- μ F capacitor (C6) in position 1 of octave selector switch S3. Then connect one clip lead between B1+ and the thumb touch contact, and another clip lead between B1+ and contact 1 on the neck of the instrument. If you are

using the frequency counter, simply set R43 (see Fig. 2) for a reading of 2093 Hz on the frequency counter.

Now, move the second clip lead to contact 2, and set R44 for a reading of 1976 Hz. Continue moving the second trimmer potentiometer and adjusting the proper trimmer potentiometers for the frequencies indicated under the "First Octave" column in the table on page 69.

To use the oscilloscope/signal generator method of tuning, set up the clip leads as described above. Then connect another pair of leads between the output of the Touch-A-Tone and the horizontal input and ground of the scope. Connect
(Continued on page 110)

One suggested layout for controls and speaker on the front panel is shown in the photo below. If headphone jack and variable-depth tremolo are to be used, mount them near R1 and R11.

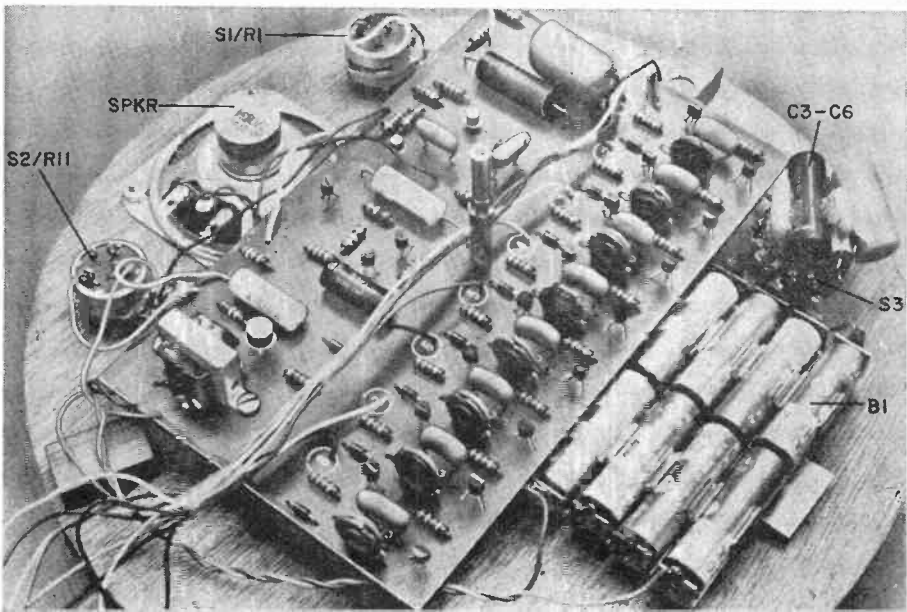



SIMPLIFIED SEVEN-SEGMENT DISPLAY IN ONE TUBE

THERE ARE MANY ways of displaying digital information. As readers of **POPULAR ELECTRONICS** are aware, digital readout can be achieved with ten small incandescent lamps; with a Nixie® glow tube, or with an incandescent-lamp, seven-segment display.* Each of these readouts is unique and has its own merits—and their use has made it possible for the electronics experimenter to build relatively low-cost digital systems.

Now RCA has developed a new type of seven-segment readout that is so simple that your editors wonder why no one thought of it before. Basically, a seven-segment readout consists of seven narrow illuminated bars arranged to form a rectangular figure 8. As the associated logic circuits determine the numerical

value to be displayed, the appropriate bars are illuminated to form the numeral on the display plane.

The RCA approach to a seven-segment readout (called a Numitron) uses seven short filament wires to form the numerals. The filaments are suitably supported against a dark background and encased in a conventional 9-pin miniature tube glass envelope. As power is applied to the various filaments, they glow to form the appropriate numerals. Operating at voltages between 3.5 and 5 volts and requiring 24 milliamperes per segment, the Numitron has an expected operating life in excess of 100,000 hours. Since the segments are voltage operated, segment voltage may be varied to control the display brightness. Also, since the segments glow white, any color filter can be used in front of the display to get the desired result.

To accompany the Numitron, RCA has also developed a decoder-driver integrat-

*See the following **POPULAR ELECTRONICS** articles: "Build a Low-Cost Counting Unit," p 27, February 1968; "All-Purpose Nixie® Readout," p 67, November 1968; "Third-Generation DCU," p 43, February 1969.

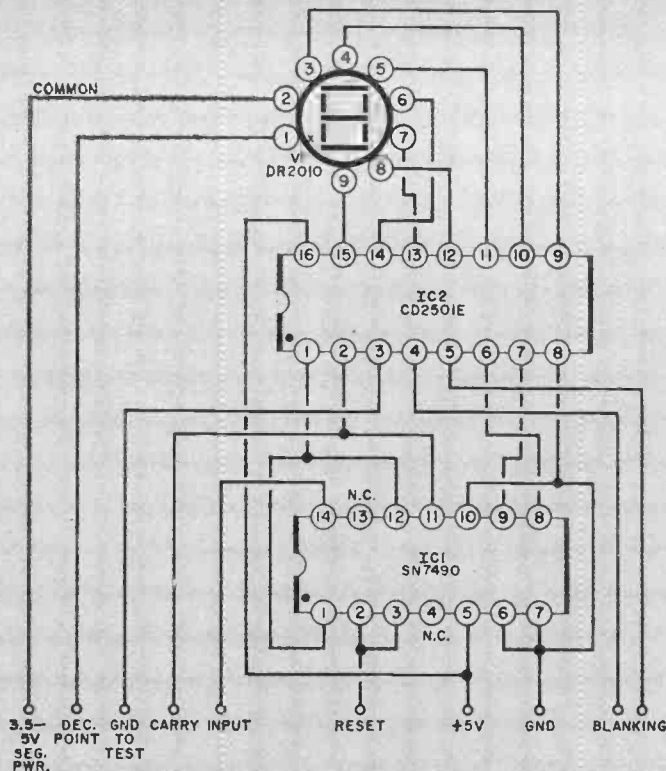

Fig. 1. The seven-segment decade counter reflects the latest in integrated circuits and display devices. Unlike other display tubes, the brightness of the Numitron can be determined by applied segment power.

PARTS LIST

IC1—Decade counter (Texas Instruments SN7490)
 IC2—BCD to 7-segment decoder-driver (RCA CD2501E)
 V1—7 segment digital display (RCA DR2010)
 Misc.—9-pin printed circuit tube socket, jumper, Amphenol PC board edge connector 143-010-01 (optional)

Note—The following are available from Southwest Technical Products Corp., 219 W. Rhapsody, San Antonio, Texas 78216: etched and drilled PC board, \$2.30; complete kit including board, IC's, and readout tube, \$25.00; both postpaid.

ed circuit. Although the Numitron can be driven with the seven-segment board described in our February 1969 issue ("Third-Generation DCU", p. 43), a much smaller and simpler PC board can be made using the new RCA CD 2501E IC. To further simplify the board and reduce the size, a Texas Instruments IC (SN7490) can be used as the decade counter to decode the incoming pulses. The circuit for the decade counter and display is shown in Fig. 1.

Construction. To take full advantage of the small-size IC's and to avoid any possible wiring error, the readout should be constructed on a printed circuit board. A foil pattern for a board is shown in Fig. 2; you can make your own or purchase one already etched and drilled. Install the components as shown in Fig. 3. A conventional 9-pin printed circuit tube socket is used for the Numitron, V1. Be sure to observe the correct terminal placement on the IC's.



Fig. 2. Actual size printed circuit foil pattern for the readout.

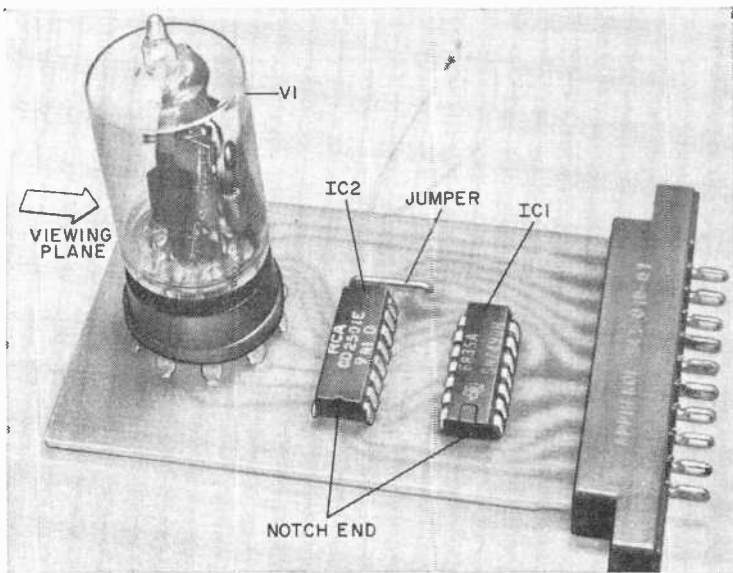

Fig. 3. Component installation is simple as long as you observe the notch code on the IC's. The connector is optional.

Connections to the board may be made by soldering directly to the foil terminations or through a conventional 10-pin Amphenol PC board edge connector.

Testing and Operation. Once this board is complete, make external connections for testing as shown in Fig. 4. The 5-volt d.c. line, which can be used for both logic and segment power, should be capable of delivering about five hundred milliamperes. With the two 5-volt supplies and the ground terminal connected, connect the "ground to test segments." All seven segments should light. This test insures that all segments are operating and should be performed each time the readout is used to make sure of correct display. For example, if the center segment is not operating, all 8's appear to be zero's. To test the decimal point, connect the "decimal point" terminal to the 5-volt source. Pushbuttons may be used to perform these two functions.

The CD2501E integrated circuit also has an optional blanking circuit. The board terminal that connects to pin 5 of IC2 is grounded in the readout associated with the most significant digit of a multi-readout display. The connection to IC2 pin 4 is then connected to the preceding board at IC2 pin 5, and so on down the

line. These connections permit the IC to blank the associated display if the input to that readout is a zero. Thus, if six readouts are used in a circuit, and only the first three digits are required, the unused displays would be dark rather than displaying a series of three zeros which may add confusion.

With the reset lead grounded, apply an input signal of about 2 volts to the board terminal marked input in Fig. 4. The signal from an audio generator may be used. As the low-frequency audio signal is applied, the display will start to indicate. To reset to zero, lift the "reset" terminal from ground and apply +5 volts d.c.

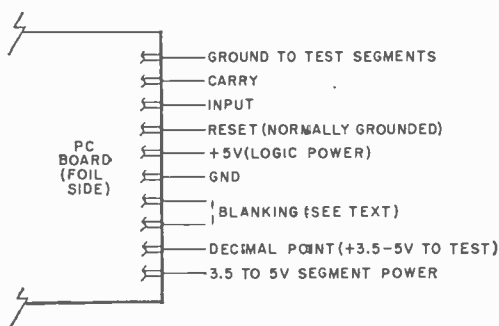

Fig. 4. Power and signal connections for each decoder. Segments should be tested before each use.

the product gallery

REVIEWS AND COMMENTARY ON ELECTRONIC GEAR AND COMPONENTS

DIGITAL DESIGN

PROGRAM

(Center for Technical

Development)

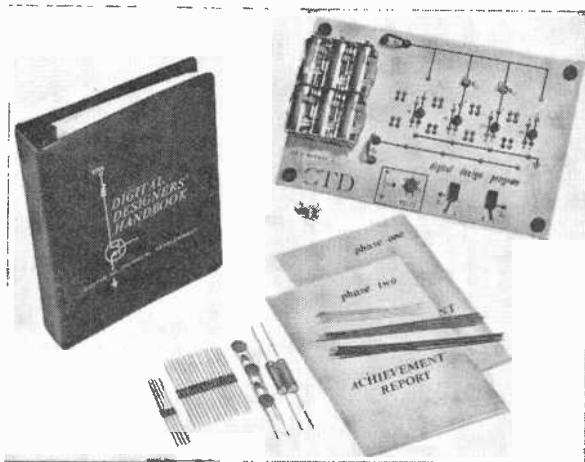

IN THE PAST few years, the impetus of research and development in all areas of electronics has created a need for supplementary training in digital techniques. Many resident and home study institutes have made digital techniques a regular part of their overall courses. To the best of our knowledge, only the Center for Technical Development (Box 103, Louisville, OH 44641) offers a supplementary program in digital electronics for home study.

Currently, only the DDP-1 Digital Design Program is available, but five more programs are in the works, scheduled for release by the time this is in print. Each program is to sell for \$99.50 complete—surprisingly inexpensive, considering the high cost of specialized quality education.

The DDP-1 program, from observation and use at POPULAR ELECTRONICS, has shown itself to be excellent. Included in the basic program are a vinyl-bound looseleaf textbook, wiring guides for suggested circuits to be used in experiments, a high quality epoxy-glass breadboard (with most components mounted in place), outboard resistors and capacitors and hookup wires, and several achievement reports.

This is a *practical* program, concentrating on design techniques instead of on theory, although theory does play an important part in the text material. The student who uses this program does not necessarily have to

have a firm grasp of technical electronics; the text is simple enough to be understood by almost anyone who has had practical experience with electronics.

The most important thing about the DDP-1 program is that the student actually sees how a digital circuit works by using the breadboard. Nor is the program inflexible. Rather, the format of the text encourages the student to pursue his experiments beyond the cutoff points in the text. In working with the breadboard and text, we found that we *wanted* to rig up our own circuits to satisfy our curiosity. It is clear that this program—and we suspect the other programs soon to be released—satisfies the prime objective of self-motivation in education.

Through the DDP-1 program, the student will become familiar with transistor and diode symbols, investigate biasing requirements and study d.c. analysis in the first section. The second section deals with the ideal and practical diode and thermal effects. The third section covers transistor switching; the fourth, inverter design; and the fifth, emitter-follower design. Specific topics include diode, DTL, RTL, and NOR gates; set/reset flip-flops; astable, bistable, and monostable multivibrators; Schmitt triggers; etc. The entire program is well-rounded and immediately useful in today's electronics.

Circle No. 98 on Reader Service Page 15 or 115

POPULAR ELECTRONICS

COMPATIBLE CB TRANSCEIVER (Regency Imperial II)

WE PUBLISH infrequent reviews of CB transceivers for the simple reason that the majority have too much in common and too little to distinguish one model of one manufacturer from someone else's model. Not so with the revamped Imperial (now Imperial II) selling for \$359.00 by Regency Electronics (7900 Pendelton Pike, Indianapolis, IN 46226).

The Imperial series introduced CB'ers to more legal-limit "talk power" through the circuit known as double sideband and reduced carrier (DSRC). Now the Imperial II has gone a step further and can radiate a double sideband signal with fully suppressed carrier—roughly equivalent to two SSB signals. On reception, the Imperial II has

straight AM detection, SSB product detection, and what appears to us to be "exalted carrier" upper or lower sideband reception. Thus the Imperial II has a receiver that separates stations far above the usual ability of the run-of-the-mill CB transceiver.

We used a 23-channel Imperial II for several weeks and were duly impressed by the receiver's ability to dig otherwise garbled and badly heterodyned signals out of the CB hodgepodge.

Although we've discussed only one feature, it's worth mentioning that the Imperial II has a load of other extras including noise blanking and separate noise limiting, speech compression and limiting, versatile tuning indicators, etc.

Circle No. 99 on Reader Service Page 15 or 115



Multi-function meter measures incoming signal strength (S), voltage to power output tube (V), and antenna loading (C). The noise blanker may be used to good advantage on SSB.



The tunable product detector (LSB/USB control) is similar to exalted carrier reception technique. The RF Gain control is a handy extra and squelch is sure and quick. Two critical adjustments that are tucked away on the side of the Imperial II (see photo at right) enable operator to properly load the transceiver to transmitting antenna. The two adjustments are simply set once and forgotten.



Four modes of signal reception are possible including straight AM with or without noise limiting, plus lower or upper sideband. The latter control is used in conjunction with LSB/USB to "clarify" incoming SSB signals.



CONTINUED

ALL-BAND SOLID-STATE RECEIVER (Hallicrafters "Star Quest" S-120A)

For the past several decades just about every short-wave listener earned his stripes with a very modestly priced "beginner's" all-band receiver. The major manufacturer of such equipment has invariably been Hallicrafters, whose model S-38 (in the late 1940's) sold in the tens of thousands.

Today, the beginner's receiver is the new solid-state model S-120A (\$59.95). It also has a code name—*Star Quest*—cute, but not very meaningful.

The S-120A has a straightforward circuit with 4 tuning ranges, a single i.f. stage,

bandsread, standby switch, and a beat frequency oscillator for interpreting CW and single-sideband ham radio signals. It may be powered from the 117-volt a.c. line, or a 12-volt battery can be plugged into the back of the receiver if you want to take it on a field trip.

This reviewer used the S-120A for a few weeks and heard just about all of the stations to be expected, considering the sensitivity and selectivity of such a simple circuit. This means that the AM broadcasters were loud and clear; numerous hams were heard; and all major international broadcasters (Moscow, Paris, London, Prague, West Germany, etc.) were heard at various times.

The S-120A is a beginner's receiver and is the sort of product that will probably whet your appetite for more and better short-wave receiving equipment.

Circle No. 100 on Reader Service Page 15 or 115

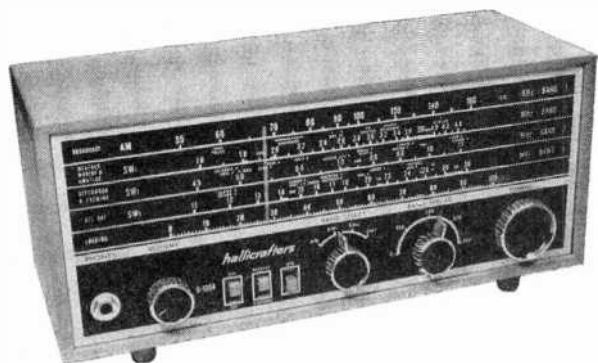

Hallicrafters S-120A is Japanese import available at modest price and ideal for someone just getting interested in short-wave reception. The accompanying "Owner's Guide" is packed with information.

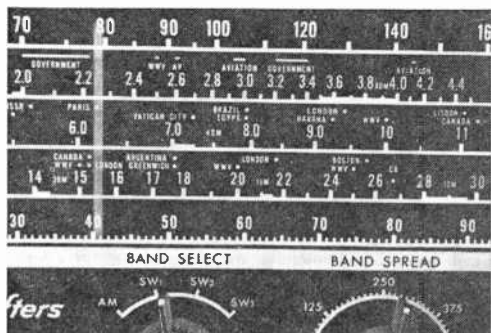

Main tuning dial is divided into four bands which embrace the spectrum from the top of AM broadcast band to the 10-meter radio amateur band. Identifications on dial are of stations that you might (optimistically) hear—but who's Boston on 25.5 MHz?

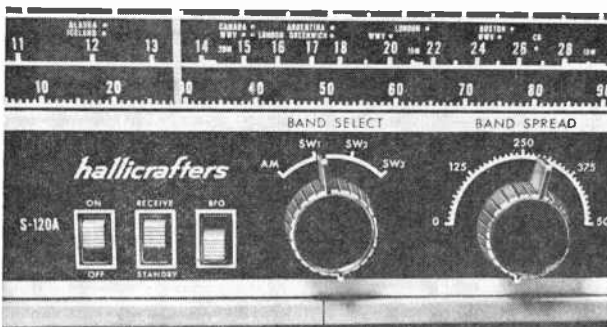

Controls of the S-120A are easy to operate and entirely self-explanatory. Bandsread dial helps to separate the multitude of stations on the international broadcasting bands. Full range coverage enables budding SWL to hear just about everything from hams to marine signals to broadcasters. Your reviewer was mystified by the station identifications "Alaska," "Iceland," etc., but soon discovered that they are aviation weather broadcasters.



OPPORTUNITY MIRROR



Thoughtful Reflections On Your Future

BY DAVID L. HEISERMAN

"Cramming" for the FCC Exam

There's a steady flow of advertisements in POPULAR ELECTRONICS aimed at stimulating interest in home study courses in FCC license preparation. Are these "cram" courses that simply prepare students to pass an examination—or what?

- There's no standard course outline for the various FCC license preparation material. Some home study schools offer short courses that mainly cover radio operation and routine maintenance and contain enough circuit theory material to give an appreciation of the operation of basic electronic equipment. These range in cost from \$180 to \$370. Other home study schools offer detailed courses that emphasize the theory of operation so that the graduate can repair radio or TV transmitting receiving equipment—in addition to knowing how it operates and being able to run routine maintenance checks.

The rising cost of living has created innumerable problems. Not the least of these is how to put your abilities to work for maximum dollar income. In some instances the solution is to "moonlight"—or find a secondary source of income. But a more realistic approach is to examine your chances for advancement in the years to come—combining career opportunities, rapid job advancement, good salary prospects, etc.

Much has been written in the past decade about jobs and careers. POPULAR ELECTRONICS has published many feature stories and has been impressed by the favorable reader response to these articles.

Feature articles, unfortunately, usually deal with only one facet of the overall problem and leave many questions about opportunities, jobs, and careers unanswered.

Starting in this issue, we will publish a new monthly department devoted to answering many of the questions that are concerned with the overall problem of doing more and earning more.

—The Editor

The most thorough FCC license preparation courses might not be called FCC courses at all. These home study programs provide full-blown material on communications or electronics technology. They range in price from \$420 to \$595 and the course schedules are about the same as those of a two-year resident technical school. In the case of these courses, the fact that the graduate can pass the appropriate FCC examination is rather incidental.

The National Home Study Council reports that none of the courses offered by its accredited member schools is based solely on the limited technical content of the FCC examinations.

Most schools that offer home study courses leading to a second or first class FCC license usually include a special warranty. This warranty states that a student who successfully completes the course and fails to pass the FCC examination will have most or all of his tuition refunded.

Will the Module Kill TV Servicing?

I am a technical electronics school graduate and have been working in industrial electronics for five years. I am seriously thinking about opening my own stereo hi-fi and TV sales or service shop. The trend of various manufacturers toward the use of modularization has me worried. If every Tom, Dick and Harry can fix his own TV receiver by replacing a module, isn't my plan rather precipitate?

- There is a chance that the smaller TV service shops that are presently just squeaking by financially will be forced out of the business when the day of fully modularized TV receivers arrives.

However, modularization of TV and stereo equipment is not exactly around the corner. At the moment, it's a great advertising gimmick, but rather thoroughly unproven in practice. There are also quite a few circuits in a TV receiver that will never be put into

modules. Besides, someone must stock the replacement modules; and have you thought of what happens to the defunct modules? Apparently, new business is coming along for the service shop that will simply make modular repairs—since according to our information most TV and stereo manufacturers don't want defunct modules back in their plants.

A decision on whether or not to go into business for yourself should not include modularization as a serious consideration. Concentrate on what you can do for your potential customers.

Study Up on Solid State

Fifteen years ago I completed a home study course in TV and radio repair. I started up my own service shop and do a respectable amount of business. However, now that people have started bringing in those little transistor television receivers, I find my life becoming more difficult day by day. Should I spend some extra money and time going back to school to learn about transistors? And, now that the TV receiver industry has announced that it is going into modules and integrated circuits, am I jumping the gun or should I wait until IC's become more common?

● Answering your question backwards, I suggest that you cheer up because the little hop from transistor technology to integrated circuits is nothing compared to the technological leap from vacuum tubes to transistors. There are a variety of excellent modestly priced self-taught transistor courses that should help you in understanding and appreciating the difference between the technologies of vacuum tubes and transistors. If you feel you want something that is more carefully planned and suited to your specific needs, I am sure that you can find a home study course that would fill the bill.

All in all, if you have spent 15 years in the repair business and have survived—hence must be fully aware of television repair problems—I think you're underrating your ability and probable quick understanding of transistor and IC technologies.

Color Blind Electronics Technician

I would like to study for a career in electronics. My friends tell me that I would be a failure and probably unable to get a job because I am totally color blind. Does it really matter that much?

● Your friends are probably giving you good advice based on their opinions that electronics engineers and technicians must work with color codes. Obviously, color television

repair is just about impossible for the color blind technician.

Although a career in electronics for someone that is color blind would obviously be restricted, you must have learned to live a normal life with your minor handicap and I am sure that you could learn to work in electronics with this handicap just as easily. Resistor color coding would be a problem, but readily soluble with an ohmmeter. Should you be fortunate enough to find employment where multi-colored wiring and color TV were not in evidence, you would probably come out okay.

Vocational Electronics

Why don't they teach electronics in high school? I think that we could eliminate the need for so many two-year technical schools if high school students could take vocational arts courses in electronics.

● We checked this question out with several high school vocational counsellors and they brought out the fact that the main objective of a high school vocational arts curriculum is to prepare students for elementary training in a trade. It appears to be the consensus of opinion that an electronics vocational training program would take much more time than high schools could afford to devote to one vocational subject.

You might be interested to know that there are several educational organizations and private concerns preparing electronics courses for junior and senior high schools. These high school courses will have as their purpose to stress the meaning of electronics and its role in our society rather than to teach the student how to design or repair equipment. They will give students a much better idea of what electronics is all about and the various kinds of careers that are open to high school graduates.

Radio Astronomy Technician

I have spent the past five years working with UHF communications systems as an electronics technician. My hobby is astronomy and I would welcome the opportunity to find employment in radio astronomy. Is there any chance?

● There are very few openings for electronics technicians in the field of radio astronomy. At the university level much of the work is performed by graduate students.

Although the chances of getting a job in radio astronomy are small, you have no chance at all unless you try. Prepare some job resumes and send them along to the Director of Personnel at the following radio telescope installations:

National Radio Astronomy Observatory
Green Bank, West Virginia 24944
Cal Tech Radio Observatory
Bishop, California 93514
University of Michigan Radio Observatory
Ann Arbor, Michigan 48104
U.S. Navy Radio Observatory
Riverdale, Maryland 20840
U.S. Navy Radio Observatory
34th and Massachusetts Aves, N.W.
Washington, D.C. 20390
Harvard College Radio Observatory
Cambridge, Massachusetts 02138
Ohio State University Radio Observatory
Delaware, Ohio 43015

According to Dr. John D. Kraus, W8JK, director of the Ohio State University radio telescope installation, anyone interested in radio telescope instrumentation should work for his EE degree and take as many astronomy courses as possible. As you are probably aware, *Sky & Telescope* magazine is the only popular publication currently publishing material on radio astronomy. They have also published notices of a few job openings in the past several years.

Although there are several amateur radio astronomy organizations (the very good one in England is the Society for Amateur Radio Astronomy, c/o F. W. M. Bright, Flat 5, 68 Derby Rd., Heaton Manor, Stockport, Cheshire, England), a brand new organization, the Amateur Radio Astronomy League, is trying to gather support from professional radio astronomers by showing that people are seriously interested in doing experiments and learning more about radio astronomy. You can reach the Amateur Radio Astronomy League through P.O. Box 3694, Columbus, Ohio 43202.

Retirement Opportunity

I have been working for the railroad for 42 years and next year I will be forced to go into retirement. I have puttered around old radio receivers and television sets for a long time and would like to learn more about electronics. I don't think I can keep up with the younger people in school any more, so what's the best way to teach myself how to fix television receivers the right way?

- You old-timers have a bad habit of selling yourselves short. Many men over 60 make a fine showing in resident schools and literally hundreds are taking home study courses in radio and television repair.

We suggest you investigate those schools that appear to advertise programs that seem best suited to your needs. A few of these schools have representatives that will help you decide the kinds of home study courses you would find most advantageous. If you

don't like the idea of doing a lot of book work, I know of one man who hired an electronics technician to teach him radio and TV repair in his own home. That man is now nearly 70 years old and has kept busy repairing television receivers for his friends, family and neighbors.

Electronics Sales Representative

I will graduate from high school this spring and I would like to be an electronics sales representative. My father has been a sales representative for about 20 years, but insists that I should study electronics first while I insist I should be studying business and marketing instead. Who's right?

- Today, the usual electronics sales representative sells service as well as various electronic products. This means that a sales rep often has to make emergency repairs on complex equipment right in the customer's office or lab.

You will be well ahead of the game to study electronics as a major home study project. Simultaneously, maybe you and your father can work out a program where he can teach you some of the business and marketing aspects.

Can a Girl Get Into Electronics?

I am a girl in my junior year in high school. I know it sounds funny, but I would like to have a career in electronics after graduation. My high school counselor thinks I am "crazy," but I'm the persistent type. Any suggestions?

- Most people generally think of electronics technology as solely a man's business, but there's no reason for this misunderstanding. There are many women who have built outstanding careers in electronics.

Besides the women working on production lines, there are women electronics technicians who are final test experts in the industries that manufacture quality components. Many technically inclined women also work as design draftswomen and quite a few are employed as research and development electronics technicians. In addition, many electronic data processing operators and programmers are women.

I would suggest that you take this letter and my response back to your high school counsellor. Hopefully, she will realize that you are serious and will recommend the proper high school math and physics courses. When you graduate, plan on entering a two-year technical school, or, if necessary, start on a home study course in electronics technology as soon as possible in your senior year.

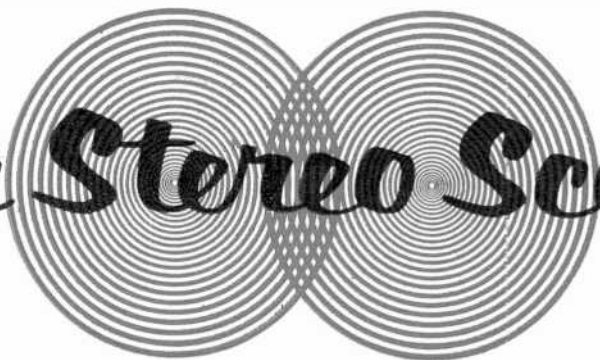

The Stereo Scene

TRUE HI-FI SPEAKS FOR ITSELF

BY ROBERT MACDONALD

CONTRARY to what some people think, you don't have to spend several thousand dollars and be an electronics expert to have true stereo-playback, high-fidelity sound in your home. If you know what you are looking for and what kind of sound you want, it's quite easy to set up, or buy, a complete, excellent system without paying a fortune.

An important first step in getting a good system is to avoid discount house and department store "off-name" brands—unless, of course, you know or have read that they have been adequately tested by stereo experts. Some of these systems do give superb results and are available at modest prices. Second, stay away from the flashy cabinets that double the selling price and do nothing for the sound—unless, again, the equipment within the cabinet is really good and decor is of prime importance.

With these two very general guidelines, then, just what do you look for? Here are some specific suggestions: first, things to beware of.

Some months ago the author of this article complained to us that what appeared in the "Stereo Scene" monthly department was fine for the big-city dweller; but what about the stereo enthusiast living in a small town with limited access to true component or compact stereo demonstrations? The author was commissioned to write this article in the hope that it would make the reader appreciate that, in stereo equipment—as in most products—you get exactly what you pay for. The emphasis is on what to look for in bargain—but beautiful—stereo systems.

—The Editor

Noise in the Player. Poor sound in a stereo system can often be traced right back to the record player or turntable. This is a favorite spot for some manufacturers of "total-system" stereo equipment to cut costs. The motor is usually the cause of most of the trouble. Manufacturers of cheap equipment almost invariably use a two-pole induction motor. These motors induce vibration and speed deviations producing: (1) *rumble*—a low sound in the speaker caused by motor vibration transmitted to the stylus; (2) *wow*—a slow rising and falling of turntable speed; and (3) *flutter*—a very fast wow occurring several times a second.

Two-pole induction motors are also sensitive to line-voltage variations, creating gross speed deviations. An unbalanced platter, slightly out of round and riding on a cheap ball-bearing surface, and slippage in the drive system also contribute to the degree of rumble, wow, and flutter.

Tone arms on most bargain-basement record players are marginally designed. Their bearings have a high degree of friction, making *tracking forces*—which keep the stylus (needle) in the record groove—unnecessarily high. This increases record wear drastically.

In the "cheapie" tone arm, an economy cartridge (where it can be hidden) is normally used—either a crystal or ceramic type. These cartridges can take the high tracking forces, but they have the unfortunate quality of low *compliance* (the ease with which a stylus is moved back and forth in the record groove). Thus the stylus hacks and chops its way through the stereo groove, literally carving out the subtle high frequencies so necessary to true hi-fi.

Then the Amplifier. In inexpensive systems, one advantage of using a ceramic or crystal cartridge is that not as much ampli-

fication is required. The output of a crystal cartridge is measured in volts rather than millivolts (as in a high-quality magnetic cartridge) so that the first stages of amplification can be done away with.

In a second-rate hi-fi system, the method of measurement of amplifier output power does not reveal the fact that the power supply is poorly designed. Inexpensive power supplies, unhappily, usually have a high degree of 60-Hz hum (if half-wave rectification is used) or 120-Hz hum (with full-wave rectification).

Distortion in an amplifier is obviously undesirable. There are many kinds of distortion, but the main types are *harmonic* and *intermodulation*. Harmonic distortion results when circuits in an amplifier generate frequencies that are integral multiples of the fundamental frequency. The ratio of the amplitudes of these undesired frequencies to the amplitude of the fundamental is measured and expressed (in published lab reports) as a percentage value.

Intermodulation distortion occurs when two audio frequencies interact and produce frequencies equal to the sum and the difference of the two—either, or both. This is also measured and expressed as a percentage value. The two kinds of distortion usually go hand-in-hand: a high degree of harmonic distortion suggests a similarly high degree of intermodulation distortion, and vice versa.

Manufacturers of true high-quality stereo equipment try to keep these distortion ratings as low as possible (0.25 to 1.0%) at the amplifier's rated power output. Bargain amplifiers permit the acceptable level to rise to 5%, which is almost intolerably high. Of course, this type of distortion is hidden by

producers of low-fidelity systems by high output power figures.

The race for power output is pulling the wool over many buyers' eyes. There exist today several different methods of measuring the power output capabilities of an amplifier. Only one, however, the rms (root-mean-square) figure is an accurate measure of the actual power an amplifier can deliver. Unfortunately, figure-wise, rms power is not as impressive as peak power; and many manufacturers use various methods of inflating power output. A complete explanation of these methods would take up too much space for our purposes here; just remember (for example) that a 10-watt rms/channel amplifier (measured by a ± 1.0 dB method) can be characterized by some people as having 150 watts of "peak dynamic power." Obviously, rms power is what you hear; so peak power is only an advertising gimmick. (See "Wattage Confidential," *Stereo Review*, June 1969) One thing to remember: if the system you are looking at has a super-high power rating, is not expensive, and the method by which the power is measured is not given, beware! It's probably a peak power rating, which is neither useful nor fraudulent.

As a broad generalization, for the average home, with a couple of efficient speakers and assuming you don't want to entertain the whole neighborhood, an amplifier with a true (rms) power of 20 to 50 watts per channel is sufficient—you probably won't use all of that, but it's nice to have.

And Finally the Speakers. The last stop on the way from record to ear is the speaker (or speakers). At this point, some low-price systems attempt to design out a phenome-

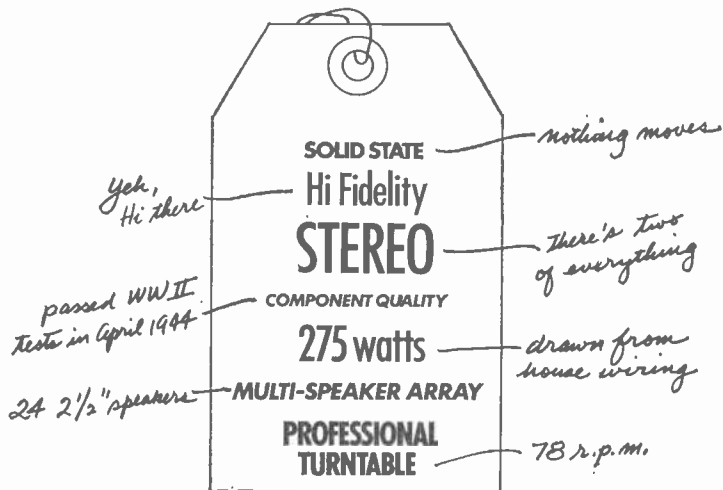

non called "acoustic feedback" which results from the housing of all components (player, amplifier and speakers) in the same cabinet. This is accomplished at the cost of general degradation of the overall sound. Acoustic feedback occurs when the speakers, mounted in the same cabinet as the player turntable, vibrate the cabinet and, hence, the turntable. The cartridge, unable to distinguish which vibrations are from the record and which are feedback, transmits both of them through the amplifier and the process begins again. Thus, acoustic feedback becomes a vicious cycle, constantly increasing in amplitude and producing an unearthly howl. In mild cases, it simply masquerades as rumble and muddies the sound long before audible oscillations occur.

To solve the problem of acoustic feedback, inexpensive speakers incapable of radiating anything below about 70 Hz are used. Most acoustic feedback occurs around 40-50 Hz and, happily, so does turntable rumble. Thus feedback and rumble are eliminated all in one fell swoop. Of course, the low notes—the string basses, contrabassoons, tubas, and organ foot pedals—are also eliminated; but this can be fixed too by creating false bass.

Cheap speakers are often designed to create harmonic and intermodulation distortion around 100 Hz. To the untrained ear, this sounds like great bass response, even if it is just distortion. A really good speaker system seems to have less bass simply because of lower distortion. The best way to tell is to listen for low organ notes; if they are true, and not simply distortion, you can tell.

Many bargain hi-fi system manufacturers are playing a numbers game with regard to the number of speakers used in their systems. Such terms as "glorious eight-speaker sound" appear in advertisements. Actually, the sheer number of speakers in a system can never be a final determination of the quality of the system. Indeed, until the laws of physics are repealed, nobody will ever be able to make a bunch of cheap speakers sound like one or two good speakers that are well designed and properly enclosed.

True High Fidelity. So much for poorly designed (possibly handsome looking) low-fidelity systems. We've mentioned what not to look for; here are some things on the positive side.

Carefully designed turntables use smooth, four-pole motors which are relatively insensitive to line-voltage variations and are carefully isolated from the platter to minimize rumble, wow, and flutter. The best turntables use synchronous motors which are completely insensitive to large voltage variations and operate with superb speed accuracy.

Good tone arms with anti-skating compensation minimize bearing friction allowing tracking forces to be reduced to almost nothing. High-quality magnetic cartridges are used; they track with low stylus pressure, are highly compliant, and greatly reduce record wear.

High-fidelity stereo amplifiers are conservatively designed, use quality components, and have stable, well-regulated power supplies. They are realistically rated in rms power output (not peak power) and distortion is kept to a minimum.

A good speaker system is well-designed, carefully enclosed, and reproduces the entire audible range from low organ pipes to high violins with as little coloration as possible.

Adding It All Up. True high fidelity speaks for itself. No fancy cabinet is going to make a complete system sound better. Good stereo is not necessarily expensive if you watch what you are getting.

If you live in a small town where there is no real hi-fi salon, you can order by mail from any of a number of firms dealing in stereo equipment. Most have a good reputation and will guarantee satisfaction. They offer pre-selected component-type systems at a substantial saving over the price of separately purchased components. Even then, however, you should check the specifications.

Last, but not least, the stereo kit may be the answer to combining top quality with maximum dollar value. Even independent consumer testing organizations have very kind things to say about stereo kit building.

So, before you go out and pay as much as \$800.00 for imitation stereo, why not know what you're doing and get the real thing? "Sound-wise" and "money-wise" there is no substitute. —30—



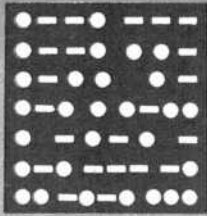

AMATEUR RADIO

By **HERB S. BRIER**, W9EGQ
Amateur Radio Editor

WANT TO GO TO THE MOON?

WHAT DO amateurs do on the air besides ragchew and chase DX? Here are some clues from recent activities of the Phil-mont Mobile Radio Club, Inc., Philadelphia. During the first manned landing on the moon, the club members conducted an international poll of amateur reaction to the moon landing. Operating the club station, W3TKQ, at the Franklin Institute, Philadelphia, on 20-meter phone, they asked each station worked three questions:

Do you think your grandchildren will ever walk on the moon?

Do you think that this first manned flight to the moon compares in importance with Columbus's discovery of America?

Will exploration of space contribute materially to peace on earth?

The majority of the 300 stations contacted in 11 countries thought that their children or grandchildren would be able to go to the moon. They also answered the other two questions in the affirmative but with many qualifications.

The Phil-mont club also provided communications and model recovery service for the week-long, national meet of the Academy of Model Aeronautics, held at Willowdale Naval Air Station. This meet is the "World Series" of free-flying model planes, which have wing spreads up to six feet or more. The club members travelled 1000 miles recovering 252 planes during the meet.

Many of the planes are valuable and represent untold hours of work; the fervor with which the contestants (including interna-

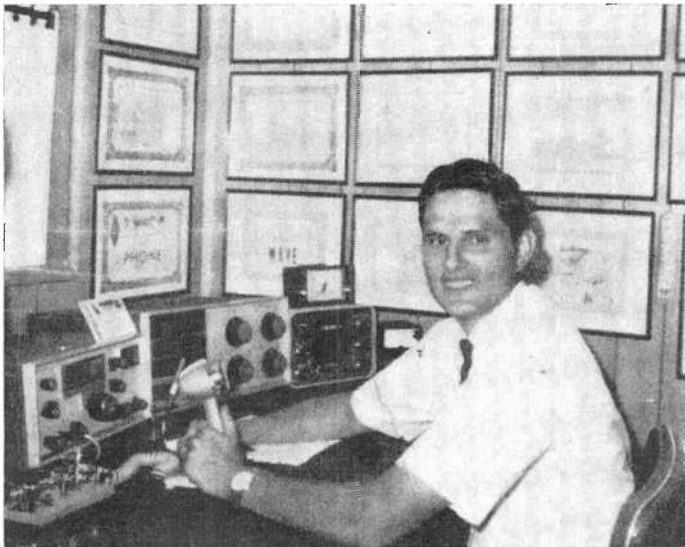

AMATEUR
STATION
OF THE
MONTH

William W. Fulcher, Jr., DDS, K4RTA, 105 Freshrun Dr., Hendersonville, Tenn. 37075, worked his first 129 countries with his National NCX-5 transceiver. Now he has an NCL-2000 linear amplifier and 229 countries. Bill is QSL manager for CX9PP, ZS3BP, ZS3C, and ZS3D and net manager for the Tennessee Post Office Net on 75-meter phone. We will send K4RTA a 1-year subscription for winning this month's Amateur Station Photo Contest. You can enter by sending us a clear picture (black and white, preferably) of yourself at the controls of your station with details about your amateur career. The address: Herb S. Brier, W9EGQ, Am. Radio Editor, POPULAR ELECTRONICS, P.O. Box 678, Gary, IN 46401.

WHERE TO TAKE YOUR NOVICE OR TECHNICIAN EXAMINATION

United States regulations specify that Novice and Technician class amateur licenses are normally to be issued by mail through the cooperation of amateurs 21 years of age or older who hold General, Advanced, or Extra class licenses. These volunteer examiners administer the examinations as agents of the Federal Communications Commission. To assist prospective Novices and Technicians who have difficulty in locating a volunteer examiner near them, POPULAR ELECTRONICS hopes to publish a list of such examiners periodically. When you think you are ready for your examination, contact the nearest examiner to make the necessary arrangements.

Qualified individuals or radio clubs wishing to cooperate in this program are invited to send the requisite information to: Volunteer Examiners, c/o Herb S. Brier, W9EGQ, Amateur Radio Editor, POPULAR ELECTRONICS, P.O. Box 678, Gary, IN 46401.

When a club is listed in the following table, the amateur listed may not be the one who witnesses your examination; most of the clubs listed have several volunteer examiners standing by to help you. Several of the listed clubs also offer regularly scheduled amateur radio classes.

California. William Welsh, W6DDB, LERC Amateur Radio Club, Lockheed Employees Recreation Club, 2814 Empire Ave., Burbank, Calif. 91504. Telephone: 213-842-1863.

Colorado. Allen Auten, WØECN, Denver Amateur Radio Club, Inc., 2575 South Dahlia St., Denver, Colorado. Telephone: 756-1211.

Connecticut (and Nationally). Membership Services Department of ARRL, American Radio Relay League, Inc., 225 Main St., Newington, Conn. 06111. (If other sources fail, may be able to put you in contact with a local ARRL affiliated amateur radio club to help you.)

District of Columbia. Beale E. Riddle, WA3MGA, 1808 Connecticut Av., Washington, D.C. 20009.

Florida. J. A. Tew, WA4ONZ, 1307 North Alabama Av., Deland, Fla. 32720.

Illinois. Wilson Thomas, W9WKA, Chicago Suburban Radio Association, 4017 Vernon Av., Brookfield, Ill. 60513. Telephone: HU5-0451. (The CSRA has other volunteer examiners in Berwyn, La Grange, Maywood, etc.)

Indiana. Calvin J. Cooley, WA3HPS/9, 2437 Waverly Drive, Gary, Indiana 46404. Telephone: 949-8051.

Indiana. Paul W. Deppert, WA9BNX, Lafayette Amateur Radio Club, 2303 Iroquois Trail, Lafayette, Ind. 97905.

Maryland. Walter Page Pyne, WA3EOP, 717 Oak Hill Av., Hagerstown, Md. 21740.

Wisconsin. Walter Glich, W9YYW, Secretary, Milwaukee Radio Amateur Club, 1221 North 72nd. Wauwatosa, Wisc. 53213.



Radio, screen, and TV personality Andy Devine, WB6RER, and Ray Meyers W6MLZ examine a 3-week exhibit of amateur radio at the Los Angeles State Mutual Savings and Loan Association sponsored by the Los Angeles Council of Radio Clubs. The equipment is a Drake 2-C receiver and 2-NT transmitter.

tional champions) thanked club members who returned lost planes they never expected to see again made the amateurs' efforts worthwhile.

A third activity of the Phil-mont club last season was to provide communications for a 50-mile Boy Scout "Paddlerama" or canoe race on the Delaware River. Thirty-six, 2-man, 17-foot aluminum canoes participated in the 2-day race. Two scouts in each canoe started the race from old Camp Weygadt, N.J., and paddled through turbulent white water and marked "gates" on the river. At the end of approximately eight miles, another pair of scouts from the same troop took over the canoe for the second lap. They, in turn, were relieved by a third crew that paddled the canoe to Eddyside Park, Easton, Pa., where the contestants camped for the night. The next day, each canoe was paddled another 25 miles to the final goal at Treasure Island, near New Hope, Pa.

Many canoes capsized in the white water in the river, but the crews quickly righted them and continued the race. One canoe was bent double, however, as it threw its crew out. But it took its crew only 20 minutes to straighten out the canoe and make sufficient repairs to continue the race. (More perma-



Paul Schuett, WA6CPP, had a First Class Commercial license for 15 years before he tried ham radio.

ment repairs were made overnight at Eddy-side Park.)

The amateurs relayed the judges' scores for each canoe as it passed each gate. Consequently, each team's score could be posted on the race scoreboard almost as fast as its canoe reached the first- and second-day finish lines. The communications link was also geared for emergency use, if the need had arisen. Thanks to the Phil-mont *Blurb* for the information on the above story.

New Zealand Cook Bi-Centenary Award.

In commemoration of the 200th anniversary of Captain Cook's landing in New Zealand, amateurs in that country may use the prefix ZM, instead of the regular ZL amateur prefix, until 31 December, 1970, if they wish. Also, the New Zealand Amateur Radio Transmitters (NZART) will issue a Cook Bi-Centenary Award to amateurs working 50 different "ZM" stations between October 1, 1969, and December 31, 1970. At least one of the stations worked must be located in each of the ZM1 through ZM4 call areas. Send complete log details verified by two other amateurs and three International Postal Reply Coupons to Awards Manager, ZL2GX, 152 Lytton Rd., Gisborne, New Zealand. No QSL cards are required.

FCC News. Effective on January 1, 1970, U.S. amateur maritime-mobile stations were authorized to operate between 7.0 and 7.1 MHz in Region II (Atlantic Ocean). This change will permit U.S. "MM" stations in the Atlantic Ocean to work European and African amateurs, whose 40-meter band extends only from 7.0 to 7.1 MHz. . . . On November 6, 1969, the FCC ordered the Extra class license of Herbert L. Rippe, W8DE, Cincinnati, Ohio, suspended for the remainder of his license term in Docket 39955. The

basis of the suspension was that Rippe had fraudulently obtained a "2-letter" amateur call sign by claiming that he had been licensed as an amateur for 25 years. He had 15 days to appeal the suspension order.

Amateur Ingenuity in France. Jean Lafont, F1RJ, has been working England across the English Channel on 2304 MHz with 300 milliwatts output. Microwave varactor diodes are scarce in France. Consequently, Jean uses a 1N914 computer diode (32 cents) as the frequency-doubling output varactor in his transmitter.

From Bill, K6KZI, Director of the West Coast Amateur Radio Service, Inc. (WCARS) in the *WCARSentinel*: On November 9, Cliff, WB6ZKK, who lives alone, suffered a serious heart attack that left him partially paralyzed. He lost his glasses while dragging himself to the telephone, and when he tried to dial "O" for help, all he got was a busy signal. Cliff then remembered that his Swan 140 transceiver was tuned to the 7255-kHz WCARS frequency, and with his remaining strength he managed to drag himself to his microphone and gasp a plea for help. WB6OEZ heard the desperate call. In a few minutes, the fire department and an ambulance came to Cliff's rescue (probably saving his life). He is now recovering.

At first sight, the South African amateur examination recently published in *Radio ZS* (Capetown), official journal of the South
(Continued on page 100)



Mike Donaldson, WN3NDJ, St. Clair, Pa., obviously has a future license plan if the microphone and Heathkit VFO mean anything. Transmitter is Heathkit DX-60V; the receiver a Hallicrafters SX-28A.

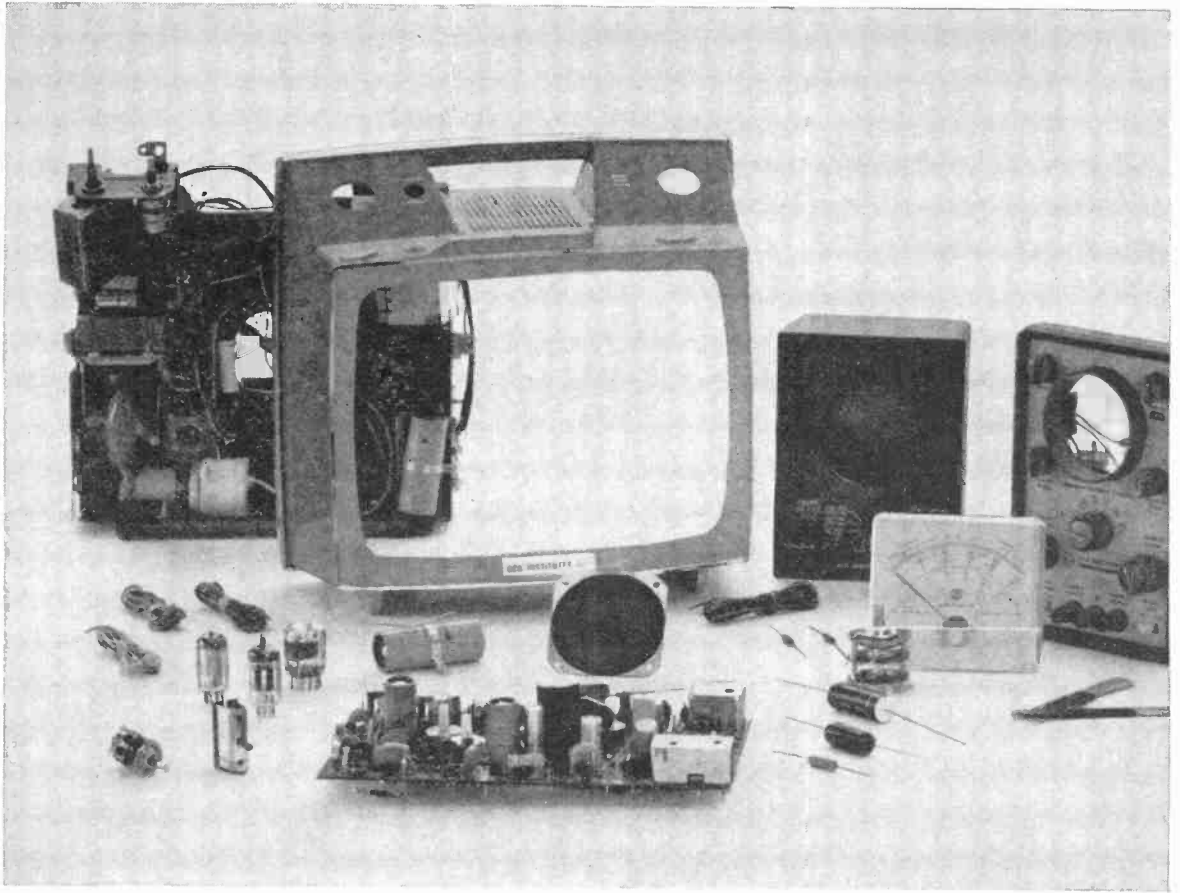

**Look! You get 25 kits...
more than ever before at no extra
cost...for your practical "hands-
on" learning of electronics and
TV with RCA Institutes Home
Training! Send postcard today!**

RCA

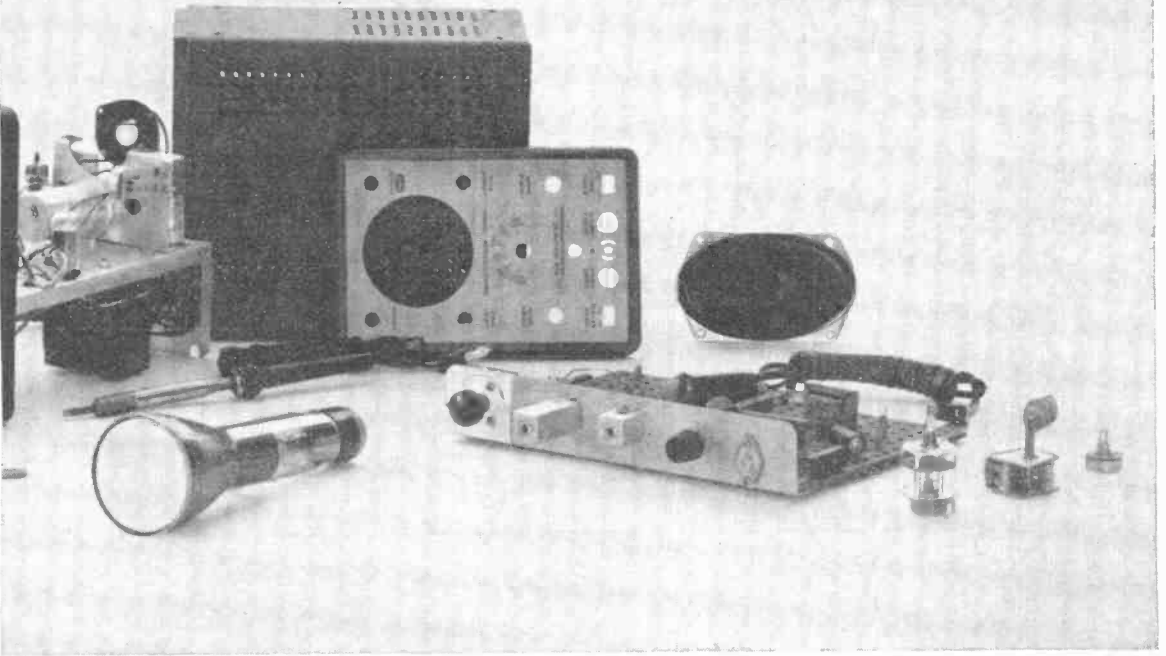

Now, RCA supplies 25 kits in its home-study career program—at no extra cost! Be sure to compare this with other home-study electronics programs. And note, you never have to take apart one kit to build another piece of equipment because there are literally thousands of parts making up the kits. Information on them is included in the catalogue which you'll get when you mail in the reply post-card or the coupon.

Absolutely practical, your kits are used to build such permanent, professional and useful equipment as an oscilloscope, a signal generator, a multimeter, and a fully transistorized breadboard superheterodyne AM receiver. They will give you years of valuable service.

In addition, an easy way to learn—the career programs are all based on the easy, step-by-step AUTOTEXT method. AUTOTEXT is unique and exclusive with RCA Institutes. Math and circuitry problems simply melt away! So check the wide range of electronics and TV career programs.

Eleven Career Programs: Television Servicing (including color TV and

CATV) • FCC License Preparation • Automation Electronics • Automatic Controls • Industrial Electronics • Nuclear Instrumentation • Electronics Drafting • *including these four all-new:* Semiconductor Electronics • Digital Electronics • Solid State Technology • Communications Electronics.

Also check the new Computer Programming course—trains you to work on today's largest data processing systems including IBM/360 and RCA Spectra 70, the Third Generation Computers.

You get tuition plans as flexible as you wish: pay-as-you-order or pay-by-the-month...you choose! No interest charges! No other electronics home study school offers both these choices.

Classroom training also available—day and evening coeducational classes start four times a year. No previous training required—you can take preparatory courses if you haven't completed high school.

Placement service, too—with RCA Institutes classroom training, you get the full benefits of the RCA Job Placement Service. RCA Institutes grad-

uates are now with companies that include Bell Telephone, GE, Honeywell, IBM, RCA, Westinghouse, Xerox, and major radio/TV networks. This placement service is also available to Home Study Graduates.

Veterans: enroll now—all courses are approved under the GI bill

Accredited Member National Home Study Council.

If reply postcard has been removed, mail this coupon.

.....

• RCA INSTITUTES, INC. •
 • Home Study Dept. 694-003-9 •
 • 320 West 31 Street, New York, N.Y. 10001 •

• Please send me free illustrated career catalog. •

• Age _____ •

• Name _____ •
 (please print)

• Address _____ •

• City _____ •

• State _____ Zip _____ •

• For GI Information, check here •

.....

ENGLISH LANGUAGE NEWS BROADCASTS FOR THE MONTH OF MARCH

Prepared by ROGER LEGGE

TO EASTERN AND CENTRAL AMERICA		TO WESTERN NORTH AMERICA			
TIME-EST	STATION AND LOCATION	FREQUENCIES (MHz)	TIME-PST	STATION AND LOCATION	FREQUENCIES (MHz)
7:00 a.m.	Peking, China	11.685, 15.095	7:00 a.m.	Tokyo, Japan	9.505
7:15 a.m.	Montreal, Canada	9.625, 11.72	8:00 a.m.	Stockholm, Sweden	15.315
7:30 a.m.	Melbourne, Australia	9.58, 11.71	5:30 p.m.	Melbourne, Australia	15.17, 17.775, 21.74
7:45 a.m.	Copenhagen, Denmark	15.165		Tokyo, Japan	15.235, 17.825, 21.64
9:00 a.m.	Stockholm, Sweden	15.315	6:30 p.m.	Johannesburg, South Africa	9.715, 11.875, 15.22
12 Noon	London, England	21.61	7:00 p.m.	Madrid, Spain	6.14, 9.76
4:30 p.m.	Hilversum, Holland	11.73, 15.425		Peking, China	15.095, 17.673, 21.735
6:00 p.m.	Montreal, Canada	9.625, 11.945, 15.19		Prague, Czechoslovakia	5.93, 7.345, 9.54, 11.99
6:45 p.m.	Tokyo, Japan	15.445, 17.825		Seoul, Korea	15.43
7:00 p.m.	London, England	6.11, 9.58, 11.78	7:30 p.m.	Tokyo, Japan	15.105
	Moscow, U.S.S.R.	9.655, 9.685, 11.90		Berlin, Germany	5.955, 9.73
	Sofia, Bulgaria	9.70		Stockholm, Sweden	11.705
7:30 p.m.	Tirana, Albania	7.30, 9.78		Tirana, Albania	6.20, 7.30
	Johannesburg, So. Africa	9.705, 11.875, 15.22	8:00 p.m.	Budapest, Hungary	6.234, 9.833, 11.91
	Stockholm, Sweden	5.99		Havana, Cuba	9.525, 11.76
7:50 p.m.	Brussels, Belgium	6.125		Lisbon, Portugal	6.025, 9.68, 11.935
	Vatican City	9.615, 11.725, 15.285		London, England	6.11, 9.58, 11.78
8:00 p.m.	Berlin, Germany	5.955, 9.73		Moscow, U.S.S.R. (via Khabarovsk)	11.85, 15.18, 17.88
	Budapest, Hungary	6.234, 9.833, 11.91		Sofia, Bulgaria	9.70
	Havana, Cuba	9.525	8:30 p.m.	Kiev, U.S.S.R. (Mon., Thu., Sat.)	9.685, 11.90
	Madrid, Spain	6.14, 9.76	8:45 p.m.	Berne, Switzerland	9.72, 11.715
	Peking, China	15.06, 17.715		Cologne, Germany	6.145, 9.545
	Prague, Czechoslovakia	5.93, 7.345, 9.54, 11.99	9:00 p.m.	Havana, Cuba	11.76
	Rome, Italy	9.575, 11.81		Hilversum, Holland (via Bonaire)	9.715, 11.73
8:30 p.m.	Berne, Switzerland	6.12, 9.535, 11.715	10:00 p.m.	Moscow, U.S.S.R. (via Khabarovsk)	11.85, 15.18, 17.88
	Cologne, Germany	6.075, 9.735		Tokyo, Japan	9.505
	Melbourne, Australia	15.17, 17.775	10:30 p.m.	Havana, Cuba	11.93
9:00 p.m.	Hilversum, Holland (via Bonaire)	11.73			
	Lisbon, Portugal	6.025, 9.68, 11.935			
	London, England	6.11, 9.58, 11.78			
	Moscow, U.S.S.R.	9.685, 9.70, 11.87			

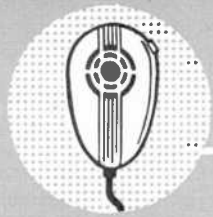

TWO WAY REACTIONS

BY G. H. REESE, KC6990

PLANNING BETTER PROGRAMS

MANY REACT teams and CB clubs have a problem making their membership meetings as interesting as possible. We have reviewed the "minutes" of many meetings and attended as many as possible. Programming is usually mediocre; but no matter where you are located, there are many sources for interesting and informative CB programs.

One thing that many program planners overlook is the need to plan ahead. You can't expect to get a good speaker on one week's notice. Several weeks might be sufficient but not always. It is also a good idea to give the speaker an option of several possible dates. If your meeting is at a regular time each month, you can offer the speaker a choice as to the month.

Ideally, you should plan your entire year's program schedule in advance. Be prepared with extra program ideas in case one or more of your plans does not work out. It is also worthwhile to keep an emergency program available in case of a very last minute cancellation. This is a perfect role

for some club member who wants to show pictures of the trip he made to some jamborees last year, or a club holiday party.

Good speakers who are interesting and well-informed can provide the greatest drawing card. The more interesting and significant the speaker, the more important it is to have a large audience for him to address. It would be appropriate to invite other CB groups or all local CB radio operators to attend a meeting where a representative of the FCC was to speak.

Other possible speakers: Communications officers of local law enforcement agencies; military and naval representatives, both active and reserve; and the FBI. The U.S. Weather Bureau may provide you with a speaker to explain their "Operation Sky-Warn" and how you can participate in this novel weather watch observation program. Red Cross and Civil Defense directors can usually provide interesting programs related to your interests.

Local electronics manufacturers and deal-



Members of the Orange County (Calif.) REACT team, Communications Officer Dick Dunham, right, and Ron Elzy, plan a future Search and Rescue Team training exercise, as part of Orange County REACT training.

ers may be able to describe new electronic developments and products of interest to your members. Don't overlook the possibility of an interesting program being developed around the appearance of an active amateur (ham) radio operator at your meeting. He might describe the advantages of the ham bands and describe the process of obtaining a license. He might also be able to show the new ARRL/Arthur Godfrey 30-minute movie.

A professional two-way radio dispatcher from your local police department or taxicab company might provide a very informative program. If they won't come to your meeting, perhaps a field trip to a communications center would be even more informative. Your telephone company may also have some interesting presentations on the future of communications.

Interesting meetings are basic to good attendance and interest in your club. Of course, they must be interesting to the members and not just to the program chairman. Ask for suggestions, and follow-up. Successful meeting programs can be repeated or expanded in the future. Prospective members are introduced to your club through the meetings they attend. Interesting programs are the best means of impressing them, and encouraging them to join. Help your club or team grow by planning better meetings.

NCR Traffic Assist Program. In a recent column, we mentioned the rule-making proposal of the FCC to permit the relay of automobile traffic information for use by broadcast stations. This was requested originally by National Capital REACT, Inc., covering the Washington, D.C. area. Now NCR is putting their plan into operation.

Members who commute on the major arteries into Washington completed a travel pattern survey form. This survey was used to assemble a systemized reporting program that funnels auto traffic information over a 60-mile radius to specific NCR monitors. The monitors relay reports directly to the District of Columbia AAA, which compiles and tapes records for local broadcast stations. Up until now, the AAA had to rely only on police traffic reports. Now CB radio will provide faster, more current information. This system is expected to be duplicated in other cities.

National Capital REACT is unique. It includes approximately 300 members scattered over the Washington metropolitan area. Some are members of NCR only, but the majority belong to the four REACT teams and six CB clubs affiliated with NCR. The combined monitoring schedule averages over 3200 hours per month. Calls per month

run between 250 and 300. Awards called the "Big Ear" are presented regularly to members who monitor at least 125 hours every three months.

Affiliated REACT teams are: Minutemen CB Radio Club of Virginia, Alexandria, Va.; Fairfax REACT Team, Fairfax, Va.; Manassas REACT Team, Manassas, Va.; and Herndon REACT Team, Herndon, Va. Affiliated CB clubs are: Citizens Band Radio Emergency Club, Inc., Washington, D.C.; Channel Busters Citizens Band Radio Club, Silver Spring, Md.; Radio Association of Montgomery County, Bethesda, Md.; Prince George Citizens Band Radio Club, Kentland, Md.; Arfax Citizens Band Radio Club, Inc., Arlington, Va.; and Metropolitan Area Radio Club, White Oaks, Md.

REACT Recruits Editor. Some time ago, we received an inquiry at REACT National Headquarters from Jim Mathews, Editor of Road Test Magazine. Jim wanted information about REACT for a story in his publication. We sent the information he requested and put him in contact with West Valley REACT in the Los Angeles area where he is located. Jim not only wrote the story (see Road Test Magazine, February, 1970), but West Valley REACT got a new member—Jim Mathews!

Current News

Denver, Colorado—Denver Metro REACT participated in a Civil Defense disaster exercise. A simulated explosion was the cause of 60 "dead" and 250 "injured" persons. REACT provided CB communications between the hospitals and the ambulances. CBS News filmed the exercise. It also received extensive coverage on all three local Denver TV stations.

(Continued on page 111)



These members of the Alamos City Radio Club (San Antonio, Texas) are obviously proud of their new shirts. They might be even better from the front.



SHORT-WAVE LISTENING

By HANK BENNETT, W2PNA/WPE2FT
Short-Wave Editor

INTERNATIONAL REPLY COUPONS

ONE OF THE most widely used and least understood forms of postage is the International Reply Coupon (IRC). Many of our readers do not know exactly what an IRC is, where it can be purchased, and what to do with one when it arrives in the mail.

The IRC is a small piece of white paper, about 3" by 4", printed in blue or blue and red. It is issued by all participating members of the Universal Postal Union. The purpose of the IRC is to provide a means of sending return postage to someone in a foreign country. Naturally, American stamps are of no value to anyone in Portugal, India, Brazil or the Tonga Islands—unless, of course, you are a stamp-collector. Nor are postage stamps of any foreign nation good for legal postage on any mail originating within the U. S. The IRC very nicely solves the problem of how to send return postage to a foreign country other than by the usually more expensive method of obtaining mint (new) stamps of the country of destination.

The IRC is available in most post offices in the United States for 15¢. The overseas addressee, upon receiving the IRC, can redeem it at his local post office for stamps of the value required to send a letter back to you by surface (sea) mail. The letter, of course, has to weigh within an amount covered by the basic single postage unit fee (usually 1 oz.), otherwise the sender will be required to purchase additional stamps to make up the difference. If you should desire your correspondent to reply by air mail, you should include two, three, or even four IRC's, depending on air mail fees from his country to the USA.

When you purchase IRC's, be sure that the post office clerk places the postmark in the proper place. There are two forms of IRC's in general usage. The older form has two round blank circles, one on each side, while the newer form has two blank circles on the right side. On the older form the left-hand circle should bear the postmark of the issuing office. On the newer form the top circle should be postmarked. An IRC with the original postmark in any other position may not be honored.

Please remember, also, that sending IRC's is not a proper way to send money within the United States—or to the United States from Mexico or Canada. For instance, if you want to send us 50¢ for a Monitor Registration Certificate, please don't send us IRC's. You pay 15¢ for them but they can only be cashed for 6¢ here in the U.S.

International Reply Coupons are to be used exactly for what the name implies—*international reply*. They're great for that purpose. And if you find that your post office does not carry them, you can order them from us at



Two styles of International Reply Coupons are in use today. The older one, above, has the blanks for cancellation on each end. On the newer one, both blanks are on the same end. When purchasing either, be sure cancellation is in the correct spot or coupon may not be honored when presented.



the standard price of 15¢ per coupon plus a 6¢ stamp so that we can send them to you.

Denmark Leaves the Air. Late in 1969 it was announced that the Radio Council of Denmark had decided to terminate all international programs, including the North American transmissions, for budgetary reasons. The effective date was to be April 1, 1970. Many reporters have written in to inform us that this date was moved back to December 31, 1969, a change evidently made after the original news release. An overseas source reports an interview with the Director General of the Danish Radio Council who reportedly stated that it was too expensive to run a station that broadcasts only to a small minority. "If people want to find out information about Scandinavia, they will have to listen to Radio Sweden".

So ends international broadcasting from Denmark, at least for the time being.

CURRENT STATION REPORTS

The following is a resume of current reports. At time of compilation all reports were as accurate as possible, but stations change frequency and/or schedule with little or no advance notice. All times shown are Greenwich Mean Time (GMT) and the 24-hour system is used. Reports should be sent to Short-Wave Listening, P. O. Box 333, Cherry Hill, N. J. 08034, in time to reach us by the fifth of each month. Be sure to include your WPE identification and the make and model number of your receiver.

Albania—*R. Tirana* has been logged on 6200 kHz at 2035 with English news and commentary; on 9500 kHz at 0630 and 1100 with English news; and on 9780 kHz with an unscheduled English xmsn at 0000-0028.

Andorra—*R. Andorra* has begun a regular English service on 701 kHz (medium-wave) each Saturday at 0000-0500. Reports go to *Radio 428 Metres*,



A Hallicrafters SX-110 is the receiver used by Leo Barth, Jr., of Newport, R.I. Registered as WPE1GOG, Leo presently has 22 states verified.

11-15 Wigmore Street, London, W1, England. An overseas source claims a new station, *R. Rupert*, has probably (by now) begun xmsn's in English to be conducted on the same format as *R. Luxembourg*. No frequency or time period was given.

Australia—New frequencies in use include Melbourne on 11,920 kHz at 2040 with music, 2045 talk, English news at 2100-2110, and Darwin on 9625 kHz, with tests at 1330-1400 with continuous recorded music. The normal xmsn's to N.A. continue to be widely heard at 0100-0300 on 15,320, 17,840 and 21,740 kHz, and at 1115-1215 on 9580 and 11,710 kHz.

Bolivia—*La Cruz del Sur*, La Paz, has moved from 4985 kHz to 5025 kHz and reports are requested to Cajon 1408, La Paz. This station recently celebrated its 20th anniversary . . . The Catholic station, CP60, *R. Pio XII*, 5955 kHz, 1 kW, was silenced as a result of the takeover of the government by General Ovando.

British Honduras—*R. Belize* is noted well on 3300 kHz at 0200-0430 s/off with news from London at 0300, local weather reports, commercials, and pop music. We have noticed exceptionally strong signals from the medium-wave outlet on 834 kHz in recent weeks at 2300-0100.

Ceylon—Voice of America's Colombo outlet, 15,285 kHz, has news in Special English at 1700, jazz at 1715, but signals on the West Coast are poor.

Colombia—*Emisora Atlantico*, Barranquilla, continues to be heard on 4905 kHz at good level around 0445.

Congo (Republic)—Brazzaville, 15,145 kHz, begins a Paris-originated English program at 1900 with a talk and music, 1930 news, 1947 s/off. ID's for both Paris and Brazzaville are given throughout the program.

Costa Rica—*R. Reloj*, San Jose, is now operating on 4690 kHz (varying up to 4701 kHz), dual to 6007 kHz, as noted at 2300-0400 with music, time checks, talking and ID's. This 64-meter outlet is often quite distorted and the frequency, according to reports, drifts.

Cyprus—A multicolored QSL card lists 15,260 and 17,885 kHz, each with 30 kW. At press time, we find that 11,910 kHz is also in use around 1900.

Ecuador—HCJB, Quito, has been logged on 15,145 kHz at 0200-0215 with English news, letters from listeners and a talk. Continued to past 0230 with usual programming and a frequency list which did include 15,115 kHz but not 15,145 kHz . . . HCRT6, *R. Paz y Bien*, Ambato, has resumed operations on 4820 kHz (it was last noted in 1963 on 6000 kHz) and has s/off at 0300 . . . HCVC3, *R.*

(Continued on page 111)

LATIN AMERICAN FREQUENCIES

4970 kHz—One of our experts on Latin American stations writes that the situation around this frequency has become quite confused in recent months with several wrong reports having appeared in different publications. The correct situation, around 0100 and later, is reported as follows:

4965 HJAF, *R. Santa Fe*, Bogota, Colombia

4967 OAX7T, *R. Sicuani*, Sicuani, Peru

This is a move from previous 4835 kHz.

4970 YVLK, *R. Rumbos*, Caracas, Venezuela

4971 OCX4T, *R. Cultural*, Huancayo, Peru

This is a new station on short-wave.

4972 HCGHI, *R. Tarqui*, Quito, Ecuador

4974 CP90, *R. Juan XXIII*, San Inacio, Bolivia

This is a move from previous 4951 kHz.

4975 OCX4H, *R. Del Pacifico*, Lima, Peru

A new station that previously tested on 9675 kHz.

4975 HJJG, *R. Internacional*, Cucuta, Colombia

This one is not being heard at present.

4977 ZYY9, *R. Timbira*, Sao Luiz, Brazil

Listed for 4975 kHz but has moved up possibly to avoid QRM from OCX4H.



SOLID STATE

By LOU GARNER, Semiconductor Editor

IC'S IN CONSUMER PRODUCTS

WITHOUT QUESTION, the largest prospective market for integrated circuits is in the consumer products. Potential applications for IC devices can be found in nearly all of the electrical appliances, vehicles, and electronic equipment used by the general public.

Although virtually untapped at present, this large market has not gone unnoticed by the major semiconductor manufacturers. A booklet entitled *State-of-the-Art Linears in Action* recently published by Motorola Semiconductor Products, Inc. (Box 955, Phoenix, Arizona 85001) has a major section devoted to "Integrated Circuits for Consumer Products." Written by Ralph Greenburg, Motorola's Manager of Consumer and Industrial Applications Engineering, the article discusses the market in general terms, examines the electrical characteristics needed in consumer products, explores potential IC applications, and describes some of the currently available units which might be suitable for consumer products.

Preliminary estimates indicate that the overall consumer market could require hundreds of millions of IC devices annually when fully exploited. According to Mr. Greenburg, this vast market can be divided into six broad areas—television receivers (98,500,000 IC's), audio/radio equipment (96,000,000 IC's), major household appliances (62,000,000 IC's), small appliances (including power tools) (95,000,000 IC's), hobbyist and recreational products (15,000,000 IC's), and automotive equipment (120,000,000 IC's). The potential IC market in each of these areas was estimated by checking the annual production or sales figures of products within that area.

If we add the potential requirements for all segments of the consumer market, then, we find that IC device usage might reach 500,000,000 units annually. But this figure is based on the present day sales volume of known products. The development and introduction of new products such as household computers, personal communication systems, automated highways, or new entertainment equipment, could make even

this figure, as large as it is, but a fraction of the actual requirements.

Reader's Circuit. Cyril H. Goulden, Ph.D., L.L.D. (10 Kitimat Crescent, Ottawa 6, Ontario, Canada) writes that he has tried a number of sophisticated burglar alarm circuits, but without satisfactory results. He found that most were sensitive to electrical noise and often could be set off by lightning during storms. He further discovered that the local police—in his words—"are not too happy about false alarms." As a result, Dr. Goulden tried his hand at devising a reasonably fool-proof system. His final circuit is illustrated in Fig. 1.

Referring to the schematic diagram, Dr. Goulden has used a medium-power SCR as his basic control element. The SCR, in turn, actuates an inexpensive electromagnetic relay, *K1* (Guardian 200), which serves to switch the alarm circuit. Gate bias for *SCR 1* is established by voltage-divider *R1-R2*, but *R2* normally is shorted by a closed conductive loop around the protected area. The SCR, then, remains in a non-conducting (open) state until the protective loop is broken by an intruder. At this point gate bias is applied, "firing" the device and furnishing power to the relay's coil through current limiting rheostat *R3*. Once fired, the

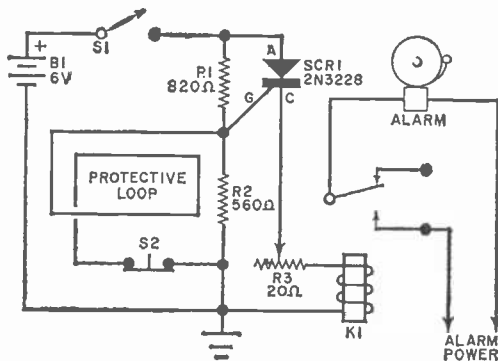

Fig. 1. The SCR in this alarm circuit is normally off until protective loop is broken by intruder.

SCR remains in a conducting state even if the loop is restored, holding the relay closed and sounding the alarm continuously. The circuit is reset by opening key-operated main power switch *S1*. Operating power is furnished by *B1* while *S2*, a normally closed pushbutton switch, is used to test system operation.

Conventional components are used in the system. While a heavy-duty six-volt lantern battery can be used for *B1*, a storage battery is the preferred source, with a line-operated trickle charger "floated" across the unit to maintain its charge. Any conventional alarm bell, horn, or buzzer can be used for a signal, while the alarm power supply can be either an independent power source or *B1*, as preferred.

Neither parts placement nor wiring arrangement is critical, although good wiring practice should be observed when assembling the project. Maximum protection can be assured by mounting the circuit in a sturdy wall-mounted, key-locked junction cabinet. Potentiometer *R3* is adjusted for positive relay closure with *S2* open and *S1* closed.

Proper installation of the protective loop is absolutely essential to system operation. Basically a closed series circuit, the loop should include foil (or fine wire) patterns cemented on all glass panes and normally closed switches on all doors, windows, access panels or similar openings to the guarded area. Circuit connections must be such that any attempt to open a door or window, whether forcibly (as by breaking a glass) or with a master key, will break the closed circuit.

Manufacturer's Circuit. An experimental project suitable for advanced hobbyists and serious students, the 100-MHz FET oscillator circuit shown in Fig. 2 is one of a score of FET application circuits illustrated in *FET Design Ideas*, a 16-page booklet recently published by Texas Instruments, Inc. (P.O. Box 5012, Dallas, Texas 75222). Issued

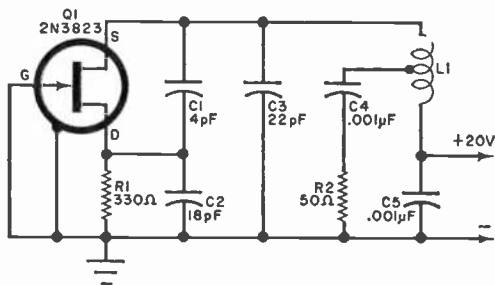

Fig. 2. Output frequency of FET oscillator can be adjusted by moving turns on *L1*. Output tap is determined experimentally to get an optimum loading.

as Bulletin No. CB-101, the brochure was prepared as an introduction to FET design techniques, and includes information on biasing as well as a list of currently available TI FET's. Among the other circuits described in the booklet are such designs as a 920-MHz FET oscillator, a FET voltmeter, a FET electrometer, an FM tuner, a 2-watt complementary amplifier, a 200-MHz cascode amplifier, and a Wien-bridge oscillator.

Basically a modified Colpitts oscillator, the design features an *n*-channel FET in the grounded-gate configuration. Referring to Fig. 2, the circuit's operating frequency is determined by a tuned circuit made up of *L1* and *C3*, shunted by the series *C1-C2* combination. The feedback needed to start and sustain oscillation is established by capacitive voltage-divider *C1-C2*, with the drain held above ground by load resistor *R1*. Output load resistor *R2* is coupled to *L1* through d.c. blocking capacitor *C4*, while *C5* serves as an r.f. bypass.

Except for hand-wound coil *L1*, commercially available parts are specified for the project. FET *Q1* is a type 2N3823 *n*-channel, and all capacitors are ceramic types with at least a 50-volt rating. Inductor *L1* consists of 3 turns of 16-gauge tinned copper wire having a $\frac{1}{16}$ " diameter.

As is typical of VHF circuitry, layout and lead dress are critical. Although perf board, etched wiring, or other construction techniques may be used, all signal leads must be kept short and direct. The case of *Q1* is grounded at a point between the drain and source electrode leads.

After assembly, check-out and test, the unit's final frequency can be adjusted by separating or "squeezing" *L1*'s turns, using an insulated tool, and checking output using a grid-dip meter, VHF receiver, or comparable test instrument. The output tap is determined experimentally for optimum loading.

Over There! Although the U.S. generally is acknowledged as the world leader in semiconductor technology and production, other nations are quite active in these fields. Among the new developments announced recently are items from England, France, West Germany, Japan and Australia.

A hi-fi stereo amplifier which utilizes IC's extensively and which has a peak output of 9 watts per channel has been developed by the Britmac Electrical Co., Ltd. (Shelley Rd., Preston PR2 2HU, Lancashire, England). The new amplifier measures only 6" \times 5 $\frac{3}{4}$ " \times 2 $\frac{1}{4}$ " overall and thus is small enough to fit under the deck of most turntables. With a virtually flat response from 40 Hz to 20 kHz, the unit can deliver its

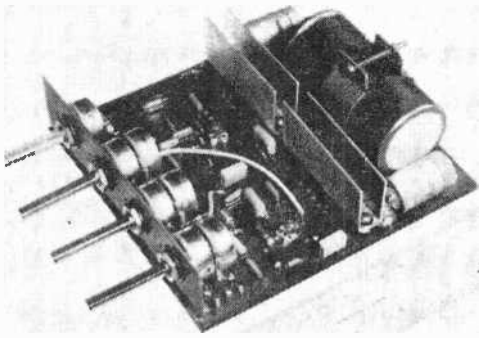

New stereo hi-fi amplifier developed by Britmac Electrical Co., Ltd. utilizes integrated circuits.

peak power of 18 watts into a pair of 8-ohm speakers when driven with a 250 mV signal. Its input impedance is 2 megohms. The amplifier is equipped with balance, gain, treble and bass controls.

La Radiotechnique Compelec, a Paris based subsidiary of Philips Gloeilampenfabrieken, has developed a new type of cadmium-telluride solar cell which can be produced on continuous sheets of pliable material. Although less efficient than the more familiar silicon solar cell, the cadmium-telluride units can be produced for a fraction of silicon's price, and, one day, may find widespread use as energy sources in underdeveloped countries or remote locations.

A West German firm, AEG-Telefunken, has developed a unique video camera tube which uses a semiconductor light-sensitive target. Dubbed the *Telecon*, the new unit is a competitively priced device intended for the commercial and industrial markets. Preliminary reports indicate that the new tube is superior to conventional vidicon and plum-bicon tubes in most performance specifications.

Matsushita's Central Research Laboratory in Osaka, Japan, has announced a new stereo pickup which uses a piezoresistive semiconductor film device as its transducer. The unit's sensitive element is a germanium semiconductor deposited on a 25- μ m film base. It translates stylus movements into electrical signals by strain-induced changes in resistivity. With no magnets or coil needed, the pickup is not only exceptionally small, but has a weight a fraction of that of conventional units.

Also from Japan comes news of a recently developed high-power silicon thyristor. According to the manufacturer, Hitachi, its new CH99 solid-state device has a maximum rating of 10,000 volts and can control currents of up to 400 amperes. Intended for use in heavy-duty industrial applications,

the CH99 is available through a U.S.-based affiliate, Hitachi New York Ltd. (501 Fifth Ave., New York, N. Y.)

A unique semiconductor-operated test instrument has been introduced by the Australian firm B.W.D. Electronics Pty. Ltd. (331-333 Burke Rd., Gardiner, Vic. 3146, Australia). Identified as the Model BWD 602 Combination Instrument, the new unit combines a number of related operational functions in a single cabinet measuring only 16 $\frac{1}{2}$ " \times 8" \times 10 $\frac{1}{4}$ " overall. It can supply sine and square wave signals simultaneously from 0.5 Hz to 500 kHz and has an integral high-gain 8-watt amplifier. In addition, the BWD 602 can furnish a variety of source voltages for external circuit or equipment operation, including 0 to plus 300 volts at 35 mA, 0 to minus 50 volts at 1 mA, 55, 15, and 6.3 volts at 1 ampere, a.c., 1-12 volts at 2 amperes, and 12-24 volts at 1 ampere. All outputs are overload or short-circuit protected. Furnished with a complete handbook, the instrument is intended for educational as well as laboratory applications.

Transitips. Non-inductive resistive loads are essential for meaningful power tests of transistorized audio amplifiers and radio transmitters. While non-inductive resistors are available commercially, they can be expensive and are not stocked by all local parts outlets. But there is an excellent low-cost substitute available—the ordinary incandescent lamp. Capable of handling relatively high powers for their size, most incandescent lamps have extremely low inductance and, therefore, can be used at moderate radio as well as audio frequencies, and even to lower VHF values if de-based. Virtually all lamps are suitable for this application, from small pilot bulbs to automotive types and even household lamps.

Unfortunately, a lamp's resistance varies considerably as its filament heats. Its "cold" resistance may be but a fraction of the value at full power levels. For accurate tests, then, it is necessary to "calibrate" each lamp in terms of its effective resistance at different power (or voltage) levels. This can be accomplished by using an experimental arrangement similar to the circuit illustrated in Fig. 3.

The test lamp is connected across a variable voltage source, with its current (I) and voltage (E) monitored by suitable meters. The applied voltage is increased in small steps and the circuit current measured each time. These values can be plotted on a standard linear graph or, if preferred, the lamp's d.c. resistance can be calculated at each step using Ohm's Law ($R=E/I$), with its resistance plotted against voltage. Ideally, a set of these "calibration charts"



**1970—WINTER
ELECTRONIC EXPERIMENTER'S
HANDBOOK** \$1.35

148 pages of the most fascinating and challenging construction projects for the electronics hobbyists. All with complete schematics, illustrations, parts list, and easy-to-follow instructions that guarantee you perfect finished products.

**1969—SPRING
ELECTRONIC EXPERIMENTER'S
HANDBOOK** \$1.25

Another big package containing the most challenging, fun-to-build electronics projects ever! Be sure to order this one today!

1970 STEREO/HI-FI DIRECTORY \$1.35

Giant 180 page buyer's guide listing more than 1,600 individual Stereo/Hi-Fi components by 176 manufacturers. Nine individual sections complete with specs, photos, prices—the works!

6 Vital Components

*For Knowledge...
For Profit... For Sheer
Electronics Enjoyment!*

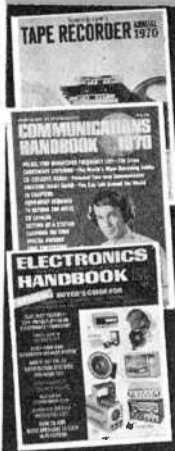

1970 TAPE RECORDER ANNUAL \$1.35

Over 130 pages covering every aspect of tape recording. Complete buyer's guide to the brands and models on the market. Expert tips on equipment—making better tapes—editing—copying—everything you want and need to know about tape recording.

**1970
COMMUNICATIONS HANDBOOK** \$1.35

148 fact packed pages for the CB, SWL or HAM. Equipment buyer's guide—photos—tables—charts—getting a license—everything to make this the world's most complete guide to communications.

**1970
ELECTRONICS INSTALLATION &
SERVICING HANDBOOK** \$1.35

Covers all 8 areas of consumer electronics servicing—all the tricks of the trade in one complete guide. The industry's "how-to" book for installing and servicing consumer electronics equipment.

ZIFF-DAVIS SERVICE DIVISION • Dept. W
595 Broadway, New York, N.Y. 10012

Please send me the annuals I've checked below:

- 1970 Electronic Experimenter's Handbook - Winter
- 1969 Electronic Experimenter's Handbook - Spring
- 1970 Stereo/Hi-Fi Directory
- 1970 Tape Recorder Annual
- 1970 Communications Handbook
- 1970 Electronics Installation & Servicing Handbook

I am enclosing \$_____ My remittance includes an additional 25¢ per copy for shipping and handling (Outside U.S.A. all magazines are \$2.00 per copy, postpaid.)

print name _____ PE-3-70

address _____

city _____

state _____ zip _____

PAYMENT MUST BE ENCLOSED WITH ORDER

could be prepared for different lamps as a permanent record.

When choosing a lamp load for a specific test, then, two factors are considered—first, its power handling capability and, second, the lamp's resistance at the anticipated power level. The first factor can be estimated from the lamp's nominal rating—a small pilot lamp, for example, would not be suitable for checking the full output of a 200-watt audio amplifier. The second factor (resistance) is important to insuring a matched load and is determined by referring to the previously prepared "calibration charts."

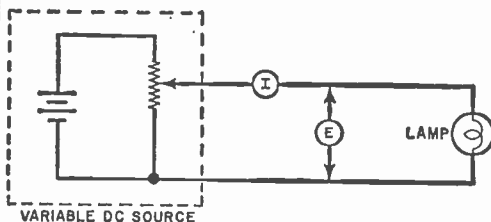

Fig. 3. In basic circuit for checking lamp resistance test lamp is placed across variable voltage.

There's a beneficial byproduct to using a lamp as a test load. If it is driven to near its rated power level, the load can furnish the light needed to record test results!

Until next month, —Lou

AMATEUR RADIO

(Continued from page 87)

African Radio Relay League, looks simple. Three of the questions—covering amateur regulations and key clicks—were compulsory; but the applicant could select which five of the remaining nine questions he wished to answer; or, if he chose to answer more than five, only his five best answers would count in his final grade. On the other hand, calculating the voltage across a 100- μ h inductor connected in series with a 1- μ f. capacitor across a 30-volt, 800-Hz source was one of the optional questions. Sixty-three percent of those taking the exam passed it. They next had to pass the code test before receiving their licenses.

News and Views

David Bushong, WB40DN, 9221 Santayna Dr., Fairfax, Va. 22030, started his amateur career as WN6CSK. He made 500 contacts under that call before moving to Virginia. There, he was issued the call WN40AO, which was replaced a few weeks later by Dave's General call letters, WB40DN. If Santa Claus came through as expected, Dave is now sporting a Heathkit HW-100 SSB/CW trans-

ceiver. Otherwise, he is still using his Heathkit HW-16 CW transceiver—plus HG-10. VFO. . . . If you would like to work all states (WAS) the hard way, you might emulate **Rene, DL3IR**, in Germany. He has worked 46 states on radioteletype! . . . Starting with an AMECO AC-1, 15-watt transmitter and a Heathkit GR-64 receiver, **Bob Fresl, WN9BJX**, 1109 Sherman Av., Janesville, Wisc. 53545, worked 32 states in 3½ months. In the meantime, Bob kept studying for his General ticket. Copying the WIAW code-practice transmissions brought his code speed up to 25 WPM; therefore he expected little trouble with the code test.

Charles Lawson, W9JWH/AF9JWH, R.R. 4, Connersville, Ind. 47331, has independently discovered what most experienced code teachers have long known. In teaching code to Scouts and budding amateurs, he has discovered that his students make faster progress if he sends individual letters at a speed equivalent to 15 WPM and controls his overall sending speed by varying the spacing between letters. . . **Alan Guilbault, VE7BZA**, Box 321, Sydney, B.C., Canada, worked 20 states and half a dozen countries in five months. He is a homebrew artist, as indicated by his 50-watt, home-built transmitter, much-modified surplus receiver, and 40-foot, tilt-over antenna mast. Next on the agenda is a 500-watt amplifier, still in the planning stage. Alan says that there is a special thrill in making contacts and getting good reports with gear you have built yourself—also you learn a great deal by doing so. . . **Dave Goodwin, WB4LCN**, thinks the record of **Sam Henry, WN4NCN**, 8407 Louis Drive, Huntsville, Ala., is worth writing about. Using dipoles for the 80-, 40-, and 15-meter Novice bands, Sam has worked 46 states and 18 countries in six months. Many of these contacts were made with a 15-watt transmitter, the rest with his Knight-Kit T-60. He receives on a Drake 2B. Wish Dave had told us what happens around his shack, too.



Joel Miller, WA7JWC, Tigard, Ore., operates in a tool shed his dad helped him convert to a ham shack.

Bill Byrnes, WN9AOF, 15 S. College St., Batavia, Ill. 60510, expects to be a General when you read this. His dad, WN9BAS, too? Bill uses a Heathkit DX-60A transmitter, a Hammarlund HQ-110-C receiver, two dipoles, and a vertical antenna. Dad uses a Heathkit Apache transmitter and Hammarlund HQ-129X receiver. . . **Scott Bauer, WN2LCC**, 816 E. Fillmore, East Aurora, N.Y. 44052, uses a receiver that is far older than he is—a Hallicrafters S-38. But it, in combination with an EICO-723 transmitter and a Hy-Gain, ground-mounted vertical antenna, has worked 29 states and Canada in six weeks on the air. . . **Allan Kush, WN9CHX**, 1516 Main St., Menomonie, Wisc. 54751, came up to

ABOUT YOUR SUBSCRIPTION

Your subscription to POPULAR ELECTRONICS is maintained on one of the world's most modern, efficient computer systems, and if you're like 99% of our subscribers, you'll never have any reason to complain about your subscription service.

We have found that when complaints do arise, the majority of them occur because people have written their names or addresses differently at different times. For example, if your subscription were listed under "William Jones, Cedar Lane, Middletown, Arizona," and you were to renew it as "Bill Jones, Cedar Lane, Middletown, Arizona," our computer would think that two separate subscriptions were involved, and it would start sending you two copies of POPULAR ELECTRONICS each month. Other examples of combinations of names that would confuse the computer would include: John Henry Smith and Henry Smith; and Mrs. Joseph Jones and Mary Jones. Minor differences in addresses can also lead to difficulties. For example, to the computer, 100 Second St. is not the same as 100 2nd St.

So, please, when you write us about your subscription, be sure to enclose the mailing label from the cover of the magazine—or else copy your name and address exactly as they appear on the mailing label. This will greatly reduce any chance of error, and we will be able to service your request much more quickly.

POPULAR ELECTRONICS SUBSCRIBER SERVICE

Please include an address label when writing about your subscription to help us serve you promptly. Write to: P.O. Box 1096, Flushing, N.Y. 11352

CHANGE OF ADDRESS: Please let us know you are moving at least four to six weeks in advance. Affix magazine address label in space to the right and print new address below. If you have a question about your subscription, attach address label to your letter.

TO SUBSCRIBE: Check below.

5 yrs. \$21 3 yrs. \$15
 1 yr. \$6 New Renewal

Specify: Payment enclosed
You get 1 extra issue per year as a BONUS!
 Bill me later.

If you have no label handy, print OLD address here.

name _____ please print

address _____

city _____

state _____ zip code _____

AFFIX LABEL

print name _____ 0392

address _____

city _____

state _____ zip code _____

Add'l postage: \$1 per year outside U. S., its possessions & Canada



Don Snortland, WA0QHL, has plenty of evidence on his shack walls that his Galaxy CW/SSB transceiver, Knight-Kit T-60 transmitter, Drake MN-2 antenna coupler and Heathkit VFO are all doing a good job.

amateur radio via the SWL/CB route. His Heathkit HW-16 transceiver feeds a "fan" dipole antenna; he has worked 26 states and Canada. Allan has a Rag Chewer's Club (RCC) certificate and bewails the lack of rag choppers in the amateur bands . . . **Walter Furtak, WN4LWE**, 4291 Applecrest Drive, Palm Beach Gardens, Fla. 33403, uses a Drake 2NT transmitter and a Drake 2C receiver. They work in conjunction with either a Hy-Gain 18-AVQ vertical antenna or an inverted-V dipole, depending upon the band or Walt's mood. The combination has come up with 30 states and 3 countries.

Paul Schuett, WA6CPP, 14472 Davis Road, Lodi, Calif. 95240, rates the "Break! Break! Breakers" as his pet peeve. His favorite band is 50 MHz, where he has worked 27 states, but he also likes 14 and 21 MHz, where he has only 95 countries to go for his DXCC. He also needs eight states for WAS. His equipment includes the Heathkit SB-301/401 and the Swan 250. Paul didn't mention his antennas . . . **Paul Barberet, WNIKOV**, 200 Morro St., Oakville, Conn. worked 28 countries and 38 states in 10 months. A Drake 2NT transmitter and 2C receiver, plus a Mosley TA-33 tri-band beam and a dipole antenna had some part in establishing Paul's record . . . **Ron Jennings, WN8CYJ**, 511 Cherry St., Negaunee, Mich. 49866, says trying to learn the code by yourself is doing it the hard way. Maybe taking three years to get his amateur license has something to do with Ron's idea. But he thinks being a Ham is worth any effort it takes. He has worked 30 states with a Knight-Kit T-50 transmitter and Lafayette HA-500 receiver.

Craig Smith, WB6ZXP, 1301 Greenwood Drive, San Carlos, Cal. 94070, saved his money for two months while designing his station console. It houses a Galaxy 5, Mark-II, transceiver and remote VFO, and a Johnson 1000-watt, Thunderbolt amplifier. Also available is a Sony TC-230 tape recorder for recording traffic. His antenna forest has one "tree" in the form of a 40-foot tower that supports a Mosley TA-33 tri-band beam, an 80/40-meter inverted V, and a 2-meter ground plane. Craig didn't mention what he uses on 2 meters; nevertheless, he likes to ragchew there as well as to operate on the lower frequencies. You can often find him in the West Coast Amateur Radio Service net on 7255 kHz, too . . . **Rune, SM5BMJ**, a dentist from Nykoping, Sweden, came to New York for the International Conference of Dentists. While there, he spent a day with **Eric Linden, WB2IBD**, 35-35 75th St., Jackson Heights, N.Y. 11372. They worked two Swedish stations in Swedish, and Rune made a recording of one of the contacts to play at his radio club when he returned to Sweden. Incidentally, Rune speaks English, German, Spanish, French, and Swedish fluently. Try him when you work SM5BMJ on 20-meter SSB.

Will we see your "News and Views" or picture here next month? The first step is up to you. And please continue to have your club paper sent to us—or put us on the mailing list. The address is: Herb S. Brier, W9EGQ, Amateur Radio Editor, POPULAR ELECTRONICS, P. O. Box 678, Gary, IN 46401. 73, Herb, W9EGQ.



Dave Mizerak, WB4EQW, Burgaw, N.C., has worked 45 states and 52 countries with his Swan 350-C transceiver, National NC-109 and Heathkit DX-60.

**DELIVERY TIME
PUTTING THE
SQUEEZE
ON YOUR SEMI CONDUCTOR NEED?**

**WE ALSO
CUSTOM TEST
TO YOUR OWN
SPECIFICATIONS**

Perhaps we can help. We are offering low prices and "off the shelf" delivery on most Jedec type devices. Here are a few examples!

Type	Price for 1K and up
2N 214.....	25c
2N 404.....	13c
2N 697.....	16c
2N 1305.....	16c
2N 3565.....	12c
2N 3638.....	13c

**NEW JERSEY
SEMI CONDUCTOR**

U.S. Highway 22, Blue Star Mall
Watchung, N.J. 07060 Tel. (201) 322-9200

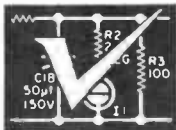

OPERATION ASSIST

Through this column we try to make it possible for readers needing information on outdated, obscure, and unusual radio-electronics gear to get help from other P.E. readers. Here's how it works: Check the list below. If you can help anyone with a schematic or other information, write him directly—he'll appreciate it. If you need help, send a postcard to Operation Assist, POPULAR ELECTRONICS, One Park Avenue, New York, N.Y. 10016. Give maker's name and model number of the unit. If you don't know both the maker's name and the model number, give year of manufacture, bands covered, tubes used, etc. State specifically what you want, i.e., schematic, source for parts, etc. Be sure to print or type everything legibly, including your name and address. Do not send an individual postcard for each request; list all requests on one postcard. Because we get so many inquiries, none of them can be acknowledged. POPULAR ELECTRONICS reserves the right to publish only those items not available from normal sources.

Pentron Model XP80 tape recorder. Accessory cord and/or parts source and instruction manual needed. (Aron R. Wiebe, General Delivery, Topley, B.C., Canada)

Meissner Model 19-2909 signal shifter. Schematic and operating manual needed. (Lawrence Gilboy, 626 South St., Avoca, PA 18641)

Central Electronics 10A transmitter, 160/10 meters. AM, CW, PM. Schematic and operating manual needed. (Richard Zultner, Jr., 741 Forest Ave., Westfield, NJ 07090)

University Model 6201 coaxial speaker wanted. (Basil N. Abbott, Jr., Colonial Forest, Rt. 5, Box 322, Mechanicsville, VA 23111)

B&K Model 1075 television analyst. Schematic and instruction manual needed. (Robert J. Spring, 714 South 22 St., Quincy, IL 62301)

E.H. Scott Model 16 tuner. Circa 1935. Schematic and speaker hook-up needed. (Wesley Bacon, 114 Andover St., N. Wilmington, MA 01857)

Arvin Model 130-TMF AM/FM radio. Schematic needed. (John Ellis, 319 Echo Valley Lane, Newtown Sq., PA 19073)

Supreme Model 561 signal generator and **RCA Model 171** station allocator. Schematics and operating manuals needed. (William Lanahan, 16 Edgewood Rd., Staten Island, NY 10303)

Wurlitzer Model 603 amp. Schematic needed. (Anthony Picagli, 79 Pierpont St., New Haven, CT 06513)

Approved Electronic Instrument Corp. Model A460 field strength meter. Alignment instructions and schematic needed. (William V. Glomb, 3836 West 134 Pl., Hawthorne, CA 90250)

Fairbanks-Morse Model 58 chassis, 5 tubes. Circa 1936. Schematic needed. (Joe Zimmerman, 7 Hazel St., Oneonta, NY 13820)

Tri-City Radio Electric Supply Co. Model W-1, serial 5360 one tube radio receiver. Schematic, operator's manual, info on type and source of tube needed. (Tom

Telex writes new specs on sensitivity and ruggedness in headphones.

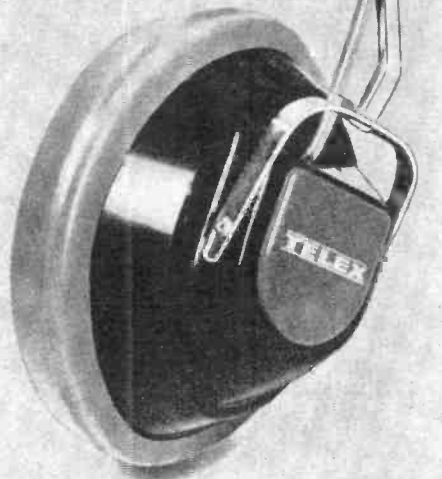

the Communicator Series

HIGH SENSITIVITY AND LOW OPERATING POWER. The new Communicator Series of headphones is designed around a dramatic new driver unit that requires only absolute minimal operating power. This added efficiency allows for a substantial increase in sensitivity without any increase in distortion, making the Communicator Series the most sensitive and versatile headphones available today.

RUGGED. CONSISTENT PERFORMANCE. Unlike the soft aluminum or paper cones in most of today's headphones, the Communicator's rugged new cone is made of special material that will provide peak performance without being affected by temperature or humidity. This means that you get consistent, high quality performance, day in and day out, under the most demanding communications conditions.

For more information on Telex's new Communicator headphones, contact your nearest Telex dealer or write.

PRODUCTS OF SOUND RESEARCH
TELEX
COMMUNICATIONS DIVISION
9600 Aldrich Avenue South
Minneapolis, Minnesota 55420



CIRCLE NO. 26 ON READER SERVICE PAGE

Go professional with Standard Communications' VHF-FM Monitor Receivers

all solid state • 12 volt power
dual conversion circuitry
148-174 MHz range



SR-C805Z
Low priced auxiliary unit with self contained speaker and antenna.

\$79.95

SR-C804Z
Designed for expanding a base station or used separately with remote speaker, power supply and antenna.

\$139.95

Both models provide 6 crystal controlled channels featuring individual crystal netting capacitors for professional performance. A technical breakthrough in performance, price and size!

Write for descriptive literature.



STANDARD COMMUNICATIONS Corp.
640 East 219th Street, Torrance, Calif. 90502

CIRCLE NO. 25 ON READER SERVICE PAGE

Live Better Electronically With

LAFAYETTE RADIO ELECTRONICS

1970 Catalog 700 **FREE!**

Now OFF PRESS
BETTER THAN EVER
496 Pages



Stereo Hi-Fi • Citizens Band • Ham Gear • Tape Recorders • Test Equipment • TV and Radio Tubes and Parts • Cameras • Auto Accessories • Musical Instruments • Tools • Books

Featuring Everything in Electronics for
• HOME • INDUSTRY • LABORATORY
from the "World's Hi-Fi & Electronics Center"

LAFAYETTE Radio ELECTRONICS
Dept. 35030 P.O. Box 10
Syosset, L.I., N.Y. 11791

Please Send the FREE 1970 CATALOG 700 35030

Name

Address

City

State Zip

CIRCLE NO. 12 ON READER SERVICE PAGE

Davidson, 632 NE Greenfield Rd., Kansas City, MO 64116)

Harvey Wells Model TBS-50C bandmaster transmitter. Schematic and operating manual needed. (Brent Nye, 3625 Berry Dr., Boise, ID 83703)

Hallicrafters Model S-36A VHF receiver and **Hewlett-Packard Model 522-B** counter. Schematics and operating manuals needed. (Gary R. Scott, 4652 Cass St., San Diego, CA 92109)

Seeburg (or other make) 78 RPM juke box needed. Playing mechanisms and additional parts also needed. (LaMar Mertz, Jr., 2141 Grove Rd., Bethlehem, PA 18018)

JAN-CEA Model 6116 reflex klystron. Basing schematic and specs needed. **Berkeley Model 705-A** decimal counting unit. Schematic and operating manual needed. (Mark Ciancone, 25 S. 23 St., Terre Haute, IN 47803)

Transis-Tonics Model TEC-S-15 stereo amp. Schematic needed. (Bernard E. Reynolds, 3300 Taibot Pl., Columbus, OH 43223)

Heathkit Model 0-10 laboratory oscilloscope. Operating manual needed. (David R. Peterson, Mann School Rd., Rt. #4, Smithfield, RI 02917)

Browning Labs, Inc. Type P4E, serial No. 187 synchroscope. Schematic needed. (Jim Hart, 607 S. Taylor St., Goldsboro, NC 27530)

Fender guitar amplifiers, 1961-3. Schematics needed. (Gregory E. Conklin, 17 Lake St., Ogdensburg, NY 13669)

Zenith Model 5X230 radio. Schematic needed. (Fred Smith, RR #1, Farmington, Iowa)

Earl Model 21 or 22 neutrodyne receiver. Circa 1928. Speaker (three leads), schematic, operating manual and cabinet needed. (Duane Hayes, 4502 Irving, Denver, CO 80211)

Gottlieb "Sea-Beiles" pin-ball machine. Schematic and any additional info needed. (Ward R. Condit, 1418 E. First Pl., Mesa, AZ 85201)

MOTION DETECTOR

(Continued from page 61)

ing and cooling ducts or heavy drafts around doors. Final location depends on the area and what you want to detect.

Once a location has been determined, connect the detector to the alarm circuit and apply power to the system. Set the gain control (*R5*) so that the external alarm is energized when a person takes about two steps into the protected area *at the maximum range*. If you make the system too sensitive, false alarms may result from slight air motions.

The external alarm circuit is activated for the amount of time that is required for *C14* to discharge. A small air disturbance in the area covered produces a short alarm signal. A longer disturbance produces a longer alarm. The amount of time the alarm is on can be reduced by lowering the value of *R12*—at the expense of some sensitivity. —50—



NTS home-training can take you to the Moon... and to lots of other exciting places.

Excitement is only the beginning. New money-making opportunities are also wide open to you. The age of Communications is just beginning in TV, Radio, Communication Satellites, Radio Tracking Telescopes, and many more. You can multiply your income with Space-age skills in missile count-down systems, giant microwave systems, stereophonics, two-way radio networks, television transmitters and cameras. You can earn better than 7 dollars an hour, over \$12,000 a year. There are no limits. And, NTS can give you everything you need to know to make you part of this big and rewarding field.

FCC License is your key. Two Communications programs get you going: (1) The FCC License Course. (2) The Master Course in Electronic Communications (which is more comprehensive and features Citizens' Band Two-way-Radio). Both programs qualify you for your FCC First Class Commercial Radio-Telephone License. NTS assures you will pass the exam, or your tuition is refunded. This NTS training program will open doors for you into a whole new world of opportunity. We prepare you for the top jobs in Communications.

14 big NTS kits included in each course at no extra cost. You build: (1) A professional Volt-Ohmmeter. (2) A Solid State (6-Transistor) Radio. (3) An Amateur Phone 6-Meter VHF Transceiver.

This Transceiver is an NTS exclusive. You send and receive. You learn both operations. Working with lessons and NTS kits you get the best possible training. And, the pay-off is big.



NTS "Project Method" makes learning come alive. The classroom-proven NTS "Project Method" home-training program is well organized and practical. It integrates valuable equipment with fascinating lesson projects. Makes complicated circuits and components easy to understand. You build these kits to put theory into practice. NTS gives you more kits than any other home-training school and they are the best kits available. With the "Project Method" you are your own man doing your own thing at your own pace, working with equipment that makes your lessons happen in your hands and your head at the same time. That's "Project Method." It makes learning easy, exciting, complete.

Send for free color catalog plus NEW Communications supplement and sample lesson. No obligation. No salesman will call.

Classroom training at Los Angeles. You can take classroom training at Los Angeles in sunny Southern California. NTS occupies a city block with over a million dollars in facilities devoted exclusively to technical training. Check box in coupon.

Approved for Veterans. Accredited Member: National Association of Trade and Technical Schools, National Home Study Council.



4000 So. Figueroa St., Los Angeles, Calif. 90037

NATIONAL TECHNICAL SCHOOLS Dept. 241-030
4000 So. Figueroa St., Los Angeles, California 90037
Please send free color catalog, NEW Communications supplement, and sample lesson. No obligation. No salesman will call.

Master Course in Electronic Communications, with FCC
 FCC License Course

Name _____ Age _____
Address _____
City _____ State _____ Zip _____

Check if Interested in Veteran Training under new G. I. Bill
 Check if interested ONLY in Classroom Training at Los Angeles

Exciting New Kit Ideas from Heath

New Heathkit 100-Watt AM/FM/FM-Stereo Receiver

World's finest medium power stereo receiver . . . designed in the tradition of the famous Heathkit AR-15. All Solid-State . . . 65 transistors, 42 diodes plus 4 integrated circuits containing another 56 transistors and 24 diodes. 100 watts music power output at 8 ohms — 7 to 60,000 Hz response. Less than 0.25% distortion at full output. Direct coupled outputs protected by dissipation-limiting circuitry. Massive power supply. Four individually heat sunk output transistors. Linear motion bass, treble, balances and volume controls. Push-button selected inputs. Outputs for 2 separate stereo speaker systems. Center speaker capability. Stereo headphone jack. Assembled, aligned FET FM tuner has 1.8 uV sensitivity. Two tuning meters. Computer designed 9-pole L-C filter plus 3 IC's in IF gives ideally shaped bandpass with greater than 70 dB selectivity and eliminates alignment. IC multiplex section. Three FET's in AM tuner. AM rod antenna swivels for best pickup. Kit Exclusive: Modular Plug-In Circuit Boards . . . easy to build & service. Kit Exclusive: Built-In Test Circuitry lets you assemble, test and service your AR-29 without external test equipment. The AR-29 will please even the most discriminating stereo listener.

Kit AR-29, (less cabinet), 33 lbs. \$285.00*
 AE-19, Assembled oiled pecan cabinet, 10 lbs. \$19.95*

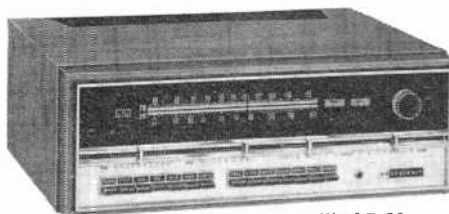

Kit AR-29
\$285.00*

New Heathkit 60-Watt AM/FM/FM Stereo Receiver

The AR-19 circuitry reflects many of the advanced concepts of the AR-29. It uses 108 transistors and 45 diodes including those in 5 integrated circuits. It delivers 60 watts music power at 8 ohms. At any power level, Harmonic and 1M Distortion is less than 0.25%. Frequency response ranges from 6 to 35,000 Hz. Direct coupled outputs are protected by dissipation-limiting circuitry. A massive power supply includes a section of electrically regulated power. The assembled, aligned FET FM tuner has 2.0 uV sensitivity.

A preassembled and factory aligned FM IF circuit board gives 35 dB selectivity. The multiplex IC circuit provides inherent SCA rejection. It features two switched noise muting circuits; linear motion controls for bass, treble, volume and balance; input level controls; outputs for 2 separate stereo speaker systems; center speaker capability; two tuning meters; stereo indicator light; front panel stereo headphone jack. The Modular Plug-in Circuit Board design speeds assembly. Built-in Test Circuitry aids assembly, simplifies servicing. "Black Magic" panel lighting, black lower panel, chrome accents. Compare it with any model in its price range . . . the AR-19 will prove itself the better buy.

Kit AR-19, (less cabinet), 29 lbs. \$225.00*
 Assembled AE-19, cabinet, 10 lbs. \$19.95*

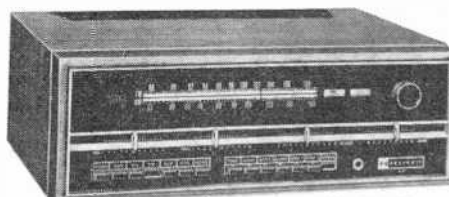

Kit AR-19
\$225.00*

New Heathkit Deluxe 18-Watt Solid-State Stereo Phono

Looks and sounds like it should cost much more. Here's why: 16-transistor, 8-diode circuit delivers 9 watts music power per channel to each 4 1/4" high-compliance speaker. Speaker cabinets swing out or lift off . . . can be placed up to 10' apart for better stereo. Has Maestro's best automatic, 4-speed changer — 16, 33-1/3, 45 & 78 rpm. It plays 6 records, shuts off automatically. Ceramic stereo cartridge with diamond/sapphire stylus. Has volume, balance & tone controls. Changer, cabinet & speaker enclosures come factory built . . . you build just one circuit board . . . one evening project. Wood cabinet has yellow-gold & brown durable plastic coated covering. This is a portable stereo you can take pride in.

Kit GD-109, 38 lbs. \$74.95*



Kit GD-109
\$74.95*

New Heathkit 80-10 Meter 2 KW Linear Amplifier

Incomparable performance and value. The new SB-220 has 2000 watts PEP input on SSB & 1000 watts on CW and RTTY. Uses a pair of Eimac 3-500Z's. Pretuned broad band pi input coils. Requires only 100 watts PEP drive. Solid-state power supply operates from 120 or 240 VAC. Circuit breaker protected. Safety interlocked cover. Zener diode regulated operating bias. Double shielded for max. TVI protection. Quiet fan — fast, high volume air flow. Also includes ALC to prevent over-driving. Two meters: one monitors plate current; the other is switched for relative power, plate voltage and grid current. Styled to match Heath SB series. Assembles in about 15 hours.

Kit SB-220, 55 lbs. \$349.95*



Kit SB-220
\$349.95*

New Heathkit Portable Fish-Spotter

Costs half as much as comparable performers. Probes to 200 ft. Spots individual fish and schools . . . can also be used as depth sounder. Manual explains typical dial readings. Transducer mounts anywhere on suction cup bracket. Adjustable Sensitivity Control. Exclusive Heath Noise-Reject Control stops motor ignition noise. Runs for 80 hrs. on two 6 VDC lantern batteries (not included). Stop guessing — fish electronically.

Kit MI-29, 9 lbs. \$84.95*



Kit MI-29
\$84.95*

NEW IMPROVED 1970 HEATHKIT® COLOR TV

New Lower-Than-Ever Prices

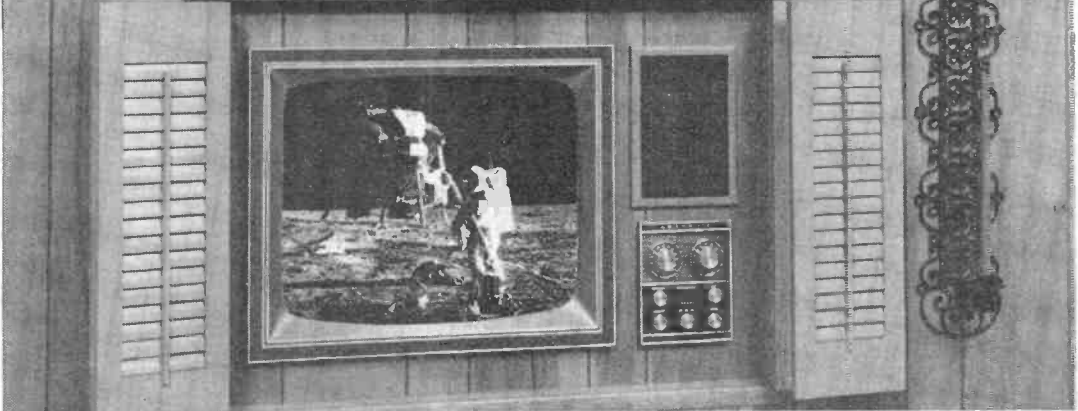

Here's How The Color TV That Thousands Call Best Became Even Better and Lower In Price

Since the very first model was introduced, thousands of owners, electronic experts, and testing labs have praised the superior color picture quality and extra features of Heathkit ColorTV. Now Heath has made improvements that make the 1970 models even better.



Sharper, More Detailed Pictures. Latest design improvement in the circuitry of Heathkit Color TV video amplifiers has increased their bandpass capabilities. The result is an increase in the number of lines of resolution . . . greater than in any other brand of color TV we have tested. This improvement means you get sharper, more detailed pictures as shown by test pattern measurements. You not only get the superior color pictures Heathkit Color TV has always been noted for, but you also get sharper pictures.

New Brighter Tube. Now all Heathkit Color TV models include the new brighter picture tube you've read so much about. These new tubes produce noticeably brighter pictures with more life-like, natural colors and better contrast. (We also offer the RCA Hi-Lite Matrix tube as an extra-cost option for the Heath GR-681 and GR-295 kits.)

New Safety Features. As an added safety precaution, AC interlocks have been added to all Heathkit Color TV cabinets.

Now The Best Costs Less. How can Heath make improvements in its Color TV Models and still reduce the prices? We have passed on to you the savings which have accrued due to reduced picture tube prices. The result is your 1970 Heathkit Color TV will cost you \$20 to \$55 less depending upon which model you choose . . . proof that Heathkit Color TV is a better buy than ever.

All Heathkit Color TV's Have These Superior Features

- New brighter American brand rectangular color tube with bonded-face, etched anti-glare safety glass
- Exclusive built-in self-servicing aids so you can adjust and maintain the set for best performance always
- Automatic degaussing plus mobile degaussing coil
- New broader video bandwidth for better resolution
- 3-stage video IF
- Improved retrace blanking
- Gated automatic gain control for steady pictures
- Automatic color control
- Exclusive Magna-Shield surrounds picture tube for better color purity
- Deluxe VHF tuner with "memory" fine tuning and precious metal contacts (models with automatic fine tuning also are available in all 3 picture tube sizes)
- 2-speed UHF solid-state tuner
- Completely shielded hi-voltage supply
- Extra B+ boost for better definition
- 2 hi-fi sound outputs for built-in speaker or your hi-fi system
- 300 ohm & 75 ohm antenna inputs
- Circuit breaker protection
- Optional wireless remote control can be added anytime
- Factory assembled and adjusted tuners, IF section, and hi-voltage supply
- Exclusive 3-way installation capability — in a wall, custom cabinet or Heath cabinets

Choose Your Heathkit Color TV Now . . .

It's Better Than Ever in Performance . . . and A Better Buy Than Ever



NEW FREE 1970 CATALOG!

Now with more kits, more color. Fully describes these along with over 300 kits for stereo/hi-fi, color TV, electronic organs, guitar amplifiers, amateur radio, marine, educational, CB, home & hobby. Mail coupon or write Heath Company, Benton Harbor, Michigan 49022.

HEATH COMPANY, Dept. 10-3

Benton Harbor, Michigan 49022

Enclosed is \$ _____, plus shipping.

Please send model(s)

Please send FREE Heathkit Catalog.

Please send Credit Application.

Name _____

Address _____

City _____

State _____

Zip _____

*Mail order prices; F.O.B. factory.

Prices & specifications subject to change without notice.

CL-377R

New Lower-Than-Ever Prices On All Models

Heathkit GR-681
(295"-AFT)
save \$30

Now only **\$469.95***



Heathkit GR-681MX
(with Matrix tube)
save \$55

Now only **\$479.95***



Heathkit GR-295
(295"-AFT)
save \$30

Now only **\$419.95***



Heathkit GR-295MX
(with Matrix tube)
save \$55

Now only **\$429.95***

cabinets from \$65*



Heathkit GR-581
(227"-AFT)
save \$20

Now only **\$399.95***

Heathkit GR-227
(227")
save \$20

Now only **\$359.95***

cabinets from \$39.95*



Heathkit GR-481
(180"-AFT)
save \$30

Now only **\$329.95***



Heathkit GR-180
(180")
save \$30

Now only **\$299.50***



cabinets from \$27.50*

CIRCLE NO. 9 ON READER SERVICE PAGE

NEW Short-Wave Listening VERTICAL ANTENNA Model SWV-7

For 11,13,16,19,25,31 and 49 meter bands Cramped quarters keeping you from installing an SWL antenna? Your problem is solved! Model SWV-7 mounts easily on the roof or on the ground and stands just 13 ft., 3-5/8 in. tall.

Extensive field testing confirms that this antenna measures up to Mosley's high standards of performance. Construction is of the finest material to bring you years of trouble free listening pleasure. Complete with installation instructions.

Get the facts from your Mosley dealer, or write factory direct, for detailed brochure.

Dept. 202
Mosley Electronics, Inc.

4610 N. LINDBERGH BLVD., BRIDGETON, MO. 63044



CIRCLE NO. 14 ON READER SERVICE PAGE

It costs only



New Easy Dispenser Pak 60/40 18 S.W.G.*

1/100 of 1¢ more



Latest PC (Printed Circuit) Pak
60/40 Extra Thin 22 S.W.G.—.028**

per solder joint to know you are using the world's finest cored solder

* Each only 59¢ per package at your dealer.

ERSIN **Multicore** FIVE-CORE SOLDER

MULTICORE SALES CORP., WESTBURY, N.Y. 11590

CIRCLE NO. 15 ON READER SERVICE PAGE

TOUCH-A-TONE

(Continued from page 72)

a final pair of leads between the output of the audio generator and vertical input and ground of the scope.

Now, first tune the audio generator to the frequency listed under the "First Octave" column in the Table, and adjust the setting of the proper trimmer potentiometer to obtain a circle on the screen of the scope. (Note: if you have a meter available, set the output signal level of the instrument to the same signal level of the generator.) The circle indicates that the Touch-A-Tone and audio generator are tuned to the same frequency. Also, remember that as you move from one trim pot to another, you will have to move the appropriate clip lead from touch contact to touch contact.

When you are finished tuning the first octave, you can, if you desire, replace the trimmer potentiometers with fixed resistors of appropriate values to obviate periodic retuning. If you leave the pots in place, readjustment about twice a year will be sufficient.

Next, install a 0.1- μ F capacitor (C_5) in position 2 of S_3 . Parallel connect a 0.15- μ F capacitor with a 0.04- μ F capacitor to make the specified 0.19- μ F value for C_4 ; connect this assembly in position 3 of S_3 . In like manner, to make the 0.377- μ F value specified for C_3 , parallel-connect a 0.33- μ F capacitor with a 0.047- μ F capacitor, and solder this assembly into position 4 of S_3 .

If you do not want the variable-depth control for the tremolo circuit, simply install and solder a 1.5-megohm resistor in the R_5 position on the circuit board. For variable-depth, mount a 1.5-megohm potentiometer in a convenient location on the front panel of the Touch-A-Tone. Solder one end of a 680,000-ohm, 1/2-watt resistor to the wiper lug of this potentiometer. Then connect the free end of the resistor to one of the R_5 holes in the board, and a length of hookup wire between the right lug of the pot (viewed from the rear) and the other R_5 hole.

Assemble the instrument, and you are ready to play a tune. With a little practice, it will not be long before you are playing like an old pro.

-30-

POPULAR ELECTRONICS

TWO-WAY REACTIONS

(Continued from page 94)

Mexico, New York—Snowmobile equip members of Oswego County REACT recently cooperated with Sheriffs and State Police in searching for a lost hunter in the rugged Adirondack Mountains. The Team's many snowmobiles are often used in such winter projects.

Oxford, New York—Chenango REACT Emergency Team was called into action when a severe ice, snow and windstorm struck their area. All communications and electric power failed. From midnight until 9:00 a.m., the team scattered mobile units over the county and coordinated communications with the Chenango County Sheriff's Department, New York State Police, the telephone company and the electric company.

Goochland, Virginia—The Goochland County CB Club recently had a very busy two weeks. First, they were called out on a Tuesday evening to assist the Sheriff's Department in a search for a prisoner who escaped from the Virginia State Prison Farm located in the county. Three mobile units covered about seventy miles in three hours and were of great assistance in the re-capture of the fugitive. One week later, the worst floods in memory hit Central Virginia. The REACT team provided communications and many other forms of assistance in this disaster.

We are all awaiting the probable designation of Channel 9 as the Official Emergency Channel by the FCC. REACT will have more of an opportunity for service and a greater challenge than ever. Find out how you can become part of this important program. Write to: REACT National Headquarters, 205 W. Wacker Drive, Chicago, Illinois 60606.

-50-

SHORT-WAVE LISTENING

(Continued from page 96)

Centinela del Sur, Loja, 5120 kHz, is strong at times with L.A. pop tunes and some anmt's around 0200.

England—London was found on 9610 kHz with a play at 2340-0000, then news, but very badly mixed with Moscow s/on with English news at 0000 and the IS of *Deutsche Welle* (Germany), also at 0000.

Formosa—BED37, Taipei, has been found on 11,970 kHz at 1528 with records, anmt's in Chinese, and to 1612 with the same format.

Germany (East)—The new English schedule of *R. Berlin International* is as follows: To Europe at 1730, 2015 and 2200 on 6080, 6115, 7185, 7300 and 9730 kHz and at 2300 on the same frequencies except for 7300 kHz. To East Coast N.A. at 0100 and 0230 on 5955 and 9730 kHz. To West Coast N.A. at 0330 on 5955, 6080 and 9730 kHz. (German to N.A. is at 0145 and 0415 on the respective xmsn's). To Africa at 0345 on 11,820 kHz, at 0615 on 9500 kHz, at 1215 and 1315 on 21,475 and 21,600 kHz, at 1815 on 15,145 and 15,390 kHz, and at 2000 on 11,810 kHz. To S.E. Asia at 0645 on 21,465 kHz, at 1200 on 17,880 and 21,540 kHz, and at 1515 on 17,880 kHz.

Germany (West)—According to anmt's, *R. Bremen*, D-28 Bremen, Heinrich-Herz-Str., 13, is very interested in reception reports in order to learn the coverage of their 10-kW outlet on 6190 kHz. Their schedule is 0500 (Sunday from 0600) to 2300.

Haiti—4VM, *Radiodiffusion Haitienne*, Port-au-

March, 1970

Build this exciting Schober Consolette Organ

for only
*\$1040!

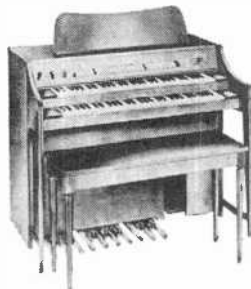

*Includes finished walnut console. (Only \$793 if you build your own console.) Amplifier, speaker system, optional accessories extra.

You couldn't touch an organ like this in a store for less than \$1800—and there never has been an organ of the Consolette II's graceful small size with 22 such pipelike, versatile voices, five-octave big-organ keyboards, and 17 pedals! If you've dreamed of an organ of your own, to make your own beautiful music, even if your home or budget is limited, you'll get more joy from a Schober Consolette II than any other "home size" organ—kit or no kit.

You can learn to play it. And you can build it, from Schober Kits, world famous for ease of assembly without the slightest knowledge of electronics or music, for design and parts quality from the ground up, and—above all—for the highest praise from musicians everywhere.

Send right now for the full-color Schober catalog, containing specifications of all five Schober Organ models, beginning at \$499.50. No charge, no obligation. If you like music, you owe yourself a Schober Organ!

The *Schober* Organ Corp., Dept. PE-33
43 West 61st Street, New York, N.Y. 10023

- Please send me Schober Organ Catalog and free 7-inch "sample" record.
 Enclosed please find \$1.00 for 12-inch L.P. record of Schober Organ music.

NAME _____

ADDRESS _____

CITY _____ STATE _____ ZIP _____

CIRCLE NO. 22 ON READER SERVICE PAGE

COOPERATE WITH THE
ZIP CODE PROGRAM
OF THE POST OFFICE
DEPARTMENT.
USE ZIP CODE
IN ALL ADDRESSES

—OIL LEASES—

\$15,799.20 - \$10,400.00 - \$9,600.00 - \$8,000.00 - \$7,800.00 - \$7,000.00 profits in recent sales by our clients of U. S. Government Oil & Gas Leases we recommended. If you are a citizen, you qualify. For complete information and how to get your lease write:

FEDERAL OIL LEASE SERVICE, Dept. PE
P. O. Box 867, Fort Worth, Texas 76101

FREE 1970 CATALOG.

1001 Bargains—Speakers—Parts—Tubes—High Fidelity Components—Record Changers—Tape Recorders—Kits—Everything in Electronics. Write:

McGEE RADIO COMPANY
PE, 1901 McGee Street,
Kansas City, Missouri 64108.

HEARING AIDS

2/3 OFF DEALER PRICES

LARGEST SELECTION of tiny, all-in-the-ear, behind the ear, eyeglass and pocket models. FREE HOME TRIAL. No obligation. Money back guarantee. No down payment. Easy terms. No salesman or dealers. Order direct, save 65%. Write for free catalog. PRESTIGE, Dept. D-184, Box 10947, Houston, Tex. 77018.



GET INTO ELECTRONICS

V.T.I. training leads to success as technicians, field engineers, specialists in communications, guided missiles, computers, radar, automation. Basic & advanced courses. Electronic Engineering Technology and Electronic Technology curricula both available. Associate degree in 29 months. B.S. obtainable. G.I. approved. Start September, February. Dorms, campus. High school graduate or equivalent. Catalog.

VALPARAISO TECHNICAL INSTITUTE
DEPARTMENT PE, VALPARAISO, INDIANA 46383



HAVE YOU GOT YOUR S-DEC YET?



Hobbyists, experimenters, and hams all over the country have found the S-DeC breadboard an invaluable tool in the quick assembly of circuits. Just the thing to check out that hunch or tip.

S-DeCs are available in packs of one, two, or four interlocking units. Each pack contains a useful booklet with circuits for ten projects. Boards accepting integrated circuits are also available.

Check with your local distributor or write us for further information and prices

Intratec Div. British Aircraft Corp. (USA) Inc.

39: Jefferson Davis Highway
Arlington, Va. 22202

Representatives: Some territories still open!

CIRCLE NO. 10 ON READER SERVICE PAGE

Prince, was logged on 4940 kHz in French at 1100-1118 with uninterrupted classical music. QRM was severe.

Holland—R. Nederland, Hilversum, has replaced 15,425 kHz with 9715 in English to Eastern N.A. at 2125-2250. News is given just after s/on and just prior to s/off. This is dual to 11,730 kHz.

Honduras—HRLP, R. America, Tegucigalpa, 6050 kHz, is definitely active as noted at 0200-0220 with a sporting event . . . HRRZ, *R. Juticalpa*, Juticalpa, was heard on 4780 kHz with L.A. music at 1040 with a strong signal on a clear channel.

India—One of the easiest frequencies on which to find *All India Radio*, at least on the West Coast, is 10,335 kHz, noted 1537-1600 s/off in English with

SHORT-WAVE CONTRIBUTORS

John Duane (WPE1HBC), Hingham, Mass.
Bob Raymond (WPE1HOE), Bradford, Mass.
George Stein (WPE1HTY), Niantic, Conn.
Henry Marbach (WPE2FHU), White Plains, N.Y.
John Sgrulletta (WPE2MXF), Bedford Hills, N.Y.
John Banta (WPE2PHU), Bay Shore, N.Y.
John Hopkins (WPE2PM), Port Washington, N.Y.
David Long (WPE2QNL), Lockport, N.Y.
Lloyd Zeidner (WPE2QRC), Bayside, N.Y.
Nicholas Zelinsky (WPE2QTB), Mantua, N.J.
Michael Szoke (WPE2QUM), South River, N.J.
Paul Wolcott (WPE2QVL), Linwood, N.J.
Robert Halprin (WPE2QZU), Fair Lawn, N.J.
Leo Alster (WPE2KBN), Rahway, N.J.
Eric Johnson (WPE2RBW), East Paterson, N.J.
Sam Alcorn (WPE2RDL), Millville, N.J.
Bob Barr (WPE3HNC), Willow Grove, Pa.
Gary Blau (WPE3HWV), Rockville, Md.
Charles Harlich (WPE3HXA), Pittsburgh, Pa.
Dan Ferguson (WPE4AUL), Coral Gables, Fla.
Grady Ferguson (WPE4BC), Charlotte, N.C.
David Weronka (WPE4KBE), Durham, N.C.
Dennis Driscoll (WPE4KDI), Asheboro, N.C.
Roger Boyd (WPE4KEK), Valdosta, Ga.
C. R. Patterson (WPE4KHW), Decatur, Ga.
Charles Bennett (WPE5WJ), Sumrall, Miss.
Jim Young (WPE6ENA), Wrightwood, Calif.
Donald Asp (WPE6HGY), Tustin, Calif.
Robert Gorsch (WPE6HII), McKinleyville, Calif.
Peter Harband (WPE6HOE), San Francisco, Calif.
Ralph Smith (WPE6IPP), La Mirada, Calif.
Kevin Slater (WPE7CNF), Salem, Ore.
David Williams (WPE7CWW), Astoria, Ore.
Anthony Marks (WPE7CYO), La Grande, Ore.
George Smith (WPE8KII), Grand Rapids, Mich.
Edward Bonk (WPE8KKI), Detroit, Mich.
Bill Lauterbach (WPE8KKW), Albion, Mich.
David Cox (WPE8KKV), Jackson, Mich.
Bob Smith (WPE8KKV), Grand Rapids, Mich.
Robert Moser (WPE9ASH), Chicago, Ill.
Martin Gallas (WPE9CFO), Springfield, Ill.
Gerry Dexter (WPE9HDB), Lake Geneva, Wis.
James Pogue (WPE9HL), Fort Wayne, Ind.
John Patterson (WPE9LQ), Oswego, Ill.
Steve Jacobsmeier (WPE9MJ), Mt. Prospect, Ill.
Tom Frisz (WPE9RU), South Bend, Ind.
Pierre Calleros (WPE9IRZ), South Holland, Ill.
A. R. Niblack (WPE9KM), Vincennes, Ind.
John Beaver (WPE0AE), Pueblo, Colo.
Gary Lovegren (WPE0FAN), St. Paul, Minn.
Mike Carrick (WPE0FLX), Omaha, Neb.
David Haskin (WPE0FOF), Manitou Springs, Colo.
Aloysius Kling (WPE0FOM), Florissant, Mo.
Robert Walker (WPE0FPO), Wichita, Kansas
Jack Perolo (PY2PE1C), Sao Paulo, Brazil
Paul Cau (VE3PE2OZ), St. Catharines, Ont.
Anthony D'Agostino (VE3PE2SD), Hamilton, Ont.
Edward Colby, Lynn, Mass.
Charles Croll, Fredericksburg, Va.
George Cuccia, Millville, N.J.
James Davis, Otisville, N.Y.
Randy Dehetre, Auburn, Maine
Thomas Hackett, New York, N.Y.
Tom Hinckley, Doylestown, Pa.
Claudio Moraes, Curitiba, Brazil
Ross Moser, Los Angeles, Calif.
Amnon Nadborny, New York, N.Y.
Bob Schultz, Shawnee Mission, Kansas
Richard Sewell, Gaylord, Mich.
Randy Vavra, Riverside, Calif.
Charles Webb, Little Rock, Ark.
Sweden Calling DX'ers Bulletin, Stockholm, Sweden



Terrance Florek, WPE9JUQ, Hammond, Ind., uses a Knight Star Roamer receiver. He has 20 countries verified out of 24 heard. An Amphenol 725 CB unit can also be seen above his master control panel.

news and commentary. Other channels logged include 11,620 kHz from 1930-2000 but generally poor reception, and 9675 kHz, a new frequency, at 0245 in language.

Iran—*R. Iran*, Tehran, 15,135 kHz, heard 2004-2030 in English and from 2030 in Iranian or Persian; the English portion was commentary and pop music.

Israel—*Kol Israel*, Jerusalem, was tuned at 0400-0415 in Russian, 1900-1930 in Hebrew and 1930-2000 in Russian, all on 9009 kHz, at 2015-2030 to Africa and Europe and to 2100 to United Kingdom and Europe, all English on 9625 kHz, at 2100-2130 in French and 2145-2200 in Russian on 9009 and 9625 kHz.

Italy—Rome is good on its new frequency of 6010 kHz at 2228-2330 in Italian to N.A., dual to 9710 and 9575 kHz with home news, music, a drama and pop Italian vocal music.

Japan—Tokyo was noted on 9560 kHz in an English commentary at 1200-1210.

Kuwait—*R. Kuwait* is often good to excellent on 15,345 kHz from 1600 s/on with recordings to past 1630, a talk at 1700, news at 1730, commentary at 1745 and until 1900 s/off with music and news.

Lebanon—Beirut's latest schedule reads: To Africa on 11,970 kHz at 1830-1900 English, 1930-2000 Arabic and 2000-2030 French. To South America on 11,810 kHz at 2300-2330 Portuguese, 2330-0030 Arabic and 0030-0100 Spanish. To N. A. and Europe on 11,790 kHz at 0130-0200 French, 0200-0230 and 0300-0330 Arabic, 0230-0300 English and 0330-0400 Spanish. Omnidirectional xmsns are at 0430-0730 and 1625-1820 on 5980 kHz and 0925-1600 on 9545 kHz.

Mexico—*R. Mexico*, Mexico City, recently new on 11,718 kHz, has also opened on 9530 and 6055 kHz from 0000-0352 and later with a variety of music and mostly Spanish-type programming but with an occasional English ID . . . Another of the high-powered border stations, XERF, Ciudad Acuna, Coahuila, advertises itself as being the "Largest Commercial Station In the World". You'll find it at 1570 kHz, medium-wave, evenings (your local time). They operate with 250 kW and reports go to Box CC, Del Rio, Texas 78840.

Morocco—*Huna Rabat* is the station being heard on 6170 kHz from 2300 on in Arabic.

Nepal—*Yo Radio Nepal Ho*, Kathmandu is good at times in native language from new 0120 s/on time; this is preceded by their IS, a great clock striking. The frequency is 11,970 kHz.

Nicaragua—*R. Nacional de Nicaragua*, Managua, has opened on 5935 kHz where it is heard from 0000-0600 s/off. Some European sources quote the frequency as 5835 kHz; this is incorrect.

Norway—*R. Norway*, Oslo, was found on a new frequency of 9645 kHz at 0200-0220 with a play and some music.

Peru—*OAX4H, R. Mil Ochenta*, Lima, 6095 kHz, is the station that's had the reporters digging deeply for the correct ID. Actually, this is the ID for the medium-wave outlet on 1080 kHz; the listed ID for 6095 kHz is *R. Oficial del Congreso*. We have agreed, for the moment, that the latter is ID'ing as the former. Try around 0300-0455 s/off and see what you make of it. . . . Meanwhile, *R. Del Pacifico*, Lima, has moved from 9675 kHz to 4975 kHz and is being heard around 2325 with a religious service.

Saudi Arabia—Jeddah is widely reported on 11,855 kHz at 0430 s/on to 0530 s/off in English with a breakfast-type show of news and music and from 0600 s/on in French.

Switzerland—Berne has Spanish to L.A. with news at 0030-0045 on 9595 kHz, English is aired at 1500 on 15,305 and 17,830 kHz and at 0535 on 11,715 kHz.

Togo—*R. Togo*, Lome, is on the air weekdays at 0530-0900, 1200-1400 and 1630-2300, Saturdays at 0530-0900 and 1200-2300, and Sundays 0530-2300 in French, English and several African languages. Frequencies used at 5047 kHz (100 kW), 6155 kHz (4 kW) and 7265 kHz (100 kW.)

Uruguay—*CXA18*, Montevideo, is not one of the most often heard stations in N.A. Currently it is fair to good on 15,274 kHz with a definite ID at 0200, current American pop records, and all Spanish language.

USSR—Moscow has been found on 7100 kHz from 0559 with anthem, a six-note IS, time check, and into news in Russian. A station on 6090 kHz is believed to be Irkutsk, Asiatic Russia, noted from 0258 with a Moscow relay. Another, on 5015 kHz, is thought to be Archangelsk, heard at 0505 dual to Tbilisi on 5040 kHz.

New Products from THE PHASE CORPORATION



FOUR TRACE PRE-AMP

Convert any single trace scope to display four separate signals at the same time without any internal modifications.

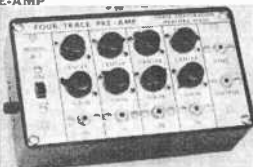

\$34.95

All Solid State
FET Input
Center & Gain
Controls for each
Channel
1 Megahertz/
channel
bandwidth

Kit with Custom cabinet (Model A1KC) \$34.95; wired & tested (Model A1W) \$64.95

Send Check, Money Order, or ask us to bill your BankAmericard or Master Charge

TEST OSCILLATOR

Generates all three functions.

SAW: 0.1HZ
—100KHZ
SQUARE: 0.05HZ
—50KHZ
PULSE: 0.1HZ
—100KHZ



\$34.95

All Solid State
FET & Unijunction
Circuitry
Calibrated ranges
Portable &
Compact

Kit with Custom Cabinet (Model O1K) \$34.95; wired & tested (Model O1W) \$64.95

THE PHASE CORPORATION, ELECTRONICS DIVISION, MEDFORD, MASS. 02155

CIRCLE NO. 18 ON READER SERVICE PAGE

NEW PRODUCTS

(Continued from page 24)

the clock. A quick flip of a switch and the reports come in instantly, loud and clear. The solid-state receiver circuit also provides high-fidelity reception on three other bands: standard AM and FM broadcast, and marine bands. Power is supplied by a battery, or through an optional a.c. adapter.

Circle No. 90 on Reader Service Page 15 or 115

TUBE-TYPE PREAMPLIFIER

Peploe, Inc., has unveiled its Model SP-1A tube-type preamplifier designed for accurate portrayal of the original sound image. This professional preamplifier has rolloff and turn-over controls, and technical specifications as stringent as required by the best studios. Technical specifications: less than 0.01% at 5 volts r.m.s. output, 1000 Hz harmonic distortion; 90 dB below 1 volt input on auxiliary and 60 dB below 10 mV input on magnetic hum and noise; 30-volt r.m.s. maximum output at 1000 Hz into high impedance; 50-volt r.m.s. auxiliary, 750-volt r.m.s. magnetic at 1000 Hz maximum input levels without overload.

Circle No. 91 on Reader Service Page 15 or 115

ELECTRONIC KEYS

An electronic keyer, Model EK-38, available from *Curtis Electro Devices*, features all IC circuitry employing dot memory and instant character start. It is variable over a range from 8 to 50 words/min. In addition to providing perfectly formed and spaced characters when used with a paddle or squeeze key, the EK-38 provides semi-automatic operation with a straight key or a "bug" for on-the-air use or as a code-practice oscillator. The power supply, side-



tone oscillator, and speaker are built in. Side-tone pitch and volume controls, as well as momentary and locked TUNE switches are also provided. Other features include external manual stand-by key jack and switch-selectable output keying for either solid-state or reed relay (optional).

Circle No. 92 on Reader Service Page 15 or 115

MINIATURE FM MONITOR RECEIVER

Built-in 117-volt a.c. and 12-volt d.c. power supplies are featured in *Lafayette Radio Electronics'* newest miniature FM monitor receiver (stock No. 99-26122), Model Micro P-100, for the 148-174-MHz band. The tunable receiver has two crystal positions for full flexibility. Technical specifications: better than 1 μ V for 20-dB signal-to-noise ratio sensitivity; three ceramic i.f. filters; variable squelch; 2-watt audio output; reception of U.S. Weather Bureau forecasts on 162.255 MHz (in certain areas); one FET, 14 transistors, nine diodes; supplied with all cables and a mounting bracket.



Circle No. 93 on Reader Service Page 15 or 115

POLICE AND FIRE RECEIVERS

JMD Electronics is currently making available low-cost crystal-controlled pocket-size police and fire receivers featuring outstanding performance. The receivers are available with or without squelch and come complete with removable 18" telescoping VHF antenna, crystal, ear-phone, battery and carrying case. The receivers can be ordered to receive any single frequency between 30 and 54 MHz or 108 to 174 MHz or to receive U.S. weather bureau broadcasts on 162.55 MHz.

The Model RTX is a single-frequency receiver without squelch; the Model RTX-2 is a two-frequency receiver without squelch; and the Model RTX-S is a single-frequency receiver with squelch.



Circle No. 94 on Reader Service Page 15 or 115

AUTOMATICALLY SCANS 8 PRE-PROGRAMMED CHANNELS — WITH PRIORITY CHANNEL FEATURE



SONAR-SCAN™
FM MONITOR RECEIVERS

A superior professional performer! **EXCLUSIVE & PAT. PENDING FEATURES.** PRIORITY CHANNEL SIGNAL® that locks to the exclusion of all other signals • CARRIER DELAY® allows operator to hear mobile callbacks • MANUAL SELECTOR® by slow-scan technique • Solid State—for rugged use over wide temperature range • Narrow band operation • Operates from 117VAC or 12VDC • Negative or positive ground • Noise free squelch • 8 crystal positions.

*Pat. Pending

<p>designed for:</p> <ul style="list-style-type: none"> • Police, Fire and Municipal Depts. • County, State & Federal agencies • Commercial & Industrial applications • Other unlimited uses 	<p>FR-2514 (25-50MHz)</p> <p>FR-2515 (150-175MHz)</p> <p>Comes with AC and DC power cables, mounting bracket, less crystals. Crystals \$5.00 ea.</p>	<p>\$189⁹⁵</p>
---	--	---------------------------

SONAR RADIO CORP., 73 Wortman Ave., Bklyn, N. Y. 11207
Please send information on SONAR-SCAN FM Monitor Receivers.

Name _____ Dept. 529

Address _____

City _____ State _____

CIRCLE NO. 24 ON READER SERVICE PAGE

POPULAR ELECTRONICS READER SERVICE PAGE

free information service:

Here's an easy and convenient way for you to get additional information about products advertised or mentioned editorially (if it has a "Reader Service Number") in this issue. Just follow the directions below... and the material will be sent to you promptly and free of charge.

1. On coupon below, circle the number(s) that corresponds to the key number(s) at the bottom or next to the advertisement or editorial mention that is of interest to you. (Key numbers for advertised products also appear in the Advertisers' Index.) Print or type your name and address on the lines indicated.

2. Cut out the coupon and mail it to: POPULAR ELECTRONICS, P.O. Box 8391, Philadelphia, PA 19101.

note: If you want to write to the editors of POPULAR ELECTRONICS about an article on any subject that does not have a key number, write to POPULAR ELECTRONICS, One Park Avenue, New York, N.Y. 10016. Inquiries concerning circulation and subscriptions should be sent to POPULAR ELECTRONICS, Portland Place, Boulder, Colo. 80302.

VOID AFTER APRIL 30, 1970

POPULAR ELECTRONICS

P.O. BOX 8391
PHILADELPHIA, PA. 19101

1 2 3 4 5 6 7 8 9 10 11 12 13 14 15 16 17 18 19 20
21 22 23 24 25 26 27 28 29 30 31 32 33 34 35 36 37 38 39 40
41 42 43 44 45 46 47 48 49 50 51 52 53 54 55 56 57 58 59 60
61 62 63 64 65 66 67 68 69 70 71 72 73 74 75 76 77 78 79 80
81 82 83 84 85 86 87 88 89 90 91 92 93 94 95 96 97 98 99 100

NAME (Print clearly) _____

ADDRESS _____

CITY _____ STATE _____ ZIP CODE _____

3 b

NEW LITERATURE

(Continued from page 16)

electronics, and jewelers' tools; unusual solderers; hard-wire cutters; glass drills; etc.

Circle No. 78 on Reader Service Page 15 or 115

Edmund Scientific's new catalog No. 701 is really an invitation to adventure with products ranging from toys and games to serious scientific research. A whole section is devoted to Behavioral Sciences in Baby's First Year, offering books, toys, and many other newly created items chosen for infant development possibilities. An assortment of unique lighting equipment is also listed, plus kits of materials for black light experiments and displays, microscopes and telescopes, pop and op art materials, and even a precision miniature lathe. One item that will find a lot of interest is Edmund's new three-channel 1.5 kW color organ.

Circle No. 95 on Reader Service Page 15 or 115

Building your own speaker system is the theme of the *Electro-Voice, Inc.*, "High Fidelity Component Speakers" brochure (Form 1263). The brochure lists seven very realistic reasons why you should build your own system, gives hints on how to select a loudspeaker, and discusses coaxial and three-way speakers. An extensive listing of component speakers and crossover networks, including prices, is included.

Circle No. 96 on Reader Service Page 15 or 115

A new catalog is available from *Audionics, Inc.*, describing the line of Sinclair electronic constructor modules that have been popular for years in their native England. More than a dozen items are listed, among them two complete amplifier systems, two types of speakers, and an integrated circuit amplifier/preamplifier with a varied range of applications.

Circle No. 97 on Reader Service Page 15 or 115

ELECTRONICS library

QUIET

SHORTWAVE VOICES OF THE WORLD

by Richard E. Wood

Oddly enough, books written about shortwave listening are rarely directed at the person who knows something about the hobby but does not want to be burdened by esoteric "hard-core" information. In fact, few books on SWL'ing are even literate and are either aimed at the very beginner or the avid SWL with lots of experience. The author has attacked SWL'ing strictly from the aspect of international shortwave broadcasting: the why, where, and how. Once you start reading this book, you will find it difficult to put down. Predicated on his vast SWL experience and knowledge of foreign languages, author Wood has a knack for expression and elucidation that many authors of hobby-type books would do well to emulate. If you want the "inside story" of international broadcasting, this is a book you will read from cover to cover.

Published by Gilfer Associates, Inc., Box 239, Park Ridge, NJ 07656. Soft cover. 96 pages. \$3.95.

HOW TO FIX TRANSISTOR RADIOS & REPAIR PRINTED CIRCUITS

by Leonard C. Lane

This book is a completely updated edition of the classic on radio repair. New material includes discussions of FET's, zener diodes, FM radios, and just about everything else related to the current state of the art. For

PROFESSIONAL TYPE MOBILE MONITOR RECEIVER

Solid State FM / Crystal Controlled / 6 Channels \$99⁹⁵

LESS CRYSTALS



SEND
FOR FREE LITERATURE



This expertly engineered, all solid-state, crystal controlled FM receiver provides instant monitoring of the VHF frequencies between 39 and 46 mcs or 153 to 157 mcs. Outdating all of the bulky tube-type monitors which take up needed space under dashboards, the compact Ameco Model MRT-6 high band or MRT-7 low band unit measures only 2-1/8" high by 5-5/16" wide by 7-7/8" deep. It's a professional type receiver with latest double conversion super-heterodyne circuitry providing 3/4 microvolt sensitivity for 20 db quieting. Has built-in speaker and mobile mounting bracket. Optional AC power supply available.

DIVISION OF AEROTRON/BOX 6527/RALEIGH, N. C. 27608

CIRCLE NO. 1 ON READER SERVICE PAGE

beginners, this book provides the practical knowledge needed to fix any transistor radio—it can also be used as a reference guide by technicians. For those readers interested in transistor physics, fundamentals are emphasized in the first two chapters of the book. Chapter 3 thoroughly covers amplifier fundamentals. The next two chapters are devoted to r.f. and i.f. amplifiers, detectors, and a.g.c. circuits, plus more advanced output stages. The remaining chapters concentrate on different types of radios and test and troubleshooting techniques.

Published by Tab Books, Blue Ridge Summit, Pa. 17214. 256 pages. \$7.95 hardbound, \$4.95 soft cover.

ELECTRONIC COMPONENTS AND MEASUREMENTS

by Bruce D. Wedlock
and James K. Roberge

What are the *modern* electronic components and instruments? What makes them work or fail to work? For what purposes are they used? The answers to these and many more such questions are contained in this book. This is not a book on electronics theory; and in fact little theoretical background is required for using and understanding it. The book's purpose is to help create the skills necessary for conducting intelligent experimental investigations both in and out of the laboratory. To accomplish this, the book provides specific information on a wide variety of electronic test equipment and outlines proper procedures for application of such equipment. Included is a set of lab exercises requiring understanding of, and practice with, measurement techniques.

Published by Prentice-Hall, Inc., Englewood Cliffs, N. J. 07632. Hard cover. 338 pages. \$12.

101 QUESTIONS & ANSWERS ABOUT HI-FI & STEREO

by Leo G. Sands and Fred Shunaman

Hundreds of thousands of hi-fi enthusiasts every day use such terms as dB, i.m. distortion, watts, IHF sensitivity, capture ratio, channel separation, music power, dynamic range, etc. without knowing their true significance. Consequently, this book, prepared in a conversational question-and-answer format, was written to explain these terms to anyone interested in faithfully reproduced music. The book is divided into six parts, Part 1 deals with high-fidelity systems in general. Parts 2, 3, 4, and 5 focus respectively on amplifiers, tuners, record and tape players, and speakers. Part 6 is devoted entirely to troubleshooting and maintenance. It is not necessary that the reader know anything about electronics or music systems; everything is explained.

Published by Howard W. Sams & Co., Inc., 4300 West 62 St., Indianapolis, Ind. 46268. Soft cover. 128 pages. \$3.50.

March, 1970

Olson ELECTRONICS

FREE Catalog

Fill in coupon for a FREE One Year Subscription to OLSON ELECTRONICS' Fantastic Value Packed Catalog — Unheard of LOW, LOW PRICES on Brand Name Speakers, Changers, Tubes, Tools, Stereo Amps, Tuners, CB, and other Values. Credit plan available.

NAME _____
ADDRESS _____
CITY _____ STATE _____
GIVE ZIP CODE _____

If you have a friend interested in electronics send his name and address for a FREE subscription also.

OLSON ELECTRONICS

DEPT. IC, 260 S. FORGE STREET, AKRON, OHIO 44308

CIRCLE NO. 17 ON READER SERVICE PAGE

It's yours
free



**GIANT 274 PAGE
1970
RADIO-TV
ELECTRONICS
CATALOG**

Write to.

**BURSTEIN-APPLEBEE CO.,
DEPT. PE-3 3199 MERCIER ST.,
KANSAS CITY, MO. 64111**

Name _____
Address _____
City _____
State _____ Zip Code _____

CIRCLE NO. 3 ON READER SERVICE PAGE

ELECTRONICS MARKET PLACE

COMMERCIAL RATE: For firms or individuals offering commercial products or services. \$1.15 per word (including name and address). Minimum order \$11.50. Payment must accompany copy except when ads are placed by accredited advertising agencies. Frequency discount: 5% for 6 months; 10% for 12 months paid in advance. **READER RATE:** For individuals with a personal item to buy or sell. 70c per word (including name and address). No Minimum! Payment must accompany copy.

FOR SALE

FREE! Giant bargain catalog on transistors, diodes, rectifiers, SCR's, zeners, parts. Poly Paks, P.O. Box 942, Lynnfield, Mass. 09140. **GOVERNMENT Surplus Receivers, Transmitters, Snooperscopes, Radios, Parts, Picture Catalog 25¢.** Meshna, Nahant, Mass. 09108.

ROCKETS: Ideal for miniature transmitter tests. New illustrated catalog. 25¢. Single and multistage kits, cones, engines, launchers, trackers, rocket aerial cameras, technical information. Fast service. Estes Industries, Dept. 18, Penrose, Colorado 81240.

LOWEST Prices Electronic Parts. Confidential Catalog Free. **KNAPP,** 3174 8th Ave. S.W., Largo, Fla. 33540.

EUROPEAN and Japanese bargains catalogs. \$1 each. Dee, 10639E Riverside, North Hollywood, Calif. 91602.

MUSIC LOVERS, CONTINUOUS, UNINTERRUPTED BACKGROUND MUSIC FROM YOUR FM RADIO, USING NEW INEXPENSIVE ADAPTOR. FREE LITERATURE. ELECTRONICS, 11500-Z NW 7th Ave., MIAMI, FLORIDA 33168.

WE SELL CONSTRUCTION PLANS. TELEPHONE: Answering Machine, Speakerphone, Carphone, Phonevision, Legal Connector, Auto Dialer, Central Dial System. **TELEVISION:** \$35.00 Color Converter, Tape Recorder, 3DTV. \$25.00 Camera. **DETECTIVE:** Infinity Transmitter, Tail Transmitter, Police Radar Detector. **HOBBYIST:** Electron Microscope, 96 Hour Tape Music System, Ultrasonic Dishwasher, Radar-Oven, Electronic Tranquilizer. Plans \$4.95 each. **COURSES:** Telephone Engineering \$39.50, Detective Electronics \$22.50, Anti-Detective Electronics \$27.50. **SUPER HOBBY CATALOG 25¢.** Don Britton Enterprises, 7906 Santa Monica Blvd., Hollywood, Calif. 90046.

WEBBER LAB'S. Police & Fire Converters. Catalog 25¢. 72 Cottage Street, Lynn, Mass. 09105.

RADIO—T.V. Tubes—33¢ each. Send for free catalog. Cornell, 4213 University, San Diego, Calif. 92105.

INVESTIGATORS, LATEST ELECTRONICS AIDS. FREE LITERATURE. CLIFTON, 11500-L NW 7th Ave., MIAMI, FLORIDA 33168.

FREE ELECTRONICS PARTS FLYER. Large catalog \$1.00 deposit. **BIGELOW ELECTRONICS; BLUFFTON, OHIO 45817.**

JAPAN & HONG KONG DIRECTORY. Electronics, all merchandise. World trade information. \$1.00 today. Ippano Kaisha Ltd., Box 6266, Spokane, Washington 99207.

FREE Catalog low priced, high performance subminiature listening devices direct from manufacturer. Emery LT-103, 156 Fifth Avenue, New York, N. Y., 10010.

ULTRA-SENSITIVE AND POWERFUL METAL DETECTORS—join the many who are finding buried coins, minerals, relics and artifacts. Don't buy till you see our **FREE catalog** of new models. Write Jetco, Box 132-PE, Huntsville, Texas 77340.

LASER parts catalog 60¢. Moynihan, 107 North Brighton, Atlantic City, New Jersey 08401.

PSYCHEDELIC catalog. Posters, lighting, etc. Send 25¢ for handling to Hole In The Wall, 6055PE Lankershim, North Hollywood, Calif. 91606.

THE ART OF DE-BUGGING—\$5.95. TRON-X PUBLICATIONS, P.O. BOX 38155, HOLLYWOOD, CALIFORNIA 90038.

CONSTRUCTION PLANS: LASER . . . \$2.00. Listening Devices—two F.M. MIC Transmitters . . . \$1.00. Tail Transmitter . . . \$1.00. Telephone Transmitter . . . \$1.00. Infinite Transmitter . . . \$2.00. Equipment and kits available. Howard, 20174 Ward, Detroit, Michigan 48235.

COMPONENTS? Kits? Hardware? Free catalog! Truvue Paks, Box 275, Chelsea, Mass. 02150.

GENERAL INFORMATION: First word in all ads set in bold caps at no extra charge. All copy subject to publisher's approval. Closing Date: 1st of the 2nd month preceding cover date (for example, March issue closes January 1st). Send order and remittance to: Hal Cymes, POPULAR ELECTRONICS, One Park Avenue, New York, New York 10016.

SENCORE TEST EQUIPMENT UNBELIEVABLE PRICES. FREE CATALOG AND PRICE SHEET. FORDHAM RADIO, 265 EAST 149TH STREET, BRONX, N.Y. 10451.

ELECTRONIC ignition, various types. Free literature. Anderson Engineering, Epsom, N.H. 03239.

AMATEUR SCIENTISTS, Electronics Hobbyists, Experimenters, Students . . . Construction Plans—all complete, including drawings, schematics, parts lists with prices and sources . . . **Laser—**Build your own coherent-light optical laser. Operates in pulsed mode, visible light range—\$6.00 . . . **Radar—**Build your own ultrasonic doppler radar. Detect motion of people, automobiles, even falling rain drops. Transistorized, uses standard small 9-volt battery—\$4.00 . . . **Long-Range "Sound Telescope"—**This amazing device can enable you to hear conversations, birds and animals, other sounds hundreds of feet away. Very directional. Transistorized. Uses 9V battery—\$3.00 . . . Or send 25¢ coin (no stamps) for complete catalog. Other items include Psychedelic strobes, light shows, robots . . . 38 different projects. Technical Writers Group, Box 5994, State College Station, Raleigh, N.C. 27607.

MECHANICAL, ELECTRONIC devices catalog 10¢. Greatest Values—Lowest Prices, Fertik's, 5249 "D", Philadelphia, Pa. 19120.

CLEARANCE SALE rectifiers, transistors, 1000's other items. Catalog 15¢. General Sales Company, 254 Main, Clute, Texas 77531.

HEARING AIDS below wholesale. Smallest, most powerful. Free home trial. No salesman will call. Free details. Write Prestige-C-42, Box 10880, Houston, Texas 77018.

LINEAR AMPLIFIERS: "Hornet" 50 watts output—\$98.50; "Raider" 100 watts—\$139.50; "Maverick-250" 250 watts—\$244.95. AM and SSB. "Scorpion" 50 watt 12 V. Mobile Amplifier—\$99.95; "Bandit II" 12 V. Mobile Amplifier—\$169.95. Mobile amplifiers positive or negative ground. Frequency range 20-35 megacycles (illegal for class D 11 meters.) Dealer inquiries invited. D & A Manufacturing Co., 1217 Avenue C, Scottsbluff, Nebraska 69361.

SEMICONDUCTORS and parts catalogue free over 100 pages. J. & J. Electronics, Box 1437, Winnipeg, Manitoba, Canada. U.S. Trade directed.

SPACE-AGE TV CAMERA KIT! Terrific for Experimenters, Industry, Education. Solid-state. Only \$116.95! Starter kits: \$18.95 up. Plans 25¢ up. Catalog FREE. Phone: 402-987-3771. Write: **ATV RESEARCH,** 1301 Broadway, Dakota City, Nebr. 68731.

EXCITING LISTENING! POLICE—FIRE—AIRCRAFT—SHORTWAVE calls on your broadcast radio! Free catalog. Salch Company, Woodsboro 24, Texas 78393.

PRINTED CIRCUITS. Magazine projects . . . experimental to specifications. Lowest prices. Vico, Box 1581, Los Angeles, California 90053.

"BRACKETS-CHASSIS" electronic chassis and aluminum sheet-metal brackets. For literature write: Seiling, 1635 E. 5th St., Dayton, Ohio 45403.

CONVERT any television to sensitive, big-screen oscilloscope. Only minor changes required. No electronic experience necessary. Illustrated plans, \$2.00. Relco-A33, Box 10563, Houston, Texas 77018.

EXPERIMENTERS—115vac Guardian Steppers; Comar, Guardian and Amperite Relays: Micro-switches and more. Everything priced the lowest you've ever seen. Send a 6¢ stamp, for bargain sheets, to: Gust & Company, Box 24081, Edina, Minnesota 55424.

DIRECTORY of Japanese Electronics Companies \$2.00, now. Jago PE3, 120 South First Avenue, Highland Park, New Jersey 08904.

RESISTORS ½ watt, 10% 7¢ each. One dollar minimum order. Specify values. Capital House, Park Plaza Station, Box 1013, Lincoln Park, Mich. 48146.

HEATHKIT GR-54 receiver, 6 XTAL controlled channels XTAL Calibrate, \$95.00. M. D. Henke, 714B Everglades Ct. South, Nav. Sta. Mayport, Fla. 32227.

FREE TV TUNER REPAIR TRICKS. Plans, Details. Complete courses: Frank Bocek, Box 833, Redding, Calif. 96001.

PSYCHEDELIC Lighting Manual: Make light-machines, strobes, organs, slides, etc. Send \$2.00. Lightrays, 713D Pine, Philadelphia, Pa. 19106.

BURGLAR and FIRE ALARM SYSTEMS and supplies. INSTALLATION MANUAL and catalog \$1.00. Refunded first order. Electronic Sentry Systems, P.O. Box 8023A, Sacramento, California 95818.

QUALITY LINEAR AMPLIFIER: 200 watts 20-35mc, base, \$125 (illegal class D, 11 meters). K. & J. B. Electronics, 120 Brookside, Darien, Conn. 06820.

FREE CATALOG surplus bargains: Fans, Bodine reduction motors, switches, relays, steppers, PC Boards, Many others. IEM Inc., Box 4280, Irvine, California 92664.

RADIO, WORLD'S SMALLEST, wear behind ear, quarter hides it! Superb tone, to 15 stations. Radio replica and brochure, \$2.00—refundable. Personal Radio Company, Box 2279, Sunnyvale, Calif. 94087.

SCHEMATICS, Diagrams, old radios \$1.50; TVs \$2.50; complete information when requesting. Gordie's TV, Hustisford, Wis. 53034.

PLANS AND KITS

RADAR INTRUDER ALARM detects human movement thirty feet away. TRANSISTORIZED. BUILD YOURSELF with complete instructions. Parts, kits and assembled units also available. Plans \$3.00. Microwave Research Co., Box 10147, St. Petersburg, Florida 33733.

BUILD color organs, computers, stereos, alarms, slide-synchronizers. Catalog. Workshop, 33E Cain, Plainview, New York 11803.

NOVEL Electronic Lock. Plans \$4.95, details 50¢. Newell Labs, Box 1254, Redondo Beach, Calif. 90278.

COLOR Organ Kit \$7.50, Power Supplies \$3.98. Catalog. Murphy, 204 Roslyn Ave., Carle Place, N.Y. 11514.

PLANS: FOUR Exceptional MiniFM bug, \$2. Three telephone voice powered, \$1. 2250 Easthills Drive, Pittsburgh, Pa. 15221.

INTEGRATED CIRCUIT KITS: COMPUTER, AUDIO, Others. 1970 catalog free. KAYE ENGINEERING, Box 3932-A, Long Beach, California 90803.

"DISTANCE Crystal Set Construction" Handbook 50¢. "Coil Winding" 50¢. Catalog. Laboratories, 12041-L Sheridan, Garden Grove, Calif. 92640.

SURVEILLANCE DEVICES IN KIT FORM: Telephone Transmitter, FM Spy Transmitter, Telephone-Recorder Actuator, Tail Transmitter, Bug Detector, Complete Kits Send \$15.00 each. ELECTRONIC SECURITY SYSTEMS, 1101 West Rosecrans Avenue, Gardena, California 90247.

DWELL Tachometer plans \$2.00. Build precision unit for under \$6.00. Utilizes one IC, few resistors and capacitors. Hillary PE, 161 Bonad, Chestnut Hill, Mass. 02167.

SYNTHESIZER, electronic music from guitar and other instruments. Complete plans \$2, kit \$15. Tomorrow, Inc., 6777 Hollywood, Los Angeles 90028.

BUILD powerful crystal radio. Easy to build. Complete plans. Send \$4.95 cash, Cash, check, money order. Radio, 2139 Eaton Rd., Charlotte, N.C. 28205.

KITS, SUPER SNOOPER \$5.95. Metal Detector \$5.95. FM Wireless Transmitter \$4.95, others. Lectronic, Box 42, Madison Heights, Michigan 48071.

HE/NE GAS LASER completed tube with internal mirrors and power supply schematic, 0.5 MW with 1 MW typical red power output—only \$49.95. Cash, check or money order. Order from C. W. Radiation, P.O. Box 1299, Mtn. View, Calif. 94040.

LASER POWER METER measures up to 5 MW laser output power at 6328A \$49.95 complete or kit \$34.95. Plans \$5.00. Rush money order to C.W. Radiation, P.O. Box 1299, Mtn. View, Calif. 94040.

1400-PC. GLASS FIBER OPTIC KIT

It's FUN!

It's Educational!

It's Gifty!



\$5.50

- ★ Make light "pipes"
- ★ Dazzling displays
- ★ Triggers photo & infra-red cells

OPTICAL SCIENTIFIC BREAKTHRU! Allows "hair thin" glass fibers (2-ft. long) to transmit & receive cold light energy of any color, by internal reflection. Bundled, jacketed, it guides, snoots, pipes light around corners, walls, even in circles, triggering such devices as light sensitive transistors, diodes, acra. IT CUTS, BENDS, ACTS like wire. Only one's imagination controls its 1000's of uses. FREE: 12-pc. accessory kit, with "how-to-do booklet".

- \$25 SURPRISE PAK: transistors, rect. diodes, etc. .. \$1
 - 50 GERMANIUM GLASS DIODES, 1N34, 1N48 no test \$1
 - 40 TOP HAT SILICON RECTIFIERS, no test/asst values \$1
 - 25 EPOXY RECTIFIERS, silicon asst, no test \$1
 - 40 PRECISION RESISTORS, 1/2-2W, 1% asst values .. \$1
 - 30 TRANSISTORS, rf, if, audio, osc. no test \$1
 - 60 TUBULAR CONDENSERS, to .5mf to 1KV, asst. \$1
 - 50 DISC CONDENSERS, to .04mf npo, temp coef, asst \$1
 - 30 POWER RESISTORS, to 25 watts, to 24K ohms \$1
 - 10 VOLUME CONTROLS, to 1 meg, switch too! \$1
 - 10 ELECTROLYTICS, to 100mf, tubulars, too, asst \$1
 - 50 RADIO & TV KNOBS, asstd colors & styles \$1
 - 10 TRANS'OR ELECTROLYTICS to 100mf, asst values \$1
 - 50 COILS and CHOKES, if, rf, ant, osc, peaking, etc \$1
 - 65 HALF WATERS, to 1 meg, 5% popular values too \$1
 - 2 FIELD EFFECT TRANSISTORS, n channel, hobby \$1
 - 10 PANEL SWITCHES, toggle, slide, micro, rotary ... \$1
 - 3 "SUN" BATTERIES, for 100's of lite sens projs \$1
 - 5 "JBM" COMPUTER BOARDS, many trans, diodes, \$1
 - 40 "MICRO" CONDENSERS, for transistor circuitry \$1
 - 50 TERMINAL STRIPS, 1 to 8 lug types \$1
 - 4 PHOTO ELECTRIC CELLS, h.v. imp., schematic \$1
 - 40 "TINY" RESISTORS, 1/10W, 5% tol! to 1 meg, .. \$1
- ADD POSTAGE, avg. wt. 1/2 lb. CATALOG 10¢

POLY PAKS

P.O. BOX 942E
LYNNFIELD, MASS,
01940

CIRCLE NO. 19 ON READER SERVICE PAGE

SHORTWAVE LISTENING

EXCITING LISTENING! SHORTWAVE—POLICE—FIRE—AIRCRAFT—MARINE stations on your car radio! Free Catalog. Salch Company, Woodsboro 25, Texas 78393.

SPY, CLANDESTINE, SPACECRAFT FREQUENCIES, SCHEDULES. \$1.00. MonAlert, P.O. Box 673, Warner Robins, Ga. 31093.

SWL GUIDE NEWSLETTER, Quarterly, \$1.00 per year, credited towards purchase of Selected Items for SWLs. 414 Newcastle, Syracuse, N.Y. 13219.

HIGH FIDELITY

FREE! Send for money saving stereo catalog # P3E, lowest quotations on your individual component, tape recorder, or system requirements. Electronic Values, Inc., 200 W. 20th St., New York, N.Y. 10011.

TRADE in your old cartridge: Send us \$7.95 and we will ship PREPAID any one of the following: ADC 220, Grado FTR, Pickering Pac/1, Shure M3D: LYLE CARTRIDGES, Dept. P, 265 East 149th St., Bronx, N.Y. 10451.

HI-FI components. Tape Recorders, at guaranteed "We Will Not Be Undersold" prices. 15-day money-back guarantee. Two-year warranty. No Catalog. Quotations Free. Hi-Fidelity Center, 239 (P) East 149th Street, New York 10451.

TRADE in your old cartridge: Send us \$13.95 and we will ship PREPAID any one of the following: Empire 808E, Empire 888, Grado FTE, Pickering V15AM-3, Pickering V15AT-3, Shure M21E, M32E, M44E, M44-7, M75-6: LYLE CARTRIDGES, Dept. P, 265 East 149th St., Bronx, N.Y. 10451.

LOW, Low quotes: all components and recorders, HiFi, Roslyn, Penna. 19001.

TRADE in your old cartridge: Send us \$17.95 and we will ship PREPAID any one of the following: ADC 660E, Empire 888E, Pickering V15ACE-3, V15ATE-3, XV15AT, Shure M55E, M75E, M92E, M93E, M91E-G95 (Garrard), M91E-D12 (Dual): LYLE CARTRIDGES, Dept. P, 265 East 149th St., Bronx, N.Y. 10451.

TAPE RECORDERS, Hi-Fi, components, Sleep Learning Equipment, tapes. Unusual Values. Free Catalog. Dressner, 1523R, Jericho Turnpike, New Hyde Park, N.Y. 11040.

GARRARD SPECTACULAR: Send us \$32.95 and we will ship **PREPAID** new Garrard changer with stereo cartridge and base: **LYLE CARTRIDGES**, Dept. P, 265 East 149th St., Bronx, N.Y. 10451.

NEEDLES: For ADC, Empire, Grado, Pickering, Shure, Stanton. Unbelievable prices: Free catalog and price sheet: **LYLE CARTRIDGES**, Dept. P, 265 East 149th St., Bronx, N.Y. 10451.

BACKGROUND MUSIC—SOLID-STATE SCA DECODER DELIVERS SUBCARRIER COMMERCIAL-FREE MUSIC PIGGYBACKED ON MANY FM STATIONS. LINE-POWERED ADAPTER SIMPLY PLUGS INTO ANY FM TUNER. NO ADJUSTMENTS OR TUNING. NEW DESIGN BREAK-THRU GUARANTEES OPTIMUM PERFORMANCE, LOWEST PRICE EVER! \$35 POSTPAID. K-LAB, BOX 572, S. NORWALK, CONN. 06856.

DON'T THROW YOUR OLD CARTRIDGE AWAY. Send us \$19.95 and any old cartridge. We will ship **PREPAID** any one of the following top rated elliptical diamond stereo cartridges **NEW**: Shure M75E, M91E, M92E, M93E, Empire 888E, Pickering V15AME3, XV15 ATE, ADC 660E, 550E. Write for lowest quotations all stereo components. Send \$1.00 for our discount catalog. **DEFA ELECTRONICS**, 2207 Broadway, New York, N.Y. 10024.

WANTED

CASH PAID! Unused tubes, electronic equipment. Barry, 512 Broadway, NYC 10012.

QUICKSILVER, Platinum, Silver, Gold, Ores Analyzed. Free Circular. Mercury Terminal, Norwood, Mass. 02062.

CASH PAID for all tubes. **DAMESCO**, 308 Hickory, Arlington, N.J. 07032.

TUBES

TUBES "Oldies", latest. Lists free. Steinmetz, 7519 Maplewood, Hammond, Indiana 46324.

RECEIVING & INDUSTRIAL TUBES, TRANSISTORS. All Brands—Biggest Discounts. Technicians, Hobbyists, Experimenters—Request **FREE** Giant Catalog and **SAVE!** **ZALYTRON**, 469 Jericho Turnpike, Mineola, N.Y. 11501.

TUBE Headquarters of World! Send 10c for Catalog (tubes, electronic equipment) Barry, 512 Broadway, N.Y.C. 10012.

RADIO & T.V. Tubes—33¢ each. Send for free list. Cornell, 4213 University, San Diego, Calif. 92105.

THOUSANDS and thousands of types of electronic parts, tubes, transistors, instruments, etc. Send for Free Catalog. Arcturus Electronics Corp., MPE, 502-22nd St., Union City, N.J. 07087.

TUBES—Lowest world prices. Foreign-American. Obsolete, current. Receiving, special purpose, transmitting tubes. Send for tube and parts catalog. United Radio Company, 56-P Ferry St., Newark, N.J. 07105.

TAPE AND RECORDERS

TAPES . . . blank recording . . . pre-recorded music. Catalog 10¢. Tower, Lafayette Hill, Pa. 19444.

BEFORE Renting Stereo Tapes try us. Postpaid both ways—no deposit—immediate delivery. Quality—Dependability—Service—Satisfaction—prevail here. If you've been dissatisfied in the past, your initial order will prove this is no idle boast. Free Catalog. Gold Coast Tape Library, Box 2262, Palm Village Station, Hialeah, Fla. 33012.

RENT 4-Track open reel tapes—all major labels—3,000 different—free brochure. Stereo-Parti, 55 St. James Drive, Santa Rosa, Ca. 95401.

TAPEMATES makes available to you **ALL 4-TRACK STEREO TAPES—ALL LABELS**—postpaid to your door—at tremendous savings. For free brochure write: **TAPEMATES**, 5727 W. Jefferson Blvd., Los Angeles, California 90016.

AMAZING DISCOUNTS on famous brand high fidelity stereo components. No small wonder that we have set new sales records each year since 1959. Write. Arkay Electronics, 1028-03 Commonwealth, Boston, Mass. 02215.

STEREO TAPES, save 20,30% and more, postpaid anywhere U.S.A. We discount batteries, recorders, tape/cassettes, 80-page catalog 25¢. **SAXITONE TAPES**, 1776 Columbia Road, N.W., Washington, D.C. 20009.

CASSETTE and 8-track blanks, language tapes, dozens of accessories and recorders. Literature 25¢. **CASSETTES UNLIMITED**, P.O. Box 13119-P, Pittsburgh, Pa. 15243.

OLD radio programs on tape. 6 hours for \$8.00. Catalog 50¢. Don Maris, 824 Owl, Norman, Okla. 73069.

FABULOUS Old Time Radio Shows, on tape. Detailed catalogue free. Box 2511, Denver 80201.

REPAIRS AND SERVICES

TV Tuners rebuilt and aligned per manufacturers specification. Only \$9.50. Any make UHF or VHF Ninety day written guarantee. Ship complete with tubes or write for free mailing kit and dealer brochure. **JW Electronics**, Box 51C, Bloomington, Indiana 47401.

PERSONALS

MAKE FRIENDS WORLDWIDE through international correspondence. Illustrated brochure free. Hermes, Berlin 11, Germany.

INVESTIGATORS, LATEST ELECTRONIC AIDS, FREE LITERATURE. CLIFTON, 11500-K NW 7th AVE., MIAMI, FLORIDA 33168.

SECRET LOANS BY MAIL. Borrow \$100 to \$1500 for any good reason in absolute privacy. No interviews, no endorsers, no co-signers. Fast service. Write Dial Finance Co., Dept. C-593, 410 Kilpatrick Bldg., Omaha, Nebraska 68102.

REMEMBER birthdays, anniversaries, etc. We remind you. Two dates: Send 50¢; Six: \$1.00; Twelve: \$1.50. DoubleM, Box 748, Beloit, Wisconsin 53511.

INSTRUCTION

LEARN ELECTRONIC ORGAN SERVICING at home all makes including transistor. Experimental kit—trouble-shooting. Accredited NHSC. Free Booklet. **NILES BRYANT SCHOOL**, 3631 Stockton, Dept. A, Sacramento, Calif. 95820.

FCC First Class License in six weeks—nation's highest success rate—approved for Veterans training. Write Elkins Institute, 2603B Inwood Road, Dallas, Texas 75235.

R.E.I.'s famous (5) week course for the First Class Radio Telephone License is the shortest, most effective course in the nation. Over 98% of R.E.I. graduates pass F.C.C. exams for 1st class license. Total tuition \$360.00. Job placement free. Write for brochure. Radio Engineering Incorporated Schools, 1336 Main Street, Sarasota, Florida 33577—or 3123 Gillham Road, Kansas City, Missouri 64109—or 809 Caroline Street, Fredericksburg, Virginia 22401—or 625 E. Colorado Street, Glendale, California 91205.

FCC FIRST CLASS LICENSE THROUGH TAPE RECORDED LESSONS. Our seventeenth year teaching FCC license courses. Radio License Training, 1060D Duncan, Manhattan Beach, Calif. 90266.

DEGREE in Electronics Engineering earned mostly by correspondence. Free brochure. Dept. G-9, Grantham School of Engineering, 1505 N. Western Ave., Hollywood, California 90027.

LEARN WHILE ASLEEP, Hypnotize! Strange catalog free. Auto-suggestion, Box 24-ZD, Olympia, Washington 98501.

ART talent? Be your own boss. Earn \$200.00 weekly free-lancing. Free brochure. Famous American Studios, Dept. PE Spring Park, Minn. 55384.

F.C.C. License training by correspondence. G.I. Bill approved. Money-Back Warranty. Free brochure. Write: Dept. Z-9, Pathfinder School of Electronics, 1505 N. Western Ave., Hollywood, Calif. 90027.

LEARN CARTOONING at home. Free book, "Key To A Cartoon Career". Write: Cartooning, Box 3176-Y, Colorado Springs, Colo. 80907.

PREPARE NOW for Rewarding Career as "ELECTRONICS TROUBLE-SHOOTING & REPAIR SPECIALIST." Highly Effective Home Study Training. Earn your **MASTER DIPLOMA**. Graduates in Great Demand. High Pay. Nationally Accredited. Write for Free Descriptive Literature. No salesman will call. **COOK'S INSTITUTE OF ELECTRONICS**, Dept. 21, P.O. Box 10634, Jackson, Miss. 39209. (Established 1945).

PLAY ORGAN EASILY! AMAZING METHOD! FREE INFORMATION. **KEGLEY, 1016-PE KELLY, JOLIET, ILLINOIS 60435.**

AMATEUR Radio School. Correspondence Sight-and-Sound no textbook courses for General, Advanced and Extra Class licenses; complete Code and Theory. These are Not memory courses. Reed Electronics School, 12217 Santa Monica Blvd., Los Angeles, Calif. 90025.

SLEEP SUGGESTION—YOGA—HYPNOTISM! Unique catalog free! Friendlyco, Box 669-ZD, Haynesville, Louisiana 71038.

TAXIDERM Success Training sure, easy way into Taxidermy. Complete training, no skipping, all steps illustrated. Request information and free samples. Box 5815, Bossier City, Louisiana 71010.

MEMORIZE: "1970 TESTS—ANSWERS" for FCC FIRST AND SECOND CLASS LICENSE. Plus "Self-Study Ability Test." **PROVEN.** \$5.00. Command, Box 26348-P, San Francisco 94126.

INVENTIONS WANTED

INVENTIONS wanted. Patented; unpatented. Global Marketing Service, 2420-P 77th, Oakland, Calif. 94605.

INVENTORS! OUR FREE EXPERT ANALYSIS of your invention can save valuable time, help you realize full sale value. Strictly confidential. **FREE INVENTION CERTIFICATE.** Write today: Pioneer Invention Service, Dept. 35, 150 Broadway, New York, N.Y. 10038.

FREE "Directory of 500 Corporations Seeking New Products." For information regarding development, sale, licensing of your patented/unpatented invention. Write: Raymond Lee Organization, 230-GR Park Avenue, New York City 10017.

INVENTORS: Protect your ideas! Free "Recommended Procedure". Washington Inventors Service, 422T Washington Building, Washington, D.C. 20005.

PATENT SEARCHES, including copies of related United States Patents. Inventors, attorneys, manufacturers use our "World-Wide" Airmail service Free: "Invention Record" form and "Information Every Inventor Needs", Hayward Company, 1029HR Vermont, Washington, D.C. 20005.

FREE PAMPHLET: "Tips on Safeguarding Your Invention." Write: United States Inventors Service Company, 501-H Thirteenth Street N.W., Washington, D.C. 20004.

PATENT Searches including Maximum speed, full airmail report and closest patent copies, \$6.00. Quality searches expertly administered. Complete secrecy guaranteed. Free Invention Protection forms and "Patent Information." Write Dept. 9, Washington Patent Office Search Bureau, 711 14th Street, N.W., Washington, D.C. 20005.

INVENTORS! Don't sell your invention, patented or unpatented, until you receive our offer. Eagle Development Company, Dept. P, 79, Wall Street, N.Y., N.Y. 10005.

INVENTORS! Sell your invention for cash or royalties! Our client manufacturers eagerly seek new items. Patented, Unpatented. Financial assistance if needed, 25 years proven performance. For free information, write Dept. 20, Gilbert Adams, Invention Broker, 80 Wall St., New York, N.Y. 10005.

GOVERNMENT SURPLUS

JEEPS Typically From \$53.90 . . . Trucks From \$78.40 . . . Boats, Typewriters, Airplanes, Multimeters, Oscilloscopes, Transceivers, Electronics Equipment. Wide Variety, Condition, 100,000 Bid Bargains Direct From Government Nationwide Complete Sales Directory and Surplus Catalog \$1.00. (Deductible First \$10.00 Order). Surplus Service, Box 820-J, Holland, Michigan 49423.

GOVERNMENT Surplus How and Where to Buy in Your Area. Send \$1.00 to: Surplus Information PE, Headquarters Building, Washington, D.C. 20036.

BOOKS

FREE catalog aviation/electronic/space books. Aero Publishers, 329PE Aviation Road, Fallbrook, California 92028.

UNUSUAL Books! Catalog free! International, Box 7798 (PE), Atlanta, Georgia 30309.

FREE book prophet Elijah coming before Christ. Wonderful bible evidence. Megiddo Mission, Dept. 64, 481 Thurston Rd., Rochester, N.Y. 14619.

ELECTRONIC and technical books at discount. Tek Book Service, Box 511, Burbank, Calif. 91502.

BOOKS for every interest! Free details. Reed Company, West Kingston, Rhode Island 02892.

MAGAZINES

BACK DATE MAGAZINES! Send needs. Midtown, Box 917-PE, Maywood, N.J. 07607.

March, 1970

AUTHORS' SERVICES

AUTHORS! Learn how to have your book published, promoted, distributed. **FREE** booklet "ZD," Vantage, 120 West 31 St., New York 10001.

HYPNOTISM

FREE Hypnotism, Self-Hypnosis, Sleep Learning Catalog! Drawer H400, Ruidoso, New Mexico 88345.

"MALE-FEMALE HYPNOTISM" EXPOSED, EXPLAINED! "SECRET METHOD"—THEY NEVER KNOW! \$2, RUSHED. **GUARANTEED!** ISABELLA HALL, SILVER SPRINGS, FLORIDA 32688.

HYPNOTIC sleep learning recordings produce fabulous results. Details Free. ASR Foundation, Box 702leg Henry Clay Station, Lexington, Ky. 40502.

HYPNOTIZE PERFECT STRANGERS—EITHER SEX—SUCCESSFULLY! Secret Methods—they never know! Illustrated Course and 10 inch Hypnodisk \$2.00. **RESULTS ABSOLUTELY GUARANTEED!** Dr. H. Arthur Fowler, Box 4399, Woodbury, New Jersey 08096.

AMAZING self-hypnosis record releases fantastic mental power. Instant results! Facts free. Write: Forum (AA3), 333 North Michigan Avenue, Chicago 60601.

MAGNETS

MAGNETISM (100) page script newly discovered magnetic principles (\$3.00). Jesse Costa, Box 26, Waquoit, Mass. 02536.

MAGNETS. All types. Special—20 disc magnets, or 2 stick magnets, or 10 small bar magnets, or 8 assorted magnets, \$1.00 Maryland Magnet Company, 5412-H Gist, Baltimore, Maryland 21215.

PHOTOGRAPHY—FILM, EQUIPMENT, SERVICES

SCIENCE Bargains Request Free Giant Catalog "CJ"—148 pages—Astronomical Telescopes, Microphones, Lenses, Binoculars, Kits, Parts. War surplus bargains. Edmund Scientific Co., 300 Edscorp Bldg., Barrington, New Jersey 08007.

RECORDS

SPECIAL interest records available, produced by the editors of the world's leading special interest magazines. Send for free catalog. Record catalog-PE, Ziff-Davis Publishing Company, One Park Avenue, New York, N.Y. 10016.

POPULAR organ albums factory direct. Concert Recording, Lynwood, Calif. 90262.

PRINTING

FREE LITERATURE: Address labels, business cards, printing, Rubber Stamps. JORDAN'S, 552 West O'Connor, Lima, Ohio 45801.

FREE Giant Discount Printing Catalog. Gables, 405C Clifton, Glen-shaw, Pa. 15116.

STAMPS

RUSSIA High-Value Collection. 32 different Russia—some over 50 years old! Commemoratives, Czarist issues, Airmails. Catalog price \$2.50. Special Get-Acquainted Offer—all for only 10¢! H. E. Harris, Dept. GG-54, Boston, Mass. 02117.

POSTMARKED MOON! Valuable Moon Landing First Day Cover post-marked from die taken to Moon and back by Apollo 11 Astronauts. This unique Cover features century-old wood cut from Jules Verne's 1869 novel predicting 3 Americans would be first to land on Moon! We'll give you one **FREE** of extra cost to introduce our famous Approval Service. Buy \$1 worth and get extra bonus of 110 stamps including spectacular Space Issues, plus Illustrated Album—or buy nothing, return stamps and album, cancel service anytime. Moon Cover is yours to keep in any case! Send 25¢ for postage and handling today. Kenmore, MC-540, Milford, New Hampshire 03055.

EMPLOYMENT INFORMATION

FOREIGN and USA job opportunities available now. Construction, all trades. Earnings to \$3,000.00 monthly. Paid overtime, travel bonuses. Write: Universal Employment, Woodbridge, Conn. 06525.

BUSINESS OPPORTUNITIES

RAISE Rabbits for us on \$500 month plan. Free details. White's Rabbitry, Mt. Vernon, Ohio 43050.

PIANO TUNING learned quickly at home. Tremendous field! Musical knowledge unnecessary. GI Approved. Free Information. Empire School, Box 327, Miami, Florida 33145.

FREE BOOK "999 Successful Little Known Businesses" Work home, Plymouth 445-W, Brooklyn, N.Y. 11216.

ELECTROPLATING Equipment and supplies. All types for home workshops and industrial. Send \$2.00 (refundable) for equipment guide formulas, operating data, catalog. HBS Equipment Division 90, 3543 East 16th, Los Angeles, California 90023.

I MADE \$40,000.00 Year by Mailorder! Helped others make money! Start with \$10.00—Free Proof. Torrey, Box 318-N, Ypsilanti, Michigan 48197.

\$200.00 DAILY in Your Mailbox! Your opportunity to do what mail-order experts do. Free details. Associates, Box 136-J, Holland, Michigan 49423.

FREE Selling Outfit. Office supplies, furniture & equipment. Oseco, 15-PE North Jefferson, Chicago 60606.

MAKE BIG MONEY raising chinchillas, rabbits, guinea pigs for us. Catalog—25¢. Keeney Brothers, New Freedom, Pa. 17349.

SELL inexpensive fire-burglar alarms. Foolproof! Write: WATCHDOG, PROFITS BROCHURE, Williamsburg, Ohio 45176.

FREE CATALOGS. Repair air conditioning, refrigeration. Tools, supplies, full instructions. Doolin, 2016 Canton, Dallas, Texas 75201.

SELL HERTEL BIBLES—Part Time. Finest reference Bible available. Demonstrator and supplies furnished. Excellent commissions. Write International Book, Dept. PE, Box 118, Wichita, Kansas 67201.

MAKE Money in mail-order imports. Work home without investment. Report includes drop-ship sources. \$1.00. Rivas Enterprises, Dept. 220, 1090 Sutter Ave., Brooklyn, New York 11208.

CATALOG free, STUART MCGUIRE fashions. Earn cash. Free clothing. Box 455, Huntington Park, Calif. 90255.

NEW IN USA RESTORE COLOR & BLACKWHITE PICTURE TUBES FOR BIG PROFITS IN YOUR COMMUNITY. AMAZING NEW CONCEPT IN PICTURE TUBE RESTORATION, U.S. PATENT PEND, makes old methods of "pushbutton rejuvenation" and "boosters" obsolete. **BUILD OUR AUTOMATIC RESTORATION DEVICE FOR UNDER \$10.00.** Complete plans sent postpaid \$4.65. BELTRON ELECTRONICS, 9208 NE 13th Avenue, Vancouver, Washington 98663.

MAKE money in mailorder, join "The Association." Send 20¢ for details. Satterfield, 3882 Via Cristobal, Campbell, Calif. 95008.

\$20,000—\$50,000 year. Ohio Bonding School, 7101 Lake, Elyria, Ohio 44035.

RUBBER STAMPS

RUBBER ADDRESS STAMP \$2.00. SIGNATURE \$3.50. FREE CATALOG. JACKSON, BOX 443-G, FRANKLIN PARK, ILL. 60131.

TREASURE FINDERS

GOLD, SILVER, RELICS! Located with powerful Detectron Metal Detectors. Free information. Terms. Detectron, Dept. PE-3, Box 243, San Gabriel, California 91778.

TREASURE FINDER locates buried gold, silver, coins, treasures. 5 powerful models. \$19.95 up. Free catalog. Relco-A33, Box 10839, Houston, Texas 77018.

TREASUREPROBES—Patented transistorized detector signals "dig" by earphone "beeping". 5" search head. PC board, two colpitt oscillators improve stability. Kit \$13.95, assembled \$18.88, with speaker \$24.88. 60 day guarantee. Send for Free Bibliography, "Treasure Maps and Books of U.S." Treasurehouse, PE-30, Tenant, N.J. 07763.

FREE TREASURE GUIDE! Fast-filled collectors edition; send 50¢ for postage. Also request free literature on ultrasensitive, professional Fisher Detectors. FISHER RESEARCH, Dept. PE3, Palo Alto, California 94303.

SAVE MONEY! 25¢ for Catalog saves 50¢ on purchase Super 8/8mm, Color. SPORTLITE FILMS-PE, 20 North Wacker Drive, Chicago, Illinois 60606.

SUMMER CAMPS

CAMP SKYCREST. 25th year. 90 boys, 6-16. Pocono Mountains. Learn Astronomy, Auto Mechanics, Biology, Chemistry, Photography, Metal, Woodworking. Get ham license. All sports, karting. Heated pool. Friendly staff. Nurse. Modern Dorms. Write: Dr. F. E. Brown, 17 Doney Drive, Glen Cove, New York 11542. 516-676-2190.

REAL ESTATE

FREE . . . SPRING 1970 CATALOG! Describes and pictures hundreds of farms, ranches, town and country homes, businesses in 33 states coast to coast! Specify type property and location preferred. Zip code, please. UNITED FARM AGENCY, 612-EP West 47th St., Kansas City, Mo. 64112.

MISCELLANEOUS

WINEMAKERS: Free illustrated catalog of yeasts, equipment. Semplex, Box 12276, Minneapolis, Minn. 55412.

UP to \$151 daily track wins with scientific computer. \$2 stakes. Proof supplied. Free details: RH-P11C, 5715, Carmel, Calif. 93921.

BILLS paid without borrowing—Nobody refused up to \$10,000.00. Bad credit no problem, not a Loan Company. Write for free application. **INTERNATIONAL ACCEPTANCE,** Dept. 50-A, 3003 N. Central Ave., Phoenix, Arizona 85012; 1000 N. Madison Avenue, Greenwood, Ind. 46142; 507 Carondelet St., New Orleans, La. 70130; 1825 Conn. Ave. N.W., Room 428, Washington, D.C. 20009.

FREE Taxidermy Supply Catalog—World's Largest selection forms. Taxidermy Supply, Route 1, Bossier City, Louisiana 71010.

\$200 CASH possible! Tax refund Legal nationwide. Info \$1.00. TAXMASTER-E, Box 6603, Mobile, Ala.

CLASSIFIED ADVERTISING IN POPULAR ELECTRONICS

Your best bet for outstanding mail order sales. These pages are read thoroughly by electronic hobbyists seeking products and services found only in **ELECTRONICS MARKET PLACE. POPULAR ELECTRONICS** readers respond readily—they rely on the advertisers appearing in the pages of their favorite magazine. Your low cost ad will result in increased sales responses for you! Send copy and payment to:

Hal Cymes, Classified Advertising Manager
POPULAR ELECTRONICS
1 Park Avenue
New York, N.Y. 10016

POPULAR ELECTRONICS

MARCH 1970

ADVERTISERS INDEX

READER

SERVICE NO.	ADVERTISER	PAGE NO.
1	AMECO, Div. of Aerotron, Inc.	116
3	Burstein-Applebee Company	117
	CREI, Home Study Div., McGraw-Hill Book Co.	36, 37, 38, 39
5	Cleveland Institute of Electronics	62, 63, 64, 65
2	Communications Div., DYNASCAN CORP.	9
6	Edmund Scientific Co.	123
4	EICO Electronic Instrument Co., Inc.	FOURTH COVER
7	Electro-Voice, Inc.	8
	Federal Oil Lease Service	112
8	GC Calctro	10, 11
	Grantham School of Engineering	125, 126
9	Heath Company	106, 107, 108, 109
	Hallcrafters	17
10	Intratec	112
11	Johnson Company, E.F.	25
12	Lafayette Radio Electronics	104
13	Mallory, P.R. & Co., Inc.	23
14	Mosley Electronics	110
15	Multicore Sales Corp.	110
	McGee Radio	112
	National Radio Institute	SECOND COVER, 1, 2, 3
	National Technical Schools	18, 19, 20, 21, 105
16	New Jersey Semi-Conductor Products	102
17	Olson Electronics	117
32	Pearce-Simpson	13
18	Phase Corp.	113
31	Pickering & Co.	7
19	Poly Paks	119
	Prestige	112
20	Progressive "Edu-Kits", Inc.	124
	RCA Electronic Components & Devices	THIRD COVER
21	RCA Electronic Components & Devices	26
	RCA Institutes, Inc.	88, 89, 90, 91
22	Schober Orgn Corp.	111
23	Solitron Devices	5
24	Sonar Radio Corp.	114
25	Standard Communications Corp.	104
26	Telex Communications Division	103
27	Turner Microphone Co., The	16
28	United Audio Products	6
29	United Technical Institute	12
30	University Sound	14
	Valparaiso Technical Institute	112

CLASSIFIED ADVERTISING 118, 119, 120, 121, 122

KEEP PACE WITH SPACE AGE! SEE MOON SHOTS—LANDINGS, SPACE FLIGHTS, CLOSE-UP!

AMAZING SCIENCE BUYS

for FUN, STUDY or PROFIT

"FISH" WITH A MAGNET

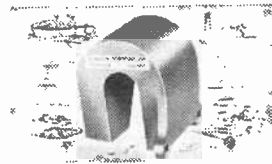

Go treasure hunting on the bottom! Fascinating fun & sometimes profitable! Tie a line to our 5-lb. Magnet—drop it overboard in bay, river, lake or ocean. Troll it along bottom—your "treasure" haul can be outboard motors, anchors, other metal valuables. 5-lb. Magnet is war surplus—Alnico-V Type—Gov't cost \$50. Lifts over 130 lbs. on land—much greater weights under water.

- Stock No. 70,571AV 5 lbs. \$14.00 Ppd.
- Stock No. 70,570AV 3 1/2 lbs. \$ 8.75 Ppd.
- Stock No. 70,572AV 7 1/2 lbs. \$18.75 Ppd.
- Stock No. 85,152AV 15 3/4 lbs. \$33.60 FOB

FIND BURIED METAL TREASURE!



Detect individual coins, rings as deep as 12" bags of coins, tools to 3'; metal chests, safes to 6 feet! Best fully transistorized, induction-balance loop detector at moderate price. Rugged, lightweight (3 1/2 lbs.) battery powered. Perfect for treasure hunters, collectors, explorers, beachcombers. Has visual and audible indicators, adjustable w/ conductivity knob, on/off switch control. "Humsealed" solid state circuitry. 32" over-

all, adj. 11" diam. loop. Includes 9 Volt 130 mA battery. \$147.50 Ppd. Stock No. 80,119AV

GET YOUR OWN 4' 7" "SLAVE"!



Really spectacular 55" light columns translate bass, vibration of sound into dazzling, throbbing, criss-cross patterns of vibrant color. Supersensitive 4-channel color organ in "master" column features individual color controls, master sensitivity knob, 1200W cap.—600 ea. for "Master" & "Slave" listed below. Easily attached to stereo amplifier. Uses 110-120V AC. 55"H x 19"W x 8"D.

Stock No. 85,188AV (57 lb. Shpg. Wt.) \$249.50 F.O.B.
 "SLAVE UNIT".....Works only in tandem w/Master! \$149.50 F.O.B.
 Stock No. 85,189AV (55 lb. Shpg. Wt.)

SPECIAL VISUAL EFFECTS PROJECTOR SET

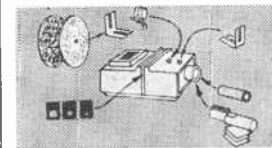

Dazzling, avant-garde visual effects. Fantastic variety. Incredibly beautiful. Special package offer contains all necessary apparatus. Create floating, exploding, fiery bursts of color like "Symphony of Sparks", "Chromatic Starbursts", "Crystal Starburst". Features 35mm 500 W. fan cooled projector—produces big image at short distance. Accepts two 9" diam. wheels (Dry Kaleidoscope & Heli-scope) 2 cylindrical accessories (6" Colored Cloud & 5" Hexidoscope w/six internal mirrored walls). Perfect for entertaining, parties, photography. Complete instructions.

Stock No. 71,212AV \$79.50 Ppd.

PSYCHEDELIC LIGHTING HANDBOOK

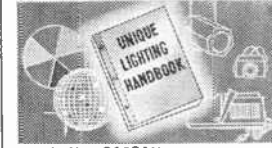

100 information packed pages! Fully explains latest in psychedelic lighting equipment, techniques, developments. Covers all facets of psychedelic light-show production including strobes, black lights, projectors, crystal, organic slides, mirrors, color organs, polarized color light boxes, MusicVision, etc. Shows how to "psychedelize" parties, musical groups, shows—or how to set up "electric trips" for private gatherings. 8 1/2" x 11" looseleaf paper for 3 rings.

Stock No. 9100AV \$3.00 Ppd.

LONG-WAVE BLACK LIGHT FIXTURE

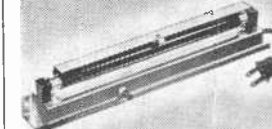

Extremely versatile, compactly designed, long wave (3200-4000 angstroms) black light (ultraviolet) fixture. Has 6-watt, 110-V lamp with built-in filter—eliminates harmful shorter wave ultraviolet rays. Use to identify minerals, fungi, bacteria—check for surface flaws, oil and gas leaks—perfect for displays with fluorescent paper, paints, chalk, crayons, trace powder, incl. adjustable aluminum reflector. Mount vert., horr., or on corner. 10" L. 1 1/2" W., 1 1/4" H.

Stock No. 70,364AV \$12.50 Ppd.
 Stock No. 60,124AV REPLACEMENT BULB \$4.50 Ppd.

Order by Stock No.—Check or M.O.—Money-Back Guarantee
 EDMUND SCIENTIFIC CO., 300 EDCORP BLDG., BARRINGTON, N.J. 08007



GIANT FREE 148 PAGE CATALOG "AV"
 Dozens of electrical and electromagnetic parts, accessories. Enormous selection of Astronomical Telescopes, Microscopes, Binoculars, Magnets, Lenses, Prisms. Many war surplus items; for hobbyists, experimenters, workshops, factory. Write for catalog "AV", include Zip. EDMUND, 300 EDCORP BLDG., BARRINGTON, N.J. 08007

CIRCLE NO. 6 ON READER SERVICE PAGE

Build Your Own Radio

and Electronics Circuits

PROGRESSIVE "Edu-Kit"® HOME RADIO COURSE



Reg. U.S.
Pat. Off.

Now Includes

- ★ 12 RECEIVERS
- ★ 3 TRANSMITTERS
- ★ SQ. WAVE GENERATOR
- ★ SIGNAL TRACER
- ★ AMPLIFIER
- ★ SIGNAL INJECTOR
- ★ CODE OSCILLATOR

- ★ No Knowledge of Radio Necessary
- ★ No Additional Parts or Tools Needed
- ★ EXCELLENT BACKGROUND FOR TV
- ★ SCHOOL INQUIRIES INVITED
- ★ Sold in 79 Countries

Training Electronics Technicians Since 1946

YOU DON'T HAVE TO SPEND HUNDREDS OF DOLLARS FOR A RADIO COURSE

The "Edu-Kit" offers you an outstanding PRACTICAL HOME RADIO COURSE at a rock-bottom price. Our Kit is designed to train Radio & Electronics technicians, using the most modern methods of home training. You will learn radio theory, construction practice and servicing. THIS IS A COMPLETE RADIO COURSE IN EVERY DETAIL. You will learn how to build radios, using regular schematics; how to wire and solder in a professional manner; how to service radios. You will work the standard type of punched metal chassis as well as the latest development of Printed Circuit chassis. You will learn the basic principles of radio. You will construct, study and work with RF and AF amplifiers and oscillators, detectors, rectifiers, test equipment. You will learn trouble-shooting, using the Progressive Code Oscillator. You will learn and practice progressive Dynamic Radio & Electronics Tester, Square Wave Generator and the accompanying instructional material.

You will receive training for the Novice, Technician and General Classes of F.C.C. Radio Amateur Licenses. You will build Receiver, Transmitter, Square Wave Generator, Code Oscillator, Signal Tracer and Signal Injector Circuits, and learn how to operate them. You will receive an excellent background for tele. Hi-Fi and Electronics.

Absolutely no previous knowledge of radio or science is required. The "Edu-Kit" will provide you with a basic education in Electronics and Radio, with many times the low price you pay. The Signal Tracer alone is worth more than the price of the kit.

THE KIT FOR EVERYONE

You do not need the slightest background in radio or science. Whether you are interested in Radio & Electronics because you want an interesting hobby, a well paying business or a job with a future, you will find the "Edu-Kit" a worth-while investment. Many thousands of individuals of all

ages and backgrounds have successfully used the "Edu-Kit" in more than 79 countries of the world. The "Edu-Kit" has been carefully designed, step by step, so that you cannot make a mistake. The "Edu-Kit" allows you to teach yourself at your own rate. No instructor is necessary.

PROGRESSIVE TEACHING METHOD

The Progressive Radio "Edu-Kit" is the foremost educational radio kit in the world, and is universally accepted as the standard in the field of electronics training. The "Edu-Kit" uses the modern educational principle of "Learn by Doing." Therefore you construct, learn schematics, study theory, practice trouble shooting—all in a closely integrated program designed to provide the various radio parts of the "Edu-Kit."

You begin by examining the various radio parts of the "Edu-Kit." You then learn the function, theory and wiring of these parts. Then you build a simple radio. With this first set you will enjoy listening to regular broadcast stations, learn theory, practice testing and trouble-shooting. Then you build a more advanced radio, learn more advanced theory and techniques. Gradually, in a progressive manner, and at your own rate, you will find yourself constructing more advanced multi-tube radio circuits, and doing work like a Professional Radio Technician.

Included in the "Edu-Kit" course are Receiver, Transmitter, Code Oscillator, Signal Tracer, Square Wave Generator and Signal Injector Circuits. These are not unprofessional "breadboard" experiments, but circuits constructed by means of professional wiring and soldering on metal chassis, plus the new method of radio construction known as "Printed Circuitry." These circuits operate on your regular AC or DC house current.

THE "EDU-KIT" IS COMPLETE

You will receive all parts and instructions necessary to build twenty different radio and electronics circuits, each guaranteed to operate. Our kits contain tubes, tube sockets, variable, electrolytic, mica, ceramic and paper dielectric condensers, resistors, tie strips, hardware, tubing, punched metal chassis, Instruction Manuals, hook-up wire, solder, selenium rectifiers, coils, volume controls and switches, etc.

In addition, you receive Printed Circuit materials, including Printed Circuit chassis, special tube sockets, hardware and instructions. You also receive a useful set of tools, a professional electric soldering iron, and a self-powered Dynamic Radio and Electronics Tester. The "Edu-Kit" also includes Code Instructions and the Progressive Code Oscillator. In addition to F.C.C. Radio Amateur License training, you will also receive lessons for servicing with the Signal Tracer and the Progressive Signal Injector, a High Fidelity Guide and a Quiz Book. You receive Membership in Radio-TV Club, Free Consultation Service, Certificate of Merit and Discount Privileges. You receive all parts, tools, instructions, etc. Everything is yours to keep. Progressive "Edu-Kits" Inc., 1189 Broadway, Dept. 685D, Hewlett, N. Y. 11557.

UNCONDITIONAL MONEY-BACK GUARANTEE

Please rush my Progressive Radio "Edu-Kit" to me, as indicated below:

Check one box to indicate choice of model

- Regular model \$26.95.
- Deluxe model \$31.95 (same as regular model, except with superior parts and tools plus valuable Radio & TV Tube Checker.)

Check one box to indicate manner of payment

- I enclose full payment. Ship "Edu-Kit" post paid.
- Ship "Edu-Kit" C.O.D. I will pay postage.
- Send me FREE additional information describing "Edu-Kit."

Name

Address

PROGRESSIVE "EDU-KITS" INC.

1189 Broadway, Dept. 685D, Hewlett, N. Y. 11557

FREE EXTRAS

• SET OF TOOLS

- SOLDERING IRON
- ELECTRONICS TESTER
- PLIERS-CUTTERS
- VALUABLE DISCOUNT CARD
- CERTIFICATE OF MERIT
- TESTER INSTRUCTIONS MANUAL
- HIGH FIDELITY GUIDE & QUIZZES
- TELEVISION BOOK & RADIO TROUBLE-SHOOTING BOOK
- MEMBERSHIP IN RADIO-TV CLUB: CONSULTATION SERVICE & FCC AMATEUR LICENSE TRAINING
- PRINTED CIRCUITRY

SERVICING LESSONS

You will learn trouble-shooting and servicing in a progressive manner. You will practice repairs on the sets that you construct. You will learn symptoms and causes of trouble in homes, portable and car radios. You will learn how to use the professional Signal Tracer, the unique Signal Injector and the dynamic Radio & Electronics Tester. While you are learning in this practical way, you will be able to do many a repair job for your friends and neighbors, and charge fees which will far exceed the price of the "Edu-Kit." Our Consultation Service will help you with any technical problems you may have.

FROM OUR MAIL BAG

J. Stataitis, of 25 Poplar Pl., Waterbury Conn., writes: "I have repaired several sets for my friends, and made money. The "Edu-Kit" paid for itself. I was ready to spend \$240 for a Course, but I found your ad and sent for your Kit."

Ron Valerio, P. O. Box 21, Magna, Utah: "The Edu-Kits are wonderful. Here I am sending you the questions and also the answers to them, I have been in Radio for the last seven years, but like to work with Radio Kits, and like to build Radio Testing Equipment. I enjoyed every minute. The Signal Tracer works fine. Also like to let you know that I feel proud of becoming a member of your Radio-TV Club."

Robert L. Shuff, 1534 Monroe Ave., Huntington, W. Va.: "Thought I would drop you a few lines to say that I received my Edu-Kit, and was really amazed that such a bargain can be had at such a low price. I have already started repairing radios and phonographs. My friends were really surprised to see me get into the swing of it so quickly. The trouble-shooting Tester that comes with the Kit is really swell and finds the trouble, if there is any to be found."

PRINTED CIRCUITRY

At no increase in price, the "Edu-Kit" now includes Printed Circuitry. You build a Printed Circuit Signal Injector, a unique servicing instrument that can detect many radio and TV troubles. This revolutionary new technique of radio construction is now becoming popular in commercial radio and TV sets.

A Printed Circuit is a special insulated chassis on which has been deposited a conducting material which takes the place of wiring. The various parts are merely plugged in and soldered to terminals.

Printed Circuitry is the basis of modern Automation Electronics, and the subject is a necessity today for anyone interested in Electronics.

The brilliance of our new color replacement tube is matched only by the sharpness of its pictures

RCA MATRIX



Now it's easier to sell up to the best. RCA has added brightness without sacrificing sharpness! Here's how and why:

To produce the brightest color picture tube in RCA's history, we developed a new phosphor-dot screening process that incorporates a jet-black matrix. But we didn't stop there. We wanted a tube that could deliver sharp, vivid pictures even in strong room light. So, we added the brilliance of new phosphors and deposited each red, green and blue phosphor-dot within the black matrix. Result: brighter pictures with no loss of contrast. Thanks to the matrix technique, combined with our new high resolution gun and greatly improved phosphors, the Matrix is also the *sharpest* color picture tube in

RCA's history. Matrix owners can turn up brightness *without* "turning down" color!

Will your customers see the difference? You bet! What's more, they'll be pre-sold on the difference—every time they see the 1970 big-screen color sets people are talking about! So when they need a replacement tube, satisfy their appetite for brighter, sharper pictures. Don't replace their old tubes with another "old" tube. Give their sets new brilliance and more vividly detailed pictures with RCA Matrix. The Matrix Tube is 100% brighter than any previous color picture tube manufactured by RCA.

For complete details, call your RCA Distributor. RCA Electronic Components, Harrison, New Jersey



The RCA 25ECP22 Matrix Tube can directly replace 25XP22, 25BAP22 and also the following types: 25ABF22, 25AFP22, 25ANP22, 25AP22, 25AP22A, 25AQP22, 25BMP22, 25CP22, 25CP22A, 25GP22, 25GP22A, 25SP22, 25WP22, 25XP22, 25A22A and 25ZP22.

Dazzle your friends with lightworks.



Sound n' Color®

The new dimension to music pleasure. EICO All Electronic Solid-State Audio-Color Organs transform sound waves into moving synchronized color images. Connect easily to speaker leads of hi-fi or radio. From \$29.95.



Translators

The electronics you need to create audio-stimulated light displays to your own imagination. Actuates: Light Display Units, Strobe Lites, any lamp configuration (Xmas trees, patio lights, etc.). From \$24.95 kit, \$39.95 wired.



Strobe Lites

High-intensity bursts of white light from Xenon tube flash in cadence with each beat of audio. From \$24.95 kit, \$39.95 wired.

Build the Stereo Kits praised by experts.

All amplifier power ratings according to IHF standards. Cortina® designed and manufactured in U.S.A. and guaranteed by EICO.



70-Watt AM/FM Stereo Receiver including cabinet. Cortina 3770, \$189.95 kit, \$279.95 wired.

70-Watt FM Stereo Receiver including cabinet. Cortina 3570, \$169.95 kit, \$259.95 wired.



150-Watt Silicon Solid-State Stereo Amplifier, including cabinet. For the audio perfectionist. Cortina 3150, \$149.95 kit, \$225 wired.

70-Watt Silicon Solid-State Stereo Amplifier, including cabinet. Cortina 3070, \$99.95 kit, \$139.95 wired.



FM Stereo Tuner including cabinet. Cortina 3200, \$99.95 kit, \$139.95 wired.



EC-1100 FM WIRELESS MIKE \$9.95

Build for fun and use with Eicocraft® jiffy project kits.

The newest excitement in kits. 100% solid-state and professional. Expandable, interconnectable. Excellent as introductions to electronics. No technical experience needed. Finest parts, pre-drilled etched printed circuit boards, step-by-step instructions. 36 kits to select from, \$2.50 to \$9.95. Just released: EC-2600 "Super Snoop" \$8.95; EC-2700 Police & Fire Converter



(to band) \$7.95; EC-2800 Aircraft Converter \$7.95; EC-2900 Police & Fire Converter (hi band) \$7.95; EC-3100 2-Station Intercom (with cases) \$10.95; EC-3200 "Do-It-Yourself" PC Etching Kit \$4.95; EC-2300 Audio Preamp \$8.95; EC-2400 Bullhorn \$8.95; EC-2500 Fuzzbox \$8.95.



EC-1900 TREASURE FINDER \$9.95

Shape up your own car/boat with EICO Engine Analyzer

For all 6V/12V systems; 4, 6, 8-cyl. engines. Now you can keep your car or boat engine in tip-top shape with this solid-state, portable, self-powered universal engine analyzer.

Completely tests your total ignition/electrical system. Complete with comprehensive Tune-up & Trouble-shooting Manual. EICO 888, \$49.95 kit, \$69.95 wired.



The first and only solid state test equipment GUARANTEED FOR 5 YEARS

Only EICO brings you laboratory precision and long life at lowest cost.



EICO 240 Solid-State FET-TVOM \$59.95 kit, \$79.95 wired



EICO 379 Solid-State Sine/Square Wave Generator \$69.95 kit, \$94.50 wired



EICO 242 Solid-State Deluxe FET-TVOM \$69.95 kit, \$94.50 wired



EICO 150 Solid-State Signal Tracer \$49.95 kit, \$69.35 wired



EICO 330 Solid-State RF Signal Generator \$59.95 kit, \$84.50 wired

You save up to 50% with EICO Kits. Since 1945, Best Buys in Electronics. Over 3 Million EICO Instruments Now in Use.

FREE 1970 CATALOG

Send me FREE catalog describing the full EICO line of 200 best buys, and name of nearest dealer.



EICO Electronic Instrument Co., Inc.
283 Malta Street, Brooklyn, N.Y. 11207
EICO Canada Ltd.
20 Millwick Drive, Weston, Ontario

Name _____
Address _____
City _____ State _____ Zip _____

PE-3