

HOLOGRAMS—MAKE THEM WITH OUR LASER

POPULAR ELECTRONICS

JANUARY
1970

50
CENTS



**QUADRASONICS:
WHAT IT'S ABOUT**

**BUILD SOLID-STATE
AQUARIUM HEATER**

**TIMER FOR
HEADLIGHT SAFETY**

**MINIATURE
STEREO SPEAKERS**

**CAN YOU MEASURE
GRAVITY WAVES?**



**BUILD THE
WAA-WAA**

(page 45)



Electronics comes alive with NRI Training Kits

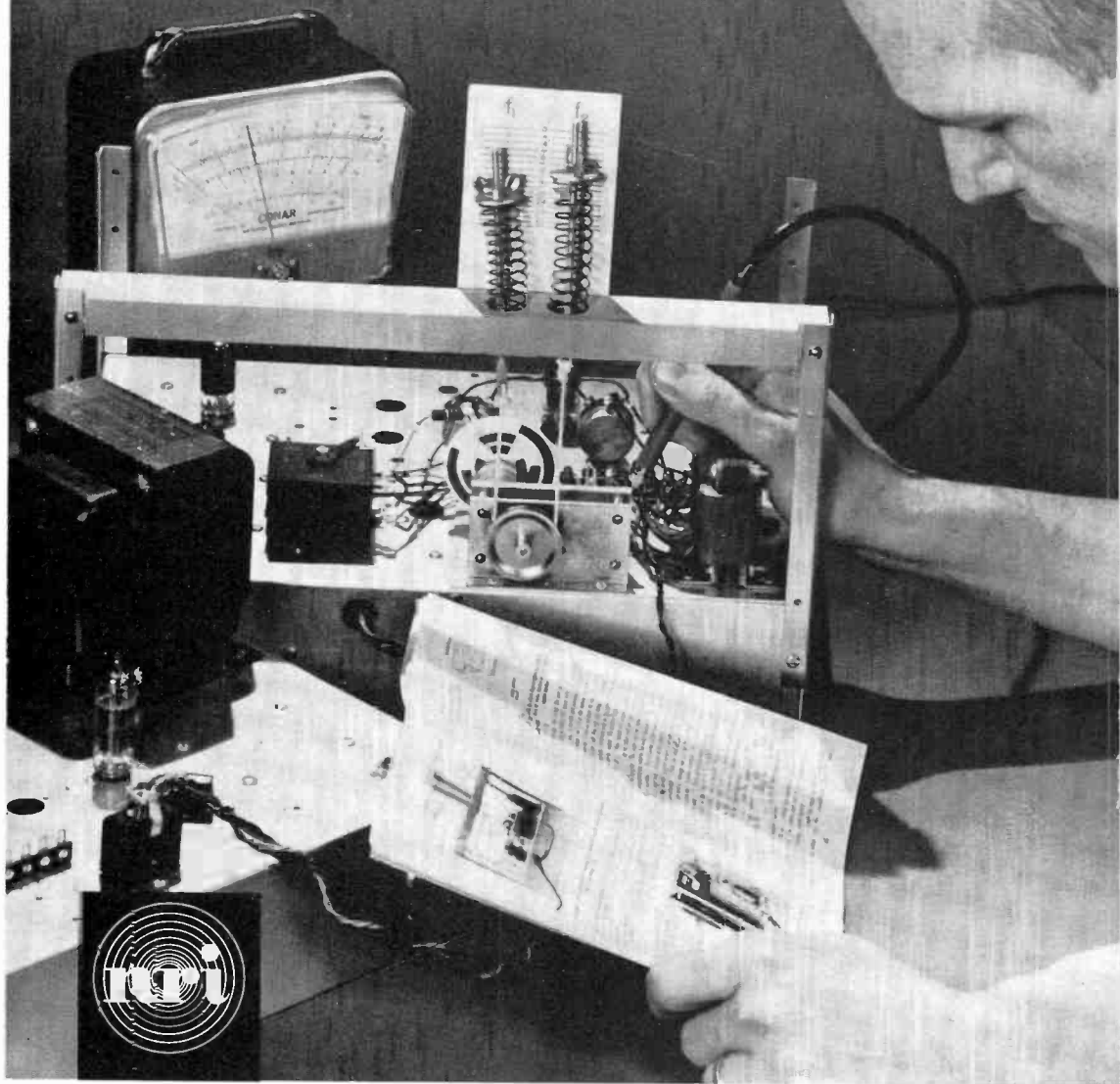

DISCOVER THE EASE AND EXCITEMENT OF TRAINING AT HOME THE NRI WAY

New Achievement Kit—Custom Training Kits—"Bite Size" Texts

Only NRI offers you this pioneering method of simplified "3 Dimensional" home-study training in Electronics, TV/Radio and Broadcasting/Communications. It's a remarkable teaching idea unlike anything you have ever encountered, the result of more than half a century of simplifying, organizing and dramatizing learning-at-home techniques. If you are an ambitious man—regardless of your education—you can effectively learn the Electronics field of your choice the NRI way.

NRI has *simplified* Electronics by producing "bite size" lesson texts averaging only 40 pages each. Dozens of illustrations open wide a picture window through which you'll see and understand practical uses of Electronics. You start out with NRI's exclusive Achievement Kit, containing everything you need to get started fast. (Illustrated at right.)

NRI has *organized* Electronics training to take you step-by-step from the first stages into more intriguing areas. Once you know the fundamentals thoroughly, it's easy to grasp more advanced theory and techniques. You move with confidence and enthusiasm into a new adventure filled with the excitement of discovery.

NRI has *dramatized* Electronics through the careful development of special training equipment that is *programmed* into your training systematically . . . beginning with your first group of lessons. Things you read about come alive in your hands as you build, experiment, purposely cause "problems" in circuits—and solve them. You learn to use test equipment, to build radios and TV sets, transmitter, or computer circuits. It's the priceless "third dimension" in NRI training . . . practical experience.

More than 50 years of leadership
in Electronics Training



YOU GET MORE FOR YOUR MONEY FROM NRI

Mail postage-free card now for your free NRI catalog. Then, compare. You'll find—as have thousands of others—NRI training can't be beat. Read about the new Achievement Kit sent the day you enroll; about "bite-size," texts and custom designed training equipment. See why NRI gives you more value. Whatever your reason for wanting more knowledge of Electronics, NRI has an instruction plan for you. Choose from major programs in TV/Radio Servicing, Industrial Electronics and Complete Communications. Or select from special courses to meet specific needs. Check the course of interest to you on postage-free card and mail today for free NRI catalog. No salesman will call. NATIONAL RADIO INSTITUTE, Electronics Div., Washington, D.C. 20016.

Available Under

NEW GI BILL

If you served since January 31, 1955, or are in service, check GI line in postage-free card.

Career? Part-Time Earnings? Hobby? Choose From 12 Training Plans

1. TELEVISION-RADIO SERVICING — Learn to fix all TV sets, including Color. Includes your choice of NRI Color Kit or 19" black-white TV Kit. Also covers radios, stereo hi-fi, etc. Profitable field spare or full-time.

2. INDUSTRIAL-MILITARY ELECTRONICS — Basics to computers. Starts with fundamentals, covers servos, telemetry, multiplexing, phase circuitry, other subjects.

3. COMPLETE COMMUNICATIONS* — Operation, service, maintenance of AM, FM and TV broadcasting stations. Also covers marine, aviation, mobile radio, facsimile, radar, microwave.

4. FCC LICENSE* — Prepares you for 1st Class FCC License exams. Begin with fundamentals, advance to required subjects in equipment and procedures.

5. MATH FOR ELECTRONICS — Brief course for engineers, technicians seeking quick review of essential math: basic arithmetic, short-cut formulas, digital systems, etc.

6. BASIC ELECTRONICS — For anyone wanting a basic understanding of Radio-TV Electronics terminology and components, and a better understanding of the field.

7. ELECTRONICS FOR AUTOMATION — Not for beginners. Covers process control, ultrasonics, telemetering and remote control, electromechanical measurements, other subjects.

8. AVIATION COMMUNICATIONS* — Prepares you to install, maintain, service aircraft in-flight and landing systems. Earn your FCC License with Radar Endorsement.

9. MARINE COMMUNICATIONS* — Covers electronic equipment used on commercial ships, pleasure boats. Prepares for FCC License with Radar Endorsement.

10. MOBILE COMMUNICATIONS* — Learn to install, maintain mobile transmitters and receivers. Prepares for FCC License exams.

11. ELECTRICAL APPLIANCE REPAIR — Learn to repair all appliances, including air conditioning, refrigeration, small gas engines. Leads to profitable part or full-time business.

12. ELECTRONICS FOR PRINTERS — Operation and maintenance of Electronic equipment used in graphic arts industry. From basics to computer circuits. Approved by major manufacturers.

* You must pass your FCC License exams (any Communications course) or NRI refunds in full the tuition you have paid.

POPULAR ELECTRONICS

VOLUME 32 NUMBER 1

JANUARY, 1970

WORLD'S
LARGEST-SELLING
ELECTRONICS
MAGAZINE

SPECIAL FEATURE

- DO IT YOURSELF LASER HOLOGRAPHY** 27 C. Harry Knowles
Create three-dimensional images on film

FEATURE ARTICLES

- A PAIR OF LOADED DICE** 40 David B. Weems
Bookshelf speakers that fit on a bookshelf
- THE WAA-WAA** 45 John S. Simanton, Jr.
A new sound for your guitar
- BUILD THE TIME OUT** 52 John Stayton
For safety in the driveway
- ELECTRONIC AQUARIUM HEATER** 60 Stacey Jarvin
- MICRO-SENSITIVE SCHMITT TRIGGER** 64 Frank H. Tooker
- SCS SIGNAL-SQUARING ADAPTER** 65 Frank H. Tooker
- AN EXPERIMENT WITH GRAVITY** 66 Cdr. Thomas Appleby
Check strange forces with your receiver
- THE STEREO SCENE** 67 Charles Lincoln
Quadrasonic (four-channel) stereo
- THE PRODUCT GALLERY** 71
PC Board Kit
"Stor-A-Tape" Carry-Pac
- ENGLISH LANGUAGE NEWS BROADCASTS TO N.A.** 76 Roger Legge
- SHORT-WAVE LISTENING** 77 Hank Bennett, W2PNA
The bootleggers are active
- TWO-WAY REACTIONS** 79 G. H. Reese, KCN6990
- AMATEUR RADIO** 81 Herb S. Brier, W9EGQ
An Oscar from Russia?
- SOLID STATE** 83 Lou Garner
What's in store for 1970?

DEPARTMENTS

- LETTERS FROM OUR READERS** 8
- OUT OF TUNE** 9
Build a Capacitance Meter (October 1969)
- NEW LITERATURE** 12
- ELECTRONICS LIBRARY** 14
- READER SERVICE PAGES** 15, 97
- NEW PRODUCTS** 22
- OPERATION ASSIST** 100

POPULAR ELECTRONICS is indexed
in the Readers' Guide
to Periodical Literature

This month's cover drawing by
Bob Korn

Copyright © 1969 by ZIFF-DAVIS PUBLISHING COMPANY. All rights reserved.

POPULAR ELECTRONICS, January 1970, Volume 32, Number 1, Published monthly at One Park Ave., New York, N.Y. 10016. One year subscription rate for U.S., U.S. Possessions and Canada, \$6.00; all other countries, \$7.00. Second class postage paid at New York, N.Y. and at additional mailing offices. Authorized as second class mail by the Post Office Department, Ottawa, Canada and for payment of postage in cash. Subscription service and Forms 3579: Portland Place, Boulder, Colorado 80302. Editorial offices for manuscript contributions, reader inquiries, etc.: One Park Ave., New York, N.Y. 10016.

Grantham School of Engineering PE-1-70

1505 N. Western Ave., Hollywood, Calif. 90027

Gentlemen:

Please mail me your free Bulletin which explains how the Grantham home-study educational program can prepare me for my Associate in Science Degree in Electronics Engineering.

Name _____ Age _____

Address _____

City _____ State _____ Zip _____



Grantham School of Engineering

has conferred on

John Doe

the degree of

Associate in Science in Electronics Engineering

with all the rights and privileges thereunto appertaining. In witness thereof this diploma duly signed has been issued by the School Administration upon recommendation of the faculty at the School on this



first day of October, 19 68

D.J. Grantham
President
E. J. Watson
Acting Dean



Grantham School of Engineering

has conferred on

John Doe

the degree of

Bachelor of Science in Electronics Engineering

with all the rights and privileges thereunto appertaining. In witness thereof this diploma duly signed has been issued by the School Administration upon recommendation of the

faculty at the school on this sixth day of December, 19 68



D.J. Grantham
President
K. J. Denney
Dean

Grantham School of Engineering Home Study Division

1505 N. Western Ave.

Hollywood, Calif. 90027

Telephone:

(213) 469-7878

CIRCLE NO. 12 ON READER SERVICE PAGE



January, 1970

Three Big Steps to Success... in

ELECTRONICS ENGINEERING

There they are — three big steps that lead electronics technicians to *greater success* — three deliberate steps to *greater recognition* and *more income*. Your future is shaped by the moves you make — by the steps you take. Begin now with Step #1.

STEP #1 is a simple request for full information on the Grantham Electronics Degree Program. You take this first step by filling out and mailing the coupon. Then, we mail our catalog to you; we do not send a salesman.

STEP #2 is earning your Associate in Science Degree in Electronics Engineering (the ASEE). If you have completed at least one year of fulltime experience as a bona fide electronics technician, you may earn your ASEE Degree almost entirely by correspondence — including a minimum resident attendance of only two weeks.

STEP #3 is earning your Bachelor's Degree in Electronics Engineering. Upon earning your ASEE Degree you may have reached your objective, or you may wish to continue and earn your BSEE Degree. The Grantham BSEE Degree program is offered in evening classes in Hollywood, and is designed especially for employed engineering technicians who hold the ASEE Degree.

Accreditation and G.I. Bill Approval

The Home Study Division of Grantham School of Engineering is accredited by the Accrediting Commission of the National Home Study Council. Both the Home Study Division and the Resident Division are approved under the G.I. Bill, and both divisions are legally authorized to grant academic degrees.

The Home-Study Method

Grantham School of Engineering is a *specialized*, college-level, educational institution—established in 1951—which teaches engineering by the so-called “new approach.” This is the method (often referred to by names such as “independent study”) that has recently created great interest among college educators. Actually, this “new approach” is not new at all. Grantham and many other good schools have been using it for years, under such names as “home study” and “correspondence instruction.”

Now that the method has become “respectable” and is being used by reputable colleges to lead to bachelor's degrees, Grantham can offer electronics technicians the opportunity to study for an accredited ASEE Degree mostly by correspondence. As a technician, you already know the “hardware” side of electronics, and you can upgrade from technician to engineer while you continue your employment as a technician. Get complete details. Mail the coupon for our free bulletin.

**The people
most likely to
appreciate the new
Dual 1209
are the least likely
to need one.**

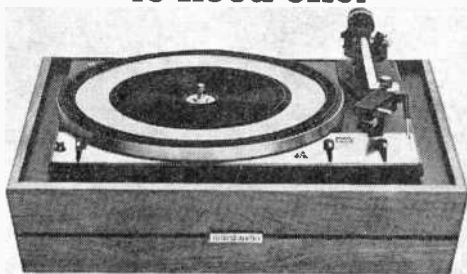

If you already own an earlier Dual automatic turntable, you can really appreciate the new Dual 1209.

Because the 1209, just like your present Dual, offers flawless tracking and smooth, quiet performance that will be yours for years to come.

All Duals are made that way. And all recent ones have such exclusive features as pitch control that lets you "tune" your records by a semitone. No wonder so many hi-fi professionals use Duals in their personal stereo component systems.

But the 1209, at \$129.50, has some new refinements of more than passing interest. A motor with high starting torque plus synchronous speed constancy. Anti-skating separately calibrated for elliptical and conical styli. A tonearm counterbalance with hundredth-gram click-stop adjustments.

These refinements aren't intended to seduce you away from your present Dual. But if you don't already own a Dual, perhaps it's time you talked with someone who does.

United Audio Products, Inc.,
120 So. Columbus Ave., Mt. Vernon,
New York 10553. 

CIRCLE NO. 30 ON READER SERVICE PAGE

POPULAR ELECTRONICS

LAWRENCE SPORN
Publisher

OLIVER P. FERRELL
Editor

LESLIE SOLOMON
Technical Editor

JOHN R. RIGGS
Managing Editor

EDWARD I. BUXBAUM
Art Director

ALEXANDER W. BURAWA
Associate Editor

ANDRE DUZANT
Technical Illustrator

PATTI MORGAN
Assistant Editor

H. BENNETT, W2PNA
H. S. BRIER, W9EGQ

L. E. GARNER, JR.
G. H. REESE, KCN6990
Contributing Editors

RICHARD J. HALPERN
Advertising Manager

ROBERT UR
Marketing Manager

MARGARET DANIELLO
Advertising Service Manager

FURMAN H. HEBB
Group Vice President
Electronics and Photographic

ZIFF-DAVIS PUBLISHING COMPANY

Editorial and Executive Offices
One Park Avenue, New York, New York 10016
212 679-7200

Midwestern Office
307 North Michigan Avenue, Chicago, Illinois 60601
312 726-0892

Midwestern Advertising Manager, JAMES WEAKLEY

Western Office
9025 Wilshire Boulevard, Beverly Hills, California 90211
213 CResview 4-0265; BRadshaw 2-1161
Western Advertising Manager, BUD DEAN

Japan: James Yagi
Ishikawa Mansion, #4, Sakuragaoka
Shibuya-ku, Tokyo, 462-2911-3

Circulation Office
Portland Place, Boulder, Colorado 80302

William Ziff, President
W. Bradford Briggs, Executive Vice President
Hershel B. Sarbin, Senior Vice President
Stanley R. Greenfield, Senior Vice President
Philip Sine, Financial Vice President
Walter S. Mills, Jr., Vice President, Circulation
Phillip T. Heffernan, Vice President, Marketing
Frank Pomerantz, Vice President, Creative Services
Arthur W. Butzow, Vice President, Production
Edward D. Muhlfield, Vice President, Aviation Division
Irwin Robinson, Vice President, Travel Division
Furman Hebb, Administrative Vice President
George Morrissey, Vice President
Sydney H. Rogers, Vice President

Ziff-Davis also publishes *Airline Management and Marketing*, *Boating*, *Business & Commercial Aviation*, *Car and Driver*, *Cycle*, *Electronics World*, *Flying*, *Modern Bride*, *Popular Photography*, *Skating*, *Skating Area News*, *Skating Trade News*, *Stereo Review*, and *Travel Weekly*.

Forms 3879 and all subscription correspondence should be addressed to POPULAR ELECTRONICS, Circulation Department, Portland Place, Boulder, Colorado 80502. Please allow at least six weeks for change of address. Include your old address, as well as new-enclosing if possible an address label from a recent issue.

EDITORIAL CONTRIBUTIONS must be accompanied by return postage and will be handled with reasonable care; however, publisher assumes no responsibility for return or safety of art work, photographs or manuscripts.



Member Audit Bureau
of Circulations

enter the vehicular base gain antenna.



With five words, Antenna Specialists Co. creates a far-reaching new concept of mobile performance—
THE VEHICULAR BEAM ANTENNA SYSTEM.

✓ **Breakthrough!** Up to 2.5 dB gain—first true gain mobile antenna system in CB history!

✓ **Breakthrough!** World's first mobile beam!

✓ **Breakthrough!** Antenna Specialists' exclusive Scanner® principle of electronic sector focusing goes mobile!

✓ **Breakthrough!** Dashboard control of your mobile antenna performance!

Mobile Scanner Vehicular Beam Antenna Systems.



*Write for
illustrated
brochure!*

the antenna specialists co.

Division of Allen Electric and Equipment Company
12435 Euclid Avenue, Cleveland, Ohio 44106
Export Offices, 2200 Shames Dr., Westbury, N.Y. 11590



Stripes of Quality®

CIRCLE NO. 5 ON READER SERVICE PAGE

letters

FROM OUR READERS

ANGRY READERS ANGER READERS

In regard to the "Angry Voice" article in the September issue and subsequent reader letters in November, I want equal time to comment.

Misguided people of the extreme right are noted for their prolific letter writing as one of the sinister means of undermining our American democracy. The reasonable middle-of-the-road outlook is our only hope for a better future. In this space-age world we cannot live with a system that stagnates at the horse and buggy.

JOHN MILLER
Dallas, Texas

The reader response is a great surprise. WINB must certainly give a negative view of American culture. Surely the readers must realize that overseas listeners are not influenced by anti-communist propaganda any

more than we are by the harangues of Radio Peking.

JACK YEAGER
Montreal, P.Q.

I am amused at the reader response. It displays the usual intolerance of those that rebel against communism, but deny others the right of freedom of speech. It all reminds me of the play "The Crucible".

NAME WITHHELD

I'm delighted you accepted responsibility for comment on the abuse of shortwaves. I wrote FCC Commissioner Johnson deploring the WINB violation of FCC regulations.

WILLIAM KIRALY
Cleveland, Ohio

I re-read the WINB story and failed to find the evil motivations. The FCC has the responsibility to insure that the airwaves (which are mine just as much as WINB) are used for the public good.

D. K. KING
Wichita, Kansas

WINB OWNER RESPONDS

It seems Mr. Kent is parroting some of the "liberal press" when he writes about WINB. Let me give you a play-by-play account:

(1) I started WGCB in October of 1950 and Dr. McIntire aired his first broadcast on our station in January 1958. I am sure I gave some credit to Dr. McIntire in helping me ac-

Patented components . . . a 30-year reputation for innovative design . . . a consistently creative approach to sound reproduction . . . this is where it all comes together, in the creation of extraordinary speakers such as the 312.

A glance at its specifications will tell you the 312 is an exceptionally fine reproducer. Unfortunately, they won't begin to show you how extraordinarily pleasing the sound is that flows from it. You must discover that for yourself, by listening. It's not inexpensive. Still, it's only about half what you'd expect to pay. Hear the 312 soon. Find out why we call it: "the speaker your other components will be proud of."

This is where it all comes together

"Listen . . .
University
Sounds
Better."

Specifications: Model 312 3-way 12" Diffaxial Speaker. Frequency response: 28 to well over 40,000 Hz. Patented Sphericon tweeter is flat within 2 db to 22,000 Hz. Power rating: 35 watts integrated program material. Impedance: 8-16 ohms. Crossover: 1000 Hz (mechanical), 3000 Hz (electrical). Dimensions: 13" overall dia 6 1/2" deep. Mounting: Front or rear baffle. Special Features: Rigid, die-cast frame. Wide-angle dispersion by patented Sphericon Super Tweeter and exclusive Diffusicone principle. Rigid cup baffle (eliminates tweeter-woofer interference). High compliance suspension with University's exclusive Critical Edge Damping.



UNIVERSITY SOUND
A DIVISION OF LTV LING ALTEC, INC.
P. O. Box 26105, Oklahoma City, Okla. 73126



CIRCLE NO. 32 ON READER SERVICE PAGE

quire WINE which was started in the fall of 1962, in that he and several friends of mine bought air time in advance and paid cash for it so that I could get under way.

(2) Up until several years ago I was the sole owner of WINB. I incorporated WINB to include my son, my attorney and myself. I feel certain that the Kent article was published to discourage advertisers that are doing business with us.

Much seems to be made of the fact that many American-made programs are aired on WINB. It is our belief that you should tell the truth to the best of your ability. It is not true that WGCB and WINB have entered into the business of editorializing. One might say that Dr. McIntire's dissent in certain areas is not acceptable as programming for international stations; however, this could be wrong since he is President of the International Council of Christian Churches with affiliates both here and abroad.

A one-point-of-view culture is unthinkable in this land of ours.

REV. JOHN M. NORRIS
WGCB AM-FM, WINB

READER SERVICE

Thank you for the Reader Service Page published in each issue. Using this Service I am able to keep up with all the new products.

R. E. ADAMS
Nashville, Ga.

We are glad that reader Adams has found the Service page useful. Manufacturers usually respond to Service inquiries within a short period of time. It is an excellent method of finding out just what products have features you most desire.

WRONG WIRE WRAPPING

I hope the picture of the wire wrapping ("Stereo Scene", November, page 70) is a reject—it's a classic example of don'ts! The specs for a good wrap are 1½ turns of insulation followed by a minimum of 5 turns of bare wire.

B. STOVALL
Opelika, Ala.

Reader Stovall is correct and our photo retoucher has been sent to school.

OUT OF TUNE

"Build A Capacitance Meter," October 1969. The B1 and B2 terminals of Q2 in Fig. 1 on page 67 are incorrectly identified; simply transpose the numbers. Also, reverse the polarity of diode D1.

January, 1970



Which of these
4 fascinating
Radio-TV
careers

interests
you?

disc jockey
 newscaster
 sportscaster
 announcer

Our Free Voice Analysis Tells You Whether You Have The Talent To Become A Broadcast Personality!

IMMEDIATE DEMAND • Radio-TV stations everywhere need both men and women to take over important good-paying jobs right now. **NATIONWIDE PLACEMENT ASSISTANCE** at No Extra Cost.

TRAIN AT HOME OR IN ONE OF OUR STUDIO SCHOOLS • You can study broadcast techniques at home, in your spare time, or in one of our many studio schools throughout the country under the supervision of our Directing Faculty of 10 Famous Broadcasters. Accredited Member National Home Study Council and National Association of Trade and Technical Schools.

Approved for Veterans' Educational Assistance Benefits ("G.I. Bill")! Check coupon for special information

Send to CAREER ACADEMY's division of famous broadcasters for free booklet, record and voice analysis details!

CAREER ACADEMY

825 N. Jefferson Street • Dept. N87212
Milwaukee, Wisconsin 53202

I want to know if I have broadcasting aptitude worth developing. Please rush more information.

name _____ age _____

address _____ phone _____

city/state/zip _____

I am interested in: Home Study
 School Study G. I. Bill



CIRCLE NO. 8 ON READER SERVICE PAGE

More New Kits From

Introducing The Advanced New Heathkit 60-Watt AM/FM/FM Stereo Receiver

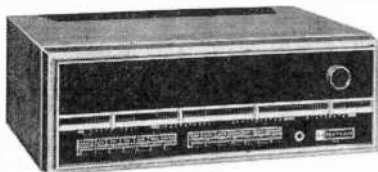
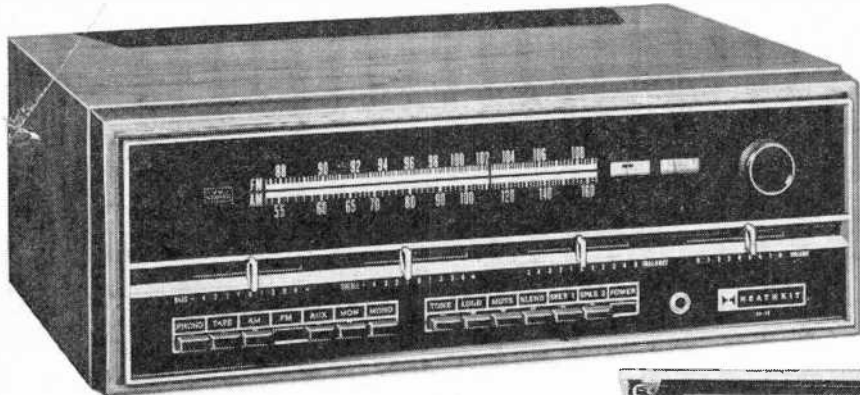

Heathkit AR-19

\$225.00*

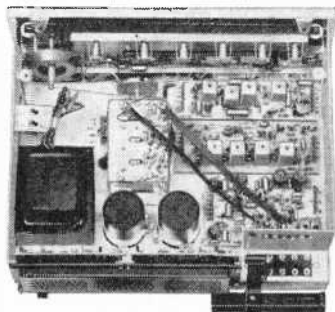

Third In The New Generation Of Superb Solid-State Receivers From Heath . . . And Low In Cost

• Advanced solid-state circuitry with 108 transistors, 45 diodes and 5 integrated circuits • 60 watts music power output at 8 ohms • Less than 0.25% Harmonic & IM Distortion at any power level • Frequency response from 6 to 35,000 Hz • Direct-coupled, transformerless outputs for lowest distortion and phase shift • Dissipation-limiting circuitry protects outputs from damage even with a short circuit • Assembled, aligned FET FM tuner has 2.0 uV sensitivity to give you more listenable stations • Ball-bearing inertia flywheel tuning for smooth, accurate station selection • Preassembled, factory aligned FM IF circuit board speeds assembly and eliminates IF alignment, gives 35 dB selectivity • Multiplex IC circuit provides inherent SCA rejection • Pushbutton Mute control attenuates between-station FM noise • Blend control reduces on-station FM noise with a push of a button • Tone-flat pushbutton disables bass & treble controls for perfectly "flat" response • New linear motion controls for volume, balance, bass & treble • Individually adjustable level controls for each input including tape monitor eliminate annoying volume changes when switching sources • Switches for two separate stereo speaker systems for stereo sound in two different locations • Center channel speaker capability • Two front panel tuning meters give exact station selection • Stereo indicator light • Front panel stereo headphone jack • 300 & 75 ohm FM antenna inputs • High fidelity AM reception • Built-in AM rod antenna swivels for best reception • Massive power supply includes section of electronically regulated-power • New Heath modular plug-in circuit board design speeds assembly, aids servicing • Built-in Testing facilities aids construction, simplifies servicing • Circuit board & wiring harness construction for easy, enjoyable 25 hour assembly

Ahead of its time . . . those who want to hear stereo high-fidelity as it will sound in the 70's can begin right now, at a modest price, with the Heathkit AR-19. Its design is an extension of the advanced circuitry concepts first introduced in the AR-15. These receivers are truly of a new generation . . . they've expanded audio engineering horizons and set the pace for the 70's.

Field Effect Transistor And Integrated Circuit Design. The AR-19 uses advanced semi-conductor circuitry . . . including five integrated circuits, with a total of 108 transistors and 45 diodes. The pre-assembled FM tuning unit uses an RF field effect transistor to provide high sensitivity and low cross modulation with no overloading

on strong local stations. In the AM RF circuit also, field effect transistors give superior sensitivity and large signal handling capacity.

Ideal For Most Home Stereo Installations. The AR-19 is just right for the medium and high efficiency speaker systems that are so popular today. It can form the nucleus of a fine stereo system . . . and will probably be the most attractive part, thanks to its rich oiled pecan wood cabinet and to the "Black Magic" front panel. The scale and dial readings appear only when the power is on.

Features To Aid The Kit Builder. All 8 circuits of the AR-19 snap in and out in seconds. Think of the resulting convenience and ease of assembly! In addition, the AR-19 has built-in test circuitry . . . two test probes with the front panel meter for indications. With it, the user can check out circuit parts without the need for expensive external test equipment. Proper use of this feature is fully covered in the manual.

Don't Wait For Something Better To Come Along . . . it'll be a long wait. Up-grade your stereo system now, with this outstanding receiver value.

Kit AR-19, 29 lbs. \$225.00*
Assembled AE-19, cabinet, 10 lbs. \$19.95*

PARTIAL AR-19 SPECIFICATIONS — AMPLIFIER: Continuous power output per channel: 20 watts, 8 ohms. IHF Power output per channel: 30 watts, 8 ohms. Frequency response: (1 watt level) —1 dB, 6 Hz —35 kHz. Power bandwidth for constant 0.25% THD: Less than 5 Hz to greater than 30 kHz. Harmonic distortion: Less than 0.25% from 5 Hz to 20 kHz at 20 watts rms output. Less than 0.1% at 1000 Hz at 1 watt output. IM Distortion: Less than 0.25% with 20 watts output. Less than 0.1% at 1 watt output. Hum and noise: Phono input, —65 dB. Phono input sensitivity: 2.4 millivolts; overload, 155 millivolts. FM: Sensitivity: 2.0 uV, IHF. Volume sensitivity: Below measurable level. Selectivity: 35 dB. Image rejection: 90 dB. IF Rejection: 90 dB. Capture ratio: 2.5 dB. Total harmonic distortion: 1% or less. IM Distortion: 0.5% or less. Spurious rejection: —90 dB. FM STEREO: Separation: 35 dB at midfrequencies; 30 dB at 50 Hz; 25 dB at 10 kHz; 20 dB at 15 kHz. Frequency response: ±1 dB from 20-15,000 Hz. Harmonic distortion: 1.5% or less @ 1000 Hz with 100% modulation. 19 kHz & 38 kHz. Suppression: 50 dB. SCA Suppression: 50 dB. AM SECTION: Sensitivity: Using a roacing loop, 130 uV/M @ 1000 kHz. Selectivity: 25 dB at 10 kHz. Image rejection: 60 dB @ 600 kHz. 60 dB @ 1400 kHz. IF Rejection: 60 dB @ 1000 kHz. Harmonic distortion: Less than 2%. Hum & noise: —40 dB.

The Leader



New Heathkit 100-Watt AM/FM/FM-Stereo Receiver

World's finest medium power stereo receiver... designed in the tradition of the famous Heathkit AR-15. All Solid-State... 65 transistors, 42 diodes plus 4 integrated circuits containing another 56 transistors and 24 diodes. 100 watts music power output at 8 ohms — 7 to 60,000 Hz response. Less than 0.25% distortion at full output. Direct coupled outputs protected by dissipation-limiting circuitry. Massive power supply. Four individually heat-sinked output transistors. Linear motion bass, treble, balances and volume controls. Push-button selected inputs. Outputs for 2 separate stereo speaker systems. Center speaker capability. Stereo headphone jack. Assembled, aligned FET FM tuner has 1.8 uV sensitivity. Two tuning meters. Computer designed 9-pole L-C filter plus 3 IC's in IF gives ideally shaped bandpass with greater than 70 dB selectivity and eliminates alignment. IC multiplex section. Three FET's in AM tuner. AM rod antenna swivels for best pickup. Kit Exclusive: Modular Plug-In Circuit Boards... easy to build & service. Kit Exclusive: Built-In Test Circuitry lets you assemble, test and service your AR-29 without external test equipment. The AR-29 will please even the most discriminating stereo listener.

Kit AR-29, (less cabinet), 33 lbs.....\$285.00*
 AE-19, Assembled oiled pecan cabinet, 10 lbs.....\$19.95*

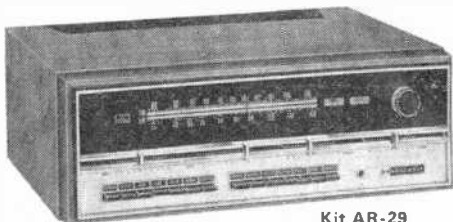

Kit AR-29
\$285*

New Heathkit Deluxe 18-Watt Solid-State Stereo Phono

Looks and sounds like it should cost much more. Here's why: 16-transistor, 8-diode circuit delivers 9 watts music power per channel to each 4 1/2" high-compliance speaker. Speaker cabinets swing out or lift off... can be placed up to 10' apart for better stereo. Has Maestro's best automatic, 4-speed changer — 16, 33-1/3, 45 & 78 rpm. It plays 6 records, shuts off automatically. Ceramic stereo cartridge with diamond/sapphire stylus. Has volume, balance & tone controls. Changer, cabinet & speaker enclosures come factory built... you build just one circuit board... one evening project. Wood cabinet has yellow-gold & brown durable plastic coated covering. This is a portable stereo you can take pride in.

Kit GD-109, 38 lbs.....\$74.95*



Kit GD-109
\$74.95*

New Heathkit 80-10 Meter 2 KW Linear Amplifier

Incomparable performance and value. The new SB-220 has 2000 watts PEP input on SSB & 1000 watts on CW and RTTY. Uses a pair of Eimac 3-500Z's. Pretuned broad band pi input coils. Requires only 100 watts PEP drive. Solid-state power supply operates from 120 or 240 VAC. Circuit breaker protected. Safety interlocked cover. Zener diode regulated operating bias. Double shielded for max. TVI protection. Quiet fan — fast, high volume air flow. Also includes ALC to prevent over-driving. Two meters: one monitors plate current; the other is switched for relative power, plate voltage and grid current. Styled to match Heath SB series. Assembles in about 15 hours.

Kit SB-220, 55 lbs.....\$349.95*



Kit SB-220
\$349.95*

New Heathkit
 Solid-State Portable
 Fish-Spotter



Kit MI-29
\$84.95*

Costs half as much as comparable performers. Probes to 200 ft. Spots individual fish and schools... can also be used as depth sounder. Manual explains typical dial readings. Transducer mounts anywhere on suction cup bracket. Adjustable Sensitivity Control. Exclusive Heath Noise-Reject Control stops motor ignition noise. Runs for 80 hrs. on two 6 VDC lantern batteries (not included). Stop guessing — fish electronically.

Kit MI-29, 9 lbs.....\$84.95*



Kit MI-19
\$69.95*

New Heathkit Solid-State Depth Sounders

Let its flashing indicator light guide you through strange waters... day or night. Sounds to 200 ft. Has Noise Rejection and Sensitivity controls. Operates from your 12 VDC boat battery. Sun-shielded dial. All solid-state.

Kit MI-19-1, (with thru-hull transducer), 7 lbs.....\$69.95*

Kit MI-19-2, (with high speed transom mount), 7 lbs.....\$69.95*



NEW
FREE 1970 CATALOG!
 Now with more kits, more color. Fully describes these along with over 300 kits for stereo/hi-fi, color TV, electronic organs, guitar amplifiers, amateur radio, marine, educational, CB, home & hobby. Mail coupon or write Heath Company, Benton Harbor, Michigan 49022.

HEATH COMPANY, Dept. 10-1
 Benton Harbor, Michigan 49022

a Schlumberger company

Enclosed is \$_____ plus shipping.

Please send model(s) _____
 Please send FREE Heathkit Catalog. Please send Credit Application.

Name _____

Address _____

City _____

State _____

Zip _____

*Mail order prices; F.O.B. factory. Prices & specifications subject to change without notice.

CL-373

CIRCLE NO. 14 ON READER SERVICE PAGE

The best base station microphone in the world.



Turner +3

Modern styling. Transistorized pre-amp. Volume control. Modu-Gard™: a compression amplifier circuit that guarantees you cannot over-modulate. Clear signal, always. No interference with adjacent channels, regardless of volume setting. 300-3,000 Hz frequency response for best voice transmission. Relay or electronic switching. Push-to-talk bar. Lock lever. The Best. At your local dealers, list price \$75.00.

The TURNER Company, Inc.

A subsidiary of Conrac Corporation
909 17th St. N.E., Cedar Rapids, Iowa 52402

CIRCLE NO. 29 ON READER SERVICE PAGE



new literature

To obtain a copy of any of the catalogs or leaflets described below, simply fill in and mail the coupon on page 15 or 97.

The 1970 Burstein-Applebee radio-TV electronics catalog, No. 701, now available on request, lists thousands of items from brand-name manufacturers. The 260-page catalog features home items such as radios and TV receivers, hi-fi equipment, electrical appliances, tools, etc. There are items listed for the ham, CB'er, SWL'er, and experimenter/hobbyist. Spotted throughout the catalog are special interest items, such as cameras and other optical equipment, electronic musical instruments, intercom systems, typewriters and adding machines, and even a portable electric refrigerator. A complete line of electronic components, test equipment, and accessory equipment round out the listings.

Circle No. 75 on Reader Service Page 15 or 97

Unique Lighting Handbook No. 9100 is available from Edmund Scientific Co. (380 Edscorp Bldg., Barrington, N.J. 08007) for \$3. It is a compilation of information on the techniques and equipment used for making large- and small-scale lighting effect displays for musical accompaniment, out-of-this-world "psychedelia" shows, and simple mood setting. The effects explained range from black light to flashing xenon-discharge tube setups. The booklet explains in detail how each effect is produced, gives specifications on the items and equipment needed, and shows how to make your own light displays. Anyone who is interested in lighting will want this handbook.

ZIP COMES TO CRYSTALS

Purchasing certain products through retail outlets is sometimes a difficult procedure if the product is not on hand—with the result that, too often, the purchaser settles for a substitute. Communications equipment is no exception and crystals, in particular, are often hard to find. Zip Crystal Certificates are now available at distributors and retailers to permit the purchaser to get the crystal he wants directly from the manufacturer (Crystek, Fort Myers, Fla.). The buyer simply purchases a certificate, mails it to Crystek, and the crystal is sent by first class mail directly to him.



NTS home-training can take you to the Moon... and to lots of other exciting places.

Excitement is only the beginning. New money-making opportunities are also wide open to you. The age of Communications is just beginning in TV, Radio, Communication Satellites, Radio Tracking Telescopes, and many more. You can multiply your income with Space-age skills in missile count-down systems, giant microwave systems, stereophonics, two-way radio networks, television transmitters and cameras. You can earn better than 7 dollars an hour, over \$12,000 a year. There are no limits. And, NTS can give you everything you need to know to make you part of this big and rewarding field.

FCC License is your key. Two Communications programs get you going: (1) The FCC License Course. (2) The Master Course in Electronic Communications (which is more comprehensive and features Citizens' Band Two-way-Radio). Both programs qualify you for your FCC First Class Commercial Radio-Telephone License. NTS assures you will pass the exam, or your tuition is refunded. This NTS training program will open doors for you into a whole new world of opportunity. We prepare you for the top jobs in Communications.

14 big NTS kits included in each course at no extra cost. You build: (1) A professional Volt-Ohmmeter. (2) A Solid State (6-Transistor) Radio. (3) An Amateur Phone 6-Meter VHF Transceiver.

This Transceiver is an NTS exclusive. You send and receive. You learn both operations. Working with lessons and NTS kits you get the best possible training. And, the pay-off is big.

NTS "Project Method" makes learning come alive. The classroom-proven NTS "Project Method" home-training program is well organized and practical. It integrates valuable equipment with fascinating lesson projects. Makes complicated circuits and components easy to understand. You build these kits to put theory into practice. NTS gives you more kits than any other home-training school and they are the best kits available. With the "Project Method" you are your own man doing your own thing at your own pace, working with equipment that makes your lessons happen in your hands and your head at the same time. That's "Project Method." It makes learning easy, exciting, complete.

Send for free color catalog plus NEW Communications supplement and sample lesson. No obligation. No salesman will call.

Classroom training at Los Angeles. You can take classroom training at Los Angeles in sunny Southern California. NTS occupies a city block with over a million dollars in facilities devoted exclusively to technical training. Check box in coupon.

Approved for Veterans. Accredited Member: National Association of Trade and Technical Schools, National Home Study Council.

NATIONAL TECHNICAL SCHOOLS

WORLD-WIDE TRAINING SINCE 1905

4000 So. Figueroa St., Los Angeles, Calif. 90037

NATIONAL TECHNICAL SCHOOLS Dept. 241-010
4000 So. Figueroa St., Los Angeles, California 90037

Please send free color catalog, NEW Communications supplement, and sample lesson. No obligation. No salesman will call.

Master Course in Electronic Communications, with FCC License Course

Name _____ Age _____

Address _____

City _____ State _____ Zip _____

Check if Interested in Veteran Training under new G.I. Bill
 Check if Interested ONLY in Classroom Training at Los Angeles





FEEDBACK ON THE MOVE

JOHN OVERLEY
Senior Engineer

One of a
series of
brief
discussions
by
Electro-Voice
engineers

Basic physics tells us that if you move a coil of wire in a magnetic field, a voltage will be created that is exactly proportional to the velocity of the coil. It is this voltage (back EMF) that has recently been harnessed by Electro-Voice to provide motional feedback control of speaker action.

The essence of the E-V development is a network that is inserted between the amplifier output and the speaker. It is capable of balancing out the driving voltage, leaving only the back EMF generated by the speaker as a product.

Output of this circuit provides a feedback voltage (reflecting cone motion) to the amplifier input. In practice it serves the same purpose as conventional inverse feedback circuits except that it includes the transducer in its path. The benefits of motional feedback are likewise similar to other feedback circuits: significant reduction of total harmonic and intermodulation distortion, and positive control of frequency response.

Since the low frequency acoustic output of a speaker in a sealed enclosure is proportional to cone acceleration, and since the feedback circuit corrects response, on the basis of speaker velocity, an additional network is required. This circuit equalizes bass at a rate of 6 db/octave to achieve acoustically flat output.

The technique permits exceptionally flat response in an integrated system, subject to the limits of available amplifier power, maximum cone excursion, and voice coil heat dissipation. Useful low frequency output can be extended an octave or more below normal speaker design limits. And careful balance of system parameters assures adequate power handling for normal listening volumes.

One notable benefit of motional feedback is the elimination of the response peak (with resulting poor transient response) at speaker cone resonance. The feedback circuit continues to provide effective control of cone motion with rising frequency up to the point where cone breakup occurs. There is no theoretical lower limit, although in practice a sharp cutoff is provided to eliminate excessive noise output below the useful range.

Currently the concept described is available only in an integrated system, the Electro-Voice Land Mark 100™ now being introduced. Other applications for motional feedback are also under study in the E-V laboratories.

For reprints of other discussions in this series, or technical data on any E-V product, write: ELECTRO-VOICE, INC., Dept. 103P, 630 Cecil St., Buchanan, Michigan 49107

Electro-Voice®

A SUBSIDIARY OF GULTON INDUSTRIES, INC.

CIRCLE NO. 11 ON READER SERVICE PAGE

ELECTRONICS library

QUIET

FUNDAMENTALS OF DIGITAL COMPUTERS

by Donald D. Spencer

Digital computers play such an important and widespread role in modern society that every person should understand something about them. Consequently, this book was undertaken to provide a good fundamental text that covers all aspects of the general field of electronic computing. It is intended as a basic introduction to the subject of computers and to open the door for those people who wish to continue into more advanced courses or careers in the field of computer science. The text is simple and understandable, and a comprehensive glossary of computer terms is included to familiarize the uninitiated with computer jargon.

Published by Howard W. Sams & Co., 4300 West 62 St., Indianapolis, Ind. 46206. Soft cover. 256 pages. \$5.50.

ELECTRONIC APPLICATIONS OF THE SMITH CHART

by Phillip H. Smith

The Smith Chart, like the slide rule and nomographs, is a mathematical aid in waveguide, circuit, and component analysis. Although much has been published about this truly versatile chart, the descriptions have generally been too restrictive and have failed to give a broad picture of its enormous possibilities in the field of electronics. In this book, however, the author and originator of the Smith Chart presents a comprehensive discussion on the construction and uses of his chart in a manner that even a non-specialist will understand. Also furnished with the book (in an envelope attached to the inside rear cover) are three fundamental types of Smith Charts and one Carter Chart, each on a write-on-and-erase plastic sheet.

Published by McGraw-Hill Book Co., 330 West 42 St., New York, N.Y. 10036. Hard cover. 222 pages. \$17.50.

INSTALLING & SERVICING HOME AUDIO SYSTEMS

by Jack Hobbs

This book serves as an up-to-date "passport" to the lucrative field of audio equipment servicing—including sales and installation. The down-to-earth "brass tacks" information presented contains all the techniques and ex-

POPULAR ELECTRONICS READER SERVICE PAGE

free information service:

Here's an easy and convenient way for you to get additional information about products advertised or mentioned editorially (if it has a "Reader Service Number") in this issue. Just follow the directions below...and the material will be sent to you promptly and free of charge.

1. On coupon below, circle the number(s) that corresponds to the key number(s) at the bottom or next to the advertisement or editorial mention that is of interest to you. (Key numbers for advertised products also appear in the Advertisers' Index.) Print or type your name and address on the lines indicated.

2. Cut out the coupon and mail it to: POPULAR ELECTRONICS, P.O. Box 8391, Philadelphia, PA 19101.

note: If you want to write to the editors of POPULAR ELECTRONICS about an article on any subject that does not have a key number, write to POPULAR ELECTRONICS, One Park Avenue, New York, N.Y. 10016. Inquiries concerning circulation and subscriptions should be sent to POPULAR ELECTRONICS, Portland Place, Boulder, Colo. 80302.

VOID AFTER FEBRUARY 28, 1970

POPULAR ELECTRONICS

P.O. BOX 8391
PHILADELPHIA, PA. 19101

1 2 3 4 5 6 7 8 9 10 11 12 13 14 15 16 17 18 19 20
21 22 23 24 25 26 27 28 29 30 31 32 33 34 35 36 37 38 39 40
41 42 43 44 45 46 47 48 49 50 51 52 53 54 55 56 57 58 59 60
61 62 63 64 65 66 67 68 69 70 71 72 73 74 75 76 77 78 79 80
81 82 83 84 85 86 87 88 89 90 91 92 93 94 95 96 97 98 99 100

NAME (Print clearly) _____

ADDRESS _____

CITY _____ STATE _____ ZIP CODE _____

1 a

Fast easy soldering is a gift from

Weller®

Give a Weller soldering tool for Christmas and you give a man the ability to make secure soldered connections quickly and easily. And because no other soldering tools match Weller for features and dependability, you know you're giving the best.



8-Piece Dual Heat Soldering Gun Kit

Gun tip heats instantly when trigger is pulled. Two trigger positions for instant switching to high 140 watt or low 100 watt heat. Built-in spotlight. Included: 3 soldering tips, tip wrench, flux brush, soldering aid, solder, plastic case. Model 8200PK. **\$9.95** list



New TEMPMATIC® Temperature Controlled Soldering Tool

Combines all the advantages of a fast heating soldering gun, a lightweight pencil iron and tip temperature control. Gives maximum component protection in the most delicate work situations. Yet it does heavy jobs like chassis soldering. Weighs only 7 ounces. Powerhead contains Weller's temperature control system. Model GT-7A has 700°F. $\frac{3}{16}$ " chisel point Powerhead. Model GT-6B has 600°F. conical **\$12.98** point Powerhead. Each tool— **\$2.98** list

Weller MARKSMAN Soldering Iron Kit

Lightweight 25-watt iron outperforms all other irons of its size and price. Has replaceable tip, stainless steel barrel, cool handle. Included: 2 extra tips, soldering aid, solder. Model SP-23K. **\$4.44** list



WELLER ELECTRIC CORPORATION, EASTON, PA.
WORLD LEADER IN SOLDERING TOOLS

LIBRARY (Continued from page 14)

plains the necessary skills employed by those who have succeeded in home audio system work. Included in the text are technical descriptions of the latest hi-fi equipment, accompanied by servicing data in each case. Thorough descriptions of all the various types of gear, illustrations of typical circuits used, and directions on how to go about locating troubles are all a part of the well-presented book.

Published by Tab Books, Blue Ridge Summit, Pa. 17214. 256 pages. \$7.95 hard cover; \$4.95 soft cover.

COMMERCIAL RADIO OPERATOR'S LICENSE STUDY GUIDE (Three Volumes)

by Julius and Jack Berens

Ever since the FCC revised the commercial radio operator licensing exams a few years ago, an authoritative study guide containing the new information covered by the exams has been sorely needed. This new three-volume set fills that need. The set is up-to-date, covering every area of electronics in which the prospective licensee is likely to be tested—including solid-state electronics theory. Volumes I through III are titled "Radiotelephone Third Class," "Radiotelephone Second Class," and "Radiotelephone First Class," respectively. This breakdown allows the prospective licensee to select the license level at which he wishes to stop, since each successive volume is a new building block.

Published by Chilton Book Co., 410 Walnut St., Philadelphia, Pa. 19106. Volume I—Hard cover. 160 pages. \$6.50. Volume II—Hard cover. 255 pages. \$7.50. Volume III—Hard cover. 255 pages. \$7.50.

DIGITAL COMPUTER METHODS IN ENGINEERING

by Shahan A. Hovanesian
and Louis A. Pipes

This comprehensive book provides an exceptionally lucid introduction to the numerical methods of solving engineering problems with digital computers. Written primarily for practicing engineers, the book covers basic digital computer methods applicable to all fields, rather than one specific practice. Throughout the book, numerical methods are illustrated with digital computer programs and numerical examples. The computer programs are written in FORTRAN and BASIC programming language. Also included in each chapter are problems which are extensions of previously covered examples, specifically designed to show "how to do it." From cover to cover, this book is packed with a wealth of helpful, detailed engineering applications.

Published by McGraw-Hill Book Co., 330 West 42 St., New York, N.Y. 10036. Hard cover. 400 pages. \$14.50.

CIRCLE NO. 33 ON READER SERVICE PAGE

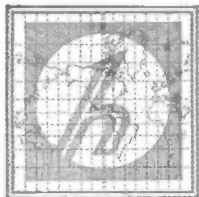

Hear it like it is, When it is, Where it is...

With the All New, Solid-State S-120A "STAR QUEST" Shortwave Radio

Every second, every minute, every day from every corner of the earth, the air is alive with exciting sounds of shortwave adventure . . . Peking Radio . . . Spy Stations . . . Voice of America . . . WWV signals . . . airplanes . . . (SSB) Single Side Band/ Code (CW) . . . Amateurs . . . plus many more. The new "STAR QUEST" Model S-120A fully transistorized takes you there . . . Hallicrafters engineered to provide you with more than 200% greater station receiving sensitivity for CW/SSB/AM. DX'ers can now enjoy incomparable performance on AM broadcast and 76 shortwave services from 1.6 MHz continuous to 30 MHz in four tuning ranges. Professionally engineered to include: BFO for CW and SSB reception • calibrated electrical band spread for precision tuning • large illuminated slide-rule dial, headphone jack, AGC, over 1000 mw of audio power • built-in communications speaker • 2-way antenna system and an exclusive emergency 12 VDC battery power capability for portable use anywhere. Today hear it like it is, when it is, where it is for only \$59.95 (Suggested List Price). At your local Hallicrafters distributor.

■ YOU'RE IN THE GLOBAL COMMUNICATIONS COMMUNITY WITH A HALLCRAFTERS

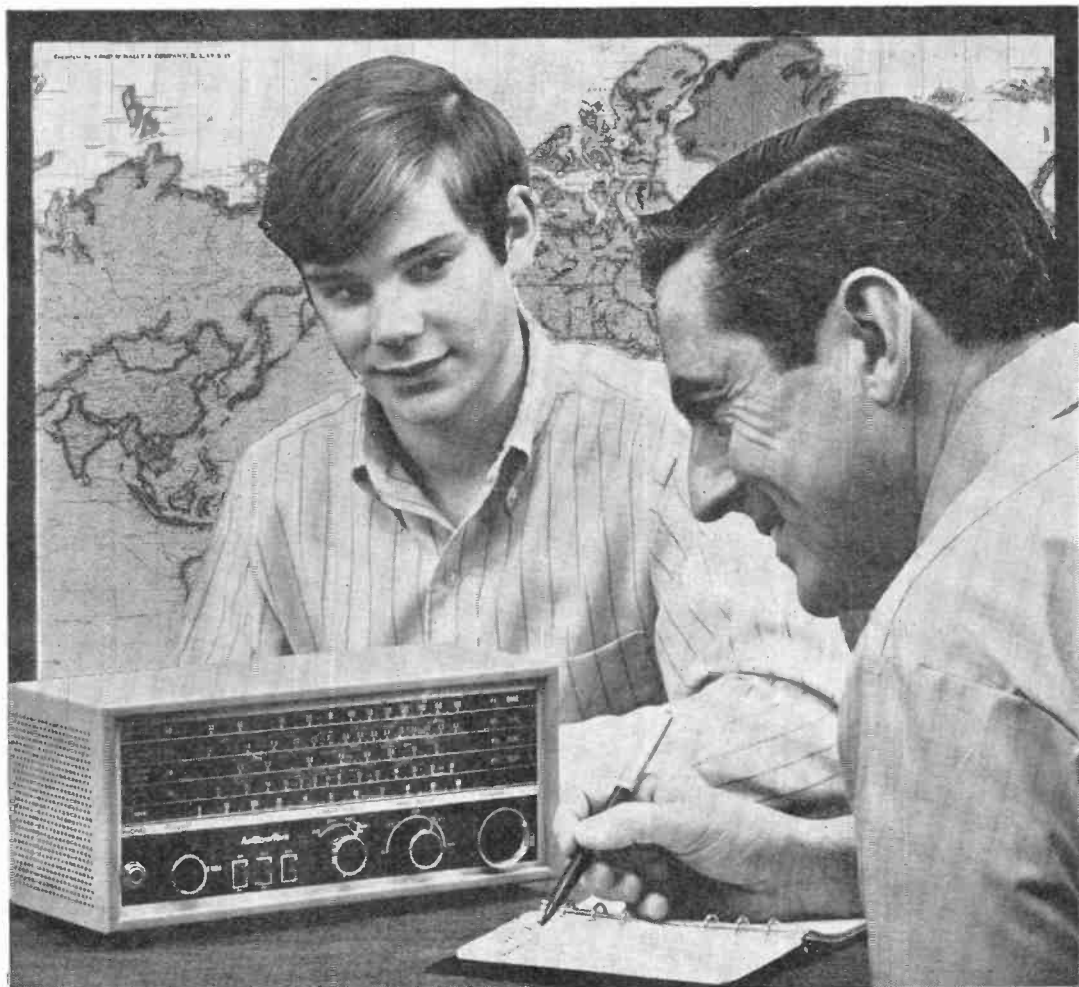

the hallicrafters co.
A Subsidiary of Northrop Corporation



600 HICKS ROAD
ROLLING MEADOWS, ILLINOIS 60008

CIRCLE NO. 13 ON READER SERVICE PAGE

One of our students wrote this ad!

Harry Remmert decided he needed more electronics training to get ahead. He carefully "shopped around" for the best training he could find. His detailed report on why he chose CIE and how it worked out makes a better "ad" than anything we could tell you. Here's his story, as he wrote it to us in his own words.

By Harry Remmert

AFTER SEVEN YEARS in my present position, I was made painfully aware of the fact that I had gotten just about all the on-the-job training available. When I asked my supervisor for an increase in pay, he said, "In what way are you a more valuable employee now than when you received your last raise?" Fortunately, I did receive the raise that time, but I realized that my pay was approaching the maximum for a person with my limited training.

Education was the obvious answer, but I had enrolled in three different night school courses over the years and had not completed any of them. I'd be tired, or want to do something else on class night, and would miss so many classes that I'd fall behind, lose interest, and drop out.

The Advantages of Home Study

Therefore, it was easy to decide that home study was the answer for someone like me, who doesn't want to be tied down. With home study there is no schedule. I am the boss, and I set the pace. There is no cramming for exams because I decide when I am ready, and only then do I take the exam. I never miss a point in the lecture because



Harry Remmert on the job. An Electronics Technician with a promising future, he tells his own story on these pages.

it is right there in print for as many re-readings as I find necessary. If I feel tired, stay late at work, or just feel lazy, I can skip school for a night or two and never fall behind. The total absence of all pressure helps me to learn more than I'd be able to grasp if I were just cramming it in to meet an exam deadline schedule. For me, these points give home study courses an overwhelming advantage over scheduled classroom instruction.

Having decided on home study, why did I choose CIE? I had catalogs from six different schools offering home study courses. The CIE catalog arrived in less than one week (four days before I received any of the other catalogs). This indicated (correctly) that from CIE I could expect fast service on grades, questions, etc. I eliminated those schools which were slow in sending catalogs.

FCC License Warranty Important

The First Class FCC Warranty* was also an attractive point. I had seen "Q" and "A" manuals for the FCC exams,

*CIE backs its FCC License-preparation courses with this famous Warranty: graduates must be able to pass the applicable FCC License exam or their tuition will be refunded in full.

and the material had always seemed just a little beyond my grasp. Score another point for CIE.

Another thing is that CIE offered a complete package: FCC License and technical school diploma. Completion time was reasonably short, and I could attain something definite without dragging it out over an interminable number of years. Here I eliminated those schools which gave college credits instead of graduation diplomas. I work in the R and D department of a large company and it's been my observation that technical school graduates generally hold better positions than men with a few college credits. A college degree is one thing, but I'm 32 years old, and 10 or 15 years of part-time college just isn't for me. No, I wanted to *graduate* in a year or two, not just *start*.

If a school offers both resident and correspondence training, it's my feeling that the correspondence men are sort of on the outside of things. Because I wanted to be a full-fledged student instead of just a tagalong, CIE's exclusively home study program naturally attracted me.

Then, too, it's the men who know their theory who are moving ahead where I work. They can read schematics and understand circuit operation. I want to be a good theory man.

From the foregoing, you can see I did not select CIE in any haphazard fashion. I knew what I was looking for, and only CIE had all the things I wanted.

Two Pay Raises in Less Than a Year

Only eleven months after I enrolled with CIE, I passed the FCC exams for First Class Radiotelephone License with Radar Endorsement. I had a pay increase even before I got my license and *another* only ten months later. I'm getting to be known as a theory man around work, instead of one of the screwdriver mechanics.

These are the tangible results. But just as important are the things I've learned. I am smarter now than I had ever thought I would be. It feels good to know that I know what I know now. Schematics that used to confuse me completely are now easy for me to read and interpret. Yes, it is nice to be smarter, and that's probably the most satisfying result of my CIE experience.

Praise for Student Service

In closing, I'd like to get in a compliment for Mr. Chet Martin, who has faithfully seen to it that my supervisor knows I'm studying. I think Mr. Martin's monthly reports to my supervisor and generally flattering commentary have been in large part responsible for my pay increases. Mr. Martin has given me much more student service than "the contract calls for," and I certainly owe him a sincere debt of gratitude.

And finally, there is Mr. Tom Duffy, my instructor. I don't believe I've ever had the individual attention in any classroom that I've received from Mr. Duffy. He is clear, authoritative, and spared no time or effort to answer my every question. In Mr. Duffy, I've received everything I could have expected from a full-time private tutor.

I'm very, very satisfied with the whole CIE experience.

ENROLL UNDER NEW G.I. BILL

All CIE courses are available under the new G.I. Bill. If you served on active duty since January 31, 1955, or are in service now, check box on reply card or coupon for G.I. Bill information.

Every penny I spent for my course was returned many times over, both in increased wages and in personal satisfaction.

Perhaps you too, like Harry Remmert, have realized that to get ahead in Electronics today, you need to know much more than the "screwdriver mechanics." They're limited to "thinking with their hands"... learning by taking things apart and putting them back together... soldering connections, testing circuits, and replacing components. Understandably, their pay is limited—and their future, too.

But for men like Harry Remmert, who have gotten the training they need in the fundamentals of Electronics, there are no such limitations. As "theory men," they think with their heads, not their hands. For trained technicians like this, the future is bright. Thousands of men are urgently needed in virtually every field of Electronics, from two-way mobile radio to computer testing and troubleshooting. And with this demand, salaries have skyrocketed. Many technicians earn \$8,000, \$10,000, \$12,000 or more a year.

Send for Complete Information—FREE

Many men who are advancing their Electronics career started by reading our famous book, "How To Succeed In Electronics." It tells of the many electronics careers open to men with the proper training. And it tells which courses of study best prepare you for the work you want.

If you're "shopping around" for the training you need to move up in Electronics, this 44-page book may have the answers you want. We'll send it to you FREE. With it, we'll also include our other helpful book, "How To Get A Commercial FCC License."

To get both FREE books, just fill out and mail the bound-in postpaid card. If the card is missing, send the coupon below.

CIE Cleveland Institute of Electronics

1776 East 17th Street, Cleveland, Ohio 44114

Accredited Member National Home Study Council • A Leader in Electronics Training. Since 1934

NEW COLLEGE-LEVEL COURSE IN ELECTRONICS ENGINEERING

for men with prior experience in Electronics. Covers steady-state and transient network theory, solid state physics and circuitry-pulse techniques, computer logic and mathematics through calculus. A college-level course for men already working in Electronics.

Cleveland Institute of Electronics
1776 East 17th Street, Cleveland, Ohio 44114

Please send me without cost or obligation:

1. Your 44-page book "How To Succeed In Electronics" describing the job opportunities in Electronics today, and how your courses can prepare me for them.
2. Your book on "How To Get A Commercial FCC License."

I am especially interested in:

- | | |
|--|--|
| <input type="checkbox"/> Electronics Technology | <input type="checkbox"/> Electronic Communications |
| <input type="checkbox"/> Broadcast Engineering | <input type="checkbox"/> Industrial Electronics and Automation |
| <input type="checkbox"/> First-Class FCC License | <input type="checkbox"/> Electronics Engineering |

Name _____ (PLEASE PRINT)

Address _____

City _____

State _____ Zip _____ Age _____

Check here for G.I. Bill information. PE-92

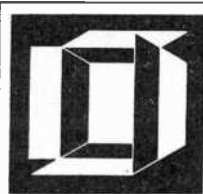

NEW PRODUCTS

Additional information on products covered in this section is available from the manufacturers. Each new product is identified by a code number. To obtain further details on any of them, simply fill in and mail the coupon on page 15 or 97.

DISTINCTIVE TURNTABLE MODULE

The quiet elegance of fine-grain natural wood and Swiss gold finish combine in the *Empire Scientific Corp.* Model 598 to make a truly rich looking turntable system. The Troubador 598 has a turntable that reaches full speed in less than one-third of a revolution and locks onto the a.c. line frequency to maintain speed accuracy with zero error. The tone arm is *Empire's* Model 990 that features "Dyna Lift," a micrometer calibrated anti-skate control, five-wire ground loop elimination circuit, -90 dB rumble, 0.01% wow and flutter, perfect cueing, and as low as 0.1 gram tracking force. When used with the *Empire* 1000ZE stereo cartridge, the entire turntable system meets the demands of the low-tracking-force cartridges currently available.



Circle No. 77 on Reader Service Page 15 or 97

ABSOLUTELY STABLE COLOR BAR GENERATOR

The Model LCG-390 color bar generator made by *Leader Instruments Corp.* employs binary counters and gates in the logic circuitry to achieve absolutely stable patterns. The ultra-compact instrument is capable of generating completely stationary patterns regardless of temperature extremes, line voltage conditions, or transmitter signals. The LCG-390 is designed for convergence and synchronizing adjustments in color and monochrome TV receivers and can be used for linearity checks on TV monitors. The five basic patterns displayed by the generator are: gated rainbow color bars; R-Y, B-Y, and -(R-Y) color bars; dots; crosshatch; and a single cross centered on the raster. Gun killers are provided for convergence adjustments. The color bar generator employs plug-in computer-style printed circuit cards and a fully regulated power supply.



Circle No. 78 on Reader Service Page 15 or 97

MONITOR RECEIVER HAS AUTO SCAN

Automatic scan monitoring of any combination of eight crystal-controlled VHF channels in the 148-174-MHz band is featured in the Model TMR 8 "Monitoradio/Scanner" developed by *Regency Electronics, Inc.* Read-out lights for each frequency show the progress of the receiver's search for a transmitted signal. Upon finding an active channel, the receiver locks onto it and "listens" to the entire message, then resumes scanning. The scan feature can be disabled for continuous monitoring of any specific channel or manual search. Programming is accomplished by activating push buttons for any combination of channels, allowing the operator to hear both sides of duplex and simulcast base/mobile networks. Technical specifications—0.5- μ V sensitivity; 50 dB at 15 kHz selectivity; 5-watt audio output at 1 kHz; 0.05 sec/channel scan rate; 117-volt a.c./12-volt d.c. operation; built-in speaker.



Circle No. 79 on Reader Service Page 15 or 97

140-WATT STEREO FM RECEIVER

The Nocturne Model 820 stereo FM receiver available from *Harman-Kardon, Inc.*, stresses wideband sound to provide a frequency response at normal listening levels from below 5 Hz to beyond 60,000 Hz for flawless audio reproduction. Distortion in the 820 is maintained below 0.5% at full power output from 20 to 20,000 Hz. Power output of the receiver is 140 watts \pm 1 dB, 110 watts IHF into a 4-ohm load. The front end which employ's MOSFET's and a linear four-ganged tuning capacitor has amazing rejection of unwanted signals and a usable sensitivity of 1.8 μ V (IHF). The use of IC's plus wideband crystal filters in the receiver yields unprecedented noise figures, while the tuning characteristic is said to be as precise as switching the channel selector of a TV receiver. Piano-type switches are used for all important functions.

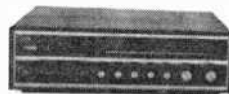

Circle No. 80 on Reader Service Page 15 or 97

DELUXE THREE-ELEMENT CB BEAM ANTENNA

A deluxe three-element beam antenna for CB radio, the Model PA-311 "Paragon Beam," is now available from *Mosley Electronics, Inc.* The Paragon Beam features a three-piece boom and perfectly balanced elements with swaged tubing to reduce vibration in the wind. Its improved gamma matching system includes a molded gamma base and connector for greater convenience and durability. Technical specifications—forward gain: 8 dB to reference dipole, 10.1 dB over isotropic source; front-to-back ratio: 24 dB; SWR: 1.5:1 or better; feed impedance: nominal 52 ohms; elements: three; maximum element



The sensibly priced tape cassette ...from MALLORY.

Just what you've been waiting for. The new Mallory DURATAPE® Cassette.

You get the quality and performance of expensive tape cassettes at a nice, lots-less price. But not the poor performance or the problems of the special-discount cheapies.

And since they're from Mallory — a company long known for quality electronic products—you can expect high fidelity, smooth operation, and long reliability. And get it . . . every time!

They'll fit any cassette recorder, player, cassette-radio. Even the new cassette changers. And you pick the recording time: 30, 60, 90, 120 minutes.

Our DURATAPE® Cassettes are tough but we put them in unbreakable, easy-to-stack containers just for extra protection. Like in the rain or through the mail.

And we make a head cleaner that's perfect for Cassette Recorders, too.

You'll find this great new thing in sound wherever Mallory products are sold.

MALLORY

MALLORY DISTRIBUTOR PRODUCTS COMPANY

a division of P. R. MALLORY & CO. INC.
Box 1558, Indianapolis, Indiana 46206; Telephone: 317-838-5353

Batteries • Capacitors • Cassette Tapes • Controls • Resistors • Semiconductors • Sonalart® • Switches • Timers • Vibrators • ICs
CIRCLE NO. 17 ON READER SERVICE PAGE

PRODUCTS (Continued from page 22)

length: 19' 2½"; turning radius: horizontal 11' 3¾", vertical 6'; wind surface: 2.6 sq ft horizontal, 3.8 sq ft vertical; wind load (EIA standard 80 mi/hr): 52 lb horizontal, 76 lb vertical; assembled weight: 11 lbs.

Circle No. 81 on Reader Service Page 15 or 97

SIX-BAND PORTABLE RECEIVER

Allied Radio Corporation's Model 2660 six-band portable receiver offers functional versatility and the most advanced design features at a popular price.

The new solid-state receiver tunes the 5-12-MHz and 12-24-MHz international shortwave bands; 30-50-MHz and 147-176-MHz police/public service bands; and 88-108-MHz and 540-1600-kHz FM and AM broadcast bands, respectively. A large slide-rule dial simplifies tuning, while a fine-tuning control helps to separate stations on shortwave. A squelch control silences the speaker between VHF calls, and a switchable a.f.c. prevents drift on FM. Other features include local/distance switch, tone control, built-in ferrite AM and telescoping FM/SW/VHF antennas, jack for external shortwave antenna, momentary-action dial light, and an earphone.



Circle No. 82 on Reader Service Page 15 or 97

IMPROVED TRACKABILITY STEREO CARTRIDGE

Shure Brothers, Inc., is making a new version of the company's famous V-15 Type II "Super Trackability" phono cartridge, which delivers even greater trackability in bass

and mid-frequency ranges than does the earlier model. The improved model represents a significant advance in trackability not only at select and discrete frequencies, but across the entire audio spectrum, at the lowest possible tracking

forces. It is capable of tracking the majority of records at ½ gram, including those records that contain heavily modulated bass drum, tympani, organ pedal, bassoon, tuba, or piano passages. Hence, there is no need to readjust tracking force of the cartridge to avoid bass flutter or i.m. distortion. Also available separately (for owners of the original V-15 Type II) is the Model VN15E Improved elliptical stylus alone.



Circle No. 83 on Reader Service Page 15 or 97

ALL-IN-ONE AUTO ANALYZER KIT

Designed for fast, easy tune-ups and simplified troubleshooting, the *Knight-Kit* Model KG-303 portable solid-state auto analyzer is



available in easily assembled kit form. The "Junior Auto Analyzer" has a full-size 2½" meter which has four r/min ranges from 0 to 6000 r/min; two dwell angle ranges from 0° to 60°; and a 0-16-volt meter range. The analyzer can be used on 4-, 6-, and 8-cylinder engines with either 6- or 12-volt, positive or negative ground, ignition systems. Tachometer scales indicate engine r/min, help set idling speed and automatic transmission shift points. The dwell meter tests points and spark advance. Technical specifications—accuracy: 6%, full scale; 0-16 volts meter range; 0-1200, 1600, 4500, 6090 r/min tachometer ranges; 0-45°, 60° dwell meter ranges; 9-volt battery power source (self-contained).

Circle No. 84 on Reader Service Page 15 or 97

SSB/AM/CW AMATEUR RECEIVER

Three FET's and two mechanical i.f. filters to assure high selectivity with superior r.f. overload and noise suppression are among the features found in *Lafayette Radio Electronics'* Model HA-800 amateur receiver.

The six-band AM/CW/SSE receiver is capable of tuning 80 through 6 meters. And its all-solid-state circuitry has a built-in zener-regulated

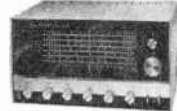

power supply for line operation (can also be operated on 12 volts d.c.). Other features include an "S" meter, product detector, and a crystal calibrator (less crystal). Technical specifications—better than 1 μV sensitivity on 80, 40, and 20 meters, 0.5 μV on 15 meters, and 2.5 μV on 6 meters; -6 dB at ±2 kHz, -60 dB at ±6 kHz selectivity; 2,608 MHz first i.f. and 455 kHz second i.f.; 455 kHz ±2.5 kHz BFO frequency; better than -40 dB image rejection; 50-ohm antenna input impedance.

Circle No. 85 on Reader Service Page 15 or 97

SOLID-STATE VOLT/OHMMETER

The new battery-powered solid-state volt/ohmmeter, Model 116, made by *Electronic Measurements Corp.* features laboratory accuracy, wide range, and small size. The



meter's FET design achieves low loading (11 megohms on d.c. and 1 megohm on a.c.) as well as sensitivity that is 500 times that of an ordinary 20,000 ohms/volt VOM. In addition, the 4½" meter movement and solid-state circuitry are fully protected. The Model 116 is available in both factory-wired and kit form. Technical Specifications: 0-3.3, 33, 330, and 1200 volts peak-to-peak a.c. ranges; 0-1.2, 12, 120, 1200 volts a.c. rms ranges; 0-1.2, 12, 120, 1200 volts d.c. ranges; 0-1 k, 100 k, 10 meg, 1000 meg resistance ranges; -24 to +56 dB range.

Circle No. 86 on Reader Service Page 15 or 97

Unless you are an advanced CBer, you probably can't use Johnson's new solid state Messenger 124



New Messenger 124 full-function, 23-channel base station. **\$289⁹⁵**
(less mike)

If you're an operator with a purpose . . . consider this, the most sophisticated of all Johnson 27 MHz base stations . . . from the largest and most experienced of all manufacturers of citizens and industrial two-way radio.

To the advanced CB operator, the Messenger 124 means complete mastery of the equipment—a degree of control and measurement that permits, for the first time, full utilization of all the enormous power, hairline selectivity, sensitivity and noise suppression of which the incomparable Johnson circuitry is capable.

Whatever your requirement, the Messenger 124 offers a new experience in base station performance.

Features

- ± 3 kHz Delta fine tuning
- Adjustable microphone gain with modulation adjustment to 100%
- 2½" four-way professional meter, measures SWR, output, % modulation and receive
- 4.3 MHz crystal filter for unequalled selectivity
- Built-in speech compression
- Panel-controlled, series-type threshold noise limiter
- Built-in tone control
- Built-in 117 VAC/12 VDC power supply
- 14 tuned circuits
- FET for superior gain
- Dual conversion receiver

E. F. JOHNSON COMPANY

Waseca, Minnesota 56093



Now there is a better Color-Bar Generator for your servicing work

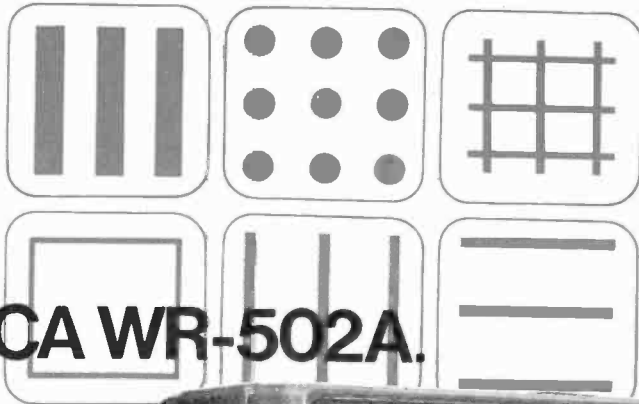

THE RCA WR-502A.

New . . . solid state . . . battery or AC operated . . . portable, weighing only four pounds.

The RCA WR-502A "CHRO-BAR" color-bar generator provides six separate test signals: color bars, dots, cross-hatch, vertical lines, horizontal lines, and blank raster.

The sound carrier, pattern, RF output, and color subcarrier are all crystal controlled. Designed for exceptional stability with no flicker.

Included as part of the package — at no extra cost — is an AC adaptor for line operation. This unit was formerly available only as an accessory at a cost of \$9.00*.

The new CHRO-BAR Generator WR-502A, complete with separate AC adaptor — now only \$148.50*.

RCA Electronic Components, Harrison, N. J. 07029.

* Optional Distributor resale price.



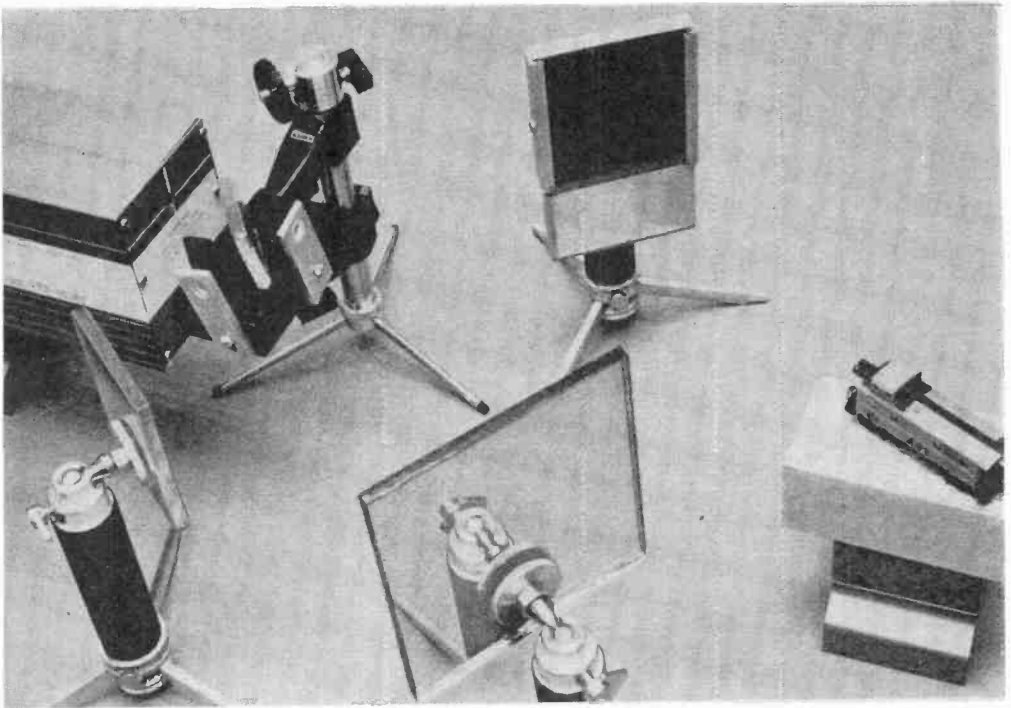

DO IT YOURSELF LASER HOLOGRAPHY

TRUE THREE-DIMENSIONAL IMAGES ON FILM

BY C. HARRY KNOWLES

THE BASIC CONCEPT of the camera was first developed in the 10th century and ever since, man has attempted to make a photographic record of himself and the world around him. The camera and photographic techniques have improved continuously over the years and no one can say that the clarity and beauty of today's full-color photographs are not truly remarkable.

But there's something lacking! Using standard photographic techniques, it is still impossible to capture on film the three-dimensional quality that characterizes life itself. Many attempts have been made to create the three-dimensional illusion, including the use of multiple cameras and projectors, special glasses for the viewer, special filtering, and a large number of other, lesser-known

methods. Most have eventually been discarded.

In the late 1940's, Dr. Dennis Gabor, working with an optical system, demonstrated that, by using coherent monochromatic light, it was possible to imprint a true three-dimensional image on photographic film emulsion. There was only one problem—a source of coherent light was hard to find. When the laser was discovered, a practical, dependable source of coherent light became available; and Dr. Gabor's brainchild, the hologram, was reborn.

Holography is based on the principle of recording interference patterns set up by a reference beam of laser light and the reflected light from a target. The result, a hologram (captured on film), is a true three-dimensional re-

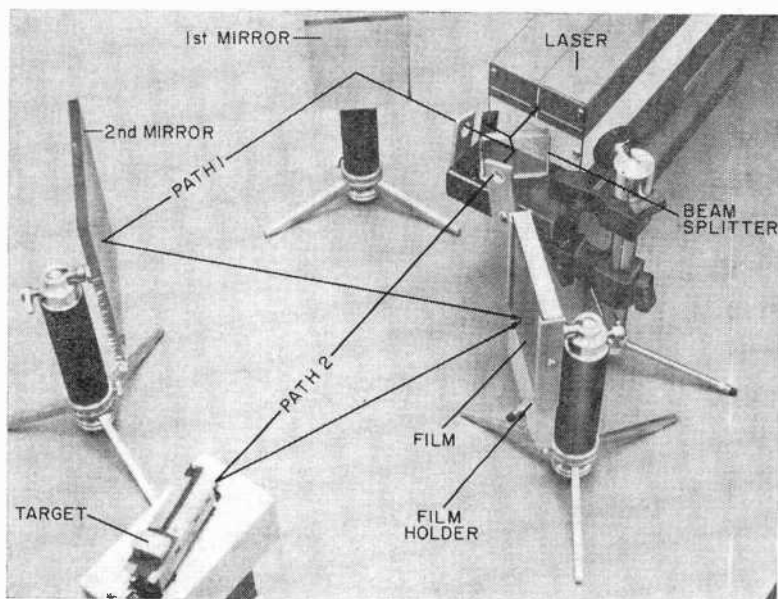

Fig. 1. The basic optical setup showing the two beam paths used to make a hologram. The mounting tripods are conventional camera tripods found in most camera shops. Remember that the most important item is stability—of both laser and optics.

production of the target. The display technique requires no imaging lenses within the system, but does require a laser. (See "What Is a Hologram?" on page 30)

Although many uses have already been found for holograms, the technology is still essentially in its infancy and promises to play a very important role in our future as laser techniques continue to be developed. For instance, holographic road signs are being developed so that drivers in different traffic lanes will get directions applicable only to them. A system of credit card validation is being developed in which each card contains a very small hologram of its identifying number. The card is inserted in a holder containing a laser which projects the number onto a large-size master transparency. Within microseconds the number is compared with all delinquent account numbers stored on a master and, if a match occurs, an alarm is given.

One major tire manufacturer uses holographic interferometry in a routine inspection of its products. Holographic memories are being developed rapidly—your telephone number and all related information may soon be stored holographically. RCA recently announced a low-cost system of video recording using

transparent tape containing holograms. When the tapes are passed between a laser (one quite similar to the one used here) and a TV camera, the images are converted to conventional video. In this low-cost system, the holograms are stored in cassette-type containers. Even color recording is practical.

Three recent developments now make holography a practical project for the electronic experimenter: the introduction of the safe, low-cost laser (POPULAR ELECTRONICS, December 1969); a new high-resolution, high-contrast, high-speed film (Agfa 10E75); and a low-cost high-quality optical kit complete with optics, film, and chemicals.

The experimenters' holographic system described here requires a working knowledge of electronics, basic optics, and photography. Assuming that the reader has the necessary background in electronics and optics, it is suggested that, before proceeding with construction and actual creation of holograms, he consult friends or some simple home photography manuals—particularly in the area of film development. A darkroom is required, both for setting up the holographic system and for developing the exposed film. It may also be used for proper viewing of a finished hologram.

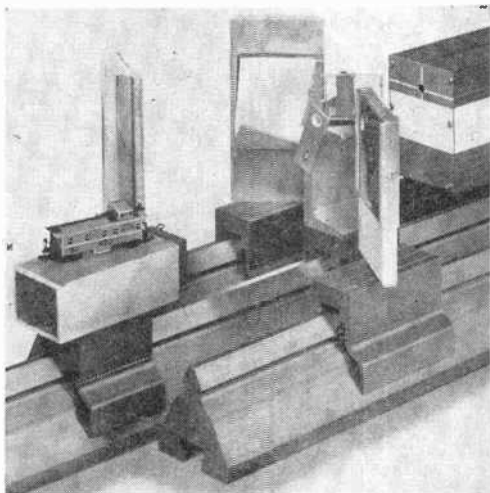

This is a commercial holographic setup that uses heavy metal extrusions as stable base. The laser shown here, and in Fig. 1, is the low-cost laser mounted within a light-tight aluminum enclosure.

Making the Optics. There are six pieces of equipment required to make a hologram: a laser, a beam-splitter assembly, two reflecting mirrors, a film holder, and a platform for the target. A complete assembly is shown in Fig. 1.

The laser is the low-cost unit described in the December 1969 issue of *POPULAR ELECTRONICS*. It must be mounted in a light-tight enclosure made of wood or metal, painted flat black on the inside.

Everything must be inside the enclosure with only a power cord coming out of it. Once the enclosure has been built, drill a small hole (about 1 mm) precisely in line with the exiting laser beam. Inside the enclosure, the laser should be placed so that its exit mirror is very close to the exit hole.

Mount the laser enclosure on a firm support. Stability is extremely important. Be sure that the enclosure does not rock or tilt in any direction. If necessary, place a weight on top of the enclosure to make sure that it sits firmly. Measure the distance from the supporting table or bench top to the laser exit hole. This distance above the table or bench establishes a horizontal plane which will be referred to frequently in the construction of the system.

The beam splitter assembly includes a glass beam splitter and a pair of diverging lenses. A piece of metal or a smooth block of wood about 2 inches square can be used for the beam splitter assembly mount. The height of the mount should be such that the laser beam will strike about the center of the beam splitter. The beam splitter is a small piece (about 1" square) of highly polished optical glass having exactly parallel surfaces. Using pitch, epoxy or other hard-drying cement, affix the glass beam splitter to the top of the wood block as shown in

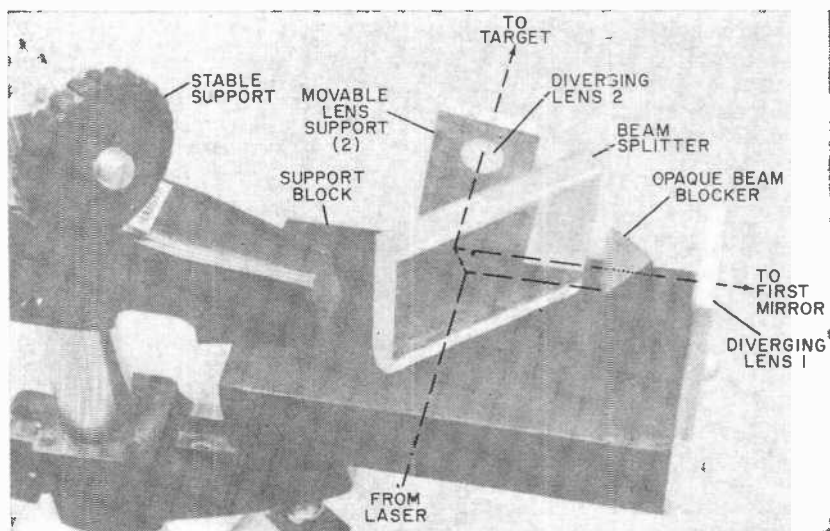

Fig. 2. Details of the beam splitter assembly. The opaque beam blocker is placed to cut out one beam from the glass splitter. The diverging lenses are oriented as required.

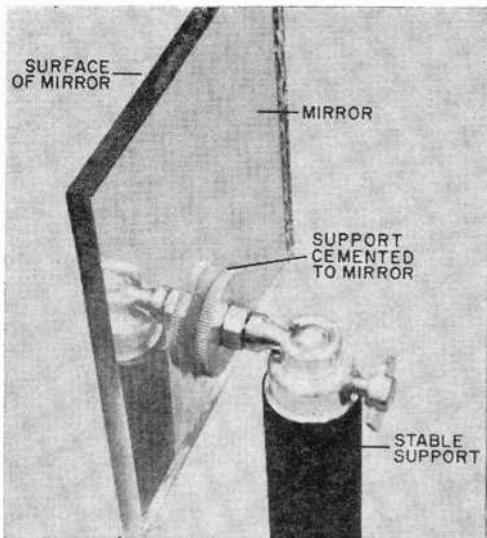

Fig. 3. Tripod support is removed and cemented to the rear surface of the front-surface mirror. Metal nut on tripod screw clamps the mirror tight.

Fig. 2. Mount the two diverging lenses in holes drilled in two pieces of aluminum $\frac{3}{4}$ " wide, 2" long and $\frac{1}{8}$ " thick. The lenses can be glued or friction fitted in place. Cut half-inch slots in the other ends of the strips to accommodate mounting screws. When mounted, the aluminum strips should be capable of being moved up or down and to left or right when the mounting screws are slightly loose. The centers of the lenses must be movable about the laser beam. The wooden vertical block on the beam splitter assembly should be ignored for the moment as it will be installed later.

The two reflecting mirrors are made from front-surface optical flat mirrors. The first mirror should be about 2 inches square. The second, larger mirror is about 3 inches square. Using firm, stable supports attach the mirrors with pitch or epoxy so that they are vertical and their centers are in the horizontal beam reference plane (see Fig. 3).

The film holder should be designed to support a piece of film $2\frac{3}{4}$ " square (70 mm) so that it fits flat against a back support. The easiest way to do this is to take a piece of solid aluminum stock $\frac{1}{2}$ " or more thick and $2\frac{3}{4}$ " wide by 3" high. Use this to fashion a holder. Secure this to a wood or metal block so that the 3" length is vertical and the center of the piece of aluminum is on the horizontal

WHAT IS A HOLOGRAM?

A hologram of an object bears absolutely no similarity to a conventional photograph of the same object. It is not even visible unless observed under special conditions. A hologram viewed under normal incoherent light looks like a slightly dirty transparency with absolutely nothing to indicate that it is a three-dimensional view of an object. Despite the fact that the hologram looks so bleak, it contains far more actual information than can be placed on an ordinary photograph. All of this information can be seen when the hologram is viewed in the coherent light from a laser. Of course the most important information that the hologram contains is the third dimension of the object—color is not yet obtainable in a hologram but the possibility is being investigated.

Another remarkable fact about the hologram is that each part of it contains all of the target information. If the hologram is cut in half, each half contains the complete image, including the third-dimension information. In fact, each portion can be cut in two again and the information is still intact. As the hologram is subdivided, although each small piece still contains a complete image, resolution suffers and a point is eventually reached where the image is no longer clear and distinct. Scratches and smears do not affect holograms as much as they do conventional negatives since all parts of the hologram contain all of the image information.

In viewing a hologram, the eye (or camera) can be focussed on different parts of the three-dimensional image. As the hologram is moved farther from the diverging lens during viewing, automatic enlargement of the image occurs. If the hologram is turned over while viewing, a very peculiar "inside out" view is obtained.

In the system used here to make holograms, two sources of light reach the film emulsion. One comes from the reference-beam mirrors and the other is reflected from the infinite number of points that make up the target. The light striking the target is exactly in phase with the light in the reference beam.

The frequency of the light from the helium-neon laser is 4.7×10^{14} MHz with a wavelength of 6328 Å or 6238×10^{-10} meters. Thus one wavelength is very short so that the light reflected from different points on the three-dimensional target reaches the film at slightly different times, depending on the distance of each point from the emulsion. An interference pattern created by the phase relationships between the reference beam and the target reflections is created on the film. It is this interference pattern that is recorded.

Because the distances involved are so small, the film must be able to resolve interference lines spaced about a wavelength apart. This means that a film resolution of about 2000 lines/mm must be used to produce a useful image. (Conventional film can resolve only a few hundred lines per millimeter.)

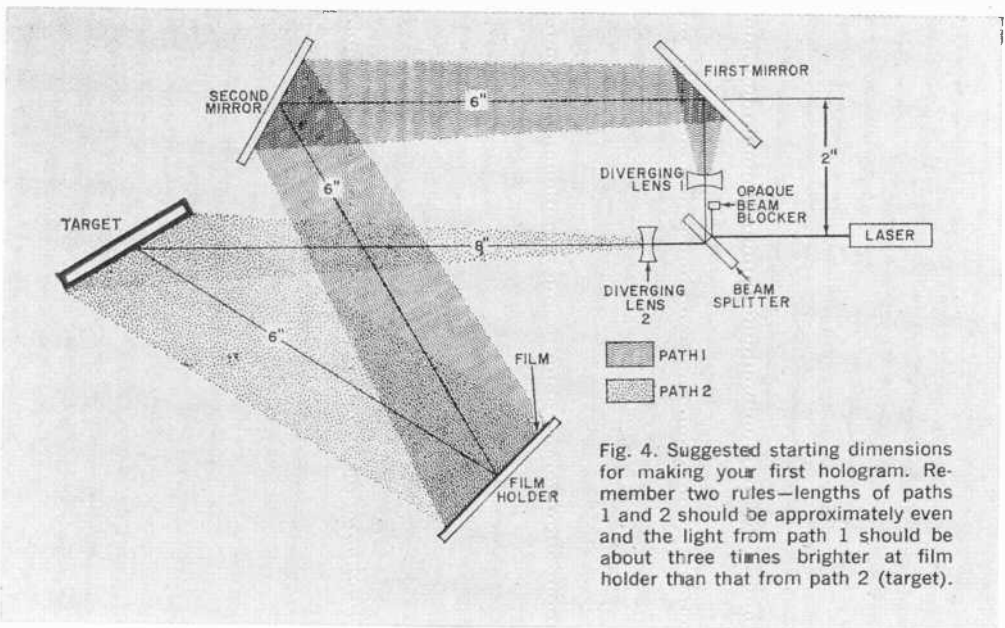

Fig. 4. Suggested starting dimensions for making your first hologram. Remember two rules—lengths of paths 1 and 2 should be approximately even and the light from path 1 should be about three times brighter at film holder than that from path 2 (target).

BILL OF MATERIALS

- 1—Beam splitter, plano-plano double-polished high-transmittance glass 1" x 2" x 1/4" (Edmund Scientific 41,264, Edmund Scientific Co., 300 Edscorp Bldg., Barrington, N.J. 08007)
 - 2—Diverging lenses, 10-mm diameter, 9-mm focal length, coated (Edmund Scientific 94-726)
 - 2—Front-surface mirror, high-reflectance coating on polished front surface, heavy glass, one 3" x 4", one 5" x 7" (Edmund Scientific 40,041 and 40,043, respectively)
- Film (Agfa 10E75, Agfa-Gevaert Inc., Scientific Products Dept., 275 North St., Teterboro, NJ 07608)
- Developer (Kodak D-19 or Metinol-U)
- Hypo fixing bath
- Developing trays (3)

Misc.—Mounting tripods for optics, adhesive, aluminum sheet 1/4" x 2" x 3" and L brackets for film holder, metal strip for supporting lenses, alcohol and lint-free tissue for lens cleaning, stable, workbench, darkroom, acetic acid, etc.

Note—A complete kit of all items except those in Miscellaneous but including a test hologram and detailed instructions are available as Model 60-625 Holography Kit from Metrologic Instruments, Inc., 143 Harding Ave., Bellmawr, N.J. 08030, \$34.75 postpaid. Mounting holders for optical components are also available for an additional \$36. A complete holography kit plus a shock-mounted rigid base with three triangular tracks is available for \$103 postpaid. For information on the laser and power supply, see the December 1969 POPULAR ELECTRONICS.

beam reference plane. Take two 3" lengths of L-shaped aluminum having one 3/16" lip and attach them to the 3" sides of the support so that the lips will hold both sides of the film (see Fig. 4). The target platform is a simple horizontal plate, made from metal or wood and mounted on a firm support so that the platform is about 1/2" below the horizontal beam reference plane.

Cleaning the Optics. All the optical surfaces must be cleaned very carefully. Any spots, smears, scratches or dust on any of the optical surfaces (including the transmission mirror of the laser) will show up as blotches or "noise" in a finished hologram.

An excellent way to clean the optics is with a fresh, untouched, lint-free facial tissue moistened slightly with pure alcohol. Take care not to let dust or fine grit that may be on a surface scratch the surface as you remove it. A soft cotton swab can be used to remove any residual particles that may be present before cleaning. After cleaning, make sure that no residue from the facial tissue is left on the optical surface.

Once cleaned, optical components should be protected with dust covers and should never be touched with the fingers.

Preparing the Developing Chemicals. Conventional darkroom techniques are

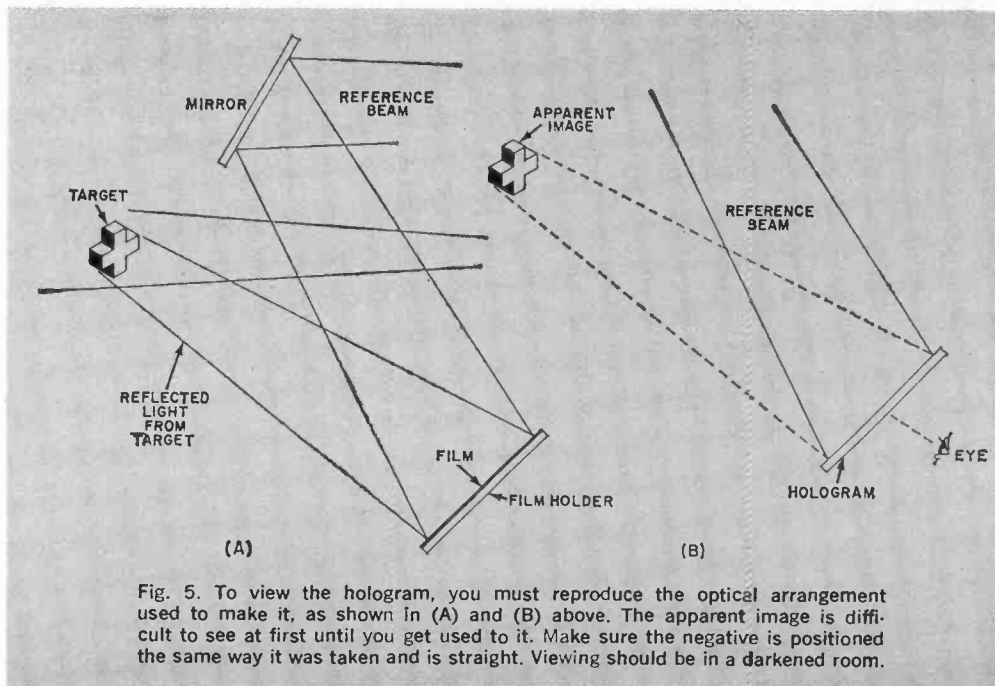

Fig. 5. To view the hologram, you must reproduce the optical arrangement used to make it, as shown in (A) and (B) above. The apparent image is difficult to see at first until you get used to it. Make sure the negative is positioned the same way it was taken and is straight. Viewing should be in a darkened room.

used in developing the hologram. Make up a solution of Kodak D-19 or Agfa Metinol-U developer in a tray. (Any other very fine-grain and high-contrast developer may be used.) Make up another tray of shortstop (dilute acetic acid) and one of fixer (ordinary hypo). Follow instructions provided with the chemicals.

A source of clean running water will be needed for washing finished negatives and you should have some type of dark-room timer to measure the seven or eight minutes required for developing. Allow all chemicals to stabilize to correct temperature. Now make sure that the dark-room can be made absolutely dark during hologram exposure and that all fans and air conditioners are shut off. Air in motion can ruin fine details on a hologram.

The film to be used is Agfa 10E75, which is very sensitive to red and blue light; therefore no safe light should be used while the film is being exposed and developed.

Setting Up and Making a Hologram. In making a hologram, you are dealing with distances as short as a wavelength of light—and shorter—so physical motion of the optical system and the air sur-

rounding the experiment must be at a minimum. Select a very solid work surface that is not affected by building vibrations. The surface need be only a foot or two wide and about three feet long.

Position the laser at one end of the working surface so that the beam shines down the center of the area. Place the optical components as shown in Fig. 4. It is suggested that you use this layout to make your first holograms. Experiment later. Place the beam splitter about 2 inches from the laser beam exit hole, positioned so that it is at a 45-degree angle to the beam. With the laser operating, use a smoke cloud to show up the beam and note that there are three red lines. One passes directly through the beam splitter and shines on down the work table. Two others come off of the beam splitter at right angles. One of these two beams comes off the front surface of the splitter, while the other comes off the internal or rear surface. Position a wooden beam blocker so that it cuts off the beam coming from the surface closest to the laser. Now there should be only two beams—one shining straight down the work surface and one at right angles to it off of the splitter.

Position the first front-surface mir-

ror (the smaller of the two) about 2 inches from the beam splitter and about parallel with the beam splitter surface. Orient this mirror carefully so that the beam from the splitter strikes close to the center of the mirror. Now there should be two separate parallel beams going down the table.

As can be seen from Figs. 1 and 4, two optical paths are required to make a hologram. One (path 1 called the reference beam) is from the beam splitter, through a diverging lens (to broaden the beam), through two front-surface mirrors, to the film holder. The other (path 2, called the target beam) comes from the beam splitter, through a diverging lens and shines on the target. The reflected light from the target shines on the film holder. The positioning of the target, the second reflecting mirror, and the film holder should follow two basic rules: (1) the lengths of paths 1 and 2 should be approximately the same; and (2) the light from path 1 should be about three times brighter at the film holder than the reflected light from the target.

For the target, it is best to use a bright, shiny white or red object less than two inches in any dimension. This type of target does not require long exposure times. A white or red chessman or an HO-gauge train car make good targets.

Once the optics are positioned as described, place a white card or piece of paper in the film holder. Adjust the mirrors in path 1 until the reference beam dot is centered on the film holder. Move the first diverging lens into position in the reference beam. The dot on the film holder should now be enlarged considerably. Do not use the exact center of the diverging lens to avoid unnecessary interference rings on the film plane. Adjust the reference beam mirrors so that the reference beam covers most of the white card in the film holder as uniformly as possible. The placement of the reference beam may also be adjusted by moving the first diverging lens.

Place the target in position and note that the path-2 beam strikes it. Position the second diverging lens for maximum coverage of the target by the beam. The reflected light from the target should cover the white card in the film holder.

Block out the light from path 2 and note the level of light from path 1. Now block the light from path 1 and note that the path-1 illumination is about 3 times as strong as that reflected from the target.

Make sure that no stray light from the target illuminating beam strikes the second mirror. Also, check that extraneous light reflected from the optics or the target mounting does not fall on or near the film holder. To do this, remove the film holder and look into the reflected beams from the film holder position. (NOTE: It is quite safe to look into the *diverged* beam from a laser with power as low as this—less than 0.5 milliwatt. However, before looking into the beam or its reflection, *be sure* that the diverging lenses are in position.) Look at the target and the second reference-beam mirror—and other places—and make sure that only light from the reference beam and target strike the film plane. Use dull black paint to touch up any shiny spots and place dull-painted blocks to prevent any stray light.

Replace the film holder and recheck the beam illumination levels. The beam balance can be changed by moving the target one way or the other or by moving the reference beam mirrors. However, the length of the beam paths must remain equal within a couple of inches. You are now ready to expose the film—emulsion side toward the target and reference beams. But wait one more minute—observe these precautions! Since the film is extremely sensitive, the room must be absolutely dark. The laser must have been operating for at least a half an hour to allow it to stabilize. The movement of air in the room must be at an absolute minimum—no air conditioners or fans, no unnecessary body movement and no talking. Air turbulence destroys the fine fringes that make up the details of the picture.

Cut out a strip of black paper for use as a shutter to cut off the beam where it comes out of the laser. With this shutter in place and making sure that there are no other light leaks in the room, take a section of film, holding it by the edge, and place it, emulsion side out, in the film holder. Be sure not to buckle or touch the film emulsion. Allow a few moments for everything to stabilize—don't move or talk or allow air to move across

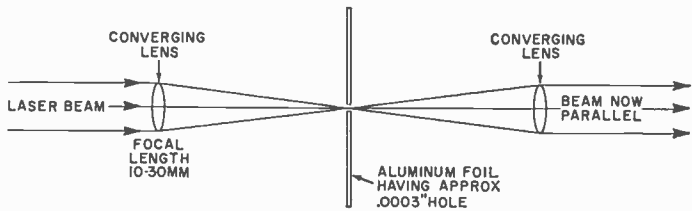

Fig. 6. A spatial filter cleans up laser beam to make better holograms. Sharp needle is used to make the fine hole required.

the beam paths. Now remove the shutter from the beam for 1½ seconds and then replace it. The hologram is now exposed and ready for development—but don't turn on the lights!

Film Development. Processing holographic film is not much different from normal photographic processing. The temperatures of the film storage area, the exposure area, and the chemical baths should be as nearly equal as possible. Handle the film as little as possible,

taking care not to touch the emulsion. Place the exposed film in the developer for the recommended amount of time—about 7 or 8 minutes, usually. If anything, a little overdeveloping doesn't hurt. Then insert the film in the conventional stop bath and fixer. After fixing, the safe light can be turned on. Wash the film for about 10 minutes in running water.

Do not be surprised at what you see, or do not see, on a finished hologram. You are not recording a focussed picture

THE STABLE BASE

A stable base is required for the optical system if you are to make a good hologram. Ideally, you should use a heavy bench having a thick slate or metal top and sitting on a thick concrete or cement floor isolated from building vibrations. Such vibrations come from elevators, heavy machinery, passing vehicles, or a walkway used by a number of people.

Unfortunately, such an ideal condition is difficult to find. As a substitute, find a location that is as close as possible to the ideal and then try either of the following vibration-reduction systems.

Partially inflate a truck or car inner tube and place it on top of your workbench. Obtain a piece of thick plywood—¾" or more—about four feet square and center it on the tube. Place heavy weights (stones or metal blocks) at each corner of the plywood and orient the weights so that the plywood is horizontal as indicated by a spirit level.

The second approach is the same as the first except that a thick layer of foam rubber—two inches or more—is used instead of the inner tube.

Once you have a stable platform, you can determine just how stable it is by using a simple interferometer setup as shown in the diagram. You can use the same equipment that is used to make a hologram.

Assemble the optical system, as shown, on the stable platform. The distances from the laser to the beam splitter and from the beam splitter to the white card are not important. However, try to make the distance from the center of the beam splitter to each mirror the same. Do not install the diverging lens at first. Turn on the laser. If things are properly positioned, two pairs of dots should be visible on

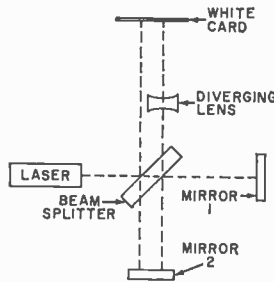

the white card. You can adjust the optics slightly to make both pairs visible. Further adjustment of the optics will cause one pair of dots to be superimposed on the other pair.

Now insert the diverging lens into one of the beam paths about three inches from the white card. One of the dots on the card will enlarge to a red area—actually, it is two areas superimposed on each other. If you examine the superimposed areas carefully, you will notice a number of black bars that may be stationary or slightly moving within the area. If you very gently touch one of the mirrors the black bars will move. These bars are the result of interference patterns and represent an optical "zero beat." Moving either mirror slightly changes the number of bars. Adjust one of the mirrors until a convenient and easily seen number of bars is visible. Leave the optical system alone and observe the bar pattern for a few minutes. The bars should not move more than about one quarter of the distance between bars over a few minutes' time. If you can obtain this type of vibration-free mounting, you can make good holograms.

so there is no actual image on the film. The most that you will see is a somewhat smudgy negative full of whorls and lines. The dark areas are noise. The actual image is down at the molecular level and can be seen as interference fringes under a microscope.

Viewing the Hologram. This can be a little tricky until you get the hang of it. An important first step is to place the hologram (after it is air dried) in a metal frame so that it is flat. The frame should at least support the hologram by the two edges that have the most curl.

The hologram can be observed without disturbing the exposure setup. Looking at the exposure arrangement from the rear of the film holder, note the angles made to the film holder by the reference beam and the target reflection beam. Referring to Fig. 5, remove the film holder platform and place the hologram in the diverged reference beam at the point where the film was originally positioned. The image should appear where the original target was as you look through the back of the film. You may have to move the hologram around a little, and unless you remember the exact orientation of the film, you will have to turn it until

you see the image. If the film is reversed, a weird, unrecognizable blown-up image will result. As previously mentioned, seeing the image is tricky until you are used to it. Have patience and try viewing a hologram that you know is good before giving up on the one you made. If you purchase the hologram optics kit mentioned in the Bill of Materials you will get a sample hologram to experiment with. Other holograms are available from Edmund Scientific Co., 300 Edscorp Building, Barrington, N.J. 08007.

Troubleshooting. If no picture can be found in the hologram, there are several possible reasons. The most probable is that something moved while you were making it. A relative motion of even a few millionths of an inch between target and other components can destroy the image. Also check the following: (1) Beam balance—ratio of approximately 3:1 must be maintained between reference and reflected beams. (2) Stray light from outside or from laser must be eliminated. (3) Exposure time may not be right. Keeping all conditions the same, vary the exposure time until you hit the

(Continued on page 90)

The finished hologram bears no resemblance to an actual picture. In fact, it may look like this. The hologram from this blotchy negative is quite an excellent three-dimensional image. The dark blotches, accentuated by the magazine printing process, are due to the random moding of the laser, and most can be cleaned up with a spatial filter. Small whorls and lines seen on the hologram are the result of small blemishes on the optics or dust motes on polished surfaces. They carry no picture information so they can be completely ignored. The actual hologram interference lines are so small they can be seen only with aid of a microscope.

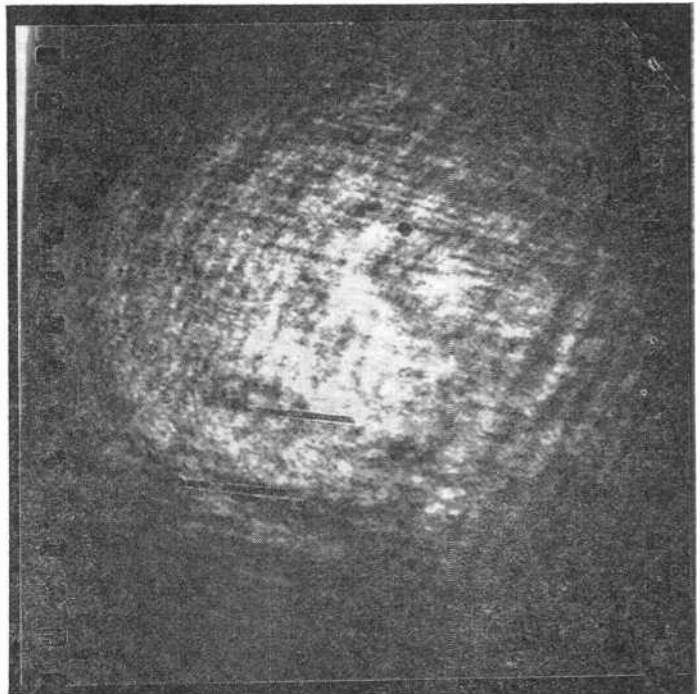

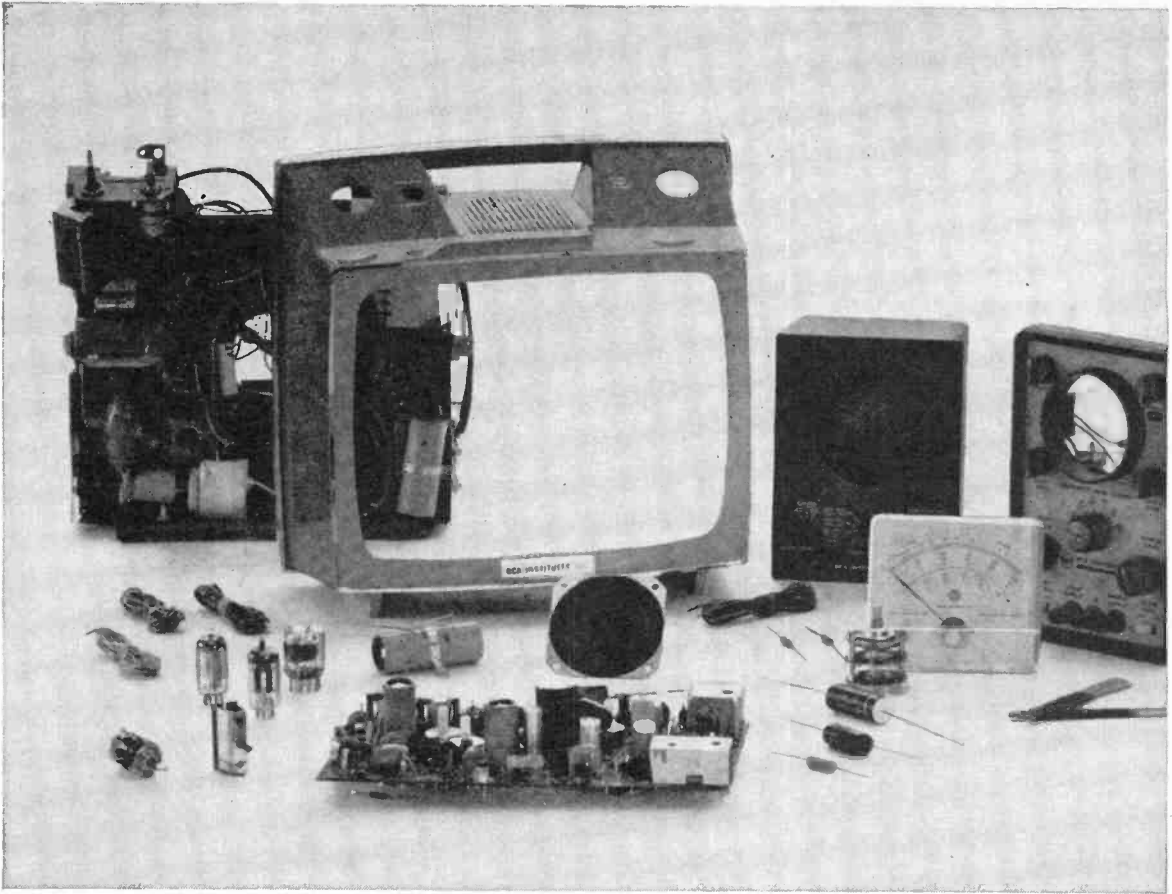

**Look! You get 25 kits...
more than ever before at no extra
cost...for your practical "hands-
on" learning of electronics and
TV with RCA Institutes Home
Training! Send postcard today!**

RCA

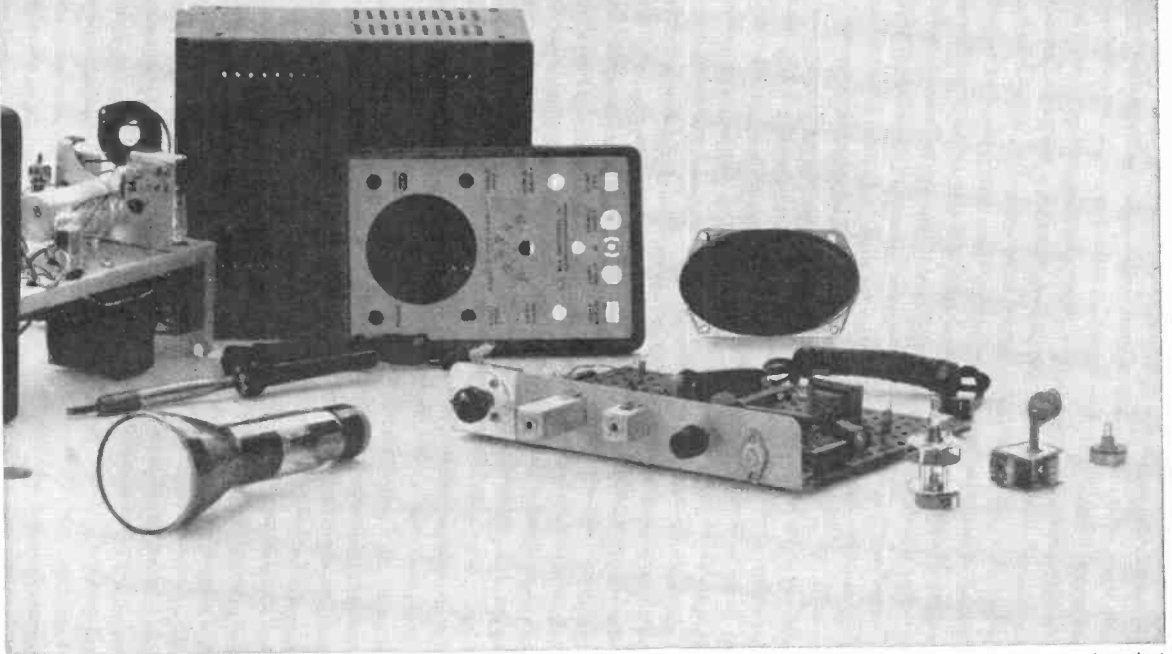

Now, RCA supplies 25 kits in its home-study career program—at no extra cost! Be sure to compare this with other home-study electronics programs. And note, you never have to take apart one kit to build another piece of equipment because there are literally thousands of parts making up the kits. Information on them is included in the catalogue which you'll get when you mail in the reply postcard or the coupon.

Absolutely practical, your kits are used to build such permanent, professional and useful equipment as an oscilloscope, a signal generator, a multimeter, and a fully transistorized breadboard superheterodyne AM receiver. They will give you years of valuable service.

In addition, an easy way to learn—the career programs are all based on the easy, step-by-step AUTOTEXT method. AUTOTEXT is unique and exclusive with RCA Institutes. Math and circuitry problems simply melt away! So check the wide range of electronics and TV career programs.

Eleven Career Programs: Television Servicing (including color TV and

CATV) • FCC License Preparation • Automation Electronics • Automatic Controls • Industrial Electronics • Nuclear Instrumentation • Electronics Drafting • *including these four all-new:* Semiconductor Electronics • Digital Electronics • Solid State Technology • Communications Electronics.

Also check the new Computer Programming course—trains you to work on today's largest data processing systems including IBM/360 and RCA Spectra 70, the Third Generation Computers.

You get tuition plans as flexible as you wish: pay-as-you-order or pay-by-the-month...you choose! No interest charges! No other electronics home study school offers both these choices.

Classroom training also available—day and evening coeducational classes start four times a year. No previous training required—you can take preparatory courses if you haven't completed high school.

Placement service, too—with RCA Institutes classroom training, you get the full benefits of the RCA Job Placement Service. RCA Institutes grad-

uates are now with companies that include Bell Telephone, GE, Honeywell, IBM, RCA, Westinghouse, Xerox, and major radio/TV networks. This placement service is also available to Home Study Graduates.

Veterans: enroll now — all courses are approved under the GI bill

Accredited Member National Home Study Council.

If reply postcard has been removed, mail this coupon.

.....

• RCA INSTITUTES, INC.
 • Home Study Dept. 694-001-9
 • 320 West 31 Street, New York, N.Y. 10001

• Please send me free illustrated career catalog.

Age _____

Name _____
 (please print)

Address _____

City _____

State _____ Zip _____

• For GI information, check here

.....

**Bookshelf
speakers
that fit on
a
bookshelf**

BY DAVID B. WEEMS

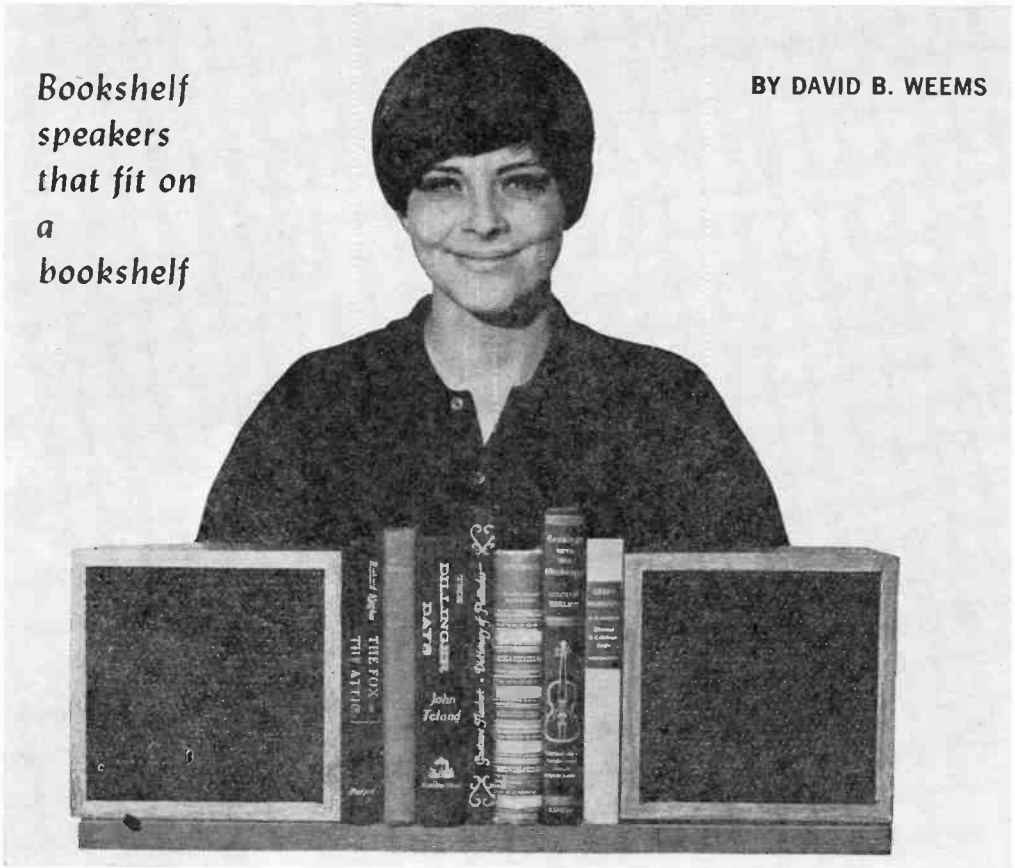

A PAIR OF LOADED DICE

It is an established fact that many so-called bookshelf speaker systems are just too large to fit on a bookshelf. The "loaded Dice," a true stereo bookshelf speaker pair, not only have the right dimensions, they are also inexpensive and easy to build. And if you prefer not to put them on a shelf, you can always use them as bookends on a tabletop or desk. (To double as bookends, each enclosure is loaded with almost three pounds of ceramic tile.)

Although the cubic shape used for the Dice is not recommended for large speaker systems, in the case of a subminiature system, it works admirably. The difference is due to the ability of the acoustical damping material to better

absorb the frequencies that would normally be accentuated by the small cube. For best results, the entire enclosure must be filled with acoustical fiberglass.

The speakers used in the Dice are low-cost versions of the currently popular high-compliance type. The small cones are suspended by a rolled edge, the design of which, when coupled with a large magnet, can produce good sound in a small sealed enclosure.

Construction. The enclosures can be built at little or no cost, depending on whether you have to buy new lumber or have scraps from a previous job that you can use. Just about the only tools you need for assembly are a hammer and a

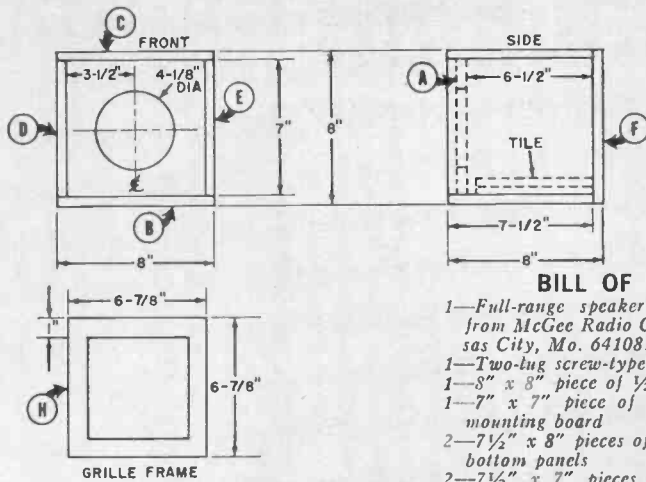

BILL OF MATERIALS

- 1—Full-range speaker (No. XS-510 available from McGee Radio Co., 1901 McGee St., Kansas City, Mo. 64108. \$3.49)
- 1—Two-lug screw-type terminal strip
- 1—8" x 8" piece of 1/2" plywood for rear panel
- 1—7" x 7" piece of 1/2" plywood for speaker mounting board
- 2—7 1/2" x 8" pieces of 1/2" plywood for top and bottom panels
- 2—7 1/2" x 7" pieces of 1/2" plywood for side panels
- 1—6 7/8" x 6 7/8" piece of 3/8" plywood for grille frame
- 2—6" x 6" x 1/2" patio tiles
- 1 yd. "Contact" plastic veneer
- Misc.—#8 x 1/2" panhead sheet metal screws (4); #10 x 1 1/2" wood screws (4); 1/4" flat washers (4); 1/2 lb. #4 finishing nails; 12" zip cord; fiberglass wool; 1/8"-thick polyfoam; wood glue; water putty; silicone rubber caulking compound; sandpapers; etc.

Fig. 1. Small cabinet size allows walls to be butt-jointed; sides are then finished with adhesive-backed vinyl covering. Grille frame fits directly into well in front of speaker.

saw since small boxes do not require the same degree of bracing and careful joining of parts that are musts with large enclosures.

You can begin construction by cutting the five enclosure panels, speaker mounting board, and grille frame for each sys-

Fig. 2. Bolted down with woodscrews and washers, patio tiles load bottom of enclosure to prevent skidding when the speaker is employed as bookend.



tem you plan to build to the dimensions given in Fig. 1. Then, after making the speaker cutout, apply two coats of flat black paint to the sides of the cutout and front surface of the speaker mounting board.

Strike a line 1/2" in from and parallel

Fig. 3. Before assembly, start finishing nails into top, bottom, and rear walls of cabinet. Then apply beads of glue and hammer home nails as shown here.



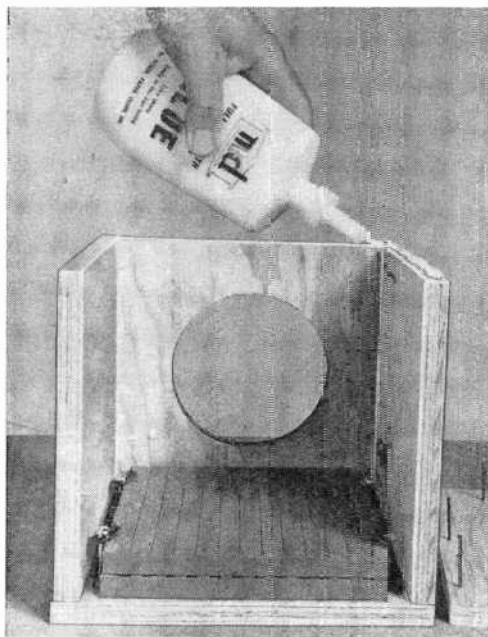

Fig. 4. Top should be last wall mounted to speaker mounting board. Note, at far right, nails partially driven into top wall to facilitate assembly.

to the front edges of the side and bottom panels to locate the position of the outer edges of the speaker mounting board. Set the speaker board onto the bottom plate, and strike another line on the bottom board along the rear edge of the speaker board. Then strike one more line 1" in and parallel to each side edge of

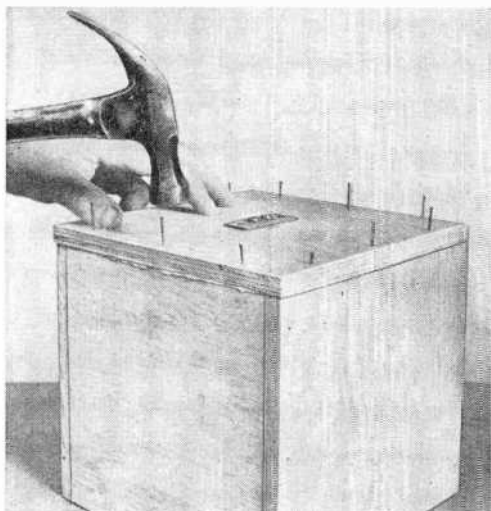

Fig. 5. Mount screw-type terminal strip to rear of cabinet; then glue and nail rear wall to cabinet shell, trueing up sides, top, and bottom as you go.

the bottom panel for the patio tiles.

Now set the patio tiles on the bottom panel, locating them within the lines previously drawn. Use glue and four #10 \times 1½" woodscrews with ¼" flat washers to secure the tiles in place as shown in Fig. 2.

Next, glue and nail the bottom and one side panel to the speaker board as seen in Fig. 3. Then glue and nail the remaining side in place. Apply a liberal bead of glue to the top edges of the speaker board and enclosure sides; also start nails into the top panel (see Fig. 4). Lower the top panel onto the enclosure assembly, square it with the sides, and hammer home the nails.

Prepare the rear panel as follows. First determine the center-to-center distance between the two screws of a two-lug, screw-type terminal strip. This distance tells you how far apart the holes must be for the terminal strip to mount on the rear panel. Now, use a ¼" drill to bore holes through the center of the rear panel. Try the terminal strip for fit; if the holes are too small to accept both the screw ends and solder lugs, enlarge the holes with a hand reamer.

Separate the conductors for a distance of 2" at one end of a 12" length of zip cord. Remove ¼" of insulation from each conductor. Then pass one conductor through each hole, and solder them to the lugs on the terminal strip. Gently pull on the zip cord until the terminal strip is flat against the outside surface of the rear panel. Use small tacks or wood screws to anchor the terminal strip in place. Then drive the screws all the way into the terminal strip contacts.

Turn over the rear panel and fill the holes passing the zip cord with silicone rubber caulking compound. Then, glue and nail the rear panel to the enclosure shell as shown in Fig. 5. This done, use a pin or center punch to countersink all nail heads. Then fill the nail holes with "water putty" or plastic wood.

After allowing sufficient time for the putty to harden, sand all surfaces (sides, top, and bottom) as in Fig. 6. Brush away all sawdust. Cut a piece of "Contact" self-sticking vinyl veneer to 9" by 33". (This material is available in many patterns, textures, and colors. The richest among them is the wood "veneer"



Fig. 6. Power sander is fast way of smoothing surfaces, but you can use wood block and sandpaper.

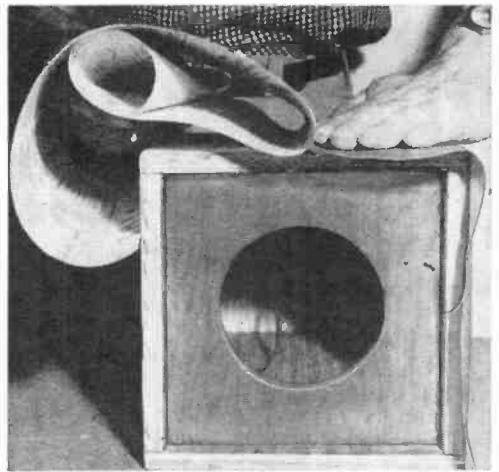
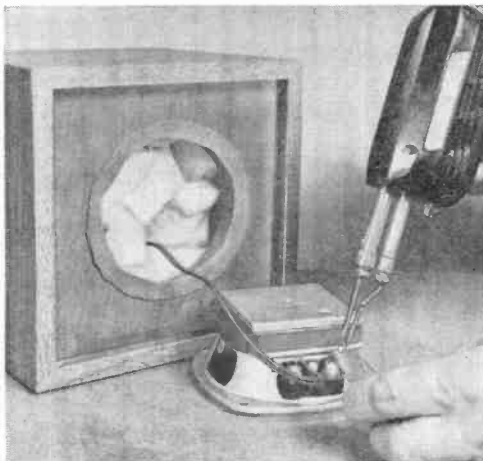

Fig. 7. Thoroughly clean off wood dust before you carefully apply adhesive-backed vinyl to cabinet.

pattern, of which there are several shades and wood grains.) Carefully following the instructions printed on the peel-away paper, stick the veneer to the enclosure sides, starting at a bottom corner so that the seam will not be visible. Apply the veneer so that it is flush with the rear edges of the enclosure and overlaps the front edges (see Fig. 7).

After pressing the Contact into place and removing all wrinkles and air bubbles, make a 90° slit at all four corners. Fold the side strips over the front edge of each side. Then cut the top and bottom strips at 45° angles so that when you fold them over, the effect will be a miter cut.

Fig. 8. Fill cabinet with cut-up pieces of fiberglass wool, cement on gasket, and wire up speaker.



Cut a piece of acoustical fiberglass to 6" X 24". Roll it up and insert it through the speaker cutout into the enclosure. Now carefully unroll it, and press it into place around the interior walls. Then press into place against the rear wall another piece of fiberglass.

Route the zip cord out of the enclosure through the speaker cutout. Then fill the interior of the enclosure with small pieces of the fiberglass, and cement a 1/8"-thick ring of polyfoam around the speaker cutout to form a gasket for the speaker.

Connect and solder the free ends of the zip cord to the speaker lugs (see Fig. 8). Set the speaker into its cutout

Fig. 9. Speaker front mounts to speaker board. Be careful to avoid cone damage in mounting speaker.

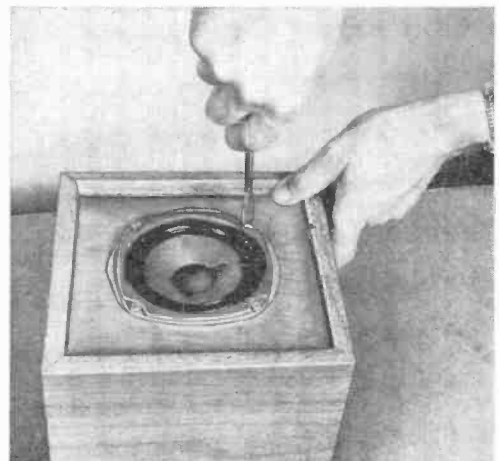

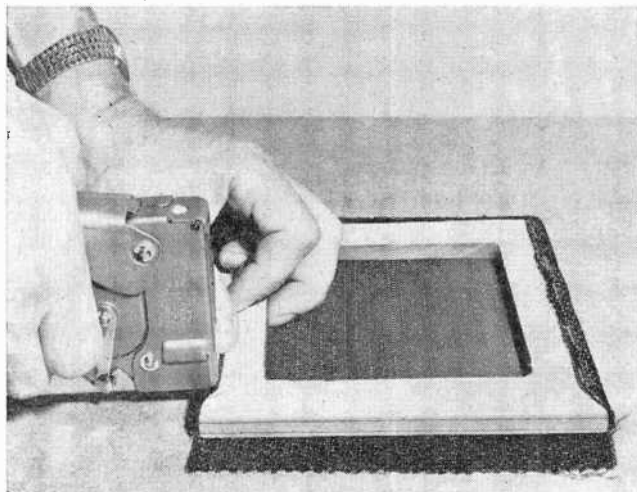

Fig. 10. To provide proper fit, the corners of the grille cloth must be notched to remove excess material before cloth is stapled to frame.

and use #8 \times $\frac{1}{2}$ " panhead sheet metal screws to fasten it down as shown in Fig. 9.

Now determine the polarity of the speaker by momentarily touching a 1.5-volt battery to the screw contacts on the terminal strip and observing cone movement. Place a red dot or other identifying mark on or near the screw contact that is the positive end of the battery when the cone moves outward.

Center the grille frame over the 9" \times 9" grille cloth, and cut a square notch at each corner of the grille cloth to obviate a thick overlapping at the corners. Tack or staple the grille cloth to the frame as in Fig. 10. The grille assembly can now be press-fitted into the front of the enclosure (Fig. 11). If you selected a very thin grille cloth that produces a loose fit, simply drive a thin wire brad through each corner of the enclosure into the frame.

Finally, cement a 7 $\frac{1}{2}$ "-square by $\frac{1}{8}$ "-thick sheet of polyfoam plastic to the bottom of the enclosure to provide protection to the furniture on which the speaker is placed and to increase surface friction between the enclosure and a shelf or table.

Connect your speaker or stereo pair to an amplifier or receiver, taking care to connect the identified screw terminal to the "hot" 8-ohm output. Better yet, try switching the leads to one speaker (if you use a stereo pair) to check for proper phasing. When properly connect-

ed, the bass response of the system will be markedly better.

Whether you use the Dice speakers as main speakers or as extensions in remote locations, you will be delighted by their appearance and clean sound reproduction. In fact, these easy-to-build boxes might prove so appealing that you will make several pairs to provide stereo listening throughout your home. -50-

Fig. 11. Grille assembly wedge fits into front of cabinet. If fit is too loose, drive thin finishing nails through cabinet corners and into frame.

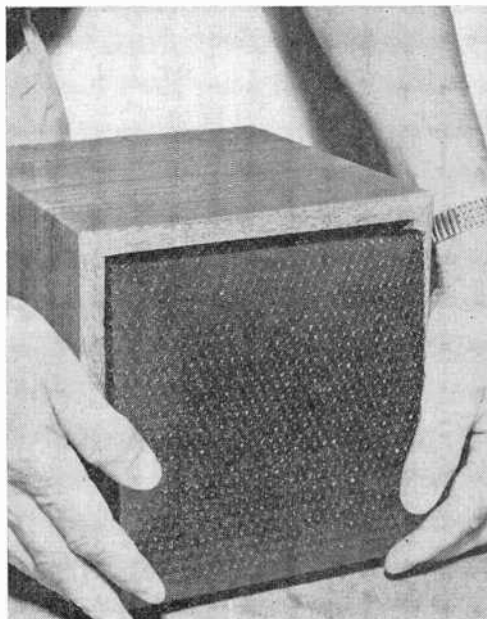

A REAL BOSS SOUND

THE WAA-WAA

*Be first
with a new
vibration*

BY JOHN S. SIMONTON, JR.



IF YOU'RE an avid admirer, and a participant in, the rock music scene, you may have noticed that really "new" sounds are coming out of a few recording studios and even fewer groups. Fuzz, reverb, tremolo, and vibrato are being overworked.

The groups that have something new have been keeping it under wraps; but now the secret is out—it's the "Waa-Waa" sound.

You don't need fancy gear to create your own Waa-Waa sound. This story tells how to build a foot-operated self-contained Waa-Waa unit that is simply plugged into the circuit (using ordinary shielded phone cables) between your guitar and amplifier.

Unless you press the Waa-Waa pedal, the sound from your guitar remains unchanged. Pressing the pedal (and releasing it according to the effect you want to create) introduces a totally new sound experience. It's pretty difficult to describe in print. Some groups think it sounds like a "wow" or "whoop"; others use the Waa-Waa to create an effect as if the music were being modulated by the gentle spring breeze. You can do all sorts of tricks with the Waa-Waa and the difference is that this is practically a musical instrument itself. It's not just an idiot box that you turn on and forget. You actually play the Waa-Waa to add a new dimension to any sound signal that is rich in harmonics.

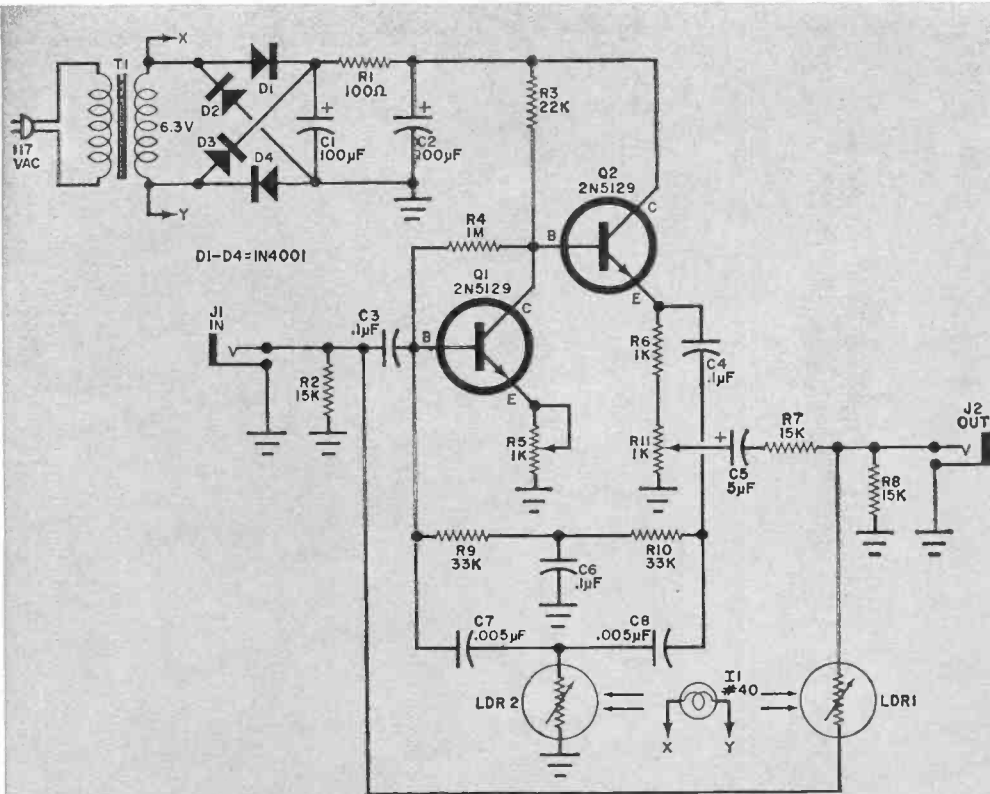

Fig. 1. The circuit is a variable-frequency, narrow-band amplifier whose gain and center frequency are determined by the amount of light on the LDR's.

PARTS LIST

C1, C2—100- μ F, 10-volt electrolytic capacitor
 C3, C4, C6—0.1- μ F disc capacitor
 C5—5- μ F, 6-volt electrolytic capacitor
 C7, C8—0.005- μ F disc capacitor
 D1-D4—1N4001 diode
 I1—#40 pilot lamp
 J1, J2—Open-circuit phone jack
 LDR1—Light dependent resistor (Claircx 703L)
 LDR2—Light dependent resistor (Claircx 703)
 Q1, Q2—2N5129 transistor
 R1—100-ohm
 R2, R7, R8—15,000-ohm
 R3—22,000-ohm
 R4—1-megohm
 R6—1000-ohm
 R9, R10—33,000-ohm
 R5, R11—1000-ohm, printed circuit type trimmer potentiometer

All resistors
 1/2-watt

T1—Transformer, secondary: 6.3 volts at 300 mA

Misc.—Chassis, wooden foot pedal, mounting bracket for light dependent resistors and light, light mask, spring, dust cover, terminal strips, rubber feet (4), line cord, strain relief, flat black paint, shielded, cable, wire, etc.

Note—The following are available from PAIA Electronics, P.O. Box 14359, Oklahoma City, Oklahoma, 73114: etched and drilled PC board #7690, \$3.00, postpaid in continental U.S.; pre-punched case including all brackets, spring, etc., unpainted, #7690C, \$5.10, plus postage for 2 pounds; complete kit including case, circuit board, and all parts, #7690K, \$18.75, plus postage for 3 pounds. Oklahoma residents, add 3% sales tax.

Construction. The electronic portion of the Waa-Waa is straightforward and follows the schematic shown in Fig. 1. Component layout is not critical and any method of assembly may be used. Use of a printed circuit board lends a professional touch and guarantees correct wiring. You can make your own board using the foil pattern shown in Fig. 2 or you

can buy one as described in the Parts List. Install the components as shown in Fig. 3.

Mechanical construction of the Waa-Waa can be done in one of a number of ways. Basically, what is needed is a U-shaped, sloping top chassis, large enough and strong enough to support the user's foot. A wooden pedal forms the

HOW IT WORKS

The circuit is basically a bandpass amplifier composed of a common-emitter gain stage ($Q1$) and an emitter-follower stage ($Q2$), with feedback through a parallel-T filter ($C6$, $R9$, $R10$ and $C7$, $C8$, $LDR2$). The width and center frequency of the pass band are controlled by the resistance of $LDR2$, a value proportional to the amount of light falling on the photoresistor's surface.

When the foot pedal is up, $LDR1$ is exposed to the light from $I1$. The light striking $LDR1$ causes its resistance to be so low that it provides a direct, low-resistance path from the input jack to the output, bypassing the amplifier.

As the foot pedal is depressed, it first blocks

the light falling on $LDR1$, thereby raising its resistance so that the signal goes through the amplifier. As the pedal is depressed further, the section of the mask which is in front of $LDR2$ gradually begins to expose the surface of this photocell. Its resistance is thus decreased, raising the center frequency of the amplifier's pass band.

Potentiometer $R5$ is used to adjust the gain around the feedback loop and is set so that the circuit is held just below the point of oscillation. Potentiometer $R11$ is used to adjust the gain at the output and is set so that there is no noticeable change in the volume of the instrument as the Waa-Waa is switched in and out.

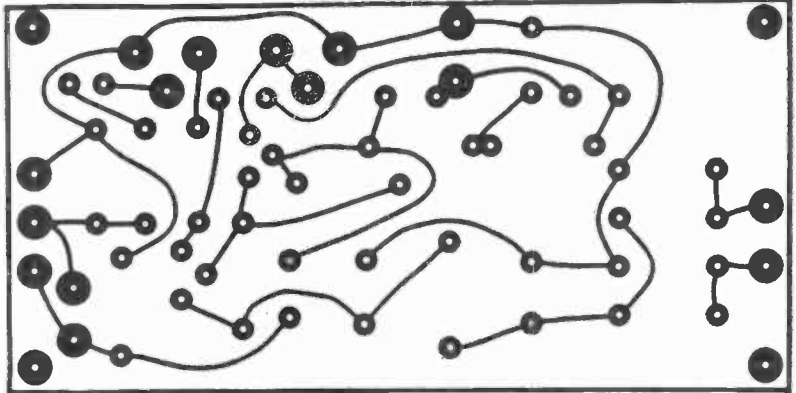

Fig. 2. Actual-size foil pattern can be used to make your own circuit board.

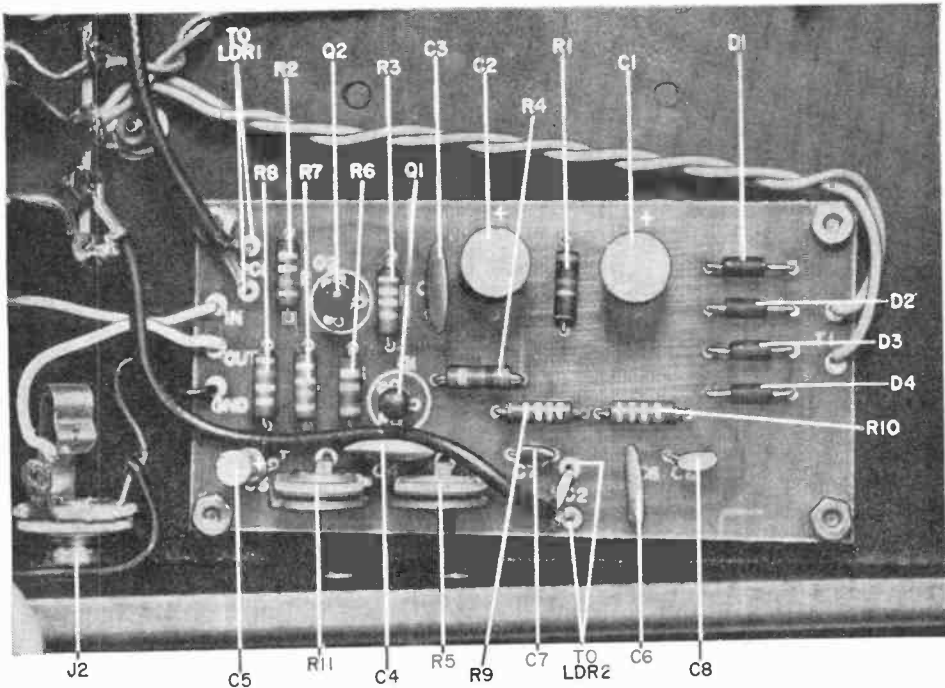

Fig. 3. After installing all components on board, make sure both trimmer potentiometers are accessible through holes drilled in side of chassis. This view also shows connections to other elements.

top of the assembly. The pedal is hinged at the heel (lower) end by a pair of long wood screws. A mild-spring steel spring supports the pedal and returns it to the top position when the foot is relaxed or removed.

On the underside of the wooden pedal, is a specially shaped light mask which, as the pedal goes up and down, passes between a light source and a pair of photoresistors or light dependent resistors.

If you have the metalworking facilities, you can duplicate the prototype chassis, using 16-gauge steel or aluminum and following the layout shown in Fig. 4. Once the chassis is made, fabricate the wooden pedal out of $\frac{3}{4}$ " plywood with the dimensions given in Fig. 5. This illustration also shows the spring that is fabricated from 16-gauge mild-spring steel. The dimensions of the support bracket for the photoresistors and the light mask are shown in Fig. 6.

The entire interior of the Waa-Waa, including the mask and photoresistor bracket, must be finished in flat black to

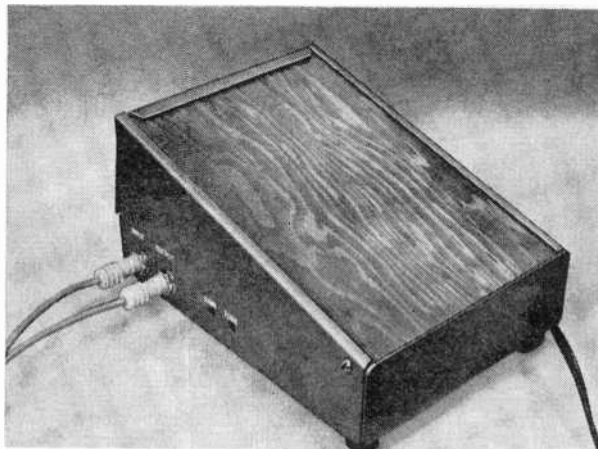

The completed Waa-Waa. Two audio leads, one input and one output, plug into the appropriate jacks. Two holes alongside are for trimmer adjustments.

minimize internal reflections from the light. After the photoresistor bracket has dried, mount it on the chassis as shown in the photos. The two photoresistors are glued in place as shown in Fig. 6.

Attach the PC board, temporarily, to

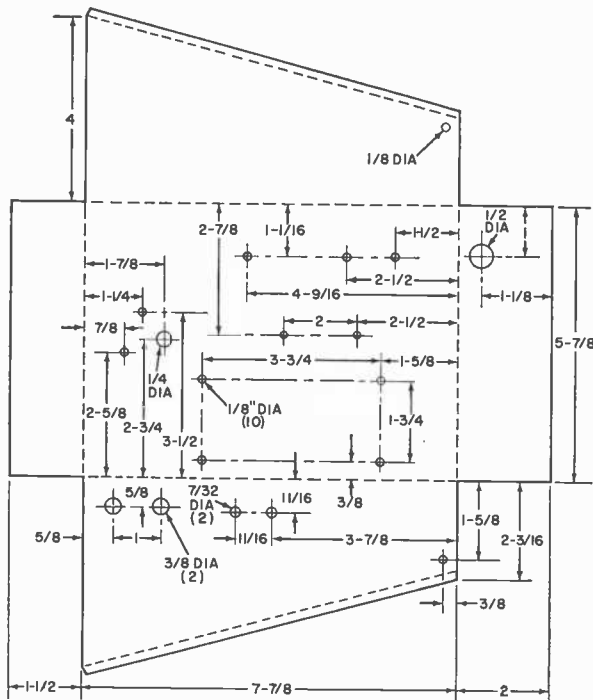

ALL MEASUREMENTS ARE IN INCHES

Fig. 4. If you want to fabricate chassis similar to the one shown in the photos, follow construction details shown here.

Fig. 5. Fabrication details for the wooden pedal and spring. Two holes in the pedal support the shadow mask. Spring serves to return the pedal to the top of its travel when the foot is removed from the top.

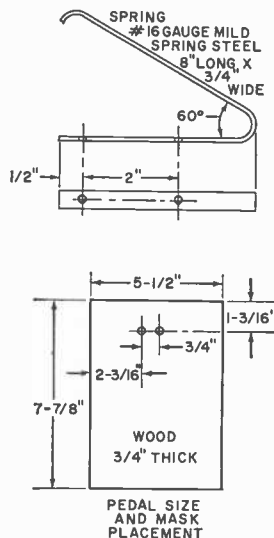

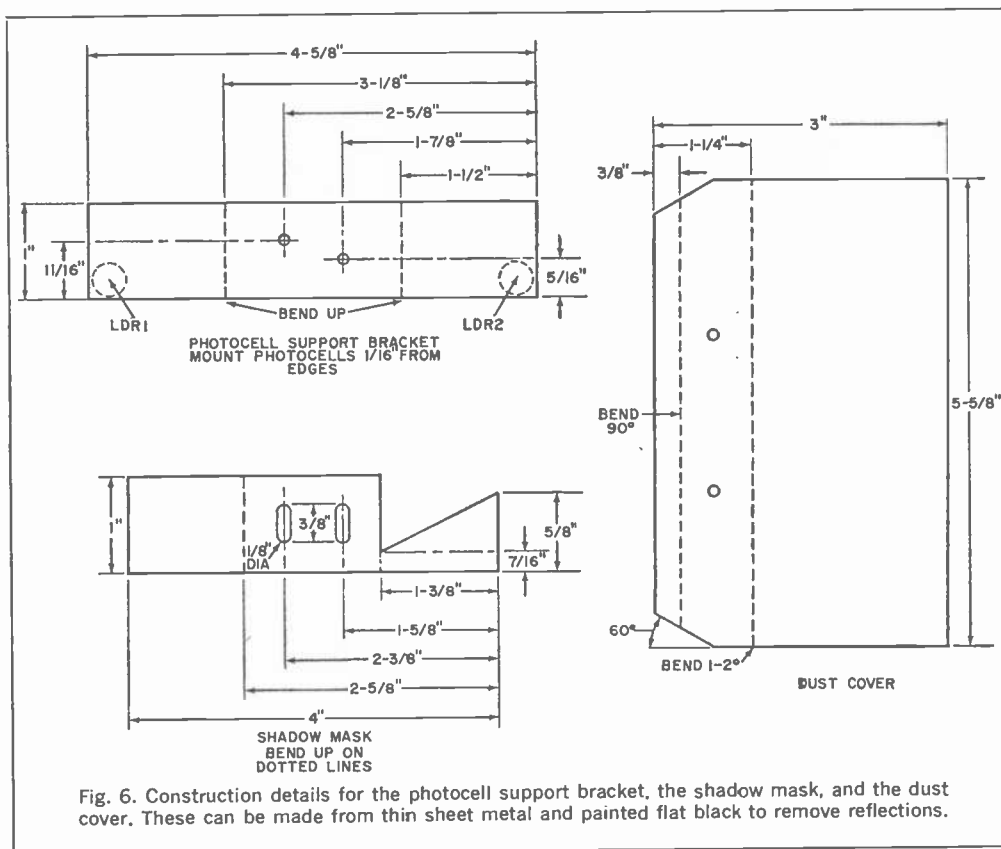

Fig. 6. Construction details for the photocell support bracket, the shadow mask, and the dust cover. These can be made from thin sheet metal and painted flat black to remove reflections.

the chassis, using four small standoffs. Note and mark the chassis for both trimmer potentiometers. Remove the PC board and drill holes in the chassis so that the trimmers can be adjusted from outside with a screwdriver.

Using suitable hardware, mount the transformer on the bottom of the chassis. Mount the input and output phone jacks. After soldering appropriately long leads on the PC board terminals, attach the board (on its spacers) to the chassis. Make sure that the two trimmers face the holes for adjustment. Mount a six-lug terminal strip (one lug grounded) close to the photoresistor support as shown in the photos. Lamp *L1* can be installed in a socket or it can be attached to heavy leads soldered to its base connectors. Connect one side of the lamp to the grounded lug on the terminal strip and the other to the adjacent ungrounded lug. Position the lamp midway between the two photoresistors. Coat the lamp with flat black paint. After the paint dries, scratch a small clear spot on

each side of the lamp so that, when it is lit, a small beam of light falls on the sensitive face of each photoresistor.

Insulate the leads on the photoresistors and connect them to the outside terminals on the terminal strip. Using shielded cable to minimize hum, connect

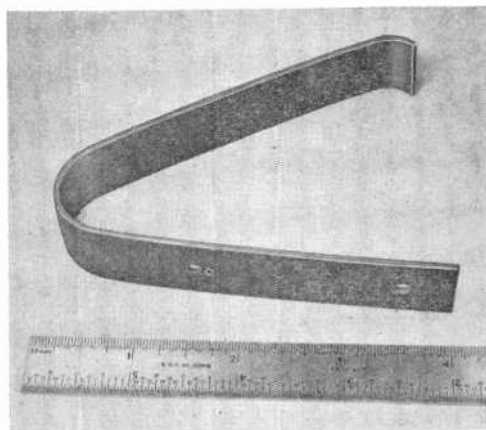

The spring has a small curve at the top to slide along the wooden foot pedal as it is depressed.

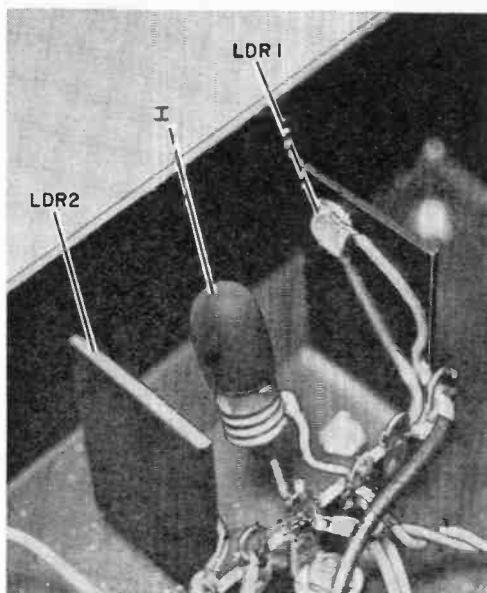

Lamp I1 is painted flat black and small dots of paint are removed on each side to shine on LDR's. Dot where paint was removed appears black here.

these terminals to the appropriate terminals on the PC board. Use a two-lug (non-grounded) terminal strip to connect the primary leads of the transformer to the line cord. Pass the cord through a hole with a grommet in it in the lower end of the chassis.

Wire the system according to Fig. 1, making sure that the photoresistors are properly installed. Install the wooden foot pedal temporarily, using the hinge screws to hold it. Hold the light mask against the bottom surface of the pedal with the angled portion covering LDR2. When the pedal is depressed, the mask must slide cleanly between the lamp and the photoresistors. Put screws through the slotted holes in the light mask to position it laterally but leave it able to move up and down on the pedal.

Remove the wood pedal. Attach the spring, using suitable hardware, so that the top of the spring is slightly higher than the chassis walls. Re-install the pedal and secure it with the hinge screws. Check that, as the pedal is depressed, the light mask slides clean. With the pedal all the way up, the uppermost surface of LDR1 may be in shadow but the majority of its surface must be fully lit by the beam from I1. Adjust the final position of the mask so that both photoresistors are completely in shadow when the foot pedal is lightly depressed and LDR2 is fully lit when the pedal is pressed all the way down. Provide some form of mechanical stop to arrest the pedal at the bottom of its travel. (In the phototype, this stop is provided by the

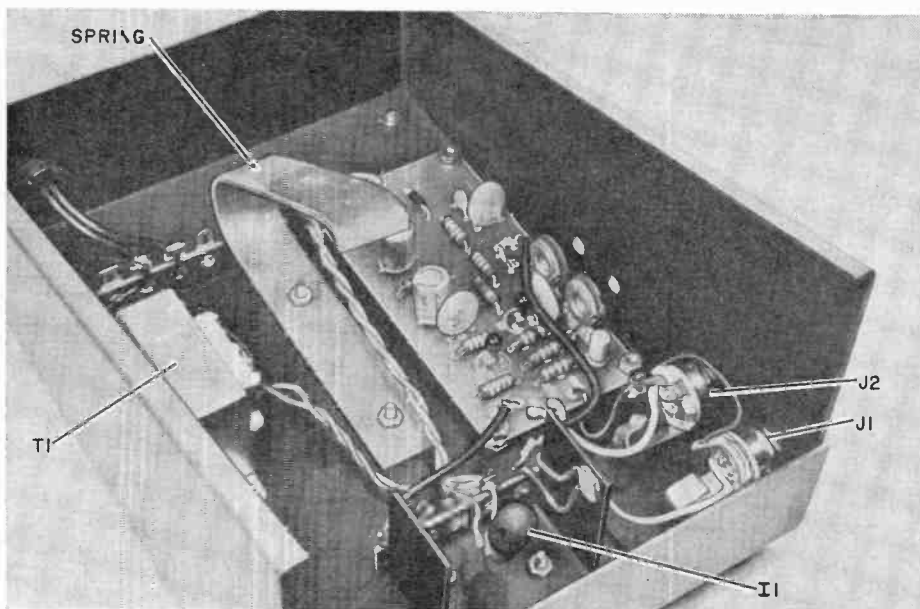

Interior view of the Waa-Waa showing the location of all parts. Note the two holes for the trimmer potentiometers. The lips on the chassis top limit the wooden foot pedal at the top of its travel.

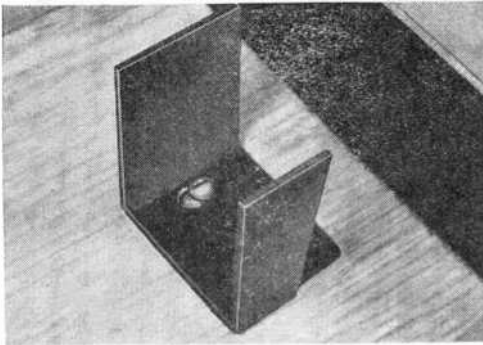

Shadow mask is secured to underside of foot pedal. The flat black paint removes all reflections.

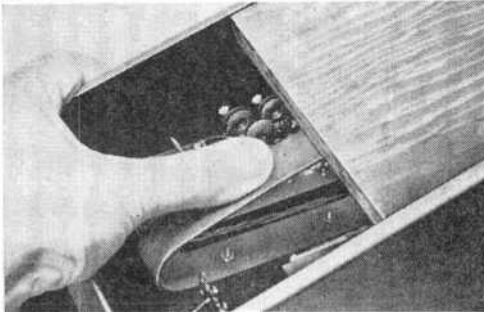

The spring must be slightly depressed to allow foot pedal to slide under the chassis upper lips.

hitting of the mask against the frame that holds the photoresistors).

Fabricate the light and dust cover as shown in Fig. 6 and mount it on the top end of the foot pedal. The inside of this cover must be painted flat black.

Operation and Use. Plug the output from the instrument you are going to use into the input jack, *J1*, of the Waa-Waa and run an audio cable from the output jack, *J2*, to the amplifier. Supply power to the Waa-Waa, set the amplifier volume to a reasonable level, and use a small screwdriver to turn the potentiometers, *R5* and *R11*, fully clockwise. At this point, a squeal may be heard from the amplifier as the Waa-Waa breaks into oscillation. Adjust *R5* until there is no oscillation at any setting of the foot pedal.

Now strike a chord on the instrument and press the pedal. The effect of the Waa-Waa should be obvious; however, there will also be a noticeable increase in volume as the pedal is depressed. Adjust *R11* so that the volume change is minimized.

As you learn to use the Waa-Waa, you may feel that only a slight motion of the pedal produces too great a change in the tone of the instrument. This can be changed by reducing the size of the hole in the paint on the side of *I1* which illuminates *LDR2*. You may eventually find that just a pinhole produces the proper results.

There may be an annoying squeak as the pedal rubs against the sides of the case and the spring. This can be eliminated by coating the offending areas with one of the silicone lubricants.

For maximum effect, the Waa-Waa should be used with instruments producing a tone rich in harmonics, such as a guitar or harmonica. The effect on a guitar is most noticeable when the strings are plucked next to the bridge but this is really a gimmick on top of a gimmick. In general the effect of the Waa-Waa is less noticeable on bass instruments (unless they generate good harmonics as does a bass harmonica). The pedal may be pressed and released rapidly to get a distinctive "wow" or it may be moved slowly to produce a weird "wind in the willows" effect.

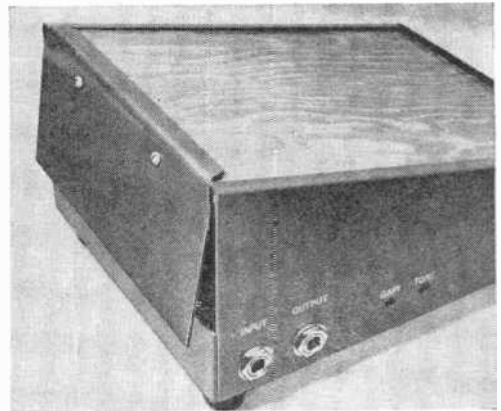

Dust cover keeps the ambient room light from affecting *LDR*'s. A pair of wood screws form a hinge at the heel (lower) end of wood foot pedal.

The thing to do is experiment. The effect is so unusual that a beginner is as expert as anyone else so no one can say you're doing it wrong.

One word, however! A little Waa-Waa goes a long way. The listener should get the impression of having heard something new, but he shouldn't be able to say exactly what it was. -50-

BUILD THE Time Out

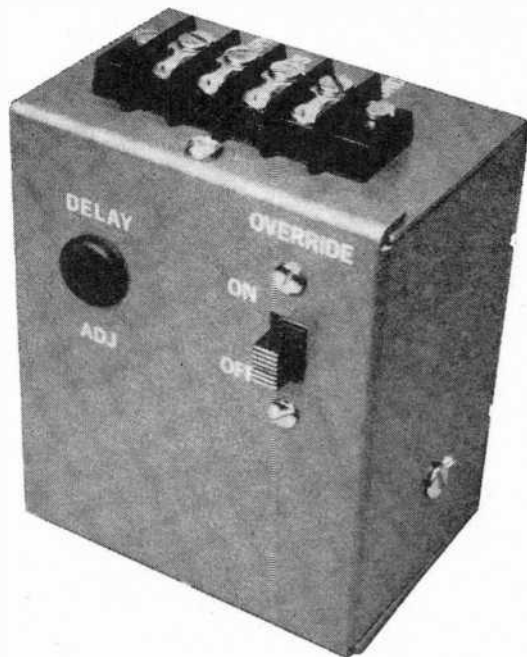

URNS OFF CAR LIGHTS WHEN YOU'RE SAFELY INSIDE

BY JOHN STAYTON

THERE ARE FEW things more aggravating to the motorist than pulling into the driveway at night and having to stumble around in the dark driveway to find the key for the garage or front door. Not only is it inconvenient; it's unsafe if there is snow on the ground, or roller skates or bicycles lying around.

Wouldn't it be helpful if you could leave the headlights on for a while after getting out and not have to go back to turn them off? With a "Time Out" you can do just that. When you have this device installed in your car, the headlights stay on after the ignition is turned off and then go off automatically after a predetermined period of time—from a few seconds to a couple of minutes. If you always park in well-lighted areas at night, the Time Out comes in handy should you forget to turn off your lights.

The Time Out is easily constructed using readily obtainable parts and it is easy to install in your car.

Construction. There is nothing critical about the circuitry of the Time Out (see

Fig. 1) and any method of construction may be used. A printed circuit board like the one used in the prototype helps to produce a sturdy compact unit and may be duplicated using Fig. 2 as a guide. When installing the semiconductors be sure you observe the proper polarities and heat sink their leads while soldering.

In the prototype, the circuit board and relay are housed in a $3\frac{3}{4}'' \times 3'' \times 2\frac{1}{8}''$ metal utility box. A barrier-type terminal strip mounted on one end of the box is used to make connections to the automobile wiring. The circuit board is mounted on short spacers and is in such a position that the delay adjusting potentiometer (*R9*) is accessible through a hole drilled in the case. Line this hole with a rubber grommet to prevent short circuits when making adjustments with a metal screwdriver.

When selecting a relay, don't scrimp on the current rating of the contacts. In the prototype, both sets of 10-ampere contacts were wired in parallel just to be on the safe side. The same principle applies to the wire used to connect the

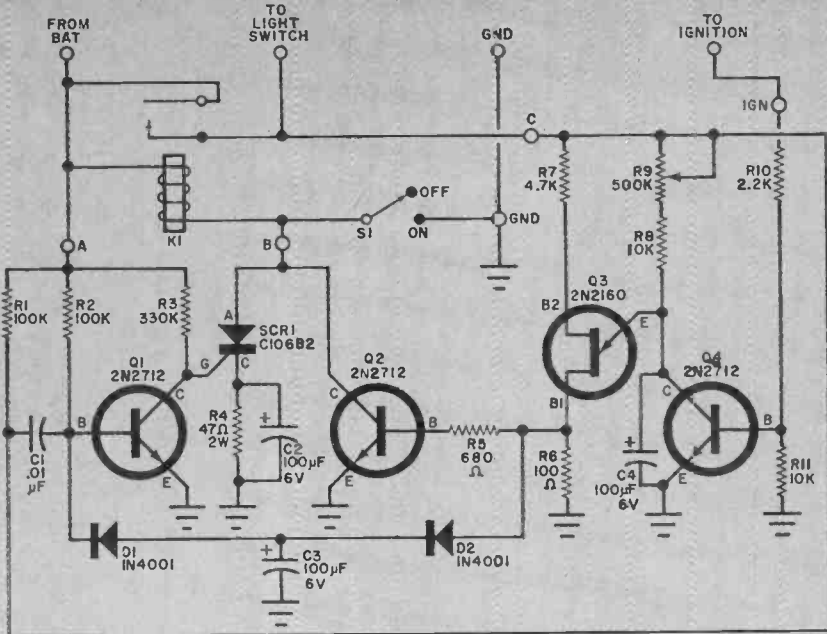

Fig. 1. The UJT turns off the lights by making Q2 appear as a momentary short circuit across SCR1. This causes the relay to open, removing power from lights and timer.

PARTS LIST

C1—0.01- μ F capacitor
 C2,C3,C4—100- μ F, 6-volt electrolytic capacitor
 D1,D2—1N4001 diode
 K1—6-volt d.p.d.t., d.c. relay, 10-ampere contacts (see text)
 Q1,Q2,Q4—2N2712 bipolar transistor
 Q3—2N2160 unijunction transistor
 R1,R2—100,000-ohm
 R3—330,000-ohm
 R5—680-ohm
 R6—100-ohm
 R7—4700-ohm
 R8,R11—10,000-ohm
 R10—2200-ohm
 R4—47-ohm, 2-watt resistor

All resistors
 1/2-watt, 10%

R9—500,000-ohm potentiometer (printed circuit board type)
 S1—S.p.s.t. slide switch
 SCR1—Silicon controlled rectifier (GEC106B2)
 Misc.—Four-contact barrier strip, 3 3/4" x 3" x 2 1/8" metal utility box, rubber grommet, spacers, mounting hardware, chassis lettering, mounting hardware, etc.
 Note—An etched and drilled PC board for \$1.65 and a complete kit of parts including case, PC board, and hardware, for \$12.95 are available from PAIA Electronics Inc., P.O. Box 14359, Oklahoma City, OK 73114. Oklahoma residents add state sales tax.

HOW IT WORKS

When the circuit is in its normal, inoperative state, relay K1 is not energized and no power is applied to either the timing circuit or the headlights. Transistor Q1 conducts because of the forward bias through R2. This holds the gate of SCR1 near ground potential.

When the vehicle's headlight switch is closed the junction of R1 and C1 is grounded through the lights and the charge stored on C1 creates a negative pulse to turn off Q1 momentarily. With Q1 off, a voltage is applied to the gate of SCR1 turning it on and energizing the relay. Power is thus applied to the headlights and the rest of the timer circuit.

When the ignition switch is closed, the positive potential at the junction of R10 and R11 causes Q4 to conduct and disables the timing circuit by shorting to ground the emitter of uni-junction transistor Q3. This condition exists as long as

the ignition switch is turned on. When it is turned off, Q4 stops conducting and a charge builds up on C4 through R8 and R9. When the charge on C4 is sufficiently high, Q3 starts to conduct and a pulse is created on the base of Q2, turning it on. With Q2 conducting, the anode of SCR1 is shorted to ground. Due to the charge built up on C2, SCR1 is then reverse biased and turns off. The relay is thus de-energized and the headlights are turned off.

When the relay's contacts open, the junction of R1 and C1 is once again grounded through the lights and a pulse is created which would begin the turn-on sequence again if it were not for the charge stored on C3 when Q3 was conducting. This charge neutralizes the pulse and keeps Q1 from turning off. Diodes D1 and D2 serve to keep the proper polarities in the circuit.

We pack your electronics course with kits to make your training fast. You'll enjoy every minute of it.

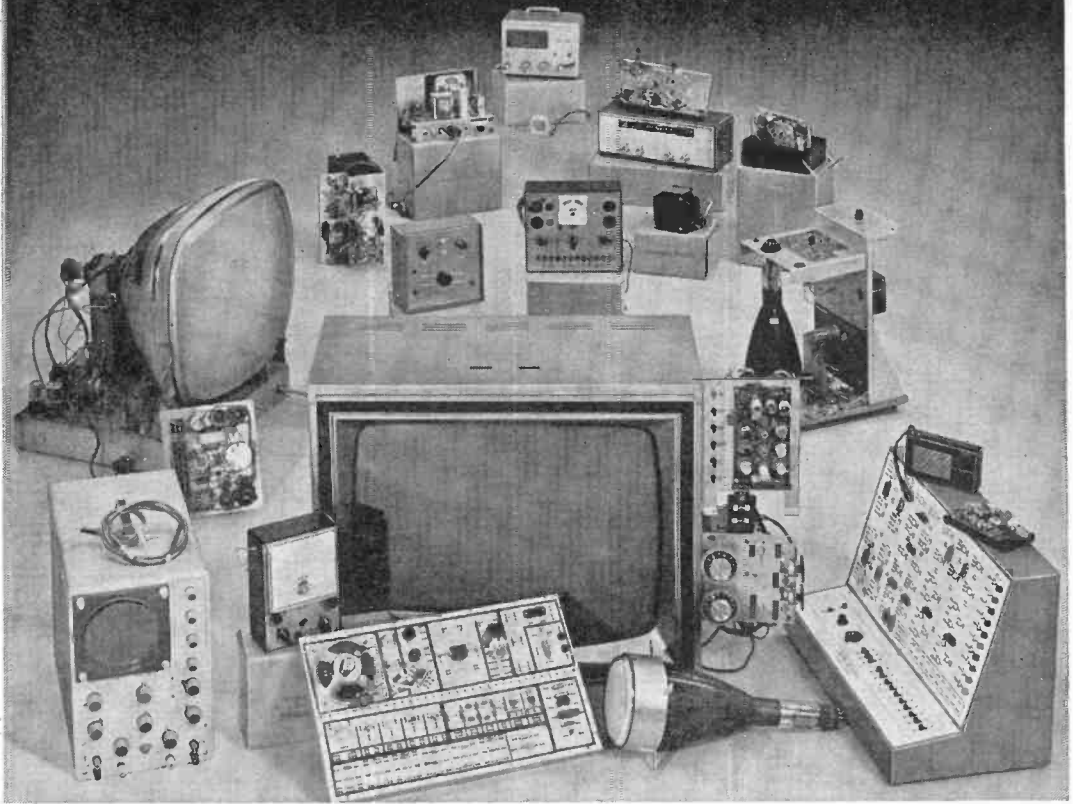

Your NTS success package

Choose a career in electronics: Computers. Color TV Servicing. Automation. Communications. Whatever the field, NTS has a complete home-study package to get you to the top *faster*. 10 thorough training courses. Each includes *everything* to give you the *working* knowledge required of successful technicians.

NTS Project-Method Training is the practical way to learn elec-

tronics. It's a proven combination of lessons and the best professional kit equipment available. NTS provides the *biggest selection of kits ever offered in home-study . . . all at no extra cost*. You'll construct these exciting kits to fully understand electronic circuits, components, and concepts. Our Project-Method lets you build skills by putting theory into practice . . . by working with your hands, as well as your head.

The NTS "learn and practice" approach makes training at home really easy. All it takes is a few hours a week . . . whether you're starting from scratch or in advanced courses. This is the all-inclusive success package that put thousands of men into the best paying jobs . . . or into their own business. If "just a living" isn't good enough for you, now is the time to get something better going for you!

NTS COMPUTER ELECTRONICS

This is the future. And it's happening now. The number of computers will *increase many times* in the next few years.



Exclusive new Compu-Trainer®

NTS offers a solid grounding in computer operation, wiring, data processing and programming. One of the 10 important kits included is our exclusive Compu-Trainer®. It's a fully operational computer logic trainer — loaded with integrated circuits — the first ever offered in home study. It introduces you quickly to how, what, when and why of computers . . . from theory to practical servicing techniques. This unit is capable of performing 50,000 operations per second. And it's sent at no extra cost.

NTS COLOR TV SERVICING

This is a broad, easily understood

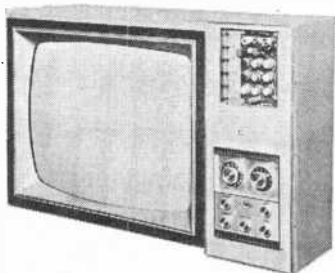

COLOR TV
295 SQ. IN. PICTURE

program designed to make you a complete home-entertainment service technician. Included, at no extra cost, is a color TV that has more features than any

set on the market. You also learn all about stereo, hi-fi, multiplex systems, and become a specialist in Color TV Servicing. Kits also include AM-SW radio, solid-state radio, field-effect transistor volt-ohmmeter, electronic tube tester.

NTS AUTOMATION/ INDUSTRIAL ELECTRONICS

You're trained in the "push-button" electronics that keep industry going and growing . . . from relay type controls to highly advanced systems essential to production. You receive 16 kits including a 5" wide band oscilloscope, and the new NTS electronics lab: a fascinating NTS exclusive experimental laboratory. A complete workshop which makes you familiar with solid-state, miniature, and integrated circuits.

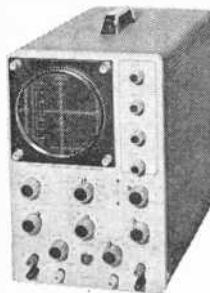

5"
Oscilloscope

NTS ELECTRONIC COMMUNICATIONS

The use of 2-way radio systems in private and commercial applications is skyrocketing. NTS prepares you for the big-money opportunities in the field of transmitting and receiving equipment. *Your tuition will be refunded in full if you cannot pass the FCC exam for a 1st Class Commercial Radio-Telephone License within*

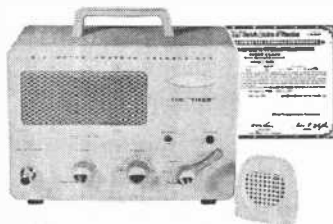

5 Watt AM Transmitter & Receiver

six months after successfully completing this course. You build valuable kits including Amateur-Phone 6 Meter VHF Transceiver, solid-state Radio, and a field-effect transistor volt-ohmmeter.

CLASSROOM TRAINING AT LOS ANGELES

You can take classroom training at Los Angeles in sunny Southern California. NTS occupies a city block with over a million dollars in facilities devoted exclusively to technical training. Check box in coupon.

NATIONAL TECHNICAL SCHOOLS

World-Wide Training Since 1905
4000 South Figueroa Street
Los Angeles, Calif. 90037, U.S.A.

APPROVED FOR VETERANS

Accredited Member: National Association of Trade and Technical Schools, National Home Study Council.

TODAY, MAIL COUPON FOR FREE COLOR CATALOG AND SAMPLE LESSON.



NATIONAL TECHNICAL SCHOOLS
4000 S. Figueroa St., Los Angeles, Calif. 90037

Please rush Free Color Catalog and Sample Lesson, plus information on field checked below. No obligation. No salesman will call.

- MASTER COURSE IN COLOR TV SERVICING
- COLOR TV SERVICING
- MASTER COURSE IN TV & RADIO SERVICING
- PRACTICAL TV & RADIO SERVICING
- MASTER COURSE IN ELECTRONIC COMMUNICATIONS
- FCC LICENSE COURSE
- MASTER COURSE IN ELECTRONICS TECHNOLOGY
- INDUSTRIAL AND AUTOMATION ELECTRONICS
- COMPUTER ELECTRONICS
- BASIC ELECTRONICS

Name _____ Age _____

Address _____

City _____ State _____ Zip _____

- Check if interested in Veteran Training under new G.I. Bill.
- Check if interested ONLY in Classroom Training at Los Angeles. Dept. 205-010

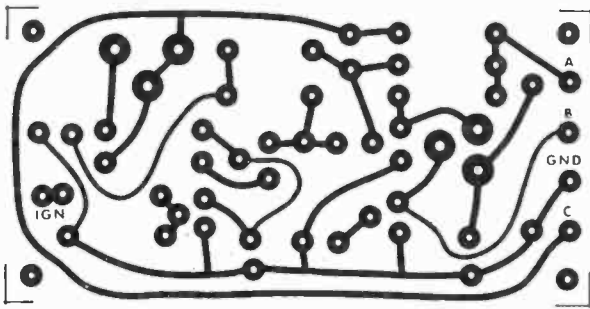
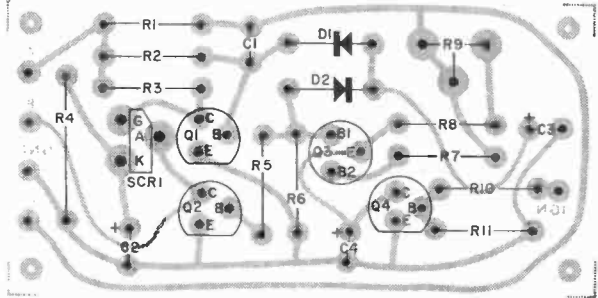

Fig. 2. Actual size foil pattern (above) and component installation (right) for the printed circuit board. Note polarities of semiconductors and capacitors.



relay contacts to the terminal strip—don't use anything smaller than #18 lamp cord or equivalent. The rest of the wiring can be standard #22 hook-up wire. Be sure to leave enough slack in the wires between the circuit and the terminal strip to remove the case.

Installation. In selecting a location for the Time Out in your car, bear in mind that you may want to be able to reach

the override switch (*S1*) from time to time and that the time delay will have to be adjusted when you first set up the system.

Electrical connections to the car are shown in Fig. 3. Locate the lead from the car's light switch to the battery and cut it. After splicing lengths of lamp cord long enough to reach the Time Out, connect the line which goes to the light switch to the terminal marked LIGHTS on

Relay K1 and override switch S1 are mounted on the metal chassis while the grommetted hole allows screwdriver adjustment of R9. Mount the PC board on four rubber shock absorbers to reduce vibrations.

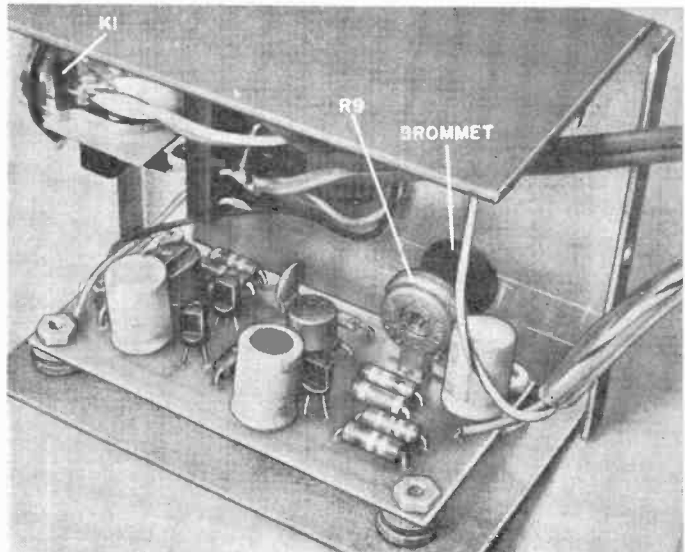

the timer. The wire that goes to the battery terminal should be connected to the BATTERY terminal on the timer. The GROUND terminal of the Time Out is connected to any convenient ground point such as under the head of an existing screw in the

firewall or dashboard. The IGN terminal of the timer is connected to any convenient point which is live only when the ignition is on—such as the radio or heater fan motor. In most cases, the Time Out can be electrically connected at the vehicle fuse block.

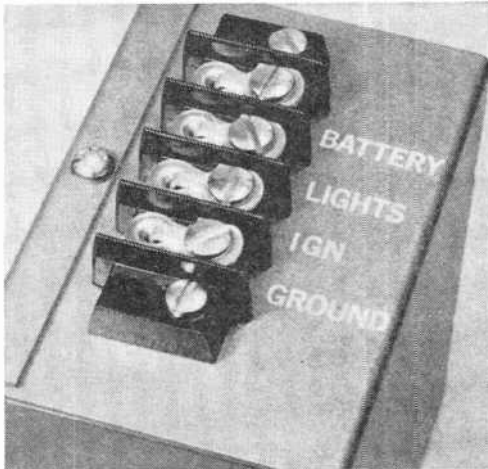

Connections to the vehicle wiring are made via a four-terminal barrier strip. Clearly identify the terminals to avoid wiring errors in installation.

Operation. The Time Out does not interfere with the vehicle's conventional lighting and ignition systems. The lights should work normally except that, when the light switch is left on and the ignition is turned off, the timer will hold the lights on for a length of time depending on the setting of the timer and then turn them off. Clockwise rotation of the timer control (*R9*) increases the time that the lights stay on.

When installed as shown in Fig. 4, the Time Out will control both parking and headlights but will not have any effect on the brake lights, turn signals, or emergency blinkers. For emergencies, turn *S1* on so that the headlights will remain lit indefinitely when the ignition is off. Be sure to turn *S1* off when override control is no longer needed. —59—

Fig. 3. Electrical connections for a typical car are shown at the right.

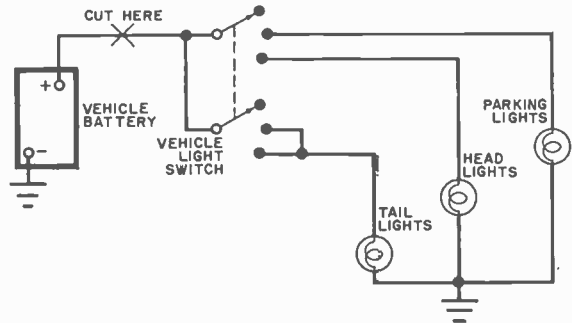
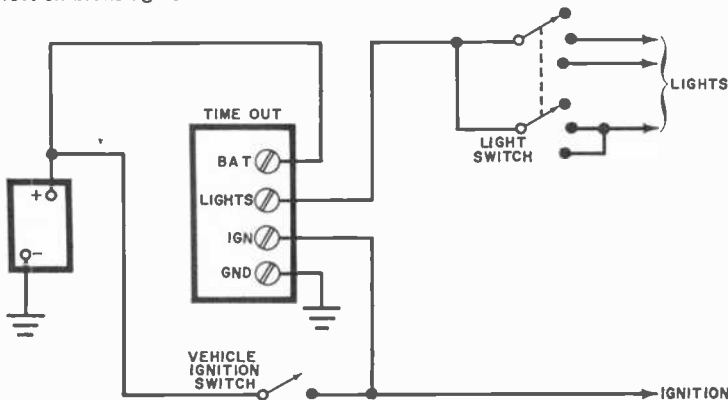
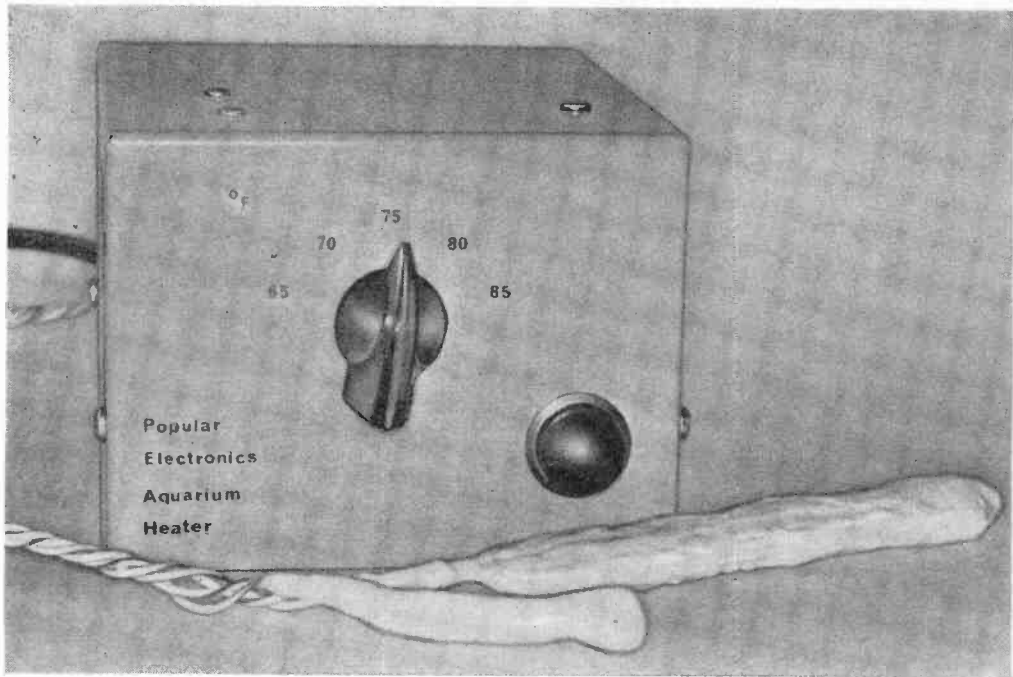

Fig. 4. When installed as shown in diagram below, Time Out has no effect on brake lights or turn indicators.





Electronic Aquarium Heater

FOR CHILLY FISH FINS

BY STACEY JARVIN

MOST AQUARIUM heaters available on the market today are unsightly, bulky, potentially unsafe, and often not reliable. They operate directly from the a.c. power line, employ an inaccurate bimetallic strip temperature sensor, and are enclosed in a glass test-tube affair, the top of which must be above the surface of the tank water. And, unless you are willing to shell out a lot of money, you cannot buy an aquarium heater that has a calibrated range of temperature settings.

The electronic aquarium heater described here overcomes the major disadvantages of commercial heaters. It is completely safe to operate, is capable of sensing temperature changes on the order of 0.1° F, can be hidden under the gravel or sand in your aquarium, and costs little more than a good commercial heater.

Construction. The heater element, *R7*, is a simple affair made up of twenty-

four (24) 300-ohm resistors connected in parallel as shown in Fig. 1. To provide rigidity to the assembly, it is suggested that you "ladder" assemble the resistors between two heavy-duty wire busses.

Although the heater arrangement is rated at only 12 watts in free air, it will safely dissipate 50 watts of "heating" power when submerged in water.

Since the heater element is to be operated completely submerged, it must be water-tight. So, after assembling the element, carefully check the heavy wires you plan to use between it and the control/power circuitry for nicks and holes in the insulation. When you are satisfied the wire is safe to use, solder a 5'-10' length to each of the heater element busses.

Now, coat the entire assembly and 2" or 3" of the wire with epoxy potting compound. (Use only a true epoxy, one that must be prepared from separate resin and hardener compounds immediately prior to use.) Do not make the

Fig. 1. Heater element (bottom) is assembled ladder fashion between two heavy-duty bus bars. Four-conductor cable is soldered to element and heat sensor.

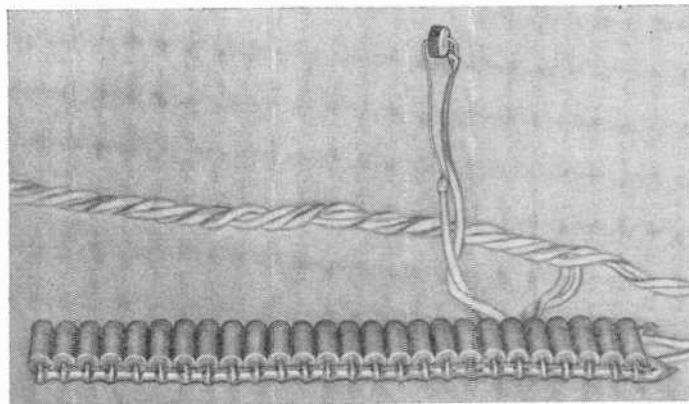

coating too thick, but make certain that the entire assembly and the attached ends of the wires are completely sealed. A water leak from improper sealing will cause the heater to fail, and copper in solution from the wires will harm your fish.

After the first application of epoxy has set (wait at least 48 hours), put on a second coat and wait for it to set. If the outer coat is not completely set, it will allow volatile solvents to enter the aquarium water—obviously also harmful to your fish.

The temperature sensor, *TDR1*, is also operated while submerged in water. Consequently, the same steps must be taken in selecting interconnecting wires and epoxy potting it as above. When both assemblies are finished, they should appear as shown in Fig. 2.

The layout of the power supply/control circuit (see Fig. 3) components is not critical, permitting any type of chassis wiring you prefer. For your convenience, an actual-size printed circuit board foil pattern and component layout guide are provided in Fig. 4.

When mounting transistors *Q1* and *Q2*, locate them close together, but not touching, to minimize thermal differences in their base-to-emitter junctions. A small heat sink might be needed for *SCR1*; hence, its tab is shown bolted to the angle bracket. (If you substitute another type of SCR for the one specified in the Parts List, check its specifications to make sure that less than 500 microamperes at the gate will drive it into conduction.)

When all components are mounted on the circuit board, mount the board, transformer, fuse holder, potentiometer, and pilot lamp inside the utility box as shown in Fig. 5. The center-tap lead of the transformer can be cut short and the stub taped.

Twist the sensor and heater element wires together and route them and the line cord through rubber-grommet-lined holes in the rear of the utility box. Tie strain relief knots in both cables inside the box, and interconnect all components and assemblies. Assemble the box.

Calibration and Use. Immerse the heat-

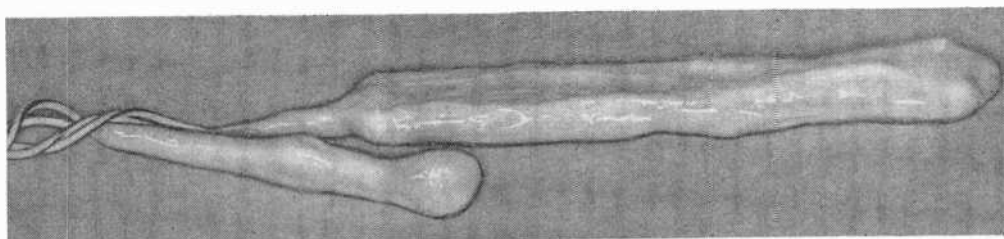

Fig. 2. Entire length of heater element and sensor, plus about 2" of connecting cables, must be thoroughly coated with epoxy potting compound to provide an airtight seal for the immersion elements.

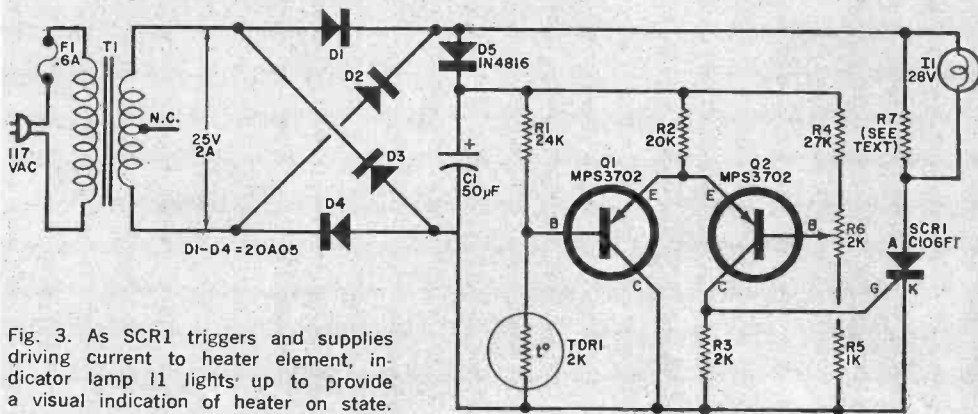

Fig. 3. As SCR1 triggers and supplies driving current to heater element, indicator lamp I1 lights up to provide a visual indication of heater on state.

PARTS LIST

- C1—50- μ F, 50-volt electrolytic capacitor
- D1-D4—2-ampere, 50-volt diode (International Rectifier 20A05 or similar)
- D5—1.5-ampere, 50-volt diode (1N4816 or similar)
- F1—0.6-ampere fuse
- I1—General Electric #GE 1819 28-volt lamp
- Q1, Q2—MPS3702 transistor
- R1—24,000-ohm
- R2—20,000-ohm
- R3—2,000-ohm
- R4—27,000-ohm
- R5—1,000-ohm

All resistors
1/4-watt

- R7—24 300-ohm, 1/2-watt resistors connected in parallel (see text)
- R6—2,000-ohm linear-taper potentiometer
- SCR1—C106F1 silicon controlled rectifier
- T1—2-ampere, 25.2-volt filament transformer (Allied Radio No. 54A4140)
- TDR1—2,000-ohm temperature-dependent resistor (Fenwall No. LP32J2)
- 1—5" x 4" x 3" metal utility box
- Misc.—Control knob; a.c. line cord; rubber grommets; epoxy potting compound; hardware; hookup wire; solder; etc.

er element sensor in a glass of cool water. NEVER operate the system unless the heater is immersed in water, preferably with the sensor in the same water. Plug in the line cord; the pilot lamp should immediately come on, indicating that the system is operating. In a few minutes, when the water heats up, the light should extinguish. Rotating the control knob clockwise should cause the light to come on again, counterclockwise to extinguish it. If the reverse happens, unplug the line cord and reverse the connections to the outer lugs of the potentiometer.

A thermometer of known accuracy is needed to properly calibrate the system. First immerse the sensor and heater in about a pint of cold water. Set the control fully counterclockwise, and plug in the line cord. Now stir the water constantly with the thermometer. As soon as the lamp extinguishes, remove the thermometer from the water and note the temperature indicated. Record your reading on the front of the utility box, in line with the index of the control knob.

Return the thermometer to the water and advance the control until the lamp just comes on again. Stir the water with the thermometer until the light again extinguishes. Record your reading. Continue this process until you have enough calibration marks. Then disconnect power from the system, and use a decal or

ABOUT THE CIRCUIT

The voltage produced by R1 and temperature-dependent resistor TDR1 at the base of Q1 is dependent on the resistance of TDR1 (see Fig. 3). This voltage is then compared to a reference potential present at the wiper of temperature control R6, through the differential amplifier formed by the Q1/Q2 circuit.

When, due to the cooling of TDR1, the voltage at the base of Q1 changes by about 0.005 volt—corresponding to a temperature displacement of about 0.1° F with the components listed in the Parts List—SCR1 fires and delivers 50 watts of power to heater element R7.

Transformer T1 isolates the circuit from the a.c. power line and steps down the line voltage to a safe 25-volt level, eliminating the danger of electrical shock. Diodes D1-D4 form a bridge rectifier circuit that supplies pulsating d.c. to SCR1, while D5 and C1 form a d.c. power supply for the differential amplifier circuit.

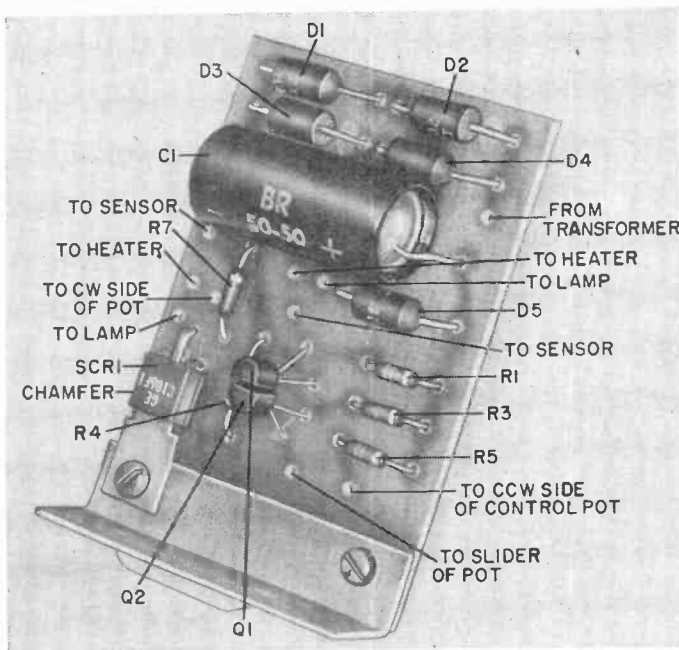
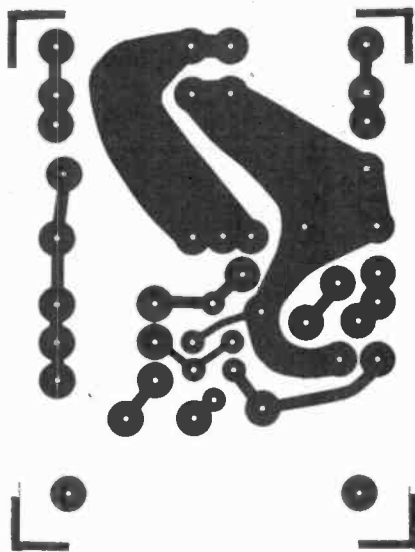

Fig. 4. Actual-size printed circuit board etching guide is given at lower left. Component locations and orientations on circuit board are shown in photo. For proper heat sinking of SCR1, bolt its tab to mounting bracket used for circuit board as shown.



desired, the sensor element can be camouflaged by the tank plants. Then plug in the line cord and set the temperature control.

The electronic aquarium heater has more than sufficient power for the standard 15-gallon aquarium. It will also serve a much larger aquarium if the water temperature is not to be too much greater than the ambient room temperature.

-30-

dry-transfer lettering kit to finish the front panel.

In use, the heater element should be buried just under the surface of the gravel and/or sand in the bottom of your aquarium, in a location where the circulator can feed the water over it. Leave the sensor suspended in the water 2" or 3" "upstream" of the heater element. If

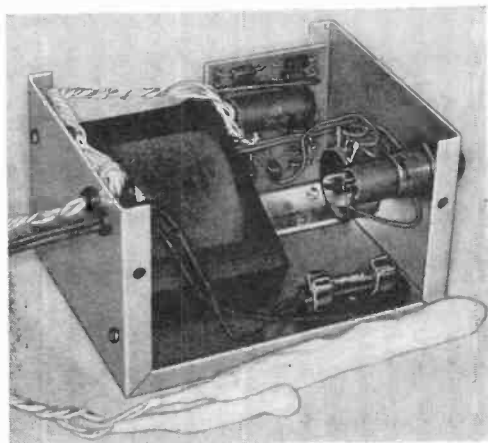
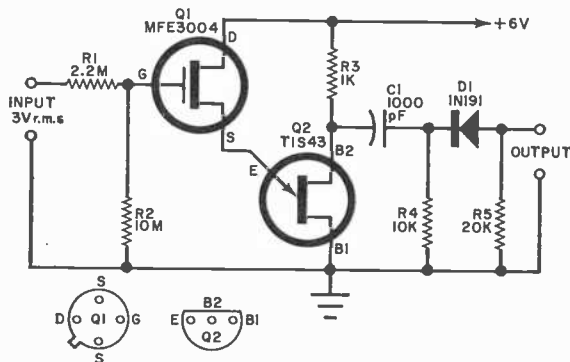

Fig. 5. Route a.c. line cord and heater element/sensor cable through rubber grommet lined holes.

Micro-Sensitive Schmitt Trigger

BY FRANK H. TOOKER



The very high input impedance of the MOSFET, and the high values of the input resistors, enable this Schmitt trigger to have a negligible loading effect on the input signal source.

PARTS LIST

C1—1000-pF capacitor

D1—Diode 1N191 (optional, see text)

Q1—MOSFET (Motorola MFE3004*)

Q2—UJT (Texas Instruments TIS43)

R1—2.2-megohm resistor

R2—10-megohm resistor

R3—1000-ohm resistor

R4—10,000-ohm resistor

R5—20,000-ohm resistor (optional, see text)

*Available from Robert A. Glassman, 20 Hampton Road, Massapequa, N.Y. 11758. Price \$1.30 each, postpaid.

A SCHMITT trigger is a pulse-generating circuit that converts an a.c. input signal into a constant-level output pulse train of the same frequency. The trigger should not be confused with a flip-flop multivibrator, which is similar except that the output is at a frequency half that of the input.

A typical semiconductor Schmitt trigger has a fairly low input resistance and requires a certain amount of power from the input to drive it. Described here is a new approach to a Schmitt trigger in which a MOSFET drives a UJT. The result is a circuit with a very high input resistance (to prevent loading) and a very steep output pulse which can be used in most any triggering application. A prototype of the circuit shown in the schematic was checked at 60 Hz and found to have an input resistance equal to $R1$ and $R2$ in series, or 12 megohms.

The input signal level required to trigger this circuit is about 3 volts r.m.s. The input current is thus $3/(R1 \div R2)$ or about 0.20 microampere and the required

driving power is less than $\frac{3}{4}$ microwatt! Unlike the more conventional Schmitt, the performance of this circuit is largely independent of the impedance of the driving source.

How It Works. The load resistance on the source of MOSFET $Q1$ is the emitter-to-base-1 of the UJT $Q2$. Since this junction is reverse biased at voltages below the UJT firing level, the effective resistance in the $Q1$ source circuit is very high.

The signal level at the source of $Q1$ follows that of the input on the gate of $Q1$. When the positive-going excursion of the sine-wave input is sufficient to cause the source potential to reach the firing level of the UJT, $Q2$ conducts. Its emitter-to-base-1 resistance then drops very rapidly and the drain-to-source current of $Q1$ increases rapidly. This drives $Q2$ hard into conduction. All of this happens very rapidly, of course, and when it does, it produces a very sharp negative-going transition in the

potential at base-2 of $Q2$. When the signal input level (at the gate of $Q1$) drops below the hold-on value of the UJT, the latter stops conducting, and remains off until the next positive-going signal is applied to the input.

Capacitor $C1$ and resistor $R4$ differentiate the negative-going pulse at base-2 of the UJT while diode $D1$ and resistor $R5$ eliminate the small positive-going spike. In applications where the presence of this spike will do no harm, $D1$ and $R5$ may be eliminated.

Although the preceding description involves a sine-wave input signal, the circuit performs well with an input of almost any waveform as long as it has

a positive-going (with respect to ground) excursion of sufficient amplitude. In circuits where the a.c. signal is superimposed on a d.c. level, the use of a coupling capacitor is suggested.

The glass insulator that forms the heart of a MOSFET is extremely fragile electrically and can be easily damaged by the static electricity of the human body or a soldering iron coming in contact with the isolated gate lead. For this reason keep all MOSFET leads in electrical contact with each other until they are fully wired into the circuit. When removing a MOSFET for any reason other than catastrophic failure, take the same precaution. -30-

SCS Signal-Squaring Adapter

BY FRANK H. TOOKER

PARTS LIST

- $B1$ —9-volt transistor battery
 - $C1$ —2.0- μ F, 100-volt, Mylar capacitor
 - $C2$ —10- μ F, 12-volt, electrolytic capacitor
 - $Q1$ —Silicon controlled switch (General Electric 3N84)
 - $Q2$ —2N2613 transistor
 - $R1$ —33,000-ohm
 - $R2$ —240-ohm
 - $R3$ —4700-ohm
 - $R4$ —10,000-ohm
 - $R5$ —5000-ohm potentiometer, linear taper
 - $S1$ —S.p.s.t. slide or toggle switch
- All resistors } $\frac{1}{2}$ -watt
 } 2% tolerance

Taking advantage of the unique switching characteristics of the SCS makes for a simple, yet a highly efficient squarer.

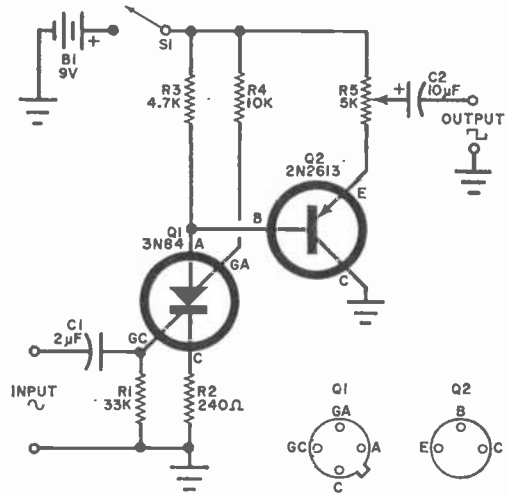

TO MAKE square waves, it is customary to start with audio-frequency sine waves, amplify the waveform and then clip off the peaks (negative and positive). Sometimes it takes three or more circuit stages to achieve the desired result—especially if the square-wave output is to have fast rise and fall times and/or if the input sine-wave signal level is low.

Another approach is to use a Schmitt

trigger to square off sine waves. This usually requires two transistors for the trigger and another one as an emitter follower. The circuit can be simplified through the use of a single silicon controlled switch (SCS), which can be triggered by the input sine wave, with a single emitter-follower transistor for current amplification.

As shown in the schematic, $Q1$ is the
(Continued on page 89)

An Experiment With GRAVITY

CHART THESE STRANGE FORCES WITH YOUR RECEIVER

BY CDR. THOMAS APPLEBY

We are all familiar with the natural phenomenon known as gravity; but most of us tend to think of gravity on the surface of the earth as being constant. In fact, it is always changing in magnitude, due mainly to the forces exerted on the earth by the sun and the moon. The variations are, of course, so minute that only in the past few years have they been detected by specially designed, highly sensitive instruments. Oddly enough, my years of research into the phenomenon have shown that the average ham radio CW receiver can apparently "detect" changes in gravity.

The effects of gravity on a receiver might account for its drifting off frequency. Even after communications receivers have had time to become thoroughly temperature stabilized, frequency drifting and periodic returning are common occurrences.

Taking advantage of the effects the forces of the sun and the moon have on

"A completely new branch of astronomy is opening up with the recent discovery of gravitational waves by Dr. Joseph Weber of the University of Maryland. The force of gravity is the most fundamental and least understood force in the universe; confirmation that gravity waves can be detected may well turn out to be as important as the discovery of radio waves by Heinrich Hertz in 1887."

—The Industrial Bulletin
Arthur D. Little, Inc.

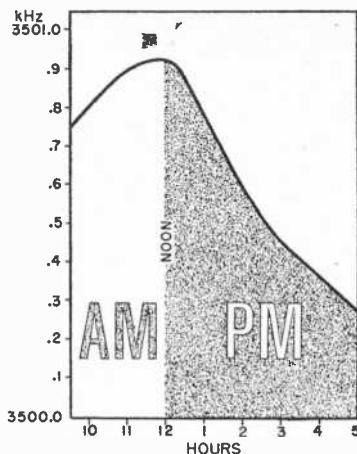

Sample graph shows the plot of frequency changes versus time. Note that plotted line peaks out shortly after noon.

the earth's gravity, you can experiment on your own. All you need is a receiver with an ultra-fine scale on its tuning dial. (One that has 10 divisions for each minor division on the main tuning dial scale.) Remember that gravity variations are on the order of only 10^{-6} part of the weight of the mass in which they are produced. Although the effect of the variations is greatly amplified by your receiver, the end result is still minute.

To perform the experiment, disconnect the antenna and any other leads that might pick up a signal at either 3500 or 7000 kHz. In the morning, set the tuning dial of your CW receiver to either of the above frequencies and adjust the BFO for zero beat.

Allow the receiver to warm up for several hours. Then reset the BFO for zero beat. Every half hour or so after this, see if it is necessary to retune for zero beat. Record the new dial setting and make up a graph similar to that shown here. The frequency changes you record will be very small so use an expanded scale.

The recorded frequency variations will increase or decrease, depending on whether the magnitude of gravity is increasing or decreasing, respectively. You will notice that after the sun or moon passes the zenith, the curve will begin to bend downward. Also, the curve will change from day to day because of variations in the orbits of the sun and the moon. —50—

The Stereo Scene

by Charles Lincoln

NOW IT'S FOUR CHANNELS

THERE'S A NEW WORD on the stereo scene: "quadrasonic." It pertains to four-channel stereo systems—that's right, four channels! Now, don't start throwing out your two-channel stereo equipment right away, but be advised that quadrasonics is on the way.

The four-channel concept was initiated recently by a relatively small record company, Vanguard Recording Society, noted primarily for classical music offerings. Vanguard

calls the system "Surround Stereo," a proprietary name, and they introduced it after several years of experimentation. They—and others involved in promoting quadrasonics—decided that the jaded audio buff needed a lift and that it was time for recorded music to get the kind of treatment that the industry has always talked about, but never managed to achieve—total realism. That last high-sounding term refers, of course, to the re-creation in the living room of aural effects actually experienced in the concert hall. Quadrasonics is another try at reaching the ultimate goal.

Listening to a quadrasonic system, sacked out in your favorite chair, you have a feeling that you're right in the middle of the orchestra and that you'd better not move or you might nudge one of the players. With popular music, the sound coming from each of the four speaker systems is generally of about the same value or volume. The engineers recorded it that way to create the illusion that the orchestra is all around you.

For classical or symphonic recordings the effect is somewhat different. In front of you, to the right and left, the music pours out just as in two-channel stereo. A little behind you and to the right and left, you hear the reflected or reverberating sounds of the orchestra, just as you would in a concert hall or recording studio. The result is a feeling that you *are there* or, vice versa, that the orchestra is in your living room (and you weren't aware that your room had such good acoustics, with resonances, etc!).

A quadrasonic system is different in another way, also. It enables you to *participate* in reproducing the music. By changing the control settings and/or speaker locations, you can create your own weird effect or overcome some acoustical deficiencies of your room. For example, by fiddling with the volume controls, you can make pop music from the two rear speakers louder than what

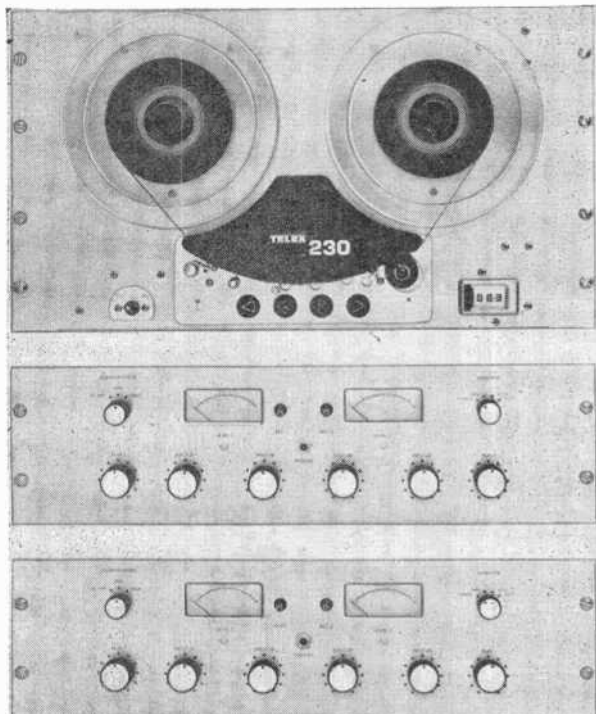

Basic "Quad/Sonic" system from Telex uses model 230 tape deck and two preamplifiers for playback only (\$670). Setup to record and playback is \$1544.

comes from the front—which gives a real off-beat sound. Actually, the sound level can be changed between the speakers to give any sort of effect you want. The placement of the speakers—close to or distant from a wall—also affect the final sound.

When listening to classical music, you can vary the volume controls to give you the effect of sitting in the front row or in the back of the concert hall. The acoustic effect can be enhanced by raising the volume of the secondary channels to a point that seems just right for you, your mood, and your guests. If the work involves a chorus, you're in for a special treat since you can play the chorus up or down, as you wish.

Approaches to Recording. The recording industry has two schools of thought as to the approach that should be used in recording quadrasonic tapes (so far, there are only tapes—no discs). One school says that standards should be set for all recording companies to follow so that the listener doesn't have to fuss with the controls for each recording if he doesn't feel like it. The other school insists that individual companies and their recording engineers should have free rein to gimmick up the sound any way they see fit so that each recording has a "personality," with unique sound results.

The second group suggests that, not only will this approach in itself revolutionize the industry, it will further stimulate matters by making four-channel stereo a medium for which composers will create specific music.

How Much Does It Cost? So far the only quadrasonic recordings you can buy are reel tapes from Vanguard and, be prepared, they are \$14.95 each. They have a playing time about the same as a long-playing disc. But you need a special deck to play them. At this time, the least expensive is a complete new play-back only deck from 3M/Wollen-

sak for about \$500. (The unit also records and plays back regular two-channel stereo tapes.) However, if you have a top-notch two-channel deck, it can be converted with heads from Nortronics or Michigan Magnetics. The heads will cost you about \$100. Unless you're a good do-it-yourselfer, the conversion work will run between \$25 and \$50 additional. If all of this doesn't sound too good, stick around—Telex is coming out with a deck for under \$300 and it should be on store shelves soon.

You will also need an amplifier with tape head inputs to accommodate the tape deck. You can use an existing stereo amplifier (or receiver) and buy another amplifier with similar capabilities for the second pair of channels. Or you might plunk down \$600 and buy an H. H. Scott "Quadrant" amplifier, the first four-channel amplifier on the scene.

Another requirement is the second set of speakers. Again there are two schools of thought. One insists that the new speakers must be of the same calibre (hopefully high) as the ones you already have to get the best results. The other school contends that lower quality or smaller size units will do since they will handle "secondary" sound information: Since there are no standards for the recording process, we'd suggest you take the former approach for the long haul, and be prepared for whatever happens.

However, there is the matter of space. If you are in a space bind, you may have to take the second approach and buy smaller speakers. If this is the case, by all means choose top quality units. A new two-in-one speaker system from Jensen might be worth considering. Called "Stereo One," it is, in effect, two speaker systems in a single housing. In fact, using one of these in conjunction with an existing pair of speaker systems might be a space-saving way for you to enjoy four-channel stereo.

What About FM Stereo? Will quadrasonics be limited to tape? No. It is possible to broadcast four-channel stereo, and it is being done in Boston by two stations on a tandem basis. The programs—by the Boston Symphony Orchestra—are broadcast by WGBH-FM and WCRB-FM, with each generating two different channels. (The broadcasts can be heard in two-channel stereo also, with traditional equipment, with no degradation of signal.) Two complete stereo reception systems are required. If you have such equipment and want to hear these broadcasts, here's what you do. Set up one system so that you hear WGBH on your front left (right channel) and rear left (left channel). Set up the other system so that the left

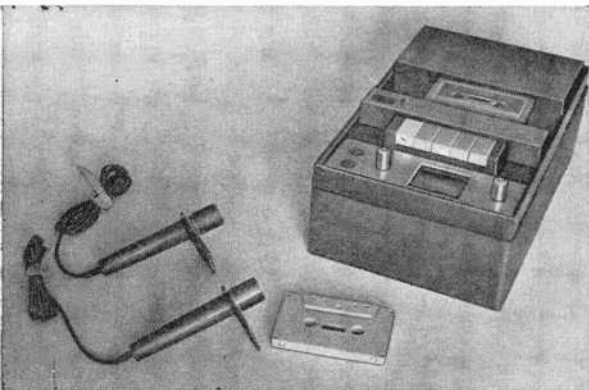

Lumistor model LP-1 cassette stereo tape deck is convertible to play and record 4-channel cassettes.

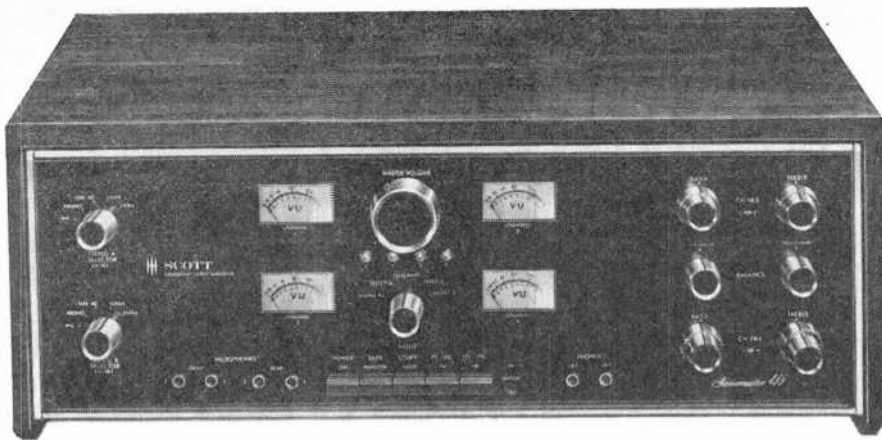

H. H. Scott's "Quadrant" amplifier has 35 watts per channel rms output power at 8 ohms. At \$600, it has integrated circuit preamps, non-capacitive direct-coupled complementary outputs.

channel of WCRB emanates from the right front and the right channel from the right rear. Make sure all speakers are in phase. If your setup is OK you should hear the voice of the commentator on the left channel only of each station or from your front right and rear left speakers. (As we go to press, two New York stations are planning similar broadcasts. Watch your FM schedules for the details.)

Can you expect quadrasonics in cassettes or continuous-loop tape cartridges? Again, there are rumors that they will be available eventually. How soon? Your guess is as good as ours.

And what about four-channel broadcasts from a single FM radio station? It can be done easily. In fact the Federal Communications Commission is already checking out proposed approaches to the matter. William Halsted and Murray Crosby, two pioneers of FM radio, are understood to be developing FM stereo multiplex systems that would enable a single station to broadcast quadrasonic programs by utilizing subcarriers now used for SCA services (background music, etc.) provided for commercial consumption by some FM stations.

As for the economics of quadrasonics—don't let the initial prices mentioned above scare you too much. In fact, sticking our neck out, we'd say that the economics will take care of themselves. When two-channel stereo came on the scene in record form in 1958, there was a big fuss about equipment costs. "A two-channel amplifier would cost nearly twice as much as a mono unit," was the cry! That turned out to be a lot of hot air. Allowing for the rise in the cost of living, today's stereo amplifier is no more expensive than a mono set of equal quality back in 1957—and in many ways it is better. Further, the industry took a hard look at

the mono speaker system of 1957 and decided something should be done about all that bulk. Hence, the bookshelf concept, with top-grade sound coming from small boxes, in a broad range of prices.

As for recorded tapes, that \$14.95 price won't hold for long. Once tape duplicators put their minds to it, they'll work out mass production techniques for four-channel tapes and prices will drop to a level close to two-channel tapes. Actually, the manufacturing costs are less of a problem than they might appear to be. Most of the high initial costs will be to offset research and development.

As for program material, there's plenty of it waiting to be worked into four-channel form. Record companies for several years have been recording in 8, 12, up to 24 channels, and these recordings can easily be remastered into four-channel form. It's actually a matter of public demand. If enough people bang on the table for quadrasonics, the recording people will come up with a deluge of tapes in no time.

Audio equipment manufacturers are a highly competitive bunch. Manufacturer A will not let Manufacturer B beat him to the market with a quadrasonic amplifier without offering him a run for the money with the lowest possible price. Tape recorder manufacturers are not going to stand by and let 3M/Wollensak, Teac, Telex and Crown have the four-channel field to themselves for very long. They're cooking up all sorts of sensibly priced equipment that the average guy on the Stereo Scene can afford. And this equipment will be able to handle "old-fashioned" four-track, two-channel stereo tapes as well as quadrasonic tapes.

Receiver manufacturers may have a long wait before they get the results of the FCC deliberations regarding quadrasonic broadcasting. The manufacturers might have to

make relatively inexpensive adapters to use with existing stereo receivers, instead of a whole new breed. If they do have to come up with new receiver designs, you can bet they won't be priced at twice the cost of current sets.

An Important Note! Manufacturers are going to insure the reality of quadrasonics. It's money in their pockets to do so. In the beginning, their profits may be a bit less as they get the concept off the ground, but they'll make up for it with a bigger sales volume later. The facts of life are that four-channel stereo adds a big dimension to music reproduction and a lot of people are going to want that dimension. Audio equipment makers are going to make it relatively easy for them to get it.

One way of doing so might be through industry adoption of a new recording technique that was announced just as we were going to press. Called the Scheiber system after its inventor, Peter Scheiber, the technique permits the recording of "compatible" records and tapes that could be played as regular two-channel discs or tapes on existing stereo equipment, or as four-channel discs or tapes through a rig consisting of a two-channel preamp, a Scheiber decoder, a four-channel amplifier and four speaker systems.

The system takes multi-channel sound in-

formation and translates it into two/four-channel compatible information via a Scheiber *encoder*. This information is recorded on standard disc-cutting equipment or existing tape master instruments into a master disc or tape, to be used for making compatible LP's or tapes. The records can be played on a regular two-channel system with the same results you get from any good stereo record. With the aid of a two-channel preamp, Scheiber decoder, four-channel amplifier and four speaker systems, you could hear the record as quadrasonics. A compatible tape would play as a regular tape on your current two-channel recorder system; and, with the proper four-channel reproducing outfit and decoder, would play quadrasonically.

Stereo FM broadcasting stations could use the compatible material for playback as regular stereo or quadrasonically. You could also tape such program material in two-channel form on an existing recorder and play it on two channels or on quadrasonic equipment.

Basically, the Scheiber system would make the transition to quadrasonics a somewhat less expensive matter because it permits the use of disc and tape equipment that you now own. The concept is up for grabs to licensees who might want to make the encoding equipment for recording studios and the decoding circuitry for the folks at home. —30—

LOOKS LIKE WOOD, BUT IT'S NOT

The General Electric Company has announced the development of a new process that completely eliminates the use of wood in the manufacture of furniture cabinetry while maintaining the appearance and texture of fine-quality hardwood. Their first product to use the new process is a stereo console in the Mediterranean style (model G915) which is finished on all four sides. (Servicing is accomplished by lifting the electronics portion out from the top.)

The process is called Acoustiform (a registered trademark) and it utilizes a combination of injection-molded polystyrene and pressure-foamed polyurethane resins. The cabinet is completely sealed

except for the bottom, and no acoustical padding is required in the speaker chambers. The G915 has six front-mounted speakers and a solid-state stereo amplifier which provides up to 30 watts of peak music power. The unit also incorporates an FM/AM/FM-stereo tuner and a four-speed changer with repeat-play option, automatic shut-off and a mass-balanced tone arm with diamond retractable stylus. The suggested retail price of this first model is \$299.95.

General Electric expects that eventually the use of the Acoustiform process will permit price reduction well below comparable models with wooden cabinets. In addition, they are working on designs in keeping with the latest modern furniture.



the product gallery

REVIEWS AND COMMENTARY ON ELECTRONIC GEAR AND COMPONENTS

PC BOARD KIT (D.S. Co. BI Cir-Kit)



WHEN YOU SEE a useful project in POPULAR ELECTRONICS, it's nice to note that an actual size printed-circuit foil pattern is included in the article. In many cases, a finished PC board is available at a modest cost; but if you have the time to spare, it's convenient to make your own—that is if you have the patience for all of that work with a fine brush and liquid resist. Now, with a Cir-Kit (F. Huddleston Assoc., Inc., 408 S. Rosemead Blvd., Pasadena, CA 91107; \$6.95) making a PC board quickly is a snap!

The kit contains two pre-sensitized, copper-coated glass boards (one 3" × 3" and the other 6" × 8"), a sheet of Mylar-backed ruby masking, a container of developer, a container of etchant, six rubber finger cots, and complete instructions.

To make a board, the first step is to lay the sheet of red masking material over the foil pattern in the magazine. Then using a sharp instrument, gently cut away all the red material where the foil is to be. When you are through, the actual foil pattern is transparent, while the remainder of the pattern is red.

Now, in a darkroom, remove the appropriately sized sensitized board from its light-tight package. Place the transparent foil pattern over the sensitized surface of the board and expose to a strong white or ultraviolet light for a few minutes.

Pour the developer into a glass dish and immerse the exposed board. After a few minutes, remove the board and allow it to dry. Then place it in another glass dish containing the etchant. After etching and washing,

dry the board, drill the necessary holes and install the components.

It's as simple as that. Depending on the type of exposure light available and how good you are at cutting the plastic pattern, a complete board can be made in an hour. —~~30~~

Circle No. 87 on Reader Service Page 15 or 97

"STOR-A-TAPE" CARRY-PAC (Modern Album & Finishing Co., Inc.)

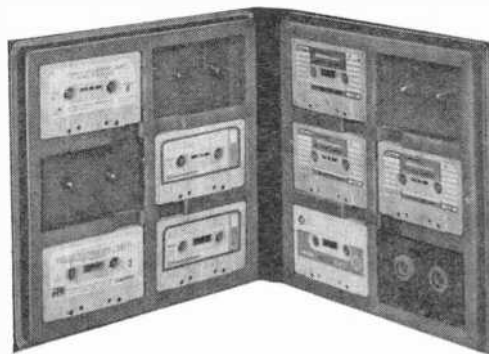

CASSETTES and cartridge tapes, unlike record albums and reel-to-reel tapes, look unsightly when just stacked on a shelf. Pigeon-hole modules are nice, but expensive, since they have to be made to order. What you really need, if you have a cassette or cartridge library, are the attractive booklike "Stor-A-Tape" Carry-Pacs made by the Modern Album and Finishing Co., Inc., 119-01 22 Ave., College Point, N.Y. 11356.

The Carry-Pacs are available in several different models for storage of six, eight, or twelve cassettes, or eight cartridges. Each Carry-Pac has a rigid bookbinder jacket, one or two plastic holders for the tapes, and an indexing strip or chart, depending on the model selected. The jackets are finished in either gold-embossed black leatherette, high-gloss blue, red, or psychedelic colors.

Four separate models are available: the CA-6, measuring 10½" × 10¼" × ¾" and capable of storing six blank cassettes, sells for \$3.49. The CA-8, measuring 10¾" × 7½" × 1⅞" and storing eight recorded cassettes, sells for \$3.98. The CA-12, 10½" square × 1½" thick, sells for \$3.98 and stores 12 blank cassettes. The 8T-8, 12½" × 11⅞" × 2¼", stores eight cartridges and is \$3.98.

Circle No. 88 on Reader Service Page 15 or 97

Growing responsibilities

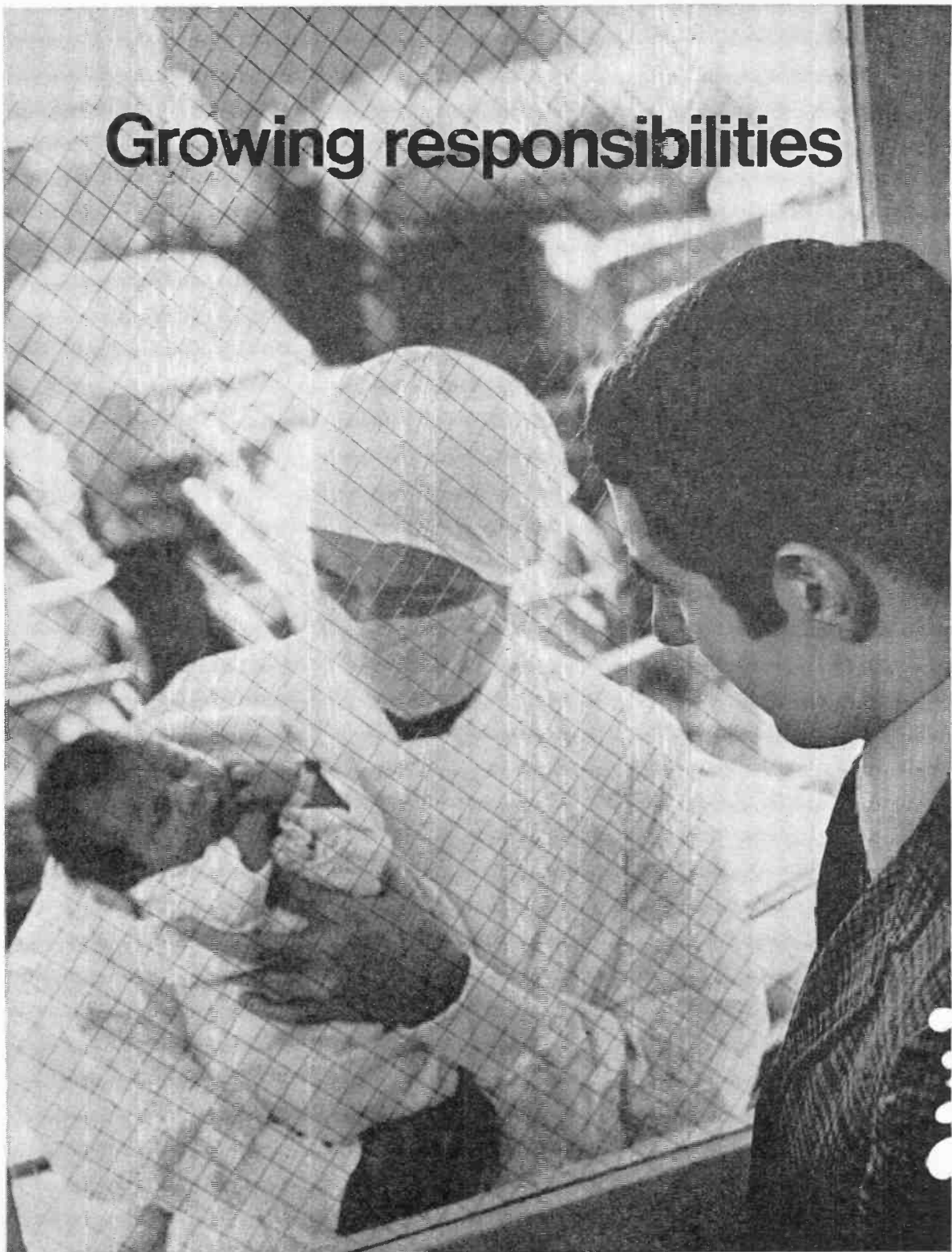

...can you handle them without more education in electronics?

You don't want to accept second-best for those who depend on you. But, without more education, you may have to. In electronics, you must learn more to earn more. And, because electronics keeps changing, you must keep on learning. Stop—and you soon won't be worth what you're earning now.

Your job and your family obligations may make it difficult for you to go back to school. But CREI Home Study Programs make it possible for you to get the additional education you need without attending classes. You study at home, at your own pace, on your own schedule.

You study with the assurance that what you learn can be applied on the job immediately.

CREI Programs cover all major areas of electronics including communications, radar, even missile and spacecraft guidance. One of them is just right for your career objective, whether it be in research, production, operation or maintenance.

You're eligible for a CREI Program if you work in electronics and have a high school education. Our FREE book gives complete information. Mail postpaid card for your copy today. If card is detached, use coupon or write: CREI, Dept. 1201A, 3224 Sixteenth Street, N.W., Washington, D.C. 20010.

Founded 1977



Accredited Member of the National Home Study Council

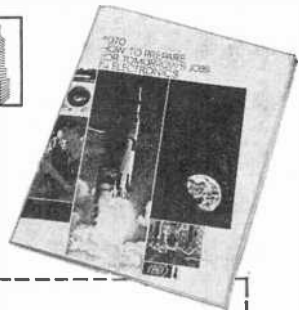

**CREI, HOME STUDY DIVISION
McGRAW-HILL BOOK COMPANY**
Dept. 1201A, 3224 Sixteenth Street, N.W.,
Washington, D.C. 20010

Please mail me FREE book describing CREI Programs. I am employed in electronics and have a high school education.

Name _____ Age _____

Address _____

City _____ State _____ Zip _____

Employed by _____

Type of Present Work _____ G.I. Bill

I am interested in: Electronic Engineering Technology
 Computers Space Electronics
 Nuclear Engineering Technology Industrial Automation
NEW! Electronics Systems Engineering

APPROVED FOR TRAINING UNDER NEW G.I. BILL

IN-DEPTH
COVERAGE OF
SOLID STATE
ELECTRONICS
...including
integrated circuits!

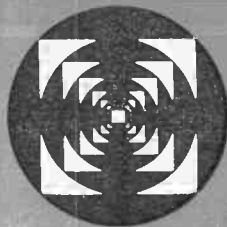

SHORT-WAVE LISTENING

By **HANK BENNETT**, W2PNA/WPE2FT
Short-Wave Editor

THE BOOTLEGGERS ARE ACTIVE

WE'VE HAD several reports of stations that would seem to be unauthorized broadcasters, more commonly known as pirates, bootleggers, or clandestine stations. On some occasions these stations broadcast for a short period of time, fearful, we assume, that they will be caught in the act, while others broadcast as though they were completely legal. The following four reports are of interest. Have you heard any of them?

A broadcast of short duration was monitored on the medium-wave frequency of 1580 kHz. It went like this: "This is Radio Jolly Rodger, Cincinnati, Ohio. It is twenty-seven minutes before two o'clock. (Logging time was 0533 GMT). If you hear this test please call collect area code 513 762 59—" This was repeated three times. The monitor logging this broadcast learned that there are no telephone numbers beginning with the digits "59" in the "762" exchange. QRM on the frequency prevented reception of the last two digits.

Another station was found on about 7320 kHz at 1955-2058 announcing as WJMS or WJNS with a location of Free State, U. S. Many Beatle records were played with announcements being made by a boy.

WGHP, "With God's Help Peace", was reported by one of the club bulletins as operating "regularly" on 7285 kHz at 0300-0400. Mutual network news is given at 0330 with the balance of the format being pop music, religious announcements and denouncements of "The Establishment". It claims to be a 50-kW broadcaster! No hint as to a location was given.

Some months back we had numerous reports of WBBH, New Brunswick, N. J., operating on frequencies between 7265 and 7400 kHz. This station was said to have been apprehended and operations terminated. However, new reports indicate a resumption of broadcasts on 7345 kHz at 2130-2230. Identifications include the callsign WBBH and the slogan "Crystal Ship". One program was called "The Bert Nazareth Show". There are no commercials and the turntable is said to run several r.p.m. too fast.

The above four stations were heard by DX'ers in Pennsylvania, New York, New York, and Maryland, respectively.

Sunrise-Sunset Maps. Don Erickson of the International Radio Club of America



This is the impressive transmitter building of "Radio Vaticano," Vatican City.

writes that he has local sunrise-sunset maps available for distribution on a first-come basis. The set of 12 maps permits determination of average sunrise and sunset for any location in the U. S. and Canada for any month of the year. Map corrections are within 10 miles of true average time. There is no charge for this set of maps other than 18¢ in U. S. or Canadian stamps for one set per person. For information on additional quantities, as well as for ordering your own set, please write directly to Mr. Erickson, 6059 Essex Street, Riverside, California 92504.

The "Sweden Calling DX'ers" Bulletin, published by *Radio Sweden*, terminated a few months ago for financial reasons, is again available. In mimeographed form, the bulletin is now issued fortnightly rather than weekly as before. We're glad to see this bulletin back on the scene.

Luxembourg anticipates placing a new 500-kW transmitter into service on 6090 kHz sometime this month. Keep your monitoring ears open for it.

An overseas bulletin confirms our information given last month of *Radio Andorra*. There is still no indication of any resumption of service on 5995 kHz. The medium-wave outlet has English at 0000-0100 Saturdays on 701 kHz.

With the coming of the New Year, *Radio Nederland* will institute a new series of programs about short-wave antennas to be broadcast on Thursdays in the English juke-box program. Printed text material will be available at no charge. Write to the station at Post Box 222, Hilversum, Holland.

CURRENT STATION REPORTS

The following is a resume of current reports. At time of compilation all reports were as accurate as possible, but stations change frequency and/or schedule with little or no advance notice. All times shown are Greenwich Mean Time (GMT) and the 24-hour system is used. Reports should be sent to Short-Wave Listening, P. O. Box 333, Cherry Hill, N. J. 08034, in time to reach us by the fifth of each month; be sure to include your WPE identification and the make and model number of your receiver.

Afghanistan—*R. Afghanistan*, Kabul, has English to Europe daily at 1800-1830 on 11,790 kHz (50 kW) and 15,265 kHz (100 kW) and to neighboring countries at 1400-1430 on 4775 kHz (100 kW).

Albania—*R. Tirania* was noted on 9495 kHz at 1530 with their IS, anthem, and s/on in Arabic; news continued to past 1536.

Angola—A logging, listed as tentative, is that of *R. Mocico*, Luso, on 5126 kHz (listed for 5137 kHz) at 2330-0100 s/off with native and U. S. pop tunes and Portuguese anmt's. S/off is with "A Portuguesa".

Australia—*R. Australia*, Melbourne, operates to N.A. at 0100-0300 on 15,170 kHz (new), 17,775 kHz (replacing 17,840 kHz) and 21,740 kHz (unchanged). English is also heard on 9550 kHz at 1500 to past 1634 with a newscast at 1500. Domestic stations VLM4 (Brisbane) and VLT4 (Port Moresby, Papua) have been heard on 4920 and 4890 kHz respectively until 1400 s/off. . . . The Australian

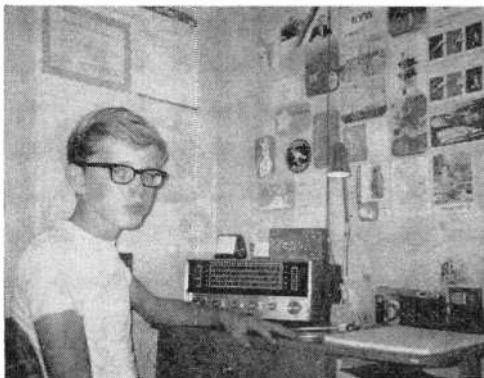

Chuck Kuchta, WPE3HYY, Pittsburgh, Pa., uses a Heathkit GR-64 receiver, a Realistic Patrolman for VHF listening and a Westinghouse tape recorder. He has 33 countries and 12 states logged.

Post Office time station, VNG, 12,000 kHz, is often good at 0500 and 0900. Other frequencies in use include 5500, 7500, 20,500 and 25,500 kHz. The ID is given five times on the hour. Reports go to Radio Section, Post Master General's Office, 57 Bourke Street, Melbourne.

Biafra—*R. Biafra*, Enugu, was heard good but with poor modulation from 0500 s/on in English on 7301 kHz. This home service was not found on 6145 kHz at this time.

Brazil—PRF7. *R. Cultura de Campos*, Campos, 4950 kHz (listed 4955 kHz) recently moved to this frequency to avoid QRM from *R. Nacional de Colombia*. It is heard in Portuguese daily to past 0100. . . . ZYE2. *R. Difusora do Macapa*, Amapa, 4910 kHz (listed 4915 kHz) is noted occasionally in Portuguese from 0900 s/on. . . . Others being heard include ZYB22, *R. Rio Mar*, Manaus, 9695 kHz, from 0045 with a soccer game, and *R. Clube de Varginha*, Varginha, 4823 kHz, from 0024-0057 s/off with music and ID's.

Brunei—*R. Brunei* was monitored on 4868 kHz at 1330-1430 s/off in all Malay with a lengthy reading of a religious (?) nature, and on 7215 kHz at 1410-1432 s/off with classical and light music and an English ID at s/off. They want reports for 7215 kHz.

Cameroon—*R. Buea*, Buea, 3971 kHz, now s/on at 0430; it was noted at 0453 in French with some music.

Colombia—A new outlet on 5943 kHz is causing some confusion among the reporters; ID's of *Emisora Colombia* (or *Colombiana*) are reported by some while others claim it is *R. Horizonte* moved from 5970 kHz. We noted one time when both ID's were given together. It's being heard from 0215-0500 with news at 0230-0240 and all Spanish programming of music and commercials for the balance of listening time. . . . *Emisora Atlantico*, Barranquilla, is active on 4906 kHz as noted in Spanish to 0500 s/off. . . . *R. Sutatenza*, Bogota, was heard on 5060 kHz from 0150 in Spanish music and comments.

Costa Rica—*R. Relej*, San Jose, is again moving around in frequency, its latest stop being on 6055 kHz as logged at 0037 with some commercials and ID's.

Ecuador—A frequency change for *R. Canal Manabita*; it is now on 4823 kHz and heard 0345-0433 with L.A. music, many ads, news, and a time check after each news item. Given location is Portoviejo. . . . *R. El Progreso* is up to 4730 kHz; music and ID's heard from 0330. . . . HCMB5. *R. Popular Independiente*, Cuenca, 4807 kHz, is often good at 0500-0515 with all-Spanish music and ads.

(Continued on page 94)



TWO WAY REACTIONS

BY G. H. REESE, KC6990

BIG YEAR FOR CB

AT THE BEGINNING of a new year, it is appropriate to take a look backward and another one forward to see where we have been and where we are going. Last year was the eleventh for Citizens Two-Way Radio. The FCC granted about 160,000 CB licenses in 1969, bringing the total issued since 1958 to 1,525,000.

There were many interesting "happenings" in CB in 1969. We're sure a record number of jamborees and other mass meetings were held. But of more importance, thousands of CB'ers performed outstanding services in the wake of Hurricane Camille and other less-publicized disasters were dealt with with equal efficiency throughout the year.

Although it wasn't a disaster (depending on your point of view), the Woodstock Music and Art Festival, in Sullivan County, N.Y., was certainly a newsworthy event, and CB'ers were there too. When the expected crowd of 50,000 turned out to be 450,000 and help in the form of food, water, and medical aid was needed, CB'ers volunteered. Nearly 40 mobile units composed of Civil Defense workers relayed information on traffic and dispatched ambulances. A steady communications link was maintained for three full days in this unusual event.

Chicago Area WARN. Citizens Radio operators are cooperating with the Chicago office of the U.S. Weather Bureau in observing and reporting weather phenomena. Loosely organized into what is called WARN (Weather Auxiliary Reporting Network), this league of CB clubs, REACT teams and interested individuals covers all of Chicago plus some of the suburbs including Elgin and Waukegan, Illinois.

Made up of about 30 base stations and 200 mobiles, the WARN system goes into operation when severe weather (such as a tornado) is threatening. Any mobile unit spotting something worthy of reporting transmits the information to its assigned base station. The information is then dispatched by telephone to the Weather Bureau radar center where it is evaluated in relation to other reports and the radar scanning. WARN members use a restricted Weather

Bureau telephone number to communicate with the radar center. If the radar center detects something that requires field verification, it contacts one of the base stations closest to the scene by telephone so that an on-the-spot report can be obtained from a mobile unit.

Bill Bishoff is probably the key man in the WARN operations. He is a Science Teacher at Glenbrook South High School in suburban Glenview, Ill., and is keenly interested in meteorology. Monthly meetings of the group are usually held at the high school. Training in weather observation and reporting is given to all participants by Bill and members of the Chicago Weather Bureau. Weather Bureau films and literature are very helpful to all.

Citizens Radio groups interested in cooperating in this program, which falls under the Weather Bureau program known as "Operation Skywarn," should direct inquiries to the nearest U.S. Weather Bureau. This is a very worthwhile and educational activity for your CB club.



Insignia, in form of embroidered patch, is available to official teams from National Headquarters.

CURRENT REACT NEWS

License Plates! California has adopted a program whereby you can get your CB call-letters on your auto license plates. There is an extra cost, but many CB operators will be happy to pay it. Many groups have been campaigning to get this service in other states. We'd like to get a report from readers in states where the service is available and from those who are campaigning to get it in their state. We will publish a roundup in an early spring issue.

Channel 9 Approval Around Corner. By the time you read this, the FCC will be reviewing comments on its decision to modify the CB Rules and set aside channel 9 for use only for emergency communications involving the safety of life, the protection of property, or assistance to motorists.

Channel 9 is now designated for emergency communications by REACT, and many other groups, and it is expected that the new proposal to modify the CB Rules will win instant approval. Also under consideration will be the substitution of either channel 8 or 15 to replace the interstation communications now conducted on channel 9.

The FCC, in making this not-too-surprising late October announcement pointed out that use of channel 9 does not preclude emergency communications on any other CB channel. And, the FCC stressed that the success of the plan to use channel 9 depended on self-policing by CB'ers.

Norfolk, Va. . . . Base station for Norfolk REACT is located in the police station of the 4th Precinct in Ocean View. The team also uses the station for a meeting place. This close cooperation with the local police has resulted in benefits to both parties.

Dover, Del. . . . Central Delaware REACT and MaryDel REACT members were called upon to provide security for a downed private aircraft. The plane had crashed in a farmer's field about 50 miles from Dover. The REACT'ers guarded it from 1:30 a.m. until the removal crew came at 1:30 p.m. the next day.

Mexico, N.Y. . . . Oswego County REACT is organized for full cooperation with local law enforcement agencies for emergency communications. Its rescue unit is equipped with snowmobiles, boats, and four-wheel drive vehicles, all owned by team members. They have conducted a Courtesy Patrol on Interstate Highway 81 on weekends and holidays.

Terre Haute, Ind. . . . Wabash Valley REACT has been busy assisting in searches for lost persons, fires, a fairground accident and a train derailment. The latter, at Lewis, Ind., included seven cars loaded with bombs! The team provided 35 units, and they worked for two days.

Toledo, Ohio. . . . Lucas & Wood County REACT conducted a Labor Day Courtesy Patrol on a 17-mile section of the Detroit-Toledo Expressway. The 60 team members cooperated with local police and the Ohio State Highway Patrol to render assistance to any motorist who needed it. The patrol was in effect from 6:00 p.m. Friday to 1:00 a.m. Saturday and from noon to midnight Saturday, Sunday, and Monday. REACT member Frank Grant stated, "We perform a number of services. If a motorist is out of gas, we give him enough to reach a gas station. We also change tires, work traffic details to assist police when an accident ties up traffic, and some of our members who are trained in first aid help out at accidents."

Ottumwa, Iowa. . . . Examination of the log of

(Continued on page 96)



Members of Lower Pinellas REACT Team serve coffee during "Bring 'Em Back Alive" safety program conducted in St. Petersburg, Fla. area. Seven such stations were manned by other area teams and clubs.

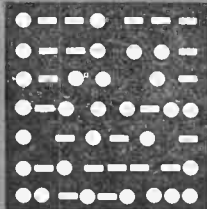

AMATEUR RADIO

By **HERB S. BRIER**, W9EGC
Amateur Radio Editor

AN OSCAR FROM RUSSIA?

WILL THE NEXT OSCAR (Orbiting Satellite Carrying Amateur Radio) be launched from Russia? It is a possibility. At the 1969 meeting of the Region 1 (European) branch of the International Amateur Radio Union, the delegates voted to approach the Russian government through the Amateur Radio Section of the Russian Sports Federation. The action was prompted by the long delay in American launching of the European OSCAR unit built by DJ4ZC. Part of this delay has been occasioned by U.S. space technicians' questioning whether the European bird was rugged enough to function.

At present, the U.S. Amateur Satellite group is completing tests on the Australian "Australis" transponder for a probable early-1970 launch as OSCAR-V. In a speech reported in *Break-in* (New Zealand) Michael J. Owen, VK3KI, Federal President of the Wireless Institute of Australia, stated that the "Australis" was designed and built by Australian university students and is the second space vehicle built in Australia. The first one was built by professionals using imported parts almost exclusively, while the "Australis" is built of components the constructors made themselves or obtained locally.



AMATEUR
STATION
OF THE
MONTH

David Selkowitz, WA0QYS, 2904 Greenway Dr., Bettendorf, Iowa 52722, earned his Novice license at 14 and is now studying for Extra class. He usually works 15-meter CW with a Drake T-4XB transmitter and R-4B receiver and a Hy-Gain 14-AVQ vertical. He has logged 30 countries and 49 states and is firmly convinced that Vermont doesn't exist. He gets a 1-year subscription to *POPULAR ELECTRONICS* for winning this month's Amateur Station Photo Contest. You can enter the contest by sending a picture (preferably black and white) of yourself at the controls of your station with some details about your amateur career to: Amateur Contest, Herb S. Brier, P.O. Box 678, Gary, IN 46401.

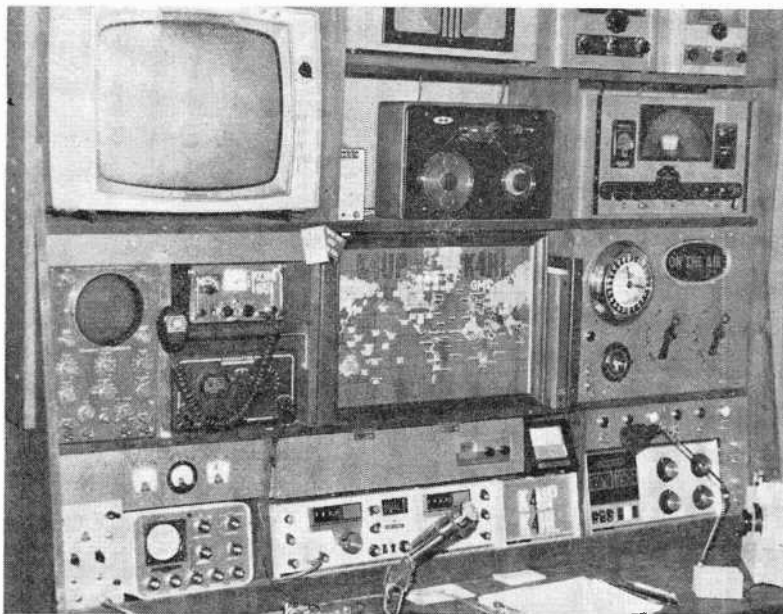

This is the station of Dr. Shailer Peterson, W5PJ, K4HL, Associate Dean of the School of Dentistry, U. of Tennessee, San Antonio branch. When not operating the National NCX-5/NCL-2000 shown here, he is probably mobile on a Drake TR-4.

More on Hurricane Camille. As soon as they realized the seriousness of the situation on the Gulf Coast, K4VFX, WA4IMC, WA4LBM, and W9CTA/4 loaded their equipment into a van (lent to them by an automobile dealer) and headed for the Gulfport, Mississippi, disaster headquarters. They were dispatched to Pass Christian, the hardest hit of all the Mississippi communities, to a schoolhouse where they supplied communications to the outside world. They set up two stations, one on CW and one on phone and sent out over 500 messages. Their operations continued for 48 hours until the authorities ordered the evacuation of Pass Christian.

Meanwhile, back in Florida, the West Florida Phone Net was in continuous session for 96 hours, before, during, and after the hurricane. Club members kept WA4ECY, station of the Pensacola Amateur Radio Club, on the air 24 hours a day to handle emergency and priority messages. Incidentally, anyone who doubts the value of amateur emergency and traffic nets could have gotten an education from listening to the efficient way messages were handled on the West Florida Phone Net (and other nets composed of experienced traffic handlers) compared to the haphazard procedures used by amateurs who were long on enthusiasm and short on message-handling experience. (Via "Florida Skip")

News From Here and There. H. R. "Duke" Ellington, W6OZD, reports in the *WCAR-Sentinel*, Carson City, Nevada, that effective January 1, all Mexican amateur radio licenses are to be cancelled until each licensee passes a 10-WPM code test. Mexico will not issue any temporary amateur operating permits (the means through which foreign amateurs have been permitted to operate in Mexico) until the new program is completed. A reciprocal operating agreement between Mexico and the United States is expected to be signed soon, however. We understand that Mexican objection to some legal mumbo-jumbo required by U.S. regulations has held up completing the agreement.

Latest English amateur license figures (June, 1969) show that there are now just under 15,000 amateurs in Great Britain. Also in "G-Land," an additional license is required for mobile operation. Three thousand hams have the mobile endorsement. English amateurs really use their mobiles and the number of attendees at rallies rival those at the largest U.S. hamfests.

Both English amateur magazines, *Short Wave Magazine* and *Radio Communications*, have commented on the increasing number of English amateurs interested in the VHF/UHF amateur bands. This contrasts with the drop in the number of Tech-

(Continued on page 91)



SOLID STATE

By LOU GARNER, Semiconductor Editor

WHAT'S IN STORE FOR 1970?

HERE IT IS January, 1970 and time for us to face up to the predictions made in our January, 1969 column. These were our predictions for 1969 and how we scored on them:

Development of an r.f. power transistor capable of handling well over 100 watts. Home run! Several high-power r.f. transistors are now on the market and RCA has announced the development of an experimental transistor capable of generating 800 watts at 1 MHz. Fairchild's 2N5008, a typical unit, has a 100-watt power dissipation rating and a minimum f_T of 40 MHz. Used as an efficient class B or C amplifier, the 2N5008 can deliver considerably more than 100 watts. A British manufacturer, Redifon Ltd. (Broomhill Road, London S.W.18, England), has utilized several high-power r.f. devices in the design of a new fully transistorized, wide-band r.f. amplifier that can deliver 100 watts over the 1.5- to 12-MHz frequency range when driven with as little as 100 mW.

A solid-state oscilloscope (either kit or factory-built) for approximately \$100. Strike out! Although solid-state scope prices have dropped somewhat, inflation has taken its toll and we haven't heard of any unit offered in the \$100 range.

IC's at over-the-counter prices of \$1 (or less) each. Home run! Motorola's MC715P and MC718P dual 3-input gate IC's are offered at catalog prices of \$1.00 each in unit quantities, while RCA's CA3053 differential cascode amplifier IC goes for a little over 80 cents. If you prefer kits, Motorola's HEK-1 kit contains five digital IC's for less than four dollars, while RCA's KD2117 includes five linear IC's at under \$5.00.

Another major firm introducing a line of experimenter/hobbyist semiconductor devices. Home run! Both Sylvania and GC Electronics' Calectro Division are now offering broad lines of blister-packaged semiconductor devices intended for experimenter applications.

Expanded use of solid-state equipment in the war against crime, including the use of radios by foot-patrol officers. Home run! Space limitations prohibit a detailed dis-

cussion of the many, many ways electronic equipment is now being used by our law enforcement agencies, but a number of cities are now equipping foot patrolmen with two-way walkie-talkies when assigned to critical areas. A closed-circuit TV surveillance system operated by the police to monitor the main business district is being used in Olean, N. Y., while some Los Angeles buses are equipped with two-way radio systems incorporating a "silent alarm" feature to signal police in the event of a hold-up or other emergency.

Lower prices for semiconductor lasers, making them suitable for some experimenter applications. Home run! In case you missed the item in our March (1969) column, Laser Diode Laboratories, Inc. (205 Forrest St., Metuchen, N. J. 08840) offers a gallium-arsenide infrared injection diode laser for only \$18.00. Identified as their model LD11, the device has a peak power rating of 5 watts in pulsed applications.

Higher manufacturing efficiencies, resulting in lower prices for FET's as well as high-voltage diodes and bipolar transistors. Home run! As predicted, FET prices dropped appreciably during the year with, today, several types available for under one dollar—a few for as little as 75¢. Among the bipolars, prices have continued to nose-dive and one manufacturer (Motorola) quotes prices for only 19¢ each in quantities of 100 for certain plastic encapsulated silicon units. High-voltage silicon rectifiers, once relatively expensive, are now cheaper than many comparable vacuum tubes. A 10,000-volt Varo type VF5-10, for example, is priced at under \$2.00 in Allied Radio's current catalog.

Development of new microwave semiconductor devices which can challenge even the more exotic vacuum tubes. Home run! New specialized types of transistors, varactors, and related devices have performance capabilities comparable to those of traveling-wave (TWT's) and other exotic vacuum tubes. United Aircraft's type S-1050 *npn* planar transistor, a typical unit, can deliver 10 watts at 1 GHz with 5 dB gain. A solid-state multiplier developed by Applied Re-

search, Inc. uses a combination of transistors and varactors to deliver 250 mW, at 16 GHz, while TRW Semiconductors, Inc. is now offering a series of microwave amplifiers with outputs up to 10 watts at frequencies as high as 2.3 GHz. In fact, microwave devices are even within the reach of the average hobbyist. See William F. Hoisington's "Microwaves For The Beginner," (POPULAR ELECTRONICS, November 1969).

So we scored 7 home runs and 1 strike-out in eight times at bat. Mets, move over!

Things to Come. During 1970, watch for: *Light-emitter diodes (LED's) at prices comparable to those of long-life incandescent lamps. . . . linear IC's with built-in special input devices, such as sensors or pick-ups. . . . moderate power (5 to 10 watts, or more) amplifiers at prices competitive with discrete component designs. . . . a virtually complete switch-over to solid state circuitry in consumer products. . . . the introduction of r.f. IC's with integral, rather than external, inductance elements. . . . the formation of a new corporation offering a broad range of specialized semiconductor-operated products at the consumer level. . . . the use of lasers as production tools in the manufacture of solid-state devices. . . . the introduction of an unusual new solid-state device—perhaps an IC opto-coupler or monolithic microwave circuit. . . . the production of "all-IC" consumer items with few, if any, discrete components, except for electro-mechanical devices, such as loudspeakers and controls, or physically large units, such as transformers. . . . the development of a new solid-state memory system suitable either for a computer or, possibly, an "electronic" camera.*

Manufacturer's Circuit. The 3-transistor regenerative receiver circuit illustrated in Fig. 1 is one of some ten projects suggested in the booklet furnished with the "S-DeC" breadboard kit marketed by the Intratec Division of the British Aircraft Corp. (399 Jefferson Davis Highway, Arlington, Va. 22202). Although intended for the AM broadcast band, the basic circuit can be used at other frequencies simply by changing the front-end tuning coils. Other projects described in the booklet include an electronic flasher, a binary counter, an audio amplifier, a CPO, a wireless microphone, a light-operated switch, and a Wien-bridge oscillator. The "S-DeC" kit itself was described in detail in the July 1969 "Product Gallery."

Referring to Fig. 1, the design features an r.f. detector/amplifier and a two-stage audio section with loudspeaker output. In operation, r.f. signals picked up by the antenna coil assembly are selected by tuned circuit $L1-Ct$ and detected by diode $D1$ in conjunction with $Q1$. The first stage is interesting in that $Q1$ has a dual collector load, an r.f. choke, RFC , shunted by $R1$, and a fixed series load resistor, $R3$. Thus, $Q1$ serves both as an r.f. amplifier (furnishing a regenerative feedback signal through $C2$ to $L1$) and as a detector-audio amplifier. Base bias is established through $R2$. The audio signal developed across $R3$ is coupled through $C4$ to gain control $R4$ and from there through d.c. blocking capacitor $C5$ to $Q2$'s base electrode. Base bias for $Q2$ is supplied through $R6$ while $R7$ serves as the collector load. The amplified audio signal appearing across $R7$ is applied through coupling capacitor $C6$ to the power amplifier, $Q3$, which, in turn, is direct-coupled to

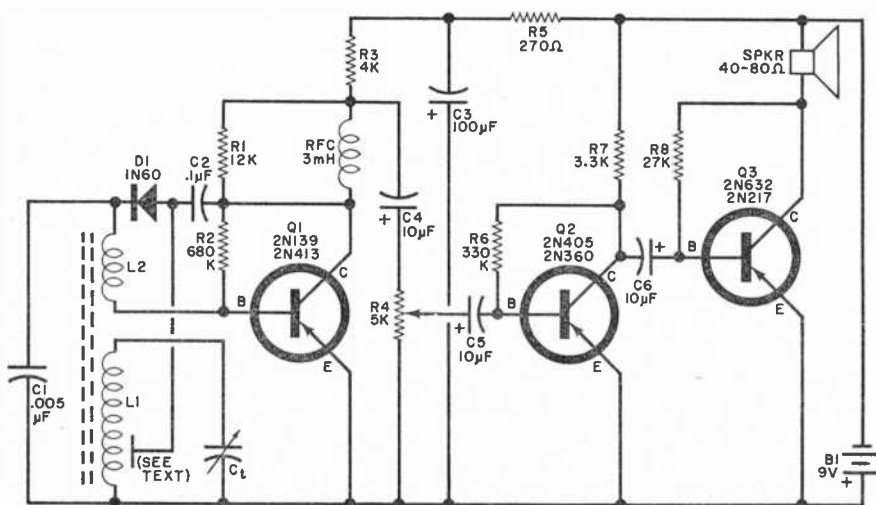
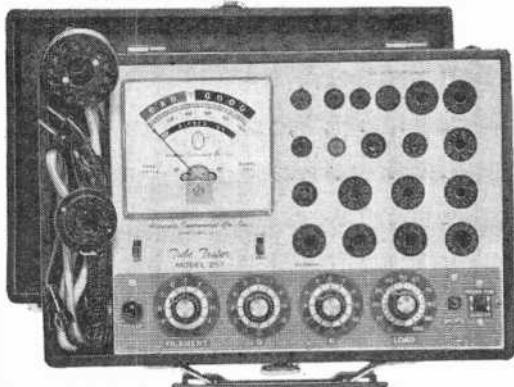

Fig. 1. Simple regenerative receiver can be used on AM or modified for other frequencies.

The New 1970 Improved Model 257 **A REVOLUTIONARY NEW TUBE TESTING OUTFIT**



COMPLETE WITH ALL ADAPTERS AND ACCESSORIES, NO "EXTRAS"

STANDARD TUBES:

- ✓ Tests the new Novars, Nuvisitors, 10 Pins, Magnovals, Compactrons and Decals.
- ✓ More than 2,500 tube listings.
- ✓ Tests each section of multi-section tubes individually for shorts, leakage and Cathode emission.
- ✓ Ultra sensitive circuit will indicate leakage up to 5 Megohms.
- ✓ Employs new improved 4½" dual scale meter with a unique sealed damping chamber to assure accurate, vibration-less readings.
- ✓ Complete set of tube straighteners mounted on front panel.

The Model 257 is housed in a handsome, sturdy, portable case. Comes complete with all adapters and accessories, ready to plug in and use. No "extras" to buy. Only

BLACK AND WHITE PICTURE TUBES:

- ✓ Single cable used for testing all Black and White Picture Tubes with deflection angles 50 to 114 degrees.
- ✓ The Model 257 tests all Black and White Picture Tubes for emission, inter-element shorts and leakage.

COLOR PICTURE TUBES:

- ✓ The Red, Green and Blue Color guns are tested individually for cathode emission quality, and each gun is tested separately for shorts or leakage between control grid, cathode and heater. Employment of a newly perfected dual socket cable enables accomplishments of all tests in the shortest possible time.

\$52⁵⁰

NOTICE

We have been producing radio, TV and electronic test equipment since 1935, which means we were making Tube Testers at a time when there were relatively few tubes on the market, 'way before the advent of TV. The model 257 employs every design improvement and every technique we have learned over an uninterrupted production period of 34 years. Accurate Instrument Co., Inc.

SEND NO MONEY WITH ORDER PAY POSTMAN NOTHING ON DELIVERY

Pay Cash or in **EASY MONTHLY PAYMENTS AFTER 15 Day Trial!**

Try it for 15 days before you buy. If completely satisfied remit \$52.50 plus postage and handling charge. (If you prefer you may **PAY MONTHLY ON OUR EASY PAYMENT PLAN.**) If not completely satisfied, return to us, no explanation necessary.

ACCURATE INSTRUMENT CO., INC. Dept. 720
2435 White Plains Road, Bronx, N. Y. 10467
Please rush me one Model 257. If satisfactory I agree to pay at the terms specified at left. If not satisfactory, I may return for cancellation of account.

Name _____
Address _____
City _____ State _____ Zip _____

Save Money! Check here and enclose \$52.50 with coupon and we will pay all shipping and handling charges. You still retain privilege of returning after 15 day trial for full refund.

CIRCLE NO. 1 ON READER SERVICE PAGE

a PM loudspeaker. Base bias for $Q3$ is furnished through $R8$. Circuit operating power is supplied by $B1$, while $C3$ and $R5$ form a simple L-type decoupling filter for the first stage.

The ferrite core antenna coil, $L1-L2$, is a standard commercial unit similar to the Calectro type D1-848, while tuning capacitor $C1$ is chosen to match $L1$ (typically, Calectro type A1-232). The feedback loop is a single turn of insulated hook-up wire wrapped loosely around $L1$ and connected only to the junction of $D1$ and $C2$. Except for gain control $R4$, which should have a log taper, all resistors are half-watt types, while $C3$, $C4$, $C5$ and $C6$ are 12-volt electrolytics.

After circuit assembly is completed and checked for possible errors, the feedback loop should be adjusted for maximum performance. This is accomplished by shifting the feedback coil's position along $L1$ while tuned to a weak station.

Reader's Circuit. Suitable for use with transistorized automobile receivers, the interesting circuit in Fig. 2 was submitted by E. M. McCormick, 8720 Ewing Drive, Bethesda, Maryland 20034. Mack devised the circuit to serve as a "commercial killer" when he found some of the longer radio commercials not only bothersome, but dangerously distracting when driving in heavy traffic. When activated, the unit shuts off the car radio for periods of up to one minute.

Referring to the schematic diagram, series npn power transistor $Q1$ controls the receiver's d.c. power source. This transistor, in turn, is controlled by nnp transistor $Q2$. Under normal conditions, $Q2$'s base bias, furnished through $R2$, $R3$ and $D1$, holds this transistor in a conducting state, permitting the application of a saturation bias to $Q1$'s base through $R4$. With $Q1$ saturated, virtually full power is furnished to the receiver, except for a small drop across $Q1$. When $S1$ is closed momentarily $C1$ is charged rapidly

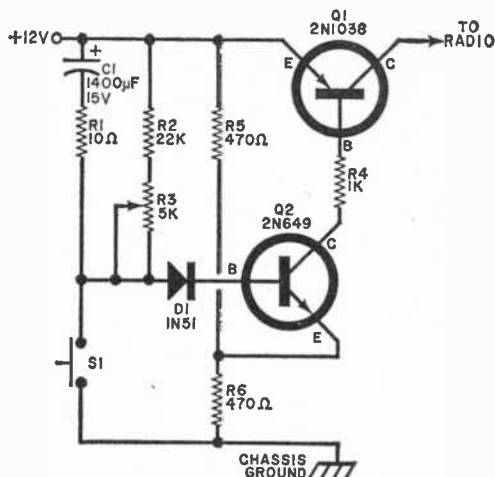
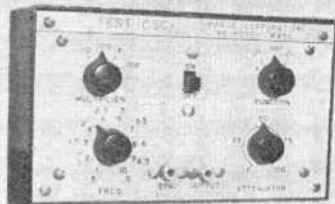

Fig. 2. A series transistor is used to cut off d.c. supply to car radio and kill unwanted commercials.

to full battery voltage through surge limiting resistor $R1$ and, thereafter, furnishes a reverse bias which switches $Q2$ to a non-conducting state. This removes $Q1$'s base bias. Thus, the receiver's power source is opened until $C1$ discharges through $R1$, $R2$ and $R3$, permitting normal biasing to be reestablished and power restored to the radio. Diode $D1$ is included to minimize transient current surges which might otherwise damage $Q2$.

Neither layout nor lead dress is critical and the unit may be assembled using any standard construction technique, provided all d.c. polarities are observed and care is taken to avoid overheating the semiconductor devices. Mack assembled his unit in a commercial 2" x 4" x 1½" metal case and suggests that heat-sink mounting be provided for $Q1$.

In use, the circuit is connected in series with the car radio's "hot" power lead and to ground, as shown, if the auto has a standard negative ground electrical system. A
(Continued on page 98)



TEST OSCILLATOR KIT

FROM THE

PHASE CORPORATION

\$ 34.95

THREE FUNCTIONS IN ONE SMALL PACKAGE
GENERATES PULSE, SAWTOOTH & SQUARE WAVES
TEST YOUR AUDIO CIRCUITS—TRIGGER YOUR LOGIC CIRCUITS
CHECK OUT YOUR SWEEP CIRCUITS

KIT CONTAINS ALL PARTS, AND COMPLETE, EASY TO FOLLOW INSTRUCTIONS.

MODEL O1K.....\$34.95
MODEL O1W [WIRED AND TESTED]..... 54.95
ETCHED & DRILLED CIRCUIT BOARD ONLY.... 7.69

ENCLOSE CHECK OR MONEY ORDER, OR ASK US TO BILL YOUR BANKAMERICARD OR MASTER CHARGE.

SPECIFICATIONS:
FREQUENCY :
SAW & PULSE .4 HZ — 100 KHZ
SQUARE .2 HZ — 50 KHZ
RISE TIME :
SQUARE & PULSE .5 µ SEC
PULSE WIDTH 1 µ SEC @ 100 KHZ

FEATURES:
ALL SOLID STATE
SEPARATE SYNC OUTPUT
PRE-PUNCHED CUSTOM CASE
ETCHED & DRILLED P.C. BOARD
UTILIZES FET AND UNIJUNCTION CIRCUITRY
PORTABLE AND COMPACT

315A BOSTON AVENUE MEDFORD, MASS. 02155

CIRCLE NO. 21 ON READER SERVICE PAGE

A new concept **100% MUSIC POWER[®]**

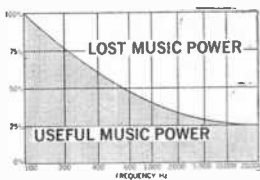

CARTRIDGE "C"
at 25% Music Power

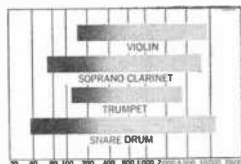

... a serious loss of definition occurs: because cartridge "C" has completely lost 75% of the Music Power at the higher frequencies.

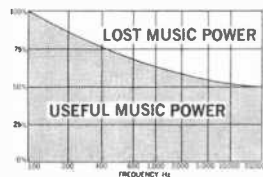

CARTRIDGE "B"
at 50% Music Power

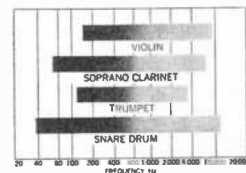

... in this case you lose definition of the instruments: because cartridge "B" loses as much as 50% at higher frequencies.

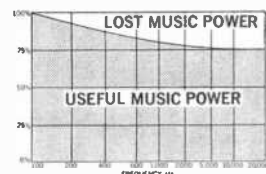

CARTRIDGE "A"
at 75% Music Power

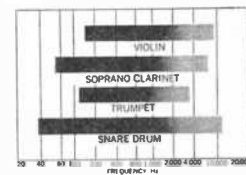

... the instruments seem a little faded in the upper frequencies: because cartridge "A" attenuates higher frequencies as much as 25%.

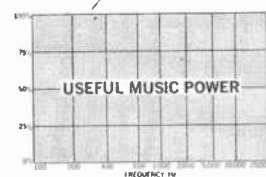

XV-15
at 100% Music Power

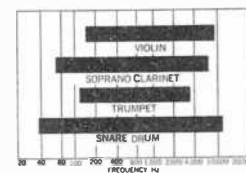

... the instruments, all of them, are distinct and clear throughout the entire fundamental frequency range.

With the Pickering XV-15 Cartridge You Get 100% Music Power — You Hear It All!

Only Pickering's XV-15 series of cartridges features 100% Music Power. With the Pickering, a harp sounds like a harp, a trumpet has the biting sound that you expect from a brass instrument, the flute has a rich romantic tone, the orchestra is the full-throated instrument the composer called for. So choose Pickering — and make the enjoyment of 100% Music Power a part of your life.

PICKERING

For those who can **HEAR** the difference



THE NEW PICKERING XV-15/750E. PREMIER MODEL OF THE XV-15 SERIES. TRACKS AT 1/2 TO 1 GRAM. DYNAMIC COUPLING FACTOR OF 750 FOR USE IN FIRST TONEARMS. \$60.00. OTHER XV-115 CARTRIDGES FROM \$29.95. PICKERING & CO., PLAINFIELD, L.I., N. Y. CIRCLE NO. 22 ON READER SERVICE PAGE



**1970—WINTER
ELECTRONIC EXPERIMENTER'S
HANDBOOK** **\$1.35**

148 pages of the most fascinating and challenging construction projects for the electronics hobbyists. All with complete schematics, illustrations, parts list, and easy-to-follow instructions that guarantee you perfect finished products.

**1969—SPRING
ELECTRONIC EXPERIMENTER'S
HANDBOOK** **\$1.25**

Another big package containing the most challenging, fun-to-build electronics projects ever! Be sure to order this one today!

1970 STEREO/HI-FI DIRECTORY **\$1.35**

Giant 180 page buyer's guide listing more than 1,600 individual Stereo/Hi-Fi components by 176 manufacturers. Nine individual sections complete with specs, photos, prices—the works!

6 Vital Components

*For Knowledge...
For Profit... For Sheer
Electronics Enjoyment!*



1970 TAPE RECORDER ANNUAL **\$1.35**

Over 130 pages covering every aspect of tape recording. Complete buyer's guide to the brands and models on the market. Expert tips on equipment—making better tapes—editing—copying—everything you want and need to know about tape recording.



1970 COMMUNICATIONS HANDBOOK **\$1.35**

148 fact packed pages for the CB, SWL or HAM. Equipment buyer's guide—photos—tables—charts—getting a license—everything to make this the world's most complete guide to communications.



1970 ELECTRONICS INSTALLATION & SERVICING HANDBOOK **\$1.35**

Covers all 8 areas of consumer electronics servicing—all the tricks of the trade in one complete guide. The industry's "how-to" book for installing and servicing consumer electronics equipment.

ZIFF-DAVIS SERVICE DIVISION • Dept. W
595 Broadway, New York, N.Y. 10012

Please send me the annuals I've checked below:

- 1970 Electronic Experimenter's Handbook - Winter
- 1969 Electronic Experimenter's Handbook - Spring
- 1970 Stereo/Hi-Fi Directory
- 1970 Tape Recorder Annual
- 1970 Communications Handbook
- 1970 Electronics Installation & Servicing Handbook

I am enclosing \$_____. My remittance includes an additional 25¢ per copy for shipping and handling (Outside U.S.A. all magazines are \$2.00 per copy, postpaid.)

print name _____ PE-1-70
 address _____
 city _____
 state _____ zip _____

PAYMENT MUST BE ENCLOSED WITH ORDER

STATEMENT OF OWNERSHIP, MANAGEMENT AND CIRCULATION (Act of October 23, 1962; Section 4369, Title 39, United States Code).

1. Date of filing: October 1, 1969.
2. Title of publication: Popular Electronics.
3. Frequency of issue: Monthly.
4. Location of known office of publication: 307 N. Michigan Avenue, Chicago, Illinois 60601.
5. Location of the headquarters or general business offices of the publishers: One Park Avenue, New York, New York 10016.
6. Names and addresses of publisher, editor, and managing editor: Publisher, Phillip T. Heffernan, One Park Avenue, New York, New York 10016; Editor, Oliver P. Ferrell, One Park Avenue, New York, New York 10016; Managing Editor, John R. Riggs, One Park Avenue, New York, New York 10016.
7. Owner: (If owned by a corporation, its name and address must be stated and also immediately thereunder the names and addresses of stockholders owning or holding 1 per cent or more of total amount of stock. If not owned by a corporation, the names and addresses of the individual owners must be given. If owned by a partnership or other unincorporated firm, its name and address, as well as that of each individual must be given.) Ziff-Davis Publishing Company, One Park Avenue, New York, New York 10016; William B. Ziff, One Park Avenue, New York, New York.
8. Known bondholders, mortgagees, and other security holders owning or holding 1 percent or more of total amount of bonds, mortgages or other securities: None.

10. Extent and nature of circulation

Average No. Copies Each Issue During Preceding 12 Months	Actual Number of Copies of Single Issue Published Nearest to Filing Date
--	--

A. Total No. Copies printed (Net Press Run)	478,319	467,904
B. Paid circulation		
1. Sales through dealers and carriers, street vendors and counter sales	74,167	79,200
2. Mail subscriptions	303,167	303,673
C. Total paid circulation	377,334	382,873
D. Free distribution (including samples) by mail, carrier or other means	5,796	5,800
E. Total distribution (Sum of C and D)	383,130	388,673
F. Office use, left-over, unaccounted, spoiled after printing	95,189	79,231
G. Total (Sum of E and F—should equal net press run shown in A)	478,319	467,904

I certify that the statements made by me above are correct and complete.

WILLIAM PHILLIPS, Assistant Treasurer

POPULAR ELECTRONICS

SCS ADAPTER

(Continued from page 65)

SCS and Q_2 is the transistor connected as an emitter follower. (See "Getting to Know the SCS," POPULAR ELECTRONICS, Sept. 1969, p 75 for a description of how the SCS works.) Potentiometer R_5 provides output-level control. Capacitors C_1 and C_2 provide d.c. isolation at the input and output, respectively.

Using this circuit and an input sine wave of approximately 1 volt r.m.s., you can obtain an output square wave with a 7-volt overall swing within the range 40 Hz to 20 kHz. Rise and fall times of the square wave are excellent, while the horizontal portions are quite flat. Maximum power required is 18 mW from a 9-volt transistor battery.

The circuit is not critical as far as layout is concerned and any neat, clean arrangement can be used. Just make sure you don't damage the semiconductors when soldering them into the circuit.

To test and use, obtain a sine-wave input signal from an audio generator and couple the square-wave output to an oscilloscope. Set R_5 for maximum output. When the output level of the audio generator is about 1 volt, the square-wave adapter will go into operation with a square wave displayed on the oscilloscope. Adjust the audio-generator output level until the square wave is symmetrical. Other than adjusting the gain via R_5 , there are no other adjustments and the signal squarer is ready to use.

A lower cost, but not as good, circuit can be made by changing the values of R_1 to 15,000 ohms and C_1 to 0.5 μ F, eliminating R_2 and R_4 (ground C and make no connection to G_A), and reducing the battery voltage to 3 volts. In this version, the input signal requirement is 0.5 volts r.m.s. and the output square wave is 2 volts, while the frequency range is 20 Hz to 15 kHz. Since power drain is only 4.5 mW, a pair of 1½-volt flashlight cells in series can be used as a power source.

-30-

Telex writes new specs on sensitivity and ruggedness in headphones.



the Communicator Series

HIGH SENSITIVITY AND LOW OPERATING POWER. The new Communicator Series of headphones is designed around a dramatic new driver unit that requires only absolute minimal operating power. This added efficiency allows for a substantial increase in sensitivity without any increase in distortion, making the Communicator Series the most sensitive and versatile headphones available today.

RUGGED. CONSISTENT PERFORMANCE. Unlike the soft aluminum or paper cones in most of today's headphones, the Communicator's rugged new cone is made of special material that will provide peak performance without being affected by temperature or humidity. This means that you get consistent, high quality performance, day in and day out, under the most demanding communications conditions.

For more information on Telex's new Communicator headphones, contact your nearest Telex dealer or write.

PRODUCTS OF SOUND RESEARCH
TELEX
COMMUNICATIONS DIVISION
9600 Aldrich Avenue South
Minneapolis, Minnesota 55420



CIRCLE NO. 27 ON READER SERVICE CARD

NEW AND IMPORTANT SAMS BOOKS

New "THIS IS ELECTRONICS" Series

This remarkable new series, written under the direction of the Training Department of ITT Educational Services, Inc., imparts to any reader a sound understanding of the basics of electronics.

Vol. 1. Basic D-C Principles. Covers: Wonderful World of Electronics; Components & Symbols; Matter and Electricity; Circuit, Voltage, & Resistance; Series and Parallel Circuits; Conductors, Semiconductors, & Insulators; Resistors; and Sources of D-C Power.
Order 20657, only.....\$5.95

Vol. 2. Basic A-C Principles. Covers: Alternating Voltage & Current; Capacitors & Capacitive Reactance; Magnetism & Electromagnetism; Magnetic Induction; Measuring Instruments; Inductors & Inductive Reactance; Transformers & Inductive Circuits; A-C Circuits I; A-C Circuits II; Resonance; and Filters.
Order 20727, only.....\$6.95

ABC's of Radio-Frequency Heating

Explains the basic principles of heating by means of radio-frequency energy, covering both induction and dielectric heating. Describes power supply sources, microwave range, special applications, and servicing of heating equipment. Includes experimental projects.
Order 20747, only.....\$2.95

FM From Antenna to Audio

Clearly explains the entire subject of fm, from basic principles through receiving equipment to latest developments in a/c and tuning aids. Also includes information on receiver measurements and alignment procedures.
Order 20723, only.....\$3.95

1-2-3-4 Servicing Automobile Stereo

This book is the first to apply the remarkable 1-2-3-4 Method to an easy understanding of the electrical and mechanical principles of automobile stereo, fm multiplex, and tape cartridge systems, and then shows how to apply the Method to the servicing of auto systems.
Order 20737, only.....\$3.95

The Famous AUDIO CYCLOPEDIA, 2nd Ed.

Completely revised—the most comprehensive reference available on audio. Covers every phase of acoustics, recording, and reproduction. Includes all the latest developments right down to the newest solid-state and integrated circuits. A one-volume library on the entire audio art.
Order 20675, only.....\$29.95

RECENT BESTSELLING BOOKS

Fundamentals of Digital Computers. 20714.....\$5.50
Learn Electronics Thru Troubleshooting. 20651... 7.95
101 Q. & A. About Amateur Radio. 20731..... 2.95
Record Changer Servicing Guide. 20730..... 3.95
Auto Radio Servicing Made Easy, 2nd Ed. 20719... 3.95
Closed-Circuit Tel. Handbook. 2nd Ed. 20726... 5.95
CB Radio Servicing Guide. 2nd Ed. 20722..... 3.95
Citizens Band Radio Handbook. 3rd Ed. 20569... 4.25
How to Build Speaker Enclosures. 20520..... 3.50
Tape Recorders—How They Work. 2nd Ed. 20445... 4.50

—HOWARD W. SAMS & CO., INC.—

Order from any Electronic Parts Distributor, or mail to Howard W. Sams & Co., Inc., Dept. PE-1, 4300 W. 62nd St., Indianapolis, Ind. 46268

Send the following books: Nos. _____

_____ \$ _____ enclosed

Send FREE 1970 Sams Book Catalog

Name _____

Address _____

City _____ State _____ Zip _____

CIRCLE NO. 24 ON READER SERVICE PAGE

HOLOGRAPHY

(Continued from page 35)

correct interval. (4) Film resolution may be lost due to poor developing techniques or uneven temperatures in the chemical developers.

Refining the Hologram. Since holography is a new technology, perfection is not easy. However, there are a few things that can be done to improve the results a great deal and the serious experimenter will want to try them.

The first refinement is to "clean up" the laser beam where it leaves the housing. You will notice that no matter how you clean the optics, the laser beam is still inclined to be "blotchy." The blotches can be cleaned up by the use of a spatial filter. The latter is easy to make: two convex lenses of short focal length (10 to 30 mm) and a pinhole in a piece of aluminum foil are all you need. The arrangement is shown in Fig. 6. Place the assembly between the laser beam exit hole and the beam splitter.

Multi-mode lasers of the type used here cannot be completely "cleaned up" by this process. There may still be "holes" in the hologram—portions of the target that are not illuminated. To remedy this, you can try a single-mode laser (\$69.95) in place of the multi-mode, low-cost laser.

Another refinement in holograms is to make them of larger objects. The optics described in this article are suitable for making larger holograms if you use a larger film holder and bigger film and lengthen the exposure time. However, if you lengthen the exposure time, the stability of the optical system becomes much more critical.

Finally, a really advanced refinement is to put two holograms of different targets on one piece of film. To do this, take one exposure (timed a little short), rotate the film 180 degrees, still with the emulsion side toward the target, change the target, and make another exposure (also timed short). When viewing a dual hologram, remember to rotate the film to see both images.

—30—

AMATEUR RADIO

(Continued from page 82)

nician licenses issued in the United States. It is difficult, however, to determine how much of the drop in Technician licenses indicates a decrease in interest in the frequencies above 50 MHz and how much of it is the result of the 1967 change in FCC regulations. Before that time, one could hold a Novice and a Technician license simultaneously. As a result, many Novices took the Technician exam just to determine if they could pass the Technician/General written examination, with nothing to lose—except the \$4.00 license fee—whether they passed or failed. Today, however, many Novices bypass the Technician license and aim for the General or Advanced license as the next step up the license ladder.

In Eire (Ireland), beginning amateurs receive an "Experimenter's License." It authorizes CW (code) operation between 7 and 7.1 MHz (the entire European 40-meter band) and 14 to 14.35 MHz with a transmitter power input of 25 watts.



Alan Winzenried, WN9ZCO, Green Bay, Wis., started out with a 15-watt, home-built transmitter before graduating to a Heathkit HW-16 CW transceiver. So far he has worked a total of 19 states.

Fifth Annual Louisiana QSO Party starts 1800 GMT, Saturday, January 17 and ends at 2200 GMT, Sunday, January 18, 1970. Suggested frequencies, 3.6, 3.91, 7.075, 7.26, 14.075, 14.3, 21.075, 21.4, 28.1, and 28.7 MHz. Same station may be worked once per band or mode (CW-phone). Louisiana stations send QSO number, signal report, and the name of their parish; and receive QSO number, signal report, and the name of the state, province, or country for a complete

January, 1970

a 'SNAP' to install

MOBILE ANTENNAS FROM MOSLEY

Off-spring of the highly successful Devant '2'.

The new *Devant* '3'....
Model DE-3 and DES-3.

Featuring the New Mosley "Snap" Mount. Completely installed in minutes from outside the vehicle. Drill only a single opening.

Both models are base loaded with deluxe high "Q" coils, field-tested up to 250 watts.

See your nearest authorized Mosley dealer, or write factory direct for detailed brochure.

Mosley Electronics Inc.

Dept. 199

4610 N. Lindbergh Blvd.

Bridgeton, Mo. 63044



CIRCLE NO. 34 ON READER SERVICE PAGE

Olson ELECTRONICS FREE Catalog

Fill in coupon for a FREE One Year Subscription to OLSON ELECTRONICS' Fantastic Value Packed Catalog — Unheard of LOW, LOW PRICES on Brand Name Speakers, Changers, Tubes, Tools, Stereo Amps, Tuners, CB, and other Values. Credit plan available.

NAME _____
ADDRESS _____
CITY _____ STATE _____
GIVE ZIP CODE _____

If you have a friend interested in electronics send his name and address for a FREE subscription also.

OLSON ELECTRONICS

548 S. FORGE STREET, AKRON, OHIO 44308

CIRCLE NO. 20 ON READER SERVICE PAGE

IT COSTS ONLY
1/100 OF 1¢ MORE
PER SOLDER JOINT
TO KNOW YOU ARE USING THE
WORLD'S FINEST CORED SOLDER

New Easy
Dispenser
Pak
60/40
18 S.W.G.



Latest PC
(Printed
Circuit) Pak
60/40 Extra Thin
22 S.W.G.—.028"



each only 59¢ per package at your dealer

ERSIN

Multicore

FIVE-CORE
SOLDER

MULTICORE SALES CORP., WESTBURY, N.Y. 11590

CIRCLE NO. 18 ON READER SERVICE PAGE

contest exchange. Vice versa for contestants outside of Louisiana. Each exchange counts one point. Louisiana stations multiply number of contacts by the number of states, provinces, and countries worked; others multiply their contacts by the number of Louisiana parishes worked. Certificates awarded to high scores in each state, province, country, and Louisiana parish. Louisiana stations are also competing for the W5PM trophy. A minimum of 50 points (25 for DX) is required to qualify for a certificate. Mail scores to: Danny Griffith, K5ARH, QSO Party Chairman, Lafayette Amateur Radio Club, 123 Normandy Rd., Lafayette, La. 70501. Include a stamped return envelope for a list of the winners.

NEWS AND VIEWS

Paul Gilbert, WA7KIY, Cedar City, Utah, knocked the "N" out of his call letters and operated in the last ARRL Field Day as a single-operator station. He made 440 contacts on 40 meters, using a pair of crystals. His station was built by Mid, W7ZC/W5CA, and was described in *CQ Magazine* for October, 1946. The receiver uses a regenerative 6K7 detector and a 605 audio amplifier. The transmitter uses a 605 crystal oscillator to drive a 6L6 amplifier. Tube filaments were heated by four #6 dry cells in series, and 180 volts of B battery supplied plate power. The antenna was a dipole made of lamp cord, 30 feet high. You just can't beat this modern equipment! Don't be too surprised to hear that Paul worked all states on 40 meters as a Novice...

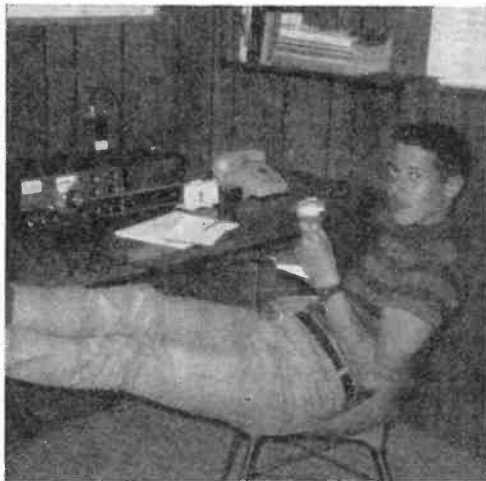

Steve Gordon, WA6MDR, Salinas, Calif., claims his 10-, 15-, 20-meter Quad antenna also works on 80 meters. He uses a dipole on 40 with a Swan 350 SSB/CW/AM transceiver doing all the inside work.

A. D. "Mid" Middleton, W7ZC, Box 303, Springdale, Utah, 84767, is celebrating his 50th year as a radio amateur. He holds DXCC, A1 Operator, and 35-WPM code certificates—among many others—and he will work prearranged schedules on 15 through 160 meters, SSB phone or CW with anyone needing a Utah contact/QSL. Tell him when you want the sked with a stamped return envelope to set up the contact. By the way, Mid is the custodian for Utah

POPULAR ELECTRONICS

All County Award, issued to amateurs who have worked all 29 Utah counties, a total of seven issued to date . . . **Paul Leuck, WA0WUW**, 2512 Pierce St., Minneapolis, Minn. 55418, operates a Knight-Kit T-60 transmitter at 60 watts to feed a 40-meter dipole, eight feet high. He receives on a Heathkit HR-10B and has 19 states, Canada, and Mexico in his log. Paul also reports a new traffic net on 7060 kHz on Mon., Wed., Fri., at 1700. EST.

R. Bruce Hibbert, WN6BPH, 559 Oriole Lane, Corona, Calif. 91720, is waiting to see if his General call letters will start with WA or WB and trying to pry cards out of the stations he has worked who have not QSL'ed. Bruce transmits with a Globe Master feeding an inverted Vee antenna and receives on a Hallicrafters S-20R . . . **Orlin D. Jenkins, WA0WYP**, 2101 5th St., Greeley, Colo. 80631, worked 35 states and four Canadian provinces in his five months as a Novice. He then failed the General class code test but returned to the Denver FCC office a month later to pass the code test and the Advanced class written exam for good measure. A Heathkit HR-10B receiver and SB-400 transmitter, and a Hy-Gain 18-AVQ vertical antenna process the electrons at W0WYP . . . **Jim Pruitt, WA7DUY/AFB7DUY**, 111 Hershbeck Heights, Aberdeen, Wash. 98520, just moved from Idaho, where he spent his Novice career. He worked 38 states and five countries as a Novice, although it took him five months to work his home state! He kept chipping away at the states as a General and Advanced licensee. The GSL card for state number 50 (Maine) arrived the day before he left Idaho. All this was done with an EICO-720 transmitter, Mosley CM-1 receiver and Hy-Gain 18-AVQ vertical antenna . . . **Alan Cowan, WNSZKO**, P. O. Box 568, Saginaw, Tex. 76079, says "You certainly do meet a lot of friendly people in amateur radio." In two months as a Novice, Alan has collected 180 QSL cards from 43 states and 10 countries. A Globe Chief transmitter and a Hallicrafters S-108 receiver, plus vertical and inverted-Vee antennas are his tools.

Max Galloway, K9OXA, has been chosen "Male Volunteer of the Year" over 2000 volunteers by the Indianapolis chapter of the American Red Cross. Max, Chairman of Emergency Communications for the chapter, designed and supervised the installation of WA9LGQ, the chapter amateur station, as well as other chapter communications equipment, including converting a truck into a mobile communications center . . . **Al Gritzmacher, WN2KJT**, 155 Waterman St., Lockport, N.Y. 14094, thanks the Lockport Amateur Radio Association's annual Novice course for his ticket. Al says that when he put up his antenna, he discovered there wasn't room for a 40-meter dipole. So, upon the advice of his father (who doesn't know any more about antennas than Al does), he put up a horizontal Vee, its center is fastened to the side of the house, one end to a tree, and the other end to a 15-foot pole. Although no good radiating to the east, Al has worked 27 states, all on 40 meters. A Heathkit DX-35 transmitter and a Lafayette HE-30 receiver decorate the WN2KJT operating table . . . **Rick Davis, WN4LWY**, 3518 Indian Lane, Doraville, Ga. 30340, takes the saying, "You can't work 'em, if you can't hear 'em," to heart. He receives on a Collins 75S-3B and transmits on a Knight-Kit T-60 through either a "trap" dipole or a 15-meter inverted-Vee. He has 20 states and four countries logged.

Will we read your "News and Views" and see your picture in your column soon? The first step is for you to write that letter. If you hold a General class or higher license, are over 21, and are willing to act as a volunteer examiner for Novice and Technician examinations, please let us know. Also, we appreciate being on the mailing list to receive your club bulletin. The address is: Herb S. Brier, W9EGQ, Amateur Radio Editor, POPULAR ELECTRONICS, P. O. Box 678, Gary, IN 46401.

Happy New Year.
73, Herb, W9EGQ.

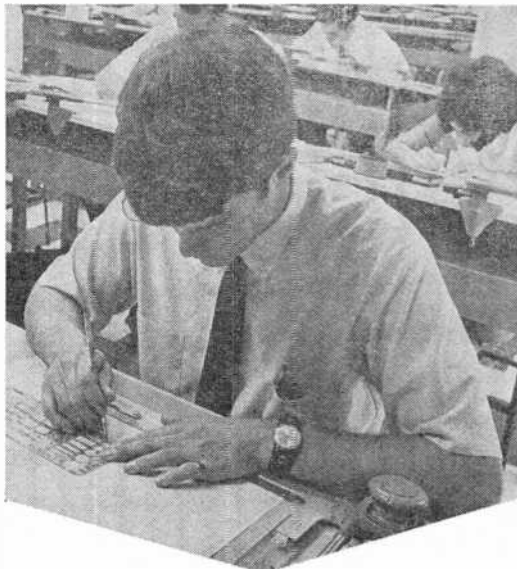

Be One of Those "SOME GUYS" Who Get All the Breaks

LEARN DRAFTING AT HOME IN SPARE TIME

The "breaks," today, can be in the exciting field of Drafting where good jobs come looking for you if you've had the right training. And now you can get just the training you need in your own home in your spare time. After an interesting and intensive course in Mechanical or Architectural Drafting you can be the one who's on the "inside" in an architectural firm, a fast-moving space industry or an electronics company. You can be the well-paid man who does fascinating work—and moves ahead rapidly.

Find out how you can turn spare time into new skills and qualify for one of these exciting jobs. Send for free booklet with all the details.

United Technical Institute

division of Career Academy

740 N. 2nd Street • Milwaukee, Wis. 53203



Please rush me your free 28 page booklet with all the details on your Drafting Course.

Name _____ Age _____

Address _____ Phone _____

City/State/Zip _____

Please send facts on the GI Bill, too.

I am interested in Home Study Resident Training

CIRCLE NO. 31 ON READER SERVICE PAGE

SAVE ON EVERYTHING IN ELECTRONICS!



Stereo hi-fi • Tape recorders & tape, electronic & hobby kits. • CB 2-way radios • Radios • Shortwave • Phonographs • Amateur gear • Automotive electronics • Tools & hardware • Tubes, transistors, parts, batteries, books ... and much more!

FREE

ALLIED 1970 ELECTRONICS CATALOG

Huge, 552-page book, our biggest ever—right off the press and crammed with values! Mail coupon now for free copy!

ALLIED RADIO Dept. 547
P.O. Box 4398, Chicago, Ill. 60680

Please
Print

NAME First Middle Last

STREET ADDRESS or ROUTE & BOX NO.

CITY

STATE ZIP

CIRCLE NO. 3 ON READER SERVICE PAGE

Go professional with Standard Communications' VHF-FM Monitor Receivers

all solid state • 12 volt power
dual conversion circuitry
148-174 MHz range



SR-C805Z
Low priced auxiliary unit with self contained speaker and antenna.

\$79.95



SR-C804Z
Designed for expanding a base station or used separately with remote speaker, power supply and antenna.

\$139.95

Both models provide 6 crystal controlled channels featuring individual crystal netting capacitors for professional performance. A technical breakthrough in performance, price and size!

Write for
descriptive
literature.



STANDARD
COMMUNICATIONS Corp.

640 East 219th Street, Torrance, Calif. 90502

CIRCLE NO. 26 ON READER SERVICE PAGE

SHORT-WAVE LISTENING

(Continued from page 78)

Egypt—Cairo has been testing to N.A. in English and asking for reports at 0135 on 11,725 kHz. Other channels heard include 9475 kHz at 0200-0330 in English with news at 0225, and 9630 at 2200 in Arabic.

England—At press time, London was using 11,845 kHz for its Asian Service at 2300-2330 in English to 2315 and Indonesian for the remainder.

Ethiopia—V. of Ethiopia, Addis Ababa, is good on 9610 kHz daily at 0330 s/on until at least 0415 with beautiful native music, and on 15,170 kHz from 0438-0456 with ID's in English, French and possibly Amharic.

France—Paris has English news daily at 1915-1930 on 15,295 kHz. The address they are giving on the air is *ORTF*, English Service, Room 4664, Paris, France.

Germany (West)—*Deutsche Welle*, Cologne, was found on a new frequency of 17,800 kHz at 2326 with German language and commentary and, at 0000, news in German.

Honduras—HRVK, Tegucigalpa, shows on 4847 kHz frequently between 0130-0200 with some na-

SHORT-WAVE CONTRIBUTORS

David Larrabee (*WPE1HRB*), Brunswick, Maine
John Banta (*WPE2PIU*), Bay Shore, N. Y.
John Herkimer (*WPE2PIL*), Caledonia, N. Y.
Robert Arnold (*WPE2QPR*), Canastota, N. Y.
Lawrence Lewandowski (*WPE2QTO*), Buffalo, N. Y.
Paul Wolcott, Jr. (*WPE2QVL*), Linwood, N. J.
Robert Halprin (*WPE2QZU*), Fair Lawn, N. J.
Steven Fix (*WPE2RAS*), Rochester, N. Y.
Ronald Carnes (*WPE2RBY*), Spotswood, N. J.
Richard Reese (*WPE3HCCX*), Falls, Pa.
Gary Blau (*WPE3HVV*), Rockville, Md.
Dan Ferguson (*WPE4AUL*), Coral Gables, Fla.
Grady Ferguson (*WPE4BC*), Charlotte, N. C.
Chuck Howard (*WPE4EHT*), Tampa, Fla.
David Truitt (*WPE4JOF*), Arlington, Va.
Edward Hendrix (*WPE4HK*), Dillon, S. C.
Homer Ingler (*WPE4JJJ*), Durant, Fla.
Glen Wilson (*WPE4KDK*), Arlington, Va.
M. F. Dressler (*WPE4KHJ*), Jacksonville, Fla.
Carroll Patterson (*WPE4KHV*), Decatur, Ga.
Ken Brookner (*WPE5EIVM*), Memphis, Tenn.
Richard Fortson (*WPE5EIVX*), Edinburg, Texas
Charles Bennett (*WPE5SIV*), Sumrall, Miss.
Jim Young (*WPE6ENA*), Wrightwood, Calif.
Michael Caditz (*WPE6HOA*), Los Angeles, Calif.
David Williams (*WPE7CWW*), Astoria, Ore.
Mark Nodine (*WPE7CXF*), Salem, Ore.
Tom Christian (*WPE7CXG*), Seattle, Wash.
Tom Palmer (*WPE8KHJ*), Detroit, Mich.
Alan Roberts (*WPE8KIZ*), Detroit, Mich.
George Smith, Jr. (*WPE8KJJ*), Grand Rapids, Mich.
Edward Bonk (*WPE8KKI*), Detroit, Mich.
Robert Moser (*WPE9ASH*), Chicago, Ill.
Gerry Dexter (*WPE9HDB*), Lake Geneva, Wis.
Richard Pistek (*WPE9HOA*), Chicago, Ill.
Bill Vogt (*WPE9IND*), Tinley Park, Ill.
Richard Coddington (*WPE9NFB*), Lockport, Ill.
John Patterson (*WPE9JOL*), Osvego, Ill.
Charles Wehking (*WPE9JTF*), St. Louis, Mo.
A. R. Niblack (*WPE9KM*), Vincennes, Ind.
John Beaver (*WPE9AE*), Pueblo, Colo.
Gary Bowers (*WPE9FNV*), Kirksville, Mo.
Jack Perolo (*WPE9PEIC*), Sao Paulo, Brazil
Paul Cau (*WPE9PEOZ*), St. Catharines, Ont.
Robert Boule, Middletown, N. J.
Ed Curran, Chicago, Ill.
Bill Grant, Worcester, Mass.
John Hurwitz, Shawnee Mission, Kan.
Michael Mayo, St. Louis, Mo.
Japanese Short Wave Club, Sendai, Japan
North American Short Wave Association, Altoona, Pa.
Sweden Calling DX'ers Bulletin, Stockholm, Sweden

tive, some U.S. pops and periodic ID's. At times they give the slogan of *Radio San Isidro* rather than the listed *Radio Católica*.

India—*All India Radio*, Delhi, 15,080 kHz, was noted at 1924-1940 with poetry in English in their General Overseas Service to East Africa.

Indonesia—*R. Indonesia*, Bandjarmasin, was heard on 5972 kHz at 1202-1211 with news in Indonesian followed by Far East music.

International Waters—An overseas source lists *The Voice of Peace* as being in the Mediterranean and beamed to the Middle East. An Israeli bar-owner reportedly bought a ship for \$45,000 and has installed an American xmtr. Broadcasts are in Arabic, English, French and Hebrew; the signature tune is "Give Peace A Chance" as recorded by the Plastic One band. No frequencies were listed. It is said to be on the air now.

Italy—Rome is on 9575 kHz in Italian at 2230-2300 to N.A. Italian is also found on 15,340 kHz at 1831-1905 s/off and on the same channel at 0305 in Spanish.

Kashmir—*R. Kashmir*, Srinigar, 3277 kHz, has English news at 1700-1705 and s/off at 1733. This should be virtually impossible to hear in N.A. at this time.

Kuwait—A new frequency for *R. Kuwait* is 15,345 kHz as heard at 1600-1900 in English with news, talks, pop music and frequent ID's. Also heard: 21,685 kHz at 1645-1700 in Arabic with news at 1700.

Lebanon—*R. Lebanon*, Beirut, is beamed to N.A. on 15,170 kHz at 0130-0200 in French, 0200-0230 and 0300-0330 in Arabic, 0230-0300 in English and 0330-0400 in Spanish. English to Africa is at 1830-1900 on 15,350 kHz.

Liberia—ELWA, Monrovia, has moved from 15,155 kHz to 15,098 kHz for French to N. Africa and W. Europe at 2000-2100; Arabic is also here at 2130.

Mexico—The new Mexican station, XERMEX, 11,718 kHz, is requesting reception reports to P. O. Box 20100, Mexico City. Reports from 0100-0205 indicate considerable English anmt's, some Spanish ID's and mostly L.A. instrumental music. ID's are also given in French and German. . . . XEQM, Merida, is good around 0100 with bell and ID, L.A. music, commercials, and ID's for XECM.

New Hebrides—*R. Vila*, 3905 kHz, has music and French at 0638; news in English or Pidgin at 0700; s/off 0710.

Nicaragua—*R. Zelaya*, Bluefields, fair to good with pop and classical music, few ID's, until 0400 s/off on 5950 kHz.

Pakistan—*R. Pakistan*, Karachi, has English news at 2000 and a letter-box, request-music show at 2015 to 2030 s/off on 15,240 kHz, beamed to Europe. English news is also given at 1340-1350 on 17,945 kHz.

Peru—OBZ40, *R. Union*, Lima, is heard well on 6115 kHz with pop music, frequent ID's and ads

at 0415-0430. Despite many reports, the station on 5061 kHz continues to give an ID for OAX8E, *R. Loyeto*, Iquitos. Repeated ID's were copied at 0430 during a period of typical Andean music and Spanish anmt's.

Portugal—A new frequency from Lisbon is 15,394 kHz, found with an ID in Portuguese at 2205.

Rhodesia—*R. Gwelo* is on 4828 kHz at 0401-0410 with English news, then into vernaculars with music to past 0415. This is dual to 5012 kHz.

Romania—*R. Bucharest* is now on 11,770 kHz, an unlisted channel. In English to Western Europe with news at 2100-2109, commentary to 2114, instrumental music and talks to 2124, closing anmt's and s/off at 2126.

Saudi Arabia—Jeddah is often good on 11,855 kHz with English at 1700-2000, then into French.

South Africa—*R. RSA*, Johannesburg, is on 9705 and 9715 kHz to N.A. in English at 0030. Reports show, as we too have noticed, that 9715 kHz is often a far better channel. A Portuguese xmsn from this station has been logged on 15,175 kHz at 2115.

Sudan—Omdurman was noted with a definite ID at 0445 in Arabic on the new frequency of 11,835 kHz.

Sweden—At press time, *R. Sweden*, Stockholm, was using 5990 kHz in English to N.A. at 0300-0100 and 0200-0230.

USA—WWV, Fort Collins, Colorado, was found on 30,000 kHz at 2230-2350; reception made on an HQ-180A.

USSR—*R. Magadan*, 4040 kHz, heard with home service in Russian at 1155 with classical music; 1200 time signals and into a newscast. . . . Petropavlovsk-Kamchatka, 4485 kHz, noted at 0730-0900 with organ music, anmt's in Russian, old American pop tunes, a speech, and what seemed to be news. . . . Khabarovsk heard on 4610 kHz in home service at 1150 with an opera in Russian and news at 1200 after time signal. . . . Tashkent, 5970 kHz, good at times with Russian music and anmt's from 0810-0903, dual to 5900, 7305 and 9375 kHz. . . . Time station RID has been heard on 15,004 kHz with time ticks and Morse ID every 15 minutes. At times it covered WWV and was unusually strong.

Vatican City—New frequencies in use by *R. Vatican* include 11,725 kHz, dual to 9615 kHz at 0110 in French and on the latter frequency at 0030-0045 in Spanish and 0050-0100 abrupt s/off in English.

Windward Islands—*Windward Islands B/C Corp.*, St. Georges, Grenada, has been heard on 3280 kHz at 0115-0215 s/off with pop music, religious programming, news and a program schedule preview, and on 11,970 kHz at 0130 in English to Jamaica. A QSL sent upon receipt of a reception report took three months from postmark date to travel from Grenada to California!

Remote Control Fleet Fueling



NOW YOU CAN CONTROL AND MONITOR FLEET FUELING OPERATIONS UP TO ONE HUNDRED MILES AWAY, 24 HOURS A DAY!

With the new all solid state TELECONTROLATOR-1521 you can supervise fleet fueling stations up to 100 miles from a central office. Think of the savings possible because of this centralized 24 hour control! More accurate, simplified records, more productive time from drivers, requires only one person to operate and record deliveries and like all CONTROLATORS, it prevents pilferage and saves fuel.

The advantages of the 1521 over old methods of fleet fueling are many and they all mean the greater efficiency that results in increased profits.

Begin up-dating your fleet fueling methods by sending for complete literature on the TELECONTROLATOR today!

Controlator / Division of Aerotron, Inc.

P.O. BOX 6527, RALEIGH, NO. CAROLINA 27608

CIRCLE NO. 2 ON READER SERVICE PAGE

Have your own Radio Station!

Learn AMATEUR RADIO



AT HOME IN YOUR SPARE TIME

Get your Amateur Radio license and "go on the air." NRI, leader in Electronics home training for more than 50 years, offers a choice of training plans leading to required FCC licenses, ranging from Basic Amateur Radio for the beginner to Advanced Amateur Radio for the ham who already has a license and wants to move up.

HAM RADIO EQUIPMENT INCLUDED

NRI's beginner's course includes your own Novice Class 25-watt transmitter, 3-band receiver and transistorized code practice oscillator with code key and headset. You learn code using special LP records. Choose from 3 Amateur Radio courses. Low tuition. Monthly payment plans. Get all the facts. Mail coupon. No salesman will call. NATIONAL RADIO INSTITUTE, Washington, D.C. 20016.



.....MAIL COUPON TODAY.....

NATIONAL RADIO INSTITUTE 58-010
Washington, D.C. 20016

Please send me information on Amateur Radio training.

Name _____ Age _____

Address _____

City _____ State _____ Zip _____

ACCREDITED MEMBER NATIONAL HOME STUDY COUNCIL

Live Better Electronically With

LAFAYETTE RADIO ELECTRONICS

1970 Catalog 700 **FREE!**



Now OFF PRESS
BETTER THAN EVER
496 Pages

Stereo Hi-Fi • Citizens Band • Ham Gear • Tape Recorders • Test Equipment • TV and Radio Tubes and Parts • Cameras • Auto Accessories • Musical Instruments • Tools • Books

Featuring Everything in Electronics for
• HOME • INDUSTRY • LABORATORY
from the "World's Hi-Fi & Electronics Center"

LAFAYETTE Radio ELECTRONICS
Dept. 35010 P.O. Box 10
Syosset, L.I., N.Y. 11791

Please Send the FREE 1970 CATALOG 700 35010

Name

Address

City

State Zip

CIRCLE NO. 16 ON READER SERVICE PAGE

TWO-WAY REACTIONS

(Continued from page 80)

Wapello County REACT discloses these routine calls: mobile requesting directions to Post Office; report of motorist swerving across bridge; request for ambulance; report of school bus accident to police; report of stalled semi-trailer on highway; request for State Police to direct traffic; report of presence of prowler to sheriff; car full of boys shouting foul language; several small auto wrecks; requests for road information; relay of messages to Red Cross at scene of drowning; request for help in searching for small boat.

St. John, N.B. . . . Cooperation between various

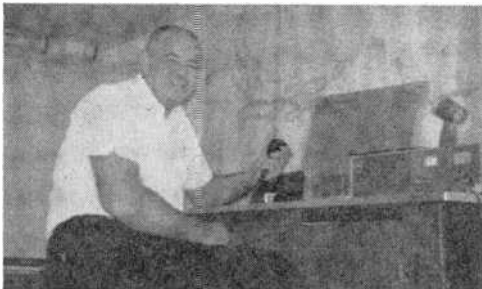

George W. Arthur, above, of Hernando County (Fla.) REACT was at post during hurricane watch. Below, Wabash (Ind.) REACT put out 10 roadside signs.



WHAT'S A REACT CLUB OR TEAM?

It has come to the attention of REACT National Headquarters that there is some confusion over the use of the name REACT in connection with some local organizations of Citizens Radio operators. The name REACT is a registered trade name and cannot be used by groups not officially recognized by REACT National Headquarters. If any organization using this designation has not received a certificate of recognition at some time from REACT National Headquarters, it is subject to legal action, which is required to protect the trademark registration. If you are in doubt about your group's status, please write for clarification to:

REACT National Headquarters
205 West Wacker Drive
Chicago, Illinois 60606

POPULAR ELECTRONICS READER SERVICE PAGE

free information service:

Here's an easy and convenient way for you to get additional information about products advertised or mentioned editorially (if it has a "Reader Service Number") in this issue. Just follow the directions below... and the material will be sent to you promptly and free of charge.

1. On coupon below, circle the number(s) that corresponds to the key number(s) at the bottom or next to the advertisement or editorial mention that is of interest to you. (Key numbers for advertised products also appear in the Advertisers' Index.) Print or type your name and address on the lines indicated.

2. Cut out the coupon and mail it to: POPULAR ELECTRONICS, P.O. Box 8391, Philadelphia, PA 19101.

note: If you want to write to the editors of POPULAR ELECTRONICS about an article on any subject that does not have a key number, write to POPULAR ELECTRONICS, One Park Avenue, New York, N.Y. 10016. Inquiries concerning circulation and subscriptions should be sent to POPULAR ELECTRONICS, Portland Place, Boulder, Colo. 80302.

**POPULAR
ELECTRONICS**

P.O. BOX 8391
PHILADELPHIA, PA. 19101

VOID AFTER FEBRUARY 28, 1970

1 2 3 4 5 6 7 8 9 10 11 12 13 14 15 16 17 18 19 20
21 22 23 24 25 26 27 28 29 30 31 32 33 34 35 36 37 38 39 40
41 42 43 44 45 46 47 48 49 50 51 52 53 54 55 56 57 58 59 60
61 62 63 64 65 66 67 68 69 70 71 72 73 74 75 76 77 78 79 80
81 82 83 84 85 86 87 88 89 90 91 92 93 94 95 96 97 98 99 100

NAME (Print clearly) _____

ADDRESS _____

CITY _____ STATE _____ ZIP CODE _____

1 b

It's yours free



**GIANT 274 PAGE
1970
RADIO-TV
ELECTRONICS
CATALOG**

Write to.

**BURSTEIN APPLEBEE CO.,
DEPT. PE-1 3199 MERCIER ST.,
KANSAS CITY, MO. 64111**

Name _____
Address _____
City _____
State _____ Zip Code _____

CIRCLE NO. 6 ON READER SERVICE PAGE

Be an Architectural DRAFTSMAN



1000s big pay jobs open to trained Draftsmen (see "help wanted" ads in city papers). U. S. Labor Dept. says "42% more Draftsmen needed in next 10 years." Easy step-by-step spare time home-study plan has helped 100s beginners toward \$\$\$\$\$, security, prestige! Why not you? Send for "DRAFTING CAREER KIT" & new 5-Way Drafting Instrument—**ALL FREE!** No salesman will call. G. I. approved. Write & state age.

**NORTH AMERICAN SCHOOL OF DRAFTING
4500 Campus Dr., Dept. 00000, Newport, California 92660**

**HEARING AIDS
2/3 OFF DEALER
PRICES**

LARGEST SELECTION of tiny, all-in-the-ear, behind the ear, eyeglass and pocket models. **FREE HOME TRIAL.** No obligation. Money back guarantee. No down payment. Easy terms. No salesmen or dealers. Order direct, save 65%. Write for free catalog. **PRESTIGE, Dept. D-184, Box 10947, Houston, Tex. 77018.**



FREE 1970 CATALOG.

1001 Bargains—Speakers—Parts—Tubes—High Fidelity Components—Record Changers—Tape Recorders—Kits—Everything in Electronics. Write:

**McGEE RADIO COMPANY
PE, 1901 McGee Street,
Kansas City, Missouri 64108.**

GET INTO ELECTRONICS

V.F.T. training leads to success as technicians, field engineers, specialists in communications, guided missiles, computers, radar, automation. Basic & advanced courses. Electronic Engineering Technology and Electronic Technology curricula both available. Associate degree in 28 months. B.S. obtainable. G.I. approved. Start September, February. Dorms, campus. High school graduate or equivalent. Catalog.

**VALPARAISO TECHNICAL INSTITUTE
DEPARTMENT PE, VALPARAISO, INDIANA 46383**



CB CODE OF COURTESY

- Extend the courtesy of channel priority for base-to-mobile communications from 6 to 8 a.m. and 4 to 6 p.m. local time when people are traveling to and from home and work.
- Pause a few seconds before keying your mike so that you can hear a "breaker" or see if you missed hearing a transmission that was already in progress.
- Try not to tie up the channel.
- Use discretion in "breaking." If it is important that you reach another station, break, but make your call as short as possible or ask party you are calling to move to another channel.
- When you turn on your transceiver or move to another channel, wait a few seconds to be sure the channel is clear before starting your transmission.
- If it is necessary to transmit a test (matching the antenna, checking SWR, etc.), wait for, or go to, a clear channel.
- Avoid discussing your transceiver's performance. If there are irregularities in your transmissions, someone will let you know about them soon enough.
- Give a clear channel to an emergency call. Give your full cooperation during an emergency situation.
- Use good taste in what you say on the air.
- Don't give names, addresses, or phone numbers on the air.

local agencies has been achieved by St. John REACT Emergency Team through a series of meetings with the Red Cross, local radio stations, Chief of Police, City Manager and various businesses. In this way, the team has received official recognition so that it is included in the disaster plan being formulated by the city authorities. Demonstrating its ability to be of service, the team provided radio communications during a local forest fire. Four days were spent in relaying messages from portable units in the field to mobile units and then to base control in the city. The team cooperated with police, fire departments, and the forestry service in this effort. The St. John team has posted REACT signs announcing it is monitoring channel 9 on the four highway approaches to the city.

-30-

SOLID STATE

(Continued from page 86)

similar connection technique may be used if the car has a positive ground system, but the circuit should be modified by replacing Q1 and Q2 with their complementary equivalent types and reversing D1 and C1 polarities. Potentiometer R3 permits a fine adjustment of off time from about 55 to 65 seconds. If a different range is preferred, C1 can be replaced with a smaller

(for shorter time intervals) or larger valued capacitor.

Transitips. Add a dash of creative imagination and virtually any basic circuit can be used in a variety of applications. Often, the only modification needed is a minor change in a component value.

Consider the basic blocking oscillator circuit illustrated in Fig. 3. Here, center-tapped transformer *T1* serves both to provide the feedback signal needed to start and maintain oscillation and to furnish a drive signal to a PM loudspeaker. The circuit's "natural" frequency is determined primarily by the transformer characteristics, while its blocking rate is determined by feedback coupling capacitor *C1* in conjunction with base resistor *R1* and series current limiting resistor *R2*. Operating power is supplied by *B1*, controlled by *S1*.

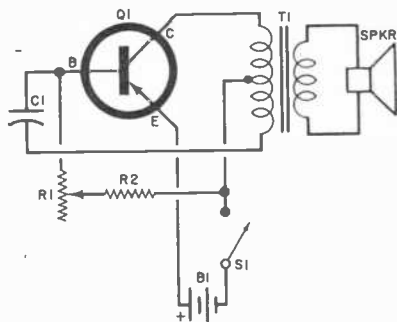

Fig. 3. Blocking oscillator has many variations.

As shown, such a circuit can supply a harmonic-rich tone—suitable, perhaps, for checking microphone placement.

Let's add our dash of imagination and see what happens . . .

Change *C1*'s value to provide a higher pitched tone (smaller *C* here) and replace *S1* with a handkey. Presto, a *code practice oscillator*.

Remove the handkey and substitute a pair of test jacks or leads, and we have a *continuity tester*.

Change *C1* to a fairly large value, and we have a *metronome*.

Return *C1* to its original value and replace the loudspeaker with a 10-ohm potentiometer, and there is a simple *audio test signal source*.

Return to our original circuit and substitute a photo relay's contacts for *S1*, and, now, an *alarm signal*.

Add additional feedback capacitors, each of a different value, and each switched into the circuit by a normally open push-button switch. Behold, a basic *electronic organ*.

Easy, isn't it?

—Lou.

ABOUT YOUR SUBSCRIPTION

Your subscription to POPULAR ELECTRONICS is maintained on one of the world's most modern, efficient computer systems, and if you're like 99% of our subscribers, you'll never have any reason to complain about your subscription service.

We have found that when complaints do arise, the majority of them occur because people have written their names or addresses differently at different times. For example, if your subscription were listed under "William Jones, Cedar Lane, Middletown, Arizona," and you were to renew it as "Bill Jones, Cedar Lane, Middletown, Arizona," our computer would think that two separate subscriptions were involved, and it would start sending you two copies of POPULAR ELECTRONICS each month. Other examples of combinations of names that would confuse the computer would include: John Henry Smith and Henry Smith; and Mrs. Joseph Jones and Mary Jones. Minor differences in addresses can also lead to difficulties. For example, to the computer, 100 Second St. is not the same as 100 2nd St.

So, please, when you write us about your subscription, be sure to enclose the mailing label from the cover of the magazine—or else copy your name and address exactly as they appear on the mailing label. This will greatly reduce any chance of error, and we will be able to service your request much more quickly.



LOOKING FOR
QUALITY
FAST DELIVERY
LOW PRICES ON
SEMI-CONDUCTORS
?

NEW JERSEY SEMI CONDUCTOR

U.S. Highway 22, Blue Star Mall
Watchung, N.J. 07060 Tel. (201) 322-9200

TESTING FACILITIES AVAILABLE

CIRCLE NO. 19 ON READER SERVICE PAGE

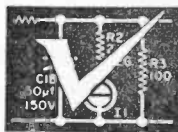

OPERATION ASSIST

Through this column we try to make it possible for readers needing information on outdated, obscure, and unusual radio-electronics gear to get help from other P.E. readers. Here's how it works: Check the list below. If you can help anyone with a schematic or other information, write him directly—he'll appreciate it. If you need help, send a postcard to Operation Assist, POPULAR ELECTRONICS, One Park Avenue, New York, N.Y. 10016. Give maker's name and model number of the unit. If you don't know both the maker's name and the model number, give year of manufacture, bands covered, tubes used, etc. State specifically what you want, i.e., schematic, source for parts, etc. Be sure to print or type everything legibly, including your name and address. Do not send an individual postcard for each request; list all requests on one postcard. Because we get so many inquiries, none of them can be acknowledged. POPULAR ELECTRONICS reserves the right to publish only those items not available from normal sources.

Hallmark Model CB2-12. Schematic needed. (Joseph Scanny, 2540 S. 67 St., Phila., Pa. 19042)

National Model NC-109 receiver. Schematic and alignment data needed. (Earl Lolley, 407 Mock St., Andalusia, AL 36420)

AK Breadboard receiver needed. (A.J. Luber, 1628 Rouse Ave., Modesto, CA 95351)

EMC Model 107A V.T.V.M. and Capacitance Checker. Schematic needed. (Hugh S. McKay, Hilbre, Manitoba, Canada)

Wilcox-Gay Model 772 "Recordio" tape recorder. Source for parts needed. (L. Herzog, 916 W. 9 St., Dixon, IL 61021)

Atwater Kent Model 60C. Schematic and source for parts needed. (Wm. Visser, 34 Church St., Norwell, MA 02061)

Polytronics Model Polycomm Pro. Schematic and operating manual needed. (Larry Riffle, 10 Summit Ave., Thurmont, MD 21788)

Hallicrafters Model S-107 SW receiver. Manual, schematic and calibration instructions needed. (W.E. Lloyd, 1 Eccleston Dr., Apt. 212, Toronto 16, Ontario, Canada)

Weston Model 665 Type 1 selective analyzer. Info on types of battery required and operating manual needed. (Charles Fleckenstein, 65-31 80 Ave., Glendale, NY 11227)

Hallicrafters Model RE-1 receiver. Alignment info, parts list, operating manual and schematic needed. (Robert Jordan, 1410 Mt. Stanley Way, San Jose, CA 95127)

Truvox of London Model PD 96 Stereo tape recorder. Tube numbers, tube locations and schematic needed. (Len Scott, 160 McDiarmid Dr., Brandon, Manitoba, Canada)

Philco 3" "IF/MF" oscilloscope. Schematic and any additional technical info needed. (Robert J. Patterson, AF16847163, 26 AMS CMR 4183, APO NY 09009)

990 MODEL

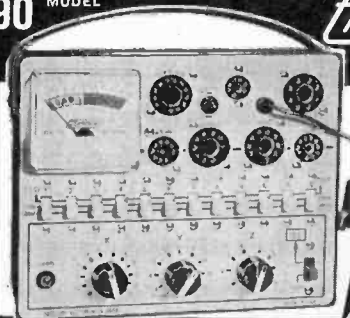

NEW COMPACT TUBE TESTER OUTPERFORMS MANY HIGHER PRICED INSTRUMENTS

- Full Conductance Cathode Test • Has All The Latest Sockets
- Tests Over 3000 Tubes • Special, Unique Open-Circuit 12-Button Master Selection Slide-Switch Row Makes Unit Truly Obsolescent Proof • Tests Multiple Element Terminations Quickly, Easily
- Complete With Latest Tube Test Data That Is Permanently Kept Up-To-Date.

ONLY
21⁹⁵ KIT
34.95 WIRED

All Mercury Test Equipment Guaranteed For One Full Year!

Write for complete catalog of Mercury Test and Repair Equipment, and name of your nearest dealer.

MERCURY ELECTRONICS CORPORATION
315 Roslyn Road • Mineola, N.Y. 11501 • (516) 742-5400

CANADA: William Cohen Corp.

Power Req.: 115V, 50/60 Hz 50W

Hi-impact molded case, 6 1/2 x 7 1/2 x 3 1/2 — 4 lbs.

American Made

CIRCLE NO. 35 ON READER SERVICE PAGE

AUTOMATICALLY SCANS 8 PRE-PROGRAMMED CHANNELS — WITH PRIORITY CHANNEL FEATURE

SONAR AUTO-SCAN FM MONITOR RECEIVERS



A highly dependable performer with superior professional features. AUTO-SCAN searches and locks automatically on any of 8 pre-programmed channels. Priority Channel locks to the exclusion of other signals. Mobile Callbacks are heard because of carrier delay. Designed for rugged use over wide temperature range. • Narrow band operation • Operates from 117VAC or 12VDC, negative or positive ground • Noise free squelch • 8 crystal positions

designed for:

- Police, Fire and Municipal Depts.
- County, State & Federal agencies
- Commercial & Industrial applications
- Other unlimited uses

FR-2514
(25-50MHz)

FR-2515
(150-175MHz)

Comes with AC and DC power cables, mounting bracket, less crystals. Crystals \$5.00 ea.

\$189⁹⁵

SONAR RADIO CORP., 73 Wortman Ave., Bklyn, N.Y. 11207

Please send information on Sonar AUTO-SCAN FM Monitor Receivers.

Name _____ Dept. 712

Address _____

City _____ State _____

CIRCLE NO. 25 ON READER SERVICE PAGE

ELECTRONICS MARKET PLACE

COMMERCIAL RATE: For firms or individuals offering commercial products or services. \$1.15 per word (including name and address). Minimum order \$11.50. Payment must accompany copy except when ads are placed by accredited advertising agencies. Frequency discount: 5% for 6 months; 10% for 12 months paid in advance. **READER RATE:** For individuals with a personal item to buy or sell. 70c per word (including name and address). No Minimum! Payment must accompany copy.

FOR SALE

FREE! Giant bargain catalog on transistors, diodes, rectifiers, SCR's, zeners, parts. Pol. Paks, P.O. Box 942, Lynnfield, Mass. 09140.

GOVERNMENT Surpl Receivers, Transmitters, Sniperscopes, Radios, Parts, Picture Catalog 25¢. Meshna, Nahant, Mass. 09108.

ROCKETS: Ideal for miniature transmitter tests. New illustrated catalog. 25¢. Single and multistage kits, cones, engines, launchers, trackers, rocket aerial cameras, technical information. Fast service. Estes Industries, Dept. 18, Penrose, Colorado 81240.

LOWEST Prices Electronic Parts. Confidential Catalog Free. **KNAPP**, 3174 8th Ave. S.W., Largo, Fla. 33540.

EUROPEAN and Japanese bargains catalogs. \$1 each. Dee, 10639E Riverside, North Hollywood, Calif. 91602.

MUSIC LOVERS, CONTINUOUS, UNINTERRUPTED BACKGROUND MUSIC FROM YOUR FM RADIO, USING NEW INEXPENSIVE ADAPTOR. FREE LITERATURE. **ELECTRONICS**, 11500-Z NW 7th Ave., MIAMI, FLORIDA 33168.

WE SELL CONSTRUCTION PLANS. TELEPHONE: Answering Machine, Speakerphone, Carphone, Phonevision, Legal Connector, Auto Dialer, Central Dial System. TELEVISION: \$35.00 Color Converter, Tape Recorder, 3DTV. \$25.00 Camera. DETECTIVE: Infinity Transmitter, Tail Transmitter, Police Radar Detector. HOBBYIST: Electron Microscope, 96 Hour Tape Music System, Ultrasonic Dishwasher, Radar-Oven, Electronic Tranquillizer. Plans \$4.95 each. COURSES: Telephone Engineering \$39.50, Detective Electronics \$22.50, Anti-Detective Electronics \$27.50. **SUPER HOBBY CATALOG** 25¢. Don Britton Enterprises, 7906 Santa Monica Blvd., Hollywood, Calif. 90046.

WEBBER LAB'S. Police & Fire Converters. Catalog 25¢. 72 Cottage Street, Lynn, Mass. 09105.

RADIO—T.V. Tubes—33¢ each. Send for free catalog. Cornell, 4213 University, San Diego, Calif. 92105.

INVESTIGATORS, LATEST ELECTRONICS AIDS. FREE LITERATURE. CLIFTON, 11500-L NW 7th Ave., MIAMI, FLORIDA 33168.

FREE ELECTRONICS PARTS FLYER. Large catalog \$1.00 deposit. BIGELOW ELECTRONICS, BLUFFTON, OHIO 45817.

JAPAN & HONG KONG DIRECTORY. Electronics, all merchandise. World trade information. \$1.00 today. Ippano Kaisha Ltd., Box 6266, Spokane, Washington 99207.

CIRCUIT Boards, Parts for "Poptronics" projects. Free catalog. S.W. Technical, Box 16297, San Antonio, Texas 78216.

FREE Catalog low priced, high performance subminiature listening devices direct from manufacturer. Emery LT-101, 156 Fifth Avenue, New York, N. Y., 10010.

ULTRA-SENSITIVE AND POWERFUL METAL DETECTORS—join the many who are finding buried coins, minerals, relics and artifacts. Don't buy till you see our **FREE** catalog of new models. Write Jetco, Box 132-PE, Huntsville, Texas 77340.

LASER parts catalog 60¢. Moynihan, 107 North Brighton, Atlantic City, New Jersey 08401.

PSYCHEDELIC catalog. Posters, lighting, etc. Send 25¢ for handling to Hole in The Wall, 6055PE Lankershim, North Hollywood, Calif. 91606.

THE ART OF DE-BUGGING—\$5.95. TRON-X PUBLICATIONS, P.O. BOX 38155, HOLLYWOOD, CALIFORNIA 90038.

CONSTRUCTION PLANS: LASER . . . \$2.00. Surveillance Devices—two F.M. Bugging Transmitters . . . \$1.00. Tail Transmitter . . . \$1.00. Telephone Transmitter . . . \$1.00. Infinity Transmitter . . . \$2.00. Surveillance equipment and kits available. Howard, 20174 Ward, Detroit, Michigan 48235.

GENERAL INFORMATION: First word in all ads set in bold caps at no extra charge. Additional words may be set in bold caps at 10c extra per word. All copy subject to publisher's approval. Closing Date: 1st of the 2nd preceding month (for example, March issue closes January 1st). Send order and remittance to: Hal Cymes, POPULAR ELECTRONICS, One Park Avenue, New York, New York 10016.

SENCORE TEST EQUIPMENT UNBELIEVABLE PRICES. FREE CATALOG AND PRICE SHEET. FORDHAM RADIO, 265 EAST 149TH STREET, BRONX, N.Y. 10451.

CONVERT any television into Oscilloscope (simplest), **SECRET** Automatic Telephone Recorder, **REMOTE** Telephonic Intrusion Alarm. Detailed, Illustrated Plans \$1.95 each, 3 for \$4.95. **WESTERN**, 28 E. 5199 Kearny Villa, San Diego, California 92123.

COMPONENTS? Kits? Hardware? Free catalog! Truvee Paks, Box 275, Chelsea, Mass. 02150.

HOW a tube amplifies \$.50. The hybrid transformer \$.50. Free catalog. **BECO**, Box A, 27011, Minneapolis, Minnesota 55427.

ELECTRONIC ignition, various types. Free literature. Anderson Engineering, Epsom, N.H. 03239.

NEW! Low cost aluminum UHF-VHF towers. **COFFELT**, 909 Hayter, Dallas, Oregon 97338.

NEW! PHONE PATCH with automatic switch. Now you can record those important conversations automatically. **ONLY \$14.95.** Chelco Electronics, 11835 Wilshire Blvd., Los Angeles, Calif. 90025.

AMATEUR SCIENTISTS, Electronics Hobbyists, Experimenters, Students . . . Construction Plans—all complete, including drawings, schematics, parts lists with prices and sources . . . Laser-Build your own coherent-light optical laser. Operates in pulsed mode, visible light range—\$6.00 . . . Radar—Build your own ultrasonic doppler radar. Detect motion of people, automobiles, even falling rain drops. Transistorized, uses standard small 9-volt battery—\$4.00 . . . Long-Range "Sound Telescope"—This amazing device can enable you to hear conversations, birds and animals, other sounds hundreds of feet away. Very directional. Transistorized. Uses 9V battery—\$3.00 . . . Or send 25¢ coin (no stamps) for complete catalog. Other items include Psychedelic strobes, light shows, robots . . . 38 different projects. Technical Writers Group, Box 5994, State College Station, Raleigh, N.C. 27607.

DIAGRAMS—Radios \$1.50, Television \$3.00. Give make and model. Diagram Service, Box 1151PE, Manchester, Conn. 06042.

CLEARANCE SALE rectifiers, transistors, 1000's other items. Catalog 15¢. General Sales Company, 254 Main, Clute, Texas 77531.

HEARING AIDS below wholesale. Smallest, most powerful. Free home trial. No salesman will call. Free details. Write Prestige-C-42, Box 10880, Houston, Texas 77018.

LINEAR AMPLIFIERS: "Hornet" 50 watts output—\$98.50; "Raider" 100 watts—\$139.50; "Maverick-250" 250 watts—\$244.95. AM and SSB. "Scorpion" 50 watt 12 V. Mobile Amplifier—\$99.95; "Bandit 11" 12 V. Mobile Amplifier—\$169.95. Mobile amplifiers positive or negative ground. Frequency range 20-35 megacycles (illegal for class D 11 meters.) Dealer inquiries invited. D & A Manufacturing Co., 1217 Avenue C, Scottsbluff, Nebraska 69361.

CONVERT any television to big-screen oscilloscope. Only minor changes required. No experience necessary. Easy, illustrated step-by-step plans, \$1.95. Secret automatic telephone recorder. Remote telephone Intrusion Alarm. Detailed illustrated plans \$1.00 each. 3 for \$3.00. Relco-A179, Box 10839, Houston, Texas 77018.

SEMICONDUCTORS and parts catalogue free over 100 pages. J. & J. Electronics, Box 1437, Winnipeg, Manitoba, Canada. U.S. Trade directed.

SPACE-AGE TV CAMERA KIT! Terrific for Experimenters, Industry, Education. Solid-state. Only \$116.95! Starter kits: \$18.95 up. Plans 25¢ up. Catalog **FREE.** Phone: 402-987-3771. Write: **ATV RESEARCH**, 1301 Broadway, Dakota City, Nebr. 68731.

EXCITING LISTENING! POLICE—FIRE—AIRCRAFT—SHORTWAVE calls on your broadcast radio! Free catalog. Saich Company, Woodboro 24, Texas 78393.

FREE TV TUNER REPAIR TRICKS, Plans, Details. Complete courses: Frank Boeck, Box 833, Redding, Calif. 96001.

SEMICONDUCTOR products. Regulated power supplies, transistor checker—for laboratories, experimenters, service shops. **SOLID STATE ASSOCIATES**, Box 4321, Clearwater, Florida 33518.

QUIT SERVICING—tubes, parts, books and instruments cheap. Wojciechowski, 101-45 94th St., Ozone Park, N. Y. 11416.

EXPERIMENTERS—Steppers, Relays, Micro-Switches and more. Discount priced. Send stamped self-addressed envelope to: **GUST & COMPANY**, Box 24081, Edina, Minn. 55424.

DESIGN with Transistors—25 page article. Anyone can design successful projects. Send \$1.00. Solid State Tekneex, R#1, Doniphan, Mo. 63935.

COLOR ORGANS from \$10.95. Free catalog. **KAS**, Box 384P, Beltsville, Md. 20705.

BURGLAR and **FIRE ALARM SYSTEMS** and supplies. **INSTALLATION MANUAL** and catalog \$1.00. Refunded first order. Electronic Sentry Systems, P.O. Box 8023A, Sacramento, California 95818.

EXPERIMENTERS! Send for our latest free catalog of **SINCLAIR** audio equipment, including the IC-10 integrated circuit amplifier and the remarkable new Z-30 amplifier module. **AUDIONICS, INC.**, 9701 S.E. Mill, Portland, Oregon 97216.

LO-VOLT Circuit Tester—Handiest ever! Free Catalog! Mathco, 4256-2 Minmor, Cincinnati 45217.

PLANS AND KITS

RADAR INTRUDER ALARM detects human movement thirty feet away. **TRANSISTORIZED. BUILD YOURSELF** with complete instructions. Parts, kits and assembled units also available. Plans \$3.00. Microwave Research Co., Box 10147, St. Petersburg, Florida 33733.

KITS GALORE! Free catalog subscription. **ALSYNCO, PE-10**, 171 S. Main, Natick, Mass. 01760.

"ONE TUBE DXER" Handbook—50¢. 15 Distance one tube plans—25¢. Catalog. Laboratories, 12041-L Sheridan, Garden Grove, Calif. 92640.

CONVERT old fashioned door bells and chimes to play your favorite melody. Illustrated plans, \$2.00. Camvoy, Box 574, Laurel, Md. 20810.

INTEGRATED CIRCUIT KITS: COMPUTER, AUDIO, Others. 1970 catalog free. **KAYE ENGINEERING**, Box 3932-A, Long Beach, California 90803.

BUILD powerful crystal radio. Easy to build. Complete plans. Send \$4.95 cash, check, money order. Radio, 2139 Eaton Road, Charlotte, N.C. 28205.

SHORTWAVE LISTENING

EXCITING LISTENING! SHORTWAVE—POLICE—FIRE—AIRCRAFT—MARINE stations on your car radio! Free Catalog. Salch Company, Woodsboro 25, Texas 78393.

HIGH FIDELITY

FREE! Send for money saving stereo catalog # P1E, lowest quotations on your individual component, tape recorder, or system requirements. Electronic Values, Inc., 200 W. 20th St., New York, N.Y. 10011.

TRADE IN YOUR OLD CARTRIDGE: Send us \$6.95 and we will ship **PREPAID** any one of the following: ADC 220; Grado FTR; Pickering PAC/1; Shure M3D. **LYLE CARTRIDGES**, 265 East 149th St., Bronx, New York 10451.

HI-FI components. Tape Recorders, at guaranteed "We Will Not Be Undersold" prices. 15-day money-back guarantee. Two-year warranty. No Catalog. Quotations Free. Hi-Fidelity Center, 239 (P) East 149th Street, New York 10451.

TRADE IN YOUR OLD CARTRIDGE: Send us \$17.95 and we will ship **PREPAID** any one of the following: ADC 660E; Empire 888E; Pickering V15ATE-3; Pickering V15AME-3; Pickering XV15AT Shure M55E; Shure M75E; Shure M92E; Shure M93E; Stanton 500E; **LYLE CARTRIDGES**, 265 East 149 Street, Bronx, New York 10451.

LOW, Low quotes: all components and recorders, HiFi, Roslyn, Penna. 19001.

TRADE IN YOUR OLD CARTRIDGE: Send us \$10.95 and we will ship **PREPAID** any one of the following: ADC 770; Empire 808; Grado FTE; Pickering V15AC-3; Pickering V15AT-3; Shure M7/N21D; Shure M44-5; Shure M44-7. **LYLE CARTRIDGES**, 265 East 149th Street, Bronx, New York 10451.

TAPE RECORDERS, Hi-Fi, components, Sleep Learning Equipment, tapes. Unusual Values. Free Catalog. Dressner, 1523R, Jericho Turnpike, New Hyde Park, N.Y. 11040.

TRADE IN YOUR OLD CARTRIDGE: Send us \$39.95 and we will ship **PREPAID** any one of the following: ADC 10EMKII; Empire 888VE; Pickering XV750E; Stanton 681EE; Empire 999VE. **LYLE CARTRIDGES**, 265 East 149th Street, Bronx, New York 10451.

TRADE IN YOUR OLD CARTRIDGE: Send us \$13.95 and we will ship **PREPAID** any one of the following: Empire 808E; Empire 888; Pickering V15AM-3; Pickering V15ACE-3; Pickering V15AC; Shure M21E; Shure M32E; Shure M44E; Shure M75-6. **LYLE CARTRIDGES**, 265 East 149th Street, Bronx, New York 10451.

BACKGROUND MUSIC—SOLID-STATE SCA DECODER DELIVERS SUBCARRIER COMMERCIAL-FREE MUSIC PIGGYBACKED ON MANY FM STATIONS. LINE-POWERED ADAPTER SIMPLY PLUGS INTO ANY FM TUNER. NO ADJUSTMENTS OR TUNING. NEW-DESIGN BREAK-THRU GUARANTEES OPTIMUM PERFORMANCE, LOWEST PRICE EVER! \$35 POSTPAID. K-LAB, BOX 572, S. NORWALK, CONN. 06856.

DON'T THROW YOUR OLD CARTRIDGE AWAY. Send us \$19.95 and any old cartridge. We will ship **PREPAID** any one of the following top rated elliptical diamond stereo cartridges **NEW:** Shure M75E, M91E, M92E, M93E, Empire 888E, Pickering V15AME3, XV15 ATE, ADC 660E, 550E. Write for lowest quotations all stereo components. Send \$1.00 for our discount catalog. **DEFA ELECTRONICS**, 2207 Broadway, New York, N.Y. 10024.

WANTED

CASH PAID! Unused tubes, electronic equipment. Barry, 512 Broadway, NYC 10012.

QUICKSILVER, Platinum, Silver, Gold, Ores Analyzed. Free Circular. Mercury Terminal, Norwood, Mass. 02062.

CASH PAID for all tubes. **DAMESCO**, 308 Hickory, Arlington, N.J. 07032.

PICTURE TUBE No. 20BP4 or any T.V. or station monitor with 20BP4. **DUMONT:** T.V.'s RA-101-RA-106, Scopes 208-241, Voltage Calibrator 264A. Schwartzman, 107 Ontario, Corning, N.Y. 14830.

TUBES

TUBES "Oldies", latest. Lists free. Steinmetz, 7519 Maplewood, Hammond, Indiana 46324.

RECEIVING & INDUSTRIAL TUBES, TRANSISTORS. All Brands—Biggest Discounts. Technicians, Hobbyists, Experimenters—Request **FREE** Giant Catalog and **SAVE!** **ZALYTRON**, 469 Jericho Turnpike, Mineola, N.Y. 11501.

TUBE Headquarters of World! Send 10c for Catalog (tubes, electronic equipment) Barry, 512 Broadway, N.Y.C. 10012.

RADIO & T.V. Tubes—33¢ each. Send for free list. Cornell, 4213 University, San Diego, Calif. 92105.

THOUSANDS and thousands of types of electronic parts, tubes, transistors, instruments, etc. Send for Free Catalog. Arcturus Electronics Corp., MPE, 502-22nd St., Union City, N.J. 07087.

TV TUBES NEW BOXED UP TO 80% OFF LIST. For catalog price sheets send \$1.00. T & T Sales Co., 4802 Ave. K, Brooklyn, N.Y. 11234.

HE/NE GAS LASER completed tube with internal mirrors and power supply schematic .3mW red power output. Only and first \$49.95 laser in the world. Order from **C. W. RADIATION**, P.O. Box 1299, Mtn. View, Calif. 94040.

TUBES—Lowest world prices. Foreign-American. Obsolete, current. Receiving, special purpose, transmitting tubes. Send for tube and parts catalog. United Radio Company, 56-P Ferry St., Newark, N.J. 07105.

TAPE AND RECORDERS

TAPES . . . blank recording . . . pre-recorded music. Catalog 10¢. Tower, Lafayette Hill, Pa. 19444.

BEFORE Renting Stereo Tapes try us. Postpaid both ways—no deposit—immediate delivery. Quality—Dependability—Service—Satisfaction—prevail here. If you've been dissatisfied in the past, your initial order will prove this is no idle boast. Free Catalog. Gold Coast Tape Library, Box 2262, Palm Village Station, Hialeah, Fla. 33012.

RENT 4-Track open reel tapes—all major labels—3,000 different—free brochure. Stereo-Parti, 55 St. James Drive, Santa Rosa, Ca. 95401.

TAPEMATES makes available to you ALL 4-TRACK STEREO TAPES—ALL LABELS—postpaid to your door—at tremendous savings. For free brochure write: TAPEMATES, 5727 W. Jefferson Blvd., Los Angeles, California 90016.

AMAZING DISCOUNTS on famous brand high fidelity stereo components. No small wonder that we have set new sales records each year since 1959. Write: Arkay Electronics, 1028-03 Commonwealth, Boston, Mass. 02215.

STEREO TAPES, save 20,30% and more, postpaid anywhere U.S.A. We discount batteries, recorders, tape/cassettes, 80-page catalog 25¢. **SAXITONE TAPES**, 1776 Columbia Road, N.W., Washington, D.C. 20009.

CASSETTE blanks, also educational and language. accessories and recorders. Literature—Write **CASSETTES UNLIMITED**, P.O. Box 13119-P, Pittsburgh, Pa. 15243.

CLASSIC Radio Shows! Custom taped! Huge catalogue, 50¢. Radio Ltd., P.O. Box 23, Ann Arbor, Michigan 48107.

OLD radio programs on tape. 6 hours for \$8.00. Catalog 50¢. Don Maris, 824 Owl, Norman, Okla. 73069.

REPAIRS AND SERVICES

TV Tuners rebuilt and aligned per manufacturers specification. Only \$9.50. Any make UHF or VHF Ninety day written guarantee. Ship complete with tubes or write for free mailing kit and dealer brochure. **JW Electronics**, Box 51C, Bloomington, Indiana 47401.

PRINTED CIRCUITS to specifications. Write requirements. Vico, Box 1581, Los Angeles, California 90053.

PERSONALS

MAKE FRIENDS WORLDWIDE through international correspondence. Illustrated brochure free. Hermes, Berlin 11, Germany.

INVESTIGATORS, LATEST ELECTRONIC AIDS. FREE LITERATURE. CLIFTON, 11500-K NW 7th AVE., MIAMI, FLORIDA 33168.

FREE Catalog low priced, high performance subminiature listening devices direct from manufacturer. Dealers welcome. Emery A-101, 156 Fifth Avenue, New York, N. Y. 10010.

INSTRUCTION

LEARN ACCIDENT INVESTIGATION. Train at home to earn \$750 to \$1,000 monthly. Car furnished. Expenses paid, no selling. No college needed. Full or spare time. Men urgently needed. Free placement service. Write for **FREE** information. No obligation, Universal Schools CZ-1, 6801 Hillcrest, Dallas, Texas 75205.

LEARN ELECTRONIC ORGAN SERVICING at home all makes including transistor. Experimental kit—trouble-shooting. Accredited NHSC, Free Booklet. **NILES BRYANT SCHOOL**, 3631 Stockton, Dept. A, Sacramento, Calif. 95820.

FCC First Class License in six weeks—nation's highest success rate—approved for Veterans Training. Write Elkins Institute, 2603B Inwood Road, Dallas, Texas 75235.

R.E.I.'s famous (5) week course for the First Class Radio Telephone License is the shortest, most effective course in the nation. Over 98% of R.E.I. graduates pass F.C.C. exams for 1st class license. Total tuition \$360.00. Job placement free. Write for brochure. Radio Engineering Incorporated Schools, 1336 Main Street, Sarasota, Florida 33577—or 3123 Gillham Road, Kansas City, Missouri 64109—or 809 Caroline Street, Fredericksburg, Virginia 22401—or 625 E. Colorado Street, Glendale, California 91205.

FCC FIRST CLASS LICENSE THROUGH TAPE RECORDED LESSONS. Our seventeenth year teaching FCC license courses. Radio License Training, 1060D Duncan, Manhattan Beach, Calif. 90266.

DEGREE in Electronics Engineering earned mostly by correspondence. Free brochure. Dept. G-9, Grantham School of Engineering, 1505 N. Western Ave., Hollywood, California 90027.

LEARN WHILE ASLEEP, Hypnotize! Strange catalog free. Auto-suggestion, Box 24-ZD, Olympia, Washington 98501.

FOLLOW THE LEADER—the nation's original four week F.C.C. 1st Class License Course. Tuition: \$295 00. Results guaranteed. Tennessee Institute of Broadcasting, 2106-A 8th Ave., South, Nashville, Tenn. 37204, or, Technical Institute of Broadcasting, 800 Silver Lane, East Hartford, Conn. 06106.

ART talent? Be your own boss. Earn \$200.00 weekly free-lancing. Free brochure. Famous American Studios, Dept. PE Spring Park, Minn. 55384.

F.C.C. License training by correspondence. G.I. Bill approved. Money-Back Warranty. Free brochure. Write: Dept. Z-9, Pathfinder School of Electronics, 1505 N. Western Ave., Hollywood, Calif. 90027.

EARN College degree at home. All subjects. Florida State Christian College, 4307 North Andrews Avenue, Fort Lauderdale, Florida 33309.

LEARN CARTOONING at home. Free book, "Key To A Cartoon Career". Write: Cartooning, Box 317B-Y, Colorado Springs, Colo. 80907.

TAXIDERMy success training sure easy way into Taxidermy. Complete training, no skimming, all steps illustrated. Request information and free samples. Box 5815, Bossier City, Louisiana 71010.

MEMORIZE: "1970 TESTS—ANSWERS" for FCC FIRST AND SECOND CLASS LICENSE. Plus "Self-Study Ability Test." **PROVEN.** \$5.00. Command, Box 26348-P, San Francisco 94126.

PREPARE NOW for Rewarding Career as "ELECTRONICS TROUBLE-SHOOTING & REPAIR SPECIALIST." Highly Effective Home Study Training. Earn your **MASTER DIPLOMA**. Graduates in Great Demand. High Pay. Nationally Accredited. Write for Free Descriptive Literature. No salesman will call. **COOK'S INSTITUTE OF ELECTRONICS**, Dept. 21, P.O. Box 10634, Jackson, Miss. 39209. (Established 1945).

AMATEUR RADIO SCHOOL. Correspondence Sight-and-Sound no textbook courses for **GENERAL, ADVANCED** and **EXTRA CLASS** licenses; complete Code and Theory. These are **NOT** memory courses. **REED ELECTRONICS SCHOOL**, 12217 Santa Monica Blvd., Los Angeles, Calif. 90025.

MOVIE FILMS

GET MORE FOR YOUR CHRISTMAS MONEY . . . Cut Rate Catalog . . . **SUPER 8/8mm—COLOR. SPORTLITE FILMS**, Dept. PE, 20 North Wacker Drive, Chicago, Ill. 60606.

INVENTIONS WANTED

INVENTIONS wanted. Patented; unpatented. Global Marketing Service. 2420-P 77th, Oakland, Calif. 94605.

INVENTORS! OUR FREE EXPERT ANALYSIS of your invention can save valuable time, help you realize full sale value. Strictly confidential. **FREE INVENTION CERTIFICATE.** Write today: Pioneer Invention Service, Dept. 35, 150 Broadway, New York, N.Y. 10038.

FREE "Directory of 500 Corporations Seeking New Products." For information regarding development, sale, licensing of your patented/unpatented invention. Write: Raymond Lee Organization, 230-GR Park Avenue, New York City 10017.

INVENTORS: Protect your ideas! Free "Recommended Procedure". Washington Inventors Service, 4227 Washington Building, Washington, D.C. 20005.

PATENT SEARCHES, including copies of related United States Patents. Inventors, attorneys, manufacturers use our "World-Wide" Airmail service Free: "Invention Record" form and "Information Every Inventor Needs", Hayward Company, 1029HR Vermont, Washington, D.C. 20005.

FREE PAMPHLET: "Tips on Safeguarding Your Invention." Write: United States Inventors Service Company, 501-H Thirteenth Street N.W., Washington, D.C. 20004.

PATENT Searches including Maximum speed, full airmail report and closest patent copies, \$6.00. Quality searches expertly administered. Complete secrecy guaranteed. Free Invention Protection forms and "Patent Information." Write Dept. 9, Washington Patent Office Search Bureau, 711 14th Street, N.W., Washington, D.C. 20005.

INVENTORS! Don't sell your invention, patented or unpatented, until you receive our offer. Eagle Development Company, Dept. P, 79, Wall Street, N.Y., N.Y. 10005.

WE manufacture your invention. Details 10¢. P.O. Box 487, Miami (Kendall), Florida 33156.

GOVERNMENT SURPLUS

JEEPS Typically From \$53.90 . . . Trucks From \$78.40 . . . Boats, Typewriters, Airplanes, Multimeters, Oscilloscopes, Transceivers, Electronics Equipment, Wide Variety, Condition. 100,000 Bid Bargains Direct From Government Nationwide Complete Sales Directory and Surplus Catalog \$1.00. (Deductible First \$10.00 Order). Surplus Service, Box 820-J, Holland, Michigan 49423.

GOVERNMENT Surplus How and Where to Buy in Your Area. Send \$1.00 to: Surplus Information PE, Headquarters Building, Washington, D.C. 20036.

BOOKS

FREE catalog aviation/electronic/space books. Aero Publishers, 329PE Aviation Road, Fallbrook, California 92028.

UNUSUAL Books! Catalog free! International, Box 7798 (PE), Atlanta, Georgia 30309.

FREE book prophet Elijah coming before Christ. Wonderful bible evidence. Megiddo Mission, Dept. 64, 481 Thurston Rd., Rochester, N.Y. 14619.

MAGAZINES

BACK DATE MAGAZINES! Send needs. Midtown, Box 917-PE, Maywood, N.J. 07607.

AUTHORS' SERVICES

AUTHORS! Learn how to have your book published, promoted, distributed. **FREE** booklet "ZD," Vantage, 120 West 31 St., New York 10001.

HYPNOTISM

FREE Hypnotism, Self-Hypnosis, Sleep Learning Catalog! Drawer H400, Ruidoso, New Mexico 88345.

"MALE-FEMALE HYPNOTISM" EXPOSED, EXPLAINED! "SECRET METHOD"—THEY NEVER KNOW! \$2, RUSHED, GUARANTEED! ISABELLA HALL, SILVER SPRINGS, FLORIDA 32688.

HYPNOTIC sleep learning recordings produce fabulous results. Details Free. ASR Foundation, Box 7021eg Henry Clay Station, Lexington, Ky. 40502.

AMAZING self-hypnosis record releases fantastic mental power. Instant results! Facts free. Write: Forum (AA1), 333 North Michigan Avenue, Chicago 60601.

HYPNOTIZE PERFECT STRANGERS—EITHER SEX—SUCCESSFULLY! Secret Methods—they never know! Illustrated Course and 10 inch Hypnodisk \$2.00. **RESULTS ABSOLUTELY GUARANTEED!** Dr. H. Arthur Fowler, Box 4399, Woodbury, New Jersey 08096.

MAGNETS

MAGNETISM (100) page script newly discovered magnetic principles (\$3.00). Jesse Costa, Box 26, Waquoit, Mass. 02536.

MAGNETS. All types. Special—20 disc magnets, or 2 stick magnets, or 10 small bar magnets, or 8 assorted magnets, \$1.00 Maryland Magnet Company, 5412-H Gist, Baltimore, Maryland 21215.

PHOTOGRAPHY—FILM, EQUIPMENT, SERVICES

SCIENCE Bargains Request Free Giant Catalog "CJ"—148 pages—Astronomical Telescopes, Microphones, Lenses, Binoculars, Kits, Parts. War surplus bargains. Edmund Scientific Co., 300 Edscorp Bldg., Barrington, New Jersey 08007.

RECORDS

SPECIAL INTEREST RECORDS AVAILABLE, PRODUCED BY THE EDITORS OF THE WORLD'S LEADING SPECIAL INTEREST MAGAZINES. SEND FOR FREE CATALOG. RECORD CATALOG-PE, ZIFF-DAVIS PUBLISHING COMPANY, ONE PARK AVENUE, NEW YORK, N.Y. 10016.

POPULAR organ albums factory direct. Concert Recording, Lynwood, Calif. 90262.

MUSIC

PLAY ORGAN EASILY, AMAZING METHOD, free information. Kegley, 1016-PE Kelly, Joliet, Illinois 60435.

CLASSIFIED ADVERTISING ORDER FORM

Please refer to heading on first page of this section for complete data concerning terms, frequency discounts, closing dates, etc.

1	2	3	4	5
6	7	8	9	10
11	12	13	14	15
16	17	18	19	20
21	22	23	24	25
26	27	28	29	30
31	32	33	34	35

_____ Words { @ 70¢ (Reader Rate) } = \$ _____
 { @ \$1.15 (Commercial Rate) }

Insert _____ time(s) Total Enclosed \$ _____

NAME _____

ADDRESS _____

CITY _____ STATE _____ ZIP _____

Signature _____

WORD COUNT: Include name and address. Name of city (Des Moines) or of state (New York) counts as one word each. Zip Code numbers not counted. (Publisher reserves right to omit Zip Code if space does not permit.) Count each abbreviation, initial, single figure or group of figures or letters as a word. Symbols such as 35mm, COD, PD, AC, etc., count as one word. Hyphenated words count as two words.

PE-170

PRINTING

FREE LITERATURE: Address labels, business cards, printing, Rubber Stamps. **JORDAN'S**, 552 West O'Connor, Lima, Ohio 45801.

PRINTING 25% discount, free catalog. Gables, 405D Clifton, Glenshaw, Pa. 15116.

STAMPS

RUSSIA High-Value Collection. 32 different Russia—some over 50 years old! Commemoratives, Czarist Issues, Airmails. Catalog price \$2.50. Special Get-Acquainted Offer—all for only 10¢! H. E. Harris, Dept. GG-54, Boston, Mass. 02117.

EMPLOYMENT INFORMATION

FOREIGN and **USA** job opportunities available now. Construction, all trades. Earnings to \$3,000.00 monthly. Paid overtime, travel bonuses. Write: Universal Employment, Woodbridge, Conn. 06525.

LIKE a job? Stateside, foreign, choice location. Details \$1.00. Unique Distributors, Box 6099, Pensacola, Florida 32503.

BUSINESS OPPORTUNITIES

RAISE Rabbits for us on \$500 month plan. Free details. White's Rabbitry, Mt. Vernon, Ohio 43050.

FREE CATALOGS. Repair air conditioning, refrigeration. Tools, supplies, full instructions. Doolin, 2016 Canton, Dallas, Texas 75201.

PIANO TUNING learned quickly at home. Tremendous field! Musical knowledge unnecessary. GI Approved. Free Information. Empire School, Miami, Florida 33145.

FREE BOOK "999 Successful Little Known Businesses" Work home, Plymouth 445-R, Brooklyn, N.Y. 11218.

ELECTROPLATING Equipment and supplies. All types for home workshops and industrial. Send \$2.00 (refundable) for equipment guide formulas, operating data, catalog. HBS Equipment Division 90, 3543 East 16th, Los Angeles, California 90023.

I MADE \$40,000.00 Year by Mailorder! Helped others make money! Start with \$10.00—Free Proof. Torrey, Box 318-N, Ypsilanti, Michigan 48197.

\$200.00 DAILY In Your Mailbox! Your opportunity to do what mail-order experts do. Free details. Associates, Box 136-J, Holland, Michigan 49423.

FREE Selling Outfit. Office supplies, furniture & equipment. Oseco, 15-PE North Jefferson, Chicago 60606.

MAKE BIG MONEY raising chinchillas, rabbits, guinea pigs for us. Catalog—25¢. Keeney Brothers, New Freedom, Pa. 17349.

SELL HERTEL BIBLES—Part Time. Finest reference Bible available. Demonstrator and supplies furnished. Excellent commissions. Write International Book, Dept. PE, Box 118, Wichita, Kansas 67201.

FREE SECRETS of How To Get Capital. Trial offer. Get \$500 to \$2,000.00, Counselor-48, Kerrville, Texas 78028.

SELL inexpensive fire-burglar alarms. Foolproof! Write: **WATCHDOG, PROFITS BROCHURE**, Williamsburg, Ohio 45176.

TREASURE FINDERS

FREE TREASURE GUIDE! Fact-filled collectors edition; send 50¢ for postage. Also request free literature on ultrasensitive, professional Fisher Detectors. **FISHER RESEARCH**, Dept. PE1, Palo Alto, California 94303.

GOLD, SILVER, RELICS! Located with powerful Detron Metal Detectors. Free information. Terms. Detron, Dept. PE-1, Box 243, San Gabriel, California 91778.

TREASURE FINDER locates buried gold, silver, coins, treasures. 5 powerful models. \$19.95 up. Free catalog. Relco-A33, Box 10839, Houston, Texas 77018.

TREASUREPROBES—Patented transistorized detector signals "dig" by earphone "beeping". 5" search head. PC board. two colpitt oscillators improve stability. Kit \$13.95, assembled \$18.88, with speaker \$24.88. 60 day guarantee. Free literature. Treasurehouse, PE10, Tennent, N.J. 07763.

COINS AND CURRENCY

\$75.00 FOR every 1928-E one dollar bill. Small fortune. Free catalog. Miller, 5-B-11, 30 Orchard St., Dover, N.J. 07801.

REAL ESTATE

FREE . . . NEW SPRING 1970 CATALOG! Describes and pictures hundreds of farms, ranches, town and country homes, businesses in 33 states coast to coast! Specify type property and location preferred. **UNITED FARM AGENCY**, 612-EP West 47th St., Kansas City, Mo. 64112.

RUBBER STAMPS

RUBBER ADDRESS STAMP \$2.00. SIGNATURE \$3.50. FREE CATALOG. JACKSON, BOX 443-G, FRANKLIN PARK, ILL. 60131.

MISCELLANEOUS

WINEMAKERS: Free illustrated catalog of yeasts, equipment. Semplex, Box 12276, Minneapolis, Minn. 55412.

32 PAGE big illustrated joke and novelty catalog. 25¢. Joke, Box 7212JJ, Chicago 60680.

UP to \$151 daily track wins with scientific computer. \$2 stakes. Proof supplied. Free details: RH-P11, 5715, Carmel, Calif. 93921.

BEERS, PEACH BRANDY, WINES—Strongest Formulas, \$2.25. (hydrometers list, brew supplies catalog included)—Research Enterprises, 29-D Samoset, Woburn, Mass. 01801.

ENJOY good beer inexpensively. Old fashioned homebrew recipe, \$1.00. Herbert, Box 6099-B, Pensacola, Florida 32503.

BILLS paid without borrowing—Nobody refused up to \$10,000.00. Bad credit no problem, not a Loan Company. Write for free application. **INTERNATIONAL ACCEPTANCE**, Dept. 50-A, 3003 N. Central Ave., Phoenix, Arizona 85012; 1000 N. Madison Avenue, Greenwood, Ind. 46142; 711-14th St. N.W., Washington, D.C. 20005; 507 Carondelet St., New Orleans, La. 70130.

POPULAR ELECTRONICS SUBSCRIBER SERVICE

Please include an address label when writing about your subscription to help us serve you promptly. Write to: Portland Pl., Boulder, Colo. 80302

CHANGE OF ADDRESS: Please let us know you are moving at least four to six weeks in advance. Affix magazine address label in space to the right and print new address below. If you have a question about your subscription, attach address label to your letter.

TO SUBSCRIBE: Check below.

5 yrs. \$20 3 yrs. \$13

1 yr. \$5 New Renewal

Specify: Payment enclosed

—You get 1 extra issue per year as a **BONUS!**

Bill me later.

state	city	address	name	If you have no label handy, print OLD address here.
zip code	please print			

← AFFIX LABEL →

print name _____ 0383

address _____

city _____

state _____ zip code _____

Add'l postage: \$1 per year outside U.S., its possessions & Canada.

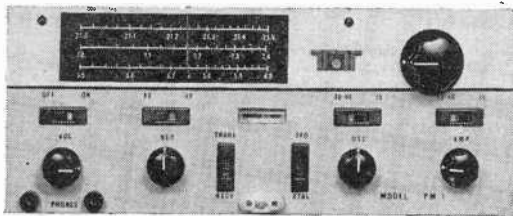

HOW YOU CAN AFFORD TO HAVE FUN IN HAM RADIO

All the world can be yours at the turn of a dial! Challenging, fascinating, educational CW amateur radio, TEN-TEC PM-1 low power CW transceiver (shown above) can be your starting point for only 49.95. Or, ready-to-connect modules only 29.95. Excellent for novice, general or higher class license. See your distributor or write today for free illustrated catalog.

Dept. C1 TEN-TEC, INC.,
Sevierville, Tenn. 37862.

CIRCLE NO. 28 ON READER SERVICE PAGE

KEEP PACE WITH SPACE AGE! SEE MOON SHOTS—LANDINGS, SPACE FLIGHTS, CLOSE-UP! AMAZING SCIENCE BUYS for FUN, STUDY or PROFIT

VISUAL EFFECTS PROJECTOR SET

Dazzling, avant-garde visual effects. Fantastic variety. Incredibly beautiful. Special package offer contains all necessary apparatus. Create flaming, exploding, fiery bursts of color like "Symphony of Spheres", "Chromatic Starbursts", "Crystal Starburst". Features 35mm 500 W. fan cooled projector—produces big picture at short distance. Accepts two 6" diam. wheels (Dry Kaleidoscope & Hexidoscope), 2 cylindrical accessories (6" Colored Cloud & 5" Hexidoscope w/1x internal mirrored walls). Perfect for entertaining, parties, photography. Complete instructions.
Stock No. 71.212AV \$79.50 Ppd.

PSYCHEDELIC LIGHTING HANDBOOK

100 information packed pages! Fully explains latest in psychedelic lighting equipment, techniques, developments. Covers all facets of psychedelic light-show production including strobes, black lights, projectors, crystals, organic slides, mirrors, color organs, polarized color light boxes, MusicVision, etc. Shows how to "psychedelias" parties, musical groups, shows or how to set up "electric trips" for private gatherings. 8 1/2" x 11" looseleaf paper punched for 3 ring binder.
Stock No. 9100AV \$3.00 Ppd.

LONG-WAVE BLACK LIGHT FIXTURE

Extremely versatile, compactly designed, long wave (6200-6000 angstroms) black light (ultraviolet) fixture. Has 6-watt, 110-V lamp with built-in filter—eliminates harmful shorter wave ultraviolet rays. Use to identify minerals, fungi, bacteria—check for surface flaws, oil and gas leakage—perfect for displays with fluorescent paper, paints, chalk, crayons, trace powder. Incl. adjustable aluminum reflector. Mount vert., horiz. or on corner. W x L x H: 1 1/2" x 1 1/4" x 1 1/4".
Stock No. 70.364AV \$12.50 Ppd.
Stock No. 60.124AV \$4.50 Ppd.

Order by Stock No.—Check or M.O.—Money-Back Guarantee
EDMUND SCIENTIFIC CO., 300 EDSORP BLDG., BARRINGTON, N.J. 08007

GIANT FREE 148 PAGE CATALOG "AV"
Dozens of electrical and electronic parts, accessories. Enormous selection of Astronomical Telescopes, Microscopes, Binoculars, Magnifiers, Magnets, Lenses, Prisms. Many war surplus items for hobbyists, experimenters, workshops, factory. Write for catalog "AV". Include ZIP, EDMUNO, 300 EDSORP BLDG., BARRINGTON, N.J. 08007
CIRCLE NO. 10 ON READER SERVICE PAGE

POPULAR ELECTRONICS

JANUARY 1970

ADVERTISERS INDEX

READER SERVICE NO.	ADVERTISER	PAGE NO.
1	Accurate Instrument Co.	85
2	Aerotron, Controtator	95
3	Allied Radio	94
5	Antenna Specialists Co., The	7
6	Burstein-Applebee Company	98
	CREI, Home Study Division, McGraw-Hill Book Co.	72, 73, 74, 75
8	Career Academy	9
9	Cleveland Institute of Electronics ...	18, 19, 20, 21
10	Edmund Scientific Co.	106
4	EICO Electronic Instrument Co.	FOURTH COVER
11	Electro-Voice, Inc.	14
12	Grantham School of Engineering	5
13	Hallcrafters	17
14	Heath Company	10, 11
15	Johnson Company, E.F.	25
16	Lafayette Radio Electronics	96
17	Mallory, P.R. & C.	23
35	Mercury Electronics	100
34	Mosley Electronics	91
18	Multicore Sales Corp.	92
	McGee Radio	98
	National Radio Institute ..	SECOND COVER, 1, 2, 3
	National Radio Institute	96
	National Technical Schools	13
	National Technical Schools	54, 55, 56, 57
19	New Jersey Semi-Conductors	99
	North American School of Drafting	98
20	Olson Electronics	92
21	Phase Corp.	86
22	Pickering & Co.	87
	Prestige	98
	RCA Electronic Components & Devices	THIRD COVER
23	RCA Electronic Components & Devices	26
	RCA Institutes	36, 37, 38, 39
24	Sams, Howard W. & Co., Inc.	90
25	Sonar Radio Corp.	100
26	Standard Communications Corp.	94
27	Telex Communications Division	89
28	Ten-Tec, Inc.	106
29	Turner Microphone Co., The	12
30	United Audio Products	6
31	United Technical Institute	93
32	University Sound	8
	Valparaiso Technical Institute	98
33	Weller Electric Co.	16

CLASSIFIED ADVERTISING 101, 102, 103, 104, 105

Printed in U.S.A.

POPULAR ELECTRONICS

solid state...up to date

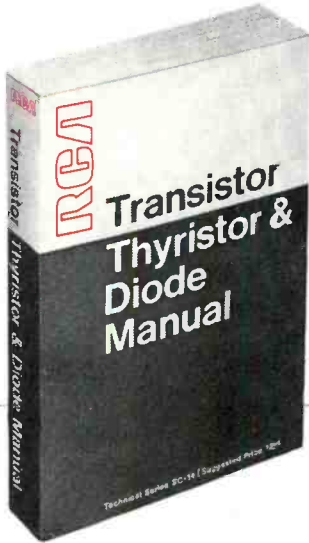

More than 100 new pages of latest information added

CONTENTS	PAGE
MATERIALS, JUNCTIONS, AND DEVICES	3
Semiconductor Materials, P-N Junctions, Current Flow, Types of Devices	
BIPOLAR TRANSISTORS	11
Design and Fabrication, Basic Circuits, Characteristics, Biasing, Bias Stability, Coupling, High-Frequency Operation, Switching, Transient Effects	
MOS FIELD-EFFECT TRANSISTORS	33
Theory of Operation, Fabrication, Electrical Characteristics, General Circuit Configurations, Handling Considerations	
THYRISTORS	40
Silicon Controlled Rectifiers, Triacs, Diacs, Gate Characteristics, Switching Characteristics, Ratings, Critical Rate of Rise of On-State Current, Holding and Latching Currents, Critical Rate of Rise of Off-State Voltage, Transient Protection, Radio-Frequency Interference	
SILICON RECTIFIERS	59
Thermal Considerations, Characteristics, Ratings, Overload Protection, Series and Parallel Arrangements	
OTHER SEMICONDUCTOR DIODES	65
Tunnel Diodes, Varactor Diodes, Compensating Diodes, Photoconductive Diodes, Light-Emitting Diodes	
LINEAR SYSTEM APPLICATIONS	74
Detection, Amplification, Oscillation, Frequency Conversion, Automatic Frequency Control, Frequency Multiplication	
TV DEFLECTION AND COLOR DEMODULATION	128
Scanning Fundamentals, Sync, Vertical Deflection, Horizontal Deflection, Color Demodulation	
POWER SWITCHING AND CONTROL	144
Nonsinusoidal Oscillators, Switching Regulators, Converters and Inverters, Automobile Ignition System, Pulse Modulators, Light, Heat, and Motor Controls	
COMPUTER CIRCUITS	174
DC POWER SUPPLIES	183
Rectification, Filtering, Regulators	
TESTING AND MOUNTING	191
SYMBOLS	211
SELECTION CHARTS	217
TECHNICAL DATA	223
OUTLINES	564
MOUNTING HARDWARE	576
CIRCUITS	582
INDEX	653

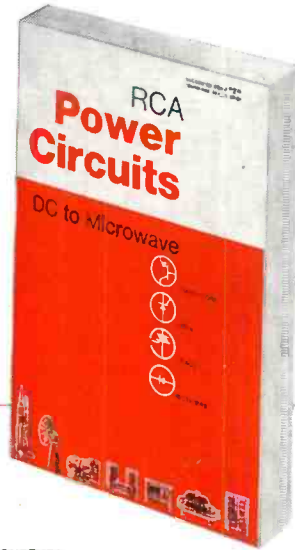

Newly expanded information for the circuit designer

CONTENTS	PAGE
SEMICONDUCTOR MATERIALS, JUNCTIONS, AND DEVICES	3
Semiconductor Materials, Current Flow, N-P-N and P-N-P Structures, Types of Devices	
SILICON RECTIFIERS	10
Theory of Operation, Characteristics and Ratings, Series and Parallel Rectifier Arrangements, High-Voltage Rectifier Assemblies, Packaging	
THYRISTORS	29
Theory of Operation, Construction, Ratings and Characteristics, Series and Parallel Operation, Transient Protection	
SILICON POWER TRANSISTORS	65
Design and Fabrication, Basic Transistor Parameters, Maximum Ratings, Thermal Considerations, Second Breakdown, Safe-Area Ratings, Small-Signal Analysis, Large-Signal Analysis, Switching Service	
RECTIFICATION	149
POWER CONVERSION	162
POWER REGULATION	200
Linear Voltage Regulators, Switching Regulator, General Triggering Considerations, Phase-Control Analysis of SCR's, Motor Controls, Incandescent Lighting Controls	
THYRISTOR AC LINE-VOLTAGE CONTROLS	226
General Considerations, Motor Controls, Heater Controls, Incandescent Lighting Controls	
HIGH-FREQUENCY POWER AMPLIFIERS	262
Design of RF Power Amplifiers, Matching Networks, Marine Radio, Citizens-Band Transmitters, Mobile Radio, SSB Transmitters, Aircraft Radio, Community-Antenna TV, UHF Military Radio, Microwave Amplifiers and Oscillators, Frequency Multipliers	
CONTROL AND LOW-FREQUENCY POWER AMPLIFIERS	379
General Considerations, Audio-Frequency Power Amplifiers, Ultrasonic Power Sources, Servo Amplifiers	
BIBLIOGRAPHY	438
INDEX	440
RCA TECHNICAL PUBLICATIONS	444

New and indispensable

Get yours today from your RCA Distributor

or RCA Electronic Components,
Commercial Engineering, Section A-133
Harrison, N. J. 07029

Dazzle your friends with lightworks.



Sound n' Color®

The new dimension to music pleasure. EICO All Electronic Solid-State Audio-Color Organs transform sound waves into moving synchronized color images. Connect easily to speaker leads of hi-fi or radio. From \$29.95.



Translators

The electronics you need to create audio-stimulated light displays to your own imagination. Actuates: Light Display Units, Strobe Lites, any lamp configuration (Xmas trees, patio lights, etc.). From \$24.95 kit, \$39.95 wired.



Strobe Lites

High-intensity bursts of white light from Xenon tube flash in cadence with each beat of audio. From \$24.95 kit, \$39.95 wired.

Build the Stereo Kits praised by experts.

All amplifier power ratings according to IHF standards. Cortina® designed and manufactured in U.S.A. and guaranteed by EICO.



70-Watt AM/FM Stereo Receiver including cabinet. Cortina 3770, \$189.95 kit, \$279.95 wired.

70-Watt FM Stereo Receiver including cabinet. Cortina 3570, \$169.95 kit, \$259.95 wired.



150-Watt Silicon Solid-State Stereo Amplifier, including cabinet. For the audio perfectionist. Cortina 3150, \$149.95 kit, \$225 wired.

70-Watt Silicon Solid-State Stereo Amplifier, including cabinet. Cortina 3070, \$99.95 kit, \$139.95 wired.



FM Stereo Tuner including cabinet. Cortina 3200, \$99.95 kit, \$139.95 wired.



EC-1100 FM WIRELESS MIKE \$9.95

Build for fun and use with Eicocraft® jiffy project kits.

The newest excitement in kits. 100% solid-state and professional. Expandable, interconnectable. Excellent as introductions to electronics. No technical experience needed. Finest parts, pre-drilled etched printed circuit boards, step-by-step instructions. 36 kits to select from, \$2.50 to \$9.95. Just released: EC-2600 "Super Snoop" \$8.95; EC-2700 Police & Fire Converter



(lo band) \$7.95; EC-2800 Aircraft Converter \$7.95; EC-2900 Police & Fire Converter (hi band) \$7.95; EC-3100 2-Station Intercom (with cases) \$10.95; EC-3200 "Do-It-Yourself" PC Etching Kit \$4.95; EC-2300 Audio Preamplifier \$8.95; EC-2400 Bullhorn \$8.95; EC-2500 Fuzzbox \$8.95.



EC-1900 TREASURE FINDER \$9.95

Shape up your own car/boat with EICO Engine Analyzer

For all 6V/12V systems; 4, 6, 8-cyl. engines. Now you can keep your car or boat engine in tip-top shape with this solid-state, portable, self-powered universal engine analyzer.

Completely tests your total ignition/electrical system. Complete with comprehensive Tune-up & Trouble-shooting Manual. EICO 888, \$49.95 kit, \$69.95 wired.



The first and only solid state test equipment GUARANTEED FOR 5 YEARS

Only EICO brings you laboratory precision and long life at lowest cost.



EICO 240 Solid-State FET-TVOM \$59.95 kit, \$79.95 wired



EICO 379 Solid-State Sine/Square Wave Generator \$69.95 kit, \$94.50 wired



EICO 242 Solid-State Deluxe FET-TVOM \$69.95 kit, \$94.50 wired

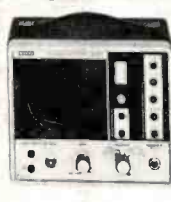

EICO 150 Solid-State Signal Tracer \$49.95 kit, \$69.95 wired



EICO 330 Solid-State RF Signal Generator \$59.95 kit, \$84.50 wired

You save up to 50% with EICO Kits. Since 1945, Best Buys in Electronics. Over 3 Million EICO Instruments Now in Use.

FREE 1970 CATALOG

Send me FREE catalog describing the full EICO line of 200 best buys, and name of nearest dealer.



EICO Electronic Instrument Co., Inc.
283 Malta Street, Brooklyn, N.Y. 11207
EICO Canada Ltd.
20 Millwick Drive, Weston, Ontario

Name _____
Address _____
City _____ State _____ Zip _____

PE-1