

BUILD JUNK-BOX HI-FI AMPLIFIER

POPULAR ELECTRONICS

SEPTEMBER
1968

50
CENTS



PITCH REFERENCE TUNES PIANO/ORGAN

BUILD "DYNADIM" HOME LIGHTING CONTROL

NEON LAMPS—DOZEN USEFUL CIRCUITS

REPORT ON SOVIET HOBBY ELECTRONICS

AUG 22 1968

BUILD G-FORCE
ACCELEROMETER
FOR YOUR CAR

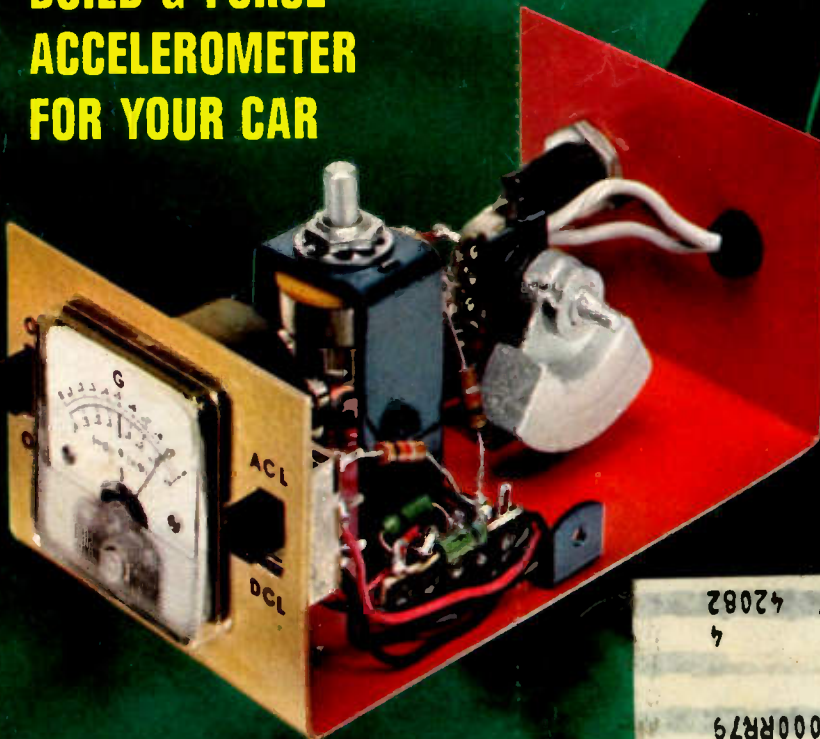

SYMSONIA KY 42082
MRS R J MC CLURE
E0269 434816CUR0000RR79

Discover the ease and excitement of learning Electronics with programmed equipment NRI sends you

When you train at home with NRI, you train with your hands as well as your head. You learn the WHY of Electronics, Communications, TV-Radio the NRI pioneering "3-Dimensional" way. NRI training is the result of more than half a century of simplifying, organizing, dramatizing subject matter, and providing personal services unique for a home study school. You get the kind of technical training that gives you priceless confidence as you gain experience equal to many, many months of training on the job.

NRI—The 53 Year Leader in Electronics Training



APPROVED UNDER NEW GI BILL

If you served since January 31, 1955, or are in service, check GI line in postage-free card.



*Earn \$5 or more an hour
spare or full time in*

TV-RADIO SERVICING

Color Television has arrived. Sales are soaring, along with the continuing popularity of other home entertainment equipment like portable radios, tape recorders, hi-fi sets, phonographs and auto radios. TV-Radio servicing is one of your best routes to spare-time earnings, a good paying job or a business of your own. NRI not only trains you quickly and expertly, but also shows you how to get started in Servicing soon after you enroll, earning as you learn. NRI trains you in today's methods of installing and repairing all Electronic equipment for the home—including booming Color TV. You even build, experiment with and keep to enjoy your own solid-state radio and your choice of black-and-white or Color TV receiver. Like thousands of others, you can be earning \$5 or more an hour extra in spare time starting soon.

*There's money and
success awaiting you in*

BROADCASTING— COMMUNICATIONS

The experience you gain from intensely practical NRI training in Complete Communications equals as much as two years of training on the job. With NRI, you can train for a choice of careers ranging from mobile, marine and aviation radio to TV broadcasting and space communications. You learn how to install, maintain and operate today's remarkable transmitting and receiving equipment by actually *doing* it. You build and experiment with test equipment, like a VTVM you keep. You build and operate amplifier circuits, transmission line and antenna systems, even build and use a phone-cw transmitter suitable for transmission on the 80-meter amateur band. Whichever of five NRI Communications courses you choose, you prepare for your FCC License exams, and you *must* pass your FCC exams or NRI refunds your tuition in full.

*Move ahead in America's
fast growing industry as*

ELECTRONICS TECHNICIAN

Electronics touches everyone's lives. This vast field of opportunity is open to you with NRI training. Industrial/Military Electronics training—like all NRI courses—prepares you quickly, thoroughly the practical "hands on" way. You build with, and learn to understand the functions of, today's miracle solid-state components like printed circuits, diodes and transistors. You build and experiment with Electronic circuitry used in automation, data processing, ultrasonics, telemetry. Whatever your interest in Electronics, NRI training can fill your needs. Prove to yourself what nearly a million NRI students could tell you ... that you get more for your money from NRI. Check the postage-free card and mail it today for your FREE NRI Color Catalog. No salesman will call. NATIONAL RADIO INSTITUTE, Electronics Division, Washington, D.C. 20016.

YOU GET MORE FOR YOUR MONEY FROM NRI — Build, test, explore, discover. Everything you see here is included in one NRI course—including Color TV. Other courses equally complete. And you'll be surprised at the low tuition costs. Text for text, kit for kit, dollar for dollar—you get more for your money from NRI.



POPULAR ELECTRONICS

VOLUME 29 NUMBER 3

SEPTEMBER, 1968

WORLD'S
LARGEST-SELLING
ELECTRONICS
MAGAZINE

SPECIAL CONSTRUCTION PROJECT

BUILD THE G-WHIZ

Check your car's acceleration performance

29 GEORGE J. WHALEN

SPECIAL FEATURE

SOVIET ELECTRONICS: A 1968 REAPPRAISAL

Space successes have increased popular interest

49 THEODORE M. HANNA, K3CUI

FEATURE ARTICLES

BUILD A MUSICAL PITCH REFERENCE

Be your own instrument tuner

41 DON LANCASTER

ARE YOU A REAL TECHNICIAN?

A true-false quiz

48 VIC BELL

ZOUNDS!

54 DAVE HARBAUGH

THE UBIQUITOUS NEON LAMP

Review of characteristics and applications

55 JIM KYLE

BUILD THE FET INTERVAL TIMER

61 B. W. BLACHFORD

ACCURATE LOW-VOLTAGE CALIBRATOR

A simple 1-volt source

66 FRANK H. TOOKER

BASIC MONO AMPLIFIER

A junk-box amplifier anyone can build

67 JOHN HORSFIELD

BUILD THE DYNADIM HOME LIGHTING CONTROL

Dim the lights as slowly as you want

71 RUSSELL J. BIK

36-24-34: WIRE SIZES—NOT BEAUTY MEASUREMENTS

How to choose and use wire

75 HERB S. BRIER, W9EGQ

SIMPLE TRANSISTOR TESTER

80 ROBERT E. KELLAND

RESISTANCE SOLDERING

Construct your own equipment

81 MELVIN WHITMER

SOLID STATE

86 LOU GARNER

AMATEUR RADIO

Sun spots improve 28-MHz conditions

92 HERB S. BRIER, W9EGQ

ENGLISH-LANGUAGE BROADCASTS TO NORTH AMERICA

94 ROGER LEGGE

SHORT-WAVE LISTENING

Gambia is the one to get

95 HANK BENNETT, W2PNA

ON THE CITIZENS BAND

Jamborees are better than ever

96 MATT P. SPINELLO, KHC2060

DEPARTMENTS

LETTERS FROM OUR READERS 8

ELECTRONICS LIBRARY 14

READER SERVICE PAGES 15, 115

NEW PRODUCTS 22

TIPS & TECHNIQUES 85

OPERATION ASSIST 97

NEW LITERATURE 124

POPULAR ELECTRONICS is indexed
in the Readers' Guide
to Periodical Literature

Copyright © 1968 by ZIFF-DAVIS PUBLISHING COMPANY. All rights reserved.

POPULAR ELECTRONICS, September 1968, Volume 29, Number 3, Published monthly at 307 North Michigan Avenue, Chicago, Illinois 60601. One year subscription rate for U.S., U.S. Possessions and Canada, \$5.00; all other countries, \$6.00. Second class postage paid at Chicago, Illinois and at additional mailing offices. Authorized as second class mail by the Post Office Department, Ottawa, Canada and for payment of postage in cash. Subscription service and Form 3579: Portland Place, Boulder, Colorado 80302. Editorial offices for manuscript contributions, reader inquiries, etc.: One Park Ave., New York, N.Y. 10016.

This month's cover photo by
Instrument Photo by Conrad Studios

Could you make it in electronics?

Why not...

Because you're not a genius? So What? All you need is a good mind and the desire to learn. We can help you learn what you need to know to get the kind of job you want. And we can help you land the job, too. We've done it before. *Thousands* of times.

Because you can't quit your job? Keep it. If you can't come to our resident schools, we'll come to you, by mail. Take the courses you need, at home. In our schools or at home, you'll get an excellent, practical education in electronics.

Because you think it's too tough? Too slow? Too expensive? Because you're afraid maybe we can't help you get a good job? Fill in the coupon, and *make us prove it!*

DE VRY INSTITUTE OF TECHNOLOGY
4141 BELMONT AVE., CHICAGO, ILL. 60641



BELL & HOWELL SCHOOLS

DE VRY INSTITUTE OF TECHNOLOGY Dept. 108-Y
4141 BELMONT AVE., CHICAGO, ILL. 60641



BELL & HOWELL SCHOOLS

Please send me your two free booklets, "Pocket Guide to Real Earnings," and "Electronics In Space Travel;" also include information about preparing for careers in Electronics. I am interested in the following opportunity fields (check one or more):

- | | |
|--|---|
| <input type="checkbox"/> Space & Missile Electronics | <input type="checkbox"/> Communications |
| <input type="checkbox"/> Television and Radio | <input type="checkbox"/> Computers |
| <input type="checkbox"/> Microwaves | <input type="checkbox"/> Broadcasting |
| <input type="checkbox"/> Radar | <input type="checkbox"/> Industrial Electronics |
| <input type="checkbox"/> Automation Electronics | <input type="checkbox"/> Electronic Control |

Name _____ Age _____

Address _____ Apt. _____

City _____

State _____ Zip Code _____

Veterans: Check here. If you were discharged after Jan. 31, 1955, the "G.I. Bill" may cover the entire cost of your tuition.

106

ACCREDITED MEMBER, NATIONAL HOME STUDY COUNCIL



The 'CADETS'

Citizens Band

Antennas by MOSLEY

Increasing numbers of campers are finding Citizens Band communications ideal for 'Keeping-In-Touch'.

For reliable communications, use a quality CB antenna by Mosley. Consider a Cadet (shown). Ideal for use on campers, boats, cars, trailers. The Cadet SUC-1 with suction cup for quick temporary installation, the Cadet PER-1 for permanent mounting.

Send for FREE Mosley CB Catalog no. 124

Mosley Electronics Inc.

4610 N. Lindbergh Blvd.,
Bridgeton, Missouri 63042



CIRCLE NO. 22 ON READER SERVICE PAGE

POPULAR ELECTRONICS

PHILLIP T. HEFFERNAN
Publisher

OLIVER P. FERRELL
Editor

LESLIE SOLOMON
Technical Editor

JOHN R. RIGGS
Managing Editor

EDWARD I. BUXBAUM
Art Director

ALEXANDER W. BURAWA
Associate Editor

ANDRE DUZANT
Technical Illustrator

PATTI MORGAN
Assistant Editor

AURORA NARDOZZI
Editorial Assistant

H. BENNETT, W2PNA

H. S. BRIER, W9EGQ

L. E. GARNER, JR.

CHARLES J. SCHAUERS, W6QLV

M. P. SPINELLO, KHC2060

Contributing Editors

RICHARD J. HALPERN

Advertising Manager

ARDYS C. MORAN

Advertising Service Manager

LAWRENCE SPORN

Associate Publisher

ZIFF-DAVIS PUBLISHING COMPANY

Editorial and Executive Offices

One Park Avenue, New York, New York 10016
212 679-7200

Midwestern Office

307 North Michigan Avenue, Chicago, Illinois 60601
312 726-0892

Midwestern Advertising Manager, JAMES WEAKLEY
GERALD L. TAYLOR

Western Office

9025 Wilshire Boulevard, Beverly Hills, California 90211

213 Crestview 4-0265; Bradshaw 2-1161

Western Advertising Manager, BUD DEAN

Japan: James Yagi

Ishikawa Mansion, #4, Sakuragaoka

Shibuya-ku, Tokyo, 462-2911-3

Circulation Office

Portland Place, Boulder, Colorado 80302

William B. Ziff, Chairman of the Board (1946-1953)

William Ziff, President

W. Bradford Briggs, Executive Vice President

Hershel B. Sarbin, Senior Vice President

Philip Sine, Financial Vice President

Walter S. Mills, Jr., Vice President, Circulation

Stanley R. Greenfield, Vice President, Marketing

Phillip T. Heffernan, Vice President, Electronics Division

Frank Pomerantz, Vice President, Creative Services

Arthur W. Butzaw, Vice President, Production

Edward D. Muhlfeld, Vice President, Aviation Division

Irwin Robinsan, Vice President, Travel Division

Furman Hebb, Administrative Vice President

George Morrissey, Vice President

Sydney H. Rogers, Vice President

Ziff-Davis also publishes Airline Management and Marketing, Boating, Business & Commercial Aviation, Car and Driver, Cycle, Electronics World, Flying, HiFi/Stereo Review, Modern Bride, Popular Photography, Skiing, Skiing Area News, and Skiing Trade News. (Travel Weekly is published by Robinson Publications, Inc., a subsidiary of Ziff-Davis Publishing Company.)

Forms 3539 and all subscription correspondence should be addressed to POPULAR ELECTRONICS, Circulation Department, Portland Place, Boulder, Colorado 80302. Please allow at least six weeks for change of address. Include your old address, as well as new—enclosing if possible an address label from a recent issue.

EDITORIAL CONTRIBUTIONS must be accompanied by return postage and will be handled with reasonable care; however, publisher assumes no responsibility for return or safety of art work, photographs or manuscripts.



Member Audit Bureau
of Circulations

POPULAR ELECTRONICS

F.C.C. COMMERCIAL OPERATOR LICENSE

Training

is part of the Grantham

A. S. E. E.

DEGREE CURRICULUM

In today's world of electronics employment, an FCC license is important — sometimes essential — but it's not enough! Without further education, you can't make it to the top. Get your FCC license without fail, but don't stop there. To prepare for the best jobs, continue your electronics education and get your Associate Degree in Electronics.

This is good common sense for those who want to make more money in electronics. It also makes sense to prepare for your FCC license with the School that gives degree credit for your license training — and with the School that can then take you from the FCC license level to the Degree level.

The first two semesters of the Grantham degree curriculum prepare you for the first class FCC license and radar endorsement. These two semesters, in addition to other parts of the Grantham

This booklet
FREE!

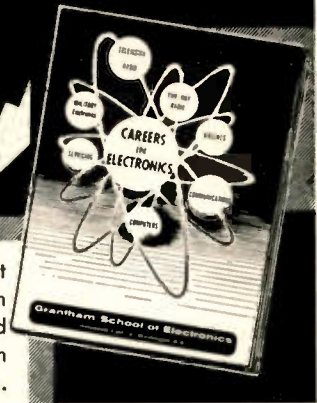

This free booklet explains what an FCC license and ASEE degree can do for your future.

degree curriculum, are available by correspondence* at very reasonable tuition. *The ASEE Degree can be earned by correspondence with a minimum of one semester in residence.*

Accreditation, and G.I. Bill Approval

Grantham School of Electronics is *accredited* by the Accrediting Commission of the National Home Study Council, and is *approved* for both correspondence and resident training under the G.I. Bill. Mail the coupon, or simply write or telephone for your free copy of our Associate Degree Bulletin which gives complete details of our educational program.



GRANTHAM School of Electronics



*Semesters 1, 2, and 3 of the Grantham electronics curriculum are available *also in resident classes* at our Washington, D.C. school — at the address shown below.

• Established in 1951 •

Grantham School of Electronics

1505 N. Western Ave.
Hollywood, Calif. 90027

or

818 18th Street, N.W.
Washington, D.C. 20006

Telephone:
(213) 469-7878

Telephone:
(202) 298-7460

Grantham School of Electronics PE 9-68
1505 N. Western Ave., Hollywood, Calif. 90027

Please mail me your free catalog, which explains how Grantham training can prepare me for my FCC License and Associate Degree in electronics. I understand no salesman will call.

Name _____ Age _____

Address _____

City _____ State _____ Zip _____

WHO WAS THAT MASKED MAN?



That was no masked man, that was a

Long Ranger

fiberglass CB antenna from Shakespeare . . . the 176 "Big Stick" (18'6") antenna to be specific. The antenna that gives you maximum wind and weather protection. It's another performance-proven No. 1 Shakespeare fiberglass product.

You won't get a shining light, fancy gain claim, gizmo or a silver bullet. We let the antenna do the talking. With a "Big Stick" you don't have to shout. Speak softly.



C/P CORPORATION

R.F.D. 3, Columbia, S. C. 29205
Phone (803) 787-8710

a subsidiary of

Shakespeare 

CIRCLE NO. 6 ON READER SERVICE PAGE

letters

FROM OUR READERS

HOW TO CUT SQUARE HOLES

I enjoy building electronic projects and giving them a neat, professional appearance. However, many projects require square holes that must be cut to close tolerances. Is there any way to cut these holes neatly without having to pay a small fortune to have a metal shop do it?

LEE MCGOWAN
Sacramento, Calif.

Sure there is! It just takes the proper tools. For example, standard-size holes can be cut with chassis punches. Some of these punches (both round and square) come with key-slot cutters. Then, for holes with non-standard sizes and shapes, there is always the hand nibbling tool. This tool cuts through 18-gauge steel and up to 1/16"-thick aluminum, brass, copper, and plastics. For holes smaller than 1/2" in any dimension, just drill a hole and go to work with a needle file. If you do a lot of chassis fabrication, it might be a good idea to have a punch set and nibbler handy.

REPLACEMENT IS A SAFE BET

I've noticed that several of the wax-coated paper electrolytic capacitors in my 17-year-old receiver have become sticky and covered with "boils" where the wax has melted from time to time. Should I replace them, and if so, must they be wax-coated paper electrolytics?

BILL MURRAY
Eugene, Ore.

It is normal for wax-coated capacitors to become tacky and develop "boils" with age; so don't become overly concerned about it. However, those old capacitors might be suffering from something of more concern—specifically, leakage that can become a major problem in the future. If you are in doubt about any of these capacitors, usually a simple ohmmeter check will let you know if it's time to replace them. Even so, it might be a good idea to replace those that are suspicious before they develop troubles. You can use any type of electrolytic that has the same value and voltage rating as those being replaced.

COLOR ORGAN LIGHTING EFFECT

Being a hi-fi/stereo enthusiast and interested in electronics, I was naturally interested in the "Sonolite" ("Build A Sonolite,"

POPULAR ELECTRONICS

10-day trial trains you to fix 70% of all TV sets

You've got to be convinced that this is the fastest, most practical training ever offered in TV Servicing/Repair or you get your money back.

Study the first two lessons in your spare time. If within 10 days you don't feel qualified to tackle 7 out of 10 TV repair jobs, stop right there. Return the course and we'll refund every cent you mailed with your application.

Complete training program

Or use your 10 days to check out all 6 illustrated texts, the dictionary of electronic terms, the exam you'll take at the end.

See how simply and graphically this new program covers complex troubleshooting problems. For color as well as black and white receivers. Including the newest solid state and printed circuit models. Find out how to set up a successful business of your own.

Get started immediately

All you need to start are a few recom-

mended tools and an old TV set to work on. No prior knowledge of electronics needed.

Self-checks guide you through each lesson. The comprehensive final exam tests your mastery of 100% of the troubles that plague TV. It leads to the famous ICS diploma and is an important step toward certification by National Electronic Associations.

Send just \$15

A down payment of \$15 and you're on your way. We'll rush your complete training program by return mail. Or enclose full payment (\$99) with your application and receive in addition a portfolio of 24 schematics, the TV serviceman's "circuitry roadmaps"—you'll need them when you open your own shop.

The faster you act, the sooner you can become a professional TV technician—within 6 months if you mail your application today. There's absolutely no risk. The 10-day trial applies to either payment plan. Take a moment to fill out coupon and apply now.



ICS, Scranton, Pa. 18515
Dept. Y5468H

Please rush me your TV Servicing/Repair Course. I understand I may return it within 10 days—and you will return my money—if not completely satisfied.

Enclosed is check or money order for:

- \$99 plus state tax (full price includes portfolio of schematics)
- \$15 (bill me at the rate of \$14 a month, plus state tax, for 6 months until total price of \$99 is paid)

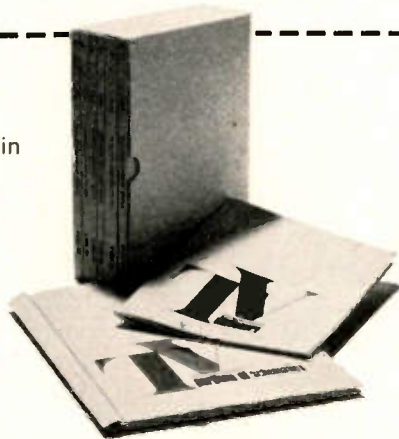

Name _____

Street _____

City _____ State _____ Zip _____

Occupation _____ Employed by _____

Course approved by National Electronic Associations for apprentice training

UNUSUAL BARGAINS

... MANY U. S. GOV'T SURPLUS

SEE YOUR MUSIC IN DAZZLING ACTION



Music Vision
Dramatic New Break-through in Audio-Visual Enjoyment.

Now you can have a thrilling psychedelic "see-in" right in your own home, club, school or business—in fact—anywhere!

You want to add sensational "mod" effects to your dance and prance, whirl and swirl in perfect time with the music—each individual note creating its own unique twisting, radiating shape. Add a spectacularly wild, new dimension to the world of music and entertainment. Combines electronics, science and art with dramatic results. Attaches in seconds to your radio, tape recorder, hi-fi or stereo with two alligator clips. Can be used on small screens, large walls, stages and whole auditoriums. Build your own MusicVision® with low-cost Do-It-Yourself Kit. Loads of fun! Fast! Easy! All you need is a light source. If you don't have one, the versatile Edmund 35mm 500 Watt Projector is a terrific bargain. All kinds of other uses too—set up to accept motorized accessories. Also available in 15" x 15" x 27" Walnut Cabinet Model, Tube Unit, or 8" and 12" Sets which include encases 8" or 12" Motondizer. Color Wheel and set of apertures for use with your own 35mm projector. Large 12" set provides fabulous effects for commercial applications. Order by stock number listed below. Money-back guarantee. Complete information in new catalog available September 10. If you want additional details now, send 25¢ in coin for fully illustrated, 16-page Booklet No. 8009AV "Introduction to MusicVision."
*Patent pending.

B" DO-IT-YOURSELF KIT, Stock No. 71.009AV \$22.50 Postpaid
EDMUND 500 WATT 35mm PROJECTOR, Stock No. 71.051AV \$24.50 Postpaid
WALNUT VENEERED CABINET MODEL, Stock No. 85.181 \$59.50 F.O.B.
8" SET (Motondizer, color wheel, apertures) Stock No. 71.030AV \$45.00 Postpaid
12" SET (Same as above w/larger Motondizer), Stock No. 71.032AV \$57.50 Postpaid

TOP-QUALITY LOW-COST STROBE

Create spectacular psychedelic lighting effects with this genuine electronic strobe. Terrific for parties, special occasions, experiments... perfect for combos, night clubs, dances, exhibitions. Adjusts from 1 to 10 short-duration flashes per second—not a make-shift mechanical device. Amaze friends with old-time movie effects. Best party ice-breaker ever—"freeze" the action and "unfreeze" your guests. Practical too—check action of moderate speed machinery. Xenon lamp gives one million flashes. 8 1/2" diam. reflector. Uses reg. 110-120 volt A.C. current. Handsome solid walnut cabinet. At new unique lightning effects.
Stock No. 70.989AV \$79.95 Ppd.

NEW! AMAZING DRY COPIER — \$29.95

Copies half-tones, all colors, even book pages. No liquids, chemicals or sprays needed. 3 easy steps make sharp black-on-white permanent copies up to 8"x10" in a minute. Automatic timer eliminates guess work. Perfect for home, school, office, clubs, assoc., etc.—1000's of uses. Does practically everything machines costing 100's of dollars can do. Made in USA under 3M Co. license—really amazing bargain. Weights only 8 lbs. Uses reg. 110-120 V.A.C.—2 150 W. bulbs, 201 1/2" x 13 1/2" x 6". Handsome, tough brown case. Paper avail. separately.
Stock No. 80.117AV \$29.95 Plus \$2 postage and handling
8"x10" PAPER (Pack of 33 Sheets) \$3.25
Stock No. 80.118AV

3" ASTRONOMICAL TELESCOPE

See the stars, moon, phases of Venus, planets close up, 60 to 180 power. Aluminized and over-coated 3" diameter f 10 primary mirror, ventilated cell. Equatorial mount with locks on both axes. Equipped with 60X eyepiece and mounted Barlow lens. 3K finder telescope, hardwood tripod. Included FREE: "STAR CHART": 272-page "HANDBOOK OF HEAVENS"; "HOW TO USE YOUR TELESCOPE" book.
Stock No. 85.050AV \$29.95 Ppd.
Stock No. 85.105AV 4" REFLECTOR \$84.50 FOB
Stock No. 85.086AV 6" REFLECTOR \$199.50 FOB

Order by Stock No.—Check or M.O.—Money-Back Guarantee
**EDMUND SCIENTIFIC CO., 300 EDCORP BUILDING
BARRINGTON, NEW JERSEY 08007**

GIANT FREE CATALOG "AV"

Completely new 1968 edition. New items, categories, illustrations, 148 easy-to-read pages packed with 4000 unusual items. Dozens of electrical and electromagnetic parts, accessories. Enormous selection of Astronomical Telescopes, Microscopes, Binoculars, Magnifiers, Magnets, Lenses, Prisms. Many war surplus items: for hobbyists, experimenters, workshops, factory. Write for catalog "AV". Include Zip.

ORDER BY STOCK NUMBER • SEND CHECK OR MONEY ORDER • MONEY-BACK GUARANTEE
**EDMUND SCIENTIFIC CO. 300 EDCORP BUILDING
BARRINGTON, NEW JERSEY 08007**
CIRCLE NO. 15 ON READER SERVICE PAGE

LETTERS (Continued from page 8)

May 1968). However, I would like to know what type of lighting was used to obtain the effects on the front cover and in the advertisement at the lower left of page 86 of the May issue. This is just the type of effect I would like, and any help you can give me will be greatly appreciated.

A1C PATRICK J. McNAMAR
USAF, APO San Francisco

The tricks of photography—not the "Sonolite"—were responsible for the effect on the front cover. As for the advertisement, a reflection-projection technique is used. Lamps located in the base of the enclosure are directed so that their light falls on the rear wall of the enclosure. This wall, covered with a light-reflecting/dispersing material, scatters the light and projects it onto the translucent screen that makes up the front of the enclosure. At the screen, the translucency allows the colored lights to blend and remove sharp edges.

So, if you want a multi-color, reflection-type color organ, a much more elaborate system than the "Sonolite" will be needed. The "Musette Color Organ" (July, 1966) with its five-channel/five-color output would fill the bill.

RETORT FROM A 13-YEAR-OLD BOY

After reading Julia Lobur's letter in the July issue ("Letters From Our Readers," July 1968), I became really mad. I am 13 years old, and like Miss Lobur, nuts about electronics. But while I agree that women in electronics are often picked on, I don't think Miss Lobur has the right to state that she is better than any 13-year-old boy.

STEVEN LIONEL
Bangor, Maine

And so it comes—the inevitable clash. But let's be fair. Julia stated in her letter that she was as good as—or better than—any 13-year-old boy. She didn't state outright that she was better. But if you would like to challenge her statement, you're welcome to try. If you do, you have a lot to learn about women, especially women as strong-minded as Julia appears to be

WHAT HAPPENS TO "BOOTLEGGERS"?

What would the FCC do to me if they caught me illegally and purposely operating a 45-watt transmitter on 2 1/2 meters?

(Name withheld)
Somewhere, Nevada

We hope you haven't already started your "bootlegging" operation. Under section 501 of the Communications Act, illegal operation of a transmitter will subject you to a maximum penalty of \$10,000 fine, one year imprisonment, or both for the first conviction. Subsequent convictions bring a maximum penalty of \$10,000 fine, two years imprisonment, or both.

The New 1968 Improved Model 257 **A REVOLUTIONARY NEW TUBE TESTING OUTFIT**

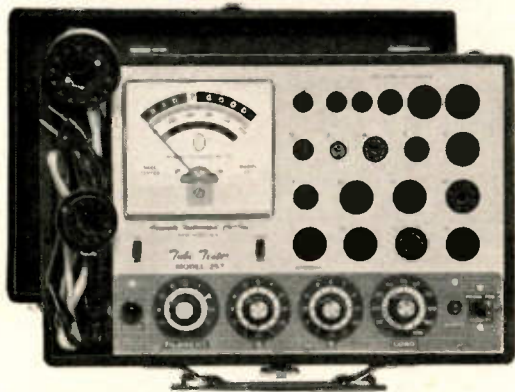

COMPLETE WITH ALL ADAPTERS AND ACCESSORIES, NO "EXTRAS"

STANDARD TUBES:

- ✓ Tests the new Novars, Nuvlators, 10 Pins, Magnovals, Compactrons and Decals.
- ✓ More than 2,500 tube listings.
- ✓ Tests each section of multi-section tubes individually for shorts, leakage and Cathode emission.
- ✓ Ultra sensitive circuit will indicate leakage up to 5 Megohms.
- ✓ Employs new improved 4½" dual scale meter with a unique sealed damping chamber to assure accurate, vibration-less readings.
- ✓ Complete set of tube straighteners mounted on front panel.

The Model 257 is housed in a handsome, sturdy, portable case. Comes complete with all adapters and accessories, ready to plug in and use. No "extras" to buy. Only

- Tests all modern tubes including Novars, Nuvistors, Compactrons and Decals.
- All Picture Tubes, Black and White and Color

ANNOUNCING...for the first time

A complete TV Tube Testing Outfit designed specifically to test all TV tubes, color as well as standard. Don't confuse the Model 257 picture tube accessory components with mass produced "picture tube adapters" designed to work in conjunction with all competitive tube testers. The basic Model 257 circuit was modified to work **compatibly** with our picture tube accessories and those components are not sold by us to be used with other competitive tube testers or even tube testers previously produced by us. They were custom designed and produced to work specifically in conjunction with the Model 257.

BLACK AND WHITE PICTURE TUBES:

- ✓ Single cable used for testing all Black and White Picture Tubes with deflection angles 50 to 114 degrees.
- ✓ The Model 257 tests all Black and White Picture Tubes for emission, inter-element shorts and leakage.

COLOR PICTURE TUBES:

- ✓ The Red, Green and Blue Color guns are tested individually for cathode emission quality, and each gun is tested separately for shorts or leakage between control grid, cathode and heater. Employment of a newly perfected dual socket cable enables accomplishments of all tests in the shortest possible time.

\$47⁵⁰

NOTICE

Accurate has been producing radio, TV and electronic test equipment since 1935, which means they were making Tube Testers at a time when there were relatively few tubes on the market, 'way before the advent of TV. The model 257 employs every design improvement and every technique learned over an uninterrupted production period of 32 years.

Maxon Electronics, Inc.

SEND NO MONEY WITH ORDER **PAY POSTMAN NOTHING ON DELIVERY**

Try it for 10 days before you buy. If completely satisfied then send \$10.00 and pay the balance at the rate of \$10.00 per month until the total price of \$47.50 (plus P.P., handling and budget charge) is paid. If not completely satisfied, return to us, no explanation necessary.

MAXON ELECTRONICS, INC.

Dept. D-102 2435 White Plains Road, Bronx, N. Y. 10467

Please rush me one Model 257. If satisfactory I agree to pay \$10.00 within 10 days and balance at rate of \$10.00 per month until total price of \$47.50 (plus P.P., handling and budget charge) is paid. If not satisfactory, I may return for cancellation of account.

Name _____

Address _____

City _____ Zone _____ State _____

Save Money! Check here and enclose \$47.50 with this coupon and we will pay all shipping charges. You still retain the privilege of returning after 10 day trial for full refund.

Look What's New In Your



NEW kit AD-27
\$169.95



NEW kit GR-17
\$43.95

NEW
kit
IP-18
\$19.95



NOW, THE TUNER AND AMPLIFIER OF
THE FAMOUS HEATH AR-15 RECEIVER ARE
AVAILABLE AS SEPARATE COMPONENTS



NEW kit AJ-15
\$189.95*



NEW kit AA-15
\$169.95*

Heathkit FM Stereo COMPONENT-COMPACT

This new Heathkit AD-27 stereo compact has features not found in other units costing twice as much for one very simple reason. It wasn't engineered to meet the usual level of compact performance. Instead, Heath took one of its standard stereo/hi-fi receivers, the AR-14, and re-arranged it physically to fit a compact configuration. The result is performance that is truly high fidelity without compromise. It features 31 transistor, 10 diode circuitry with 15 watts per channel dynamic music power (enough to let you choose most any speaker systems you prefer), full-range tone controls, less than 1% distortion, and 12 to 60,000 Hz response. The pre-assembled FM stereo tuner section with 4-stage IF offers 5 μ V sensitivity, excellent selectivity, AFC, and the smoothest inertia tuning. The BSR McDonald "500" turntable offers features usually found only in more expensive units . . . like low mass tubular aluminum tone arm, anti-skate control, cueing and pause control, plus a Shure magnetic cartridge with diamond stylus. It's all housed in a smart oiled walnut cabinet with sliding tambour door that disappears inside the cabinet. For value and performance choose the AD-27, the new leader in stereo compacts. Shpg. wt. 41 lbs.

Heathkit AM-FM Portable Radio

Here's performance others can't match. The new Heathkit GR-17 portable has 12 transistor, 7 diode circuit with the same front end as Heathkit hi-fi tuners; 3-stage IF; big 4" x 6" speaker; tone control; AFC on FM and amplified AGC on AM; built-in AM rod antenna plus telescoping 34" FM antenna; 350 milliwatt output; and 200-300 hour battery life. Shpg. wt. 5 lbs.

HEATHKIT 1-15 VDC Regulated Power Supply

Labs, service shops, hams, home experimenters . . . anybody working with transistor circuitry can use this handy new Heathkit All-Silicon Transistor Power Supply . . . use it in place of conventional battery power supply. Voltage regulated (less than 50 mV variation no-load to full-load; less than 50 mV change in output with input change from 105-125 VAC). Current limiting, adjustable from 10-500 mA. Ripple and noise less than 0.1 mV. Transient response 25 μ S. Output impedance 0.5 ohm or less to 100 kHz. AC or DC programming (3 mA driving current on DC). Circuit board construction. Operates 105-125 or 210-250 VAC, 50/60 Hz. 6 lbs.

HEATHKIT AJ-15 Deluxe Stereo Tuner

For the man who already owns a fine stereo amplifier, and in response to many requests, Heath now offers the superb FM stereo tuner section of the renowned AR-15 receiver as a separate unit. The new AJ-15 FM Stereo Tuner has the exclusive design FET FM tuner for remarkable sensitivity, the exclusive Crystal Filters in the IF strip for perfect response curve and no alignment; Integrated Circuits in the IF for high gain, best limiting; elaborate Noise-Operated Squelch; Stereo-Threshold Switch; Stereo-Only Switch; Adjustable Multiplex Phase, two Tuning Meters; two variable output Stereo Phone jacks; one pair variable outputs plus two fixed outputs for amps, recorders, etc.; front panel mounted controls; "Black Magic" panel lighting; 120/240 VAC operation. 18 lbs. *Walnut cabinet AE-18, \$19.95.

HEATHKIT AA-15 Deluxe Stereo Amplifier

For the man who already owns a fine stereo tuner, Heath now offers the famous amplifier section of the AR-15 receiver as a separate unit. The new AA-15 Stereo Amplifier has the same superb features: 150 watts Music Power; Ultra-Low Harmonic & IM Distortion (less than 0.5% at full output); Ultra-Wide Frequency Response (± 1 dB, 8 to 40,000 Hz at 1 watt); Ultra-Wide Dynamic Range Preamp (98 dB); Tone-Flat Switch; Front Panel Input Level Controls; Transformerless Amplifier; Capacitor Coupled Outputs; Massive Power Supply; All-Silicon Transistor Circuit; Positive Circuit Protection; "Black Magic" Panel Lighting; new second system Remote Speaker Switch; 120/240 VAC. 26 lbs. *Walnut cabinet AE-18, \$19.95.

Free 1969 Heathkit® Catalog

New Lower Prices On Heathkit Color TV
Make Them A Better Buy Than Ever!

Deluxe "295" Color TV... Model GR-295 **now only \$449⁹⁵**
(less cabinet)

New improved phosphors and low voltage supply with boosted B+ for maximum color fidelity and operation • automatic degaussing • exclusive Heath Magna-Shield • AGC and AGC assures color purity, flutter-free pictures under all conditions • preassembled IF with 3 stages instead of the usual 2 • deluxe VHF turret tuner with "memory" fine tuning • choice of installation—wall, custom or optional Heath factory assembled cabinets • Easy to assemble.

Big, Bold, Beautiful... With Advanced Features and Exclusive Heathkit Self-Servicing. Top quality, American brand color tube... 295 sq. inch viewing area. The built-in dot generator and full color photos and simple instructions let you set-up, converge and maintain the best color pictures at all times. Add to this the detailed trouble-shooting chart in the manual and you put an end to costly TV service calls for periodic picture convergence and minor repairs.

GRA-295-4, Mediterranean cabinet shown..... \$119.50
Other cabinets from \$62.95

Deluxe "227" Color TV... Model GR-227 **now only \$399⁹⁵**
(less cabinet)

Has same high performance features and built-in servicing facilities as the GR-295, except for 227 sq. inch viewing area. The vertical swing-out chassis makes for fast, easy servicing and installation. The dynamic convergence control board can be placed so that it is easily accessible anytime you wish to "touch-up" the picture.

GRA-227-1, Walnut cabinet shown..... \$59.95
Mediterranean style also available at \$99.50

Deluxe "180" Color TV... Model GR-180 **now only \$349⁹⁵**
(less cabinet)

Same high performance features and exclusive self-servicing facilities as the GR-295 except for 180 sq. inch viewing area. Feature for feature the Heathkit "180" is your best buy in deluxe color TV viewing... tubes alone list for over \$245. For extra savings, extra beauty and convenience, add the table model cabinet and mobile cart.

GRA-180-5, table model cabinet and cart..... \$39.95
Other cabinets from \$24.95

Now, Wireless Remote Control For Heathkit Color TV's

Control your Heathkit Color TV from your easy chair, turn it on and off, change VHF channels, volume, color and tint, all by sonic remote control. No cables cluttering the room... the handheld transmitter is all electronic, powered by a small 9 v. battery, housed in a small, smartly styled beige plastic case... feather-light and contoured to fit comfortably in your hand for easy pushbutton operation. The receiver contains an integrated circuit (15 resistors, 10 transistors, 1 diode) and a meter for adjustment ease. Circuit board construction and plug-in wire harness make installation of receiver and control motors easy. For greater TV enjoyment, order yours now.

kit GRA-295-6, 9 lbs., for Heathkit GR-295 and GR-25 Color TV's..... \$69.95
kit GRA-227-6, 9 lbs., for Heathkit GR-227 and GR-180 Color TV's..... \$69.95

3 HEATHKIT® COLOR TV'S
NOW! ALL WITH 2-YEAR
WARRANTY ON PICTURE TUBE



kit GR-295



kit GR-227



kit GR-180



NEW Wireless
TV Remote Control

\$69⁹⁵

FREE 1969 Heathkit Catalog

Shows these and over 300 other easy-to-build kits that save up to 50%... Electronic Organs, Stereo, Marine, CB, Ham Radio, Test, Photography, Educational for home & hobby. No skills or experience needed. Send for your free copy today. Mail coupon or write Heath Co., Benton Harbor, Michigan 49022.

HEATH COMPANY, Dept. 10-9
Benton Harbor, Michigan 49022
In Canada, Daystrom Ltd.

Enclosed is \$_____ plus shipping.

Please send model (s)
 Please send FREE Heathkit Catalog
 Please send Credit Application.

Name _____

Address _____

City _____

State _____

Zip _____

Prices & specifications subject to change without notice.

CL-336

CIRCLE NO. 19 ON READER SERVICE PAGE

ELECTRONICS library

QUIET

ELECTRONIC MUSIC INSTRUMENTS, Third Edition

by Richard H. Dorf

The electronic organ is rapidly becoming the number two "family-type" musical instrument in the United States—second only to the piano in mass appeal. But who is going to service these complex electronic devices? Pipe organ servicemen obviously aren't qualified. Equally obvious is the fact that the person who does decide to become a serviceman will have to be an electronic technician. The new edition of this book—since 1954 considered to be the "bible" of electronic organs—is a one-source reference for virtually everything technical about electronic organs. Besides information on tone generation, coloring and special effects, the third edition details practically every organ on the market (Thomas, Baldwin, Lowrey, Wurlitzer, Hammond, etc.). If you own, plan to own, or plan to

service electronic organs, this book is a "must" on your shelf.

Published by Radiofile, 43 West 61 St., New York, N.Y. 10023. Hard cover. 393 pages. \$10.00.

WAVEFORM MEASUREMENTS

by Rufus P. Turner

This is perhaps the first single-source book providing complete instructions for measuring and analyzing common oscilloscope waveforms. From troubleshooting to signal synthesis, the "how-to" approach used in this book can be an indispensable aid to people in electronics who have to understand and use oscilloscopes. Equal attention is given to instrument measuring of frequency components that determine the particular shape of a wave and influence circuit behavior. The step-by-step procedures show the correct use of various associated instruments, including wave analyzers, distortion meters, and recorders. A special section shows how to check total distortion in modulated and unmodulated waves. In addition, practical methods of measuring modulated waves are set forth.

Published by Hayden Book Company Inc., 116 West 14 St., New York, N. Y. 10011. Soft cover. 86 pages. \$2.95.

PRACTICAL SEMICONDUCTOR EXPERIMENTATION

by Ronald R. Meyers

If you're interested in semiconductors, the 25 experiments in this book will help you to

Add LIFE to your color TV, stereo radio and electronic equipment

 DELWYN™

Whisper Fan®

- Made especially for cooling transistors, tubes and other heat generating components
- Helps guard against part failure
- Ensures trouble-free life — peak performance
- Costs only a few pennies to operate — saves dollars in repair bills
- So quiet and noise-free, you have to feel the breeze to know it is at work
- Quickly and easily installed

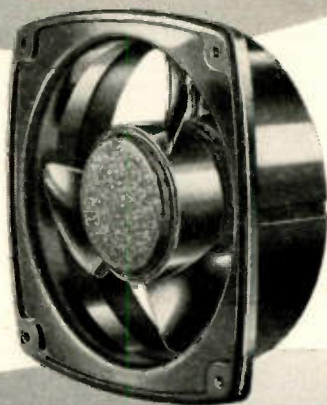

Only
\$14.85
Complete!

Ask your dealer to demonstrate how the Delwyn Whisper Fan will pay for itself in savings on just one heat-caused repair bill.

 DELWYN

BOX 195 B, Route 28
Kingston, New York 12401

CIRCLE NO. 13 ON READER SERVICE PAGE

POPULAR ELECTRONICS

POPULAR ELECTRONICS READER SERVICE PAGE

free information service:

Here's an easy and convenient way for you to get additional information about products advertised or mentioned editorially (if it has a "Reader Service Number") in this issue. Just follow the directions below... and the material will be sent to you promptly and free of charge.

1. Print or type your name and address on the lines indicated. Circle the number(s) on the coupon below that corresponds to the key number(s) at the bottom of the advertisement or editorial mention(s) that interest you. (Key numbers for advertised products also appear in the Advertisers' Index.)

2. Cut out the coupon and mail it to the address indicated below.

3. This address is for our product "Free Information Service" only. Editorial inquiries should be directed to POPULAR ELECTRONICS, One Park Avenue, New York 10016; circulation inquiries to Portland Place, Boulder, Colorado 80302.

**POPULAR
ELECTRONICS**

VOID AFTER OCTOBER 31, 1968

P.O. BOX 8391
PHILADELPHIA, PA. 19101

1 2 3 4 5 6 7 8 9 10 11 12 13 14 15 16 17 18 19 20
21 22 23 24 25 26 27 28 29 30 31 32 33 34 35 36 37 38 39 40
41 42 43 44 45 46 47 48 49 50 51 52 53 54 55 56 57 58 59 60
61 62 63 64 65 66 67 68 69 70 71 72 73 74 75 76 77 78 79 80
81 82 83 84 85 86 87 88 89 90 91 92 93 94 95 96 97 98 99 100

NAME (Print clearly) _____

ADDRESS _____

CITY _____ STATE _____ ZIP CODE _____

9 a

Dynaco



World-renowned for excellence in stereo high fidelity components. Ready built, or economical easy do-it-yourself kits. A wide choice of prices and power outputs to suit your needs. One performance level—the best. Sophisticated engineering enables assembly by the novice with assurance of laboratory standards of excellence. Dynakits have been recommended by every major testing organization.

TO: Dynaco Inc., 3060 Jefferson Street, Phila., Pa. 19121
Please rush detailed information to:

1 Name _____
2 Address _____
3 City _____ State _____ Zip _____

PE 968

CIRCLE NO. 14 ON READER SERVICE PAGE

FOR \$14.95

**THIS BUG WILL TELL
YOU EVERYTHING
IT HEARS**



For Business!—Pleasure!—Intrigue!

Concealed inside this decorative Insect's innocent exterior is a miniature microphone and radio transmitter, which broadcasts a strong signal to any FM radio within 200 feet.

Simply switch this intercom on, and have anyone you choose tune to 88-90 mc on their FM. Normal conversations will be picked up loud and clear (remember FM is static-free). There are no wires. We're sure you can think of dozens of fun ways to use the bug, but here are a few thought starters:

Play with it at your next party, with the guys at the office. Use it as an intercom with your secretary or to the kids' room. You can even tape record what you hear for posterity.

The sophisticated electronic components were designed by Continental, America's leading specialist in security equipment. Get the bug. For yourself. For friends. For fun.

BUY 2 ONLY \$28.00

SPECIAL: Complete 1968 security and crime deterrent catalog. ONLY \$2.35. Send check or money order.

Pathe



ELECTRONICS MANUFACTURING COMPANY O-N
47 East 19th Street New York, N.Y. 10003
Telephones: 674-2494 674-2430-1
DIVISION OF PHONOPATHE

Dealer Inquiries Also Invited

CIRCLE NO. 24 ON READER SERVICE PAGE

LIBRARY (Continued from page 14)

understand semiconductor technology. The solid-state experiments range from diodes and bipolar transistors to the more modern UJT, SCR, and FET. Also discussed are the uses in typical circuits, providing a basic description of the semiconductor and circuit under test. You are told what the object of each experiment is, what materials and test equipment are needed, and how to perform the experiment. Tables for entering the results of your experiments and questions designed to help you find out what you have learned are also provided. This is a practical workbook, but for the more enterprising, a lengthy appendix shows how to mathematically attack various problems.

Published by Prentice-Hall, Inc., Englewood Cliffs, N.J. 07632. Soft cover. 185 pages. \$5.95.

HOW TO USE YOUR VOM, VTVM, AND OSCILLOSCOPE

by Martin Clifford

The three most widely used—and indispensable—pieces of test equipment are the VOM, VTVM, and oscilloscope. Unfortunately, most people take these instruments for granted and seem to know less about them than the equipment they test. This book should help to alleviate this problem. It is written in an easy-to-grasp style and is profusely illustrated. The book is divided into three parts which deal individually with each of these important instruments. Each part is further subdivided into three chapters. The lead chapters describe in detail the specific instrument in a given section. The next chapters cover the proper use of the instruments, suggesting basic and unique applications. The final chapters cover maintenance procedures and troubleshooting charts. This book will make a fine addition to your bookshelf.

Published by TAB Books, Blue Ridge Summit, Pa. 17214. Soft cover. 192 pages. \$3.95.

TRANSISTOR CIRCUIT APPROXIMATIONS

by Albert Paul Malvino

A simplified, practical approach to handling transistor circuit analysis and design concepts which will be welcomed by non-engineering level hobbyists who do not want to wade through tough mathematics. Most of the book stresses the "ideal-transistor" approach so that the reader can obtain the most significant (though often approximated) features of transistor action. Second-order effects and more exact analyses are discussed in the final chapters of the book. Complete study aids for each chapter include a summary, a glossary, review questions, and practice problems. The only prerequisite for tackling this book is a sound knowledge of algebra and basic electricity.

Published by McGraw-Hill Book Company, 330 West 42 St., New York, N. Y. 10036. Hard cover. 404 pages. \$7.95.

POPULAR ELECTRONICS

FREE!

1969
CATALOG
No. 690

JUST OFF THE PRESS!!
SEND FOR YOUR EXCITING COPY NOW!



**BIGGER
& BETTER
THAN EVER**
OVER **500** PAGES!

**YOUR 1st GUIDE TO
EVERYTHING IN
ELECTRONICS**

- ★ CITIZENS BAND
2-WAY RADIO
- ★ STEREO/HI-FI
COMPONENTS
- ★ MUSICAL INSTRUMENTS
AND AMPLIFIERS
- ★ PUBLIC ADDRESS
- ★ AMATEUR RADIO
- ★ TEST EQUIPMENT
- ★ PARTS
- ★ PORTABLE AND
TABLE RADIOS
- ★ PHOTO EQUIPMENT
- ★ TOOLS
- ★ AUTO ACCESSORIES
- ★ EDUCATIONAL
AND OPTICAL
- ★ TV AND ANTENNAS
- ★ BOOKS

LAFAYETTE Radio ELECTRONICS
Dept. 35098, P.O. Box 10
Syosset, L.I., N.Y. 11791

Mail This Coupon Today
For Your 1969 Catalog
No. 690.

Please send the FREE 1969 LAFAYETTE Catalog 690 35098

Name

Address

City State

Zip

(please include your Zip Code No.)

CIRCLE NO. 20 ON READER SERVICE PAGE

How to get into

One of the hottest money-making fields in electronics today—servicing two-way radios!



HE'S FLYING HIGH. Before he got his CIE training and FCC License, Ed Dulancy's only professional skill was as a commercial pilot engaged in crop dusting. Today he has his own two-way radio company, with seven full-time employees. "I am much better off financially, and really enjoy my work," he says. Read here how you can break into this profitable field.

More than 5 million two-way transmitters have skyrocketed the demand for service men and field, system, and R&D engineers. Topnotch licensed experts can earn \$12,000 a year or more. You can be your own boss, build your own company. And you don't need a college education to break in.

HOW WOULD YOU LIKE to start collecting your share of the big money being made in electronics today? To start earning \$5 to \$7 an hour... \$200 to \$300 a week... \$10,000 to \$15,000 a year?

Your best bet today, especially if you

don't have a college education, is probably in the field of two-way radio.

Two-way radio is booming. Today there are more than *five million* two-way transmitters for police cars, fire department vehicles, taxis, trucks, boats, planes, etc. and Citizen's Band uses—

and the number is still growing at the rate of 80,000 new transmitters per month.

This wildfire boom presents a solid gold opportunity for trained two-way radio service experts. Many of them are earning \$5,000 to \$10,000 a year *more* than the average radio-TV repair man.

Why You'll Earn Top Pay

One reason is that the United States Government doesn't permit anyone to service two-way radio systems unless he is *licensed* by the Federal Communications Commission. And there simply aren't enough licensed electronics experts to go around.

Another reason two-way radio men earn so much more than radio-TV service men is that they are needed more often and more desperately. A home radio or television set may need repair only once every year or two, and there's no real emergency when it does. But a two-way radio user must keep those transmitters operating at all times, and *must* have their frequency modulation and plate power input checked at regular intervals by licensed personnel to meet FCC requirements.

This means that the available licensed experts can "write their own ticket" when it comes to earnings. Some work by the hour and usually charge at least \$5.00 per hour, \$7.50 on evenings and Sundays, plus travel expenses. A more common arrangement is to be paid a monthly retainer fee by each customer. Although rates vary widely, this fixed charge might be \$20 a month for the base station and \$7.50 for each mobile station. A survey showed that one man can easily maintain at least 100 stations, averaging 15 base stations and 85 mobiles. This would add up to at least \$12,000 a year.

Be Your Own Boss

There are other advantages too. You can become your own boss—work entirely by yourself or gradually build your own fully staffed service company. Instead of being chained to a workbench, machine, or desk all day, you'll move around, see lots of action, rub shoulders with important police and fire officials and business executives who depend on two-way radio for their daily operations. You may even be tapped for a big job working for one of the two-way radio manufacturers in field service, factory quality control, or laboratory research and development.

How To Get Started

How do you break into the ranks of the big-money earners in two-way radio? This is probably the best way:

1. Without quitting your present job, learn enough about electronics fundamentals to pass the Government FCC Exam and get your Commercial FCC License.
2. Then get a job in a two-way radio service shop and "learn the ropes" of the business.
3. As soon as you've earned a reputation as an expert, there are several ways you can go. You can move *out* and start signing up and servicing your own customers. You might become a franchised service representative of a big manufacturer and then start getting into two-way radio sales, where one sales contract might net you \$5,000. Or you may even be invited to move *up* into a high-prestige



THIS COULD BE YOUR "TICKET" TO A GOOD LIVING. You must have a Commercial FCC License to service two-way radios. Two out of three men who take the FCC exam flunk it... but nine out of ten CIE graduates pass it the first time they try!

salaried job with one of the major manufacturers either in the plant or out in the field.

The first step—mastering the fundamentals of Electronics in your spare time and getting your FCC License—can be easier than you think.

Cleveland Institute of Electronics has been successfully teaching electronics by mail for over thirty years. Right at home, in your spare time, you learn electronics step by step. Our **AUTO-PROGRAMMED™** lessons and coaching by expert instructors make everything clear and easy, even for men who thought they were "poor learners." You'll learn not only the fundamentals that apply to all electronics design and servicing, but also the specific procedures for installing, troubleshooting, and maintaining two-way mobile equipment.

Get Your FCC License... or Your Money Back!

By the time you've finished your CIE course, you'll be able to pass the FCC License Exam with ease. Better than nine out of ten CIE-trained men pass the FCC Exam the first time they try, even though two out of three non-CIE men fail. This startling record of achievement makes possible the famous CIE

warranty: you'll pass the FCC Exam upon completion of your course or your tuition will be refunded in full.

Ed Dulaney is an outstanding example of the success possible through CIE training. Before he studied with CIE, Dulaney was a crop duster. Today he owns the Dulaney Communications Service, with seven people working for him repairing and manufacturing two-way equipment. Says Dulaney: "I found the CIE training thorough and the lessons easy to understand. No question about it—the CIE course was the best investment I ever made."

Find out more about how to get ahead in all fields of electronics, including two-way radio. Mail the bound-in postpaid reply card for two FREE books, "How To Get A Commercial FCC License" and "How To Succeed In Electronics." If card has been removed, just send us your name and address on a postcard.

ENROLL UNDER NEW G.I. BILL

All CIE courses are available under the new G.I. Bill. If you served on active duty since January 31, 1955, OR are in service now, check box on reply card for G.I. Bill information.

CIE Cleveland Institute of Electronics
1776 E. 17th St., Dept. PE-70, Cleveland, Ohio 44114

A Leader in Electronics Training... Since 1934 • Accredited Member National Home Study Council



CIRCLE NO. 9 ON READER SERVICE PAGE



NEW PRODUCTS

Additional information on products covered in this section is available from the manufacturers. Each new product is identified by a code number. To obtain further details on any of them, simply fill in and mail the coupon on page 15 or 95.

FET-INPUT MULTIMETER

Sencore's Model FE149 "Senior" FET-input multimeter features full-range measuring capabilities coupled with a 7" mirrored scale, push-button range and function selection, a.c./battery powering, and VTVM operating characteristics. Eight ranges are provided for each of the a.c. and d.c. voltage, resistance, and decibel functions, while nine ranges are assigned to each of the a.c. and d.c. current functions. In addition, with the use of an accessory probe, voltages as high as 5, 15, or 50 kV can be measured. Without the accessory probe, the basic d.c. voltage range is 0-1500 volts (with a 0.5-volt range for low-voltage applications). In the a.c. function, the meter can measure 0-1500 volts r.m.s. or 4500 volts peak-to-peak. Currents up to 5 amperes in both the a.c. and d.c. functions can be measured, while the resistance function covers a range up to and including 6000 megohms.

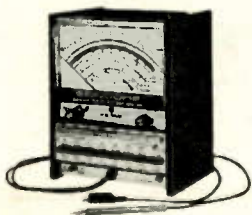

Circle No. 75 on Reader Service Page 15 or 115

DUAL-BAND VHF-FM MONITOR RECEIVER

To serve the demands of people who enjoy listening to the 30-50 MHz and 152-174 MHz bands, Allied Radio Corp. offers its dual-band Model A-2589 VHF-FM monitor receiver. Covering both bands, the new receiver employs four i.f. stages, a tuned r.f. stage, and a mixer stage to insure maximum sensitivity and selectivity. It has automatic volume control and a squelch circuit to silence the speaker between transmissions. A powerful push-pull audio output drives a built-in speaker. The power supply uses zener-diode voltage regulation. An output jack mounted on the front panel is provided for an external 8-ohm speaker or headphones.

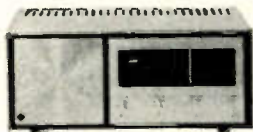

Circle No. 76 on Reader Service Page 15 or 115

AM/FM STEREO RECEIVER

Integrated circuits and field-effect transistors are combined in the tuner section of Fisher Radio Corp.'s Model 175-T AM/FM stereo receiver. The tuner section includes "Stereo Beacon" automatic mono/stereo switching.



Specifications include: 2- μ V sensitivity; 45-dB alternate channel selectivity; wide-band AM tuner with AGC; and a built-in ferrite antenna. In

the amplifier section: 50 watts of IHF music power; all-silicon complementary-symmetry power amplifier circuits; overload protection; four-way main/remote speaker switch; program selector; tape and phono facilities; loudness contour control; and bass, treble, and balance controls.

Circle No. 77 on Reader Service Page 15 or 115

PARABOLIC REFLECTOR MIKE PICKUP

Where it is not possible or convenient to place a microphone close to a sound source, Ercona Corporation's Parabolic Reflector for microphones comes in handy. The reflector is designed to pick up and concentrate sounds from a distance, focusing them on a point occupied by a microphone head. With frequencies up to 1000 Hz contained within a 10° angle from the focal point, losses do not exceed 5 dB; with angles exceeding 20°, rejection is typically up to 20 dB. Sound 100' away with range of 500-5000 Hz, can be recorded with an increase of 14 dB when the reflector is used. The Parabolic Reflector is constructed of aluminum and measures 24" in diameter.

Circle No. 78 on Reader Service Page 15 or 115

ANTENNA ROTOR SYSTEM FOR FM AND TV

The "Dyna-Rotor", made by Jerrold Electronics Corp., combines an all-solid-state control device with a lightweight, fast-responding, and accurate positioning rotor for home-TV antennas. Powered by a spline drive that contains fewer moving parts than the conventional planetary drive, the new rotor develops high starting torque to overcome inertia and wind and ice loading. The system's mast-mounted rotor is permanently synchronized with the control device to lock automatically into any selected position. A "Dyna-Rotor" will support the largest of TV antennas and will rotate a full 360° arc in about 40 seconds.



Circle No. 79 on Reader Service Page 15 or 115

LOUDSPEAKER FOR INSTRUMENT AMPLIFIERS

University Sound's Model GS-100 loudspeaker is designed to provide the high-quality sound and high power handling capabilities demanded by instrumentalists who use elec-

CIRCLE NO. 12 ON READER SERVICE PAGE →

\$149 Courier Traveller. All 23 channels.



We put everything into the new Courier Traveller to make it the industry's smallest 23-channel CB transceiver. And the smallest thing of all is its price—\$149. Every feature you'd look for to assure total performance—honed down into a compact 5¼" W x 6¼" D x 1⅞" H. Start with silicon-transistors throughout. Exclusive incoming signal indicator, which lights up automatically when receiving S-6 or better signal—keeps your eyes on the road. Super efficient transmitter designed to help pierce "skip."

Add illuminated channel selector, auxiliary speaker jack, modulation indicator, and single-knob tuning. Plus exclusive Courier "Safety Circuit" to protect against mismatched antenna, incorrect polarity, and overload. All packed into that remarkably small chassis that fits so conveniently into any auto.

Sorry. There's nothing small about Traveller's guarantee. It's so trouble-free, we had to guarantee it for 10 full years.

Just **\$149**
Complete with crystals
for all 23 channels.
(Base station power
supply available.)



**COURIER
COMMUNICATIONS, INC.**

439 Frelinghuysen Avenue, Newark, N.J. 07114

a subsidiary of **Whittaker** corporation

Yes. Tell me all about
the new \$149 Courier Traveller.

Name PE-89

Address

City

County

State

Zip

PRODUCTS (Continued from page 22)

tronic amplifiers. The speaker handles up to 100 watts of continuous r.m.s. power. The voice-coil former is made of 2"-diameter hardened aluminum for maximum efficiency and cooling. An 8.5-lb magnet provides the high acoustical output level and doubles as a heat sink for the voice coil. The speaker cone is made of seamless, one-piece molded-fiber material with high heat-resistance and strength properties. The impedance of the GS-100 is rated at 8 ohms.

Circle No. 80 on Reader Service Page 15 or 115

ELECTRONIC HOME-PROTECTION SYSTEM

An unusual "load" signal method developed by Berkley Scientific Laboratories is utilized by the *Heath Company's* kit for an electronic home-protection system. The kit consists of a minimum of three interrelated units: a

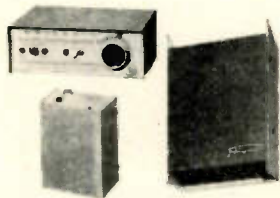

Model GD-77 receiver/alarm; Model GD-87 smoke/heat detector-transmitter; and Model GD-97 utility transmitter. Other units can be used as needed. For example,

extra heat sensors can be added to the smoke/heat detector, and the utility unit accepts any type of switch or high-to-low resistance sensor. The signal developed by the transmitter is seldom duplicated in normal devices or random-noise sources so false alarms are extremely rare. A fail-safe feature signals when a.c. power fails, or if failure occurs in any of the units.

Circle No. 81 on Reader Service Page 15 or 115

LOW-COST MICROPHONES

Six new "Starmaker Series" microphones for professional and home use are available from *RCA Electronic Products*. Models 96 and 97 are professional-type cardioids, exhibiting



unidirectional pickup patterns, three-position bass roll-off switch to reduce rumble and unwanted background noise, and frequency responses of

50-15,000 Hz. The omnidirectional Model 98, also a professional mike, has a frequency response of 40-17,000 Hz and output impedances of 200 ohms and 15,000 ohms (-78 dB and -60 dB output levels, respectively). Cardioid Model 99 (80-10,000 Hz, 500 ohms, -76 dB) and omnidirectional Model 100 (100-8000 Hz, 50,000 ohms, -57 dB) are designed for home recording use. Model 101 is designed for paging applications and ham, CB mobile, and

base station communications. Its frequency response is 70-9000 Hz; output level is -55 dB; and impedance is 50,000 ohms.

Circle No. 82 on Reader Service Page 15 or 115

POWER ADAPTER FOR MOBILE TRANSCEIVER

Appropriately termed the "Power Pedestal" by *Amphenol Corporation*, the Model 790 power adapter can convert nearly all five-

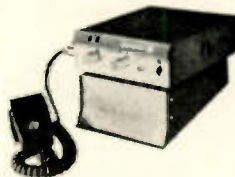

watt CB and low-power ham transceivers for base station use. Unusual design techniques used in the power adapter enable the cabinet to deflect sound from a bottom-mounted

mobile transceiver toward the listener, improving sound quality and eliminating "tinniness." The output voltage of the power adapter is a nominal 13.5 volts d.c. at 5% regulation with 0.05% a.c. ripple. Low-current ripple is typically 0.4 mV at 100 mA, while high-current ripple is 4 mV at 1 A. The all-solid-state adapter features dual rectifier diodes, transistor capacitor multiplier, and zener-diode voltage regulation.

Circle No. 83 on Reader Service Page 15 or 115

DISAPPEARING "RABBIT EARS" ANTENNA

If you're sick of unsightly "rabbit ears" antennas cluttering up the top of your TV set, *Gavin Instruments' Monitor 100UV* "disappearing" antenna is probably just what you've been looking for. This new VHF-UHF antenna is housed in an adhesive-backed plastic base that can be attached to the back of almost any TV set. Featured in the new antenna is a dual-loop UHF antenna, chrome-plated brass VHF elements, and separate leads for VHF and UHF. In use, the dipole elements telescope out from the hidden base. When not in use, the antenna folds out of sight behind the TV set.

Circle No. 84 on Reader Service Page 15 or 115

HAND-HELD METAL FINDER

Electronic metal finder, Model ML-11, from *G S Electronics Company*, is 2" x 4" and operates from a 9-volt transistor



battery. To operate: turn a knob on the right side of the case until the meter pointer on the front deflects upscale. When the instrument is brought close to a metal object, the object's presence is indicated by a dip in the pointer reading. The Model ML-11 metal finder can detect studs, plumbing pipes and fixtures, electrical boxes, heating ducts, nails, and almost any other type of metal

object. The electronic metal locator detects metals through dry-wall, concrete, plaster, and wood.

Circle No. 85 on Reader Service Page 15 or 115

There has never been a better color-bar generator than the RCA WR-64B...

until now!



The RCA WR-502A CHRO-BAR color-bar generator is all solid-state, battery operated... Provides color bars, dots, crosshatch, vertical lines, horizontal lines, blank raster... has rock-solid stability. It's the greatest yet. The CHRO-BAR. \$168.00*.
RCA Electronic Components, Harrison, N.J.

*Optional Distributor resale price. Prices may be slightly higher in Alaska, Hawaii and the West.

RCA

September, 1968

CIRCLE NO. 32 ON READER SERVICE PAGE

25

Which of these 4 fascinating Radio-TV careers



interests
you?

- disc jockey
 newscaster
 sportscaster
 announcer

Our Free Voice Analysis Tells You Whether You Have The Talent To Become A Broadcast Personality!

IMMEDIATE DEMAND • Radio-TV stations everywhere need both men and women to take over important good-paying jobs right now. Free placement assistance!

TRAIN AT HOME OR IN ONE OF OUR STUDIO SCHOOLS • You can study broadcast techniques at home, in your spare time, or in one of our many studio schools throughout the country under the supervision of our Directing Faculty of 8 Famous Broadcasters. Accredited Member National Home Study Council and National Association of Trade and Technical Schools.

Approved for Veterans' Educational Assistance Benefits ("G.I. Bill")! Check coupon for special information

Send to CAREER ACADEMY's division of famous broadcasters for free booklet, record and voice analysis details!

CAREER ACADEMY

825 North Jefferson Street • Studio 251
Milwaukee, Wisconsin 53202

I want to know if I have broadcasting aptitude worth developing. Please rush more information.

name age

address phone

city/state/zip

I am interested in: Home Study
 School Study G. I. Bill

N8719-68



PRODUCTS (Continued from page 24)

PORTABLE STEREO TAPE SYSTEM

Removable cube-shaped speaker units that nest inside the recorder cabinet are featured in the Model 761 tape recording system available from *Amper Corporation*.

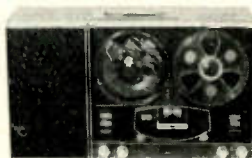

Three tape heads provide monitoring, sound-on-sound, sound-with-sound, echo, and duet effects. Other features include headphone output jacks, automatic shutoff, record

safety interlock, individual channel volume controls, separate bass and treble controls, and an illuminated VU meter. Performance specifications: three-speed operation with frequency responses of 50-15,000 Hz ± 4 dB at 7½ in./sec; 50-7500 Hz ± 4 dB at 3¾ in./sec; and 50-3500 Hz ± 6 dB at 1½ in./sec. Signal-to-noise ratio is 39 dB on all speeds. Output power is 8 W continuous r.m.s. per channel, and preamplifier output is 0.7 V r.m.s. Wow and flutter are 0.2% or better except on 1½ in./sec.

Circle No. 86 on Reader Service Page 15 or 115

MOBILE PA AMPLIFIER

Designed for mobile use, *Lafayette Radio Electronics'* solid-state public address amplifier (stock number 44 H 0140WX) has three separate, illuminated, fiber-optic controls. The amplifier is capable of 55 W of peak output



power. Inputs are provided for low-impedance microphone, high-level crystal or ceramic phono, and auxiliary

for tuner, tape recorder, etc. A 12-15 V d.c. power and audio output socket for siren, foghorn, etc., is also provided. Frequency response is 150-15,000 Hz; gain is 90 dB for radio-auxiliary, 110 dB for mike inputs; noise below rated output is -95 dB on radio auxiliary, -90 dB on mike; sensitivity is 0.4 V on radio-auxiliary, 1 mV on mike. Output impedance is 4, 8, and 16 ohms.

Circle No. 87 on Reader Service Page 15 or 115

FOUR-CHANNEL AUDIO MIXER

Up to four mono or two sets of stereo inputs from any combination of sources add up to full versatility in *Switchcraft, Incorporated's* Model 308 TR solid-state audio mixer. Program input levels can be controlled individually or simultaneously, and equalization for magnetic phono cartridges is provided. Frequency response is 20-20,000 Hz with a 60-dB minimum (referred to 1-mV input) signal-to-noise ratio. Distortion is typically 1% or less at 4 V output. Low output impedance allows use of up to 2000' of feed cable without degradation of frequency response.

Circle No. 88 on Reader Service Page 15 or 115

CIRCLE NO. 7 ON READER SERVICE PAGE

HOWARD W. SAMS BOOKS

for Everyone in Electronics

New Titles

Handbook of Electronic Tables & Formulas. New enlarged 3rd Edition. Complete reference for all charts, math tables, formulas and laws, symbols, constants, and standards. Special color insert shows latest FCC frequency spectrum assignments. 20648 \$5.50

Advanced & Extra-Class License Handbook. Provides all you need to know to obtain the top amateur radio licenses. Covers license requirements, building up code speed, advanced data required, etc. Includes sample questions for each exam. 20649 \$3.95

Transistor TV Training Course. Provides a complete understanding of modern transistor television circuitry by progressive analysis of each stage of a typical receiver. Includes review questions. 20619. \$3.95

North American Radio-TV Station Guide. New 5th Ed. Lists call letters, frequencies, locations, etc., for all a-m, f-m and tv stations (both vhf and uhf) in the U.S. and possessions, Canada, Cuba, Mexico, and the West Indies. 20635. \$2.95

Transistor Fundamentals Series

A complete and definitive 4-volume study and reference work on transistors. Programmed text.

- Vol. 1. Basic Semiconductor and Circuit Principles. 20641 \$4.50
- Vol. 2. Basic Transistor Circuits. 20642 \$4.50
- Vol. 3. Electronic Equipment Circuits. 20643 \$4.50
- Vol. 4. Digital & Special Circuits. 20644 \$4.50
- 4 Vol. Set in Slipcase. 20645... \$15.95

Know Your Tube & Transistor Testers. Explains principles and circuits used in typical testers; provides troubleshooting data for repair of various makes of instruments. 20630 \$3.50

FET Principles, Experiments & Projects. Teaches operating principles of FET's (field-effect transistors). Also includes experiments and projects to enhance learning. A fascinating book for the hobbyist. 20594 \$4.95

Electrical & Electronic Signs & Symbols. Not only describes the symbols used in schematics, diagrams, graphs, etc., but explains how they are constructed and used to convey meaning. 20633 \$4.50

Current Bestsellers

Second-Class Radiotelephone License Handbook. New 3rd Edition. Complete study course for elements I, II and III of the latest FCC exams. Helps you earn the license you need for two-way radio work. 20316. \$5.75

Citizens Band Radio Handbook. Enlarged 3rd Edition. Covers latest CB equipment and circuits, antenna systems, fixed and mobile installations, maintenance and repairs, FCC rules, etc. 20569 \$4.25

Color TV Servicing Made Easy. Full explanation of color principles, circuitry, setup adjustments, and servicing of color TV sets. Takes the mystery out of servicing color TV. Vol. 1. 20135 \$3.95
Vol. 2. 20523 \$4.95

Tape Recorders—How They Work. 2nd Edition. Fully explains principles of magnetic recording, various types of recorders, mechanisms and components, testing procedures, etc. Best reference on the subject. 20445 \$4.50

How to Build Speaker Enclosures. Provides a wealth of both practical and theoretical information for constructing high-performance speaker enclosures for music systems. 20520 \$3.50

99 Ways to Improve Your CB Radio. Packed with invaluable tips on how to operate, service, and maintain CB radio equipment to achieve optimum performance. 20515... \$2.95

How to Read Schematic Diagrams. Enlarged 2nd Ed. Not only shows you how to read and interpret diagrams, but analyzes each component, its construction, and its circuit purpose and use. 20568. \$3.50

- Photofact Television Course. 3rd Ed. 20595. \$4.95
- Modern Dictionary of Electronics. 3rd Ed. 20600. 9.95
- So You Want to Be a Ham. 4th Ed. 20607 4.50
- Short-Wave Listener's Guide. 2nd Ed. 20542 1.95
- 101 Easy Audio Projects. 20608 3.50
- 49 Easy Transistor Projects. 20617 1.75
- Walkie-Talkie Handbook. 20572 3.95
- TV Tube Symptoms & Troubles. 2nd Ed. 20476 2.50



ABC's of Computers. 2nd Ed. Explains clearly just how computers work and what they do. Covers analog and digital types; describes circuitry, memory devices, programming, etc. 20012 \$2.95

ABC's of Lasers and Masers. 2nd Ed. Clearly explains the operation and applications of the laser, the amazing device which produces light radiations capable of performing astounding feats. 20262 \$2.95

Color TV Training Manual. 2nd Ed. Best guide for technicians preparing to service color TV. Detailed explanation of color principles, circuits, setup procedures, alignment, and troubleshooting; full-color illustrations. 20472 \$6.95

Know Your Oscilloscope. 2nd Ed. Latest use of scopes for servicing and observing circuit action. New data on transistorized scope circuitry, triggered-sweep and dual-trace scopes. 20549 \$3.50

101 Ways to Use Your VOM & VTVM. 2nd Ed. Shows how to get the most from these popular instruments, how to make required connections, how to test properly, how to evaluate results. 20510 \$3.50

Tube Substitution Handbook. 11th Ed. Lists over 11,000 direct substitutions for receiving, picture tubes, subminiature, industrial, and communications types. Tells when and how to make proper substitutions. 20614 \$1.75

HOWARD W. SAMS & CO., INC.

Order from your Sams Distributor, or mail to Howard W. Sams & Co., Inc.
4300 W. 62nd St., Indianapolis, Ind. 46268 Dept. PE-9

Send the following books: Nos. _____
\$ _____ enclosed

Name _____

Address _____

City _____ State _____ Zip _____

CIRCLE NO. 27 ON READER SERVICE PAGE

Talk to the

POWERFUL

CB MAN

(Your Squires-Sanders Dealer)

Your Squires-Sanders dealer is **POWERFUL SMART** . . . he knows the best in CB transceivers . . . and how to get the best performance from your base—or mobile. He recommends Squires-Sanders CB equipment. Your Squires-Sanders dealer is also **POWERFUL DEPENDABLE** . . . he is well established and will be around for a long time to serve you . . . like the Squires-Sanders CB equipment he recommends.



THE ADMIRAL

The ADMIRAL: luxurious new all solid state 23 channel CB base station • highly sensitive receiver • Pulse Eliminator • 5 watt transmitter • Speech Compression • +2 mike • dual antenna • HiLo sensitivity • Public Address • Delta Tune • adjustable squelch • ON-THE-AIR light • illuminated S meter • digital panel clock • ear-phone jack • regulated AC power supply • 9 lbs: 5¼ x 13¼ x 10¼ **\$329.95**



The SKIPPER

The SKIPPER: new low priced solid state 23 channel CB transceiver • superb dual conversion FET/IC no-overload receiver • advanced design noise limiting • illuminated S meter and channel • solid state T/R switching • Speech Clipping • 100% modulation • P.T.T. mike • Local/Distant sensitivity • external speaker jack • Public Address • Exclusive "All Position" Safety Breakaway Mount • 3 lbs: 1¼ x 6 x 8 **\$159.95**

Write today for the name of the **POWERFUL** Squires-Sanders dealer in your area.

Squires  Sanders

SQUIRES-SANDERS, INC., Martinsville Road, Liberty Corner, New Jersey 07938

CIRCLE NO. 29 ON READER SERVICE PAGE

BUILD THE G-WHIZ

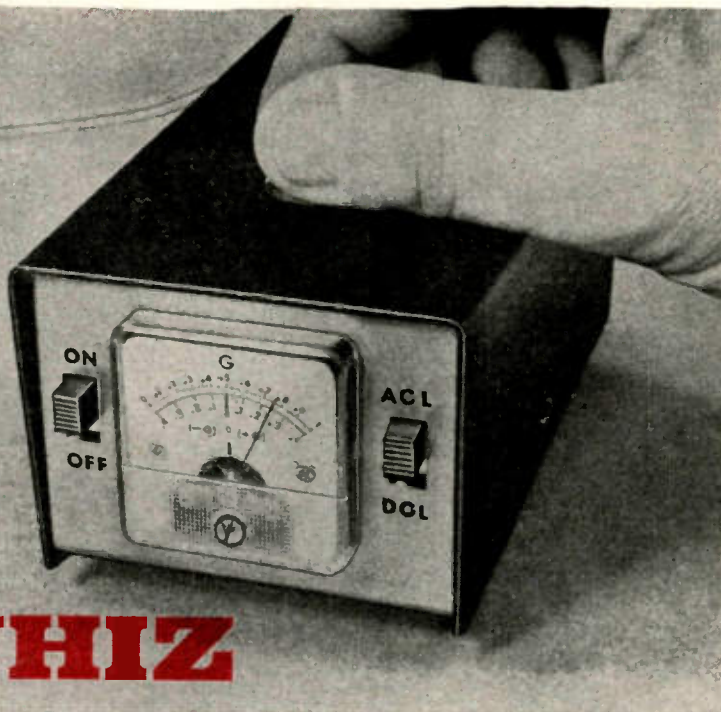

SIMPLE ACCELEROMETER MEASURES
POSITIVE OR NEGATIVE G FORCE

BY GEORGE J. WHALEN

EVER WISH THAT YOU had some way to check your car's acceleration performance under actual road conditions? Or, would you like to check the effect that a tune up, carburetor adjustment, change of fuel grade, timing correction, valve setting, or change in tire pressure has had on your car's performance? Or, if you have stick shift, would you like to determine the optimum shift speeds for each gear to get best performance and fuel economy?

You can do all of this with the "G-Whiz," an indicating accelerometer similar to instruments used widely in aerospace applications, military aircraft, and missile systems. The G-Whiz is specially designed for automotive use and measures both acceleration and deceleration. Except for a 12-volt power supply, it requires no electrical connection to the vehicle. It provides the driver with an accurate means of checking the car's

overall road performance and may even help in correcting poor driving habits.

In coming years, accelerometers like this one may become standard equipment on all new high-performance cars, so here is your chance to get ahead of the times.

Construction. The circuit of Fig. 1 is assembled in the U-shaped portion of a 5" x 3" x 2¼" metal case, drilled as shown in Fig. 2. A cover fabricated by following the layout of Fig. 3 can be covered with a contact-adhesive leatherette finish. Construct the mounting brackets for *R5* and *R4* as shown in Fig. 4. Build, or purchase (see Parts List) the pendulum following the information given in Fig. 5.

Mount zero-adjust potentiometer *R5* on its bracket (see Fig. 4), and mount the bracket as shown in the photos. Mount all the other parts, except for po-

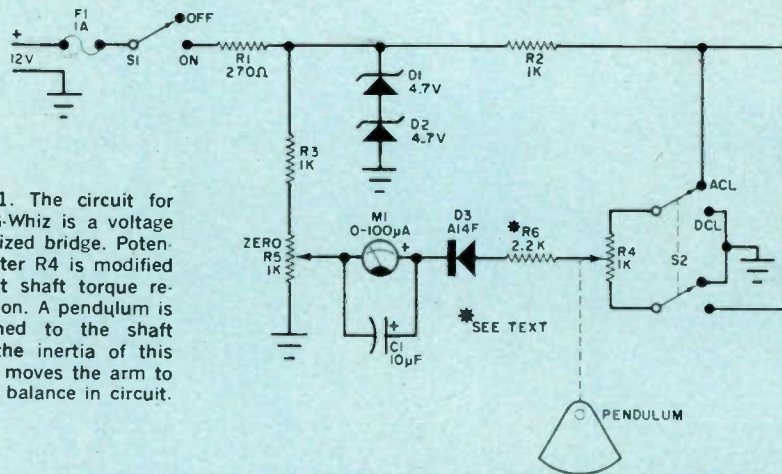

Fig. 1. The circuit for the G-Whiz is a voltage stabilized bridge. Potentiometer R4 is modified to cut shaft torque restriction. A pendulum is attached to the shaft and the inertia of this mass moves the arm to upset balance in circuit.

PARTS LIST

C1—10- μ F, 15-WVDC electrolytic capacitor
 D1, D2—4.7-volt zener diode
 D3—A14F silicon diode (General Electric)
 F1—1-ampere fuse
 M1—100- μ A meter
 R1—270-ohm, $\frac{1}{2}$ -watt resistor
 R2, R3—1000-ohm, $\frac{1}{2}$ -watt resistor
 R4—1000-ohm subminiature linear potentiometer (Mallory MLC-13L or similar)
 R5—1000-ohm linear potentiometer

R6—2200-ohm, 5%, $\frac{1}{2}$ -watt resistor (see text)
 S1—S.p.d.t. switch
 S2—D.p.d.t. switch
 Misc.—Pendulum lead weight (see text), 5-point terminal strips (2), case, fuseholder, right-angle brackets, knob, wire, solder, etc.

A complete kit of parts including punched case, mounting material, etc., is available from Southwest Technical Products Corp., 219 W. Rhapsody, San Antonio, Texas 78216, \$12.75 postpaid.

tentiometer R_4 and the pendulum as shown in the photos, and wire point-to-point in accordance with the schematic. The author elected to solder S_1 and S_2 to the front wall of the chassis. Mount a 5-pin terminal strip at R_5 bracket mounting screw (point B in Fig. 2) and a 5-pin terminal strip at R_4 mounting bracket (point A in Fig. 1).

Potentiometer R_4 will have to be opened and its wiper contacts adjusted to reduce its shaft torque requirement to the minimum. Remove the nut and lock-washer from the shaft bearing and hold the potentiometer so that the shaft faces you. Using a small, thin-blade screwdriver, gently pry up the tabs securing the metal cover to the shaftplate. Slip the cover off to expose the resistance element and wiper assembly. Hold the potentiometer by the shaft and look through the side into the space between the wiper assembly and the resistance element. The larger wipers contact the resistance element and are arranged in opposition. To reduce contact friction, slip a tiny jeweler's screwdriver (or sewing needle) under the back of each con-

tact and gently pry upward a fraction of an inch. After doing this to both wipers, check shaft rotation and note that less

HOW IT WORKS

The circuit, shown in Fig. 1, is basically a bridge that can be balanced at zero G by means of potentiometer R_5 . The pendulum is physically attached to the shaft of potentiometer R_4 ; and if the pendulum tries to rotate about its pivot axis, the bridge becomes unbalanced and meter M_1 indicates the amount of unbalance (meter scale is calibrated in G values). The position of S_2 determines the direction of current flow through R_4 so that an increasing positive-going voltage may be obtained from the movement of the R_4 wiper arm in response to either a backward swing (acceleration) or forward swing (deceleration) of the pendulum. Resistor R_6 is selected to set the full-scale current through M_1 to correspond to +45°, or -45° of potentiometer shaft rotation from its normal (zero G) position.

Diode D_3 , in series with the meter, permits current to flow in only one direction, preventing the needle of M_1 from slamming against its limit stop during a sudden stop when S_2 is set for acceleration, or vice versa. Capacitor C_1 provides electrical damping of the meter to smooth out peak transients due to the inertial effects of the eccentric weight.

Power is obtained from the car's 12-volt d.c. system via fuse F_1 , current-limiting resistor R_1 , and a 9.4-volt regulator consisting of zener diodes D_1 and D_2 .

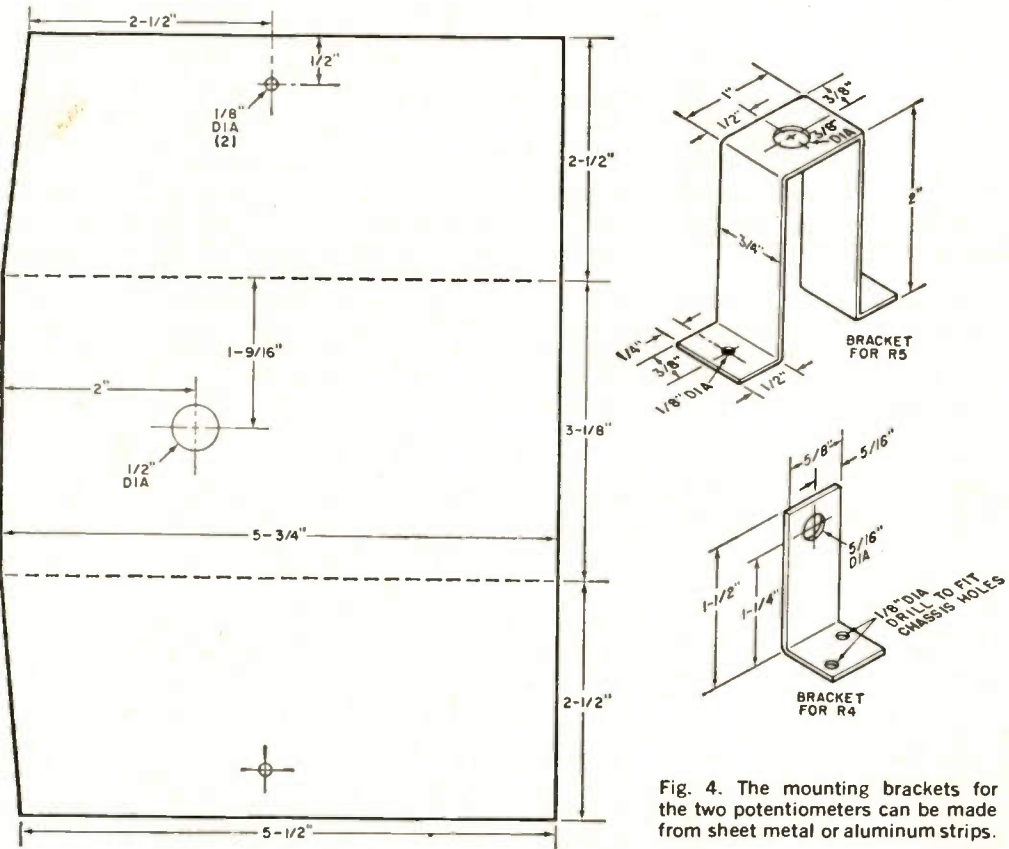
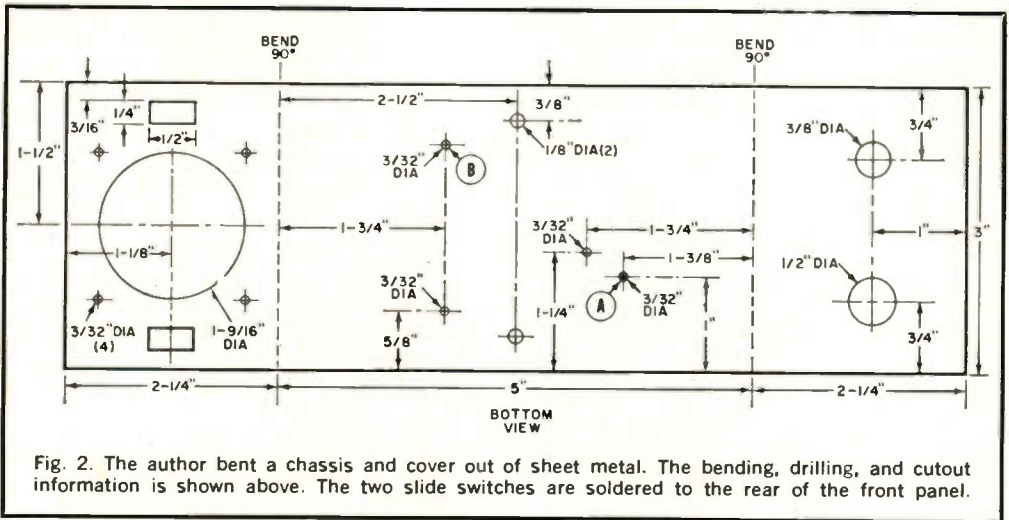

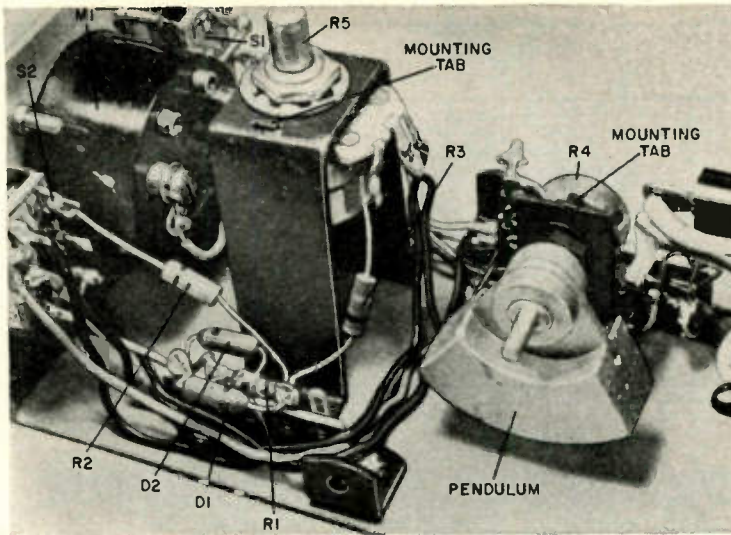

Wiring and assembly is open but very rigid. The pendulum must have room to swing freely. The shaft of zero-G setting potentiometer R5 is accessible through a hole in cover of the metal box.

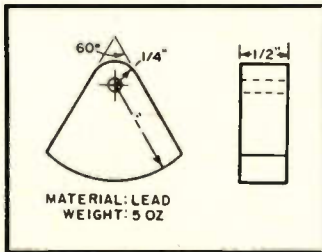

Fig. 5. You can fashion a pendulum from a piece cut from an old tuning flywheel.

torque is required to rotate the shaft. Next, loosen the tiny pair of wipers directly opposite the first pair (riding on

the center slip ring). Use a tiny sewing needle to lift each finger gently to reduce contact pressure. Again check shaft torque to see that it has again been reduced. Inject a drop of contact cleaner and lubricant on the contacts. Calibrate the meter using the table as a guide.

Before replacing the cover, check the resistance between either end terminal and the rotor to make sure that contact is still established. If necessary, you may have to tighten up on the contact fingers very slightly. Slip the metal cover back on the pot, making sure that the cutout is opposite the three terminals and does not contact either of the terminals. Use

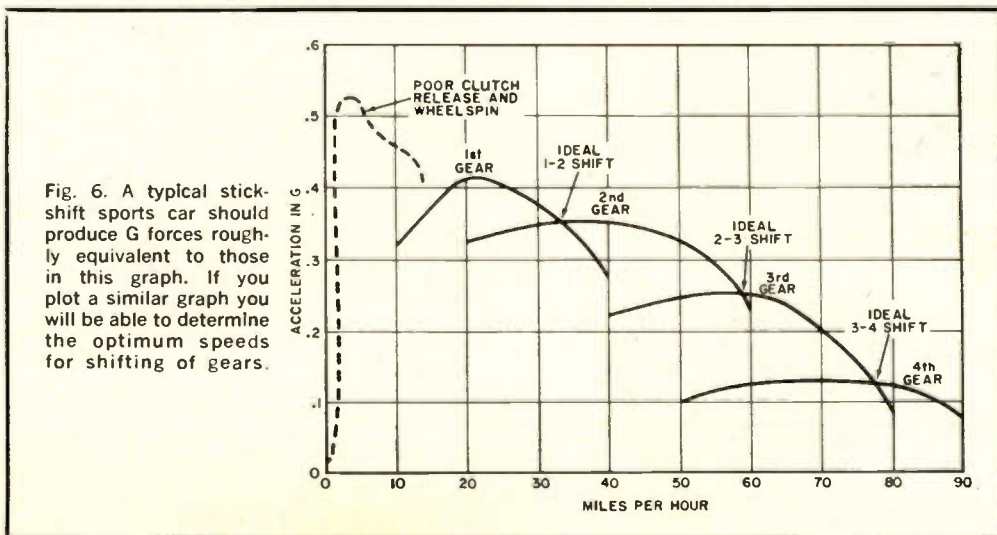
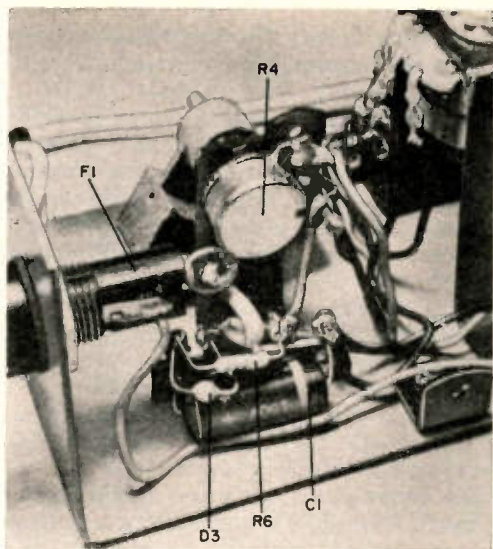

Fig. 6. A typical stick-shift sports car should produce G forces roughly equivalent to those in this graph. If you plot a similar graph you will be able to determine the optimum speeds for shifting of gears.

the flat blade of a screwdriver to bend the securing tabs flat against the shaft-plate. Mount R_4 in its right-angle bracket (see Fig. 4) so that its mounting tab rests atop the bracket. Secure the bracket in place.

Being very careful, coat the potentiometer shaft with solder from its end to a point about $\frac{1}{2}$ inch from the shaft bearing. Do not get any solder between the shaft and bearing. After the shaft has been tinned, install it in position on its mounting bracket as shown in the photos. Temporarily jumper the two end terminals and connect an ohmmeter between the end terminals and the wiper. Rotate the shaft of the pot for maximum indication on the ohmmeter and leave the shaft there. Slide the pendulum on the pot shaft, trying to keep the pot shaft from rotating. When the pendulum is positioned close to the shaft bearing, recheck that R_4 is at true midscale with the pendulum hanging straight down, then solder the pendulum to the shaft. After the metal cools, swing the pendulum back and forth and note that the ohmmeter shows a resistance variation, and that the weight swings freely across a 90° arc. Connect R_4 into the circuit.



Drilled and tapped right-angle brackets (top center and bottom right) are used to hold cover in place.

Install a pair of small right-angle brackets on the chassis base (see photos) so that the cover can be easily attached. Make sure that all wiring is dressed away from the area of pendulum swing so as not to hinder operation.

HOW A PENDULUM RESPONDS TO ACCELERATION

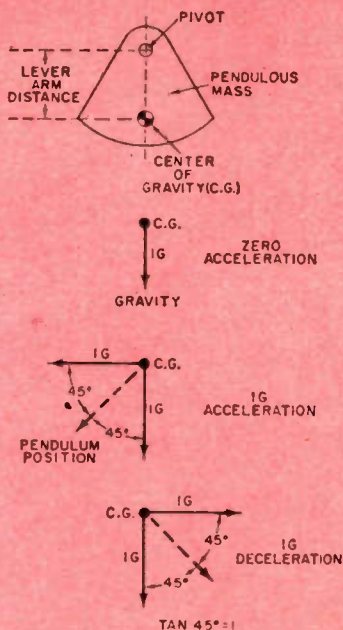

All forces acting on the pendulum mass act on its center of gravity, which is eccentric with respect to its pivot point. The lever arm is the distance from the pivot point to the center of gravity and transmits the force acting on the center of gravity to the pivot in a rotational manner.

The pendulous mass responds to the "pull of gravity" and tends to hang down (toward the center of gravity of the earth) unless acted upon by the horizontal push of acceleration or deceleration forces. Thus, gravity provides the reference against which the horizontal forces are compared.

The physical response of the pendulum to gravity and acceleration is a vectorial quantity, since the two forces act at right angles to the center of gravity. The pendulum acts to maintain an equilibrium position, balancing the two forces by rotating in a vertical arc about the pivot. If the two forces are equal, the pendulum assumes a 45° angle from its zero acceleration position. For lesser acceleration or deceleration forces, the pendulum pivots to a smaller angular position. The tangent of the angle described by the pendulum's position under acceleration or deceleration is equal to the horizontal G force.

Testing. Insert the fuse (*F1*) and connect the power cord to source of 12 volts d.c. observing lead polarity. With *S1* turned ON, the voltage across zener diodes *D1* and *D2* should be 9.4 volts, indicating that the regulator is working properly. Place the G-Whiz on a flat horizontal table and with the power still turned on, set *S2* at ACL and adjust *R5* (zero control) until the meter just indicates zero G (left-hand scale limit).

Since it is difficult to simulate one-G forces, the best thing to do is displace the pendulum to simulate this force. For this, you will need a 45° triangle. Stand the triangle up on one of its sides (not the hypotenuse), and place the case on the hypotenuse with the meter facing down. Note that the pendulum swings so as to "point" straight down due to the pull of gravity. The meter should indicate one G (at right-hand scale limit). If the meter does not read exactly full scale (one G), the value of *R6* will have to be adjusted.

Now place the device on a flat horizontal surface, set *S2* to DCL and adjust *R5* for a zero indication on *M1*. Place the case on the hypotenuse of the triangle, meter face up, and note that the pendulum swings to hang down and the meter indicates full scale (right-hand limit).

Once tested, install the cover on the device, feeding the shaft of *R5* through

its hole and place a small knob on the shaft of *R5*.

Installation. The G-Whiz can be installed almost anywhere in the car as long as it is mounted as horizontal as possible. Make sure that the long side of the chassis is always parallel to the direction of travel of the vehicle. (The swing arc of the pendulum must be in the direction of vehicle travel.) The device can be bolted, strapped, or secured with two-sided adhesive tape to the top of the dashboard or other convenient horizontal surface. If the case is slanted to one side or the other, the pendulum will not respond to true acceleration but to an angular component of this force, thus producing erroneous indications. However, if the long side of the chassis is slightly tilted, this can be corrected by adjusting *R5* for a true zero.

Road Testing. Before testing the G-Whiz, make sure that you can observe all traffic safety laws before performing the following tests. It is advisable to have a passenger use a clipboard, pad, pencil, and stopwatch to record the meter readings.

Before making the road tests, remember that the G-Whiz is sensitive to horizontal attitude, so try to use a level road for best accuracy.

SPEED		BRAKING DISTANCE AFTER BRAKE APPLICATION AT 0.5G DECELERATION	MINIMUM ACCEPTABLE DISTANCES DRUM-TYPE BRAKES
MILES PER HOUR	FEET PER SECOND		
20	30	22FT	
30	45	50FT	
40	60	89FT	
50	75	139FT	
60	90	200FT	

Fig. 7. The G-Whiz is an excellent device to check performance of drum or disc-type brakes. A good test is to decelerate at 0.5 G and measure the braking distance vs. miles per hour. Acceptable distances are shown in this graph. Brake fading can be observed on the G-Whiz as described in the text on page 40.

With the car stopped, turn on the power (S1), set S2 to ACL, and rotate R5 to set the meter needle just to the left-hand zero mark (0 G). The driver watches the road and keeps an eye on the speedometer, while the passenger watches the G-Whiz dial. Start the car, put it in low gear, and make as fast a start as possible. At each 10-mph interval, the driver calls out "check," and the passenger records both speed and G readings. Carry out this procedure to at least 10 mph faster than your normal shift speed for this gear. This speed depends on your type of car. Therefore, before you begin, check your manual to determine just how fast you can go in this gear without damaging the vehicle.

Next, perform the same test in second gear. Start in first, then shift to second about 10 mph slower than the normal shift speed. Accelerate full throttle to at least 10 mph faster than normal second-to-third shift speed, calling out each 10 mph so that the passenger can record both speed and G value. Do the same for any other gears you have in your vehicle, starting at about 10 mph slower than normal and running to about 10 mph faster.

Once all the data has been recorded, a graph similar to that shown in Fig. 6 can be plotted. On a sheet of conventional linear graph paper, draw a horizontal axis marked in miles per hour from zero to 100 mph, letting each small box represent 2.5 mph. Draw a vertical line from the 0-mph point and mark this off from zero to one G with each small box representing .025 G.

Once the acceleration curves have been drawn on the graph, they can be interpreted. Obviously, first gear is the big performer, as indicated by the sharp rise in G readings in comparison with the other gears in Fig. 6. This is also the gear in which most errors can be made. For example, popping the clutch or excessive wheel spin may decrease efficiency in this gear as shown by the sudden high-G peak of the dashed-line curve of Fig. 6. If your actual curve shows this characteristic, you need to improve your clutching and braking techniques.

Note that the curves for each gear overlap. The crossover point in each case represents the ideal shift point between the two gears. If you shift out of a lower

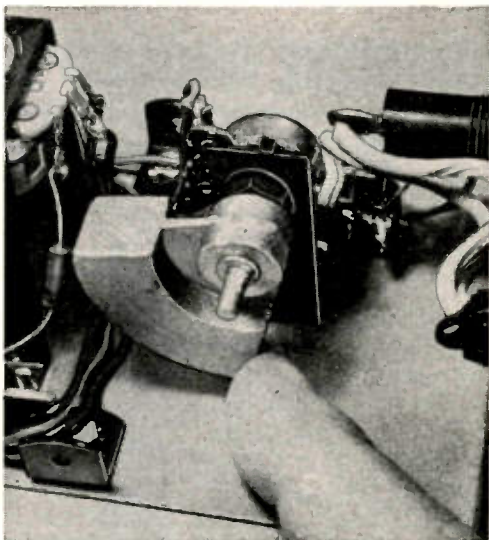

Before sealing up the G-Whiz makes a bench test to be absolutely positive that the pendulum is free.

gear as the acceleration is tapering off into a higher gear where more acceleration can be picked up, you can maintain a higher overall acceleration. If your car is equipped with an engine tachometer (RPM), you may be surprised at the relatively low RPM readings corresponding to each ideal shift point. Contrary to popular belief, winding out in each gear and running near the engine red line actually wastes time, results in deceleration

WHAT IS G?

To understand what "G" is, you must first understand the difference between speed and acceleration. Speed is a measure of distance traveled per unit of time, usually expressed in feet per second or miles per hour. Acceleration is a measure of change in speed per unit of time, expressed in feet per second per second or miles per hour per second. Remember that you can have speed without acceleration, but you can't have acceleration without speed.

Since the units for acceleration are somewhat cumbersome, it is usually expressed simply in terms of the letter G. Taken from the word *gravity*, the G is an international standard unit defined as the acceleration produced on a dropped object by the earth's gravitational field. In actual figures, an acceleration of one G is equal to 32.2 ft/sec/sec/or 22 mph/sec.

Precise measurements of low values of G can tell us quite a bit about the performance of our cars, as explained in the article.

SOMEONE SHOULD DEVELOP AN EASY WAY TO LEARN ELECTRONICS AT HOME

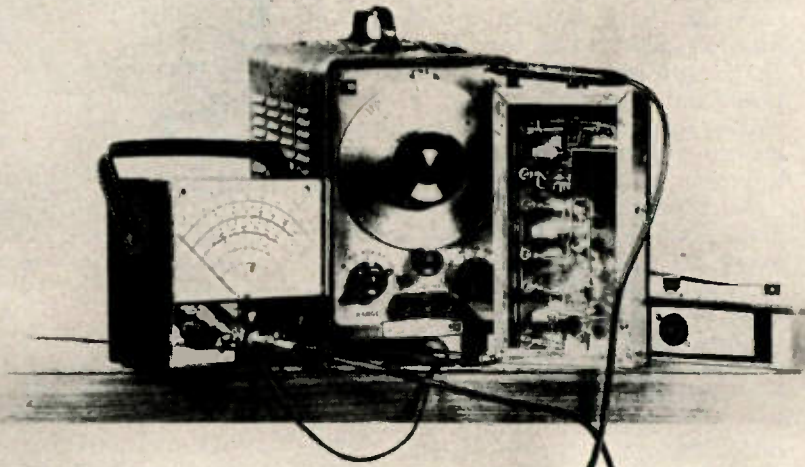

RCA INSTITUTES DID!

Here is a whole new approach to learning electronics at home! RCA Institutes, one of the nations' largest schools devoted to electronics, has developed a faster, easier way for you to gain the skills and the knowledge you need for the career of your choice. Here for the first time, is a student-proved, scientifically designed way to learn. If you have had any doubts in the past about home training in electronics—if you have hesitated because you thought you might not be able to keep up—or that electronics was too complicated to learn—here is your answer! Read how RCA Institutes has revolutionized its entire home training ideas!

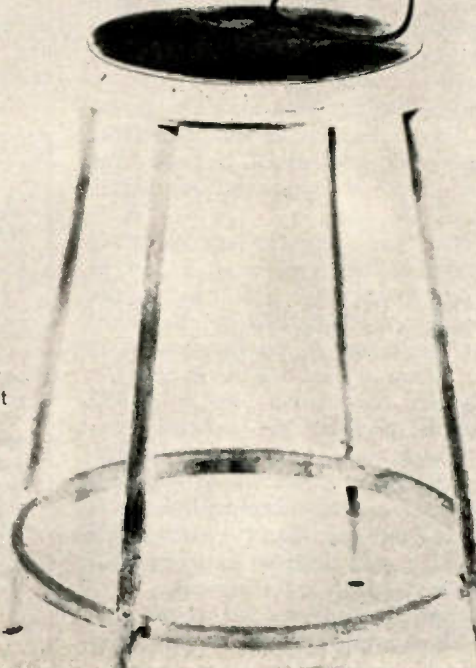

NEW CAREER PROGRAMS BEGIN WITH "AUTOTEXT" INSTRUCTION METHOD!

Start to learn the field of your choice immediately!

No previous training or experience in electronics needed!

With this new revolutionized method of home training you pick the career of your choice—and RCA Institutes trains you for it. RCA's Career Programs assure you that everything you learn will help you go directly to the field that you have chosen! No wasted time learning things you'll never use on the job! The Career Program you choose is especially designed to get you into that career in the fastest, easiest possible way!

And each Career Program starts with the amazing "AUTOTEXT" Programmed Instruction Method—the new, faster way to learn that's almost automatic! "AUTOTEXT" helps even those who have had trouble with conventional home training methods in the past. This is the "Space Age" way to learn everything you need to know with the least amount of time and effort.

CHOOSE A CAREER PROGRAM NOW

Your next stop may be the job of your choice. Each one of these RCA Institutes Career Programs is a complete unit. It contains the know-how you need to step into a profitable career. Here are the names of the programs and the kinds of jobs they train you for. Which one is for you?

Television Servicing. Prepares you for a career as a TV Technician/Serviceman; Master Antenna Systems Technician; TV Laboratory Technician; Educational TV Technician.

FCC License Preparation. For those who want to become TV Station Engineers, Communications Laboratory Technicians, or Field Engineers.

Automation Electronics. Gets you ready to be an Automation Electronics Technician; Manufacturer's Representative; Industrial Electronics Technician.

Automatic Controls. Prepares you to be an Automatic Controls Electronics Technician; Industrial Laboratory Technician; Maintenance Technician; Field Engineer.

Digital Techniques. For a career as a Digital Techniques Electronics Technician; Industrial Electronics Technician; Industrial Laboratory Technician.

Telecommunications. For a job as TV Station Engineer, Mobile Communications Technician, Marine Radio Technician.

Industrial Electronics. For jobs as Industrial Electronics Technicians; Field Engineers; Maintenance Technicians; Industrial Laboratory Technicians.

Nuclear Instrumentation. For those who want careers as Nuclear Instrumentation Electronics Technicians; Industrial Laboratory Technicians; Industrial Electronics Technicians.

Solid State Electronics. Become a specialist in the Semiconductor Field.

Electronics Drafting. Junior Draftsman, Junior Technical Illustrator; Parts Inspector; Design Draftsman Trainee Chartist.

SEPARATE COURSES

In addition, in order to meet specific needs, RCA Institutes offers a wide variety of separate courses which may be taken independently of the Career Programs, on all subjects from Electronics Fundamentals to Computer Programming. Complete information will be sent with your other materials.

LIBERAL TUITION PLAN

RCA offers you a unique Liberal Tuition Plan—your most economical way to learn. You pay for lessons only as you order them. No long term contracts. If you wish to stop your training for any reason, you may do so and not owe one cent until you resume the course.

VALUABLE EQUIPMENT

You receive valuable equipment to keep and use on the job—and you never have to take apart one piece to build another. New—Programmed Electronics Breadboard. You now will receive a scientifically programmed electronic bread-

board with your study material. This breadboard provides limitless experimentation with basic electrical and electronic circuits involving vacuum tubes and transistors and includes the construction of a working signal generator and superheterodyne AM Receiver.

Bonus From RCA—Multimeter and Oscilloscope Kits. At no additional cost, you will receive with every RCA Institutes Career Program the instruments and kit material you need to build a multimeter and oscilloscope. The inclusion of both these kits is an RCA extra.

CLASSROOM TRAINING ALSO AVAILABLE

RCA Institutes maintains one of the largest schools of its kind in New York City where classroom and laboratory training is available in day or evening sessions. You may be admitted without any previous technical training; preparatory courses are available if you haven't completed high school. Coeducational classes start four times a year.

JOB PLACEMENT SERVICE, TOO!

Companies like IBM, Bell Telephone Labs, GE, RCA, Xerox, Honeywell, Grumman, Westinghouse, and major Radio and TV Networks have regularly employed graduates through RCA Institutes' own placement service.

SEND ATTACHED POSTAGE PAID CARD FOR COMPLETE INFORMATION, NO OBLIGATION. NO SALESMAN WILL CALL.

ALL RCA INSTITUTES COURSES AVAILABLE UNDER NEW GI BILL.

Accredited Member
National Home Study Council

RCA INSTITUTES, Inc., Dept. PE-98
320 West 31st St., New York, N.Y. 10001

RCA

tion due to frictional losses, and poses the threat of valve float. The reasons can be found in your engine manual. Most engines deliver maximum torque at fairly low RPM, while maximum horsepower occurs at a somewhat higher RPM. Always remember, it is the torque that counts!

Checking Brakes. To check the brakes, place *S2* in the DCL position and rotate *R5* until the meter needle just rests on the left-hand zero-G mark. Accelerate the car to 40 mph and firmly apply the brakes as you would for a hard stop. The meter should indicate about 0.5 G if your car is an American make, equipped with conventional drum brakes. If your car is equipped with disc brakes, you may pull as high as 0.7 to 0.9 G. Minimum acceptable braking distances for cars equipped with drum brakes are shown in Fig. 7. You should obtain a 0.5-G reading within these distances.

To check the fade characteristics of the brakes, make a series of hard stops from 40 mph, noting the G readings. Fade will be evidenced by a lowering of the G value each time.

Economy Driving. Except for major repair costs, the biggest expenses incurred in operating a car are for gasoline and tires. Exact figures vary, but they may total 12% of the original cost of the car each year. It is assumed that the driver uses the proper driving techniques—no jack-rabbit starts or hard stops—and that the car is kept tuned up.

While the car is in motion, place *S2* in the ACL position, and adjust *R5* until the meter indicates the zero-G center of the lower scale. In this way you can check both drag and accelerator "diddle" at highway cruising speeds. Drag results from the aerodynamic resistance of the car, excessive tire friction, and the viscosity of the lubricant in the crankcase. Accelerator "diddle" is a driver problem. Some people unconsciously tap the accelerator; and with each tap, the carburetor pump squirts a stream of gas into the throat. The amount of gas is not enough to alter the vehicle speed much, but the wasted gas can add up. Once you have attained the desired highway speed, drive to keep the needle at the zero-G center mark.

METER CALIBRATION		
METER CURRENT (μ A)	G	PENDULUM ANGLE (deg)
0-to-1 G scale ^a		
0	0	0
13	.1	6
26	.2	11
39	.3	17
51	.4	22
62	.5	26.5
71	.6	31
79	.7	35
87	.8	38.5
94	.9	42
100	1.0	45
.4-0-.4 scale		
100	+ .4	22 (aft)
89	+ .3	17 (aft)
76	+ .2	11 (aft)
63	+ .1	6 (aft)
50	0	0 (null)
37	- .1	6 (fwd)
24	- .2	11 (fwd)
11	- .3	17 (fwd)
0	- .4	22 (fwd)

^aPendulum angle is measured from the normal null when the chassis is horizontal and the pendulum hangs straight down. The 0-to-1 G scale applies for either ACL or DCL conditions. In the second, zero-center scale, aft (+) is for acceleration with the pendulum swing to the rear of the chassis, while fwd (forward) is for deceleration with the pendulum swing to the front of the chassis. A low-voltage power source and a series potentiometer can be used to produce the desired meter current deflections.

You can detect drag by removing your foot from the accelerator after reaching a constant speed and observing the reading in G's as the needle deflects to the left of the center-scale zero. Drag increases with speed, so make this test at an initial speed of 60 mph. The deeper the needle dips, the greater the fuel-robbing drag. Drag can be reduced by keeping tire pressure up to recommended value and compensating for excessive weight (passengers, etc.) by increasing the tire pressure slightly.

Heavyweight lubricants are also a source of drag. These thick lubricants may be all right for hot weather driving, but they can become a sticky medium that contributes to drag at moderate and cold temperatures. Change your lubricant to fit the season.



BUILD A MUSICAL
PITCH REFERENCE

INTEGRATED CIRCUITS ARE USED TO DEVELOP
TWELVE MIDDLE TONES FOR ORGAN TUNEUP

BY DON LANCASTER

NOTHING MARS THE PLEASURE of playing a musical instrument like having it be out of tune. If your ear is good, you can tune a guitar or a violin using a pitch pipe or a tuning fork. Tuning a piano or an organ is more difficult, requiring complex equipment, lots of experience, and an expert ear.

Tuning a musical instrument of any type is made almost foolproof if you

have available a source of musical pitches covering one whole octave. That's what the "Pitch Reference" does. It is an integrated-circuit frequency synthesizer that generates twelve of the middle notes of the equally tempered musical scale to an accuracy better than the best ear can determine and with a stability unattainable by the finest set of tuning forks.

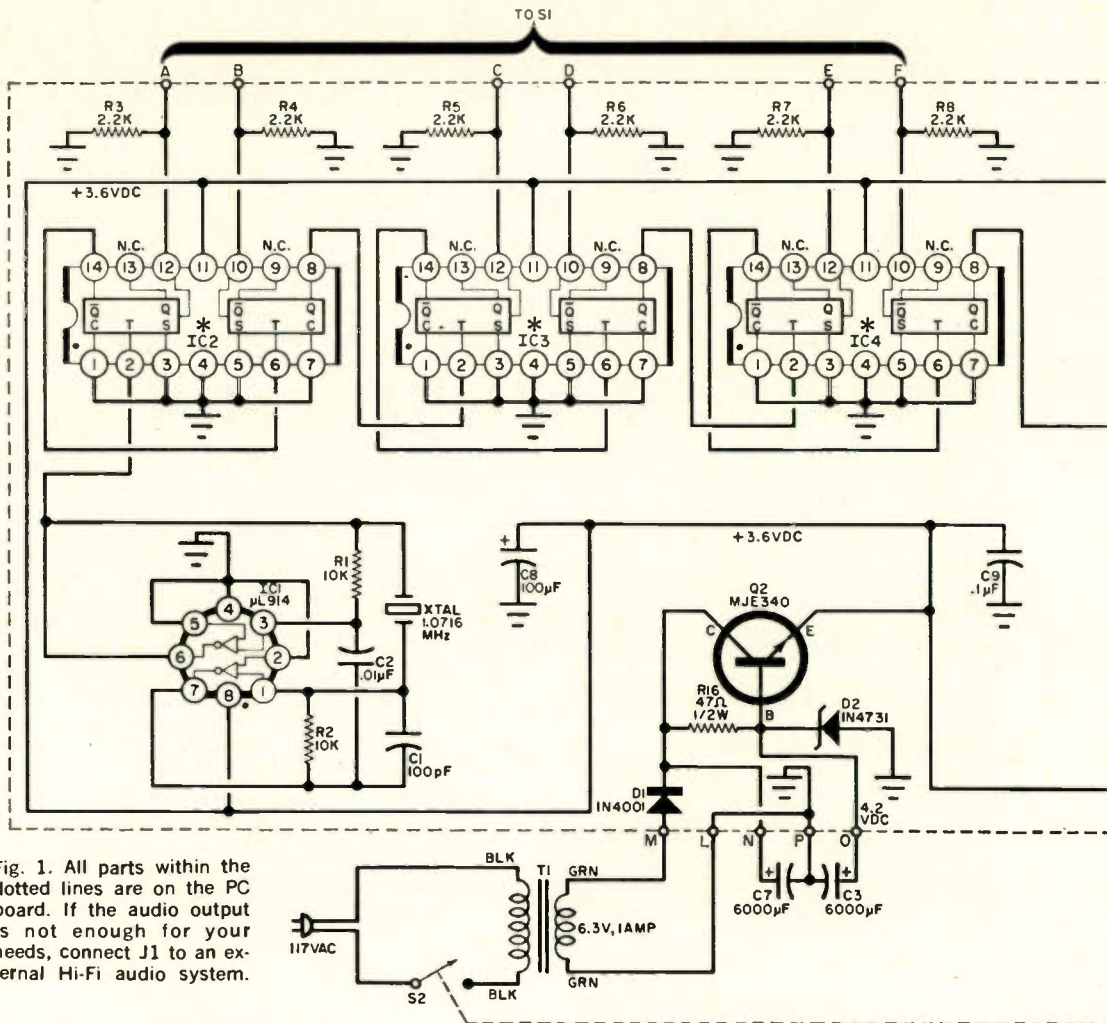
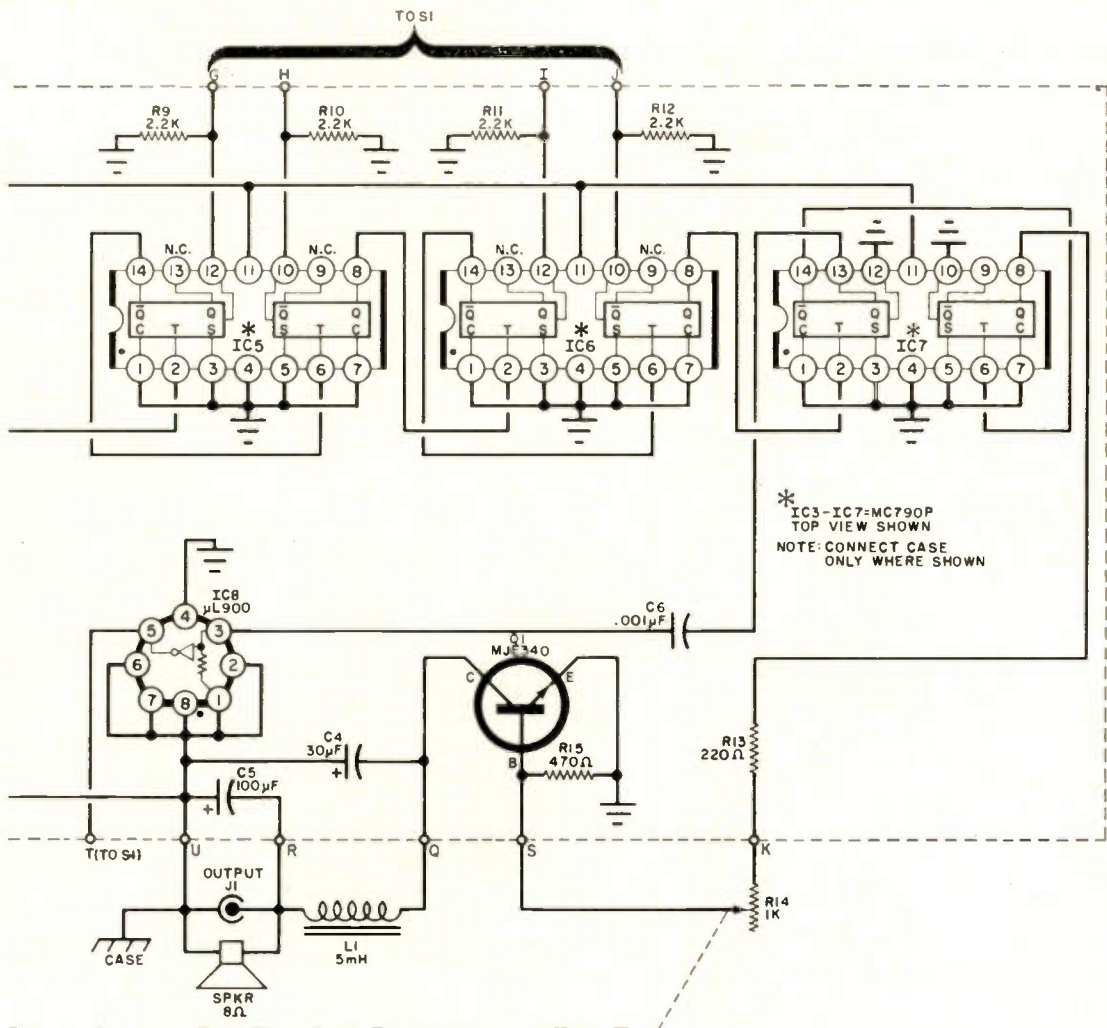

Fig. 1. All parts within the dotted lines are on the PC board. If the audio output is not enough for your needs, connect J1 to an external Hi-Fi audio system.

PARTS LIST

- C1—100-pF dipped mica capacitor
 C2—0.01- μ F mylar capacitor
 C3, C7—6000- μ F, 10-volt computer-grade electrolytic capacitor (Sprague 36D602G010A2A or similar)
 C4—30- μ F, 6-volt electrolytic. Do not substitute
 C5, C8—100- μ F, 6-volt electrolytic. Do not substitute
 C6—0.001- μ F mylar capacitor
 C9—0.1- μ F, 10-volt ceramic disc capacitor
 D1—1N4001 diode (Motorola)
 D2—1N4731 4.2-volt zener diode (Motorola)
 IC1— μ L914 dual two-input gate (Fairchild)
 IC2-IC7—MIC790P dual flip-flop (Motorola)
 IC8— μ L900 buffer (Fairchild)
 J1—RCA phono jack
 L1—0.01-millihenry toroid (Thordarson TOR779 or Triad EA005. Do not substitute.)
 Q1, Q2—MJE340 transistor (Motorola)
 R1, R2—10,000-ohm, $\frac{1}{4}$ -watt resistor
 R3-R12—2200-ohm, $\frac{1}{4}$ -watt resistor
 R13—220-ohm, $\frac{1}{4}$ -watt resistor
 R14—1000-ohm linear potentiometer with s.p.s.t. rotary switch (S2)

- R15—470-ohm, $\frac{1}{4}$ -watt resistor
 R16—47-ohm, $\frac{1}{2}$ -watt carbon resistor
 S1—7-pole, 12-position, continuous rotation, non-shorting selector switch
 S2—S.p.s.t. switch attached to R14
 Spkr—3 x 5 oval PM speaker, 8-ohm
 T1—Filament transformer; secondary 6.3-volt, 1-ampere
 XTAL—1.0716-MHz series-resonant crystal
 Misc.—Case, dialplate, line cord and strain relief, wirenut, front decorative grill, knobs, mounting feet, capacitor clips, standoffs, terminals, pop rivets, wire solder, backup plate for controls, crystal clip, PC terminals, heat-sink clip and plastic mounting hardware for Q1 and Q2, sleeving, cement, etc.
 Dialplate: Genuine Metalphoto Dialplate available from Reill's Photo Finishing, 4627 N. 11 St., Phoenix, Ariz. 85014. In black and silver \$2.75; red, gold, or copper \$3.25, postpaid in USA. Stock number PRF-1.
 Kits and Special Parts: The following are available from Southwest Technical Products Corp., Box 16297, San Antonio, Texas 78216. Etched



and drilled printed-circuit board (part number 154), \$3.50. Write for price list on other available components.

The following manufacturers will grind the 1.0716-MHz crystal and encase it in a wire-lead holder. Check for price and delivery time. Texas Crystals, 1000 Crystal Drive, Ft. Myers, Florida 33901 International Crystal Mfg. Co. Inc., 10 N. Lee, Oklahoma City, Oklahoma 73102 CTS Knights Inc., 101 E. Church St., Sandwich, Illinois 60548

Note: All Motorola semiconductors available from Allied Radio, 100 N. Western Ave., Chicago, Ill. 60680. Related data sheets from Motorola Semiconductor, Box 955, Phoenix, Ariz. 85001. Data sheets and distributor list on IC1 and IC8 available from Fairchild Semiconductor, 313 Fairchild Dr., Mt. View, Calif.

With the Pitch Reference, tuning an electronic organ or guitar is a snap. Add the basic wedges and a tuning hammer, and you can easily tune a piano electronically, listening only for fundamental unison beats that even an untrained ear can easily detect. The Pitch Reference is also dandy for tuning up a band, an orchestra, or even for making intonation studies on a solo instrument. Unlike a tuning fork, the Pitch Reference will "sound off" all day if necessary. Any pitch can be selected by the flicking of a switch and the volume can be adjusted. The device can also be used in physics demonstrations and sound experiments, or as a good entry in a science fair.

The line-powered Pitch Reference is built into a vinyl-clad aluminum case and

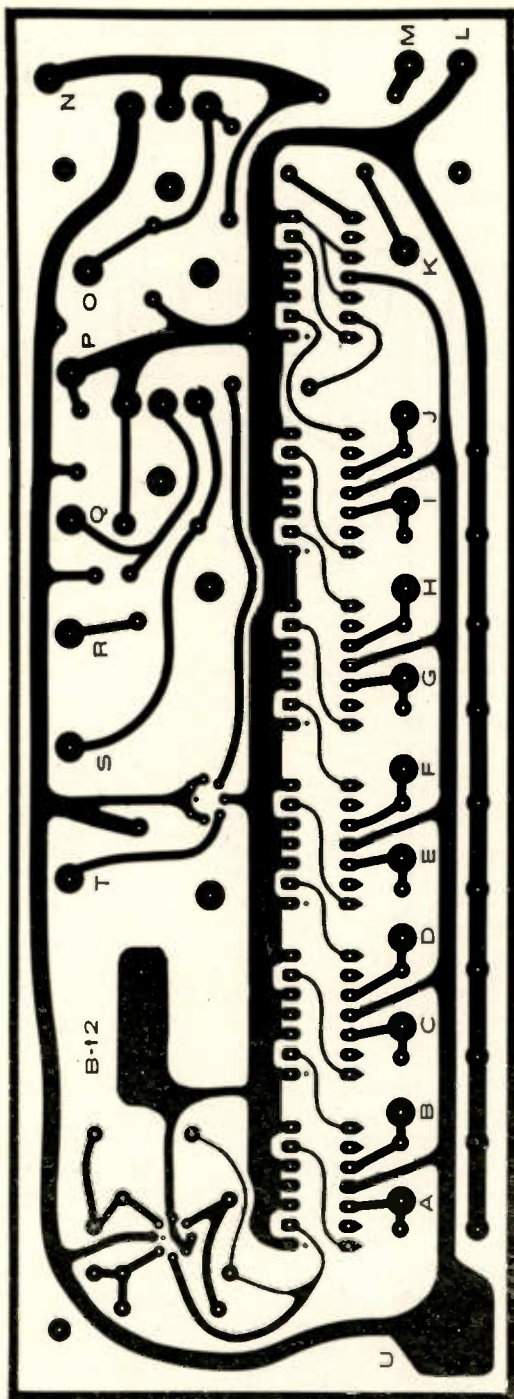
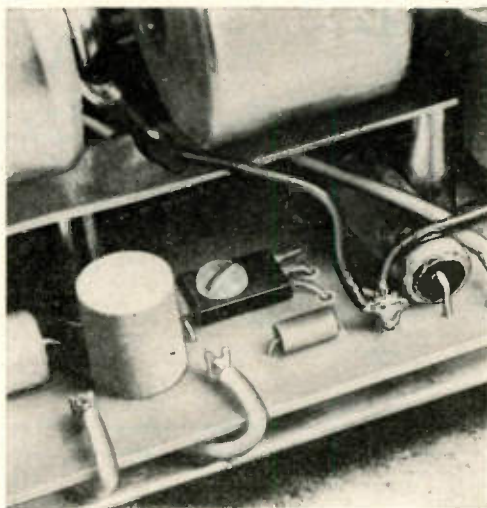

Fig. 2. Actual-size printed-board foil pattern layout. Because of circuit complexity, such a board is necessary to avoid troublesome wiring errors.

contains 8 integrated circuits and two transistors. Depending on the degree of refinement you want, you can build it for \$30 to \$45. Printed circuit boards, dialplates, complete kits, and any special parts are available.

Construction. The schematic of the circuit is shown in Fig. 1. A printed circuit board is mandatory for this project. You can buy one already etched and drilled (see Parts List of Fig. 1) or you can make your own by following the layout guide of Fig. 2. Drilling details are shown in Fig. 3. A clip is riveted to this board to secure the crystal, XTAL. Insert the components as shown in Fig. 4 being very sure that the IC's are positioned and oriented as shown. Units IC1 and IC8 have a flat beside pin 8; the others have a code notch and dot.

The three large holes in the PC board allow you to "double deck" the filter



Transistors are secured to the board metallized-side down, using a plastic screw. Transistors are black, flat rectangles (Q1 shown at center).

capacitors and save some space. Use plastic bolts when mounting Q1 and Q2, and make sure that both are mounted with the metallized side down. A small U-shaped heat radiator should be added to Q2 for extra heatsinking.

The selector switch should be wired in accordance with Fig. 5. Be extra careful with the wiring; any wrong connection will throw off the frequency by at least one note.

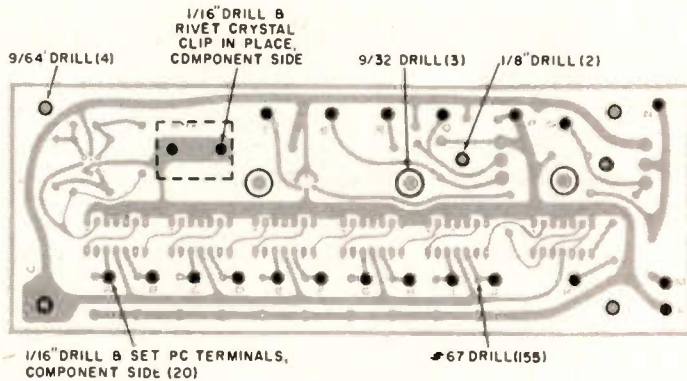
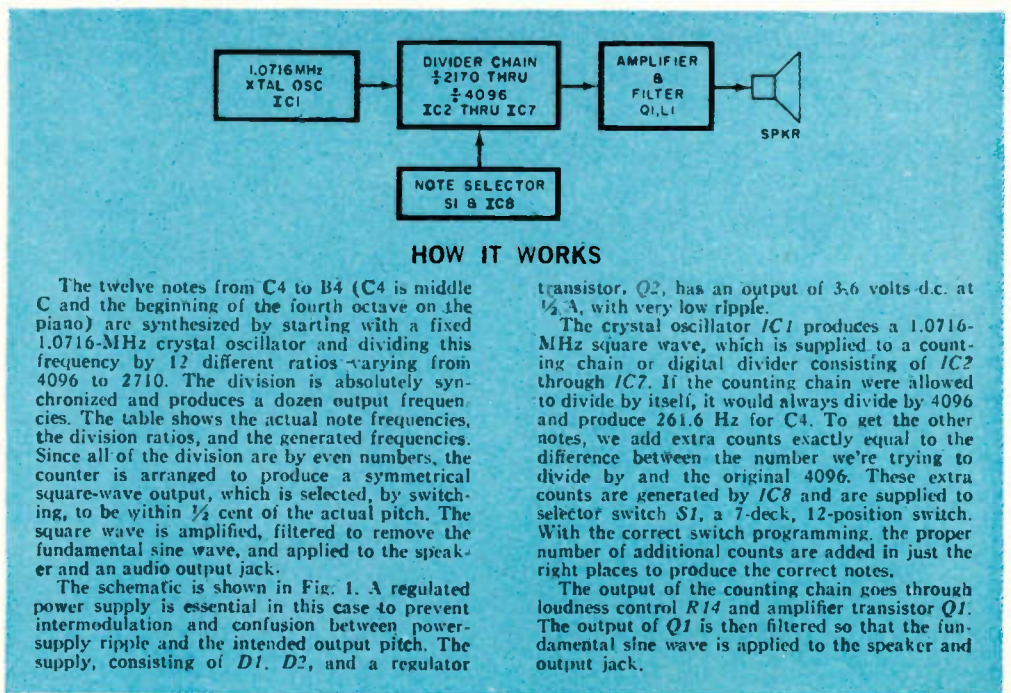
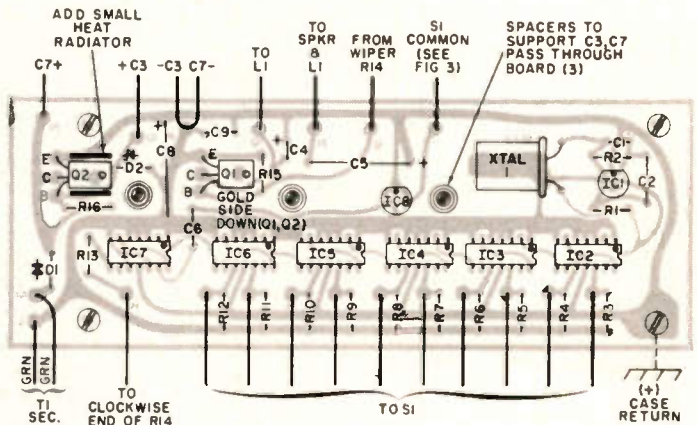

Fig. 3. Drill the PC board as shown here. The three largest holes mount the filter capacitors' standoffs. The use of PC terminals is optional. They are not supplied with the kit.

Fig. 4. Component installation. The six rectangular IC's (IC2 through IC7) are identified by a notch and dot at one end; IC1 and IC8 have either a flat or dot adjacent to pin 8. Both transistors are mounted metalized side down and secured by plastic screws. A heat sink is required at power transistor Q2.



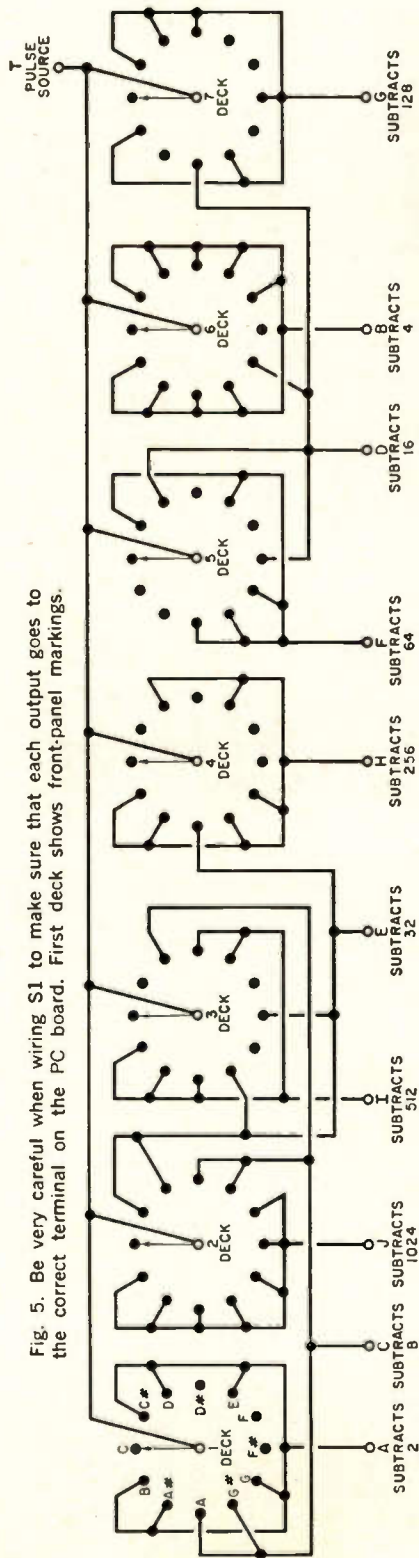
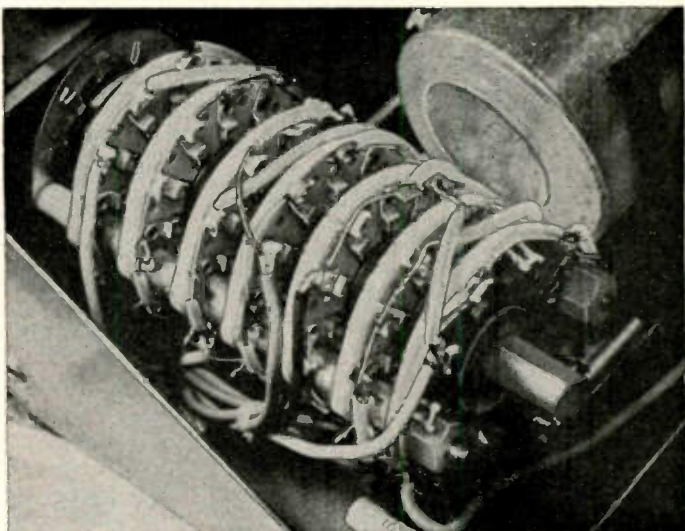
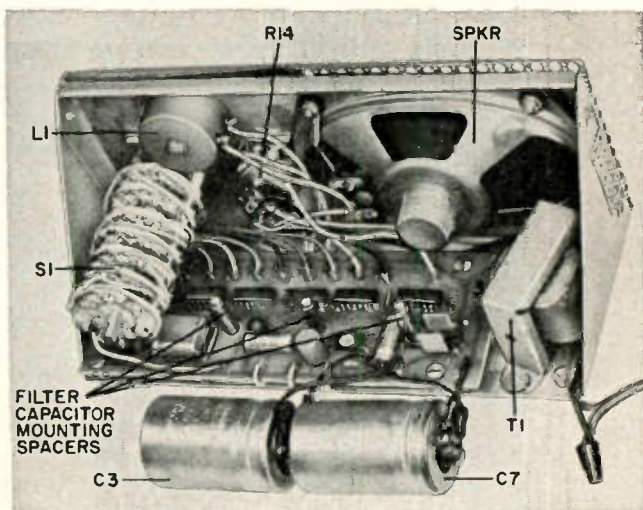

Fig. 5. Be very careful when wiring S1 to make sure that each output goes to the correct terminal on the PC board. First deck shows front-panel markings.



Good wiring practice and neat soldering will ease switch assembly. Use insulated wire where possible.

You can use almost any enclosure you wish, but watch out for any possible mechanical resonance. Fairly large ventilation holes should be provided in the rear to prevent case resonance and any back-pressure effects. The 3×5 speaker should be shock-mounted using grommets or some other means. Finally, the grill and grillcloth should be glued in place to prevent any possible rattle from vibration.



Capacitors C3 and C7 "double-deck" over PC board. With a little care, a compact assembly is possible.

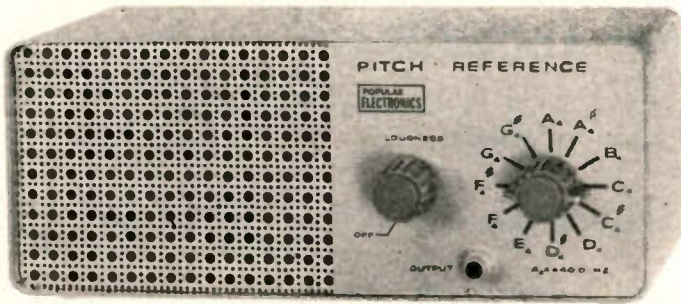

The completed Pitch Reference can be dressed up by using a commercially available dial-plate (see Parts List). The cover should have one or two one-inch holes at the rear to prevent any cabinet resonances.

The two filter capacitors are clip mounted to a short strip of metal secured to the three spacers. Make sure that the end of the capacitor does not short-circuit any of the switch terminals.

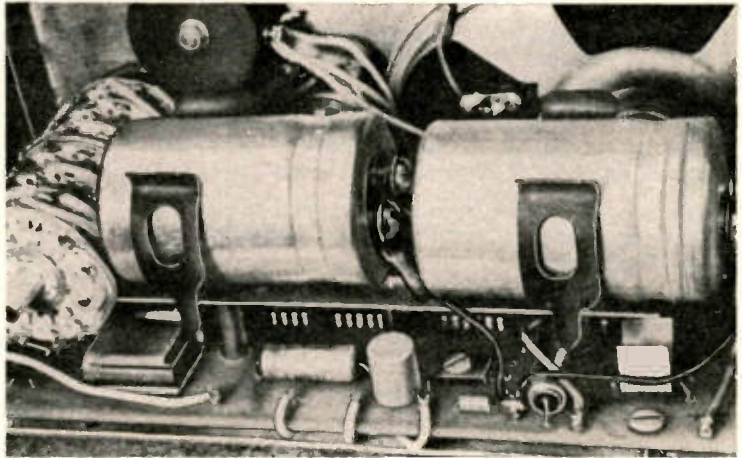

ABOUT PITCH

Each octave of a piano scale consists of 12 notes spread out over a 2:1 frequency range, the frequency of the 13th note being precisely twice that of the first. For centuries, musicians have experimented with absolute pitch and the spacing between individual notes. In common use today, however, is the equally tempered, 12-note scale with A4 (the A above middle C) set at 440.0 Hz.

Equal temperament means simply that there is a constant percentage difference in frequency between every two notes. To get twelve notes equally spaced on a percentage basis over a 2:1 frequency spread, each successive note must be $\sqrt[12]{2}$ or roughly 6% higher or lower in pitch than its neighbor. In this way, slight differences in sharps and flats for the various musical keys are averaged out so that twelve different notes per octave can handle virtually any key.

The 6% interval between notes is called a *semitone*, and musicians call 1/100 of a semitone a *cent*. A 1-cent accuracy in frequency is equal to 0.06%.

Since $\sqrt[12]{2}$ is an irrational number, there is no possible way to generate it exactly, and consequently no way to generate a scale precisely. The question is, "How good can we get?" The very best musicians can sometimes spot a ± 3 -cent cyclic error in pitch, and the very finest tuning forks are only accurate to ± 1 cent. They drift a cent or so for every four degrees F of temperature variation.

The Pitch Reference described here is accurate to ± 0.5 cent, making it twice as good as the best tuning fork you can buy and six times better than the best musician. Being crystal controlled, it is permanently calibrated and does not age or drift over long periods of time.

Operation. Usually, you will set the Pitch Reference to the same note to which you are tuning the instrument. If the instrument is out of tune, you will hear a distinct low-frequency beat note, perhaps several times a second. Adjust

the instrument tuning until the beat note disappears. This is called unison tuning (zero beating). Further adjustment of the instrument will cause detuning in the opposite direction, and a beat note
(Continued on page 103)

Are You A Real Technician?

BY VIC BELL

TEST YOUR KNOWLEDGE OF GENERAL ELECTRONICS—
FROM DESIGN TO SERVICE

(Answers on page 111)

- 1 The Plumbicon is the latest and, perhaps, most promising color CRT.
TRUE _____ FALSE
- 2 The FET is a recent development designed to overcome the low input-impedance characteristics found in most other transistors.
TRUE _____ FALSE
- 3 In color analysis for TV, black is considered to be mid-way between red and violet on the standard color-spectrum scale.
TRUE _____ FALSE
- 4 When a TV is "out of horizontal hold," two diagonal bars across the screen signify that the set's horizontal oscillator is running at 31.5 kHz.
TRUE _____ FALSE
- 5 The normal voltage across the emitter junction of a silicon-transistor amplifier stage is dependent on the divider resistors.
TRUE _____ FALSE _____
- 6 A "balanced relay" operates with an idling current that holds the armature at a half-way point—neither open or closed.
TRUE FALSE _____
- 7 A trapezoid waveform is developed for vertical deflection in the modern TV set.
TRUE FALSE _____
- 8 When a VOM shows a voltage approaching B+ at the cathode of an audio output tube, the cathode resistor may be open.
TRUE FALSE _____
- 9 A TV ghost will always appear to the right of the real image.
TRUE _____ FALSE
- 10 The Esaki diode and tunnel diode are one and the same.
TRUE FALSE _____
- 11 A neon lamp's firing point may be affected by ambient light level.
TRUE FALSE _____
- 12 The time-base multiplex principle used for FM stereo sound transmission is similar to the color-TV transmission principle.
TRUE FALSE _____
- 13 More red phosphor dots are used on the three-gun CRT to compensate for red phosphor's lower efficiency.
TRUE _____ FALSE
- 14 High-level demodulation used in color TV eliminates the need for color difference amplifiers to drive the CRT.
TRUE _____ FALSE
- 15 A two-stage ring counter could be considered to be a bistable flip-flop.
TRUE _____ FALSE _____
- 16 A ring counter is roughly the electronic equivalent of a stepping relay.
TRUE _____ FALSE _____
- 17 Tube-type audio amplifiers sometimes have a connection between the filament circuit and the audio-output cathodes. This feeds a 60-Hz cancelling signal to the output for hum suppression.
TRUE _____ FALSE _____

by Theodore M. Hanna, K3CUI

SOVIET

ELECTRONICS

A 1968 REAPPRAISAL

THE TEMPO IS SPEEDING UP AND ELECTRONICS IS REACHING DOWN TO THE MAN IN THE STREET

ACCORDING TO SOVIET claims, it was Alexander Popov who "invented radio." Whether he did or not—and the evidence is that he didn't—there is no question that Soviet electronics, like electronics everywhere, has made tremendous strides since Popov's time. Just how far *have* the Russians come in this important field? What is the state of communications-electronics in the Soviet Union today, and how does it compare with electronics technology in other countries, particularly the United States? What are some of the unusual features of Soviet radio and TV? What is it like to be a "radio sportsman" in the USSR? While these questions are difficult for an American to answer with complete certainty, a careful reading of Soviet electronics publications gives a fairly good picture of Soviet electronics, 1968 style. And this is the way it looks . . .

The General Situation. Soviet successes in space have demonstrated that Soviet electronics can be very good indeed. But

while Soviet space vehicles are orbiting the earth and probing the planets, and while a laser beam is being used experimentally to carry telephone calls in Moscow, the average Russian may still be plagued by a TV receiver that seems always to be breaking down*, and the electronics hobbyist may still be winding his own transformers and making his own switches because these parts are not available at the local radio store. Why this great disparity? The reason is, obviously, that in a planned economy such as that of the Soviet Union, the State's needs get first priority. From the consumer's standpoint, the situation is, however, improving. More money and resources are being devoted to consumer goods, and this includes consumer electronics.

Circuitry. The Russians are rapidly improving their solid-state technology. In 1922, according to an article in a Soviet

*PEMOHT, Lewis A. Harlow, **POPULAR ELECTRONICS**, August, 1967, page 57.



Drawings illustrate a few of the lapel-pin awards for which Soviet "Radio Sport" contestants strive. Competition is stiff, and winning such awards is an achievement.

magazine, a 19-year-old Russian named O. V. Losev developed an oscillating crystal receiver that amounted to a "low-powered semiconductor oscillator." The author of the article then speculates that if today's problems in electronics had existed then, the semiconductor era might have begun in 1922. Perhaps so. But in any case solid-state is now very much the order of the day in Soviet electronics. That is not to say that vacuum tubes have disappeared from the scene. They haven't; they are in fact used more than

they are in the United States. But the trend to solid-state is clearly evident.

A look at the schematic diagrams in Soviet electronics magazines reveals few surprises in semiconductor technology. Both the devices and circuits used are very much like those with which we are familiar. Even the names have a familiar ring—"tranzistor," "termistor," and "varikap," for example. Tunnel diodes, zener diodes, transistors, and thermistors of all kinds are used, often with printed circuit construction. An exception may be integrated circuits. Although IC's and thin-film circuitry are discussed in the technical magazines, there seems to be little commercial application, except for two matchbox-sized radios developed a few years ago. These sets used five or six transistors in a two-band, tuned-radio-frequency circuit.

The Soviet magazine *Radio*, most nearly like *POPULAR ELECTRONICS*, is featuring more and more solid-state construction articles. With the young reader in mind, these articles describe the building of simple transistor receivers, audio amplifiers, and basic test equipment.

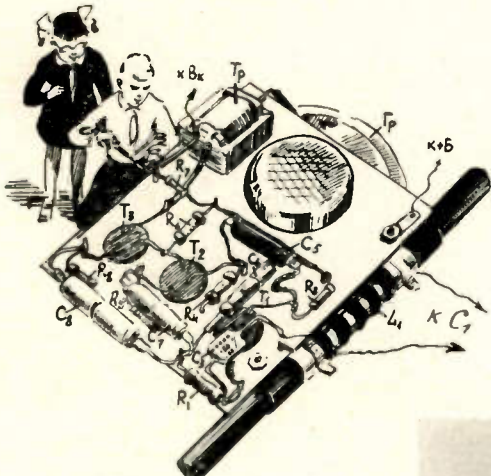

How-to articles, such as the one titled "Your First Transistor Receiver," featured in the Soviet magazine *RADIO*, are often lavishly illustrated with construction and component-orientation and placement drawings like this one.

A less complex project like "Your Pocket Receiver" in the "Radio for Young People" series, also featured in *RADIO*, may even give hints for modifying the basic circuit and other such ideas for getting better results from the project.

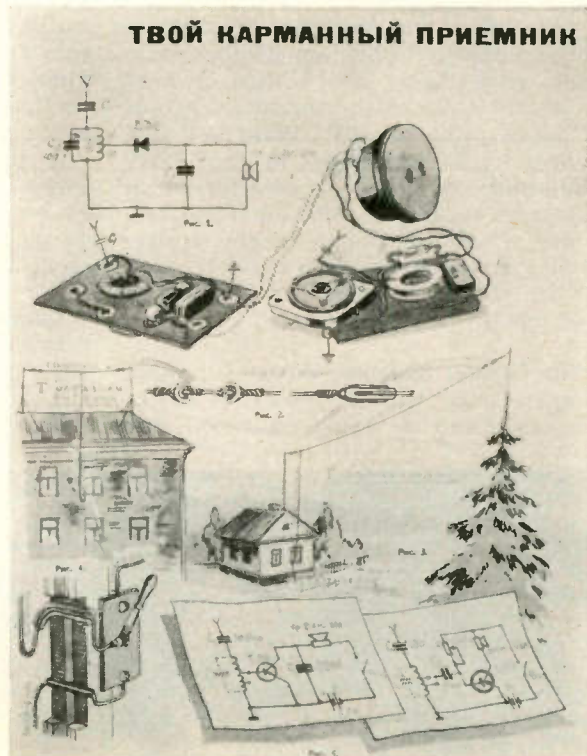

While most of the equipment itself would be familiar to Americans, one device—a transistor audio amplifier—is used in a way that might not be so familiar. Its job is to amplify voice broadcasts carried over the “wired-radio network”. A phenomenon peculiar to Communist countries, “wired radio” is a means of disseminating the government’s radio broadcasts to the people via a network of local, government-operated receiving stations. The receivers are connected to high-powered audio amplifiers which feed the programs to loudspeakers installed in homes, apartments, public buildings, schools and factories, and on street corners, parks, and farms. Local announcements and recorded music can also be broadcast over the system. In 1966 there were about 37 million such speakers in operation in the Soviet Union. The number of receiving points tuned to Moscow and other major cities was about 35,000. At one time, wired radio accounted for most of the radio broadcasting in the USSR. And even though a larger number of conventional radio receivers is now being built, wired radio is still considered an important part of Soviet broadcasting today.

Radio and TV Broadcasting. It would be easy to say that the Russians are “X” number of years behind the United States in radio and TV broadcasting, but that would be to miss the point. The fact is that very few countries have the kind of radio-TV system that exists in the United States, and it would be misleading to try to compare different kinds of systems. The real question is, does the Soviet broadcasting network meet the needs of the Soviet Union? The Russians are trying hard to see that it does. More broadcasting stations of all kinds are being built; FM stereo is being broadcast; color TV has just begun; UHF TV is on the way; and the world’s first nationwide TV coverage via communications satellite is now in operation.

The Russians also claim another “first”—the world’s tallest free-standing structure. This is the new All-Union Radio-Television Center, scheduled for completion late this year. Consisting of a 485-foot antenna mast atop a reinforced concrete supporting structure, the building will stand 1,750 feet above Moscow



Antenna tower for All-Union Radio-Television Center will be some 300' taller than Empire State Building.

—or almost 300 feet higher than the Empire State Building and its TV mast. In addition to radio and television transmitters and equipment, the center will contain a revolving restaurant and several observation platforms.

The Russians are also probably the first to put a videotelephone system into commercial operation. Their system, which is similar to the Bell System's *Picturephone* system, went into operation several years ago and is now in use between several cities.

Color television is now seen regularly in Moscow, but on a very limited scale (a few hours each weekend). The production of color TV sets is also small—2,000 sets in 1967, 15,000 planned for 1968. Three color sets are on the market—two 23-inch models priced at 1200 rubles (about \$1330) and a 16-inch model that sells for 900 rubles (about \$1000). One of the 23-inch sets uses 15 transistors, 24 tubes, and 45 diodes; the other uses 46 transistors, 11 tubes, and 45 diodes. As their standard for color television, the Russians have adopted the French SECAM system, and the Soviet communications satellite has been used to relay experimental color transmissions between Moscow and Paris.

To maximize broadcast coverage and to reduce production costs, many Soviet TV sets are designed to receive FM radio programs, which in the Soviet Union are broadcast between 67 and 73 MHz.

Hi-Fi: There is a Difference. Perhaps the best way to understand the state of hi-fi in Russia today is to recall what hi-fi was like in the United States 20 years ago. Like the Americans then, Russians today are just becoming aware of hi-fi; they are also very much in the do-it-yourself stage of development. There are no kits available, so the audio enthusiast builds his own equipment from scratch. In some cases, this means that he even machines his own gears and cams for tape recorders. Ready-made equipment runs largely to complete-in-a-cabinet construction. Some of these units are truly deluxe. One model, for example, features an all-band AM-FM stereo receiver and a four-speed stereo phonograph.

Tape recorders are quite popular. The inexpensive models are typically two-track machines running at a single speed (3- $\frac{3}{4}$ in/s). Four-track, three-speed recorders are available, but stereo cartridges have yet to be introduced.

Stereo tuners and amplifiers, so popular with American electronics enthusiasts, are given little attention in the Soviet electronics magazines. The same is true of speaker enclosures. This is probably because there is relatively little FM stereo broadcasting at the present time. And, component hi-fi has not yet caught on to any great extent.

"Radio Sport": A Serious Business. In the Soviet vocabulary, the electronics en-

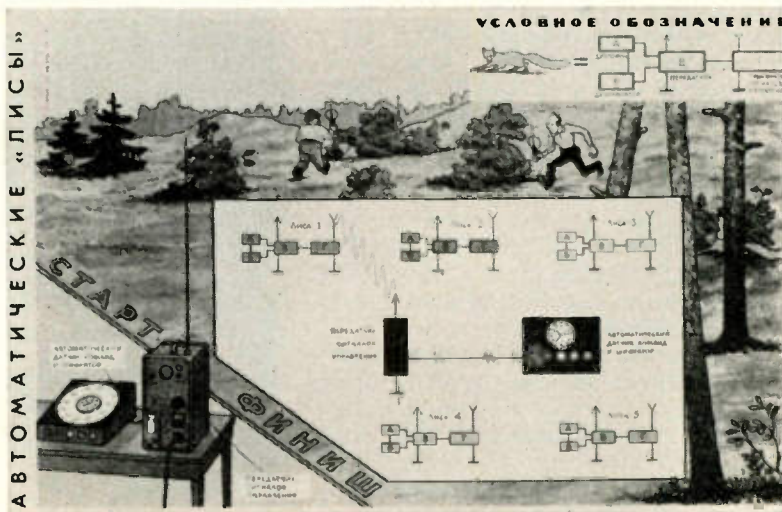

In "Fox Hunt," contestants locate small hidden transmitters with direction finders. Contestants must locate each transmitter in its proper numbered sequence.

The August, 1967, cover of RADIO magazine illustrates contestants in action during the "Fox Hunt," a big highlight of "Radio Sport" events. Winners and their trophies are also shown.

ЧЕМПИОНЫ СЕЛА ЧЕРНИЕВО

... Главным в оборонно-спортивной работе Общества является массовое привлечение молодежи к военно-техническим видам спорта, повышение уровня спортивного мастерства.
(Из резолюции VI съезда ДОСААФ)

8 АВГУСТ 1967 В Н О М Е Р Е

РАДИО

Депутаты VI съезда ДОСААФ: на чужбину станицы ● Расцвет советской радиотехники ● Общественные Телерадиотелевизионные центры ● Радиоспортивные в Советском Союзе ● Ряды ИСАЕИОНА ● Талантливость детей, воспитанников Школы радиотехнической молодежи ● Федерация спортивной физкультуры ● Сделай сам ● Лето в ● Занимательное замечание по телефону ● Прогноз трансформации природы ● Усилитель для магнитофона



The hidden "foxes" transmit their short, number-coded signals only once every 5 minutes.

thusiast, the ham, and the SWL are all known as "radio sportsmen." Far from being the casual pursuit that the name would suggest, "radio sport" is a highly organized, serious activity supported and administered by the government. The organization responsible for administering radio sport is called, appropriately enough, the Radio Sports Federation of the USSR. The president of the Federation is Ernst Krenkel, a Hero of the Soviet Union and holder of the distinctive amateur call RAEM.

In "radio sport," the key word is competition. Electronics enthusiasts compete for prizes in building equipment; hams and SWL's compete in on-the-air contests; CW operators compete in high-speed sending and receiving contests. There are, of course, rewards for all of this—trophy cups, lapel pins, and certification as "Radio Sportsman Third Class," "Second Class," or "First Class." The

(Continued on page 110)

ZOUNDS!

BY DAVE HARBAUGH

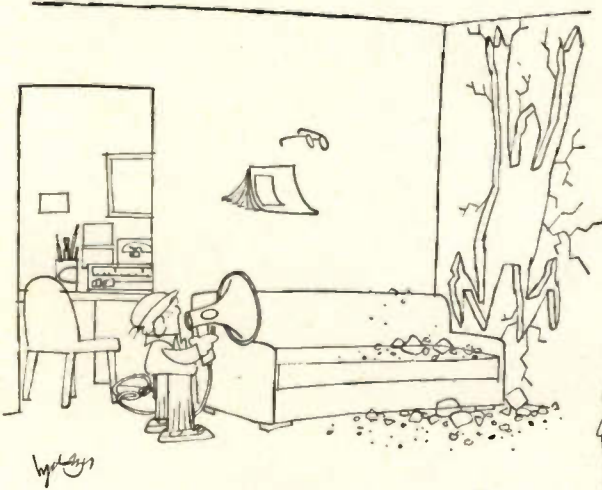

What's this, Dad?



Look, forget the protest songs!



Gesundheit!

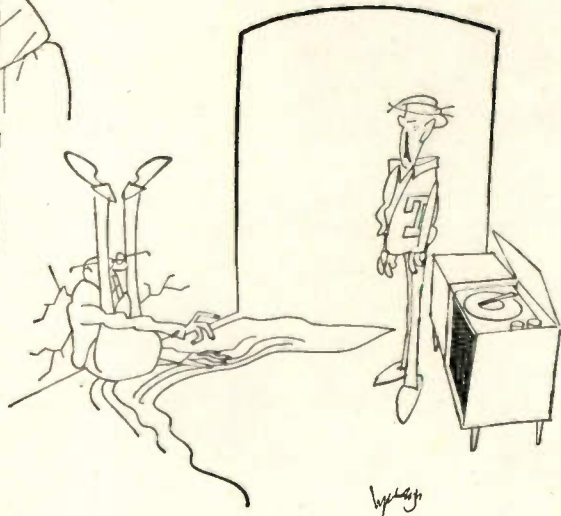

That knob cuts in the other 3 speakers.

**WHAT HAS RESISTANCE,
CAPACITANCE, INDUCTANCE,
COUNTER-EMF, AND EVEN
NEGATIVE RESISTANCE?**

The Ubiquitous NEON LAMP

BY JIM KYLE

WHEN SIR WILLIAM RAMSAY and M. W. Travers in 1898 first distilled neon from 15 liters of liquid argon, they surely didn't know that they were lighting up the world with millions of garish electric signs. They probably didn't realize either that they had found the basis for the glow lamp—a device that eventually would be one of the important components in electronic circuits.

The neon glow lamp is a relatively "old" device. In the 1940's it was principally used as a low-brightness indicator light. About the same time, its voltage-regulating qualities were recognized. Simple audio oscillators with neon lamps as the only active elements were built 15-20 years ago, but only within the past 10 years have designers begun to realize the number and scope of electronic circuits in which the neon lamp can perform a unique service that is reliable and economical.

As a computer element, the neon lamp performs a memory function and, as a bonus, gives visual indication of the stored information. The neon-lamp oscillator converted to a frequency divider is used in electronic organs to produce six-octave coverage from 12 master tone generators. In digital logic circuits, certain characteristics of the neon lamp make it an excellent on-off switch. Other new applications include improved voltage regulation, time delay and (in conjunction with photocells) control.

Basic Characteristics. The usual neon glow lamp consists of two electrodes (an anode and a cathode) in a miniature glass bulb filled with a gas which is usually *not* pure neon. Commercial neon almost always contains traces of both helium and argon; and mixtures are often used purposefully to achieve specific electrical characteristics.

Not all neon lamps have only two electrodes. Some lamps have a third electrode so that the device can be "triggered" with lower applied energy than is required by the conventional two-element lamps.

The gas within the lamp acts as an almost perfect insulator until a critical "breakdown" voltage is reached. This voltage ranges from 65 to 200 volts depending on such design factors as electrode spacing, gas pressure, gas mixture, etc. When the breakdown voltage is reached, the gas ionizes and becomes a relatively good conductor of electrical current. At this time, the voltage across the lamp drops to a level less than the breakdown voltage. Known as the "maintaining" voltage, this level ranges from 48 to 80 volts, depending on lamp design and is almost constant regardless of current flow in the lamp. These characteristics are shown in Fig. 1. If the voltage drops below the maintaining level, or if current flow through the lamps drops below the minimum, the gas deionizes and returns to its insulating condition.

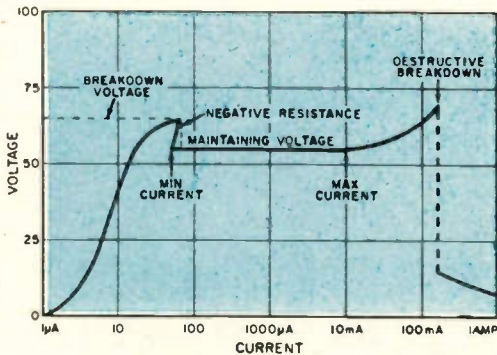

Fig. 1. Typical voltage-current characteristics of a neon glow lamp. The values apply to no specific type. Current flow before breakdown may be much less than indicated (note that the current scale is logarithmic rather than linear). Normal operating region is plateau between minimum and maximum current points indicated. Destructive breakdown changes characteristics so as to render neon useless.

At such times the resistance of the lamp is on the order of 1000 to 10,000 megohms shunted by 0.5 pF, which may be considered to be an open circuit. When the gas is ionized and the lamp is conducting, the resistance is between 1000 and 10,000 ohms. This million-to-one change in resistance is what makes the neon lamp an effective logic or switching element.

The neon lamp is a low-current device; normal operating currents range from 0.1 to 10 mA. Theoretically, a tube such as that whose characteristics are shown in Fig. 1 could be operated at currents up to 100 mA. However, destructive breakdown occurs very rapidly at high currents; and, for this reason, a resistor is always used in series with a neon lamp to limit the maximum current. The size of the resistor is not critical; the higher its resistance, the lower the current; and the lower the current, the longer the lamp life. However, with low current, light output is reduced and the time delay before breakdown (discussed in the next paragraph) is increased. The value of resistance actually used is thus usually a compromise with a range of 47,000 to 220,000 ohms being typical.

Since it takes a finite time for the gas in the lamp to break down and conduct, the neon lamp has a built-in time-delay characteristic. The delay ranges from several hundred milliseconds for slow lamps operated just at breakdown volt-

age to 4 microseconds for fast lamps driven at high voltage levels. The principal effect of the time delay is to set an upper frequency limit of about 200 kHz for the use of neons in oscillators, frequency dividers, and logic circuits.

The life of a neon lamp frequently exceeds that of the remainder of the equipment in which it is used. Average life rating is about 7500 hours. However, this is *on* time so that the actual life depends on the duty cycle of the circuit. Total life may run as high as 50,000 hours (6 years).

To sum up, the neon lamp has a constant terminal voltage when conducting, undergoes a million-to-one change in resistance between *off* and *on* states, remains *on* after being turned *on* by a brief pulse, and provides visible indications of its *on* state.

Neon-Lamp Oscillator. When a capacitor is charged and discharged at a fixed rate, it can be used in a circuit known as a relaxation oscillator. A neon lamp, a resistor, and a timing capacitor form one of the simplest of relaxation oscillators. See Fig. 2.

The capacitor charging rate is determined by the value of the resistor. When the voltage across the capacitor reaches

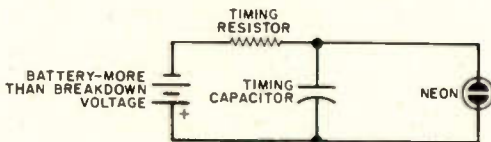

Fig. 2. Basic neon oscillator circuit includes only voltage source, resistor to establish current level, capacitor to be charged, and neon glow lamp. Resistor should have a value of about 100,000 ohms.

the lamp's breakdown rating, it is turned *on* and the capacitor discharges through this newly opened path.

When the capacitor voltage drops below the lamp's maintaining voltage, however, the neon switches *off* and the discharge stops. Thus, after the first cycle of operation, the voltage across the capacitor swings between the maintaining and breakdown voltages—normally a variation of about 10 volts.

The waveform of the oscillating voltage is essentially a sawtooth, and oscillators of this type were used as time-base generators in early oscilloscopes.

The frequency may range from as low as one cycle in 45 minutes to as high as 20 kHz.

The frequency of the neon-lamp oscillator is determined by the characteristics of all three components. For a high capacitance, a high resistance, or a large difference between breakdown and maintaining voltages, the frequency is low. The voltage level of the output is determined almost entirely by the difference between breakdown and maintaining voltages.

The actual design of an oscillator is not an exact process; but, since the circuit may be trimmed to the desired operating frequency by adjusting either the resistance or capacitance, the inaccuracies of the design procedure are of little importance.

The first design step is to calculate a constant, $K1$, which is defined as the difference between breakdown and maintaining voltage for the lamp to be used, divided by the difference between supply voltage and maintaining voltage. The value of $K1$ should be less than 0.63 for best results. With $K1$ calculated, Fig. 3 can be used to determine another constant, $K2$. The RC time constant of the resistor and capacitor can then be calculated from the equation

$$RC = K2/\text{frequency}$$

where frequency is in hertz. As a starting point use at least 470,000 ohms for $R1$ and vary R and C as necessary to obtain the proper time constant.

To reach the desired oscillator frequency, it is always necessary to design the circuit to generate a higher frequency. Therefore, the first step in making a new design is to look up the desired frequency in Table 1 and base the design on the "Use Frequency."

Neon-Lamp Frequency Dividers. The circuit of Fig. 4 can be used as a frequency divider. With additional modifications, it can also be used to provide exact frequency division from 2 to 10, while simultaneously preventing the lower output frequency from being fed back to the input.

This application of the neon lamp is used widely in electronic organs. A single master tone generator for each of the 12 tones of the musical scale is constructed. Frequency dividers then scale each tone

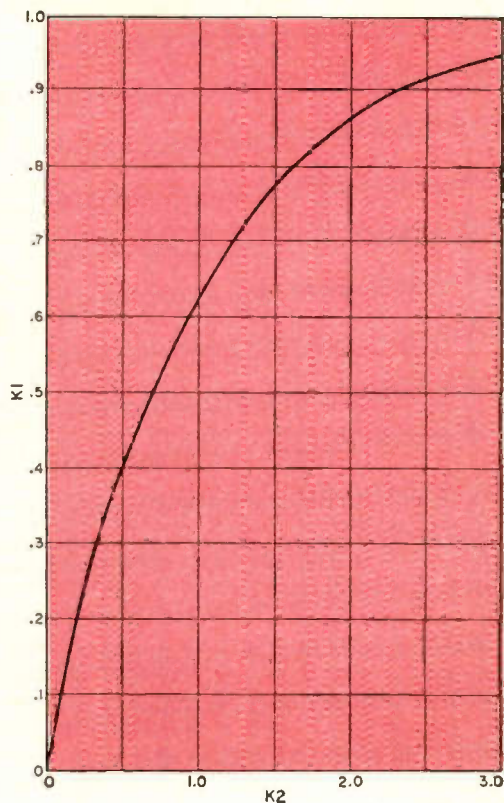

Fig. 3. Relationship of constants $K1$ and $K2$.

COMPENSATION FOR IONIZATION	
DESIRED FREQUENCY (Hz)	USE FREQUENCY (Hz)
10 - 100	5% greater
200	215
300	330
400	460
500	600
750	900
1000	1250
1500	2100
2000	3000
3000	4800
5000	9000
7500	14.25 kHz
10 kHz	20 kHz
15 kHz	34 kHz
20 kHz	48 kHz

down an octave at a time to cover the desired musical range. Since at least 5 octaves are required for each of the 12

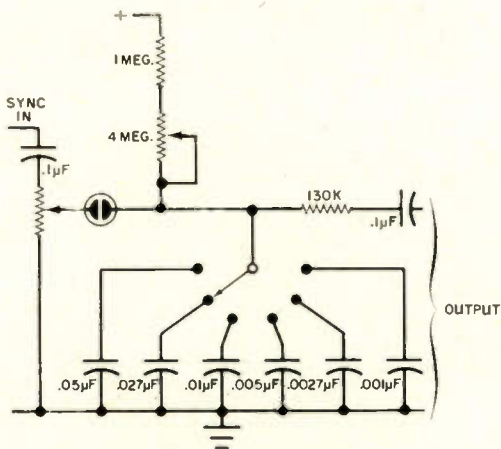

Fig. 4. Neon sawtooth oscillator with facilities to change frequency (six switched positions) and synchronize from external circuit. Supply voltage is usually 3 times breakdown level of the neon glow lamp. This circuit appears in some oscilloscopes.

tones—a minimum of 48 dividers—the simplicity and economy provided by the neon circuit are of great importance.

One stage of such a multiple divider circuit is shown in Fig. 5. This stage has an input at a frequency of 523.3 Hz and produces an output at 261.7 Hz, middle

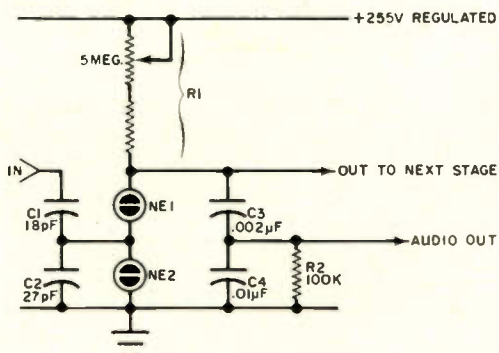

Fig. 5. This is a single stage of a frequency divider using neon glow lamps. Input capacitors aid in preventing reverse feedthrough and the output is chosen to produce a low source impedance. Resistor R1 is adjusted to bring frequency into synchronizing range so that circuit automatically produces integral submultiple of input frequency. This circuit is designed to divide by two; dividing by ten in a circuit very similar to this is often practical.

C on the scale. Here's how it works. The neon lamp of Fig. 6A is actually NE1 and NE2 of Fig. 5. It is the use of two lamps and two capacitors which prevents feedback of output signal to the input.

In the absence of any input signal, the circuit oscillates; the frequency of self-oscillation is adjusted by R1 to be slightly lower than the desired output frequency. Each time the previous stage fires, a negative-going pulse is generated across C1 and C2. The pulse amplitude divides across the two capacitors according to the ratio of their capacitances, so about 40% of the pulse is applied to NE2. Unless the neon is already about to fire (due to self-oscillation), the pulse will have no effect. If the neon is just ready to fire, the pulse will cause breakdown.

When NE2 breaks down, the difference between its firing and maintaining voltages is applied to NE1, and it fires also. This causes C3 and C4 to discharge at a time determined precisely by the signal from the previous stage. The oscillation of this circuit is then locked at a frequency exactly half that of its input signal if the self-oscillation frequency is slightly less than half that of the input. Wave forms are shown in Fig. 6B.

The values shown for C1, C2, C3, and C4 are not particularly critical, being determined in part by the specific frequencies involved. The ratios of their values, however, play an important role in circuit operation. In this application, it is essential that none of the low-frequency tone finds its way back into the preceding stage. Since C1 is so much smaller than either C3 or C4, any signal coming back from the next stage (by way of that stage's C1) will be attenuated by a volt-

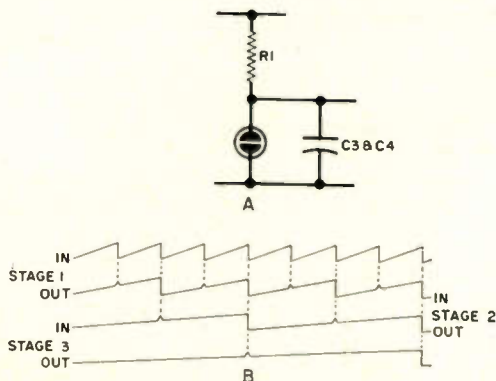

Fig. 6. Frequency divider operation is basically a relaxation oscillator as shown at A. Waveforms at B show how the divider operates. Input of one stage is output of previous stage. Output of third stage is only $\frac{1}{8}$ the frequency of the input. Process could be repeated to produce low frequencies.

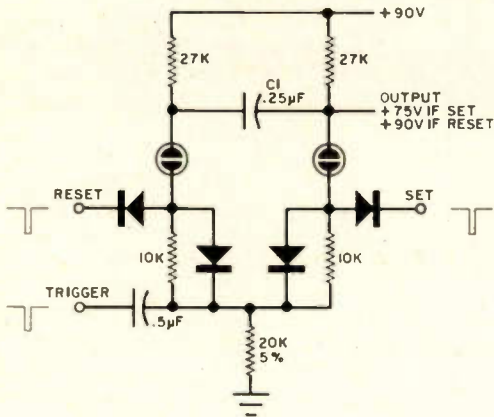

Fig. 9. This circuit could be used to construct binary counters or other digital circuits. Each of the flip-flops may be driven directly by output of preceding flip-flop. Use identical diodes, at least equivalent to 1N91. The 1N34 diode will not work.

can't fire. The capacitor is charged to the voltage developed across $R1$ or $R2$ (whichever is carrying current). Now a positive input pulse, greater than the difference between breakdown and maintaining voltage, temporarily reduces the voltage across the *on* neon, turning it *off*. The charge on the capacitor is then sufficient to turn the other lamp *on* and the status of the circuit is reversed.

While a single flip-flop of this type demonstrates the simplicity of the basic circuit, some modifications are necessary to allow several to be connected in series for any practical counting applications. Such a modified circuit is shown in Fig.

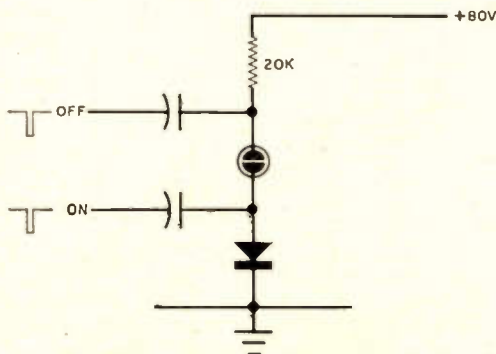

Fig. 10. Single neon-lamp memory circuit is turned on by negative-going pulse at lower input or positive-going pulse at upper input. Circuit turns off with opposite polarities. Supply voltage and resistor value are relatively critical; once turned on, lamp must remain on after pulse has decayed.

9. By permitting easy current flow in one direction but inserting resistance in the other, the diode-bypassed resistors increase the sensitivity of the circuit, so that the major portion of the triggering pulse is delivered to the neon which is *on*. When this neon turns *off*, $C1$ turns the other *on*. The diode-gated set and reset inputs permit control of the starting condition of the flip-flop.

A single neon lamp can perform a digital memory function, since a higher voltage is required to turn it *on* than is required to maintain it, once fired. Such a single-bit memory circuit is shown in Fig. 10. Here the supply voltage is between the maintaining and breakdown voltages of the lamp so that it will re-

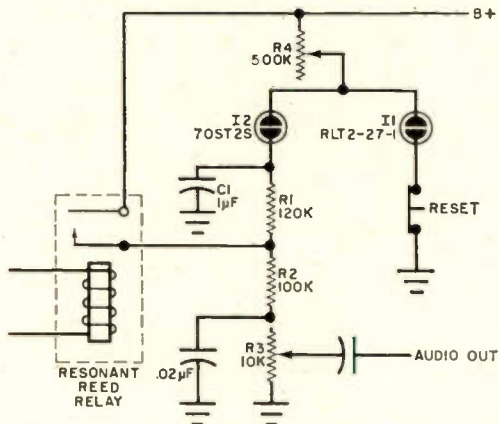

Fig. 11. Practical use of the neon-lamp memory appears in E.F. Johnson "Tone Alert". Neon lamp I1 is visible to operator, lamp I2 is hidden inside metal case of the unit. When call is received, I1 is turned on and stays on until reset switch is operated. Lamp I2 is in audible warning circuit.

main *off* when voltage is initially applied. To turn the neon *on* and thus store a single information bit, a negative-going pulse at least equal to the difference between maintaining and breakdown voltage is applied to the *on* input. This pulse adds momentarily to the supply voltage, bringing it above breakdown and firing the neon.

A memory circuit based on this principle, but using a second neon to provide
(Continued on page 104)

BUILD THE FET INTERVAL TIMER

**Accuracy and simplicity
in a single transistor circuit**

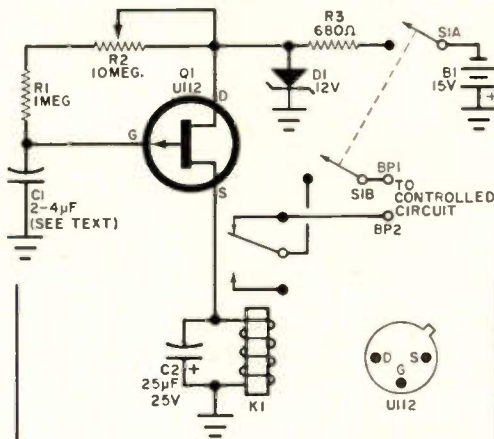

Almost any p-channel FET similar to the recommended U112 can be used. A type n-channel may work if the polarities are reversed.

- B1*—15-volt battery
BP1, BP2—Five-way binding posts
C1—2- to 4- μ F, 100-volt capacitor (see text)
C2—25- μ F, 25-volt electrolytic capacitor
D1—12-volt, $\frac{1}{2}$ -watt zener diode
K1—S.p.d.t. relay with 1-mA energizing current (Sigma type 4F-8000-S/SIL, or see text)
Q1—Field-effect transistor, p-channel (Siliconix U112, or similar)
R1—1-megohm, $\frac{1}{2}$ -watt resistor
R2—10-megohm, linear-taper potentiometer
R3—680-ohm, $\frac{1}{2}$ -watt resistor
S1—D.p.s.t. switch

THE ACCURACY OF THE TIMER you use for experimenting, photography, and the like is not usually too critical. When it is, why compromise by using an inexpensive, not-too-accurate timer? You don't have to spend a small fortune to make a very accurate, very stable interval timer. The timer described in this article is extremely accurate and relatively inexpensive.

As shown in the schematic diagram,

when *S1* is closed, power is simultaneously applied to the timer circuit and the device being controlled. (If you prefer a timed-off cycle, *BP2* can be connected to the open contact of *K1*.) As soon as power is applied, *C1* begins to charge through *R1*, *R2*, and *R3*.

The potentials at the gate and source of *Q1* rise as *C1* is charging, and consequently, the current through the coil of *K1* also rises. At some point, determined by the setting of *R2*, the charge on *C1* is sufficient to cause enough current flow through *Q1* to energize *K1* and remove (or apply) power to the controlled device.

Current through the circuit is, at most, 1.5 mA when the components specified are used, even after *K1* closes; so neither *K1* nor *Q1* can be damaged if *S1* is left in the ON position after energization. Opening *S1* puts *Q1*'s gate-to-source terminals into a forward-bias condition, allowing *C1* and *C2* to discharge through the winding of *K1* and resetting the timer for the next cycle. As a result, a delay of about 1-2 seconds must be allowed before the timer will again accurately time another cycle.

The timing rate of the circuit depends on the values of *R1*, *R2*, *R3*, and *C1*, and the characteristics of the particular FET used. The timing rate can be varied between 6 and 60 seconds with the resistance values specified and a 2- to 4- μ F capacitor for *C1*.

In use, *K1* must be adjusted so that it picks up at approximately 0.5 mA. The Sigma relay specified has a mechanical adjustment for this purpose. If you use another brand or model relay, its winding should be rated at about 8000 ohms and require a maximum of 1-mA pull-in current. Almost any p-channel FET can be used for *Q1*.

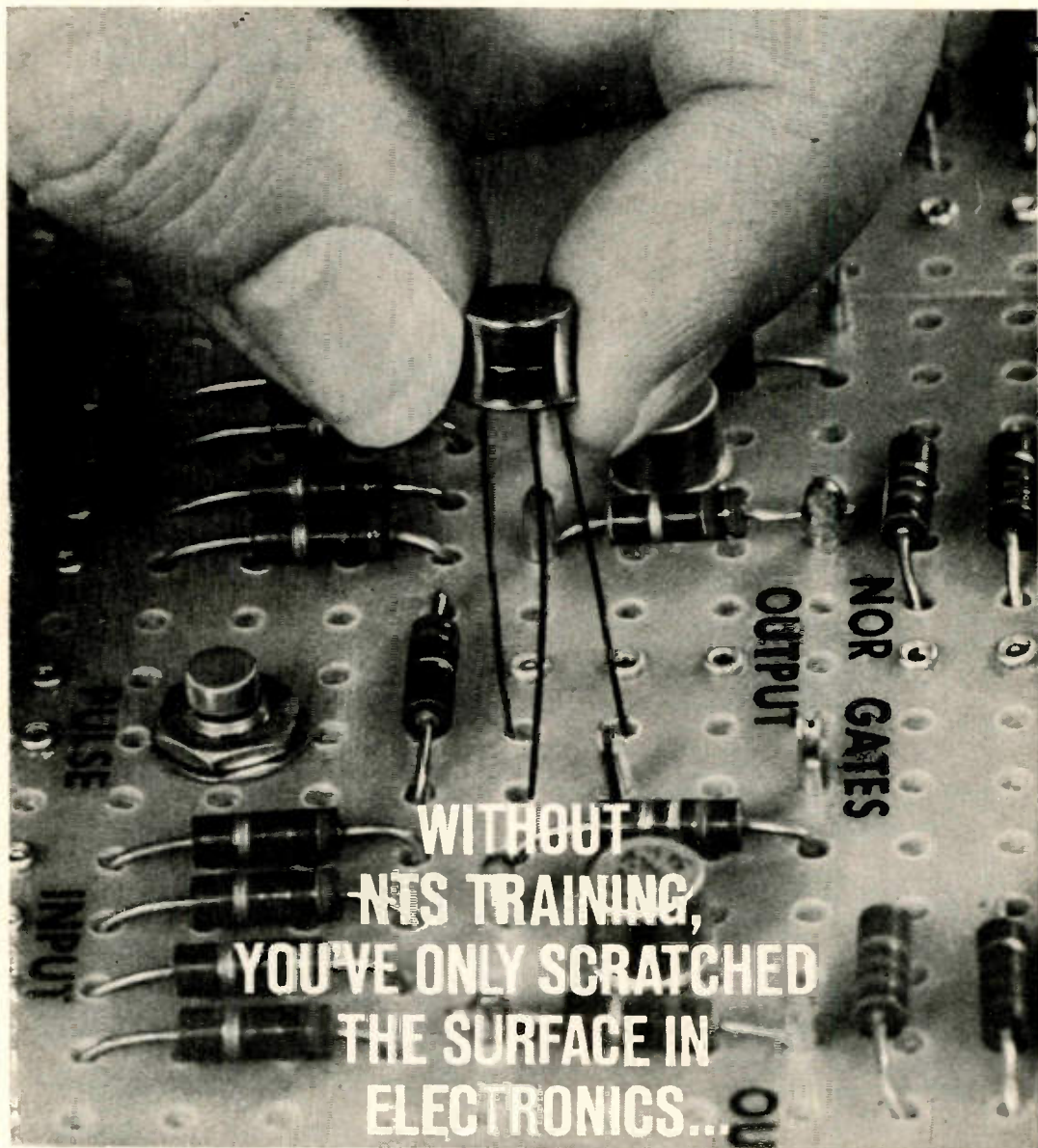

Only NTS penetrates below the surface. Digs deeper. Example? Take the above close-up of the first transistorized digital computer trainer ever offered by a home study school.

It's called The Compu-Trainer®—an NTS exclusive. Fascinating to assemble, it introduces you to the exciting world of computer electronics. Its design includes advanced solid-state NOR circuitry,

flip-flops, astable multivibrators and reset circuits. Plus two zener and transistorized voltage-regulated power supplies. The NTS Compu-Trainer® is capable of performing 50,000 operations per second.

Sound fantastic? *It is!* And at that, it's only one of many *ultra-advanced* kits that National Technical Schools offers to give you incomparable, in-depth career training.

PROVE IT YOURSELF. SEND FOR OUR NEW CATALOG. SEE THE LATEST, MOST ADVANCED KITS AND COURSES EVER OFFERED BY A HOME STUDY SCHOOL.

NTS...THE FIRST HOME STUDY SCHOOL TO OFFER LIVE EXPERIMENTS WITH INTEGRATED CIRCUIT KITS

You build a computer sub-system using the new, revolutionary integrated circuits. Each one, smaller than a dime, contains the equivalent of 15 resistors and 27 transistors.

And your kits come to you at no extra cost. These kits are the foundation of the exclusive *Project-Method* home study system... developed in our giant resident school and proven effective for thousands of men like yourself.

With Project-Method, all your kits are carefully integrated with lesson material. Our servicing and communication kits are *real* equipment—not school-designed versions for training only. As you work on each of the projects, you soon realize that even the most complicated circuits and components are easy to understand. You learn *how* they work. You learn *why* they work.

NTS Project-Method is a practical-experience approach to learning. The approach that works *best!* An all-theory training program can be hard to understand — difficult to remember. More than ever before you need the practical experience that comes from working with real circuits and components to make your training stick.

NTS SENDS YOU KITS TO BUILD THESE IMPORTANT ELECTRONICS UNITS!

- ◆ 25" COLOR TV
- ◆ 21" BLACK & WHITE TV
- ◆ SOLID-STATE RADIO
- ◆ AM-SW TWIN-SPEAKER RADIO
 - ◆ TUBE-TESTER
 - ◆ TRANSCEIVER
 - ◆ COMPU-TRAINER®
 - ◆ VTVM
- ◆ SIGNAL GENERATOR
- 5" OSCILLOSCOPE

See them all illustrated in
the new NTS Color Catalog.

CLASSROOM TRAINING AT LOS ANGELES: You can take classroom training at Los Angeles in sunny California. NTS occupies a city block with over a million dollars in facilities devoted exclusively to technical training. Check box in coupon.

NATIONAL TECHNICAL SCHOOLS

WORLD-WIDE TRAINING SINCE 1905
4000 So. Figueroa Street, Los Angeles, Calif. 90037

APPROVED FOR VETERANS

Accredited Member: National Home Study Council
Accredited Member: National Association of
Trade and Technical Schools



COMMUNICATIONS

This transceiver is included in Communications courses. You build it. With it, you easily prepare for the F.C.C. license exam. You become a fully-trained man in communications, where career opportunities are unlimited.

25" COLOR TV ▼

Included in Color TV Servicing Courses. With it you advance yourself into this profitable field of servicing work. Color is the future of television, you can be in on it with NTS training.



YOUR OPPORTUNITY IS NOW

New ideas, new inventions, are opening whole new fields of opportunity. The electronic industry is still the fastest growing field in the U.S. There's a bigger, better place in it for the man who trains today. So, whatever your goals are — advanced color TV servicing, broadcasting, F.C.C. license, computers, or industrial controls, NTS has a highly professional course to meet your needs.

GET THE FACTS! SEE ALL NEW COURSES AND KITS OFFERED IN THE NEW NTS COLOR CATALOG. SEND THE CARD OR COUPON TODAY!

There's no obligation. You enroll by mail only. No salesman will call.

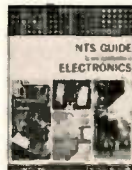

NATIONAL TECHNICAL SCHOOLS

DEPT. 205-98

4000 S. Figueroa St., Los Angeles, Calif. 90037

Please rush Free Color Catalog and Sample Lesson, plus information on field checked below. No obligation.

- | | |
|---|--|
| <input type="checkbox"/> MASTER COURSE IN COLOR TV SERVICING | <input type="checkbox"/> PRACTICAL TV & RADIO SERVICING |
| <input type="checkbox"/> COLOR TV SERVICING | <input type="checkbox"/> FCC LICENSE COURSE |
| <input type="checkbox"/> MASTER COURSE IN TV & RADIO SERVICING | <input type="checkbox"/> INDUSTRIAL & COMPUTER ELECTRONICS |
| <input type="checkbox"/> MASTER COURSE IN ELECTRONIC COMMUNICATIONS | <input type="checkbox"/> STEREO, HI FI & SOUND SYSTEMS |
| | <input type="checkbox"/> BASIC ELECTRONICS |

NAME _____ AGE _____

ADDRESS _____

CITY _____ STATE _____ ZIP _____

Check if interested in Veteran Training under new G. I. Bill.

Check if interested ONLY in Classroom Training at Los Angeles.

ACCURATE LOW-VOLTAGE CALIBRATOR

NOVEL CIRCUIT
UNAFFECTED BY LOAD

BY FRANK H. TOOKER

HERE IS A D.C. VOLTAGE standard and calibrator circuit that can be used to check the accuracy of any voltmeter from a 1000-ohms/volt VOM to a vacuum-tube voltmeter or TVM.

This standard is insensitive to variations in its own battery voltage. When the 9-volt battery potential has dropped to 5 volts under load, the accuracy of the standard is only affected 2%.

How It Works. As shown in the schematic diagram, field-effect transistor *Q1* is connected in series with resistor *R1* and potentiometer *R2* across the battery. The resulting current flow (about 700 μ A) in *R1* creates a voltage drop which provides the gate bias for *Q1*.

Since *Q1* is reverse-biased, any decrease in its bias voltage causes an increase in source current which tends to restore the current flow in *R1* to its original value. Similarly, an increase in source current increases the gate bias and thus tends to decrease the source current.

Fundamentally *Q1* operates as a constant-current device and thus creates a constant voltage drop. The potential between the source electrode of *Q1* and ground is fixed despite wide variations in the value of the supply voltage.

The output resistance at the source electrode of *Q1* would be adequate for calibrating a VTVM or a TVM with a high input resistance, but it will not accommodate a VOM with a resistance as low as 1000 ohms/volt. The output of *Q1* is therefore current-amplified by tran-

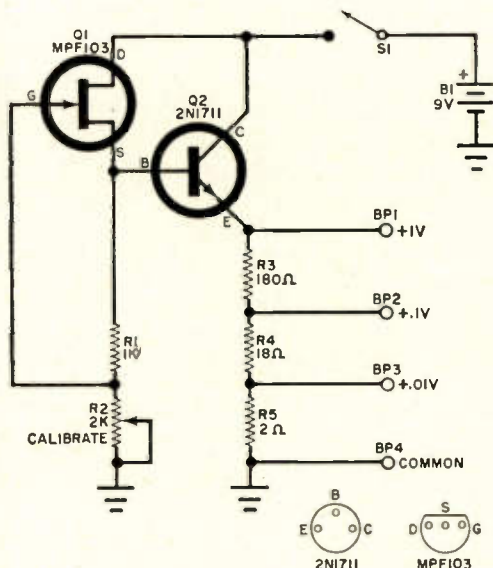

PARTS LIST

- B1*—9-volt transistor battery
 - BP1, BP2, BP3, BP4*—Five-way binding post
 - Q1*—MPF-103 field-effect transistor
 - Q2*—2N1711 transistor
 - R1*—1000-ohm, 2%, 1/2-W metal-glaze resistor*
 - R2*—2000-ohm, wire-wound miniature potentiometer
 - R3*—180-ohm, 2%, 1/2-W metal-glaze resistor*
 - R4*—18-ohm, 2%, 1/2-W metal-glaze resistor*
 - S1*—S.p.s.t. switch
 - Misc.—Battery holder, battery terminal clip, suitable small cabinet, wire, solder, etc.
- *IRC type RG20 or equal

All resistors in this circuit should have a tolerance of 2% or better. Author used metal-glaze resistors (IRC-RG-20). Battery should be alkaline.

sistor *Q2*, reducing the effect of loading by a factor of about 100:1. Simultaneously, the meter being calibrated or checked is presented with a terminal resistance no higher than 20 ohms. Thus, a high order of accuracy is maintained.

Calibration. The unit can be calibrated against any accurate voltmeter standard having at least 1000 ohms/volt resistance. Simply connect the voltmeter across the +1.0 V and COM terminals and adjust potentiometer *R2* until the meter reads exactly 1 volt. Lock the shaft of *R2* in place.

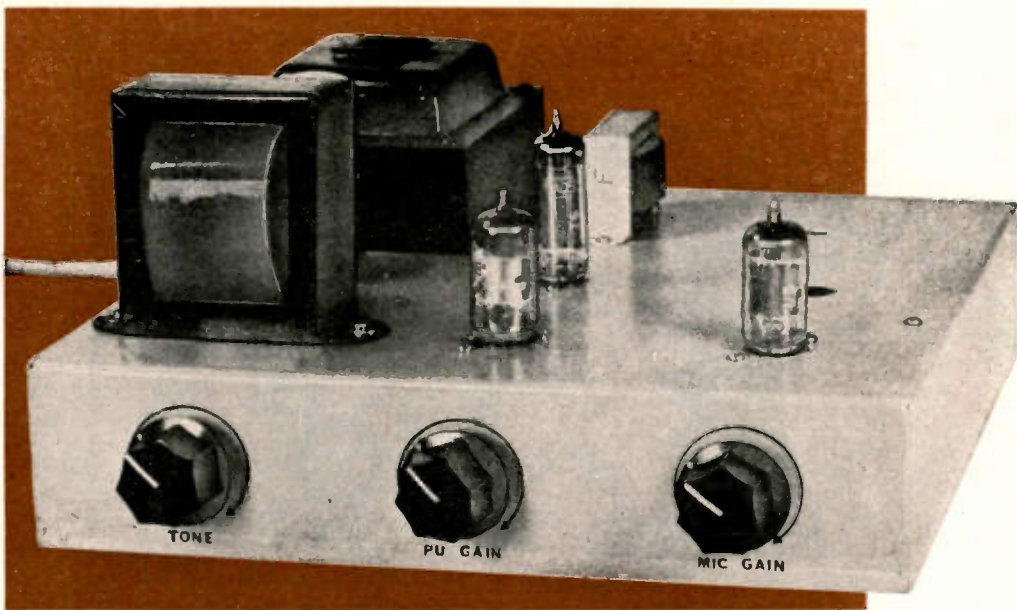

Basic Mono Amplifier

A TRUE JUNK-BOX AMPLIFIER ANYONE CAN BUILD

BY JOHN HORSFIELD*

THIS ARTICLE PROVIDES an answer to a request from a high school science teacher who wanted a design for a simple audio amplifier to be built from a near-random stock of junk parts. The amplifier was to be capable of delivering 3 or 4 watts of audio power to a loudspeaker and might be operated in conjunction with a microphone, phono cartridge, or an AM/FM tuner.

The basic mono amplifier that satisfies that request consists of three stages: a microphone preamplifier, a voltage amplifier, and a power amplifier. And, of course, there is a power supply, involving a power transformer, rectifier, and filter system.

The need to allow for components of various shapes and sizes rules out any idea of compactness. In fact, it is suggested that the chassis of the basic amplifier be larger than is actually necessary—something on the order of 9 $\frac{3}{4}$ " deep \times 10 $\frac{1}{2}$ " wide \times 2 $\frac{1}{4}$ " high being

about right. With proper care and construction, the finished amplifier can look quite neat and the larger chassis size may be an actual advantage.

Choice of Tubes. The amplifier is primarily designed to use 7- or 9-pin miniature vacuum tubes, but there is no objection to using octal-base tubes. The tables of substitutions accompanying this article illustrate the wide variety of tube substitutions that can be made.

Only octal and miniature tubes are included in the substitution tables since they are generally most readily available. You will notice also that most of the tubes listed for the amplifying stages have 6.3-volt heaters so you can use a common power transformer.

In general, the use of multiple-function tubes was avoided, though there are

*Reprinted with special permission from Electronics Australia.

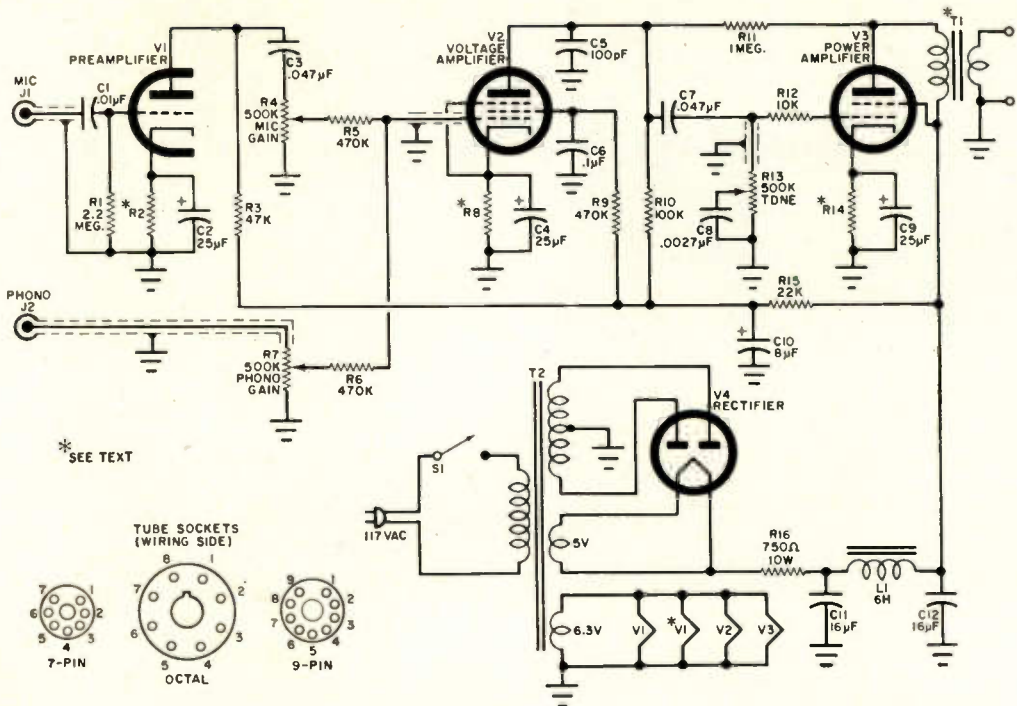

PARTS LIST

C1, C6—0.01- μ F ceramic capacitor
 C2, C4, C9—25- μ F, 25-volt electrolytic capacitor
 C3, C7—0.47- μ F ceramic capacitor
 C5—100-pF ceramic or Mylar capacitor
 C8—0.0027- μ F (2700-pF) ceramic or Mylar capacitor
 C10—8- μ F, 300-volt electrolytic capacitor
 C11, C12—16- μ F, 350-volt electrolytic capacitor
 J1, J2—Phono jack
 L1—6-henry, 60-mA filter choke
 R1—2,200,000-ohm, $\frac{1}{2}$ -watt resistor
 R2, R8, R14—4-watt resistors (see Tables for values)
 R3—47,000-ohm, $\frac{1}{2}$ -watt resistor
 R4, R7, R13—500,000-ohm potentiometer
 R5, R6, R9—470,000-ohm, $\frac{1}{2}$ -watt resistor
 R10—100,000-ohm, $\frac{1}{2}$ -watt resistor

R11—1,000,000-ohm, $\frac{1}{2}$ -watt resistor
 R12—10,000-ohm, $\frac{1}{2}$ -watt resistor
 R15—22,000-ohm, $\frac{1}{2}$ -watt resistor
 R16—750-ohm, 10-watt resistor
 S1—S.p.s.t. switch
 T1—Output transformer (see text and Tables)
 T2—Power transformer—117-volt primary; 285-0-285 high-voltage secondary (100-mA or higher), heater windings—6.3 volts and 5 volts
 V1, V2, V3—Vacuum tubes (see text and Tables)
 1—9 $\frac{3}{4}$ " X 10 $\frac{1}{2}$ " X 2 $\frac{1}{4}$ " metal chassis
 Misc.—Power cord and plug; tag strip or terminal board; shielded cable; tube sockets to match tubes selected; rubber grommets; knobs; terminal strip; wire; solder; hardware; etc.

Fig. 1. Designed to accommodate a near-random selection of junk-box parts, the amplifier also features microphone and phono inputs and a full complement of gain and tone controls.

some in the microphone preamplifier. These have 12.6-volt heaters, but because only one section of the tube is used, a 6.3-volt filament winding is quite adequate. Many of the rectifier tubes specified have 5-volt filaments, but many power transformers are available with this extra winding.

The column headings for the base connections in the substitution tables refer to the tube electrodes as follows: P—plate; C—control grid; S—screen grid; K—cathode (and suppressor grid

of pentodes); and HH—heater. Where two or more numbers are listed in one column (except HH), the points indicated are to be wired in common.

In the amplifying tube tables, the recommended values for the cathode resistor (R_k), screen-grid resistor (R_s), and output transformer primary impedance (Z_1) are given. Headings E_H and MAXIMUM E_{IN} in the rectifier tube table refer to the heater voltage required and the maximum allowable voltage to be applied to the plates, respectively.

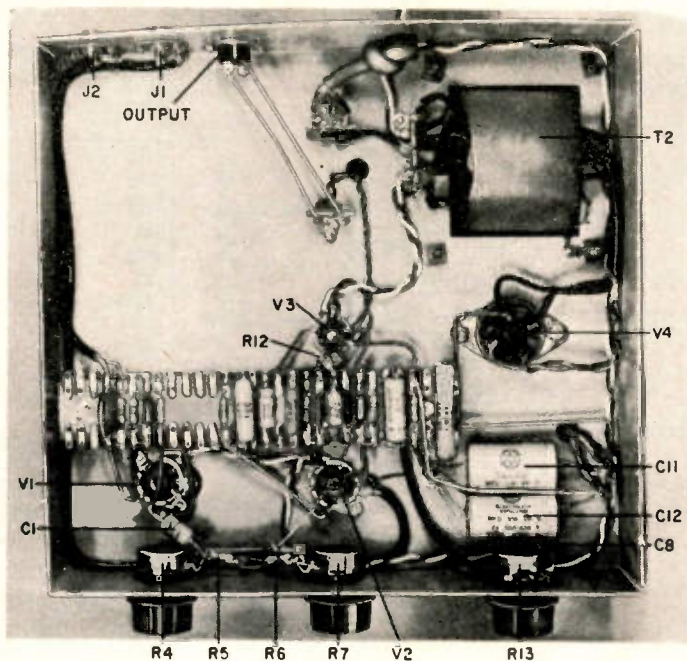

Fig. 2. All controls, including optional power switch, should be mounted on front apron of chassis. Rear apron can be machined to accept input jacks and output socket and provide convenient entry for power cord.

PREAMPLIFIER TUBE SUBSTITUTION TABLE

TYPE	BASE	P	G	K	HH	Rk	REMARKS
EC92	7-pin	1	6	7	3,4	1.8k	ground pin 2
ECC91	7-pin	1,2	5,6	7	3,4	1.8k	
6AB4	7-pin	1	6	7	3,4	1.8k	ground pin 2
6J6	7-pln	1,2	5,6	7	3,4	1.8k	
6F8	octal	3,6	5, T/C*	4,8	2,7	2.2k	
6J5	octal	3	5	8	2,7	2.2k	ground pin 1
6SL7	octal	2,5	1,4	3,6	7,8	2.2k	
6SN7	octal	2,5	1,4	3,6	7,8	2.2k	
ECC83	9-pin	1,6	2,7	3,8	4,5,9	1.5k	
12AT9	9-pin	1,6	2,7	3,8	4,5,9	1.8k	
12AU7	9-pin	1,6	2,7	3,8	4,5,9	1.8k	
12AX7	9-pin	1,6	2,7	3,8	4,5,9	1.5k	

POWER AMPLIFIER TUBE SUBSTITUTION TABLE

TYPE	BASE	P	S	G	K	HH	Rk	Z1	REMARKS
EL90	7-pin	5	6	1,7	2	3,4	270	5k	
EL91	7-pin	5	7	1	2	3,4	680	16k	
6AM5	7-pin	5	7	1	2	3,4	680	16k	
6AQ5	7-pin	5	6	1,7	2	3,4	270	5k	
6F6	octal	3	4	5	8	2,7	390	7k	ground pin 1
6V6	octal	3	4	5	8	2,7	270	5k	
EL80	9-pin	7	1	2	3	4,5	180	7k	
EL84	9-pin	7	9	2	3	4,5	220	7k	
6BQ5	9-pln	7	9	2	3	4,5	220	7k	
6CM6	9-pin	9	1	3,6	7	4,5	270	5k	
6M5	9-pin	7	1	2	3	4,5	180	7k	

VOLTAGE AMPLIFIER TUBE SUBSTITUTION TABLE

TYPE	BASE	P	S	G	K	HH	Rk	Rs	REMARKS
EF94	7-pln	5	6	1	2,7	3,4	1k	220k	
6AU6	7-pin	5	6	1	2,7	3,4	1k	220k	
6BC6	7-pin	5	6	1	2,7	3,4	2.7k	220k	
6CB6	7-pin	5	6	1	2,7	3,4	2.7k	220k	
6J7	octal	3	4	T/C*	5,8	2,7	1k	470k	ground pin 1
6HS7	octal	8	6	4	3,5	2,7	1.8k	220k	ground pin 1
6SJ7	octal	8	6	4	3,5	2,7	1k	330k	ground pin 1
EF80	9-pin	7	8	2	1,3,9	4,5	1.8k	330k	ground pin 6
6BX8	9-pin	7	8	2	1,3,9	4,5	1.8k	330k	ground pins 2,7
EF86	9-pin	6	1	9	3,8	4,5	1k	470k	ground pins 2,7
6BK8	9-pin	6	1	9	3,8	4,5	1k	470k	ground pins 2,7
6BX6	9-pln	8	8	2	1,3,9	4,5	1.8k	330k	ground pin 6

*Top cap.

About the Circuit. Like all tube-type amplifiers, this one requires an output transformer (*T1* in Fig. 1) to match the output impedance of *V3* to the voice-coil impedance of the speaker selected. However, it is important to bear in mind that the primary impedance of *T1* is valid only if the secondary is connected to a speaker coil of the correct impedance. Thus, a 16-ohm speaker should be fed by an output transformer intended to work into 16 ohms. If the secondary of the output transformer is connected to an incompatible speaker impedance, the speaker and amplifier will be mismatched—even if the primary imped-

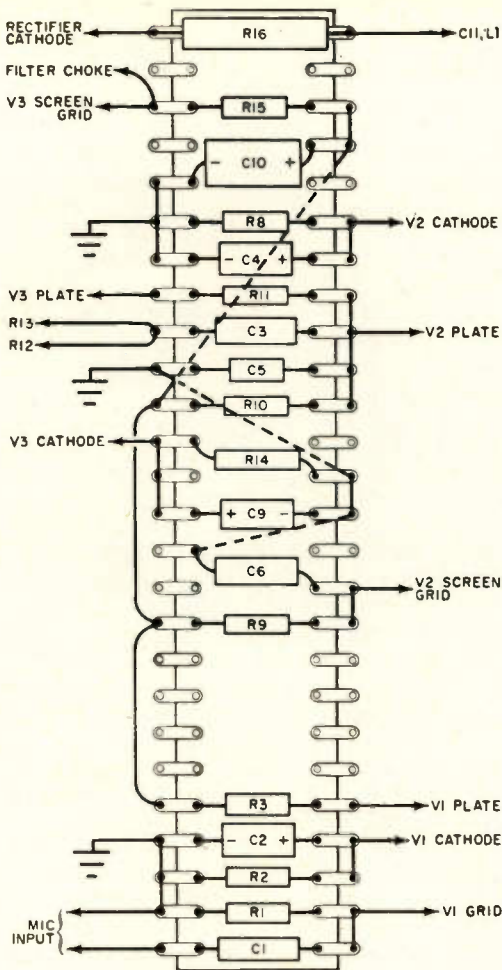

Fig. 3. Use of a terminal board or tag strip speeds assembly and lends a neat, professional appearance.

ance is selected correctly according to the *Power Amplifier Tube Substitution Table*.

It will be noticed that a 1-megohm resistor, *R11*, has been included in the circuit between the plates of *V3* and *V2*. This is to provide some negative feedback to improve the audio tonal quality and to curtail the generation of high-voltage peaks in the output circuit on signal transients.

This particular type of negative feedback is somewhat less effective—but also less critical—than the use of a resistor between the secondary of *T1* and the cathode circuit of *V2*. Like all types of negative feedback, the use of *R11* reduces the overall gain of the amplifier

RECTIFIER TUBE SUBSTITUTION TABLE

TYPE	BASE	PP	K	HH	E _{II}	MAXIMUM E _{IN}
EZ90	7-pin	1,6	7	3,4	4	
EZ91	7-pin	1,6	7	3,4	4	
6AV4	7-pin	1,6	7	3,4	4	
6X4	7-pin	1,6	7	3,4	4	
GZ32	octal	4,6	8	2,8	5	
5U4	octal	4,6	*	2,8	5	
5V4	octal	4,6	8	2,8	5	375-0-375
5Y3	octal	4,6	*	2,8	5	
6AX5	octal	3,5	8	2,8	6	
6X5	octal	3,5	8	2,8	6	
EZ80	9-pin	1,7	3	4,5	6	350-0-350
EZ81	9-pin	1,7	3	4,5	6	350-0-350
6CA4	9-pin	1,7	3	4,5	6	350-0-350
6V4	9-pin	1,7	3	4,5	6	350-0-350

*These tubes have directly-heated cathodes, same as HH.

by three or four times, but there is still ample gain for most applications.

Other than the two special features mentioned above, the basic mono amplifier operates much the same as any other single-channel audio amplifier. The controls are simple, consisting of individual MIC GAIN and PHONO GAIN (*R4* and *R7* respectively), and TONE control *R13* to provide for individual listening tastes. The use of individual gain controls also provides a convenient mixing medium to allow both sources to be used simultaneously.

Construction. After getting together all of the components you plan to use in your mono amplifier prototype, check their condition. Be especially careful when checking electrolytic capacitors; excessively leaky capacitors should be avoided. The same applies to tubes that have very low emission.

Most of the components in the prototype shown in the photo at the beginning of this article and in Fig. 2 are mounted on a pre-wired tag strip fitted between the tube sockets. A wiring diagram for the tag strip (you can substitute a terminal board if you desire) is shown in Fig. 3. Note that shielded cable must be used for the microphone and phono inputs and for some of the interstage connections. This is essential to minimize hum and prevent stray coupling.

(Continued on page 104)

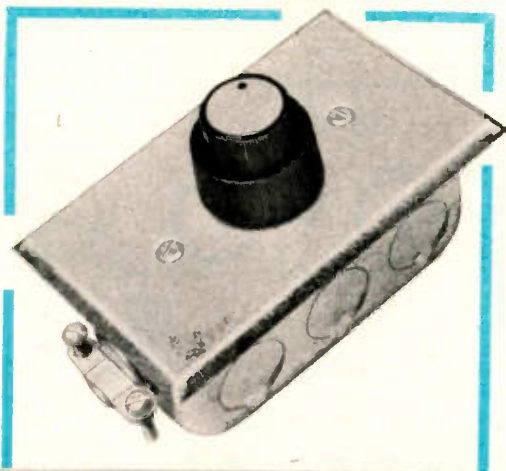

Build The **DYNADIM**

Home Lighting Control

THE DIMMER
WITH A
DIFFERENCE

BY RUSSELL J. BIK

YOU'RE ENTERTAINING and would like the lights down low to set the "mood." But to have them there to start with or to lower them noticeably would spoil the effect. If your home lighting is equipped with the "Dynadim"—the dimmer with a difference—you're in business.

The Dynadim is an unobtrusive wall-mounted device that lets you dim room lighting to any preset level, even full off, automatically and at an almost unnoticeably slow rate. All you do is set a control for the dimming level desired and push in a knob.

Aside from its obvious use as a mood setter at parties, the slow extinguishing action of the lighting possible with the Dynadim can serve as a sleep inducer and a safety device in the home. For example, after setting the Dynadim for timed full off, you have ample opportunity to get into bed before the lights extinguish. So, stubbed toes, bruised shins, and even broken bones that result from collisions with furniture in the dark are eliminated.

If the extinguish rate is set for a sufficiently long time, the slow dimming action can help you to relax, making your eyes heavy-lidded. Before you know it, you're fast asleep. And the Dynadim is especially handy to have around when the kids insist that the lights be left on after they are put to bed.

How It Works. To obtain proper dimming action, the Dynadim must be connected in series with the a.c. power source and the load (lamp or fixture to be controlled) via terminals *A* and *B* in Fig. 1.

The power to the load is regulated by the dimmer, specifically by the triac *Q3*. The triac acts as a switch that closes at some point during each alternation of the input power. To cause *Q3* to conduct, a trigger pulse (produced by the discharge action of *C2* through *Q2* and the primary of *T1*) is applied to the gate of the triac. The triac continues to conduct for the remainder of the alternation.

The point in the alternation where *Q3* is triggered into conduction determines how much power is supplied to the load. If triggering is early, the lighting glows at a higher average intensity than if triggering is late.

The time constant of *R9* and *C2* is rather long compared to a single alternation. (The values shown were selected

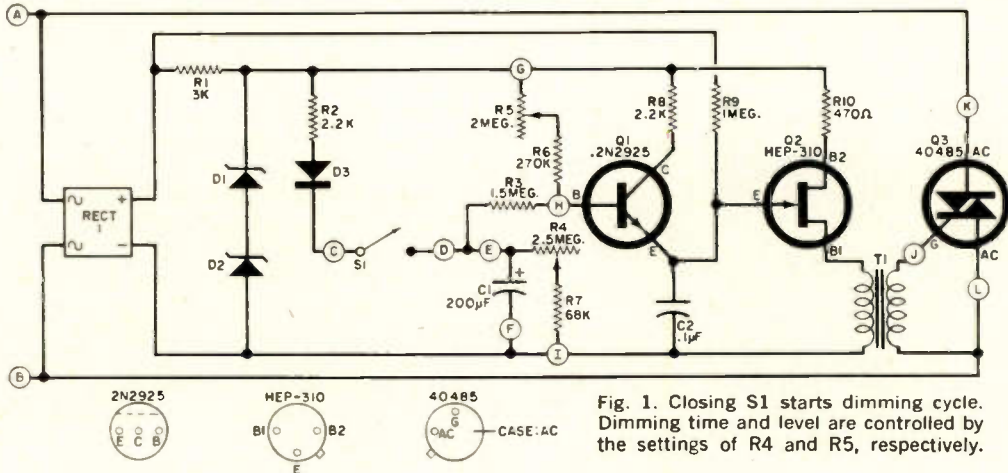

Fig. 1. Closing S1 starts dimming cycle. Dimming time and level are controlled by the settings of R4 and R5, respectively.

PARTS LIST

- C1—200- μ F, 25-volt electrolytic capacitor
 C2—0.1- μ F, 25-volt paper or mylar capacitor
 D1, D2—12-volt, 1-watt zener diode (General Electric Z4XL12B or similar)
 D3—HEP-154 diode (Motorola)
 Q1—2N2925 transistor
 Q2—HEP-310 unijunction transistor (Motorola)
 Q3—40485 triac (RCA)
 R1—3000-ohm, 5-watt resistor
 R2, R8—2200-ohm, $\frac{1}{2}$ -watt resistor
 R3—1,500,000-ohm, $\frac{1}{2}$ -watt resistor
 R4—2,500,000-ohm, linear-taper potentiometer
 R5—2,000,000-ohm, linear-taper potentiometer in tandem with R4
 R6—270,000-ohm, $\frac{1}{2}$ -watt resistor
 R7—68,000-ohm, $\frac{1}{2}$ -watt resistor
 R9—1-megohm, $\frac{1}{2}$ -watt resistor

- R10—470-ohm, $\frac{1}{2}$ -watt resistor
 RECT1—VS-248 bridge rectifier assembly
 S1—S.p.s.t. switch, push-pull type (part of R4-R5 combination)
 T1—1:1 pulse transformer (Sprague 11Z12)
 Misc.—General Electric #14-10 heat spreader; Scotch #27 glass-cloth tape; $1\frac{1}{8}$ " X $3\frac{3}{4}$ " heatsink mounting plate; printed circuit board; dual concentric knobs; hookup wire; solder; hardware, etc.
 The following parts are available from Pacific Circuit Systems, Box 1281, San Luis Obispo, Calif. 93401. Etched and drilled printed circuit board, \$2.25; complete kit including parts, printed circuit board, and machined mounting plate, \$14.95 (residents of California, add 5% sales tax).

so that the potential across C2 just barely attains an amplitude sufficient to drive Q2 into conduction when zero voltage is across C1, and R5 is set for maximum resistance.)

Closing S1 causes the voltage across C1 to rise, increasing the biasing of Q1 and raising the potential across C2. The charging curve of R9-C2, therefore, begins from a slightly higher potential on each successive a.c. power cycle. As a result, oscillator Q2 produces the triggering pulses for the triac (Q3) slightly earlier in the cycle as C1 charges through D1 and R2.

An earlier triggering can also be obtained by reducing the value of R5. The effect on the bias of Q1 is the same as that of raising the potential across C2 except that a static control over lighting intensity is provided. A later triggering is obtained by opening S1 and allowing C1 to discharge slowly through R4 and

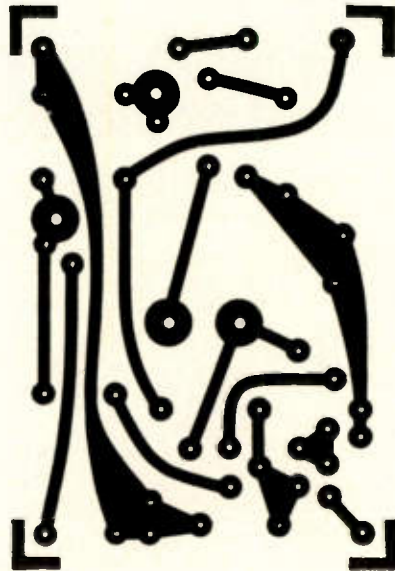

Fig. 2. Drawing shows, in actual size, the resist pattern to be copied if you make your own PC board.

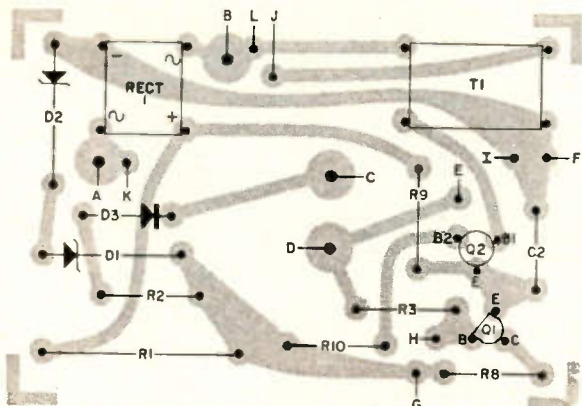

Fig. 3. Observe proper polarities when mounting diodes, transistors, triac, and rectifier assembly.

R7—the lighting diminishes as the triac triggering pulses are produced later and later in each cycle.

The high resistance necessary to prevent the voltage from being shunted away from C1 too rapidly is obtained by inserting R3 in the base circuit of Q1. The rectified power applied to the timing circuit from RECT1 is maintained at a 24-volt level, regardless of changes in load, by zener diodes D1 and D2.

Construction. The Dynadim was designed to be mounted inside a standard 4" × 2" junction box for wall mounting. Ample space is available inside the box for parts mounting and entrance of wires through both ends. For most permanent installations, the Dynadim's circuit sim-

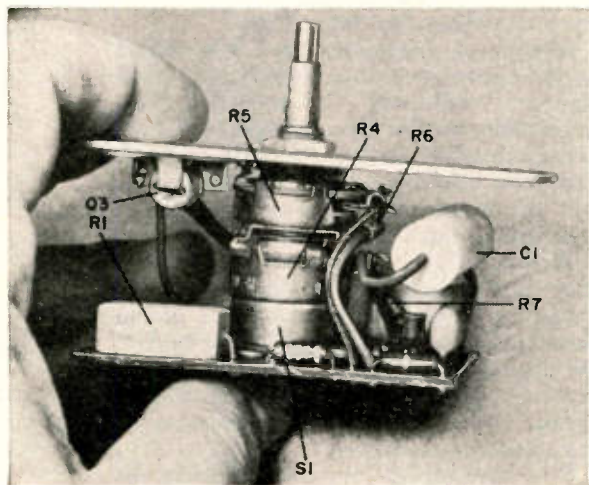

Fig. 4. For components that are not mounted flush with board, use insulated sleeving on exposed leads.

ply takes the place of your present power switch. You can, however, mount the circuit inside a high-impact/heat-resistant plastic box (equipped with a power receptacle) for portable use.

An aluminum mounting plate must be fabricated to support the exterior switch plate and serve as a heat sink for the triac. The plate should be just large enough to fit inside the front of the junction box and rest on the box mounting brackets. Two holes must be drilled and tapped in the mounting plate to facilitate mounting of the exterior switch plate. Then drill the holes for mounting the plate in the box and for the shaft of the control/switch assembly.

For maximum utilization of the space available, printed circuit board construction is recommended. If you plan to etch your own board, an actual-size etching guide is provided in Fig. 2. Component placement and orientation must be the same as that shown in the drawing given in Fig. 3. When all components are mounted and soldered to the board, cut off the excess leads close to the foil.

The potentiometer/switch assembly supports the circuit board as shown in Fig. 4. This is done by plugging the switch terminals at the rear of the assembly into the holes in the board. If necessary, bend these terminals to fit. Before final mounting and soldering, apply a bead of epoxy cement to the rear of the assembly to provide solid mechanical support. For maximum safety, also cement T1 to the board (see Fig. 5).

Mount the parts that do not sit directly flush with the circuit board. Be sure to connect the positive lead of C1 to hole E (negative to hole F). Resistors R6 and R7 connect from the wiper lug of R5 to hole H and from the center lug of R4 to hole I, respectively. Use insulated sleeving over the exposed leads.

The method recommended for mounting the triac is shown in Fig. 6. First carefully apply a thin film of solder to the underside of the triac's case. When cool, press the triac into the heat spreader, and apply enough heat to solder bond the two pieces together. Now apply a thick film of epoxy cement to the underside of the heat spreader, attach a 1½" to 2" long piece of heat-setting tape to the mounting plate opposite R1, and press the heat spreader onto the tape. Allow

the cement to set over night; then slip insulated tubing over the leads of the triac and solder them in place.

It is recommended that you look over the circuit board carefully to make sure that all solder connections are good and all polarities are correct. Then check for short circuits to ground. (Ground, in this case, is the front mounting plate.) Temporarily connect a power cord and load to the Dynadim. (See first paragraph of "How It Works" section.) Apply line power, and check with an a.c. voltmeter to make certain that there is no voltage between the mounting plate and a cold water pipe ground. When you are satisfied that the circuit is safe, remove the power and disconnect the load and line cord.

The next step is to cut the power feed to the switch that the "Dynadim" is to replace. Make absolutely certain that the 117-volt a.c. line is "dead" before removing the switch. Remove and set aside the wall plate and switch, and locate and identify the power and load wires inside the junction box.

Connect the appropriate wires to holes A and B on the circuit board as described earlier. Then twist tightly together the remaining load and line wires and secure them with an electrical wire nut. When the wire nut is in place no bare wire must be allowed to show.

Finally, mount the Dynadim in the junction box. Carefully arrange the wires so that they do not interfere with any of the components. Replace the exterior switch plate, and set the dual-concentric knobs onto the control shafts.

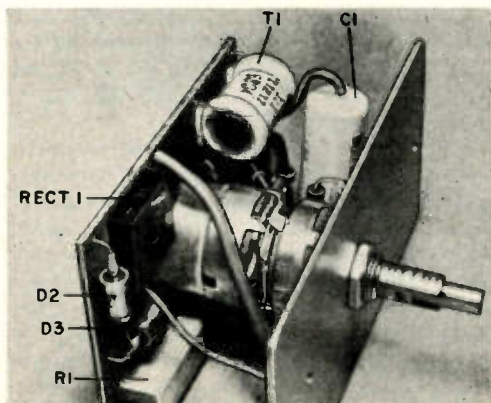

Fig. 5. Capacitor C1 should be oriented so that it sits between transformer T1 and the mounting plate.

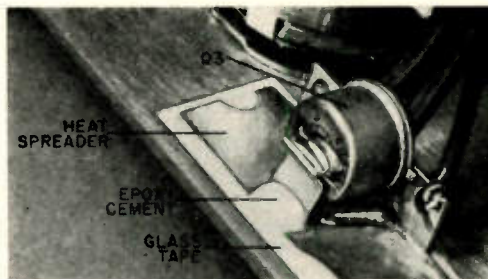

Fig. 6. Epoxy cement and glass-tape anchor insulate Q3 from front plate, provide maximum heat transfer.

How To Use. Although conventional on/off control over lighting is sacrificed with the use of the Dynadim, the sacrifice is not great. When properly operated, the lights can be switched off and become fully extinguished—even from full on—in a matter of a few seconds.

For dimming action, a great deal of flexibility can be obtained from the Dynadim's extremely simple controls. For example, if you wish the lights to be full on and extinguish to a very dim glow over a period of say, 10 minutes, the following procedure would be followed: First rotate both concentric knobs fully counterclockwise, and push in on the smaller knob. The lights will extinguish quickly. Then, adjust the large knob to the position that gives the desired minimum illumination. Set the smaller control to a position about $\frac{3}{4}$ clockwise, pull out until the lights come up to full intensity, and push in. It may be necessary to experiment with the setting of the smaller knob to obtain the exact time.

In general, dimming action is obtained by the above procedure. It may be a good idea to "calibrate" the controls (two concentric circles, for example) so that experimentation is unnecessary. The inner circle could be calibrated in minutes, and the outer for intensity—high; medium-high; medium; medium-low; etc.

If longer dimming times are desired, they can be obtained by increasing the values of C1 and/or R7. As a rule of the thumb, the dimming time is equal to $\frac{5}{8}$ of the time in seconds obtained by multiplying the value of the capacitor in microfarads by the sum of the resistances of R4 and R7 in megohms.

The "Dynadim" draws very little power when it is off. It can be treated like any electric clock or night light.

—30—



Photo courtesy ITT Wire & Cable Division.

36-24-34 Wire Sizes— Not Beauty Measurements

BY HERB S. BRIER, W9EGQ

*HOW TO CHOOSE
AND USE WIRE*

SINCE 1827, when Joseph Henry constructed electromagnets by insulating his wire with silk (instead of space-winding bare wire on an insulated iron core), the story of electric wire has been largely the story of insulation. Although wire and insulation are treated as separate subjects in this article, they are generally inseparable for electronics work.

There are times when as much attention should be given to the selection of wire, cable, and insulation as you would give to the choice of components for a project. Wire and cables are limited to the amount of current they can safely handle. If the specified maximum current is exceeded, the wire may fuse, or the insulation around it can melt because of heat build-up due to the resistance of the wire. If the bare wire from which the insulation has melted sags and touches another point in the circuit, it can cause extensive damage.

While the main determining characteristic in the selection of wire is current-carrying ability, the choice of insulation depends on a number of different factors. The first consideration used to be the maximum voltage present in the circuit,

but in today's solid-state circuitry this is certainly not the major factor. Of equal importance is the "local" environment of the wire itself, including temperature, wear or abrasion, humidity, etc.

You don't have to be an expert on wire and insulation to make a good choice every time. In most cases, all you have to do is know what the circuit requirements are and match them against a prepared table to determine the most suitable wire and insulation for your application.

Conduction Problems. From the viewpoint of cost, pure copper is the best low-cost electrical conductor for the great majority of wiring applications in electronics. Performance-wise, copper ranks second only to silver in electrical conductivity, but copper is by no means "perfect."

The main disadvantage of pure copper, a tendency to corrode when exposed to air, can be effectively combatted by plating copper wire with resistant metals such as gold, silver, platinum, tin, etc. Gold, for example, has 1.42 times the electrical resistance of copper, but it is virtually immune to corrosion; therefore, gold plating is used in ultra-critical applications (such as our satellites) where the slightest corrosion could be disastrous. Silver, on the other hand, is not quite as corrosion-resistant as gold, but it has approximately 5% less resistance than copper; consequently, silver plating is used for lowest surface resistance. Cost naturally limits the use of gold and silver plating, although such a thin layer of gold is required that gold plating is not as expensive as it sounds.

By far the most common method of controlling corrosion of copper wire, however, is by tin plating. "Tinning" once meant a coating of tin; now a coating of solder does the same job more economically.

Although "tinning" is the answer to one problem, the tin or solder coating on a copper wire introduces another problem—r.f. resistance. Direct current and low-frequency alternating current flow through the entire cross-section of the conductor, but as the frequency of the applied a.c. increases, current flow tends to concentrate more and more at the surface of the conductor.

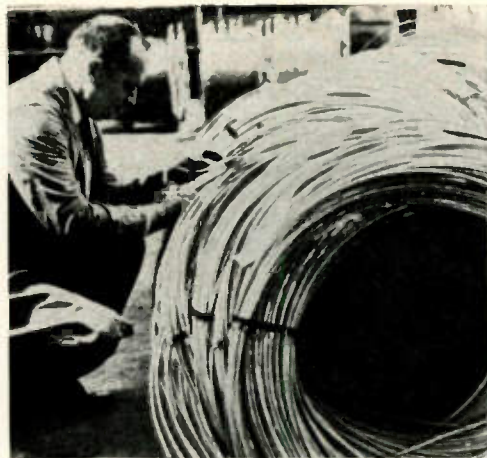

Just one of these rolls of copper can produce enough #40 wire to reach from Chicago to Salt Lake City—with about 100 miles to spare. (ITT Wire & Cable)

At some sufficiently high frequency, the entire current appears to flow along the surface—and none in the center—of the conductor. This phenomenon is known as "skin effect," and is characteristic of all conductors of electricity. ("Skin effect" also explains why copper tubing is often used in high-frequency, high-power transmitters instead of solid copper wire.)

Since solder has a greater resistance than copper, tinned copper wire has a higher r.f. resistance than bare copper wire. The difference in r.f. resistance is usually unimportant at frequencies below 100 MHz if adequately large diameter conductors are used in the first place.

For electronics work, most wire and cables are available with solid and stranded conductors. The solid conductor has a lower r.f. resistance than equivalent-size stranded conductor wire, and it is also less expensive. Stranded conductor cable, on the other hand, is more flexible and has greater effective strength when subjected to mechanical stresses.

Some insulation materials will withstand weather better than others; some are for high-voltage applications; and some others are designed for use at high temperatures. The first objective of anyone who uses or specifies wire or cable is to determine the best conductor size and choose the insulation according to the mechanical and environmental conditions under which it will be used.

How To Select Wire. The selection of wire for a given job depends on a number of things—among them current-carrying capacity, length, and strength. You should know the important characteristics of the most commonly available copper wire (solid and stranded) which are given in Table 1.

Not mentioned in Table 1 is the flex strength of each wire size. In general, flex strength is a function of the number of strands of wire that make up the cable. The more flexing or other mechanical stresses a cable is subjected to, the greater the number of strands it should contain. An 18-gauge cable, for example, might contain 7 strands of #26 wire for routine wiring; 41 strands of #34 wire for microphone cables; or 65 strands of #36 wire for flexible test leads.

The conservative approach to selecting hookup wire for mobile, marine, and other types of equipment that will be subjected to mechanical stresses is to decide on stranded wire; for TV sets, hi-fi amplifiers, radios, etc., solid wire is more convenient. Then you should determine the size wire needed for the nominal current-carrying capacity.

First use the third column in Table 1; then move to the first column to find the wire size needed for your application. (The figures given in the third column apply only for solid wire. For stranded wire, you can use the figures given, but when you move over to the first column, select the next largest size wire. For ex-

ample, if the circuit operates at 5 amperes, 18-gauge solid wire will suffice, but it is safer to use 16-gauge stranded wire if stranded wire is called for.)

When the current involved is low, strength of the wire should be the determining factor in your selection (see columns headed "Breaking Point In Pounds"). A good choice for routine work is #22 wire. For transistor circuits where this size of wire might prove too bulky, use #28 or #30 solid wire. Something larger than #22 wire is called for when the current to be handled is high, especially if the voltage is low.

For example, consider modern amateur radio transceivers with separate power supplies where the connecting cable must deliver heater current. A typical power cable is 8' to 10' long, and the tube heaters require 12.6 volts at approximately 5 amperes. Now, reading down the third column in Table 1, you will find that for a 5-ampere current-carrying ability #18 wire (at least) should be used. You will also note from the second column that #18 wire has a characteristic resistance of 6.385 ohms per thousand feet.

Now, if the power cable is 8' long, the round-trip length of the heater conductors is 16 feet—representing a resistance of 0.1 ohm. As small as this figure appears, it is sufficiently large to produce a 0.5-volt drop at 5 amperes. Therefore, if the power supply delivers exactly 12.6 volts, the voltage actually appearing at the tube heaters will be only 12.1 volts,

TABLE 1: CHARACTERISTICS OF COPPER WIRE

AWG WIRE SIZE	RESISTANCE (ohms/1000') ANNEALED WIRE	CURRENT RATING (AM- PERES)	BREAKING POINT IN POUNDS		
			Copper		Copper- Clad Steel
			Soft	Hard	
#10	0.9989	18	314	530	1300
#12	1.588	12	200	335	650
#14	2.525	9	120	215	410
#16	4.016	7	78	135	250
#18	6.385	5	49	83	163
#20	10.15	4	31	52	102
#22	16.14	3	19	33	64
#24	25.67	2	12	21	40
#26	41.0	1.5	8	12	—
#28	65.22	1	5	7	—
#30	103.4	0.7	3	5	—

which is about the minimum acceptable. A longer cable or smaller size of wire would drop the heater voltage below acceptable limits, but a larger size wire could be used for better results.

Going a step further, if the transceiver is operated from a 12-volt car battery, the heaters will still draw 5 amperes, but the power supply might draw an additional steady 8 or 10 amperes, plus as much as 20 additional amperes on voice peaks. As a result, the minimum size wire from the battery to the power supply would have to be ≈ 10 —if the distance between the power source and power supply is very short. Number 4 or 6 automotive primary wire would be a better choice in this case.

Incidentally, when more than two conductors in a multiconductor cable carry appreciable amounts of current, the individual conductors should be 30% larger than minimum to decrease the effects of cumulative heating.

In projects where space is at a premium, magnet wire comes in handy, although its primary function is one of space saving in power transformers and other inductive components. The synthetic enamel insulation used on magnet wire will easily withstand a few hundred volts.

Magnet wire is also used in winding coils and small r.f. chokes. Unfortunately, no two designers ever seem to use the same size of wire for the same given inductance value. Any size wire that will permit winding the specified number of turns in the specified winding length on a coil form will yield the same inductance as the original coil. For most experimental coils, therefore, exact wire size is seldom critical. However, in most radio-frequency circuits, the best insulation is

air (the dielectric constants of most insulators cause leakage, and in the case of coils it lowers the Q).

How To Select Insulation. Over the years, practically every non-metallic material from asbestos to the modern synthetic materials has been used to insulate wire. Table 2 lists the most common insulations available today for wires and cables. Of the insulations represented, wire experts agree that polyvinyl chloride (PVC) thermoplastic insulates well over 90% of all electric wire presently in use. Based on performance-versus-cost, PVC comes out on top.

Almost all electronic devices for the home—radios, TV sets, hi-fi amplifiers, CB and amateur rigs, etc.—are wired with PVC-insulated hookup wire; and, unless it was wired many years ago, so is your home. Grady T. Morgan, W4UJW, Technical Information Department of Western Electric Company, reports that 99%-plus of the 160 billion conductor feet of wire and cable used by the American Telephone & Telegraph Company last year was PVC-insulated.

As indicated in Table 2, standard PVC is available in 80° and 105° C (175° and 220° F) ratings. The lower rating is adequate for the majority of electronic hobby requirements, but wire using 105° PVC is easier to solder without melting the insulation—a feature that might make its slightly higher cost worthwhile.

Standard PVC is available with a 1000-volt rating, and 105° PVC comes in 600-volt and 3000-volt ratings. These ratings are very conservative, although from a design point of view they should be taken into consideration.

Aside from economy, PVC insulation has one very important advantage both

TABLE 2: PROPERTIES OF COMMON WIRE AND CABLE INSULATIONS

INSULATION MATERIAL	BREAKDOWN VOLTAGE	R. F. LOSSES	OPERATING TEMP. (°C)	WEATHER RESISTANCE	FLEXIBILITY	SUGGESTED USE
Standard PVC	High	Medium	-20 to +80	Good	Fair	General purpose
Premium PVC	High	Medium	-55 to +105	Good	Fair	General purpose
Polyethylene	High	Low	-60 to +80	Good	Good	R. f. cables
Natural rubber	High	High	-40 to +70	Poor	Good	Light duty
Neoprene	Low	High	-30 to +90	Good	Good	Rough service
Waxed cotton	Low	High		Poor	Good	Experimenting
Teflon	High	Low	-70 to +260	Good	Fair	High temperature

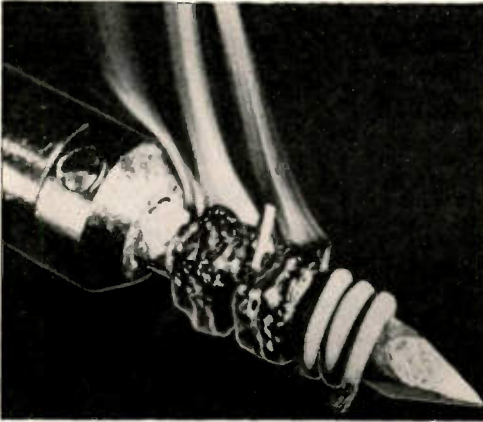

Dynamic test shows how teflon resists high heat, while other insulations melt. (ITT Wire & Cable)

for industry and the average hobbyist. If you look inside most commercial electronic equipment, you will find a profusion of rainbow colors for the insulation on hookup wires. The different colors make construction, circuit tracing, and troubleshooting less tedious in devices where a lot of wiring is necessary.

While on the subject of PVC insulation, it is worthwhile to mention the merits of irradiated PVC—or, as it is more commonly known, “polyolefin heat-shrinkable” plastic tubing. This relatively new material is ideal for insulating and weatherizing soldered connections. The tubing is superior in most cases to plastic electrical tape, and it does not “gum” up or become brittle over long periods of time. Six-inch lengths in assorted diameters are available from most electronics parts suppliers at reasonable prices.

Polyethylene insulation is extensively used for TV antenna transmission lines and flexible coaxial cables. It is more flexible than PVC and is often used to insulate microphone and similar cables, usually in conjunction with an outer

jacket of vinyl. Shielded polyethylene cables have up to 50% less capacitance per foot than comparable rubber-insulated cables. This is important in long shielded cables used in high-impedance circuits.

Rubber insulation is used where the greatest amount of flexibility is required. Unfortunately, natural rubber does not weather well, nor can it withstand exposure to temperatures above 120° F. Oddly enough, rubber insulated wire and cable is easier to solder without damage to the insulation than PVC-insulated wire. While ordinary rubber-insulated cables are best suited for indoor use, jacketing them with a coating of neoprene produces a flexible, all-weather cable with almost unlimited life.

If it were not for the much greater cost of Teflon (four to five times that of PVC), this material would probably be the most-used all-purpose insulation. Teflon is tough and weather-resistant, and is immune to all known chemicals and solvents. Besides its unsurpassed high-temperature qualities, Teflon's high-voltage characteristics are outstanding, and its r.f. losses are as low as those of polystyrene.

The conductors in Teflon-insulated wire are generally silver-plated since Teflon must be processed at very high temperatures where copper corrodes and tin melts. Silver, however, withstands the processing temperatures for 200° C Teflon.

Waxed-cotton insulation, which many old-timers will remember as push-back insulation, is still available but rapidly becoming obsolete. However, it does come in handy for experimental projects.

The selection of insulation for wires and cables boils down to matching the physical properties of the materials to the environment—weather, temperature, mechanical, etc.—in which it is to be used.

-30-

HISTORICAL RADIO CONFERENCE The Antique Wireless Association will meet at the Smithsonian Institution, Washington, D.C. on October 4, 5, and 6. A very full program is planned. Details may be obtained from W2QY, 69 Boulevard Parkway, Rochester, N. Y. 14612. Moderating a panel discussion on radio history and activities in the early 1920's will be POPULAR ELECTRONICS' Editor, Oliver P. Ferrell.

Simple Transistor Tester

COSTING LESS THAN ONE BUCK, THIS TESTER SORTS THE GOOD GUYS FROM THE BAD

BY ROBERT E. KELLAND

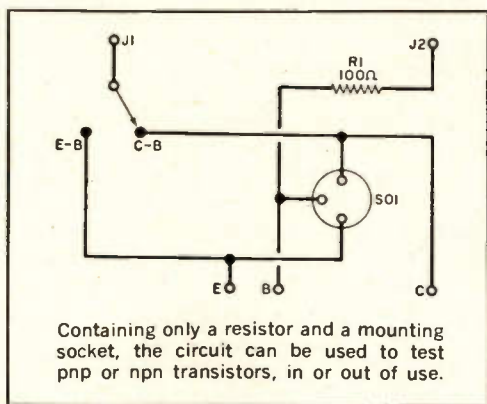

THE SIMPLEST WAY to test a transistor is with an ohmmeter. In this case, the transistor is considered to be a double diode and the ohmmeter compares the forward and back resistances of the two diodes.

The ohmmeter is connected first between the base and emitter, and the resistance is noted. The ohmmeter leads are then reversed and the new resistance is noted. With a good diode, one reading will be greater than 200,000 ohms and the other less than 500 ohms. The same procedure is repeated for the base-collector diode.

To build a simple set to make this test, you will need an ohmmeter with a built-in switch for polarity reversal. Such a switch is common in most ohmmeters, and it is usually marked $-DC$ and $+DC$.

Construction. The test circuit is wired as shown in the diagram and can be built in any type of small enclosure. Jacks $J1$ and $J2$ are conventional 5-way binding posts, $SO1$ is an ordinary transistor socket, and $S1$ can be any s.p.d.t. switch. The

three terminals marked E, B, and C are used for connecting three test leads when the transistor under test is already installed in a circuit. Resistor $R1$ is a current-limiting resistor which protects the transistor from incorrect ohmmeter range selections.

Operation. Set the ohmmeter in the $R \times 100$ range, and place the polarity switch on either $-DC$ or $+DC$. Adjust the ohmmeter test leads to $J1$ and $J2$ (polarity not important).

Insert the transistor in the socket (or connect to terminals E, B, and C). Place $S1$ in the E-B position and note the ohmmeter reading. Change the ohmmeter polarity switch and note the new reading. A high ratio between the two values indicates a good diode. A high reading in both directions means an open diode, while a low reading in both directions indicates a shorted diode. To check the base-collector diode, place $S1$ in the C-B position and repeat the procedure. Both *pnp* and *npn* transistors are tested in the same way without regard to polarity.

In-Circuit Testing. Transistors connected in circuits can be tested in the manner described above; however, although the low readings will be about the same as for an isolated transistor, the high readings will be somewhat lower, depending on the resistance of other circuit components. In most cases you should get at least a 5:1 ratio, which would indicate a good transistor when tested in a circuit. When an in-circuit test reveals a bad transistor, remove it from the circuit, and retest it as an isolated component.

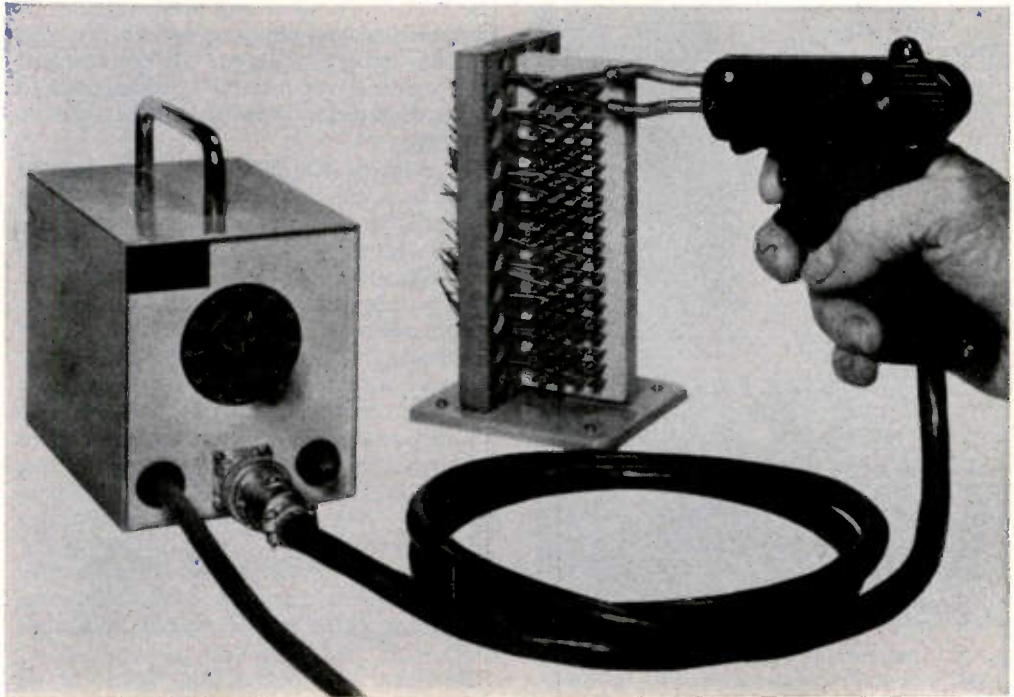

RESISTANCE

SOLDERING

*A safe, economical,
and reliable
technique for
soldering modern
electronic
equipment*

BY MELVIN WHITMER

MOST HOBBY ELECTRONICS enthusiasts struggle along with soldering irons and transformer-type soldering guns, little aware that a much safer and more reliable soldering tool is in the offing. This superior tool employs a resistance soldering technique that can eliminate or vastly reduce heat damage, cold-solder connections, and the hazard of burns to the operator.

Resistance soldering—relatively new in hobbyist and experimenter circles—is used in many industrial applications where it is considered to be superior to soldering irons and guns. Advantages include considerable savings in time and cost, better quality in soldered connections, and long-term soldering-equipment reliability. In some instances, particularly the space program, the U. S. Government specifies only the resistance soldering technique.

The purpose of this article is to introduce you to the advantages of resistance soldering and point out that most of the problems that can arise in soldering are due to the use of “conventional” soldering tools.



This is a tweezers-type electrode assembly that is commonly used with resistance soldering equipment.

Resistance Soldering Technique. In a conventional soldering iron, heat is produced within the tool by a heating element or cartridge. The heat is then stored in a metal soldering tip. The size of the tip determines the soldering iron's ability to store heat; a small tip stores less heat than a larger tip, thus restricting the application of a small iron to relatively few soldering applications.

Transformer-type soldering guns fare slightly better than the conventional iron. Since the heat is developed directly in the low-mass tip of the soldering gun, no heating element is required. However, any heat produced by soldering irons and guns must be transferred from the soldering tip to the connection being soldered. It is inevitable, since the thermal activity takes place within the tool itself, that some of the heat will be transferred to the connection and some to the air surrounding the soldering tip. And, there is the ever-present possibility of damaging nearby components and wiring while soldering.

A more direct approach to developing heat is employed in the resistance soldering technique. Heat is not developed in

the resistance soldering tool. Rather, it is generated and confined within the connection being soldered. To accomplish this, a technique similar to that used in the transformer-type soldering gun is employed.

In practice, the 117-volt line is stepped down to a low voltage (25 volts or less) by transformer action, just as for the gun. However, no tip is used in resistance soldering. Instead, two electrodes are applied to opposite sides of the connection to be soldered. Power is applied and alternating current circulates between the two electrodes and the connection. The high current flowing through the connection causes the connection itself to heat up almost instantly to the melting temperature of solder. (The connection generally has much higher resistance than the electrodes, which accounts for the generation of heat.) As a result, individual connections can be soldered in less time than with conventional soldering tools.

Because the connection itself must attain the melting temperature of solder, "wetting" of the joint, necessary to a well-soldered connection, is complete and cold-soldered connections are eliminated. Stating this in more meaningful terms, resistance soldering creates the optimum soldering conditions without passing through a middleground. You can't apply solder to a "cold" connection.

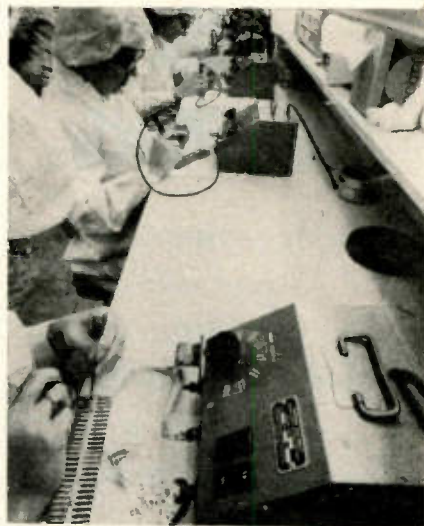

Selectable power ranges and timed-on cycles are features in most industrial equipment.

Advantages Of Resistance Soldering. Once the basic principle of resistance soldering is understood, the advantages of this tool become more obvious. In the first place, generation of instantaneous, yet confined, heat does away with idling time, wasted power, and the potential source of dangerous operator burns. Because the heat is confined to a very small area, heat damage to delicate components and wiring is minimized. (This applies only if the tool is used according to the recommended procedure. Heat damage can still occur if power is applied for too long a time.)

There are also some less obvious advantages to resistance soldering. Most of these are of the long-term type, such as extended equipment reliability. The soldering electrodes, made of carbon, graphite, or an alloy metal, do not become heated while soldering, nor do they corrode—so replacement is an infrequent problem. Finally, efficient generation of heat also means lower electrical power

consumption and a saving in the amount of solder used.

The only disadvantage of resistance soldering is the possibility of causing high-voltage damage to some types of delicate transistors and integrated circuits. Bear in mind that a high-current voltage produces the heat. If this applied voltage is allowed to bridge the terminals of some solid-state devices, permanent damage can result. However, a properly designed tool will eliminate this problem.

Some people may feel that the relatively high cost of resistance soldering tools is a disadvantage. But when weighed against the many advantages of resistance soldering equipment, the difference in cost is negligible. And if you construct your own equipment, it is likely you will pay less for parts than you would expect to pay for a top-quality soldering gun.

Now that you're aware of the advantages of resistance soldering, perhaps you'll want to build your own equipment. The instructions follow. —50—

BUILD A RESISTANCE SOLDERING TOOL

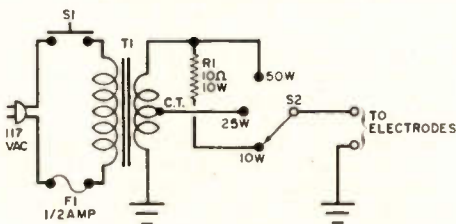

Fig. 1. Center tap and current-limiting resistor provide selection of three power ranges.

THE FACT THAT MOST KITS returned to the manufacturer or supplier suffer from little more than bad soldering is argument enough for the hobbyist to become acquainted with resistance soldering. If you feel that you must exercise undue caution when soldering, then you owe it to yourself to investigate resistance soldering at first hand.

The Power Supply. The schematic diagram of an inexpensive resistance soldering setup is shown in Fig. 1. It consists of a simple low-voltage a.c. source for supplying the high current needed for resistance soldering. Trans-

former T1 is a 10-volt center-tapped, 5-ampere filament transformer (Allied Radio number 54B3720, or similar). It is capable of delivering the power ranges indicated at the contacts of S2. The 50- and 25-watt ranges are tapped directly from the "hot" and center-tap leads, while the 10-watt range is derived by installing a current-limiter resistor (R1) in the 10-volt line.

A top limit of 50 watts may not appear to be adequate for point-to-point soldering, but the power is converted into heat that is contained only within the connection being soldered. As a result, 50 watts is generally more than adequate for all but the largest connections you are likely to encounter.

Switch S1 almost of necessity must be a foot-switch. When a footswitch is used, one hand is free to use the soldering electrode assembly while the other feeds solder.

Construction. Since potentially hazardous 117 volts a.c. is present in the primary circuit of T1 it is necessary that the power-supply circuit be housed inside a sturdy container, such as a steel or aluminum utility box. The transformer should be located so that all components associated with the primary circuit are completely isolated from those in the secondary circuit. The location of each component, however, is not critical.

When running the line cord and the footswitch cable into the box, use heavy-duty plastic, line-cord strain reliefs to prevent the cables from chafing or working loose. Also, a pair of five-way insulated binding posts or banana jacks will provide a convenient means of connecting the electrode assembly cable to the power supply.

Wire the components together, using Fig. 1 as a guide. Make absolutely sure that neither of the primary taps of *T1* are grounded or otherwise shorted to ground. The only points that should be grounded are in the secondary, low-voltage circuit.

The body or handles of the electrodes must be relatively heat-resistant and non-conductive. Fiber test probes (H. H. Smith Type 323, or similar), or bakelite or fiberglass tubing, are ideal for the handles. Do not use plastic utility test prods.

Two types of materials are commonly used as electrodes. The most rugged electrodes are made of a metal alloy. For careful constant use, carbon or graphite (pencil lead) is suitable. However, for the relatively low power available from the power supply shown in Fig. 1, the original test probe tips will suffice—as long as the chrome plating remains intact.

When you use commercially available alloy electrodes or graphite, the test probes must be fashioned into pin chucks. The drawing in Fig. 2 demonstrates how this is done. First, you cut

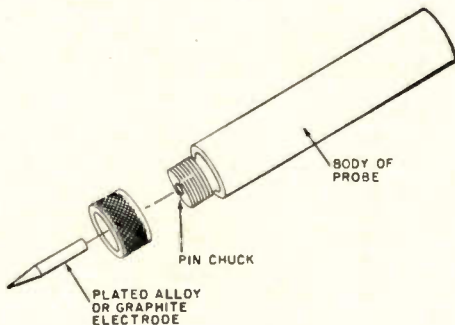

Fig. 2. Fiber test prods, fashioned into pin chucks, serve as holders for the electrodes.

away the pin tip of each probe, remove the knurled retainer cap, and chuck the probe in a vise. Next, drill a hole, slightly smaller than the diameter of the electrode you choose, about $\frac{3}{8}$ " deep at the tip of the probe. Screw an appropriate brass nut on the threaded end of the probe, and carefully cut a $\frac{1}{4}$ "-deep notch, as shown, with a fine hacksaw blade. Finally, spread the notch just enough to allow the electrode to drop into the hole.

The drawing in Fig. 3 shows how to make a simple tweezer-type electrode assembly. The spring should be secured to the probe bodies by tightly winding a single layer of #22 bare wire around the probe bodies and spring extensions

as shown. Liberally apply epoxy cement over the wire winding, line the probe tips up, and chuck the assembly in a vise until the cement sets.

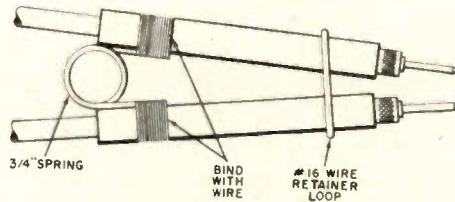

Fig. 3. Tweezer assembly can be fastened by securing electrode holders to torsion spring.

When the epoxy cement sets, form a flat loop of 16- or 14-gauge wire with the inside of the loop measuring slightly larger than the diameter of the probe body. Its length should be calculated to allow a maximum tip travel of 1" when the loop is fixed in place, again with epoxy cement, to only one probe body as shown.

Slide one end of a 5' length of heavy-duty test lead wire into each probe, securing them in place with the knurled retainer cap removed earlier. Affix suitable connecting plugs to the other ends of the test lead wire.

How To Use. With the electrodes chucked into the probe tips, plug the electrode assembly cable into the power supply and the power-supply line cord into an a.c. receptacle. Connect the leads of an a.c. voltmeter to the probes and momentarily actuate the footswitch. The meter should indicate either 10 or 5 volts, depending on the position of S2. Do this for all three settings of S2. If you obtain 10 volts in position 1, 5 volts in position 2, and 10 volts in position 3 (50, 25, and 10 watts, respectively), your wiring is correct.

Use the probes as you would use a pair of tongs, closing them until the tips of the electrodes touch the opposite sides of the connection being soldered. Depress the footswitch, and touch the tip of your solder feed to the connection as close as possible to the electrodes. As soon as the solder begins to flow, release the footswitch and remove the electrodes and solder feed.

To determine which of the three ranges you should use for a given job, start with the lowest range and follow the procedure outlined above. However, if the solder fails to flow after applying power to the electrodes for approximately three seconds, move to the next highest range. The correct range to use is the lowest one that causes the solder to flow within the allotted time.

Two precautionary notes are worth mentioning. First, never apply power to the electrodes before the electrodes are in contact with the connection being soldered—only after. And make sure the electrodes touch only the connection being soldered to prevent a circulating current through nearby components.

tips & techniques

DON'T BE CHEATED BY LEAKPROOF DRY CELLS

The leakproof "C" or "D" cell is a wonderful invention, but it has introduced a new problem. Some cells go dead unexpectedly when there should still be plenty of life left in the battery's electrolyte. This condition is generally



due to an imperfect contact between the inner and outer shells of the leakproof container. If you suspect that there's life in your batteries, dent the bottom of the cell gently with a blunted nail (see photo). This will reestablish contact between the two shells. Be careful not to tap too hard. To be on the safe side, drill a $\frac{3}{8}$ "

hole in a block of wood, and insert the positive terminal into the hole so that the wood supports the battery case. —*William S. Gohl*

NEED A HEATSINK? CHECK YOUR WIFE'S CURLER BOX.

You may not have given much thought to it, but your wife probably has a wide variety of custom-made heatsinks tucked away in her curler box. Those clips make dandy heatsinks—if you can wrest them away from your wife. They come in various shapes and sizes—probably more shapes and sizes than you'll ever find uses for.

Some have wide gripping jaws to handle high heat radiation requirements, while others have very narrow—and sometimes bent—jaws to fit into even the tightest of spots inside a chassis. Three or four different sizes and shapes will cover most heatsinking jobs. —*Henry R. Rosenblatt*

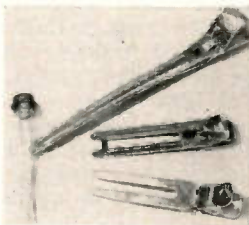

NAIL CLIPPER MAKES PC BOARD TOOL

A heavy-duty toenail clipper can be a handy item to have on your workbench if you do a

lot of printed-circuit board work. Wires and component leads protruding through the foil side of the boards should be trimmed as close as possible to the foil pattern after soldering. Diagonal cutters are generally inadequate for the job, but the flat cutting blades of a toenail clipper let you trim as close as you want. And if you use PVC-insulated #22 hookup wire, you can even cut notches (just large enough to sever through the insulation without nicking the wire) in the cutting blades to obtain a handy wire stripper. Be sure to use a good quality steel clipper, or the cutting edges will turn when trimming component leads. Keep a sharpening stone handy to sharpen the cutting edges occasionally.

—*Robert A. Dormer*

COLORED LAMPS AID LOGGING DX

Add color to the tuning dial of your short-wave receiver and you can make logging stations easier. The colored glow lets you distinguish between main tuning and bandspread at a glance. This works especially well with the Knight-Kit Model R-100A re-

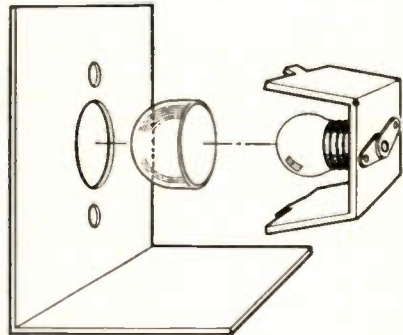

ceiver. Remove the #47 lamps, and replace them with #51 lamps. Then place colored dome-type lenses (for example, red for main tuning and green for bandspread) over the lamps, and replace the lamp holder on its bracket. —*Gary Hummell*

MECHANICAL PENCIL SERVES AS SOLDER HOLDER

For easy soldering in tight places, a draftsman's mechanical chuck pencil can come in handy. You simply load the chuck pencil with a 6" length of #16 solder. The chuck jaws, when the button is released, will grasp the solder and hold it firmly in place to form a working bit. Leave the solder bit straight, or bend it as required by the job. When the exposed solder is consumed, simply depress the chuck button until a convenient length of solder slides out. Keep a stock of 6" lengths of solder handy. —*Martin J. Leff*





SOLID STATE

By LOU GARNER, Semiconductor Editor

A NEW IC MANUFACTURING technique developed by the Bell Telephone Laboratories may make the term "micro-miniature" obsolete and require a new word to describe the resulting ultra-dense integrated circuits.

Using techniques developed by Bell scientists B.T. Murphy and V.J. Glinski, circuit arrays have been fabricated with a density of nearly one million devices per square inch. This density of components is from five to ten times that obtainable with conventional manufacturing methods. Silicon wafers comparable in size to a common postage stamp (see Fig. 1) . . . and not much thicker . . . can contain hundreds of individual circuits, each of which is small enough to fit within a stamp perforation hole.

Designed primarily for use in low-voltage switching, memory, and digital computer logic applications, the new circuits have epitaxial layers only one micron thick (about 40 millionths of an inch) in contrast to conventional IC's in which the layers are 5 to 7 microns thick. These thin epitaxial layers permit a corresponding reduction in the space between circuit elements.

At present, silicon integrated circuits are fabricated by diffusing an *n*-type silicon collector layer selectively into a *p*-type layer grown epitaxially. Circuit elements are then isolated by diffusing *p*+ impurities down through the epitaxial layer to the substrate. The diffusion extends the same distance sideways in the epitaxial layer as it does down through it. In the thinner layers used in the new method, the diffusion has less distance to penetrate down and, therefore, does not spread so far along the surface between devices. The devices themselves are formed by diffusing additional *p*-type and *n*-type layers selectively into the epitaxial layer.

Although the new technique represents a major breakthrough, other approaches to element isolation are being investigated at Bell Labs. For example, one involves growing a *p*-type instead of an *n*-type layer, thereby extending the base of the transistor from the emitter to the buried collector diffusion. Normally, this approach produces a wide transistor base and poor frequency response, but the use of ultra-thin layers re-

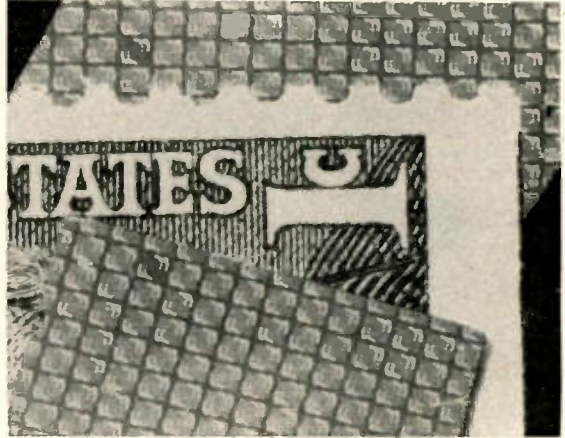

Fig. 1. Bell Labs' new IC manufacturing technique produces ultra-tiny circuits, each of which can fit into a single postage stamp perforation hole.

sults in narrow bases and good high-frequency characteristics. This procedure also simplifies manufacture since only one diffusion step is required to penetrate the thin epitaxial layer, establish contact with the buried diffusion, define the base area, and isolate the circuit element. The two steps presently required include a diffusion masking for isolation and a separate masking to form the transistor base.

In all the structures investigated thus far, the thin epitaxial layers result in transistors with higher inverse gain. In the new circuits, this characteristic can be used for improving switching speed, reducing power dissipation, and improving noise margins.

Since the new manufacturing method is still in the developmental stage, it may be several months before it is used in the production of "off-the-shelf" devices. Eventually, though, this new technique could have a significant effect on the use of IC's in consumer products.

Reader's Circuit. Suitable for rapid tests of both *pnp* and *nnp* bipolar devices, the dynamic transistor checker circuit illustrated in Fig. 2 was submitted by reader Timm Vanderelli, WPE6GUF, 12567 Debell

Fig. 2. This transistor tester circuit is basically a modified Hartley oscillator. It checks for modest gain and will reject shorted, open, excessively leaky, and very low gain npn and pnp transistors.

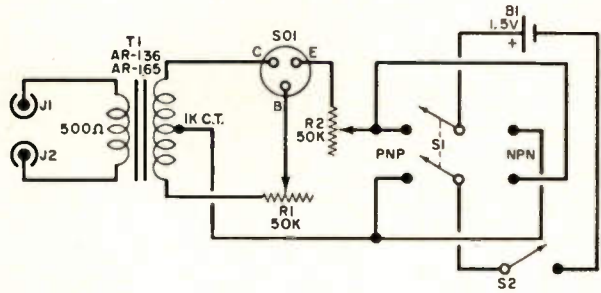

St., Arleta, Calif. 91311. Although it does not permit quantitative measurements, it can be used to find out if a transistor provides modest gain and will reject open, shorted, excessively leaky, and very low-gain units. The instrument could be quite valuable for quick checks of bargain or low-cost "surprise package" transistor purchases.

Referring to the schematic diagram, the instrument is basically a modified Hartley audio oscillator, with variable resistance elements $R1$ and $R2$ serving to adjust base bias current and emitter loading, respectively. The feedback needed to start and maintain oscillation is provided by $R1$'s center-tapped winding. Polarity reversing switch $S1$ permits tests of both *pnp* and *nnp* units, while s.p.s.t. switch $S2$ serves as a "Push-to-Test" control. A single 1.5-volt cell, $B1$, acts as a power source, thus making the unit safe to use on low-voltage transistors as well as conventional units.

Timm has used conventional, readily available parts in his design. Transformer $T1$ is a small 500- to 1,000-ohm center-tapped output transformer (typically, Argonne types AR-165 or AR-136), while $S2$ is a s.p.s.t. normally open, spring-return, lever or push-button type. A universal transistor socket is used for $SO1$, and $J1$ and $J2$ are conventional phone-tip or banana jacks. The power supply may be either a penlight or flashlight cell.

Neither parts arrangement nor wiring dress are critical. Timm assembled his model on

perf board, but point-to-point chassis wiring or an etched circuit board may be used if preferred. A plastic or metal case may be used for housing the instrument, with decals applied to identify the controls. If desired, flexible test leads with alligator clips may be used in place of transistor socket $SO1$. In this case, these leads should be color-coded or marked for ready identification of the base (B), emitter (E) and collector (C).

In practice, the instrument is used in conjunction with a pair of sensitive high-impedance headphones, which serve as an output indicator. Connect the headphones to jacks $J1$ and $J2$ and insert the transistor in socket $SO1$. Adjust $R1$ and $R2$ to their mid-positions and set $S1$ for the type of transistor being tested (*pnp* or *nnp*). Close $S2$ and listen for an audio tone in the phones. If no tone is heard, try readjusting $R1$ and $R2$ through their respective ranges. If still unable to get an audio signal, the transistor is defective and should be discarded.

Manufacturer's Circuit. Although many of us think of IC's only in terms of their use in audio equipment, in i.f. stages and in digital computer or logic applications, there are a number of commercial units which can be used as high-frequency (r.f.) amplifiers. One such unit is Fairchild's type $\mu A703$, a linear integrated circuit using two high-frequency transistors as an emitter-coupled pair, with additional transistors
(Continued on page 100)

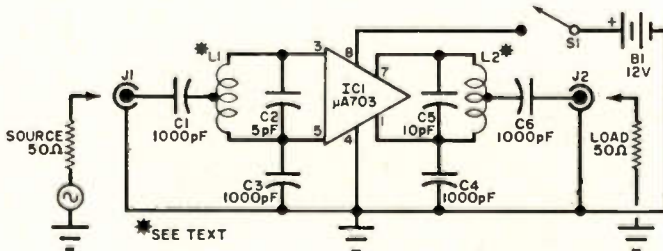
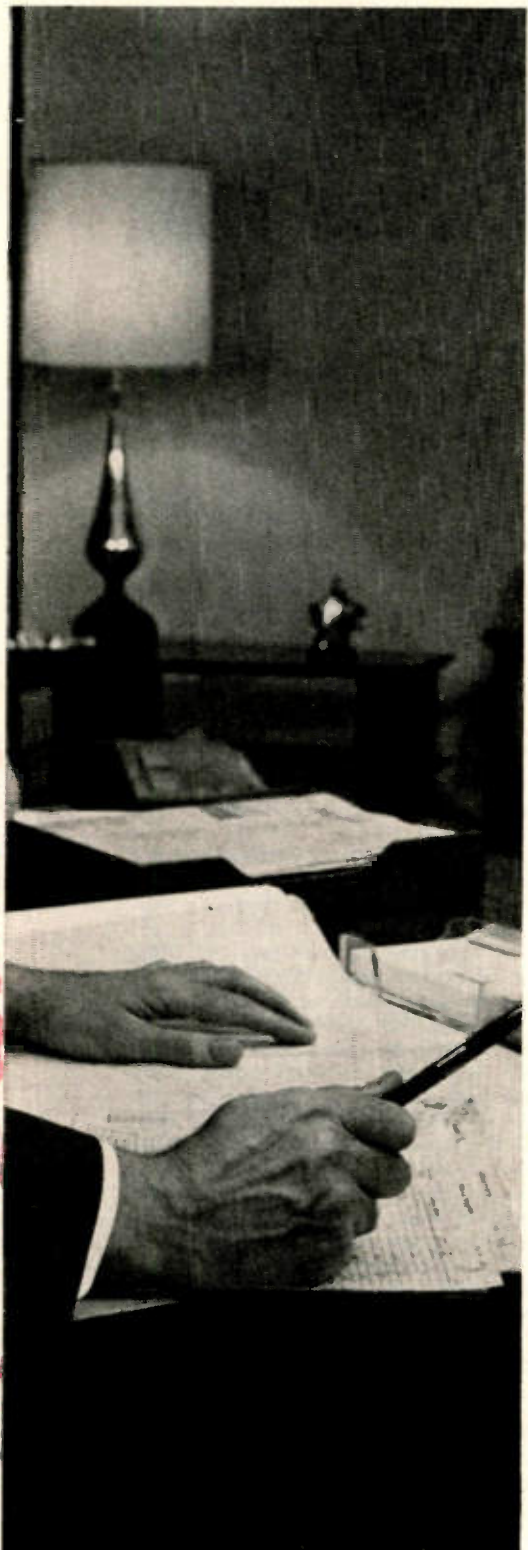

Fig. 3. Believe it or not, the circuit shown here will amplify signals up to 200 MHz. The secret is the specially designed Fairchild type $\mu A703$ linear IC.

**“Get more
education
or
get out of
electronics
...that’s my advice.”**





Ask any man who really knows the electronics industry.

Opportunities are few for men without advanced technical education. If you stay on that level, you'll never make much money. And you'll be among the first to go in a layoff.

But, if you supplement your experience with more education in electronics, you can become a specialist. You'll enjoy good income and excellent security. You won't have to worry about automation or advances in technology putting you out of a job.

How can you get the additional education you must have to protect your future—and the future of those who depend on you? Going back to school isn't easy for a man with a job and family obligations.

CREI Home Study Programs offer you a practical way to get more education without going back to school. You study at home, at your own pace, on your own schedule. And you study with the assurance that what you learn can be applied on the job immediately to make you worth more money to your employer.

You're eligible for a CREI Program if you work in electronics and have a high school education. Our FREE book gives complete information. Airmail postpaid card for your copy. If card is detached, use coupon below or write: CREI, Dept. 1209G, 3224 Sixteenth Street, N.W., Washington, D.C. 20010.

Founded 1927



Accredited Member of the National Home Study Council



**CREI, Home Study Division
McGraw-Hill Book Company
Dept. 1209G, 3224 Sixteenth Street, N.W.
Washington, D.C. 20010**

Please send me FREE book describing CREI Programs. I am employed in electronics and have a high school education.

NAME _____ AGE _____

ADDRESS _____

CITY _____ STATE _____ ZIP CODE _____

EMPLOYED BY _____

TYPE OF PRESENT WORK _____ G.I. BILL

- I am interested in Electronic Engineering Technology
 Space Electronics Nuclear Engineering Technology
 Industrial Electronics for Automation
 Computer Systems Technology

APPROVED FOR TRAINING UNDER NEW G.I. BILL

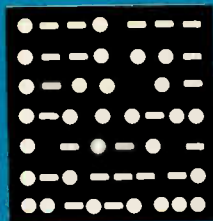

AMATEUR RADIO

By **HERB S. BRIER, W9EGO**
Amateur Radio Editor

CHANGING CONDITIONS AND LICENSING CHANGES

Apparently the propagation experts at the Central Propagation Laboratories of the U. S. Bureau of Standards believe that the peak of the present sun-spot cycle occurred this spring. Other experts predict, however,

that the peak will occur this winter. Whoever is correct, the 28-MHz amateur band should be at its best for the next six or seven months.

Ten meters should be open for DX on most "normal" days from shortly after Labor Day until the spring of 1969. It is also possible that 50-MHz operators may be able to make a few DX contacts over all-daylight paths on the best days of each month. Static will decrease sharply on the lower frequencies, and "long-skip" signals will start popping through on the 7-, 3.5-, and even 1.8-MHz bands as the sun goes down.

The best way to take advantage of these improved fall and winter conditions is to be prepared to operate the bands up to 29.0 MHz in the daylight hours and those below 7.3 MHz after dark.



Mike Wright, WA7HRE, Scottsdale, Ariz., worked 48 states and 21 countries as a Novice using a homebrew 70 watt'er, a Collins 75A-1 receiver—a gift from his father, W7IMA—a 2-element, 15-meter beam, and a 30-foot vertical to work the 40-meter band.

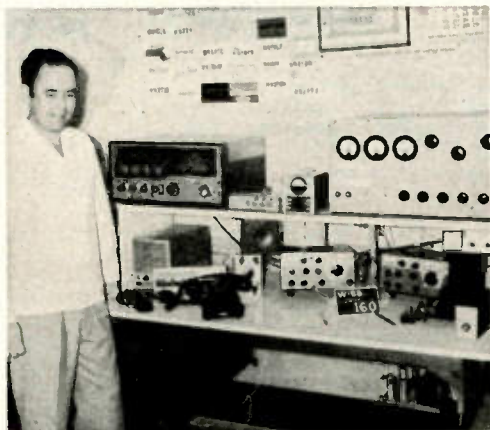

Hercillio Ferreira, PY2BJH, Sao Paulo, Brazil, worked many U.S. and Canadian stations on 160 meters last season and expects to do even better this year. He also worked U.S. Novice stations. (Photo via W1BB)

FCC Actions. The Federal Communication Commission has rejected three more proposals for liberalizing amateur licensing procedures. Rejected proposal RM-1171 requested a code-free license for 147-MHz operation. Proposal RM-1185 would have made the Novice license a 5-year, renewable license, and RM-1064 would have allowed Technicians to operate in the 28- to 29.7-MHz band and reduced the General class code test to five words per minute.

In view of these FCC actions, the proposals of the Amateur Radio section of the Electronic Industries Association (EIA) probably will not get very far. The EIA has suggested that the Novice license be issued for five years and be renewable and that the Novice code test be a token test in which the applicant would only have to recognize the code characters. The EIA also wants the FCC to allow Novices to operate phone in 200 kHz of the 28-MHz amateur band.

More realistically, the American Radio Relay League, Inc. (ARRL) has petitioned the FCC for changes in Novice/Technician eligibility rules along the lines of the so-called "Roanoke Retread" proposal. The proposal is that previous holders of one-year Novice licenses and Technician licenses

be made eligible for the new two-year Novice license. In fact, the FCC has already reinterpreted its own amateur regulations to rule that Technicians who have never held any previous type of U. S. amateur license are eligible for Novice licenses.

The ARRL has also petitioned the FCC to postpone implementation of the requirement scheduled to go in effect on November 22, 1968, that an Advanced or Extra class license must operate between 50 and 50.1 MHz.

In May, the FCC ordered the General class license of Harvey Z. Chesser, WB6TTF, 8616 Cadillac Ave., Los Angeles, Calif. 90034, suspended for six months for allegedly willfully or maliciously interfering with other stations.

News From the Club Papers. The Chicago Suburban Radio Association meets each Wednesday at 8:00 p.m. in the Brookfield National Hall, 3907 Prarie Ave., Brookfield, Ill. The CSRA is one of those clubs which are doing an outstanding job helping pro-

spective amateurs to obtain licenses and assisting already licensed amateurs to upgrade their licenses.

As this is being written, there are 15 in the CSRA Novice class, eleven in the Intermediate class (code speed, eight to nine w.p.m.), and 15 in the Advanced class (code speed, 13 to 15 w.p.m.). In addition to code, each group studies the theory required to pass the appropriate FCC technical examination. Two YL's (women operators), Rita Akim, WA9VYM, and Maureen Goode, WN9YQG, are among the 10 students in the current classes who have obtained their licenses.

Incidentally, Wilson Thomas, WA9UHR, who teaches code to the intermediate class, is a graduate of the CSRA code and theory classes. He recently passed his Advanced class examination—not bad for a 70-year old beginner!

The Oklahoma Central VHF Amateur Radio Club News reports that Admiral P. N. (Continued on page 112)

AMATEUR STATION OF THE MONTH

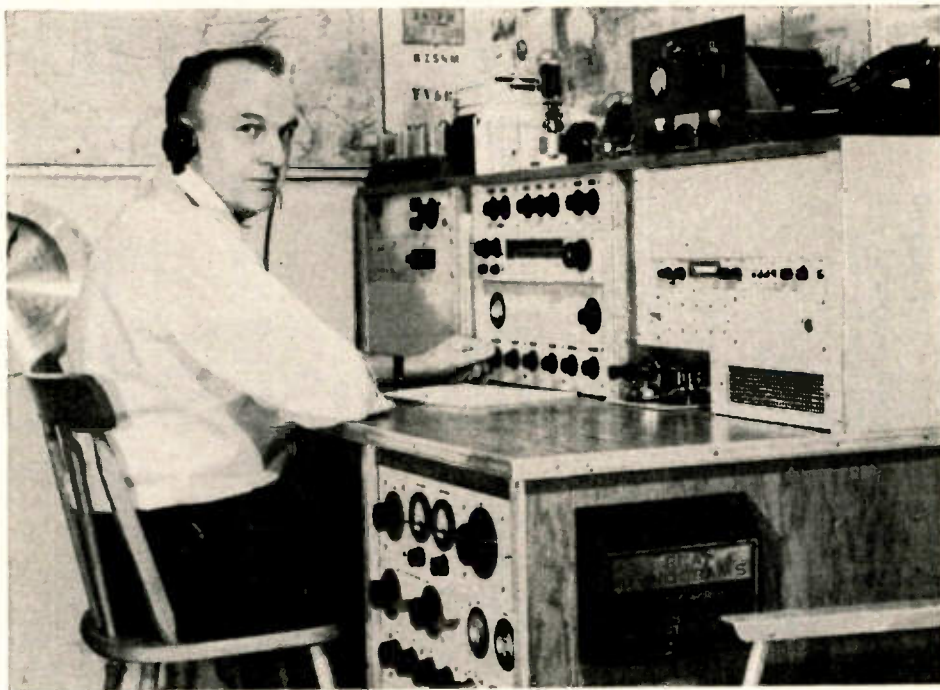

Robert V. McGraw, W2LYH, 9 Peg's Lane, Riverhead, N.Y. 11901, is one of those rare operators (amateur or commercial) who can copy code at 60 w.p.m. Bob designed and built all the equipment in his station. On the air, he likes to rag chew and chase DX—not too hard—on 80-, 40-, 20-, 15-, and 10-meter CW. We are sending W2LYH a 1-year subscription to POPULAR ELECTRONICS for the winning entry in this month's Amateur Station Photo Contest. You may enter by sending us a clear, black-and-white photograph of yourself operating your amateur station. Include some details about your amateur career and operating achievements and mail to: Amateur Radio Photo Contest, c/o Herb S. Brier, W9EGQ, Amateur Radio Editor, POPULAR ELECTRONICS, P. O. Box 678, Gary, Ind. 46401.

ENGLISH-LANGUAGE BROADCASTS TO NORTH AMERICA FOR THE MONTH OF SEPTEMBER

Prepared by ROGER LEGGE

TO EASTERN AND CENTRAL NORTH AMERICA			TO WESTERN NORTH AMERICA		
TIME—EDT	STATION AND LOCATION	FREQUENCIES (MHz)	TIME—PDT	STATION AND LOCATION	FREQUENCIES (MHz)
7:00 a.m.	Stockholm, Sweden	15.24	8:00 a.m.	Tokyo, Japan	9.505
7:15 a.m.	Melbourne, Australia	9.58, 11.71	7:00 p.m.	Melbourne, Australia	15.32, 17.84, 21.74
8:15 a.m.	Montreal, Canada	9.625, 11.72		Taipei, China	15.125, 15.345, 17.89
8:45 a.m.	Copenhagen, Denmark	15.165		Tokyo, Japan	15.235, 17.825, 21.64
6:30 p.m.	Vilnius, U.S.S.R. (Sun., Fri.)	11.79, 11.96	7:30 p.m.	Johannesburg, South Africa	9.705, 11.875
7:00 p.m.	Helsinki, Finland	15.185	8:00 p.m.	London, England	6.11, 9.58, 11.78
	London, England	6.11, 11.78, 15.14		Madrid, Spain	6.13, 9.76
	Montreal, Canada	9.625, 15.19		Peking, China	15.095, 17.68, 17.795
7:45 p.m.	Tokyo, Japan	15.135, 17.825		Seoul, Korea	15.43
8:00 p.m.	Moscow, U.S.S.R.	11.735, 11.87, 11.90	8:30 p.m.	Berlin, Germany	11.84, 11.97
	Sofia, Bulgaria	9.70		Bonaire, Neth. Antilles	9.695
8:30 p.m.	Budapest, Hungary	9.833, 11.91, 15.16		Prague, Czechoslovakia	7.345, 11.99, 15.365
	Johannesburg, South Africa	9.705, 11.875		Stockholm, Sweden	11.705
	Kiev, U.S.S.R. (Mon., Thu., Sat.)	11.90, 12.03	9:00 p.m.	Havana, Cuba	9.525, 15.285
	Oslo, Norway (Sun.)	11.85, 15.175		Lisbon, Portugal	6.025, 9.68, 11.935
	Stockholm, Sweden	11.805		Moscow, U.S.S.R. (via Khabarovsk)	15.18, 17.79, 17.88
8:50 p.m.	Vatican City	9.69, 11.76, 15.285		Peking, China	15.095, 17.68, 17.795
9:00 p.m.	Berlin, Germany	9.50, 9.73		Sofia, Bulgaria	9.70
	Havana, Cuba	9.525, 15.285	9:30 p.m.	Bucharest, Rumania	11.885, 11.94, 15.25
	Madrid, Spain	6.13, 9.76		Budapest, Hungary	9.833, 11.91, 15.25
	Melbourne, Australia	15.32, 17.84, 21.74		Kiev, U.S.S.R. (Mon., Thu., Sat.)	11.735, 11.90
	Peking, China	15.06, 17.68, 17.90		Oslo, Norway (Sun.)	11.85
	Prague, Czechoslovakia	7.345, 11.99, 15.365, 17.84	9:45 p.m.	Berlin, Germany	11.84, 11.97
	Rome, Italy	9.575, 11.81		Berne, Switzerland	9.72, 11.715
9:30 p.m.	Berne, Switzerland	6.12, 9.535, 11.715		Cologne, Germany	9.545, 11.945
	Bucharest, Rumania	11.885, 11.94, 15.25	10:00 p.m.	Havana, Cuba	9.525, 15.285
	Cologne, Germany	9.64, 11.945		Tokyo, Japan	15.105
	Hilversum, Holland	9.59 (Bonaire relay)	11:00 p.m.	Moscow, U.S.S.R. (via Khabarovsk)	15.18, 17.79, 17.88
	Tirana, Albania	7.30, 9.50	11:30 p.m.	Havana, Cuba	9.655
10:00 p.m.	Cairo, Egypt	9.475			
	Lisbon, Portugal	6.025, 9.68, 11.935			
	London, England	6.11, 9.58, 11.78			
	Moscow, U.S.S.R.	11.735, 11.87, 11.90			
	Stockholm, Sweden	11.805			



SHORT-WAVE LISTENING

By **HANK BENNETT**, W2PNA/WPE2FT
Short-Wave Editor

GAMBIA—HAVE YOU VERIFIED IT?

In the process of trying to log new countries, many DX'ers find it necessary to tune to channels that are used for other than normal international short-wave broadcasting. However, many frustrations develop as a result of sending reception reports to utility stations. Those stations operated by Cable and Wireless, Ltd., generally refuse to verify correct reports even for transmissions of a non-security nature such as running markers or voice mirrors. An article appearing in a recent bulletin of the American Short-Wave Listeners' Club lists one station owned by this company that has been verifying reports. It is VSH64, 13,777 kHz, with an English language single-sideband voice mirror around 0800. If you're lucky enough to hear it, send a reception report (with return postage) to Cable and Wireless, Ltd., Bathurst, Gambia. Country listings sent to Monitor Awards indicate that extremely few DX'ers have verified this country.

WNYW Expands Its Service. *Radio New York Worldwide* (WNYW) has expanded its English service to include a new transmission to the Caribbean. Closing stock reports, network news, music, and commentaries will all be beamed by WNYW's 50/100 kW transmitters from 2200 to 0100 GMT.

In announcing this new service, Miller R. Gardner, Vice President and General Manager of *Radio New York* said, "We intend to fill a real need in the Caribbean . . . to provide the kind of programming that just cannot be heard at this time in that area. These items are just part of our new broadcast plans for Latin America."

The frequencies in use by WNYW for its English language schedule are: (daily except as noted) to Europe at 1600-2200 on 17,845 kHz, Monday to Friday only at 1600-1915 on 21,525 kHz and 1930-2200 on 15,405 kHz; to Africa at 1600-2200 on 21,525 kHz; to Latin America at 1600-2000 on 17,730 kHz, 1600-1815 on 15,440 kHz, 1830-0100 on 17,845 kHz, 2000-2200 on 17,760 kHz, 2200-2345 on 21,525 kHz and 0000-0100 on 15,215

kHz; to Latin America (Saturday and Sunday only) at 1600-1915 and 1930-2200 on
(Continued on page 114)



If you don't recognize that receiver, it's because not too many of them are used for SWL'ing. It is a Collins 75S-3C. Dave Reichelt, WPE4JWU, has just moved to Mary Esther, Fla. Dave also has a stand-by Hammarlund HQ-150. His total is 90 countries.



This modest setup is used by Eric Hansen, WPE6HBT, Salem, Calif. Eric tunes the short waves with one of those popular Knight-Kit Star Roamers and a new Packard-Bell 5R1 (not shown) on the BCB. A long wire antenna rounds out this fine monitoring post.



ON THE CITIZENS BAND

By **MATT P. SPINELLO**, KHC7060, CB Editor

10 YEARS AND 5000 JAMBOREES LATER

THIS MONTH THE CITIZENS Radio Service celebrates its tenth anniversary. Someone has said that CB suffers from growing pains. Federal Communications Commission statistics, published reports, and gossip among CB'ers seem to add credence to that statement. We don't deny it. But despite occasional flagrant misuse of the CB frequencies, many lives have been saved by individual CB'ers, the small businessman has profited from the use of mobile radio equipment, and many women now drive at night with confidence knowing that the CB equipment under the dashboard can bring help in a matter of minutes. That's the same declaration your columnist made five years ago. Today we maintain that all of this personalized communicability has been made possible since (and because of) the advent of CB.

If the number of CB Jamborees being held this season is any indication, CB is alive and well. There are large numbers of licensees who find CB 2-way radio a must in their daily routines, and as an emergency system for their own protection and to help others in need.

From the jamboree reports, it is encouraging to note that clubs with successful events have profited from the mistakes of smaller, less organized clubs. The most successful groups seem to be entering their 4th, 5th, or 6th jamboree season. Their programs this year included technical sessions, displays by manufacturers or their representatives, and professional entertainment for all ages.

The Rock River Valley Citizens Band Radio Club, Rockford, Ill., held its 4th Annual CB Jamboree on May 19th, repeating its successes of previous seasons. Attendance was estimated at between 8,000 and 10,000. Half of the 40 display booths were used by electronic equipment and accessory manufacturers. Entertainment was continuous, and well-planned activities held the attention of young and old, far beyond the original cutoff time of 5:00 p.m.

Hy-Gain Electronic Corporation's pretty KBO2068, "The Hellcat," was in attendance at the Rockford Jamboree and became one of the event's best attention-getters. The Illinois jamboree was her first. She remarked to us that she enjoyed the chance to meet with CB'ers from all over the U.S. and looked forward to visiting with other 2-way radio buffs across the country on her scheduled tour of jamborees. She will also appear with her Hy-Gain entourage at the Lincoln Metro CB Jamboree, August 24 and 25, Lincoln, Neb., and at the Maumee Valley CB Roundup, September 22, Ft. Wayne, Ind.

(Continued on page 102)



"The Hellcat," KBO2068, takes time out to pose with Hy-Gain Sales Manager Jim Taylor, right, and CB Editor Matt Spinello at the Rock River CB Jamboree.

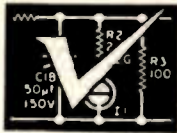

OPERATION ASSIST

Through this column we try to make it possible for readers needing information on outdated, obscure, and unusual radio-electronics gear to get help from other P.E. readers. Here's how it works: Check the list below. If you can help anyone with a schematic or other information, write him directly—he'll appreciate it. If you need help, send a postcard to Operation Assist, POPULAR ELECTRONICS, One Park Avenue, New York, N.Y. 10016. Give maker's name and model number of the unit. If you don't know both the maker's name and the model number, give year of manufacture, bands covered, tubes used, etc. State specifically what you want, i.e., schematic, source for parts, etc. Be sure to print or type everything legibly, including your name and address. Because we get so many inquiries, none of them can be acknowledged. POPULAR ELECTRONICS reserves the right to publish only those items not available from normal sources.

Firestone "Sky Chief" receiver. Coils, schematic and operating manual needed. (Randy Bannister, Rte. 2, Belton, S.C. 29627)

Eldico Model SSB 100 MI transmitter. Manual or source needed. (William Rinker, 9 South Ln., Englewood, Colo. 80110)

Kahn Model KC-101 modulation monitor. Operating manual and schematic needed. (Danny Moeller, 700 W. 178 St., New York, N.Y. 10033)

Heathkit Model 0-6 oscilloscope. Operating manual, schematic, and servicing data needed. (Steve Wenzel, 316 S. Scoville, Oak Park, Ill. 60302)

Glove Star 300 Model 651971 transceiver. Schematic and service manual needed. (Donald H. Lark, 7871 Compass Lake Dr., San Diego, Calif. 92119)

Motorola Model PAS270J transceiver; covers 2 bands; has 4 tubes. Operators' manual and schematic needed. **Precision Apparatus** vacuum tube multi-range tester, series EV-10-S. Operator's manual needed. (Jim Gasan, 13109 Magellan Ave., Rockville, Md. 20853)

Automatic Radio Model C-360. Manual AR-15 needed. (Edward A. Kozacki, 501 156th St., Calumet City, Ill. 60409)

Sparton Model 58 radio, circa 1932. Schematic and tube placement diagram needed. (M.A. Short, R.R.3, Stouffville, Ont., Canada)

Hallicrafters Model SX-25 receiver. Schematic and operating manual needed. **Johnson** Model 240-104. Viking Valiant transmitter. Operating manual needed. (Justin DeVault, Jr., 610 Foxx St., Johnson City, Tenn. 37601)

RCA Model 1614. Schematic and parts list needed. (Roger Aitken, 6021 S.W. 93rd Ave., Miami, Fla. 33143)

Philco Model 37-116. Schematic needed. (Robert Bandler, #76-2, Box A, W. Brentwood, L.I., N.Y. 11717)

National WC-2-40C receiver, circa 1946. Schematic and tube layout needed. (Thomas Verra, Jr., 17 Kendall Ave., Framingham, Mass. 01701)

Westinghouse International Model 8-T-104. Schematic, parts source, and tube placement diagram needed. (Paul-Emile Dionne, 61 Commerciale Cabano, Cte. Temiscouata P. Que., Canada)

Accurate Instrument Model AT162 dwell tachometer. Schematic and manual needed. (Richard L. Gagnon, 84 Hampshire St., Holyoke, Mass.)

Philco Model 40-125 radio, circa 1943. Schematic and instruction manual needed. (Billy Weinel, 1320 Hawthorne Rd., Wilmington, N.C. 28401)

Brunswick Radiola Regenoflex. Schematic needed. (Gerald Allison, 845 S.E. Bridgeway, Corvallis, Ore. 97330)

Hallicrafters Model S-38 receiver. Schematic, alignment data, and parts list needed. (David Garrison, 6164 E. 14, Indianapolis, Ind. 46219)

Heathkit Model 06 oscilloscope. Operating manual needed. (Jim Schmidt, 2124 Lincoln Way East, Mishawaka, Ind. 46544)

Fujiya FL-352 tape recorder. **Philco** Model 41-608 radio. Schematics and parts source needed. (D. Rossi, 809 Brooklyn Ave., Brooklyn, N.Y. 11203)

Fairbanks Morse Model 5C SW receiver. Schematic and parts source needed. (Jim W. Miller, 15250 Stanislaus, Kerman, Calif. 93630)

Neutrowound Super Six radio, 1926. Schematic and instruction manual needed. (Jim Bahls, 416 Reber, Waterloo, Iowa 50701)

National HRO. Rack panel and B-E-F coils needed, plus conversion article on bandspreading 31-meter band. (Nathan Copeland, 72 Groveside Rd., Portland, Me. 04102)

Hallicrafters Model 1052 TV. Any information on 94X1160 service data sheet starting with page 1953-312 to page 1953-349 needed. (Jeff Jones, 3111 W. L-6, Lancaster, Calif. 93534)

Edison home phonograph, 1900-1915. Drive belt, reproducer, and source of parts needed. (Ronnie Russell, 5611 Rte. 5 & 20, Avon, N.Y. 14414)

Link Model 6000-30VR-C1 FM transceiver. Service manual and schematic or alignment procedure data needed. (Clifford R. King, 2804 Windsor St., Eureka, Calif. 95501)

Transcrome Model SBT3 transceiver. Schematic, manual, and source for parts for unit plus its 110-V power supply needed. (Bill Henderson, 233 N. Ridgewood Pl., Los Angeles, Calif. 90004)

Fairbanks Morse Model BC-600 TV camera. Schematic needed. (Al Amendola, Jr., 502 Steubon St., Staten Island, N.Y. 10305)

Packard Model 51 "Pia-Mor" amplifier. Schematic needed. (Roy Lohringer, 3270 Rancho La Carlota, Covina, Calif. 91722)

Firestone Model R-3111 radio. Schematic needed. (Max W. Stapleton, Preston Ranch, Blue Lake, Calif.)

Lafayette Model HA-350. Mechanical filter needed. (Del Huneycutt, Box 535, Norwood, N.C. 28128)

Rollin Co. Model 60 RF wattmeter, circa early 1940's. Technical information, service manual, and parts list needed. (E.B. Duvall, Sr., Box 409-1 Forest Dr., Gambrills, Md. 21054)

Century Electronics Model 201 condenser-resistor analyzer. Schematic needed. (Dan Vogler, 1005 Boyd St., Midland, Texas 79701)

Edison director electronic voicewriter with part no. 72500. Amplifier and quadruphone needed. (W.P. Montgomery, Jr., 104 Monte Ave., Piedmont, Calif. 94611)

Electronics Specialty Model 2732 "Quick Test" tube tester. Schematic and tube setting needed. (Dr. Arthur W. Rowe, 162 Four Brooks Rd., Stamford, Conn. 06903)

Scott Model SLRM marine radio. Schematic or alignment data needed. (John C. Markley, 130 Gartield, Gallopis, Ohio)

Precision Model 107-C gelger counter. Schematic, instructions, and probe tube needed. **Precision** Model 117-B special scintillator. Schematic and instructions needed. (Robert C. Sorber, Webster Groves, Mo. 63119)

Stewart-Warner Model 9161-B radio, circa 1960. Schematic needed. (Leo Cravines, 1660 Lantana Way, Turlock, Calif. 95380)

Majestic Model 310-B AM broadcast band receiver. Schematic and operating instructions needed. (Mark Owens, 45 Chieftain Dr., Creve Coeur, Mo. 63141)

Atwater Kent Model 10. Operating manual and horn/driver unit needed. **Fred Eisemann** Model NR-6. Operating manual and horn/driver unit needed. (E.C. Yeargan, 220 Albany St., Paducah, Ky. 42001)

Heathkit Model SG-8 signal generator, circa 1958. Operating manual needed. (Dick Houghton, 174 Hudson St., New Bedford, Mass. 02744)

Supreme Model 551 analyzer. Schematic and operating manual needed. (Francis E. Horton, 630 S. 4th St., Festus, Mo. 63028)

Hickok Model 1-77 dynamic mutual conductance tube tester. Schematic for updating and tube chart needed.

(Continued on page 98)

(Sam Vance, 125 N. Stokes, Havre de Grace, Md. 21078)

Heathkit Model AR-3 receiver. Schematic and instruction manual needed. (John F. Schey, 716 S. Bruner St., Hinsdale, Ill. 60521)

Superior Model TV-11 tube tester. Schematic, parts, and test chart needed. (Vergniaud Richard, 439 1st St., Brooklyn, N.Y. 11215)

GE Model ES-1-B mobile FM unit. Schematic, operating manual, and 115-volt power supply for fixed station use needed. (J. Adelbert Schick, Farmer, Wn. 98858)

Precise Model 300 oscilloscope. Schematic and source of parts needed. (Pat Rutherford, 3833 Jackson Ave. #9, Memphis, Tenn. 38128)

Precision Model 106C "Lucky Strike" geiger counter. Schematic and operating manual needed. (George Kap-sokavadis, Kolokotroni 13, Corfu, Greece)

Utica T&C II CB transceiver. Schematic and operating manual needed. (Rob Nilsen, 4729 N. Woodruff Ave., Milwaukee, Wis. 53211)

Pilot Radio Corp. Model AF605 AM and FM tuner. Schematic, alignment plan, and parts list needed. (Henry Leong, 180 Park Row, Apt. 12B, New York, New York 10038)

Sams Photofast set 78. Folder 7 needed. (Steve Rislser, 12 Greystone Rd., Larchmont, N.Y. 10538)

Heathkit Model DX-35 transmitter. Assembly manual needed. (Tom Crook, 229 Hudson St., New Bedford, Mass. 02744)

Stromberg-Carlson 17897 receiver; serial #156607. Schematic, operating instructions, and parts needed. (R.W. Fowler, 1309 Kinneys Lane, Portsmouth, Ohio 45662)

Heathkit Model QF-1 Q multiplier. Operating manual needed. **Lafayette Model TE-20 r.f. signal generator.** Operating manual needed. (Robert F. Malone, Jr., 21 Joysan Terr., R.F.D. #1, Freehold, N.J. 07728)

Hallicrafters Model S-53, circa 1946. Schematic, operating manual, and any information needed. (Douglas Smith, 1281 Nuala St., Concord, Calif. 94520)

Hammarlund Model SP-200 Super Pro receiver. Front end coils for 1.25-2.5 mc and 20-30 mc and good S-meter needed. (Wayne N. Storch, 1708 Houston Ave., Joliet, Ill. 60433)

Superior Model 2130 signal generator. Schematic and instruction manual needed. (Donald Sadowski, 419 1st Ave., Bellaire, Ohio 43906)

Pioneer Model SX-110 AM/FM multiplex receiver. Schematic needed. (S.C. Williams, 804 Royce St., Apt. 116, Pensacola, Fla. 32503)

Knight-Kit Model T-150A transmitter. Schematic and operating manual needed. (Ken Wyatt, 12391 Marilyn Circle, Garden Grove, Calif. 92641)

Airline Model 73271 AM radio. Schematic needed. (Larry Kase, 2817½ Montana Ave., Billings, Mont. 59101)

Dumont Model RA105 A-2 Teletest TV receiver. Schematic, operating manual, and source for deflection yoke needed. (Joseph S. Aumond, 90 Mason Dr., Newark, Dela. 19711)

Meccablitz Model 103 electronic flash for camera. Source for battery ("Dryfit" 3AX2, 102B 1/A-3 Sonnenschein; made by Metz Radio, Germany) needed. (John A. Sudalnik, 4635 N. Damen Ave., Chicago, Ill. 60625)

Radio City Products Model 123 flyback and yoke tester, serial 1222. Operating instructions needed. (Jesse C. Broussard, 6101 Octavia, Houston, Texas 77026)

Triumph Model 830 oscillograph wobbulator. Schematic and operating manual needed. (Jim Eakins, 319 State Highway #1, Grover City, Calif. 93433)

E. H. Scott Model SLRM marine radio, series 686. Schematic and any other information needed. (Ricardo Valenilla, Calle Abreu #90, Santo Domingo, Dominican Republic)

Philco Model RF65 or RF85 receiver, circa 1943. Schematic needed. (Roger Cartier, RR2, Thamesville, Ont., Canada)

Dumont Model 4D1A oscilloscope. Schematic and manual needed. (John Thomas, 11 Sussex N., Lindsay, Ont., Canada)

Heathkit Model AR-3 receiver. Schematic and operating manual needed. (Norman Dulebohn, RR #6, Wapakoneta, Ohio 45895)

Solar Model CE capacitor analyzer. Owner's manual and/or operating instructions needed. (Paul J. Lapinski, Pantry Rd., N. Hatfield, Mass. 01066)

Hallicrafters Model SX-16. Instruction manual needed. **Hallicrafters Model SX-25.** Source for receiver and manual needed. (E.A. Sjolander, Jr., 119 7th St., Ashland, Wis. 54806)

National Model NC-98 S-meter needed. (Paul Heffler, 3510 Crosshill Rd., Mt. Brook, Ala. 35223)

EICO Model 625 tube tester. **Philco Model 7030 dynamic tester.** **RTTA RF-AF generator.** Schematics and instructions needed. (D. Baco, 1520 Beacon St., New Smyrna Beach, Fla. 32069)

Atwater Kent Model 80 receiver. Part 3J2 capacitor or close substitute needed. (Mark S. Foster, 1515 Avenue B, Eau Claire, Wis.)

Soundview Marine Co. Model 706 6 V. receiver. Schematic and alignment instructions needed. (Earl Vincent, Rt. 1, Box 172A, Old Saybrook, Conn. 06475)

GE Model 3C-3A tube checker. Tube chart and operating manual needed. (Joseph L. Herrera, 815 14th St., Denver, Colo. 80202)

Tritronic Model RX-127 Rangexpander, serial #12126. Schematic needed. (M.G. Clay, 923 E. Giddens Ave., Tampa, Fla. 33603)

Sparton Equasonne Models #39 and 69, circa 1926. Operating manual and tube layout needed. (Harrison L. Church, 848 3rd Ave. W., Dickinson, N.D. 58601)

Hallicrafters Model S-85 receiver. Operating instruction needed. (Serge Andreychek, 916 Mifflin Ridge Rd., Pittsburgh, Penna.)

Philco Model 38-3 receiver, circa 1930's. Schematic, source for parts, and any other information needed. (Karl Salmon, 2915 Fifth Ave., York, Penna. 17402)

Gonset G-76 Model 3338 transceiver. Schematic containing modification needed. (R. Anderson, 53 Garside Ave., Wayne, N.J. 07470)

Superior Model 76 C.R. bridge and signal tracer. Manual and schematic needed. (Thomas S. Kiedrowski, 124 W. Townsend St., Milwaukee, Wisc. 53212)

Heathkit Model 0-6 oscilloscope. Schematic and operating manual needed. (James L. Bolich, 460 Doris Circle, Aberdeen, Md. 21001)

Electronic Development Laboratory Model 44 VTVM. Schematic and operating instructions needed. (Paul A. Roberge, 40 Watson Ave., Staten Is., N.Y. 10314)

Silvertone Model 4500A, circa 1930's. Schematic and any information needed. (Rick Drollinger, 865 Vernon Hts. Blvd., Marion, Ohio 43302)

Weston Model 982 battery-operated VTVM. Schematic and/or instruction manual needed. (David Newman, 1204 N. 9th, Van Buren, Ark. 72956)

RCA Model MI-20900 TV camera, 1939. Schematic and operating manual needed. (John Engleman, 743 Meadow Ln., Bryan, Texas 77801)

Radio City Products Model 664 VTVM. Schematic needed. (Donald Rochford, 3560 Olinville Ave., Bronx, N.Y. 10467)

Philips-Norelco Type 160 B1 TV projector. Schematic and hookup instructions needed. (Steve Grauel, Box 56, Buckingham, Ill. 60917)

(Continued from page 97)

SOURCES OF INFORMATION

"Operation Assist" is published as a service to the readers of POPULAR ELECTRONICS who cannot find schematics, parts, etc., for old or no-longer-manufactured equipment. Military—or Government surplus—equipment is not itemized in this column, since schematics and copies of Tech Manuals for military equipment can be obtained from a variety of independent sources: Slep Electronics, Drawer 178, Ellenton, Florida 33532; Quaker Electronics, P.O. Box 215, Hunlock Creek, Pa. 18621; etc. Unusual or difficult-to-find schematics and servicing information can frequently be obtained from Supreme Publications, 1760 Balsam Rd., Highland Park, Ill., for a slight charge.

Cobra 98

the new standard of CB quality.

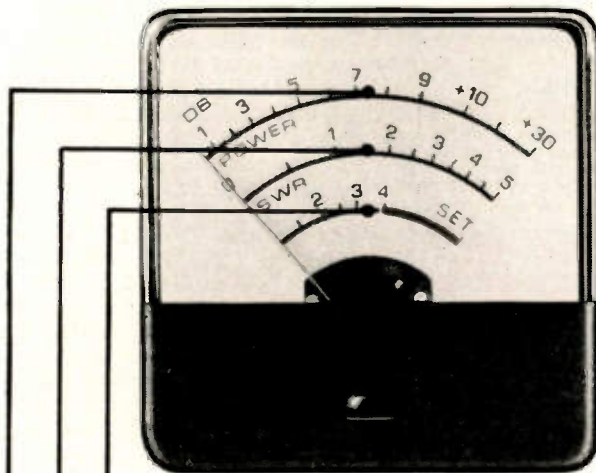

1. Built-in SWR bridge lets you tune your antenna for maximum output.
2. Forward-Reverse reflected Power Output Meter tells you how much power is going out.
3. "S" meter measures strength of incoming signals.



Outgrown your present CB? Step up to the new B&K Cobra 98, the new, 23-channel, fully deluxe CB that's built to outperform and outvalue most other rigs. The new triple scale (shown above) is only part of the story . . . the Cobra 98 looks like a million! The heavy die-cast aluminum front panel is magnificently finished in black and brushed aluminum.

And the Cobra 98 has all the power and performance features B&K is famous for—including exclusive Dyna-Boost that intensifies speech signals and extends range even farther!

Cobra—the big name in CB—now brings you the flagship of the line—the COBRA 98—it's the most! **\$239.95**

B&K Division of Dynascan Corporation

1801 W. Belle Plaine Avenue/Chicago, Illinois 60613



Where Electronic Innovation Is A Way Of Life

CIRCLE NO. 4 ON READER SERVICE CARD



Winter 1968 ELECTRONIC EXPERIMENTER'S HANDBOOK

Special 10th Anniversary Issue! Complete schematics, illustrations, parts lists and easy-to-follow instructions that guarantee you perfect finished products.

Spring 1968 ELECTRONIC EXPERIMENTER'S HANDBOOK

Another big package containing over 30 of the most challenging, fun-to-build electronics projects ever! Be sure to order this one today!

1968 STEREO/HI-FI DIRECTORY

A giant 182-page buyer's guide to virtually every new audio component on the market today. Over 1600 products in all! Includes valuable "what to look for—how to buy" advice!

6 Vital Components

For Knowledge...
For Profit... For Sheer
Electronics Enjoyment!

ONLY \$1.25 EACH



1968 TAPE RECORDER ANNUAL

Contains over 130 pages, 19 complete features, covering every aspect of tape recording. PLUS complete directories of machines and accessories!

1968 COMMUNICATIONS HANDBOOK

For the ham, CB'er, SWL'er or business radio operator. 150 pages of "how to do it better" information. Directories of ham and CB gear!

1968 ELECTRONICS INSTALLATION & SERVICING HANDBOOK

Now, get the tricks of the trade for servicing everything. A 140-page "encyclopedia" that's a must for every serviceman and serious hobbyist!

ZIFF-DAVIS SERVICE DIVISION • Dept. W
595 Broadway, New York, N.Y. 10012

Please send me the annuals I've checked below:

- Winter 1968 Electronic Experimenter's Handbook
- Spring 1968 Electronic Experimenter's Handbook
- 1968 Stereo/Hi-Fi Directory
- 1968 Tape Recorder Annual
- 1968 Communications Handbook
- 1968 Electronics Installation & Servicing Handbook

\$1.25 each. In U.S.A., add 15c each for shipping and handling. Outside U.S.A., add 50c each.

TOTAL ENCLOSED \$ _____

print name _____

address _____

city _____ PE-98

state _____ zip _____

PAYMENT MUST BE ENCLOSED WITH ORDER

SOLID STATE (Continued from page 87)

serving as decoupling diodes and the emitter load. This device is suitable for amplifier and harmonic mixer applications to frequencies slightly above 200 MHz.

A 100-MHz amplifier circuit featuring the $\mu A703$ (IC1) is illustrated in Fig. 3. Abstracted from Application Bulletin APP-135, published by Fairchild Semiconductor (313 Fairchild Dr., Mt. View, Calif.), this basic circuit may be used at lower frequencies or as high as 200 MHz simply by changing the values of the tuned circuit elements (L1-C2 and L2-C5). According to Fairchild, the 100-MHz version shown can provide a power gain of 21.5 dB, with a bandwidth of 5 MHz and a noise figure of only 6 dB. A 200-MHz version can provide a 14-dB power gain, with a bandwidth of 10 MHz and a noise figure of 7.5 dB.

The $\frac{1}{4}$ "-diameter coils are handwound of #20 AWG wire with L1 having 8 turns, tapped at 3.5 turns, and L2 also 8 turns, but tapped at 0.75 turn. Both C2 and C5 are good-quality ceramic or glass capacitors, while C1, C3, C4, and C6 are ceramic or silver-mica types. The lead numbers shown on IC1 refer to the $\mu A703$ pin connections. A 12-volt battery (C1) or well-filtered, line-operated power supply is used, controlled by s.p.s.t. switch S1. Both J1 and J2 are standard coaxial r.f. connector jacks.

As might be expected, lead dress and layout are reasonably critical. Good r.f. wiring practice should be followed, whether the amplifier is assembled for use in experimental applications or as part of another piece of equipment. Signal carrying leads should be kept short and direct, with cross-overs minimized and distributed wiring capacitance kept to a minimum.

Although the basic circuit illustrated was originally designed primarily for test purposes, it can be modified for use as an r.f. or interstage amplifier in receivers, transmitters or low-power transmitters.

Transitips. "I am in need of a 400-watt audio power amplifier. No, I'm not crazy; I manage rock 'n' roll bands (I play in one myself), and since all tone controls, volume controls, fuzz effects, etc., are in the preamplifiers. I wish to put all of these inputs into a single amplification stage. By doing so, I hope to create a more even sound (separate amplifiers have a tendency to be "aimed"), more ease in transportation of the equipment, and possibly a financial saving on the total cost of equipment."

Thus begins a recent letter from a reader, who then justifies his need for such an amplifier on the basis of the total "music power" used in large groups. He asks about the possibility of treating individual amplifier stages as modules, with a series-parallel combination used to get the desired power.

His questions are not unusual. We've received an increasing number of similar inquiries. Let's handle the basic questions first, then take a closer look at the overall problem.

First, 400-watt, 1-kilowatt, or even larger amplifiers are not only feasible, but have been built for military applications. Such amplifiers are used for voice commands under battlefield conditions and for propaganda broadcasts at great distances or from a hovering helicopter. In general, they are very expensive and have a limited frequency response, being designed primarily for coverage of voice frequencies.

Second, parallel amplifier stages can be (and have been) used to obtain higher powers. But this technique is considered "poor engineering practice," for great care must be taken to achieve a perfect balance between the individual stages. Otherwise, one or another of the parallel stages may assume a greater portion of the load, causing distortion and, under extreme conditions, overheating and burn-out.

Third, as a general rule, a very high-power amplifier costs considerably more than the overall cost of smaller amplifiers delivering the same total power.

However the overall problem of the high-power amplifier is based on an erroneous premise—that one simply adds the power ratings of the individual amplifiers used by the members of a musical group to determine the total power needed to achieve a corresponding volume level with a single amplifier. This might be true if all the amplifiers handled the same signal at the same time, but, in practice, each is used with but a single instrument. As a result, the total peak audio power delivered at any specific instant may be only slightly more than that furnished by a single amplifier.

In actual fact, the 70-watt amplifier described some months ago in this magazine (The "Brute-70," February, 1967), properly matched to an efficient loudspeaker system, can deliver virtually ear-splitting volume even in fair-sized auditoriums. Further, due to the logarithmic response characteristic of the human ear, it would be virtually impossible to tell the difference between the power levels delivered by a 70-watt amplifier and a 100-watt unit, all other factors being equal.

That's our Solid-State story for this month . . . until October, —Lou—

September, 1968

Olson



* **FREE**

Fill in coupon for a **FREE** One Year Subscription to **OLSON ELECTRONICS'** Fantastic Value Packed Catalog—Unheard of **LOW, LOW PRICES** on Brand Name Speakers, Changers, Tubes, Tools, Stereo Amps, Tuners, CB, and other Values. Credit plan available.

NAME _____
 ADDRESS _____
 CITY _____ STATE _____
 GIVE ZIP CODE _____

If you have a friend interested in electronics send his name and address for a **FREE** subscription also.

OLSON ELECTRONICS
 INCORPORATED

945 S. Forge Street, Akron, Ohio 44308

CIRCLE NO. 30 ON READER SERVICE PAGE



not by a long shot it isn't !!

There's certainly nothing top secret about Popular Electronics' classified pages. They're wide open to every buyer in the market for the product or service he knows can be found in Electronics Market Place.

More than 400,000 buyers of Popular Electronics, largest readership of any electronics magazine in the world, guarantee that your ad is being read by people constantly looking for and buying electronics products. It is these people to whom you **MUST** direct YOUR advertising as do the many key advertisers appearing in this issue and in each issue throughout the year.

No doubt about it—there's a vast market of buyers searching the classified advertising pages of Popular Electronics and it's important that your ad be exposed to them. Prove to yourself that the leading electronics magazine **MUST ALSO** be the leader in sales responses to the many classified ads presently enhancing its pages—it makes a great deal of sense—give it a try.

See classified section for rate information or write to **HAL CYMES, Classified Advertising Manager**
ZIFF-DAVIS PUBLISHING COMPANY
 One Park Avenue, New York, N. Y. 10016

NOW OFFERED FOR THE FIRST
TIME TO THE PUBLIC

GRAYMARK

ELECTRONICS PROJECTS

Hobbyist / Experimenter / Student

For years, teachers have used Graymark classroom projects to provide (1) the basics of electronics theory and (2) valuable and workable end products. Now, for the first time, Graymark offers certain of these projects to the public. You can now embark on an exciting, step-by-step journey toward the building of your own highly professional, eight-transistor or five-tube radio . . . besides learning a great deal about electronics. Each project comes complete with all parts and easy-to-follow instructional manual. All parts fully warranted.



"COMACHO" EIGHT-TRANSISTOR RADIO. Project provides basics of superheterodyne transistor theory operation. Builds into an attractive printed circuit-board radio, mounted in plastic case. Compares favorably with more expensive units. Earphone included. \$19.95 each.



"SCALLON" FIVE-TUBE RADIO. Easy-to-understand project approach to superheterodyne circuitry. Assembles into a distinctive table-type radio. Tubes, contemporary walnut cabinet included. \$21.95 each.

 Send order today to:
GRAYMARK Enterprises, Incorporated
Dept. 101, P.O. Box 54343, Ter. Annex, Los Angeles, Calif. 90054

Send Projects Checked
 COMACHO (\$19.95 ea.) SCALLON (\$21.95 ea.)
 Send Postpaid. Enclosed find check/money order for full amount. (Calif. Res. add 5% to total purchase)
 Send C.O.D. I will pay full amount, plus postage.

Name _____
 Address _____
 City & State _____ Zip _____

CIRCLE NO. 18 ON READER SERVICE PAGE

ON THE CITIZENS BAND

(Continued from page 96)

"The Hellcat" informed us that the Lincoln Metro CB Jamboree promises to be as active as the one at Rockford and is one of the nation's largest CB events. Expected attendance is 15,000-20,000. A dozen or more major manufacturers will display; there will be technical sessions, a style show for the ladies, and a free camping area. Hy-Gain has donated its 35-acre site on N.E. Highway 6, as well as a complimentary swimming pool for the event. Chow will be available from a licensed catering service.

Monitour Report. Our on-location monitoring reports continue this month with statistics drawn from a 10-day trip to Oklahoma City, Los Angeles, and San Francisco.

Oklahoma City, Okla. We spent three enlightening days with Federal Aviation Agency personnel learning the details of the agency's important functions and touring FAA facilities. The nights were spent monitoring CB. For a time, legal calls were split 50/50 with chit-chat calls. But as the evening wore on, heavy skip transmissions on channels 9, 11, 17, 21, and 22 nearly took over at the local level. The most outlandish call we heard in the area was, "Mickey Mouse breaking in Kingston, Jamaica!" Surprisingly, some local violators used proper call-signs, then originated calls with phoney frequency checks, followed by 20 minutes of gabbing, swearing on occasion, and chewing one another out for breaking rules while breaking them in the process. The only relief from rule-breaking in the area came in waves of skip from south of the border, literally covering local chatter with a foreign language.

Los Angeles, Calif. California still holds the tarnished trophy for being the nation's

1968 OTCB JAMBOREE CALENDAR

The following are jamborees that are scheduled for the month of September. For more information contact the clubs or club representatives at the addresses below.

Oshawa, Ontario September 14
Event: National GRS Convention. Location: Carousel Inn

Huntsville, Alabama September 14-15
Event: Fall Festival CB Jamboree. Sponsor: Emergency Citizens Band Monitors, Inc. Contact: ECBM, P.O. Box 1542, Huntsville, Ala., 35807.

Schenectady, N.Y. September 15
Event: Annual Jamboree. Location: Tawasentha Park, Rt. 146, near Albany. Sponsor: Electric City CB Club, Inc.

CB troublespot. Our "live" monitoring confirmed published reports we have received in the past. There were more than twice as many chit-chatters as legal calls, and violators are still gabbing more than ever without call-signs. The FCC flew in a squad of field personnel several months ago to issue citations and impose monetary forfeitures for such violations.

We monitored with a Messenger 300 portable with battery pack from the eighth floor of our hotel. On channel 4, a feminine voice called "Pacifica" dominated the air talking to "Whistling Turtle!" We also heard tidbits such as, "This is the Bogey man, do you read?" and "Calling Candy Cane!" Would you believe every call was originated by a physically mature adult?

We found that channel 6 in the Los Angeles area was used by intelligently speaking adults, but many of them were bootleggers (individuals who purchase transceivers and put them on the air but have never heard of the FCC or part 95).

Only on channel 9 did we discover CB transmissions conducted in orderly fashion. We learned from Fred Berger, KQY0030, that 9 was generally used by the legal operators in the area. Fred, a monitor for Northeast REACT, shed some light on the conditions in Los Angeles and assured us that all was not as discombobulated as it may have sounded on channels 4 and 6.

San Francisco, Calif. This area seemed as much plagued by skip transmissions as Oklahoma City and L.A., but local conditions were not as deranged as other places. Over a three-day period, transmissions were nearly normal, blemished only by a skip caller from the midwest who wanted to know whether Southern California copied "Indiana Top Dog." He received no answer.

Upcoming: Monitor reports from Philadelphia, Penna., New York City, Hartford, Conn., and Boston, Mass.

I'll CB'ing you,

-Matt, KHC2060

PITCH REFERENCE

(Continued from page 47)

will occur again, the number of beats increasing the farther out of tune the instrument is made. Beat notes may possibly be caused by ear nonlinearity. You'll get the best results if the sound from both the instrument and the reference go in the same ear.

The Pitch Reference can be used to tune octaves other than the one starting at middle C. For example, any C in the scale can be tuned by using the C4 reference. If sufficient volume is not available, an amplifier and speaker system can be connected to the front-panel output jack.

Variations in pitch can be purposely introduced by changing the crystal in the reference to one that is higher or lower in frequency (sharper or flatter in pitch). This is sometimes desirable in tuning certain older instruments and for tuning the extreme octaves on a piano. 30

PITCH REFERENCE OUTPUT DATA

NOTE	DIVISION RATIO	APPROXIMATE FREQUENCY (Hz)	STANDARD TRUE FREQUENCY (Hz)
C4	4096	261.6	261.6
C4 #	3866	277.2	277.2
D4	3650	293.6	293.7
D4 #	3444	311.2	311.1
E4	3250	329.7	329.6
F4	3068	349.3	349.2
F4 #	2896	370.0	370.0
G4	2734	392.0	392.0
G4 #	2580	415.4	415.3
A4	2436	439.9	440.0
A4 #	2298	466.3	466.2
B4	2170	493.8	493.9



LISTEN TO: POLICE & FIRE REPORTS

FOR INDUSTRIAL, COMMERCIAL, UTILITY AND GOVERNMENT USE

CRYSTAL CONTROLLED • DUAL CONVERSION • LOW POWER DRAIN

Specifically designed for simplicity of operation and efficiently engineered for dependable service. Fits the smallest autos yet powerful enough to deliver a clean clear signal. Features: 6 crystal controlled frequencies, Dual Limiter, Quorum tuned RF stage for greater image rejection, Noise Free squelch, PLUG IN crystals for instant freq. change. Compatible with all major continuous tone systems. Operates on 117VAC & 12VDC. Size: 6 7/8" x 2 1/4" x 8 1/2" / Wt: 3 lbs. 8 oz.

Perfect For
POLICE • FIRE
Other Law Agencies • Tow Trucks
• Civil Defense •

Complete with AC and DC power cables, Mounting bracket, less crystals. Crystals \$5.00 ea.

FR-104

(25-50 MHz)

FR-105

(150-175 MHz)

\$140⁰⁰

SONAR RADIO CORP., 73 Wortman Ave., Bklyn, N. Y. 11207

Please send information on FR-104/105 FM Monitor Receivers. Dept. 701

Name _____

Address _____

City _____

State _____

NEON LAMP

(Continued from page 60)

a starting condition, is employed in E. F. Johnson, Inc.'s "Tone Alert." The basic circuit is shown in Fig. 11.

The Tone Alert is a selective calling system used in CB and Business Radio transceivers. In use, the receiver/speaker is muted until a special audio tone signal is received and the reed relay vibrates at its resonant frequency. Rather than turn on the speaker, the Tone Alert reed system applies B+ supply to the memory circuit.

In the memory circuit, neon lamp *I1* has a breakdown rating of 155 volts minimum while the maximum breakdown rating of *I2* is 120 volts. Thus, when the circuit is first energized, *I2* will always fire first. The maintaining voltage of *I2* is too small to permit *I1* to fire. Since *I1* is the "call received" indicator, the operator knows that no call for him has been received.

When a call comes in and the vibrating reed applies B+ voltage to the junction of *R1* and *R2*, both terminals of *I2* receive essentially full supply voltage and the voltage across it goes to zero. Lamp *I2* switches off and *I1* immediately comes on, indicating that the call has been received. At the same time, a portion of the square wave produced by the vibration of the reed relay is picked off by *R3* and applied to the receiver's audio circuits to indicate audibly that the call is being received.

If the operator is not present, the audible indication will not be answered. However, when the operator returns, *I1* will still be glowing to inform him that a call came in during his absence. When he answers the call, the "Reset" switch breaks the ground lead of *I1* and extinguishes the indicator. Lamp *I2* then fires, returning the circuit to its initial condition.

Part II of this story will appear in a forthcoming issue. To be discussed in Part II will be the use of neon lamps in voltage regulation circuits, control indicators, test equipment, etc.

MONO AMPLIFIER

(Continued from page 70)

The grid-circuit wiring of *V2* is fairly critical, and it is suggested that you use the values specified for *R4* and *R5*. Potentiometers *R4* and *R7* should be mounted side by side on the chassis with *R5* and *R6* between them and a shielded cable running to the grid. If this general method is not followed, instability may result.

The components on the tag strip are positioned so that those related to a given stage are adjacent to that stage, allowing the signal to follow a logical sequence from input to output as it does in the schematic drawing. The dashed lines in Fig. 3 indicate wiring that is routed under the tag strip.

Other than these precautions, construction is fairly simple and should present no problems even to a beginner in electronics. Of course, pay particular attention to the information given in the substitution tables for the particular tubes you select; electrode connections and resistance values vary.

Referring to Fig. 1, you might wonder where the other half of *V1* is used and why two heater symbols are shown for *V1* in the power supply. This is done to show that even multi-function tubes can be used. (The last four specified in the *Microphone Preamplifier Tube Substitution Table* are multi-function tubes.) Only half of the tube is used; the other half can be left disconnected or can be connected in parallel with the one being used. In the latter case, both heaters must be energized.

Almost any AM/FM tuner or a crystal or ceramic phono pickup can be used to feed signals into the amplifier through *J2*. Jack *J1* will accept most types of microphones, and the individual gain controls and amplifier setups allow the signals to be conveniently mixed so that both sources can be reproduced at the speaker simultaneously. If you use the mono amplifier to play stereo records, be sure you use a stylus that will not damage your records.

-30-

NOW YOU CAN AFFORD TO EXPERIMENT WITH INTEGRATED CIRCUITS

Motorola HEP breaks the price barrier on integrated circuits. With our new I.C. Experimenter Kit, containing 5 of the most popular RTL Integrated Circuits, you pay only 79¢ for each Integrated Circuit you buy.

The Motorola HEP Kit Includes:

- One J-K Flip Flop
- One Dual Buffer
- One 4-Input Gate
- Two Dual 2-Input Gates

which will function in many existing and new digital and linear applications

**ALL FIVE
JUST**

\$3.95

Also

You receive with the Experimenter Kit "Tips On Using I.C.'s" including an Integrated Circuit Cross Reference Guide and 8 I.C. Project Circuits.

Check with your HEP Supplier now to get this new HEK-1 Kit, or if you can't find a HEP distributor near you, just drop us a line. We'll send you a list of HEP suppliers in your area.



**MOTOROLA
HEP
PROGRAM**

MOTOROLA HEP PROGRAM
HOBBYIST • EXPERIMENTER • PROFESSIONAL
P. O. BOX 13408 / PHOENIX, ARIZONA 85001

CIRCLE NO. 33 ON READER SERVICE PAGE

**Now Over 300
Radio Shack Stores**

ALABAMA — Birmingham
 ARIZONA — Phoenix, Tempe, Tucson
 ARKANSAS — Ft. Smith, Little Rock
 CALIFORNIA — Albany, Anaheim, Bakersfield, Concord, Covina, Downey, Garden Grove, Glendale, La Habra, Lakewood, Long Beach, Los Angeles, Mission Hills, Mountain View, No. Hollywood, Oatland, Pasadena, Pomona, Reseda, Sacramento, San Bruno, San Diego, San Francisco, San Jose, San Mateo, San Pablo, San Rafael, Santa Ana, Santa Barbara, Santa Clara, Santa Monica, Stockton, Torrance, West Covina
 COLORADO — Aurora, Colorado Springs, Denver, Englewood, Pueblo, Thornton
 CONNECTICUT — Bridgeport, Hamden, Manchester, New Britain, New Haven, New London, Orange, Stamford, Torrington, West Hartford
 FLORIDA — Cocoa Beach, Fort Meyers, Jacksonville, Orlando, W. Palm Beach
 GEORGIA — Atlanta, Decatur
 ILLINOIS — Belleville, Chicago, Elgin, Harvey, Waukegan
 INDIANA — Richmond
 IOWA — Sioux City
 KANSAS — Overland Park, Wichita
 KENTUCKY — Bowling Green, Lexington, Louisville, Newport
 LOUISIANA — Baton Rouge, Gretna, Monroe, New Orleans, Shreveport
 MAINE — Bangor, Portland
 MARYLAND — Baltimore, Langley Park, Rockville
 MASSACHUSETTS — Boston, Braintree, Brockton, Brookline, Burlington, Cambridge, Dedham, Dorchester, Framingham, Leominster, Lowell, Medford, Natick, Quincy, Saugus, Springfield, Waltham, West Springfield, Worcester
 MICHIGAN — Dearborn, Detroit, Grand Rapids, Lincoln Park
 MINNESOTA — Crystal, Duluth, Minneapolis, St. Paul
 MISSISSIPPI — Jackson
 MISSOURI — Florissant, Grandview, Kansas City, Kirkwood, St. Joseph, St. Louis
 NEBRASKA — Omaha
 NEVADA — Las Vegas
 NEW HAMPSHIRE — Manchester, Portsmouth
 NEW JERSEY — Fords, Pennsauken, Trenton
 NEW MEXICO — Albuquerque, Santa Fe
 NEW YORK — Albany, Bayshore, Bathpage, Binghamton, Buffalo, East Northport, Flushing, Freeport, Hempstead, Huntington, Jackson Heights, New Hyde Park, New York, Ozone Park, Patchogue, Rochester, Schenectady, Syracuse, Valley Stream, Westbury, Yonkers
 NORTH CAROLINA — Charlotte
 OHIO — Cincinnati, Cleveland, Columbus, Lima, Willoughby
 OKLAHOMA — Oklahoma City, Tulsa
 OREGON — Portland
 PENNSYLVANIA — Ardmore, Greensburg, Philadelphia, Pittsburgh, Plymouth Meeting
 RHODE ISLAND — Providence, East Providence, Warwick
 TENNESSEE — Memphis, Nashville
 TEXAS — Abilene, Amarillo, Arlington, Austin, Beaumont, Brownsville, Corpus Christi, Dallas, El Paso, Fort Worth, Houston, Irving, Lubbock, Midland, San Antonio, Sherman, Stephenville, Tyler, Waco
 UTAH — Salt Lake City
 VIRGINIA — Arlington, Hampton, Norfolk, Portsmouth, Virginia Beach
 WASHINGTON — Bellevue, Olympia, Puyallup, Seattle, Tacoma
 WEST VIRGINIA — Martinsburg
 WISCONSIN — Appleton, Fond du Lac, Menitowac, Sheboygan
 WYOMING — Cheyenne



1795

**RADIO SHACK'S
NEW LINE OF
Science Fair™
ELECTRONIC PROJECT
KITS**

- Challenging, Educational!
- Low-Cost Introduction to Basic Electronics! No Soldering!

Ideal for first-time kit builders! Radio Shack SCIENCE FAIR KITS let you build the way the pros do — by "breadboarding". Each kit is complete with detailed instructions, pictorials and schematics; only the battery (in DC kits) needs to be added. Get in on the fun!

28-102, 2-Transistor Radio Kit	3.95
28-100, 1-Tube DC Radio Kit	3.95
28-101, Transistor Organ Kit	5.95
28-103, Wireless AM Mike Kit	3.95
28-104, AC/DC Power Supply Kit	6.95
28-105, 3-Way Code Oscillator Kit	3.95
28-106, "OTL" Audio Amplifier Kit	4.95
28-107, Siren/Burglar Alarm Kit	5.95
28-010, 5-Tube AM Radio Kit	9.95
28-109, Wireless FM Mike Kit	6.95
28-110, Shortwave Receiver Kit	7.95
28-108, Speed Control/Dimmer Kit	6.95
28-113, Stereo Amplifier Kit	8.95
28-115, FM Receiver Kit	7.95
28-111, Night Light/ Photo-Switch Kit	7.95
28-112, Bell/Buzzer/Code Key Kit	1.49

**THIS IS THE BIG ONE!
50-in-1 PROJECT KIT**

The Complete Self-Teaching Course
in Basic Modern Electronics Featuring
a 62-Page Instruction Manual

You have an entire electronics lab right on your table top! Build 50 solid state projects, including 15 solar energy experiments! The 50-in-1 kit comes in a 17½x11x2" fitted hardwood case, complete with speaker, solar and photo cells — everything you need! The clearly written, well illustrated manual is your guide to electronics adventure. #28-201.

**DISCOVER BASIC ELECTRO-CHEMISTRY WITH RADIO SHACK'S
EXCITING NEW**

Science Fair™ BATTERY KIT

- Make and Use 2 "D" Cell Batteries!
- Contains All Parts and Step by Step Instruction Manual!

Developed and approved by educators for youngsters from 7 to 16 — Radio Shack's new SCIENCE FAIR BATTERY KIT is an ideal introduction to the theory of electric power. Assemble two Radio Shack long-life D cells; use them to power projects or toys! It's entertaining, educational and useful, and the completed batteries are first quality! Illustrated manual gives assembly details, theory and suggested experiments. #28-125



125

RADIO SHACK

SPECIAL PURCHASE!

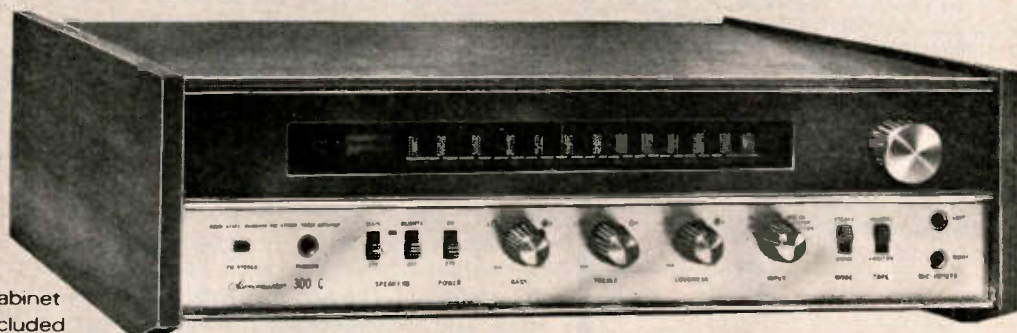

Cabinet
Included

199⁹⁵

NO MONEY
DOWN

SCOTT 300C FM STEREO RECEIVER

You've Finally Seen a Scott Receiver Under \$200!

EVEN THE MOST CALLOUS BARGAIN HUNTER will gasp at the unprecedented effectiveness of Radio Shack's buying power now that it has produced an H. H. SCOTT receiver at \$199.95! This is a *made-in-1968* receiver—*not a closeout*—featuring Scott silver-plated FET-Transistor FM tuner and 18-25,000 cps 40-watt amplifier. The mighty and mighty gorgeous Scott 300C combines the latest IC/FET solid state circuitry with every feature dear to the heart of an audiophile. Impeccable FM stereo. Dual concentric control of bass, treble, volume. Dual speakers switching for: main only, remote only, or both combined plus headphone privacy as you like it. Tuning meter. Tape monitor, stereo/mono, and AC power switches—each separate. Front panel inputs (3) for phones, microphones, and guitar. Automatic "Auto Sensor" FM stereo plus indicator light. Internal FM antenna with external provisions. Scott's patented channel balance switching circuits. Scott's 2-YEAR factory guarantee. Cat. No. 31-2040

SPECIFICATIONS: music power rating at 0.8% harmonic distortion: 40W @ 4Ω. Frequency response at ±1 db 18-25,000 cps and 30-20K power bandwidth. Hum and phono noise -55 db. Usable FM sensitivity, 2.3 μV—9FM-IF limiting stages, 35 db tuner stereo separation, 3 db capture ratio, 60 db S/N ratio. Rear panel stereo connections: magnetic phono, antenna (terminal), 4 speakers (new phased RCA-type jacks), tape in, tape out. Front panel inputs: low level phones guitar or other musical instrument, dynamic mike. Power supply: 117VAC, 50/60 cy. Size: 17¹/₂x5¹/₂x15¹/₄".

Exclusive! Scott \$19 Speaker System



39⁹⁵

Perfect Com-
panion to Scott
300C Above.
With H.H.
Scott 2 Year
Guarantee!
Cat. No. 40-1981

FILL IN AND MAIL ORDER TODAY!

RADIO SHACK { EAST: 730 Commonwealth Ave., Boston, Mass. 02215 Dept. YX
WEST: 2615 West 7th St., Fort Worth, Texas 76107

Rush me the items I've listed below. I enclose \$ _____,
including 50¢ for handling and postage anywhere in the U.S.A.

Name _____
Street _____
City _____
State _____ Zip _____

CIRCLE NO. 26 ON READER SERVICE CARD

BACK ISSUES AVAILABLE

Use this coupon to order back issues of POPULAR ELECTRONICS

We have a limited supply of back issues that can be ordered on a first-come, first-served basis. Just fill in the coupon below, enclose your remittance in the amount of 65¢ for each copy ordered.

ZIFF-DAVIS SERVICE DIVISION

Dept. BCPE, 589 Broadway
New York, New York 10012

Please send the following back issues of POPULAR ELECTRONICS. I am enclosing _____ to cover cost of the magazine, shipping and handling.

Month _____ Year _____

Month _____ Year _____

Month _____ Year _____

Name _____

Address _____

City _____

State _____ Zip Code _____

Payment must be enclosed with order

ABOUT YOUR SUBSCRIPTION

Your subscription to POPULAR ELECTRONICS is maintained on one of the world's most modern, efficient computer systems, and if you're like 99% of our subscribers, you'll never have any reason to complain about your subscription service.

We have found that when complaints do arise, the majority of them occur because people have written their names or addresses differently at different times. For example, if your subscription were listed under "William Jones, Cedar Lane, Middletown, Arizona," and you were to renew it as "Bill Jones, Cedar Lane, Middletown, Arizona," our computer would think that two separate subscriptions were involved, and it would start sending you two copies of POPULAR ELECTRONICS each month. Other examples of combinations of names that would confuse the computer would include: John Henry Smith and Henry Smith; and Mrs. Joseph Jones and Mary Jones. Minor differences in addresses can also lead to difficulties. For example, to the computer, 100 Second St. is not the same as 100 2nd St.

So, please, when you write us about your subscription, be sure to enclose the mailing label from the cover of the magazine—or else copy your name and address exactly as they appear on the mailing label. This will greatly reduce any chance of error, and we will be able to service your request much more quickly.

SOVIET ELECTRONICS

(Continued from page 53)

highest award, one held by a relatively few "sportsmen" is "Master of Radio Sport."

One particularly interesting form of radio competition is called "Fox Hunting." This is a contest in which teams of "hunters" (young people carrying portable direction finders) race against time to find "foxes" (hidden transmitters). The rules call for the three "foxes" to take up positions one or two miles apart in a large wooded area. At the starting signal, the "foxes" begin identifying themselves by voice announcements at one-minute intervals, each "fox" therefore being on the air once every five minutes. The announcements, which are very brief ("I am the first fox"), are made on amateur bands by means of low-powered transmitters, usually homemade. The winning "hunter" is the one who first locates all three "foxes" in sequence. The latest twist in "Fox Hunting" is to conduct the sport on skis, a technique that serves to make this a year-round sport.

For SWL's, there are contests to see who can log the greatest number of ham stations in a given period of time. In past years, the winners have logged around 1000 CW QSO's in a 12-hour period; on the phone bands they have logged several hundred QSO's in six hours. The highest award for SWL's is a trophy cup inscribed "Best SWL in the USSR."

For the electronics enthusiast, there is a contest involving the building of a broadcast receiver. Contestants are given a set of parts, a punched chassis, and a schematic diagram. The aim is to build the neatest, best performing receiver in the shortest amount of time, usually no more than 35 minutes.

The kind of competitive spirit that characterizes "radio sport" is typical of Soviet electronics in general. Whether it be technological state of the art, TV via communications satellite, or techniques for electronics training, the Russians are fully aware of the importance of communications-electronics in the space age, and they intend to remain competitive in every possible way.

-30-

TECHNICIAN QUIZ ANSWERS

(Quiz appears on page 48)

- 1 **FALSE** The Plumbicon is a camera tube which has the advantages and disadvantages of the orthicon and vidicon tube.
- 2 **FALSE** The FET was described in theory almost 20 years ahead of the point-contact transistor. It was commercially produced in the late 1950's.
- 3 **FALSE** Black is not a color and is not a part of the spectrum. It is the zero-intensity point of any color.
- 4 **FALSE** Two diagonal bars on the TV screen indicate that the horizontal oscillator is running 120 Hz off frequency.
- 5 **FALSE** The emitter junction voltage is normally determined by the transistor type: about .7 V for silicon and .2 V for germanium.
- 6 **TRUE** Balanced relays are often used when an indicator is needed for an "under" or "over" condition such as too much or too little voltage, current, etc.
- 7 **TRUE** A trapezoid wave is developed. However, this becomes sawtooth when applied to the yoke.
- 8 **TRUE** Consider the meter to be a large resistor in the circuit. The tube conducts but most of the voltage is dropped across the meter.
- 9 **FALSE** A long distance ghost may appear after the horizontal blanking interval and sometimes appears to the left of the object.
- 10 **TRUE** Esaki is the inventor and "tunnel" is the principle.
- 11 **TRUE** Special neon lamps can be purchased which have a radioactive material added to reduce the effect of light.
- 12 **TRUE** Though not commonly associated, the color broadcasting principle is also a time-base multiplex.
- 13 **FALSE** All three phosphors have about the same total number of dots on a color CRT screen.
- 14 **TRUE** The CRT is directly driven from the demodulators when high-level demodulation is employed.
- 15 **TRUE** In a ring counter, the last stage resets the first. A two-stage ring counter would only count 1-2, 1-2, etc.
- 16 **TRUE** With every pulse applied, the ring counter, like the stepping relay, advances to the next "state."
- 17 **FALSE** The connection between the output cathode and filament in some audio amplifiers applies a small positive voltage to the filament circuit to prevent electron flow (and hum) from the filament to the cathode or grid.

When you write for our
condensed high fidelity
SPEAKER, ELECTRONICS
or **MICROPHONE** catalogs...

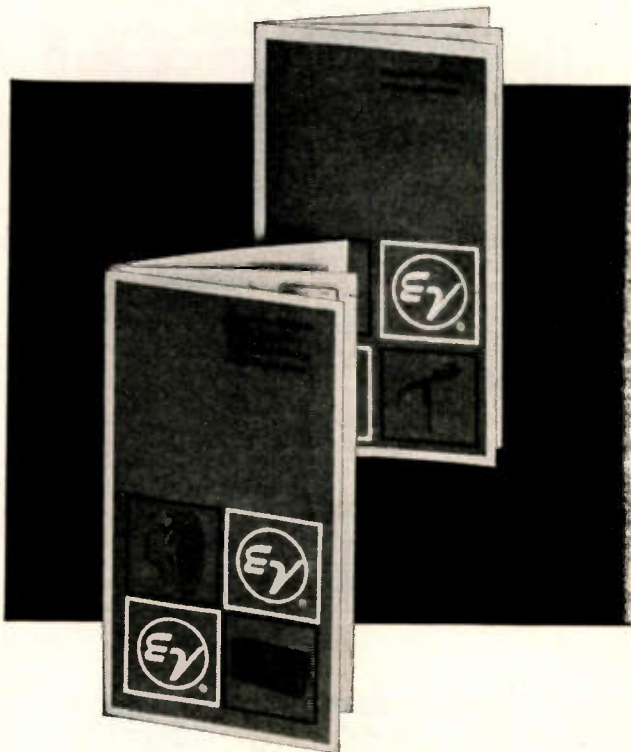

you really get a
brief progress
report on the state
of the art in sound.

Both **FREE**
for the asking,
of course.



.....
ELECTRO-VOICE, INC., Dept. 983P
630 Cecil Street, Buchanan, Michigan 49107

Please send me the latest word on

E-V high fidelity E-V microphones

I am particularly interested in E-V Model: _____

Name _____

Address _____

City _____

State _____

Zip _____

CIRCLE NO. 16 ON READER SERVICE PAGE

Deluxe POPULAR ELECTRONICS MAGAZINE CASES DESIGNED TO HOLD A FULL YEAR'S COPIES

These decorative cases are just what you've been looking for to keep your copies of Popular Electronics Magazine in easy-to-find order.



Constructed of reinforced fibreboard and covered in rich leatherette, these durable cases guard against soiling and tearing of your magazines while lending themselves handsomely to the decor of any room. The magazine cases are available with embossed gold lettering in either all black or attractive maroon back with black sides.

**\$3.50 ea., 3 for \$10, 6 for \$19
FULLY GUARANTEED!**

Ziff-Davis Publishing Co., Dept. SD

1 Park Ave., N.Y., N.Y. 10016

Please send me _____ Popular Electronics Magazine

Files as checked below:

All black, gold embossed

Maroon back, gold embossed/black sides

NAME _____

PE-98

ADDRESS _____

CITY _____

STATE _____

ZIP _____

Enclosed is \$ _____ at \$3.50 per case,
3 for \$10, 6 for \$19 (Quantity prices apply for combination orders of more than one title). Orders outside U.S.A. \$4.50 ea., 3 for \$13, 6 for \$25.

■■■■ (Payment must accompany order) ■■■■

AMATEUR RADIO

(Continued from page 93)

Charbonnet, U.S.N., Commandant of the Eighth Naval District, presented Mary F. De Mand, WA5HUN, Oklahoma City, with a citation for being the most valuable operator in the Eighth Naval District in 1967. Mary was commended for "her outstanding performance in passing messages from the Republic of Vietnam on Navy MARS circuits." Making the sentiment unanimous, Mary's fellow Eighth Naval District MARS members presented her with a wired Heath-kit SB-200 linear amplifier.

Also from the OCVARC paper is a roster of 51 amateurs who, we presume, are members of the club. The unusual thing about the list is that, of the 51 amateurs, at least 29 of them are related to one to three other amateurs on the list. Certainly, it is not unusual to have more than one licensed amateur in the same family, but to have so many husbands and wives, sons and daughters, brothers and sisters, etc., in the same amateur group is unusual.

Overseas News. From *Break-In*, the official organ of the New Zealand Amateur Radio Transmitters, we learn that the New Zealand government officially thanked New Zealand amateurs for being the sole means of communication between many areas of New Zealand during and after disastrous 1967 snow storms.

The New Zealand government has vetoed the NZART's suggestion that it issue a Novice license with a 5-w.p.m. code test and a simplified technical examination permitting code operation in the 80-meter band. In denying the request, the government spokesman said that it thought the present 12-w.p.m. code requirement was a reasonable minimum requirement and that it was averse to lowering the technical standards of the written examination.

New Zealand does have a Technician class license with a 5-w.p.m. code test and simple written examination that permits the licensee to operate on the amateur VHF bands.

In Great Britain, the General Post Office (the English licensing authority) recently authorized holders of the Amateur (Sound) License B, no-code license, to operate in the 144-MHz band. Previously, such licensees could operate only above 420 MHz.

And on March 11, the Postmaster General of Great Britain really shook up British amateurs by unexpectedly announcing in

THE CARTRIDGE TAPE CLUB OF AMERICA OFFERS YOU



- 1/3 OFF on all cartridge tapes—4-track, 8-track, cassette
- Special members' prices on home and auto stereo tape players
- 81-monthly magazine with complete listings, features, news and pictures
- Free gifts and special offers

All it costs is just \$5 for a lifetime membership. There's no other club like it... you buy only what you want when you want, no minimum purchases required. You can choose from a library of more than 6,000 tapes... everything that's available, all artists, all labels. Send \$5 today and receive a FREE gift, or write for complete details.

CARTRIDGE TAPE CLUB OF AMERICA Dept. 9C
1509 South Michigan • Chicago Illinois 60605

CIRCLE NO. 8 ON READER SERVICE PAGE

Parliament that he intended to issue a new beginner's amateur license in the next few months for those who were not yet qualified to pass the regular amateur examination. The Radio Society of Great Britain (RSGB) was especially chagrined by this announcement, pointing out that it had already informed the PMG that it was opposed to a beginner's license because it did not like the United States' Novice program.

-50-

NEWS AND VIEWS

Richard Mahler, WN6YUI, 3111 Brian Court, Arcata, Calif. 95521, closes out his Novice career with 30 states, including Hawaii and Alaska, worked on 80 and 40 meters in eight months of operation. Equipment he uses include a Globe-Scout 90A transmitter and a Conar 400 transmitter, war-surplus BC-455, Hallcrafters S-120 and S-40B receivers. Among his antennas are a 40-foot, ground-plane vertical, 75- and 135-foot end-fed wires, and inverted V's. Rich rates a solid contact to Colorado (1000 miles) running eight watts to an antenna 12 feet high as his best DX. Next was a 3500 mile contact with the Aleutian Islands running 75 watts. When the new WB6 ticket arrives, a tri-band Quad antenna will blossom at Rich's QTH . . . By the time this reaches print, we hope that the Teen Net on 7220 kHz will be well established. Net time is 1530 to 1630, GMT, each Saturday. More details are available from **Lee Hayes, WASPPF**, 426 So. Mockingbird Lane, Abilene, Texas 79605 . . . **Ron Philip, VE7BCP**, 12227 4½ Ave., Haney, B.C., Canada, works CW exclusively, except for an occasional 10-meter phone contact. Last year, he used a home-brew 10- and 15-meter Quad antenna and almost every eastern U. S. station he worked told him that he was their first VE7. Then, he put up a 40-meter dipole and worked 40 meters, including Russia, New Zealand, Brazil, and 46 states. With an 80-meter dipole and a new Mosley tri-band beam, VE7BCP can work five bands and is always open for skeds—especially with Novices. He would also like to hear Maine, even if he can't work it. Ron has a Heathkit DX-60A and Hammarlund HQ-170A.

Possibly a reader or two would like to write to **Peter J. Dehl, U.S.M.C.**, Delta Co., 1st Platoon, 1st Bn., 26th Marines, FPO, San Francisco, Calif. 96602. He says that he and five of his buddies are very interested in becoming amateurs, but they have neither the necessary knowledge or equipment . . . **Andrew D. Leckart, WN1????**, 30 Elm St., Taunton, Mass. 02780, has a 2-element beam for 15 meters and a Hy-Gain 18V vertical antenna for 40 meters to go with a Knight-kit T-60 transmitter

and a Lafayette HA-350 receiver. In five months, Andy has worked 24 countries and 42 states—mostly on 15 meters. Andy promises to write again when his General ticket arrives. Don't forget to include your call letters the next time, Andy . . . **Neil Ragsdale, WB6WDI**, 1105 Oxford Rd., Burlingame, Calif. 94010, runs 40 watts into a Johnson Navigator transmitter to feed 40- and 15-meter dipoles. A Knight-kit T-60 is used for occasional forays on AM phone and as a standby transmitter. A Hallcrafters SX-110 handles the reception. Although Neil pooh-poohs his DX record, he has worked 35 states and eight countries. Included in the country total are 48 Japanese and many Canadian contacts. A 200-watt amplifier and a 15-meter Quad antenna are under construction, and a visit to the FCC to take his Advanced class exam is next on Neil's agenda.

Capt. Norman W. Stryer, Jr., WA3BZA, DL4NS, DL4NS/LX, PA9CK, HBØXCO, etc., OF102017, 3rd Bn., 6th Arty, APO, San Francisco, Calif. 96318, is now in the Republic of Vietnam, trying to find some way of getting an amateur transmitter on the air from there. His chances aren't very good, but he says U.S. West Coast signals come in strong almost every night. Norm expects to go on a short "R and R" leave to Australia soon and hopes to make a few contacts with old friends from there . . . **Peter J. Malvasi, Jr., WN2BYQ**, 447 Abbot Rd., Paramus, N.J. 07652, waited until he passed his General exam before mailing his letter. As a Novice, he worked 28 states and Canada using a Heathkit DX-40 transmitter driving a horizontal dipole and a vertical antenna. Helping put together the Heathkit SB-101 transceiver for the Paramus High School Radio Club prepared Pete for the General test . . . **Doug Tabor, WA7GFB**, 1964 John St., Layton, Utah 84041, renews his offer of a year ago to sked anyone needing Utah on 40, 15, or 10 meters. His Gonset Commander transmitter runs 50 watts on CW and 35 watts on AM phone. Receivers are Lafayette HA-230 and Geloso G-209. Antennas are a 40-meter dipole and inverted-V, 50 feet high. Doug has worked 42 states and six countries—mostly on 40 meters. His favorite pastime is working AM phone in "Sideband Alley" on 40 meters and rag-chewing at speeds up to 35 w.p.m. on CW . . . **Greg Noneman, WN6ZSU**, 15961 Lonecrest Dr., Hacienda Heights, Calif. 91745, started out in overdrive. In a month, he has worked 25 states and five countries with a Heathkit SB-101 transceiver. An inverted V and a Hy-Gain 15-meter beam give his neighbors something different to look at.

Why not start out the fall operating season by sending us your "News and Views," photographs (black and white, please) and club papers. The address is: Herb S. Brier, W9EGQ, Amateur Radio Editor, POPULAR ELECTRONICS, P. O. Box 678, Gary, Ind. 46401.

73. Herb, W9EGQ

NEW WATTS BOOK IS HERE!

"Professional Methods for Record Care and Use", edited by the internationally recognized authority, Cecil E. Watts, Ltd. is "must" reading for everyone using the new ultra-lightweight cartridges, tracking at 2 grams or less, and/or using an elliptical stylus. Essential for getting the finest sound from your equipment. Price: 50¢

ALSO AVAILABLE! "How to Clean, Maintain and Protect Records" by Cecil E. Watts is the basic book on record care. Covers such topics as dust, static, static behavior, how to use record changers properly, and how to rejuvenate records.

Order both books! Price: 25¢

At your high fidelity dealer, or use the coupon. Please do not send stamps. No C.O.D.'s



ELPA MARKETING INDUSTRIES, INC.
New Hyde Park, N. Y. 11040

Dear Sirs:

Please send the following book(s) on record care.

- Professional Methods 50¢
 How to Clean 25¢

Enclosed is _____

Name _____

Address _____

City/State/Zip _____

Pg

CIRCLE NO. 17 ON READER SERVICE PAGE

SHORT-WAVE LISTENING

(Continued from page 95)

15,405 kHz, 2200-0100 on 17,845 kHz, 2200-2345 on 21,525 kHz and 0000-0100 on 15,215 kHz.

Random Notes. The plans of the German Postal Ministry to construct a large transmitter site (24 units of 500 kW each) for *Deutsche Welle* in the Illertal (Wurttemberg) seem to have been cancelled. The site has been changed to one near Gifhorn in Lower Saxony.

An article in a recent issue of *Newsweek* magazine claims that the Russians have accused the Chinese of violating maritime and international broadcasting rules by transmitting passages from the works of Mao on 500 kHz, which is the frequency customarily reserved for SOS signals. They reportedly broadcast these Maoisms up to 30 times a day from the ports of Darien, Shanghai, Tientsin, and Tsingtao.

A weekly special program for short-wave listeners and radio amateurs is broadcast Saturdays at 1300 on 3678 kHz and Sundays at 1000 on 7040 kHz by Der Landesender des Landesverbandes Niederosterreich and Burgenland des Osterreichischen Versuchsverbandes (!) Reports go to *Radio Austria*, Vienna.

CURRENT STATION REPORTS

The following is a resume of current reports. At time of compilation all reports were as accurate as possible, but stations change frequency and/or schedule with little or no advance notice. All times shown are Greenwich Mean Time (GMT) and the 24-hour system is used. Reports should be sent to Short-Wave Listening, P. O. Box 333, Cherry Hill, N. J. 08034, in time to reach Your Short-Wave Editor by the fifth of each month; be sure to include your WPE identification and the make and model number of your receiver.

Albania—*R. Tirana* has been noted on two new

frequencies: 9760 kHz at 2345 in Spanish with s/off at 0000, and 9780 kHz in Spanish with ID and talks at 0230 to 0253 s/off. *R. Peking* immediately s/on at 0300 with a signal that sounded and looked (on an oscilloscope) similar.

Ascension Island—The BBC relay station here has exchanged frequencies with BBC in London; the relay now uses 15,260 kHz with London moving 15,140 kHz. Both channels are noted at 2300-0000 in the World Service, dual to 11,780 kHz, with world news, commentary, documentary programs, a mailbag and a program of folk music from around the world.

Belgium—Brussels now has some English as indicated in their newest schedule: "Belgium Speaking" is aired at 2205-2215 on 15,335, 9615 and 6010 kHz; a program for Belgians over the world, and beamed expressly to N.A. in French and Dutch is given at 0000-0050 followed by "Belgians Speaking" in English at 0050-0100, both on 9615, 6125 and 6010 kHz.

Bermuda—DX'ers needing this country might look for ZBM1, Hamilton, on the medium waves at 1235 kHz; best time is Monday 0500-0700 when many U. S. stations are silent.

Bolivia—As reported last month, *La Cruz del Sur*, La Paz, has moved up from 4985 kHz to 5025 kHz where they are anxiously awaiting reception reports to determine whether the move was satisfactory. This missionary station has some English around 0245 with a complete ID at 0300. The new frequency, as indicated in our loggings, is much improved with a far better signal level.

Brazil—Whether coincidentally or strictly by accident, *R. Aparecida* has opened a religious outlet on 4985 kHz; best signals in Portuguese seem to be around 2300 and later. This is the channel just vacated by *La Cruz del Sur*, Bolivia. Although listed as inactive by some sources, *R. Nacional Brasilia*, 6065 kHz, is very much in action as noted at 0000-0015 with typical Latin American format. A nice letter and card verification has been received from Sanir Razuk, Director Commercial of *R. Bandeirantes*, operator of ZYR78, 11,925 kHz, 2030-1500; ZYR77, 6185 kHz, 2030-1500; and PRH9 (FM), 96.1 mHz, 24 hours daily.

Burundi—*R. Cordac* is now broadcasting in English on 4895 kHz with s/on at 0330; correct reports are being promptly verified. *R. Cordac*, B. P. 1140, Bujumbura, Burundi, Africa.

Columbia—*R. Tumaco*, Tumaco, is noted weakly with L.A. pop tunes and few IDs in Spanish until 0400 closing on 3645 kHz.

COSTA RICA—TIFC, San Jose, is generally good on 9645 kHz between 0400-0500 with talks and L.A. music and an ID after nearly each musical selection.

Cuba—English language broadcasts from Havana to Northern Europe are scheduled for 2010-2140 on 17,705 kHz, and to North and South America at

PROFESSIONAL TYPE MOBILE MONITOR RECEIVER

Solid State FM / Crystal Controlled / 6 Channels..... \$99⁹⁵
LESS CRYSTALS



SEND
FOR FREE LITERATURE



This expertly engineered, all solid-state, crystal controlled FM receiver provides instant monitoring of the VHF frequencies between 39 and 46 mcs or 153 to 157 mcs. Outdating all of the bulky tube-type monitors which take up needed space under dashboards, the compact Ameco Model MRT-6 high band or MRT-7 low band unit measures only 2-1/8" high by 5-5/16" wide by 7-7/8" deep. It's a professional type receiver with latest double conversion super-heterodyne circuitry providing 3/4 microvolt sensitivity for 20 db quieting. Has built-in speaker and mobile mounting bracket. Optional AC power supply available.

DIVISION OF AEROTRON / BOX 6527 / RALEIGH, N. C. 27608

CIRCLE NO. 1 ON READER SERVICE PAGE

POPULAR ELECTRONICS READER SERVICE PAGE

free information service:

Here's an easy and convenient way for you to get additional information about products advertised or mentioned editorially (if it has a "Reader Service Number") in this issue. Just follow the directions below... and the material will be sent to you promptly and free of charge.

1. Print or type your name and address on the lines indicated. Circle the number(s) on the coupon below that corresponds to the key number(s) at the bottom of the advertisement or editorial mention(s) that interest you. (Key numbers for advertised products also appear in the Advertisers' Index.)

2. Cut out the coupon and mail it to the address indicated below.

3. This address is for our product "Free Information Service" only. Editorial inquiries should be directed to POPULAR ELECTRONICS, One Park Avenue, New York 10016; circulation inquiries to Portland Place, Boulder, Colorado 80302.

**POPULAR
ELECTRONICS**

VOID AFTER OCTOBER 31, 1968

P.O. BOX 8391
PHILADELPHIA, PA. 19101

1 2 3 4 5 6 7 8 9 10 11 12 13 14 15 16 17 18 19 20
21 22 23 24 25 26 27 28 29 30 31 32 33 34 35 36 37 38 39 40
41 42 43 44 45 46 47 48 49 50 51 52 53 54 55 56 57 58 59 60
61 62 63 64 65 66 67 68 69 70 71 72 73 74 75 76 77 78 79 80
81 82 83 84 85 86 87 88 89 90 91 92 93 94 95 96 97 98 99 100

NAME (Print clearly) _____

ADDRESS _____

CITY _____ STATE _____ ZIP CODE _____

9 b

POPULAR ELECTRONICS SUBSCRIBER SERVICE

Please include an address label when writing about your subscription to help us serve you promptly. Write to: Portland Place, Boulder, Colo. 80302

CHANGE OF ADDRESS:
Please let us know you are moving at least four to six weeks in advance. Affix magazine address label in space to the right and print new address below. If you have a question about your subscription, attach address label to your letter.

TO SUBSCRIBE:
Check boxes below.

- New Renewal
 5 years \$20
 3 years \$13
 1 year \$5

SPECIFY:

- Payment enclosed
 -You get 1 extra issue per year as a BONUS!
 Bill me later.

← AFFIX LABEL →

state city address name please print zip code

If you have no label handy, print OLD address here.

Add'l postage: \$1 per year outside U.S., its possessions & Canada.

name please print 0286

address

city

state zip code

ELECTRONIC EXPERIMENTER'S HANDBOOK



The most fascinating and challenging construction projects for the electronics hobbyist. Over 148 pages.

- 1968 Winter Edition #50
 1967 Spring Edition #49
 1966 Fall Edition #39
 1966 Spring Edition #36
 1965 Fall Edition #9

Titles listed above \$1.25 each
 Order by number from

Ziff-Davis Service Div., 595 Broadway • New York, N.Y. 10012. Enclosed add'l 15¢ per copy for shipping and handling (50¢ for orders outside U.S.A.)

PAYMENT MUST BE ENCLOSED WITH ORDER

2050-2150 and 15,285 and 17,815 kHz, 0100-0450 on 9525 kHz, 0100-0600 on 15,285 kHz, 0330-0600 on 11,760 kHz and 0630-0800 on 11,930 kHz.

Ecuador—The English schedule for HCJB, Quito, reads: 0700-1000 to S. Pacific on 11,915, 9745 and 6050 kHz and to Europe on 15,325 kHz; 1400-1530 (to 1600 Sunday, 1630 Saturday) to N.A. and Jamaica on 17,880 and 15,115 kHz; 1845-2000 to Europe and Eastern Caribbean and from 2100 to Europe on 17,880 and 15,325 kHz; from 2330 to N.A., Eastern Caribbean and Europe on 17,890 and 15,115 kHz; and 0200-0430 to N.A. on 15,115 and 11,915 kHz and to the Americas on 9745 kHz. The 15,115 kHz channel continues to N.A. to 0530. "DX Party Line" is aired to Europe on Monday at 2100, to N.A. Mondays at 0230, and to South Pacific and Europe on Wednesday at 0930. HCBK2, R. *El Mundo*, Guayaquil, maintains an irregular schedule on 4742 kHz with s/off time varying from 0200 to 0330; programs are in Spanish.

Egypt—Cairo observed at 1810 in Arabic on a new channel of 17,950 kHz.

Fiji Islands—Suva, 3230 kHz, was heard in the midwest with an unbelievably strong signal in English on a Saturday with ID and complete frequency list just prior to 1105 s/off; two anthems followed. The 3284 kHz outlet was also heard during the same time segment in Hindi.

France—Paris opens at 0230 with multilingual aunts (although no English), to South America on 15,200 kHz.

Germany (East)—R. *Berlin International* has been logged on three new 19-meter frequencies: 15,190 kHz, in English from 0330 s/on, 15,170 kHz, in English commentary at 0300 to 0312 s/off and announced parallel channels of 9730, 15,190, 15,225 and 15,315 kHz; these same channels to be in use

SHORT-WAVE ABBREVIATIONS

anmt—Announcement	mHz—Megahertz
BBC—British Broadcasting	N.A.—North America
B/C—Broadcasting	QRM—Station interference
ID—Identification	R—Radio
IS—Interval signal	s/off—Sign-off
kHz—Kilohertz	s/on—Sign-on
kW—Kilowatts	xmsn—Transmission
L.A.—Latin America	W—Watts

again at 0330 and 0445, and 15,110 kHz, at 0205 with Portuguese news, probably to Brazil, and causing QRM to the Mexican on this spot.

Germany (West)—At press time, *Deutsche Welle*, Cologne, is scheduled to N.A. in English and French at 0130-0250 on 11,945 and 9640 kHz and in English at 0445-0545 on 11,945 and 9545 kHz, 1045-1055 on 15,315 and 11,905 kHz and at 1900-1910 on 17,790, 15,405 and 11,795 kHz.

Holland—Three new channels are in use by R. *Nederland*, Hilversum: 17,750 kHz in language at 2340-2350; 17,810 kHz in English to N.A. (replacing 15,425 kHz) and dual to 11,730 kHz, and 11,945 kHz at 2305-2345 in Dutch and Spanish to the West Indies (replacing 15,320 kHz).

India—All India Radio, Delhi, may be heard well at times on 15,165 kHz in the General Service; try around 1000-1100. A new frequency is 15,235 kHz, in use with English news at 2300, dual to 11,710 and 9740 kHz to S. E. Asia and on 9615 and 11,965 kHz to N. E. Asia. This English runs to 0115.

Iraq—A new schedule from R. *Baghdad* shows no service to N. A. Their complete European schedule is 1930-2020 English, 2020-2110 German and 2110-2200 French on 6030 and 6095 kHz.

Italy—Rome has Italian to N. A. on 15,310 kHz (replacing 11,905 kHz) with light and popular vocal and instrumental music at 2300-2330. A dual channel is 11,810 kHz.

Lebanon—R. *Lebanon*, Beirut, has English to Africa at 1830-1900 on 21,610 kHz and to N. A. at 0230-0300 on 15,280 kHz. Arabic to N.A. on the same frequency is given at 0200-0230 and 0300-0330.

Malawi—A new schedule from *Malawi B/C Corp.* gives this schedule: 0345-0605 (Sunday from 0355) and 1530-2105 on 3380 kHz and 0700-1515 (Saturday and Sunday from 0620) on 5995 kHz. Correct reports are verified promptly; send yours to Chief Engineer, *Malawi Broadcasting Corp.*, P. O. Box 453, Blantyre.

Martinique—Fort-de-France has been logged on 11,015 kHz. From 2230-0130 with French anmts. pop music, dramas, and news with a bell between each item. A good signal but severe teletype QRM. (This appears to be a point-to-point relay station as opposed to a regular short-wave broadcaster—Editor)

Monaco—*Trans World Radio*, Monte Carlo, has English on Sunday at 0625-1000 and 1415-1530; Monday through Friday at 0625-0800 and Saturday at 0610-0830, all on 7295 kHz.

Pakistan—Karachi is noted with good signals in their English European Service on 15,340 kHz with news to 2010, then a commentary.

Peru—West Coast loggings: OAX9G, *R. Nor Peruan*, Chachapoyas, 9655 kHz, at 0409 with L.A. music; OAX4Q, Victoria, 6020 kHz, in the clear after 0600 s/off of XEUW, Mexico; OAX4V, Lima, 6011.5 kHz, to 0555 s/off; ID is listed as *R. America* but it may announce as *R. Nuevo Mundo*; OBX4Q, *R. El Sol*, Lima, 5970 kHz, has news in Spanish at 0500-0530 and a distinctive theme that is similar to "Anchors Aweigh". New stations: OBX7K, *R. La Convencion*, Quillabamba, 3335 kHz; OCY4S, *R. La Nueva Voz del Centro*, El Tambo, 4800 kHz; OBX5I, *R. Apurimac*, Abancay, 4830 kHz. 4 kW: OAZ8A, *R. Instituto Linguistico*, Yarinacocha (?), 4902 kHz, 500 W; OCY4H, *R. Santa Rosa*, Lima, 6045 kHz, 10 kW. Some sources are listing OAX7Z, *R. Juliaca*, Juliaca, as being on 5018 kHz. The station is on—and has not moved from—5081-5082 kHz since 1962. S/off time is 0400 or slightly earlier. The station on 5018 kHz is almost certainly Bolivian, not Peruvian.

Poland—*The Polish Pathfinders Station*, Konopnickiej 6, Warsaw, now verifies reports with a colorful card. Light and popular music is scheduled weekdays except Mondays 1100-1700 and Sundays 0900-1700 on 6850 and 7306 kHz, 300 W.

Saudi Arabia—Jeddah is the Arabic speaker noted on 11,900 kHz, with native music and a closing that varies from 2330-2338. This new frequency is being heard in the midwest just prior to closing.

Sweden—*R. Sweden*, Stockholm, has this new English schedule: to Europe at 1100-1130 on 9625 kHz and 2045-2115 on 6065 kHz. To the Middle East at 1600-1630 on 21,585 kHz and 1900-1930 on 21,690 kHz. To the Far East at 1230-1300 on 15,310 kHz, 2045-2115 on 11,915 kHz and 2245-2315 on 15,445 kHz. To Africa at 1230-1300 on 21,675 kHz and 1900-1930 on 15,240 kHz. To Asia at 1400-1430 on 21,585 kHz and 0515-0545 on 17,845 kHz. To N.A. at 1100-1130 on 15,240 kHz, 1400-1430 on 17,760 kHz and 0030-0100 and 0200-0230 on 15,275 kHz. To N.A., (western areas) at 1600-1630 on 15,310 kHz and 0330-0400 on 11,705 kHz. To South America at 2245-2315 on 11,705 kHz. The 15,275-kHz signal is being widely reported in the U. S. with good signals.

Switzerland—Transmissions from Berne to N.A., according to the newest schedule, are at 0130, 0230 and 0330 on 15,305, 11,715 and 9535 kHz and at 0445, 0545 and 0615 on 11,715 and 9720 kHz. The Brazilian transmission in Portuguese is also noted well at times on 15,125 kHz from 2315.

Syria—Damascus, 15,165 kHz, evidently has re-scheduled. Noted at s/on just prior to 0300 with guitar IS, then Arabic chants.

Upper Volta—Ouagadougou, 4815 kHz, is heard at good level from 0600 s/on with IS on a balafon, an anthem, then into French with music.

USSR—*R. Kiev*, Ukraine, operates to N.A. at 0430 on 15,390 kHz. *R. Vilnius* (Lithuanian SSR), 17,740 kHz, has English as noted from 2240-2300 s/off with mostly talks. This is on Friday and Sunday only. *R. Yerevan*, Armenian SSR, has issued a verification showing 17,800 and 15,125 kHz

September, 1968

IT COSTS ONLY
1/100 OF 1¢ MORE
PER SOLDER JOINT
TO KNOW YOU ARE USING THE
WORLD'S FINEST CORED SOLDER



New Easy
Dispenser
Pak
60/40
18 S.W.G.

Latest PC
(Printed
Circuit) Pak
60/40 Extra Thin
22 S.W.G.—.028"

each only 69¢ per package at your dealer

ERSIN **Multicore** FIVE-CORE SOLDER

MULTICORE SALES CORP., WESTBURY, N.Y. 11590
CIRCLE NO. 23 ON READER SERVICE PAGE



LOOK! A NEW ELECTRONICS SLIDE RULE
WITH COMPLETE INSTRUCTION COURSE

Professional 10" all-metal Electronics Slide Rule. Designed specifically for technicians, engineers, students, hobbyists. Has special scales not found on any other rule. Enables you to solve electronics problems quickly, accurately. Made to our rigid specs by Pickett, Inc. Slide Rule plus four lesson AUTO-PROGRAMMED Instruction Course with grading service, and top-grain leather carrying case . . . a \$50 value for less than \$25! Send coupon for FREE booklet. Cleveland Institute of Electronics, Dept. PE-148, 1776 E. 17th St., Cleveland, Ohio 44114.

SEND COUPON FOR FREE BOOKLET

Cleveland Institute of Electronics

1776 E. 17th St., Dept. PE-148,
Cleveland, Ohio 44114



Please send FREE Electronics Slide Rule Booklet. SPECIAL BONUS: Mail coupon promptly and get FREE Pocket Electronics Data Guide, too!

GET THIS FREE!

NAME _____ (Please Print)
ADDRESS _____ COUNTY _____
CITY _____ STATE _____ ZIP _____

A leader in Electronics Training . . . since 1934
CIRCLE NO. 10 ON READER SERVICE PAGE

FREE

RADIO-TV ELECTRONICS

BA

69

ANNUAL CATALOG No. 691

BURSTEIN-APPLEBEE
WITH STORES IN...
KANSAS CITY, MISSOURI
LIVERMORE, CALIFORNIA
SPRINGFIELD, MISSOURI
MARTIN, CALIFORNIA

THE BIG NAME OF THE ELECTRONICS INDUSTRY

QUOTE SERVICE

1978 EAST RIVERSIDE AVENUE, CHICAGO, ILLINOIS 60617
3199 MERCIER ST., KANSAS CITY, MO 64111



GIANT 1969
RADIO-TV
ELECTRONICS
CATALOG
228 GIANT
VALUE-PACKED
PAGES

WRITE FOR YOUR FREE COPY TODAY

BURSTEIN-APPLEBEE CO., DEPT. PEU
3199 MERCIER ST., K. C., MO. 64111

NAME _____

ADDRESS _____

CITY _____ STATE _____ ZIP _____

CIRCLE NO. 5 ON READER SERVICE PAGE

Argos' new speaker technology
creates a genuine
price breakthrough in
two-way system design.

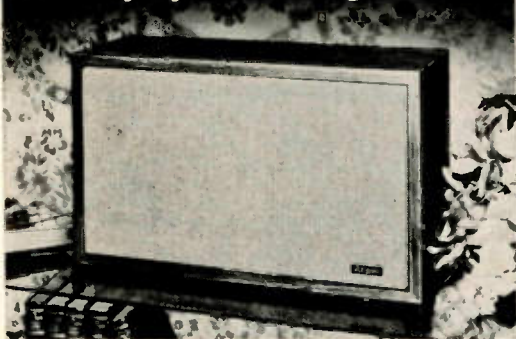

The new Argos TX-200 is a totally new dimension in high fidelity sound reproduction systems—a superb instrument offering fine-furniture construction, big-system performance and compactness for maximum versatility. The TX-200 matches a specially-designed high compliance, low-resonance woofer with a new high-compression horn-loaded driver component to produce distortion-free response from 30 Hz to the inaudibles at 18,000 Hz.

Specifications

Cabinet: Select walnut, Belgian linen grille. Size: 18 3/4" x 11 1/2" x 7 7/8". Price: Audiophile net \$45.00.

Argos

Products Company
Genoa, Illinois 60135

CIRCLE NO. 3 ON READER SERVICE PAGE

in use from 0300-0330, presumably to U. S. West Coast; actual channels, however, are closer to 17,885 and 15,140 kHz. Xmsn days are Tuesday, Friday and Saturday.

Windward Islands—The latest schedule for *Windward Islands B/C Service*, St. Georges, Grenada; to Eastern Caribbean at 1545-1800 on 9550 kHz, 1545-2245 on 5015 kHz and 2155-0215 on 3280 kHz; to Jamaica at 1545-1800 on 15,105 kHz, 1545-2245 (no frequency given) and 2315-0215 on 11,970 kHz; to British Isles at 1945-2130 on 15,105 kHz (November to February) and 2015-2130 on 21,690 kHz (March to October). Special broadcasts listed at 1445-2000 on 21,515 kHz and 2000-2130 on 15,100 kHz. Also listed: Grenada, 535 kHz, 500 W; Carriacou, 1045 kHz, 25 W; Dominica, 695 kHz, 500 W; St. Vincent, 705 kHz, 500 W; Chateaubelair, 1535 kHz, 25 W; and St. Lucia, 1575 kHz, 250 W.

73, Hank. WPE2FT/W2PNA

SHORT-WAVE CONTRIBUTORS

- Michael Collins (WPE1GFG), Stratford, Conn.
- Conrad Baranowski (WPE1GAX), Boston, Mass.
- Henry Michalenka (WPE1HBY), Central Falls, R. I.
- Bruce Millar (WPE1HFE), Goshen, Conn.
- John Kiernan (WPE2EMN), New York, N. Y.
- Eric Linden (WPE2JFY), Jackson Heights, N. Y.
- Robert Holbrook (WPE2LQP), Plattsburg, N. Y.
- Al Sauerbier (WPE2NDA), Washington, N. J.
- Peter Macinta (WPE2ORB), Kearny, N. J.
- Morey Goldstein (WPE2PGR), East Meadow, N. Y.
- William Cangemi (WPE2PII), Staten Island, N. Y.
- Andy Kodau (WPE2PRX), Hewlett, N. Y.
- Robert Kozlarek (WPE2QDX), North Arlington, N. J.
- Michael Spengler (WPE2QFB), Englewood, N. J.
- Tom Shultz (WPE2QJJ), Cherry Hill, N. J.
- Robert Nagle (WPE3DIX), Allentown, Pa.
- George Sprout (WPE3GMW), Reading, Pa.
- Clark Turner (WPE3HKC), Wyoming, Pa.
- Teddy Toczek, Jr. (WPE3HNP), Allentown, Pa.
- John Cobb (WPE4AJ), Cartersville, Ga.
- Grady Ferguson (WPE4BC), Charlotte, N. C.
- Glenn Little (WPE4IYC), Somewhere in Jamaica
- Baine Keel (WPE4JGL), College Park, Ga.
- Ray Bacon (WPE5BFU), Baton Rouge, La.
- John Le Jeune, III (WPE5EWE), Belle Chasse, La.
- Stewart MacKenzie (WPE6AA), Huntington Beach, Calif.
- Don Kenney (WPE6AET), Santa Monica, Calif.
- Terrill Coker (WPE6GOV), Long Beach, Calif.
- Paul Farmanian (WPE6GVG), Glendale, Calif.
- Artbur Blair (WPE6GXV), San Francisco, Calif.
- Sherman Wing (WPE6HBI), Hanford, Calif.
- Eric Hansen (WPE6HBT), Selma, Calif.
- Robert White (WPE6HBZ), San Francisco, Calif.
- Bruce Smith (WPE6HCR), San Diego, Calif.
- Ron Keimers (WPE6HCZ), Cupertino, Calif.
- David Peters (WPE6HDM), Modesto, Calif.
- Steve Lare (WPE6JSS), Holland, Mich.
- Barry Woodyard (WPE6JVP), Norwalk, Ohio
- Carl Miller (WPE6JWE), South Euclid, Ohio
- Richard Pistek (WPE6JOA), Chicago, Ill.
- Zachary Widup (WPE6JYS), Plainfield, Ill.
- Gary Bullinger (WPE6JYZ), Aurora, Ill.
- Clayton Ruth (WPE6JGY), Munster, Ind.
- Fred Lynch (WPE6JHD), Girard, Ill.
- A. R. Niblack (WPE6KAM), Vincennes, Ind.
- John Beaver, Sr. (WPE6OAE), Pueblo, Colo.
- John Allen (WPE6DXW), Pueblo, Colo.
- Rob Harrington (WPE6FDL), Englewood, Colo.
- Jack Perolo (PY2PE1C), Sao Paulo, Brazil
- David Alpert, Morton Grove, Ill.
- Leo Alster, Rahway, N. J.
- David Berg, Buzzards Bay, Mass.
- Gerry Dexter, Lake Geneva, Wis.
- Werner Funkenhauser, Guelph, Ont.
- Steve Harsch, Jackson, Miss.
- Kenneth Hillis, Casper, Wyo.
- Mike Manry, Houston, Texas
- Bill Mullerbeck, Toronto, Ont.
- Terry Petrarca, Derry, Pa.
- Tim Reske, Ellicott City, Md.
- Thomas Roach, Shaw Heights, S. C.
- Deutsche Welle, Cologne, West Germany
- HCJB, Quito, Ecuador
- Radio Lebanon, Beirut, Lebanon
- Radio Switzerland, Berne, Switzerland
- Radio Sweden, Stockholm, Sweden
- Sweden Calling DX'ers Bulletin, Stockholm, Sweden

ELECTRONICS MARKET PLACE

COMMERCIAL RATE: For firms or individuals offering commercial products or services. \$1.00 per word (including name and address). Minimum order \$10.00. Payment must accompany copy except when ads are placed by accredited advertising agencies. Frequency discount: 5% for 6 months; 10% for 12 months paid in advance.

READER RATE: For individuals with a personal item to buy or sell. 60c per word (including name and address). No Minimum! Payment must accompany copy.

FOR SALE

FREE! Giant bargain catalog on transistors, diodes, rectifiers, SCR's, zeners, parts. Poly Paks, P.O. Box 942, Lynnfield, Mass. 01940.

GOVERNMENT Surplus Receivers, Transmitters, Sniperscopes, Radios, Parts, Picture Catalog 25¢. Meshna, Nahant, Mass. 02908.

R.F. CONVERTERS. World's largest selection. Also CCTV cameras, etc. Lowest factory prices. Catalog 10¢. Vanguard 196-23 Jamaica Ave., Hollis, N.Y. 11423.

TELEPHONE VOICE SWITCH: (LS-500). ACTUATES AUTOMATICALLY AND UNATTENDED ANY TAPE OR WIRE RECORDER. PICTORIAL INSTALLATION INSTRUCTIONS INCLUDED. \$23.75. POST PAID USA, WJS ELECTRONICS, P.O. BOX 1508, LAS VEGAS, NEVADA 89101.

INVESTIGATORS: KEEP IN STEP WITH ADVANCEMENTS IN THE ART OF ELECTRONICS FOR THE PROFESSIONAL. SEND \$1.00 FOR EQUIPMENT BROCHURE. WJS ELECTRONICS, P.O. BOX 1508, LAS VEGAS, NEVADA 89101.

BUG DETECTOR: WILL DETECT AND LOCATE SURREPTITIOUS TRANSMITTING DEVICES IN CONFERENCE ROOMS, HOME AND OFFICES, ETC. WRITE FOR DETAILS. WJS ELECTRONICS, 737 NORTH SEWARD, HOLLYWOOD, CALIF. 90038.

ROCKETS: Ideal for miniature transmitter tests. New illustrated catalog, 25¢. Single and multistage kits, cones, engines, launchers, trackers, rocket aerial cameras, technical information. Fast service. Estes Industries, Dept. 18, Penrose, Colorado 81240.

LOWEST Prices Electronic Parts. Confidential Catalog Free. KNAPP, 3174 8th Ave. S.W., Largo, Fla. 33540.

CRYSTALS . . . largest selection in United States at lowest prices. 48 hr. delivery. Thousands of frequencies in stock. Types include HCG/U, HC18/U, FT-241, FT-243, FT-171, etc. Send 10¢ for catalog with oscillator circuits. Refunded on first order. Jan Crystals, 2400F Crystal Dr., Fort Myers, Fla. 33901.

FREE ELECTRONICS (new and surplus) parts catalog. We repair multimeters. Bigelow Electronics, Bluffton, Ohio 45817.

TREASURE Hunters! Prospectors! Relco's new instruments detect buried gold, silver, coins. Kits, assembled models. Transistorized. Weighs 3 pounds. \$19.95 up. Free catalog. Relco-A33, Box 10836, Houston, Texas 77018.

DIAGRAMS—Radios \$1.50, Television \$3.00. Give make and model. Diagram Service, Box 1151PE, Manchester, Conn. 06042.

EUROPEAN and Japanese bargain catalogs. \$1 each. Dee, 10639E Riverside, North Hollywood, Calif. 91602.

INVESTIGATORS, FREE BROCHURE, LATEST SUBMINIATURE ELECTRONICS SURVEILLANCE EQUIPMENT, ACE ELECTRONICS, 11500-L NW 7TH AVE., MIAMI, FLA. 33168.

TRANSISTORIZED CONVERTER KITS: Two models, converts car radio. Receive 30-50mc or 100-200mc (one mc tuning) \$5.00 with simple instructions. Crystal \$2.50. Meshna, No. Reading, Mass. 01864.

MECHANICAL, Electronic devices catalog 10¢. Greatest Values—Lowest Prices. Fertik's, 5249 'D', Philadelphia, Pa. 19120.

MUSIC LOVERS, CONTINUOUS, UNINTERRUPTED BACKGROUND MUSIC FROM YOUR FM RADIO, USING NEW INEXPENSIVE ADAPTOR. FREE LITERATURE. ELECTRONICS, 11500-Z NW 7th AVE., MIAMI, FLORIDA 33168.

NEW Sensitive Treasure Metal Detectors. New low prices. Professional models from \$29.95 to \$129.50. Write for free catalog today. Jetco Electronics, Box 132-E, Huntsville, Texas 77340.

GENERAL INFORMATION: First word in all ads set in bold caps at no extra charge. Additional words may be set in bold caps at 10c extra per word. All copy subject to publisher's approval. Closing Date: 1st of the 2nd preceding month (for example, March issue closes January 1st). Send order and remittance to: Hal Cymes, POPULAR ELECTRONICS, One Park Avenue, New York, New York 10016.

JAPANESE or EUROPEAN DIRECTORY 200 firms \$1.00. **SURVEILLANCE EQUIPMENT,** Catalog 25¢. Wireless **SNOOPERMIKE** \$25.00. **SUBMINIATURE** 3/8 x 3/8 x 3/16 \$4.00. **SIERRATRONICS,** Box 7497, Las Vegas, Nev. 89101.

WE SELL CONSTRUCTION PLANS. TELEPHONE: Answering Machine, Speakerphone, Carphone, Phonevision, Legal Connector, Auto Dialer, Central Dial System. **TELEVISION:** \$35.00 Color Converter, Tape Recorder, 3DTV, \$25.00 Camera. **DETECTIVE:** Infinity Transmitter, Tail Transmitter, Police Radar Detector. **HOBBYIST:** Electron Microscope, 96 Hour Tape Music System, Ultrasonic Dishwasher, Radar-Oven, Electronic Tranquillizer. Plans \$4.95 each. **COURSES:** Telephone Engineering \$39.50, Detective Electronics \$22.50, Anti-Detective Electronics \$27.50. **SUPER HOBBY CATALOG** 25¢. Don Britton Enterprises, 7906 Santa Monica Blvd., Hollywood, Calif. 90046.

CIRCUIT Boards, Parts for "Poptronics" projects. Free catalog. S.W. Technical, Box 16297, San Antonio, Texas 78216.

SURVEILLANCE COUNTERMEASURES BROCHURE \$1.00. ENGINEERING LABORATORIES, BOX 1036, ANDERSON, INDIANA 46015.

WEBBER LAB's. Police & Fire Converters. Catalog 10¢. 72 Cottage Street, Lynn, Mass. 01905.

ELECTRONIC Ignition, various types. Free literature. Anderson Engineering, Epsom, N.H. 03239.

PROXIMITY switch. Detects nearness of human body! Free information. Claremont Products, 860 Reed, Claremont North, Calif. 91711.

RADIO—T.V. Tubes—33¢ each. Send for free catalog. Cornell, 4213 University, San Diego, Calif. 92105.

SONAR Monitor Receivers unsurpassed. Fire, police, ambulance, taxi, highway patrol communications, exceptional values. Griffin's, 322 West State, Ithaca, N.Y. 14850.

REGULATED Power Supply Range 3.6V to 18V 5A short circuit protection with schematic \$9.95. 115VAC 1000W photocell units \$4.95. Alpatronics, 14251 East Colfax, Aurora, Colorado 80010.

WHOLESALE COMPONENTS: Manufacturers and distributors only. Request free catalog on business letterhead. WESCOM, Box 2536, El Cajon, California 92021.

CONVERT any television to sensitive, big-screen oscilloscope. Only minor changes required. No electronic experience necessary. Illustrated plans, \$2.00. Relco-A33, Box 10563, Houston, Texas 77018.

TELEVISION CAMERA KITS! Wide selection tube and transistor models. Starter kits, \$18.95 up. Complete kits \$149.50 up. Plans available separately; tube camera \$3.00, transistor camera \$5.00, TV station \$1.00, ATV literature anthology \$2.50. Catalog **FREE.** **ATV RESEARCH,** 13th & Broadway, Dakota City, Nebraska 68731.

THOUSANDS and thousands of types of electronic parts, tubes, transistors, instruments, etc. Send for Free Catalog. Arcturus Electronics Corp., MPE, 502-22nd St., Union City, N.J. 07087.

RECTIFIERS, transistors, other components. Catalog free. Electronic Components Co., Box 2902C, Baton Rouge, La. 70821.

JAPAN DIRECTORY. Electronics products and parts. General merchandise and Asia trade information. Just \$1.00 today. Ippano Kaisha Ltd., Box 6266, Spokane, Washington 99207.

ELECTRONIC PROPERTY PROTECTOR. Walloping 1200 volt shock from 6 volt battery. No battery drain until touched. Non-lethal. Protects property for months on one battery. \$5.95. Catalog of interesting projects, plans, kits, free. Franks Scientific Co., P.O. Box 156, Martelle, Iowa 52305.

CONTROL panels, name plates, labels. Modernize your electronic equipment with a professional anodized aluminum plate made to your specifications. Send for sample. Prereppo, P.O. Box 95, South Willington, Conn. 06265.

ELECTRONICS BARGAINS: Government Surplus, Semiconductors, Tubes, Panel Meters, and Much More. **FREE CATALOG.** Texas Electronics, 3401-B Ross Avenue, Dallas, Texas 75204.

HUGE excess inventory of new components. \$2.00 buys \$25.00 true value of top quality reed switches, diodes, transistors, resistors, rectifiers, capacitors, etc. Send \$2.00 per box to Nale Industries, 2429 University Avenue, St. Paul, Minnesota 55114. Parts sent Parcel Post. Satisfaction guaranteed.

POWER Supply 3-in-1, regulated. For linear-digital integrated circuits. Outputs adjustable 0 to +25 and 0 to -25 volts, at 100 milliamps; and 0 to +9 volts at 1/2 amp. 115 volt a.c. input. \$85.00 assembled. Free literature. Teledata, 3202 Superior Lane, Bowie, Maryland 20715.

BARGAIN FLYER AND SIX NEW RESISTORS—25¢ (stamps or coin). **BIGELOW ELECTRONICS, BLUFFTON, OHIO 45817.**

DIAGRAMS, Parts List, Etc.—TV \$2.00. Radio, CB, Hi-Fi, Etc. \$1.00. Airmail. Evergreen Electronics, P.O. Box 2233, Everett, Washington 98201.

NEW BSR record changers—\$13. Garrards—\$22. Radio-phonos stereo receivers—\$15. "Changers PE", 2737 3rd Ave., Bronx, N.Y.

AUTOMOTIVE BURGLAR ALARM, Eliminates outside switches, drilling, false triggering; **AUTOMINDER,** 4480 Broadview Road, Cleveland, Ohio 44109.

CB EQUIPMENT and ACCESSORIES. All makes, Transceivers, Antennas, Crystals, Mikes, etc. Lowest Prices, Write for Price Quote. Evergreen Electronics, P.O. Box 2232, Everett, Washington 98201.

LINEAR AMPLIFIERS: "Hornet" 50 watts output—\$98.50; "Raider" 100 watts—\$139.50; "Maverick-250"—250 watts—\$244.95. AM and SSB. "Bandit II"—12 V. Mobile Amplifier—\$169.95. Frequency range 20-35 megacycles (illegal for class D 11 meters.) Dealer inquiries invited. D & A Manufacturing Co., 1217 Avenue C, Scottsbluff, Nebraska 69361.

SECURITY AND PRIVACY PROTECTION DEVICES. FREE DATA: SECURITY ELECTRONICS PE, 15 EAST 43RD STREET, NEW YORK, N.Y. 10017.

PLANS AND KITS

BEGINNERS Allwave \$5.00, Two Band \$5.00, F-M Tuner Chassis \$10.00, Headset \$2.50, Two Band Wired \$10.00. Ekeradio, Box 131, Temple City, Calif. 91780.

CONNECT EXTENSION TELEPHONE(S), maintain (or insert) ring—undetectable, inexpensive. Detailed plans \$1.95. Eilin, 161 Bonad, Chestnut Hill, Mass. 02167.

BUILD-IT-YOURSELF. Save big dollars. Transistor stereo amplifiers. Color organs. Speakers. Write Workshop, Box 87, Bethpage, New York 11714.

16 TESTED TRANSISTOR PLANS—25¢. "Radio Operator's Handbook" 50¢. Catalog. Laboratories, 12041-L Sheridan, Garden Grove, Calif. 92640.

SHORT PROOF power supply—0.05 ohm ohmmeter—power diode curves. Use your Battery Eliminator/Charger and new **E/I CONTROLLER!** Plans \$3.50. Kits. **ALSYNCO,** Dept. (PE-82), 171 S. Main, Natick, Mass. 01760.

INTEGRATED CIRCUIT KITS; COMPUTER CIRCUIT KITS; Others. New catalog free. **KAYE ENGINEERING,** Box 3932-A, Long Beach, California 90803.

HOBBY experimenter kit makes 20 different kits, Universal Dist. Co., Box 156, Flatbush Sta., Brooklyn, New York 11226.

50 WATT CW TRANSMITTER PLANS, very good, inexpensive to build, Crystal or VFO. \$2.00. Bert Dawson, 304 3rd Street, Eau Claire, Wis. 54701.

HIGH FIDELITY

FREE! Send for money saving stereo catalog #P9E and lowest quotations on your individual component, tape recorder, or system requirements. Electronic Values, Inc., 200 W. 20th St., New York, N.Y. 10011.

HI-FI Components, Tape Recorders, at guaranteed "We Will Not Be Undersold" prices. 15-day money-back guarantee. Two-year warranty. No Catalog. Quotations Free. Hi-Fidelity Center, 239 (P) East 149th Street, New York 10451.

LOW, Low quotes: all components and recorders. HiFi, Roslyn, Penna. 19001.

TAPE RECORDERS, Hi-Fi, components, Sleep Learning Equipment, tapes. Unusual Values Free Catalog. Dressner, 1523R, Jericho Turnpike, New Hyde Park, N.Y. 11040.

ACOUSTIC RESEARCH products now available to citizens of foreign countries, overseas personnel, diplomats, government employees, etc. Write for full product and dealer information, **AR INTERNATIONAL,** Dept. PE, 24 Thorndike St., Cambridge, Mass. 02141.

CLASSIFIED ADVERTISING ORDER FORM

Please refer to heading on first page of this section for complete data concerning terms, frequency discounts, closing dates, etc.

1	2	3	4	5
6	7	8	9	10
11	12	13	14	15
16	17	18	19	20
21	22	23	24	25
26	27	28	29	30
31	32	33	34	35

Words { @ 60¢ (Reader Rate) } = \$ _____
 { @ \$1.00 (Commercial Rate) }

Insert _____ time(s) Total Enclosed \$ _____

NAME _____

ADDRESS _____

CITY _____ STATE _____ ZIP _____

Signature _____

WORD COUNT: Include name and address. Name of city (Des Moines) or of state (New York) counts as one word each. Zip Code numbers not counted. (Publisher reserves right to omit Zip Code if space does not permit.) Count each abbreviation, initial, single figure or group of figures or letters as a word. Symbols such as 35mm, COD, PO, AC, etc., count as one word. Hyphenated words count as two words. PE 968

WANTED

CASH Paid! Unused tubes, electronic equipment. Barry, 512 Broadway, NYC 10012.

QUICKSILVER, Platinum, Silver, Gold, Ores Analyzed. Free Circular. Mercury Terminal, Norwood, Mass. 02062.

CASH for terminals—red, blue, yellow. **HALCAP**, Box 19183, Houston, Texas 77024.

SEEKING inexpensive small electronic item suitable for my new mail order venture. Marcus Electronics, P.O. Box 855, Port Arthur, Texas 77640.

TUBES

TUBES "Oldies", latest. Lists free. Steinmetz, 7519 Maplewood, Hammond, Indiana 46324.

RECEIVING & INDUSTRIAL TUBES, TRANSISTORS. All Brands—Biggest Discounts. Technicians, Hobbyists, Experimenters—Request **FREE** Giant Catalog and **SAVE!** **ZALYTRON**, 469 Jericho Turnpike, Mineola, N.Y. 11501.

TUBE Headquarters of World! Send 10¢ for Catalog (tubes, electronic equipment) Barry, 512 Broadway, N.Y.C. 10012.

RADIO & T.V. Tubes—33¢ each. Send for free list. Cornell, 4213 University, San Diego, Calif. 92105.

DON'T BUY TUBES—Radios TV-Xmitting, special-purpose types until you get our price list! Lowest prices in U.S.A. 5,000 types—Guaranteed Brand New. Send postcard for TV-Special Purpose Price List. **UNITED RADIO COMPANY, P.O. BOX 1000, NEWARK, N.J. 07101.**

TAPE AND RECORDERS

BEFORE Renting Stereo Tapes try us. Postpaid both ways—no deposit—Immediate delivery. Quality—Dependability—Service—Satisfaction—prevail here. If you've been dissatisfied in the past, your initial order will prove this is no idle boast. Free Catalog. Gold Coast Tape Library, Box 2262, Palm Village Station, Hialeah, Fla. 33012.

HI-FI Components. Tape Recorders, at guaranteed "We Will Not Be Undersold" prices. 15-day money-back guarantee. Two-year warranty. No Catalog. Quotations Free. HiFidelity Center, 239 (PT) East 149th Street, New York 10451.

SCOTCH Recording Tapes. Tape Recorders. Catalog 10¢. Tower, Lafayette Hill, Pa. 19444.

RENT STEREO TAPES—75¢ WEEK. CATALOG. ART'S TAPE SERVICE, 1613½ North Mariposa Ave., Hollywood, Calif. 90027.

TAPE transport. NAB recording studio quality. Build yourself for amazingly low cost. Detailed plans \$5.00. Free particulars. Pepke Laboratories, 309-B West 19 Street, New York, N.Y. 10011.

TAPEMATES makes available to you **ALL 4-TRACK STEREO TAPES—ALL LABELS**—postpaid to your door—at tremendous savings. For free brochure write: **TAPEMATES**, 5727 W. Jefferson Blvd., Los Angeles, California 90016.

WHOLESALE—4-8 track **STEREOTAPES**—Car, Home **PLAYERS**—CB, Recorders. **MUSICO**, Box 11045, Montgomery, Alabama 36105.

RENT 4-Track open reel tapes—all major labels—3,000 different—free brochure. Stereo-Parti, 55 St. James Drive, Santa Rosa, Ca. 95401.

STEREO TAPES, Save 30% and up; no membership or fees required; postpaid anywhere U.S.A. Free 70-page catalog. We discount batteries, recorders, tape/accessories. Beware of slogans, "not under-sold", as the discount information you supply our competitor is invariably reported to the factory. **SAXITDNE**, 1776 Columbia Road, N.W., Washington, D.C. 20009.

TAPE RECORDER SALE. Brand new nationally advertised brands. \$10.00 above cost. Amazing discounts on stereo components. Arkay Electronics, 1028-C Commonwealth Avenue, Boston, Mass. 02215.

STEREO TAPE CLUB: Average cost \$3.78—\$4.20. Cartridges, Cassettes, Reels. No minimum monthly purchases. Free brochure—catalog. Star Recordings, Box 1055, El Paso, Texas 79946.

EXCLUSIVE! New **NORELCO** Conference 'Carry-Corder'. Four hour recording on C-120 cassette. Unique accessories. Free data: Security Electronics-PER, 15 East 43 Street, New York, N.Y. 10017.

REPAIRS AND SERVICES

TV Tuners rebuilt and aligned per manufacturers specification. Only \$9.50. Any make UHF or VHF. Ninety day written guarantee. Ship complete with tubes or write for free mailing kit and dealer brochure. **JW Electronics**, Box 51C, Bloomington, Indiana 47401.

SPEAKER REPAIR. Hi-Fi, guitar, organ speakers reconed good as new at fraction of new speaker price. For details and reconing center in your area write: **Waldom Electronics, Inc.**, Dept PE, 4625 W. 53rd St., Chicago, Ill. 60632.

CHASSIS: All types and sizes. Will build to your specifications. Phone 307-532-5752. **A & T Manufacturing, Inc.**, 1902 West C., Torrington, Wyoming 82240.

PRINTED CIRCUIT BOARDS, made to order. **STAFFORD ELECTRONICS**, 427 South Benbow Road, Greensboro, N.C. 27401.

TV AID send symptoms, make, model chassis number. Individual diagnosis \$5.00. **TELAID**, Box 16, Middletown, DE. 19709.

PERSONALS

INVESTIGATORS, FREE BROCHURE, LATEST SUBMINIATURE ELECTRONIC SURVEILLANCE EQUIPMENT. **ACE ELECTRONICS**, 11500-K NW 7th Ave., MIAMI, FLA. 33168.

MAKE FRIENDS WORLDWIDE through international correspondence. Illustrated brochure free. **Hermes**, Berlin 11, Germany.

FREE Catalog low priced, high performance subminiature listen-in devices direct from manufacturer. Dealers welcome. **Audiotronix-E**, 156 Fifth Avenue, New York, N.Y. 10010.

INSTRUCTION

LEARN While Asleep, hypnotize with your recorder, phonograph. Astonishing details, sensational catalog free! **Sleep-Learning Association**, Box 24-ZD, Olympia, Wash. 98501.

LEARN ELECTRONIC ORGAN SERVICING at home all makes including transistor. Experimental kit—trouble-shooting. Accredited **NHSC**, Free Booklet. **NILES BRYANT SCHOOL**, 3631 Stockton, Dept. A, Sacramento, Calif. 95820.

ASSOCIATE Degree In Electronics Engineering earned through combination correspondence-classroom educational program. Free brochure. **Grantham Technical Institute**, 1505 N. Western Ave., Hollywood, Calif. 90027.

FCC First Class License in six weeks—nation's highest success rate—approved for Veterans Training. Write **Elkins Institute**, 2603B Inwood Road, Dallas, Texas 75235.

R. E. I.'s famous (5) week course for the first class radio telephone license is the shortest, most effective course in the nation. Over 98% of R.E.I. graduates pass F.C.C. exams for 1st class license. Total tuition \$350.00. Job placement free. Write for brochure **Radio Engineering Incorporated Schools**, 1336 Main Street, Sarasota, Florida 33577—or 3123 Gillham Road, Kansas City, Missouri 64109—or 809 Caroline Street, Fredericksburg, Virginia 22401.

HIGHLY EFFECTIVE home study course in Electronics Engineering Mathematics with circuit application. Earn your Associate in Science Degree. Free Literature. **Cook's Institute of Electronics Engineering**, P.O. Box 36185, Houston, Texas 77036. (Established 1945.)

ART TALENT? Make money right away. A course may not be necessary. Free Brochure. **Famous American Studios**, Spring Park, Minnesota 55384.

FREE! Illustrated brochure on **CARTOONING** and Commercial Art. **Famous American Studios EP**, Spring Park, Minnesota 55384.

FCC LICENSE THROUGH TAPE RECORDED LESSONS. Radio License Training, 1060D Duncan, Manhattan Beach, Calif. 90266.

FCC First Class Phono License in six weeks. \$333.00 complete tuition. Guaranteed. Write **Electronics Institute**, 2202 West Erwin, Tyler, Texas 75701.

RADIO AND TELEVISION REPAIR COURSE, BASIC TEST EQUIPMENT AND INSTRUCTION NECESSARY FOR STARTING PROFITABLE BUSINESS. WRITE **HOOSIER TECHNICAL INSTITUTE**, BOX 88401, INDIANAPOLIS, INDIANA 46208.

INVENTIONS WANTED

INVENTIONS wanted. Patented; unpatented. **Global Marketing Service**, 2420-P 77th, Oakland, Calif. 94605.

PATENT Searches including Maximum speed, full airmail report and closest patent copies, \$6.00. Quality searches expertly administered. Complete secrecy guaranteed. Free Invention Protection forms and "Patent Information." Write Dept. 9, Washington Patent Office Search Bureau, 711 14th Street, N.W., Washington, D.C. 20005.

INVENTORS. We will develop, help sell your idea or invention, patented or unpatented. Our national manufacturer clients are urgently seeking new items for outright cash sale or royalties. Financial assistance available. 10 years proven performances. For free information, write Dept. 41, Wall Street Invention Brokerage, 79 Wall Street, New York N.Y. 10005.

INVENTORS! Outright cash sale or royalties for your inventions. Patented. Unpatented. Active demand from our client manufacturers. Financial assistance available. Write Dept. 35, United States Invention Brokerage, 78 Wall Street, New York, N.Y. 10005.

PATENT SEARCHES \$15.00! FREE "INVENTION RECORD" /Information. Hayward Company, 1029HR Vermont, District of Columbia 20005.

INVENTORS! OUR FREE EXPERT ANALYSIS of your invention can save valuable time, help you realize full sale value. Strictly confidential. **FREE INVENTION CERTIFICATE.** Write today: Pioneer Invention Service, Dept. 35, 150 Broadway, New York, N.Y. 10038.

INVENTORS! Sell your invention for cash or royalties! Our client manufacturers eagerly seek new items. Patented. Unpatented. Financial assistance if needed. 25 years proven performances. For free information, write Dept. 20, Gilbert Adams, Invention Broker, 80 Wall St., New York, N.Y. 10005.

INVENTORS! Don't sell your invention, patented or unpatented, until you receive our offer. Eagle Development Company, Dept. P, 79 Wall Street, N.Y., N.Y. 10005.

MANUFACTURERS NEED NEW ITEMS! Many million-dollar corporations have authorized us to locate new products. Free details regarding development, sale, licensing of your invention. **RAYMOND LEE ORGANIZATION**, 230-GR Park Avenue, New York City 10017. Member: **UNITED STATES CHAMBER COMMERCE.**

QUALITY Patent Searches \$15.00! Preferred by Professional Inventors, Lawyers, Manufacturers. "Confidential Report" Including related United States patent copies "Airmailed Certified." **FREE** information! United States Inventors Service Company, 501-H Thirtieth Street, N.W., Washington, D.C. 20005.

GOVERNMENT SURPLUS

GOVERNMENT Surplus How and Where to Buy in Your Area. Send \$1.00 to: Surplus Information PE, Headquarters Building, Washington, D.C. 20036.

BUY GOVERNMENT SURPLUS Direct. Complete Detailed Booklet With Addresses—\$1.00. Anything—Anywhere. Crider Block and Tile, Box 368, Portsmouth, Ohio 45662. Satisfaction Guaranteed.

JEEPS Typically From \$53.90 . . . Trucks From \$78.40 . . . Boats, Typewriters, Airplanes, Multimeters, Oscilloscopes, Transceivers, Electronics Equipment, Used. 100,000 Bld Bargains Direct From Government Nationwide. Complete Sales Directory and Surplus Catalog \$1.00 (Deductible First \$10.00 Order). Surplus Service, Box 820-J, Holland, Michigan 49423.

BOOKS

FREE catalog 950 aviation/electronic/space books. Aero Publishers, 329PE Aviation Road, Fallbrook, California 92028.

UNUSUAL Books! Catalog free! International, Box 7798(PE), Atlanta, Georgia 30309.

FREE Book. Prophet Elijah Coming Before Christ. Wonderful Bible Evidence. PE Megiddo Mission, Rochester, New York 14619.

FREE Catalogue self help books. Lynne's, Box 1573, Waco, Texas 76703.

FREE CATALOG. BOOKS FOR ADULTS. CATALOG, 2217 LACKLAND, ST. LOUIS, MISSOURI 63114.

MUSIC

POEMS wanted for new songs. Nashville Music Institute, Box 532-E, Nashville, Tennessee 37202.

POEMS, songs wanted for new song hits and recordings by America's most popular studio. Tin Pan Alley, 1650-PE Broadway, New York, N.Y. 10010.

AUTHORS' SERVICES

AUTHORS! Learn how to have your book published, promoted, distributed. **FREE** booklet "ZD," Vantage, 120 West 31 St., New York 10001

MUSICAL INSTRUMENTS

ACCORDIONS, GUITARS, AND INSTRUMENTS! Save to 50%. Terms. Trades. Free Trail. Free catalog. Mention instrument. Music Mart, 5535-PE Belmont, Chicago 60641.

REMAILING SERVICE

GREENUP POSTMARK, 25¢. Burgage, 89 Ohio River Road, Greenup, Ky. 41144.

HYPNOTISM

FREE Hypnotism, Self-Hypnosis, Sleep Learning Catalog! Drawer H400, Ruidoso, New Mexico 88345.

"MALE-FEMALE HYPNOTISM" EXPOSED, EXPLAINED! "SECRET METHOD"—THEY NEVER KNOW! \$2, RUSHED. GUARANTEED! ISABELLA HALL, SILVER SPRINGS, FLORIDA 32688.

SELF-HYPNOSIS for self-improvement. Safe, effective! Free literature. McKinley, Dept. T-4, Box 3038, San Bernardino, California 92404.

HYPNOTIZE MALES, FEMALES! —Unnoticed! Quickly! Nerves! Exciting! \$2.25. Research Enterprises, 29-SN21 Samoset, Woburn, Mass. 01801.

FEMALE, MALE HYPNOTISM!! Easily! Instantly! Secret Nerve Centers! \$2.20. Brugenheimer, Box 158-E30, Lexington, Mass. 02173.

HYPNOTIZE SUCCESSFULLY! "Instantaneous—One Word—Against Will". Methods Exposed! Complete Illustrated course including "Secret Nerve Pressure Technique—Self-Hypnosis"—10" Hypo-Disk. **\$2.00 RESULTS ABSOLUTELY GUARANTEED.** Fowler, Box 4396, Woodbury, N.J. 08096.

SHORTWAVE LISTENING

POLICE—FIRE—AIRCRAFT—MARINE—AMATEUR CALLS on your broadcast radio with **TUNAVERTER!** Tunable and crystal in one! Guaranteed! Free catalog. Salch Co., Woodsboro-PEC, Texas 78393.

SHORTWAVE Listeners DX Guide \$1.75. Limited offer. SWLDXG, P. O. Box 385, Berwick, Penna. 18603.

DRAKE SW-4A. FINEST FOR SWL. WRITE FOR SPECIAL OFFER. HOWARD ALAN INDUSTRIES, 8920 NILES CENTER ROAD, SKOKIE, ILLINOIS 60076.

MAGAZINES

MAGNETS. All types. Special—20 disc magnets, or 2 stick magnets, or 10 small bar magnets, or 8 assorted magnets. \$1.00. Maryland Magnet Company, 5412-H Gist, Baltimore, Maryland 21215.

RUBBER STAMPS

RUBBER ADDRESS STAMP \$1.50. SIGNATURE \$3.50. FREE CATALOG. JACKSON, BOX 443-G, FRANKLIN PARK, ILL. 60131.

THREE LINE. Name, address, zip—\$1.49—Refundable. Staydri, Whitestone, New York 11357.

PHOTOGRAPHY—FILM, EQUIPMENT, SERVICES

MEDICAL Film—Adults Only—"Childbirth"—1 reel 8mm \$7.50—16mm \$14.95. International-E, Greenvale, L.I., New York 11548.

SCIENCE Bargains—Request Free Giant Catalog "CJ"—148 pages—Astronomical Telescopes, Microscopes, Lenses, Binoculars, Kits, Parts. War surplus bargains. Edmund Scientific Co., Barrington, New Jersey 08007.

RECORDS

RECORDS!!! 45rpm—15¢; LP'S \$1.00. Details \$2.00. Records, 129 Carol Avenue, Aberdeen, Maryland 21001.

SPECIAL INTEREST RECORDS AVAILABLE, PRODUCED BY THE EDITORS OF THE WORLD'S LEADING SPECIAL INTEREST MAGAZINES. SEND FOR FREE CATALOG, RECORD CATALOG-PE, ZIFF-DAVIS PUBLISHING COMPANY, ONE PARK AVENUE, NEW YORK, N.Y. 10016.

PLASTICS

CASTOLITE Liquid Plastic pours like water and hardens like glass without heat. Clear, Colors. Embed real flowers, butterflies, photos, coins. Also new molding formulas for perfect reproductions. Illustrated booklet shows **HOW**. Send 25¢—Dept. 68-108K. **CASTOLITE**, Woodstock, Ill. 60098.

EDUCATIONAL OPPORTUNITIES

LEARN WHILE ASLEEP. Miraculously build Mind Power, achieve Self-Confidence, improve Health, gain Success. Method 92% effective. Details free. ASR Foundation, Box 7021EG Henry Clay Sta., Lexington, Kentucky 40502.

PRINTING

FREE LITERATURE: 1000 Address Labels \$1.00, 1000 Business Cards \$4.95. Printing, Rubber Stamps. Jordan's, 552 West O'Connor, Lima, Ohio 45801.

THERMOGRAPHED business cards, \$3.49—1,000, free samples. Gables-4058 Clifton, Glenshaw, Pa. 15116.

REAL ESTATE

FREE . . . New FALL-WINTER CATALOG! Describes and pictures over 2,000 farms, ranches, town and country homes, businesses in 32 states coast to coast! Specify type property and location preferred. Zip code, please. **UNITED FARM AGENCY**, 612-EP West 47th St., Kansas City, Mo. 64112.

STAMPS

SPACEPHOBIA? Monaco Nudes, 50 different, 10¢ with approvals BKJ, Boston, Mass. 02123.

BUSINESS OPPORTUNITIES

INVESTIGATE ACCIDENTS: Earn to \$1000 monthly. Men urgently needed. Car furnished. Business expenses paid. No selling. No college education necessary. Pick own job location. Investigate full time or earn to \$8 hour spare time. Write for **FREE** information. No obligation. Universal Schools, CZ-9, 6801 Hillcrest, Dallas, Texas 75205.

RAISE Rabbits for us on \$500 month plan. Free details. White's Rabbitry, Mt. Vernon, Ohio 43050.

FREE CATALOGS. Repair air conditioning, refrigeration. Tools, supplies, full instructions. Doolin, 2016 Canton, Dallas, Texas 75201.

PIANO TUNING learned quickly at home. Tremendous field! Musical knowledge unnecessary. GI Approved. Information free. Empire School, Miami, Florida 33145.

ELECTROPLATING Equipment and supplies. All types for home workshops and industrial. Send \$1.00 (refundable) for equipment guide formulas, operating data, catalog. HBS Equipment Division 90, 3543 East 16th, Los Angeles, California 90023.

I MADE \$40,000.00 Year by Mailorder! Helped others make money! Start with \$10.00—Free Proof. Torrey, Box 318-N, Ypsilanti, Michigan 48197.

\$200.00 DAILY In Your Mailbox! Your opportunity to do what mail-order experts do. Free details. Associates, Box 136-J, Holland, Michigan 49423.

FREE Book "990 Successful little-known Businesses." Work home. Plymouth 245J, Brooklyn, N.Y. 11218.

SELL LIFETIME. Metal, Social Security Plates. Big profits! Sample and Sales Kit Free. Russell, Box 286-PE, Pulaski, Tennessee 38748.

SELL HERTEL BIBLES—Part Time. Finest reference Bible available. Demonstrator and supplies furnished. Excellent commissions. Write International Book, Dept. PE, Box 118, Wichita, Kansas 67201.

SILVER—STRIKE IT RICH! Earnings unlimited reclaiming pure bullion silver from photographic developing solutions. Be first in your area. Rush \$3.00 for step-by-step instructions. Associated Ag. Processors, 210-H Fifth Avenue, New York City 10010.

Buy 10 PAKS & CHOOSE 1 FREE

- \$25 SURPRISE PAK: transistors, rect. diodes, etc. ... \$1
- 5 ONE AMP 800 PIV RECTIFIERS, silicon top hat \$1
- 10 KODAK LENSES, convex, piano, etc. Hobby must \$1
- 50 GERMANIUM GLASS DIODES, 1N34, 1N48 no test \$1
- 40 TOP HAT SILICON RECTIFIERS, no test/asst values \$1
- 25 EPOXY RECTIFIERS, silicon asst. no test \$1
- 40 PRECISION RESISTORS, 1/4-2W, 1% asst values .. \$1
- 30 TRANSISTORS, rf, if, audio, osc, no test \$1
- 60 TUBULAR CONDENSERS, to .05mf to 1KV, asst \$1
- 50 DISC CONDENSERS, to .05mf p.p.s., temp coef, asst \$1
- 60 TUBE SOCKETS, receptacles, plugs, audio, etc. ... \$1
- 30 POWER RESISTORS, to 25 watts, to 21K ohms \$1
- 3 2N3568 NPN TRANSISTORS, 200me, 200V, 200hfe. \$1
- 3 2N3563 TRANSISTORS, npn, 600me, 100hfe, epoxy \$1
- 10 VOLUME CONTROLS, to 1 meg, switch too! \$1
- 10 ELECTROLYTICS, to 100mf, tubulars too, asst \$1
- 50 RADIO & TV KNOBS, asst'd colors & styles \$1
- 10 TRANS'OR ELECTROLYTICS to 100mf, asst values \$1
- 50 COILS AND CHOKES, if, rf, ant, osc, peaking, etc \$1
- 65 HALF WATTERS, to 1 meg, 5% popular values too \$1
- 60 HI-QUALITY RESISTORS, 1/2, 1, 2W asst values ... \$1
- 10 RCA PHONO PLUGS & JACK SETS, tuners, etc. \$1
- 4 INTEGRATED CIRCUITS, gates, etc. no test \$1
- 2-PC INFRA-RED DETECTOR & FILTER SET science proj \$1
- 2 FIELD EFFECT TRANSISTORS, n channel, hobby \$1
- 50 TERMINAL STRIPS, 1 to 8 lug types \$1
- 3 PHOTO ELECTRIC CELLS, hi. imp., schematic \$1
- 3 TRANS'OR AMPLIFIER, WIRED, 3x2x3/4" schematic \$1
- 10 PRINTED CIRCUIT BOARDS, copper clad, 100 uses \$1
- 10 TRANSISTOR SOCKETS, for npn & npn types..... \$1
- 10 PANEL SWITCHES, toggle, slide, micro, rotary ... \$1
- 5 "SUN" BATTERIES, for 100's of lite sens proj's ... \$1
- 5 RAYTHEON CK-722 TRANSISTORS, npn, most pop \$1
- 5 G.E. 2N107 TRANSISTORS, npn, audio ekts \$1
- 6 "IBM" COMPUTER BOARDS, many trans, diodes, \$1
- 40 "MICRO" CONDENSERS, for transistor circuitry \$1
- 3 14W. EPOXY TRANSISTORS, npn, silicon, B-5000, \$1
- 15 3 to 12 AMP STUD RECTIFIERS, up to 600 PIV \$1

ADD POSTAGE, avg. wt: 1/2 lb. CATALOG 10¢

POLY PAKS

P.O. BOX 942E
LYNNFIELD, MASS.
01940

CIRCLE NO. 25 ON READER SERVICE PAGE

EMPLOYMENT INFORMATION

OVERSEAS Jobs all trades and professions. Free information write: National Employment Service, Box 2235 A.M.F., Miami, Florida 33159.

MISCELLANEOUS

WINEMAKERS: Free illustrated catalog of yeasts, equipment. Semplex, Box 7208, Minneapolis, Minn. 55412.

BILLS PAID WITHOUT BORROWING—Nobody refused up to \$18,000.00. Bad credit no problem—Not a Loan Company. Write for **FREE** application—INTERNATIONAL ACCEPTANCE, Dept. 50A, Phoenix, Arizona 85012—711 14th St., N.W., Washington, D.C. 20005—507 Carondelet St., New Orleans, La. 70130.

EMPLOYMENT Resumes. Get a better job & earn more! Send only \$2.00 for expert, complete Resume Writing Instructions. J. Ross, 80-34 Kent St., Jamaica, N.Y. 11432, Dept. PE.

STOP BURGLARS THE EASY WAY!! Affix authentic "Protected by Electronic Sentry Alarm" Decals to auto windows, doors & windows of home, retail stores, vending machines, etc. Whether you have an alarm or not—thieves stay away! Only \$1.00 each set of two. J. Ross, 80-34 Kent St., Jamaica, N.Y. 11432 Dept. PE.

WATCHES AND CHRONOGRAPHS—Import from Switzerland, save 50%. Color catalog. DFI, West Dennis, Massachusetts 02670.

TEN Winemaking Recipes and Winemaking supplies catalog 10¢. Country Winemaker, Box 191E, RFD 1, Mattapoisett, Mass. 02739.

BEERS, PEACH BRANDY, WINES—Strongest Formulas, \$2.25. (complete brew supplies hydrometers catalog included)—Research Enterprises, 29-D Samoset, Woburn, Mass. 01801.

STAMMER — Stutter — No more. (Dr. Young.) Write Gaucho, Box 9309-EB, Chicago 60690.

E=MC² EXPLAINED, \$1.00. No. 1, 3000 Hatley, Austin, Texas 78746.

TAKE ONE



new literature

To obtain a copy of any of the catalogs or leaflets described below, simply fill in and mail the coupon on pages 15 or 115.

Features, specifications, and prices of professional test equipment for servicing radio, color and monochrome TV, hi-fi, communications, and other types of electronic equipment are detailed in the "B&K Professional Test Equipment Catalog," AP 24. Highlighted is the Model 1450 diagnostic oscilloscope with built-in intermittent analyzer circuit that saves time servicing TV set. Also featured is the Model HV-30 high-voltage tester for measuring picture-tube potentials to 30 kV.

Circle No. 89 on Reader Service Page 15 or 115

A catalog listing the full selection of stock panel meters manufactured by its Precision Meter Division has been issued by *Honeywell Inc.* The 16-page, two-color booklet presents ranges, prices, resistances, photographs, diagrams, and mounting specifications for a.c. and d.c. meters in the 1½", 2½", 3½", and 5" sizes. Designated catalog 35F, this booklet also lists models, sizes, voltages, and prices for elapsed-time indicators, VU meters, etc.

Circle No. 90 on Reader Service Page 15 or 115

A new 12-page booklet, "Can Johnson 2-Way Radio Help Me?" published by the *E. F. Johnson Company*, describes in detail how two-way radio can increase efficiency and cut operating costs on the farm. It tells how to set up a two-radio system on a farm, what kind of equipment is needed, and how the system works. The booklet answers typical questions frequently asked about two-way radio, and it can help an individual to make an informed decision on the practicality of two-way radio.

Circle No. 91 on Reader Service Page 15 or 115

A comprehensive 20-page "full-line" catalog featuring detailed mechanical and electrical specifications for panel meters has been released by the *Triplett Electrical Instrument Company*. Catalog D-68 is perforated for three-ring binders for easy reference storage. Triplett's entire line of panel meters, from d.c. to a.c. to r.f. types, is featured, and information on such meter accessories as a.c. ammeter donut transformers, d.c. ammeter shunts, and overload protection devices are detailed.

Circle No. 92 on Reader Service Page 15 or 115

POPULAR ELECTRONICS SEPTEMBER 1968 ADVERTISERS INDEX

READER SERVICE NO.	ADVERTISER	PAGE NO.
1	Aerotron, Inc	114
2	Allied Radio	125, 126
3	Argos Products Company	118
4	B & K	99
	Bell & Howell Schools	5
5	Burstein-Applebee	118
6	C/P Corporation	8
	CREI, Home Study Division, McGraw-Hill Book Company	88, 89, 90, 91
7	Career Academy	26
8	Cartridge Tape Club of America	112
9	Cleveland Institute of Electronics	18, 19, 20, 21
10	Cleveland Institute of Electronics	117
12	Courier Communications, Inc	23
13	Delwyn	14
14	Dynaco, Inc	16
11	EICD Electronic Instrument Co., Inc	
	FOURTH COVER	
15	Edmund Scientific Co	10
16	Electro-Voice, Inc	111
17	Elpa Marketing Industries, Inc	113
	Grantham School of Electronics	7
18	Graymark Enterprises, Incorporated	102
19	Heath Company	12, 13
	International Correspondence Schools	9
20	Lafayette Radio Electronics	17
21	Maxon Electronics, Inc	11
22	Mosley Electronics, Inc	6
33	Motorola Hep Program	105
23	Multicore Sales Corp	117
	National Radio Institute SECOND COVER, 1, 2, 3	
	National Technical Schools	62, 63, 64, 65
30	Olson Electronics Incorporated	101
24	Pathe Electronics Manufacturing Company	16
25	Poly Paks	123
	RCA Electronic Components & Devices	
	THIRD COVER	
32	RCA Electronic Components & Devices	25
	RCA Institutes, Inc	36, 37, 38, 39
26	Radio Shack	106, 107, 108, 109
27	Sams & Co., Inc., Howard W	27
28	Sonar Radio Corp	103
29	Squires-Sanders, Inc	28
	Classified Advertising 119, 120, 121, 122, 123	

FREE

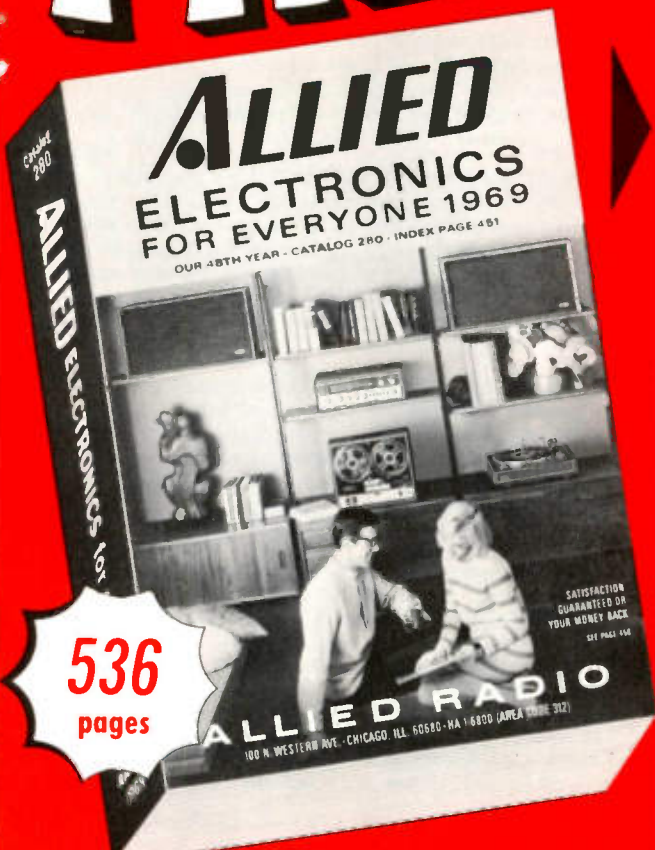

536
pages

New 1969 Allied Catalog

Brand new! Fresh off the press! Allied's 1969 Catalog... 536 fascinating pages jam-packed with the very latest in Hi Fi, Tape Recorders, CB, Kits, Radios, Tools, Electronic Parts, Books. Probably nowhere else on earth will you find such a complete selection of everything in electronics... and virtually all new as tomorrow! Literally thousands of items... many of them never shown before. Allied's all new 1969 Catalog makes wonderful reading... and it's yours absolutely FREE! Tear off the card... mail it in today... and we'll rush you your own personal copy of the newest and most complete book of what's new in electronics... Allied's 1969 Catalog!

NO MONEY DOWN—24 MONTHS TO PAY!
Low Monthly Payments to fit your budget.

DO A FRIEND A FAVOR—give him this card to send for his FREE ALLIED CATALOG

058

fill this card out!

PLEASE PRINT

NAME _____

First Middle Last

ADDRESS _____

CITY _____

STATE _____ ZIP _____

MAIL IT NOW!

free!
ALLIED
1969
CATALOG

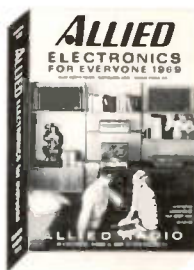

WORLD'S LARGEST SELECTIONS. SATISFACTION
GUARANTEED OR YOUR MONEY BACK

059

fill this card out!

PLEASE PRINT

NAME _____

First Middle Last

ADDRESS _____

CITY _____

STATE _____ ZIP _____

MAIL IT NOW!

free!
ALLIED
1969
CATALOG

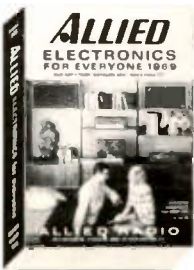

WORLD'S LARGEST SELECTIONS. SATISFACTION
GUARANTEED OR YOUR MONEY BACK

FREE

1969
ALLIED
CATALOG

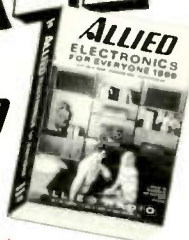

TO:
ALLIED RADIO
P.O. BOX 4398
CHICAGO, ILLINOIS 60680

PLACE
STAMP
HERE



Why Buy by Mail from **ALLIED?**

Because you buy from the
most unique store in the world!

Why do hundreds of thousands of people ... electronics experimenters, music lovers, engineers, Amateur operators, professional radio-TV servicemen, kit builders, hobbyists, hi-fi fans, and just plain "bargain-hunters"... *order tens of millions of dollars* worth of merchandise-by-mail from ALLIED each year?

Variety, selection, price, and quality-testing are the answers! If we can satisfy the experts...we can satisfy you! Our continuous program of quality-testing assures you that everything you buy meets the highest standards. And nowhere else on the face of the earth are so many famous brands (and so many different models of every brand), gathered together to choose from. When it comes to *parts* that both beginners and experts need...ALLIED is the one source that has them *all*.

Thousands and thousands of items to choose from ... and you'll like shopping from ALLIED because you do it in your easy chair. Our entire stock is spread before you, as it could never be in a conventional store. It takes ALLIED over 500,000 square feet of floor-space (with merchandise stacked to the ceiling!), to keep on hand all the items you hold in *one hand* when you pick up an ALLIED catalog.

You never had shopping so good, as when you do it at home with this famous book to guide you. No clerk, no expert, no salesman in all the world could begin to supply you with the wealth of facts, the exact specifications, the comparable data—all at your fingertips in this popular book. Almost anything you may want or need or have an interest in...is pictured, priced, and described in detail. You'll discover things you never knew existed. You'll find bargains unmatched anywhere else you may shop. You'll revel in choices, varieties, and selections beyond imagination. You'll find a whole new way to buy both the commonplace and the rare, the inexpensive and the luxurious.

Best of all—with an ALLIED Credit Fund Account, you pay no money down, and take up to 2 years to pay!

Shop Where the Experts Buy— Choose from the Biggest and Most Fabulous Selection Ever Gathered Together:

- | | | |
|-----------------------------|---------------------------|------------------------|
| STEREO HI-FI | FM, AM & VHF
RADIO'S | TOOLS &
HARDWARE |
| ELECTRONIC
& HOBBY KITS | PORTABLE
TV SETS | BOOKS |
| TAPE RECORDERS
AND TAPES | AMATEUR GEAR | CAMERAS |
| CITIZENS BAND
EQUIPMENT | INTERCOMS | NEEDLES |
| WALKIE-TALKIES | P.A. EQUIPMENT | HEADPHONES |
| SHORTWAVE
RECEIVERS | TEST EQUIPMENT | MICROPHONES |
| PHONOGRAPHS | ANTENNAS | INTEGRATED
CIRCUITS |
| SPEAKERS | TUBES AND
TRANSISTORS | WIRE &
CABLE |
| RECORD CHANGERS | AUTOMOTIVE
ELECTRONICS | PARTS AND
BATTERIES |

FREE

1969
ALLIED
CATALOG

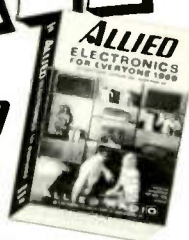

TO:
ALLIED RADIO
P.O. BOX 4398
CHICAGO, ILLINOIS 60680

PLACE
STAMP
HERE



How else but with RCA HI-LITE color picture tubes
can you bring today's color to your customers?

Your service reputation is the cornerstone of your business. That's why there's no room to compromise with quality in the components you install.

RCA HI-LITE picture tubes enable you to offer your customers TODAY'S COLOR... incorporating the latest technology of the world's most experienced picture tube manufacturer. They're the same tubes that go into today's original equipment sets.

RCA's new Perma-Chrome process for rectangular picture tubes, for example, means locked-in color purity from the moment the picture comes on. Faster servicing for you. Added customer satisfaction.

Install an RCA HI-LITE and you literally "up-date" your customer's set while, at the same time, enhancing your service reputation.



RCA

EICO Makes It Possible

Uncompromising engineering—for value does it!
You save up to 50% with Eico Kits and Wired Equipment.



Cortina Stereo

THE VERDICT IS IN. High fidelity authorities agree:

Cortina's engineering excellence, 100% capability, and compact dramatic esthetics all add up to Total Stereo Performance at lowest cost.

NEW



A Silicon Solid-State 70-Watt Stereo Amplifier for \$99.95 kit, \$139.95 wired, including cabinet. Cortina 3070

A Solid-State FM Stereo Tuner for \$99.95 kit, \$139.95 wired, including cabinet. Cortina 3200.

NEW

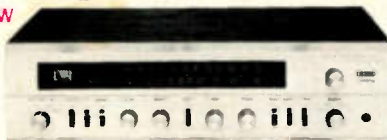

A 70-Watt Solid-State FM Stereo Receiver for \$169.95 kit, \$259.95 wired, including cabinet. Cortina 3570.

NEW Silicon Solid State 150-Watt Stereo Amplifier designed for audio perfectionists. Less than 0.1% harmonic distortion, IM distortion. Less than 0.6% at full output. Controls and inputs for every music source. \$149.95 kit, \$225.00 wired including cabinet. Cortina 3150.

NEW 70 Watt Solid State AM/FM Stereo Receiver for \$189.95 kit, \$279.95 wired including cabinet. Cortina 3770.

Eicocraft

The newest excitement in kits.

100% solid-state and professional.

Fun to build and use. Expandable, interconnectable. Great as "jiffy" projects and as introductions to electronics. No technical experience needed. Finest parts, pre-drilled etched printed circuit boards, step-by-step instructions.

- EC-100 Electronic Siren \$4.95, EC-101 Electronic Burglar Alarm \$6.95,
- EC-102 Electronic Fire Alarm \$6.95, EC-200 Electronic Intercom \$5.95,
- EC-300 Audio Power Amplifier \$5.95, EC-400 Electronic Metronome \$3.95,
- EC-500 Tremolo \$9.95, EC-600 Electronic Light Flasher \$3.95,
- EC-700 Electronic "Mystifier" \$4.95, EC-800 Photo Cell Nite Lite \$4.95,
- EC-900 Power Supply \$8.95, EC-1000 Code Oscillator \$2.50,
- EC-1100 FM Wireless Mike \$9.95, EC-1200 AM Wireless Mike \$9.95,
- EC-1300 Electronic VOX \$8.95, EC-1400 Solid State FM Radio \$9.95,
- EC-1500 Solid State AM Radio \$8.95, EC-1600 Electronic Bongos \$7.95

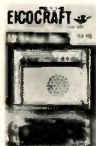

6 EXCITING NEW PROJECTS

- EC-1700 Ham/CB Vox \$8.95,
- EC-1800 Electronic "TOX" \$8.95,
- EC-1900 "Treasure Finder" \$9.95,
- EC-2000 Electronic Organ \$9.95,
- EC-2100 Electronic "Eye" \$9.95,
- EC-2200 Electronic Touch Switch \$8.95

Color n' Sound



Add a new dimension to your music system. Introducing the first inexpensive solid-state electronic system which provides true synchronization of color with sound. Watch the music you love spring to life as a vibrant, ever shifting interplay of colors.

Simply connect to speaker leads of your Hi-Fi system (or radio). Kit can be assembled in several hours — no technical knowledge or experience necessary. Kit \$49.95, Wired \$79.95.

Automotive

EICO 888—Car/Boat Engine Analyzer.

For all 6V/12V systems; 4, 6, 8-cyl. engines.

Now you can keep your car or boat engine in tip-top shape with this solid-state, portable, self-powered universal engine analyzer. Completely tests your total ignition/electrical system.

Complete with a Tune-up & Trouble-shooting Manual. Model 888; \$49.95 kit, \$69.95 wired.

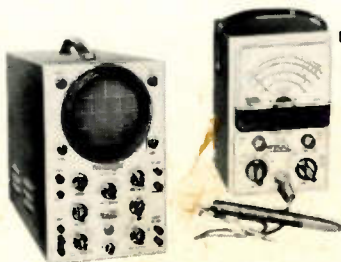

Test Equipment EICO®

100 best buys to choose from.

"The Professionals"
—laboratory precision at lowest cost.

Model 460 Wideband Direct-Coupled 5" Oscilloscope. DC-4.5mc for color and B&W TV service and lab use. Push-pull DC vertical amp., bal. or unbal. input. Automatic sync limiter and amp. \$99.95 kit, \$149.95 wired.

Model 232 Peak-to-Peak VTVM. A must for color or B&W TV and industrial use. 7 non-skip ranges on all 4 functions. With exclusive Uni-Probe.* \$34.95 kit, \$49.95 wired.

FREE 1969 CATALOG

PE-9

EICO Electronic Instrument Co., Inc.
283 Malta Street, Brooklyn, N.Y. 11207

Send me FREE catalog describing the full EICO line of 200 best buys, and name of nearest dealer.

Name _____

Address _____

City _____

State _____ Zip _____