

SWEET 16 HI-FI SYSTEM GOES STEREO

POPULAR ELECTRONICS

JANUARY
1962

35
CENTS

MAC 1

Build "10-8" Police FM Deluxe Converter
PLUS 8 More Construction Projects

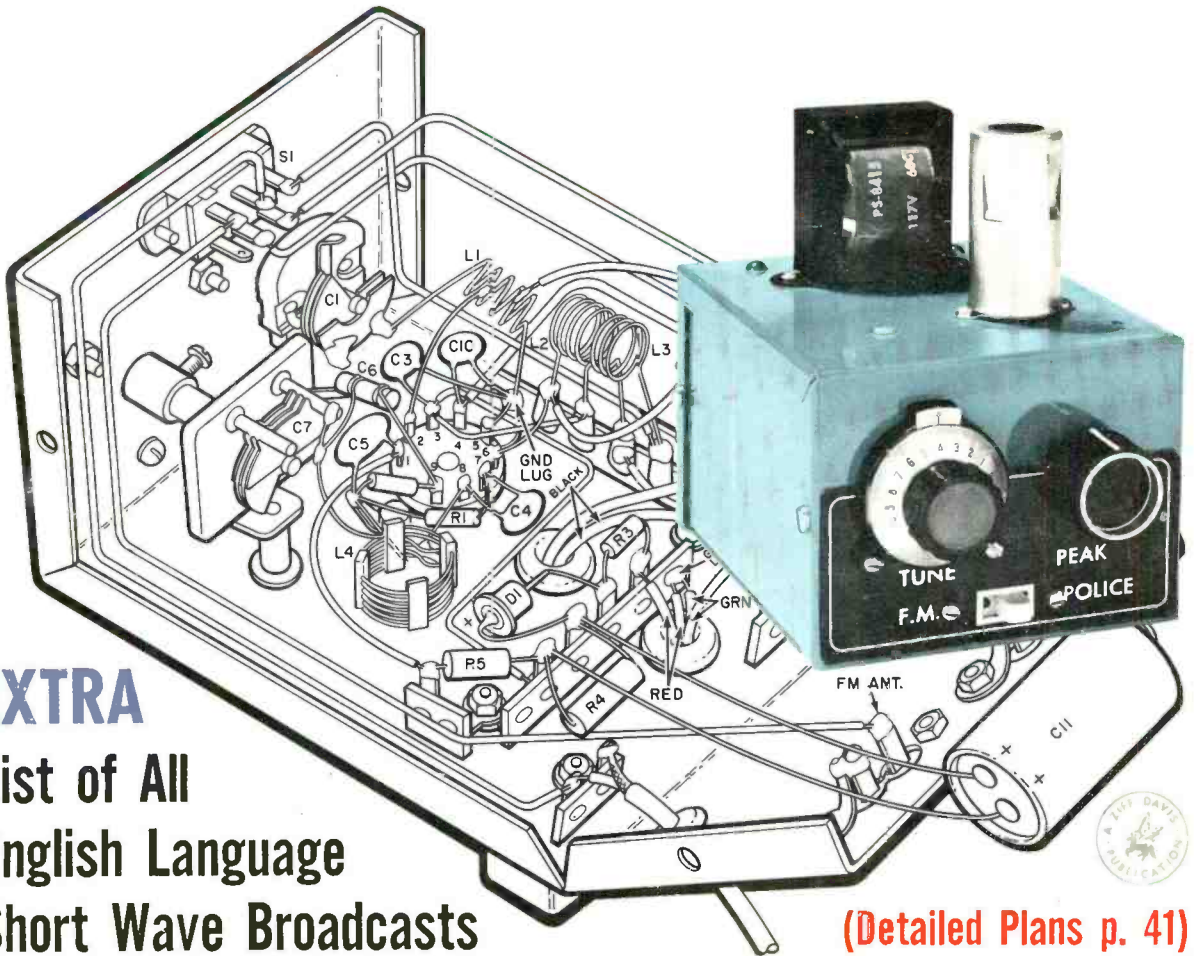

EXTRA
List of All
English Language
Short Wave Broadcasts

(Detailed Plans p. 41)





Personal two-way radio
is serious business. Wherever
you plan to use it, your only
important measures of performance
are ruggedness, reliability
and range. This was our target
in designing the CB-4.
No gadgets, no gingerbread.
Just an extremely dependable 27 Mc.
portable communications system.

littlefone
CB-4
\$89⁹⁵

Power input: 100 MW • Receiver
sensitivity: 1 microvolt • Plug-in
crystals and transistors for easy
channel changeover and service •
Shatter-proof, vinyl-clad aluminum
cabinet • Fully transistorized • Mer-
cury-type battery (not included).



hallicrafters

Quality and Reliability in Communications

Dealers: A limited number of Authorized Hallicrafters Dealerships are available in some territories. See your Hallicrafters distributor, representative, or write to: The Hallicrafters Co., 4401 W. Fifth Ave., Chicago 24, Ill.



RF
GAIN

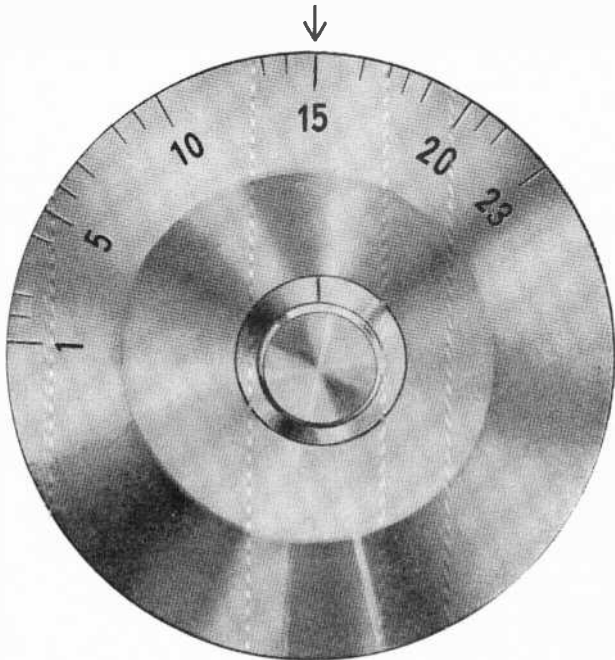

SQUELCH

CB SELECTIVITY?



write for free brochure

\$189.50

Slightly higher west of Rockies

Consider this situation . . . You own the exciting new Courier 1. You're transceiving on Channel 15 from your second floor den. Next door, a CB friend is working his set on Channel 14 with another party. Image response? Ghosting? . . . Never with Courier 1! It's truly selective, has maximum adjacent channel rejection and drift-free receiving! Now, check these other exclusive Courier 1 features . . . see for yourself:

- TRIPLE CONVERSION
- 12 CHANNEL TRANSMITTING
- UNITIZED CHASSIS, HAND-WIRED
- BUILT-IN NOISE LIMITER & SQUELCH
- ELECTRONIC SWITCHING (no relays)
- CADMIUM PLATED FOR MARINE USE
- FULLY MODULATED (100%)
- BUILT-IN "S" & "RF" METER
- LOWEST NOISE FRONT END (NUVISTOR)
- MOBILE OR BASE (117 V AND 12 V)
- ENTIRE UNIT SLIDES OUT ON TRACKS
- OVER 3 WATTS OUTPUT



electronics communications, inc. 325 no. macquesten pkwy, mt. vernon, n. y.

POPULAR ELECTRONICS is published monthly by Ziff-Davis Publishing Company at 434 South Wabash Avenue, Chicago 5, Illinois. **Subscription Rates:** One year United States and possessions, \$4.00; Canada and Pan American Union Countries, \$4.50; all other foreign countries, \$5.00. Second Class postage paid at Chicago, Illinois, and at additional mailing offices. Authorized as second class mail by the Post Office Department, Ottawa, Canada, and for payment of postage in cash. January, 1962, Volume 16, Number 1.

POPULAR ELECTRONICS

JANUARY

1962

VOLUME 16

NUMBER 1



POPULAR ELECTRONICS is indexed
in the Readers' Guide
to Periodical Literature

This month's cover photo by Joe Petrovec
Diagram by Technical Illustrators, Inc.

Special Construction Feature

The "10-8" De Luxe.....*Hartland B. Smith, W8VVD* 41

Electronic Construction Projects

In-Car FM for MPL.....*Walter Robson* 55
The Squarer.....*F. H. Calvert, W9JCV* 58
Flood Life Stretcher.....*W. F. Gephart* 61
TD Power Supply.....*Rufus P. Turner* 72
High-Performance Transmitter.....*Herb S. Brier, W9EGQ* 76

Audio and High Fidelity

Stereo Sixteen Plus Four.....*Jim Kyle, K5JKX/6* 45
Audio Breadboard.....*Art Trauffer* 49
Mike for "Big Ear".....*Art Trauffer* 51
Why Tune By Ear?.....*Rocco J. Carlucci* 54

Theory

Resistor Function Quiz.....*Robert P. Balin* 64
Taking Your Transistor's Temperature.....*Franklin C. Fitchen* 65
Getting to Know the Bypass Capacitor.....*John M. Doyle* 91

Electronic Features and New Developments

Crossword Puzzle.....*Thomas Windser* 60
"Line Blender" for TV Screens..... 71
Hobnobbing with Harbaugh: Just Plain QRM.....*Dave Harbaugh* 74
Transistor Topics.....*Lou Garner* 78
Carl and Jerry: Wired Wireless.....*John T. Frye, W9EGV* 82
Quick-Check Audiometer.....*Hans F. Kutschbach* 95
Wordonics.....*Sgt. V. J. Ambrose* 95

Amateur, CB, and SWL

FCC Report.....*Robert E. Tall* 8
Short Wave for Beginners.....*Hank Bennett, W2PNA* 52
On the Citizens Band.....*Dick Strippl, 2W1452* 69
Across the Ham Bands: ARRL "Novice Roundup".....*Herb S. Brier, W9EGQ* 75
Short-Wave Report: Q-Multiplier and Receiver Kits.....*Hank Bennett, W2PNA* 81
Short-Wave Monitor Certificate Application..... 101

Departments

POP'tronics News Scope..... 6
Coming Next Month..... 14
Hi-Fi Showcase..... 20
Letters from Our Readers..... 28
New Products..... 34
Tips and Techniques..... 38
POP'tronics Bookshelf..... 96

Copyright © 1961 by ZIFF-DAVIS PUBLISHING COMPANY. All rights reserved.

If you can't afford a Fisher tuner...



build one!

Introducing the newest Fisher StrataKit:
the KM-60 FM-Stereo-Multiplex Wide-Band Tuner

Fisher FM tuners have always been reasonably priced considering their unsurpassed sensitivity and matchless overall design—but, even so, not everyone can afford them. If economics have thus far deterred you from buying the very finest, the new Fisher KM-60 StrataKit solves all your problems in exchange for a few evenings of entertaining and instructive work. It incorporates Fisher FM engineering at its most advanced, including built-in Multiplex and sophisticated wide-band circuitry—yet it costs almost one-third less than the nearest equivalent Fisher-built tuner.

This spectacular saving involves absolutely no risk, even if you are 'all thumbs.' The StrataKit method of kit construction has eliminated the difference between the expert technician and a totally unskilled person as far as the end result is concerned. You assemble your StrataKit by easy, error-proof stages (strata), each stage corresponding to a particular page in the Instruction Manual and to a separate transparent packet of parts. Major components come already mounted on the chassis, and wires are pre-cut for every stage—which means every page! You can check your work stage-by-stage and page-by-page, before you proceed to the next stage. There can be no last-minute 'surprises'—success is automatic.

In the KM-60 StrataKit, the front-end and Multiplex circuits come pre-aligned. The other circuits are aligned by you after assembly. This is accomplished by means of the tuner's laboratory-type d'Arsonval signal-strength meter, which can be switched into each circuit without soldering.

The KM-60 is the world's most sensitive FM tuner kit, requiring only 0.6 microvolts for 20 db quieting! (IHFM-standard sensitivity is 1.8 microvolts.) Capture ratio is an unprecedented 2.5 db; signal-to-noise ratio 70 db. The

famous Fisher 'Golden Cascade' RF stage, plus four IF stages and two limiters, must take most of the credit for this spectacular performance and for the superb rejection of all spurious signals. Distortion in the audio circuits is virtually non-measurable.

An outstanding feature of the Multiplex section is the exclusive Stereo Beam, the Fisher invention that shows at a glance whether or not an FM station is broadcasting in stereo. It is in operation at all times and is completely independent of the tuning meter. Stereo reception can be improved under unfavorable conditions by means of the special, switchable subcarrier noise filter, which does not affect the audible frequency range.

Everything considered, the Fisher KM-60 StrataKit is very close to the finest FM tuner that money can buy and by far the finest you can build. Price \$169.50.*

KX-200 80-watt stereo control amplifier StrataKit, \$169.50.*

*Walnut or Mahogany cabinet, \$24.95. Metal cabinet \$15.95. Prices slightly higher in the Far West.

USE THIS COUPON FOR FURTHER INFORMATION

Fisher Radio Corporation
21-52 44th Drive,
Long Island City 1, N. Y.

Please send me without charge the complete
Fisher StrataKit catalogue.

Name _____

Address _____

City _____ Zone _____ State _____



PE113

CREATIVE ELECTRONICS KITS from CONAR



Mail Coupon for
FREE
1962 CATALOG

TEST INSTRUMENTS • STEREO
& MONO HI-FI • HAM RADIO
EQUIPMENT • CITIZEN'S BAND
TRANSCIVERS • TOOLS

CONAR products are low in cost, high in quality and kit-engineered for easy construction. All American-made parts. Performance-tested, approved and **GUARANTEED** by NRI... the first name in Electronics training for half a century. Monthly payment plans.

MAIL TODAY FOR FREE CATALOG

CONAR INSTRUMENTS
3939 Wisconsin Ave., Washington 16, D. C. AA2C

Print Name.....

Address.....

City..... Zone..... State.....

A DIVISION OF NATIONAL RADIO INSTITUTE

the new **23**
S-NINE
all-channel CB
transmitter
with built-in
SWR indicator
is the talk of
the airwaves.

Enjoy a Happy New Year with all new Browning Citizens Band Radio Equipment. Send today for free brochure with full details and specifications.

BROWNING Laboratories, Inc.
104 UNION AVENUE, LACONIA, NEW HAMPSHIRE

POPULAR ELECTRONICS

World's Largest-Selling Electronics Magazine
Net Paid Circulation 387,690

Publisher **PHILLIP T. HEFFERNAN**

Editor **OLIVER P. FERRELL**

Managing Editor **JULIAN M. SIENKIEWICZ, WA2CQL**

Art Editor **JAMES A. ROTH**

Associate Editors **MARC E. FINKEL**

RICHARD A. FLANAGAN

MARGARET MAGNA

Draftsman **ANDRE DUZANT**

Editorial Assistant **MARY ANNE O'DEA**

Editorial Consultant **OLIVER READ, W4TWV**

Contributing Editors **H. BENNETT, W2PNA**

H. S. BRIER, W9EGQ

J. T. FRYE, W9EGV

L. E. GARNER, JR.

D. STRIPPEL, 2W1452

Advertising Manager **WILLIAM G. McROY, 2W4144**

Advertising Service Manager **ARDYS C. MORAN**

ZIFF-DAVIS PUBLISHING COMPANY

Editorial and Executive Office (ORegan 9-7200)
One Park Avenue, New York 16, New York

William B. Ziff, Chairman of the Board (1946-1953)

William Ziff, President

W. Bradford Briggs, Executive Vice President

Hershel B. Sarbin, Vice President and General Manager

M. T. Birmingham, Jr., Vice President and Treasurer

Robert P. Breeding, Circulation Director

Charles Housman, Financial Vice President

Midwestern and Circulation Office (WAbash 2-4911)

434 South Wabash Avenue, Chicago 5, Illinois

Midwestern Advertising Manager **JAMES WEAKLEY**

Western Office (CRestview 4-0265)

9025 Wilshire Boulevard, Beverly Hills, California

Western Advertising Manager **WILLIAM J. RYAN**

Foreign Advertising Representative

D. A. Goodall Ltd., London, England



Member
Audit Bureau of
Circulations

SUBSCRIPTION SERVICE: All subscription correspondence should be addressed to POPULAR ELECTRONICS, Circulation Department, 434 South Wabash Avenue, Chicago 5, Illinois. Please allow at least six weeks for change of address. Include your old address as well as new—enclosing if possible an address label from a recent issue.

EDITORIAL CONTRIBUTIONS must be accompanied by return postage and will be handled with reasonable care; however, publisher assumes no responsibility for return or safety of art work, photographs or manuscripts.

**NOW...GET
EVERYTHING
YOU NEED TO
PREPARE TO EARN
REAL MONEY IN**

ELECTRONICS

**From RADIO • TELEVISION • RADAR
To GUIDED MISSILE CONTROL, etc.**

**One of
Today's
BRIGHTEST
Opportunity Fields!**



Today's great Electronics field offers you a chance of a lifetime to prepare for highly interesting work and a wonderfully promising future! With so many new developments coming up in Electronics, opportunities for trained men were never brighter. Send coupon for details.

Right in your own home you may now get one of today's most interesting . . . **PRACTICAL WAYS** to prepare for a good job or your own business in Electronics. No previous technical experience or advanced education are needed! DeVry Tech brings you a unique **3-WAY COMBINATION** of texts, home movies and real equipment—the same type of basic equipment as found in our well-equipped Chicago and Toronto Laboratories.

EMPLOYMENT SERVICE

. . . helps you get started toward a good job, or toward advancement in the company you now work for. **FREE** to all graduates.

EARN WHILE YOU LEARN

DeVry Tech's practical program helps you to earn **EXTRA MONEY** in your spare time, servicing Radio and TV sets.

Your Guide

to **PROFITABLE JOB OPPORTUNITIES**

See how **YOU** may get ready for Jobs as:

TV-Radio Broadcast Technician
Color Television Specialist
Radar Operator • Laboratory Technician
Air-line Radio Man • Computer Specialist
Quality Control Manager

Your Own Sales & Service Shop...**PLUS MANY OTHERS**

SEND FOR FREE BOOKLET!

"One of North America's Foremost Electronics Training Centers"



Accredited Member
of National Home
Study Council

**DeVRY TECHNICAL
INSTITUTE**

CHICAGO 41, ILLINOIS

E-X-C-L-U-S-I-V-E EQUIPMENT!

As part of your home laboratory projects, you **BUILD** and **KEEP** this fine quality combination 5-inch **COLOR OSCILLOSCOPE** and a Jewel Bearing **VACUUM TUBE VOLTMETER**. You will find this latest DeVry equipment ideal for helping you earn in your spare time while a student—and later when working full time in the field.

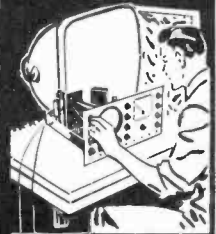

HOME MOVIES

Thanks to this exclusive home training aid, many important fundamentals quickly become "movie clear." Now you can actually see electrons on the march and other "hidden actions"—a wonderful advantage that is almost like having a teacher at your side.



300 EXPERIMENTS

Build over 300 practical projects from many shipments of Radio-Electronic parts. You build and operate TV-Radio circuits . . . wireless microphone . . . and many other major projects—all designed to provide outstanding practical experience at home.



BUILD AND KEEP A BIG 21-INCH TV SET

For added practical experience, you can also build and keep this quality 21-inch TV SET that provides TV reception at its finest (DeVry Tech also offers another home training without the TV set).

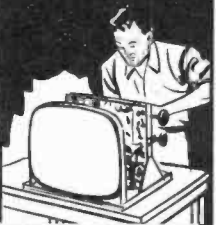

MAIL COUPON TODAY!

DeVry TECHNICAL INSTITUTE

4141 Belmont Avenue, Chicago 41, Ill., Dept. PE-1-S

Please give me your **FREE** booklet, "Electronics in Space Travel," and tell me how I may prepare to enter one or more branches of Electronics.

Name _____ Age _____

Street _____ Apt. _____

City _____ Zone _____ State _____

2046

Canadian residents address: DeVry Tech of Canada, Ltd.
970 Lawrence Avenue West, Toronto, Ontario



◀ **OUT OF THE DARK** come video pictures from the Bendix Corporation's new TV "owl." Their transistorized closed-circuit TV system, which "sees" in the dark, has been adapted to missile surveillance. Using an image orthicon tube, it combines ruggedness with high sensitivity and contrast that can meet strict military requirements. In fact, the "owl" doesn't give a hoot how rugged the surroundings are, and can see in brilliant daylight as well as in the dark of a moonless night. Bendix engineers say the system's optional automatic controls make it easier to operate than most closed-circuit TV equipment, pretty operators notwithstanding.



◀ **NUCLEAR HEDGE-HOPPER**—Computers flying by the seat-of-their-pants are now capable of guiding Republic Aviation's F-105D tactical fighters at "hedge-hopping" altitudes of 500 to 1000 feet. In a recent test flight, the supersonic jet was flown blind on radar instruments, by Col. Paul Hoza of the U.S. Air Force, through the rugged mountain passes of New Mexico and Arizona, just a few hundred feet above the terrain. This flight demonstrated the F-105D's all-weather capability of penetrating enemy territory beneath a radar detection network. No special training was given to Col. Hoza other than that normally given pilots who fly Mach 2 aircraft.

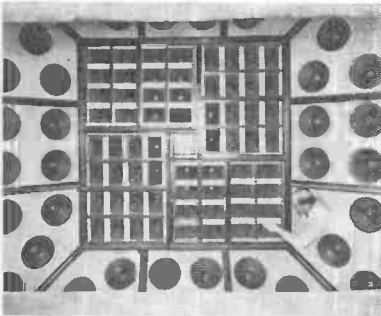

◀ **HI-FI NOISE**—The man peering at the hi-fi speaker system through one of the 48 woofer ports is not an audio addict but a Goodyear engineer checking out the giant acoustic testing facility in Litchfield Park, Arizona. The Goodyear Aircraft Corporation uses the titanic baffle to test the reliability of modern aircraft and missile parts under the enormous stresses and strains of one of nature's underrated but most destructive forces—sound. The giant noisemaker duplicates exactly the awesome sound vibrations of jet and missile engines that can, at 150 decibels, damage or even mutilate a piece of steel. So powerful is the speaker system that a bop phonograph record played into its amplifier will keep Phoenix, 20 miles away, in step with the twist.

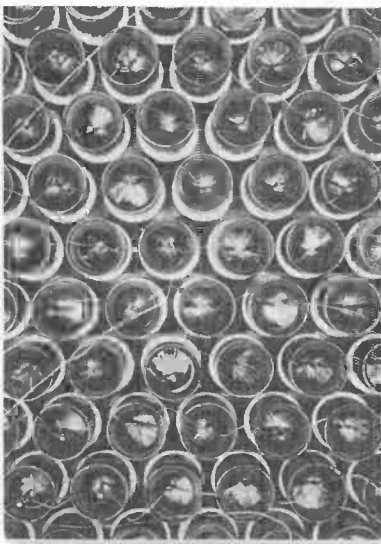

◀ **WHAT IS IT?** Although it looks like a display of trout fishing flies, the photo actually shows the interior of an ozone generator—part of a new six million dollar ozone-oxidation plant put into operation by Emery Industries, Inc. of Cincinnati. Ozone is produced by subjecting oxygen to a high voltage inside of 3-inch glass tubes where a silent electrical discharge converts it to ozone. A unique three-atom molecule, ozone oxidizes oleic acid in producing "unique" acids used in the growing plastics and synthetic lubricant industries.



"a CREI home study program helped me become an electronics engineer"

—Robert T. Blanks

Engineer, Research & Study Division
Vitro Laboratories, Silver Spring, Md.

Division of Vitro Corporation of America



"THROUGH A CREI HOME STUDY PROGRAM I learned the practical theory and technology I needed to become a fully-qualified engineer—not a 'handbook' engineer, either—and I did it while I was on the job," says Robert T. Blanks. Today thousands of advanced electronics personnel—engineering technicians, engineers, administrators, executives—attribute their present high salaries and positions to their home study of CREI Programs in Electronic Engineering Technology.



DEMAND FOR CREI-PREPARED MEN today far exceeds the supply—has exceeded the supply for many years. Specifically designed to prepare you for responsible positions in electronics, CREI Home Study Programs are the product of 35 years of experience, include the latest advancements in the field. CREI's curricula were among the first accredited by the Engineers' Council for Professional Development. Here Blanks discusses CREI with Director Wayne G. Shaffer of Vitro Labs.



WHEN YOU ENROLL IN A CREI Home Study Program, you join more than 20,500 students working in electronics in all 50 states and most countries of the free world. One CREI Program helped Robert Blanks become an Electronics Engineer. Another helped Robert I. Trunnell become an Electronics Technician. While John H. Scofield—a Mathematician—is enrolled in still a different CREI Program relating mathematics to electronics. All work at Vitro Laboratories.



YOUR LIVING IS BETTER when you prepare for—and get—desired promotions through CREI Home Study. CREI alumnus Blanks is understandably proud of his home in a comfortable neighborhood. The positions of CREI-prepared men in such companies as Pan American Airways, Federal Electric Corporation, The Martin Company, Northwest Telephone Company, Mackay Radio, Florida Power and Light and many others attest to the high calibre of CREI Programs.



YOUR WHOLE FAMILY BENEFITS. Engineer Blanks' growing family pitched in to provide free time for his CREI Home Study. Now they share his success. We invite you to check the thoroughness and completeness of CREI Home Study Programs in Electronic Engineering Technology in the catalog provided on request. For those who can attend day or evening classes in person, CREI maintains a Residence School in Washington, D.C. also offering ECPD Accredited Technical Institute Curricula.

INDUSTRY-RECOGNIZED CREI HOME STUDY PROGRAMS PREPARE YOU FOR INCREASED RESPONSIBILITIES, HIGHER-PAYING POSITIONS IN ELECTRONICS.

REQUIREMENTS FOR ENROLLMENT Pre-requisite is a high school education or equivalent plus basic electronics training and/or practical electronics experience. (Electronics experience and/or training not necessary for Residence School.) If you qualify, send for the latest CREI catalog at no cost. Veterans may apply under the G.I. Bill. If you're doubtful about your qualifications, let us check them for you. Mail coupon or send your qualifications to: The Capitol Radio Engineering Institute, Dept. 1201-K 3224 Sixteenth St., N.W., Washington 10, D. C.

Mail coupon today for **FREE 58-page book**

THE CAPITOL RADIO ENGINEERING INSTITUTE

ECPD Accredited Technical Institute Curricula — Founded 1927
Dept. 1201-K, 3224 Sixteenth St., N.W., Washington 10, D.C.

Please send me details of CREI Home Study Programs and Free Book, "Your Future in Electronics and Nuclear Engineering Technology." My qualifications are noted to obtain immediate service.

CHECK FIELD OF GREATEST INTEREST:

<input type="checkbox"/> Servo and Computer Engineering Technology	<input type="checkbox"/> Automation and Industrial Electronic Engineering Technology
<input type="checkbox"/> Electronic Engineering Technology	<input type="checkbox"/> Nuclear Engineering Technology
<input type="checkbox"/> Aero and Navigational Engineering Technology	

Name Age

Address

City Zone State

Employed by

Type of present work

Education: Years High School Other

Electronics Experience

Check: Home Study Residence School G.I. Bill # 5





FCC Report

☆☆☆☆☆ ☆☆☆☆☆☆☆☆☆☆☆☆☆☆☆☆☆☆☆

By **ROBERT E. TALL**
Washington Correspondent

THE INCIDENCE of Citizens Band rule violations of a "technical nature" is not high enough at the moment to induce the FCC to launch a "type-acceptance" program among manufacturers of CB equipment. Some thought has been given to the idea, however, and the agency has cautioned that such a step is "not beyond the realm of possibility."

In offering its views on the subject, the Commission was responding to a number of suggestions that an equipment type-acceptance program—which involves a strict laboratory test of specific models of radio equipment and the manufacturer's guarantee to keep production-line models in con-

formity with the standards of the tested unit—might be one way to weed out technical rule offenders working the Citizens Band.

Several CB equipment manufacturers have voluntarily submitted their units to the FCC for a type-acceptance inspection, and have received the Commission's endorsement. The agency would like to leave it on the voluntary basis, however.

Home-Constructed Units. The Commission has not departed from its position that either factory-assembled models, certified kits, or home-designed or -constructed CB units are all acceptable for use, provided that the equipment is built to specifications to insure its operation consistent with the CB rules, and further, that the home-constructed units are "checked out" by or under the direct supervision of a holder of an FCC first- or second-class radio operator's license before they're put on the air.

The agency warns, however, that its experience since the establishment of the CB service has been that "in general, persons constructing such equipment do so as a hobby and lack not only the necessary construction and test facilities, but the required technical skills as well." In other words, the official government line is that anyone can

(Continued on page 12)

FOR SHARPEST, CLEAREST VOICE TRANSMISSION WITH ANY CITIZENS BAND TRANSCEIVERS, SPECIFY THE TURNER 350C

Even the best citizens band equipment is no better than the microphone it uses. That's why more Turner 350C microphones are used as original equipment in CB than any other. That's why it will pay you to specify the Turner 350C when you buy CB equipment or replace your microphone.

■ The 350C is furnished with an 11" retracted (five foot extended) coiled cord. Hanger button and standard dash bracket are included for mobile rig mounting. Response: 80 to 7000 cps. Output: -54 db. Net price: \$10.08

■ See Turner microphones at your electronic parts distributor or write for complete information and the name of your nearest Turner distributor.



TURNER 254C FOR BASE STATION

Desk type ceramic mike operates by a touch bar off-on switch and lever lock on-off switch. Response: 80-7000 cps. Output: -54 db. Net price: \$14.10.

THE **TURNER** MICROPHONE COMPANY
946 17th Street NE,
Cedar Rapids, Iowa

Do you WISH you were EMPLOYED in ELECTRONICS?

Get Your First Class Commercial F.C.C. LICENSE QUICKLY!

F.C.C. LICENSE—THE KEY TO BETTER JOBS

An F.C.C. *commercial* (not amateur) license is your ticket to higher pay and more interesting employment. This license is Federal Government evidence of your qualifications in electronics. Employers are eager to hire *licensed* technicians.

WHICH LICENSE FOR WHICH JOB?

The **THIRD CLASS** radiotelephone license is of value primarily in that it qualifies you to take the second class examination. The scope of authority covered by a third class license is extremely limited.

The **SECOND CLASS** radiotelephone license qualifies you to install, maintain and operate most all radiotelephone equipment except commercial broadcast station equipment.

The **FIRST CLASS** radio telephone license qualifies you to install, maintain and operate every type of radiotelephone equipment (except amateur) including all radio and television stations in the United States, its territories and possessions. This is the highest class of radiotelephone license available.

GRANTHAM TRAINING PREPARES YOU

The Grantham course covers the required subject matter completely. Even though it is planned primarily to lead directly to a first class FCC license, it does this by **TEACHING** you electronics. Some of the subjects covered in detail are: Basic Electricity for Beginners, Basic Mathematics, Ohm's and Kirchhoff's Laws, Alternating Current, Frequency and Wavelength, Inductance, Capacitance, Impedance, Resonance, Vacuum Tubes, Transistors, Basic Principles of Amplification, Classes of Amplifiers, Oscillators, Power Supplies, AM Transmitters and Receivers, FM Transmitters and Receivers, Antennas and Transmission Lines, Measuring Instruments, FCC Rules and Regulations, and extensive theory and mathematical calculations associated with all the above subjects explained simply and in detail.

OUR GUARANTEE

If you should fail the F. C. C. exam after finishing our course, we guarantee to give additional training at **NO ADDITIONAL COST**. Read details in our free booklet.

Learn by Correspondence or in Resident Classes

Grantham training is offered by correspondence or in resident classes. Either way, we train you quickly and thoroughly---teach you a great deal of electronics and prepare you to pass the F. C. C. examination for a first class license. Get details now. Mail coupon below.

This booklet FREE!

This free booklet gives details of our training and explains what an F. C. C. license can do for your future. Send for your copy today.

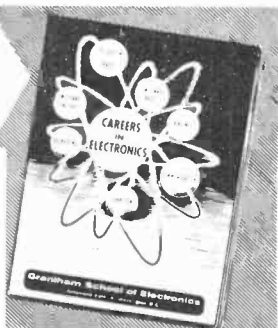

To get ahead in electronics—first, you need the proper training; then, you need “proof” of your knowledge. Your first class commercial F. C. C. license is a “diploma” in communications electronics, awarded by the U. S. Government when you pass certain examinations. This diploma is recognized by employers. Grantham School of Electronics specializes in preparing you to earn this diploma.

Grantham training is offered in resident classes or by correspondence. Our free booklet gives complete details. If you are interested in preparing for your F. C. C. license, mail the coupon below to the School's home office at 1505 N. Western Ave., Hollywood 27, California—the address given in the coupon—and our free booklet will be mailed to you promptly. No charge—no obligation.

Grantham School of Electronics

HOLLYWOOD CALIF.

SEATTLE WASH.

KANSAS CITY MO.

WASHINGTON D. C.

RESIDENT CLASSES HELD IN FOUR CITIES

If you are interested in attending day or evening classes mail the coupon for free information to our home office in Hollywood, Calif.

MAIL COUPON NOW—NO SALESMAN WILL CALL →

(Mail in envelope or paste on postal card)



TO: GRANTHAM SCHOOL OF ELECTRONICS
1505 N. Western Ave., Hollywood, Calif.

Gentlemen:

Please send me your free booklet telling how I can get my commercial F.C.C. license quickly. I understand there is no obligation and no salesman will call.

Name _____ Age _____

Address _____

City _____ State _____

I am interested in: Home Study, Seattle classes

Hollywood classes, Kansas City classes, Washington classes 23A

AUTHENTIC! COMPLETE! MODERN!



DOWN-TO-EARTH TRAINING

that helps you repair any TV or radio set ever made!

Let these two famous training books teach you to handle all types of AM, FM and TV service jobs by approved professional methods—and watch your efficiency and earnings soar! Almost 1500 pages and over 800 clear pictures and diagrams explain EVERY troubleshooting and repair operation as clearly as A-B-C. No needless mathematics. No involved theory. You get straight-from-the-shoulder training of the type that teaches you to do the best work in the shortest time!

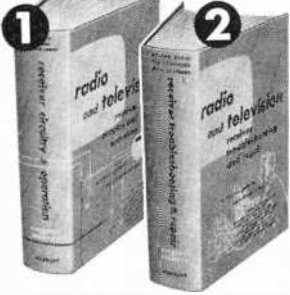

SAVE \$2.00

Make your service library complete! Get both these famous Ghirardi books at a saving of \$2.00 under the regular price. See MONEY-SAVING COMBINATION OFFER in coupon.

1 Complete Training in MODERN CIRCUITS

You can repair ANY radio, TV or other electronic equipment lots easier, faster and better when you're fully familiar with its circuits and know just why and how each one works... and that's exactly the kind of specialized training you get in Ghirardi's 668-page RADIO & TV CIRCUITRY AND OPERATION training guide. It gives a complete understand-

ing of basic modern circuits, then shows what troubles to look for and how to eliminate needless testing and guesswork in servicing them. Throughout, it gives you the above average training that takes the headaches out of troubleshooting and fits you for the best-paid servicing jobs. 417 clear illustrations. Price \$9.00 separately.

2 Complete guide to PROFESSIONAL SERVICE METHODS

RADIO & TV TROUBLESHOOTING AND REPAIR is a complete 822-page guide to professional service methods... the kind that help you handle jobs faster more profitably. For beginners, this giant book with its 417 clear illustrations is an easily understood course in locating troubles fast and fixing them right. For experienced servicemen, it is an ideal way to

develop better methods and shortcuts; or to find fast answers to problems. You learn troubleshooting of all types from "static" tests to dynamic signal tracing methods. Step-by-step charts demonstrate exactly what to look for. A big television section is a down-to-earth guide to all TV service procedures. Price \$10.00 separately.

LEARN ELECTRIC MOTOR REPAIR!



Handle ANY Job from minor repairs to complete rewinding.

It pays to train for something different! ELECTRIC MOTOR REPAIR is a complete guide that helps you cash in on this growing field. Shows how to handle all repair jobs (including complete rewinding) on practically ANY AC or DC motor or generator in common use—from fractional horsepower to giant industrial motors. Special duo-spiral binding brings text and related how-to-do-it diagrams side by side so that you learn fast, easily and right. It's the ideal book whether you want to train for a good-pay motor repair job or simply want to fix motors as a sideline or hobby! 560 pages; over 900 pictures. Price \$9.25.

SHORT CUTS TO TV REPAIRS!



Eliminate needless testing!

Just turn the dial of the pocket-size PIX-O-FIX TROUBLE FINDER GUIDE! When the picture in the PIX-O-FIX window matches the image on the TV screen— presto!—you've got your clue. PIX-O-FIX shows the likely causes of the trouble—indicates the receiver section involved—then gives clear repair instructions. Two PIX-O-FIX units Nos. 1 and 2 cover 48 different TV troubles. Together, they're a comprehensive guide to quick "picture analysis" servicing of any TV. Price only \$3.95 for the two.

CASH IN ON APPLIANCE REPAIRS!



ONLY \$6.75 FOR THE COMPLETE TRAINING

Give service details on: Stoves & automatic washers; irons; toasters; kettles; cleaners; mixers; hot plates; razors; clocks; motors; water heaters; bottle warmers; seafle irons, and many more. Price \$6.75.

Save on repair bills! Earn in spare time!

When you consider the prices charged for electrical appliance repairs these days you'll quickly recognize the tremendous money-making opportunities open to trained men in this literally tremendous field!

At only a small fraction of prices charged for mail-order training courses, this 370-page, low cost book teaches you step-by-step how to repair practically any home electrical appliance. Troubleshooting charts help you locate faults quickly. Book even explains how to make your own inexpensive test tools and trains you in modern appliance refinishing methods. Includes specifications for: Stoves & automatic washers; irons; toasters; kettles; cleaners; mixers; hot plates; razors; clocks; motors; water heaters; bottle warmers; seafle irons, and many more. Price \$6.75.

FIX OLD RADIOS FAST!

Without Useless Testing!



Just look up the how-to-do-it data on that old radio! Four times out of 5, this giant, 3½-pound, 744-page Ghirardi RADIO TROUBLESHOOTER'S HANDBOOK tells what is likely to be causing the trouble... shows how to fix it. No useless testing. Covers every model made by 202 mfrs. from 1925 to 1942. The only guide of its kind still in print. Cuts service

time in half! Includes common trouble symptoms and their remedies for over 4,800 models of old home, auto radios and record changers. Airline, Apex, Arvin, Atwater Kent, Belmont, Bosch, Brunswick, Clarion, Crosley, Emerson, Fada, G-E, Kolster, Majestic, Motorola, Philco, Pilot, RCA, Silvertone, Sparton, Stromberg and dozens more. Price \$10.00.

DIGITAL COUNTERS and COMPUTERS



A good working knowledge of electronic computers may not be as complicated as you think—and this new 248-page book proves it! Written for technicians, students and experimenters it explains computer theory, design, application and output interpretation in readily understandable terms. Includes details on number systems; binary counters; readout indicators and special counter tubes; decade counters; storage devices; logic circuits; computer applications; digital-to-analog and analog-to-digital conversion and many others. By explaining basic circuit configurations, DIGITAL COUNTERS AND COMPUTERS by E. Bukstein, quickly breaks down computer "mysteries" and starts you on a clear understanding of one of the "hottest" subjects in Electronics today! Fully illustrated. Price \$8.75.

SPECIALIZED TRAINING GUIDES!

Complete, Easy-to-Understand!

Each of these famous books is the equivalent of a complete training course in its subject—written for fast, easy understanding—and priced far less than you might ordinarily expect to pay for

such remarkably complete and authentic training. Hundreds of thousands of copies have been sold for home study purposes—because they are so clearly written and so remarkably complete.

Guide to ELECTRONIC TEST PROCEDURES!

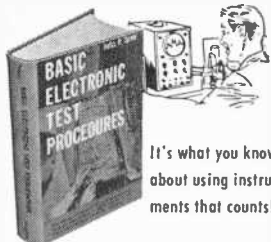

It's what you know about using instruments that counts!

Rufus P. Turner's 316-page BASIC ELECTRONIC TEST PROCEDURES manual with more than 100 illustrations, pattern photos and procedure diagrams teaches you to test any circuit, equipment or component in a fraction of the usual time. It is a complete course in professional testing techniques! For instance, you learn to check for distortion by the 'scope, rejection filter, harmonic distortion meter, wave analyzer or oscillator methods. You learn to measure resistance with a current meter, a volt-ammeter, voltmeter, ohmmeter, or via the bridge method—and so on.

Includes Current checks; measuring Power, Capacitance, Resistance, AP, RF Phase, Distortion & Modulation; testing Tubes and Semiconductors; testing Amplifiers; checking Sensitivity, RF Gain, Fidelity, AVC Voltage, etc. Even includes industrial electronic test procedures. Price \$8.50.

Here's What You Need to Know About SCOPES!

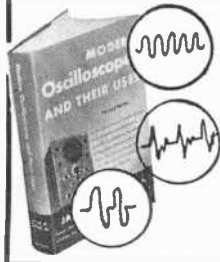

Men who really know how to use oscilloscopes locate troubles faster, repair them more accurately—and this famous manual teaches you the methods they use. In short, MODERN OSCILLOSCOPES AND THEIR USES gets right down to earth in bringing you the complete "know how" of using the handiest, most versatile instrument of them all!

Particular attention is paid to reassignment proce-

dures. Every detail of testing is explained from connecting the scope and setting its controls to adjusting components in the chassis being tested. Illustrated instructions teach you to analyze patterns. Even includes data on quantitative measurements (as used in color TV servicing) and use of 'scopes in industrial electronics and atomic work. 370 illustrations.

Price \$8.75.

NEW! Practical guide to SEMICONDUCTORS



- Diodes
- Transistors
- Thermistors
- Varistors
- Rectifiers
- Photo cells, etc.

PLUS

use, test and measurement data

This down-to-earth, 278-page book gives you a good working knowledge of all commonly used semiconductors. It answers your questions. It makes semiconductor construction, circuit applications and use understandable without a lot of highly technical training. In short Rufus P. Turner's SEMICONDUCTOR DEVICES has been specifically written for technicians, servicemen and experimenters who now find these tiny devices so important in their work. Standard and special types are explained. Over 250 illustrations demonstrate semiconductor circuitry, operational and construction features. Semiconductor test and measurement methods are described in detail. Price \$7.50. Use coupon.

USE COUPON FOR 10 DAY FREE TRIAL

Dept. PE-12, Technical Division, HOLT, RINEHART & WINSTON, Inc., 383 Madison Ave., New York 17, N. Y.

623900

Send books checked for 10 DAY FREE EXAMINATION at prices indicated plus postage. *Save!* Send cash with order and we pay postage. Same 10 day return privilege with money promptly refunded.

MONEY-SAVING SERVICE TRAINING COMBINATION—Radio & TV Circuitry & Operation; and Radio & TV Troubleshooting & Repair, only \$17 for both books. (Regular price \$19 separately—you save \$2.00).

Check here to order individual Books

- | | |
|--|---|
| <input type="checkbox"/> Radio & TV Circuitry and Operation (#708214) \$ 8.00 | <input type="checkbox"/> Digital Counters & Computers (#708131) \$8.75 |
| <input type="checkbox"/> Radio & TV Troubleshooting and Repair (#708578) 10.00 | <input type="checkbox"/> Basic Electronic Test Procedures (#708633) 8.50 |
| <input type="checkbox"/> Electrical Appliance Service Manual (#708172) 6.75 | <input type="checkbox"/> Modern Oscilloscopes & Their Uses (#708918) 8.75 |
| <input type="checkbox"/> Radio Troubleshooters' Handbook (#708297) 10.00 | <input type="checkbox"/> Semiconductor Devices (#709003) 7.50 |
| <input type="checkbox"/> Electric Motor Repair (#708715) 0.25 | <input type="checkbox"/> Practical Television Servicing (#705657) 7.95 |
| <input type="checkbox"/> PLY-O-FIX Trouble Finder Guides (#708412) 3.95 | |

(OUTSIDE USA—Add 50c to each book. Cash with order, but money refunded if books are returned in 10 days.)

Name

Address

City Zone.....State.....

(Above offers expire Oct. 15, 1962)

PRACTICAL TV SERVICING

JUST OUT!



Most complete, genuinely helpful television training in 10 years!

Written by a man who has actually done the work himself and knows how to make things clear.

This big, fully revised book is an up-to-the-minute guide to modern Television trouble-shooting and repair procedures. Saves experienced men loads of time! Is a complete training course for beginners.

The "Cream" of Modern Television Service Methods—Clearly Explained

First, PRACTICAL TELEVISION SERVICING by J. R. Johnson acquaints you with receiver layouts, sections and construction. A big troubleshooting section teaches you to pinpoint troubles in a minimum of time. Case histories on specific service calls demonstrate service procedures as clearly as A-B-C. Over 40 pages describe critical alignment procedures including connecting and adjusting instruments. Common faults in TV circuits are explained section by section. A chapter on Color Television principles brings you up-to-date in this field.

448 pages and over 325 illustrations help you handle any job by approved professional methods—helps you say "goodbye" to guesswork on even the toughest jobs! Price \$7.95.

find new
adventure in
amateur
radio...

with

Viking

1st choice of
amateurs the
world over!

loaded with features... kit or wired!



ADVENTURER—50 watts CW input 80 through 10 meters. 240-181-1... Kit Am. Net \$54.95	RANGER—75 watts CW input; 65 watts phone—160 through 10 meters. 240-161-2... Kit Am. Net... \$229.50 240 161-1...Wired Am. Net.. \$329.50	VALIANT—275 watts CW and 558; 200 watts A.M.—160 through 10 meters. 240-104-2... Kit Am. Net... \$349.50 240-104-2...Wired Am. Net... \$439.50
---	--	---

FREE
CATALOG



Complete specifications and schematics on all Johnson transmitters, amplifiers, station accessories, keys and practice sets!



E. F. JOHNSON CO.

2430 10th Ave. S.W. • Waseca, Minn.

NAME _____

ADDRESS _____

CITY _____ STATE _____

CB Owners: IT'S WHAT GOES OUT ON THE AIR THAT COUNTS!

Get maximum amplifier output and outstanding performance from your 5-watter by using famous PR CRYSTALS. These high-active crystals get greater distance than ordinary sluggish crystals. Clearer reception too. Put PR Crystals in your set today, and get the STRONGEST SIGNALS POSSIBLE WITHIN POWER LIMITS.

SWITCH TO A BETTER CHANNEL

Be smart... have several sets of PR Crystals... two or three sets at least. Then you can switch channels at will, to avoid jamming. PR CRYSTALS ARE AVAILABLE IN ALL 23 CITIZENS BAND CHANNELS.

Type Z-9R, Calibrated .005%, \$2.95 each. EVERY PR CRYSTAL IS UNCONDITIONALLY GUARANTEED.

Get PR's Now From Your Jobber.



PETERSEN RADIO CO., INC.

2800 West Broadway
Council Bluffs, Iowa



FCC Report

(Continued from page 8)

go ahead and make his own unit if he wants to, but it should be checked out thoroughly by someone who knows what he is doing before it is put to use.

Civil Defense. Of all the current uses of CB radio, the FCC is probably proudest of the way it is being used in civil defense activities. The agency has specifically included in the Citizens rules a provision that Class D stations may transmit messages relating to CD activities in connection with official tests or drills conducted by appropriate civil defense authorities.

Several cases have cropped up recently, however, which precipitated an observation by the Commission that, in such a CD drill, some other division or branch of the civil defense organization involved must be tested in addition to the radio group, so that there will be some actual test messages to transmit.

Any civil defense use of CB is limited to communications relating to official operations initiated and directed by the civil defense authority responsible for the particular locality, and "roll-calls" of CB stations, in the absence of official civil defense message traffic, the Commission says, are prohibited.

Check on Illegal Uses. As the second half of the current Congress gets under way early in January, Senator Karl E. Mundt (Republican, South Dakota) and his colleagues on the Senate Government Operations investigations subcommittee will have a chance to run a check on some advice Mr. Mundt issued to the FCC during anti-gambling hearings in the closing stages of Congress last fall.

Observing that two-way radio—including CB facilities—has been a boon to the underworld as well as to the more law-abiding elements of our society, the Senator said he feels that the FCC should direct more of its attention to monitoring and enforcement of various safety and special radio services, with a view to cracking down on illegal uses of the non-broadcast radio facilities.

Senator Mundt asked FCC Assistant General Counsel Dee W. Pincock to relay his concern to the full Commission with the request that the agency concentrate a little more in this area, and a little less on broadcast matters.

CB Measurements. For CB'ers with questions about the proper procedure for measuring the power of their transmitters, the FCC has come up with a one-paragraph explanation.

"The input power to those stages or circuits of a transmitter which contribute

Always say you saw it in—POPULAR ELECTRONICS

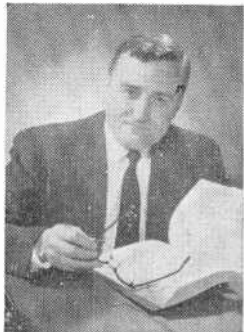

Are You Interested In Electronics - TV - Radio?

CARL E. SMITH
E. E., President

then you will want to know

What IS The FCC?

It's amazing what the future holds for you in this modern world of electronics. Let me send you the entire story—FREE!

- How to pass the FCC Exam
- Successful Electronic Training

We can train you to pass the Valuable FCC exam in a minimum of time if you have any practical experience and a fair knowledge of mathematics.

Get All 3 Booklets Free



Get This Handy Pocket Electronics Data Guide Free . . .

Puts all the commonly used conversion factors, formulas, tables, and color codes at your finger-tips. Yours absolutely free if you mail the coupon today. No further obligation!

TO GET THIS FREE GIFT, MAIL COUPON TODAY!

Sorry—Not For Beginners

Please inquire only if you really want to get ahead and to add to what you have already learned in school, in the service, or on the job. Some previous schooling or experience in electronics, electricity, or related fields is necessary for success in Cleveland Institute programs.

Cleveland Institute of Electronics

1776 E. 17th St. Desk PE-85 Cleveland 14, Ohio

January, 1962

FCC Regulations Require
CITIZENS BAND
Maintenance Personnel
to be licensed
Get In on the Ground Floor . . .
Get Your License Now!

Your FCC Commercial License —or Your Money Back

Completion of the Master Course (both Sections) will prepare you for a First Class Commercial Radio Telephone License with a Radar Endorsement. Should you fail to pass the FCC examination for this license after successfully completing the Master Course, you will receive a full refund of all tuition payments. This guarantee is valid for the entire period of your enrollment agreement.

Cleveland Institute of Electronics

1776 E. 17th St. Desk PE-85 Cleveland 14, Ohio

Accredited by the

National Home Study Council



Cleveland Institute of Electronics
1776 E. 17th St., Cleveland 14, Ohio

Please send Free Career Information Material prepared to help me get ahead in Electronics and a free copy of your "Pocket Electronics Data Guide." I have had training or experience in Electronics as indicated below.

- | | |
|---|---|
| <input type="checkbox"/> Military | <input type="checkbox"/> Broadcasting |
| <input type="checkbox"/> Radio-TV Servicing | <input type="checkbox"/> Home Experimenting |
| <input type="checkbox"/> Manufacturing | <input type="checkbox"/> Telephone Company |
| <input type="checkbox"/> Amateur Radio | <input type="checkbox"/> Other _____ |

In what kind of work are you now engaged?

In what branch of Electronics are you interested? _____

Name _____ Age _____

Address _____

City _____ Zone _____ State _____

PE-85

the HiFi Stereo Compact

EXTENSION SPEAKER

THIS AMAZING SPEAKER WILL BRING THE FINEST SOUND YOU HAVE IN YOUR HOME TO ANY ROOM YOU DESIRE.

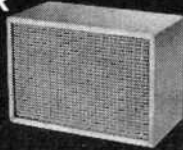

Here is a speaker system ideal for the home, office or even industrial applications where clear undistorted sound is required.

By simple connections to your present sound source, such as Hi Fi and stereo components, consoles, TV, radio and public address or intercom systems, the "compact" will produce crystal clear sound with almost no distortion, even at high volume levels.

Dimensions of cabinet 5" x 7" x 10"

100% MONEY BACK GUARANTEE

If you do not feel this is the finest dollar value you have ever received in the high fidelity industry

NEWPORT MANUFACTURING CORP.
1823 E. 40th St., Cleveland 3, Ohio

Please send _____ Compact Systems

Name _____

Address _____

Enclosed find Money Order Check

\$6⁹⁵

UNFINISHED

Please add 75¢ per unit to cover shipping and handling.

QUICKLY CUT HOLES

in metal, plastics,
hard rubber...



GREENLEE CHASSIS PUNCHES

Make smooth, accurate openings in 1 1/2 minutes or less... for sockets, plugs, controls, meters, panel lights, etc. Easy to use... simply turn with wrench.

Many sizes and models.

Write for literature.



GREENLEE TOOL CO., 1915 Columbia Ave., Rockford Illinois

FCC Report

(Continued from page 12)

radio frequency energy to the antenna system shall be measured with d.c. voltmeters and milliammeters of good accuracy. The sum of the d.c. voltage-current products thus measured shall not exceed 5 watts. Where the d.c. input power fluctuates with modulation, the power at the maximum voice peak shall not exceed 5 watts, as indicated by the meters. For this purpose, the maximum time constant of the meters shall not be greater than 0.25 of a second."

Application Trouble. One paramount difficulty the Commission is running into at the moment in processing CB applications results from the prospective CB'ers not specifying in their applications the uses to which the radio units are to be put. This one factor is causing more CB applications to be returned without FCC action than any other.

For the fastest possible processing of your application—and it's slow enough at best—please spell out in your application *exactly* what *each* CB unit mentioned on the application is going to be used for. -50-

COMING NEXT MONTH



The young lady at left doesn't realize that she has just 'tripped' the POPULAR ELECTRONICS capacity-operated relay. Based on a very simple circuit using a minimum of parts, this sensitive detector has numerous uses around the house.

(ON SALE JANUARY 25)

● ELECTRONIC TRADE SCHOOLS—1962

A three-part story on your career and the important role an electronic school can play in it starts in the February issue. Part I will tell about the opportunities available and the various types of schools to choose from. Part II (in the March issue) will cover correspondence schools and Part III (April issue) resident schools. You won't want to miss any of these issues.

● THE "S-9"ER"

At long last, a short-wave all-band pre-selector—with regeneration—that needs no plug-in coils. Unbelievable? We thought so, too, but it really isn't. Easy and foolproof to build, it's guaranteed to hop up any s.w. receiver.

Always say you saw it in—POPULAR ELECTRONICS

FREE!

LAFAYETTE

340 PAGE
1962 Lafayette Radio Electronics
CATALOG # 620

"America's Hi-Fi & Electronics Shopping Center"

Yours free for the asking — the biggest, best and most comprehensive catalog in the 41-year history of Lafayette Radio. Audiophile, Experimenter, Hobbyist, Technician, Engineer, Student, Serviceman, Dealer — you'll find what you want in this latest Lafayette catalog.

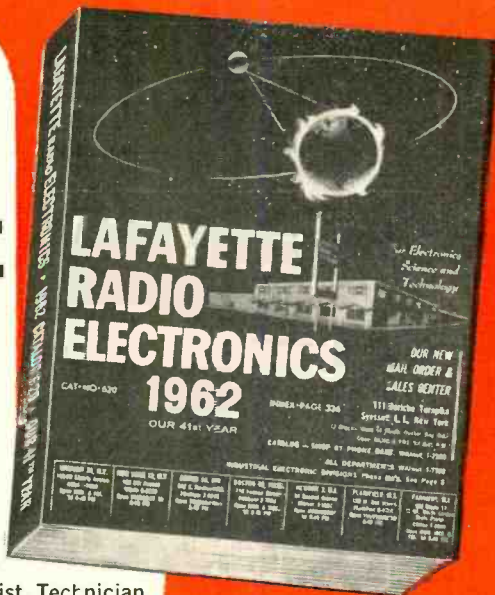

LARGEST STOCK SELECTION. Stereophonic Hi-Fi equipment, Citizens Band, Ham and Amateur equipment, Radio & TV parts, Optics, Industrial Supplies, and much more, including all the favorite name brands.

LAFAYETTE EXCLUSIVES. Featured are the famous Lafayette Kits . . . dollar for dollar the best value for your money today. You'll also see hundreds of Lafayette specials . . . available only from Lafayette. And, as always, **SATISFACTION GUARANTEED OR MONEY REFUNDED.**

LOWEST PRICES. You'll save money too with Lafayette's low, low prices. The lowest prices are always in the Lafayette catalog.

24-HOUR SERVICE. Quick, courteous service is your guarantee at Lafayette. Most orders are fully processed within 24 hours after receipt in the mail Order Division.

NEW EASY-PAY PLAN. Now, **NO MONEY DOWN . . .** up to 24 months to pay.



COMPLETELY WIRED, FULL SIZE TUBE TESTER
TE-15 19.95



SUPERHETERODYNE COMMUNICATIONS RECEIVER
KT-200, Kit 64.50
HE-10, Wired 79.95



10,000 OHMS-PER-VOLT MULTITESTER
TE-10 9.95



CITIZENS BAND MOBILE ANTENNA WHIP
HE-800WX 6.95



NEW! KORDEX™ TRANSISTORIZED SEMI-KIT TAPE RECORDER
RT-201 17.95



NEW! FM MULTIPLEX ADAPTER
LT-200 39.50

LAFAYETTE'S

NEW MAIL ORDER HEADQUARTERS
111 JERICHO TURNPIKE
(2 Blocks West of South Oyster Bay Rd.)
SYOSSET, LONG ISLAND, NEW YORK



LAFAYETTE RADIO, Dept. IA-2
P. O. Box 10, Syosset, N. Y.

- Rush my **FREE Lafayette 1962 Catalog 620**
- Please send me # _____, shipping charges collect.
- I am enclosing \$ _____

Name _____

Address _____

City _____ Zone _____ State _____

A PROPHECY

For men and women with a sincere desire to succeed



"In the years that have passed since my days on the faculty of RCA Institutes, I have become even more firmly convinced that the individual who continues his education . . . particularly his technical education . . . is the individual who profits both as a thinking man and as a working man. Science and industry will reward you for your talents and energy. Out of your efforts may come inventions, new products, processes and services. There is everything good yet to be accomplished in our lives and in our work. What man has done, man can do better."

David Sarnoff

Chairman of the Board,
Radio Corporation of America

RCA Institutes Offers the Finest of Home Study and Resident Training for Your Career in the Rapidly Expanding World of Electronics

RCA Institutes, founded in 1909, is one of the largest technical institutes in the United States devoted exclusively to electronics. A service of Radio Corporation of America, RCA Institutes offers unparalleled facilities for technical instruction . . . tailored to *your* needs. The very name "RCA"

means dependability, integrity, and scientific advance.

RCA Institutes Home Study School, licensed by the New York State Department of Education, offers a complete program of integrated courses for beginners and advanced students rang-

ing from electronic fundamentals to automation. All courses are designed to prepare you for a rewarding career in the rapidly expanding world of electronics. *The caliber of the training you receive is the finest!* And you get top recognition as an RCA Institutes graduate!

HOME STUDY COURSES *in*

*Electronic Fundamentals • TV Servicing
Color TV • Electronics for
Automation • Transistors*

Voluntary Tuition Plan. The important thing to remember about RCA Institutes Training is the convenient, *no-obligation payment plan*. This plan affords you the most economical possible method of home study training because you pay for each study group only when you order it. If you interrupt your course *at any time, for any reason*, you owe nothing more. You *never* have to pay for the whole course if you don't complete it. No other obligations. No monthly installment payments!

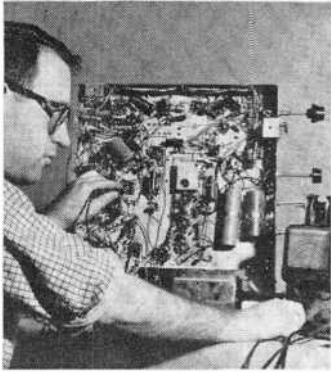

RCA Instruction is Personal. With RCA Home Study training you set *your own pace* in keeping with *your own ability*, finances, and time. The Institutes allows you ample time to complete the course. Your lesson assignments are individually graded by

technically trained personnel, and helpful comments are added where required. You get theory, experiment, and service practice beginning with the very first lesson. All lessons are profusely illustrated. You get a *complete training package* throughout the entire course.

You Get Prime Quality Equipment. All kits furnished with the course are complete in every respect, and the equipment is top grade. You keep all the equipment furnished to you for actual use on the job... *and you never have to take apart one piece to build another!*

* * *

RESIDENT SCHOOLS *in*

*Los Angeles and
New York City train
you for any field of
Electronics you may
choose!*

No Previous Technical Training Required For Admission. RCA Institutes Resident Schools in Los Angeles and New York City offer training that will prepare you to work in re-

warding positions on research and production projects in fields such as automation, communications, technical writing, television, computers, and other industrial and advanced electronics applications. Even if you did not complete high school, RCA will prepare you for such training with courses specially designed to provide the basic math and physics required for a career in electronics.

Free Placement Service. RCA Institutes graduates are now employed in important jobs at military installations such as Cape Canaveral, with important companies such as IBM, Bell Telephone Labs, General Electric, RCA, and in radio and TV stations all over the country. Many other graduates have opened their own businesses. A recent New York Resident School class had 92.06% of the graduates who used the Free Placement Service accepted by important electronics companies... *and had their jobs waiting for them on the day they graduated!*

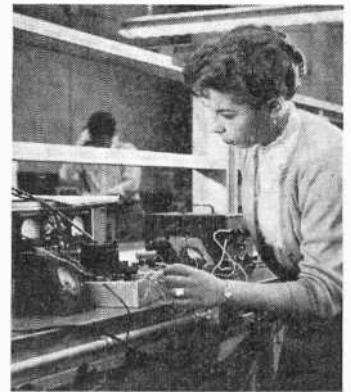

Coeducational Day and Evening Courses. Day and Evening Courses are available at Resident Schools in New York City and Los Angeles. You can prepare for your career in electronics while continuing your normal full-time or part-time employment. Regular classes start four times each year.



SEND POSTCARD FOR FREE ILLUSTRATED BOOK TODAY! SPECIFY HOME STUDY OR RESIDENT SCHOOL

RCA INSTITUTES, INC. A Service of Radio Corporation of America 350 W. 4th St., N.Y. 14, N.Y. • 610 S. Main St., Los Angeles 14, Calif. Dept. PE-12



The Most Trusted Name in Electronics



NOW YOU CAN
BUILD A FINE
Schober Organ
FOR ONLY
\$550

You can assemble this new Schober Spinet Organ for \$550 — or half the cost of comparable instruments you have seen in stores. The job is simplicity itself because clear, detailed step-by-step instructions tell you exactly what to do. And you can assemble it in as little as 50 hours.

You will experience the thrill and satisfaction of watching a beautiful musical instrument take shape under your hands. The new Schober Electronic Spinet sounds just like a big concert-size organ — with two keyboards, thirteen pedals and magnificent pipe organ tone. Yet it's small enough (only 38 inches wide) to fit into the most limited living space.

You can learn to play your spinet with astounding ease. From the very first day you will transform simple tunes into deeply satisfying musical experiences. Then, for the rest of your life, you will realize one of life's rarest pleasures — the joy of creating your own music.

For free details on all Schober Organs, mail the coupon now. No salesman will call.

THE *Schober Organ* CORPORATION

43 West 61st Street, New York 23, N. Y.
Also available in Canada and Australia.

MAIL THIS COUPON TODAY

The Schober Organ Corporation, Dept. PE-7
43 West 61st Street, New York 23, N. Y.

- Please send me FREE booklet and other literature on the Schober Organs.
- Please send me the Hi-Fi demonstration record. I enclose \$2 which is refundable when I order my first kit.

Name.....

Address.....

City.....Zone...State.....

Hi-Fi



Showcase

*A quick look at
new products in the
stereo/hi-fi field**

AFTER playing one "side" of a 4-track stereo tape from start to finish, the S505 tape recorder automatically reverses and plays the other half—it's the newest addition to the *American Concertone* line. Equipped with a hysteresis-synchronous capstan drive motor for timing accuracy, it operates at both 3 3/4 and 7 1/2 inches per second; 7 1/2- and 15-ips operation is available at slight extra cost. The S505 is supplied complete with record/playback preamplifiers, each with its own bias and equalization adjustments; and low-impedance, cathode-follower outputs provide a perfect means of matching to an existing stereo system. Prices range from \$495.00 to \$644.50, depending on type of case and whether 2- or 4-track record and the "Reverse-O-Matic" feature are desired. . . . From *DuKane's* Ionovac Division comes a de luxe columnar speaker system, the DuK-60. It employs four speakers: an Ionovac tweeter to handle frequencies from 3000 to 30,000 cycles and beyond; an 8" speaker for the mid-range; and another 8" and a 12" for the lows. In addition, two controls allow precise adjustment of the output above 3000 cycles and between 800 and 3000 cycles. Price, \$246.00.

Find yourself in the market for an inexpensive monophonic amplifier? *Heath's* AA-181 preamp/amplifier kit, designed to

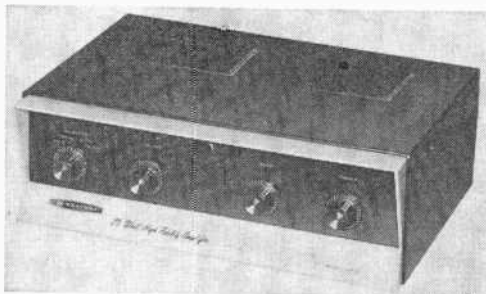

Heathkit AA-181 monophonic amplifier

match the new Heathkit AJ-21 and AJ-31 tuners, delivers a full 25 watts, ±1 db, 30 to 15,000 cycles. This attractive amplifier has inputs for microphone, magnetic phono,

**Write to the manufacturers listed at the end of this column for more data on products mentioned*

Always say you saw it in—POPULAR ELECTRONICS

Coming Soon!

THE 1962 ELECTRONIC EXPERIMENTER'S HANDBOOK

Each year thousands of electronics hobbyists eagerly await the new edition of the Electronic Experimenter's Handbook! And no wonder — each edition presents dozens of challenging and intriguing do-it-yourself projects, plus invaluable charts and tables.

This year's Electronic Experimenter's Handbook is bigger and better than ever — with 5 sections on:

- Citizens Band
- Stereo and Hi-Fi
- Short Wave Listening and Ham Radio
- Electronics around the Home
- Electronics in the Workshop

Watch for the 1962 ELECTRONIC EXPERIMENTER'S HANDBOOK — on sale February 10th at your newsstand or electronic parts store. Only \$1.00

Or send in this handy coupon and we'll send your copy to you on the date of publication.

1962 POPULAR ELECTRONICS
**ELECTRONIC
EXPERIMENTER'S
HANDBOOK**



Reservation Form

Retail Sales Division
Ziff-Davis Publishing Company
One Park Avenue
New York 16, New York

Please reserve a copy of the 1962 ELECTRONIC EXPERIMENTER'S HANDBOOK. I enclose \$1.00 and 10¢ to cover mailing and handling charges. (Canada and Foreign \$1.25 p us 10¢ postage.)

NAME _____

ADDRESS _____

CITY _____ ZONE _____ STATE _____

(add 3% sales tax if New York City resident)

Showcase

(Continued from page 20)

crystal or ceramic phono, and "auxiliary;" in addition, it boasts separate bass and treble controls. Kit price (f.o.b. Benton Harbor, Mich.), \$42.95. . . . Also available from Heath is the AS-51 series of speaker system kits. Suitable for either vertical or horizontal mounting on bookshelves, tables, etc., the AS-51 features a special tweeter mounting board which can be rotated so that the speaker maintains its proper position for wide-angle sound dispersion. Two Jensen speakers—an 8" woofer and a compression-type tweeter—provide smooth response from 50 to 12,000 cycles with the aid of a built-in 1600-cycle crossover network. Kit prices range from \$39.95 to \$46.95.

Kenwood Electronics' 60-watt stereo receiver consists of an AM/FM multiplex tuner and a 60-watt stereo amplifier in one cabinet. Manufactured in Japan, the KW-60 stereo receiver has inputs for magnetic phone cartridge, tape head, and auxiliary sources; an output jack for stereo headphones; and whistle, rumble, and scratch filters. Price, \$299.95, complete with case. . . . Another product from Kenwood and another

Japanese import is the KD-1 FM stereo adapter. Designed for use with almost any FM tuner, the KD-1 measures only 4 3/4" x 7 7/8" x 7 7/8", contains four tubes and consumes 25 watts. Price, \$49.95.



Kenwood KW-60 stereo receiver

A new hi-fi offering from Allied Radio is the **Knight-Kit KF-90** stereo FM/AM tuner, complete with built-in multiplex circuit. Designed to reproduce the full dynamic range of stereo FM, the KF-90 kit features a front-panel "dimension" control which allows the listener to vary channel separation on multiplex broadcasts. Separate tuning indicators simplify tuning on both AM and FM, and a built-in 10-kc. AM whistle filter eliminates annoying "squeals." Price, complete with case, sweep-aligned r.f. and i.f. transformers, and hardware,

(Continued on page 26)

Here is America's NEWEST!

TWO-WAY RADIO

MODEL
TR 27
\$239

- 18 Tube Performance
- 6 Crystal Controlled Channels
- Manual Tuning of All 23 Channels
- Dual Superhetrodyne Receiver
- Pi Network & Harmonic Trap
- Adjustable Squelch
- Series Gated Noise Limiter
- Ext. Speaker & Headphone Jack



ENGINEERED BY TRAM ELECTRONICS

The superb TR 27 combines the finest components with the ultimate in engineering design to provide a reliability and range newly satisfying to business users and the most exacting C.B. "Buff".

Sophisticates will appreciate the absence of drift, readability of weak signals, new freedom from adjacent channel interference, and the 4 watts of undistorted audio. The transmitter with its sensational 3.5 WATT MINIMUM output from the FCC limited 5 watt input reaches hitherto inaccessible locations. This equipment is for the perfectionist.

A New Mobile? Yes, Very Soon.
With The Same Performance? Emphatically Yes!

FOR MORE DETAILED INFORMATION
AND SPECIFICATIONS, WRITE TO



TRAM ELECTRONICS
P. O. BOX 187, WINNISQUAM, N. H.

Now you can build almost any kind of electronic device!



Here are the ABC's of 50 vacuum-tube circuits for electronics experimentation and project construction—all fully diagramed, complete with parts list.

HOW many times have you wanted a diagram of a basic vacuum-tube circuit which you could use as a guide in building hi-fi components, receivers, transmitters, intercom systems, test equipment and other electronic gear? At last, in one book, you can find all the basic diagrams, schematics and other vital information on vacuum tubes and their circuits essential for such projects!

You'll Become An Expert On All Types of Vacuum Tubes

Beginning with the Edison effect (the birth of the diode), Julian M. Sienkiewicz, Managing Editor of Popular Electronics, leads you right up to the multi-element vacuum tubes used in everyday circuits. The first four chapters are devoted to the operation of diodes, triodes, tetrodes, and pentode and beam-power tubes. Chapter five covers construction practices, tools, and test equipment, along with workshop hints that will be a real boon to all who want to get the most out of their equipment. Chapter six contains a collection of fifty vacuum-tube circuits that gives you a basic library of useful circuits for quick and trouble-free reference.

One hundred vacuum-tube schematics, plate-characteristic curves, simplified diagrams, test circuits and other selected illustrations supplement the informative text to make this book one of the most useful and invaluable manuals for your electronic experiments and hobby projects.

192 pages, 100 illustrations \$4.95

SEE YOUR ELECTRONICS PARTS JOBBER OR BOOKSELLER OR USE COUPON BELOW!

PARTIAL CONTENTS:

DIODE VACUUM TUBES. Emission—Diode Operation—Rectification Power—Supply Filters—Detection (AM and FM). TRIODE VACUUM TUBES. Triode Operation—The Triode Test Circuit—Control—Triode Characteristics—Plate Characteristic Curves—Plate Resistance—Amplification Factor. TRIODE AMPLIFIERS. Load Lines—Operating Point—Cathode Bias—Cathode Load Lines—Signal Amplification—Signal Inversion—Voltage Gain—Computing Voltage Gain—Distortion. MULTI-ELEMENT TUBES. Miller Effect—Tet-

rodes—Pentodes—A.C. Plate Resistance—Transconductance—Amplification Factor—The Pentode Voltage Amplifier—Operating Point—Cathode Bias—Distortion—Beam-Power Vacuum Tubes—Audio Output Stage. CIRCUIT CONSTRUCTION HINTS. Checking Components—Fixed Resistors—Capacitors—Transformers and Coils—Vacuum Tubes—Where To Buy—Test Equipment—Vacuum Tube Voltmeter—Oscilloscope—Signal Generators—Tools—Soldering—Chassis Construction—BASIC VACUUM TUBE CIRCUITS.

ELECTRONICS BOOK SERVICE

One Park Ave.,
New York 16, N.Y.



Please send me VACUUM-TUBE CIRCUITS FOR THE ELECTRONIC EXPERIMENTER for a free 7-day trial examination. I understand that if I am not completely satisfied, I may return the book and owe you nothing. Otherwise, I will remit \$4.95 plus small charge for postage, packing and handling. Same return privilege and prompt refund guaranteed!

NAME _____
(please print)
ADDRESS _____
CITY _____ ZONE _____ STATE _____

EF631

BRING 'EM BACK ALIVE!



THE FIRST TRULY HIGH-QUALITY LOW-COST 3-WAY SPEAKER... ONLY \$29.50

It takes the most modern facilities in the industry to accomplish this:

The most spectacular loudspeaker value ever offered — a high-quality 3-way speaker at the cost of a coax!

And only Electro-Voice has these facilities, plus the production "know-how" . . . all under one roof! Every vital process from die-making to die-casting, from wire-flattening through automatic voice-coil winding, precision grinding, plating and polishing, to a completely automated belt assembly is under E-V's continuous personal control.

Introducing the new Wolverine LT12 — the latest addition to the famous Wolverine budget-priced line of quality speakers!

Imagine! A speaker that sounds better than speakers costing twice as much. With deep, rich bass and clean, clear treble from two cones, coupled by the famous E-V Radax principle. Plus smooth, peak-free highs that spread evenly throughout the room — without beaming — for outstanding stereo any-

where in the listening area . . . possible only with an E-V diffraction-horn compression-type tweeter.

The impressive list of LT12 "high-priced" features also includes a new ceramic magnet, plus edgewise-wound voice coil for highest efficiency . . . rugged die-cast frame to ensure perfect alignment of all moving parts . . . "deep-dish" bass cone design for higher power handling . . . long-throw suspension for minimum distortion . . . 3-position tonal balance switch that matches the LT12 to your acoustics . . . and a rich, jewel-like precision finish to all vital parts.

But, best of all, the LT12 is versatile: mounts in most high fidelity speaker enclosures, in the wall, ceiling, or even in a closet. And its wide dispersion makes placement far less critical than ordinary speakers — even for stereo!

See and hear the exciting new Wolverine LT12 at your nearby Electro-Voice/Wolverine high fidelity headquarters . . . today!

SPECIFICATIONS: Frequency response, 40 to 18,000 cps. Power handling capacity, 20 watts, program. Built-in crossover and 3-position balance switch. Impedance, 8 ohms. Size, 12 1/4 inches diameter, 6 inches deep. Shipping weight 15 pounds.

NOW, A COMPLETE LINE OF BUDGET-PRICED WOLVERINE SPEAKERS

- Model LS15 15" coax speaker, \$24.50
- Model LS12 12" coax speaker, \$19.50
- Model LS8 8" coax speaker, \$18.00
- Model HF1 Tweeter Step-Up Kit, \$20.00
- Model MF1 Mid-range Step-Up Kit, \$25.00

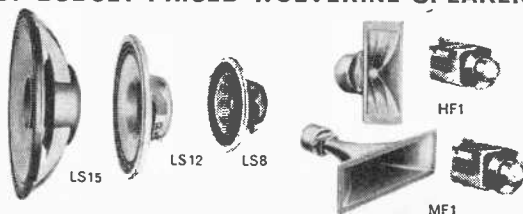

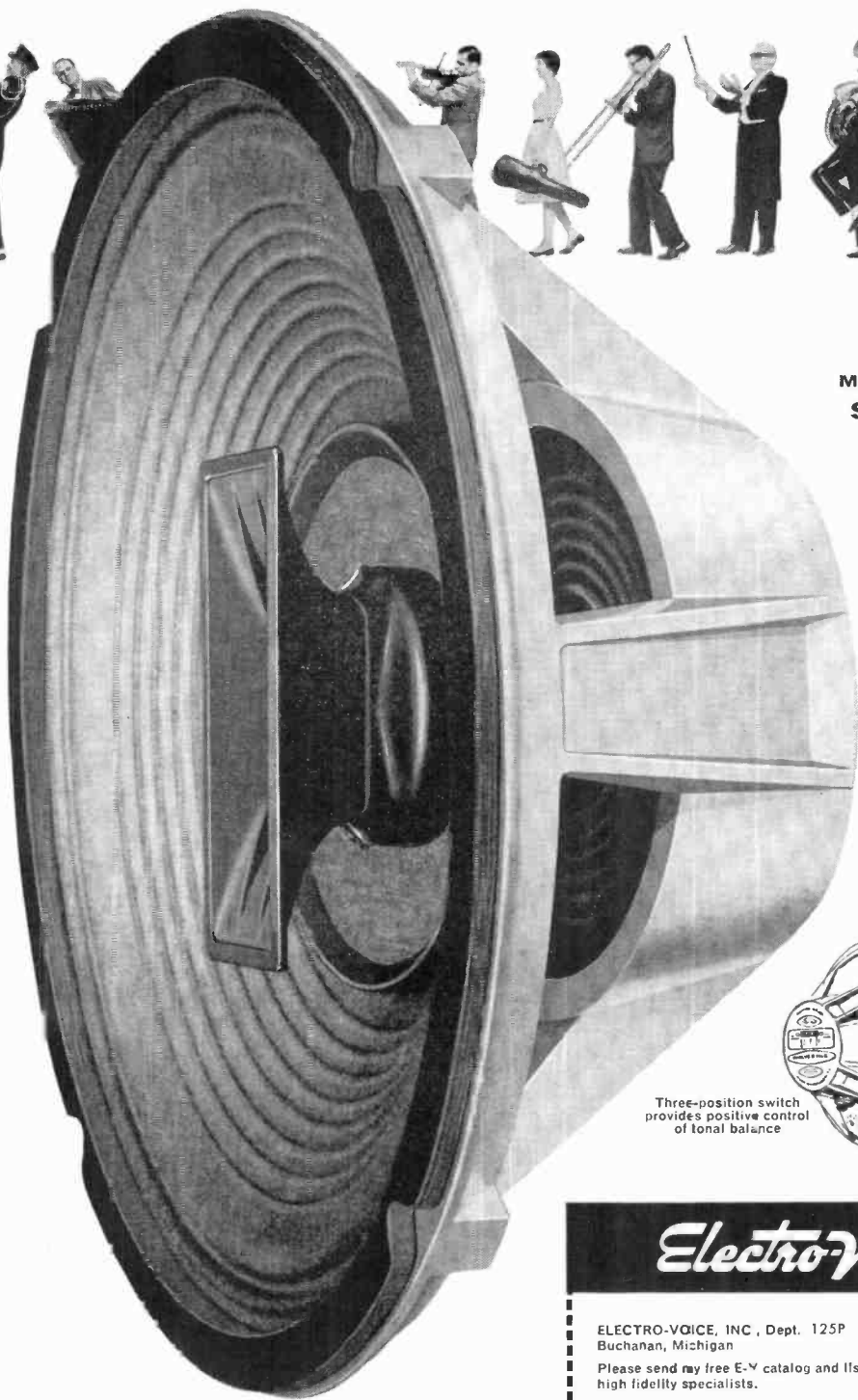

Model LT12
\$29.50

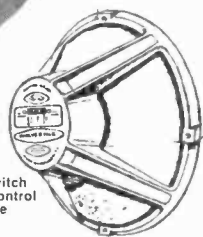

Three-position switch
provides positive control
of tonal balance

Electro-Voice[®]

ELECTRO-VOICE, INC., Dept. 125P
Buchanan, Michigan

Please send my free E-V catalog and list of E-V/Wolverine
high fidelity specialists.

Name _____

Address _____

City _____ State _____

ELECTRO-VOICE, INC.
Consumer Products Division, Buchanan, Michigan

" THE DELUXE TOUCH "

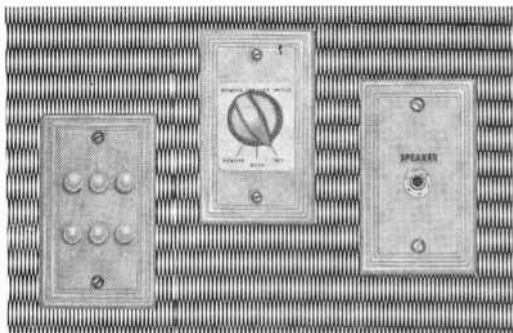

MOSLEY Hi-Fi Accessories

For the ardent hi-fi enthusiast who wants true "built-in" beauty, and convenience in his hi-fi system. Decor-designed and easily installed by you, or your contractor, this varied line of Mosley speaker switches, attenuator plates and speaker wall outlets may be obtained from over 2,000 radio distributors coast to coast...or write Dept. PE-162 for complete catalog.



Electronics Inc.
BRIDGETON, MISSOURI

YOU SAVE MONEY!

RUSH US YOUR LIST
OF HI-FI COMPONENTS
FOR A VERY SPECIAL
GROUP QUOTATION

WRITE FOR FREE AUDIO
DISCOUNT CATALOG A-15

New low prices on tape re-
corders, amplifiers, tuners,
loudspeakers, cartridges, etc.

KEY ELECTRONICS COMPANY
120 LIBERTY STREET
NEW YORK 6, N. Y.

Showcase

(Continued from page 22)

\$99.95. . . . Another tuner, the Realistic TM-214 by *Radio Shack*, is expressly designed for FM multiplex reception. Available in either kit or factory-wired form, the TM-214 makes use of three i.f. and three limiting stages to provide constant output and high-gain bandwidth control without distortion. As for the 3-tube multiplex circuit, it features factory-set balance and separation controls for perfect performance at all times. Prices: \$149.95 in kit form; \$189.95, factory-wired.

Roberts Electronics has a new stereo tape recorder, complete with built-in stereo amp-

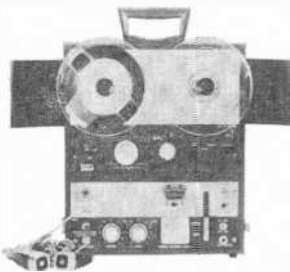

Roberts 1040 tape recorder

lifiers and extended - range stereo speakers. Basically a 7½-ips unit, the 1040 can be readily adapted for either 3¾- or 15-ips operation by means of a conversion kit. Other features: dual microphone inputs,

dual phono/radio inputs; automatic shut-off; push-button function switches; and automatic muting on rewind. Price, \$299.50. . . . Two new cartridges from *Shure Brothers*—the M33 and the M77—possess exceptional performance characteristics: high output levels, effective hum shielding, and ease of stylus replacement. The M33 cartridge, recommended for turntable and record-changer arms tracking at 1 to 3 grams, offers a frequency response from 20 to 20,000 cycles and a channel separation that exceeds 22.5 db at 1000 cycles. The M77, on the other hand, is recommended for arms tracking at pressures in excess of 3 grams; frequency response is from 20 to 17,000 cycles, channel separation 20 db at 1000 cycles. As a bonus feature, either cartridge will accept Shure's new N78 diamond stylus, ideal for playing 78-rpm "collector's items." The M33 is priced at \$36.50, the M77 at \$27.50, and the N78 stylus at \$8.55. -30-

Allied Radio Corp. (Knight-Kit), 100 N. Western Ave., Chicago 80, Ill.
American Concertone, Inc., 9449 W. Jefferson Blvd., Culver City, Calif.
DuKane Corp., Ionovac Div., St. Charles, Ill.
Heath Co., Benton Harbor, Mich.
Kenwood Electronics Div., American Commercial, Inc., 212 Fifth Ave., New York 10, N.Y.
Radio Shack Corp. (Realistic), 730 Commonwealth Ave., Boston 17, Mass.
Roberts Electronics, Inc., 5920 Bowcroft St., Los Angeles 16, Calif.
Shure Bros., Inc., 222 Hartrey Ave., Evanston, Ill

The Same School That Originated The RTS BUSINESS PLAN

...NOW
Proudly
Presents...

A SPECIAL COMPACT COURSE COVERING ALL THREE PHASES OF **ELECTRONICS**

The Entire Course Is Made
Up Of The Following:

- 35 LESSONS COVERING BASIC AND INTERMEDIATE ELECTRONICS
- 9 EQUIPMENT KITS COMPLETE WITH TUBES AND BATTERIES
- SOLDERING IRON
- 25 LESSONS COVERING THESE ADVANCED ELECTRONIC SUBJECTS:

Thyratron Tubes • Semiconductors •
Electronic Symbols and Drawings •
Voltage-Regulators • Electronic-
Timers • Control Systems • X-Rays •
Photoelectric Devices • Dielectric
Heating • Geiger Counters • Pulse
Circuitry • Clippers and Limiters •
Multivibrators • Electronic Counters •
Radar • Magnetic Amplifiers • Analog-
Computers • DC Amplifiers • Digital
Computers • Storage Systems • Input
and Output Devices • Servomechanisms •
Telemetering

- 60 EXAMINATIONS
- UNLIMITED CONSULTATION SERVICE
- KIT MANUALS
- DIPLOMA UPON GRADUATION

AND MUCH MORE...

RTS' Membership in
The Association of
Home Study Schools
is your assurance of
Reliability, Integrity and
Quality of Training.



RTS ELECTRONICS DIVISION
815 E. ROSECRANS AVENUE
LOS ANGELES 59, CALIFORNIA

Est. 1922

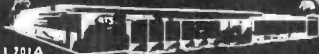

L 201A

BASIC • INTERMEDIATE • ADVANCED
DESIGNED FOR THE BUSY MAN OF TODAY

This is MODERN training for the MODERN man. You'll find no "horse and buggy" methods here. Every page of this streamlined course is devoted to important Electronics principles and practical projects. You'll be amazed how fast you grasp Electronics the R'S way. RTS has combined modern THEORY and PRACTICE to make this the finest training program of its kind available!

SATISFIES NOVICE, TECHNICIAN OR HOBBYIST

Whether you're new to Electronics or an old "pro," chances are you'll find this to be the ideal course for you. The novice will appreciate the completeness of the training. It starts with the most basic considerations, covering each important point thoroughly, yet concisely. The technician will enjoy the practical review of fundamentals and profit from the 25 advanced subjects covered.

RTS GIVES YOU "TOP MILEAGE" FOR YOUR TRAINING DOLLAR

The price quoted below buys EVERYTHING — there are no extras to pay for. RTS has gone "all out" to give you the best training value in America. Why pay hundreds of dollars for training such as we offer when it's available for this LOW PRICE? If you can find a better training bargain... BUY IT!

CAN BE COMPLETED IN MONTHS INSTEAD OF YEARS

Some students will complete this course with "Jet-Like" speed but we allow up to two years if your circumstances require it. You study at your own rate. You are ENCOURAGED but not pushed. You'll find the lessons professionally written but easy to understand. LET US SEND YOU ONE OF THESE LESSONS ALONG WITH YOUR CAREER BOOKLET SO YOU CAN SEE FOR YOURSELF. NO OBLIGATION!

COMPLETE
COST...
INCLUDES ALL KITS,
TUBES, BATTERIES, ETC.
\$125.00*

*TERMS ALSO AVAILABLE

AS LITTLE AS...

\$5.00 DOWN

\$5.00 PER MONTH

THE FIRST TRAINING KIT IS SENT
IMMEDIATELY UPON ENROLLMENT

DON'T LOSE OUT — FIND OUT!

RTS ELECTRONICS DIVISION Dept. PE-12
815 E. ROSECRANS AVENUE LOS ANGELES 59, CALIFORNIA
Rush me full information by return mail. (Please Print)

Name _____ Age _____
Address _____
City _____ Zone _____ State _____

NO SALESMAN WILL CALL ON YOU!

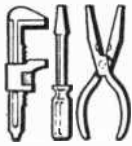

ELECTRIC APPLIANCES

PAYS \$3 TO \$5 AN HOUR
Spare Time, Full Time • Learn at Home

FREE BOOK offered below shows how YOU can now have a good-paying business of your own right in your home. No experience needed, just simple tools. Learn to repair Electric Appliances. Pays \$3-\$5 an hour!

400 MILLION Appliances are in American homes right now. 76 MILLION MORE bought each year. People need them fixed, good times or bad.

FREE BOOK SHOWS HOW FREE LESSON STARTS YOU

YOU make good money doing it. In your base-

ment, garage, even on your kitchen table.

QUICK WAY TO GET STARTED

For less than 20¢ a day our easy, pictured instruction — backed by 45 years of success in home training — prepares you for top earnings in this booming field. Earl Reid of Thompson, Ohio says: "Made \$510 in one month spare time. NRI course is priceless." At no extra charge you even get all parts for your own Appliance Tester, too. Finds trouble-spots, speeds and checks your work.

Get your **FREE Book** and **FREE Sample Lesson!** Mail coupon below, letter or post-card, now.

FREE BOOK

FREE LESSON

NATIONAL RADIO INSTITUTE, Appliance Division
Dept. D4A2, Washington 16, D.C.

Send **Free Book, Free Appliance Repair Course Lesson.** Am interested in:

- Spare Time Earnings My Own Business
 Better Job

Name.....

Address.....

City.....Zone...State.....

Accredited Member National Home Study Council

BUILD THE PROJECTS DESCRIBED IN THIS ISSUE OF

POPULAR ELECTRONICS

WITH THESE



PRODUCTS

THE 10-8 DeLUXE CONVERTER

Uses Bud CU-2105A.....\$1.20

THE SQUARER

Uses Bud CU-3005A.....96c

TD POWER SUPPLY

Uses Bud CU-2105A.....\$1.20

HIGH PERFORMANCE TRANSMITTER

Uses Bud AC-402.....\$1.17

THE FLOOD LIFE STRETCHER

Uses Bud CU-2108A.....\$1.65

All Bud products are available for immediate delivery from your authorized Bud Distributor. They are the best for applications described in these projects.

WATCH FOR THESE LISTINGS EVERY MONTH
IN POPULAR ELECTRONICS

BUD RADIO, INC.

2118 East 55th Street Cleveland 3, Ohio
Dept. P.E.

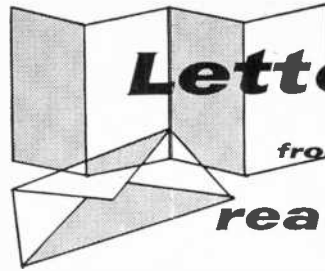

Letters

from our

readers

BBC Far Eastern Station

■ In the October, 1961, "Short-Wave Report," I noticed with interest the statement that the transmitter of the BBC Far Eastern Station is located in Malaya, though the studios are in Singapore. This I can confirm with some authority, having supervised the installation of the equipment.

The station is remote-controlled and located at a place called Tebrau, in the State of Johore, about 14 miles from the causeway linking Singapore and Malaya. The site is in the middle of a rubber estate and, while the station was under construction, was attacked several times by Chinese Communist bands.

If my memory serves me correctly, the station is equipped with two 100-kw. Marconi transmitters



and the first program transmitted (1950) was the Christmas speech of King George VI to the British troops serving in Korea. Though now a resident of the U.S.A., I'm still a British subject, and the report brought back very pleasant memories of an interesting and rewarding project.

SYDNEY A. BIGGS
La Puente, Calif.

Many thanks for your background material on the BBC Far Eastern Station, Mr. Biggs. We're sure that everyone will enjoy reading it as much as we did.

Cooking Up Blueprints

■ Thanks very much for the fine article entitled "Cooking Up Your Own Blueprints" which appeared in the September 1961 issue. I read it and, an hour later, made a highly successful first experiment. But there is an error in the text to which I'd like to draw your attention. The last sentence in the first column on page 96 reads, in part: "... place a piece of carbon paper with its coated

Always say you saw it in—POPULAR ELECTRONICS

BUILD YOUR OWN RADIO

CIRCUITS AT HOME

with the New

PROGRESSIVE RADIO "EDU-KIT"®

A Practical Home Radio Course

Reg. U. S.
Pat. Off.



Training Electronics Technicians Since 1946

- Now Includes**
- ★ 12 RECEIVERS
 - ★ 3 TRANSMITTERS
 - ★ SQ. WAVE GENERATOR
 - ★ SIGNAL TRACER
 - ★ AMPLIFIER
 - ★ SIGNAL INJECTOR
 - ★ CODE OSCILLATOR
 - ★ No Knowledge of Radio Necessary
 - ★ No Additional Parts or Tools Needed
 - ★ EXCELLENT BACKGROUND FOR TV
 - ★ SCHOOL INQUIRIES INVITED
 - ★ Sold in 79 Countries

**YOU DON'T HAVE TO SPEND
HUNDREDS OF DOLLARS FOR A RADIO COURSE**

The "Edu-Kit" offers you an outstanding PRACTICAL HOME RADIO COURSE at a rock-bottom price. Our Kit is designed to train Radio & Electronics Technicians, making use of the most modern methods of instruction. You will learn radio theory, construction practice and servicing. THIS IS A COMPLETE RADIO COURSE IN EVERY DETAIL. In a professional manner; how to build radios, using regular schematics; how to wire and solder punched metal chassis as well as the latest development of Printed Circuit chassis. You will learn the basic principles of radio. You will construct, study and work with RF and AF amplifiers and oscillators, detectors, rectifiers, test equipment. You will learn trouble-shooting, using the Progressive Signal Tracer, Progressive Signal Injector, Progressive Dynamic Radio & Electronics Tester, Square Wave Generator and the accompanying instructional material.

You will receive training for the Novice, Technician and General Classes of F.C.C. Radio Amateur License. You will build 20 Receiver, Transmitter, Square Wave Generator, Code Oscillator, Signal Tracer and Signal Injector circuits, and learn how to operate them. You will receive an excellent background for television, Hi-Fi and Electronics. Absolutely no previous knowledge of radio or electronics required. The "Edu-Kit" is the product of many years of teaching and engineering experience. The "Edu-Kit" will provide you with a basic education in Electronics and Radio, worth many times the complete price of \$26.95. The Signal Tracer alone is worth more than the price of the entire Kit.

THE KIT FOR EVERYONE

You do not need the slightest background in radio or science. Whether you are interested in Radio & Electronics because you want an interesting hobby, a well paying business or a job with a future, you will find the "Edu-Kit" a worth-while investment. Many thousands of individuals of all

ages and backgrounds have successfully used the "Edu-Kit" in more than 79 countries of the world. The "Edu-Kit" has been carefully designed, step by step, so that you cannot make a mistake. The "Edu-Kit" allows you to teach yourself at your own rate. No instructor is necessary.

PROGRESSIVE TEACHING METHOD

The Progressive Radio "Edu-Kit" is the foremost educational radio kit in the world, and is universally accepted as the standard in the field of electronics training. The "Edu-Kit" uses the modern educational principle of "Learn by Doing," therefore you construct, learn schematics, study theory, practice trouble shooting—all in a closely integrated program designed to provide an easily-learned, thorough and interesting background in radio. You begin by examining the various radio parts of the "Edu-Kit." You then learn the function, theory and wiring of these parts. Then you build a simple radio. With this first set you will enjoy listening to regular broadcast stations, learn theory, practice testing and trouble-shooting. Then you build a more advanced radio, learn more advanced theory and techniques gradually in a progressive manner, and at your own rate, until you will find yourself constructing more advanced multi-tube radio circuits, and doing work like a professional Radio Technician.

Included in the "Edu-Kit" course are twenty Receiver, Transmitter, Code Oscillator, Signal Tracer, Square Wave Generator and Signal Injector circuits. These are not unprofessional "breadboard" experiments, but genuine radio circuits, constructed by means of professional wiring and soldering on metal chassis, plus the new method of radio construction known as "Printed Circuitry." These circuits operate on your regular AC or DC house current.

THE "EDU-KIT" IS COMPLETE

You will receive all parts and instruction necessary to build 20 different radio and electronics circuits, each guaranteed to operate. Our Kits contain tubes, tube sockets, variable, electrolytic, mica, ceramic and paper dielectric condensers, resistors, tie strips, hardware, tubing, punched metal chassis, instruction Manuals, hook-up wire, solder, selenium rectifiers, volume controls and switches, etc.

In addition, you receive Printed Circuit materials, including Printed Circuit chassis, special tube sockets, hardware and instructions. You also receive a useful set of tools, a professional electric soldering iron, and a self-powered Dynamic Radio and Electronics Tester. The "Edu-Kit" also includes Code instructions and the Progressive Code Oscillator, in addition to F.C.C.-type Questions and Answers for Radio Amateur License training. You will also receive lessons for servicing with the Progressive Signal Tracer and the Progressive Signal Injector, a High Fidelity Guide and a Quiz Book. You receive Membership in Radio-TV Club. Free Consultation Certificate and Discount Privileges. You receive all parts, tools, instructions, etc. Everything is yours to keep.

PRINTED CIRCUITRY

At no increase in price, the "Edu-Kit" now includes Printed Circuitry. You build a Printed Circuit Signal Injector, a unique servicing instrument that can detect many Radio and TV troubles. This revolutionary new technique of radio construction is now becoming popular in commercial radio and TV sets.

A Printed Circuit is a special insulated chassis on which has been deposited a conducting material which takes the place of wiring. The various parts are merely plugged in and soldered to terminals.

Printed Circuitry is the basis of modern Automation Electronics. A knowledge of this subject is a necessity today for anyone interested in Electronics.

FREE EXTRAS

• SET OF TOOLS

- SOLDERING IRON
- ELECTRONICS TESTER
- PLIERS-CUTTERS
- ALIGNMENT TOOL
- WRENCH SET
- VALUABLE DISCOUNT CARD
- CERTIFICATE OF MERIT
- TESTER INSTRUCTION MANUAL
- HIGH FIDELITY GUIDE & QUIZZES
- TELEVISION BOOK & RADIO TROUBLE-SHOOTING BOOK
- MEMBERSHIP IN RADIO-TV CLUB; CONSULTATION SERVICE & FCC AMATEUR LICENSE TRAINING
- PRINTED CIRCUITRY

SERVICING LESSONS

You will learn trouble-shooting and servicing in a progressive manner. You will practice repairs on the sets that you construct. You will learn symptoms and causes of trouble in home, portable and car radios. You will learn how to use the professional Signal Tracer, the unique Signal Injector and the dynamic Radio & Electronics Tester. While you are learning in this practical way, you will be able to do many a repair job for your friends and neighbors, and make fees which will far exceed the price of the "Edu-Kit." Our Consultation Service will help you with any technical problems you may have.

FROM OUR MAIL BAG

J. Statatits, of 25 Poplar Pl., Waterbury, Conn., writes: "I have repaired several sets for my friends, and made money. The "Edu-Kit" paid for itself, I was ready to spend \$240 for a course, but I found your ad and sent for your Kit."

Ben Vaterio, P. O. Box 21, Magna, Utah: "The Edu-Kits are wonderful. Here I am sending you the questions and also the answers for them. I have been in Radio for the last seven years, but like to work with Radio Kits, and like to build Radio Testing Equipment. I enjoyed every minute I worked with the different kits; the Signal Tracer works fine. Also like to let you know that I feel proud of becoming a member of your Radio-TV Club."

Robert L. Shuff, 1534 Monroe Ave., Huntington, W. Va.: "Thought I would drop you a few lines to say that I received my Edu-Kit, and was really amazed that such a bargain can be had at such a low price. I have already started repairing radios and phonographs. My friends were really surprised to see me get into the swing of it so quickly. The Trouble-shooting Tester that comes with the Kit is really swell, and finds the trouble, if there is to be found."

UNCONDITIONAL MONEY-BACK GUARANTEE

ORDER DIRECT FROM AD—RECEIVE FREE BONUS

RESISTOR AND CONDENSER KITS WORTH \$7

- Send "Edu-Kit" postpaid. I enclose full payment of \$26.95.
- Send "Edu-Kit" C.O.D. I will pay \$26.95 plus postage.
- Rush me FREE descriptive literature concerning "Edu-Kit."

Name

Address

PROGRESSIVE "EDU-KITS" INC.

1186 Broadway, Dept. 588-D, Hewlett, N. Y.

TV PICTURE TUBES AT LOWEST PRICES

ALL ALUMINIZED GLASS TYPES					
Type	With Old Tube Price	Type	With Old Tube Price	Type	With Old Tube Price
10BP4	\$ 7.95	17CDP4	\$11.50	21DEP4	\$21.00
12LP4	8.95	17OK/CA/		21DFP4	21.00
14AJP4	14.00	BZ/BRP4	17.00	21DLP4	21.00
14ATP4	14.00	17DLP4	17.00	21DSP4	21.00
14B/E/CP4	10.00	17H/RP4	12.50	21EP4	14.25
14HP4	11.00	17L/VP4	12.50	21FP4	14.50
14QP4	11.00	17GP4	11.50	21WP4	16.00
14RP4	11.00	20C/DP4	13.50	21XP4	16.50
14W/ZP4	11.00	20H/MP4	14.50	21YP4	16.00
14XP4	11.60	21AC/BS/		21ZP4	15.50
16DP4	12.00	AMP4	15.75	24C/VP4	23.50
16K/RP4	9.95	21AL/ATP4	16.75	24AEP4	24.50
16LP4	12.50	21AU/AVP4	15.75	24AHP4	26.50
16TP4	9.95	21AW/P4	15.75	24BP4	24.50
16WP4	12.00	21BTP4	16.75	27EP4	39.95
17AT/AVP4	12.50	21CBP4	16.75	27RP4	39.95
17BP4	9.95	21CEP4	21.00	27SP4	40.95
17BJP4	11.50	21CXP4	15.75		
METAL TYPES					
12UP4	12.00	16GP4	14.50	19AP4	16.00
16AP4	13.50	17CP4	17.00	21AP4	19.75
16EP4	14.00	17GP4	17.60	21MP4	20.75
		17TP4	17.60		
TEST TUBES					
8XP4	16.07	8YP4	16.07		

One Year Factory Registered Warranty
Give size and number of old tube, set make and model if possible. Prices are FOB CHICAGO, ILLINOIS, and tubes will be shipped express, collect unless otherwise specified. Tubes cannot be shipped by parcel post, 25% deposit required on COD shipments. Minimum deposit \$10.00.
These tubes are made from reprocessed glass. All materials including electronic gun are brand new.
Return old tube under vacuum, prepaid, for refund of deposit. We pay shipping charge on orders for 5 or more tubes. We ship to the Continental U.S. and Canada, only.

—PICTURE TUBE OUTLET—
2922 MILWAUKEE AVE., CHICAGO 18, ILLINOIS
Dickens 2-2048

KUHN ... "LEADERS IN SPECIALIZED RECEIVING EQUIPMENT"

MOBILE FIXED CONVERTERS

- POLICE
- FIRE
- COMMERCIAL
- CITIZEN'S BAND

345A Complete \$29.95

A new high gain Crystal Controlled Converter. Excellent sensitivity. Rugged construction. Easy to install. Designed for standard transistor car radios. Requires no high voltage supply. 2-54 MC or 150-162 MC.



KUHN CONVERTERS ... the most advanced line ... designed for optimum performance.

348A Complete \$34.95

Transistorized, directly tunable Converter. Powered with self-contained mercury cell. Excellent sensitivity and stability. Designed for car, home or portable receivers. Two tones available: Aircraft VHF 115-130 MC or 150-162 MC.

344A Complete \$23.95

A new low cost Crystal Controlled Converter designed for use with standard transistor car radios. Operates directly from 12V DC. Rugged construction. Good sensitivity. Range 2-54 MC.



ORDER TODAY or SEND FOR FREE CATALOG ... containing complete information on a full line of CONVERTERS AND RECEIVERS FOR EVERY APPLICATION

315A Complete \$14.95

A low cost Tunable Converter for any 10 MC area of: 26-34 MC, Aircraft VHF, or 150-160 MC. Easily installed. For use with home or auto sets. 316A Directly Tunable Converter. Available in four ranges: 26-30 MC, 30-50 MC, 115-130 MC, or 150-160 MC. Complete \$21.95



KUHN ELECTRONICS INC.
20 GLENWOOD CINCINNATI 17, OHIO

Letters

(Continued from page 28)

side against the back of the sensitized sheet." It should read "... place a piece of carbon paper with



its coated side against the back of the typing paper." Don't you agree?

ARYEH ORGAHD
Jerusalem, Israel

Your correction is correct, Reader Orgahd. Thanks for telling us about it. And we're glad that the article gave you such a good start in making your own blueprints.

Spies Take Notice

■ The article titled "Mikes From Lamp Sockets" (October, 1961) was quite interesting. Mr. Trauffer, however, didn't mention one thing—the excellent "bugging" opportunity afforded by a lamp-socket mike. All you have to do is install it in place of one

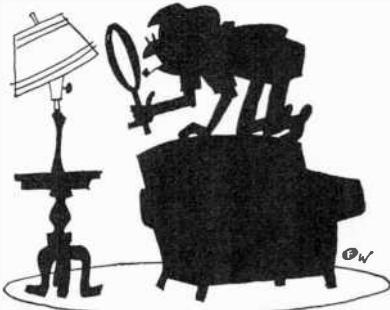

of the normal sockets in a floor or table lamp! I think every spy should know about this excellent method for hiding a microphone.

KEN GREENBERG
Chicago, Ill.

All active spies—and many potential ones—have probably already drawn their own conclusions from Mr. Trauffer's article. We advise readers with anything to hide to take a close look at their lighting equipment.

Carl & Jerry in College

■ Being a student of electrical engineering myself, I'd like to congratulate Mr. Frye on having the foresight to send Carl and Jerry to college. After all, how many more years could the boys stay in

DON'T TURN ANOTHER PAGE until you clip out this coupon!

It could be the turning point in your life!

Make More Money Soon... with Electronics!

GET 2
"PROFITS FROM ELECTRONICS"

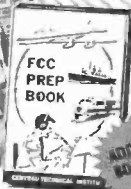

Central Technical Institute's 64-page book on *electronics* is packed with *free information* on amazing *career opportunities* for you in: Industrial Electronics, Automation, Radio, Color TV, Radio-TV Broadcasting, Electrical Wiring, Appliance Servicing, Communications Electronics, Radar, Missiles, Computers, Nuclear Energy, and many others! This *free book* tells all about Central Technical Institute's *different NEW Home Study Course*, "PRACTICAL ELECTRONICS." This Home Study course is so complete, it even contains instructions on how to set up and run your own

FREE BOOKS

"FCC PREP BOOK"
This handy 31-page book tells you all you need to know to pass the 3rd class FCC Radiotelephone examination, qualifying you to operate radio-telephone transmitting stations used by airlines, police, railroads, emergency services, etc.

electronics servicing business. FREE "PROFITS FROM ELECTRONICS" book also contains full information on Central's new Instant Kits, below. All you need do to get this valuable book is fill in your name and address on the above coupon, and MAIL IT TODAY!

GET INTO THE DYNAMIC, \$11,000,000,000 FIELD OF ELECTRONICS!
Gain Higher Income! New Prestige! A Fine Future!

BUILD CENTRAL'S NEW INSTANT KITS®

Central Technical Institute's new INSTANT KITS are designed to *teach you as you build*. Each inexpensive kit comes complete, ready to assemble . . . in only a few short hours of building and learning, you have a piece of test equipment that meets commercial standards, can be used in your business, or sold to customers at a profit. And Central Technical is developing *new kits* for you to build. See the sample selection below:

VOM Tester	Appliance Tester	Transistorized Volt-Ohmmeter Tester	4-Transistor Portable Radio	Transistor Signal Generator	Transistor Photoelectric Switch	Transistor Code Oscillator	All-Purpose Oscilloscope

YOU CAN EARN EXTRA MONEY SOON!
Study at home in spare time—no High School diploma required!

With a sincere desire to get ahead, make more money and enjoy an interesting career . . . you can earn while you learn, keep your present job, and set your own pace. Find out how much fun electronics can be! See how you can add to your income! High income, prestige, and security for you and your family can be yours! Don't let a 4c stamp stand in your way. MAIL THE ABOVE COUPON TODAY and GET YOUR 2 FREE BOOKS NOW. The little time you spend mailing this coupon may be one of the best investments you'll ever make!

MAIL THIS NOW!

Please give me my **TWO FREE BOOKS ON ELECTRONICS** and tell me how I can cash in on opportunities in electronics.

Name.....Age.....

Address.....

City.....Zor e.....State.....

CENTRAL TECHNICAL INSTITUTE
1644 WYANDOTTE, DEPT. PE 12C
KANSAS CITY 8, MO.
Accredited Member National Home Study Council

CLIP OUT THIS COUPON, FILL IN YOUR NAME AND ADDRESS, AND MAIL TODAY . . . FOR 2 FREE BOOKS PACKED WITH EXCITING INFORMATION ON ELECTRONICS.
NO OBLIGATION!

START A BUSINESS OF YOUR OWN . . . OR QUALIFY FOR A HIGH PAY CAREER!
Over 50,000 successful graduates since 1931!

"THANKS to my Central training, I have my First Phone (FCC) Ticket, which gives me an advantage over my competitors. I am a franchised RCA dealer, employ a bookkeeper and usually two servicemen." R. R. "Jack" Merrill, Pryor, Oklahoma.

Superintendent of Communications for the K. C. Southern Railway Company is Central graduate Lawrence D. Fry, with 15 years of railroad communications experience. "Central is a fine school," says Mr. Fry. "I've always recommended it, and have sent several students to Central."

Field Service Representatives for the Bendix Computer Division, L. A., California, are Central graduates E. John Kempf, left, and Robert Young. Mr. Kempf was employed as a maintenance man before he became interested in radio and TV. His first project was building test equipment at home. After enrolling with Central, he began to make extra money repairing radios, auto radios, etc. "The field of Computers is expanding, and there's a real need for trained technicians," he says. "I have found the work to be both profitable and interesting!"

Central Technical Institute

1644 WYANDOTTE, KANSAS CITY 8, MISSOURI
RESIDENT TRAINING—Central also offers a full-time ECPD-Accredited Technical Institute program at its resident school in Kansas City, Missouri. Mail the coupon at page top for information.

Build your own superb SCOTT KITS!

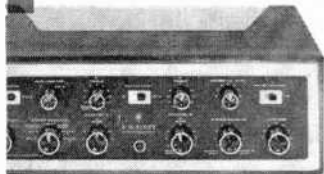

**HAVE
FUN...
SAVE
MONEY**

Have fun . . . save money . . . build the best! Now you can get world-famous Scott stereo components in kit form. Think of it . . . you can build the fabulous new LT-110 FM Multiplex Stereo Tuner . . . your choice of two complete stereo amplifiers, or a preamp and separate power amp . . . all from H. H. Scott!

Write today. Find out about these exciting Scott kits.

**Choice of 3 Booklets
FREE**

H. H. SCOTT

H. H. Scott, Inc. 111 Powdermill Road, Dept. 520-01, Maynard, Mass.

Send me the booklets checked below:

20-page "Guide to Custom Stereo" Complete technical information on kits 16-page booklet explaining FM Stereo

Name _____

Address _____

City _____

Zone _____

State _____

Export: Morhan Exporting Corp., 458 Broadway, N.Y.C.



**SELL YOUR USED
EQUIPMENT Through
POPULAR ELECTRONICS'
Classified Columns!**

The 400,000 purchasers of **POPULAR ELECTRONICS** are always interested in good used equipment or components. So, if you have something to sell, let PE readers know about it through our classified columns. It costs very little: **just 60¢ a word**, including name and address. Minimum message: 10 words.

For
further
information
write:

Martin Lincoln
POPULAR ELECTRONICS
One Park Avenue
New York 16, N. Y.

Letters

(Continued from page 30)

high school? I'm sure that I, and the many other readers of the column, will enjoy their further adventures.

ARTHUR H. RUDER
Brooklyn, N.Y.

Pen Pal Wanted

■ I'm a 26-year-old radio operator for Ferihegy Airport in Budapest, Hungary, and would like to



correspond—in English, French, or German—with an OM or YL about my own age.

PERGOVACZ LAJOS
Budapest 7oPf.73
Hungary

Compactron V.H.F. and FM Receivers

■ I plan to build the Compactron v.h.f. receiver which was described in the September 1961 issue. Can you tell me what changes in the hookup would be required to cover the FM band?

ERNEST PILE
Akron, Ohio

Apparently you missed the August 1961 issue, Mr. Pile. If you check, you'll find complete plans for a Compactron FM receiver in it. Why not become a subscriber?

■ I'm interested in building the Compactron v.h.f. receiver, but am having trouble finding the Merit P-3046 power transformer. Can you tell me where to locate one?

JOHNNY MANS
Riceville, Iowa

If you're having difficulty finding a dealer in your area who stocks Merit units, we suggest that you write Lajayette Radio, 165-08 Liberty Ave., Jamaica 33, N.Y. They'll be able to supply you with an equivalent model.

■ I've been reading the article on the Compactron FM tuner/receiver in the August 1961 issue. Upon checking my catalogs, I found that it was possible to obtain all of the parts except the 12-pin socket for the GE 6D10 Compactron. Would you please publish the address of a company that sells these sockets?

LEONARD M. HARDAWAY
Stockton, Calif.

Two of the many manufacturers producing 12-pin Compactron sockets are: Cinch Manufacturing Co., 1206 S. Homar Ave., Chicago, Ill. (Cat. No. SM-12-D-003) and I. H. Manufacturing Co., 121 Greene St., New York 12, N.Y. (Cat. No. CM-288). Write directly to these companies for a list of dealers in your area.

-30-

We'd like to send you these important new books for a 7-DAY FREE TRIAL EXAMINATION

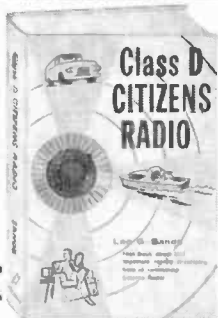

CLASS D CITIZENS RADIO

Leo G. Sands

Here is the first complete book on Citizens Radio Operation. Ever since the initial use of 2-way radiotelephone by police departments, this field has been growing in importance and application. Now, with more than a million vehicles equipped for its use, Citizens Radio is a major phase of the electronics field. This important new volume covers every aspect of the field—its history, rules, and everything about how it works—in seven big chapters with one hundred major sections. You'll learn exactly what Citizens Radio is, its applications, what equipment you need, the full story on receiver circuits and transmitters, antennas, installation, and maintenance, full FCC rulings, how to apply for licenses, etc. Many illustrations.

\$4.95

COMPUTERS AND HOW THEY WORK by James Fahnstock

Here is a fact-filled exciting guidebook to the wonderworld of electronic computers, with more than 120 illustrations and easy-to-follow tables in 10 big chapters. Step by step, you'll see and understand the workings of every type of computer ever used. This important new book illustrates the basic principles of computers in methods that require no knowledge of electronics. You'll learn all about computer memories, flip-flops and the binary counting system. You'll learn the mathematical language of computers where $1 + 1 = 10$. Other chapters show you how computers use tubes and transistors to make complex logical decisions in thousandths of a second. **COMPUTERS AND HOW THEY WORK** is must reading for career minded students and for electronics pros who want a more complete knowledge of this field.

\$4.95

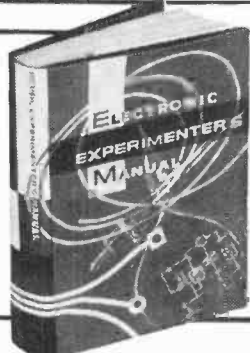
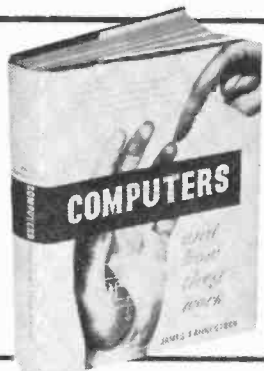

THE ELECTRONIC EXPERIMENTER'S MANUAL

by David A. Findlay

With a few dollars worth of basic tools, and this book to guide you, you can explore the magic of electronics experimentation more completely than ever before. In a few short hours, you'll start your first project. You'll learn about every component used in experimentation, every tool, its function and why it is used. There are 10 big sections, each covering a specific phase of construction. There's a giant section of projects you can build, test equipment you'll construct and use in your future work. **THE ELECTRONIC EXPERIMENTER'S MANUAL** will give you the professional know-how you must have no matter what phase of electronics is your specialty.

\$4.95

SEE YOUR ELECTRONICS PARTS JOBBER OR BOOKSELLER OR USE COUPON BELOW!

7 DAY FREE EXAMINATION

When your books arrive, read and enjoy their diversity of contents, the thoroughness of their coverage. Then after seven days examination, if you decide that they are not everything you want, send them back and receive a complete refund of the purchase price.

ELECTRONICS BOOK SERVICE •

One Park Avenue, New York 16, N. Y.



Please send mecopies of **CLASS D CITIZENS RADIO** and bill me at only \$4.95 a copy plus postage and handling.

Please send mecopies of **COMPUTERS AND HOW THEY WORK**, and bill me at only \$4.95 a copy plus postage and handling.

Please send mecopies of **THE ELECTRONIC EXPERIMENTER'S MANUAL**, and bill me at only \$4.95 a copy plus postage and handling.

If I don't agree that this is one of the best electronics investments I've ever made, I may return the book(s) within seven days and get a full refund.

\$.....enclosed. (SAVE MONEY! Enclose payment with your order and we'll pay the postage.)

Name

Address

City Zone..... State..... EF 630

NEW products

ELECTRONIC ORGAN KIT

Now being manufactured by the *Schober Organ Corporation*, 43 West 61st St., New



York, N. Y., is a "do-it-yourself" electric Spinet organ kit. No technical background is required to put the Spinet together, and its construction is simplified by the use of printed-circuit boards. The completed 88-

key, 13-pedal instrument weighs less than 100 pounds. Price of the kit, about \$500.00, considerably less than the cost of a comparable factory-built unit.

MULTI-FACED HAMMER

A multi-faced hammer made by Ramset is particularly well adapted to the electronic

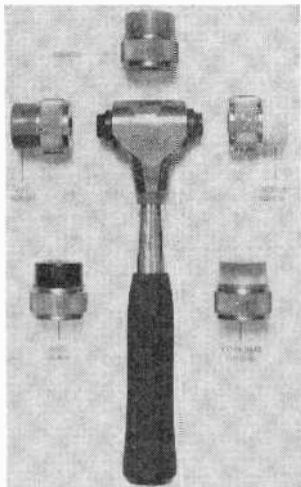

and electrical industries. The "Shure-Drive" can be fitted with any of five interchangeable tips. Color-coded to indicate degrees of hardness, the tips are available in soft, medium, hard, extra-hard, and raw-hide types. Rebound is reduced by 40% by means of a steel striker "floating" within the

head, and a contoured rubber grip is fitted to the handle. The hammer holder is priced at \$10.50; tips run from \$1.25 to \$1.75 each. (*Ramset Fastening System*, New Haven, Conn.)

ECONOMY COMMUNICATIONS RECEIVER

The HE-40 receiver, available from *Lafayette Radio Electronics Corp.*, 111 Jericho

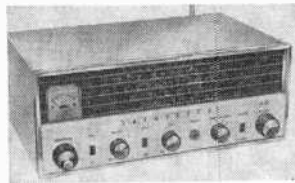

Turnpike, Syosset, L.I., N.Y., covers 1600 kc. to 30 mc. and the standard AM broadcast frequencies in four bands.

The main tuning dial has a 0-100 logging scale and a separate bandspread tuning capacitor is provided. Among the HE-40's other features are a calibrated "S"-meter, BFO/selectivity control, and built-in 5" speaker. The set has a ferrite loop antenna for the broadcast band, telescoping whip for short wave, and provision for connecting an external antenna. Price, \$54.50.

VERSATILE TUBE TESTER

Besides testing all standard radio and TV tubes, Precision's Model 650 grid-circuit-



type tester handles 10-pin miniatures, 12-pin Compac-trons, 5- and 7-pin nuvis-tors, novar tubes, and a wide variety of voltage-reg-ulating, industrial and foreign types. Gas currents as low as 1 micro-

ampere can be measured, and leakage sensitivity is over 100 megohms. An accessory adapter (Model PTA) permits checking TV picture tubes. The tester is priced at \$69.95, the accessory adapter at \$9.95. (*Precision Apparatus Co.*, 70-31 84th St., Glendale 27, L. I., N. Y.)

SIX-METER TRANSCEIVER

The WRL "TechCeiver-6," one of a new series of "Comet"-brand kits, is said



to be among the smallest commercially available 6-meter transceivers. Its superhet receiver is tunable from 48

to 54 mc. and has a built-in noise limiter. The r.f. output of the plate-modulated transmitter is over

NOW!
at a price
you can afford!

MAKE MORE MONEY in ELECTRONICS

TELEVISION-RADIO

**BETTER...MORE COMPLETE...LOWER COST...
WITH NATIONAL SCHOOLS SHOP-METHOD
HOME TRAINING!**

BETTER... Training that is proved and tested in Resident School shops and laboratories, by a School that is the **OLDEST and LARGEST** of its kind in the world.

MORE COMPLETE... You learn **ALL PHASES** of *Television-Radio-Electronics*.

LOWER COST... Other schools make several courses out of the material in our **ONE MASTER COURSE**... and you pay more for less training than you get in our course at **ONE LOW TUITION!**

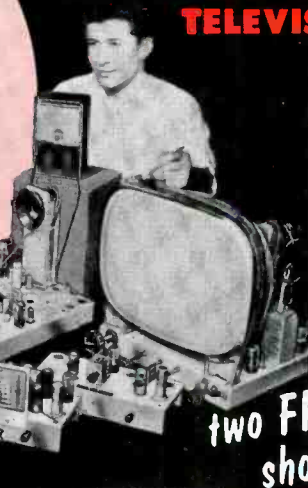

These
two FREE books will
show you how!

You get all information
by mail... You make
your own decision... at
home! **NO SALESMAN
WILL CALL**

**TOP PAY... UNLIMITED OPPORTUNITIES
LIFETIME SECURITY CAN BE YOURS!**

You are needed in the Television, Radio, and Electronics industry! Trained technicians are in growing demand at excellent pay—in **ALL PHASES**, including Servicing, Manufacturing, Broadcasting and Communications, Automation, Radar, Government Missile Projects.

NATIONAL SCHOOLS SHOP-METHOD HOME TRAINING, with newly added lessons and equipment, trains you in your spare time at home, for these unlimited opportunities, including many technical jobs leading to supervisory positions.

YOU LEARN BY BUILDING EQUIPMENT WITH KITS AND PARTS WE SEND YOU. Your National Schools course includes thorough Practical training—**YOU LEARN BY DOING!** We send you complete standard equipment of professional quality for building various experimental and test units. You advance step by step, perform more than 100 experiments, and you build a complete TV set from the ground up that is yours to keep! A big, new TV picture tube is included at no extra charge.

EARN AS YOU LEARN. We'll show you how. Many students pay for their course—and more, while studying.

**GET THE BENEFIT OF OUR
OVER 50 YEARS EXPERIENCE**

APPROVED FOR
GI TRAINING



ACCREDITED
MEMBER



NATIONAL TECHNICAL SCHOOLS
World-Wide Training Since 1905

Write to Dept. R2G
4000 So. Figueroa Street
Los Angeles 37, California

YOU GET...

- 19 Big Kits—**YOURS TO KEEP!**
- Friendly Instruction and Guidance
- Job Placement Service
- Un limited Consultation
- Diploma—Recognized by Industry
- **EVERYTHING YOU NEED FOR SUCCESS!**

**IMPORTANT
SEE OTHER SIDE**

**SEND FOR FREE FULLY-
ILLUSTRATED BOOK AND
ACTUAL LESSON TODAY.**
Your own copy of "Your
Future In Electronics-Tele-
vision-Radio" will be mailed
to you at once. No salesman
will call; there is no obli-
gation. Cut out card along dot-
ted lines, fill in and rush
air-mail today!
NO POSTAGE NECESSARY

CUT OUT AND MAIL THIS CARD TODAY

Yes, I want to make more money in Electronics-
TV-Radio. Send me your **FREE Fully-Illustrated
Opportunity Book and Actual Lesson** today.

RUSH AIR MAIL—NO POSTAGE NECESSARY



Name _____ Age _____

Address _____

City _____ Zone _____ State _____

Check here if interested only in Resident Training at Las Angeles. R2G-12
Veterans: Give date of discharge _____

NO SALESMAN WILL CALL; NO OBLIGATION ON YOUR PART

DON'T BE HALF-TRAINED

Be a MASTER TECHNICIAN in ELECTRONICS-TV-RADIO

Only N.T.S. offers you ALL 8 PHASES in
ONE MASTER COURSE



SUCCESS IS THEIRS; IT CAN BE YOURS TOO!



When I enrolled with N.T.S. last November, I was trained as a Seismograph

Observer. I was promoted to that job on May 1st of this year. With your school and my practical work in the field, my superiors recognized that I was capable of handling the job of Seismograph Recording. My superiors highly praise your school. The day I enrolled started me off to success.

Edgar Wesatzke

As field director of Berean Mission Inc., I have complete charge of our radio work.

With the expert advice and training I am receiving from you I can do my own repairs on our recorders and P.A. systems, besides keeping our radios going. My training from N.T.S. helps keep us on the air. I feel privileged to be a member of such a fine institution.

Rev. Enoch P. Sanford



Thanks to N.T.S. I have a business of my own right in my home. I am still in the

Air Force but I have paid for all my equipment with money earned servicing TV sets. Yes, N.T.S. gave me my start in television.

Louis A. Tabat

I have a TV-Radio shop in Yorkville, Illinois, about 4 miles from my home, and it has been going real good. I started part-time but I got so much work that I am doing it full-time. Thanks to National Technical Schools.



Alvin Spera

ALL 8 PHASES IN ONE MASTER COURSE

PHASE 1 TELEVISION
INCLUDING COLOR TV
90% of homes have at least one set. Color TV is becoming more popular daily. TV Stations grow in number, need technicians. Maintenance and repair offer big opportunities.

PHASE 5 FCC LICENSE PREPARATION
FCC License holders have a wide range of top jobs open to them. FCC License now a requirement for most Communication jobs.

PHASE 2 RADIO—AM & FM
Radios in homes, cars, schools, all need expert upkeep. Stations expand as FM becomes popular. Now transistors boom entire field.

PHASE 6 RADAR AND MICROWAVES
These are the communications systems of the future, already used in tracking and contacting satellites.

PHASE 3 ELECTRONICS
Computers, Data-Processing machines, Electronic Controls, Guided Missile Systems are new fields where Electronics play a vital role.

PHASE 7 AUTOMATION & COMPUTERS
Automation and Computer electronics are the new tools of industry and commerce. Skilled Technicians in these fields are in great demand at top pay.

PHASE 4 SOUND SYSTEMS
New popularity of Hi-Fi Stereo, as well as industrial sound systems and business intercoms make this a highly specialized and important field.

PHASE 8 BROADCASTING & COMMUNICATIONS
In the entertainment industry, or in commerce, communications and broadcasting have great importance. Installation and maintenance of equipment requires trained technician know-how.

SEE OTHER SIDE

BUSINESS REPLY MAIL
NO POSTAGE STAMP NECESSARY IF MAILED IN THE UNITED STATES

VIA AIR MAIL

FIRST CLASS

Permit No. 3087

Los Angeles, Calif.

— POSTAGE WILL BE PAID BY —

NATIONAL TECHNICAL SCHOOLS

WORLD-WIDE TRAINING SINCE 1905

4000 So. Figueroa Street

Los Angeles 37, California

RESIDENT TRAINING
AT LOS ANGELES

If you wish to take your training in our famous Resident School in Los Angeles—the oldest and largest school of its kind in the world—check special box in coupon.



Approved for GI Training

NATIONAL TECHNICAL SCHOOLS

WORLD-WIDE TRAINING SINCE 1905

Address correspondence to Dept. R2G

4000 So. Figueroa Street

Los Angeles 37, California

National Technical Schools also offers complete Home Study Training Programs in Auto Mechanics & Diesel, and Air Conditioning-Refrigeration-Electrical Appliances. For information and Free Book write the School, Department RDC, stating course desired.

one watt. Transmitter tuning and power indicators are included as well as a push-to-talk relay, and separate power supplies are available for fixed or mobile operation. The transceiver uses standard 8-mc. crystals and sells for \$39.95. (*World Radio Laboratories, 34th and Broadway, Council Bluffs, Iowa*)

LICENSE-FREE "WALKIE-TALKIE"

The EICO #740 CB transceiver has a 100-milliwatt-input transmitter and a super-heterodyne receiver—both crystal-controlled. No license is required to operate the hand-held unit, which is powered by a nickel-cadmium battery; the battery provides 10-12 hours of intermittent use and can be recharged up to 500 times with the charger supplied. The communicating range between two #740's runs from a few blocks in heavily built-up areas to 10 miles in open country. A single transceiver, however, can cover substantially



greater distances in cities when communicating with a conventional 5-watt input CB unit. Price: \$54.95 in kit form; \$79.95 wired. (*EICO Electronic Instrument Co., Inc., 33-00 Northern Blvd., L.I.C. 1, N. Y.*)

WORKBENCH LEGS

No previous experience is needed to build your own workbench if you use "Pridecraft"

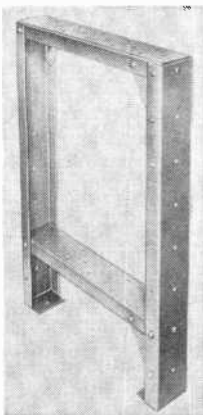

workbench legs made by Pollard. Free plans illustrate the six simple steps involved in the construction and list the hardware, lumber, and tools required. Following these plans and using two Pridecraft legs, anyone can set up a custom workbench in three hours or less. Furthermore, the easy-to-assemble legs are said to have all the rigidity and strength of industrial-type units. Available in green, silver, or gold, they cost \$8.50 each and

are shipped individually packed in 4" x 4" x 33" cartons. (*Pollard Bros. Manufacturing Co., 5504 Northwest Highway, Chicago 30, Ill.*)

AUTOMATIC VTVM

Only one scale is visible at a time on the "Dynamatic 375" automatic VTVM; changing the range switch automatically inserts the proper direct-reading scale in the meter. The instrument measures 0-1500 volts



d.c., r.m.s. a.c.,

or peak-to-peak a.c. (seven ranges for each). It also handles d.c. currents from 0 to 500 ma. in three ranges and ohms from 0 to 1000 megohms in seven ranges. Accuracy is $\pm 3\%$ (full-scale a.c. and d.c.), and a 100-microampere meter movement is used. Price, \$89.95. (*B&K Manufacturing Co., 1801 Belle Plaine Ave., Chicago 13, Ill.*)

AUTO ANTI-THEFT DEVICE

An automobile anti-theft device marketed by PECO discourages car thieves in two ways. When it is installed and turned on, the car's ignition, lights, and other electrical accessories are prevented from functioning. Furthermore, if any of this electrical equipment is switched on, the auto's horn will sound. Provision is made for normal operation of parking lights, electric clock, and any other electrical device ordinarily in use while the car is unattended. The anti-theft device sells for about \$9.95 and comes with complete installation instructions. (*The Protection Equipment Co., Inc., Hopkins, Minn.*)

SOLDERLESS CONNECTOR

A unique solderless connector, the "Omni-Grip Type A," is being produced by *Cosmic Voice, Inc.,*

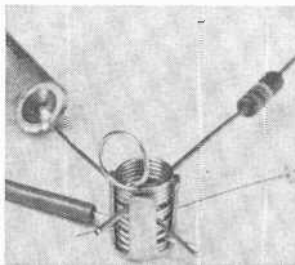

Box 11, Jackson, Mich. Designed for use in experimental hookups, it consists of a tension spring mounted in a forked cup. The cup is installed on a breadboard or

panel with screws supplied. Connections are then made by expanding the spring (a looped handle is provided for this purpose) and sliding a lead through the coils. The connector will hold tightly as many as eight leads (up to #14 size) from any direction. A package of one dozen "Omni-Grips" costs \$1.20.

—50—

Tips and Techniques

MINIATURE SOCKET WRENCHES

Allen-head cap screws can be easily made into convenient socket wrenches for popular sizes of miniature hex nuts. Select an assortment of 1" or 1½" screws whose heads fit the miniature hex-nut sizes you'll

be most likely to encounter, and drill a hole through the end of the threaded portion of each one. Insert a 1" rod cut from a nail or brad in each hole and solder it in place to make a "T" handle.

—Charles W. Bittner



SCREEN SORTS OUT KIT PARTS

One of the first steps in putting a kit together or constructing a project is to sort

out the parts. You can make this job considerably easier by using a section of old window screen mounted over a shallow cardboard box. Just arrange capacitors, resistors, transistors, etc., on the screen by pushing their leads through the holes.

—Bob Culter

"HANG UP" STORAGE JARS

The glass jars in which baby food comes packed are very well suited for small-parts storage—and most families with small babies have an unlimited supply of such jars. Just attach a 1" angle bracket to the top of each jar and paint the assembly flat black. Related components can be grouped together and the jars hung on perforated panels using standard pegboard hardware.

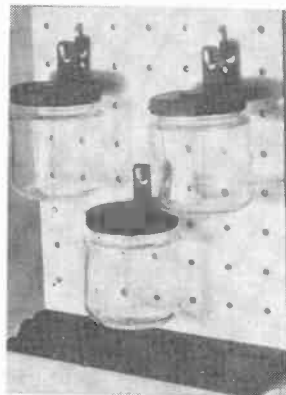

A glance will reveal the contents of any particular jar.

—James A. Fred

BUILD THE FINEST

Professional Quality
CUSTOMIZED

TV KIT

The "PROFESSIONAL" Series—designed for the perfectionist seeking the finest in TV performance. Easy to assemble. No technical knowledge required. An ideal "Learning" Kit with a Complete Course of Study is available.

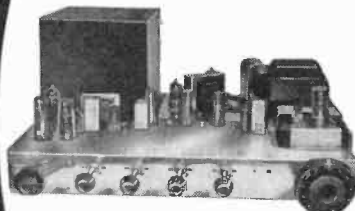

Also available:
WIRED CHASSIS
for custom installations with a choice

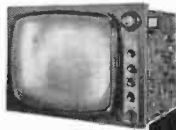

of vertical or horizontal controls and the newest 19", 23" or 27" Picture Tube.

On Easy "Pay As You Wire" Terms. Only \$15 for the Starting Package!

A few of the **Professional Quality Features:**
Choice of push-pull 10-watt audio or cutput to your Hi-Fi system... D.C. restoration... Ultra-linear sweep circuits... Standard Coil Guided Grid Turret Tuner... Super-sensitivity for fringe areas... Complete line of Accessories for Custom Installations.

Choice of 19", 23" or 27" CRT. Prices range from \$119 to \$199.

U.S. Armed Services and over 4000 schools and colleges have selected *Transvision* Receivers for educational television.

Interested in Electronics?

Learn the basic principles of electronics from the Course available with the Kit.



New Rochelle, N.Y.
NE 6-6000



Beautiful Cabinets designed to enhance sound quality and blend with modern decor. For TV or combination TV and Hi-Fi.

ASSEMBLY MANUAL - \$2

See how easy it is to assemble the Transvision Kit. Cost of Manual refunded on purchase of Kit.

START NOW — MAIL THIS COUPON —

- Transvision Electronics, Inc., New Rochelle, N.Y. Dept. PE
- Send Free 8-page Catalog Enclosed is \$2. for Assembly Instructions so that I might see how easy it is to assemble the Transvision Kit. I understand that this will be refunded if I purchase a kit.
- Enclosed is \$15 for the Starting Package. I understand that I can buy packages one at a time as I wire. (Models range from \$119 to \$199.)

Name..... Address.....
City..... Zone..... State.....

SOLDERING GUN REPAIRS CRACKS

You can repair a cracked plastic radio cabinet in a jiffy by bonding the pieces together

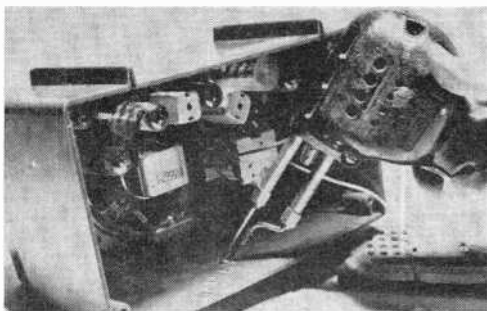

with a soldering gun or iron. Working from the inside of the cabinet, melt small furrows across the crack in several places. If desired, these dents can later be covered with masking tape.

—Homer L. Davidson

GROMMET LIMITS TAP TRAVEL

When threading holes in an electronic chassis, you can avoid damaging the delicate components mounted underneath the chassis by limiting the distance of tap travel. This is easily done by slipping a snug-fitting rubber grommet over the end of the tap. Place the grommet just far enough in so that the tool can do its work properly.

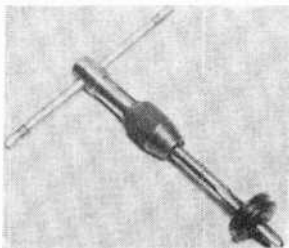

—John A. Comstock

SOLUTION FOR NOISY CONTROL

Next time you need some control cleaner in a hurry and all the radio shops are closed, try using some alcohol-base before-shave lotion. It'll do just about as good a job as the standard cleaner... and it smells nice, too. The best way to apply the solution to the noisy control is with a small syringe but, if you don't have one, an old fountain pen can be used as a substitute.

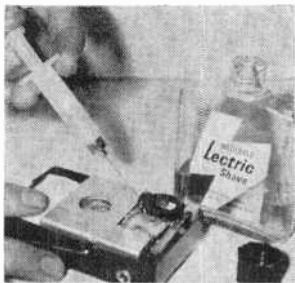

—James Clifford

"DIAL LIGHT" FOR PORTABLES

If you occasionally use your portable radio outside at night, you've probably wished that you had an illuminated dial. Pilot lights are difficult to build into today's compact sets and, even if installed, would be an excessive drain on the battery. The answer is to use the non-poisonous luminous paint now stocked at many hardware stores. Apply it to the set's dial pointer and numerals with a toothpick or a small brush.

—Konrad Axelrod

QUICK-CHANGE BINDING POST

One fast saw-cut will convert a standard binding post to the quick-change type. Just slit the screw down the middle with a sharp hacksaw blade and you'll be able to slide in several leads without crimping their ends. A small washer should be inserted under the binding post head to prevent the wires from becoming jammed. If you would like to increase the wire capacity of the binding post, try substituting a longer screw for the original one.

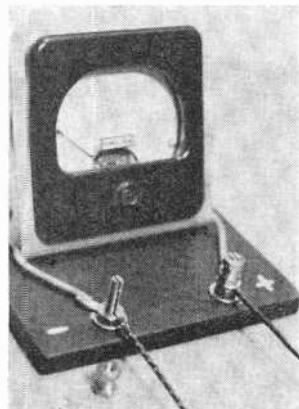

—Robert Micals

QUICK CHECK FOR TEST INSTRUMENTS

The resistance section of an RC substitution unit can be used to make a fast check on your ohmmeter scales. In the case illus-

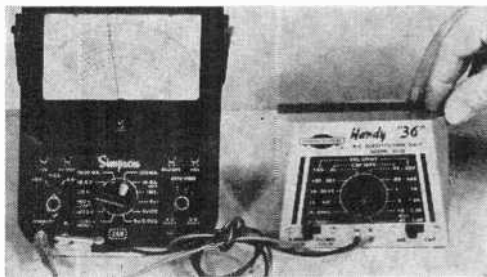

trated, the unit is set for 18 ohms—verifying (approximately) the accuracy of the R x 1 scale of the multimeter. Similarly, the capacitance section may be used to check out a capacitor tester.

—H. Leeper

BEST BUYS IN STEREO AND MONO HI-FI

New Transistorized Stereo/Mono 4-Track Tape Deck RP100 Semikit (electronics in kit form) \$299.95 Wired \$ 99.95



New FM-AM Stereo Tuner ST96 Kit \$89.95 Wired \$129.95 Incl. FET

New 70-Watt Integrated Stereo Amplifier ST70 Kit \$94.95 Wired \$149.95



New 40-Watt Integrated Stereo Amplifier ST40 Kit \$79.95 Wired \$129.95

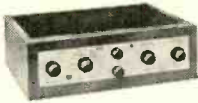

28W Integrated Stereo Amplifier HF81 Kit \$69.95 Wired \$109.95

FM Tuner HFT90 Kit \$39.95 Wired \$65.95 Incl. FET Metal Cover \$3.95



AM Tuner HFT94 Incl. FET Kit \$39.95 Wired \$65.95



Stereo Preamplifier HF85 Kit \$39.95 Wired \$64.95

Stereo Power Amplifiers

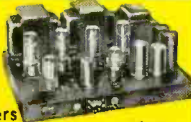

	Kit	Wired
100W HF89:	\$99.50	\$139.50
70W HF87:	\$74.95	\$114.95
28W HF86:	\$43.95	\$ 74.95



NEW FM-Multiplex Autodaptor MX99 Kit \$39.95 Wired \$64.95 (Patents Pending)



Bookshelf Speaker System HFS1 Kit \$39.95 Wired \$47.95

BEST BUYS IN CITIZENS TRANSCEIVERS, HAM GEAR, RADIOS

Citizens Band Transceivers from Kit \$59.95 Wired \$89.95



New 60W CW Transmitter #723 Kit \$49.95 Wired \$79.95

NEW Walkie-Talkie Citizens Band Transceiver #740 Kit \$54.95. Wired \$79.95. Complete with rechargeable battery & charger.



EXCELLENCE IN CREATIVE ELECTRONICS

Over 2 MILLION EICO instruments in use throughout the world. Compare, take them home — right "off the shelf" — from 1500 neighborhood dealers, most of whom offer budget terms.

BEST BUYS IN TEST EQUIPMENT

New Metered Variable Auto-Transformer AC Bench Supplies Model 1073 (3 amps) Kit \$35.95 Wired \$47.95 Model 1078 (7½ amps) Kit \$42.95 Wired \$54.95



Peak-To-Peak VTVM #232 & Uni-Probe® Pat. #2,790,051 Kit \$29.95 Wired \$49.95



VTVM #221 Kit \$25.95 Wired \$39.95

DC-5 MC 5" Scope #460 Kit \$79.95 Wired \$129.50
5" Push-Pull Scope #425 Kit \$44.95 Wired \$79.95



Tube Tester #625 Kit \$34.95 Wired \$49.95



RF Signal Generator #324 Kit \$26.95 Wired \$39.95



1000 Ohms/Volt V-O-M #536 Kit \$12.90 Wired \$16.90



6- & 12V Battery Eliminator & Charger #1050 Kit \$29.95 Wired \$38.95
Extra-filtered for transistor eqpt. #1060 Kit \$38.95 Wired \$47.95



NEW AC Volt-Watt Meter #260 Kit \$49.95 Wired \$79.95



Multi-Signal Tracer #145A Kit \$19.95 Wired \$28.95



EICO, 3300 N. Blvd., L.I.C. 1, N.Y. PE-1
 Send free Catalog describing over 80 top-quality products, free Stereo Hi-Fi Guide, free Short Course for Novice License, name of nearest EICO dealer. Send new 36-page GUIDEBOOK TO HI-FI for which I enclose 25¢ for postage & handling.

Name.....
 Address.....
 City..... Zone..... State.....
 Add 5% in the West

Listen to the EICO Hour, WABC-FM, N. Y. 95.5 MC, Mon.-Fri., 7:15-8 P.M.

© 1962 by EICO, 33-00 N. Blvd., L. I. C. 1, N.Y.

COVER STORY

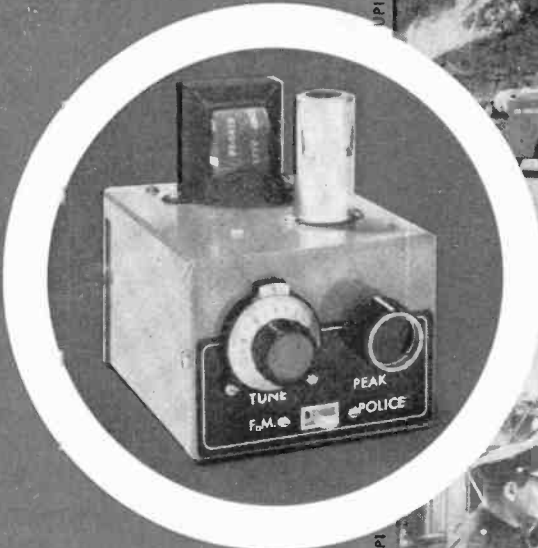

By
HARTLAND B. SMITH
W8VVD

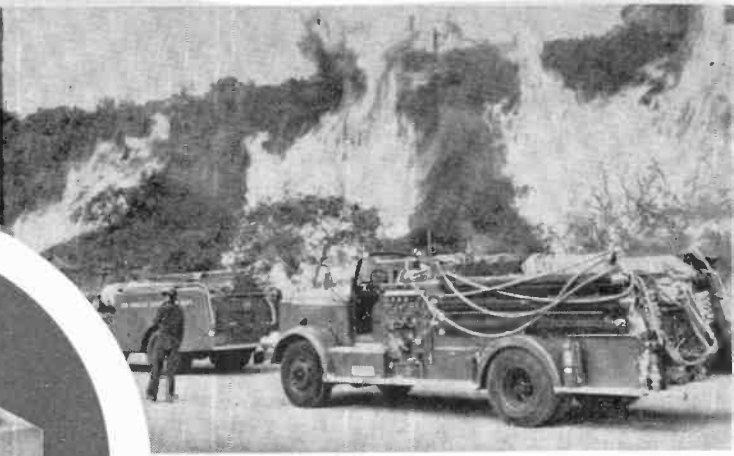

The "10-8" DE LUXE

*Eavesdrop on the news
while it's happening—
with a converter that pulls in everything
from police cruisers to cabs and fire engines*

ALTHOUGH a good many SWL's are unaware of it, one of the busiest portions of the radio spectrum extends from 150.8 to 162 mc. This band is literally alive with police and fire calls, mobile telephone conversations, and the voices of taxicab dispatchers! Public utilities employ this segment of the ether to keep in touch with their repair crews. And, in coastal areas, even steamships can be heard on these frequencies.

Attached to a standard FM receiver or

tuner, the 10-8 converter enables you to eavesdrop on all this exciting activity. If you're the kind of fellow who enjoys "keeping up with the news" while it's happening, you'll undoubtedly want to try your hand at building this little gadget. Costing less than \$20.00, it can provide you with many hours of fascinating entertainment.

Why is the converter dubbed the 10-8? Because "10-8" in the "10" system used by the police means "in service"—

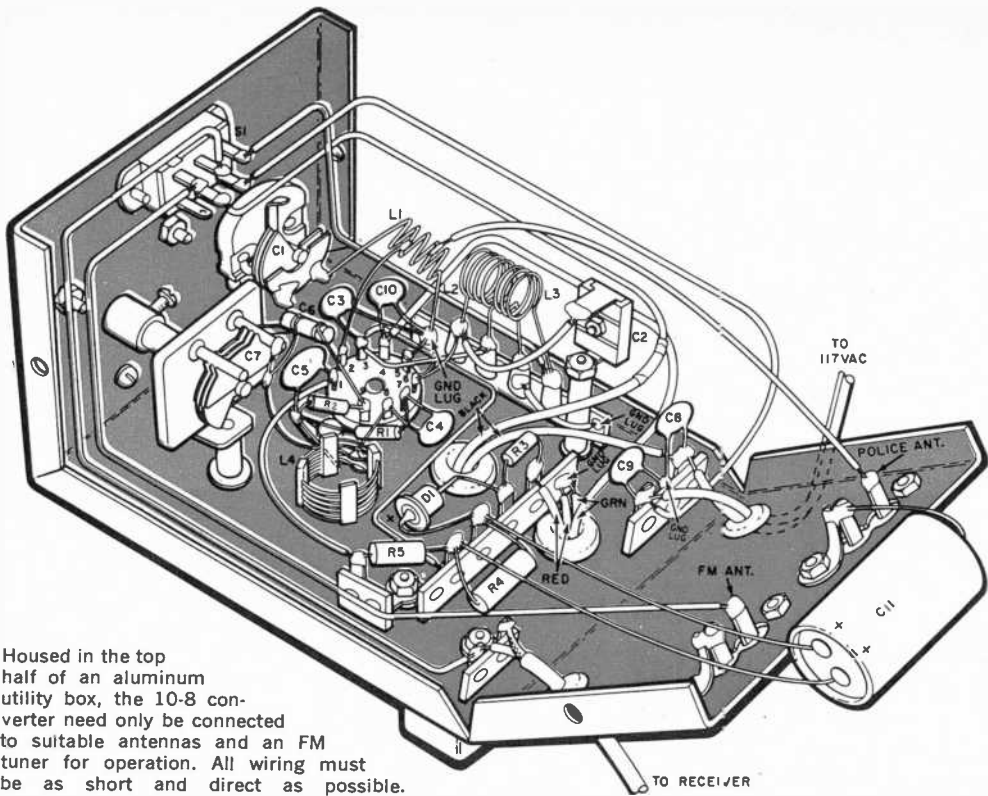

Housed in the top half of an aluminum utility box, the 10-8 converter need only be connected to suitable antennas and an FM tuner for operation. All wiring must be as short and direct as possible.

which is just what your 10-8 will be most of the time.

Construction. The top half of a 5" x 4" x 3" aluminum utility box supports all of the parts. Component placement should closely follow that of the original, since changes in layout may adversely affect the circuit's performance.

Capacitor *C7*, a Hammarlund HF-15 variable driven by a small vernier dial, is supported on a 1/2" metal spacer held in place with a 6-32 machine screw. The dial should be set so that it reads 10 when the capacitor's plates are completely unmeshed.

The other tuning capacitor, *C1*, can be any small variable with a maximum capacity between 10 and 15 $\mu\mu\text{f}$. Mount it on the front panel and orient it so that the stator lugs are positioned as illustrated. A capacitor taken from the author's spare-parts box was used in the prototype. However, if you don't happen to have such a unit on hand, a second HF-15 can be used at this point.

The socket for *V1* should be mounted

with pins 1 and 9 pointing toward the center of the chassis and pins 4 and 5 near the edge. One mounting lug of a four-lug terminal strip is held by the tube-socket mounting nut near pins 4 and 5. The other mounting lug on the terminal strip is fastened to the chassis with a 1 1/4" 6-32 screw, and this same screw also holds *C2* atop a 1" metal spacer. Make certain that the movable plate of this capacitor is the one which is grounded to the spacer.

Another four-lug terminal strip, held by *T1*'s mounting nuts, provides support for *D1*, *R3*, *R4*, and one end of *R5*; a single-lug tie point acts as a convenient terminal for the other end of *R5*. In addition, a couple of two-lug, screw-type terminal strips are mounted on the rear of the chassis and serve as antenna connectors. One terminal of each strip is grounded to the chassis.

Grommets should be placed in two holes in the top of the chassis through which the transformer leads pass. Two other grommets at the rear of the chassis

Circuit of 10-8 employs a 6EA8 mixer/oscillator to convert incoming signals to 108 mc. Switch S1A selects police or FM antenna.

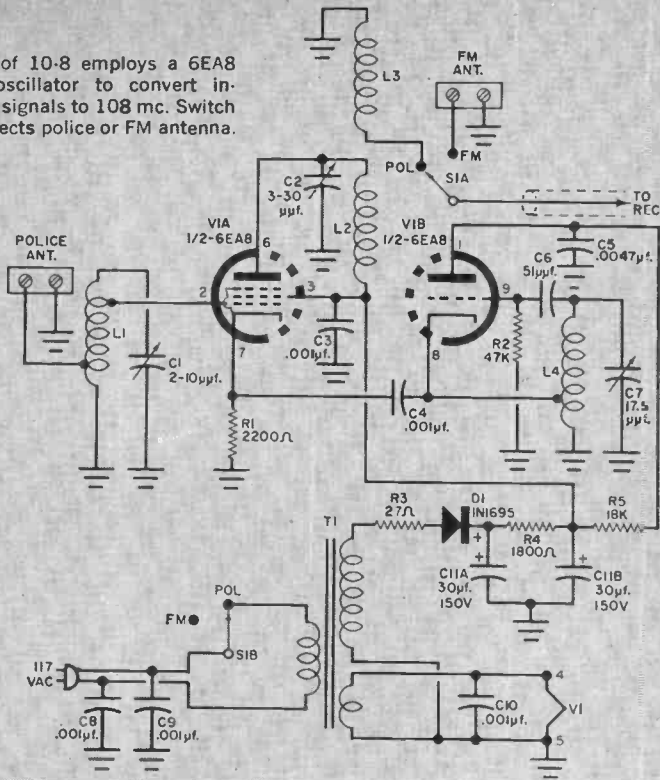

PARTS LIST

- C1—2 - 10 μf . midget variable capacitor—see text
 C2—3 - 30 μf . mica trimmer capacitor
 C3, C4, C8, C9, C10—0.001- μf ., 600-volt disc capacitor
 C5—0.0047- μf ., 600-volt disc capacitor
 C6—51- μf . tubular ceramic capacitor, zero temperature coefficient
 C7—2.8 - 17.5 μf . midget variable capacitor (Hammarlund HF-15 or equivalent)
 C11—30/30- μf ., 150-volt electrolytic capacitor
 D1—1N1695 diode
 L1—Five turns of #20 tinned solid copper wire, $\frac{1}{8}$ " in diameter, spaced 4 times the diameter of the wire and tapped $1\frac{1}{2}$ turns from each end, with $\frac{3}{8}$ " leads—see text
 L2—Four turns of #20 Nyclad wire, $\frac{3}{8}$ " in diameter, close-wound, with $\frac{3}{8}$ " leads—see text
 L3—Three turns of #20 Nyclad wire, $\frac{3}{8}$ " in diameter, close-wound, with $\frac{3}{8}$ " leads—see text
 L4—Six turns of #20 tinned solid copper wire, spaced the diameter of the wire, $\frac{5}{8}$ " in diam-

- eter, tapped 3 turns from the ground end, with $\frac{3}{8}$ " lead at ground end, 1" lead at grid end (Barker and Williamson 3007 Miniductor)
 R1—2200-ohm, $\frac{1}{2}$ -watt resistor
 R2—47,000-ohm, $\frac{1}{2}$ -watt resistor
 R3—27-ohm, $\frac{1}{2}$ -watt resistor
 R4—1800-ohm, 1-watt resistor
 R5—18,000-ohm, 1-watt resistor
 S1—D.p.d.t. slide switch
 T1—Power transformer; primary, 117 volts a.c.; secondaries, 125 volts @ 15 ma. and 6.3 volts @ 0.6 amp. (Stancor PS-8415 or equivalent)
 V1—6EA8 tube
 1—Nine-pin miniature tube socket, shield base (Amphenol 59-407 or equivalent)
 1—Miniature tube shield for above (Amphenol 5-408 or equivalent)
 1—5" x 4" x 3" aluminum chassis box (Bud CU-2105A or equivalent)
 1—36-mm. ($1\frac{1}{2}$ ") vernier dial (Lafayette F-348 or equivalent)
 1—15" length of RG-122/U coaxial cable
 Misc.—Screws, grommets, knobs, terminal strips, ground lugs, etc.

protect the a.c. power cord and the coaxial lead which runs between the FM receiver and the 10-8. Four more grommets, inserted in holes drilled at each corner of the bottom cover, serve as

protective feet for the device. Additional holes include those for C1 and C7 as well as one in the side of the cover to provide access for adjusting C2.

Wind the coils exactly as specified in

THE "10" SIGNALS

The APCO "10" signals were developed by the Associated Police Communication Officers, Inc., to reduce the content of police messages to a codified form. Listed below are the "10" signals most often heard on the air, together with their meanings.

- 10-1 Receiving poorly—move to better location.
- 10-2 Receiving well.
- 10-3 Stop transmitting.
- 10-4 Acknowledgment (OK).
- 10-5 Relay.
- 10-6 Busy.
- 10-7 Out of service.
- 10-8 Repeat, conditions bad.
- 10-10 Out of service—subject to call.
- 10-11 Dispatching too rapidly.
- 10-12 Officials or visitors present.
- 10-13 Advise weather and road conditions.
- 10-14 Convoy or escort.
- 10-15 We have prisoner in custody.
- 10-16 Procure prisoner at _____.
- 10-17 Procure papers at _____.
- 10-18 Complete present assignment as quickly as possible.
- 10-19 Return to your station.
- 10-20 What is your location?
- 10-21 Call this station by telephone.
- 10-23 Stand by.
- 10-24 Trouble at station—unwelcome visitors—all units in vicinity report at once.
- 10-29 Check for wanted.
- 10-31 Is lie detector available?
- 10-32 Is drunkometer available?
- 10-33 Emergency traffic at this station.
- 10-34 Clear for local dispatch?
- 10-35 Confidential information.
- 10-36 Correct time?
- 10-37 Operator on duty?
- 10-38 Station report satisfactory.
- 10-40 Advise if Officer _____ is available for radio call.
- 10-60 What is next message number?
- 10-63 Net is directed.
- 10-64 Net clear.
- 10-67 Stations _____ carry this message.
- 10-68 Repeat dispatch.
- 10-70 Net message.
- 10-71 Proceed with traffic in sequence.
- 10-83 Have Officer number _____ call this station by telephone.
- 10-92 Your quality poor—transmitter apparently out of adjustment.
- 10-97 Arrived at scene.
- 10-98 Finished with last assignment.
- 10-99 Unable to receive your signals.

All municipal, county, and state police; special emergency; forestry; fire department; local government; and highway maintenance radio stations appear in the 200-page "Official Registry of Public Safety Radio Systems." Available from Communication Engineering, Box 629, Mineola, N. Y., for \$4.00, the book lists frequencies, call-signs, locations, and number of mobile units.

the Parts List. Strip the insulation from a short length of No. 20 tinned solid hookup wire to make $L1$, and solder this coil between the terminal strip mounting lug near the tube socket and the closest stator terminal of $C1$. Next, run a bare 1" lead from pin 2 of $V1$ to a point $1\frac{1}{2}$ turns from the "capacitor" end of $L1$. Finally, solder a $5\frac{1}{2}$ "-long insulated wire between the ungrounded end of the police antenna terminal strip and a point $1\frac{1}{2}$ turns from the opposite end of the coil.

Nyclad wire (No. 20), with its tough, chip-resistant coating, is recommended for both $L2$ and $L3$; be certain to scrape the insulation carefully from the leads at the ends of these coils. Note that coil $L2$ is supported by the 4-lug terminal strip's two insulated lugs nearest the tube socket. A $\frac{3}{4}$ " length of bare wire runs from pin 6 of $V1$ to the near end of $L2$; a $2\frac{1}{2}$ " wire is also soldered to this end of $L2$ and then run to the fixed plate of $C2$. A wire soldered to tube pin 3 is connected to the opposite end of $L2$.

Coil $L3$ is fastened to the two insulated lugs nearest $C2$. A short insulated wire runs from the end of $L3$ next to $L2$ to the grounded terminal strip mounting lug near $C2$. A $6\frac{1}{4}$ "-long insulated wire is then run from the other end of $L3$ to the "Police" terminal of $S1a$.

Before installing $L4$, solder a $\frac{3}{4}$ " piece of bare wire to the third turn from the bottom end of the coil. More room will be available for making this tap if you bend the second and fourth turns inward by pushing on them with a screwdriver. Place the coil between the ground lug near pin 9 of $V1$ and the adjacent stator lug of $C7$. The wire from the tap at turn 3 can now be soldered to tube pin 8.

Finally, trim the leads of $C6$ to $\frac{1}{2}$ ". One end of this capacitor is soldered to pin 9 of the tube; the opposite end is wrapped around and soldered to the lead of $L4$ which connects to $C7$.

Alignment. With power applied to the 10-8 and the bottom cover removed, there are a number of exposed high-voltage points in the converter which are apt to shock the unwary. Therefore, it's wise to "play it safe" and put on a pair of gloves before making the following adjustments.

First, connect a 150-mc. antenna to the
(Continued on page 106)

STEREO SIXTEEN PLUS FOUR

*Sixteen 5" speakers and
four 2" tweeters deliver
super-sweet stereo sound
from a single enclosure*

By **JIM KYLE**, K5JKX/6

DO STEREO SPEAKERS pose a space problem for you? If so, here's a complete stereo speaker system, housed in a single enclosure measuring less than 2 feet deep and 3 feet wide, which you can build in a single weekend for less than \$50.00. Based on the principles of the "Sweet Sixteen" (see January, 1961, *POPULAR ELECTRONICS*, p. 55), this speaker system, consisting of sixteen 5" units and four tweeters, reproduces the full audible range with outstanding clarity and definition. What's more, it effectively spreads the stereo effect over the entire room rather than along the conventional "line down the middle."

The only "drawback" (if it is a drawback) to the "Stereo Sixteen" is that it *must* be placed against a wall so that the sound will be reflected into the room. (Its stereo effect disappears when the sound is not reflected, due to the need for greater "spread" between the two

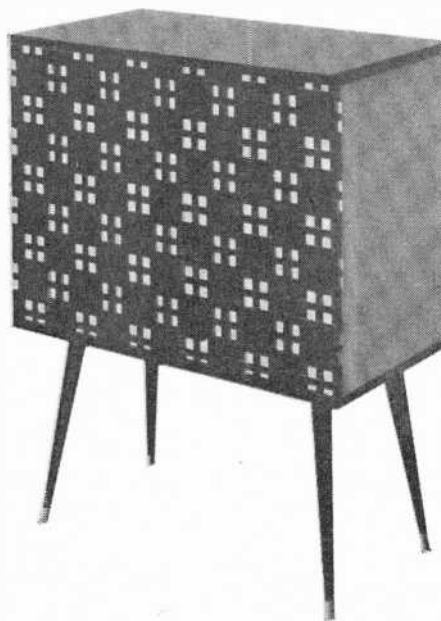
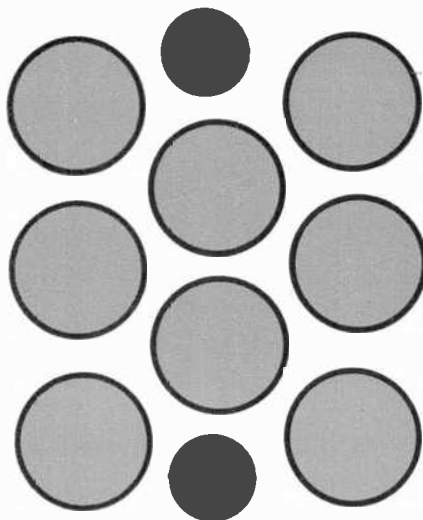

"groups" of speakers.) When reflecting from a wall, however, this system has outperformed a hundred-dollar-plus, factory-assembled system hands down, both in response and separation!

Despite the outcome of this comparison, the "Stereo Sixteen" is admittedly a compromise, since it is designed for maximum performance in limited space. As a result, bass response drops fairly sharply below about 45 cycles, and the high end tapers off rapidly above 14,000 cycles. The reasons for this are that the

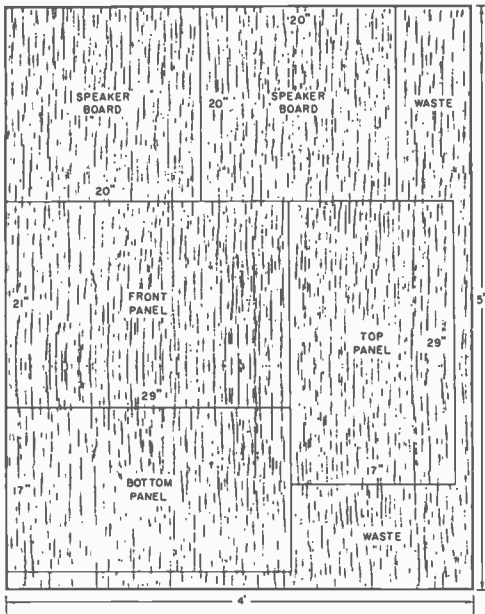

Wire speakers as shown here, paying particular attention to polarities. An 8-ohm, 10-watt resistor in series with each speaker array decreases damping and improves bass response.

All major pieces are cut from a single sheet of 4' x 5' plywood, with a minimum of waste. Since the two speaker boards are identical (see dimensions at left), holes can be marked in both panels at once. Speaker system, wired as shown below, has impedance of 8-16 ohms.

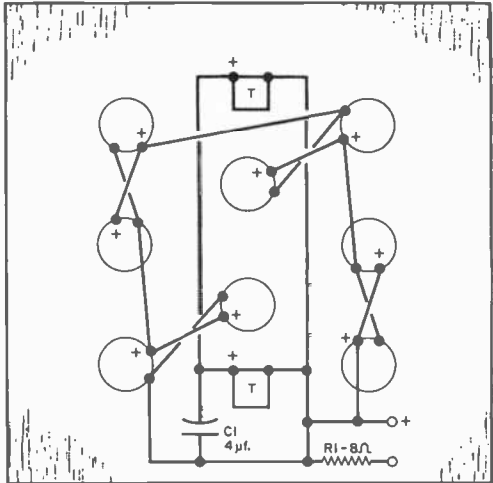

small size limits the bass, while the inexpensive tweeters limit the high end.

Total enclosure volume is less than optimum for even a "Sweet Sixteen" system, and individual speaker quality was deliberately held to the minimum which would produce acceptable results. The speakers themselves are very inexpensive—the 5" units generally sell for approximately \$1.70 each, and the cost of the tweeters is only about \$2.50 each.

Ready to build it? Gather the necessary materials and let's begin.

Getting Started. If you have complete confidence in your woodworking ability, you can begin by cutting all pieces to size as shown above. However, if your carpentry skills are no greater than the author's, it's best to measure each new item against the preceding pieces.

The place to start is with the speaker boards: cut them 20" square, and sand the edges to eliminate splinters. Next, take eight 5" speakers and two tweeters and position them on one of the boards, leaving a 2" margin on all four edges to

accommodate the 2" x 2" bracing which will be attached later. When you have all 10 speakers positioned on the board, carefully mark through each mounting hole with a soft lead pencil. Then remove the speakers and put them to one side.

Place the marked speaker board over the other one and drill through both boards at each mounting hole, using a $\frac{1}{16}$ " drill; this serves the dual purpose of providing screw-starting holes and marking both boards simultaneously. Next, draw lines to connect opposite mounting holes so as to locate the center of each individual speaker, and insure that each speaker will be concentric with its hole in the final board.

When all speaker centers have been marked, you're ready to mark and cut the speaker holes. A saber-saw or power jig-saw is best for cutting the large holes, while the $1\frac{1}{2}$ " holes for the tweeters are best cut with either a hole saw or an adjustable circle cutter in a power drill.

After you have cut all 20 speaker holes, take one of the 20" x 2's and at-

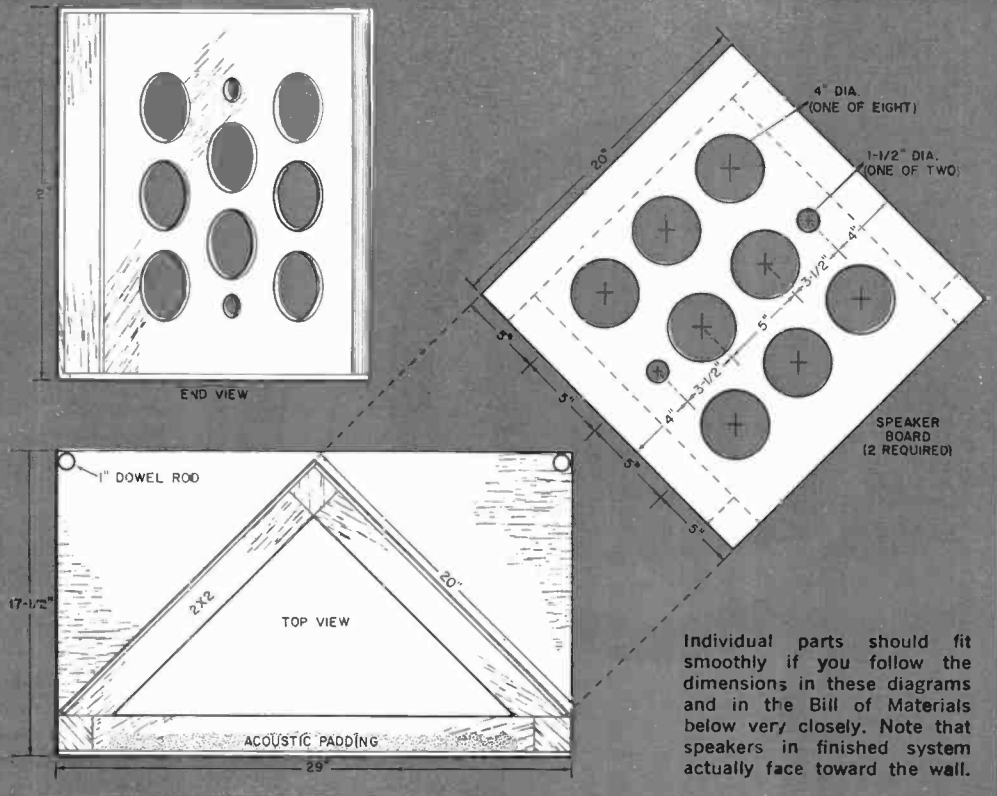

Individual parts should fit smoothly if you follow the dimensions in these diagrams and in the Bill of Materials below very closely. Note that speakers in finished system actually face toward the wall.

tach it firmly to one edge of one speaker board, using at least three wood screws; this will be the back brace. Next, attach the other speaker board to the adjacent edge of the 2 x 2 to form a right-angled corner.

At this point, you're ready to mark the top and bottom panels for cutting. Place a length of 2 x 2 along what will be the 29" edge of one of the panels. Position the speaker-board assembly on the panel against this temporary spacer, and check to see that the 17" depth allows the panel to overhang approximately 1/2" beyond the back brace at this point; if it does not, make the panel deeper or shallower until it does. Mark the cutting lines square with the edges, and cut both the top and the bottom panels the same size. Then sand the cut edges lightly to remove splinters.

Wiring the Speakers. Remove the speaker boards from the back brace and attach all the speakers to them. (No. 6 x 1/2" sheet-metal screws are excellent for mounting the speakers, since they

- BILL OF MATERIALS**
- 1—4' x 5' sheet of 1/2" plywood, cut in'o:
 - 2—20" x 20" sheets (speaker boards)
 - 2—17" x 29" sheets (top and bottom panels)
 - 1—21" x 29" sheet (front panel)
 - 2—8' lengths of 2 x 2 framing stock, cut into:
 - 4—18" lengths
 - 3—20" lengths
 - 2—25" lengths
 - 2—20" x 1" diameter dowel rods
 - 72—No. 8 x 1" flat-head wood screws
 - 80—No. 6 x 1/2" sheet-metal screws
 - 16—5" speakers (Oaktron 5B3, Lafayette SK-26, Olson S-336, or equivalent)
 - 4—2" hard-cone tweeters (Oaktron 3C8T, Lafayette SK-122, Olson S-297, or equivalent)
 - 2—4-μ capacitors (non-polarized electrolytic or paper)
 - 2—7.5-ohm, 10-watt resistors
 - 1—Sq. yd. acoustic padding (or 6 papier-mache egg cartons—see text)
 - Misc.—Wire staples or thumbtacks, wire, solder

hold more firmly in the plywood than most other types.) After all the speakers are attached to the boards, wire them as shown on page 46.

When wiring, make certain that the speakers are correctly phased—i.e., that they are so connected that the cones all move in the same direction at the same

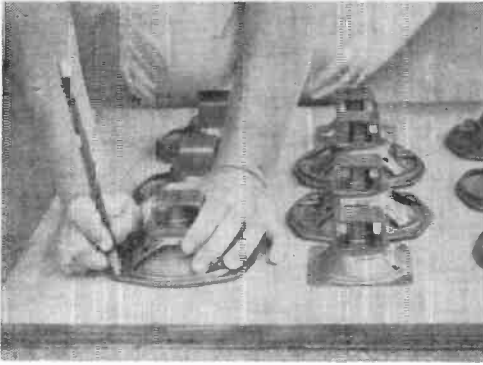

Begin construction by placing speakers on speaker boards and marking through each mounting hole with a soft pencil.

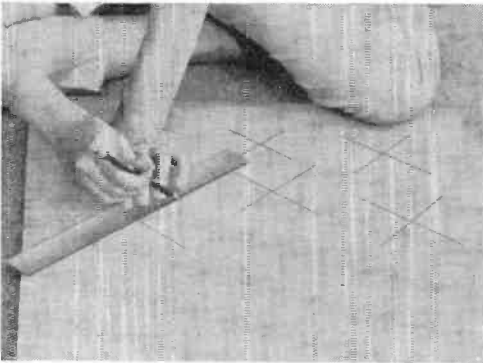

After speaker mounting holes have been marked, the next step is to mark and cut holes for the speakers themselves.

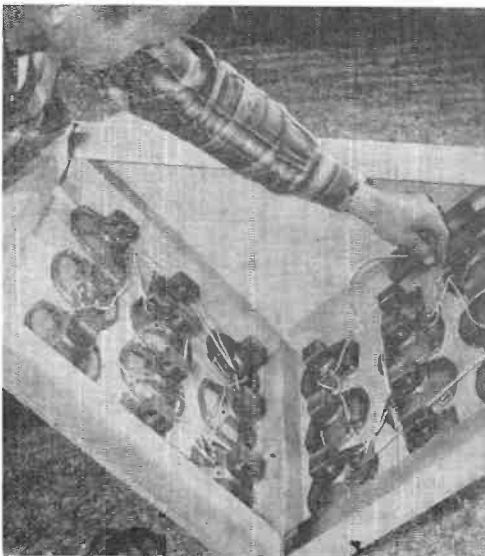

time. If all the speakers are of identical make, simply connect right-hand to right-hand terminals and left-hand to left-hand terminals. Alternatively, if speakers of mixed manufacture are used, check each one with a flashlight cell and mark "+" on the terminal which makes the cone move out when it's positive.

Putting It Together. With the wiring completed, reattach the speaker boards to the back brace and add the upper and lower braces (18" x 2's), using at least three wood screws per brace and ignoring the overhang at the front. Next, position the speaker-board assembly on the bottom panel as you did when marking the bottom panel for cutting. The overhang of the braces will prevent use of the 2 x 2 spacer, but it must be allowed for.

Now, at the top of the speaker-board assembly, align a straightedge with the front edges of the speaker boards. Mark the upper braces for cutting off the overhang, and cut along the markings. After cutting, turn the speaker-board assembly over on the panel and repeat the procedure for the lower braces. (With the upper overhang removed, the 2 x 2 spacer can be used when aligning the assembly on the bottom panel the second time.)

Take the remaining 29"-wide piece of plywood and attach a 20" 2 x 2 to one of the narrow edges, allowing the panel to overhang the lower edge of the 2 x 2 by
(Continued on page 99)

Speakers (left) are easy to wire—see diagram on page 46—but proper phasing is of utmost importance.

Rear view of basic unit, showing relative positions of speakers for each channel. Acoustic padding or an egg-carton "diffuser" should be attached to the inside front panel before it is screwed in place.

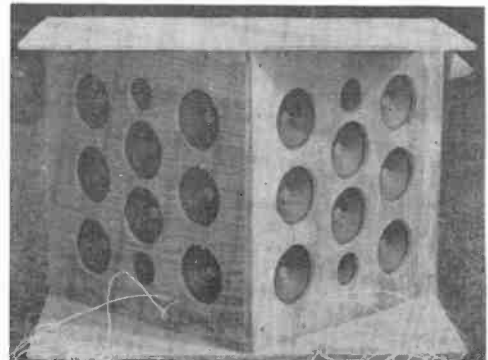

AUDIO BREADBOARD

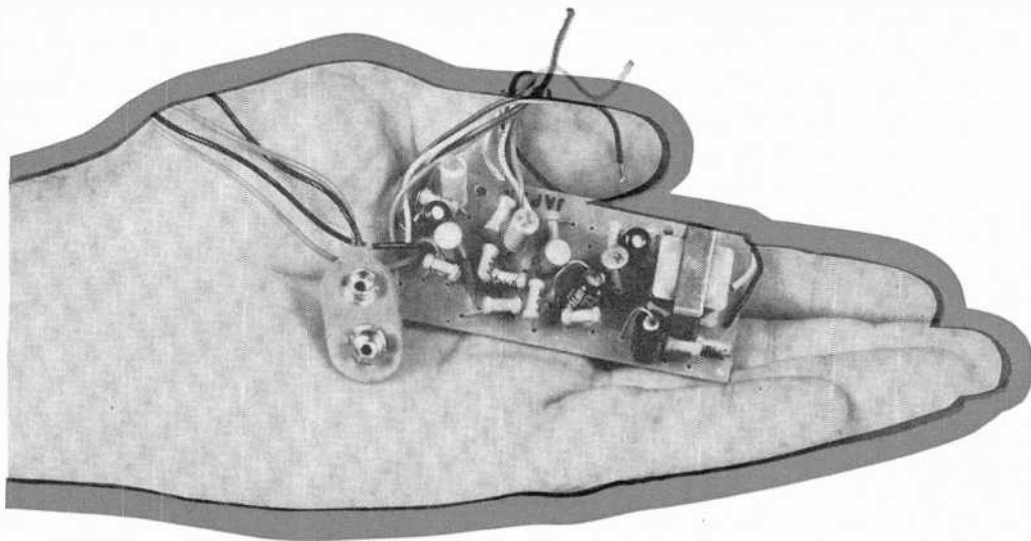

Six uses for a ready-made transistorized amplifier which is ideal for experimenting "breadboard-style"

By ART TRAUFFER

THE three-transistor subminiature amplifier pictured above more than fills the bill for experimenters who want an economical, ready-made utility amplifier. Designated as the PK-522, this little amplifier measures only $1\frac{1}{4}$ " x $2\frac{1}{8}$ ", yet delivers an output of 100 milliwatts when used with a 9-volt battery. It's available from Lafayette Radio Electronics Corp., 111 Jericho Turnpike, Syosset, L.I., N.Y., for \$3.75, plus postage.

To adapt the PK-522 for various experiments, the author mounted his unit on an 8" x 4" x $\frac{3}{4}$ " wooden base or "breadboard" (see Fig. 1 on page 50). Leads from the PK-522 were soldered to Fahnestock clips, and the clips were numbered as shown in Fig. 2.

The author also made three simple additions to the PK-522 to improve its operation. A miniature volume control and switch were added, as well as a miniature input transformer which provides a better match for a crystal mike—this transformer can be cut in or out of the circuit by means of a wire jumper across clips 3 and 4. In addition, a pair of wire leads was soldered to the primary of the output transformer (at the bottom side of the panel) and then soldered to clips 8 and 9. Crystal earphones work fine when connected to clips 8 and 9 because the d.c. passes through the primary

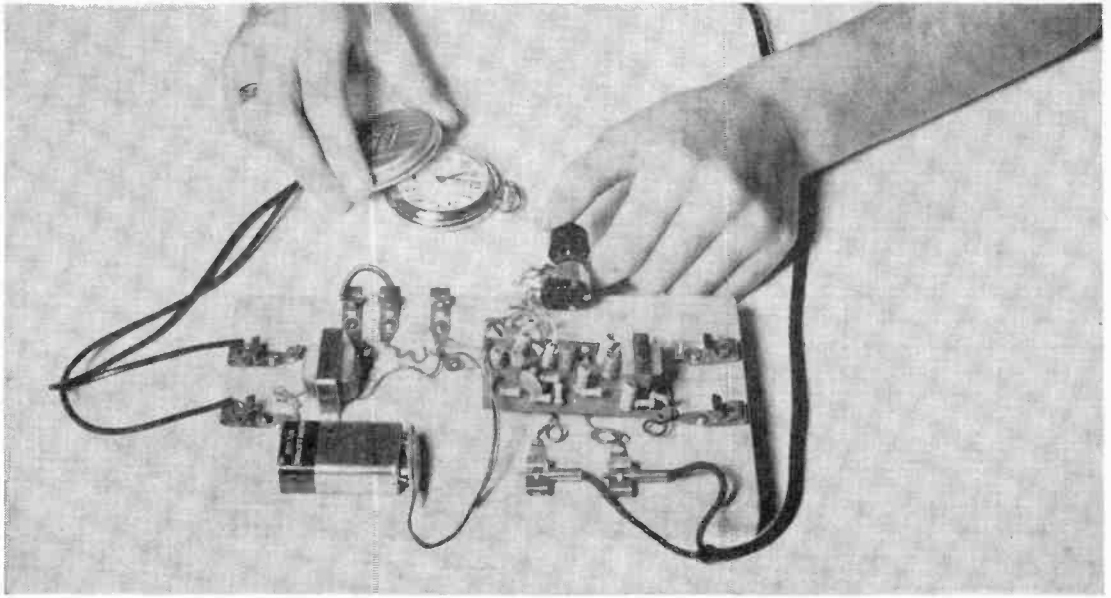

Fig. 1. Audio breadboard becomes an electronic "stethoscope" with addition of a crystal microphone and a pair of earphones. Circuit also functions as amplifier, signal tracer, or code-practice device.

BILL OF MATERIALS

- 1—Subminiature three-transistor audio amplifier (Lafayette PK-522 or equivalent)
- 1—9-volt transistor radio battery (B1) (Burgess 2U6 or equivalent)
- 1—Miniature input transformer; primary, 200,000 ohms; secondary, 1000 ohms (Argonne AR-100 or equivalent)
- 1—Miniature 5000-ohm volume control with s.p.s.t. switch (Lafayette VC-27 or equivalent)
- 1—Mounting bracket for volume control, $1\frac{3}{4}$ " x $\frac{1}{2}$ " x $\frac{1}{8}$ "
- 1—Knob for volume control
- 9—Fahnestock clips, $\frac{3}{4}$ " long x $\frac{5}{16}$ " wide
- 9—Soldering lugs (for Fahnestock clips)
- 12—Round-head wood screws, $\frac{1}{2}$ " long
- 1—Length of insulated hookup wire
- 1—Wooden base, 8" x 4" x $\frac{3}{4}$ "
- 1—0.01- μ f., 600-volt capacitor (C1)
- 1—1N54A diode (D1)
- Misc.—Speaker, probe, alligator clip, etc.

of the output transformer; high-impedance magnetic phones also work better when connected to clips 8 and 9, since clips 6 and 7 are attached to the output transformer secondary and have an impedance of only 8 ohms.

Electronic Stethoscope. Figure 1 shows the PK-522 being used as an electronic "stethoscope" to listen to the ticking of a pocket watch. A crystal mike cartridge was connected to clips 1 and 2, a wire jumper across clips 3 and 4, and a pair of high-impedance magnetic earphones

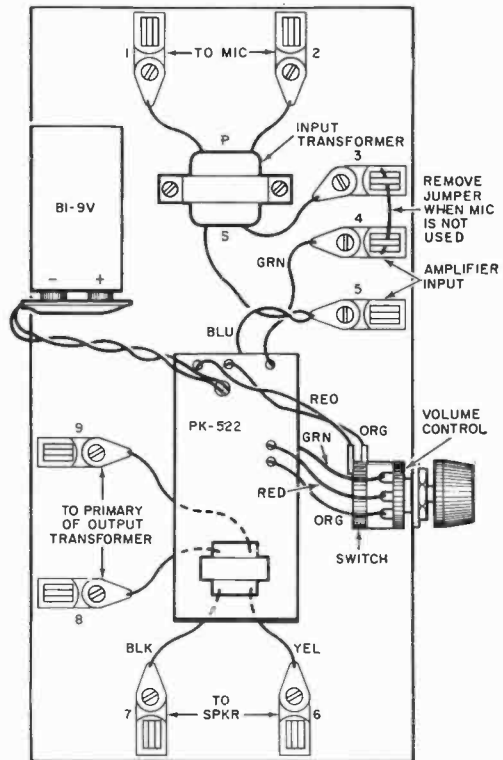

Fig. 2. Wooden base, 8" x 4" x $\frac{3}{4}$ ", serves as a "breadboard" in this easy-to-wire circuit. Volume control mounts on bracket fastened to edge of base.

across clips 8 and 9. If you want to use a PM speaker instead of the phones, simply connect its voice coil to clips 6 and 7.

"Big Ear." To use the PK-522 as a "big ear" for listening to birds, aircraft, etc., hook it up exactly as you did for the electronic stethoscope above. Make a large horn from a sheet of heavy paper or follow the instructions at right. High-impedance magnetic or crystal phones will be required for listening, since a speaker might cause acoustic feedback.

Phono Amplifier. Connect a crystal or ceramic phono pickup to clips 4 and 5, and a PM speaker (3- to 8-ohms impedance) to clips 6 and 7. Do not use a jumper across clips 3 and 4.

Amplifier for Crystal Radio. Disconnect the earphones from the crystal radio and run two leads to clips 4 and 5. The "ground" side of the crystal radio circuit

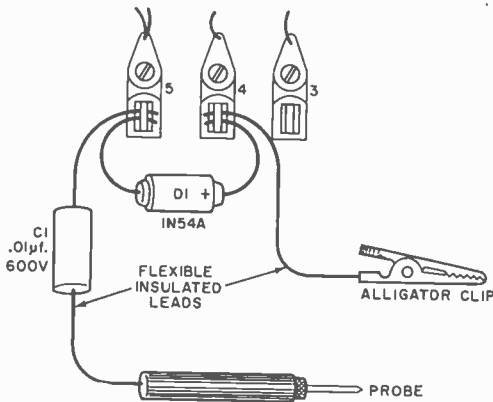

Fig. 3. Adding a few more components turns the breadboard into a signal tracer. Remove diode from Fahnestock clips 4 and 5 when tracing a.f. circuits.

goes to clip 4, and the "diode" side goes to clip 5.

Signal Tracer. Figure 3 shows how to use the PK-522 as an a.f. signal tracer. To trace a.c., simply disconnect the 1N54A diode from the circuit.

Code Practice Outfit. Connect a crystal mike to clips 1 and 2, a wire jumper across clips 3 and 4, and a PM speaker to clips 6 and 7. Place the mike and speaker near each other and turn up the volume control until you hear a loud "howl." Remove the wire jumper, connect a key to clips 3 and 4, and you're ready to practice code.

-30-

MIKE FOR "BIG EAR"

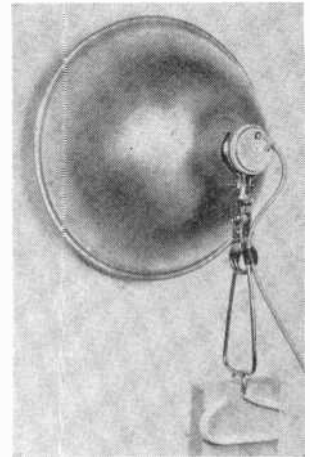

HERE is a simple way to funnel more sound into a mike cartridge for a "big ear" or other experimental sound project. As shown in the photo, the secret is a clamp-on type photo-flood reflector which "catches" the sound and feeds it into a crystal mike cartridge. The swivel clamp allows the mike to be clamped onto a variety of objects and tilted to any desired angle.

To assemble the mike, twist the reflector bowl off the lamp socket, then attach the clamp to the neck of the bowl, as shown. Using Duco cement, glue a 1½"-diameter crystal mike cartridge (an Argonne Type AR-52 or equivalent will do nicely) onto the opening in the neck of the bowl.

Any lightweight mike cable, such as Belden 8411, can be used between the mike and the amplifier—the shield of the cable should be soldered to the "ground" terminal on the rear of the cartridge, and the inside conductor soldered to the "hot" terminal. To finish off the mike assembly, the cable can be anchored to the clamp with plastic tape, and a standard mike cable connector soldered to the free end of the cable.

—Art Trauffer

SHORT WAVE FOR

IF YOU'RE one of the many persons who are fascinated with short-wave radio but who have never known quite how to "get started," why not give English-language broadcasts a try? Even though you may not be a "dyed-in-the-wool" short-wave listener, such broadcasts are usually a sure bet, especially if you know when and where to listen.

Do you say that you don't have the desire to sit for hours on end, tuning patiently for stations? Do you complain that the "time element" doesn't ever seem to favor you? Then take a good look at the listings below—a country-by-country compilation of English-language broadcasts beamed from foreign countries to North America.

COUNTRY	CITY	TIME (EST)	FREQUENCIES (kc.)
Argentina	Buenos Aires	2200-2300 ¹	9690
		0002-0102 ²	9690
Australia	Melbourne	0710-0815 ¹	11,710
		1014-1115 ²	11,710
Austria	Moosbrunn	1900-2100	9540
		Deutsch-	6155
		Altenburg	9540
Belgium	Brussels	1900-2000 ³	9745, 9705, 6140
Bulgaria	Sofia	1835-1900,	9700
		2000-2030,	
		2300-2330	
China	Peking	2000-2100, ¹	17,765, 15,115, 15,030
		2100-2200	11,975, 11,945, 11,730
			9480, 7480
		2200-0000 ²	17,745, 15,250, 15,060
			12,055, 11,820, 9785,
			9457, 7350
Congo	Leopoldville	2130-2200 ^{4,5}	11,755
Cuba	Havana	2200-2340, ⁴	11,770
		0000-0100	
Czechoslovakia	Prague	2200-2300,	15,285, 11,990, 9795,
		0000-0100	9550, 7345
Denmark	Copenhagen	2100-2130, ⁶	9520
		2230-2300	
Ecuador	Quito	0900-1030,	17,890, 15,115
		1830-1900	
		2100-0000	
England	London	1030-1245	21,675
		1100-1300	17,810
		1615-1715	9825
		1615-2200	6195
Finland	Helsinki	0630-0700 ⁷	15,190, 11,805, 9555
Germany	Cologne	1715-1895 ¹	9605, 6100
		0000-0020 ²	9640, 6100
Guatemala	Guatemala City	2200-2300 ⁶	9668
Hungary	Budapest	1900-2000,	11,910, 9833, 7220
		2230-2330	

BEGINNERS

By **HANK BENNETT**
W2PNA/WPE2FT

Bear in mind that there are many other English-language broadcasts which are not beamed to North America but which you may be able to hear with little or no difficulty. Remember, too, that although these listings were correct at time of compilation, short-wave stations change their frequencies and/or schedules with little notice. You're invited to

send in any additions or corrections you may have—please address your letters to Hank Bennett, Short-Wave Editor, POPULAR ELECTRONICS, P. O. Box 254, Haddonfield, N. J.

The times given for all of these broadcasts are Eastern Standard, and the 24-hour system is used instead of "a.m." and "p.m." designations. -30-

COUNTRY	CITY	TIME (EST)	FREQUENCIES (kc.)
Italy	Rome	1930-1950 ¹	11,905, 9575
		2205-2225 ²	11,905, 9575
Japan	Tokyo	1930-2020	21,520, 17,725, 15,135
Jordan	Amman	2015-2045	7155
Katanga	Brazzaville	2015-2100 ⁴	11,725
		0015-0030	9730
Liberia	Monrovia	2000-2230 ⁸	11,980
Netherlands	Hilversum	1630-1720 ⁶	11,730, 9590, 6020
		2030-2120 ⁶	9590, 6020, 5980
		2100-2230 ⁹	9590, 6020, 5980
Norway	Oslo	2100-2125 ^{1,9}	11,850, 9610, 6130
		0000-0025 ^{2,10}	11,850, 9610, 6130
Rumania	Bucharest	2030-2130	11,810, 9570, 7225, 7195, 6190, 5980
		2200-0000	15,380 11,810, 9570 9510, 7225, 7195, 6190
Spain	Madrid	2215-2300, 2315-0000	9363, 6130
		0015-0100	9363, 6130
		0900-0930 ¹ 2045-2115 ¹ 1915-1945 ²	17,840, 9725
Switzerland	Berne	2030-2215 2315-0000	11,865, 9535, 6165
Thailand	Bangkok	2315-0015	11,910
Turkey	Ankara	1815-1900	9515
U.S.S.R.	Moscow	1800-0100	¹¹
Venezuela	Caracas	2130-2245 ⁹	6170 ¹²

NOTES:

1. Beamed to East coast.
2. Beamed to West coast.
3. 1900-1915, Monday and Friday.
4. Beamed to the Americas.
5. Monday through Saturday.
6. Monday through Friday.
7. Tuesday and Saturday only.
8. Tuesday only.
9. Sunday only.
10. Monday only.

11. Frequencies of U.S.S.R. stations are subject to frequent change. The latest list, based on published schedules and listening observations includes: 12,010; 11,960; 11,860; 11,820; 11,690; 9760; 9680; 9660; 9650; 9620; 9600; and 9570 kc.
12. Latest observations indicate an English program on Saturday at 1630-1800. In addition, the Sunday program may have been changed to 2230-0000.

WHY TUNE BY EAR?

By ROCCO J. CARLUCCI

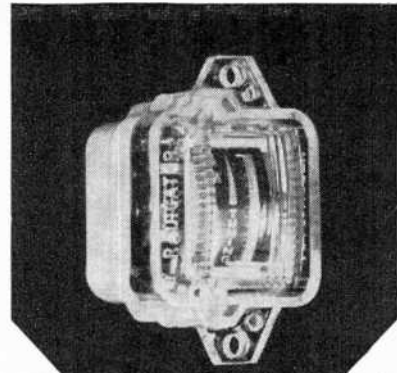

*Tricky tuning,
says this author,
is strictly
a matter for meters*

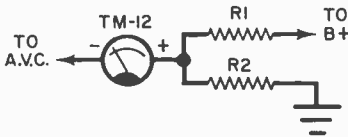
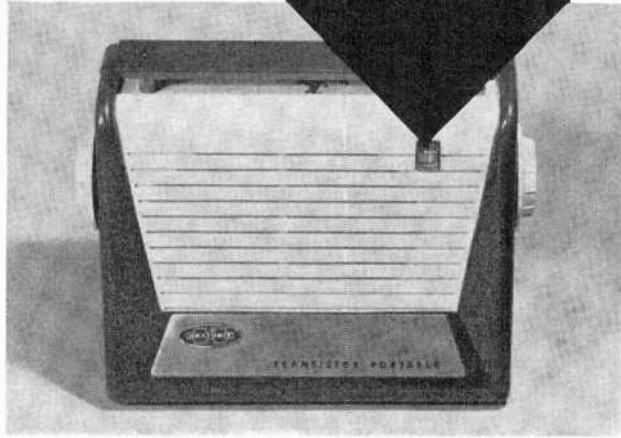

MOST EXPERIMENTERS are well aware that the eye is far more "sensitive" than the ear, but a good many fail to put this observation into practice. Take the matter of receiver tuning, for instance—a simple tuning meter can easily be added to almost any AM receiver to make accurate tuning as simple as 1, 2, 3.

Two of the less expensive tuning meters on the market are the Lafayette TM-12 (\$2.95) and the Radio Shack R94L106 (\$2.88). Instructions furnished with the Lafayette meter explain that it should be installed in the cathode circuit of the receiver's last i.f. stage. However, the author installed this meter in a Heath XR-1-P transistor portable, only to discover that the variations in current were so small that the meter was insensitive even on the strongest stations.

To remedy this situation, the author connected the meter between the a.v.c. line and a positive reference point provided by the junction of a 100,000- and a 1000-ohm resistor ($R1$ and $R2$, respectively, in the diagram above) across the battery. When the receiver is mis-tuned, there is little or no a.v.c. voltage, so the difference in potential across the meter is very small. However, when a station is tuned in, the a.v.c. voltage is greatest, and the difference of potential across the meter is also at a maximum. Naturally, the amount of deflection will vary with the receiver circuit and the value of the divider resistors used, so some juggling of values may be necessary for optimum operation.

-30-

Whether you buy a converter or revamp a standard tuner, it's



*Mighty Pleasurable Listening

By WALTER ROBSON

DOES FM in your car sound like a worthwhile proposition? Sure it does! And one easy way to put it there is to purchase one of the FM converters now on the market (Granco's Model ARC 60, for example, sells for \$42.95). Or, if you already have an FM tuner or two around the house, you may decide to do just what the author did—modify your present FM tuner for in-car use.

Fortunately, the sensitivity and readily satisfied voltage requirements of many ordinary FM tuners make them a "natural" for this modification. The author's tuner has provided flawless, static-free performance for over a year at distances up to 100 miles from broadcast stations. And while the author uses only an ordinary folded dipole, an antenna specifically designed for mobile FM reception would naturally produce even more spectacular results.

The easiest modification involves a.c.-operated tuners with common 6.3-volt tubes such as the 6AU6, 6AL5, etc. If your tuner is one of these, and if your auto electrical system is of the 6-volt variety, you can perform the modification in a matter of minutes.

If your car has a 12-volt electrical sys-

tem, you can usually replace the tuner's tubes with 12.6-volt equivalents (i.e., a 12AL5 for a 6AL5, and so on); alternatively, a suitable dropping resistor could be inserted into the heater circuit. Such tube substitutions can also pave the way for using an a.c./d.c. tuner with a 6- or 12-volt car battery; naturally, the tube heaters would have to be rewired so that they are in parallel or perhaps series/parallel rather than in series.

The Power Supply. One of the simplest ways to handle the power supply problem, of course, is to purchase a d.c.-to-a.c. inverter—ATR makes a portable, plug-in type unit for 6-volt operation which sells for \$16.30 and a 6/12-volt model priced at \$18.91 while the Electric Storage Battery Company's Model I-152 inverter operates from 12-volt batteries only and sells for \$59.95. Such units pack enough punch to power almost any small FM tuner, and obviate the need to revamp the tuner's circuitry.

A less expensive solution is to purchase a small d.c. power supply for the B+ requirements and run the heaters directly off the car battery. The Heathkit VP-1-6 vibrator power supply, designed for 6-volt operation, or its 12-volt

equivalent, the VP-1-12, are especially well suited for the purpose; each is priced at \$8.95 in kit form.

As a third possibility, you may decide to follow the author's lead and tap the necessary B+ from your auto radio. In this case, you'll have to arrange some means to switch off the auto radio's r.f. and i.f. stages when using the FM tuner to reduce drain on the vibrator. The author solved this problem with a d.p.s.t. selector switch.

Regardless of the voltage source you select, its d.c. output should equal or exceed that at the input to the filter section of your FM tuner. If the voltage source is too high—and this is likely to be the case, a suitable dropping resistor can be added.

AM/FM Selector Switch. Even if you decide not to use your AM radio as a source of B+ voltage, an AM/FM selector switch is almost a necessity, since the car radio will be called upon to furnish the audio stages. In the author's case, this switch serves to turn off all tubes in the AM receiver except the audio and rectifier tubes and thus provide B+ for the FM tuner when switched to FM.

In addition, the FM audio output is switched to the AM receiver's audio amplifier in the FM position and removed in the AM position in order to prevent

the low output impedance of the FM tuner from lowering the AM volume level. Still another function of the selector is to switch the antenna from the AM receiver to the FM tuner.

The AM/FM selector switch can be mounted anywhere within reach of the driver, but for simplicity of wiring it should be installed so that the AM antenna lead will reach it without splicing. A small chassis box might be used to mount the switch and antenna connector.

To feed the output from the tuner to the AM receiver's audio section, first locate the AM volume control. Connect the inner conductor of a length of shielded cable to this control's "hot" terminal, and connect the shield to some convenient chassis ground point. Connect the opposite end of this shielded cable to the AM/FM selector switch. A short length of shielded audio cable and an RCA phono plug connects the FM audio output to this switch section.

The FM position of the AM/FM selector switch also connects the AM whip or a whip-connected auto FM antenna to a length of 300-ohm twin lead attached to the FM tuner's antenna input terminals by means of twin-lead connectors. Naturally, this switch section can be eliminated if a dipole is used in addition to the AM whip—a dipole would be con-

Actual method of mounting will vary with the type of tuner you decide to install as well as where you mount it. Here's how one experimenter went about mounting his Heathkit FM-4 under the dashboard.

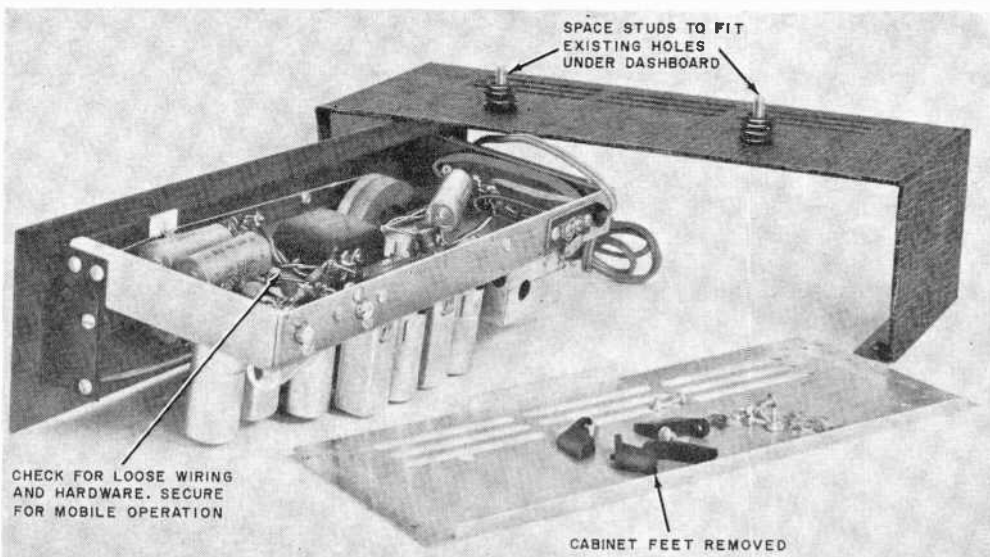

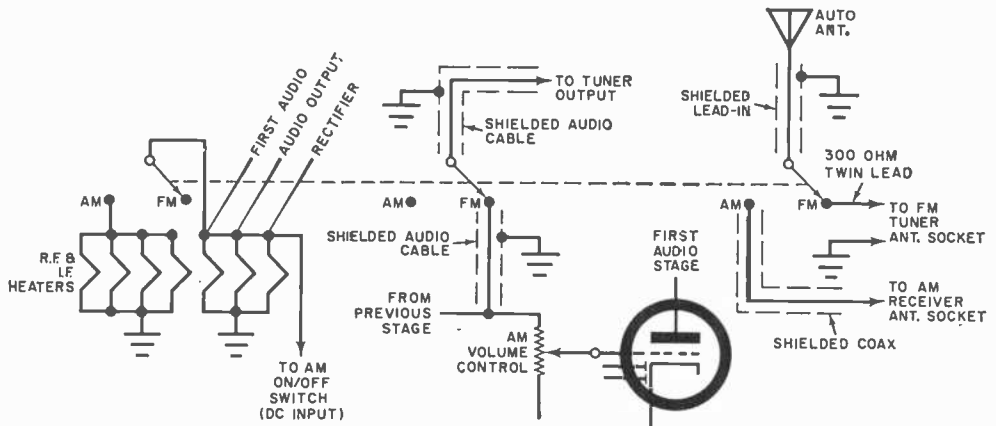

Typical circuit showing how AM/FM selector switch is wired. Switch will be required in most cases; exact circuitry will vary with each installation.

nected directly to the FM antenna input terminals via standard 300-ohm twin-lead of the type used for television lead-in.

The antenna itself can consist simply of the auto's ordinary AM whip, or a halo antenna designed for FM auto operation can be slipped over the AM whip for better reception. An ordinary dipole clamped to the AM auto antenna should provide improved performance over whip operation, and it will be only slightly directional. The halo and whip antenna, of course, are completely non-directional.

Installation. Where and how you mount your FM tuner will vary according to its size and shape as well as with the physical features of your car. It might be mounted on a small shelf under the dashboard. Or your glove compartment, if it is large enough, might be a convenient spot for it.

Since the tuner will be subject to all the bumps and jolts encountered in day-to-day driving, it's wise to employ some sort of shock-mounting. Rubber or felt padding, springs, or other shock-absorbers will suggest themselves, depending on your particular installation.

Next time you go for a drive, arrange to take your FM with you. On the road, just as in the home, FM equals MPL—Mighty Pleasurable Listening!



A d.c.-to-a.c. inverter, such as the ESB Model I-152 shown above, can be used to provide the power for your FM tuner.

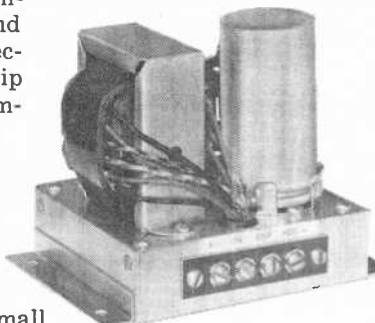

Another possibility for powering the tuner without tapping into the AM radio's circuitry lies in a d.c. power supply, such as the Heathkit at left.

You may be able to mount one of the new FM converters below your AM radio, as in the "Thunderbird" below.

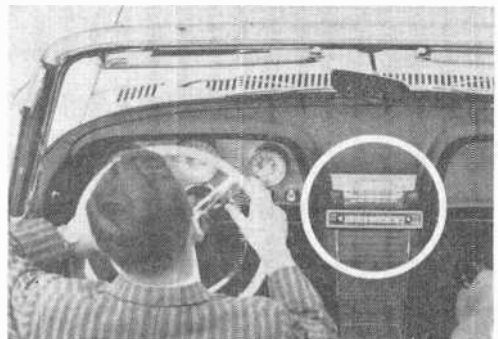

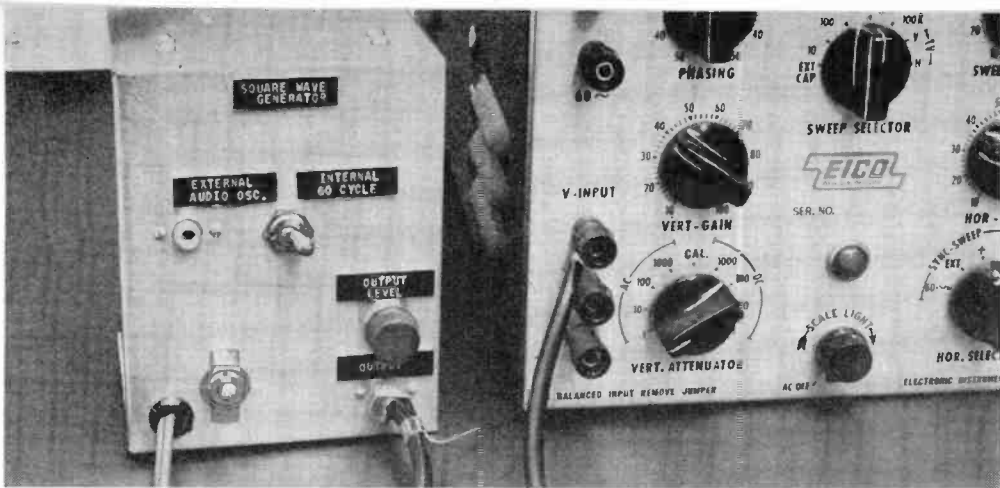

The SQUARER

Simplify your hi-fi testing procedures with this low-cost square-wave generator

By F. H. CALVERT, W9JCV

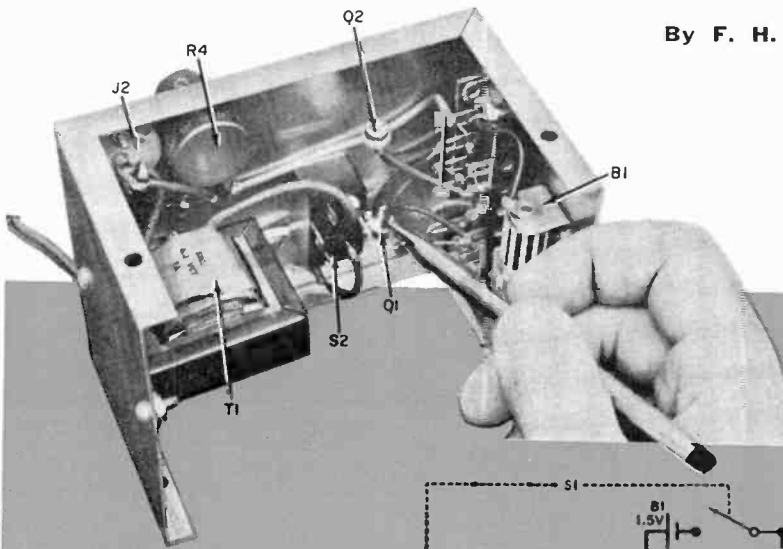

Transistors (pencil points to Q1) are soldered into circuit without sockets. Be careful not to apply too much heat.

The circuit is essentially an overdriven transistorized amplifier. Transformer T1 acts as internal 60-cycle source.

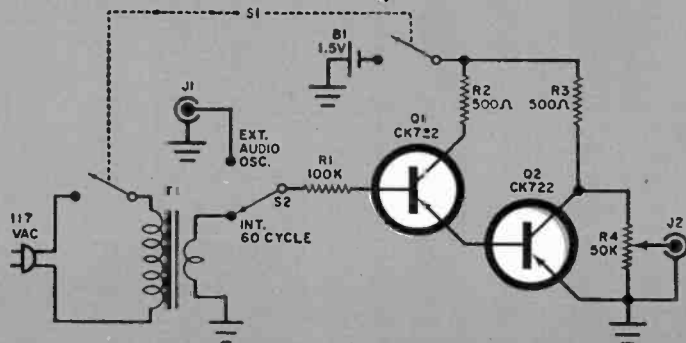

OVER the past several years, square-wave testing of hi-fi amplifiers (see "The Square Wave Generator," February, 1961, page 68) has become increasingly popular. Testing with square waves is an efficient way to get a good idea of an amplifier's phase shift, "ringing" characteristics, and response to transients. In addition, because of the square wave's rich harmonic content, the frequency response of an amplifier throughout the complete range of hearing can be judged by using only three fundamental test frequencies.

The current models of audio signal generators generally have a square-wave

—as well as a sine-wave—output. If your generator is an older model, however, you can modernize it with the "Squarer." This simple device will convert to square waves the output of any sine-wave generator capable of delivering about 6 volts r.m.s. The output of the Squarer is about 1 volt, and the unit will provide a 60-cycle square-wave signal without an external generator.

About the Circuit. The Squarer is basically nothing more than an overdriven transistorized amplifier. The input signal originates either from the secondary of *T1* or from a sine-wave generator connected to external-input jack *J1* (depending on the setting of switch *S2*). After passing through *S2*, the signal is applied to the base of transistor *Q1* through resistor *R1*.

Resistor *R2* serves as the collector load for *Q1*, and this transistor is directly coupled to *Q2*. Resistor *R3* loads the collector circuit of *Q2*, and the amplifier output is tapped off by *R4* and fed to jack *J2*. Power for the circuit is supplied by battery *B1*. Switch *S1* simultaneously controls both the battery and transformer primary voltages.

The transistors conduct only on the negative half-cycles of the sine-wave input signal. Saturation occurs when the input reaches a few millivolts, steepening the sides and flattening the top of

PARTS LIST

B1—1.5-volt penlight cell (Burgess Type Z or equivalent)

J1, J2—Phono jack

Q1, Q2—CK722 transistor

R1—100,000-ohm, ½-watt resistor

R2, R3—500-ohm, ½-watt resistor

R4—50,000-ohm potentiometer

S1—D.p.s.t. switch

S2—S.p.d.t. switch

T1—Filament transformer; primary, 117 volts; secondary, 6.3 volts—current not critical (Thorndarson 21F08, secondary center tap not used—or Stancor P6465)

1—5" x 4" x 3" aluminum utility box (Bud CU-3005-A or equivalent)

Misc.—Battery holder, terminal strips, hardware, line cord and plug, etc.

Pictorial diagram shows simplicity of the parts layout and wiring.

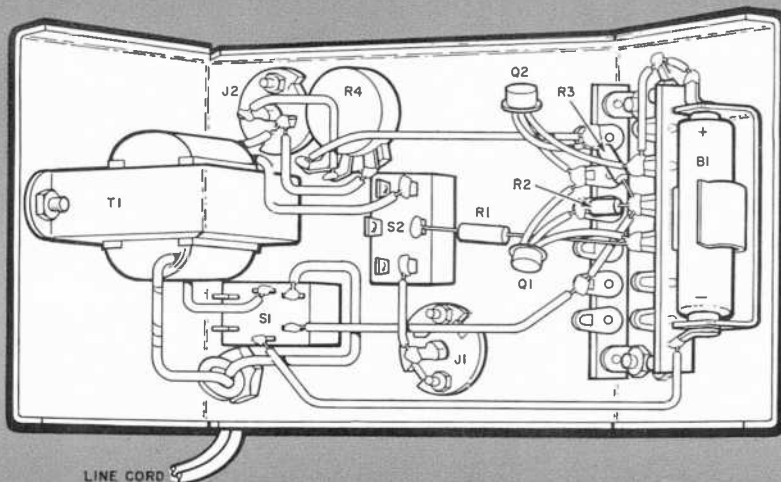

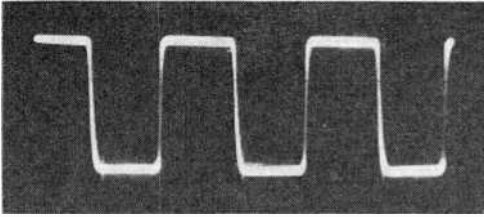

Oscilloscope trace of Squarer's output when operated with a 1000-cycle, sine-wave input. Notice the sharp rise time and the flat tops of the waveform.

the signal's waveshape. The resulting output is essentially a square wave.

Construction. The parts are housed in a 5" x 4" x 3" aluminum utility box, and there's plenty of room to spare. Switches *S1* and *S2*, jacks *J1* and *J2*, potentiometer *R4*, and the line cord grommet are mounted behind the top of the box. Transformer *T1* is mounted on one of the box sides, the battery holder and two 6-lug terminal strips on the other.

The wiring is quite simple and can be completed very quickly. No transistor sockets are used and both *Q1* and *Q2*,

together with load resistors *R2* and *R3*, are wired directly to the two terminal strips (see pictorial diagram). Be careful not to apply too much heat when soldering in transistors *Q1* and *Q2*, and be sure to install battery *B1* with the correct polarity.

Using the Squarer. If the device is to be used with an external signal generator, it's not necessary to plug in the line cord. Just plug the output of the generator into *J1* and the input of your test circuit into *J2*. Then flip on *S1*, switch *S2* to *External Audio Osc.*, and you're ready to go. To use the internal 60-cycle signal, the procedure is the same, but the line cord must be plugged in and *S2* switched to *Internal 60 Cycle*. In either case, the output level of the Squarer is controlled with potentiometer *R4*.

Once you've added the Squarer to your stock of test equipment, you'll wonder how you ever got along without it. The POPULAR ELECTRONICS article mentioned earlier will give you a good start toward understanding the theory of square wave testing, and some practical work with the Squarer will do the rest. -30-



CROSSWORD PUZZLE

By Thomas Windser

ACROSS

- 1 An electron microscope uses a magnetic _____.
- 5 Tube type.
- 10 Discoloration on a TV picture tube: two words.
- 12 There's at least one such stage in every superheterodyne.
- 14 Lassos.
- 15 Amplitude modulation: abbrev.
- 16 Raced.
- 18 Pale.
- 19 Mischievous child.
- 20 Cathode-ray oscilloscope: abbrev.
- 21 G.I. aspirin.
- 22 United Arab Republic: abbrev.
- 23 Grow old.
- 26 New: combining form.
- 27 Inside diameter: abbrev.
- 28 Trigonometric function: plural.
- 30 Railroad: abbrev.
- 31 Varied the amplitude.
- 33 Type of lug.
- 34 Stations: abbrev.

DOWN

- 2 Its product is usually expressed in watts.
- 3 Neither . . . _____.
- 4 Noise visible on a TV picture tube.
- 5 A blown fuse is an _____ circuit.
- 6 Commanding officers: abbrev.

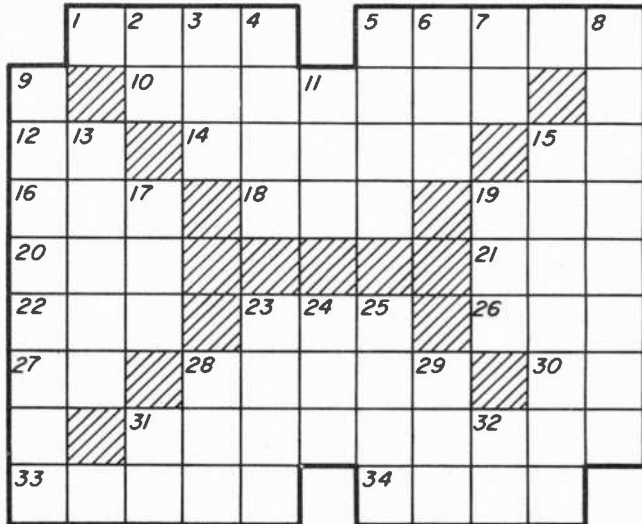

- 7 Telephone and Telegraph: abbrev.
- 8 Zip cord: two words
- 9 Electric current paths.
- 11 Mineral spring.
- 13 Unit of capacitance.
- 15 Units of current.
- 17 Norway: abbrev.
- 19 Man's name.

- 23 Assistant.
- 24 African antelope.
- 25 Teleost fishes.
- 28 Soil.
- 29 Occupied a chair.
- 31 Milliampere: abbrev.
- 32 Symbol for tantalum. (Answers on page 98)

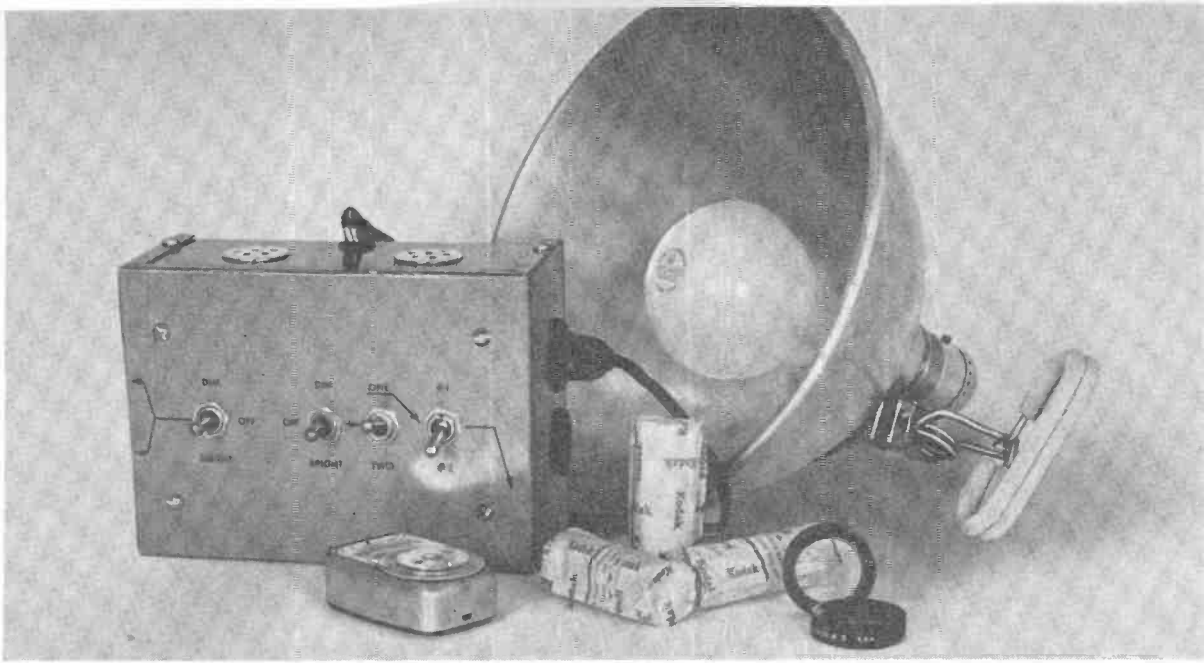

FLOOD LIFE STRETCHER

*Spare the voltage and save those photofloods
with this easy-to-build light control center*

By W. F. GEPHART

EVERY PHOTOGRAPHER appreciates the value of a photoflood "dimmer." With the lights on "dim," his subjects are much more comfortable during the setting-up and focusing ritual. Even more important, the life of the floods is appreciably extended.

When two lights of the same type are used, only a simple switch is necessary to connect them in series and dim them equally. But suppose you want to use a No. 1 bulb with a No. 2 bulb, or that you need three bulbs? While two mismatched bulbs *can* be used with a simple series switch, they won't dim equally, and the lighting can't be balanced properly when they are on "dim." The situation is even worse when three bulbs are used, since the two "paired" ones will ordinarily

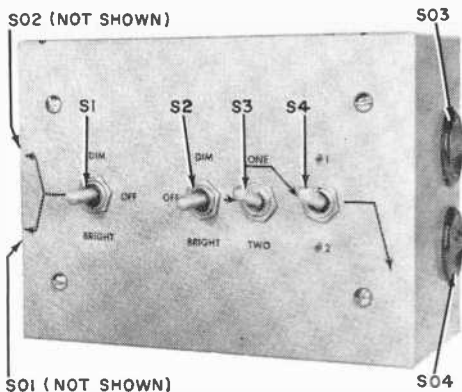

Fig. 1. Front view of switchbox. Author placed arrows on front panel to indicate which switches relate to which sockets; decals next to switches identify switch functions.

be connected through the switch, while the third will be connected directly to the 117-volt a.c. line.

The photoflood switchbox shown here is a very practical solution to the "dimming" problem. Not only will it handle up to four bulbs in almost any combination, but it will also permit dimming odd or unmatched bulbs equally so that the lights can be positioned and balanced with the bulbs on "dim." Construction is simple—you should be able to build the entire unit in a few hours' time.

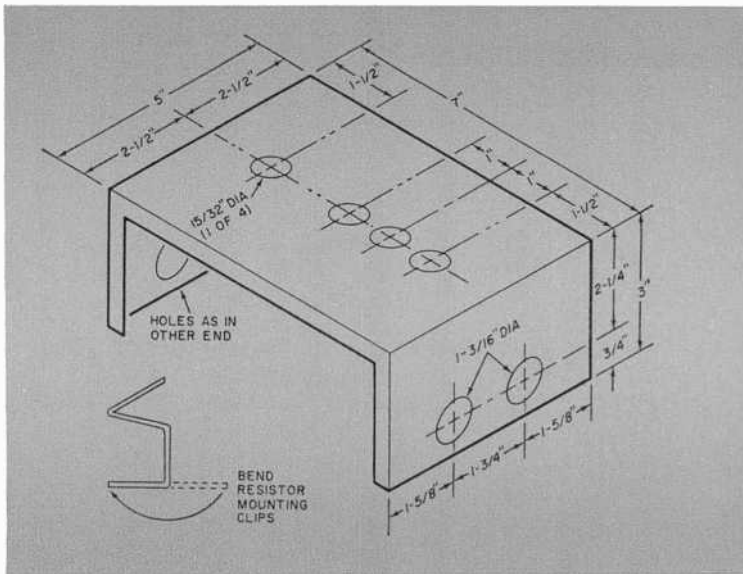
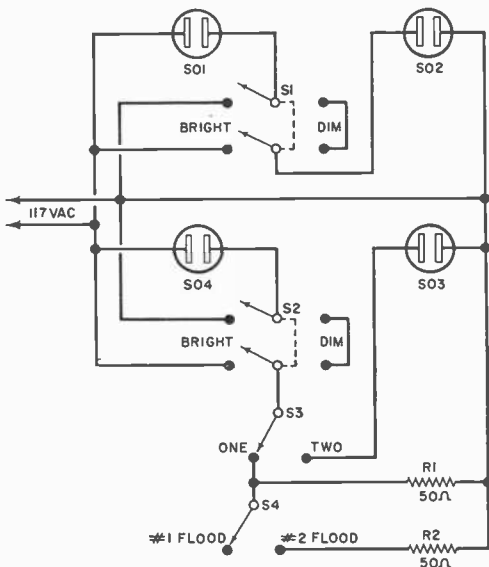

Fig. 2. Switchbox consists essentially of four receptacles, four switches, and two resistors. Note that switch positions shown below correspond to decals in photo above.

Fig. 3. Chassis box should be easy to punch and drill if you follow the dimensions shown above. Clips for power resistors R1 and R2 must be bent as indicated if resistors are to fit within box.



About the Circuit. The circuitry of the switchbox is extremely simple: as you can see from the schematic diagram at left, it consists of only four switches, two resistors, and four sockets.

Switch *S1*, which controls sockets *S01* and *S02*, is the conventional series/parallel control for use with two paired bulbs. Either two No. 1 or two No. 2 bulbs can be plugged into these sockets.

Switch *S2*, in conjunction with switches *S3* and *S4*, controls sockets *S03* and *S04*. If two paired bulbs are being used in these sockets, switch *S3* is set to "Two,"

PARTS LIST

R1, R2—50-ohm, 100-watt, wire-wound resistor (IRC 6½E or equivalent)
S1, S2—D.p.d.t. toggle switch with center "off" position, 15 amp. @ 125 volts (Carling 2GM53-73 or equivalent)
S3, S4—S.p.d.t. toggle switch, 15 amp. @ 125 volts (Carling 2FB53-73 or equivalent)
SO1, SO2, SO3, SO4—2-pole, female a.c. receptacle (Amphenol 61-F1 or equivalent)
1—7" x 5" x 3" aluminum chassis box (Bud CU-2108A or equivalent)
Misc.—Heavy-duty appliance cord with plug, 1" screw-type plug buttons (optional), wire, solder, etc

lighting can be balanced with three bulbs on "dim."

Construction Hints. The unit is built in a 7" x 5" x 3" aluminum chassis box, with sockets at each end—see Fig. 1. The schematic diagram appears in Fig. 2, drilling layout in Fig. 3, and wiring details in Fig. 4. Decal letters and arrows on the front panel show the functions of the various switches and sockets.

The mounting brackets supplied with the resistors must be bent as shown in Fig. 3. No mounting holes are indicated

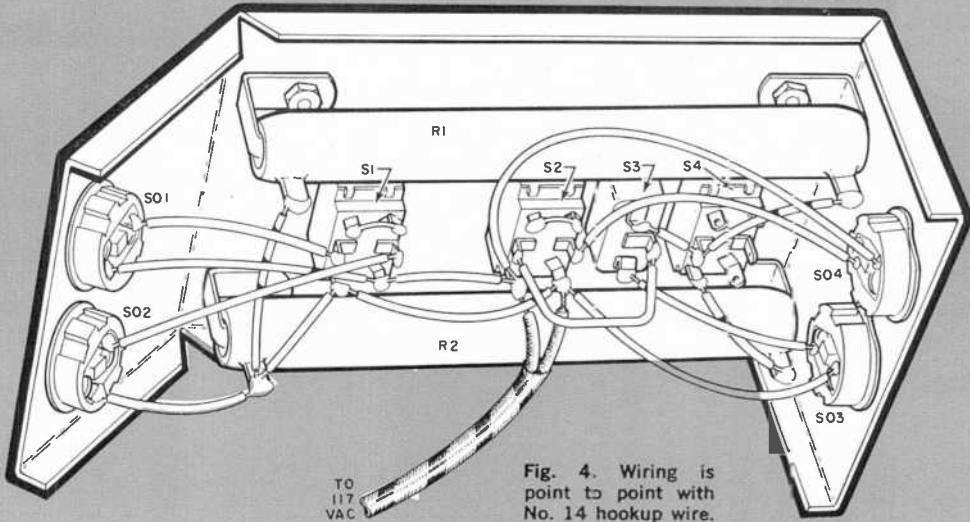

Fig. 4. Wiring is point to point with No. 14 hookup wire.

and switch S_4 is not used. If only one bulb is to be used, it is plugged into SO_4 , switch S_3 is set to "One," and switch S_4 is set to the size bulb being used.

When a single No. 1 bulb is plugged into SO_4 and switch S_4 is on "#1," resistor $R1$ is in the circuit and takes the place of a second bulb for dimming purposes. With a No. 2 bulb plugged into SO_4 , switch S_4 is set on "#2," resistor $R2$ is connected in parallel with $R1$, and the $R1/R2$ combination acts as a second "bulb."

The value of these resistors is such that they enable the single bulb to dim to half its normal intensity, just as though two bulbs were connected in series. The light value of the single bulb is then in proportion to the dimmed effect of the paired bulbs in SO_1 and SO_2 , so overall

for these brackets, since their exact position will depend on how the brackets are bent.

All wiring should be done with No. 14 wire, and the line cord should be an asbestos-insulated, heavy-duty type. Two 1" vent plugs can be placed on each of the sides of the bottom half of the box to provide ventilation for the resistors.

Operation. When using the switchbox, keep in mind that each No. 1 photoflood draws about 2.2 amperes and each No. 2 photoflood draws about 4.4 amperes on "bright." Since the average household outlet is designed to handle a maximum current of about 15 amperes, an absolute maximum of three No. 2 bulbs and one No. 1 bulb can be used at one time, assuming there is nothing else connected to that particular circuit.

-30-

RESISTOR FUNCTION QUIZ

By ROBERT P. BALIN

Resistors find more uses in electronic equipment than any other component. See if you can match the functions of the resistors listed at right with the letters (A through I) representing their applications in the diagrams at left.

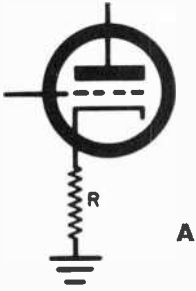

A

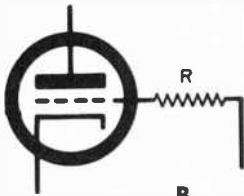

B

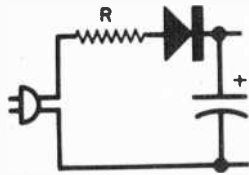

D

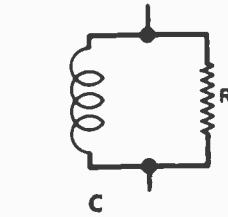

C

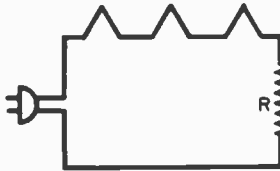

E

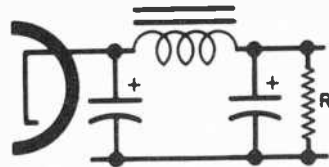

F

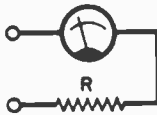

G

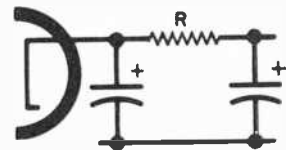

H

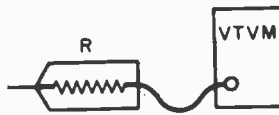

I

- 1 Current limiting resistor _____
- 2 Damping resistor _____
- 3 Ballast resistor _____
- 4 Filter resistor _____
- 5 Self-bias resistor _____
- 6 Isolation resistor _____
- 7 Range resistor _____
- 8 Parasitic suppressor _____
- 9 Bleeder resistor _____

(Answers appear on page 111)

TAKING YOUR TRANSISTOR'S TEMPERATURE



By **FRANKLIN C. FITCHEN**

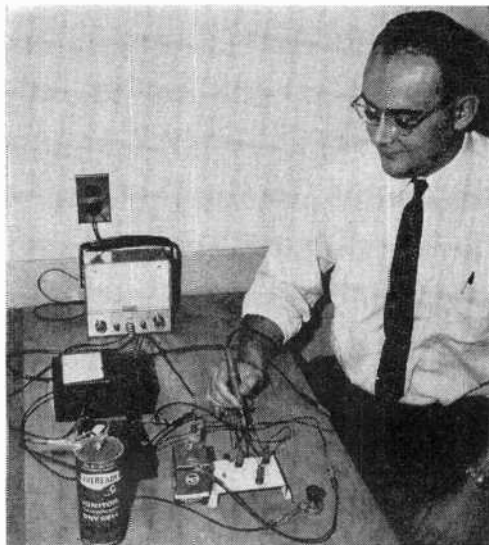

ABOUT THE AUTHOR

FRANKLIN C. FITCHEN calls on his broad knowledge of semiconductor theory in this, his first article for POPULAR ELECTRONICS. An associate professor of electrical engineering at his own alma mater (the University of Rhode Island), Mr. Fitchen is also the author of Transistor Circuit Analysis and Design, recently published by the D. Van Nostrand Company.

MOST EXPERIMENTERS know only too well that transistors don't like heat. The simple truth of the matter: any transistor will be permanently damaged if subjected to temperatures high enough to break down its crystalline structure. In practice, the upper temperature limit for high-quality germanium transistors is about 200°F, while silicon devices can withstand temperatures up to about 300°F.

Not so well known is the fact that the sources of heat may be internal as well as external. High temperatures from such external sources as soldering irons and nearby electronic parts can be minimized by careful soldering techniques and intelligent parts placement. Heat from internal sources, on the other hand, is far less easy to deal with. Let's see precisely how much heat is generated inside a transistor under operating conditions, and how we can measure this heat to insure that the transistor is operating within its temperature range.

Thermal Resistance. Suppose we begin by examining the manufacturer's specification sheet on any transistor for a state-

ment about *thermal resistance*. You will find that this characteristic is usually expressed in units of *degrees Centigrade per milliwatt* ($^{\circ}\text{C}/\text{mw}$). To determine the transistor's internal temperature under no-signal conditions, all you have to do is multiply the *thermal resistance* by the power (in milliwatts) being converted to heat at the transistor's collector-base junction. The result is the transistor's internal temperature rise in degrees Centigrade, and adding this amount to the room or air temperature (also in degrees Centigrade) will give you the transistor's calculated internal temperature.

This may sound easy to do, but the average experimenter is faced with two problems. First of all, how does one find the power being converted to heat at the collector-base junction? And secondly,

Fig. 1. Power converted into heat at the collector-base junction is determined by finding the product of the voltage and current at the junction.

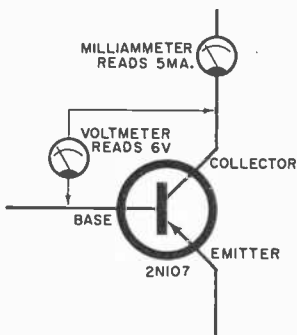

how are degrees Centigrade converted to degrees Fahrenheit and vice-versa? Let's tackle each problem separately.

Figure 1 shows the typical no-signal current and voltage conditions for a 2N107 transistor—a type commonly used in experimenters' circuits. The voltage drop across the collector-base junction is 6 volts, and the current leaving the collector (hence, the current that must pass through the collector-base junction) is 5 milliamperes. To determine the power being converted into heat in the transistor, simply multiply 6 volts by 5 milliamperes. The answer, of course, is 30 milliwatts.

The manufacturer's specification sheet states that the thermal resistance for the 2N107 is $0.5^{\circ}\text{C}/\text{mw}$. Multiply this constant by the computed 30 mw., and the temperature rise in the transistor can be predicted to be 15°C . Now, to find the transistor's calculated internal temperature, all you have to do is add this temperature rise to the room temperature, having first insured that both temperatures are in degrees Centigrade.

To convert a temperature in degrees Centigrade to degrees Fahrenheit, you just multiply the Centigrade temperature by $9/5$ and then add 32. Stated in equation form,

$$^{\circ}\text{F} = \frac{9}{5}^{\circ}\text{C} + 32$$

(equation 1)

Working the other way—i.e., converting $^{\circ}\text{F}$ to $^{\circ}\text{C}$, you subtract 32 from the temperature in degrees Fahrenheit and multiply by $5/9$. Again, this can be reduced to a simple equation,

$$^{\circ}\text{C} = \frac{5}{9} (^{\circ}\text{F} - 32)$$

(equation 2)

If you have no head for equations or computations, you can find the desired Fahrenheit or Centigrade temperature very easily on the conversion chart in Fig. 2.

Earlier, we saw that the temperature rise in the 2N107 was 15°C . Let's assume the room temperature is 77°F . Using equation 2, we find that the room

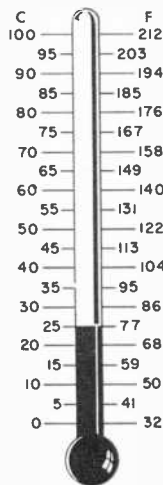

Fig. 2. The thermometer-type graph permits rapid conversion of temperature between the Fahrenheit and Centigrade systems.

temperature in degrees Centigrade is 25. So, we add 15°C to 25°C and find that the temperature at the collector-base junction is 40°C. Since the manufacturer's specifications for the 2N107 specify a 60°C maximum temperature at the collector-base junction, the transistor is operating well within its maximum temperature rating.

When you predict the internal temperature of a transistor using the thermal resistance calculations just described, you assume that the transistor is one which just meets manufacturer's specifications. In an actual production run, the thermal resistance of the transistors passed by quality inspection is usually less than the published specifications. This means that the temperature of the 2N107 collector-base junction will not be more than the 40°C just calculated. In fact, it will usually be less.

Leakage Current. To obtain a true measure of a transistor's collector-base junction temperature, we can make use of a known relationship that exists between the collector-base junction leakage current, I_{co} , and temperature. This leak-

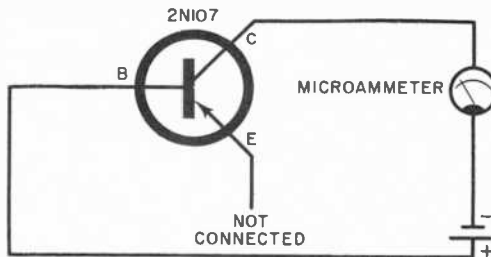

Fig. 3. Test circuit for measuring collector-base junction leakage current, I_{co} , of pnp transistors; reverse battery polarity to test npn types.

age or reverse current at the collector-base junction can be measured as shown in Fig. 3.

A dry cell is connected in series with the base and collector, with the positive terminal of the battery connected to the n -type terminal, and the negative battery terminal to the p -type terminal; the emitter is left disconnected. A microammeter inserted into the circuit measures the current flow, which, for low-power germanium transistors, is on the order of 1 to 20 microamperes.

The curve of the variation in I_{co} versus

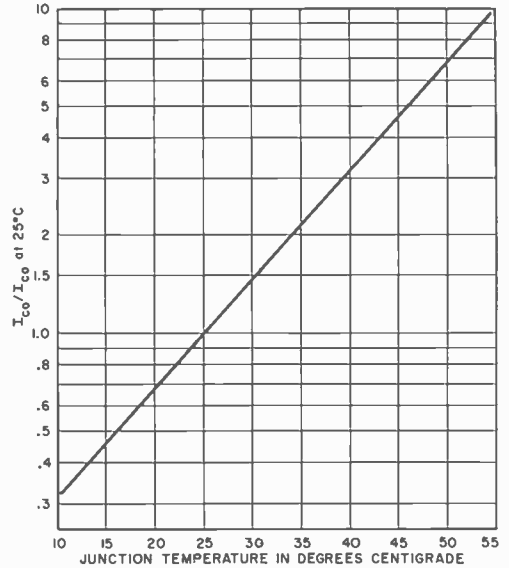

Fig. 4. Variation of I_{co} with temperature for the 2N107 pnp transistor. Refer to specification sheets for junction temperature curves of other transistors.

collector-base junction temperature is shown in Fig. 4. Similar graphs for most low-power (below 200 mw.) germanium transistors usually appear on the transistor's specification sheet.

Five steps are required to determine the ratio I_{co}/I_{co} at 25°C:

(1) Disconnect the transistor from its circuit and put it aside for a few minutes. This will insure that the transistor is at room temperature.

(2) Insert the transistor into the test circuit shown in Fig. 3 and measure the I_{co} at 25°C. Record this reading.

(3) Return the transistor to its original circuit, turn on the power, and allow a few minutes for the transistor to heat to a stable temperature; five minutes should be enough time.

(4) Remove the transistor from its circuit and quickly reinsert it in the test circuit shown in Fig. 3. Record the value of I_{co} before the transistor temperature has a chance to fall.

(5) Divide the value recorded in Step 4 by the value of I_{co} recorded in Step 2. The result will be the ratio of I_{co}/I_{co} at 25°C.

Now, to find the transistor's operating temperature in the circuit in which it will

be used, all you have to do is mark the value determined in Step 5 on the vertical axis of the graph shown in Fig. 4. Then, draw a horizontal line from this point across to the sloping line, and draw a vertical line from the point of intersection to the horizontal axis of the graph.

The point of intersection with the horizontal axis will indicate the transistor's operating temperature in degrees Centigrade. As long as this operating temperature is below the manufacturer's stated maximum operating junction temperature, you can be sure that heat will not destroy the transistor.

Using a Switch. The author inserted a switch into an a.f. amplifier circuit (Fig. 5) to permit the transistor to heat up to actual operating temperature. Then, at a flip of the switch, the transistor was taken out of the circuit and placed in the test circuit. The switch enables the I_{co} reading to be made at almost the same instant, giving the transistor no time to cool off. In Fig. 5, the switch is shown

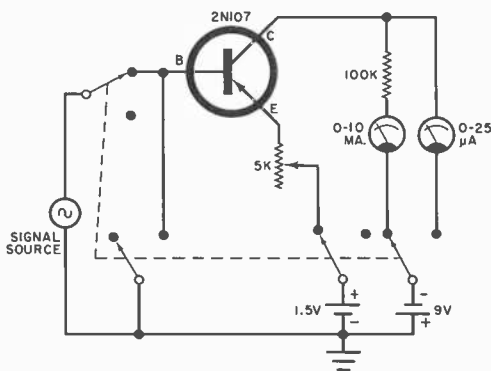

Fig. 5. Test circuit used by author to check collector-base junction temperature rise in a 2N107 pnp transistor under normal operating conditions.

in its normal position, i.e., with the transistor connected in the amplifier circuit.

It is important that the switch open the lead to the emitter before closing the line to the microammeter; otherwise the meter might be damaged if the collector current is too large. The switch used is commonly called a telephone key (Fig. 6) and has the advantage that all of its

contacts do not "make" at the same instant. Therefore, a "slow" one was used for the microammeter connection.

In operation, the circuit must be allowed to stabilize for several minutes at

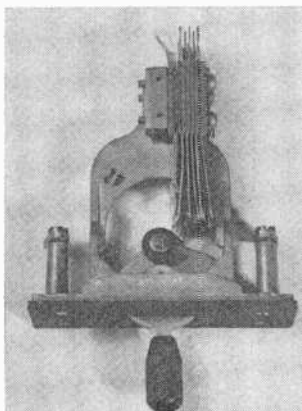

Fig. 6. Telephone-type key switches test circuit in Fig. 5. It is important that slow-make contacts be used to switch the 0-25 microampere ammeter.

its normal operating point. Then the switch is thrown to its other position and the microammeter read as soon as the needle stops moving—it is important to take this reading immediately, before the transistor begins to cool off. After the "hot" reading is taken, the transistor is allowed to cool for a few minutes to room temperature, then the microammeter is read again. The second reading is divided into the first for the I_{co}/I_{co} at 25°C. This ratio is entered on the graph (Fig. 4) and the collector-base junction temperature found as before.

Under "standby" or no-signal conditions, the transistor in Fig. 5 draws a collector current of 5 ma. with a collector-to-emitter voltage of 7 volts. Thus, the power dissipation at the junction is 35 mw. The I_{co} measures 14 μ a., and the I_{co} at room temperature is 6.5 μ a., resulting in a ratio of 2.15. From the graph in Fig. 4, the internal temperature under these operating conditions is 35°C or 95°F. Since the manufacturer's specified maximum junction temperature for the 2N107 is 60° (140°F), the transistor is operating at a safe temperature in the designed circuit.

—50—

On the Citizens Band



By DICK STRIPPEL, 2W1452

GUESS WHAT? It's 1962, and the Citizens Band is a little more than three years old. A lot has happened during those three years—the quality of equipment has improved greatly, and probably more than a half-million CB transmitters have gone on the air. (Since about 250,000 licenses have been issued, this estimate assumes an average of two transmitters per license.)

However, in this writer's opinion, CB'ers have not quite "come of age" yet. Too often there are still discourteous and even downright illegal operations on the band. So we have drawn up a set of New Year's resolutions which, if followed, should make our band a better place to operate.

- Never initiate a transmission without first checking the channel to see if it is in use.
- Keep down the number of "breaks." You wouldn't just charge into a private,

face-to-face conversation, so why do it on the air?

- When requested to stand by while traffic is being passed, do so with a minimum of chatter—a simple "11-4" will suffice.
- Monitor your channel for a few moments after you sign off. Someone may have an important message for you, or even emergency traffic.
- Keep the "rat pack" "round robins" down. Nothing breeds chaos more quickly than five or six stations all trying to get their "nickel's worth" in during the same five minutes.
- Courteously assist CB visitors in your area when they request travel information.
- Last, and certainly not least, simply obey all FCC rules and regulations.

Tech Notes. Our mail has indicated that a number of CB'ers are interested in a simple converter to make a broadcast-band receiver into a double-conversion CB superhet. The schematic diagram at left shows a circuit for such a device which uses a 6AN8 tube.

If you presently use a super-regenerative receiver employing a 6AN8, you'll be able to modify it slightly and thus keep the converter in your transceiver cabinet. If you decide to do this, you can use the coils (L_1 and L_2 in the diagram) which are already in the receiver section. If not, you can order replacement-type coils from the manufacturers of such units. The major electronic supply houses also stock coils suitable for use in this converter. Naturally, you'll also have to pick up suitable capacitors (C_1 and C_2) to match the coils.

Caution: note that both the

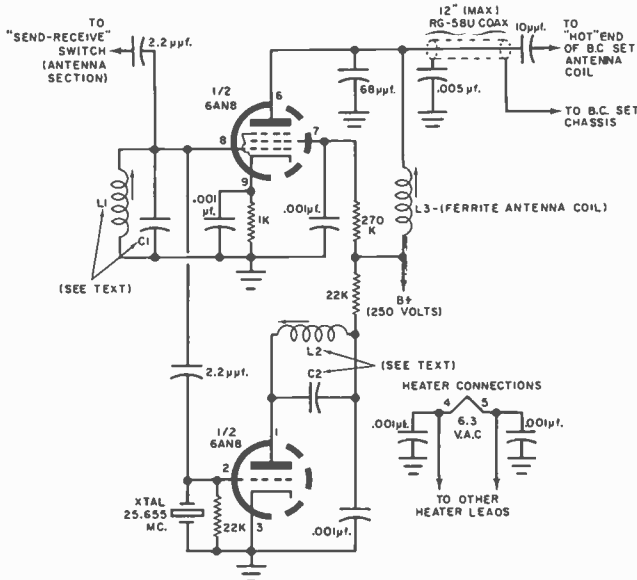

inner and outer conductors of the coaxial cable are connected to the transceiver through capacitors. These capacitors are important, since without them the case of your transceiver could be carrying the full line voltage, making operation extremely dangerous.

The 25.655-mc. crystal shown in the diagram should be of the "third overtone" type, and it can be obtained from any one of a number of manufacturers. Also note that the converter should be connected to the broadcast set through not more than one foot of coaxial cable.

After connecting the converter to the BC set, adjust the trimmer on the large (r.f.) section of the BC set's tuning capacitor for maximum volume. You'll be able to receive CB signals from about 1300 kc. through 1600 kc. on the dial.

To align the converter, simply adjust the slugs in *L1*, *L2*, and *L3* for maximum noise output from the BC set.

TVI and You. We recently received a telephone call from a somewhat distraught CB'er who had been told that he was causing interference on a neighbor's TV set. Unfortunately, the complainer—who was quite angry—refused to give his name, and the distressed CB'er wanted to know what he should do.

Every now and then we hear about similar cases of TVI (television interference), and only a few days ago we came across a newspaper clipping which told of CB interference to a public address system in a church. Of course, the people interfered with are understandably annoyed, and the complaints must be handled with diplomacy.

Interference to TV, radio, or other electronic devices is caused by two factors. The first is harmonic radiation. This is usually only picked up on TV Channel 2, since the second harmonic of CB transmissions falls within this channel. The FCC has set down rules covering harmonic radiation, and if your rig is causing Channel 2 interference, it's a safe bet that your transmitter is not operating properly.

Most commercial CB rigs do not produce enough Channel 2 interference to bother a TV set in the same room. If your set does, it's almost certain that either your output or TVI trap is improperly adjusted. Check your instruction book and make necessary changes.

The diplomacy part comes in when someone must tell the person suffering the interference that his trouble may be due to poor design in his TV, radio, or p.a. system. The best thing to do is enlist the support of a good local radio and TV repairman.

The second, and far more common type of interference, is caused by improper design or malfunction of the set which is being interfered with. In the case of a public address amplifier, certain leads could be just the right lengths to act as coils tuning the CB band. Again, a corroded or poor solder joint could be acting like a simple crystal detector.

Many older TV sets use an intermediate frequency in the 27-mc. band, and poor circuit design can cause a CB signal to be picked up in the 27-mc. section of the set. This type of TVI is easily identified because it is received on all channels. The only cure is for the person owning the set to have a "high-pass filter" installed at the TV set's antenna terminals.

Club Notes. We have finally received some word about club participation during hurricanes "Carla" and "Esther" last September. . . . In Lubbock, Tex., members of the Lubbock Citizens Band Radio Club joined forces with the Salvation Army and the Red Cross in providing communications for relief work, such as distributing food and clothing. . . . Up Rhode Island way, the Bristol County CB'ers volunteered their services to local Civilian Defense officials when "Esther" came along. They set up a base station in the Bristol police station to control 15 mobile units. Fortunately, damage was light, but the CB'ers gave a good account of themselves and won the respect of local officials.

The 10/99 Club of Anaheim, Calif., plans events every Monday and Friday night to keep up club interest. Most of these activities are simply "coffee breaks" when members can get together to discuss CB, or whatever. Guest speaker at their October meeting was Mr. Bernard "Pop" Linden, recently retired engineer in charge of the 11th FCC District.

In closing, here's a bid for you to keep that club news coming in. If your club participates in a local emergency or activity, let us know about it as soon as it's over.

-30-

"LINE BLENDER" for TV Screens

*Plastic filter optically "removes"
scanning lines from picture tubes*



Photo at top shows effect of scanning lines on TV screen; photo at right shows identical screen with lines "removed." Note that difference has been exaggerated here for emphasis.



RECENTLY introduced in Germany by the giant Saba Works, a unique television "filter" will soon be available for American scanning systems.

As you probably know, the "picture" on your television set is actually comprised of a succession of individual lines which sweep at a slight angle from left to right across the screen. In the United States, the "525-line" system is standard. Even so, less than 480 lines actually appear on the screen, since some are lost in the interval it takes the electron beam to travel from the bottom of the picture back to the top to start its "trip" all over again.

As TV screens have gotten larger and larger, the scanning lines have become more and more noticeable, especially at short viewing distances. Now, by placing Saba's specially designed plastic filter in front of the picture tube, the individual lines can be blended into one smooth picture. The result is an image which appears to be "lineless" at any distance and which looks very much like the picture you see on the screen of your neighborhood movie theatre. -50-



Unlike electronic systems (the "wobulator," for example), Saba's new filter is optical in nature. Its effect is to blend individual lines into a single, "lineless" picture.

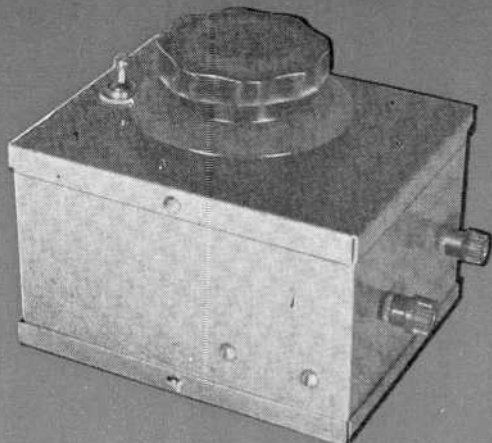
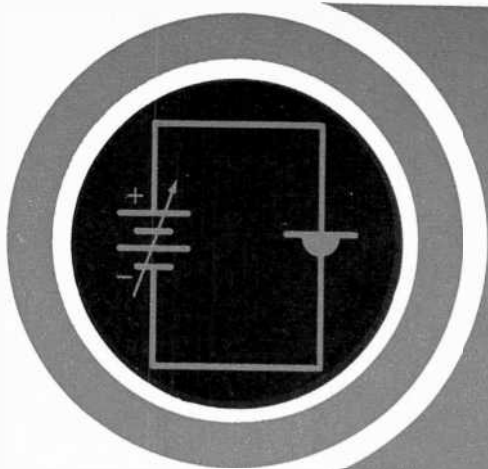

For Experimenters ...

TD POWER SUPPLY

By RUFUS P. TURNER

ONE of the annoying drawbacks in experimenting with tunnel diodes* is that an adequate power supply is usually not available on the experimenter's bench. The easy-to-assemble TD power supply described in this article fulfills the three basic specifications a tunnel diode power supply should have. They are: (1) an internal resistance of 10 ohms or less, (2) a d.c. output continuously variable from 10 to 500 millivolts, and (3) good regulation—since tunnel diodes operate best when their supply voltage "stands still."

The simplest kind of variable power supply for powering tunnel diode circuits, shown in Fig. 1, consists of a 1.5-volt dry cell (*B1*) and a voltage divider consisting of a potentiometer (*R1*) and two fixed resistors (*R2* and *R3*) in series. The current through the divider ranges from 1.5 ma. when *R1* is set at 1000 ohms to 50 ma. when *R1* is set at zero. Accordingly, the d.c. output voltage varies from 15 to 500 millivolts. The output resistance is a bit less than 10

ohms (determined primarily by the value of *R3*). But this simple supply has two disadvantages: (1) a large current flows through the potentiometer when the latter is set near its low-resistance end, and (2) fluctuations in battery voltage cause the output voltage to fluctuate.

Transistorizing. The disadvantages of the circuit in Fig. 1 can be overcome by substituting a low-priced power transistor for the potentiometer. The transistor can safely carry much higher currents and, if it is operated as a common-emitter d.c. amplifier, a small control current (safe to vary with a small potentiometer) will vary the high current through the output resistor. A further advantage results from the almost flat collector current-voltage curve; the battery voltage can fluctuate without causing very much of a change in the output voltage.

Figure 2 shows the complete circuit of the transistorized TD power supply. The 2N255 power transistor (*Q1*) operates as a common-emitter amplifier. The base input current (*I1*) can be varied between 0.13 and 2 ma. by adjusting potentiometer *R1*, causing the collector current (*I2*) to vary between zero (ap-

*For detailed information on how the tunnel diode works, see POPULAR ELECTRONICS, September, 1960, page 52.

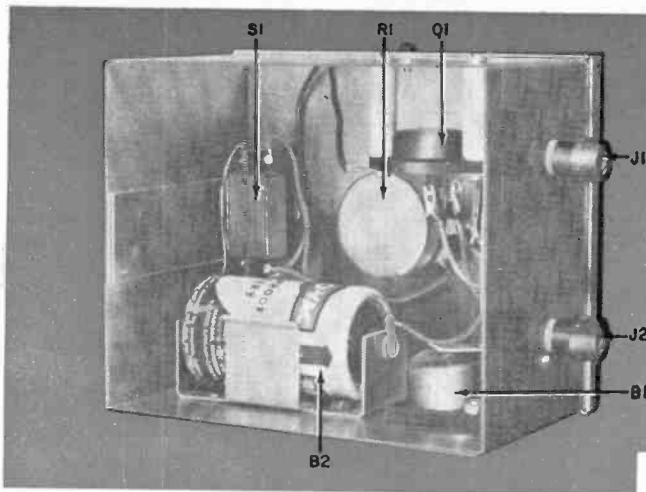

Before inserting dry cells in wired unit, check for open circuit between transistor Q1's case and chassis.

To test tunnel diode circuits, you will need a continuously variable, well-regulated low voltage

proximately) and 50 ma. The collector current flows through the 10-ohm resistor ($R3$) and produces an output voltage drop that varies from 10.0 to 500 millivolts.

The output voltage does not drop to zero because the 1-ma. static collector current of the transistor used in the author's model produces a voltage drop of 10 mv. across $R3$. This minimum voltage will vary with the make of transistor. In the event that the output voltage of the power supply you assemble exceeds 500 millivolts, it will be necessary to increase the value of $R2$ by 50 to 100 ohms—as required—by a trial-and-test technique.

Collector voltage is provided by a 1.5-volt size "D" flashlight dry cell ($B2$), while base input (control) voltage is provided by $B1$. To insure a steady input voltage, a 1.35-volt mercury cell is used for $B1$. A mercury cell maintains a relatively constant voltage throughout its useful life.

Because of the amplification provided by the transistor, the base input (control) current, $I1$, should be limited to

(Continued on page 116)

PARTS LIST

- B1—1.35-volt mercury cell (Mallory RM3R)
- B2—1.5-volt size "D" dry cell (Burgess #2 or equivalent)
- J1—Insulated binding post, red (E. F. Johnson 111-102 or equivalent)
- J2—Insulated binding post, black (E. F. Johnson 111-103 or equivalent)
- Q1—2N255 transistor
- R1—10,000-ohm potentiometer
- R2—300-ohm, 1-watt resistor
- R3—10-ohm, 1-watt resistor
- S1—D.p.s.t. toggle switch
- 1—5" x 4" x 3" aluminum utility box (Bud CU-2105A or equivalent)
- 1—Battery holder for B1 (Keystone 104 or equivalent)
- 1—Battery holder for B2 (Keystone 175 or equivalent)
- 1—Transistor mounting kit—optional (Motorola MK-15)

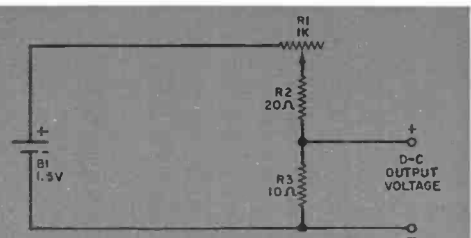
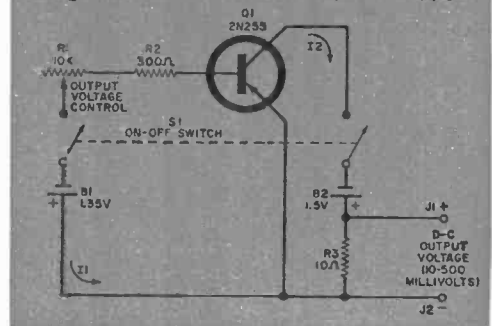

Fig. 1. Simplest tunnel diode power supply.

Fig. 2. The transistorized TD power supply.



Hobnobbing with Harbaugh

Just Plain QRM

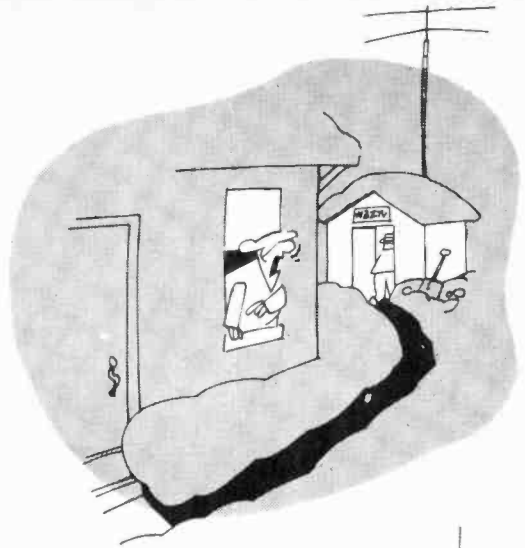

"I said the front walk!!!"

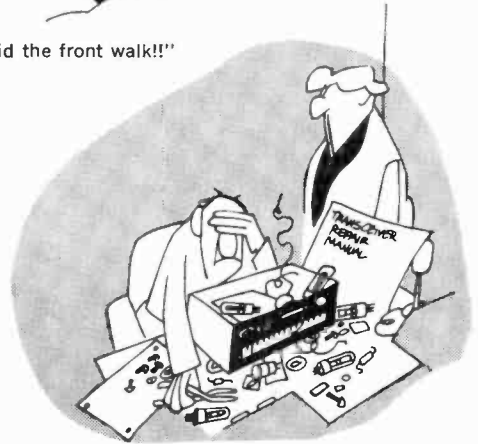

"I forgot to tell you, I was dusting in here and pulled the cord out."



"I'd like to see something with an early American antenna."



"The TV man left it here by mistake ... all I can get on it is a wiggly line."

W. Harbaugh



Across the Ham Bands

By
HERB S. BRIER
W9EGQ

ARRL "NOVICE ROUNDUP"

WANT TO WORK a bunch of new states and receive a batch of new QSL cards? A golden opportunity for you to do both is presented by the Eleventh Annual ARRL "Novice Roundup" contest which starts February 3 at 6:00 p.m., local time, and continues until February 18 at 9:00 p.m., local time. The rules are simple: each operator works as many stations as possible over a total of 40 hours or less in the contest period, using any or all of the Novice bands. Contacts are made by calling "CQ NR" or answering such calls by other stations.

To complete a contact, each operator sends the other a contest number (beginning with Nr. 1 for his first contact) and the name of his section. The ARRL sections correspond to the U. S. states, the

Canadian provinces, the West Indies (Puerto Rico, Cuba, etc.), and the Canal Zone. California, however, is divided into eight sections; New York into three; Florida, Massachusetts, New Jersey, Pennsylvania, and Texas into two each.

One point is earned for each completed contact, and your final score is the number of contact points multiplied by the number of different sections worked—with a bonus. If you have an ARRL Code Proficiency Certificate, you can add the code speed shown on the certificate to your contact points. For example, if you work 15 stations in eight sections, and have a 10-wpm certificate, your total score will be: $(15 + 10) \times 8 = 200$ points.

The scores are sent to the American Radio Relay League, Inc., 38 La Salle Rd.,

Novice Station of the Month

Lou Waters, WV2TCW, 356 2nd Ave., Troy, N. Y., sent in the winning entry in the photo contest this month. WV2TCW uses an EICO 720 transmitter, a National 270 receiver, a 15-meter dipole, and an "all-band" antenna. In three months, he has made over 500 contacts in 31 states, Canada, Belgium, and other countries. Incidentally, his log includes contacts with nine YL's.

Lou will receive a 1-year free subscription to P.E. for his photo. If you'd like to try for a similar award, send us a picture of your station—preferably with you at the controls, and include some information about yourself, your equipment, and your activities. Maybe you'll be one of the lucky winners. All photo entries should be sent to Herb S. Brier, c/o POPULAR ELECTRONICS, Box 678, Gary, Indiana.





High stability of Mosley CM-1 ham receiver belies its low price tag. Set uses six tubes, two diodes.

West Hartford, Conn., and the winning Novice in each section receives a certificate. (A prior request to the same address will promote some contest log sheets and an ARRL section map to help you tabulate your score.)

While General Class and Canadian hams are not eligible for an award, they are nevertheless invited to participate in the Novice Roundup and help Novices add points to their scores.

Reciprocal Licensing. Many countries extend the courtesy of reciprocal licensing privileges to each other's amateurs. But a provision of the United States radio laws—not originally aimed at hams—prevents amateurs from other countries (except Canada) from operating in the United States. This is a source of resentment against the United States for many foreign amateurs, and it also prevents U.S. hams from operating in countries with reciprocal licensing laws.

As mentioned in the *FCC Report* (November, 1961, *POPULAR ELECTRONICS*), Senators Barry Goldwater (ex-6BPI), Arizona, and Andrew F. Schoepel, Kansas, are trying to do something about this situation. They introduced a bill (S.2361) in the United States Senate on August 1, 1961, to amend the Communications Act of 1934 so that foreign amateurs would be permitted to operate in the United States under proper safeguards. The bill is now being considered by the Senate's Interstate and Foreign Commerce Committee, and you can help get it enacted into law by writing to your two U. S. senators and telling them that you favor it. Ask your friends to write to their senators, too.

Receiver Breakthrough. Judging from the specs of the new CM-1 10- to 80-meter

ham receiver, Mosley Electronics, Inc., 4610 North Lindbergh Blvd., Bridgeton, Mo., may have achieved a real breakthrough in ham receivers by producing a rock-stable set for \$169.95. (An accessory matching speaker is priced at \$16.95.)

The crystal-controlled h.f. oscillator, variable first i.f., voltage regulation, and temperature compensation account for the CM-1's high stability. Include 2.5-kc. selectivity, ½-microvolt sensitivity, an S-meter, and a noise limiter, and you have a lot of performance from six tubes and two semiconductor diodes.

You can write to Mosley for more information or see the CM-1 at most ham supply houses.

HIGH-PERFORMANCE TRANSMITTER

Though simple to build, this 25- to 30-watt, crystal-controlled c.w. transmitter will, under the same conditions, produce a signal within one "S" unit of that emitted by a transmitter running the full Novice power of 75 watts. Especially designed for the 80- and 40-meter ham bands, the rig also works well on 20 meters. The power supply is built-in, the signal is ripple-free, and keying characteristics are good.

Construction. A 5" x 7" x 2" aluminum chassis comfortably accommodates the transmitter and its power supply. The key jack and power switch are at the front of the chassis and the output connector and power cord are at the rear. The fixed capacitors, r.f. chokes, and resistors are supported by their leads; wiring is point to point; and ground connections are made to solder lugs placed under strategically located mounting screws.

The stator terminals of dual variable capacitor *C8* are connected together, placing the two sections in parallel. For extra rigidity, each lead of coil *L3* is doubled back upon itself and wrapped once around the plastic coil-form strip where it terminates. Coil *L3* is then mounted between the stator terminals of capacitors *C7* and *C8*. Taps made of looped wire are soldered to *L3* at 6 and 14 turns from the *C7* end. A 3" length of insulated wire is connected to the *C8* side of *L3* and a small battery clip soldered to its free end.

PARTS LIST

- C1**—100- μ f. mica capacitor
C2, C3, C4, C5, C10—0.005- μ f. ceramic capacitor
C6—0.001- μ f., 1000-volt mica capacitor
C7—409- μ f. variable capacitor (Allied 61 H 009 or equivalent)
C8—Dual 468- μ f. variable capacitor (Allied 61 H 059 or equivalent) with both sections in parallel
C9—20- μ f., 500-volt electrolytic capacitor
J1—Open-circuit phone jack
J2—Chassis-type coaxial connector (Amphenol 83-1R or equivalent)
L1, L2—1-mh. r.f. choke
L3—29 turns of #20 wire, 1" diameter, 1 $\frac{1}{8}$ " long, tapped 6 and 14 turns from output end (cut from B&W 3015 Miniductor or equivalent)
R1—47,000-ohm, $\frac{1}{2}$ -watt resistor
R2—20,000-ohm, 10-watt resistor
R3—7500-ohm, 5-watt resistor
S1—S.p.s.t. switch
T1—Power transformer; primary, 117 volts; secondaries, 700 volts CT @ 90 ma., 5 volts @ 2 amperes, 6.3 volts @ 3 amperes (Stancor PM-8409 with filament CT unused, or equivalent)
V1—6L6-G tube
V2—5Y3-GT tube
X1—Transmitting crystal—see text
1—5" x 7" x 2" aluminum chassis (Bud AC-402 or equivalent)
Misc.—Insulated tie points, tube sockets, solder lugs, power cord and plug, crystal socket, etc.

Schematic of high-performance c.w. transmitter shows simplicity of circuit. Only two tubes are needed, including power-supply rectifier.

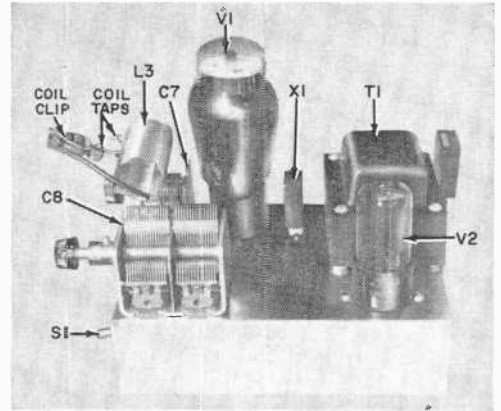
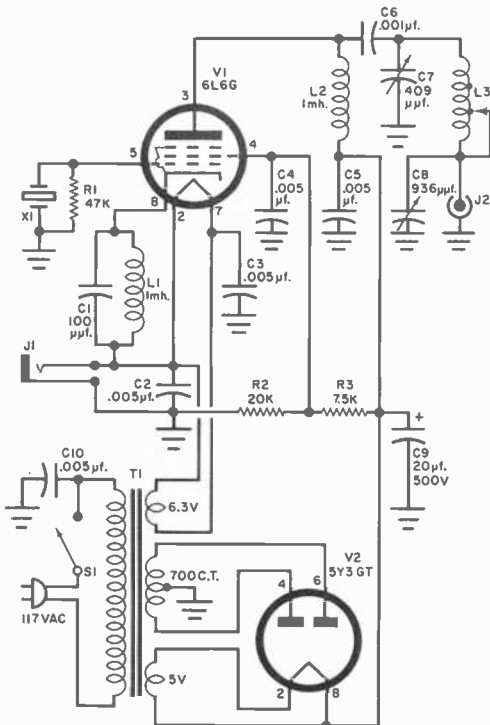

There's not much wasted space on the transmitter chassis, as can be seen in these top and bottom views. Top view (above) shows that the power supply components take up one third of the area.

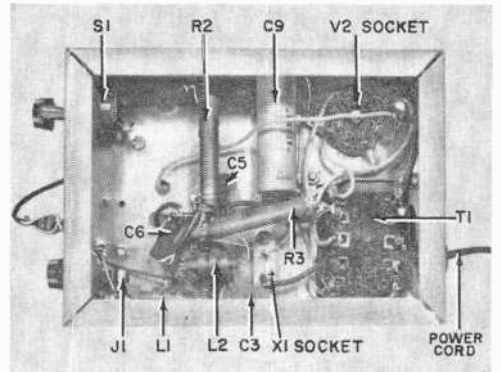

Tuning and Operation. On 80 meters, all of coil *L3* should be in the circuit—so the coil-shortening clip is not used; to get it out of the way, clip it to one of the *C8* stator terminals. For 40-meter operation, attach the clip to the 14-turn tap; on 20 meters, use the 6-turn tap.

With the coil adjustment made, plug in a crystal for the band you will be using. Eighty-meter crystals are normally used on "80," 40-meter crystals on "40." It's possible, however, to use an 80-meter crystal whose second harmonic falls in the 40-meter band for 40-meter operation. Forty-meter crystals with second harmonics on the 20-meter band are always used on "20."

Now connect a No. 45 pilot lamp or a 100- to 150-ma. d.c. meter in series with the ungrounded key lead. With the antenna connected and both variable ca-

(Continued on page 108)

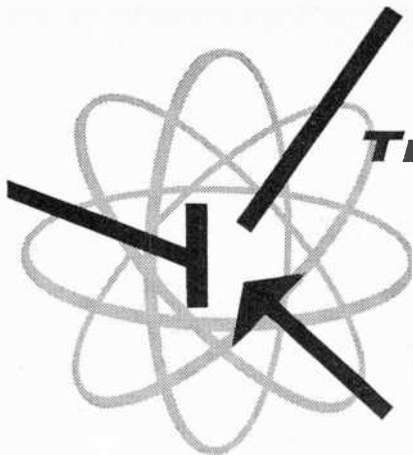

Transistor Topics

By LOU GARNER

With the beginning of a new year, it is once again time to open our "secret chest" and drag out our dusty crystal ball, cleaning and polishing it in anticipation of successful predictions for the coming year.

This annual guessing game with the semiconductor industry is a lot of fun, even if embarrassing at times. Nearly all of our predictions come to pass, but the timing is often a wee bit off. In some cases, the industry moves so fast that the "prediction" actually comes true before the January issue rolls off the presses. In other cases, however, manufacturers are several months late in offering the products anticipated by yours truly.

For example, in January of 1960 we predicted that a "two-bit" transistor would be offered that year. The prediction came true—but not until mid-1961, when Radio Shack, Lafayette Radio and other distributors offered "packs" of four transistors at slightly under one dollar. Perhaps we should check out the printed

circuits in our crystal ball—with special reference to the time constants!!

Before turning to the coming year and sticking our neck out again, let's review the box-score of "guesstimates" for last year. In our January 1961 column, we predicted:

✓ A race towards transistors among CB equipment manufacturers—*double-check*—look at the types and models offered in current ads!

✓ A medium-power transistorized CB transmitter—*double-check*—Cadre Industries offers such equipment, and rechargeable batteries can be installed, just as predicted.

✓ Increasing use of transistors in amateur radio gear—*check*—but, as of this date, no manufacturer is offering a transistorized SSB transmitter, so we struck out on this part of our forecast.

✓ Medium-power r.f. transistors at under three dollars—*struck out again*—but, as the old saying goes, "Wait 'til next year!"

✓ A swing to transistors for R/C work—*double-check*.

✓ Increased use of transistors in hi-fi equipment—*triple-check*—see our October 1961 column, and refer to current catalogs!

Things To Come. Even after double-checking the circuits in our crystal ball, we're still a little dubious about the time constants . . . but here goes!!

In 1962, watch for . . . "experimenters" tunnel diodes at tube prices or less . . . *transistorized CD gear for fall-out shelters and personal use* . . . a transistorized stereostethoscope for doctors . . . *high-frequency medium-power transistors for under \$5.00* . . . silicon transistors for hobbyists for under \$2.00 . . . *a medium-priced (under \$350.00) transistorized oscilloscope* . . . a new type of



Among the latest in hi-fi equipment is this all-transistor stereo amplifier kit from Allied Radio.

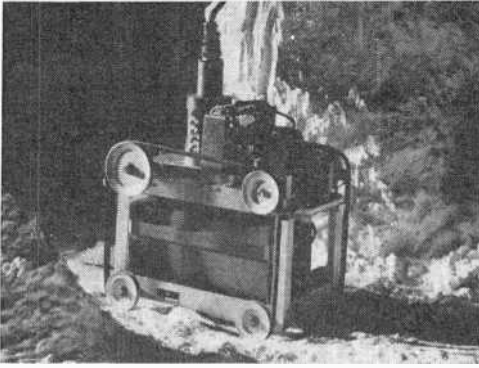

First U.S. "moon-shot" will undoubtedly call on a battery of transistorized equipment. Lunar vehicle shown above will collect data on moon, yet be controlled from earth. Cutler-Hammer is the designer.

transistor or semiconductor device based on the use of crystalline carbon (diamond) . . . an increase in the use of transistors in hi-fi equipment, coupled with a drop in the number of firms offering transistorized CB "walkie-talkies" . . . the introduction of a transistorized personal small-arms detector . . . and, finally, a U.S.-sponsored "moon-shot" carrying a transistorized TV camera.

Reader's Circuit. Assuming that a transistor is neither excessively leaky nor "open," its most important parameter as far as general experimental work is concerned is its gain or *beta*. This value may range from as low as 5 to well over 100, depending on the type of transistor and the conditions under which it is checked. In many switching and control circuits, low-*beta* transistors will give quite satisfactory results. In preamplifiers, receivers, and similar projects, on the other hand, high-*beta* units are required for optimum performance. Finally, in some cases—push-pull circuits, for example—the exact value of *beta* is not overly important, provided a pair of transistors with identical gain characteristics can be found.

Unfortunately, a transistor's *beta* is seldom given as an exact value, even under specified test conditions. Rather, semiconductor manufacturers will list "minimum," "average," and "maximum" values. Better-quality transistors generally have a specified *beta* spread of three to one; typically, from 25 to 75. Inexpensive transistors can have a *beta* range as high as 10 or 20 to 1, and a unit will be

considered "good" if its *beta* falls anywhere between 10 and 100.

With these facts in mind, and realizing that most hobbyists prefer to use low-cost transistors, a number of readers have suggested designs for inexpensive d.c. *beta* checkers. One of the more in-

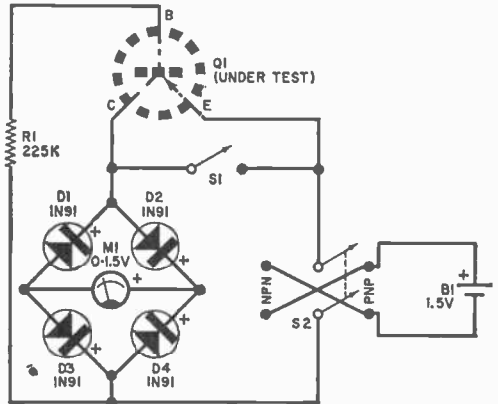

Fig. 1. Inexpensive beta tester designed by reader P. L. Conant will check either npn or pnp transistors, depending upon position of d.p.d.t. switch S2.

teresting circuits is illustrated in Fig. 1. It was designed by P. L. Conant.

Referring to the schematic diagram, and ignoring the diodes and switches for the moment, *beta* is checked by using the transistor, *Q1*, as a d.c. amplifier in the common-emitter arrangement, applying a fixed base bias, and measuring the resulting collector current. In this case, the base bias is determined by series base resistor *R1* and the supply voltage *B1*, with the collector current directly proportional to *Q1*'s *beta*. In practice, *R1*'s value is chosen so that *beta* can be read directly on the 1.5-volt d.c. voltmeter (*M1*) used as *Q1*'s collector load. Meter readings are multiplied by 100, permitting *beta* readings of up to 150.

The circuit has several interesting features. Either *npn* or *pnp* transistors can be checked simply by reversing the polarity of the supply voltage; a cross-connected d.p.d.t. switch, *S2*, is used for this purpose. A diode bridge circuit (*D1*, *D2*, *D3*, and *D4*) insures correct meter polarity and an "up-scale" reading regardless of supply voltage polarity. A s.p.s.t. push-button switch, *S1*, connects the battery directly across the diode/meter circuit, permitting a built-in test

of battery condition. Operating power is supplied by a single flashlight cell (*B1*) rather than a more expensive 9-volt battery.

All the components are standard and readily available through regular parts distributors. The only critical items are the bias resistor, *R1*, and the meter (*M1*). A 225,000-ohm, 1% unit should be

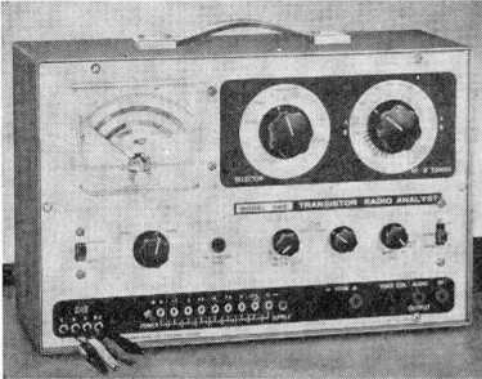

The Model 960 tester made by B & K Manufacturing Co. is designed for servicing transistor radios.

used for *R1*, and a standard 0-1.5 volt d.c. voltmeter with a sensitivity of 1000 ohms/volt for *M1*. Although type 1N91 diodes are specified, other general-purpose units should give satisfactory results. Switch *S1* can be a push-button or spring-return slide or rotary switch; a toggle, slide, rotary, or lever switch may be used for *S2*, depending on individual preferences.

The *beta* checker can be assembled in a single evening without difficulty, even allowing time for a coffee or "Coke" break. A sloping-front meter cabinet, a Minibox, or a small plastic box can be used as a case, with a standard transistor socket and/or flexible test leads and miniature alligator clips provided for the transistor. Neither layout nor lead dress is critical, but the usual precautions should be observed when soldering the diodes in place to avoid heat damage.

In operation, the condition of the battery is checked first by throwing on *S1*; a full-scale reading should be obtained. Afterwards, *S2* is thrown to the proper position for the type of transistor to be checked and the transistor is inserted in

the test socket. If flexible leads are used for connecting the transistor, the *emitter* and *collector* terminals should be connected first, the *base* terminal last. Finally, the meter reading (0 to 1.5 volts) should be multiplied by 100 to arrive at the *beta* figure.

This test assumes that the transistor has negligible leakage—as will be the case for most units in good condition. If collector leakage is high (as determined by a check with the base lead disconnected), this value must be subtracted from the final meter reading.

Product News. An interesting test instrument has been announced by the B & K Manufacturing Co. (1801 W. Belle Plaine, Chicago 13, Ill.) Known as the Model 960 Transistor Radio Analyst, this

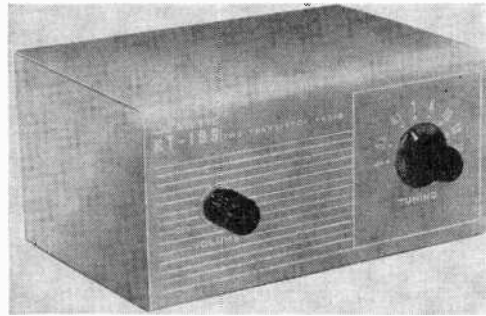

Low-cost transistorized AM radio kit by Lafayette Radio is battery-operated and requires no soldering.

instrument sells for \$99.95 and is intended to simplify transistor radio servicing. It combines, in one unit, the features of a signal generator, d.c. power supply, VTVM, milliammeter, ohmmeter, and transistor checker. As a signal generator, the "960" supplies modulated r.f. signals for signal injection tests of r.f., i.f., converter, and detector stages, as well as an audio signal for checking audio stages and speakers. As a substitute power source, the unit can supply from 1.5 to 12.0 volts, d.c., in 1.5-volt steps. Both in-circuit and out-of-circuit transistor test provisions are included.

Featuring a unique type of construction, a transistor radio kit recently introduced by Lafayette Radio (165-08 Liberty Ave., Jamaica 33, N. Y.) is intended for the hobbyist with limited
(Continued on page 100)

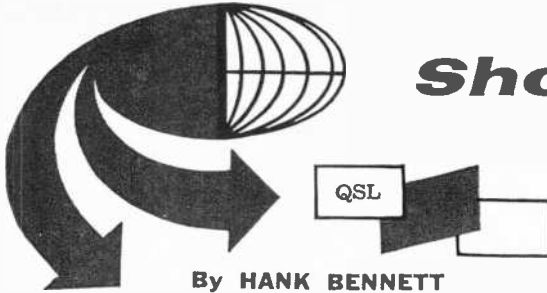

Short-Wave Report

By **HANK BENNETT**
W2PNA/WPE2FT

Q-MULTIPLIER AND RECEIVER KITS

THERE ARE two new kits available from the Heath Company which will be of interest to SWL's: the HD-11 Q-multiplier and the GR-91 receiver. Both are easy to build with the instructions provided and both should help furnish many hours of listening pleasure.

The *HD-11 Q-multiplier* can be used with any communications receiver having an i.f. between 450-460 kc., and with

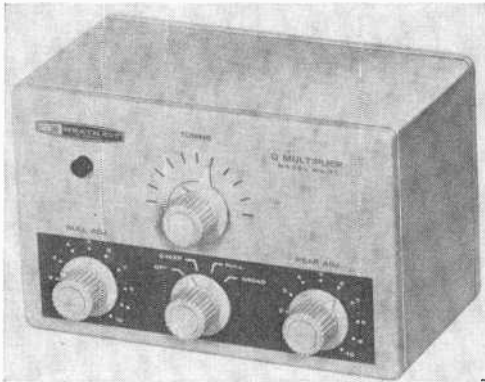

either a.c./d.c. or transformer-operated receivers. This "electronic filter" greatly increases receiver i.f. selectivity (it has an effective *Q* of approximately 4000) for peaking or rejecting a signal on AM, c.w., or SSB. It can be used to produce a sharply peaked i.f. curve for c.w. reception, broad peaked i.f. for phone operation, or a deep rejection notch to eliminate a closely interfering heterodyne; both peak and notch positions are tunable to any point in the receiver's i.f. bandpass.

Weighing only two pounds (net), the HD-11 has a built-in power supply and comes complete with connecting i.f. cable, plug and socket for receiver attachment.

It's priced at \$14.95, f.o.b., Benton Harbor, Mich.

The *GR-91 receiver* covers 500 kc. to 30,000 kc. in four bands which are clearly marked on an illuminated 7" slide-rule dial. High sensitivity and good stability are insured by the modern four-tube plus silicon rectifier superheterodyne circuit, the tubes being a 12BE6 oscillator/mixer; a 12BA6 i.f. amplifier and BFO; a 12AV6 second detector, a.v.c., and first audio amplifier; and a 50C5 beam power output tube.

Among the special features of the GR-91 is an all-new illuminated tuning meter that shows relative signal strength of each station; front-panel controls

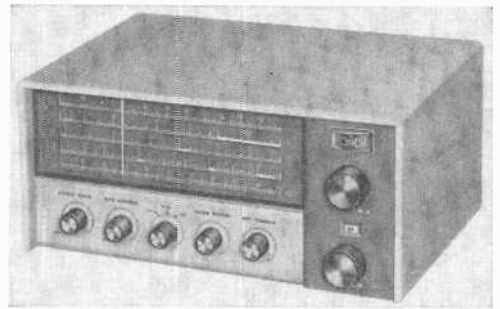

include audio gain, electrical bandspread, AM/standby/e.w. switch, bandswitch, BFO, main tuning, and antenna trimmer. On the rear of the chassis is a noise limiter switch, a headphone jack, a Q-multiplier jack, and an antenna jack with provisions for both balanced (300-ohm) or unbalanced (75-ohm) inputs. A built-in 3" x 5" speaker is also included.

Furnished in an all-steel cabinet, the GR-91 weighs nine pounds and is priced at \$42.50, f.o.b., Benton Harbor, Mich.

(Continued on page 110)



Carl and Jerry

Wired Wireless

"MIND telling me why we're climbing to the sixth floor of Gary Hall?" Jerry puffed as he followed his athletic chum, Carl, up the stairs.

"Jimmy Young, chief technical and maintenance engineer of WCCR, master station of the carrier-current campus radio network, wants to see us. And we've been itching to see the station. Need I say more?" Carl asked as he pushed open the door at the top of the stairs.

A stocky, dark-complexioned young man rose from a chair across the large room and came to meet them. "You must be Jerry Bishop; and you, Carl Anderson," he said, holding out his hand. "I'm Jimmy Young. Thanks for coming. Want to take a quick look around the station before we get down to the little matter I have in mind?"

"Yeah!" Carl and Jerry chorused.

A grin spread over Jimmy's face as he brushed back his dark hair with his hand. "Okay, but first you gotta suffer through my two-dollar lecture," he warned.

"You're now standing in the office and lounge of WCCR, master station of what we think is the oldest and largest carrier-current campus radio network in the world. There are four other stations in the net: WMRH in H1 Residence Hall, WHRC in H2, KMRX in H3, and WCTS in the State Street Courts. As soon as it's completed, we expect to add a sixth station, WGRG, in the Women's Residence Hall.

"Each station," he continued, "operates on a selected crystal-controlled frequency somewhere between 570 and 660 kilocycles. The r.f. from the transmitter is fed into the power circuits of the particular residence unit so that any radio inside the building can pick up the program but no signal can be heard outside.

Each station is self-sufficient; it's constructed, maintained, and operated by students housed in that building, and it furnishes programs for the residents of that one housing unit.

"At the same time, each satellite station is connected to the patch board of this master control station by a closed telephone loop so we can feed programs to it or it can furnish programs for the network. All five stations take turns furnishing network programs. A simplex telephone circuit in connection with each telephone loop permits exchanging information about programing, etc.

"Now, let's go into Studio A, our master control room."

THE BOYS followed him through the door, and the first thing that caught their eyes was a couple of standard six-foot racks filled with electronic equipment. A control console, two turntables, tape recorders, an AM-FM tuner, and other assorted pieces of equipment were arranged for maximum convenience.

"I'll talk about WCCR," Jimmy announced, "for it's the oldest and most sophisticated station, and it's the one I know the most about; but the basic transmitters of the other stations are similar. This is the station for Gary

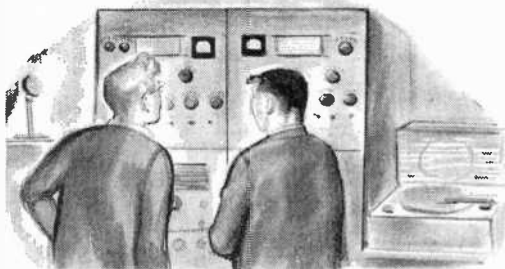

SUPERIOR'S NEW MODEL 85

TRANS-CONDUCTANCE TYPE

TUBE TESTER

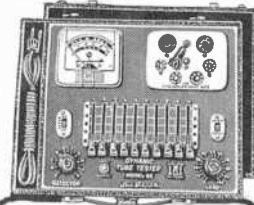

Model 85—Trans-Conductance Tube Tester. Total Price \$52.50 Terms: \$12.50 after 10 day trial, then \$8.00 monthly for 5 months if satisfactory. Otherwise return, no explanation necessary.

• FREE FIVE (5) YEAR CHART DATA SERVICE. Revised up-to-date subsequent charts will be mailed to all Model 85 purchasers at no charge for a period of five years after date of purchase.

Model 85 comes complete, housed in a handsome portable cabinet with slip-on cover. Only

\$52.50

• Employs latest improved TRANS-CONDUCTANCE circuit. Test tubes under "dynamic" (simulated) operating conditions. An in-phase signal is impressed on the input section of a tube and the resultant plate current change is measured as a function of tube quality. This provides the most suitable method of simulating the manner in which tubes are actually operated in radio, TV receivers, amplifiers and other circuits. Amplification factor, plate resistance and cathode emission are all correlated in one meter reading.

• SYMBOL REFERENCES: Model 85 employs time-saving symbols (A, B, C) in place of difficult-to-remember letters previously used. Repeated time-studies proved to us that use of these scientifically selected symbols speeded up the element switching step. As the tube manufacturers increase the release of new tube types, this time-saving feature becomes more important and advantageous.

• "FREE-POINT" LEVER TYPE ELEMENT SWITCH ASSEMBLY marked according to RETMA basing, permits application of test voltages to any of the elements of a tube.

SUPERIOR'S NEW MODEL 83A

C.R.T. TESTER

Tests and Rejuvenates ALL PICTURE TUBES

ALL BLACK AND WHITE TUBES

From 50 degree to 110 degree types —from 8" to 30" types.

ALL COLOR TUBES

Test ALL picture tubes—in the carton—out of the carton—in the set!

Model 83A provides separate filament operating voltages for the older 6.3 types and the newer 8.4 types. Model 83A properly tests the red, green and blue sections of color tubes individually — for each section of a color tube contains its own filament, plate, grid and cathode. Model 83A will detect tubes which are apparently good but require rejuvenation. Such tubes will provide a picture seemingly good but lacking in proper definition, contrast and focus.



Model 83A — C. R. Tube Tester. Total Price \$38.50 Terms: \$8.50 after 10 day trial, then \$6.00 monthly for 5 months if satisfactory. Otherwise return, no explanation necessary.

Rejuvenation of picture tubes is not simply a matter of applying a high voltage to the filament. Such voltages improperly applied can strip the cathode of the oxide coating essential for proper emission. The Model 83A applies a selective low voltage uniformly to assure increased life with no danger of cathode damage.

Comes housed in handsome portable Saddle Stitched Texon case—complete with sockets for all black and white tubes and all color tubes. Only

\$38.50

SUPERIOR'S NEW MODEL 79

SUPER-METER

WITH NEW 6" FULL VIEW METER



Model 79—Super-Meter Total Price \$38.50 Terms: \$8.50 after 10 day trial, then \$6.00 per month for 5 months, if satisfactory. Otherwise return, no explanation necessary.

SPECIFICATIONS: D.C. VOLTS: 0 to 3.5/15/150 • A.C. VOLTS: 0 to 15/30/150/300/1,500/3,000 • D.C. CURRENT: 0 to 1.5/15/150 Ma. • 0 to 1.5/15 Amperes • RESISTANCE: 0 to 1,000/100,000 Ohms • 0 to 10 Megohms • CAPACITY: .001 to 1 Mfd. 1 to 50 Mfd • REACTANCE: 50 to 2,500 Ohms, 2,500 Ohms to 2.5 Megohms • INDUCTANCE: .15 to 7 Henries, 7 to 7,000 Henries • DECIBELS: -6 to +18, +14 to +38, +34 to +58.

The following components are all tested for QUALITY at appropriate test potentials. Two separate BAD-GOOD scales on the meter are used for direct readings: All-Electrolytic Condensers From 1 MFD to 1000 MFD • All Selenium Rectifiers • All Germanium Diodes • All Silicon Rectifiers • All Silicon Diodes

Model 79 comes complete with operating instructions and test leads. Only

\$38.50

SUPERIOR'S NEW MODEL TV-50A

GENOMETER

7 Signal Generators in One!

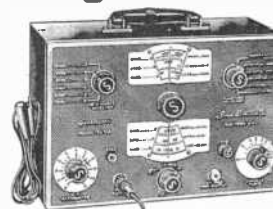

Model TV50-A—Genometer Total Price \$47.50 Terms: \$11.50 after 10 day trial, then \$6.00 monthly for 6 months if satisfactory. Otherwise return, no explanation necessary.

- ✓ R.F. Signal Generator for A.M.
- ✓ R.F. Signal Generator for F.M.
- ✓ Audio Frequency Generator
- ✓ Bar Generator
- ✓ Marker Generator
- ✓ Color Dot Pattern Generator
- ✓ Cross Hatch Generator

A versatile all-inclusive GENERATOR which provides ALL the outputs for servicing:

A.M. Radio • F.M. Radio • Amplifiers • Black and White TV • Color TV

The Model TV-50A comes complete with shielded leads and operating instructions.

Only **\$47.50**

SHIPPED ON APPROVAL NO MONEY WITH ORDER — NO C.O.D.

Try any of the above instruments for 10 days before you buy. If completely satisfied then send down payment and pay balance as indicated on coupon. No Interest or Finance Charges Added! If not completely satisfied return unit to us, no explanation necessary.

MOSS ELECTRONIC, INC.

Dept. D-918, 3849 Tenth Ave., New York 34, N. Y.

Please send me the units checked on approval. If completely satisfied I will pay on the terms specified with no interest or finance charges added. Otherwise, I will return after a 10 day trial positively cancelling all further obligations.

Name

Address

CityZone.....State.....

Model 85.....Total Price \$52.50 \$12.50 within 10 days. Balance \$8.00 monthly for 5 months.

Model 79.....Total Price \$38.50 \$8.50 within 10 days. Balance \$6.00 monthly for 5 months.

Model 83-A.....Total Price \$38.50 \$8.50 within 10 days. Balance \$6.00 monthly for 5 months.

Model TV-50A.....Total Price \$47.50 \$11.50 within 10 days. Balance \$6.00 monthly for 6 months.

All prices net. F.O.B., N. Y. C.

Carl and Jerry

(Continued from page 82)

Hall, often called the Men's Quadrangle because it actually consists of six residence halls arranged in a rectangle. Power circuits for the Quadrangle are fed from six different power boxes furnishing 220 volts single phase a.c.; so we have to feed our r.f. into each of these boxes."

"Must take lots of r.f.," Carl said. "How many kilowatts do you run?"

"We use two separate transmitters here at WCCR so we can transmit the same program on two different frequencies and provide stereo reception, but each transmitter inputs only about 30 watts! In fact, the transmitters are revamped Heathkit DX-35's. We put in new oscillator coils and plate-tank pi-networks designed to have a satisfactory Q at a low, broadcast-band frequency, and to feed a 72-ohm coax line. These transmitters are plate-modulated in each case by a pair of 5881's in Class AB, driven by a 12AX7 as a combination amplifier and phase-inverter."

"Then what's the rest of that stuff?" Carl asked, waving at the big racks.

"Preamplifiers, monitor amplifiers, cue amplifiers, limiter amplifiers, patch board, power supplies, and other little goodies needed to transmit really high quality programs and to serve as a master control station. Our preamps and line amps are flat from 10 cycles to 25,000 cycles, but we restrict the high end to 9000 cycles and boost the bass before feeding the signal to the modulator. We do this to prevent splatter and to compensate for the poor low-frequency response of the small radios used to receive us."

"You say you run two different r.f. signals into your single 'antenna,' the power lines, when you're operating stereo," Jerry commented. "How do you prevent interaction between the two transmitters?"

"We use what we call a hybrid junction. This is similar to the diplexer unit a TV station employs to feed both the audio and video transmitters into the same antenna. Actually, it's a form of r.f. bridge that permits each transmitter to feed the line but prevents r.f. from backing up into the other transmitter."

"How do you actually couple into the power boxes?" Carl wanted to know at this point.

"We use an r.f. transformer for each box. The primary is tapped so we can hook several in parallel and still get a proper impedance for our 72-ohm line. Each side of the secondary goes through an 0.0005 blocking capacitor and a 10-ohm, 5-watt resistor to one side of the 220-volt line. The capacitor, of course, keeps the 60-cycle a.c. out of the transformer winding.

"We've found that the impedance from one side of the power line to ground varies between $\frac{1}{4}$ and $\frac{1}{2}$ ohm at our carrier frequency as different devices in the building are switched on or off. Naturally a two-to-one change in load impedance would badly upset any established match; but when the resistor is inserted, the impedance seen by half the transformer secondary can only vary between $5\frac{1}{4}$ and $5\frac{1}{2}$ ohms, and that can be tolerated. Lots of power is lost in the resistors, but we've enough left."

"Can you pick up the program on a transistor radio in one of the rooms, or does the radio have to be plugged into the line?" Carl asked.

"You know you can pick it up on any kind of radio; so stop pulling my leg! In fact, you can receive it with only a pair of earphones clipped across a 1N34 diode. Remember, you're practically sitting on the antenna, for every wire in the building is radiating r.f. for a short distance."

"What hours do you operate?" Jerry questioned.

"We're on twenty-four hours a day, seven days a week. We start with some rock-and-roll wake-up music around 7:30 a.m. During the rest of the morning we feature good-to-study-by music, not too distracting, and a special lunch program of music is on during the noon hour. In the afternoon we play 20 or 30 of the top records. Dinner music is on from 5:30 to 6:30, and after dinner we have more pop tunes—but no rock-and-roll. From 9 until 11 it's semi-classical; from 11 to 12 we have an hour of the very best classical music. Then we switch over to the tuner bringing in one of the clear channel broadcast stations that operate all night, and we ride that until morning."

(Continued on page 87)



Special Training EQUIPMENT INCLUDED

Pick the field of your choice—and train at home with the leader—NRI. In addition to Industrial Electronics and FCC License training explained at the right, NRI offers comprehensive courses in Radio-TV Servicing and Radio-TV Communications. Except for the FCC course, all NRI courses include—at no extra cost—special training equipment for actual practice at home building circuits and working experiments. Makes theory you learn come to life in an interesting, easy-to-grasp manner.

Multiplexing, FM Stereo Broadcasting Included

NRI training keeps up with the times. New, additional profit opportunities exist for the Technician who understands the latest technical advances. Course material now covers FM Stereo Broadcasting, tells you about Multiplexing equipment, other recent developments.

Learn More to Earn More
Act now. The catalog NRI sends you gives more facts about the field of your choice, shows equipment you get and keep. No obligation. Cost of NRI training is low. Monthly payments. 60-Day Trial Plan. Mail postage-free card today.
NATIONAL RADIO INSTITUTE, Washington 16, D.C.

Send for
64-Page
CATALOG
FREE

The Amazing
Field of
Electronics



NRI—Oldest and Largest Radio Television School Now Offers NEW HOME STUDY TRAINING IN INDUSTRIAL ELECTRONICS

This is the age of Electronics. Rapidly expanding uses for Electronic Equipment in industry, business, the military demand more trained men. Prepare now for a career as an Electronic Technician. NRI now offers a complete course in **ELECTRONICS**



—Principles, Practices, Maintenance. Computers, telemetry, automation, avionics are changing our world, yet all employ the same basic principles . . . and that is what this NRI course stresses with illustrated lessons, special training equipment. Mail card below.

NEW HOME STUDY TRAINING FOR YOUR FCC LICENSE



An FCC Commercial License combined with NRI time-tested training can be the keys to a better future for you with higher pay, interesting work, more rapid advancement. Prepare at home *quickly* for your FCC examinations through NRI's new, low-cost, special training. Like other NRI-trained men, you can be monitoring TV shows, radio broadcasts, operating shipboard and aviation radio, or holding down other important jobs. Get full details—mail the card below.

**TURN
PAGE**

Cut Out and Mail—No Stamp Needed



**NATIONAL RADIO INSTITUTE
WASHINGTON 16, D. C.**

Send me your Electronic, Radio-TV catalog without cost or obligation. I am interested in the course checked below: (No representative will call. Please PRINT.)

- Industrial Electronics Communications
 FCC License Servicing

9

Name _____ Age _____

Address _____

City _____ Zone _____ State _____

ACCREDITED MEMBER NATIONAL HOME STUDY COUNCIL

**ELECTRONICS NEEDS
4 TO 7
QUALIFIED TECHNICIANS**

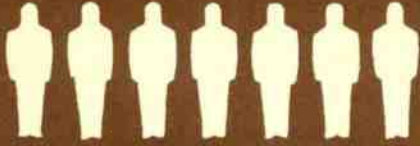

FOR EVERY ENGINEER



Join The Thousands Who Trained For Advancement With NRI

Thousands of NRI graduates throughout the U. S. and Canada are proof that it is practical to train at home. NRI graduates are in every kind of Electronics work: inspectors, maintenance men, lab technicians, testers, broadcasting and mobile communications operators, Radio-TV service technicians, or in essential military and government posts. Catalog tells more about what NRI graduates do and earn. Mail postage free card.

Choose from 4 Courses

1. INDUSTRIAL ELECTRONICS

Learn about Electronic equipment used today by business, industry, the military. Covers computers, servos, telemetry, multiplexing, other subjects.

2. FCC LICENSE

Communications stations must have FCC-licensed operators. New NRI course prepares you for your First Class FCC exams. Train at home in spare time.

3. COMMUNICATIONS

Operation and maintenance of radio and TV stations; police, marine, aviation, mobile radio, etc. Includes FM Stereo broadcasting. Course also prepares you for your FCC license exam.

4. SERVICING

Service and maintain AM-FM Radios, TV sets, Stereo Hi-Fi, PA systems, etc. A profitable, interesting spare or full-time business of your own.

SEE OTHER SIDE



"THE FINEST JOB I EVER HAD" is what Thomas Bilak, Jr., Cayuga, N. Y., says of his position with the G. E. Advanced Electronic Center at Cornell University. He writes, "Thanks to NRI, I have a job which I enjoy and which also pays well."



BUILDING ELECTRONIC CIRCUITS on specially-designed plug-in type chassis, is the work of Robert H. Laurens, Hammonton, N. J. He is an Electronic Technician working on the "Univac" computer. Laurens says, "My NRI training helped me to pass the test to obtain this position."



"I OWE MY SUCCESS TO NRI" says Cecil E. Wallace, Dallas, Texas. He holds a First Class FCC Radio-telephone License and works as a Recording Engineer with KRLD-TV.



MARINE RADIO OPERATOR is the job of E. P. Searcy, Jr., of New Orleans, La. He works for Alcoa Steamship Company, has also worked as a TV transmitter engineer. He says, "I can recommend NRI training very highly."



FROM FACTORY LABORER TO HIS OWN BUSINESS that rang up sales of \$158,000 in one year. That's the success William F. Kline of Cincinnati, Ohio, has had since taking NRI training. "The course got me started on the road," he says.

FIRST CLASS
PERMIT
NO. 20-R
(Sec. 34.9, P.L.&R.)
Washington, D.C.

BUSINESS REPLY MAIL

NO POSTAGE STAMP NECESSARY IF MAILED IN THE UNITED STATES

POSTAGE WILL BE PAID BY



National Radio Institute

**3939 Wisconsin Avenue
Washington 16, D.C.**



Oldest and Largest School of Its Kind

Training men to succeed by home study has been the National Radio Institute's *only* business for over 45 years. NRI is America's oldest and largest Electronics home-study school. Don't delay. Cut out and mail **POSTAGE-FREE CARD**.

MAIL POSTAGE-FREE CARD

Carl and Jerry

(Continued from page 84)

"Do you get permission to rebroadcast their programs?"

"Yes, although strictly speaking we wouldn't have to. We're not rebroadcasting. Our wired-wireless is actually just a big p.a. system."

"Do you do any live shows?" Jerry asked.

"Oh, sure. We do interviews in our studios here, and we do remote pickups from all over the campus. We may do a poolside program from the Co-Rec Gym during a swimming meet; we may broadcast a baseball game; or we may work remote from a record hop, or dance, or any other spot calculated to stir up interest among our listeners. Our patch board is connected to that of the university broadcast station by a permanent loop, and sometimes they let us use their remote lines when we're doing a remote show. But let's take a look at the rest of the station.

"Here, next door, is Studio C, which is just an announcing studio. Studio B, over there to the left, has a console and turntables, and is set up as a control room for monophonic work. On down the hall is our record library—we have 5000 45's and about 2000 LP's in there, and among the latter are many of the finest classical records. We're starting to stock up on stereophonic records and tapes now, for the fellows seem to like our stereo programs."

"Where do you get the money for all this?" Carl asked bluntly.

"As you know," Jimmy replied, "each residence hall has its own social organization or club. You automatically join this club when you take up residence and are charged a membership fee of \$15 a year to pay for social activities, music groups, camera club, residence-hall radio station, etc. Each station prepares a budget each year and receives a certain amount of the club dues to pay for records, maintenance, and new equipment."

"Those studios must be soundproofed," Carl remarked as he watched the lips of an announcer in Studio C moving but heard no sound.

"They are. The walls are double-studded, and each wall contains two

layers of acoustical wall tile, two layers of Celotex, and two 2" layers of star foam. The glass partition windows have double panes set in rubber so they can't conduct sound. Over here, next to the stairs, is our lab and workshop where we build and test our equipment. You see we have the usual meters, signal generators, and 'scope . . .

"Say, fellows, I'd like to go into more detail, but I'm running out of time. Suppose we go over to the desk and I tell you why I had you come up."

THEY SAT DOWN at the desk, and Jimmy peered at them from beneath his heavy brows as he toyed with a set of keys fastened to his belt with a silver chain.

"Some joker always tries to get into the act, and we have one here at Gary Hall," he said with a sigh. "For the past week someone in the southwest wing has been jamming our programs. He sits on the frequency, plays records, makes sarcastic remarks about our programs, and tries to get the listeners to tune to another frequency where he says he is going to put on a *real* program.

"We thought he'd soon get tired and quit this foolishness, but apparently he's not going to; so we've got to find him and put a stop to it. Too many students are complaining that they're not getting much satisfaction out of the money they've paid for carrier-current entertainment."

"How do you know the guy is in the southwest wing?" Carl quizzed.

"That's the only place his signal is heard. Signals won't feed back through the r.f. transformers from one power box to the others."

"Where do we come in?" Jerry asked.

"We need some outsiders to help track the wildcatter down. Members of the WCCR staff are too well known here at Gary Hall; as soon as one of us steps into that southwest wing, the station goes off the air. But I hear you two are pretty good electronic technicians. Will you help?"

"Sure, but how can we?" Carl wanted to know.

Jimmy opened a drawer and took out a small transistorized tape recorder. A shielded cord ran from the microphone

(Continued on page 90)

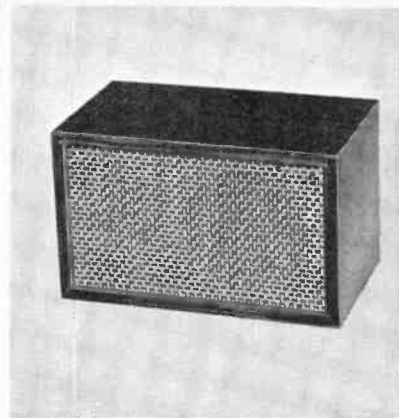

FM STEREO AT LOW COST

A "value packed" combination for exciting stereo FM entertainment! Tuner has pre-assembled, prealigned FM tuning unit for fast, easy assembly. Features flywheel tuning, automatic frequency control, handsome modern styling. Stereo converter has self-contained power supply, cathode follower outputs for A & B channels. 12 lbs.

Kit AJ-31S (includes AJ-31 tuner and converter)... no money down, \$7 mo...
Saves \$2.50 only **\$69.95**

SPACE-SAVING AS-81 SERIES MINIATURE HI-FI SPEAKER SYSTEM KITS

Measures only 10 $\frac{3}{4}$ " x 6 $\frac{1}{2}$ " x 6 $\frac{3}{8}$ ". 70-14,000 cps response. 6" woofer, 3" tweeter. 8 ohm imp. 6 watt power rating. Factory assembled cabinet. 10 lbs.

Kit AS-81... Unfinished **\$17.50**
Mahogany or Walnut **\$19.95**

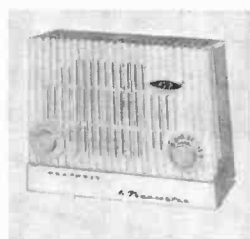
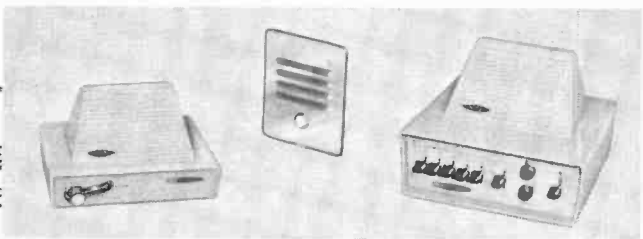

SAVE TIME & STEPS WITH A HEATHKIT INTERCOM SYSTEM

Complete indoor & outdoor communications facilities in easy to build kit form. All-transistor master handles up to five indoor or outdoor remotes. Powerful 1 watt output and specially designed frequency response assure crisp, clear communications. Costs only 5c a month to operate!

Kit GD-121 Master Station ... 5 lbs. ... no money down, \$5 mo. **\$29.95**
Kit GD-131 Indoor Remote ... 3 lbs. **\$8.95**
Kit GD-141 Outdoor Remote ... 2 lbs. **\$5.95**

"CORDLESS" AM RADIO

Battery powered. 4" x 6" PM speaker; transistor circuit; ivory & green. 3 lbs.

Kit GR-131 Radio (less battery) **\$19.95**
GRA-131-1: Battery pack 2 lbs. **\$1.10**

HEATHKIT® offers MORE-more new

Whatever your interest, there's a Heathkit for you. Over 250 kits—each priced to save you money. Guaranteed to be easy to build and to provide years of enjoyment and superior performance.

*Why take chances in kit buying—
Heathkit's broad guarantee
assures satisfaction every time.*

Compare this guarantee with any competitive electronic kit manufacturer. See why Heathkit gives you more. Our pride in our quality, in our reputation and goodwill, in our painstakingly engineered "check-by-step" instructions is reflected in the unconditional guarantee that you, regardless of technical knowledge or experience, can build any Heathkit.

MONEY BACK GUARANTEE

The Heath Company unconditionally guarantees that you can build any Heathkit product and that it will perform in accordance with our published specifications, by simply following and completing our check-by-step instructions, or your purchase price will be cheerfully refunded.



**WORLD-WIDE REACH!
SHORT WAVE RECEIVER**

Covers 550 kc to 30 mc in four bands. Illuminated 7" slide-rule dial & meter. Versatile controls for top reception. "Velvet touch" tuning. Easy circuit board assembly. Beige & aqua color. 9 lbs.

Kit GR-91...no money down, \$5 mo. **\$39.95**



**NEW! FIRST COMPLETE FILTER-TYPE
SSB TRANSMITTER IN KIT FORM!**

Another Heathkit first! Every desired SSB feature at half price. Send for full specifications and compare for yourself! Operates 80 through 10 meters with out-of-band coverage for MARS operation. 180 watts PEP—SSB & CW. 75 watts AM. Parallel 6146's in final. All power supplies built-in. Unique simplified alignment procedure!

Kit HX-10 SSB TRANSMITTER...92 lbs....no money down, as low as \$22 mo. **\$334.95**



NEW CITIZEN'S BAND TRANSCEIVERS

New high-efficiency transmitter. 3-crystal controlled transmitting channels; single crystal or variable receiver tuning. Adjustable squelch, automatic noise limiter. Press-to-talk mic. Signal meter. 13 lbs.

Kit GW-11... specify AC or DC...
no money down, \$7 mo. ea. **\$69.95**



**POCKET SIZE
"WALKIE TALKIE"**

4-transistor; crystal-controlled. Range 1 mile. Easy circuit board assembly. 2 lbs.

Kit GW-31 ea. **\$24.95**

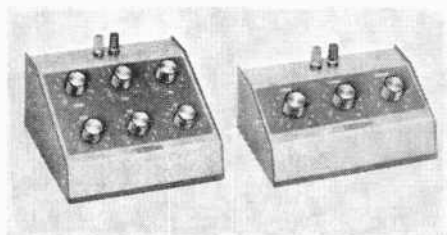

RESISTANCE & CAPACITOR DECADES

Provide precision resistor values from 1 ohm to 999,999 ohms in one ohm steps, at 1/2 of 1% accuracy... capacitor values from 100 mmfd to 0.111 mfd in 100 mmf steps.

Kit IN-11...6 decade resistance kit...4 lbs....
no money down, \$5 mo. **\$24.95**
Kit IN-21...3 decade capacitor kit...3 lbs.... **\$17.95**

kits, better guarantee, easier terms

*Don't wait to buy the kit you need!
Heathkit's easy terms let you
enjoy it while you pay!*

No need for cash. Beginners, enthusiastic amateurs and dedicated professionals will find kits to meet their needs... and pocketbooks. Here is tremendous quality at the lowest possible cost PLUS new relaxed credit terms. You can purchase any kit from \$25 to \$600 with no down payment and take up to 18 months to pay. What's more, when you purchase the kit of your choice, you purchase with confidence, with the sure knowledge that it will outperform any competitively priced product. Enjoy it today... pay for it tomorrow. Remember, no money down and up to 18 months to pay. With a Heathkit every dollar invested gives double enjoyment, double value!

HEATH COMPANY
Benton Harbor 10, Michigan



Yes, send me my free 1962 Heathkit catalog

Free Catalog!

NAME _____
ADDRESS _____
CITY _____ ZONE _____ STATE _____

Order direct by mail or see your Heathkit dealer.
Ship Parcel Post Express C.O.D. Best Way

Ordering instructions: Fill out the order blank. Include charges for parcel post according to weight shown. Express orders shipped delivery charges collect. All prices F. O. B. Benton Harbor, Mich. A 20% deposit is required on all C.O.D. orders. Prices subject to change without notice. Dealer and export prices slightly higher.

ITEM	MODEL NO.	PRICE



Send in today for your free 100-page catalog. Over 250 kits, more than 40 are new in this most complete catalog of kits. Every price is top quality... save up to 50%. Get a catalog now and receive 1962 Heathkit supplements.

This Christmas Give a Heathgift... from the World's Shopping Center for Electronic Kits

Carl and Jerry

(Continued from page 87)

jack to a little black metal box with a small coil sticking out one end.

"This is a ferrite-rod antenna coil tuned to the frequency of the wildcat station," Jimmy explained. "A crystal diode inside the box detects the signal picked up by the coil and feeds it to the recorder amplifier. With the monitoring earphone of the recorder, you can hear anything picked up by this r.f. probe and being recorded.

"The wildcatter can't be running much power; so his signal should fall off rapidly on this insensitive detector as the distance from the room where he is feeding the signal into the line increases. I want you two to use this to spot his room; then call me, and the hall counselor and I will take it from there."

"When?" Carl asked.

"In about ten minutes, if you will. He comes on every evening at four, and it's nearly that now. We'll play piano music from four until four-fifteen so you can tell his station from ours. Then I'll fake a station breakdown so you'll have his signal in the clear. Okay?"

Before they quite knew what they were doing, Carl and Jerry found themselves walking down the hall on the second floor of the west wing of the Quadrangle. They tried to saunter along very nonchalantly, but they felt as conspicuous as a couple of skunks at a perfume manufacturers' convention. The recorder was humming away in Jerry's overcoat pocket, and his turned-up coat collar concealed the earphone.

"I'm hearing both stations," he muttered to Carl. "The joker's rock-and-roll

is beginning to drown out the piano. We must be getting close. He's stronger on this side of the hall. Oh, oh! There goes the piano music off. The wildcat station is really getting loud now, but keep walking. Now it's beginning to fall off. Let's turn around.

"Right here it's the loudest. He's talking now. Pretend to show me something in that math book while I take this earphone out of my ear. Say! I can hear him talking through the ventilator at the same time I hear him on the earphone. This is the room. Call Jimmy while I keep the recorder going."

Carl called from a telephone booth in the hall, and in only a few minutes Jimmy came dashing up with another young man. They took the tape recorder, listened to the sounds coming from the ventilator, and then knocked at the door. Carl and Jerry walked on down the hall as the door finally opened and two flustered-looking youths let Jimmy and the counselor in.

Fifteen minutes later, the door opened again, and Jimmy and the counselor emerged. They were carrying a small 45-rpm record player and what the two boys recognized as being a wireless phono-oscillator.

"Well, fellows, there goes our wildcat radio station," Jimmy said as he joined them and the three started for the stairs. "When they heard the tape recording, they broke down and confessed. The equipment has been confiscated, and I'm pretty sure we won't have any more of that sort of thing. And I certainly want to thank you for helping. I've got to scamper back and put the station on the air again now, but I'll see you around."

BIG lazy snowflakes started drifting down as Carl and Jerry walked briskly toward H3 in the gathering darkness. The patterns of lighted windows in the residence halls looked warm and friendly.

"Say, Carl," Jerry suddenly exclaimed, "I like being part of a school where the students can design and build and maintain and operate an elaborate radio network like that in their spare time—especially when we both know how precious little spare time they have."

"Yeah, me too," Carl agreed. "I think we're in the right place."

—50—

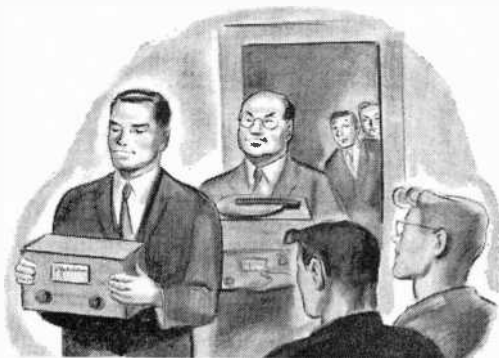

Getting to know the. . .

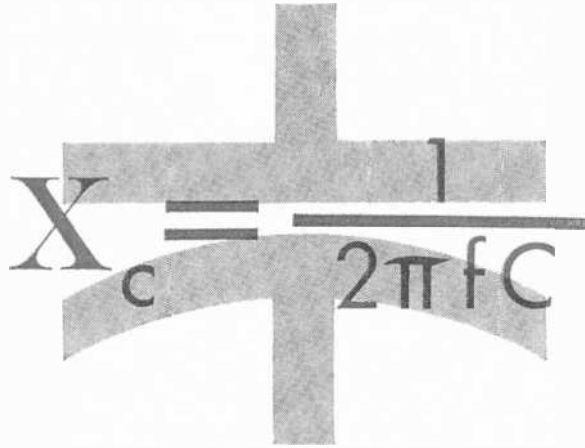

BYPASS CAPACITOR

By **JOHN M. DOYLE** Technical Editor
National Radio Institute

CAPACITORS are used in modern electronic circuitry for such purposes as blocking, filtering, timing, and bypassing. The last-mentioned application—bypassing—is by far the most common. It's also much more critical than many people suspect, since the selection of a wrong-value bypass capacitor can result in poor frequency response, phase distortion, circuit instability, or even outright oscillation.

Now, you may feel that this problem is no concern of yours, but is rather one for the design engineer. "Shucks," you say. "If a capacitor—bypass or otherwise—goes bad, I'll replace it."

This approach works fine in most cases. But how many times have you wished you could help fix a piece of equipment after a well-intentioned, but poorly instructed, do-it-yourself fan has been hard at work with his trusty solder-

ing gun? Or how many times have you felt like throwing that cheap "screech-box" receiver out of the window, when a 15¢ bypass capacitor would do much to quiet the demon of temptation? Finally, remember that despite our ultra-modern manufacturing methods, "goofs" are still made by people who do the physical wiring and inspection but who know nothing about the workings of the circuit.

If you're now convinced of the importance of knowing a little more about bypassing (and shame on you if you aren't), let's get on with the job.

Reactance. When a capacitor is used as a bypass, it must provide a low-impedance path for electrical currents of certain frequencies and a high-impedance path for those of other frequencies. The property which permits it to operate in this manner is called *reactance*. The

value of reactance for a given frequency is determined by the basic formula:

$$X_c = \frac{1}{2\pi fC}$$

where X_c is the capacitive reactance in ohms, 2π is a constant (approximately 6.28), f is the operating frequency in cycles per second, and C is the capacitance in farads.

This relationship tells us that the reactance of a given capacitor decreases as frequency increases. For example, the value of X_c for a 0.01- μ f. capacitor at a frequency of 500 cycles is about 31,800 ohms. But at a frequency of 5000 cycles, the reactance has decreased to about 3180 ohms.

Not only must we be able to calculate X_c , but we must also know how to determine what value capacitor is needed to obtain a certain reactance at some specified frequency. All that we have to do is rearrange the above equation as:

$$C = \frac{1}{2\pi fX_c}$$

where all symbols have the same meaning as before. For example, if we want to know what value capacitor will provide a reactance of 18 ohms or less at a frequency of 500 cycles, we just substitute known values in the above formula. The calculated answer is 17.7 μ f., approximately, but the next highest standard capacitance value available will be okay for most applications.

Audio-Frequency Amplifiers. In a typical audio-frequency amplifier, such as that shown in Fig. 1, a capacitor, $C1$, is used

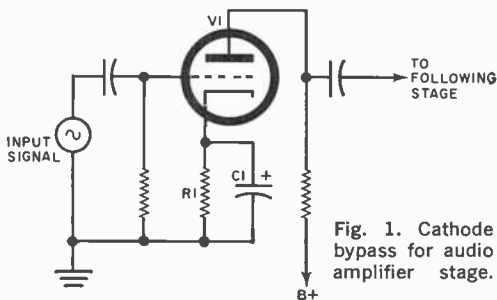

Fig. 1. Cathode bypass for audio amplifier stage.

to bypass audio frequencies around the cathode resistor, $R1$. If capacitor $C1$ is omitted or if it does not operate properly, the a.c. plate current component

develops a voltage drop across $R1$ which opposes the input signal applied to the grid. This effectively reduces stage gain and results in inverse feedback or "degeneration."

Now, let's see what requirements are placed on the capacitor if it is to prevent degeneration. Suppose the amplifier is to pass all frequencies between 100 and 5000 cycles, and the value of cathode resistor recommended by the manufacturer for class A operation is 1500 ohms. Because the reactance of the capacitor decreases as frequency increases, a capacitor that satisfactorily bypasses the resistor at the lowest frequency will work quite nicely over the entire range.

A rule-of-thumb used by circuit designers is that *the reactance of the capacitor at the lowest frequency to be passed should not exceed one-tenth the value of the resistor it bypasses*. Using this rule, we substitute known values in the equation developed for finding C :

$$C = 1 / (6.28 \times 100 \times 150) \\ = 11 \mu\text{f.}$$

An electrolytic capacitor is suitable for this purpose because its leakage resistance is not important and high capacitance is obtained in a compact size.

In some applications, such as high-quality audio amplifiers, the ratio of resistance to reactance at the lowest frequency passed is made 20 to 1 or even higher, but the ratio used in our example is adequate for most cases. Needless to say, the working voltage of the capacitor selected for any bypassing applications must be larger than the maximum voltage present.

Bypassing in the case of a transistorized audio-frequency amplifier is very similar. A typical *pnp* transistor amplifier, using the common-emitter arrangement, is shown in Fig. 2. Base bias is obtained from the voltage-divider network, consisting of $R1$ and $R2$, and the emitter is forward-biased (negative in the case of a *pnp* transistor, and positive for the *npn* type). To prevent signal degeneration, the emitter-bias resistor ($R3$) is bypassed with a high-value electrolytic capacitor ($C1$).

In either type amplifier discussed above, a certain amount of degeneration is sometimes intentionally used. There-

fore, before jumping to any wrong conclusion, always make sure that degeneration is in fact undesirable before attempting to correct a case of "faulty" design. If bypassing is improved where degeneration is needed, the circuit will not operate properly.

Other Applications. When a pentode-type tube is used, additional bypassing is needed in the screen grid which must operate at ground potential, as far as all signal voltages are concerned, if degeneration is to be avoided. A typical case is the television i.f. amplifier shown in Fig. 3.

In this circuit, screen potential is obtained from the plate-supply source through the screen-dropping resistor, $R2$. If bypass capacitor $C1$ fails to operate properly at any frequency, the gain of the amplifier falls off at that frequency. The value of $C1$ is again determined by the rule-of-thumb that its capacitive reactance at the lowest frequency passed should not exceed one tenth the value of the resistor it bypasses.

Generally, mica or ceramic capacitors, ranging in value from about $50 \mu\mu\text{f.}$ to $0.01 \mu\text{f.}$, are used for r.f. bypassing arrangements of this type. If the pentode is employed as an audio-frequency amplifier, high-quality paper or electrolytic capacitors are used. Their proper value can be determined in the same way.

Sometimes it is necessary to bypass radio but not audio frequencies. A typical case is in the detector circuit of an AM receiver, as shown in Fig. 4. Assuming that the r.f. carrier frequency is 455 kc., if the reactance of $C1$ is to be one-tenth the value of $R1$ at this frequency, its value—using the formula previously

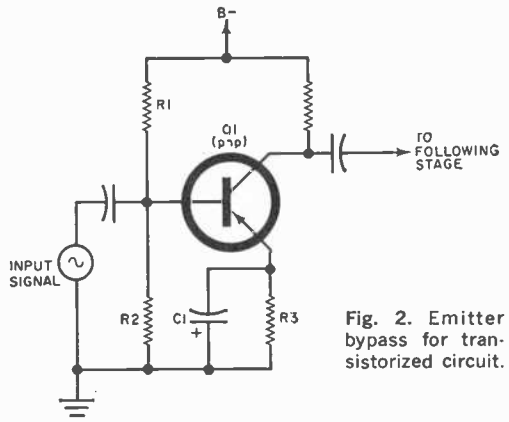

Fig. 2. Emitter bypass for transistorized circuit.

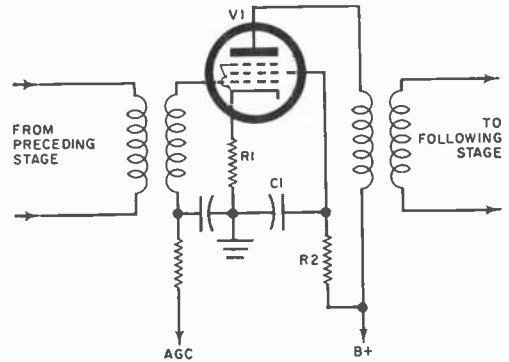

Fig. 3. Screen bypass for typical i.f. amplifier in a television set.

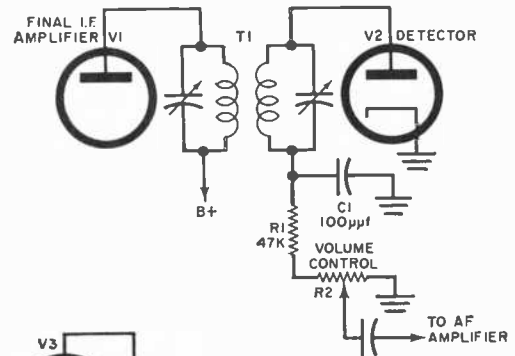

Fig. 4. R.f. bypass for diode detector stage.

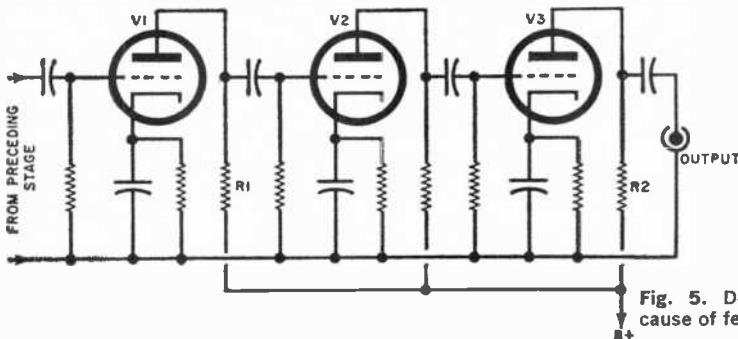

Fig. 5. Decoupling is required because of feedback through $R1$ and $R2$.

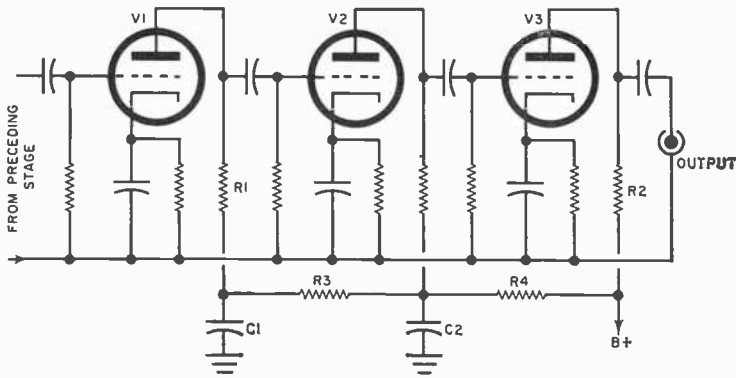

Fig. 6. Networks R4/C2 and R3/C1 prevent undesired feedback between stages.

given—is approximately 75 μf . We would use a standard 100- μf . mica or ceramic capacitor. If the highest audio frequency to be passed is 5000 cycles, the reactance of the capacitor at this frequency is better than 300,000 ohms.

Another circuit in which bypassing is important is illustrated in Fig. 5, where three amplifier stages are fed from a common plate-voltage supply. Since most power supplies possess a finite impedance, the output of V3 will be returned to the plate circuit of V1 through load resistors R2 and R1. This effective signal voltage is then fed to the grid circuit of V2 and then into V3. Naturally, if the gain of these stages is high enough, oscillation occurs.

To prevent instability of this type, decoupling networks are used, a typical example of which is shown in Fig. 6. The reactance of C1 and C2 at the lowest operating frequency is made very small compared to the resistance of R3 and R4. Because R3/C1 and R4/C2 form

Fig. 7. Decoupling capacitors should be grounded at one point for best results at high frequencies.

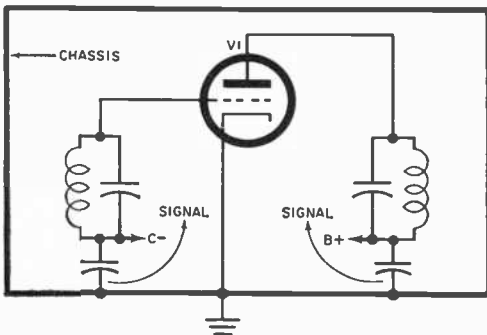

voltage dividers, almost the entire voltage developed across the common impedance is dropped by R3 and R4. Essentially, no feedback voltage is then coupled into the plate circuit of V1 or V2.

The values of R3 and R4 should be kept as low as possible to accomplish the job without dropping a prohibitive amount of the d.c. plate voltage for V1 and V2. In cases where a very small drop in this voltage is all that can be tolerated, R3 and R4 can be replaced by an inductance of low d.c. resistance. The value of inductance needed for a given reactance at a specified frequency is determined by the formula:

$$L = X_L / 2\pi f$$

where X_L is the inductive reactance in ohms, and f is the operating frequency in cycles per second.

Chassis Grounds. Here's a final word about connecting bypass capacitors. At frequencies of 30 mc. and below, the dimensions of the chassis are usually only a fraction of a wavelength, and it can be considered a fixed reference. Above 30 mc., however, the chassis is essentially a conducting sheet on which points of maximum current and voltage appear.

In the circuit of Fig. 7, grid and plate "ground" currents pass through the chassis to the cathode of the stage. A good practice, generally, is to separate these ground currents from the chassis by returning all leads to the cathode or a bus bar. Just be sure, however, that the leads are kept as short as possible to prevent cross-coupling and undesirable feedback.

QUICK - CHECK AUDIOMETER

A new medical instrument which may soon be as common in doctors' offices as the stethoscope or blood-pressure gauge is known as the "Quick-Check Audiometer." Designed to give the physician a quick summary of his patients' hearing losses, the instrument is not meant to replace the standard clinical audiometer. It does, however, check hearing at the three most important frequencies (250, 1000, and 4000 cycles) and at three key volume levels. In use, the audiometer is held to the patient's ear and the patient instructed to signal when he hears a tone. The frequency control, level control, and on-off key are placed so that they can be manipulated by one hand.



Battery-operated, the audiometer employs standard mercury cells which need be changed only once a year. The normal voltage drop after one year's use causes no frequency deviation and not more than 1 db variation in level. Manufactured by Danavox, Copenhagen, Denmark, the unit is available with ASA (10, 30, and 50 db above threshold) or BSI (20, 40, and 60 db above threshold) calibrations.

—Hans F. Kutschbach

Wordonics

Suggested by **SGT. V. J. AMBROSE**

*This is what would happen if words
were not only words, but also pictures*

VERTICAL

HOLD

IN T E R M I T T E N T

SHORTED

OP EN

**ROOT
S M
Q U E A
A R E N**

**BY P A S S
CAPACITOR**

VOLTAGE

DROP

TUNNEL DIODE

GRID CURVES

F O C U S

ERRATIC



COYNE
TRAINS YOU
IN SPARE TIME
AT HOME

COYNE
QUALITY
TRAINING
AT LOWEST
COST

TELEVISION
RADIO-COLOR TV

Only from famous COYNE do you get this modern up-to-the minute TV Home Training. Easy to follow instructions—fully illustrated with 2150 photos and diagrams. Not an old Radio Course with Television tacked on. Includes UHF and COLOR TV. Personal guidance by Coyne Staff. *Practical Job Guides* to help you EARN MONEY QUICKLY IN A TV-RADIO SALES AND SERVICE BUSINESS—part time or full time. COSTS MUCH LESS—pay only for training—no costly "put together kits."

SEND TODAY FOR FREE BOOK

SEND COUPON or write to address below for Free Book and full details including EASY PAYMENT PLAN, NO COST OR OBLIGATION—NO SALESMAN WILL CALL.



B. W. COOKE, Jr., **COYNE** FOUNDED 1899
Pres. **ELECTRICAL SCHOOL**

CHARTERED AS AN EDUCATIONAL INSTITUTION NOT FOR PROFIT
1501 W. Congress Pkwy. Dept. 12-H2, Chicago 7, Ill.

COYNE Television Home Training Div.
New Coyne Building, Dept. 12-H2
1501 W. Congress Pkwy., Chicago 7, Ill.

Send FREE BOOK and details of your Television Home Training offer.

Name _____
Address _____
City _____ State _____

**NEVER FAIL—
ZONE YOUR MAIL**

The Post Office has divided 106 cities into postal delivery zones to speed mail delivery. Be sure to include zone number when writing to these cities; be sure to include **your** zone number in **your** return address—after the city, before the state.

B. S. DEGREE IN 36 MOS.

INDUSTRY AND GOVERNMENT NEED 50,000 NEW ENGINEERS EACH YEAR!
Accelerated year-round program puts you in the job-market a whole year early! Also B.E. degree in 27 mos. Aeronautical, Chemical, Civil, Electrical, Mechanical, Electronics; Math, Chemistry, Physics. Quality instruction; widely recognized. Graduates employed from coast to coast. Self-help program. Modest rate. Start January, March, June, July, September. Catalog: 2312 E. Washington Blvd., Fort Wayne 2, Indiana.

INDIANA TECHNICAL COLLEGE

**POP'tronics
Bookshelf**

TUBE SUBSTITUTION HANDBOOK, Volume 2 by the Howard W. Sams Engineering Staff

Revised to take into consideration the hundreds of new tube types which have been introduced since its original publication (as Volume 1), this handbook now contains over 4450 recommended substitutions. It's divided into five sections, the largest of which is a directory of over 2500 interchangeable receiving tubes. The remaining sections list industrial tubes which substitute for receiving tubes, European replacements for American receiving tubes and vice versa, and interchangeable television picture tubes.



Published by Howard W. Sams & Co., Inc.,
1720 E. 38th St., Indianapolis 6, Ind. Soft cover. 96 pages. \$1.50.



NEW SHORTCUTS TO TV SERVICING
(in two volumes) by Leonard C. Lane

Based on a home-study course prepared for a prominent TV manufacturer, this two-volume set is written in a simple style—yet is complete and accurate. The books are not concerned with theory or mathematics, but devote themselves solely to defects appearing in basic circuits of TV receivers and their cures. Bench-tested techniques for finding troubles in the front end, r.f., i.f., a.g.c., sync., picture tube, detector, low voltage, audio, and other circuits are given.



Published by Gernsback Library, Inc., 154 West 14th St., New York 11, N.Y. 160 pages per volume. Soft cover edition, \$5.90. Hard cover edition, \$9.90.

Always say you saw it in—POPULAR ELECTRONICS

BASIC MATHEMATICS, Vol. 2, by Norman H. Crowhurst

In the second volume of a planned four-volume course in basic mathematics, the author builds on the foundation laid in Volume I. He takes the reader through simple, simultaneous, and quadratic equations; powers and roots; imaginary numbers; simple mechanics, including resonance; proportion and ratio; simple trigonometry calculations; and properties of triangles and circles. The step-by-step "pictured text" presentation poses a problem, then discusses it and explains one or more methods of solution.

Published by John F. Rider Publisher, Inc., 116 West 14th St., New York, N.Y. 144 pages. Soft cover. \$3.90.



INDUSTRIAL TRANSISTOR AND SEMI-CONDUCTOR HANDBOOK by Robert B. Tomer

A modern sourcebook for industrial semiconductor data, this volume contains information on all types of transistors and diodes. Operating characteristics, circuit-design procedures, and typical applications are fully discussed, enabling the reader to select those units best suited to his re-

quirements. The newer semiconductor areas, such as thermoelectricity, energy conversion, micromodules, integrated circuits, etc., are also covered.

Published by Howard W. Sams & Co., Inc., 1720 East 38th St., Indianapolis 6, Ind. 256 pages. Soft cover. \$4.95.



RADIO CONTROL MANUAL

by Edward L. Safford, Jr.

Written by a guided missile expert and winner of many model plane competitions, this

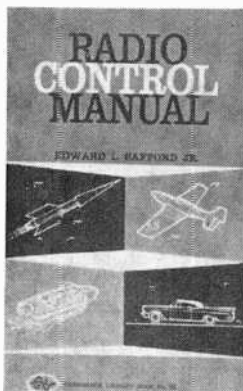

book minimizes theory and tells, in a simple step-by-step way, how to acquire "the ultimate" in radio control systems. It starts with a simple basic system and shows how, by adding and modifying components, the R/C fan can develop a highly efficient multi-channel design. Realizing that not all R/C



PERSONAL Messenger

- No license required—may be used at once!
- Meets FCC requirements for use with licensed Citizens' Band stations, too!

This is the new "Personal Messenger"—a superbly engineered 2-way crystal-controlled transceiver so compact it fits in your hand—so flexible it can be used in thousands of applications! 11 transistors and 4 diodes—superheterodyne receiver with exclusive tuned R.F. amplifier gives you twice the sensitivity and more than 40% more range than units with conventional circuitry! Powerful two-stage transmitter delivers more power output than similar units with the same rated input! Unmatched audio intelligibility and razor-sharp voice reproduction—automatic noise limiter—automatic volume control—positive squelch control—elastic hand stop—operates on night or rechargeable nickel-cadmium batteries. **\$109.50**

ILLUSTRATED AT LEFT—The Viking "Messenger"—maximum legal power Citizens' Band crystal-controlled transceiver. Excellent receiver sensitivity and selectivity—highly efficient transmitter punches your signal home! Built-in squelch—AVC—ANL. With tubes, push-to-talk microphone and crystals for 1 channel. **FROM \$134.95**



FREE Color Brochure

E. F. JOHNSON COMPANY
2401 Tenth Avenue S. W. • Waseca, Minnesota
• Please rush me your full color brochure.

NAME _____
ADDRESS _____
CITY _____ STATE _____

WRITE TODAY

Manufacturers of the world's most widely used personal communications transmitters

Your Copies of POPULAR ELECTRONICS



**ARE
VALUABLE**

**KEEP THEM NEAT . . . CLEAN . . .
READY FOR INSTANT REFERENCE!**

Now you can keep a year's copies of POPULAR ELECTRONICS in a rich-looking leatherette file that makes it easy to locate any issue for ready reference. Specially designed for POPULAR ELECTRONICS, this handy file—with its distinctive, washable Kivar cover and 16-carat gold leaf lettering—not only looks good but keeps every issue neat, clean and orderly. So don't risk tearing and soiling your copies of POPULAR ELECTRONICS—always a ready source of valuable information. Order several of these POPULAR ELECTRONICS volume files today. They are \$2.50 each, postpaid—3 for \$7.00, or 6 for \$13.00. Satisfaction guaranteed or your money back. Order direct from:

JESSE JONES BOX CORP. Dept. PE
(Established 1843)
Box 5120 Philadelphia 41, Pa.

Bookshelf

(Continued from page 97)

fans are do-it-yourself'ers, the author also explains where and how commercial components may be used.

Published by Gernsback Library, Inc., 154 West 14th St., New York 11, N.Y. 192 pages. Soft cover. \$3.20.

New Literature

Harman-Kardon has released an illustrated catalog describing the new "Commander" series of public-address amplifiers and systems. It details the features, prices, and applications of 12-, 35-, and 100-watt amplifiers; a phonograph top which may be used with all units; locking panel covers; and a combination mixer/preamplifier. Write to Commercial Sound Division, Harman-Kardon, Inc., Plainview, N.Y., for your free copy.

A completely revised edition of the Bendix Radio Station Guide can be obtained from Bendix Marine dealers or from Bendix Marine Department, North Hollywood, Calif. It lists the exact locations of broadcast and airways beacon stations by latitude and longitude—as well as their frequencies and call-signs—on the Atlantic, Gulf, and Pacific coasts and in the Great Lakes area.

Copies of a new replacement chart of oscilloscope cathode-ray tubes are now available from Sylvania Electric Products Inc. (1100 Main St., Buffalo 9, N.Y.) or from Sylvania industrial tube distributors. The chart lists the scopes of 78 different manufacturers by name and model number, indicating the proper replacement CRT for each one. —30—

Solution to Crossword Puzzle

(Puzzle appears on page 60)

	L	E	N	S		O	C	T	A	L
C	/	I	O	N	S	P	O	T	/	A
I	F	/	R	O	P	E	S	/	A	M
R	A	N	/	W	A	N	/	I	M	P
C	R	O	/	/	/	/	/	/	A	P
U	A	R	/	A	G	E	/	N	E	O
I	D	/	S	I	N	E	S	/	R	R
T	/	M	O	D	U	L	A	T	E	D
S	P	A	D	E		S	T	A	S	

Always say you saw it in—POPULAR ELECTRONICS

Stereo Sixteen Plus Four

(Continued from page 48)

the thickness of the bottom panel. Position the panel at the front of the enclosure, with the bottom edge flush with the surface of the bottom panel, and mark the other edges for cutting. After the front panel is cut and edge-sanded, attach the remaining 20" x 2 to the other narrow edge and the two 25" x 2's to the top and bottom edges.

Pad or Diffuse. The acoustic padding is attached to the inside of the front panel with either thumbtacks or a staple gun; if desired, an inexpensive substitute for acoustic padding can be made from six egg cartons of the *papier-mache* variety. Simply tack the bottom halves of the egg cartons to the inside of the panel; they will absorb and diffuse all sound waves reaching them, preventing reflections.

To attach the front panel to the enclosure, position it in place and drill through the front edges of the speaker-board panels for a No. 8 x 1" wood screw (three screws per panel), drilling through the panel at an angle so as to go into the front-corner-brace 2 x 2 straight. In addition, attach the top and bottom panels to the front-edge braces with four screws per panel, and, if you haven't already done so, tie the top and bottom down to the upper and lower speaker-board braces with two screws per brace.

The rear corner supports are attached by a single wood screw run into each end of each dowel, through the top and bottom panels, and pulled up tight. This done, the electro-acoustical part of the system is now complete, and you can give it its test run.

Finishing the System. If you keep in mind that both sides and the back must be acoustically open to let the sound out without restriction, the "sky's the limit" on finishing.

The original system was finished in an Oriental motif, with solid gloss black top, ebony and brass legs, and a mosaic Masonite front-panel overlay. This results in a striking piece of furniture, but a simple "wrap-around" of grille cloth (hard-weave drapery fabric does as well and is less expensive) will also look extremely professional.

-30-



* FREE

* FREE

* FREE

* FREE

* FREE



**11 OLSON STORES
PLUS MAIL ORDER**

Olson Stores In:

AKRON, OHIO
69 W. State Street

ATLANTA, GA.
485 Peachtree St., N.E.

BUFFALO, N.Y.
711 Main Street

CHICAGO, ILL.
4101 N. Milwaukee Ave.

CHICAGO, ILL.
123 N. Western Ave.

CLEVELAND, OHIO
2020 Euclid Ave.

CLEVELAND, OHIO
6813 Pearl Road

COLUMBUS, OHIO
142 N. High Street

INGLEWOOD, CALIF.
4642 W. Century Blvd.

MILWAUKEE, WISC.
423 W. Michigan

PITTSBURGH, PENN.
5918 Penn Ave.

Fill in coupon for a FREE One Year Subscription to OLSON'S Fantastic Bargain Packed Catalog — Unheard of LOW, LOW, WHOLESALE PRICES on Brand Name Speakers, Changers, Tubes, Tools, Hi-Fi's, Stereo Amps, Tuners and other Bargains.

MAIL TO:



OLSON ELECTRONICS
828 S. Forge Street
Akron 8, Ohio

NAME _____

ADDRESS _____

CITY _____ ZONE _____ STATE _____



If you've recently changed your address, or plan to in the near future, be sure to notify us at once. We'll make the necessary changes on your mailing plate, and see to it that your subscription continues without interruption. Right now—print the information requested in the spaces below and mail it to: POPULAR ELECTRONICS, 434 So. Wabash Ave., Chicago 5, Illinois.

Name _____ Please PRINT!

*Account No. _____

Old Address _____

City _____ State _____

New Address _____

City _____ Zone _____ State _____

Mail copies to new address starting with _____ issue.

*(Your Account Number appears directly above your name on the mailing label.)

ELECTRONICS

Better income . . . advancement. *BACHELOR OF SCIENCE DEGREE IN 27 MONTHS* in Engineering. *IN 36 MONTHS* in Business Administration. *Low costs.* Enter Mar., June, Sept., Jan. Write *J. D. McCarthy* for Catalog.

TRI-STATE COLLEGE

3612A College Avenue Angola, Indiana



Save 30% 4 track Stereo music on tape

EMPTY 3 in. plastic reels 7¢ ea.

Bargain Prices! Send for our Recorder/blank/pre-recorded tape catalog E-1 and see why!

SAXITONE TAPE SALES
(Div. of Commissioned Electronics, Inc.)
1776 Columbia Road, Washington, D.C.

WALKIE TALKIE RADIO SENDING SET



YOUR OWN POCKET SIZE RADIO STATION
Talk to any house or car radio without wires or hookups of any kind! Built-in antenna. Self-contained flashlight batteries—Power transistor! Talk to radios in the same building and to cars or between cars up to a mile or more away—depending on local conditions. No license or permit needed! SEND ONLY \$3.00 (cash, ck, mo) and pay postman only \$9.95 plus COD postage or send \$12.99 for postpaid delivery. Shipped complete ready to operate. Order yours now—today! Available only from: WESTERN RADIO, Dept. TEL-1, Kearney, Nebr.

Transistor Topics

(Continued from page 80)

experience in circuit wiring. Designed around a transistors-and-diode reflex circuit, the receiver is powered by a single 9-volt battery and tunes the standard AM broadcast band (550-1600 kc.). A pre-punched etched-circuit board is utilized in conjunction with Fahnestock clips; since all components are connected to these clips, no soldering is required. Designated as Catalog No. KT-199, the kit sells for \$9.95 net, less earphones and battery.

The Milton Ross Metals Co. (237 Jacksonville Rd., Hatboro, Pa.) is now pro-

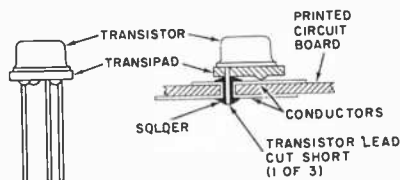

Fig. 2. Plastic spacers by Milton Ross Metals Co. serve to cushion transistors.

ducing an extensive line of small plastic spacers dubbed "Transipads" (see Fig. 2). These are used when mounting transistors on etched-circuit boards and serve to cushion the transistor, to reduce lead stresses, and to protect against heat damage.

A well-known semiconductor manufacturer, the U.S. Transistor Corp. (Syosset, N. Y.) is developing a transistorized remote control unit for use in a new line of toys to be manufactured by the Ideal Toy Corp. (Hollis, L. I., N. Y.) Designated as a "Remotrol" unit, the device employs three germanium *pnp* transistors and will enable youngsters to activate and stop toy tanks, airplanes, submarines, animals, and rockets by remote control at distances up to 30 feet. The new line of toys using the "Remotrol" device will probably be introduced by Ideal at the New York Toy Show next spring.

That does it for now. To paraphrase good old Omar: *The Moving Finger Writes, and having writ . . . will be back next month.*

—Lou

SHORT-WAVE MONITOR CERTIFICATE APPLICATION

To become a Short-Wave Monitor registered with POPULAR ELECTRONICS, just follow these simple directions:

1 Fill out the form below. (You must be a short-wave listener presently active in the hobby to be eligible for a Short-Wave Certificate.)

2 Send us 10 cents in coin to cover the cost of the certificate as well as the handling and registration

costs. If you live outside the United States and cannot obtain U. S. coins, send either 15 cents in Canadian currency or two International Reply Coupons (IRC's).

3 Insert the application form, coins (or IRC's) and a stamped, self-addressed envelope in another envelope and mail it to:

Monitor Registration, POPULAR ELECTRONICS
One Park Avenue, New York 16, N. Y.

(Please Print)			
Name		Ham Call-Area Prefix	
Address		City	Zone State
Receivers	Make	Model	
	Make	Model	
Principal SW Bands Monitored		Number of QSL Cards Received	
Type of Antenna Used			
Signature		Date	

TV-RADIO Servicemen or Beginners...

Send for *Coyne's*
7-Volume Job-Training Set
on 7-Day **FREE TRIAL!**

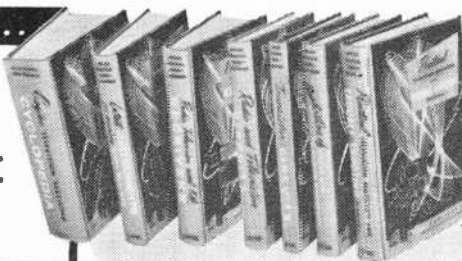

The First
Practical
TV-RADIO-
ELECTRONICS
Shop
Library!

Answers ALL Servicing Problems QUICKLY ...
Makes You Worth More On The Job!

Put money-making, time-saving TV-RADIO-ELECTRONICS know-how at your fingertips—examine Coyne's all-new 7-Volume TV-RADIO-ELECTRONICS Reference Set for 7 days at our expense! Shows you the way to easier TV-Radio repair—time saving, practical working knowledge (that helps you get the BIG money. How to install, service and align ALL radio and TV sets, even color TV, UHF, FM and transistorized equipment. New photo-instruction shows you what makes equipment "tick." No complicated math or theory—just practical facts you can put to use immediately right in the shop, or for ready reference at home. Over 3000 pages; 1200 diagrams; 10,000 facts!

SEND NO MONEY! Just mail coupon for 7-Volume TV-Radio Set on 7-Day FREE TRIAL! We'll include the FREE BOOK below. If you keep the set, pay only \$3 in 7 days and \$3 per month until \$27.25 plus postage is paid. Cash price only \$24.95. Or return set at our expense in 7 days and owe nothing. Either way, the FREE BOOK is yours to keep. Offer limited, so act NOW!

Like Having An Electronics Expert Right At Your Side!

- VOL. 1—EVERYTHING ON TV-RADIO PRINCIPLES! 300 pages of practical explanations; hundreds of illustrations.
- VOL. 2—EVERYTHING ON TV-RADIO-FM RECEIVERS; 403 pages; fully illustrated.
- VOL. 3—EVERYTHING ON TV-RADIO CIRCUITS! 336 pages; hundreds of illustrations, circuit diagrams.
- VOL. 4—EVERYTHING ON SERVICING INSTRUMENTS! How they work, how to use them. 368 pages; illustrated.
- VOL. 5—EVERYTHING ON TV TROUBLESHOOTING! Covers all types of sets. 437 pages; illustrations, diagrams.
- VOL. 6—TV CYCLOPEDIA! Quick and concise answers to TV problems in alphabetical order, including UHF, Color TV and Transistors; 868 pages.
- VOL. 7—TRANSISTOR CIRCUIT HANDBOOK! Practical Reference covering Transistor Applications; over 200 Circuit Diagrams; 410 pages.

BOOKS HAVE BRIGHT, VINYL CLOTH WASHABLE COVERS

FREE BOOK—FREE TRIAL COUPON!

Educational Book Publishing Division
COYNE ELECTRICAL SCHOOL
1455 W. Congress Parkway, Dept. 12-PE, Chicago 7, Ill.
Yes! Send me COYNE'S 7-Volume Applied Practical TV-RADIO-ELECTRONICS Set for 7-Days FREE TRIAL per offer. Include "Patterns & Diagrams" book FREE!

Name Age

Address

City Zone State

Check here if you want Set sent C.O.D. (Coyne pays postage on C.O.D. and cash orders. 7-Day Money-Back Guarantee.

FREE DIAGRAM BOOK!

We'll send you this big book, "150 Radio-Television Picture Patterns and Diagrams Explained" ABSOLUTELY FREE just for examining Coyne's 7-Volume Shop Library on 7-Day FREE TRIAL! Shows how to cut servicing time by reading picture-patterns, plus schematic diagrams for many TV and radio sets. Yours FREE whether you keep the 7-Volume Set or not! Mail coupon TODAY!



"LEARNED MORE FROM THEM THAN FROM 5 YEARS WORK!"

"Learned more from your first two volumes than from 5 years work."

"Swell set for either the serviceman or the beginner. Every service bench should have one."—Melvin Masbruch, Iowa.

Coyne

Educational Book Publishing Division
ELECTRICAL SCHOOL
1455 W. Congress Parkway Dept. 12-PE, Chicago 7, Illinois

Free

ALLIED

444-PAGE ELECTRONICS CATALOG

WORLD'S BIGGEST • MOST COMPLETE

best buys for 1962

EVERYTHING IN ELECTRONICS including exclusive products & special values available only from ALLIED

Send for it today!

ALLIED ELECTRONICS for everyone

1962 OUR 41ST YEAR

CATALOG 210 INDEX: PAGE 201

ALLIED RADIO 100 N. WESTERN AVENUE • CHICAGO 90, ILLINOIS • HAYMARKET LABCOO

SAVE MOST ON EVERYTHING IN ELECTRONICS

- New Stereo Hi-Fi Systems—Everything in Hi-Fi Components
- New Multiplex Stereo FM • All-Transistor Stereo Hi-Fi
- Money-Saving Build-Your-Own KNIGHT-KITS® for Every Need
- Best Buys in Tape Recorders, Tape, and Supplies
- Citizens Band 2-Way Radios • Short-Wave Receivers
- Amateur Receivers, Transmitters, and Station Gear
- Latest Public Address Systems, Paging and Intercom Equipment
- TV Tubes, Antennas, Accessories • Batteries, Wire and Cable
- Test and Laboratory Instruments • Tools, Hardware
- Huge Listings of Parts, Tubes, Transistors, Technical Books

NEW Multiplex Stereo FM All-Transistor Stereo Hi-Fi

exclusive money-saving KNIGHT® products SAVE MOST on famous KNIGHT Stereo Hi-Fi—comparable to the best in quality, styling and performance, yet priced far lower. Select super-value KNIGHT components or complete systems (including latest Multiplex Stereo and All-Transistor hi-fi) and save most. KNIGHT products are acclaimed by all those who recognize integrity in design and manufacture and who appreciate value.

new

NO MONEY DOWN on Allied's new Credit Fund Plan

Now—enjoy 50% more buying power—up to 24 months to pay—see our 1962 Catalog for simple details.

SEND FOR 444-PAGE CATALOG TODAY!

Satisfaction Guaranteed or Your Money Back

ALLIED

Always say you saw it in—POPULAR ELECTRONICS

Free



Send for
**MONEY-
SAVING**

1962

ALLIED ELECTRONICS CATALOG

**444
PAGES**

VALUE-PACKED

featuring exclusive products
and special values available
only from ALLIED..

SAVE MOST on everything in Electronics for everyone! Enjoy every buying advantage: get fastest service from the world's largest stocks, lowest money-saving prices, expert personal help—satisfaction guaranteed or your money back. Get the world's biggest Electronics Catalog now—FREE!

EASY TERMS—NO MONEY DOWN

**ACT
NOW!**

For **FREE** catalog, fill in,
detach, mail card today!

Name
PLEASE PRINT

Address

City _____ Zone _____

State _____

324



your

1962

ALLIED ELECTRONICS CATALOG!

**SAVE ON
EVERYTHING:**

- **KNIGHT-KITS®**—Best in Build-Your-Own
- Everything in Stereo Hi-Fi
- **KNIGHT® Super-Value Stereo Hi-Fi**
- Tape Recorders & Phono Equipment
- Citizens Band Transceivers
- TV Tubes, Antennas, Accessories
- Parts, Tubes, Transistors, Books, Tools
- Amateur Station Equipment
- Public Address & Intercom Systems
- Test & Lab Instruments

324

TO:
ALLIED RADIO
100 N. WESTERN AVE.
CHICAGO 80, ILL.

PLACE
STAMP
HERE

Free

Send for the
444-PAGE 1962



ALLIED ELECTRONICS CATALOG!

MOST COMPLETE • SAVE ON EVERYTHING

Kit Builders, Experimenters, Hi-Fi fans, Servicemen, Engineers — SAVE MOST ON:

• Knight-Kits® — Greatest Build-Your-Own Kit Line
• Knight® famous Stereo Hi-Fi • Everything in Stereo Systems & Components • Tape Recorders & Phono Equipment • TV Tubes, Antennas, Accessories • Parts, Tubes, Transistors • Tools & Books • Amateur Station Equipment • Public Address Systems



Satisfaction Guaranteed or Your Money Back!

EASY TERMS—NO MONEY DOWN

**ACT
NOW!**

**FOR FREE ALLIED CATALOG
FILL IN OTHER SIDE OF
THIS CARD—DETACH
AND MAIL IT TODAY!**

BIG PLUS!

in your 1962
ALLIED
CATALOG

includes complete catalog featuring over 90 exciting

knight-kits 
A PRODUCT OF ALLIED RADIO

NEW for '62 and simply great!

available only from **ALLIED**



new
HI-FI KITS



All-In-One FM-AM Tuner-Amplifier Kit with latest built-in MULTIPLEX Stereo FM, less case \$129.95



MULTIPLX Self-Powered Adapter Kit, for Stereo FM reception \$19.95



Deluxe Stereo FM-AM Tuner Kit with latest built-in MULTIPLEX Stereo FM \$99.95



ALL-TRANSISTOR 50-Watt Stereo Amplifier Kit, less case \$79.95

new
HOBBYIST KITS



ALL-TRANSISTOR Wireless Intercom System Kit (2 units) \$45.90



TRANSISTORIZED Electronic Tachometer Kit \$24.95



Amazing 100-In-1 Electronic Science Lab Kit \$29.95

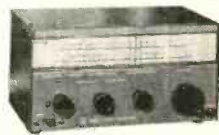

ALL-TRANSISTOR 2-Band AM-Shortwave DX'er Radio Receiver Kit \$19.95

Knight-Kits offer the most satisfying build-your-own experience in the world!

5 BIG REASONS WHY:

- **Convenience Designed**—makes you a kit-building expert—even the very first time!
- **Wonderful to Build**—you'll marvel at the sheer ease of assembly with the exclusive "show-how" manual guiding you like a good instructor.
- **You Own the Best**—you'll enjoy with pride a true custom-built product, professional in its engineering and performance.
- **You Save So Much**—because you buy direct from Allied at our money-saving volume prices—and because you do the easy assembly yourself.
- **Easiest to Buy**—NO MONEY DOWN on Allied's new Credit Fund Plan—easiest terms ever!

MONEY BACK GUARANTEE: Buy any Knight-Kit. Build it! Use it! You must be satisfied or you get your money back!

see more than 90 KNIGHT-KITS

- 21 HIGH-FIDELITY KITS
- 25 HOBBYIST KITS
- 31 INSTRUMENT KITS
- 14 AMATEUR & CITIZENS BAND KITS

KNIGHT-KITS are also available in Canada



RADIO  World's Largest Electronic Supply House

Send for it today!

new



Phone and CW 6C-Watt Ham Transmitter Kit \$49.95



Mutual Conductance Tube Tester Kit \$99.50

- World's Largest Stocks • Lowest Money-Saving Prices
 - Fastest Shipment • Expert Help • Easiest-Pay Terms
 - Satisfaction Guaranteed or Your Money Back
- send for the world's biggest electronics catalog!

Free

ALLIED RADIO, Dept. 201-A2
100 N. Western Ave. Chicago 80, Ill.

Send FREE 1962 ALLIED 444-page Catalog

Name _____
PLEASE PRINT

Address _____

City _____ Zone _____ State _____

The "10-8" De Luxe

(Continued from page 44)

"police" antenna terminal strip and an FM antenna to the FM antenna strip. Run the output cable from the 10-8 to the antenna terminals of the FM set, and temporarily solder a 1" wire between pins 5 and 7 of V1.

Next, set the FM receiver dial at 108 mc. and C7 at maximum capacity, then adjust C2 for the loudest hiss in the receiver's speaker. Spread the turns of L2 slightly if maximum noise occurs with C2 wide open. Bend L3 back and forth with respect to L2 until you determine the position which results in the greatest background noise.

Remove and discard the wire between pins 5 and 7, then tune C7 from maximum to minimum capacity. As you do this, you should hear several signals which are harmonics of the variable oscillator. If no signals are evident, V1b is not oscillating—try increasing the plate voltage by reducing R5 to approximately 4000 ohms. If this fails to start the oscil-

lator, look for a defective component or a wrong connection.

Once you have the oscillator perking, tune the vernier dial back and forth in search of police calls and other v.h.f. transmissions. When you come across a signal, peak C1 for maximum volume. Since this particular adjustment is rather broad, a slight touch-up will suffice when tuning from one end of the band to the other. If C1 must be fully meshed for best reception, squeeze the turns of L1 closer together. If optimum results are obtained with C1 at minimum capacity, open up the coil a bit.

Mobile telephone and taxicab dispatcher signals should be picked up with the vernier dial set somewhere between 3 and 5. Likewise, police calls should come in between 5 and 7. If you can receive no mobile phones, but police calls are found between 1 and 3 on the dial, add a turn to the top of L4. On the other hand, if mobile phones are heard around 7 or 8, remove a turn from the coil.

Performance. Naturally, the performance of the converter depends to a large extent on the quality of the antenna in-

TRU-VAC

FREE

UP TO 100
1-YR. GUARANTEED
TRU-VAC TUBES

TO QUANTITY BUYERS!

Now quantity buyers get a FREE assortment of individually-boxed, regular stock TRU-VAC tubes with each order.

PLACE YOUR ORDER TODAY!
GET UP TO 100 TUBES FREE!

Here's how this FREE offer works!

15	FREE TUBES	With Order of	\$25
25	FREE TUBES	With Order of	\$50
50	FREE TUBES	With Order of	\$100
100	FREE TUBES	With Order of	\$500

LOOK! 1000 USED TV'S
Costly, famous make console models with little or no tube replacement. Require only minor adjustments. Perfect for re-sale, or as your own second set! 16", 17" and 19" screens none smaller! Sets shipped FOB, Harrison, N. J.

\$16.95

(As is)

1-yr. guaranteed Radio & TV Tubes

Factory Used or Factory Second Tubes! TRU-VAC will replace FREE any tube that becomes defective in use within 1 year from date of purchase! All tubes individually boxed, code dated & branded "TRU-VAC."
Partial Listing Only—Thousands More Tubes in Stock!

35¢

SPECIAL 65N7GT.....30¢ 6W4GT.....30¢

0Z4 48Z7	GAL5	6BC5	6CA8	6DQ6	6SL7	7B1				
1A7GT 4CB6	GAMB	6BC8	6CB6	6FE	6SQ7	7B8				
1B3GT 5AM8	GANS	6BD5	6CDSG	6MB	6SR7	7C4				
1W5GT 5AN8	GAOS	6BE6	6CF6	6J5	6T4	7C5	12A8	12BD6	12SJT	
1R5 5AT8	GAQ6	6BF5	6CL6	6J6	6T8	7C6	12AH5	12BE6	12SK7	
1S5 5AV8	GAQ7	6BGG	6CC7	6J7	6U5	7C7	12AD6	12BH7	12SN7GT	
1T 5AZ4	GARS	6BH6	6CG8	6KGGT	6UR	7E5	12AF6	12BL6	12SQ7	
1U4 5CG8	GASS	6BJ6	6CH8	6K7	6V6GT	7E6	12AQ5	12BQ6	12V6GT	
1U5 5R4	GAT6	6BK5	6CL6	6N7	6V6GT	7E7	12AT6	12BR7	12W6GT	
1V2 5T8	FAUGT	6BK7	6CM6	6Q7	6X4	7T7	12AT7	12BT7	12X4	
1X2 5U4	GAUSGT	6BL7GT	6CM7	6S4	6X5GT	7F8	12AUB	12CA5	17AX4	
2AF4 5V4	GAUS	6BR8	6CN7	6S5GT	6X8	7G7	12AUF	12CN5	17G4	
2BN4 5V6	GAUB	6BQ6GT	6CQ8	6S7	6V6GT	7H7	12AV6	12D4	19A4GT	
2CY5 5V6GT	SAV5GT	6BQ7	6CR6	6SCT	7A4/XXL	7N7	12AV7	12F8	19BG6G	
3AL5 5X8	GAUS	6B8	6CS6	6T7	6D7GT	7A5	7G7	12X4GT	12K5	19T8
3BC5 5Y3	FAW8	6BS8	6CU5	6SF5	7A6	7G7	12AX	12N7	25V6GT	
3BN6 6AB4	GAX4GT	6BY6G	6CU6	6SG7	7A7	7X6	12AZ7	12L6	35A3	
3PZ6 6AC7	GAX5GT	6BZ6	6D6	6SB	7B4	7X7	12B4	12Q7	35B3	
3CB5 6AF4	6BB	6BZ7	6DE6	6S7	7B5	7Y4	12BA6	12R5	35C5	
354 6AG5	6BA6	6C4	6D6GT	6SK7	7B6	7Z4	12BA7	12S47	35W4	

1-YEAR GUARANTEED TV PICTURE TUBES These tubes are made only from new parts and materials, except for the envelope which is re-used. Below listed prices do not include duty. Add Additional \$5.00 Deposit on tube sizes to 20"; on 21" and 24" tubes—\$7.50. Deposit refunded immediately when dud is returned prepaid. Aluminized tubes—\$4.00 extra. Picture tubes shipped only to contiguous US and Canada—All tubes P.O.B. Harrison, N. J.

10BP4 7.99	17CP4 16.99	21AMP4 17.99	21KP4 18.39
16CP4 16.09	17TP4 16.99	21AVP4 18.79	21VP4 18.39
16RP4 11.99	20CP4 15.99	21AWP4 17.49	21WP4 17.49
17AVP4 15.49	20HP4 17.99	21EP4 17.29	21XP4 18.39
17BP4 13.49	21ALP4 18.79	21FP4 18.39	24CP4 27.79

ATTENTION QUANTITY USERS! Bulk Discounts Are Yours... Call or Write For Our 1000 Tube "Private Label" Special!
Money cheerfully refunded within five (5) days, if not satisfied.

SHIPPING INSTRUCTIONS: TRU-VAC PAYS YOUR POSTAGE on orders of \$5 or more in USA and Territories. Send approximate postage on Canadian and foreign orders. Any order less than \$5 requires 25¢ handling charge. Send 25¢ on C.O.D.'s.

TRU-VAC

Harrison Avenue • Box 107 • Harrison, N. J. HUmboldt 4-9770

stallation. At an average location, mobile stations will come through at distances up to about five miles. Base stations, especially the higher powered ones, will be audible for at least 20 miles.

Be sure to log the dial settings of the various services you hear so that you can retune to them in the future. And always set the FM dial to exactly 108 mc.

HOW IT WORKS

Many police, fire, public utility, and maritime mobile stations operate between 150.8 and 162 mc. The 10-8 makes it possible to tune in these signals on an ordinary FM radio.

A 155-mc. police call, for example, arrives at the antenna, drops down the feedline, and finally reaches coil *L1*. Since *L1* and capacitor *C1* form a resonant circuit that can be tuned to 155 mc., a 155-mc. voltage can be built up across this *LC* combination and applied to the grid of *V1a*.

Tube *V1a* is a variable-frequency oscillator which, in this case, is tuned to 47 mc. The 47-mc. output of *V1b* is fed to the cathode of *V1a* via capacitor *C4*. Because *V1a* is a non-linear device, the 47-mc. energy combines in the tube with the 155-mc. police signal to produce two new frequencies. These new frequencies, or "beats," are equal to the sum of and the difference between 47 and 155 mc.

The sum (202 mc.) and the difference (108 mc.), as well as the 47- and 155-mc. signals, are all present at the plate of *V1a*. Only one of these, the 108-mc. signal, is desired. Consequently, coil *L2* and capacitor *C2* are resonated to this particular frequency. Coil *L3*, which is inductively coupled to *L2*, picks up 108-mc. energy and feeds it, via switch *S1a* and the coaxial cable, to the input of the FM receiver. The 155-mc. police signal will now be heard when the FM set is tuned to 108 mc.

To cavedrop on a mobile telephone conversation at 152 mc., *C1* is peaked to this new frequency and capacitor *C7* reset for an oscillator frequency of 44 mc. The FM set need not be retuned, because the difference between 152 and 44 is again 108.

Power to operate the 10-8 is supplied by a small isolation transformer, *T1*, and a silicon rectifier, *D1*. When normal broadcast reception is desired, *S1* is thrown to the FM position. This action shuts down the power supply, disconnects the converter from the FM set, and connects an FM antenna to the input of the receiver.

when using the 10-8—failure to do so will nullify your loggings.

Readers who live close to a TV transmitter on Channel 2 may pick up its audio signal in the middle of the band and its raw a.c. video carrier at 8 or 9 on the dial. Two or three unmodulated carriers may also be noted as you tune across the band. In the unlikely event that one of these signals falls on the frequency of a desired station, simply shift the FM dial to 107.5 mc.; this will "move" the offending carrier so that it will no longer be troublesome. -30-

FREE CAREER BOOKLET

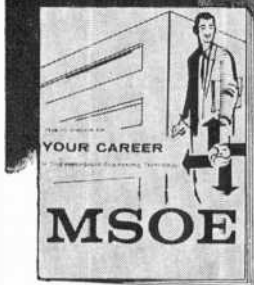

To guide you to a successful future in

ELECTRONICS RADIO-TV COMPUTERS ELECTRICAL ENGINEERING

This interesting pictorial booklet tells you how you can prepare for a dynamic career as an Electrical Engineer or Engineering Technician in many exciting, growing fields:

MISSILES • AVIONICS • AUTOMATION
SALES • DEVELOPMENT
ELECTRICAL POWER • ROCKETRY
RADAR • RESEARCH

Get all the facts about job opportunities, length of study, courses offered, degrees you can earn, scholarships, part-time work — as well as pictures of the Milwaukee School of Engineering's educational and recreational facilities. No obligation — it's yours free.

MILWAUKEE SCHOOL OF ENGINEERING

MAIL COUPON TODAY!

Milwaukee School of Engineering
Dept. PE-162, 1025 N. Milwaukee St., Milwaukee, Wis.
Please send FREE "Your Career" booklet
I'm interested in
 Electronics Radio-TV Computers
 Electrical Engineering Mechanical Engineering

Name _____ Age _____
PLEASE PRINT

Address _____

City _____ Zone _____ State _____

I'm eligible for veterans education benefits.
Discharge date _____ MS-117

YOU NEED THIS

FREE GIANT B-A CATALOG



SAVE UP TO 50% ON B-A SELECTED KITS

HI-FI AND STEREO SYSTEMS & COMPONENTS

TOP VALUES IN POWER AND HAND TOOLS

30 PAGES OF BARGAINS NOT IN ANY OTHER CATALOG

BURSTEIN-APPLEBEE CO.

Dept. PE, 1012 McGee St., Kansas City 6, Mo.
 Rush me New 1962 B-A Catalog No. 621

Name.....
 Address.....
 City..... State.....

SEND FOR IT TODAY

SAVE OVER 40% ON HI-FI

USE OUR EASY-PAY-PLAN Up to 24 months to pay

- 24LJ—Grommes—24 W. Stereo Amp. w/cover.....\$119.95
- 101GTA—Grommes—FM/AM Stereo Tuner w/cover.. 119.95
- Garrard Type "A" Changer..... 79.50
- Audio Empire #108 Stereo Diam. Cart..... 34.50
- 2—Leyton E. V. Spkr. Systems..... 157.00

Send for FREE Quotations on Your Package or Single Component
 Catalog Price\$510.90
 YOUR COST 295.00
 You Save
 Over 40%\$215.90

BEFORE YOU BUY HI-FI—write for no obligation quotation on your Hi-Fi requirements. We guarantee "We Will Not Be Undersold Policy." FREE WHOLESALE CATALOG.

ELECTRONIC WORLD HI-FI RECORDING TAPE

7" Spools - Splice Free - Freq. Resp. 30-15KC

		3-11	12-23	24-100
12A	1200' Acetate	\$1.29	\$1.17	\$.99
18A	1800' Acetate	1.79	1.59	1.45
18M	1800' Mylar	2.09	1.99	1.85
24M	2400' Mylar	2.69	2.59	2.49

Any assortment permitted for quantity discount. Add 15c per spool postage. 10c 24 or more.

All mdse. sold on 15-day money-back guarantee.

HI-FIDELITY CENTER
 "The House Of Low Low Prices"
 220-PE East 23rd St., New York 10, N. Y.

Across the Ham Bands

(Continued from page 77)

pacitors at maximum capacitance, turn on the transmitter and wait a minute for the tubes to reach operating temperature. Press the key and adjust capacitor C7 for minimum glow of the pilot bulb (it may go out completely) or minimum meter reading. Then decrease the capacitance of C8 a small amount—say 10%—and readjust C7 for minimum glow or meter indication. This minimum reading will be higher than before.

Continue adjusting the two capacitors as above until you reach the highest "minimum" that still allows good transmitter keying. Check the keying by listening to the transmitter signal in your receiver; for best results, it may be necessary to detune capacitor C7 slightly to the low-capacitance side of the minimum point. When properly tuned, the transmitter plate current will be in the region of 60 to 75 ma. (dull red glow of the pilot bulb), representing a power of 25 to 30 watts input.

After tuning, capacitor C7 should be approximately 1/2-meshed on 80 meters, 1/3-meshed on 40 meters, and 1/5-meshed on 20 meters. Settings far different from these may produce an output on out-of-the-band harmonics of the crystal frequency.

News and Views

Dick Gray, W6RVM, 5833 Sherwood Dr., El Sobrante, Calif., is a versatile ham. During the school year, he is a high-school music teacher; in the summer, he is a Ranger in Yosemite National Park. Dick built his operating desk from an old door and some plastic-covered plywood; his home-brew transmitter is based on the plans of the 6DQ5 rig in the ARRL handbook. In his "spare time," Dick gets on the air. . . . Walt "Bud" Simciak, K9QXS, Room A-302, 71 E. 32nd St., Chicago 16, Ill., lives at that address while attending the Illinois Institute of Technology. But he does his operating from a suburb of Gary, Indiana. In his six months as a Novice, Bud's 2-meter Gonset Communicator (running about 10 watts) racked up over 200 contacts in six states. His 22-element beam (two stacked 11-element beams) is 50' high and helps give his signal the "voice of authority." . . . Incidentally, it's remarkable how many hams are working surprisingly long distances on two meters with inexpensive, low-power transceivers such as the Heathkit "Two'er," etc. Ralph Roales, W9RVM, Vincennes, Ind., for example, thinks nothing of

working 100 miles with his "Two-er" feeding a 9-element, home-brew beam. Not bad for a power of 0.005 kilowatt, as Ralph puts it.

Jim Hegedus, WV2PHY, 202 Route 156, Trenton 20, N.J., transmits with a Heathkit DX-40 and receives on a Lafayette HE-10. A 40-meter dipole and a 15-meter dipole also do their parts. In six months, Jim has logged 42 states and 16 countries: he rates Pakistan and Latvia as his best DX (who wouldn't?). . . . **Kenneth Stoddard, KN5MQV**, Box 323, Perry, Okla., proves that "you never know whether it will work until you try it" by using a 6BQ6 and a 2E26 in parallel running 40 watts in his home-built transmitter. Feeding a long-wire antenna and receiving on a Hallicrafters S-38, Ken has knocked off 37 states and four Canadians in six weeks—all on 80 meters. . . . **Harry Peterson, KN7PSG**, 1825 Northview, Phoenix 21, Ariz., reports that his first contact was with KN7PRQ. Guess who was KN7PRQ's first contact? You're right, KN7PSG. Harry transmits with a DX-40 and receives with a Hallicrafters S-76. The T/R switch described in our August, 1960, column connects the receiver and transmitter to a 40-meter dipole antenna. Harry has had good luck with several of our other construction projects, too.

William L. Kern, KN3PLW, 605 Edna St., Connellsville, Pa., really is tied up in communications. During the day he works for the telephone company; at night, he "pounds brass" on 40 meters. A Knight-Kit T-50 transmitter and a Knight-Kit R-55 receiver have put 27 states and a Canadian in Bill's log. . . . **Tom Becker, KN8BQX**, 915 Golfview Dr., Dayton 6, Ohio, didn't mention what kind of an antenna he is using, but it must be a pretty good one. In only a few weeks, Tom's AMECO AC-15 transmitter, running 15 watts, and his National NC-57 receiver have exchanged signals with 10 states. . . . One of the claims to fame of **Mike Gallo, WA2LSK**, 1 Jay St., Binghamton, N.Y., is that he QSL's 150%. I hope the message gets through to some of the non-QSL'ers. Mike has worked 14 states on 6 meters with a home-brew, 50-watt transmitter feeding a 10-element Taco beam, 55' high. For receiving, he put together a converter which makes his rebuilt 1938 Philco broadcast set think it is a short-wave radio.

Vant Morrell, WN4CTC, 659 Cardinal Lane, Lexington, Ky., really kept his Johnson Adventurer transmitter and Hallicrafters S-120 receiver hot his first week on the air. Fifty-eight contacts in 23 states (all on 40 meters) are the evidence. His antenna is a folded dipole 25' high, and his receiver is abetted by a home-built signal booster and a Heathkit QF-1 Q-Multiplier. . . . **Ralph "Lucky" King, K1KOB**, Jones Ave., Portsmouth, N.H., is doing his part to keep New Hampshire on 6 meters. In 10 months, his Lafayette 6'er (a 7-watt powerhouse) driving a Cush Craft 3-element beam has worked over 300 different stations. Exactly how many states Lucky has worked is a bit of a mystery, but he has QSL cards from 20 of them.

Until next month, 73,

Herb, W9EGQ

37

MICRO

ELECTRON TUBE CO.

P.O. Box 55, Park Station
Paterson 3, New Jersey

\$35

PER HUNDRED ASSTD

SEND FOR FREE COMPLETE LIST OF TUBES

0A2	3Q4
0Z4	
1A7GT	4B2Z
1B3GT	5A58
1H4G	5A78
1H5GT	5A78
1L4	5AW4
1L6	5BK7
1N5GT	5J6
1Q5GT	5T8
	5U4G
	5U8
2A3	
2A4F4	
3BC5	6A7
3BN6	6AR
3BZ6	6AB4
3CB6	6AC7
3CF6	6AF4
3CS6	6B9
3LF4	6BA6

6BC5	12A8
6BC8	12AQ5
6BD6	12AT6
6C4	12AT7
6C5	12AU6
6C6	12AU7
6CB6	12AV6
6CD6G	12AV7
	12AX4GT
	12AX7
7A4/XXL	
7A5	19B6G6
7A6	1916
7A7	42
7A8	1978
7B4	24A
7B5	25AV5
7B6	25BQ6
7B7	25D6
7B8	25L6GT
7C4	25W4GT

25Z5
25Z6
26
35A5
35B5
35C5
35L6GT
35W4
35Y4
35Z5GT
37
39/44
42
43
45
50A5
78
80
84/6Z4
117Z3

• All tubes included for mutual conduction, life test. • Guar. FRER 1 yr. replacement any tube failing under all operating cond. • Adv. tubes not necessarily new; may be elec. perf. fact. seconds or used—clearly marked.

POSTAGE PAID. Send 25c handlg. for orders under \$5. 25% dep. C.O.D. Send approx. post. on Cart. & foreign orders.

GROVE CB SALE!!

Closing out our stock of CB kits. Nationally advertised at \$39.95 up. Complete with power supply, tubes, crystal, cabinet, coils, etc., less mike. Kit sales final. Rush your order today!!

- 110 VOLT CB TRANSCEIVER KITS \$19.95
- 12 VOLT CB TRANSCEIVER KITS \$22.95
- 6 VOLT CB TRANSCEIVER KITS \$22.95
- LOW-PASS FILTER (Reg. \$3.95) \$2.49
(Coax Type—Famous Make)
- 3-ELEMENT BEAM ANTENNA (Reg. \$29.95) \$11.99
(Mounts horizontally or vertically)
- GROUND PLANE ANTENNA (Mod. GP-27) \$7.99
(Spec. Close-Out Price)
- 11-PC. MOBILE NOISE SUPPRESSION KIT (Includes tunable Generator Filter) \$3.99
- BODY MOUNT + 102" WHIP + SPRING \$6.99
- BUMPER MOUNT + 102" WHIP + SPRING .. \$8.99
- 100 ft.—RG 58U COAX CABLE \$2.99
- 100 ft.—RG 8U COAX CABLE \$7.99
- JK RECEIVING CB CRYSTALS (.002% Tol.—Specify make, model & channel) \$2.49
- JK CB XMTG CRYSTALS (.002%) (27MC Series—Specify make, model & channel) \$1.99

Lots of 3 or more, \$1.89 ea.—6 or more, \$1.79 ea.
Check items wanted. Return ad w/check or M.O. Include Postage. Excess returned. C.O.D. orders 50% down (Note: Beam & Ground Plane Antennas must be shipped railway express collect)

GROVE ELECTRONIC SUPPLY COMPANY
4103 W. Belmont Ave., Chicago 41, Ill.
 Rush items checked
 Send FREE 1962 catalog of GIANT CB VALUES

Name
Address (please print)
City Zone State

NEW MODEL 107A DELUXE "TRI-TESTER"

SECO

ONLY
\$14950
NET



TESTS ALL TUBES

Here's the finest, fastest tester at a popular price. Tests 9-pin NOVARS, 12-pin COMPACTRONS, new 10-pin tubes, NU-VISTORS and all previous standard types. Triple test offers every important check you need to make money servicing—*Dynamic Mutual Conductance Test* on pre-wired chassis, *Cathode Emission Test* by free point selector system, and patented *Grid Circuit Test* with up to 11 simultaneous checks for leaks, shorts and grid emission. In handsome carrying case with handy chart for tube set-up data. Meets specifications for Federal Stock Classification: Tube Tester Type 107—FSN—6625-713-9075.

See your distributor for complete information.

SECO

SECO ELECTRONICS, INC.
5033 Penn Ave. So., Minneapolis 19, Minn.

Please send FREE 107A operating instructions and schematic "How To Test Tubes" chart Seco full line folder.

Name

Address

City State

PORT ARTHUR COLLEGE ELECTRONICS COMMUNICATIONS

AM FM Television Broadcast Engineering
Industrial Electronics—Automation

CHECK THESE FEATURES: Tuition \$36 per mo., room & board \$52 per mo. in dorm on campus. College operates 5 KW broadcast station. Students get on-the-job training at studios on campus. FCC license training with all courses. Well equipped classrooms & lab., am fm transmitters, radar & marine eqmt., television camera chain, experiment lab test eqmt. & other training aids. Our graduates in demand at good salaries. Free placement service. Have trained men from all 50 states. Approved for GI. Write to Dept. P-162 for Free Booklet.

PORT ARTHUR COLLEGE Port Arthur
Texas
Established in 1909

WALKIE-TALKIE RADIOPHONES

Made in U.S.A.

From \$24.98 for electronic chassis



Send for FREE literature on the new SPRINGFIELD TR-28 kit, or the VANGUARD Mark-1 factory assembled Radio phone. Fully transistorized, portable High quality industrial types, C B or amateur bands. 5 year service guarantee. VANGUARD ELECTRONIC LABS. 190-48 99th Ave., Hollis 23, N. Y.

Dept. E-1

GET INTO

ELECTRONICS

V.T.I. training leads to success as technicians, field engineers, specialists in communications, guided missiles, computers, radar, automation. Basic & advanced courses in theory & laboratory. Assoc. degree in 20 mos. B. S. obtainable. ECPD accredited. G.I. approved. Graduates with major companies. Start Feb. Sept. Dorms, campus. H. S. graduates or equivalent. Catalog.

VALPARAISO TECHNICAL INSTITUTE

Dept. PE

VALPARAISO, INDIANA

Short-Wave Report

(Continued from page 81)

The following is a resume of current reports. At time of compilation all reports are as accurate as possible, but stations may change frequency and/or schedule with little or no advance notice. All times shown are Eastern Standard and the 24-hour system is used. Please send reports to P. O. Box 254, Haddonfield, N. J., in time to reach your Short-Wave Editor by the eighth of each month—be sure to include your WPE call.

Antigua—DX'ers who would like to log this British West Indies country (although it no longer counts as a separate country) should try for the Antigua Broadcasting Service on 644 kc., 1000 watts. The schedule is 0630-0900, 1130-1300, and 1800-2100 daily, and reports will be verified. Send your reports to Mr. Campbell Matthew, VP2AR, Hood Street, St. John's, Antigua, B.W.I. According to Mr. Matthew, this station receives only about a half dozen reports yearly, mostly from New Zealand, Australia, and Sweden. (DC)

Argentina—Radiodifusion Argentina al Exterior, Buenos Aires, operates weekdays as follows: to Central Europe at 1400-2000 in Spanish, German, Italian, French, Eng., and Port. on 11,730 kc.; to Eastern N.A. at 2100-2300 and to Western N.A. at 2302-0102 in Eng. and Spanish on 9690 kc. (WPE1BD, WPE3BIK, WPE8BBL, WPE8CKW, WPE8MS, WPE8OG)

Australia—R. Australia has placed a new xmtr in use on 9570 kc. at 0458-1230 to S.E. Asia, replacing the former outlet on 9565 kc. The VL- call-signs have been dropped. A new QSL card has been printed and will be issued when the supply of old cards is exhausted. (WPE6BPN, WPE8MS)

Austria—A portion of the schedule for Oesterreichischer Rundfunk, P. O. Box 700, Vienna 50, Austria, reads: 1800-2100 on 6155 kc.; 1900-2300 on 9540 kc.; 2100-0000 on 15,255 kc.; 1200-1300 on 17,800 kc.; 0900-1000 on 17,850 kc.; and 0500-0645 on 21,570 kc. The latter channel replaces 21,705 kc. (WPE2CRX, WPE2FHU, WPE3RB, WPE4FI, WPE0VB, VE3PE1KC)

Belgium—Brussels operates at 0715-0800 on 15,140 kc., replacing 15,435 kc. The 1945-2000 program on Mondays and Fridays has been switched to 1900-1915 on 9765 kc.—replacing 11,805 kc.—and on 9745 kc., and to Europe on 6000 kc. (WPE2FHU, WPE4FI, WPE8DCG)

Brazil—A rarely heard station is R. Tabajaras, Joao Pessoa, Brazil, on 4795 kc. It has been logged at 1830-1900 with L.A. music and Port. announcements. (WPE1HC)

ZYH21, R. Iracema de Fortaleza, was logged on 4815 kc. at 0315 with an excellent signal. Their s/on time is listed as 0300. (WPE0JJ)

R. Relogio, Rio de Janeiro, 4905 kc., was heard around 1700 with time checks each minute, commercials, and irregular ID's; all Portuguese. R. Difusora de Petropolis, 5042 kc., was heard with "Agencia Nacional," a government program, in Port., ending at 1800. (PY2PE1C/W2)

POPULAR ELECTRONICS

British Guiana—ZFY, Georgetown, has moved from 3255 kc. to 3265 kc. and is tuned at 0000 with classical music. (WPE2MI)

Colombia—HJGF, R. Bucaramanga, 4845 kc., has an Eng. period scheduled on Wednesdays at 2200-2300. Has anyone heard it? (VE7PE1R)

A station being heard on 14,605 kc. is a third harmonic of R. Netva on 4868 kc., which, in turn, is a change from 4855 kc. Their s/off is listed as 0000. They frequently play the opening of "The William Tell Overture." (WPE6BPN)

Congo Republic—Leopoldville, 11,755 kc., operates with 50 kw. daily except Sundays as follows: to Africa in French and Port. at 1200-1500; to Europe, Asia, and Oceania in German, Eng. (1630), French, Spanish, and Italian at 1530-1830; to the Western Hemisphere in Spanish (2000), French (2045), and Eng. (2130). The latter xmsn is not listed for Saturdays. Newscasts are aired in French at 1330, 1715, 2045; in Port. at 1430; in German at 1545; in Eng. at 1630, 2130; in Spanish at 1745, 2000; and in Italian at 1800. (WPE2DTO, WPE4DMF, WPE4JO, WPE8MS, WPE9BTA, WPE9CGQ, WPE0BTN, WPE0BXN, FA)

Cuba—R. Habana is observed as follows: in Eng. on 11,770 kc. at 2200-2340 and 0000-0100; in Port. on 11,875 and 11,770 kc. at 2030-2100 and on 11,875 and 11,760 kc. at 2300-2330; in French on 11,770 kc. at 2340-0000; in Spanish on 11,875 and 11,770 kc. at 1500, 1830, and 2100, and on 11,875 and 11,760 kc. at 0300 and 0530. The European xmsn at 1200-1400 in Spanish, Eng., and French is noted irregularly on 15,300 kc. The 11,875- and 11,760-kc. outlets are directed to South America, the 11,770-kc. broadcasts to N.A. (WPE6BPN, WPE8MS)

Ecuador—New stations and frequency changes: R. Mercurio, Cuenca, is on 6350 kc. at 1900-2300; Centro Radiofonico de Imbabura, Ibarra, is now on 5070 kc. and noted at 1900-2000; R. Once de Noviembre, Latacunga, on 6272 kc., is tuned at 1900-2300; R. Nacional Espejo, Quito, has moved from 4680 kc. to 4633 kc. and is heard at 1900-0000. (WPE4FI)

Finland—Helsinki operates to N.A. at 0630-0900 with Eng. on Tuesdays and Saturdays at 0630-0900 on 15,190, 11,805, and 9555 kc.; and to Europe with Eng. on Mondays and Fridays at 1100-1130 on the same channels as well as at 1600-1630 Fridays on 6120 kc. (WPE4FI, WPE8CYR, WPE8DCG, WPE8MS, WPE9DPU)

Formosa—Taipei was heard weak to fair

Resistor Quiz Answers

(Quiz on page 64)

1 D 4 H 7 G
 2 C 5 A 8 B
 3 E 6 I 9 F

January, 1962

LATEST SAMS BOOKS FOR EVERYONE IN ELECTRONICS



USE THIS HANDY ORDER FORM

- Electronic Games & Toys You can Build.** Here are 15 fun-filled, exciting projects you can easily build—not available commercially. Wonderful variety—projects that challenge players' judgment, test manual dexterity, achieve "magic" effects, etc. Order EGT-1, only.....\$2.50
- Sams Modern Dictionary of Electronics.** New—most comprehensive dictionary now available on electronics. Defines over 10,000 words and terms; includes over 350 illustrations. Over 350 pages. Order DIC-1, only.....\$6.95
- ABC's of Electronic Organs.** Explains theory, development, features and operation of electronic organs, electronic circuitry used, how to select an organ, maintenance and troubleshooting. Order ECO-1, only.....\$1.95
- BASIC ELECTRONICS SERIES.** These books present a dynamic new approach to the explanation of electronic circuit action, through the use of unique 4-color diagrams which help you visualize exactly what takes place inside the circuit.
- Oscillator Circuits.** Order BEO-1, only.....\$2.95
- Amplifier Circuits.** Order BEA-1, only.....\$2.95
- Detector & Rectifier Circuits.** BED-1,.....\$2.95
- General Class Amateur License Handbook.** A complete guide, including typical questions and answers, to prepare the novice or aspirant for the Technician, Conditional, or General class Amateur radio exam. Order ALP-1, only.....\$2.50
- 101 More Ways to Use Your VOM—VTVM.** Sequel to the best-selling first book on this subject; all-new uses described for troubleshooting electronic appliances and industrial devices. Tells how to use units as S-meter, cavity-wave meter, tachometer, field-strength meter. Order TEM-8, only.....\$2.50
- Sams Citizens Band Radio Manual.** Famous Standard Notation Schematics and PHOTOFACT® Folders providing full details on 46 important 1960-61 CB Transceiver models. Includes valuable text section on servicing CB equipment. Order CB-1, only..\$2.95
- ABC's of Ultrasonics.** Tells the fascinating story of how sound waves above the normal audible range are being used to perform jobs ranging from cleaning tiny watch movements to huge missile cases, homogenizing milk, measuring thickness and depth, locating schools of fish, etc. Describes theory and equipment used. Order ULT-1, only.....\$1.95



FREE! Ask for Free Sams Index to PHOTOFACT—the world's finest circuit data on more than 44,000 TV, radio, hi-fi, recorder models and related equipment. Send coupon below!

HOWARD W. SAMS & CO., INC.

Order from any Electronic Parts Distributor, or mail to Howard W. Sams & Co., Inc., Dept. A-92 1720 E. 38th St., Indianapolis 6, Ind.

Send books checked above. \$ _____ enclosed

Send Free Sams Index Send FREE Book List

Name _____

Address _____

City _____ Zone _____ State _____

IN CANADA: A. C. Simmonds & Sons, Ltd., Toronto 7 (outside U.S.A. priced slightly higher)

DEWALD



MFD. BY . . .



LEADS AGAIN WITH CITIZENS BAND "RADIO-PHONE" TR-910 TRANSCEIVER



Amazing at only

99.95

LIST

- Push-to-talk Mike with foolproof relay
- Full Squeich control
- Built-in "S" and plate current meter
- 5 channel Transmit
- 22 channel Verner controlled receive
- Automatic noise limiter

Furnished with Ceramic Microphone and one Transmitting Crystal

Write for Brochure and Name of Your Nearest Dealer

Made by . . . **UNITED SCIENTIFIC LABORATORIES, INC.**
35-09 37th AVE., LONG ISLAND CITY 1, N. Y.
Also Mfr's of DeWald Hi-Fi Stereo Components and FM Radio

THE SWITCH

Shakespeare
normal mode
helical antenna
for Citizens Band

The proven efficiency of Shakespeare's space wound coil and air core — it's all molded into this shapely 4' CB whip of white fiberglass that looks and mounts like a handsome car radio antenna. (—Use for both purposes by adding your own antenna coupler.)

Flex it
Bend it
tip-to-buttl

Shakespeare
construction,
always
rugged, is
at its best
in this keen
whip.



COLUMBIA
PRODUCTS
COMPANY

Shakespeare subsidiary
Columbia, S. C.

—Rad, adjustable cowl mount and choice of 54" cable (STYLE 156-1) — \$10.50
or 9' cable (STYLE 156-2) — \$10.95

on 17,785 kc., dual to 15,345 kc., with the N.A. xmsn at the new time of 2110-2140. (WPE4FI)

Greece—*R. Athens* operates to France and England at 1215-1245 and to N.W. Europe at 1400-1445 on 17,745 and 15,345 kc.; and to mariners at 1700-1730 and 1800-1830 on 15,345 and 11,720 kc. Reports go to: Hellenic National B/C Institute, Technical Services Directorate, 16 Mourousi Street, Athens, Greece. (WPE3BOC, WPE4DSZ)

Guinea—Conakry has a new 100-kw. xmtr in service on 4910 kc. and is noted with a fair signal at 1600-1700. (WPE4FI)

Haiti—4VU, *R. Lumiere*, Cayes, 2410 kc., was noted at 2021 during a French religious period. An ID was given at 2044. This one is weak and may be difficult to hear. (PY2PE1C/W3)

Israel—There has been some doubt regarding the use of 11,920 kc. by the Israel B/C Service. WPE2DTO wrote them and the following is a portion of the reply that he received. "It happens that the information in POPULAR ELECTRONICS was correct: *Kol Israel* does use the 11,920-kc. outlet although we believe 9009 kc. to be the most clearly received in most parts of the world." The letter was signed by Eileen Hyman, Assistant to the Director, Overseas Department, Israel B/C Service. (Ed.)

Ivory Coast — *Radiodiffusion Cote Ivoire*, Abidjan, was noted on 11,820 kc. from 1345 to 1430/fade-out with Eng. and French programs of news, jazz, and dance music. (WPE8AGY)

Jordan—Amman was noted on a new frequency of 15,345 kc., replacing 15,170 kc., at 1800-2000 to L.A. (WPE4FI)

Luxembourg—*R. Luxembourg*, 6090 kc., is heard in Europe at 1300-1830 and in Eastern U.S.A. at 1545-1615 with American pop tunes. Reports go to 38 Hertford St., London, W1, England. (WPE2CRX, JH)

Martinique—Fort de France has been logged on 4895 kc. at 2005 with operatic music and in French; on 3315 kc. at 1930-1940 with a French newscast; on 2420 kc. with a Hindi religious program at 2010-2030 and records to 2040. (WPE1HC, WPE0VB)

Mexico—XESC, Mexico City, formerly on 15,205 kc. and now on 15,200 kc., has become active again after a year's absence and is being noted at 1700-2100; XEWW, Mexico City, has moved to 9515 kc. from the 9500-kc. band-edge channel used for the past 20 years; XEHH, 11,880 kc., Mexico City, is tuned at 1200-2030 with Mexican music, many commercials and frequent ID's, all Spanish. (WPE2ENZ, WPE4FI, WPE8CKW)

The following up-to-date listing of the Mexican s.w. broadcasting stations was received from the Mexican Government by Thomas Mount, WPE2AJR, Red Bank, N. J. Call-sign, frequency, power, and mailing address for each station are given, in that order. The two asterisked items represent frequency shifts as reported by Roger Legge, WPE4FI, and the last five stations listed are Mexican cultural stations.

XEBR, 11,820 kc., 150 watts; Carlos Balderrama, Rosales y Vildosola, Edificio San Alberto, Hermosillo, Son.

XEBT, 9625 kc., 10,000 watts; Radio Satellite, S.A., Dr. Rio de la Loza 182, 2° piso, Mexico, D. F.

XECMT, 6090 kc., 1000 watts; Ricardo Lopez Mendez, Km. 560 Carretera Mexico-Laredo, Ciudad Mante, Tams.

XEFT, 9545 kc., 250 watts; Sucrs. de Jose Rodrigues Lopez, Independencia num. 74, Veracruz, Ver.

XEHH, 11,880 kc., 5000 watts; ARSE, S.A., Quemada num. 40, Mexico, D. F.

XEKW, 6030 kc., 500 watts; Jose Martinez Ramirez, Casco de Quiroga y Mariano Elizaga, Morelia, Mich.

XEMZ, 11,860 kc., 1000 watts; Manuel Zetina Gonzalez, Rio Poo num. 48, Mexico, D. F.

XENN, 11,780 kc., 500 watts; Salvador del Conde, Zacatecas 229 "Condominio Yuca-tan," Mexico, D. F.

XEOI, 6010 kc., 2500 watts; Fomento de Radio, S.A., Ayuntamiento num. 101, Mexico, D. F.

XEQM, 6105 kc., 250 watts; Lazaro Achurra Suarez, Calle 60 num. 735-D, Merida, Yuc.

XEQQ, 9680 kc., 1000 watts; Radio Mexicana del Centro, S. A., Jose Maria Marroqui num. 11, Mexico, D. F.

XERCM, 6130 kc., 100 watts; Radio Central de Mexico, S.A., Vallarta num. 1. 6° piso, Mexico, D. F.

XESC, 15,200 kc.*, 5000 watts; Dolores G.

SHORT-WAVE ABBREVIATIONS

B/C—Broadcasting	Port.—Portuguese
Eng.—English	QSL—Verification
ID—Identification	R.—Radio
kc.—Kilocycles	s/off—Sign-off
kw.—Kilowatts	s/on—Sign-on
L.A.—Latin American	xmsn—Transmission
N.A.—North America (n)	xmtr—Transmitter

Estrada de Ferreiro, Calz. Mexico a Xochimilco Km. 17, Parada Rio Blanco, Mexico, D. F.

XETT, 9555 kc., 500 watts; Guillermo Morales B., Dolores num. 10, Primer Piso, Mexico, D. F.

XEUW, 6020 kc., 250 watts; Fernando Pazos Sosa, Independencia num. 230, Veracruz, Ver.

XEWV, 9515 kc., 10,000 watts; Cadena Radiodifusora Mexicana, S.A., Ayuntamiento num. 54, Mexico, D. F.

XEXE, 11,900 kc., 1000 watts; Radiodifusora Mexico, S.A., Jose Maria Marroqui num. 11, Mexico, D. F.

XEXG, 6065 kc., 5000 watts; Radiodifusora Mexico, S.A., Jose Maria Marroqui num. 11, Mexico, D. F.

XEJG, 4820 kc., 250 watts; Gobierno del Estado de Jalisco, Palacio de Gobierno, Guadalajara, Jal.

XERUU, 15,300 kc., 250 watts; Universidad de Chihuahua, Domicilio Conocido, Chihuahua, Chih.

XESE, 2380 kc., 350 watts; Secretaria de Educacion Publica, Direccion de Asuntos, Indigenas, Seccion Administrativa, Mexico, D. F. (Station location is Samachique, Chih.)

XEXA, 6175 kc., 100 watts; Radio Gober-

Get Into One Of Today's TOP OPPORTUNITY FIELDS

ELECTRICITY

—ELECTRONICS

TELEVISION

RADIO · ELECTRONICS

COYNE

Train in the New Shop-Labs of Oldest, Best Equipped School of Its Kind in U.S. Founded 1899

in Chicago—Electrical and Electronic Center. Prepare for a better job and a successful future. Train on real equipment — no advanced education or previous experience needed. Lifetime employment service to graduates. Part time employment help to students. Finance Plan—enroll now, pay most of tuition later.

FREE BOOK—Mail Coupon or write to address below for Big Free Illustrated Book—"Guide to Careers."

Information comes by mail. No obligation and NO SALESMAN WILL CALL.

COYNE ELECTRICAL SCHOOL

Chartered as an Educational Institution Not for Profit
1501 W. Congress Pkwy., Chicago 7, Ill., Dept. 12-2C

COYNE ELECTRICAL SCHOOL, Dept. 12-2C
1501 W. Congress Pkwy., Chicago 7, Ill.

Send FREE Book, "Guide to Careers" and details of all training you offer. I am especially interested in

Electricity Television Both Fields

Name _____

Address _____

City _____

State _____

(I understand no salesman will call)

POPULAR JANUARY 1962
ELECTRONICS

Send
POPULAR
ELECTRONICS
Every
Month

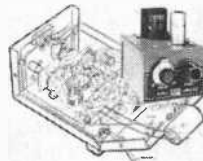

NAME.....

ADDRESS.....

CITY..... ZONE..... STATE.....

3 years for \$10

Check one: 2 years for \$7

1 year for \$4

In the U. S., and possessions.

Payment Enclosed Bill Me

Foreign rates: Canada and Pan American Union countries, add .50 per year; all other foreign countries, add \$1 per year.

Mail to: POPULAR ELECTRONICS

Dept. PE-1624, 434 S. Wabash Ave., Chicago 5, Ill.

on 21,495 kc. (also on 17,880 kc. at 0900-1200 except Sundays and holidays); to East and South Africa (Eng.) at 1315-1430 on 15,380 kc.; to W. Africa (Eng.) at 1430-1840 on 15,380 kc., and at 1645-1840 on 12,080 kc. (also on Sundays and holidays at 0400-0815 on 17,880 and 21,700 kc., and at 1215-1630 on 17,880 kc.); to Guinea, Cape Verde Islands, and Brazil, at 0900-1200 on 17,880 kc. (also on 15,125 kc. except Sundays and Holidays), at 1430-1600 on 17,895 kc., and at 1430-2100 on 11,915 kc.; to the fishing fleet at 1600-1930 on 11,840 kc.; to adjacent islands at 0400-1300 on 11,875 kc. (also Saturdays at 1440-1800 on 6025 kc.); and to Europe (Eng.) at 1315-1430 on 6025 kc. (WPE2E1W, WPE2GEH, WPE0TA, VE3PE1LT, VE1PE1R)

Syria—Damascus has moved from 5805 kc. to 5794 kc., where it is noted at 0035-0045 with Arabic music; this is dual to 11,750 and 7398 kc. (WPE1HC)

Trinidad—A radiotelephone station, ZBD85, Port of Spain, 18,075 kc., has been working Miami mornings and afternoons. They verify by letter. (WPE8CXT)

Turks Island—The British Cable and Wireless Station, VSI, operates daily except Sundays at 1100 on 4560 kc. with local news, shipping information, and a few items of general traffic—usually running no longer than 10 minutes. They are NOT looking for reports although they will be welcome; return postage is mandatory. The address: Mr. Hyatt, Superintendent, Radio Station VSI, British

Cable and Wireless, Grand Turk, Turks Island, British West Indies. (DC)

Venezuela—R. Junin, San Cristobal, 4930 kc., is heard well at 1900-2230. The s/off time is scheduled as 2330. This station does not seem to use call-signs although the assigned call may be YVOT. (WPE4FI, WPE6BPN, WPE8FV)

Radiodifusora Nacional, Caracas, 6170 kc., announces Eng. for 1630-1800 on Saturdays and 2230-0000 on Sundays to N.A. and Europe. (WPE4BC, WPE6BPN, WPE7AT, WPE8MS)

A new station, R. Tropical, Caracas, 4870 kc., is being heard with "Cavalcada Musical de Medianoche" until 0130. Announcements give the call as YVKT, with YVRT on 1050 kc., and YVKQ on 6110 kc. The latter has not yet been heard. (WPE6BPN)

Zanzibar—According to a schedule received from the station through a friend, the Voice of Zanzibar now seems to be using 6005 kc. at 0525-0630 and 0830-1130. Programs all appear to be in Swahili or a related language. Has anyone heard these broadcasts? (WPE8AGY)

Clandestine—A station has been noted at 1330 with a Congolese newscast. The ID seems to be Voice of Free Katanga. Before the start of each program a series of chimps are sounded; a musical program begins at 1344 and is still on after 1415. This channel is in the middle of the DX portion of the 15-meter amateur band. (JJH)

34¢

ELECTRONIC MARKET
1 YEAR GUARANTEED
RADIO-TV TUBES

EACH

\$32

Per 100 TUBES

ELECTRONIC MARKET
3750 E. 10th CT. HIALEAH, FLORIDA
Phone: OXford 1-5331
ONE OF THE LARGEST INVENTORIES IN THE COUNTRY

all tubes not necessarily new—but may be electronically perfect factory shells or used. Each clearly marked. Each becomes defective in use within 1 year from date of purchase. All tubes individually tested and warranted. Partial listing only. Thousands More Labels in Stock!

214	215	216	217	218	219	220	221	222	223	224	225	226	227	228	229	230	231	232	233	234	235	236	237	238	239	240	241	242	243	244	245	246	247	248	249	250	251	252	253	254	255	256	257	258	259	260	261	262	263	264	265	266	267	268	269	270	271	272	273	274	275	276	277	278	279	280	281	282	283	284	285	286	287	288	289	290	291	292	293	294	295	296	297	298	299	300	301	302	303	304	305	306	307	308	309	310	311	312	313	314	315	316	317	318	319	320	321	322	323	324	325	326	327	328	329	330	331	332	333	334	335	336	337	338	339	340	341	342	343	344	345	346	347	348	349	350	351	352	353	354	355	356	357	358	359	360	361	362	363	364	365	366	367	368	369	370	371	372	373	374	375	376	377	378	379	380	381	382	383	384	385	386	387	388	389	390	391	392	393	394	395	396	397	398	399	400	401	402	403	404	405	406	407	408	409	410	411	412	413	414	415	416	417	418	419	420	421	422	423	424	425	426	427	428	429	430	431	432	433	434	435	436	437	438	439	440	441	442	443	444	445	446	447	448	449	450	451	452	453	454	455	456	457	458	459	460	461	462	463	464	465	466	467	468	469	470	471	472	473	474	475	476	477	478	479	480	481	482	483	484	485	486	487	488	489	490	491	492	493	494	495	496	497	498	499	500	501	502	503	504	505	506	507	508	509	510	511	512	513	514	515	516	517	518	519	520	521	522	523	524	525	526	527	528	529	530	531	532	533	534	535	536	537	538	539	540	541	542	543	544	545	546	547	548	549	550	551	552	553	554	555	556	557	558	559	560	561	562	563	564	565	566	567	568	569	570	571	572	573	574	575	576	577	578	579	580	581	582	583	584	585	586	587	588	589	590	591	592	593	594	595	596	597	598	599	600
-----	-----	-----	-----	-----	-----	-----	-----	-----	-----	-----	-----	-----	-----	-----	-----	-----	-----	-----	-----	-----	-----	-----	-----	-----	-----	-----	-----	-----	-----	-----	-----	-----	-----	-----	-----	-----	-----	-----	-----	-----	-----	-----	-----	-----	-----	-----	-----	-----	-----	-----	-----	-----	-----	-----	-----	-----	-----	-----	-----	-----	-----	-----	-----	-----	-----	-----	-----	-----	-----	-----	-----	-----	-----	-----	-----	-----	-----	-----	-----	-----	-----	-----	-----	-----	-----	-----	-----	-----	-----	-----	-----	-----	-----	-----	-----	-----	-----	-----	-----	-----	-----	-----	-----	-----	-----	-----	-----	-----	-----	-----	-----	-----	-----	-----	-----	-----	-----	-----	-----	-----	-----	-----	-----	-----	-----	-----	-----	-----	-----	-----	-----	-----	-----	-----	-----	-----	-----	-----	-----	-----	-----	-----	-----	-----	-----	-----	-----	-----	-----	-----	-----	-----	-----	-----	-----	-----	-----	-----	-----	-----	-----	-----	-----	-----	-----	-----	-----	-----	-----	-----	-----	-----	-----	-----	-----	-----	-----	-----	-----	-----	-----	-----	-----	-----	-----	-----	-----	-----	-----	-----	-----	-----	-----	-----	-----	-----	-----	-----	-----	-----	-----	-----	-----	-----	-----	-----	-----	-----	-----	-----	-----	-----	-----	-----	-----	-----	-----	-----	-----	-----	-----	-----	-----	-----	-----	-----	-----	-----	-----	-----	-----	-----	-----	-----	-----	-----	-----	-----	-----	-----	-----	-----	-----	-----	-----	-----	-----	-----	-----	-----	-----	-----	-----	-----	-----	-----	-----	-----	-----	-----	-----	-----	-----	-----	-----	-----	-----	-----	-----	-----	-----	-----	-----	-----	-----	-----	-----	-----	-----	-----	-----	-----	-----	-----	-----	-----	-----	-----	-----	-----	-----	-----	-----	-----	-----	-----	-----	-----	-----	-----	-----	-----	-----	-----	-----	-----	-----	-----	-----	-----	-----	-----	-----	-----	-----	-----	-----	-----	-----	-----	-----	-----	-----	-----	-----	-----	-----	-----	-----	-----	-----	-----	-----	-----	-----	-----	-----	-----	-----	-----	-----	-----	-----	-----	-----	-----	-----	-----	-----	-----	-----	-----	-----	-----	-----	-----	-----	-----	-----	-----	-----	-----	-----	-----	-----	-----	-----	-----	-----	-----	-----	-----	-----	-----	-----	-----	-----	-----	-----	-----	-----	-----	-----	-----	-----	-----

ORDER SHIPPED SAME DAY RECEIVED.
SHIPPING INSTRUCTIONS: ELECTRONIC MARKET PAYS YOUR POSTAGE on orders of \$10 or more in U.S.A. and Territories. Send address, postage on Canada and foreign orders. Any order less than \$10 requires 25¢ handling charge. Send 25¢ on C.O.D.'s.
ANY RECEIVER TUBE NOT LISTED ALSO AVAILABLE AT 34¢ EACH!



NOW... Tomorrow and for years to come!

Sonar CITIZENS BAND RADIO

- 8 Channels, crystal controlled transmitter and receiver
- Tunable receiver for 22 channels
- Transmitter 100% Class B modulated
- Adjustable squelch
- Automatic noise limiter
- R. F. Power indicator
- 1 Year guarantee
- Easy to install. Ideal for home, boat, car or business. Weighs only 9 lbs. . . 4 3/4 x 9 1/2 x 1 1/4
- FCC Type accepted (*) in preference to only certification.

SONAR RADIO CORPORATION, 3050 W. 21 St. • B'klyn 24, N.Y.

Please send me complete information on Model "E" CB Radio.

NAME _____

ADDRESS _____

CITY _____ STATE _____

with 1 pair of crystals,
microphone and power cables

\$17950

POPULAR ELECTRONICS

January 1962 Advertisers' Index

ADVERTISER	PAGE NO.
Accordian Corporation of America	114
Allied Radio	102, 103, 104, 105
American Institute of Engineering & Technology	114
Browning Laboratories, Inc.	4
Bud Radio, Inc.	28
Burstein-Appleebe Co.	108
Capitol Radio Engineering Institute, The	7
Central Technical Institute	31
Cleveland Institute of Electronics	13
Columbia Products Company	112
Commissioned Electronics, Inc.	100
Conar Instruments	4
Coyne Electrical School	96, 101, 113
DeVry Technical Institute	5
E.C.I. Electronics Communications, Inc.	1
EICO (Electronic Instr. Co. Inc.)	40
Electro-Voice, Inc.	24, 25
Electronic Market	115
Electronics Book Service	23, 33
Esse Radio Company	114
Fisher Radio Corporation	3
Grantham School of Electronics	9
Greenlee Tool Co.	14
Grove Electronic Supply Company	109
Hallicrafters	2nd COVER
Heath Company	88, 89
Hi-Fidelity Center	108
Holt, Rinehart & Winston, Inc.	10, 11
Indiana Technical College	96
Johnson Company, E. F.	12, 97
Key Electronics Company	26
Kuhn Electronics, Inc.	30
Lafayette Radio	15
McGee Radio Company	114
Micro Electron Tube Co.	109
Milwaukee School of Engineering	107
Mosley Electronics Inc.	26
Moss Electronic, Inc.	83
National Radio Institute	28, 85, 86
National Technical Schools	35, 36
Newport Manufacturing Corp.	14
Olson Electronics	99
Petersen Radio Co., Inc.	12
Picture Tube Outlet	30
Port Arthur College	110
Progressive "Edu-Kits" Inc.	29
R.A.E. Society	3rd COVER
RCA Institutes, Inc.	16, 17, 18, 19
RTS Electronics Division	27
Rad-Tel Tube Co.	120
Sams Co., Inc., Howard W.	111
Saxitone Tape Sales	100
Schober Organ Corporation	20
Scientific Development Corporation	2nd COVER
Scott Inc., H. H.	32
Seco Electronics, Inc.	110
Sleep-Learning Research Ass'n	114
Sonar Radio Corporation	115
Tram Electronics	22
Transvision Electronics, Inc.	38
Tri-State College	100, 114
Tru-Vac	106
Turner Microphone Company, The	8
United Scientific Laboratories, Inc.	112
Valparaiso Technical Institute	110
Vanguard Electronic Labs	110
Western Radio	100

TD Power Supply

(Continued from page 73)

a maximum of 2 ma. by inserting a 300-ohm current-limiting resistor ($R2$) in series with $R1$. Resistor $R2$ holds the base current at a safe value when $R1$ is set at zero; this prevents the output voltage from increasing to a value which would be high enough to damage a tunnel diode.

Construction. Figure 2 and the photographs on pages 72 and 73 give the necessary details for assembling the TD power supply. It's housed in a 5" x 4" x 3" aluminum box, and neither its layout nor wiring is critical. Potentiometer $R1$ and switch $S1$ are mounted on the top lid of the box; all other components are mounted on the side walls. Dry cell $B2$ is held by a Keystone 175 battery holder, and mercury cell $B1$ by a Keystone 104; both of these holders are fastened to the same chassis wall.

Power transistor $Q1$ does not need a heat sink; but do not fasten it directly to the metal box, because its collector is connected internally to the metal envelope. Instead, mount the transistor upside down on two ceramic or plastic studs. If you wish, a Motorola transistor mounting kit can be used.

Resistor $R2$ is held by a 2-lug tie-point, and resistor $R3$ by the solder lugs of the two insulated binding posts ($J1$, $J2$) which serve as the plus and minus d.c. output voltage terminals. For safety's sake, use a red binding post for the positive terminal and a black one for the negative terminal. A 3" finger-grip knob allows smooth, comfortable adjustment of $R1$.

Using the Supply. It is a good practice, in experimenting with tunnel diodes, to start with switch $S1$ open and with potentiometer $R1$ set to its maximum resistance (for zero output voltage). Then snap $S1$ to "on" and increase the voltage slowly until the tunnel diode circuit begins to operate.

The output terminals of the TD power supply are unbypassed. Due to the high radio frequencies on which most tunnel diode circuits operate, it is wiser to insert bypass capacitors in the tunnel diode circuit itself rather than at the output of the power supply.

-50-

ELECTRONICS MARKET PLACE

RATE: 60¢ per word. Minimum 10 words prepaid. March issue
POPULAR ELECTRONICS, 1 Park Ave., New York 16, N. Y.

closes January 6th. Send order and remittance to Martin Lincoln,

FOR SALE

GOVERNMENT Sells Surplus: Electronics; Oscilloscopes; Transceivers; Test Equipment; Radar; Sonar; Walkie-Talkies; Boats; Jeeps; Aircrafts; Misc.—Send for "U.S. Depot Directory & Procedures"—\$1.00—Brody, Box 425(PE), Nanuet, New York.

TV Tuners—Rebuilt or Exchanged \$9.95 complete—all types—fast, guaranteed service. Send tuner with all parts to: L.A. Tuner Exchange, 4611 West Jefferson Blvd., Los Angeles 16, California.

GOVERNMENT Surplus Receivers, Transmitters, Snooper-scopes, Parabolic Reflectors, Picture Catalog 10¢. Meshna, Malden 48, Mass.

WPE-SWL-CB-QSL Cards—Samples 10¢—"Brownie" W3CJ1, 3110A Lehigh, Allentown, Penna.

DIAGRAMS for repairing Radios \$1.00, Television \$2.00. Give make, model. Diagram Service, Box 672-PE, Hartford 1, Conn.

BEFORE You Buy Receiving Tubes or Hi-Fi Components send now for your giant Free Zalytron current catalog—featuring nationally known Zalytron First Quality TV-Radio Tubes, Hi-Fi Stereo Systems, Kits, Parts, etc. All priced to Save You Plenty—Why Pay More? Zalytron Tube Corp., 220 W. 42nd St., NYC.

"SPECIAL! WPE-SWL-CB-QSL cards, 3 colors, \$2.50 per 100—Free Samples, Garth, Jutland, New Jersey."

FAST Computer. Tells time anywhere. Instructions included. \$1.25 P. P. Loeber, 224-T2 Wyatt, Lincoln, Ill.

CITIZENS Band—Maximum quieting with OZCO "Snoozer." Largest selling add-on squelch still only \$2.00 each, \$3.95 pair postpaid! Guaranteed. OZCO, Canaan, Connecticut.

GARAGE Door Operators \$59.95. Rugged chain drive automatic units. Highest quality. Free literature. Demso, Inc., Sebring 27, Ohio.

QUALITY Printing at low prices. Free catalogue. Jon Hevelone, Sterling, Kansas.

GARAGE Door Operator Kits—Edwards famous KR-50 kit. Easily assembled and installed. Available with or without remote car control. Thousands sold. Priced from \$59.95. Write for literature. Edward T. Fink Co., Inc., 284 Nepperhan Ave., Yonkers, N. Y., Dept. PE.

GW-10 Owners. Update your Heath Transceiver. A GW-10 Signal Booster Will Increase Receiver R.F. Gain and Sensitivity By 12db. Complete Kit, Less Tube, \$9.95 Plus 20¢ Postage and Insurance. Ray-Tronics, P.O. Box 938, Battle Creek, Mich.

SPECTACULAR Dancing Lights from your HI-FI or radio. Costs about \$15.00. Up to 50 lamps may be used. Patented design. Easy plans \$4.50. J. Strang, 1478 No. Kings Rd., Los Angeles 69, Calif.

AT last International Executive Owners (all models) may improve efficiency and save wear on tubes, etc. by installing new completely ventilated case. \$3.95 plus postage. L.A. Enterprises, 10742 South Western, Chicago 43, Illinois.

ELECTRONIC Pedalboard: would you like the bass notes for your electronic organ or piano? Brochure 50¢. Wolverine Music Company, P.O. Box 142, Dearborn, Michigan.

NEW Grille Cloth, 10 cents, square foot. Send self-addressed envelope for free samples. Naefly Lastics, Inc., 4909 Midmoor Rd., Madison 4, Wis.

TRANSISTOR Ignition—Save gas, tune-ups. Points, plugs last up to 50,000-100,000 miles. Improved cold starting, high-speed performance. Complete negative ground 12v system \$29.50. Special coil \$9.50. Palmer Electronics, Carlisle, Massachusetts.

DIAGRAMS—For T.V. \$2. Radio \$1. Hiett Diagrams, Box 816, Laredo, Texas.

HI-FI Strobolamp & Disc \$3.00. Transistor Hearing Aid \$39.95, \$10.00 down, \$3.00 month. C. James—P.O. Box 929, Indio, California.

CB-QSL-SWL cards. Samples 10c. Excellent Christmas gifts. Include your personal picture on cards. Signal, Adams County, Manchester, Ohio.

INVESTIGATORS! Do your own sound work. Write for free brochure of latest electronic equipment. WJS Electronics, 1130 N. Highland Ave., Los Angeles 38, Calif.

TELEPHONE Extension in your car. Answer your home telephone by radion from your car. Complete diagrams and instructions \$2.00. C. Carrier Co., 5880 Hollywood Blvd., Hollywood 28, Calif.

EAVESDROP with a pack of cigarettes. Miniature transistorized FM Radio Transmitter. Complete diagrams and instructions \$2.00. C. Carrier Co., 5880 Hollywood Blvd., Hollywood 28, Calif.

BE A Spy. Correspondence course on wire tapping, bugging, telescopic sound pickup, recording techniques, microphotography, and invisible photography. Lessons in surveillance, tailing, and use of equipment. Complete course \$22.50. C. Carrier Co., 5880 Hollywood Blvd., Hollywood 28, Calif.

TV Tape Recorder. Build your own Video Recorder. Complete correspondence course and construction details \$22.50. C. Carrier Co., 5880 Hollywood Blvd., Hollywood 28, Calif.

JUNK Your Distributor and Voltage Regulator. Improve automobile mileage and performance. Construction details for transistorized distributor and voltage regulator \$4.75. No moving parts. DB Enterprises, 8959 Wonderland Ave., Hollywood 46, Calif.

TV Camera. Build for less than \$50. Construction Details \$4.75. DB Enterprises, 8959 Wonderland Ave., Hollywood 46, Calif.

TELEPHONE Voice Switch (LS-500). Actuates automatically and unattended any tape or wire recorder. Pictorial installation instructions included. \$23.75. Post Paid US. WJS Electronics, 1130 N. Highland Ave., Los Angeles 38, Calif.

POLICE Radar Detector and legal jammer. Stop before those radar speed traps. Easy to build for less than \$10; used with your car radio. Complete construction details \$3.75. C. Carrier Co., 5880 Hollywood Blvd., Hollywood 28, Calif.

MORSE Code by Sleep Teaching. Guaranteed. 4 Taped lessons to 18WPM; \$12.95 each. Electro-Sleep, 8959 Wonderland Ave., Hollywood 46, Calif.

CONVERT Any television to sensitive, big-screen oscilloscope. Only minor changes required. Simple plans \$1.95. Relco, Box 10563-C, Houston 18, Texas.

INVESTIGATORS, Write for Free Brochure on Latest Subminiature Electronic Listening Devices. Dept. 2A Ace Electronics, 11500 NW 7th Ave., Miami 50, Fla.

DUMMY Load Flat to 160 MC. 200 Watt \$7.95. Also Change Crystal Frequency Safely with Etching Kit. .001 Tolerance With Instructions. Ham Kits Cranford, N. J. Box 175E.

TV Tuners Rebuilt \$9.95—Ninety Day Guarantee. Western Tuner Rebuilders, 4130 El Cajon Blvd., San Diego 5, California.

SAVE dollars on radio, TV-tubes, parts at less than manufacturer's cost. 100% guaranteed! No rebrands, pulls. Request Bargain Bulletin. United Radio, 1000-E, Newark, N. J.

ENJOY short wave broadcasts from your car radio! Converter installs in 2 minutes by anyone. Complete ready to use on 75 meter, 40 meter, 20 meter, or 11 meter citizens band, \$12.95 Postpaid. State band you wish and if 12 or 6 volt car. Guaranteed! Astro Electronics, 5212 Wea Drive, Kokomo, Indiana.

TELEPHONES—Antique, French, Modern, Any Model—Also Parts & Misc. Telephone Equipment of All Kinds—Price List 35c—Delta, Box 2262, Dallas 21, Texas.

CBERS—Increase sensitivity of Heathkit GW-10 by three "S" units with our SK3-RF preselector. Easily wired, inconspicuously installed. Complete kit, \$8.99; wired \$11.99. Holstrom Associates, P.O. Box 8640-PE, Sacramento 22, Calif.

ADAPTERS for foreign and obsolete tubes. Details. K6PFA, 1224 Mills, Modesto, Calif.

PRINTED Circuits, free catalog lists hundreds of circuits. Cloud "9" Engineering, Brookdale, Calif.

PLANS Distance crystal Set (SW record 5800 miles)—25c. 24 page Handbook for same—50c. Catalog. Laboratories, 1131-L Valota, Redwood City, California.

WALKIE-Talkie radiophones from \$24.98. Free literature. Vanguard Labs, 190-48 99 Ave., Hollis 23, N. Y.

RADAR King Plans \$1 refundable on Kits \$19.95 or wired units \$29.95. Extra Antennas \$4.50 each. Simultaneous operation of S and K band. S band antenna shipped with kit or wired unit unless otherwise specified. Wardell Smith, 65 Glenwood Road, Upper Montclair, New Jersey.

HIGH-FIDELITY

DISGUSTED with "Hi" Hi-Fi Prices? Unusual discounts on your High Fidelity Requirements. Write Key Electronics, 120 Liberty St., New York 6, N. Y. Cloverdale 8-4288.

DON'T Buy Hi-Fi Components, Kits, Tape, Tape Recorders until you get our low, low return mail quotes: "We Guarantee Not To Be Undersold." Wholesale Catalog Free. Easy time payment plan, 10% down—up to 24 mos. to pay. Hi-Fidelity Center, 220 PC-E 23 St., New York 10, N. Y.

PROMPT Delivery, Lower Prices. Amplifiers, Tape Recorders, Tuners, etc. No Catalogs, Individual Quotes. Compare. L. M. Brown Sales Corp., Dept. P, 239 E, 24 St., N. Y. 10, N. Y.

PRICES? The Best! Factory-Sealed Hi-Fi Components? Yes! Send for free catalog. Audion, 25P Oxford Road, Massapequa, N. Y.

RECORDERS, Components. Free wholesale catalogue Carston, 125-P East 88, N. Y. C. 28.

TAPE AND RECORDERS

TAPE Recorders, Hi-Fi, components, Sleep Learning Equipment, tapes. Unusual Values. Free Catalog. Dressner, 1523PE, Jericho Turnpike, New Hyde Park, N. Y.

RENT Stereo Tapes—over 2,000 different—all major labels—free catalog. Stereo—Parti, 811-G Centinela Ave., Inglewood 3, California.

SELF-Hypnosis may help you many ways. New tape or LP-record teaches you quickly, easily! Free literature. McKinley Company, Box 3038, San Bernardino, California.

WANTED

TRIGGER—W9IVJ. We Buy Shortwave Equipment For Cash. 7361 W. North, River Forest, Ill. Phone PR 1-8616. Chicago TU 9-6429.

QUICKSILVER, Platinum, Silver, Gold. Ores Analyzed. Free Circular. Mercury Terminal, Norwood, Massachusetts.

REPAIRS AND SERVICING

QUALITY Electronic Kit or Custom Construction by Qualified Technicians. Write Elcon, P.O. Box 271, Ft. Wayne, Indiana.

ELECTRONIC kits wired and tested. Write for free estimate. Naczas Kit Service, 18 Wolfe Street, Manchester, New Hampshire.

GOVERNMENT SURPLUS

JEEPS \$278, Airplanes \$159, Boats \$7.88, generators \$2.68, typewriters \$8.79, are typical government surplus sale prices. Buy 10,001 items wholesale, direct. Full details, 627 locations, procedure only \$1.00. Surplus, Box 789-C92, York, Penna.

CANADIAN Surplus, Used and New. Equipment and parts. Export Prices. Thousands of items. \$1.00 For Giant Catalogs. ETCO, Box 741, Montreal, Quebec.

NEW electronics surplus. Free catalog on request. JRB Surplus Sales Co., P.O. Box E, Pismo Beach, California.

PATENTS

PATENT Searches, \$6.00. For free Information Record, and "Information Inventor's Need, write: Miss Heyward, 1029 Vermont Avenue NW, Washington 5, D. C.

INVENTIONS WANTED

INVENTIONS wanted. Patented; unpatented. Global Marketing Service. 2420-P 77th. Oakland 5, Calif.

INVENTIONS Wanted for immediate promotion! Patented, unpatented. Outright cash; royalties! Casco, Dept. BB, Mills Building, Washington 6, D. C.

PHOTOGRAPHY-FILM, EQUIPMENT, SERVICES

SCIENCE Bargains—Request Free Giant Catalog "CJ"—144 pages—Astronomical Telescopes, Microscopes, Lenses, Binoculars, Kits, Parts. War surplus bargains. Edmund Scientific Co., Barrington, New Jersey.

COLOR film developing. Low prices. 20 exposure Kodachrome, Ektachrome, \$1.00. Write for free mailers and prices. Acme Photo, Box 6025 Z, Minneapolis, Minnesota. 7X35 Binoculars Central Focus, Coated Lens, Leather Case. Guaranteed. \$9.95 postpaid. Mail Mart, 1475 Prospect. Trenton 8, N. J.

STAMPS AND COINS

TERRIFIC Stamp Bargain! Israel—Iceland—San Marino—plus triangle set—Plus Antigua—Borneo—Virgin—Scouts—Congo—Russia—Plus large stamp book—all four offers free—Send 10¢ for mailing cost. Empire Stamp Corporation, Dept. Z2, Toronto, Canada.

"WANTED" Old Coins, also rolls and proof coins. Send 15¢ for our buying list. Coins, Box 81PE, Sebree, Kentucky.

FOR Sale—Newfoundland Stamps! 100 Fine Newfoundland Stamps—\$1.00. 100 all different—\$3.50. Harry Phillips Sales, Bonavista-2S, Nfld, Canada.

INSTRUCTION

EARN \$150 Week Mechanical, Electronics Drafting. Send \$2 First Lesson. \$25 Complete Home Study Course. Prior, Inc., 23-09 169th Street, Whitestone 57, New York.

BEGINNERS. Radio Electronics Explained Simply. Clear. Basic. Plans. 24 Pages. Send \$1. Transpace Laboratory, Box 111, Princeton Junction, New Jersey.

LEARN While Asleep, hypnotize with your recorder, phonograph. Astonishing details, sensational catalog free! Sleep-Learning Association, Box 24-ZD, Olympia, Washington.

BOOKS

BOOKS—All 15¢, 2000 titles, all subjects, catalog free. Cosma, Clayton, Ga.

PLASTICS

NEW Liquid Casting Plastic, clear, colors. Embed real flowers, butterflies, photos, coins. Send 25c for two handbooks "How to Cast Liquid Plastics" and "How to Make Extra Money at Home." Castolite, Dept. A-108, Woodstock, Illinois.

LEATHERCRAFT

FREE "Do-It-Yourself" Leathercraft Catalog. Tandy Leather Company, Box 791-B44, Fort Worth, Texas.

Always say you saw it in—POPULAR ELECTRONICS

MUSIC

ACCORDIONS, Chord Organs, Guitars! Buy direct—save to 1/2. Famous makes. Free home trial. Easy terms. Trades. Free catalogs. Mention Instrument. International Music Mart, Dept. PE, 2003 Chicago Avenue, Chicago 22.

EDUCATIONAL OPPORTUNITIES

ENGINEERING Education for the Space Age. Northrop Institute of Technology is a privately endowed, nonprofit college of engineering offering a complete Bachelor of Science Degree Program and Two-Year accredited technical institute curricula. Students from 50 states, many foreign countries. Outstandingly successful graduates employed in aeronautics, electronics, and space technology. Write today for catalog—no obligation. Northrop Institute of Technology, 1179 West Arbor Vitae Street, Inglewood 1, California.

ENGINEERING—Electronic Technical Institute, College of Engineering, Inglewood, California offers you a complete electronics program leading to the A.S. and B.S. Degrees. Send for a folder which contains the course description and a picture of one of our unique labs. Morning and evening classes permit you to work full time and attend school. ETI also has schools at San Diego and Costa Mesa, California.

DETECTIVE Profession. Home Study. Lapel pin, Certificate. Future. Box 41197-AG, Los Angeles 41, Calif.

100,000 Scholarships, many unclaimed, free cash, travel, study, all levels of education. Information \$1.00. Box 202, Hoquiam, Wash.

COMPLETE Your High School at home in spare time with 64-year-old school. Texts furnished. No classes. Diploma. Information booklet free. American School, Dept. X136, Drexel at 58th, Chicago 37, Illinois.

EMPLOYMENT INFORMATION

HIGH Paying Jobs in Foreign Lands! Send \$2.00 for complete scoop! Foreign Opportunities, Box 172, Columbus 16, Ohio.

EARN Extra money selling advertising book matches. Free samples furnished. Matchcorp, Dept. MD-12, Chicago 32, Illinois.

ELECTRONIC Technician to Engineer via well-written resume. Revise to suit yourself. True copy \$1.00. Resumes, Box 622, Scranton, Penna.

BUSINESS OPPORTUNITIES

BUY Direct from factories. Appliances, cameras, watches! Free details! Cam Co., 436 PE Bloomfield Ave., Verona, N. J.

VENDING Machines—No Selling. Operate a route of coin machines and earn amazing profits. 32-page catalog free. Parkway Machine Corporation, Dept. 12, 715 Ensor St., Baltimore 2, Md.

ELECTROPLATING equipment and supplies. All types for home work shops. Free Catalog. HBS Equipment Division, 1624 East First Street, Los Angeles 33, California.

MAKE \$25-\$50 Week, clipping newspaper items for publishers. Some clippings worth \$5.00 each. Particulars free. National, 81-EG, Knickerbocker Station, New York City.

FREE Book "990 Successful, Little-Known Businesses." Work home! Plymouth—455R, Brooklyn 4, New York.

SECOND Income From Oil Can End Your Toil! Free Book And Oilfield Maps! National Petroleum, Panamerican Bldg.—ZD, Miami 32, Florida.

MAILMAN Brings us \$150 Daily. Operate Home Mail Order Business. Write Publicity, Box 727ZE, Kalamazoo, Michigan.

EARN \$3.00 hour—no home spartime. Easy Pump Lamps assembling, No canvassing. Write: Ougor, Caldwell 15, Arkansas.

FREE Book: "609 Unusual, Successful Businesses." Box 1001-ZGB, Evanston, Illinois.

HOMEWORK, Typing. \$20-\$70 weekly. Details \$1 (refundable). Nationalco, 20 Southmountain, Millburn 50, New Jersey.

MAKE Money Making Leathergoods 1148 Ideas, Free information. Tandy Leather Co., Box 791-G2, Fort Worth, Texas.

FREE Book "711 Bizarre, Successful Ventures." How I retired. Work home! Haylings-MP, Carlsbad, Calif.

MISCELLANEOUS

SEND me your name and I'll tell you about a method that lets you take giant bass out of waters that other folks say are "fished out." Facts free. Write Eric W. Fare, Highland Park 72, Illinois.

"**HYPNOTIZE** . . . One word . . . One fingersnap," on stage. Satisfaction—or refund. \$2. Hypnomaster, Box 9309-E8, Chicago 90.

"**GIANT** Arms." Dr. Young's, D.C. Revolutionary discovery. \$2. Satisfaction or refund. Gaucho, Box 9309-E8, Chicago 90.

INDEPENDENT Thinkers—investigate Humanism! Write American Humanist Association, Dept. PE, Yellow Springs, Ohio.

2700 **NOVELTIES**, Tricks, jokes, science, hobbies. World's biggest gadget catalog 10¢. Johnson-Smith, D529, Detroit 7.

"**WINEMAKING**, "Beer," Ale." Strongest methods. Illustrated. \$2.20. Easton Beverage Supplies, Box 1242-C, Santa Rosa, California.

HYPNOTIZE Unnoticed, quickly, effortlessly or refund! Thousands satisfied! \$2.00. Timner, Box 244, Cedarburg, Wisconsin.

WRITERS!—Free list of top-notch USA markets for short stories, articles, books and plays. Write for your free copy today! Literary Agent Mead, 915 Broadway, N. Y. 10.

PRINTING Presses; type, Supplies. Lists 4¢. Turnbough Service, Mechanicsburg, Pa.

PEACH Brandy—Cherry Cordial—Wine—Beer—old rare formulas for personal use. Send \$1.00. Research Enterprises, Dept. D 29 Samoset Road, Woburn, Mass.

1000 Printed, Gummed, Name & Address Labels, \$1.00. Labels, Box 80, Wall Street Station, N. Y. 5, N. Y.

STATEMENT REQUIRED BY THE ACT OF AUGUST 24, 1912, AS AMENDED BY THE ACTS OF MARCH 3, 1933, JULY 2, 1946 AND JUNE 11, 1960 (74 STAT. 208) SHOWING THE OWNERSHIP, MANAGEMENT, AND CIRCULATION OF Popular Electronics published monthly at Chicago, Illinois, for October 1, 1961.

1. The names and addresses of the publisher, editor, managing editor, and business managers are: Publisher, Ziff-Davis Publishing Company, 434 S. Wabash Ave., Chicago 5, Ill.; Editor, Oliver P. Ferrell, 1 Park Ave., New York 16, N. Y.; Managing editor, Julian M. Sienkiewicz, 1 Park Ave., New York 16, N. Y.; Business manager, Matthew T. Birmingham, Jr., 1 Park Ave., New York 16, N. Y.

2. The owner is: Ziff-Davis Publishing Company, 434 S. Wabash Ave., Chicago 5, Ill.; Estate of William B. Ziff, 1 Park Ave., New York 16, N. Y.; A. M. Ziff, 1 Park Ave., New York 16; N. Y.

3. The known bondholders, mortgagees, and other security holders owning or holding 1 percent or more of total amount of bonds, mortgages, or other securities are: None.

4. Paragraphs 2 and 3 include, in cases where the stockholder or security holder appears upon the books of the company as trustee or in any other fiduciary relation, the name of the person or corporation for whom such trustee is acting; also the statements in the two paragraphs show the affiant's full knowledge and belief as to the circumstances and conditions under which stockholders and security holders who do not appear upon the books of the company as trustees, hold stock and securities in a capacity other than that of a bona fide owner.

5. The average number of copies of each issue of this publication sold or distributed, through the mails or otherwise, to paid subscribers during the 12 months preceding the date shown above was: (This information is required by the act of June 11, 1960, to be included in all statements regardless of frequency of issue.) 372,592.

M. T. BIRMINGHAM JR.
Business Manager

Sworn to and subscribed before me this 19th day of September, 1961.

(SEAL) WILLIAM PROEHMER,
Notary Public
(My commission expires March 30, 1962)

COSTS YOU LESS...

RAD-TEL'S Quality Brand New Tubes

up to 75% OFF

ONE-DAY SERVICE

1 YEAR GUARANTEE



SEND FOR FREE TROUBLE SHOOTING GUIDE AND NEW TUBE & PARTS CATALOG

TERMS: 25% deposit must accompany all orders, balance C.O.D. Orders under \$5: add \$1 handling charge plus postage. Orders over \$5: plus postage. Approx. 8 tubes per 1 lb. Subject to prior sale. Prices subject to change. No C.O.D.'s outside continental U.S.A.



RAD-TEL TUBE CO.

Dept. PE-162 55 CHAMBERS STREET, NEWARK 5, NEW JERSEY

EACH TUBE INDIVIDUALLY & ATTRACTIVELY BOXED & BRANDED RAD-TEL

Qty.	Type	Price	Qty.	Type	Price	Qty.	Type	Price	Qty.	Type	Price
074	.79		6AT8	.79		6GN8*	.94		12CU5	.58	
1AX2	.62		6AU4	.82		6H6	.58		12CU6	1.06	
1B3	.79		6AU6	.52		6J5GT	.51		12CX6	.54	
1DN5	.55		6AU7	.61		6J6	.67		12D4*	.69	
1G3*	.79		6AU8	.87		6K6	.63		12DB5	.69	
1J3*	.79		6AV6	.41		6L6	1.06		12DE8	.75	
1K3*	.79		6AW8	.90		6N7	.98		12DL8	.85	
1R5	.62		6AX4	.66		6S4	.51		12DQ6	1.04	
1S4	.59		6AX5	.74		6SA7GT	.76		12DS7	.79	
1S5	.51		6AX7	.64		6SG7GT	.41		12DT5*	.76	
1T4	.58		6AX8*	.92		6SH7GT	.49		12DT7*	.79	
1U4	.57		6BA6	.50		6SJ7	.88		12DT8*	.79	
1U5	.50		6BA8	.88		6SK7GT	.74		12DU7	1.01	
1X2B	.82		6BC5	.61		6SL7GT	.80		12DW8*	.89	
2AF4	.96		6BC7	.94		6SN7GT	.65		12DZ6	.56	
2BN4	.64		6BC8	.97		6SQ7	.99		12ED5	.69	
2EN5*	.45		6BD5	1.26		6TA4	.73		12EG6	.54	
3AL5	.42		6BE6	.55		6T8	.85		12EK6	.56	
3AU6	.51		6BF5	.90		6U8	.83		12EL6	.50	
3AV6	.41		6BF6	.44		6V6GT	.54		12EM6	.79	
3BA6	.51		6BG6	1.66		6W4	.60		12EN6	.78	
3BC5	.54		6BH6	.65		6W6	.71		12EZ6	.53	
3BE6	.52		6BH8	.87		6XA	.39		12F8	.66	
3BN6	.76		6BJ6	.62		6X5GT	.53		12FA6	.79	
3BU8	.78		6BJ7	.79		6X8	.80		12FM6	.43	
3BY6	.55		6BK7	.85		7A8	.68		12FR8	.91	
3BZ6	.55		6BL7	1.00		7AU7	.61		12FX8	.85	
3CB6	.54		6BN4	.57		7B6	.69		12GC6	1.06	
3CS6	.52		6BN6	.74		7EY8*	.73		12J8	.84	
3DG4*	.85		6BQ6	1.05		7F8	.90		12K5	.65	
3DK6*	.60		6BQ7	1.00		7H7	.90		12L6	.58	
3DT6	.50		6BS8	.90		7S7	1.01		12SA7	.92	
3Q4	.63		6BU8	.70		7Y4	.69		12SF7	.69	
3Q5	.80		6BX7	1.02		8AU8	.83		12SH7	.49	
3S4	.61		6BY5	1.15		8AW8	.93		12SJ7	.67	
3V4	.58		6BY6	.54		8BQ5	.60		12SK7	.74	
4BQ7	1.01		6BY8	.66		8CG7	.62		12SL7	.80	
4BZ7	.96		6BZ6	.55		8CM7	.68		12SN7	.67	
4BZ8	1.10		6BZ7	1.01		8CN7	.97		12SQ7	.78	
4CS6	.61		6BZ8	1.09		8CS7	.74		12U7	.62	
4DT6	.55		6C4	.43		8CX8	.93		12V6	.53	
5AM8	.79		6CB6	.55		8EB8	.94		12W6	.69	
5AN8	.86		6CD6	1.42		8SN7	.66		12X4	.38	
5AQ5	.52		6CE5*	.57		9CL8	.79		17AX4	.67	
5AS8*	.86		6CF6	.64		11CY7	.75		17BQ6	1.09	
5AT8	.80		6CG7	.61		12A4	.60		17DQ6	1.06	
5AV8	1.01		6CG8	.77		12AB5	.55		17W6	.70	
5BC8	.79		6CK4*	.70		12AC6	.49		18FW6*	.49	
5BE8	.83		6CL8	.79		12AD6	.57		18FX6*	.53	
5BK7	.82		6CM6	.64		12AE6	.43		18FY6*	.50	
5BQ7	.97		6CM7	.66		12AE7	.94		19AU4	.83	
5BR8	.79		6CM8*	.90		12AF3	.73		19B66	1.39	
5BT8*	.83		6CN7	.65		12AF6	.49		19C8	1.14	
5CG8	.76		6CQ8	.84		12AJ6	.46		19T8	.80	
5CL8	.76		6CR6	.51		12AL5	.45		21EX6	1.49	
5CM8*	.90		6CS6	.57		12AL8	.95		25AV5	.83	
5CQ8	.84		6CS7	.69		12AQ5	.60		25AX4	.70	
5CZ5*	.72		6CU5	.58		12AT6	.43		25BK5	.91	
5EA8	.80		6CU6	1.08		12AT7	.76		25BQ6	1.11	
5EU8	.80		6CY5*	.70		12AU6	.51		25C5	.53	
5I6	.68		6CY7	.71		12AU7	.60		25CA5	.59	
5T8	.81		6DA4*	.68		12AV6	.41		25CD6	1.44	
5U4	.60		6DB5	.69		12AV7	.65		25CU6	1.11	
5U8	.81		6DB6	.51		12AX4	.67		25DN6	1.42	
5V3	.90		6DE8	.58		12AX7	.63		25EH5	.55	
5V6	.56		6DG6	.59		12AY7	1.44		25L6	.57	
5X8	.78		6DK6	.59		12AZ7	.86		25W4	.88	
5Y3	.46		6DN6	1.55		12B4	.63		32ET5	.55	
6AB4	.46		6DQ6	1.10		12BA7	.84		32L7	.90	
6AC7	.96		6DT6	.53		12BD6	.50		35B5	.60	
6AF3	.73		6DT8*	.79		12BE6	.53		35C5	.51	
6AF4	.97		6EA8	.79		12BF6	.44		35L6	.57	
6AG5	.68		6EB5*	.72		12BH7	.77		35W4	.42	
6AH4	.81		6EB8	.94		12BK5	1.00		35Z5	.60	
6AH6	.99		6EM5*	.76		12BL6	.56		36AM3*	.36	
6AK5	.95		6EM7	.82		12BQ6	1.06		50B5	.60	
6AL5	.47		6EJ8	.79		12BR7	.74		50C5	.53	
6AM8	.78		6EW6	.57		12BV7	.78		50EH5	.55	
6AQ5	.53		6EY6*	.75		12BY7	.77		50L6	.61	
6AR5	.55		6F5GT	.39		12BZ7	.75		70L7	.67	
6AS5	.60		6FE8	.75		12C5	.56		70Z5	.69	
6AS6	.80		6GH8	.80		12CN5	.56		80T	.70	
6AT6	.43		6GK6*	.79		12CR6	.54		117Z3	.61	

Popular New Tube Types Offered by Rad-Tel*

NOT AFFILIATED WITH ANY OTHER MAIL ORDER TUBE COMPANY

(advertisement)

How to get the most out of building Radio·Audio·Electronic kits

A new plan by Milton Sleeper, noted figure in electronics

"For a long time," Milton Sleeper explains, "I felt that a society should be formed for the benefit of everyone interested in kit building. There are clubs and leagues to represent and further the interests of stamp collectors, photo fans, and radio hams. Similarly, there should be a kit builders' society, and it should have its own publication to voice the opinions of the members, for the exchange of experiences, and to provide news and information on this fascinating hobby."

Now, at last, there is a such a national society. Here's how it came about:

THE R·A·E SOCIETY

Nearly two years ago, a group of kit builders in the Berkshire Hills area of Massachusetts—comprised of businessmen, lawyers, engineers, and bankers—elected Mr. Sleeper chairman of what they called the R·A·E Society, because the members were all interested in building Radio·Audio·Electronic equipment.

As news of the Society spread, people from far and wide inquired about joining. Letters came from high school and college students, and from men of many different professions. Their enthusiastic interest showed that the Society could be more useful to more people than had been anticipated.

Also, there were many requests for a Society journal to serve a membership growing to national proportions. That posed a problem, however, for it meant setting up offices for the Society, with a paid staff at a cost which could not be met from membership dues.

A SPONSOR FOR THE SOCIETY

Meanwhile, the original members had undertaken to work out their own ideas of components to be assembled from kits. Certainly there was room for many improvements, because no basic changes had been made in kits and instructions over the past 20 years.

They first made a study of the advanced designs and techniques now employed in commercial and military equipment. Then they applied their findings to the design of components to be assembled from kits, and to the preparation of error-proof instructions.

Their undertaking was successful beyond expectations, so much so, in fact, that a company—R·A·E Equipment, Inc.—was formed to produce kits from their unique designs. Then, logically, this Company assumed sponsorship for expanding the Society nationally, and for the Society's R·A·E Journal.

THE R·A·E JOURNAL

Publication of the quarterly R·A·E Journal is important to members of the Society because it provides two much-needed services. First, it is an open forum for the exchange of opinions, suggestions, and experiences. Through it, members can make their views known to the record, tape, and equipment manufacturers, the radio and TV broadcasters, and to the Federal Communications Commission.

Second, the Journal fills a growing need for more specific, less technical information on kit assembly, home workshop projects, plans for stereo and mono record, tape, and radio installations, correct operation of components, and testing methods. Also, since no advertising space is sold, the Journal can carry unprejudiced reports, free of commercial bias, on all new developments.

With Milton Sleeper as editor, you will certainly find the Journal interestingly written from cover to cover, easy to understand, elaborately illustrated, and handsomely printed on fine paper. Please note that only members of the Society will receive the Journal. No copies will be sold.

YOU ARE INVITED

You are cordially invited to become a member of the R·A·E Society, an organization that started from the activities of a dozen kit building hobbyists, and is now growing into a national institution.

Membership is open to high school and college students, to men of all professions, and to hobby-minded women, too. Whether you are a beginner, an experienced kit builder, or an advanced enthusiast, you are welcome to join the Society, and to share in the privileges of membership. By applying for membership now:

- You will take part in various group activities and opinion polls
- You will receive accurate, advance information on new radio, audio, and electronic kits
- You will qualify to serve on one of the Advance-Test Panels, and if you are selected you will receive a free R·A·E kit in return for writing a report on it
- You will receive the four annual issues of the R·A·E Journal
- You may use the buy, sell, and swap columns of the Journal without charge
- You will receive an official membership card identifying you with the R·A·E Society.

CHARTER MEMBERSHIP NOW OPEN

For a limited time (expires January 31, 1962) you can join the Society as a Charter Member. Dues for the first year are only \$1.00. This entitles you to receive the Journal for one year, and to enjoy all the other benefits of membership.

Use the coupon below or your own stationery to apply for Charter Membership.



Milton Sleeper originated the idea of step-by-step kit instructions and picture wiring diagrams in the 20's. A pioneer radio engineer and manufacturer, he is an author and magazine publisher, founder of High Fidelity magazine, and a recognized authority on kit design techniques.

[R·A·E SOCIETY (sponsored by R·A·E Equipment, Inc.)
 COUNTY BANK BUILDING
 GREAT BARRINGTON, MASS.]

[Yes, I want to take part in the Society's activities,
 to receive the R·A·E Journal edited by Milton
 Sleeper, and I want to qualify to serve on one of
 the Advance-Test Panels. I enclose \$1.00 for
 Charter Membership dues for one year.]

[NAME]
 [STREET]
 [CITY & ZONE STATE.....]

[I understand that I am not required to purchase any
 R·A·E kit in order to enjoy full membership privileges.
 I am a Beginner Experienced Kit Builder
 Advanced Enthusiast]

[UNCONDITIONAL MONEY-BACK GUARANTEE. If I am
 not completely satisfied after I receive the first issue of
 the R·A·E Journal, my money will be refunded on
 request.]

TWENTY-FIVE THOUSAND DOLLARS IN RESEARCH TIME

... NOTHING LIKE IT ON THE MARKET!

Minivac® 601

**scientific exploration ... education ...
experimentation at the 24" console
of this amazing computer**



DECIMAL INPUT-OUTPUT

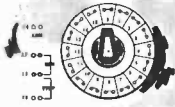

Motor-driven, sixteen position, non-shorting sequences.

BINARY INPUT

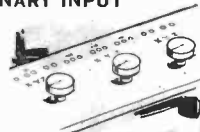

Transmits information for processing, six primary, double-pole, double-throw switches.

BINARY OUTPUT

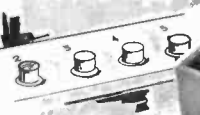

Communicates to the operator results of the programming.

STORAGE PROCESSING

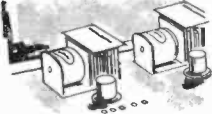

Six double-throw relays receive information ... process it ... transmit it to other components.

MINIVAC 601 is a unique digital computer — the small brother of huge electronic brains that are the newest tools of science and industry. MINIVAC has memory — it thinks ... it can even play games. It prepares teenagers and adults for the world of tomorrow.

A complete set of 6 instruction manuals included. "Getting Acquainted with MINIVAC 601", "What is a Digital Computer?", "How Computers Make Logical Decisions", "How Computers Do Arithmetic", "How Computers Work for Man", and "MINIVAC Games".

Created as a private project by Dr. Claude E. Shannon, now Donner Professor of Science, MIT, and developed by the SDC staff, MINIVAC 601 is built of professional components to professional standards.

It opens the way to exciting experimentation with circuits that solve problems and make decisions. It enables you to duplicate control systems like those used in advanced missiles. You may program it to demonstrate data processing techniques used in business. Hundreds of experiments are contained in the booklets. But this is only the beginning. The only limit to MINIVAC's accomplishments is the imagination of the machine's master.

\$8500



Scientific Development Corp., Data Processing Division
372 Main Street, Watertown, Massachusetts

SCIENTIFIC DEVELOPMENT CORPORATION

Data Processing Division

372 Main St., Watertown 72, Massachusetts

Gentlemen:

Please send free brochure giving complete information on Minivac 601 ... what it is ... what it does ... how it operates.

Name

Address

City Zone State