

INTRODUCING: POPTRONICS INTERACTIVE

www.poptronics.com

OCTOBER 2002

Poptronics®

Formerly **Popular Electronics®** and **Electronics NOW**

A GERNSBACH PUBLICATION

BUILD AN AFFORDABLE MULTI-PROCESSOR WORKSTATION

Illustrated instructions inside



SPECIAL REPRINT

Theremin, Part I

Learn how to create a legendary electronic instrument

BUILD THIS



Also Inside:

- Sundials
- Salvaging Parts
- Optical Computing
- PIC-Controlled A-Patch
- TriField Natural EM Meter

\$5.99 U.S.
\$6.99 CAN.

#BXBDCCH*****AUTO**3-DIGIT 210 #
 #21046DHM951RD007# TRON 203 #
 3 S101 P329 MAY 2003 #
 ROBERT DAHM
 9515 RED RAIN PATH
 COLUMBIA MD 21046-2073

Audio Products



What You Want.....
Today!™

click it
phone it
fax it

You Must Provide
this Source Code to
Receive Special Pricing

POP101

call toll free

1-800-543-4330

fax toll free

1-800-765-6960

customer service call toll free

1-877-626-3532

For more
Electronics
Visit our website

- Audio Products
- Books
- Cameras
- Car Audio and Security
- Computer Accessories
- Games
- Headphones
- Home Theater
- Joysticks
- Personal Electronics
- Radios
- Receivers
- Test Equipment
- Tools
- Tool Boxes/Cases
- More

www.mcmelectronics.com/magazine

Source Code: POP101

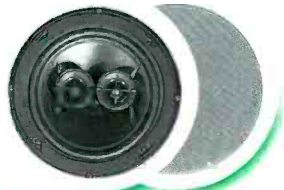

MCM CUSTOM AUDIO Single Point Stereo Ceiling Speaker

• Perfect when adding sound to smaller rooms in the house • Dual ¾" dome tweeters • 6½" dual voice coil poly cone woofer • Connects to both left and right channels • Attached mounting tabs for easy installation in virtually any ceiling (requires 7¼" opening) • 70Hz~20KHz response • 25W RMS power capacity • Sold individually

Order
#51-881
\$30²⁹



MCM CUSTOM AUDIO 250W Subwoofer Amplifier Module

• Mount in existing passive subwoofer cabinets • Incorporate into your own new design • 250W RMS continuous output into 4ohms • 40Hz~160Hz variable crossover, with bypass • 0~180° variable phase • High and low level inputs and outputs • Signal sensing for "auto power on" • Measures 10½" (H) x 10¾" (W) x 3¾" (D)

Order
#50-6281A
\$129⁰⁰

MCM CUSTOM AUDIO 4" LCD Color Monitor Module

• Incorporate into custom panels, cabinets and automotive seat backs • Bright color display provides 383 x 234 resolution • Accepts standard composite video input from cameras, VCRs or DVD players • Operates on 12VDC, 500mA • Measures only 5" (W) x 1½" (D) x 3¾" (H)

Order # 60-9855 Reg. \$105.00

Only!
\$85⁰⁰

You must provide this Source Code to receive a discount

SOURCE CODE #POP101



MCM CUSTOM AUDIO Outdoor Speaker Pair

• Two way design • 5½" woofer, 1" mylar tweeter • 80Hz~20KHz response • 30W RMS capacity per speaker • Weatherproof design permits outdoors mounting • Internal 70V transformer allows compatibility with large scale commercial systems • Recessed rotary control selects 5W, 10W, 20W, 30W and 8ohm taps • Each measures 9" (H) x 6" (W) x 5½" (D) • Sold in pairs

Order #	Color	(pair)
80-492	Black	\$59.95
80-493	White	59.95

MCM CUSTOM AUDIO Replacement 8" Woofer

• Perfect for new speaker design, or replacement/repair use • 1½" voice coil handles 70W RMS, 100W peak • Heavy duty stamped steel frame • Treated paper cone and rubber surround • Frequency response: 35Hz~5KHz • Fs: 34Hz • Vas: 1.13ft³ • Qts: 0.26 • Qes: 0.343 • Qms: 3.11 • Xmax: 3.8mm • Le: 0.62mH • Impedance: 8ohm

Order # 55-1520 Reg. \$15.95

Only!
\$11²⁵

12 Watt Audio Amplifier Module

• Handy compact amplifier is perfect for prototypes, refurbis and projects • Accepts line level input • Delivers 12W output into a 4ohm load • Operates on 6~16VDC • Rugged, fully potted enclosure • Measures only 2½" (W) x 1½" (D) x 1" (H)



Order
#28-6402
\$9³⁹

Prices effective September 2 thru November 29, 2002.

CIRCLE 324 ON FREE INFORMATION CARD

A Premier Farnell Company

Poptronics®

FEATURES

BUILD AN AFFORDABLE MULTI-PROCESSOR WORKSTATION..... Ted, Bryan, & Scott Needleman 21
Step-by-step instructions show you how to piece together the workstation of your dreams.

BUILD THIS THEREMIN, PART I..... John Simonton 27
*In this classic reprint from **Electronics Now**, learn how to create a variation of the legendary electronic instrument.*

PRODUCT REVIEWS

HANDS-ON REPORT..... 4
We function check the TriField Natural EM Meter from AlphaLab, Inc.

GIZMO®..... 5
Take a look at the latest consumer electronics that range from handwriting converters to home theaters.

DEPARTMENTS

PROTOTYPE..... 8
Catch up on new technology and receive a primer on surface-mount construction.

COMPUTER BITS..... Peter Pietromonaco 12
If you think optical computing requires a prescription, then you need to read this.

SURVEYING THE DIGITAL DOMAIN..... Reid Goldsborough 14
Learn whether or not people are still turning to the Web for enterprise.

PEAK COMPUTING..... Ted Needleman 19
Motherboards are increasing in options and, believe it or not, decreasing in cost.

ALL ABOUT..... William Sheets and Rudolph F. Graf 33
And now, the conclusion of RC-timer circuits is presented for your reading pleasure.

Q&A..... Dean Huster 37
Solder-slingers and circuit sultans swap solutions and suppositions.

PIC-TRONICS..... TJ Byers 42
Find out how to use a PIC to control a repeater A-patch for use in ham radio.

AMAZING SCIENCE..... John Iovine 45
The ongoing saga of the bi-pedal walker continues, as the author inserts servos into the prototype.

SERVICE CLINIC..... Sam Goldwasser 48
Self-confessions of a cannibal: How to recognize and recover parts from junked equipment.

BASIC CIRCUITRY..... Charles Rakes 53
Electronic sundials offer a new twist on an ancient chronograph design.

AND MORE

EDITORIAL..... 2 **POPTRONICS SHOPPER**..... 61

YESTERDAY'S NEWS..... 3 **ADVERTISING INDEX**..... 80

NEW GEAR..... 57 **FREE INFORMATION CARD**..... 80A

NEW LITERATURE..... 59

Poptronics (ISSN 1526-3681) Published monthly by Gemsback Publications, Inc. 275-G Marcus Blvd., Hauppauge, NY 11788. Second-Class postage paid at Hauppauge, NY and at additional mailing offices. One-year, twelve issues, subscription rate U.S. and possessions \$24.99, Canada \$34.81 (includes G.S.T. Canadian Goods and Services Tax Registration No. R125166280), all other countries \$35.99. Subscription orders payable in U.S. funds only. International Postal Money Order or check drawn on a U.S. bank. U.S. single copy price \$4.99. Copyright 2002 by Gemsback Publications, Inc. All rights reserved. Hands-on Electronics and Gizmo trademarks are registered in U.S. and Canada by Gemsback Publications, Inc. Poptronics trademark is registered in U.S. and Canada by Poptronix, Inc. and is licensed to Gemsback Publications, Inc. Printed in U.S.A. Can reprint only with written permission. Postmaster: Please send address changes to Poptronics, Subscription Dept., P.O. Box 459, Mount Morris, IL 61054-7629

A stamped self-addressed envelope must accompany all submitted manuscripts and/or artwork or photographs if their return is desired should they be rejected. We disclaim any responsibility for the loss or damage of manuscripts and/or artwork or photographs while in our possession or otherwise.

As a service to readers, Poptronics publishes available plans or information relating to newsworthy products, techniques, and scientific and technological developments. Because of possible variances in the quality and condition of materials and workmanship used by readers, Poptronics disclaims any responsibility for the safe and proper functioning of reader-built projects based upon or from plans or information published in this magazine.

Larry Steckler, EHF, CET,
editor-in-chief and publisher

EDITORIAL DEPARTMENT

Chris La Morte, managing editor
Evelyn Rose, assistant editor
Maria Orlando, assistant editor

CONTRIBUTING EDITORS

TJ Byers
Reid Goldsborough
Sam Goldwasser
Rudolf F. Graf, KA2CWL
Dean Huster
John Iovine
Ted Needleman
Peter Pietromonaco
Charles D. Rakes
Marc Spiwak
William Sheets, K2MQJ

PRODUCTION DEPARTMENT

Kathy Campbell, production manager
Michele L. Musé, prepress specialist

ART DEPARTMENT

Russell C. Truelson, art director
Michele L. Musé, graphic artist

CIRCULATION DEPARTMENT

Gina Giuliano, circulation manager

REPRINT DEPARTMENT

Maria Menichetti, Reprint Bookstore x235

BUSINESS AND EDITORIAL OFFICES

Gernsback Publications, Inc.
275-G Marcus Blvd.
Hauppauge, NY 11788
M-F 8:30 AM - 4:30 PM EST
631-592-6720
Fax: 631-592-6723

President: Larry Steckler
Vice-President: Adria Coren
Vice-President: Ken Coren

SUBSCRIPTION CUSTOMER SERVICE/ ORDER ENTRY

800-827-0383
7:30 AM - 8:30 PM EST

Advertising Sales Offices
listed on page 80

Cover by
Michele Lyn Musé

VISIT US ON THE INTERNET AT:

www.gernsback.com
or www.poptronics.com

Since some of the equipment and circuitry described in POPTRONICS may relate to or be covered by U.S. patents, POPTRONICS disclaims any liability for the infringement of such patents by the making, using, or selling of such equipment or circuitry, and suggests that anyone interested in such projects consult a patent attorney.

First off: In regards to last month's editorial, Arthur C. Clarke is the brilliant author/scientist/inventor and Stanley Clarke is the legendary bassist/composer/visionary. Me not exercise brain enough. Must read more periodicals and watch less cable news. —La Morte

Harvesting Parts

Would you like to take part in a poll? We are asking hobbyists, such as you, three simple questions:

- 1) Where do you get most of your parts? Be specific. Are they from a particular catalog, a particular brick-and-mortar store, or do you cannibalize from trash heaps and yard sales?
- 2) What are the hardest parts to come by? Is there a specific variable inductor you always need, but have to hunt for?
- 3) Lastly, what is the most abundant part(s) in your junk box?

Well then...if you want to participate, simply send in your answers via e-mail to editor@gernsback.com, or through the post at Parts Poll, c/o **Poptronics**, 275-G Marcus Blvd., Hauppauge, NY 11788. Thanks for your effort and enjoy this month's magazine.

And now for a special announcement:

JUST LAUNCHED!

POPTRONICS has just launched a companion edition on the Web. It's called **POPTRONICS Interactive Edition** and is entirely Web-based and will be updated monthly. This is a completely new concept. It's a complete e-magazine each month and not simply a collection of downloadable files. You will be able to sit and enjoy a range of articles and projects aimed at the instructional and constructional side of electronics, as well as newsworthy topics. The first issues will contain a **Basic Electronics Course** (as well as other articles). This will bring readers up to the level of understanding circuit diagrams and the operation of components. It will include a full **Library of Symbols** with links for each symbol. The **Basic Electronics Course** is based on the **Building Block** approach and as you become familiar with a range of "blocks," you will be able to combine them to create larger, more complex, circuits of your own design. Other areas to be covered in the first issues include **PIC microcontroller programming**. Microcontrollers are the heart of projects of the future. Projects requiring six, ten, or even fifteen discrete chips can now be designed around a microcontroller. These chips can be considered to be very similar to "blank chips," after you write a program and load it into the chip, the input/output pins will allow you take in information and output it to LEDs, displays, and motors, etc. You can configure the chip to perform almost any feature. The end result is a project you have designed yourself and with the code-protection feature of the chip, you will be able to market your product and prevent others from duplicating it. This is "down the track," but is one of the paths the e-magazine will be promoting. Also included in the first issues will be a number of very interesting projects designed around electroluminescent emission in the form of sheet and "tubing." Electroluminescence produces a glow suitable for background lighting of signs and displays and with the recently invented tubular "string" or "cable" you can produce miniature effects similar to neon. Electroluminescent material comes in all shapes and sizes and is available in more than ten colors. By combining your knowledge of electronics with EL materials, you can produce flashing, running, and dimming signs similar to the "Las Vegas Strip. Another feature of the e-magazine is the availability of a kit of parts for each project. Simply click the "**BUY ME**" button at the side of the article, and you will be taken to an order form. This is the first time ordering has been made so simple. No faxing, posting or long-distance phone calls—just a click and it's ordered! These are just some of the features offered by the Web, and no doubt you will see lots of other advantages, too. The Web is an ideal instructional medium as pages can be laid out very clearly with an almost unlimited potential for color, graphics, and animation. We have taken advantage of this in many ways and one feature is the "moving circuit" to show how a technical person "sees" it operating. After fixing more than 35,000 TV sets, the author of the **Basic Electronics Course** shows how he sees a circuit working and how he goes about locating a fault. This type of material has never been available before, and that's why this e-magazine is an entirely new concept. Another advantage of the Web is linking. Once you enter the address of the e-magazine in the address-line of your browser, all the remaining pages are just a click away. You can log onto **POPTRONICS Interactive Edition** today and see the content. Some of the pages and articles are viewable FREE while the content of the courses require a password. To obtain a password, you will need to subscribe. A subscription costs **\$19.95** for 12 issues. This allows unlimited viewing and downloading. Alternatively, you can take a two-issue trial subscription for **\$3.99**. The content of the site will increase with each issue; and many of the articles, tables and data sheets will be linked to keep information "at your finger-tips," so it's important to keep your subscription current as you will be constantly referring to the data. If you are already a subscriber to **POPTRONICS**, a special offer is available. Simply quote your **POPTRONICS SUBSCRIPTION NUMBER** (located on your subscription label) when subscribing and the cost is **\$9.99** for 12 issues. A two-issue trial subscription costs **\$1.99**. Go to: www.poptronics.com/interactive/intro.html and view the sample pages. **POPTRONICS** will, of course, remain in its printed format. The material and content of **POPTRONICS** and **POPTRONICS Interactive Edition** will be kept separate, and if you are into electronics, you will enjoy both versions.



YESTERDAY'S NEWS

A PEEK INTO THE GERNSBACK ARCHIVES



Dateline: October 1952 (50 years ago)

Hugo Gernsback talks about "Our Electronic Universe," in this month's **Radio Electronics**. He describes how "the heavens are the major producer of all electrons" and claims that the sun is a gigantic radio transmitter. Interesting, huh? Another highlight is the Eidophor Projector, a theater TV system that fills a 15-foot wide screen with a detailed, full-color picture—a breakthrough for the motion picture industry.

1900

1910

1930

1940

1952

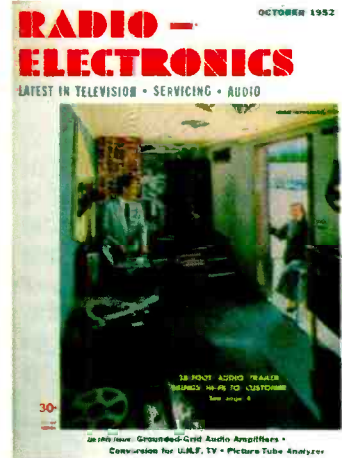

1960

Dateline: October 1972 (30 years ago)

Radio Electronics reveals that domestic satellites are now being considered for such entities as network television, cable TV systems, telephones, computers, and more. Also in this issue—electronic editing instruments are used for the first time by United Press International to report live news. New products include an electronic calculator to be assembled, an automatic turntable, and a background music system that uses a loading tape magazine.



1972

1980

Dateline: October 1992 (10 years ago)

Did you know that you can make a speaker out of flame? This issue of **Popular Electronics** shows you how to experiment with plasma acoustics. Also discussed is the classic experiment by Heinrich Hertz that proved Maxwell's theory of electromagnetic waves. Construction articles include building a baby monitor that will keep a constant watch on your little one, and a personal message recorder that lets you leave a message for a family member or co-worker without paper and pen.

1992

2000





The TriField Natural EM Meter

We put this meter—the pride of parapsychologists—to the test.

Seeing that it's Halloween season, we decided to take a close look at one of the most talked-about tools of the ghost-hunting trade—the *TriField Natural EM Meter* from AlphaLab, Inc. The verdict is in. Now, before you begin to moan, we didn't go poking around graveyards or haunted houses to test the meter; instead, we tested the meter using simple experiments that ranged from detecting the presence of magnetic material to measuring the trace outputs of various microwave ovens. The results proved that the TriField Natural EM Meter can be used as a legitimate tool, as well as employed in much more questionable "sciences."

What Does It Do?

The TriField Natural is an analog meter that can measure changes in magnetism (in a range of 0–100 microteslas) that are as little as .5% of the Earth's own magnetic field. It can also measure electricity as weak as 3 V/m (multiply the scale by ten to get volts/meter). Also, a SUM feature allows the user to measure changes in either electric or magnetic field at the same time. Finally, the last setting available on the meter is for measuring RF/microwave frequencies ranging from 100 kHz to 2.5 GHz (in mW/cm²). This setting is invaluable to signal "sniffers" and even for hams who want to check for the presence of RF.

The unit is powered by one 9-volt battery and weighs less than a can of soda pop. An audible alarm sounds when a change is detected, and this alarm can be adjusted for sensitivity.

How Did You Test It?

In order to test the various transducers onboard the TriField Natural, we used a powerful magnet from a 17-inch bass speaker, a cell phone, and a microwave oven. The first test was fun. We placed the speaker in a cardboard box and hid it

When the meter was within one foot, it was able to detect the fluctuation of both electric and RF energies. The meter seemed to be very sensitive to electricity. It was equally as successful at tracing power lines within the walls of our offices.

Finally, the meter was used to detect a leak from our community microwave oven. We are happy to say that there was no presence of microwaves within six feet of the oven. When the meter closed the gap to one foot the alarm became a high-pitched wail. Moral of that story is simple—DO NOT sit and stare at your food as it cooks in the microwave oven; otherwise, you might just cook a little more than your leftovers.

In Conclusion

Overall, the TriField Natural EM Meter proves its worth as a detection meter for electricity, magnetism, and RF/microwave. As far as its use as a ghost detector, we'll have to leave that up to you. Ironically though, debunkers have often dismissed ghost sightings as the effects of a strong presence of, you guessed it, electricity, magnetism, and RF.

One neat feature we did notice though, was the meter's capability to detect the minute electricity and magnetism given off by certain individuals. Some people indeed have a magnetic persona, as we found from the TriField Natural tests.

The meter sells for \$220 and is available from AlphaLab, Inc. Want to know more? Contact AlphaLab, Inc. at 808-874-9126, or write to AlphaLab, Inc., Attn: David—PT, 1280 South Third West, Salt Lake City, UT 84101-3049, or you can browse www.trifield.com. **P**

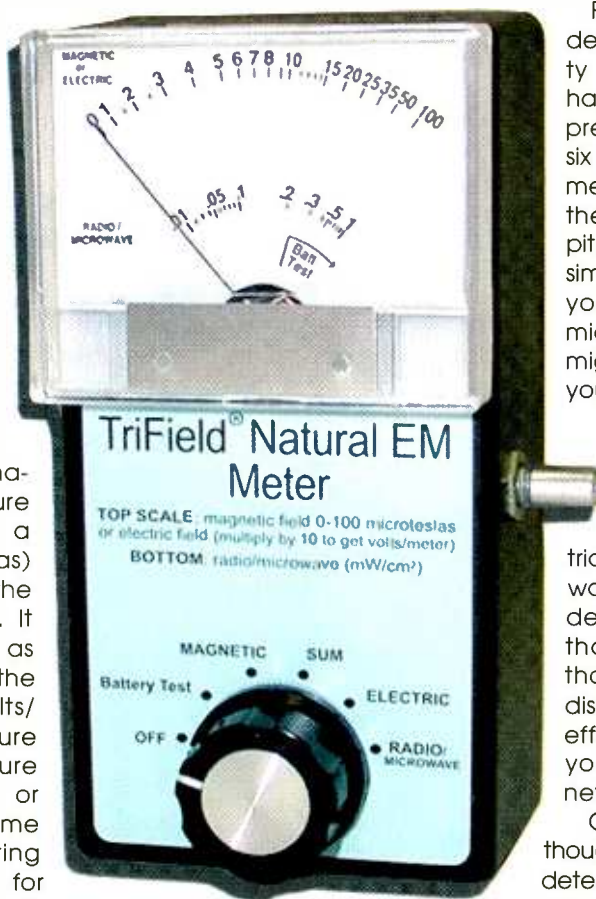

among a group of boxes containing paper goods. A volunteer was given the meter and sent to work. It only took ten minutes to find the box with the speaker magnet.

The second test involved the meter's ability to detect both electricity and RF/microwaves. While one person held the meter, another person dialed a cell phone and transmitted a call.

GIZMO®

For more information go to page 80A

or e-mail: requests@berkshire-is.com

Purely Flat

Designed with streamlined, silver-finish cabinets, the *Flat-Screen FST Pure 36-Inch Color TV* (\$2299) comes with double-baffle stereo side speakers and matching stands. Improved screen geometry and advanced tube design create high-quality imagery with less image distortion and glare, while the perfectly flat screen offers viewers the widest possible viewing angle from anywhere in the room. It also boasts digital video noise reduction, a cyclone subwoofer, and a control panel with hidden buttons.

Toshiba American Consumer Products, Inc., 82 Totowa Rd., Wayne, NJ 07470; 973-628-8000; www.toshiba.com.

CIRCLE 50 ON FREE INFORMATION CARD



Cinema-Style Sound

It may be worth your while to stay home and watch your favorite flick if you're hooked up to the *Mordant-Short Premiere System 300 Home Theater Speaker System* (\$999). The system consists of left and right front and rear satellite speakers, plus a center-channel speaker and 8-inch powered subwoofer. The speakers are also designed to blend seamlessly for an expansive, 360-degree soundfield.

Marantz America, Inc., 1100 Maplewood Drive, Itasca, IL, 60143; 630-741-0300; www.marantz.com.

CIRCLE 52 ON FREE INFORMATION CARD

Portable VeloCD Burner

Easy to connect and use, this "go anywhere" *Portable VeloCD Burner Model FP-241032* (\$199) is great for business travelers, telecommuters, students, and music enthusiasts who need a high-speed, ultra-reliable CD burner. Measuring 7- x 5.5- x 1.25-



inches, this compact model delivers the high-performance capabilities to match its breakthrough design, offering 24X write, 10X rewrite, and 32X read/rip speeds—fast enough to burn a CD-R in just four minutes. It also features FireWire/IEEE-1394 connectivity for use with both Windows and Mac OS-based laptops and computers.

TDK Electronics Corp., 901 Franklin Ave., Garden City, NY 11530; 516-535-2600; www.TDK.com.

CIRCLE 51 ON FREE INFORMATION CARD

Find It Fast!

Always misplacing your keys, glasses, and other personal belongings? The "*Now You Can Find It*" *Wireless RF Electronic Locator* (\$49.95) can help you find these lost items with its universal locator system. Just attach one of the four RF receiver beeper discs to any object you most often lose, lose it, and press the button on the system's portable radio-frequency transmitter base. When you get within 30 feet of the misplaced object, its attached disc will emit a loud series of beeps.

The *Sharper Image* (stores in 28 states and Washington, DC); P.O. Box 7031, San Francisco, CA 94120-9703; 800-344-4444; www.sharperimage.com.

CIRCLE 53 ON FREE INFORMATION CARD



Prime Cinema

Powerful and compact, this stylish *Grand Cinema HT200 Dual Mode DLP Projector* (\$8595) is fully compatible with a wide range of multimedia sources and is designed to complement almost any décor. Dual modes help optimize viewing preferences, and two selectable resolution modes—16:9 wide-screen standard with a resolution of 848 x 480 pixels and 4:3 format with a resolution of 800 x 600 pixels—offer high-quality, distortion-free images.

SIM2 Selec USA, 10108 USA Today Way, Miramar, FL, 33025; 954-442-2999; www.sim2selecousa.com.

CIRCLE 54 ON FREE INFORMATION CARD



Home Theater In A Box

Enhancing the experience of home theater, the *Home-Theater-In-A-Box Model HTB-805DV* (\$700) is equipped with "Cinema EQ" processing to improve the playback of music and movie soundtracks through small home-speaker systems. Featuring a five-disc DVD changer with MP3 audio playback, progressive scan output, main channel speakers based on a two-way twin woofer design, Dolby Digital, and more, the system yields high-fidelity audio in an easy-to-use package.

Kenwood USA Corp., P.O. Box 22745, Long Beach, CA, 90801; 800-536-9663; www.kenwood.usa.

CIRCLE 55 ON FREE INFORMATION CARD



The Singing Machine



Created for kids—and kids at heart—the *Nickelodeon 129 Home Karaoke Machine* (\$49.99) features characters and songs straight from Nick, like *Sponge Bob*, *Rugrats*, and *Rocket Power*. The portable system has a CD stereo, microphone, demo CD, and lyrics, and is cast in blue, yellow, and orange with a splash of famous Nick characters. It also has a built-in speaker system, AC/DC power operation, and microphone volume and echo controls.

The Singing Machine Company, Inc., 6601 Lyons Rd., Coconut Creek, FL, 33073; 954-596-1000; www.singingmachine.com.

CIRCLE 57 ON FREE INFORMATION CARD

Sound In Style

A perfect combination of functionality and style, these *Soundstage Speaker Stands* (\$109) can be mixed and matched to create 24 possibilities. Bases are available in black, silver, dark cherry, and light oak tones and can be paired with black or silver heavy-gauge aluminum risers. The matching feet have rubber tips for hardwood floors and optional isolation spikes for carpeted floors. The stands are easily assembled with only a screwdriver, and the speaker wires are run through the risers so they are hidden.

Vantage Point Products Corp., 10233 Palm Dr., Santa Fe Springs, CA 90670; 562-946-1718; www.vantagepoint.com.

CIRCLE 56 ON FREE INFORMATION CARD



Let The Music Be With You

You can listen to 1000 hours of music in your car or at home with the *Dension Music Player 3* (\$339). This hard-disk-based MP3 player is compatible with most PC mobile racks, has a WIN98/NT/WIN2000/ME/XP-compatible file system, a pre-configured and user-defined equaliser, and a large blue and white graphic LCD display. It also features an easy-to-use menu system and regular free software updates.

Dension USA, Inc., 3553 Atlantic Blvd., #318, Long Beach, CA, 90807; 562-595-5153; www.dension.com.

CIRCLE 58 ON FREE INFORMATION CARD



Outdoor Adventure

Ideal for hiking, camping, and boating, this *Night Owl Explorer* (\$299.95) has a sleek, Titanium-finished, two-piece body and a camera-quality 50mm objective lens.

The range of view is 575 feet, and the field of view is 628 feet at 1000 yards. Ergonomically placed operational buttons provide easy, single-handed operation.

The weather-resistant rubber-coated body makes it perfect for outdoor activity in any weather.

Scientifics, 60 Pearce Ave., Tonawanda, NY 14150; 800-728-6999 or 716-874-9091; www.scientificsonline.

CIRCLE 59 ON FREE INFORMATION CARD



CD-Writer

Enabling users to store data quickly and safely, the *CD-Writer Plus 935i* (\$49.99) is a versatile tool for sharing and backing up important files. The high-performance CD-RW drive delivers 32X read speed, 10X write speed, and 4X rewrite speed. It records up to 74 minutes of music files or 650 MB of data on a single CD in as little as eight minutes. The CD Writer Plus comes bundled with HP CD creation software, *HP MusicMatch Jukebox*, *CD Labeler*, and more.



Hewlett-Packard, www.hp.com.

Casual Carrying

This laid-back alternative to corporate laptop computer cases, the *Nylon Notebook Computer Backpack* (\$59.95) has a side pocket for a cell phone and front zip pocket with an accessory panel. It also has thick padding for maximum protection of your notebook computer and adjustable, ergonomic straps that form-fit to your shoulder for all-day comfort.



Case Logic, Inc, www.caselogic.com.

Multi-Talented Machine

Need a color Bubble Jet printer? A fax machine, copier, and a scanner? The *Canon Multipass F50* (\$399) is all of that and more. Compatible with either a PC or Mac, this multifunctional machine plugs into any parallel or USB port. Fast faxes—six seconds per page, photo-quality color printing, 600-dpi scanning capability, and special software tools are just some of its features. A free business Web site is an added bonus with purchase.



Canon USA, www.canon.com.

Hand To PC

Transform your handwritten notes into an electronic format with the *Inklink* (\$99.95), a pocket-sized digital tool that allows users to hand-write text and then convert and store it on their PC or PDA. Weighing only 4.75 ounces, it comes packaged in a sleek carrying case that contains an electronic ballpoint pen, data clip, and the IrDA receiver. Inklink's software lets you cut, copy, paste, e-mail, and store your data.

Seiko Instruments USA Inc, www.seikosmart.com.

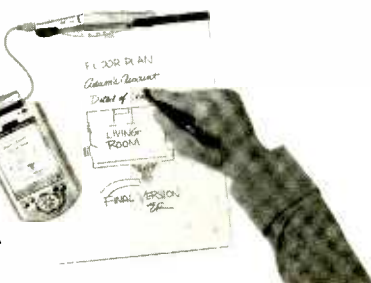

Optical Mouse

Now your mouse can be free! The *Cordless Optical Mouse* (\$49.95) offers cordless freedom and optical precision in a simple mouse that fits comfortably in either hand. Just about any surface can become your workplace, as there is no mouse pad required. It has a powerful optical sensor that's twice as fast and accurate as a standard mouse, three customizable buttons, a scroll wheel, and *WebWheel* software to enhance Internet surfing.



Logitech Inc., www.logitech.com.



Business Buzz

PROJECT RAINBOW

Word is around the radio tower that big names like Intel Corp, IBM, AT&T Wireless, Verizon Communications and Cingular are currently holding hands and talking nice as they plan a massive wireless-web network that will be based on the 802.11 standard. The talks have been code-named Project Rainbow and have been under way for a little less than one year. The service would be available at public venues such as airports, but no plans have been made to supply service to private residences. Planners hope that this network would provide high-speed broadband access to the growing numbers of handheld/portable computer users.

iPod GOES PC

At the recent MacWorld convention in Manhattan, Apple announced that by fall the iPod player would be compatible with PCs running on a Windows OS. The device—which retails from \$299 for a 2000-song model to \$499 for a 4000-song model—will soon be competing for market share against such notables as the Rio and the Nomad. The Apple iPod uses the popular/notorious MP3 format that has become somewhat of the standard format for audio exchange across the Web. Web surfers can visit www.apple.com/ipod for more information about the iPod.

SHUTTERBUGS GO WIRELESS

AT&T Wireless Services Inc. has become the first wireless operator in the U.S.A. to offer a digital-camera option with their phones. The Sony Ericsson T68i phone can be outfitted with a digital-camera accessory that uses the phone's screen as a view finder. This new service allows users to snap a digital photo with their phone and then send it via the wireless network to an e-mail address. The Sony Ericsson phone retails for \$199, while the camera attachment retails for \$129. Customers must subscribe both to an AT&T Wireless voice-calling plan and to the mMode mobile Web service.

Virtual Reality Helps Train Those Who Wear Hard Hats

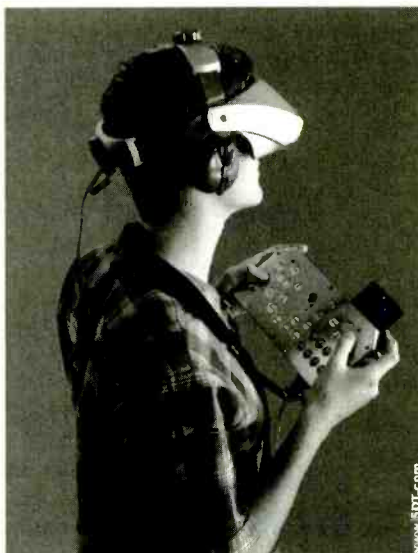

The trainee wears a head-mounted Virtual Reality display, while operating a piece of remotely controlled equipment.

The shovel operator trainee misses the dump truck and drops most of the load on the dump truck's roof. No harm done because the training was done in Virtual Reality (VR) using computers and Head-Mounted Displays (HMD) rather than actual, and expensive, equipment. Virtual reality simulators are now routinely used in training soldiers, sailors, and airmen to perform complex tasks like flying aircraft, driving tanks, and firing weapons. VR is also being used to train operators of surface- and underground-mining vehicles and other heavy equipment. Fifth Dimension Technologies (5DT) in Santa Clara, CA is applying its experience in developing simulators for military tasks to train any heavy equipment operator.

Virtual Advantage

While these simulators are relatively expensive to develop, mainly because of the high-quality graphics and animation need-

ed to make the users think they are in the real environment, they offer many advantages over training with real equipment. Virtual Reality is ideal for the training of operators who perform tasks that are dangerous or hazardous. Trainees can be exposed to life-threatening scenarios in a safe and controlled environment. It is also an ideal tool to train operators of expensive heavy equipment, which also normally have high earning potential. With VR simulation, it is not necessary to take the equipment away from productive work for training purposes, saving on fuel, electricity, and wear and tear. Of course, VR is the best, and often the only way, to train for dangerous or emergency situations.

Mining Reality

In this initial mining application, 5DT's technology involves developing and interconnecting a range of network-ready training simulators for surface-mining and underground-mining vehicles and systems. While the simulators can be used for individual training, they also can be interconnected via a computer network so several trainees can "work" in the same virtual mine. Operators of the different simulators can interact with each other in the same way that they would work together in a real mine. The value of interaction has been well proven with the Joint-Force training used by the military, where, for example, aircraft and land vehicle simulators are networked to work together. Like the Joint-Force experience, Integrated Virtual Mine (IVM) can result in better teamwork and big picture thinking amongst operators because of the added realism.

5DT has already built a Continuous Miner (CM) VR training simulator for its VR Coal system that enables operators to control a CM in a virtual underground coal or potash mine. Using a

TYPE

HMD and a remote-control unit, the trainee controls the CM in the virtual mine with controls that closely resemble those of a real CM. The HMD features two miniature computer screens to view the virtual coal mine, CM, and a shuttle car. The operator can work through a series of training scenarios that vary in complexity from simple tasks to very complex and difficult ones.

Headphones in the HMD let the operator hear the different sounds in the virtual environment—for example, coal spilling from an overfilled shuttle car. A head tracker measures the orientation of the operator's head so a computer can calculate the image that the operator would view in a real mine. This image is then displayed on the miniature screens in the HMD, with the computer calculating a new image about 30 times per second.

Mining For Coal

The VR Coal system (co-developed by 5DT and Sasol Coal in South Africa, as well as the newest version with BHP Billiton, San Juan Mine) can be used to train new operators or to evaluate and re-train existing operators. This system consists of an instructor and operator computer-networked together. When an event occurs, or if the operator does something wrong, event messages and/or error messages are superimposed on the instructor's view. The messages are not visible to the operator; however, at the end of each training session, both the trainee and instructor receive a com-



Here is a cockpit view from a heavy piece of equipment.

plete training report.

The more ambitious 5DT IVM Initiative, planned for completion by the time of publication, incorporates several interconnect-able simulators. Several Surface Mining Training Simulators are now up and running with fine tuning proceeding. The range of network-ready training simulators for surface mining includes (1) Haul Truck Training Simulator, (2) Electric Shovel Training Simulator, (3) Hydraulic Shovel Training Simulator, and (4) Dragline Training Simulator. Simulators for tracked and wheeled dozers and drilling rigs will follow shortly.—**Bill Siuru** **PT**

As a special treat to readers, below are a few words from Roger Griswold over at Maxim Integrated Products Inc. He has recently been experimenting with basic surface-mount constructing techniques and he'd like to share his results with the rest of you garage-based developers. And so, with no further delay...—Editor



This is a virtual cockpit view as a haul truck drives towards a shovel for loading.

Prototyping with Surface-Mount Devices

Many engineers and technicians are used to, and comfortable with, prototyping electrical circuits using through-hole devices. Commonly available perforated fiberglass board and IC sockets can be used with wire-wrap or point-to-point wiring to successfully

Research Notes

DICK TRACY TECH

It looks as if wrist TVs are just around the corner if companies like Cambridge Display Technology (CDT) of the UK continue their course. According to researchers at CDT, recent experiments with Light Emitting Polymers (LEPs) have proven successful in creating super-thin video screens. This research stems from the discovery of p-phenylenevinylene back in 1989. This LEP emitted a green-yellow glow when a voltage was applied. After some mixing and experimenting, scientists were able to develop a LEP that also produced red and blue, allowing for full color resolution. Already applications, such as roll-up battlefield maps and portable battery chargers, are being dreamt-up for this budding technology.

GIANT OWL FOR OUTER SPACE

Researchers and engineers are hard at work at the European Southern Observatory (ESO) in Garching, Germany, as they prepare to embark on a seventeen-year task. Their goal is to build the world's largest ground-based telescope, dubbed the OWL. The name OWL is both a tribute to the keen-eyed night prowler and a short-form of "Overwhelmingly Large." The telescope's aperture will be a massive 100-meters and will be constructed of separate segments allowing for a deformable mirror structure for resolution adjustments. A technology known as Adaptive Optics will be employed in order to overcome our atmosphere's blurring effect.

MARS PLANE GROUNDED

Picture the scene: It's December 17, 2003—the 100th anniversary of Wilbur and Orville Wright's Kitty Hawk flight—and soaring through the skies of Mars is a flying-wing aircraft from planet Earth. Well, too bad. It seems as if NASA will not be funding the estimated \$100 million Mars plane for a proposed 2002 launch aboard a French rocket. The flight was to be part of the new Mars Micromission program, but apparently NASA will be diverting funds to replace a Mars communications satellite instead. The "Administration" has rescheduled the flight for 2005.

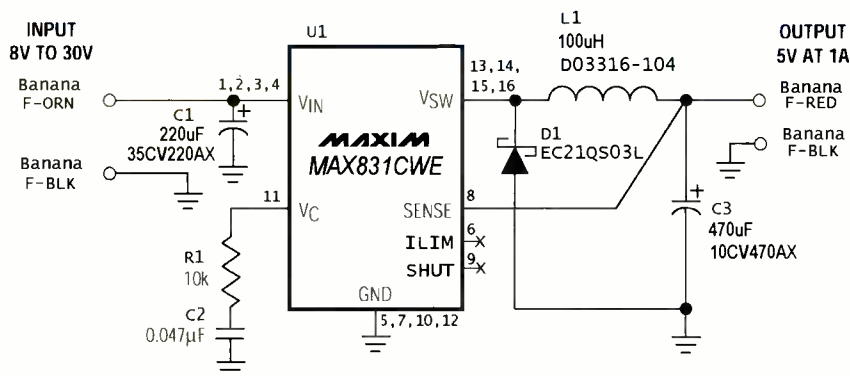

Fig. 1. This DC-DC converter circuit is used to illustrate SMT prototyping techniques.

build most one-of-a-kind or prototype circuits. In the last decade, however, Surface-Mount Technology (SMT) has become much more prevalent. In fact, many newer ICs are available only in surface-mount packaging. Prototyping with surface-mount devices requires different materials and tools than prototyping with through-hole devices, yet in some ways it is easier once the proper skills have been developed.

The basic idea is to cut narrow slots in a copper-clad board, creating rectangular pads, and place the components across the slots. Each rectangular pad is a node in the circuit. It requires copper-clad board and a roto-type hand-held grinding tool, plus a few other basic tools. This technique is readily used for ICs with a lead pitch down to 0.05 inches (1.27 mm) and, with practice, can be used down to 0.025 inches (0.64 mm). It works well for SOICs and virtually all passive SMT components. To illustrate this technique, I built the circuit of Fig. 1, a 5-W DC-DC step-down voltage converter.

Start with a fully annotated schematic and gather the parts, so you have a good idea of their relative sizes. It is also helpful to have the pin-configuration drawings for any ICs in the circuit. Use blank paper and two pencils of different colors (I use a green pencil and a regular pencil) to make a rough drawing of the physical circuit layout. An eraser is essential, and quite often a few iterations are required. Make the drawing larger than life, but stay more-or-less true to scale (you don't need to be very picky with size, just placement). Use the lighter color to draw the component outlines, placing parts that share a node close together where practical.

Once all the part outlines are drawn, use the darker color to draw lines separating the different nodes of the circuit (Fig. 2). A typical line will go around a few IC pads, "through" a resistor, and back around (the resistor will straddle the line). The lines represent where cuts to the copper-clad will be made. If only straight lines and 90° turns are used, it makes the cutting easier.

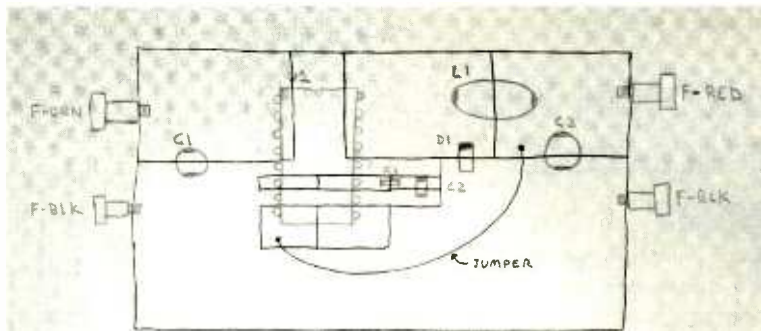

Fig. 2. Here is the layout drawing for the SMT prototype of the circuit in Fig. 1, showing the component outlines and the node outlines. Note that the components bridge the node outlines.



Fig. 3. This is an example of a roto-tool bit useful for cutting slots into copper-clad board. Shown is the Dremel bit #194.

Note that in the circuit implemented here one jumper wire is used, connecting U1-8 to the output node. The connection could be cut into the copper-clad, but doing so would either interrupt the ground plane or force the trace to run under the IC, neither being desirable. On a multi-layer circuit board, the trace would likely be placed on a different layer.

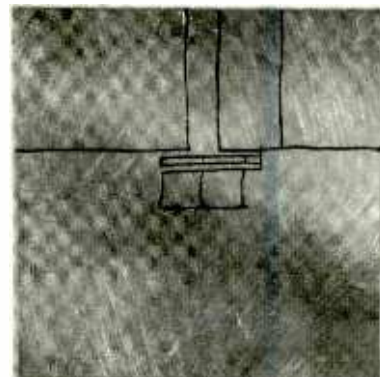

Fig. 4. The cut circuit board, made using copper-clad and a roto-tool, realizes the layout drawing of Fig. 2.

To transfer the layout to the copper-clad board, set the board on a flat surface and place the components on it, using the drawing as a guide. With an awl or other sharp object, bore a small dot into the copper-clad at points corresponding to the end of each dark line segment in the drawing. This takes some practice because all those little parts tend to bounce around. After all the dots are in place, scribe lines into the copper-clad, connecting the dots as indicated by the drawing.

Now, cut the slots into the board. Use a roto-tool with a small, flat tip bit (a Dremel bit #194 works well, see Fig. 3)

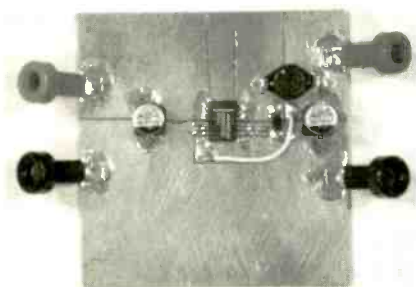

Fig. 5: Above is the finished SMT prototype circuit board, a working version of the Fig. 1 schematic.

to cut slots into the copper-clad along the scribed lines. This, too, takes a little practice. After all the slots are finished, go over them with a utility knife to cut away any pesky little shorts, double-checking the corners where burrs are usually the worst. A once-over with some Scotch-Brite adds a nice finishing touch. Wash and dry the board, and then use an ohmmeter to verify that no pad is shorted to any of its neighbors. Now, all that's left is to install the components and test the circuit. Figure 4 shows a photo of the slotted board, and Fig. 5 shows the finished product.

One of the nice features of this technique is the natural ground plane that usually emerges. If you are combining SMT and through-hole technology, through-hole devices can be easily adapted to mount on copper-clad by splaying their legs and soldering them down. Prototyping with SMT is not difficult, and with a little practice many prefer it to wire-wrap or point-to-point wiring.—Roger Griswold of Maxim Integrated Products Inc. PT



Frustration? No, thanks. Fun? Yes, please.



Satisfied customers - the key to our success

- ▶ that's why every new EAGLE version is based on the feedback from our customers
- ▶ that's why all our customers have access to our highly acclaimed, comprehensive support, free of charge
- ▶ that's why EAGLE has no hidden costs for libraries or modules which prove to be indispensable after purchasing
- ▶ that's why we really want customers to enjoy working with EAGLE
- ▶ that's why EAGLE is one of the top-rated programs for schematic capture and board layout

EAGLE 4.0

Schematic Capture • Board Layout
Autorouter



for Windows®



Windows is a registered trademark of Microsoft Corporation. Linux is a registered trademark of Linus Torvalds.

- Version 4.0 High lights**
- New Library Management with Component Browser
 - Technology and Package variants for components
 - Design your own commands via User Language
 - Unlimited length for component names/values
 - Design Rules define pad/via dimensions and shapes
 - Net Classes for Autorouter and DRC
 - Minimum Autorouter grid: 0.02 mm
 - SMD pads can be rounded or round
 - Different pad shapes for Top, Bottom, or Inner layers

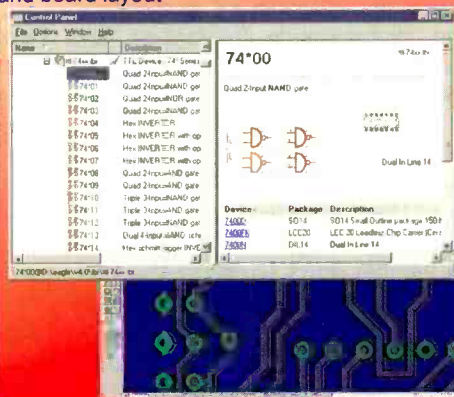

EAGLE 4.0 Light is Freeware!

You can use EAGLE Light for testing and for non-commercial applications without charge. The Freeware Version is restricted to boards up to half Eurocard format, with a maximum of two signal layers and one schematic sheet. All other features correspond to those of the Professional Version. Download it from our Internet Site or order our free CD.

The Standard Version is suitable for boards in Eurocard format with up to 4 signal layers. The Professional Version has no such limitations.

<http://www.CadSoftUSA.com>

800-858-8355

CadSoft Computer, Inc., 801 S. Federal Highway, Delray Beach, FL 33483
Hotline (561) 274-8355, Fax (561) 274-8218, E-Mail: Info@cadsoftusa.com

Prices	Light	Standard	Professional
Layout		199\$	399\$
Layout - Schematic		398\$	798\$
Layout - Autorouter		398\$	798\$
Layout - Schematic + Autorouter	49\$	597\$	1197\$

Pay the difference for Upgrades.

CIRCLE 283 ON FREE INFORMATION CARD

MAY THE SOURCE BE WITH YOU

Don't let the dark forces of ignorance defeat you. Right in this galaxy you can tap into the source—the free Consumer Information Catalog. It lists free and low-cost federal publications on a variety of important topics.

So dispel the darkness and get the source. Call toll-free 1-888-8 PUEBLO for your free Catalog. Or set your coordinates for the Consumer Information Center Web site:

www.pueblo.gsa.gov

Optical Computing: The Wave Of The Future

Just think about this for a second (no pun intended!). We think of everyday time in seconds. Some sports are timed in tenths and hundredths of seconds. In the past, computers have worked in milliseconds (thousandths), then microseconds (millionths), and are now moving on to nanoseconds (billionths). Still it just isn't fast enough for our ever-changing needs.

Present-day computers are lacking in efficiency due to their natural limitations. They just aren't fast enough to keep up with the demands of the modern Internet world. Currently, the information in a computer is passed through copper wires. In an optical computer, information would pass through light beams—at the speed of light, which is 186,000 miles per second. That's pretty fast. (See Table 1 for a comparison of electronic and optical

computers.)

Ultimately, optical desktop computers will be extremely fast, compact, lightweight, and less expensive. They would be able to process information 1000 to 100,000 times faster. They would have optimum optical storage and could cruise the Internet—at the speed of light. Though this would have a profound effect on critical aspects of life such as aerospace and defense, it would most definitely affect business as well as personal life in a positive way.

Computers that are completely optical are still lingering in the not-so-far future, and it may take 10 to 15 years for them to appear on the consumer market. The problem is that the materials used in optical technology require way too much power to work in mass-produced products. Finding the right materials may take a little more time.

Let's face it, though. Electronic computers have really improved on the computing end—but optical computers "leave them in the dust" at transmitting information.

Still ahead are quantum computers, a somewhat hypothetical concept though a promising one. Those computers are based on the laws of quantum physics, and there's still much research to be done before we reach that milestone.

THE EFFICIENCY OF OPTICAL COMPUTERS

To understand the efficiency of optical computers, it may be helpful to first look at the "inefficiency" of electronic computers. Manjari Mehta of Information Systems Research Center (ISRC) at the University of Houston explains it best through the following comparison.

"Take, for example, e-mail. Today a message is first converted from electronic to photonic form and then transmitted over fiber-optic cables. The light signal at the other end must then be converted back into electronic form for processing by the receiving computer. These conversions are inefficient and limit the instantaneous nature of computing. If we can find ways of storing the optical message in photonic format and then processing those light encoded signals, there would be no need to convert from electronic to photonic form. In simplified terms, this describes an optical computer—performing computations, operating, storing, and transmitting data—using only light."

For many of us, it seems bizarre at first to imagine data traveling along a beam of light, or a laser. However, scientists conclude that optics have many advantages over electrons. Optics are:

- Immune to electromagnetic interference
- Free from short electrical circuits
- Able to have low-loss transmission
- Able to provide large bandwidth



Dr. Hossin Abdeldayem of NASA is working with lasers as part of an optical system for pattern recognition. (Photo courtesy of NASA.)

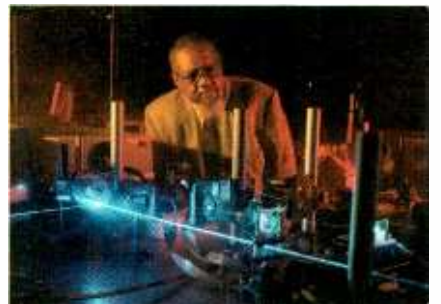

NASA researcher Dr. Donald Frazier uses an ultraviolet blue laser shining through a quartz window into a special mix of chemicals to generate a polymer film on the inside quartz surface. (Photo courtesy of NASA.)

**TABLE 1
COMPARISON OF COMPUTER CAPABILITY**

PRESENT COMPUTERS	OPTICAL COMPUTERS
Uses electronic circuits for computations and transfer of data	Uses Photonic circuits
Uses silicon chips	Uses organic compounds like metal-free phthalocyanine compound, polydiacetylene
Chance of short circuits	No short circuits, as light beams can cross each other without interfering with each other's data
With electronic circuits, information has to travel sequentially, or one packet at a time.	Light beams can travel in parallel; therefore, they can transfer data in parallel; and there is no limit to the amount of data.
There is a physical limit to the distance between components of a computer, which in turn limits the processing speed.	Though there is a physical limit, the design of the optical memory storage is conducive to reusing space.
The speed of electrons in copper wire is literally half the speed of light in a vacuum.	The speed of light in photonic circuits is the speed of light in a vacuum—the highest attainable speed.
Since circuits react to noise level, data can be misinterpreted.	Circuits are immune to noise level, so data is more accurate.
There is more heat dissipation in silicon circuits.	Since optical circuits use different compounds, they do not dissipate as much heat as silicon chips.
Silicon chips use very little power, the materials are readily available, and almost perfectly designed.	The materials required to support photonic circuits take up way too much power to work in consumer products. More research needs to be done.

(Table 1 is derived from material from Manjari Mehta, ISRC.)

(capable of communicating several channels in parallel without interference)

- Capable of propagating signals within the same or adjacent fibers with no interference
- Compact, lightweight, and inexpensive to manufacture

TECHNICALLY SPEAKING

So why do we need computers to be so darn fast? According to Dr. Hossin Abdeldayem from NASA, Terabit speeds, or one trillion bits, are needed to accommodate the growth rate of the Internet and increasing demand for bandwidth-intensive data streams.

"All-optical switching using optical materials can relieve the escalating problem of bandwidth limitations imposed by electronics," states Dr. Abdeldayem. "In 1998, Lucent Tech-

nologies introduced a lithographic sub-micron technology to further minimize electronic circuits and enhance computer speed. Additional miniaturization of electronic components only provides a short-term solution to the problem. There are also physical problems accompanied by miniaturization that might affect the computer's reliability."

One of the most amazing features of optical computing is that optical data processing can perform several operations simultaneously, which will result in phenomenal computational power and speed. As an example, a calculation that would take a conventional electronic computer more than eleven years to complete could be performed by an optical computer in a single hour. That is absolutely mind-boggling, and one can just imagine the unlimited potential it holds for everything!

THE PAST, PRESENT, AND FUTURE

"Entirely optical computers are still some time in the future," says Dr. Donald Frazier at NASA, "but electro-optical hybrids have been possible since 1978." Back in the 80s, there was much research in optical computing. However, due to limitations on needed materials—materials that were essential to making opto-chips small and inexpensive enough—the researchers backed off a little.

Now, in the new millennium, they are back with a vengeance. Mehta explains "Researchers are using new types of conducting polymers to make transistor-like switches smaller and 1000 times faster than silicon transistors. Previously it was thought that light could not be trapped long enough

(Continued on page 16)

The Net: A MEGA RESOURCE

The Web is a gargantuan repository of information. Google, the popular Internet search tool, indexes a whopping three billion Web documents. You might think that the Web contains everything you could possibly need to know.

Not so. Professional researchers know well that good research involves more than just searching the Web. More than two-thirds of the publications used most often by knowledge workers either don't have Web sites or don't make their material available on the Web for free, according to a study by Outsell—a market research firm that focuses on the information industry.

COMMERCIAL DATABASES

The Web can also be a source of information that's biased, outdated, or inaccurate. It often makes sense to start with the free Web when searching for information. However, when the information you need is for critical business or academic purposes, it's smart to then go beyond the Web. Libraries are traditionally sources of information, and they still serve that function well. One resource used by librarians and professional researchers alike is the commercial research database.

There are countless scenarios for using a commercial research database, but three common ones are looking for information about a possible business partner, doing market research on the potential customers and existing competitors for a new product or service, and searching for Ph.D. dissertations.

These days, you can access commercial research databases yourself, though you may not always want to. In the past, the world of commercial research databases was a forbidding one, where information was difficult to

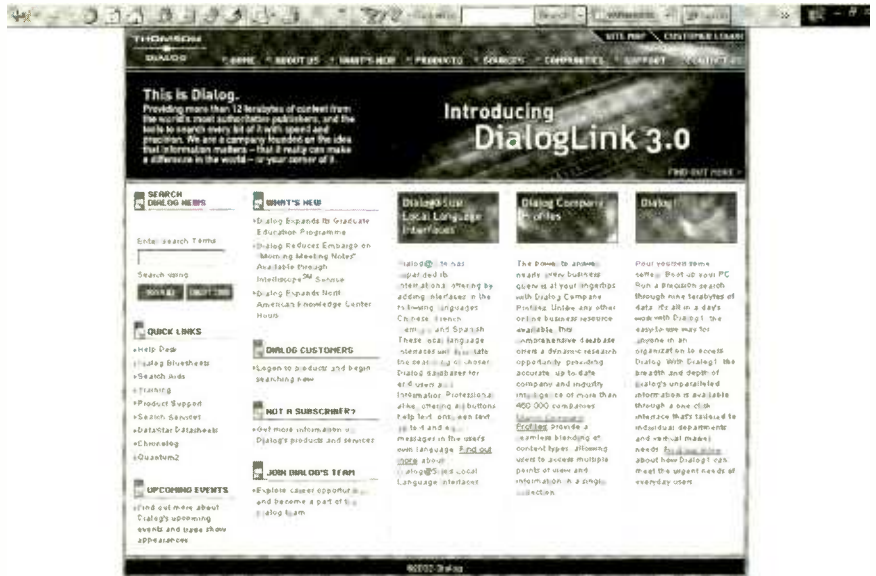

Dialog, created in 1972, is the oldest example of an information aggregator that is used by researchers to search through numerous sources of data ranging from technical and scientific to intellectual-property material.

get and expensive once you got it. This situation has changed somewhat in recent years, with the big three commercial research databases offering easier-to-use Web interfaces and lower-priced options.

THE TOP THREE

Dialog, LexisNexis, and Factiva are more accurately referred to as information aggregators. They gather information from hundreds of third-party databases and let you quickly search through any or all of them using the same search procedures. Each service has its strengths, according to Cindy Shamel, president-elect of the Association of Independent Information Professionals. She runs her own research company, Shamel Information Services, in San Diego.

Dialog, at www.dialog.com, is the

oldest of the three, created in 1972 as the world's first online information retrieval system. It has traditionally been strong on scientific, technical, and intellectual-property material; and it's still that way. Now, it's also excellent with general and business news.

LexisNexis, at www.lexis-nexis.com, is a combination of Lexis (the premier source of in-depth legal and regulatory information and public records) and Nexis (a good site for general and business news, market research, and company information).

Factiva, at www.factiva.com, is a joint venture of Dow Jones and Reuters. The place to go for breaking business news and global content, it combines the full text of the *Wall Street Journal* with the Dow Jones and Reuters newswires. For information about worldwide business and interna-

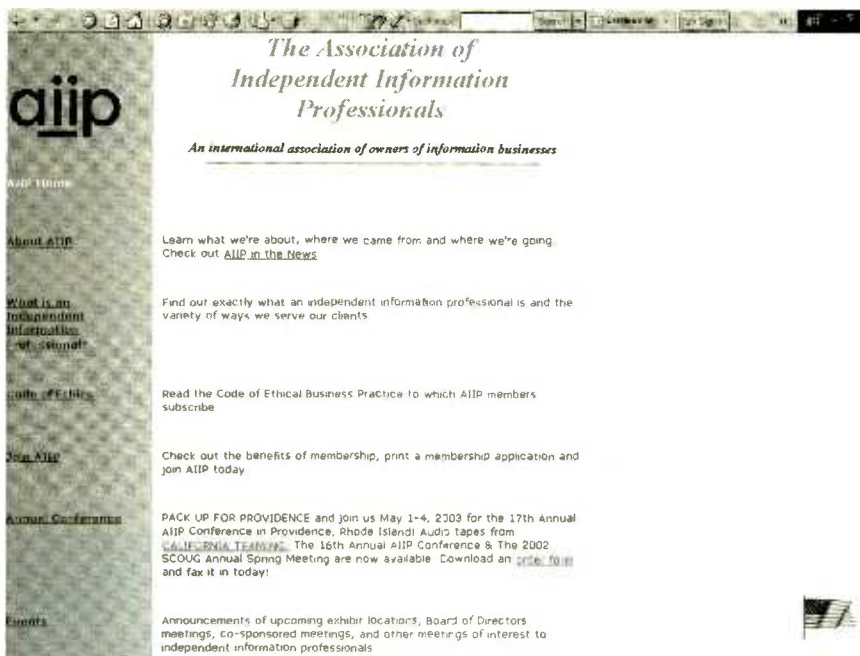

The Association of Independent Information Professionals (AIIIP) maintains a Web site where visitors can search for researchers by services, subject matter, and geographic area.

tional affairs, it provides material from nearly a thousand non-English sources in 118 countries and 22 languages.

Each of the big three database aggregators has material that the others don't have. The best strategy for any given project might be to select the appropriate one(s) to search through.

Each service has different pricing options for individuals, small businesses, large businesses, and information professionals. For individuals and small businesses, a pay-as-you-go plan makes the most sense.

You don't pay a subscription fee, but instead pay only for those articles or records you download. Searching through the databases and viewing headlines are both free. Each article or record you read in its entirety costs around \$3, though fees can vary widely. I've found these services very useful, but if you get carried away, costs can escalate.

HELP FROM THE PROS

Shamel mentions that the possibility of an expensive search is one reason to hire a professional researcher to do the searching for you. "You need experience to do cost-effective searching," she says. Professional researchers also typically bypass the Web and dial into these database services directly, which gives them more advanced searching options.

Others reasons to hire a profession-

al researcher are not wanting to do it yourself and/or not having the time. "You can find yourself spending so much time searching for information that you don't have enough time to run your business," says Penny Leidtke-Sienkiewicz, principal of the Philadelphia-based research company On-Target Information Services.

The Web site of the Association of Independent Information Professionals, at www.aikip.org, lets you search for researchers by services, subject matter, and geographic area.

For more on online researching, check out David Novak's Information Research FAQ, at spireproject.com/faq.htm.

MAKING MONEY ON THE WEB

Not only is the Internet a source of information, but it can also be a wealth of—well, wealth. Until the middle of 2000, the Internet economy was flying high—elevating with it the larger economy, not to mention the stock market and the portfolios of millions of investors. Then it all caved in.

During the first quarter of 2001, in the middle of the implosion, 164 Internet companies declared bankruptcy or shut down completely, a drastic increase from the five that did so during the first quarter of 2000, according to Webmergers, Inc., a market research company in San Francisco. Things have improved lately, though

the shakeout continues, with 54 dot-coms failing during the first quarter of this year.

What's a Net entrepreneur to do? Can you still make a profitable go of it in today's leaner-and-meaner dot-com world? Yes, you can, according to Jim Romeo, author of the new book *Net Know How: Surviving the Bloodbath—Straight Talk from 25 Internet Entrepreneurs*. You just have to think differently, and more traditionally, than many of the still wet-behind-the-ears digerati who created the dot-com bubble.

SOME HELPFUL ADVICE

From talking to and writing about these 25 dot-com entrepreneurs, Romeo in a phone interview offered five pieces of advice.

1. Strive for profit, not just market share. In the dot-com heyday, Net entrepreneurs priced their goods or services below cost to gain market share, create a buzz, and attract venture funding. Many achieved wildly successful initial public offerings. Scores of millionaires were born virtually overnight.

The whole digitalada came crashing down when investors demanded that Internet companies justify their sky-high valuations with hard earnings.

"Dot-com entrepreneurs today should go back to basics," says Romeo. "The new economy is a misnomer. It's just the old economy with a different look. You need to follow the same principles that created the industrial revolution and built the wealth of nations."

2. Minimize your expenses. It was the failure to do this that was the biggest culprit in the dot-com collapse, the author maintains. In the old days—two or three years ago—many Net entrepreneurs started off by hiring lots of people before they even had any market share. Lavish salaries and funky perks such as Friday afternoon pool parties were common.

Today, he believes, you better watch your cost of operation. Expenses should follow revenue, not vice versa. Don't spend on head count and overhead and hope you can make enough money to cover your costs. Romeo argues "This is a recipe for bankruptcy."

3. Be realistic about funding. You 15

used to be able to attract funding from venture capitalists by doing little more than writing a gushy business plan and including the word "Internet" in it.

"There's still venture funding out there for dot-coms, but it's tight," says Romeo. "These days funding is usually given for ventures already up and running with proven track records."

To fund a new dot-com today, you have to either do it yourself or find "angel" investors—family members or friends or, perhaps, local business people or philanthropists you know who are willing to bet the farm or part of it on your ideas.

4. Don't expect overnight success. In the dot-com go-go days, the watchword was instant gratification. Too many people had too little patience for the grunt work necessary for long-term success.

You need to create a realistic business plan today, he explains, and monitor it over time. Give yourself enough time to achieve success. Expect to pay dues.

You also need to do market research. You can't assume that if you build it, they will come. One reason many dot-coms failed is that people did not come.

5. Think twice about relying solely on the Web. "Pure-play" Web businesses—based strictly on the Web—have a smaller chance of success than those backed by a "brick and mortar" physical presence. Most Web successes have other sources of profit, according to the author.

POINT AND CLICK

Association of Independent Information Professionals
www.aiip.org

David Novak's Information Research FAQ
<http://spireproject.com/faq.htm>

Dialog
www.dialog.com

Factiva
www.factiva.com

LexisNexis
www.lexis-nexis.com

Despite the economies created by the Internet, many people still like to see and pick up what they buy or shake the hands of those they're making deals with. "It's a matter of trust."

Romeo believes that because of the trust issue, it can be easier to make a success of a business-to-business Web venture than a business-to-consumer Web venture.

For more advice on making money on the Web, from those who have been there and done that, check out Romeo's book. It's available on Amazon.com, which incidentally is a pure-play Web business founded in 1995 that, despite consistently stellar reviews and billions of dollars in sales, recently reported its first profitable quarter.

Reid Goldsborough is a syndicated columnist and author of the book *Straight Talk About the Information Superhighway*. He can be reached at reidgold@netaxs.com or www.netaxs.com/~reidgold/column.

COMPUTER BITS

(continued from page 13)

to be stored. Now researchers ...have shown that photons can be stored."

The competition is fierce, however.

OPTICS AT NASA

NASA reports that photonics development is booming around the globe in the areas of optics and optical components for computing and other applications. Estimates of global technology sales are upwards of \$100 billion per year worldwide—and counting.

Dr. Frazier states "Newer advances have produced a variety of thin films and optical fibers that make optical interconnections and devices practical. We are focusing on thin films made of organic molecules, which are more sensitive to light than inorganics. Organics can perform functions such as switching, signal processing, and frequency doubling, using less power than inorganics. Inorganics such as silicon used with organic materials let us use both photons and electrons in current hybrid systems, which will eventually lead to all-optical computer systems."

Countries like Japan and Switzerland are currently developing new methods and making technological advances in the field. Only time will tell when and where the first such computers will be on the market.

Electronic Projects 1.0

By Max Horsey

A series of ten projects to build along with audiovisual information to support hobbyists during construction. Each project is complete with schematic diagrams, circuit and PCB layout files, component lists and comprehensive text to guide the hobbyist through the project. A shareware version of CAD-PACK—schematic capture and PCB design software is also provided. Projects include a reaction timer, logic probe, egg timer and seven more. Get your own copy of this CD-ROM today.

\$75 including shipping in the U.S.
Order from CLAGGK Inc., P.O. Box 12162, Hauppauge, NY 11788. Visa, MC, Discover, OK.



CLX2

Yours for only \$3.99

Price includes shipping!



HAVE A THOUSAND YUCKS FOR ONLY THREE AND A HALF BUCKS! That comes to one-third of a cent per laugh. Electronics Comics is a compilation of over 125 riotous, outrageous and phenomenal cartoons that appeared in **Popular Electronics** and **Electronics Now**. Only **\$3.99**—price includes shipping. **Claggk, Inc., Reprint Bookstore, P.O. Box 12162, Hauppauge, NY 11788.** All payments in U.S. funds. Sorry, no orders outside U.S.A. and Canada. Check or money order only—send no cash. NY state residents add applicable tax. MA04

Wireless & Electrical Cyclopedia



ETT1—Wireless & Electrical Cyclopedia \$4.99. Step back to the 1920's with this reprinted catalog from the Electro Importing Company. Antiquity displayed on every page with items priced as low as 3 cents. Product descriptions include: Radio components, kits, motors and dynamos, Leyden jars, hot-wire meters, carbon mikes and more. The perfect gift for a radio antique collector. To order ETT1, send **\$6.99 (includes s&h)** in the US and Canada to **Electronic Technology Today Inc., P.O. Box 240, Massapequa Park, NY 11762-0240.** US funds only. Use US bank check or International Money Order. Allow 6-8 weeks for delivery. MA11

Season's Greetings

Plug a Friend into

Poptronics[®]

*and Save \$44.89**

*This holiday season you can give an electrifying gift ... plug a friend into **Poptronics**[®] and brighten the whole new year! Whether electronics is your friend's livelihood or hobby, your gift will illuminate the whole spectrum of electronics throughout the coming year and provide a monthly reminder of your friendship.*

Poptronics[®] Magazine will keep your friend informed and up-to-date with new ideas and innovations in all areas of electronics technology ... computers, video, radio, stereo, solid-state devices, satellite TV, medical electronics, communications, robotics, and much, much more.

Poptronics[®] combines the best attributes of *Electronics Now* and *Popular Electronics*. It is the magazine for the hands-on electronics activist. We will be presenting articles on just about everything electronic—from satellite TV equipment to DVDs, gadgets and gizmos to energize your life, audio amplifiers, professional service features, PC-related projects, and much, much more.

PLUS: A selection of computer-oriented columns that explore the digital realm from the inner workings of a PC to the latest the Web has to offer. On the electronics side, there is something for everyone—from the beginner (Basic Circuitry and Q&A) to the expert. Whether your interest is fixing equipment (Service Clinic), tinkering with robots (Robotics Workshop),

or adventuring to the farthest reaches of electronics and science (Amazing Science)—**Poptronics**[®] takes you there.

SAVE \$44.89* ... OR EVEN \$89.78* ... For each gift of **Poptronics**[®] you give this holiday season, you save a full \$44.89* off the newsstand price. And as a gift donor, you're entitled to start or extend your own subscription at the same Special Holiday Gift Rate—you save an additional \$44.89*!

No need to send money ... if you prefer, we'll hold the bill till January, 2003. But you must rush the attached Gift Certificate to us to allow time to process your order and send a handsome gift announcement card, signed with your name, in time for the holidays.

So do it now ... take just a moment to fill in the names of a friend or two and mail the Gift Certificate to us in its attached, postage-paid reply envelope. That's all it takes to plug your friends into a whole year of exciting projects and new ideas in **Poptronics**[®]!

*Newsstand price—8 issues @ \$4.99 each
4 issues @ \$5.99 each

RETAILERS THAT SELL OUR MAGAZINE EVERY MONTH

ARIZONA

Elliott Elec. Supply
1251 S. Tyndell Ave.
Tucson, AZ 85713

CALIFORNIA

All Electronics
14928 Oxnard Street
Van Nuys, CA 91411

California Electronics
221 N. Johnson Ave.
El Cajon, CA 92022

Electronics Plus, Inc.
823 4th St.
San Rafael, CA 94901

Electronics Warehouse
2691 Main Street
Riverside, CA 92501

Ford Electronics
8431 Commonwealth Ave
Buena Park, CA 90621

HSC Electronics
5681 Redwood Drive
Rohnert, CA 94928

HSC Electronics
4837 Amber Lane
Sacramento, CA 95841

Halted Specialties Co.
3500 Ryder Street
Santa Clara, CA 95051

Kandarian Electronics
1101 19th Street
Bakersfield, CA 93301

Mar Vac Electronics
2001 Harbor Blvd.
Costa Mesa, CA 92627

Mar Vac Electronics
1759 E. Colorado Blvd.
Pasadena, CA 91106

Mar Vac Electronics
4747 Holt Blvd.
Montclair, CA 91763

Mar Vac Electronics
5184 Hollister Blvd.
Santa Barbara, CA 93111

Mar Vac Electronics
2537 Del Paso Blvd.
Sacramento, CA 95815

Mar Vac Electronics
2000 Outlet Center Dr. #150
Oxnard, CA 93030

Mar Vac Electronics
12453 Washington Blvd.
Los Angeles, CA 90066

Metro Electronics
1831 J Street
Sacramento, CA 95814

Orvac Electronics
1645 E Orangethorpe Ave.
Fullerton, CA 92631

Sav-On Electronics
13225 Harbor Blvd.
Garden Grove, CA 92643

COLORADO

Centennial Elec. Inc.
2324 E. Bijon
Colorado Springs, CO
80909

CONNECTICUT

Archway News, Inc.
64 Bank Street
New Milford, CT 06776

Cables & Connectors
2315 Berlin Turnpike
Newington, CT 06111

Park Dist. Retail Outlet
347 Railroad Ave.
Bridgeport, CT 06604

ILLINOIS

Tri State Elex
200 W. Northwest Hwy.
Mt. Prospect, IL 60056

MARYLAND

Mark Elec. Supply Inc.
11215 Old Baltimore Pike
Beltsville, MD 20705

MASSACHUSETTS

Electronic Hook-Up
104 Main St.
Milford, MA 01757

"You-Do-It" Electronics
40 Franklin Street
Neeham, MA 02494

MICHIGAN

Purchase Radio Supply
327 East Hoover Avenue
Ann Arbor, MI 48104

The Elec. Connection
37387 Ford Road
Westland, MI 48185

MINNESOTA

Radio City Inc.
2663 County Road I
Mounds View, MN 55112

MISSOURI

Gateway Electronics
8123-25 Page Blvd.
St. Louis, MO 63130

NEVADA

Sandy's Electronic Parts
961 Matley Lane #150
Reno, NV 89502

NEW JERSEY

Lashen Electronics Inc.
21 Broadway
Denville, NJ 07834

NEW YORK

Hirsch Sales Corp.
219 California Drive
Williamsville, NY 14221

LNL Distributing Corp.
235 Robbins Lane
Syosset, NY 11791

T&M Elec. Supply, Inc.
472 East Main Street
Patchogue, NY 11772

Unicorn Electronics
Valley Plaza
Johnson City, NY 13790

OHIO

Parts Express
725 Pleasant Valley Drive
Springboro, OH 45066

OREGON

Norvac Electronics
7940 SW Nimbus Avenue
Beaverton, OR 97005

TEXAS

Computers Electronics Etc.
110 E. Medical Center Blvd.
Webster, TX 77598

Electronic Parts Outlet
3753 B Fondren
Houston, TX 77063

Tanner Electronics
1301 W Beltline
Carrollton, TX 75006

WASHINGTON

Supertronix Inc.
16550 W. Valley Hwy.
Tukwila, WA 98188

**Barnes & Noble • B. Dalton • Crown Books
Tower Books • Super Stand • Borders Book Store
On Cue • Hastings • Media Play • Walden Book Store
Just About Every Major Book Store!**

**If you'd like to sell our magazine in your store, please circle 180 on
free information card or Contact Gina Giuliano at (631) 592-6720 ext 215**

IT'S IN THERE!

Maybe things have changed in the 40 or so years that I've been reading **Poptronics** in all of its iterations. I still think that many of you like to take a screwdriver and soldering iron in your hand every once in a while. That's why I go back to the "heart" of a PC, the motherboard, so often in this column. Given that it usually doesn't take more than a half hour or so to replace a mobo, it's a tempting upgrade.

Not everyone, however, really wants to fiddle with loads of peripheral cards. That's why the integrated motherboards (with video, audio, and, frequently, Ethernet adapters contained in the core logic) are still as popular as ever.

Core logic is the two major support ICs for the CPU and memory. They come in a two-chip set (called the Northbridge and Southbridge) and, between the two, help handle video and audio control and memory usage and access.

This time, we'll take a look at two somewhat different approaches to providing an integrated motherboard.

INTEL INSIDE

Many people don't realize it, but giant chip manufacturer Intel makes more than processors. Intel also makes core logic chipsets that support its CPUs, as well as motherboards based on these core logic sets. Open many of the first-tier PCs, such as Gateway, Compaq, Dell, and Hewlett-Packard, and you'll find an Intel motherboard. In most cases, you can buy this very same motherboard, though you'll pay a much different price for it than Dell.

One of the newest motherboards from Intel that we've tested is the D845GBV. This is based on one of the



Here is a photo of the D845GBV motherboard from Intel. Selling for around \$110, this motherboard is an affordable foundation for a state-of-the-art system.

latest core logic sets that Intel has released, the 845G. The 845 core logic set was introduced last year and offered support for DDR RAM, rather than the faster, but more expensive RD RAM. Motherboards based on the 845 core logic set really jumpstarted Pentium4 sales. Intel hopes that providing a motherboard with onboard graphics and sound will help revive flagging PC sales. The vendor's OEM customers, such as those listed above, are the major places that Intel hopes to sell the D845GBV. You won't have much trouble, however, finding this mobo at retail.

We popped the D845GBV into one of our favorite cases, an Antec with one of the new PowerPlus power supplies. The D845GBV's onboard graphics are nothing spectacular, but they are adequate. Intel calls its embedded graphics controller "Extreme Graphics" and devotes 48MB of system RAM for frame buffering. Audio is SoundMAX, which uses the AC97 code for generating software wave-table sound. Audio output is only 2.1 channels, not surround sound.

We configured both the Intel and AMD systems we built as similarly as we could, using the same case and

power supply (alternately) for the systems, 512MB of DDR RAM, a 20-GB Maxtor hard-disk drive, and a 2-GHz Pentium 4 CPU in the Intel mobo and an Athlon XP1900+ in the NFORCE-based motherboard.

We ran a variety of benchmark suites on both configurations. Not surprisingly, the Intel-based system did better on SysMark2002, which uses applications such as DreamWeaver to test the system performance. The AMD-based system, however, did better on the benchmarks that primarily tested video performance.

NVIDIA INSTEAD!

When you start looking at new motherboards, it seems like everyone is getting into the act. ALi (Acer Labs, Inc.) and VIA Technologies are two companies that have been offering core logic chipsets for AMD's Athlon, Duron, and Athlon XP processors. More recently, graphics vendors ATI and NVIDIA have joined the core logic fray. We've yet to see any motherboards using ATI's core logic offering, which seems to be targeted more to the set-top box industry. NVIDIA, however, has had moderate success with its core logic set, which it calls the NFORCE chipset.

As with a standard core logic set, which uses Northbridge and Southbridge chips, the NFORCE core logic set also has two major chips. NVIDIA gives them somewhat different names, however, calling them a System Platform Processor (SPP) /Integrated Graphics Processor (IGP) and a Media and Communications Processor (MCP). The SPP/IGP does much the same work as a Northbridge chip, while the IGP handles the audio and networking tasks. NVIDIA offers the NFORCE

core logic set in the 415 and 420 models. The 420 chipset provides integrated graphics, while the NFORCE 415 foregoes this and offers only the standard AGP slot.

Unlike Intel, NVIDIA does not actually make motherboards for resale, though it does offer motherboard manufacturers a reference design that they can modify to their particular markets. We tested the K7N420 Pro motherboard from Micro Star International (MSI). Their Web address is www.msi-computers.com. This motherboard is used in a variety of popular mail-order systems, as well as being available for direct purchase.

The K7N420 Pro can accommodate most of AMD's recent CPUs, from the original Athlon to the Duron and the new Athlon XP+ processors. We tested the board with an Athlon XP1900+ CPU. This doesn't actually run at 1.9 GHz, but at 1.4 GHz. AMD has revived the old "performance rating" approach pioneered by Cyrix, so the CPU's appellation is meant to imply that the Athlon XP1900+ provides the same level of performance as a 1.9-GHz Intel Pentium 4. Sometimes it does, sometime it doesn't. It all depends on what kind of application you are running, and whether that application has been optimized for the Pentium 4's new microcode.

Of more interest than direct performance comparisons is the difference in approach that NVIDIA has taken with the NFORCE core logic set. As with Intel's 845G core logic set, the NFORCE provides integrated video and audio. The video, however, is the GeForce2 MX video-controller core that is offered in the add-in GeForce2 video cards. It's not top-of-the-line video (the GeForce4), but it's definitely much more oriented to the gamer than Intel's integrated chipset.

The Micro Star K7N420 Pro motherboard also has some other really nice features. The integrated audio controller can supply Dolby Digital 5.1 channel output with an included bracket. MSI also offers an optional plug-in card that lets the motherboard provide S-Video output.

As with the Intel motherboard, the MSI board has lots of USB ports, up to six. However, these are the older 1.1 ports, not the newer faster USB 2.0 ports that Intel offers. On the other hand, MSI's motherboard has built-in

10/100BaseT Ethernet. You either have to add a card to Intel's motherboard or buy the version that incorporates an Ethernet adapter.

WHICH ONE'S FOR ME?

Neither motherboard is very expensive. The Intel D845GVB sells for about \$110, while the Micro Star International K7N420 Pro is selling for about \$140 as we write this. The \$30 price difference is well worth it if you want the built-in Ethernet and GeForce 2 MX graphics capability.

The real distinction is what uses you intend to put the upgraded system to. More business-oriented tasks don't need the highly accelerated graphics, so the Intel motherboard may be the more desirable purchase. Also, if you are looking for all-out computational performance, the Intel D845GVB provides support for the 533-MHz front-side bus, USB 2.0. It will also accept the 2.53-GHz Pentium 4, which is considerably more powerful and more expensive than any CPU that AMD offers at the moment.

On the other hand, the MSI and other NFORCE motherboards provide better graphics for gamers and 5.1-channel audio output. So if you love to fool around with the hardware, or overclock components (something we do not advocate unless you are willing to chance burning components), you might be better off with the NFORCE core logic-based motherboard.

NFORCE—THE NEXT GENERATION

As we were finishing up this column, NVIDIA announced a new generation of its NFORCE core logic set, the NFORCE2. By the time this appears, motherboards based on this new core logic should actually be supplanting the NFORCE motherboards we looked at for this column.

These new NFORCE2 motherboards should be less expensive and will incorporate GeForce 4MX embedded graphics controllers. The NFORCE2 boards will eliminate support for processors that came before the Athlon XP+ and provide faster memory access and support. The new motherboards add USB 2.0 and IEEE 1394 Firewire ports and dual Ethernet ports, and they continue to provide 5.1-channel audio output.

At the time this is being written, no

vendor has actually announced an NFORCE2 motherboard, so we don't have any prices to share. An NVIDIA spokesperson who briefed us said that he expected many of the motherboards based on the NFORCE2 core logic set will hit the retail market at less than a hundred dollars, making this core logic set even more attractive to hands-on builders. P

Get your copy of the CRYSTAL SET HANDBOOK



Go back to antiquity and build the radios that your grandfather built. Build the "Quaker Oats" type rig, wind coils that work and make it look like the 1920's! Only \$10.95 plus \$4.00 for shipping and handling. Claggk Inc., PO Box 12162, Hauppauge, NY 11788. USA Funds ONLY! USA and Canada—no foreign orders. Allow 6-8 weeks for delivery. MA01

CRYSTAL SETS: VOLUME V.



Volume V of the Society newsletter includes six issues ending November 1995. Great for new members to get current, those wanting a bound copy for their reference bookshelf, or as a gift to get a friend started. Contents include: The Design of Unpowered AM Receivers, Radio Outfit in a Headset, A Crystal Set Revisited-Reconstructed, Grounded Loop-stick Tuner, The Matching Secret, and lots of membership correspondence. 8 1/2 x 5 1/2 paperback, \$10.95 plus shipping.—Electronic Technology Today Inc., PO Box 240, Massapequa Park, NY 11762-0240. US funds only. Allow 6-8 weeks for delivery. MA06

Introducing Robotics with Lego® Mindstorms™

For Robot Lovers. Shows how to build a variety of increasingly sophisticated computer-controlled robots using the brilliant Lego mindstorms Robotic Invention System (RIS). Covers the fundamental building techniques needed to construct strong and efficient robots. Explains to the reader how robot control programs may be simply constructed on their PC screens. Detailed building instructions are provided for all the robots featured. 270 pages, 7 1/2 x 10 5/7 in. \$19.99. Plus \$2.45 shipping in U.S. Order from CLAGGK Inc., P.O. Box 12162, Hauppauge, NY 11788 CLX1

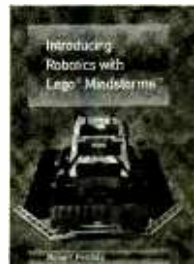

Build Your Own Affordable Multi-Processor Workstation

TED, BRYAN, and SCOTT NEEDLEMAN

Several months ago, we featured a build-it-yourself "Monster Workstation" project based around a Tyan motherboard and dual Intel Xeon CPUs ("Peak Computing," **Poptronics**, March and April 2002). At a bit over \$4000, this project was a great value, especially for anyone who performs tasks that can benefit from multiprocessing, such as CAD, modeling, and even PC circuit-board layout. Even some games, especially those built using the Quake game engine, can be set to make use of dual processors, if available.

Still, four grand is a lot of money. So this time around, we'll show you how to build a dual processor system for almost half that price. The price difference comes from using AMD processors, rather than Intel's Xeon CPUs. Not only are the CPUs themselves considerably less expensive, but the motherboard used in the system costs about a quarter of the price of the one used in our "Monster Workstation."

We built our *Affordable Workstation* using strictly top-of-the-line components. You can save even more, though, by cutting a few corners here, as well. We'll show you where you can safely use less expensive components that will save you several hundred dollars more while still providing eye-popping performance.

Taking it Step-by-Step. Putting together a high-performance workstation like ours is really a pretty easy task. In fact, the hard part is getting all of the components together. We recommend that you do this before you start. Photo 1 shows the workstation "before," with most of the components still in their original packaging. Those of you with sharp eyes will notice that we forgot to stack the hard disk drive and keyboard/mouse in the photo, but we did have both of them on hand.

Before you get started, also make sure that you

have a clean work area and a long piece of wire that you can run to a ground connection. Many of the components including the motherboard can be damaged by static electricity. We removed this ground wire for ease in photography, but please do take a moment to put a grounding strap on. If you don't want to make your own, you can buy a 3M strap in most computer stores for about a buck.



Initial Preparations. We know that you'll be greatly tempted to start right in, but take a few moments to set things up so you can experience a smooth assembly process. Even though the Antec case we used is nice and roomy inside, you'll find it even easier

to work with if you temporarily remove the power supply. There are only four small Phillips-head screws holding it in place. If you carefully remove these screws (store them where you will be able to find them again), you can lift the power supply and the nest of attached cables out of the way while you work on the motherboard.

Before you do anything else, remove the rear-panel motherboard cut-out and replace it with the one that came in the box with the ASUS motherboard. The one that comes with the Antec case is a generic model, and the cutouts don't match the connectors on the ASUS motherboard. This panel just pops right out, and the replacement one snaps right in.

Building The Workstation. The next step is to install the standoffs for the motherboard. These are included in a big bag of hardware that comes with the case. The Antec case that we used has holes in different places for different motherboard layouts, and there aren't

Find out how to save money and still use top-of-the-line components.



Photo 1. The ultimate "Before" picture shows most of the components in their original packages. The hard drive and keyboard/mouse are absent.

enough standoffs supplied for you to just stick a standoff in every hole. The answer is to position the motherboard in the case and use a marking pen to indicate where standoffs need to be mounted. This is easier to accomplish with the holes on the outside edges of the motherboard, but with a little trial and error, you can also correctly mark the interior holes where standoffs also need to be mounted.

While you may be tempted to simply forego using standoffs with the interior mounting holes of the motherboard, don't get lazy in this area. Some of the com-



Photo 2. The motherboard has been mounted in the case in this photo. Look carefully, and you'll see the hand-drawn arrows used to point out standoff locations.

ponents mounted on the motherboard are rather heavy; and the standoffs reduce circuit-board flex, which, in turn, reduces the chance that a motherboard component or solder connection will fail.

Once the standoff positions are correctly marked, install the standoffs, and test fit the motherboard to make sure that all of the mounting holes have a standoff positioned under them. Once you are certain that all of the standoffs are correctly positioned, mount the motherboard to the standoffs. Photo 2 shows the motherboard mounted in the case. If you look careful-

ly, you can see some of the arrows we drew to point out where standoffs needed to be installed.

The next step is to mount the CPUs. These are inserted into the ZIF (zero insertion force) sockets on the motherboard. A small lever on each of the sockets needs to be lifted out the side slightly, and then up, so that the lever is standing vertically. This unlocks the socket so that the CPU can be inserted. Be careful when inserting the processors. They are fragile, as well as sensitive to static charges. The CPU pins are keyed—they only fit one way



Photo 3. Take extra care in cleaning the contact point of the CPU that will bond with the heatsink. Here a cotton swab is dipped in rubbing alcohol and swabbed over the CPU's center.

into the socket, so position the processor correctly before putting it into the socket. Don't force the CPU into the socket. If the socket has been unlocked properly and the CPU is positioned correctly, the processor will simply drop down into the socket. If it doesn't, you need to recheck that you've unlocked the socket and correctly positioned the CPU. When the processor is firmly seated in the socket, push the locking lever down and back under the retaining lip. This locks the CPU firmly into the socket.

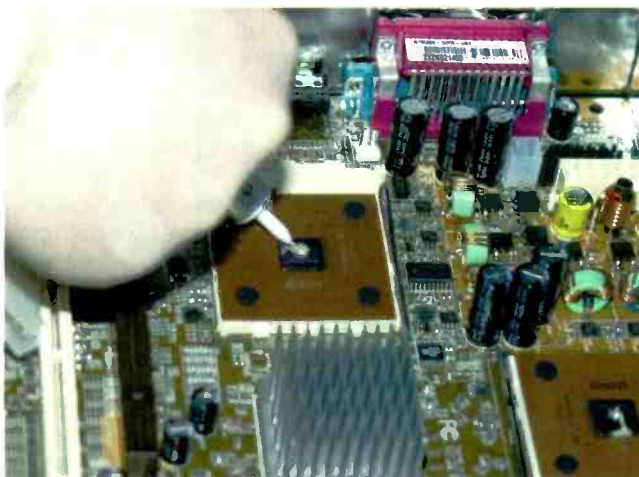

Photo 4. Silver compounds have been found to rival the heat dissipation of plain thermal greases that contain Zinc Oxide or silicone-based grease. Here, some Antec Silver is used to coat the CPU.

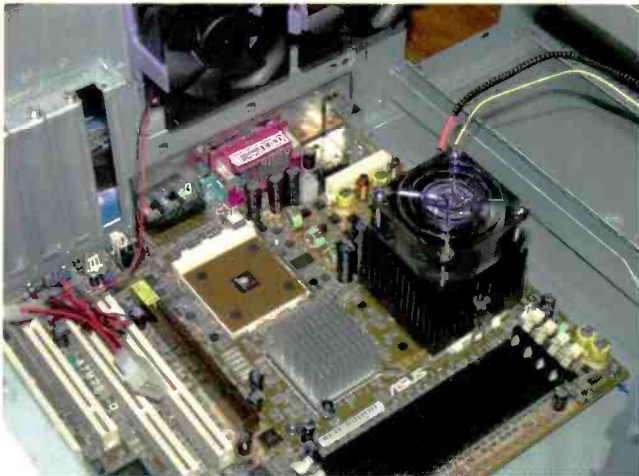

Photo 5. Here is a photo showing the first heatsink correctly mounted on the processor. Another heatsink will be mounted and then both will be fastened down.

The next few steps seem like overkill, but they are very important. Before attaching the heatsink to each of the CPUs, you must first clean the CPU and then apply a thermal transfer media to the processor. Both of these steps are important in getting the best transfer of heat from the small area of the CPU that actually radiates the heat build-up into the heatsink where it can be dissipated.

The first step is to make sure that the part of the processor that contacts the heatsink is as clean as you can get it. To do this, dip a cotton swab in medicinal or rubbing alcohol, and swab off the top center of the CPU, as shown in Photo 3. This will remove any oils or dirt from the manufacturing process or storage.

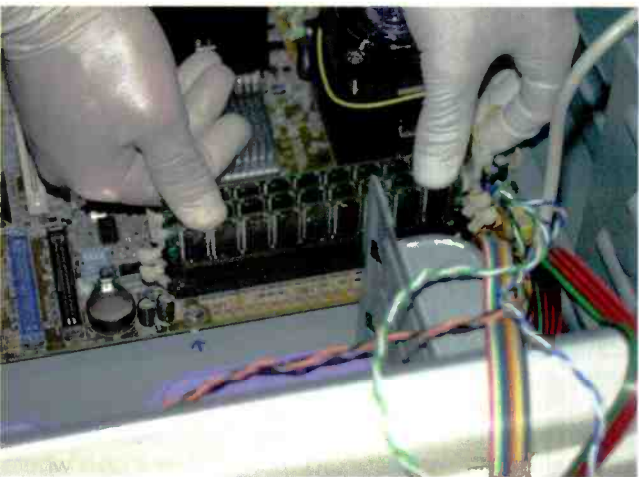

Photo 6. The third of a total of four DIMM RAM boards is shown being inserted into the memory expansion slot of the motherboard. The chips are sensitive to electrostatic discharge.

Next, you need to put on a healthy drop of thermal conductive media. Most heatsinks come with "heatsink grease," usually Zinc Oxide or a Silicone-based grease. We usually throw these little plastic bags away and instead use a silver compound. One of the best-known of these is called Artic Silver, but we used Antec's formulation, which also provides a 99-percent silver content. The silver-based thermal mediums provide a much bet-

ter heat transfer than simple thermal grease. Photo 4 shows the Antec Silver being applied. You want to put enough of this on the CPU so that it completely covers the center part of the CPU when the heatsink is applied, but not so much that excess thermal silver compound comes shooting out the sides of the heatsink!

Once you've applied the silver compound to both CPUs, you'll need to fasten the heatsinks. You'll have to be careful here—there's only one correct direction to set these down, and you'll need to check and make sure that they are correctly positioned if they are to do the right job in keeping the processors cool. The heatsinks

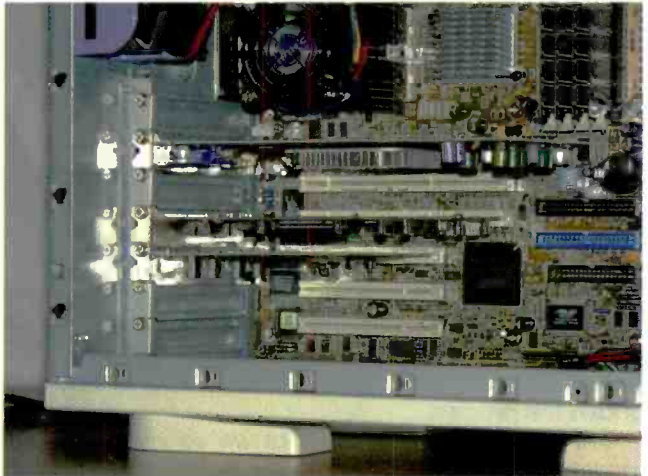

Photo 7. Three peripheral cards have been inserted into the board: a PCI-based USB 2.0 jack, an Intel Gigabit Ethernet card, and an NVIDIA Quadro4 750 video card.

have small metal clips on two sides that fasten over lips on the ZIF sockets. You'll probably have to use a screwdriver blade to get these clips fastened, so be careful that the screwdriver doesn't slip and gouge the motherboard. Photo 5 shows the first heatsink correctly positioned on the processor and motherboard. Once both heatsinks are fastened down, plug the fan leads from each into the proper connectors on the motherboard.



Photo 8. This detailed photograph shows the TEAC CD-RW being set to "Slave" mode. This is done so that the DVD burner can be set to "Master," decreasing the failure rate of expensive DVD mis-copies.

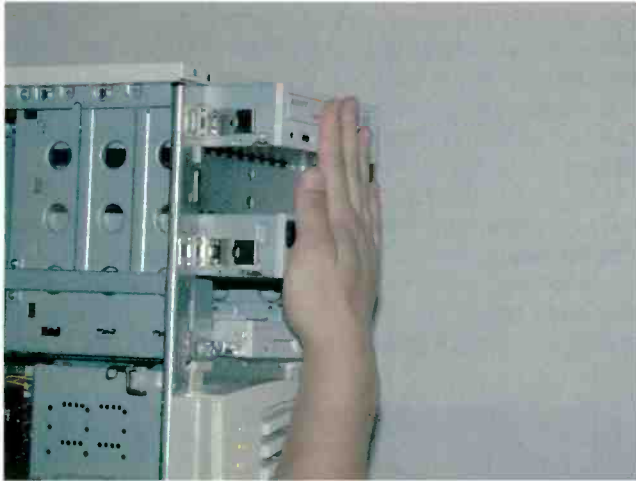

Photo 9. Both optical drives are mounted on the rails provided with the Antec case, and then they are slid into position inside the case.

The RAM is inserted next. We used four 512MB DIMMs from Kingston Technologies. Other vendors, including Crucial Technology, Viking, and PNY also provide DDR RAM modules that will work well with the ASUS motherboard. These DIMMs are sensitive to static, so be careful when inserting them. The DIMMs are keyed, with a slot that fits only the right way in the RAM socket. Take your time, and you can't make a mistake. Photo 6 shows this process.

In Photo 7, you can see that we've inserted three peripheral cards. This particular ASUS motherboard does not have USB 2.0 on board, so ASUS included a separate PCI card that adds this capability. We also installed an Intel Gigabit Ethernet card, since we run that version of Ethernet here. There is no onboard Ethernet adapter on the ASUS motherboard, so you

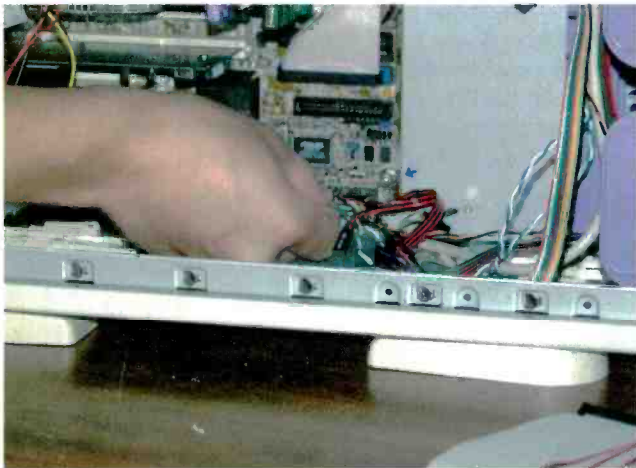

Photo 10. Following the diagram included in your motherboard manual, carefully run the cables for each component to its appropriate jack on the board.

will need to add the appropriate adapter if you have a network or broadband Internet connection. Finally, the third card in the photo is the NVIDIA Quadro 4 750 video card. This is mounted in the AGP slot.

The next part of the process is mounting the various drives that will be used. On our Antec case, we had to

remove some metal shielding plates that were located under the plastic filler panels on the front of the case. The floppy-disk drive was mounted in the position designed to hold it, and the drive cage for the hard disk was removed so that the hard-disk drive could be easily mounted. Before mounting the two optical drives, we checked to see that the TEAC CD-RW drive was set in "Slave" mode. Photo 8 shows this being done. Generally, the faster optical drive will be set as the Master; but with a DVD burner, you will usually want the



Photo 11. Voilà! The system is complete and ready for initial power-up procedures. Be sure to take one last look around the case to spot any faux pas.

DVD burner set to this position to make sure that expensive DVD+R discs aren't ruined. Photo 9 shows both optical drives mounted on the drive rails that come with the Antec case and being slid into position.

Now it's time to finish everything up. Photo 10 shows the cables from the front panel being connected. There's a diagram in the motherboard manual that shows where you need to plug in the Power, Hard Disk LED, Reset, Speaker, and other connectors from the case. These connectors are marked, at least on the Antec case we used. Connecting them is simply a matter of plugging them into the right motherboard sockets.

Next, connect the floppy-drive cable and the IDE cables from the hard-disk and optical-disc drives to the proper connectors on the motherboard. When you are sure that everything is properly seated, connect the power cables to the motherboard connectors and the power connectors on all of the various drives. Photo 11 shows the system completed and

ready for the initial power-up.

In the final step, we've moved in the wireless keyboard and mouse and an LCD monitor. After we connected them, it was time to perform our initial power up. Our system booted, and we set the BIOS to boot first from the Sony DVD+RW drive. This was necessary so that the Windows XP Professional CD would boot the system and proceed with the install. Installing Windows XP Professional takes about ¾ of an hour, almost the same amount of time we spent assembling it.

Saving Some Bucks. In putting together our Affordable Workstation, we decided to max the system out. (See Table 1.) There are some areas, however, where you can save some significant money by using lower performance parts or by eliminating components completely. (See Table 2.) For example, we wanted the convenience of really high-capacity backup and storage on our system, so we included a DVD+RW drive. We also used an expensive TEAC 40X CD-RW drive as a second optical drive, making it easier to do backups of CDs. By eliminating the DVD+RW drive and using a less expensive 32x CD-RW drive, you can save about \$550. You might also keep the DVD+RW drive and eliminate the CD-RW drive. The DVD+RW drive can also write CD-R and CD-RW discs, and you would save about \$140.

We also went whole hog on the video card, an NVIDIA Quadro4 750. The real benefits of this card don't really show up on the benchmark that we used, which is very processor-dependent. Not all applications, even those which are highly graphical, always reflect the power that the video card brings to the table. Check to see if your applications do make use of the video card's capability. If you are running an application that does, such as AutoCAD, the extra money spent on a high-end workstation video card like the Quadro4 750 is well worth it.

We used an NVIDIA reference design; though you would probably have to purchase this card from PNY, the vendor that NVIDIA chose to initially produce the

Quadro4 card. Although the Quadro4 leverages off of the GeForce4 core design, it has been optimized for both 2D as well as 3D performance. Workstations meant for graphic-design work often are used in both modes. While CAD and PC circuit-board design are 2D applications, many modeling and ray-tracing applications are three-dimensional tasks. Substituting a video card that works well in 2D, such as the Matrox G500, an entry-level Quadro4 200 card, or even a Quadro2 card, if you can find one, for the Quadro4 card will also save you some significant dollars. We also added a Gigabit over Copper Ethernet adapter card to our system, as we are running this high-speed Ethernet protocol in our home. A slower standard 100BaseT Ethernet adapter should cost as little as \$20.

Finally, you can purchase a bargain keyboard and mouse, as well as a smaller hard-disk drive. You might be tempted to save money on the case and power supply, since the Antec Performance Plus case runs about \$110. Searching the Internet, we came up with cases that have AMD-compliant power supplies for as little as \$60. While the cost difference adds up to \$50 or more, don't look to save money here. The Antec case has a high-capacity power supply with excellent regulation. It also has the Extended Pentium 4 power connectors, which the motherboard, although it is for dual AMD processors, requires. A cheap power supply can nuke your motherboard and CPUs or, if you are lucky, simply self-destruct. With two CPUs and two gigabytes of RAM, the ASUS motherboard is drawing a fair amount of power. Using the case that we did, or one of similar high quality, helps assure that your system will not experience any power problems. The Antec case is also a dream to work inside of.

We also received our CPUs directly from AMD, so they came without heatsinks. We could have gotten away with purchasing less expensive heatsinks for about \$20 each, but because excessive heat build-up can damage the CPU or, at the very least, cause your system to slow down, we went for the new Reference Series heatsinks from Antec. These have massive solid

**TABLE 1
PARTS AND PRICES (AS BUILT)**

COMPONENT	VENDOR	MODEL	PRICE
Case	Antec	Performance Plus	\$109
Motherboard	ASUS	A7M266-D	\$250
CPU	AMD	Athlon MP2000 (two)	\$420
RAM	Kingston	Four 512MB DDR RAMs	\$360
Heatsinks	Antec	Reference Series (two)	\$60
Video Card	NVIDIA	Quadro4 750	\$515
Keyboard & Mouse	Logitech	Cordless Freedom	\$80
Operating System	Microsoft	Windows XP Professional	\$180
Hard-Disk Drive	Maxtor	80GB DiamondMax	\$150
DVD+RW Drive	Sony		\$499
CD-RW Drive	TEAC	40x12x48	\$140
Gigabit Ethernet Card	Intel		\$120
Floppy-Disk Drive	Generic		\$20
TOTAL			\$2903

TABLE 2
AN EVEN MORE ECONOMICAL CONFIGURATION

COMPONENT	VENDOR	MODEL	PRICE
Case	Antec	Performance Plus	\$100
Motherboard	ASUS	A7M266-D	\$250
CPU	AMD	Athlon MP2000 (two) Retail Packaging with Heatsinks	\$420
RAM	Kingston	Two 512MB DDR RAMs	\$180
Video Card	Matrox	G550	\$125
Keyboard & Mouse	Generic	Any that are on sale	\$20
Operating System	Microsoft	Windows XP Professional	\$180
Hard-Disk Drive	Maxtor	60GB	\$100
CD-RW Drive	IOmagic	32x10x40	\$100
100BaseT Internet Card	Generic	Any that are on sale	\$20
Floppy-Disk Drive	Generic		\$20
TOTAL			\$1515

aluminum heatsinks and high-volume, high-RPM fans. They also cost about twice as much as less expensive models. Again, two CPUs mean twice the heat generation inside the case. Thermal protection is one place you don't want to save money at the expense of frying your processors.

Start It Up! Before you rush out to build your own dual CPU system, keep in mind that many typical applications get absolutely no benefit from running on a system with more than a single CPU. With these applications, the second CPU just sits idly by, watching its twin do all the work. Only applications that are designed to run in a multi-processor environment will actually show a performance benefit from being run on a system such as this one.

Keep in mind that you should also match the components to the tasks that you expect to do. For example, heavy graphics rendering, such as modeling and CAD, really do benefit from using a video card/subsystem designed for that type of task. That's why we equipped our workstation with an NVIDIA Quadro4. Be very careful about trading performance for cost savings.

Putting It To The Test. To see just how much performance you can get from an economical workstation, we constructed two benchmarks that are workstation-oriented. The first of these was constructed using Caligari's *TrueSpace 5.2*. This is a 2D modeling and animation application and makes use of dual processors where available.

We also intended to construct a second benchmark using Corel Software's *Bryce*. *Bryce* is a modeling application for creating virtual environments. Every pixel in the *Bryce* screen needs to be individually rendered, an extremely compute-intensive task. While *Bryce*'s compute-intensiveness makes it an excellent benchmark for testing workstations, we found that it does not make use of dual processors where available and so decided not to use it for testing the AMD workstation.

We ran the *TrueSpace* benchmark on a trio of systems. Obviously, one was the AMD Dual CPU worksta-

tion. The second was a high-performance PC using Intel's newest 2.53-GHz Pentium 4 CPU and a motherboard with the newest 533-MHz front-side bus. The video card in this system was an older GeForce2 MX. Finally, we ran the benchmarks a third time on the Dual 2.2-GHz Intel Xeon "Monster Workstation" we built for the March and April 2002 "Peak Computing" columns. The results are not surprising. The *TrueSpace* benchmark completed in 2 minutes and 32 seconds on the AMD workstation and in 2 minutes and 5 seconds on the Intel dual-Xeon workstation. That's a pretty close time considering that the AMD processors run somewhat slower than the Xeons and the ASUS motherboard uses DDR RAM, rather than RDRAM. Of course, the actual differential between the two systems will vary with the specific benchmarks that you use, but the dual AMD workstation does make a good showing for the money.

Obviously, the dual Athlon MP workstation isn't the right choice for everyone. If, however, you do have applications (including some games), which can benefit from having two CPUs available, our dual AMD processor workstation can provide you with great performance at a surprisingly affordable price. P



"Actually, it means 'unleaded fuel only!'"

Build This Theremin,

Part I

Reprinted from
Electronics Now®
February 1996

JOHN SIMONTON

Since its introduction to the general public in the late 1920s, the image and tone of the theremin has captured the imagination. Eyes widened at the sight of a musician producing sound using only a conductor's gestures. The theremin's pure tones, able to stand out without distortion against even the full fortissimo of a symphony orchestra, were like nothing anyone had ever heard before.

Was it a hit? You bet! Theremin concerts were performed in front of standing-room only crowds in halls where

audiences were ordinarily sparse. The place of the theremin in a "modern" orchestra was a given for such maestros as Leopold Stokowski, who used one or more in numerous concerts of the Philadelphia Orchestra during the late 1930s. RCA thought that every cultured home would have a theremin, but things didn't work out that way for a lot of reasons.

We'll talk more about these things shortly and also look at how to build a theremin that is based on the same heterodyning principles that were key to the original. *Theremax* produces the classic sound while adding embellishments made possible by the economy of transistors and integrated circuits. It can function as a stand-alone instrument or as a gesture-sensing controller for other musical instruments or in performance art applications.

The Theremin Zeitgeist. The Aetherphon that Lev Termen showed to a Russian physics conference in 1920 was an adaptation of his earlier invention, the Radio Watchman. What has this to do with our story? Just this: Lev shortly moved to New York, Anglicized his name to Leon, and began calling the instrument by his new American surname of Theremin. And this: Both the Aetherphon and the Radio Watchman, which emitted a squeal in a pair of head-

phones when a person entered a protected area, were among the earliest applications of heterodyning, a principle that in one form or another underlies all forms of electronic communications. In fact, if Theremin's work did not precede the invention of the superheterodyne by

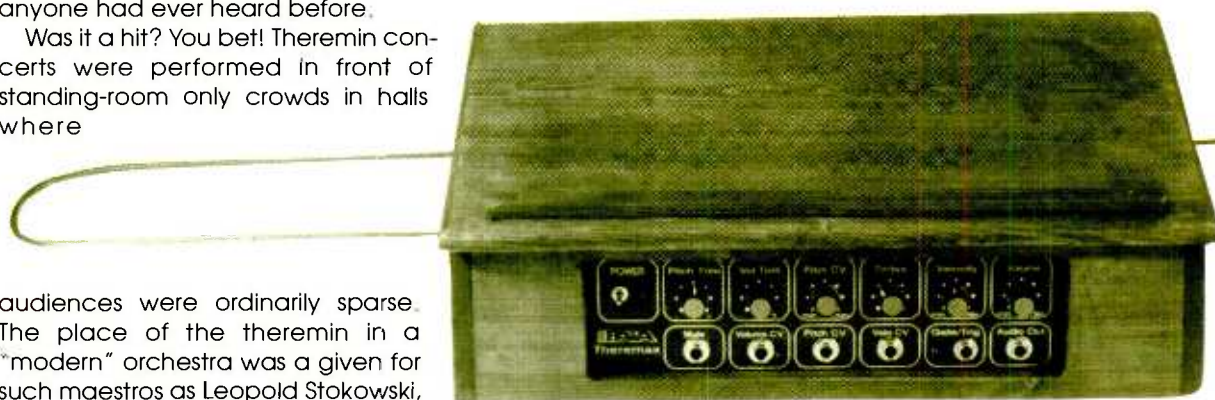

Edwin Armstrong in 1918, it was at least happening at the same time.

You likely already know that when two signals are combined in a mixer the result is a signal with new frequency components that are the sums and differences of the frequencies that were in the originals, as well as the original themselves. This is the basic principle behind AM radio. For example, if 100-kHz and 99-kHz sine waves are combined in this way, the result will be a new wave form that also has 1-kHz and 199-kHz components. There are a couple of neat things about this—the first is that while the two original frequencies are both well above the range of human hearing, as is the sum frequency of 199 kHz, the 1-kHz difference is right in the middle of what we hear best. The second neat thing is that relatively small changes in either of the source signals will produce a relatively

large change in the difference frequency. If the 100-kHz signal changes by ½% to 99.5 kHz, the output signal will halve (an octave change) to 500 Hz.

All of this is important in Radio Watchmen and Aetherphons because the presence of a human body can easily produce a few picofarad change in the

Make eerie noises and melodic tones with the Theramax.

capacitance of a piece of wire hanging off in space. If the capacitance of the wire is part of a tuned circuit, the result is a small change in the resonant frequency. In much electronic equipment, such parasitic capacitance is a flaw that must be overcome through shielding, buffering oscillator circuits, and so on. Here, however, it's the whole point.

Here you have your basic theremin: A pair of high-frequency oscillators is running at essentially the same frequency—one fixed and the second connected to a sensing antenna. As the hand of the performer approaches the antenna, the frequency of the sensing oscillator goes down, so the frequency difference between the two oscillators increases. The outputs of the oscillators are combined; and a low-pass filter is used to allow only the lower difference frequency to pass, which is the sound you hear. The original Aetherphon was little more than this: a foot pedal was used to control the volume and a switch was provided to mute the tone completely.

On the way to becoming a theremin, some changes were made. By the time the design was licensed by RCA in 1929, a circuit had been added so the performer controlled the volume and could articulate notes with movements of his left hand relative to a horizontal "volume" antenna—which, interestingly enough, was *not* part of a heterodyne circuit. The right hand controlled pitch by its proximity to a vertical "pitch" antenna. There were several different package configurations for the theremin, including one that looked like a music stand with antennas and another one with a massive "U"-shaped case with

antennas on the vertical arms of the U. The most common was the lectern style case we've used.

One of the more unusual configurations was the Terpsitone, a dance platform with theremin antennas spread around it so that the dancers would create the music as they danced to it. That seems to be a pretty cool idea even when compared to today's world of hip performance art. Theremax has control-voltage and gate outputs that make it even more appropriate for these kinds of applications.

For a number of reasons, the theremin never replaced the spinet in the parlors of America: the depression was not a good time to be introducing new musical instruments. Also, the RCA design was one that was deemed unplayable by the leading thereminist of any age, Clara Rockmore. In that design, volume, and consequently articulation, were controlled by the varying power to the filaments of a tube. Thermal lag of the filaments meant that everything had to be played glissando—it was essentially impossible to add quiet spaces between notes played quickly. The theremin used by Clara Rockmore in all of her concerts was a unit custom-made by Leon Theremin that used a different approach to controlling volume. After a single run of a couple of hundred units, RCA discontinued theremin production.

Yes, and let's be honest: The biggest reason that theremins have never become overwhelmingly popular is that, spooky sci-fi noises aside, they are much more difficult to play than you might think—despite RCA's claim that "anyone who can hum can play one."

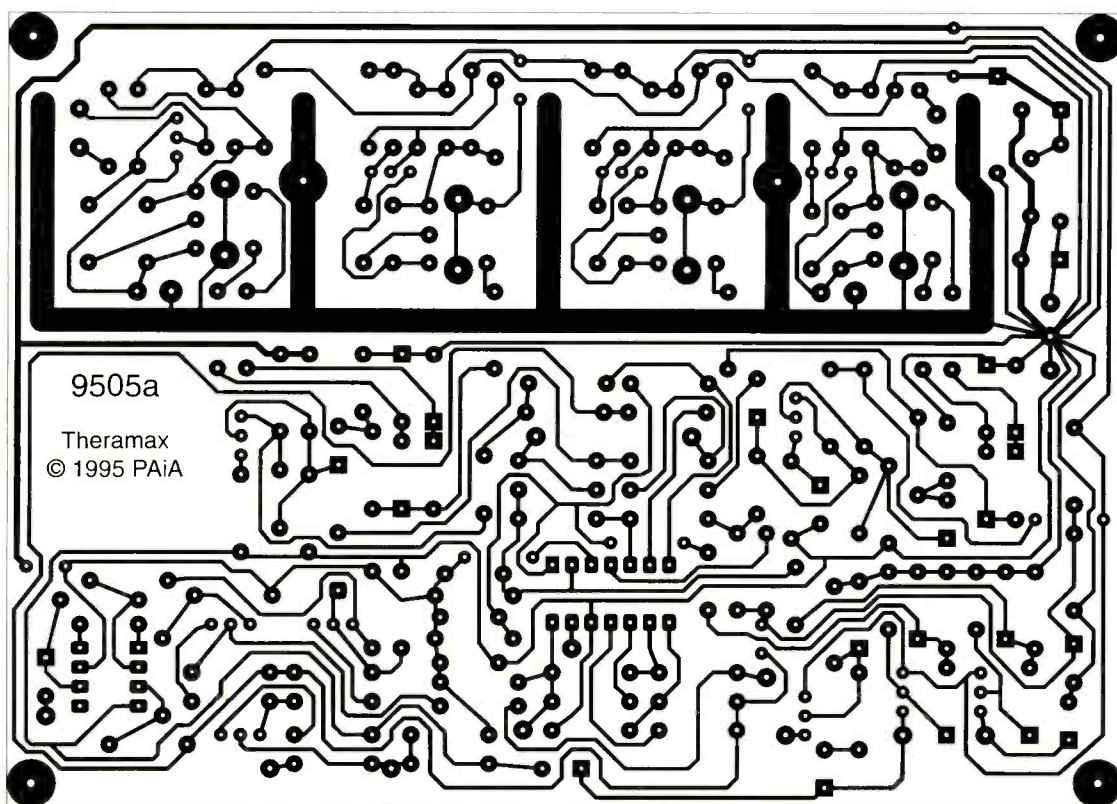

Here is a full-size printed circuit board foil pattern for the Theremax.

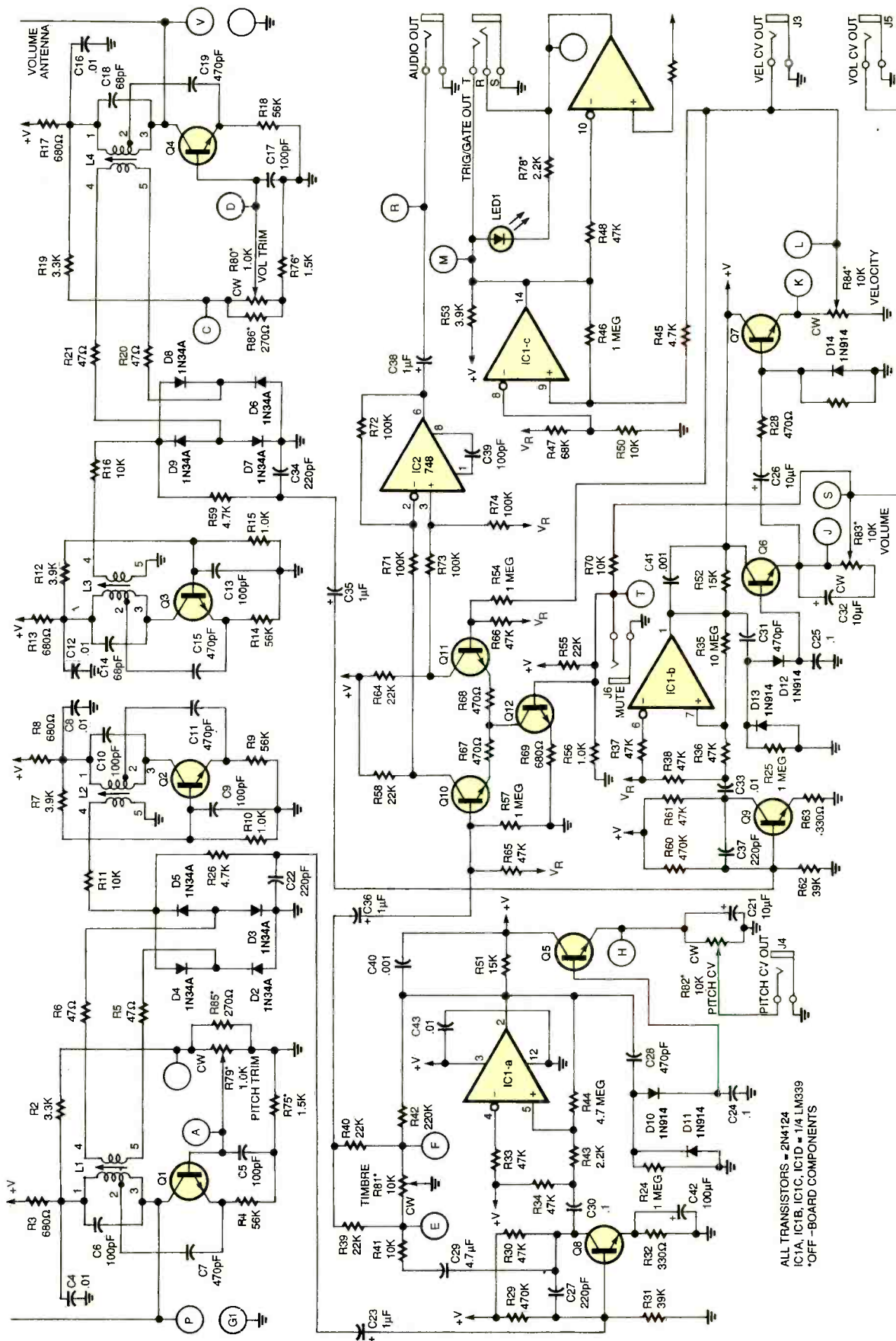

ALL TRANSISTORS = 2N4124
 IC1A, IC1B, IC1C, IC1D = 1/4 LM339
 *OFF-BOARD COMPONENTS

Fig. 1. This is the main Theremax schematic. All components marked with an asterisk mount off the circuit board.

Well, actually, riffs like the theremin lick in Brian Wilson's "Good Vibrations" aren't too bad, and the one in Led Zeppelin's "Whole Lotta Love" won't take forever to master either. The common complaint is that there is no tactile feedback, no keys or frets, and the pitch response to hand position is nonlinear. That attitude might not get you much sympathy from violinists, but they do at least have a fingerboard to touch.

You've been warned. Let's see about building one of these beasts.

Design Analysis. The main Theremax schematic is shown in Fig. 1. Its power-supply section is shown in Fig. 2. At the heart of the circuitry are four oscillators, two of which are mixed to produce the pitch signal and two of which are mixed to produce the volume-control signal. If it occurs to you that one oscillator could serve as reference for both pitch and volume sensing, you have a good designer's instincts—it would be more economical. Unfortunately, multiple oscillators operating near the same frequency have a tendency to "pull" and lock to exactly the same frequency—just like the swing of multiple compound pendulums will tend to synchronize. It's not too difficult to minimize this tendency in a single pair of oscillators by physically isolating them from one another, putting guard bands around them on a circuit board, and decoupling them from their common power supply. However, doing so for three oscillators, all heading for essentially the same frequency, is considerably more difficult.

If the oscillators lock, there is no more difference frequency, so the output goes to zero. It would be bad enough if at the lowest notes the sound suddenly stopped, but the worst part is that just prior to locking, the oscillators go through an unstable region where the synchronization is chaotic. Instead of just suddenly going quiet, there is a burst of noise first. These are very unmusical characteristics. Having four oscillators allows us to offset the frequency ranges of the pairs so that they do not interact.

The basic oscillator is a classic

Clara and Leon

Lev Termen, who later changed his name to Leon Theremin, was born in St. Petersburg, Russia, at the turn of the century. So was Clara Reisenberg, who later took her husband's name of Rockmore. Although destiny was to join their lives, the two didn't meet one another until after they both had emigrated to the U.S. in the late 1920s.

Leon began his studies of physics and music composition at the University of St. Petersburg. While continuing his study of physics at the Petrograd Physico-Technical Institute in 1919, he became director of the Laboratory of Electrical Oscillators. In this environment, he was able to combine his interests in music and physics to produce what is generally accepted as the first electronic musical instrument. He began demonstrating the Aetherphon, as he originally called the instrument, in 1920; and it is known that Lenin, the revolutionary father of communism, was among those who saw a demonstration. Lenin may have been responsible for Leon's trips to western Europe and the USA in search of cultural acceptance of the revolution and capital for Leon's many inventions.

Clara was a musical prodigy who began playing the violin at the age of 4. The following year she was the youngest student ever admitted to the Imperial Conservatory of Music in St. Petersburg. It is difficult to reconcile the time lines of various accounts, but by 1927 she and Leon were both in New York after successful independent concert tours.

During this time, Clara's hand muscles began to show the devastating effects of childhood malnutrition, which was widespread in Russia during the transition from czarist to Bolshevik control. It appeared that her career as a concert violinist would soon be over. She realized that the theremin was her only hope of continuing her musical career and over a period of several years she worked closely with Leon to develop an instrument that would allow her the expressive control needed for concert work. To the end of his days, Leon was never able to provide her with her greatest wish, a polytonic theremin capable of playing more than one note at a time.

While it is said that there was a romantic relationship between the two, Clara eventually married a prominent impresario of the time to become Clara Rockmore. This marriage had a very beneficial effect on her career and, consequently, on the exposure that the theremin received. Leon married a dancer and established an acoustical laboratory in New York, where he continued the development of various electronic musical instruments.

Clara spent the rest of her life in New York and gave many coast-to-coast concert tours. In the late 1930s Leon disappeared. It isn't known whether he was responding to the pressures of his inter-racial marriage and yearning for his homeland, or if his homeland was yearning for him. Following the purges of the 1917 revolution, Russia was short of technical talent, and some sources say he was taken involuntarily. It is typical of the romanticism of the theremin mythology that by some accounts he was kidnapped by the KGB, an organization that did not exist until 1954. In any case, one morning in 1938 he was missing from his New York apartment and never again contacted his wife and children or any of his associates. Now it is known that he did return to Moscow and was involved in electronic research for the government until 1964 when he retired to become a professor of acoustics at the University of Moscow.

In 1991, as a consequence of glasnost and with permissions obtained by John Chowning of Stanford University, Leon was able to return to the US for lectures and to participate in the filming of Steven Martin's "Theremin: An Electronic Odyssey." At one of the lectures where Leon was only to speak, he gave a spontaneous solo concert that was a moving performance for a man in his 95th year. Clara, always proud of her appearance, is said to have had great reservations about seeing him again in her old age, but she finally agreed; and they were reunited on this trip.

After a brief stay in the US, Leon returned to Moscow where he died in 1993.

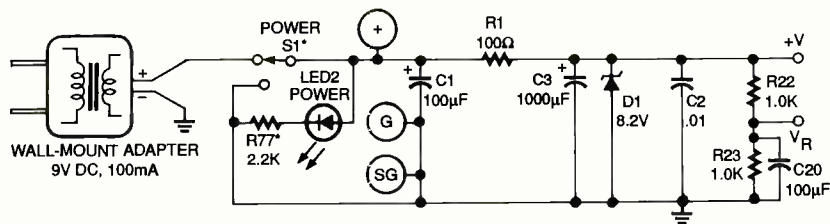

Fig. 2. A 9-volt DC adapter provides power for the power supply shown above.

PARTS LIST FOR THE THEREMAX

SEMICONDUCTORS

IC1—LM339 quad comparator
 IC2—748 op-amp
 Q1—Q12—2N4124 NPN transistor
 D1—8.2-volts, 400-milliwatts, Zener diode
 D2—D9—1N34A germanium diode
 D10—D14—1N914 silicon diode
 D15, D16—Light-emitting diode, red

RESISTORS

(All resistors are 1/4-watt, 5%, unless otherwise noted.)
 R1—100-ohms
 R2, R19—3300-ohms
 R3, R8, R13, R17, R69—680-ohms
 R4, R9, R14, R18, R48, R49, R61, R65, R66—56,000-ohms
 R5, R6, R20, R21—47-ohms
 R7, R12, R53—3900-ohms
 R10, R15, R22, R23, R56—1000-ohms
 R11, R16, R41, R50, R70—10,000-ohms
 R24, R25, R54, R57—1-megohm
 R26, R45, R59—4700-ohms
 R27, R29, R60—470,000-ohms
 R28, R67, R68—470-ohms
 R30, R33, R34, R36, R37, R38—47,000-ohms
 R31, R62—39,000-ohms
 R32, R63—330-ohms
 R35, R46—10-megohms
 R39, R40, R55, R58, R64—22,000-ohms
 R42—220,000-ohms
 R43, R77, R78—2200-ohms
 R44—4.7-megohms
 R47—68,000-ohms
 R51, R52—15,000-ohms
 R71, R72, R73, R74—100,000-ohms
 R75, R76—1500-ohms
 R79, R80—1000-ohms, panel-mount potentiometer
 R81, R82, R83, R84—10,000-ohms, panel-mount potentiometer
 R85, R86—270-ohms

CAPACITORS

C1, C20, C42—100-µF, 10 volts, electrolytic
 C2, C4, C8, C12, C16, C33, C43—0.01-µF, ceramic disc

C3—1000-µF, 10-volts, electrolytic
 C5, C9, C13, C17, C39—100-pF, ceramic-disc
 C6, C10—100-pF, NPO, ceramic-disc
 C7, C11, C15, C19, C28, C31—470-pF, ceramic-disc
 C14, C18—68-pF, NPO, ceramic-disc
 C21, C26, C32—10-µF, 10-volts, electrolytic
 C22, C27, C34, C37—220-pF, ceramic-disc
 C23, C35, C36, C38—1-µF 10-volts, electrolytic
 C24, C25, C30—0.1-µF, Mylar
 C29—4.7-µF, 10-volts, electrolytic
 C40, C41—0.001-µF, ceramic-disc

ADDITIONAL PARTS AND MATERIALS

J1, J3, J4, J5, J6—1/4-inch phone jack
 J2—1/4-inch stereo phone jack
 S1—SPST switch
 P1—DC wall-mount adapter, 9-volts, 100-mA
 L1, L2, L3, L4—796-kHz (nom.) oscillator coil
 Knobs, circuit board, wire, solder, hardware, case, etc.

Note: The following items are available from PAiA Electronics, Inc., 3200 Teakwood Ln., Edmond, OK 73013; 405-340-6300; www.paia.com/paia. Complete kit of all electronic parts including power supply, circuit board and knobs less antennae and case (#9505K): \$88.75 plus \$7 shipping. Case kit with pieces cut from white pine and drilled for assembly, includes hardware; formed antennae; bottom plate; and punched, anodized, and legended control panel (#9505C): \$77.25 plus \$12 shipping. Partial Case Kit*: Front panel, antennae and antennae mounting hardware only (#9505fPA): \$28.50 plus \$7 shipping. Please NOTE: The mounting hardware is not appropriate for metal cases.

Hartley type as typified by transistor Q2 and associated circuitry. The primary winding of oscillator coil L2 and capacitor C10 form a resonant tank circuit load for the transistor, which is configured as a common-base amplifier stage. A tap on the coil is coupled by C11 to the input of the amplifier (the emitter of Q2) for feedback. Resistors R7 and R10 set the operating point of Q2 to provide the gain necessary to maintain oscillation. R8 and C8 provide decoupling between the power supply and the oscillator to minimize unwanted interactions between the four oscillators. In this oscillator, and the identical one built around Q3, the frequency is set solely by the combination of C10 and the inductance of the primary winding of L2. It is adjusted by varying the ferrite slug in the oscillator coil.

The sensing oscillators, typified by the one for pitch comprising Q1 and associated components, have a couple of tweaks. The capacitive reactance of the tank has the additional component of the pitch-sensing antenna, which is effectively in parallel with capacitor C6. The parasitic capacitance of this antenna is greatly affected by the presence of objects, particularly flesh-and-blood objects. As an object approaches the antenna, capacitance increases causing the resonant frequency of the circuit to go down.

The sensing oscillator also provides for vernier control of frequency using potentiometer R79, which allows a variable setting of the operating point of Q1. Varying the operating point changes frequency by increasing or decreasing the DC current flow through the primary of L1, which changes the permeability of the core slightly and consequently the reactance of the inductor. The volume-sensing oscillator (built around Q4) follows this same design.

For both pitch and volume, the outputs of the reference and sensing oscillators are taken off the secondary windings of their respective transformers to buffer them from the effects of loading by the rest of the circuitry. Let's consider the pitch circuitry as typical, where the

oscillators are mixed in the ring modulator consisting of D2–D5. The output of the modulator consists almost entirely of the sum and difference frequencies with some small leakage at the frequencies of the oscillators. The higher frequencies are rejected by the low-pass filter consisting of R26 and C22, and only the audible difference frequency passes. Transistor Q8 and associated components comprise a single-stage amplifier that boosts the output of the modulator to a more usable level, with C27 providing a second pole of filtering for further suppression of the higher frequencies. The comparable circuit elements in the volume-sensing side of the circuit should be apparent from inspection of the schematic.

Pitch and volume-control voltages are produced in the same way: A comparator converts the sine-wave difference frequency to square waves. These waves are differentiated to a string of pulses, which are then integrated to a control voltage (CV). Consider the pitch CV as typical, where the output of the amplifier Q8 is coupled by C30 to the Schmitt trigger wired around IC1-a. The inverting input of the comparator is tied to a half-of-supply reference, V_R , that comes from R22 and R23. R38 ties the non-inverting input to V_R , and R43 and R44 combine to provide a slight hysteresis that speeds switching and prevents "chattering" when the Schmitt trigger fires.

The output appears across the load resistor, R51, and it is coupled by C28 to R24 so that the rising edge of the square wave produces a positive-going pulse. On falling edges of the square wave, D11 becomes forward-biased and quickly charges C28 for the next pulse while also clamping to ground the negative spike that would be produced. As the frequency increases, the constant-width pulses come closer together so the equivalent DC value of the pulse train increases. The average value of the pulse train is recovered by charging C24 through D10. The voltage on the capacitor is "read out" by the high-impedance emitter follower consisting of Q5 and R82, which is also the panel control

that sets the control voltage available at the PITCH CV jack. The volume CV is generated in the same way, using the comparator built around IC1-b.

Potentiometer R81 allows either the sine wave at the collector of Q8, the square wave at the output of the IC1-a, or a mix of the two to serve as the audio signal. At the counterclockwise end of the rotation of R81, its grounded wiper shorts out the junction of R40 and R42 allowing only the sine wave to pass to the next stage through C29, R41, and R39. At the other end of its rotation, the wiper shorts out the sine wave. At intermediate settings, the two are mixed. This audio signal is coupled by C36 to the voltage-controlled amplifier or VCA.

In the VCA, the gain of a differential pair of transistors (Q10, Q11) is controlled by setting the current flow through them with a third transistor, Q12. The volume CV, as set by front-panel control R83, is converted to a current by R70. This current sets the collector current of Q12. As this current increases, the gain of Q10 and Q11 increases as well. The significant shift in DC voltage at their collectors is canceled out in the differential amp built around the 748 op-amp, IC2. The output of IC2 is coupled by C38 to J1.

The volume CV is also used to derive a velocity CV. Natural instruments are sensitive to how hard you play them. With MIDI instruments, this quality has come to be known as velocity. In Theremax, velocity is proportional to the rate of increase of volume—the "velocity" with which your hand approaches the volume antenna. Changes in the volume CV are coupled by C26 through current-limiting resistor R28 to the base of the emitter-follower, Q7. When the volume CV is decreasing, D14 forward biases to clamp the velocity CV to ground and provide a high-current recharge path for C26. Panel-mounted potentiometer R84 serves as a load resistor for the emitter follower and an attenuator for the CV.

The velocity CV is available at the front-panel jack, J3. It also routes to the base of Q11 in the VCA differential pair. There it makes the response non-symmetrical,

which adds even harmonics to the output to give the sensation of being played hard. The velocity CV also is routed to the Schmitt trigger consisting of IC1-c and associated components. When velocity exceeds a threshold, the Schmitt changes state to provide a triggering pulse to external equipment. Since many vintage analog synthesizers initiate musical events with a switch closure to ground (or "S" trigger), the final comparator in IC1 is used as an open collector to ground turned on by the gate. Both of these signals appear at the stereo phone jack, J2, with the gate connected to the tip and the open collector to the ring. A mono plug may be used to access the gate, since the open collector tied to the ring can be grounded with no problem.

The 8.2-volt Zener diode, D1, stabilizes the voltage from the wall-mounted DC adapter so that power-line transients don't cause pitch glitches.

Next month, we'll show you how to build, test, and tune Theremax. **P**

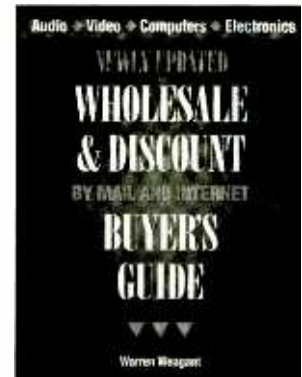

**Wholesale & Discount
Buyers Guide.
#CP-1 – \$19.95**

Save up to 90% off list prices. Audio and video equipment and materials; electronic products and surplus; pro recording and specialty items; computers and components. Source listings include complete address, phone, fax, e-mail and website addresses. 8½ x 11", 72pp. paperback.

**Send \$19.95 plus \$5.00 S&H to:
Clagck, Inc. PO Box 12162,
Hauppauge, NY 11788; Tel: 631-
592-6721; Fax: 631-592-6723;
email: clagck@gernsback.com.**



SORRY No orders accepted outside of USA & Canada. All payments must be in U.S. funds.

CLX3

NE555 Timer Circuits

The NE555 timer and its companion devices, the NE556 dual timer and NE558 quad timer, can be used in a number of applications—limited only by your ingenuity. These versatile timers can function both as astable and as monostable devices (one-shot) and can be triggered in several ways. With suitable component changes, they may be customized for a particular application or otherwise used as is. We will discuss a few circuits that feature these devices.

Infrared Firefly

The first circuit (Fig. 1), called the Infrared Firefly, is a marker device used for surveillance work. It can be packaged on a postage-stamp-sized PC board, is designed for placing in a small box with an attached ceramic magnet, and runs from a 9-volt battery. The device can be placed in an inconspicuous spot on the vehicle being trailed.

The Firefly generates a short pulse every few hundred milliseconds that drives six infrared LEDs, which do not produce any visible light. There is no RF carrier that might be detected with a bug detector. A CCD camera or snooper-scope (similar to a night-vision scope) “sees” the LEDs, which will appear like a firefly or blinking beacon. In this way, a vehicle can be “marked” and followed without anything noticeable to the human eye. Naturally, visible-light LEDs of suitable color(s) can be substituted for the infrared LEDs, if desired.

In this circuit, the NE555-type device is actually a 7555-type CMOS version. Consuming negligible power, the device drives the LEDs (two separate groups of three series-connected LEDs). A cycle length of around $\frac{1}{4}$ of a second works well, with a ten percent duty cycle. This cycle saves battery power, cutting the average drain to about ten percent of that of the LEDs if they were fully on. Each LED string of three LEDs in series draws in about 20 mA with a 9-

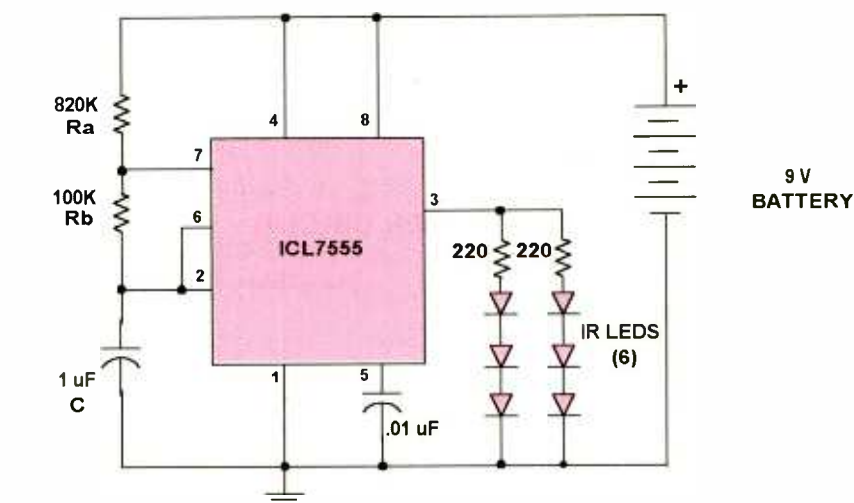

FIG 1
INFRARED FIREFLY

volt supply, so all six LEDs draw about 40 mA. While six LEDs could be connected in series, a higher supply voltage would be needed. The current drawn by the 7555 is very small (about 50 μ A at 9V) and can be disregarded, so the aver-

age current drain is approximately 40 μ A \times 10 percent or 4 mA

The CMOS version is also advantageous when long delays are needed. Higher resistances and smaller capacitances can be achieved with it, as con-

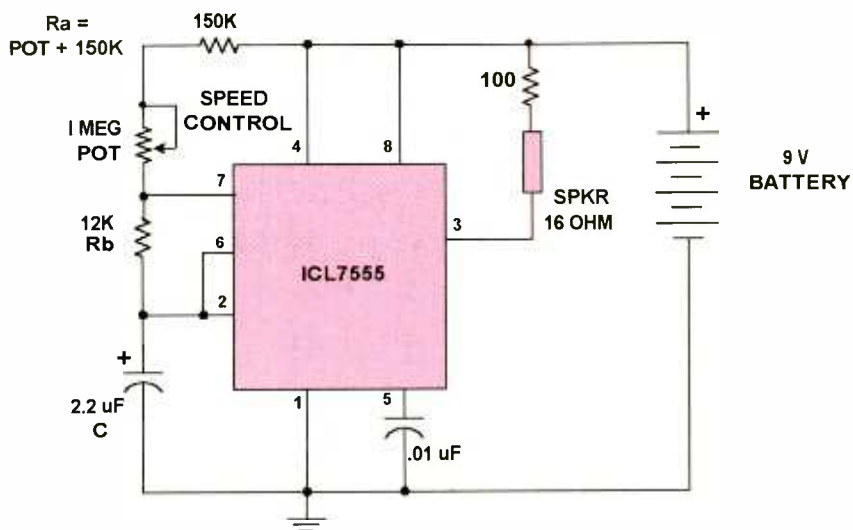
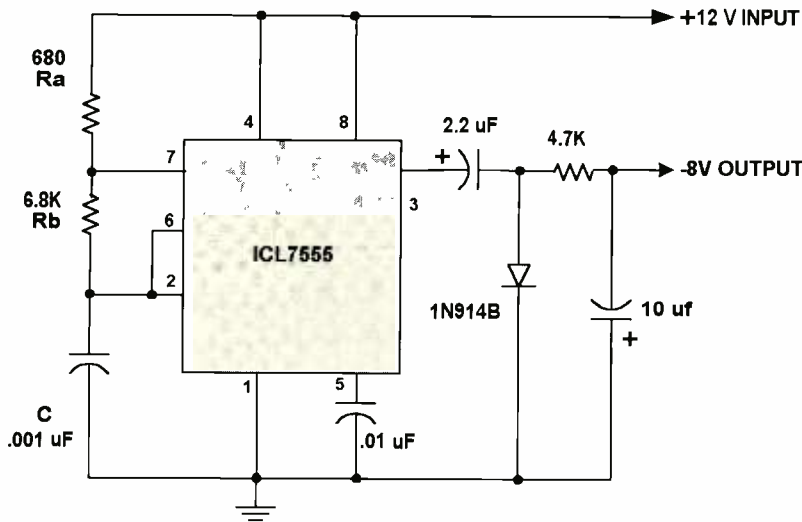

FIG 2
METRONOME CIRCUIT



**FIG 3
DC-DC CONVERTER CIRCUIT**

trusted with the NE555, which limits resistor size to about 10 megohms. This feature allows long time delays with more reasonable-size components.

In this circuit, we used a 1- μ F tantalum capacitor for its small size, low leakage, and stability. For a frequency of 1.33 Hz with a ten percent (0.1) duty cycle

$$(R_a + 2R_b) = 1.05M = 1050K$$

and

$$\text{Duty Cycle} = R_b / (R_a + 2R_b) = 0.1$$

Then

$$R_b = 0.1 (R_a) + 0.2 (R_b)$$

or

$$R_a = 8 R_b$$

Then

$$1.33 = 1.4 / (R_a + 2R_b)(1)$$

substituting

$$R_a + 2R_b = 10R_b = 1.05M$$

and

then

$$R_b = 0.105M$$

and

$$R_a = 8R_b = 0.84M$$

In practice, an 820-K resistor could be used for R_a and a 100-K for R_b . The values could be increased by a factor of 10 if a 0.1- μ F timing cap was used instead of 1- μ F. Using surface-mount components with a surface-mount IC and LEDs, this circuit can be packaged into a very small configuration, limited only by the battery size. This reduction is very close to 50% without any extra components needed.

The square wave present at pin 3 is fed to a rectifier and filtered to obtain a DC bias voltage. Since very low current is required (a few tenths of a milliampere), small capacitors and large resistors can be used. A frequency of around 50 to 100 kHz is appropriate to minimize component size. R_a and R_b will determine the duty cycle and frequency. Choosing C to be .001 μ F (a convenient standard value) and the frequency to be 100 kHz

$$F = 1.4 / (R_a + 2R_b)C$$

and, therefore

$$R_a + 2R_b = 1.4 / (F \times C)$$

If $C = .001 \mu$ F and $F = 100$ kHz, then

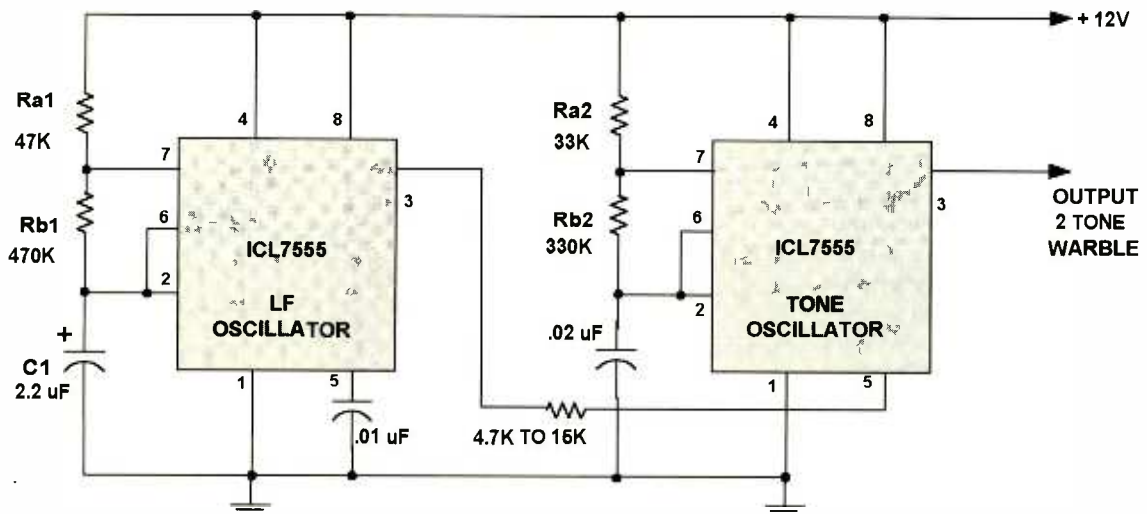

**FIG 4
WARBLING TONE GENERATOR**

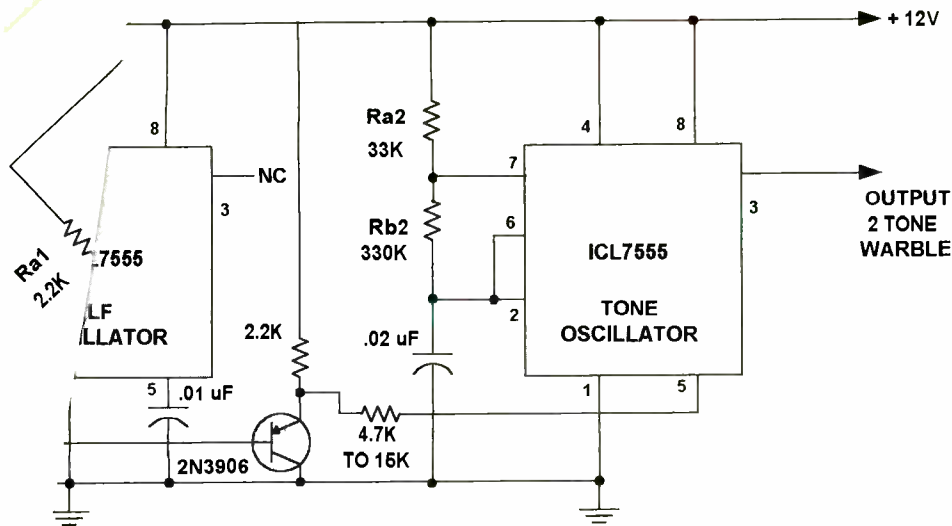

FIG 5
SLIDING TONE GENERATOR

$$.01 = 1.4 / (.001 \times 100,000) = 1.4 / 100 = .014 \text{ M}$$

Since Ra was set equal to 0.1Rb, 2.1 Rb = .014M, and Rb = .014/2.1 = .00666M or 6.66K (close to the standard value of 6.8K, using 6.8K for Rb), then Ra will be 680 ohms.

The Electronic Metronome

The 555 can also be used as a tone or pulse generator for various purposes. The output can drive loads up to 100 mA under certain conditions. Consult the manufacturer's data sheet for a detailed explanation of maximum current and voltage ratings. A circuit of an electronic metronome is shown in Fig. 2. This circuit generates a variable frequency pulse of from 40 to 200 pulses per minute and drives a speaker, producing a click each cycle. Using a commonly available 1-M potentiometer with a 150-K series resistor for Ra, we get a 150K-1.15M-resistance range. Since the maximum frequency will be 200 Pulses Per Minute (ppm), this frequency is 200/60 = 3.33 Hz, or 300 msec between pulses. If a 20-msec pulse is used to produce a good audible click in the speaker, the duty cycle at 200 ppm will be 20/300 or 6.67 percent. Under these conditions, Ra is 150K (pot set at zero resistance). Then Rb/Ra + 2Rb will equal .0667. As Ra is 150K with the pot set at zero resistance

$$Rb / (Ra + 2Rb) = .0667$$

and then

$$.0667Ra = .867Rb$$

or

$$Rb = .076 Ra = 11.5K$$

(Closest standard value of 12K will be used.)

Then

$$F = 1.4 / (Ra + 2Rb) C$$

and solving for C

$$C = 1.4 / F(Ra + 2Rb)$$

where C is in μF , R is in megohms, and F is in Hz,

$$C = 1.4 / 3.33 (.174) = 2.416 \mu\text{F}$$

(use a 2.2- μF 10% tantalum electrolytic)

Then

$$F = 1.4 / (.174)(2.2) = 3.657 \text{ Hz}$$

this is

$$3.657 \times 60 = 219.4 \text{ ppm}$$

As a check, at full resistance pot setting Ra + 2Rb will be 1.174M. Using C = 2.2 μF , then

$$F = 1.4 / (1.174) (2.2) = 0.542 \text{ Hz}$$

or

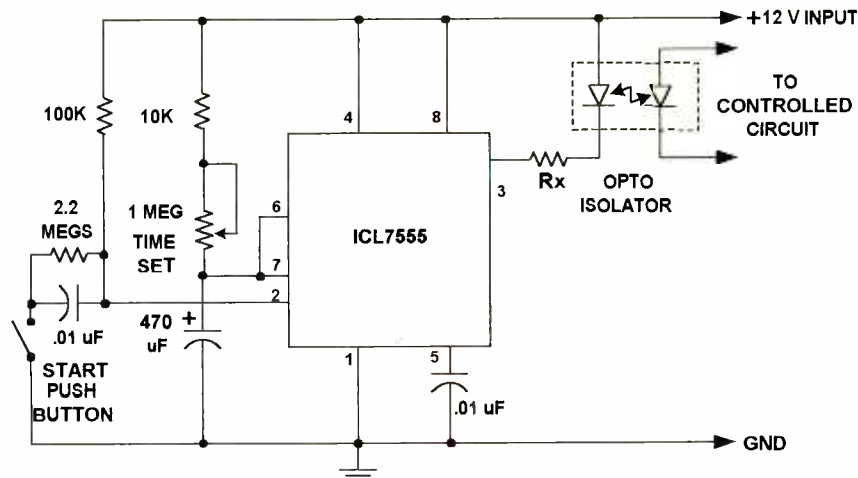

FIG 6
TIMER CIRCUIT

$$0.542 \times 60 = 32.5 \text{ ppm}$$

Therefore, the 40- to 200-ppm range is covered with room to spare.

Since frequency is inversely proportional to capacitance, substituting a smaller capacitor will increase the frequency. If we wanted a 300-Hz minimum frequency, the 2.2- μF capacitor can be changed by a factor of $3.33/300 = 0.0111$ and would be $.0244 \mu\text{F}$ (use $.0022 \mu\text{F}$ in parallel with $.022 \mu\text{F}$ for standard values to get $0.0242 \mu\text{F}$, close enough). This capacitor would give a range of 300 to 1500 Hz. A log taper pot is recommended for a smoother acting control, as this will make it less critical to adjust at the high frequency end of the range.

Voltage Converter

The next circuit is a voltage converter using the 555. While dedicated ICs for this purpose are available, the common NE555 or 7555 can be used instead for non-critical applications—without troubling to obtain the specialized IC. Figure 3 illustrates a circuit to obtain negative bias for an automatic gain-control application. Minus 5 volts was required, but +12V was the only DC supply available. The NE555 is set up as a square-wave oscillator of about 40-percent duty cycle. Ideally a 50-percent duty cycle would be used in this application, but without a few extra components this is not possible. If R_a is made equal to $0.1R_b$,

$$\text{Duty Cycle} = R_b/2.1R_b$$

or 47.6 percent.

The square wave appearing at the output (pin 3) is fed to C_2 , which couples it to rectifier diode D_1 and filter network R_1 and C_3 . The negative DC

output appears across C_1 . Depending on load, up to -8 volts DC is available for biasing purposes. If more current is needed, use smaller values of R_2 and larger values of C_3 . The DC voltage output will not exhibit very close regulation, but it will be good enough for the intended bias purposes. One of the 79L series of regulators could regulate the output voltage to -5 volts, if desired. This circuit could be run at low frequencies if RFI generation is a consideration, as larger but still reasonable component values could be used. If C was made equal to $1 \mu\text{F}$ and C_3 was $1000 \mu\text{F}$, the circuit would run at 100 Hz with similar performance.

Time Generators

The NE555 can be frequency modulated by another NE555 to produce tones whose frequency varies with time. Pin 5 sets the threshold voltage at which the internal comparator causes the internal flip-flop to change state. Normally this is $2/3 V_{CC}$, but since the voltage is derived from an internal resistive divider, it is possible to superimpose an external modulation signal on it. Shifting this voltage will change the time on the R-C charging curve when the threshold is reached, which causes a change in frequency. A positive-going voltage lowers the frequency, a negative raises it. Figure 4 shows how it can be done. IC1 generates a low-frequency square wave. The output voltage is used to shift the threshold of IC2. This circuit will produce alternating high and low tones.

A way to generate a swept tone is presented in Fig. 5. The capacitor voltage is read with an emitter follower and shifts the threshold voltage with a sawtooth. By using waveshaping circuits and

inverted, may generate

555 Timer

A timer ^{sawtooth polarity} device is shown in Fig. 6. By ^{providing} ^{can be} using short times (light enlargers, cameras, etc.) can be used for hours (lighting chargers, etc.) can be used for safety reasons, an optoisolator can be used to control the circuit from the AC power source, controlling a triac or solid-state device (not shown). The circuit uses the 555 timer in the monostable mode. It is triggered by a triggering pulse applied to pin 2. This voltage can be derived from a manual switch of some sort (pushbutton, etc.) or a logic circuit, and it must drive this pin below $1/3 V_{CC}$. The time interval in this application is

$$T = 1.1 RC$$

where $R = M$ and $C = \mu\text{F}$.

There are many, many other uses for these timers. Consult the manufacturer's application notes and the literature for more examples and ideas for their circuit applications. P



YOU CAN WIND YOUR OWN COILS?

There's no trick to it except knowing what you are doing. In a unique, 106-page book you can become expert in winding RF, IF,

audio and power coils, chokes and transformers. Practically every type of coil is discussed and necessary calculations are given with the mathematical data simplified for use by anyone. Get your copy today!

Mail coupon to:

Electronics Technology Today, Inc.
P.O. Box 240
Massapequa Park, NY 11762-0240

Please send me my copy of *Coil Design and Construction Manual* (BP160). I enclose a check or money order for \$8.99 to cover the book's cost and shipping-and-handling expenses. NY state residents must add local sales tax.

Name _____
Address _____
City _____ State _____ ZIP _____

All orders must be paid in U.S. funds only. Sorry, no orders accepted outside of USA and Canada. Please allow 6-8 weeks for delivery. ET07

NORTH COUNTRY RADIO: A HAVEN FOR WIRELESS BUFFS

Graf and Sheets are no strangers to the pages of Gernsback. Their educational projects, such as the *RF-Field Strength Meter* and the *MPX2000 FM Transmitter*, can be found at **North Country Radio**. Established in 1986, this company offers projects related to amateur TV transmitters/receivers, AM and FM transmitters/receivers, video cameras, and numerous other subjects. Visit the Web site at www.northcountryradio.com for more information.

Ordering Information: PO Box 53, Wykagyl Station, New Rochelle, NY 10804-0053; Voice: 914-235-6611; Fax: 914-576-6051; e-mail: Rgraf30832@aol.com.

Engineering and Technical Support
PO Box 200, Hartford, NY 12838
Voice/Fax: 518-854-9280
e-mail: support@northcountryradio.com

Varying Resistor Tolerances

Several readers wrote to point out an error I made concerning the overall tolerance of several series-connected resistors. My mind was on things like risetimes of cascaded instruments when I stated (July 2002) that the tolerance would be worse than that of an individual resistor. In the case of the risetimes, you use the square root of the sum of the squares of the individual risetimes. I don't know what I was thinking when I quickly applied that same equation to the resistors. Regardless of the resistor values (whether they are in series, parallel, or a series-parallel combination) and as long as they have equal tolerances, the tolerance of the circuit will be the tolerance of an individual resistor.

First of all, a pile of thanks is due for Gary Gustafson, Stephen Hayes, Michael Mahon, and Howard Mark, all of whom contributed their knowledgeable views on this topic. I love hearing from readers on a variety of topics. Ya'll don't have to wait until I make a mistake to write! These readers have brought up some interesting points regarding multiple-resistor circuits.

Regarding just our original series circuit, similar to the 5-resistor circuit in Fig. 1, some folks will throw in a few laws of statistics and probability to come up with an even lower tolerance for the string than what an individual resistor contributes. I would normally hold to statistics if the subject were machining or cesium beam frequency standards. Does the general population of a state prison follow the same statistical tables on the propensity to commit crimes as does the population of Oskaloosa, Iowa? Of course not! It's a batch problem. I hold more with Murphy's Law (nth-degree-sure-thing-when-you-least-need-it vs. probability) than I do statistics and probability when it comes to design. If I have three resistors in series, I'll assume that all three could go worst case and shift their full tolerance in the same direction at the same time. My feeling is that statistics go out the win-

dow because resistors, like yarn and fabric, are made in batches. The components within a batch will have similar characteristics; and although they were manufactured such that they had an even distribution around the design center value, they cannot be trusted to necessarily hold to that distribution ratio even though their values change. Carbon resistors, being what they are, tend to drift higher in value as they age. Unlike the story of other electronic components, you cannot necessarily count on an even distribution about the design value to hold over time so that you can assign a tighter tolerance to a series string. That assumption would be if one goes high in value, it's likely that another will go low—which isn't a sure thing with carbon resistors. The statistical assumption is that if the resistor values change, they will randomly move up and/or down, yet still remain centered about the design value, such that if you averaged the values of a thousand of the critters, you'd end up with the original marked value. Carbon resistors just don't do that. They tend to move higher in value, especially if they're the older carbon-composition types.

Now, even after writing all that, I will concede that while carbon-composition resistors will fit that description regarding statistics after they're first made, carbon-FILM resistors will likely behave a little better because they don't have the clay component in their construction. Although the carbon still has a rotten *temperature coefficient* (tempco), changing value with changes in ambient temperature, the "clay" component of a composition resistor probably contributes as much to some of the unreliable characteristics as anything.

A statistical computation was illustrated by one reader, showing that multiple resistors in series will exhibit a lower overall tolerance than that of an individual resistor. In fact, Michael offered the excellent example of a machinist clamping across multiple threads of a lead screw to tighten the tolerance for making an even better lead screw in order to make a better metal lathe using a lousier lathe. What I don't

like about this computation is that the more resistors you have in series, the lower the overall projected tolerance becomes. It can be extrapolated that if you have enough resistors in series, the tolerance will drop to nearly zero percent. Presto: We have a standard on our hands that is equal in uncertainty to the standard used to manufacture the resistors. If that original standard were a primary standard, we would then have an identical "primary standard" on our hands, although it would take a few thousand resistors to do so. There is a limit to how far you can use statistics to form such a projection. Although this computation can be applied to other disciplines, I don't think it truly works with fixed resistors. Again, all this is going to be subject to batch problems at the manufacturing end.

Let's examine that lead screw example to see what's really happening overall. A lead screw is a lot like a 10-turn precision wirewound potentiometer such as a Helipot. There are two specifications—accuracy and linearity. The 10-turn pot has lousy overall accuracy of 5%, but a linearity figure of 0.25%. Whether clamping across multiple threads of a lead screw or using lots of resistors in a string, you're dependent upon one thing—the accuracy of the original standard. The multiple threads being used are giving you more precision in the resulting lead screw. If the original screw had a linearity figure of 0.001 inch, clamping across multiple threads might improve the linearity of the new screw to 0.0005 inch. If someone had messed up in making the original screw such that the pitch was off by 10%, the resulting screw, although linear along its length to 0.0005 inch, will be no more accurate overall than 10%—whether you had clamped across 5 threads or 50 threads.

Another downside to the lots-of-resistors-make-for-better-tolerance issue also revolves around statistics and probability. As the component count increases, so does the likelihood of failure. Ergo, a 32-resistor divider, though statistically having a better tolerance, will also be prone to a higher failure rate

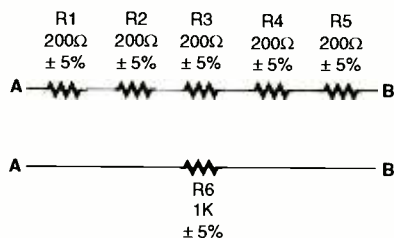

Fig. 1. Both of these circuits have the same resistance value, 1000 ohms. The question is— is one more accurate or more precise than the other?

than a 4-resistor divider.

An interesting batch problem existed in the Tektronix 2213/2215 oscilloscopes where five 510 K-ohm, +-watt carbon-composition resistors were used in a series-string voltage divider in the high-voltage circuit, very much like the circuits we are discussing. A common problem with these resistors in this circuit is that one by one, they would increase in value, anywhere from 600K ohms to over 20 megohms! It might be only one resistor in that circuit or several resistors that would go sour. If only one resistor had taken the trip, do you think we'd replace only that one? Goodness, no! If it was a 510K-ohm, +-watt, carbon-composition resistor, it was replaced, even if it measured exactly 510K ohms. I always replaced them with carbon-film resistors with no problems later on. Although there may have been some high-voltage concerns where a film resistor might perform worse than the comp resistor, the film resistors certainly ended up being less of a problem than the original comp resistors. By the way, if you own one of those scopes and you run out of range for adjusting the focus, I'd bet my next column paycheck that those resistors are to blame if they're the original comp types.

If all series resistors are of the same value but have different tolerances, the resultant tolerance will be the AVERAGE of the individual tolerances. If the resistors are different in value and tolerance, the resulting tolerance will be a goofy number. I'm quite sure that it's mathematically predictable, but for what we're doing here, it's a wasted effort. It would be like having a chain where no two links are alike.

A lot of this comes down to the difference between accuracy and precision. We might have an increase in precision to 0.0001% with lots of resistors (or lots of lead screw threads), but the final accuracy (tolerance) is still no better than the

original standard or the ability of the resistors to hold their value over environmental and age changes. Try as you might, I don't believe for a minute that you're going to improve upon a 5% resistor tolerance by putting multiple 5% resistors together, for that very reason alone.

Now, whether I'm 100% right on all this, I cannot guarantee. My true intention was to throw some doubt into what I feel is an artificially high confidence level in statistics and component tolerances. Have I succeeded? Would I have succeeded by using only the preceding paragraph and not wasting your time with the first nine paragraphs?

Resistor Types

Although this subject came up as part of Stephen Hayes' comment concerning that same high-voltage voltage divider, I'm breaking this subject out as a separate item. Stephen mentioned several characteristic differences between carbon-composition and carbon-film resistors. I thought it would be good to mention some of these differences here while we're on the subject.

Fixed carbon resistors are available as two types: composition and film. It's a lot more difficult now to find carbon-composition resistors. Allen-Bradley quit making them about ten years ago. Asian carbon-film resistors are the ones commonly available these days. There are differences between the two types of resistor construction that you should know about, and there are good and bad things about both that may help you make a selection of one over the other in your next project. You can still find carbon-composition resistors in the Mouser Electronics (www.mouser.com) catalog. They are Asian imports just like all the rest, but they're composition resistors, nonetheless.

Comp resistors are made from slugs of a carbon/"clay" mixture that has an outer insulating layer. As such, it has more mass in the resistive element and that allows a comp resistor to absorb short-term power surges. A film resistor is made by depositing a carbon film on an insulating ceramic substrate with an insulating layer over the top. There's not much substance to the resistive element in a film resistor since it has very little cross-sectional area. A +-watt comp resistor can take a 10-watt surge for a half-second or so and survive intact with

not much harm. That same surge will smoke a film resistor having the same value and power rating. For long-term steady-state or average power levels, the two types of resistors will pretty much work the same. It's the spikes and short-term overloads that you have to watch.

Another advantage of a carbon-comp resistor is the old-timers' method of making custom value resistors. They would select a resistor whose standard value was just higher than the actual value they needed. Then they'd use a triangular saw file to file a notch in the side of the resistor, filing out part of the resistive cross-section. They'd file a little and measure the resistance until they achieved the value they needed. If they filed too far, they had to start over with a fresh resistor. The smarter ones would seal the wound on the resistor with several dabs of clear fingernail polish. Then the lie would issue forth: "Yep, it's just like one o' them fancy one-percenters, but a lot cheaper," and they'd build a complete item of test equipment around a bunch of the things or use one to replace an off-value precision resistor in their meter. The truth is that a carbon resistor has a lousy tempco. If Melvin shaved a resistor out in his 30-degree garage one winter, the resistor will have moved outside of its intended 1% tolerance by mid-summer if not early spring. And long-term aging will take its toll, too. Carbon resistors are just not that stable. That filing process that eats away a chunk of the resistor also eats away some of the power-handling characteristics of the component. Also, the resistor becomes more fragile and easy to break.

I've found that most carbon-film resistors will measure well within 1% of their marked value even though they may have a 5% tolerance. Comp resistors, even new ones back in 1970, didn't do that well. Beware of buying "NOS" (New Old Stock) carbon-comp resistors. They're unused, maybe still in a wrapper, but might have been made in 1953. Most of the time, if you check them with an ohmmeter, you'll find that they're far outside of their specified tolerance. It seems that the higher the marked value, the worse this problem is. I had to trash an entire drawer of NOS 390K-ohm resistors once because they had all shifted up in value by nearly 20%. Finding that problem had involved some intense troubleshooting of a project involving one of them.

Film resistors are also a lot cheaper than comp resistors. I've always made it

a practice that when needing a specific quarter-watt film-resistor value, I'd order a package of 200 rather than a smaller package of 10 or just what I need. That way, you're paying less than two cents each for them and you're building up your stock. In fact, they've gotten so cheap that when I tear apart a breadboarded project, it's a temptation to just throw the resistors away with the broken pieces of wire rather than painstakingly putting each of them back into their proper drawer.

Although not the subject of the topic, I'll throw in the fact that 1% tolerance

metal-film resistors, which used to cost one or two bucks each back in 1965, are now so reasonable in cost that it makes sense to build some circuits using them rather than carbon-film types. Whenever I build an oscillator, timer, filter, low-noise amplifier or precision-gain amplifier, I'll usually use metal-film resistors so that the set frequencies and gains don't appreciably drift. Along the same lines, I'll use polyester-film capacitors in the frequency-determining portions of those circuits rather than ceramic capacitors. The tempo of ceramic capacitors, other than the NP0 types, is horrible.

Rail Gauge?

The term "rail-to-rail" has one meaning to model railroaders. To the electronics hobbyist, the term "rail-to-rail" describes a new breed of electronics that enhances device operation, typically aimed at lower supply voltages.

A question on this subject came up on the Gernsback forum recently and involved a "Q & A" circuit that was published in the June 2001 column in response to a reader who needed a unity-gain inverter for an automotive application. The circuit, shown in Fig. 2, needed to invert an analog signal with a zero to +5 volt range so that the output would be from +5 to zero volts instead. The question was "What's a rail-to-rail op-amp and why do I need it in this circuit?" Since these devices are becoming more commonplace, I thought than an explanation was in order.

Most op-amps and most discrete amplifiers, for that matter, have a power supply of a certain voltage; in this case, we'll assume 12 volts. It may have a +12 and a -12-volt bipolar supply or a +12-volt single-ended supply. In any case, the transistors in the op-amp cannot completely saturate, so the output can never quite make it all the way to either supply extreme. For instance, the popular 741 op-amp with a bipolar supply can only put out a maximum of about +11 or -11 volts before ugly things start to happen. At around 10 or 10.5 volts, the output may start to get a little nonlinear and not follow the input waveform faithfully, resulting in distortion in an audio system. Once the output voltage reaches the 11- or 11.5-volt point, the transistors saturate and the voltage won't get any higher regardless of what the input wants it to do. This is the "clipping point" of the op-amp.

In most instances, we don't have to worry about the signal in those areas because we design the circuit so that the output signal normally stays within reasonable limits. It's the "Mom" thing: "If you don't run with the wrong people or go to the wrong places, you won't get into trouble."

Over the years, designers have been lowering the supply voltages in their systems. They want their batteries to have fewer cells; they don't want to have to use voltage converters; and digital circuits can run a little faster if the output logic swings don't have to be as large. Analog circuits are adversely affected by

HOW TO GET INFORMATION ABOUT ELECTRONICS

On the Internet: See our Web site at www.poptronics.com for information and files relating to **Poptronics** and our former magazines (**Electronics Now** and **Popular Electronics**) and links to other useful sites.

To discuss electronics with your fellow enthusiasts, visit the newsgroups sci.electronics.repair, sci.electronics.components, sci.electronics.design, and rec.radio.amaieur.homebrew. "For sale" messages are permitted only in rec.radio.swap and misc.industry.electronics.marketplace.

Many electronic component manufacturers have Web pages; see the directory at www.hitex.com/chipdir/, or try addresses such as www.ti.com and www.motrola.com (substituting any company's name or abbreviation as appropriate). Many IC data sheets can be viewed online: www.questlink.com features IC data sheets and gives you the ability to buy many of the ICs in small quantities using a credit card. You can also get detailed IC information from www.icmaster.com, which is now free of charge although it formerly required a subscription. Extensive information about how to repair consumer electronic devices and computers can be found at www.repairfaq.org

Books: Several good introductory electronics books are available at RadioShack, including one on building power supplies.

An excellent general electronics textbook is *The Art of Electronics*, by Paul Horowitz and Winfield Hill, available from the publisher (Cambridge University Press, 800-872-7423) or on special order through any bookstore. Its 1125 pages are full of information on how to build working circuits, with a minimum of mathematics.

Also indispensable is *The ARRL Handbook for Radio Amateurs*, comprising over 1000 pages of theory, radio circuits, and ready-to-build projects, available from the American Radio Relay League, Newington, CT 06111, and from ham-radio equipment dealers.

Back issues: Copies of back issues of and past articles in **Electronics Now**, **Popular Electronics**, and **Poptronics** can be ordered on an "as available basis" from Clagg, Inc., Reprint Department, P.O. Box 12162,

Hauppauge, NY 11788; Tel: 631-592-6721. To ensure receipt of the correct material, readers must supply complete information on the article or issue that they wish to buy.

Poptronics and many other magazines are indexed in the *Reader's Guide to Periodical Literature*, available at your public library. Copies of articles in other magazines can be obtained through your public library's interlibrary loan service; expect to pay about 30 cents a page.

Service manuals: Manuals for radios, TVs, VCRs, audio equipment, and some computers are available from Howard W. Sams & Co., Indianapolis, IN 46214; (800-428-7267). The free Sams catalog also lists addresses of manufacturers and parts dealers. Even if an item isn't listed in the catalog, it pays to call Sams; they may have a schematic on file which they can copy for you.

Manuals for older test equipment and ham radio gear are available from Hi Manuals, PO Box 802, Council Bluffs, IA 51502, and Manuals Plus, 130 N. Cutler Dr., N. Salt Lake, UT 84054.

Replacement semiconductors: Replacement transistors, ICs, and other semiconductors, marketed by Philips ECG, NTE, and Thomson (SK), are available through most parts dealers (including RadioShack on special order). The ECG, NTE, and SK lines contain a few hundred parts that substitute for many thousands of others; a directory (supplied as a large book and on diskette) tells you which one to use. NTE numbers usually match ECG; SK numbers are different.

Remember that the "2S" in a Japanese type number is usually omitted; a transistor marked D945 is actually a 2SD945.

Hamfests (swap meets) and local organizations: These can be located by writing to the American Radio Relay League, Newington, CT 06111; (www.arri.org). A hamfest is an excellent place to pick up used test equipment, older parts, and other items at bargain prices, as well as to meet your fellow electronics enthusiasts—both amateur and professional.

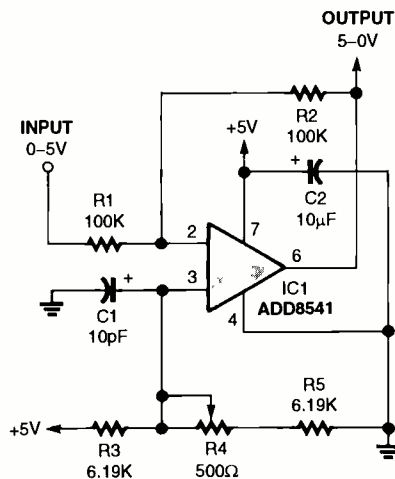

Fig. 2. This precision, unity-gain inverter features a rail-to-rail op-amp for full operation over the zero-to-five volt supply range.

this. In the “old days,” an op-amp with a 12-volt supply could swing a full 22 volts from rail-to-rail (from positive supply to negative supply), which was about 92% of the available supply voltage. Today, this same op-amp, if it could work with a single 5-volt supply, could only swing from +1 to +4 volts. That’s about 60% of the available supply voltage, limited by the saturation of the transistors. To add insult to injury, most common op-amps don’t like to work on these lower supply voltages anyway.

Enter the rail-to-rail op-amp. This puppy is designed so that the output can swing very close to the supply rails. Early versions could get within 0.1 volt of the supply rail. Current production units can get within just a few millivolts of the rails. Now that op-amp with the single-ended 5-volt supply can have an output that swings almost the full amount from nearly zero to nearly +5 volts, almost 100% of the available supply voltage. While the output is heading toward a rail, it’s remaining linear in operation all the way to the point where it hits the rail and clips. In addition, they’re made to operate on supply voltages as low as 3 volts with no problems.

There are a couple of versions of rail-to-rail op-amps. Some are rail-to-rail on the output only, which in most cases is fine. However, if you’re running the amplifier at unity gain or less, that will be a problem because the input transistors and other transistors that drive the output circuit may saturate on the input signal before the output has a chance to do anything significant. So, later versions of the op-amps will be rail-to-rail input and rail-to-rail output, usually

marked as “rail-to-rail I/O” on data sheets.

A follow-up question was “Are there any common NExxx, LMxxx, or TL0xx op-amps that will work in that circuit?” As far as the common chips that you can find at your retail electronics stores, I don’t know of any. Rail-to-rail op-amps will always have that capability noted in the device description on the data sheet, exemplified in Maxim’s MAX4162, which is described as a “MICROPOWER, SINGLE-SUPPLY, RAIL-TO-RAIL, I/O OP AMP.” Rail-to-rail operation is an important characteristic, so it goes in the description.

A third question popped up regarding the fact that “... this circuit really won’t go all the way to exactly zero or all the way to exactly +5 volts. You should design a circuit that will go all the way.” If you think about it, rarely do you have to have a perfect output at an extreme. In this application, which was for a MAP (manifold absolute-pressure) sensor on a car, an output at one of those extremes is more of a failure or problem mode than anything. It’s a moot point whether the voltage is +4.95 or exactly 5.00 volts as long as everything in between the extremes is linear. When Thelma and Louise drove their car off the rim of the Grand Canyon, it didn’t make much difference whether they were doing 60 mph or 120 mph—they were already operating at an extreme and the outcome was the same regardless of their speed.

The fourth and last question was “The trimpot only made a slight difference to the output.” That’s true. I tend to use 1% resistors for circuits like this and really should have specified 6.19K-ohm, 1% resistors for R3 and R5 in the voltage divider rather than 6.2K-ohm, 5% resistors as I did originally. I’ve made that change in the schematic this time. In either case, the lower value pot is there to compensate for tolerance variations in the fixed resistors of the voltage divider. A larger value pot could have been used with a resulting larger range of adjustment, but that would have made adjustment to the exact that much more difficult. This way, instead of a “coarse” control, you have a “fine” control that’s easier to set right on.

A final point on the circuit was that I noticed that in the original column, I had never even mentioned R4, a 500-ohm trimpot, and how to adjust the thing. With an input of exactly 2.5 volts,

adjust the trimpot for exactly 2.5 volts at the output. Simple as that. For an even better adjustment, use an input voltage that is in the center of the range where the MAP sensor will be operating. Set the input at that voltage and adjust the output for a value that is five volts minus that input voltage. That way, any gain error will be negligible at the center of the operating range where accurate unity gain is the most important.

Picture-In-Picture

Q I checked the Poptronics Web site, but I couldn’t find information about a circuit to be used as a TV accessory to allow thumbnail pictures of five or six designated channels to be displayed at the bottom of the TV screen. Kindly enlighten or guide me to some sources where I can find this information.—S.M., India

A This is a technique known as “picture-in-picture” (PIP), and there are two or three versions of this concept. Each active, full-motion “thumbnail” inset picture will require a tuner, so the more active insets you have, the more expensive the TV or accessory becomes. Most PIP sets that have a lot of insets will have frozen images on the insets that may be updated every few hundred milliseconds. One tuner output displays the main image and the second tuner, operating a lot like a scanner receiver, updates each image in sequence, having to electronically tune for each channel’s update. The images end up looking a lot like stop-action photography. It’s trickier than you might think, because to display each image correctly, the tuner has to wait long enough to synchronize with the incoming signal so that the black bar of the vertical interval doesn’t pop up in the middle of the picture.

I haven’t had enough disposable income lately to even consider walking through a big upper-end A/V store to know what’s available. It’s a three-hour trip to do that, because where I live, whatever comes out of Bentonville, AR is what I have for a selection. With the high-speed, frequency agile components that are becoming available, I don’t know why PIP couldn’t almost be “real time” on the images, at least no worse than a 10 frame-per-second refresh rate. I don’t suppose that the refresh rate could ever be any faster than 60 per-second divided by the number of PIP images, and that’s only if all channels

perfectly synchronized their frames with each other. I use 60 rather than 30 there, figuring that a PIP image is so small that we wouldn't have to worry about inter-lacing the fields.

I'm not aware of any accessories or construction articles for a project such as this. There is a point where it's actually less expensive to just buy eight 13-inch TVs and tune each to a different channel, much like the Reverend Jim did on one episode of *Taxi*. Of course, if all the TVs are the same brand, using the remote can be a bit tricky.

Salem Watch Hunts

Q *Is there any circuit or instrument that would detect the low-voltage power source of an electronic wrist watch? I have lost a wristwatch inside a house wall. Besides a metal detector or a non-linear junction detector, is there anything else that could pinpoint this electric wristwatch?—A.D., via e-mail*

A You've lost a device that can run on a 1.5-volt battery for three years and expect to find it electronically? Maybe. That's a pretty low signal level and it's well-shielded unless it's in a plastic case. Most electronic watches, save the original Bulova Accutron, are based on a crystal oscillator operating at 32.768 kHz. Can we pick up a harmonic of that signal on a radio receiver? First, I grabbed my 10-year-old Casio all-digital LCD (Liquid Crystal Display) watch, still running on its second battery, but with side buttons so corroded that they quit working years ago. Figuring on a 32,768-Hz square wave signal, I checked for the 17th harmonic at 557.056 kHz, the lowest harmonic that I could tune with my HF receivers. Whether using my RadioShack DX-375 or my Knight-Kit R-100A, I couldn't find a signal. Then I tried my quartz Timex with the mechanical analog dial that pulses the second hand each second (of course). No signal ... except that I did get an electromagnetic pulse of static every second if I held the watch within one or two inches of the loop antenna in the DX-375. No pulse heard on the R-100A. So, you have some hope. If it's an analog dial watch (mechanical, not fake LCD dial) and the watch dropped to the bottom plate in the wall, use a portable radio tuned to a dead spot on the AM broadcast band around 550 kHz. Hold the edge of the radio where the loop antenna is against

the wall near the bottom plate and start searching.

You might take a trip to RadioShack and tell them that if one of their portable receivers can pick up your watch signal, they have a sale. Get a similar watch and find a RS receiver that will tune to the LF (Low Frequency) or better yet, the VLF (Very Low Frequency) band. Hold the watch right next to the antenna and tune to an odd harmonic of the watch oscillator (32.768 kHz times any odd number that will get you to the low end of the receiver's band). For instance, the third harmonic will be 98.304 kHz. If the receiver can pick up WWVB at 60 kHz, maybe it can hear the watch at 98.304 kHz. I don't know how a synthesized receiver will work against an accurate crystal reference since you can't tune it "right on," but the receiver bandwidth should be wide enough that it'll work if the signal is strong enough. I don't hold out much hope in the signal strength department. Even after taking the back off my Casio, I couldn't get a signal at the higher frequencies.

Disgusting. I can pick up the radio frequency interference from my computer and monitor all over the house, but can't hear a watch that's sitting right on the radio. The simplest tool for finding the watch may be a claw hammer. That's how you discover where the watch really is. Bang! Bang! Rip! Rip! "Daddy, whatcha doin'?" "Trying to find my watch, son." "Da one I put in my dwesser dwawer?"

Writing to Q&A

As usual, we welcome your questions. Please be sure to include:

- (1) plenty of background material,
- (2) your full name and address on the letter (not just the envelope),
- (3) and a complete diagram, if asking about a circuit; and
- (4) type your letter or write neatly.

Send questions to Q&A, **Poptronics**, 275-G Marcus Blvd., Hauppauge, NY 11788 or to q&a@gernsback.com, but do not expect an immediate reply in these pages (because of our backlog). We regret that we cannot give personal replies. Please no graphics files larger than 100K.

BUY BONDS

5 GREAT PROJECT BOOKS

[] **BP-410 35 Opto-Display Terminal Block Projects. \$6.99.** If you use terminal blocks, no soldering is required to make complete this series of opto-displays that range from light-telegraphs, flashing lapel badges, magnetic detectors, plus more advanced projects including a dusk detector, games, and twinkling Christmas decorations.



[] **BP-411 Introduction to Surface-Mount Devices. \$6.99.**

Surface-mount construction can be easier, faster and less costly, and even the hobbyist can produce one-of-a-kind circuits using SMDs. PCB design, chip control, soldering techniques and specialist tools are fully covered. A complete variety of construction projects are also included.

[] **BP-413 Remote Control Projects. \$7.99.** A wealth of circuits and circuit modules for use in all kinds of remote-control applications are provided. There are complete details for 14 novel and practical remote control projects. Also included are techniques for interfacing a PC to a remote control system.



[] **BP-416 Practical Alarm Circuits. \$6.99.** Details of inexpensive but effective burglar alarms for the home constructor. The circuits include switch-activate alarm, FM audio alarm generator, Modulated fiber-optic loop alarm, Ultra-sonic breaking window alarm, Doppler shift ultrasonic sensor and more.

[] **BP-432 Simple Sensor Terminal Block Projects. \$6.99.** Sensors are the eyes, ears and noses of electronic systems. They include contact, light, heat, sound, magnetic, motion, resistance and voltage-operated devices. The projects in this book show you how you can build all of these, and if you use terminal blocks, no soldering is required. There are 31 individual projects to build and use.



To order one of these Books send amount indicated plus \$3.00 for shipping in the U.S. and Canada only to Electronics Technology Today Inc., P.O. Box 240, Massapequa Park, NY 11762-0240. Payment in U.S. funds by U.S. bank check or International Money Order. Please allow 6-8 weeks for delivery. MA09

Master PIC Interrupts And Build A DTMF Controller

My mother taught me that it's impolite to interrupt. I can't help myself. I must interrupt, over and over again. I'm referring to PIC interrupts. Without them, not a lot would get done.

Interrupts are used for many things. A timer will generate an interrupt when its time expires, and data registers often generate interrupts if they overflow (have more data than they can hold). The 16F628 has ten sources of interrupt, among which are

- External Interrupt RB0/INT
- TMR0 Overflow Interrupt
- PortB Change Interrupts (pins 4, 5, 6, 7)
- Comparator Interrupt
- USART Interrupt
- CCP Interrupt
- TMR1 Overflow Interrupt
- TMR2 Match Interrupt

An interrupt control register, labeled INTCON (Table 1), enables/disables the interrupts, and monitors and records individual interrupts. Each time an interrupt is detected, a flag is set inside this register—a flag that can direct your software to stop what it's doing to take care of a more pressing task, and then go back to what it was doing.

Interrupts may be enabled or disabled at two levels: global or specific. Global interrupts are controlled by Bit 7 of the INTCON register, which enables/disables all interrupts in one fell swoop. When it's not wanted or convenient to use a global interrupt, individual interrupts can be enabled or disabled on a case-by-case basis.

About The RB0/INT Port

The most common use of interrupts is to notify the PIC of incoming data

LISTING 1

```
movlw 1 ;Make PORTB,0 an input for the interrupt.
tris PORTB

movlw b'11000000' ;Interrupt triggers on rising edge.
option

bsf INTCON, INTE ;Turn on RB0 interrupt.
bcf INTCON, INTF ;Clear INTF flag.
bsf INTCON, GIE ;Enable global interrupts.
clrf keyval ;Clear the data register.
```

from an external source, like an ADC or decoder. The edge-triggered RB0/INT port (pin 6) is a general-purpose input that generates an interrupt on either the rising or falling edge of an input pulse when that port is enabled as an interrupt. The interrupt feature is turned on by the INTE bit (Bit 4) of the interrupt control register; the INTEDG bit (Bit 6) in the option register determines which edge the input triggers on.

As always, I'm going to teach you through example. For this exercise I've chosen a DTMF decoder that will interrupt the PIC when a valid key press is detected. See Listing 1 for part of the Main code for that program.

Let's take it line by line so that you get the gist of what's going on. First Port B pin 0 (RB0) is made an input and the other Port B pins are defined as outputs by issuing the "tris" command. The next line is kinda tricky, because here I call the option register directly and set the interrupt to trigger on the rising edge. You really need to know your way around registers to do this. Another way to do this is to set that register bit using the bit set command (bsf). It looks like this.

```
bsf OPTION, INTEDG ;Enable RB0/INT for rising edge
```

In fact, that's what I do in the next line

LISTING 2

```
Loop
btfss PORTB,7 ;check output to see if it's high or low
goto Loop ;back to the beginning to see if PORTB,7 is high
bsf PORTB,6 ;if it's high, turn on the LED
call OneSecDel ;call the one-second delay module
bcf PORTB,6 ;turn off LED
call OneSecDel ;call the one-second delay module
goto Loop ;back to the beginning to see if PORTB,7 is still high
```

TABLE 1
INTERRUPT CONTROL REGISTER (INTCON)

Bit 7	Bit 6	Bit 5	Bit 4	Bit 3	Bit 2	Bit 1	Bit 0
GIE	EEIE	TOIE	INTE	RBIE	TOIF	INTF	RBIF
Control bits					Flag bits		
0 = Disable 1 = Enable					0 = No interrupt or change 1 = Overflow, interrupt, change		

to turn on the RB0 interrupt. (Another alternative is `bsf OPTION, 6`, where the bit is called by number rather than label.) Why mix it up, you ask? Just to show you that there's more than one way to skin a cat.

The rest of the code is pretty straightforward. Next the interrupt flag bit (INTF) is cleared. This has to be done every time to ensure that the interrupt bit will go high when the interrupt occurs. Same goes for clearing the data register, `keyval`.

Hey There!

What we do now is wait for something to happen. In our case, it's a signal from the DTMF decoder telling us a key has been pressed and that we should read the value of that key. On interrupt, a flag bit associated with that interrupt is set. In our example, this would be the INTF flag, which is set by the rising edge of a pulse on the RB0/INT pin. The interrupt also clears the Global

Interrupt Enable flag (Bit 7), which puts all other interrupts on hold until the requesting interrupt is serviced.

The program is halted and directed to program location 004H. That part of the program is structured like this.

```

org    000H
;a reset redirects program to this point
goto  Main
;jump to Main program
org    004H
;an interrupt redirects the program to here
goto  ints
;jump to interrupt routine
    
```

This causes the interrupt routine to run. First, the interrupt flag is cleared, and the binary value from the decoder is loaded into the appropriate registers.

```

ints
;a-patch key search routine
bcf   INTCON,1;Clear the interrupt.
movwf wsave
    
```

```

;Save W and STATUS
swaph STATUS,w
;Have to save STATUS w/out affecting
  its bits
clrf  STATUS
;Swaph doesn't change any bits.
movwf statsv
    
```

I'll spare you the remainder of the code and simply summarize its actions (you can read the well-annotated code in the `A-patch.asm` module posted on the Poptronics Web site: www.gernshack.com).

PARTS LIST FOR THE DTMF CONTROLLER

SEMICONDUCTORS

- IC1—CD22204
- IC2—16F628
- IC3—78L05
- Q1—2N2222A
- LED1—1N4001

RESISTORS

- (All resistors are 1/4-watt, 5% units.)
- R1—270,000-ohms
 - R2—33,000-ohms
 - R3—1-megohm
 - R4, R5—1000-ohms

CAPACITORS

- C1, C3—.01- μ F
- C2—0.33- μ F
- C4—1500-pF (optional)

ADDITIONAL PARTS AND MATERIALS

- XTAL1—3.5795-MHz color-burst crystal
- RY1—5-volt DIP relay (DS2Y-S-DC5V -DPDT 5V 2A)
- J1, J2—2-pin berg connector

A kit of the above parts is available for \$35 from Futurlec, 1133 Broadway, Suite 706, New York, NY 10010 (www.futurlec.com), and includes a programmed PIC and printed circuit board. A programmed PIC is also available separately for \$12.

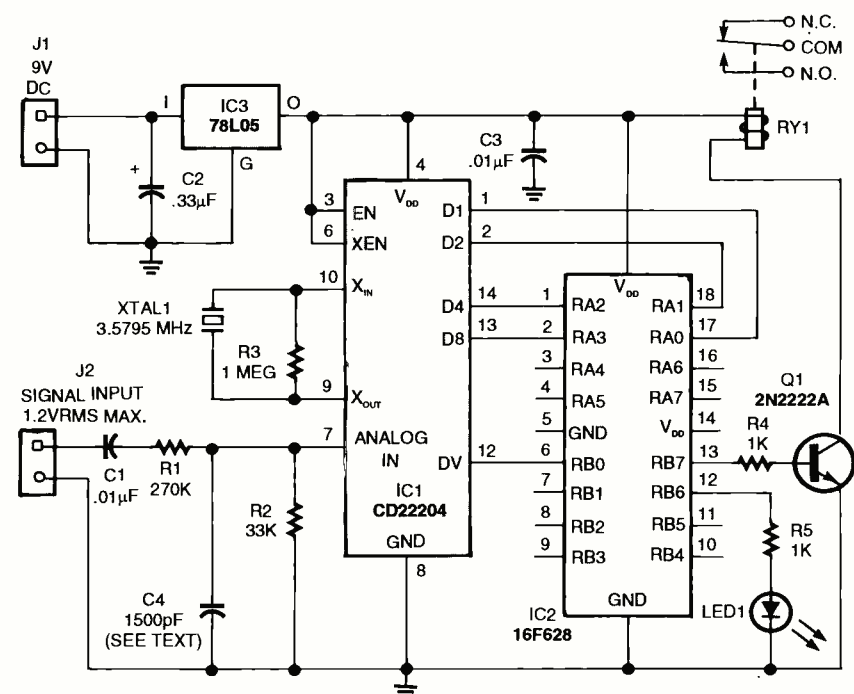

Fig. 1. The A-patch consists of a DTMF decoder and a 16F628 controller. The complete schematic for the patch is shown here.

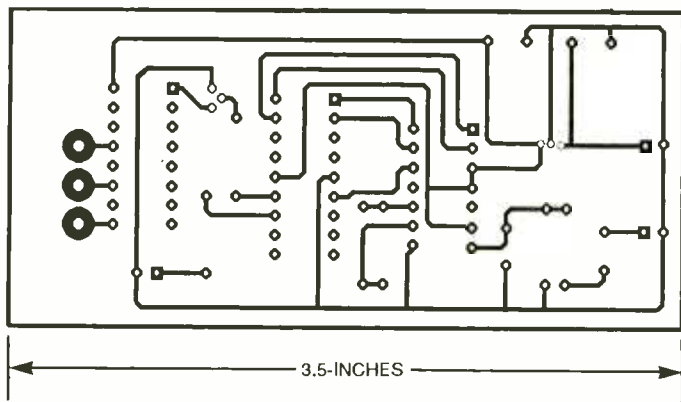

Fig. 2. This is the foil pattern for the A-patch circuit. A kit that comes complete with a printed circuit board is available from Futurlec, as noted in the Parts List.

First, the STATUS register is checked for data. When data is detected (loaded from the decoder), its value is checked to see if it equals '*' or '#'. If it doesn't, the register is cleared; and the program returns to the Main code. If it's a value we're looking for, the interrupt routine continues looking for our second value. Again the data is either discarded or saved, depending on the outcome of the comparison tests. In either event, you are eventually returned to the Main program, which patiently waits for the next interrupt.

Project: Repeater Autopatch

It's time to go from the classroom to the workshop and put together our project for this month using what we just learned. I selected a repeater autopatch.

A repeater is a radio "station," which consists of both a transmitter and a receiver that's located at a high place with a good "view" of the surrounding area. Its purpose is to allow radio operators to talk over a hill that would otherwise block their signal. The signal is received on one frequency and retrans-

mitted (repeated) on a different frequency.

Normally, the repeater has to be monitored, which limits the hours of operation to those times the owner can be on duty. However, it's possible to make the repeater autonomous by using what's called an autopatch (also known as an A-patch). Using standard DTMF telephone tones, the autopatch can turn the repeater on and off upon request. The tones may be broadcast by the initiator's station and received by the repeater's receiver or sent via landline (telephone) to the repeater site.

In either case, these tones have to be decoded at the repeater using an autopatch. That's what our project does. The tones themselves are decoded by a CD22204 DTMF receiver chip, while the PIC sorts the tones and reacts accordingly. Refer to the schematic in Fig. 1 for this discussion.

The CD22204 contains eight band-pass filters in the DTMF sequence of 697 Hz, 770 Hz, 852 Hz, etc. A common TV color-burst crystal (3.5795 MHz) provides the clock that operates the filters. The decoded tones are output

in hexadecimal format for input to the PIC. The DV output (pin 12) goes high when the data outputs are stable and ready to read. This is the interrupt to the PIC that starts the A-patch controller routine. A *1 key combination turns on the repeater, and #2 turns it off via a relay on the RB7 (pin 13) output. Other sequences can be used as well by changing the program's comparison numbers. Additional outputs can be engaged to create multiple interrupt routines to control various functions.

There is a piece of code I'd like to point out that is rather unique. (See Listing 2.) It's an "On the air" flashing LED. It uses a project-specific timer module that pulses the LED on and off only while the relay is engaged. I believe you'll find it self-explanatory.

For this project, I've designed a printed circuit board (Fig. 2). A full-size foil pattern is available on the **Poptronics** Web site under the file name A_PATCH_PCB.BMP. Figure 3 is the component placement guide. If you find the background noise excessive, adding the optional C4 capacitor can reduce it by creating a low-pass filter with a cut-off frequency of 3.9 kHz.

A kit of parts, including a programmed PIC and circuit board, is available (see Parts List). I used a 9-volt AC adapter (wall-wart) to power the circuit, but you can use batteries if you wish. As for an enclosure, I leave that up to you. 'Til next month, have fun. **P**

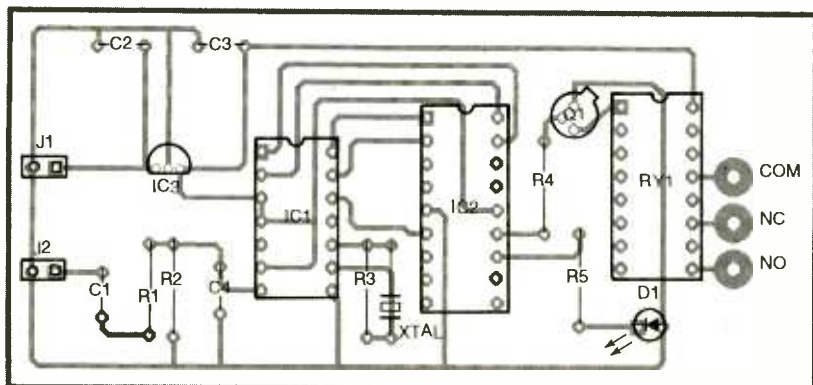



Fig. 3. Refer to this component-placement guide when attaching the various components to the board during the construction phase of the project.

www.poptronics.com

An Introduction
to Light in Electronics

An Introduction to
Light in
Electronics

F. A. WILSON



Taken for granted by us all perhaps, yet this book could not be read without it, light plays such an impressive role in daily life that we may be tempted to consider just how much we understand it. This book makes a good start into this fascinating and enlightening subject. It has been written with the general electronics enthusiast in mind.

To order Book #BP359 send \$6.99 plus \$3.00 for shipping in the U.S. and Canada only to Electronics Technology Today Inc., P.O. Box 240, Massapequa Park, NY 11762-0240. Payment in U.S. funds by U.S. bank check or International Money Order. Please allow 6-8 weeks for delivery.

Bi-Pedal Walker, Part 4

Welcome to Part Four of our bi-pedal robot walker. For those who are curious, the bi-pedal robot walker should be finished next month (Part 5). In Part 3, we left our bi-pedal walker standing up with two new PIC-microcontroller-based servomotor controllers.

I was able to improve the PIC-microcontroller program (slightly) for the servomotor controller. Essentially, to improve the update speed to the four servomotors I reduced the update speed to the LCD display. The servomotor movements are improved, but not perfect. About once a second, the control signals for the servomotors disappear while the LCD display is updated. When the LCD display is updated, the servomotor signals disappear for approximately $\frac{1}{8}$ th of a second.

This signal loss prevents the servomotors from developing their full torque and prevents accuracy in the holding position; however, it is a sufficient tool to approximate a walking gait. Before we make this improvement, let's build a couple of feet for the bottom servomotors.

Feet

The feet provide a larger surface area that will make it easier for the bi-ped to balance and walk. They are attached to the bottom U-bracket of the bottom servomotor. I arbitrarily chose to make the footpad two inches wide by four inches long. I cut out this size rectangle from $\frac{1}{4}$ -inch thick acrylic plastic. The location of the servomotor bracket on the feet is shown in Fig. 1. The bracket is not centered on the plastic foot; it is located toward one end (considered the back). Drill four $\frac{1}{8}$ -inch diameter holes in the plastic that line up with the four holes on the U-bracket. Each drilled hole must be countersunk on the bottom of the foot so that the machine screw head will not protrude from the bottom, see side view and close-up of Fig. 1 and finished foot pad in Fig. 2. This will allow the foot to lay flat against the floor.

On the prototype the corners of the footpads are square, see Fig. 2. I plan to round the corners of the footpads so they will be less likely to catch onto something and trip the robot when walking. The footpads are attached to

the U-bracket using four 4-40 machine screws, nuts, and lock washers.

The bottom of the acrylic plastic feet can be slippery, depending upon the surface material the bi-pedal robot is walking on. I plan to glue soft rubber-sheet gasket material to the bottom of the acrylic feet to create a non-skid bottom

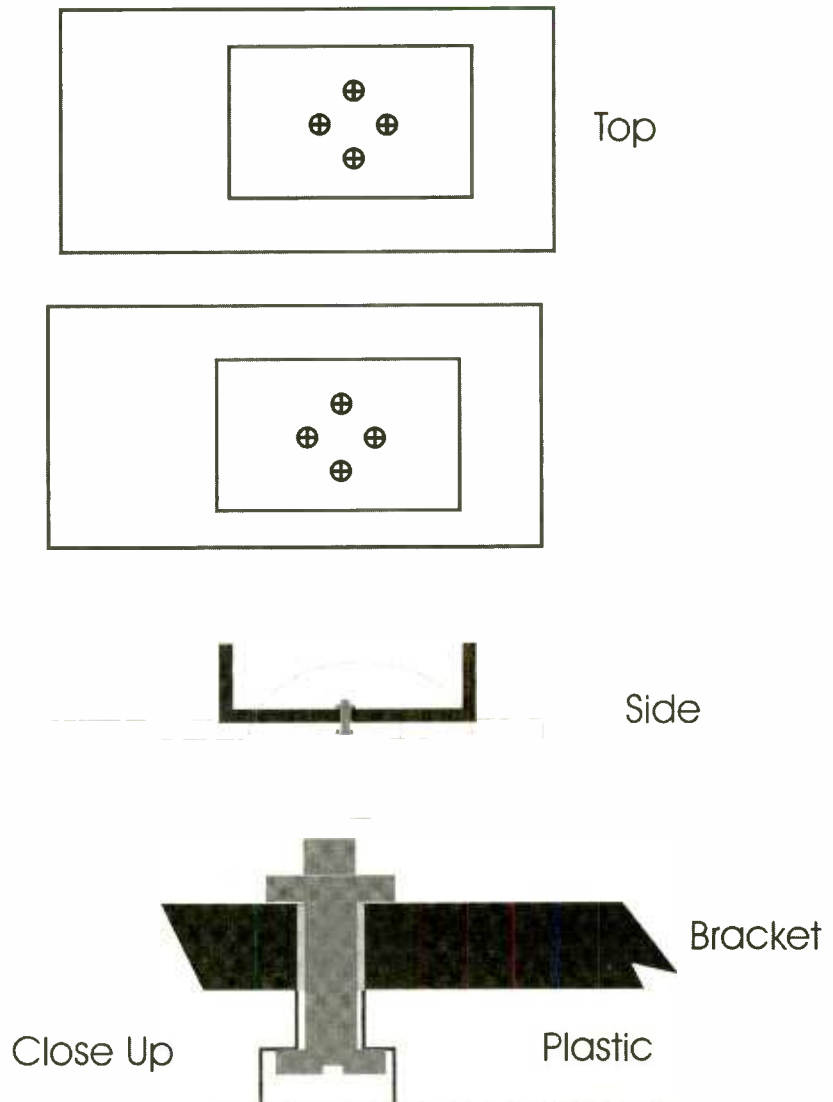

Fig. 1. Here are the construction details of the acrylic footpad.

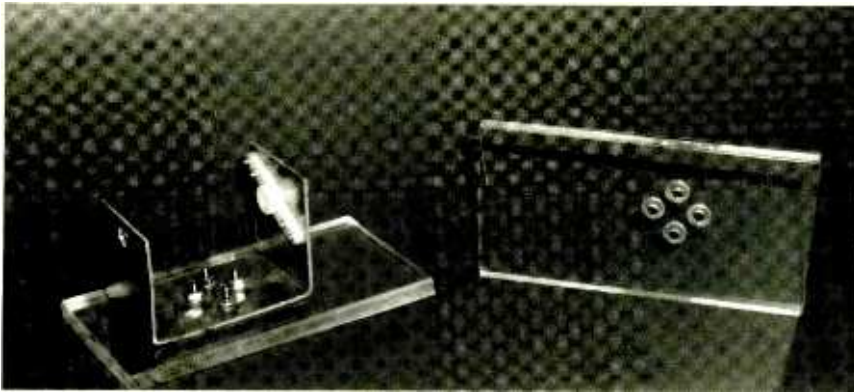

Fig. 2. This illustration shows the finished footpad and its attachment to the U-bracket.

surface. If just the front and back of the gasket material is glued to the plastic foot, a small flat pocket is created in the center section. This flat pocket is ideal for locating a flat sensor that could be slid in between the gasket material and the acrylic plastic. While we will not be using any flat sensor in this robot at this time (see below), it may become a future modification. You may want to leave this option open when gluing the gasket material to the footpad.

Tilt and Balance

The bi-ped needs to shift its weight from side to side. To do so, the robot will tilt to one side using its ankle servomotor. When I attempted to do this, I immediately found out that the legs were too far apart. While this wide stance made standing more stable, it prevented the robot from shifting its weight from leg to leg.

To correct this, I shortened the hip

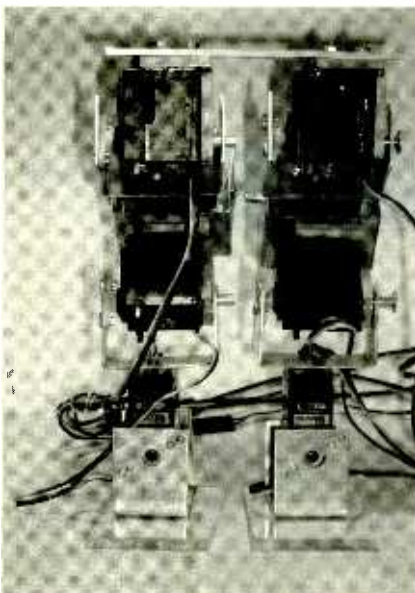

Fig. 3. Above is the bi-pedal walker with narrower stance and a smaller hip bar.

bar and moved the legs closer together, see Fig. 3. The clearance between the two legs at their closest point was reduced to approximately .250 inches. This worked out to approximately 2.5 inches between the closest two mounting holes (center to center) on the hip bar for the 4-40 machine screws.

With the legs re-adjusted, it became possible to shift the weight from leg to leg and tilt the robot. Originally, I thought to use a weight sensor on each foot to determine when the full weight of the robot was on one leg or the other. While I feel this is a good idea, I don't believe it's necessary for this bi-pedal robot at this time. Those sensors will be useful when the robot's weight may change dynamically.

Power Supply

At this point, I assumed I would build a platform to hold a 4 "C" battery pack to power the bi-pedal walker. However, I am not satisfied with the performance (torque) I am able to obtain from the servomotors thus far. This appears to be primarily due to the control program and not the servomotors (at this point) themselves. So, instead of a platform to hold the power supply and microcontroller, I will use a tethered power supply and control cable(s) to the bi-pedal walker. Later, I may decide to add the platform to carry the batteries and controller if I see the servomotors are developing sufficient torque to do so.

Digital Servomotors

This bi-pedal robot uses standard (42 in/oz torque) medium-size servomotors. There are digital servomotors that are the same size and weight as our standard analog servomotors that deliver 3X greater torque. This additional torque also requires additional electrical power. If the standard servomotors prove to be

too weak for the task of carrying itself plus the battery pack, we can upgrade to the digital servomotors. I am not advocating a change of servomotors at this time, just pointing out that a viable option exists if the standard servomotors turn out not to be strong enough.

First Step

Manually working the servomotor controls was far more daunting than I anticipated. To keep things straight, I had to clearly mark all the servomotor switches, or I quickly became lost as to what servo I was moving or had just moved. Keep in mind these pulse-width numbers will be different for your walker. The numbers as stated relate to the pulse-width signal provided to each individual servomotor. For instance, the number 254 represents a pulse width of 2.54 milliseconds. The number 75 represents a pulse width of .75 milliseconds.

In addition, I anticipate when operating a walking program from the microcontroller without the serial LCD display delay, the pulse-width numbers will need to be altered because the servomotors will be developing greater torque and better position-holding capabilities. We will talk more about this next month.

The following list details the servomotor number and its position in the leg.

Servomotors 0 and 4	hip
Servomotors 1 and 5	knee
Servomotors 2 and 6	ankle (vertical)
Servomotors 3 and 7	ankle (horizontal)

Table 1 shows twenty movements used to make the bi-pedal robot take one complete step using the manual controllers. The numbers at the start line are the pulse width to each servomotor to have the robot standing in a balanced position ready to move. To keep things simple only one servomotor is moved at a time. In the lines following "Start," only the servomotor that is being moved has its pulse-width number shown in the step. All the other servomotors' pulse-width numbers are assumed to be holding at their preceding position.

Notice that the single-step sequence ends with all the servomotor pulse-width numbers at the same position as when the step started. This makes walking a matter of repeating the same single-step sequence over and over.

I hesitate to provide the pseudo-code

**TABLE 1
LEG MOVEMENTS**

Left Leg Servomotors				Right Leg Servomotors				
0	1	2	3	4	5	6	7	
Start	207-	201-	152-	152-	208-	199-	176-	169-
1								160
2		230						
3			167					
4	193							
5								169
6						215		
7				166				
8		201						
9						192		
10							204	
11						170		
12				152				
13						189		
14							176	
15						192		
16	207							
17			152					
18					208			
19						199		
20							176	

for this single step until I have tested it further and polished it up, although if you want you can pretty much work it out by analyzing the pulse-width numbers listed above. For instance in step 1, the right leg horizontal ankle servomotor (7) is moved from 169 to 160. This corresponds to tilting the robot to one side and shifting the robot's weight to the right leg. The next three steps (steps

2, 3, and 4) involve lifting the left leg and moving it forward. In step 5, the robot is tilted back to its original position, balancing its weight on both legs. In step 6, the robot tilts to the other side and so on.

Next Month

Next month, we should finish this project. I will provide a pseudo-code listing for programming the bi-pedal robot to walk. 

TIPS FOR MAIL ORDER PURCHASE

It is impossible for us to verify the claims of advertisers, including but not limited to product availability, credibility, reliability and existence of warranties. The following information is provided as a service for your protection. It is not intended to constitute legal advice and readers are advised to obtain independent advice on how to best protect their own interests based upon their individual circumstances and jurisdictions.

- 1. Confirm price and merchandise information** with the seller, including brand, model, color or finish, accessories and rebates included in the price.
- 2. Understand the seller's return and/or refund policy**, including the allowable return period, who pays the postage for returned merchandise and whether there is any "restocking" or "return" charge.
- 3. Understand the product's warranty.** Is there a manufacturer's warranty, and if so, is it for a U.S. or foreign manufacturer? Note that many manufacturers assert that, even if the product comes with a U.S. manufacturer's warranty, if you purchase from an unauthorized dealer, you are not covered by the manufacturer's warranty. If in doubt, contact the manufacturer directly. In addition to, or instead of the manufacturer's warranty, the seller may offer its own warranty. In either case, what is covered by warranty, how long is the warranty period, where will the product be serviced, is there a charge for service, what do you have to do to obtain service and will the product be repaired or replaced? You may want to receive a copy of the written warranty before placing your order.
- 4. Keep a copy of all transactions**, including but not limited to cancelled check, receipt and correspondence. For phone orders, make a note of the order including merchandise ordered, price, order date, expected delivery date and salesperson's name.

- 5. If the merchandise is not shipped within the promised time**, or if no time was promised, within 30 days of receipt of the order, you generally have the right to cancel the order and get a refund.
- 6. Merchandise substitution** without your express prior consent is generally not allowed.
- 7. If you have a problem with your order or the merchandise**, write a letter to the seller with all the pertinent information and keep a copy.
- 8. If you are unable to obtain satisfaction from the seller**, contact the consumer protection agency in the seller's state and your local Post Office.

If, after following the guidelines, you experience a problem with a mail order advertiser that you are unable to resolve, please let us know. Write to Advertising Department, Gernsback Publications Inc., 275 G Marcus Blvd. Hauppauge, NY 11788

Be sure to include copies of all correspondence.

From Not-Working to Networking!

Troubleshooting Local-Area Networks!

Now, complete for the first time in one detailed booklet!

Gain a fuller knowledge of network fundamentals and how they developed from the early days of main frames, from XNS to Ethernet technology, the OSI stack for interconnecting different computers, basic and specialized test instruments, etc. Several tough LAN case histories brings you from theory to the practical side of troubleshooting.



ONLY \$4.99

CLAGGK Inc., Reprint Bookstore
P.O. Box 12162, Hauppauge NY 11788

Please rush my copy of "From Not-Working to Networking." I enclosed payment of \$4.99 which includes shipping charges. U.S.-First Class, Canada and Overseas-Surface Mail.

Name _____
Address _____
City _____ State _____ Zip _____

All Payments must be in U.S. funds. Send check or money order payable to CLAGGK Inc.—do not send cash or stamps. New York State residents add applicable sales tax. Allow 6 to 8 weeks for delivery **RBS02**

Salvaging Treasure From “Dead” Appliances

WARNING! The devices described in this article involve the use of materials and substances that are hazardous to health and life. DO NOT attempt to implement or use the information contained in this article unless you are experienced in the construction and safety considerations that apply to high-voltage devices of this nature. Although all possible measures have been taken to ensure the accuracy of the information presented, neither Gernsback Publications Inc., nor the author are liable for damages or injuries, misinterpretation of directions, or the misapplications of information.

Many dead appliances, as well as consumer electronic and computer equipment, contain parts and sub-assemblies that are not only neat and interesting, but also are useful for various experiments and projects.

I bet you tossed that big, heavy, slow 5¼-inch hard drive in the garbage when you upgraded, didn't you? Admit it! Did you know that if it was a high-performance drive, it contained several of the most powerful permanent magnets you would ever be likely to find anywhere? And, they would have been free!

That big old microwave oven? Too bad. There are more magnets, a nice high-voltage power transformer, rectifier, capacitor, an electronic or mechanical timer, fans, other motors, etc.

What about that dot-matrix printer? Too bad—at least two stepper motors, a nice power supply, and various other electronic and mechanical components. More steppers are in the floppy drives and, also, probably a regulated-speed

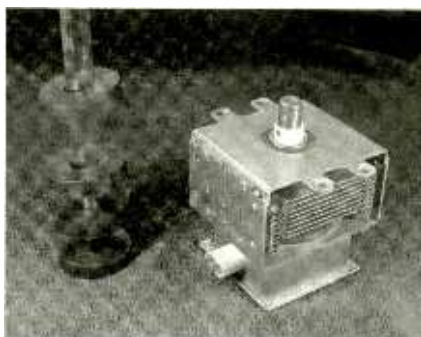

Here we can see four magnets that once were two magnetrons from a microwave oven. Notice that their repulsions causes them to float on the magnetron tube.

pancake motor.

Old TV or monitor? Another mistake. The high-voltage power supply was probably good for 12 to 30 kV_{DC} at 1 or 2 mA. This is useful for many high-voltage experiments, plasma globes, negative ion and ozone generators, bug disintegrators, starters for really LARGE HeNe lasers, etc.

In this article, we cover just a few of these potential goodies.

Safety Considerations

The devices, equipment, circuits, and other gadgets described in this article may be dangerous. Much of it deals with potentially lethal voltages. Getting electrocuted could ruin your whole day. Before thinking about experimenting with anything using or producing high voltages or connected to the AC line—even opening up a disposable camera that may have been laying around gathering dust (the capacitor can still be charged—arggh!), see the document: “Safety Guidelines for High Voltage and/or Line Powered Equipment” at my

Web site, www.repairfaq.org, or the safety info in previous **Poptronics** issues.

A large percentage of equipment that is perfectly safe from the outside has dangers lurking inside. In addition to electrical dangers, there might be sharp sheet metal, wound-up springs, powerful magnets, and other potential risks to your outer surface integrity like CRT implosion—just to name a few. Be careful!

Places To Obtain “Sacrificial” Equipment

So, where do you find the equipment from which to remove parts other than your basement, your attic, or those of your relatives or friends? Consider garage, yard, tag, estate, and other sales; thrift stores (which may even have a ‘free’ table); junk, salvage, and surplus yards (including those run by the Department of Defense!); the town dump and other landfills if they let you take things away; trash rooms of high-rise apartment complexes; the curb on pick-up day, college campuses around the end of the Spring term; and any other place where perfectly good equipment gets tossed in this throw-away

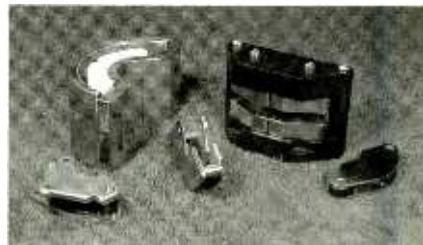

These are the magnet yoke assemblies from several disk drives. The large ones are from older Micropolis (left) and Seagate (right) drives, while the small magnets are from modern diskette drives.

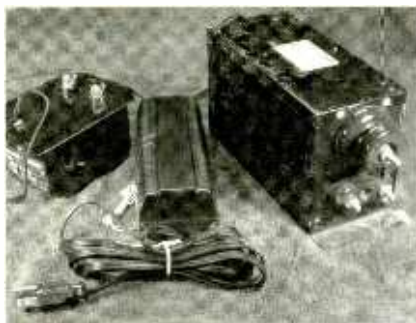

These are neon-sign and oil-burner ignition transformers. The oil burner ignition is on the left, an electronic neon sign transformer is in the middle, and an iron transformer is on the right.

society!

Of course, don't overlook high-tech flea markets, as well as ham and computer fests. Regular flea markets are usually overpriced (where do you think they get the stuff??), but sometimes you will be able to negotiate a great price because they have no idea of what they are selling! Yes, we are a strange bunch.

Magnets

Let's start with magnets. Two excellent sources of magnets are described below. These are at least as strong as the more well-known speaker types, possibly much stronger, and generally easier to remove.

Microwave oven magnetron tubes. Go to your local appliance repair shop and ask—they just toss bad ones. Each one has two ring-shaped ferrite magnets about 2¼-inches in diameter with a ¾-inch hole, magnetized N-S on the faces. Surplus places typically charge \$3 to \$6 each for one of these magnets. A photo shows four magnets (two magnetron's worth) floating on a plastic tube.

Large hard-disk drives, especially

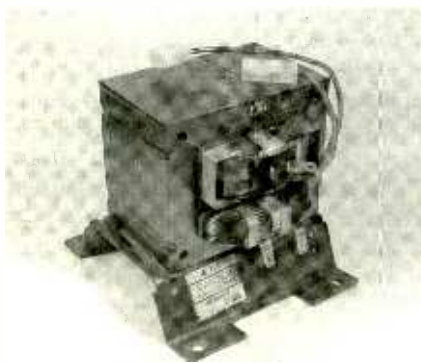

Extreme care must be taken when you attempt to extract a high-voltage transformer, such as the one pictured above, from a microwave. The voltages involved are lethal.

full-height 5¼-inch high-performance types, e.g., Seagate WREN series or Micropolous boat anchors (the rare earth magnets in these are wicked). (The magnets in small drives are even stronger but are, well, much smaller.) A typical size for a large drive is about 1- × 1¼- × ½- inches. Since almost no one wants such large slow drives anymore, they are often found at swap meets or yard sales for next to nothing. These magnets are a few thousand Gauss—about the most powerful field you're likely to find outside a medical MRI scanner. Another photo shows the magnet yoke assemblies from several disk drives. The large ones are from Micropolous (left) and Seagate (right) 5¼-inch full-height high-performance (for their day) drives. The small ones are from more modern 3½-inch drives.

Here is a quick easy experiment to try with these powerful magnets: Slide one such magnet over a thick aluminum plate. What do you feel? Let a ½- × 2- × 12-inch aluminum plate drop through the intact yoke from a Seagate WREN series 5¼-inch full-height hard-drive positioner. What happens? Why? What material might produce an even more pronounced effect? Why?

For more things to do with these neat magnets, see the Neodymiumium Web site, www.netcomuk.co.uk/~wvwl/neo-dym.html.

Caution: Both these types are powerful and will squash flesh as they suck all the bits off of your magnetic media! I am not kidding about the part about squashed flesh—with some you actually need a small crowbar to pry the assembly apart!

Additional Disclaimer: I will not be responsible when your spouse or parents come home to find the microwave or PC missing some key components and as dead as a brick!

Other Sources of Fairly Powerful Magnets

The following are other possibilities. However, they are not likely to be nearly as strong!

- Spent laser printer toner cartridges where the entire developer assembly is part of the cartridge (e.g., EPS-2 for Canon engines). These include a page-width ferrite magnet. However, expect to make a mess disassembling the cartridge as there will still be considerable toner remaining inside.



This photo shows various after-market replacement ignition coils that could be incorporated into high-voltage experiments. Caution and common sense must be used when handling any such device.

WARNING: The toner is a possible health hazard. A good dust mask should be used while working on these. Also, do not vacuum what remains—static can set off a dust explosion—use wet rags or paper towels to clean up the mess! The coating on the photosensitive drum may also be a hazardous material.

- Loudspeakers. Smaller or older speakers use AlNiCo-type magnets, which are usually in the form of a cylinder (about as tall as it is wide). AlNiCo is an extremely hard metal alloy. AlNiCo magnets are not as powerful as ferrite or rare earth types and are easily demagnetized (but just as easily remagnetized). Passing a stack of these through the center hole of a strong ferrite magnet will increase their strength dramatically—until they are separated from each other! Modern loudspeakers use ring-shaped ceramic ferrite magnets (similar to those in a microwave oven magnetron) glued to the pole piece (yoke) assembly within which the voice coil moves. The ferrite is



The flyback transformer pictured on the left is from a 21-inch monitor, while the one pictured on the right is from a 12-inch video terminal. Even smaller ones may be found in camcorders and mini-TVs.

extremely hard but very brittle, so care must be used to extract these from the yoke assembly.

- Permanent magnet stepper and servo motors. These will use ferrite or rare earth magnets usually in strange shapes. Note: Removing the magnets may result in partial demagnetization (reduction in magnetic strength) as the rotor is part of the magnetic circuit. Therefore, I do not recommend this source. There is generally no practical way of remagnetizing the strange shapes involved.
- Optical (laser) pick-ups from CD players, CD-ROM drives, and other optical data-storage devices. These may have some very tiny, but strong, rare earth magnets in the focus and tracking actuator. However, it seems a shame to sacrifice the beautiful mechanics in such a device just to get the magnets! Caution: Tiny magnets are even more fragile than bigger ones!

High-Voltage Power Supplies from Dead Equipment

There are a surprisingly large number of common consumer electronics equipment and appliances that employ high voltage in one form or another.

TVs, monitors, and computer terminals—All contain a source of high voltage for the CRT. Depending on the particular model, up to 30 kV_{DC} or more at 1 to 2 mA will be available—assuming the deflection/HV subsystem of your sacrificial equipment is in operating condition. However, you cannot (or at least should not) just string HV wires from the back of the family's 35-inch TV to your lab.

How much circuitry you actually need (and what you will have to add) depends on design, but figure on the mainboard with the deflection drive and flyback and probably the yoke (to keep the system properly tuned, though this may not be essential). Some capacitance on the HV output may be needed as well (though the ones I have tried were happy enough with just the stray capacitance of the wiring). Originally, the CRT envelope provided this capacitance. Power will either be the AC line (**WARNING:** very dangerous) or a DC supply typically 12 to 24 V_{DC}. They will usually operate on somewhat lower

input voltages with correspondingly reduced output.

A 555 timer-based oscillator or other horizontal sync source may be needed as well, if the system doesn't free-run at close to the normal horizontal scan rate. This is probably easier where the guts came from a monitor or terminal (since a separate TTL compatible horizontal drive input is likely to be available), but it should be possible to fake out a TV, as well.

Depending on design, these may require signals like 'HV Enable' and/or a feedback or reference voltage to operate properly. Small B/W TVs, mono computer monitors, and computer terminals will provide about 12 to 15 kV. Large B/W TVs and color TVs and monitors will provide 15 to 30 kV. Even more from projection sets!

Some larger high-performance color monitors may have a separate self-contained HV module. One particular type (found in a 19-inch Monitronix EZ series workstation monitor) is rated at 25 kV, 1.1 mA (and produces several other voltages) from a 26-V_{DC}, 2.5 A-power supply. However, by tweaking some internal pots, over 30 kV is available.

One key advantage of using pre-designed circuitry is that you are less likely to destroy power transistors and other expensive parts—and I have blown my unfair share.

High-voltage power supplies—These come from plasma globes, electrostatic dust precipitators, photocopiers and laser printers, bug zappers, negative ion and ozone generators, electric fences, cattle prods, and other 'common' equipment. Any of these may be pressed into service for your applications. Since these HV generators are not combined with anything else, they are likely to be self-contained modules and can be very easily used by themselves. However, available current from some of these sources is generally less than from TVs or monitors. Details are left to the highly motivated student.

- Plasma globes: Pulsed (not rectified or filtered) 10 to 15 kV
- Electrostatic dust precipitators: 5 to 10 kV_{DC}
- Photocopiers and laser printers: Two outputs at 5 or 6 kV_{DC}
- Bug zappers: 10 kV???

Caution: Since these power supplies were designed for a specific purpose under specific operating conditions, their behavior when confronted with overloads or short circuits on the output will depend on their design. It may not be pretty—as in they may blow up! Take care to avoid such events and/or add suitable protection in the form of fast-acting fuses and current-limiting to the switching transistor.

High-Voltage Transformers

There are many transformers capable of generating high voltages for hobbyist-type projects. Some operate from the AC line directly, while others require an interrupter or solid-state high-frequency driver.

Neon-sign or luminous-tube transformers (same thing) (10 to 15 kV at 15 to 60 mA, current-limited)—Some may be higher. There are also smaller ones. Current-limited means that the transformer will deliver the rated current (I_o) into a short circuit and produce the rated voltage (V_o) with no load. In between, it is designed to produce a somewhat constant current up to a substantial fraction of its no-load output voltage. This is somewhat similar to being in series with a resistor equal to $n \cdot V_o / I_o$ (where n may be 2 or 3 or more) over this range, but it's implemented without silicon as the magnetic design of the core and windings with no extra power dissipation. (It isn't really this straightforward, but will serve as a first approximation.)

Therefore, a short circuit on the output will not blow a fuse or trip a breaker (though the transformer will overheat if left this way for too long). Both iron (an actual transformer) and electronic (high-frequency inverter) types are available. The iron types are more robust and will survive repeated abuse that may destroy the others, but they are heavy. Sources: Your local sign shop, demolition company, or salvage yard. New: \$100 or more. Used: \$5 to \$50 or free. **WARNING:** Though current-limited, the available current from neon-sign transformers—especially the larger ones—is far into the range where lethal consequences are likely under the wrong circumstances.

Oil-burner ignition transformers (8 to 10 kV at 10 to 25 mA, current-limited. See description for neon-sign transformers, above.)—Sources: Your local HVAC contractor, probably for the asking, as the ignition transformers are

thrown out along with old oil burners when they are replaced. Of course, you will probably have to take the entire icky smelling disgusting burner assembly as part of the deal. However, there will be a nice motor and small oil pump in there, as well. Take a look at the photo that shows an oil-burner ignition transformer on the left, an electronic neon-sign transformer in the middle, and an iron one on the right.

WARNING: Though current-limited, the available current from oil-burner ignition transformers is still more than enough to kill under the wrong circumstances.

Both neon-sign and oil-burner ignition transformers generally have center-tapped secondaries connected to the case—which **MUST** be grounded (via a three-wire cord and properly wired outlet) for **SAFETY**. Therefore, it is generally not possible to construct a totally isolated HV power supply with these devices.

Microwave oven high-voltage transformers (1.5 to 3 kV at 0.25 to 0.5 amps)—Sources: Dead microwave ovens (the transformer is rarely the problem). Try your local appliance repair shop. However, you will probably have to cart away the entire oven—but other useful parts inside.

WARNING: The electrocution danger from microwave oven transformers cannot be overemphasized. They are not current-limited and, even if they were, could be instantly lethal given the least excuse for a suitable path through your body; since the rated current is a substantial fraction of an Amp at several thousand volts. Normally, one end of the high voltage secondary is bonded to the core—which must be grounded for safety. However, it may be possible to disconnect this and construct an isolated HV power supply (which will be only marginally less dangerous).

Automotive ignition coils (25 to 75 kV—depending on model—at low current)—Sources: Your 1997 Honda. Just kidding. Auto repair shops or parts stores, salvage yards. Note the photo that shows some (probably older) aftermarket replacement ignition coils.

WARNING: While unlikely to be lethal, the HV output of an ignition coil can still result in a seriously unpleasant shock and possible collateral damage.

Flyback transformers (FBTs) from TVs, monitors, computer terminals, or other HV power supplies—Little teeny ones in CRT-based camcorder

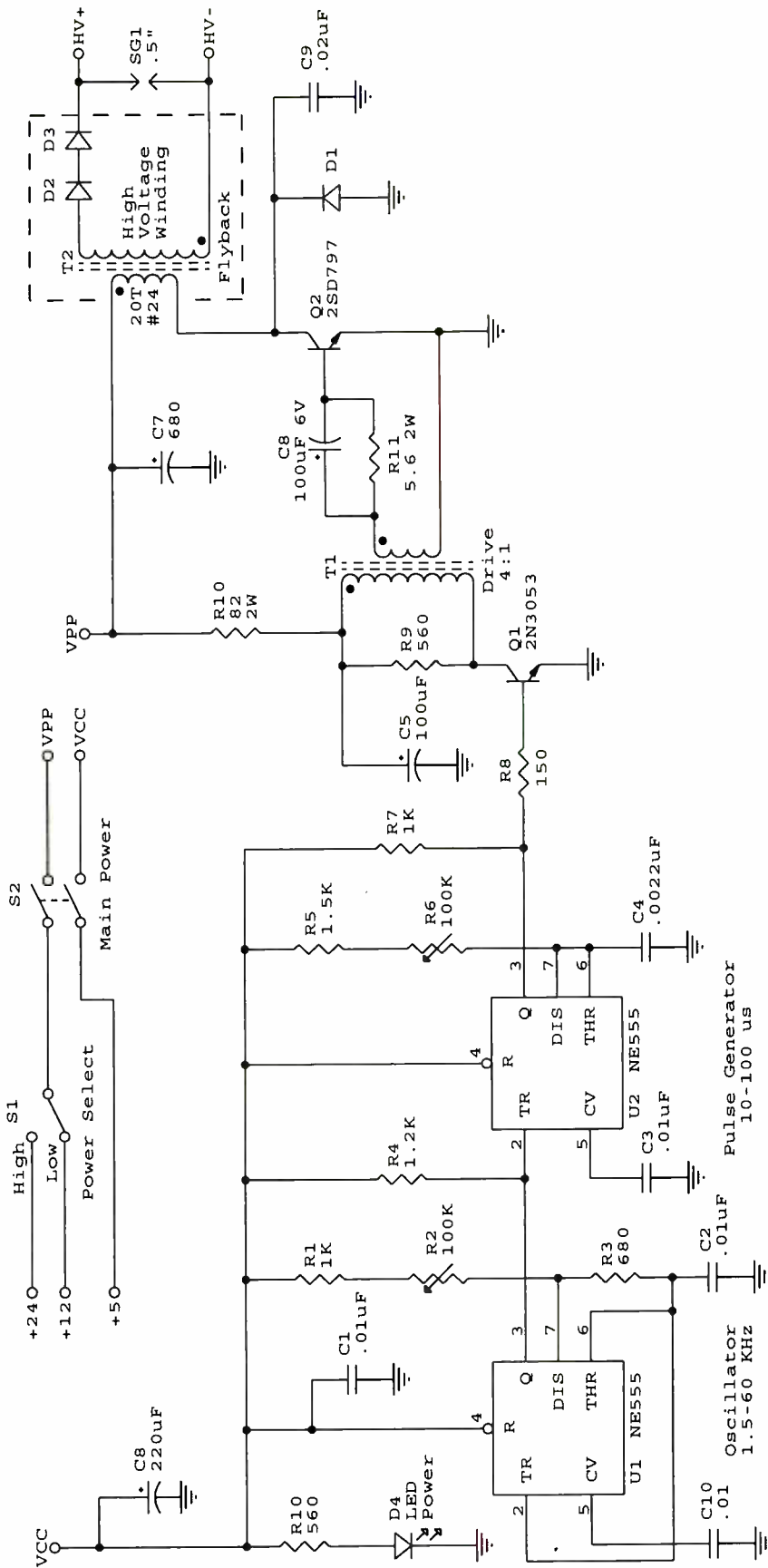

Fig. 1. This is a schematic of a high-voltage power supply circuit. It is capable of generating up to 30 kV or more (depending on the flyback and supply voltage involved).

viewfinders and older Watchman TVs. Output from less than 3 kV to over 30 kV at 1 to 2 mA, depending on model. Most include a high-voltage rectifier, though some may use an external one or voltage multiplier (also a useful and neat device). For many hobbyist uses, the only portion of the flyback that is important will be the high-voltage winding (and rectifier, if present). It is a simple matter to add your own drive and feedback windings on the flyback core. This eliminates the uncertainty of determining the number of turns and wire size for the existing windings. Sources: CRT-based equipment tossed for failures NOT caused by a defective flyback.

However, sometimes even a bad flyback can be used for HV projects. This will be the case if the problem is: No one actually buys flyback transformers for experimentation! Take note of the photo that shows the large and the small of FBTs. The one on the left is from a high-performance 21-inch workstation monitor; the one on the right is from a 12-inch monochrome video display terminal. Even smaller ones may be found in CRT-based camcorder viewfinders and mini-TVs.

WARNING: Flyback transformers are capable of producing shocking experiences. However, when run at high frequencies, your first hint of bodily damage may be via your sense of smell—from burning flesh. Keep clear! Note: Ignition coils and flyback transformers can generate very high voltages, but must be driven by a pulsed or high-frequency drive circuit. These cannot be plugged into the wall socket directly!

Flyback-Transformer-Driver Circuit

Here's a circuit you could build with that flyback transformer you just salvaged. (See Fig. 1.) This is an adjustable high-voltage power supply capable of generating up to 30 kV or more (depending on the flyback and supply voltage).

This circuit uses a pair of 555 timers to provide variable-frequency, variable pulse-width drive to an inverter using a flyback transformer salvaged from a black-and-white or color TV or computer monitor. At very low repetition rates, it will produce individual sparks. At high rates with a low μF value, high-voltage capacitor, the output will essentially be HV DC with a specific value dependent on input voltage, pulse rate

and width, and load. None of the component values are critical. The particular transistor used for Q2 seemed to be zap-pier better than a common horizontal-output type, but they work as well.

The input voltage can range from about 5 to 24 V. Using a flyback from a MAC Plus computer that had its bad primary winding excised, an output of more than 20 kV is possible (though risky since the flyback is probably not rated for more than about 12 kV) from a 24- V_{DC} , 2 -A power supply. Adjusting the drive frequency and duty cycle makes a wide range of output voltages and currents possible, depending on your load.

With the addition of a high-voltage filter capacitor (.08 μF , 12 kV), this becomes a nice little helium neon laser power supply, which operates on 8 to 15 V_{DC} —depending on required tube current and ballast resistor. The transistor types are not critical. Those were selected basically because I had them in my junk box. A TV or monitor horizontal-output transistor (HOT) should be satisfactory for the chopper, but will require a good strong drive. The lower voltage, high-current transistor I used (2SD797) has both a higher current and higher Hfe rating than typical HOTs. Even a 2N3055 will probably survive and not be too bad in the performance department.

The drive transformer is from a B/W computer monitor (actually a video-display terminal) and has a turns ratio of 4:1 wound on a $\frac{3}{16}$ -inch square by $\frac{1}{8}$ -inch long nylon bobbin on a gapped-ferrite double E core. The primary has 80 turns and the secondary has 20 turns, both of #30 wire. Make sure you get the polarity correct: The base of the switching transistor should be driven when the driver turns on. You should be able to wind a transformer similar to this in about 10 minutes if a similar size (doesn't need to be exact) core is available.

Where the flyback includes an internal rectifier and/or you are attempting to obtain the maximum output voltage of a specific polarity, the direction of drive matters as the largest pulse amplitude is generated when the switching transistor turns off. Since flyback transformers are not marked, you will have to try both possible connections to the drive coil. Use the one that produces the higher output voltage for a given set of input conditions (drive and pulse rate/width).

Many variations on this basic circuit

are certainly possible. The dual 555 circuit can be reduced to a single 555 with some loss in flexibility (unless you use the cute non-standard modification that allow independent adjustment of the high and low times—left as an exercise for the student).

One nice thing about running it at 24 V_{DC} or less is that it is much more difficult to let the smoke out of the circuit! The 5-A power supply I was using shut down on several occasions due to over-current, but the only time I blew the chopper transistor was by accidentally shorting the base to collector.

Wrapup

The above represents just a small fraction of what's available for experienced scroungers. Anyone can go into a store and buy parts and equipment. However, I consider it much more rewarding to create useful or at least interesting devices from scrap parts. More ideas can be found on my Web site, www.repairfaq.org.

As always, I welcome feedback of almost any type via e-mail to sam_gp@repairfaq.org. Note change to my e-mail address: I was forced to disable the previous address due to excess SPAM. E-mail to that address will result in an autoreply with a Web address to use to contact me. P

Poptronics® Interactive Edition

Projects...Courses...Articles...& more

Read it on the WEB!

- An e-magazine for everyone who loves electronics.
- Aimed at teaching electronics from the beginning with courses, tests and interactive questions to guarantee your success.
- Interesting articles and related items.
- Contains projects that can be ordered directly from the page, by simply clicking a button.

[www.poptronics.com/
interactive](http://www.poptronics.com/interactive)

Sundials—Or The Shadow Tells All

My better half has wanted a sundial for her flower garden for some time now, and that got me thinking about building an electronic version. Quickly, to take the pressure off, I purchased my wife a very nice heavy equatorial sundial for her garden and for hands-on experimenting.

The sundial method of telling time dates back to before 1000 years BC. Basically, all sundials indicate time by the sun's shadow cast on a dial marked in hours. The sun-blocking object that casts the shadow is called the gnomon and usually is positioned at a right angle

to the dial. Generally, the dial is divided into twelve hour periods from 6 AM to 6 PM, with 12 noon in the middle.

As the sun moves across the sky, the shadow cast by the gnomon moves across the dial marking the hour from sunrise to sunset.

The earth does not move at a constant speed while whizzing through space around the sun, and that's one of the reasons why sun time varies from clock time. The sundial can be a very accurate time piece; however, our efforts will be to simulate a basic sundial's performance electronically and to have fun along the way.

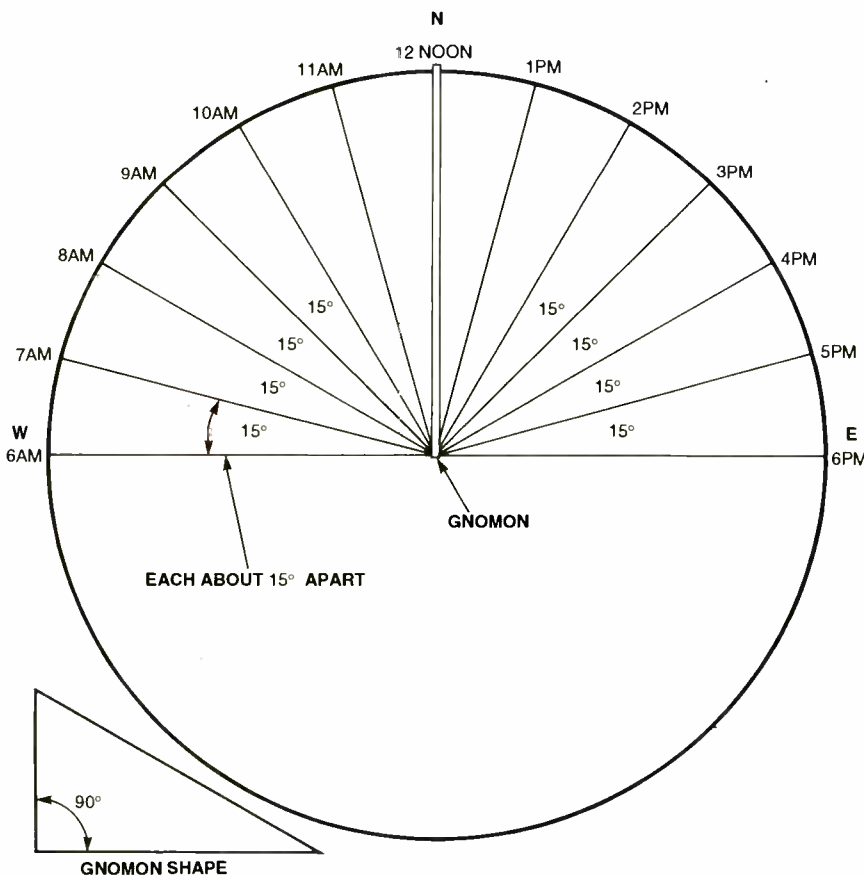
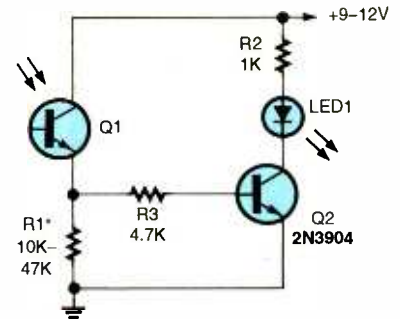

Fig. 1. The author's first thought was to build a basic shadow-casting sundial and use phototransistors to indicate when light is and is not present. Here is a diagram of that basic sundial.



*Q1 PHOTOTRANSISTOR, SEE TEXT

Fig. 2. The circuit shown above turns an LED off when the gnomon casts a shadow on the phototransistor. The phototransistor draws current when activated by a light source—causing its emitter to go positive, turning on Q2, and lighting the LED.

PARTS LIST FOR THE SHADOW-CASTING CIRCUIT (FIG. 2)

SEMICONDUCTORS

- Q1—Phototransistor, (see text)
- Q2—2N3904 NPN transistor
- LED1—Light-emitting diode, any type or color

RESISTORS

- (All resistors are 1/4-watt, 5% units, unless otherwise noted.)
- R1—10,000- to 47,000 ohms (see text)
 - R2—1000-ohms
 - R3—4700-ohms

There are gobs of information on sundials on the Web and in books to help in designing a specific sundial and in obtaining an accurate time readout. Believe me, the sundial is a very interesting subject that's worth the *time* to research and enjoy.

Avenues To Follow

The first thought was to build a basic shadow-casting sundial, see Fig. 1, and

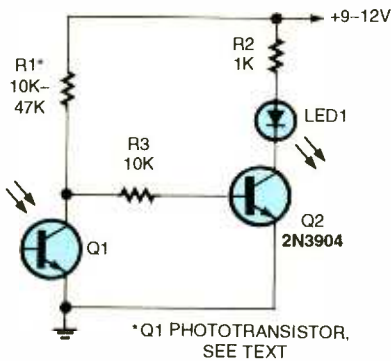

Fig. 3. This circuit allows the shadow to turn on the LED to indicate the hour. Sun hitting Q1 causes it to draw current, and the voltage at its collector is near ground level.

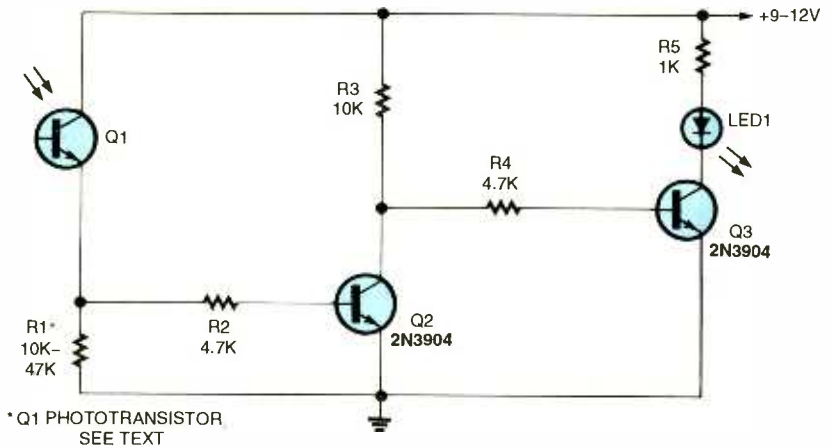

Fig. 4. The use of a lower gain phototransistor is possible within this circuit. It will also work with a high-gain phototransistor; however, it does require an additional component.

PARTS LIST FOR THE LIGHT-ACTIVATED CIRCUIT (FIG. 3)

SEMICONDUCTORS

- Q1—Phototransistor (see text)
- Q2—2N3904 NPN transistor
- LED1—Light-emitting diode, any type or color

RESISTORS

- (All resistors are 1/4-watt, 5% units, unless otherwise noted.)
- R1—(See text)
 - R2—1000-ohms
 - R3—10,000-ohms

PARTS LIST FOR THE LOW-GAIN PHOTOTRANSISTOR (FIG. 4)

SEMICONDUCTORS

- Q1—Phototransistor (see text)
- Q2, Q3—2N3904 NPN transistor
- LED1—Light-emitting diode, any type or color

RESISTORS

- (All resistors are 1/4-watt, 5% units, unless otherwise noted.)
- R1—(See text)
 - R2, R4—4700-ohms
 - R3—10,000-ohms
 - R5—1000-ohms

use phototransistors to indicate when light is and is not present. The circle may be any size and the gnomon's height will depend on your latitude; however, start with a gnomon about as high as the radius of the circle used for the dial and cut or extend as needed.

Next, we'll work electronics into the mix with the aid of phototransistors and LEDs. If we were to place a phototransistor in each hour position and feed the output to an array of LEDs positioned in a similar arrangement, the shadow position could be shown by a correspondingly positioned LED. We could choose to either light the LED or have it go dark to indicate the hour.

The circuit in Fig. 2 turns an LED off when the gnomon casts a shadow on the phototransistor. The phototransistor draws current when activated by a light source causing its emitter to go positive, turning on Q2, and lighting the LED. When the light source is covered by a shadow, the voltage at the phototransistor's emitter goes low—turning off Q2

and the LED. The phototransistor's gain and the amount of light hitting it determine the phototransistor's collector resistor value (R1). If the light level is high or a high-gain phototransistor is used, the value of R1 will fall near the 10K value. For less light and a lower gain phototransistor, the value will run toward the high-resistance value. The circuit in Fig. 3 can be used to determine the value needed for R1.

This circuit allows the shadow to turn on the LED to indicate the hour. Sun hitting Q1 causes it to draw current, and the voltage at its collector is near ground level. When the shadow is cast on Q1, its collector current goes very low—allowing the voltage at its collector to climb, turning on Q2, and lighting the LED. The value of R1 can be determined using this circuit in both sunlight and in shadow. If the value of R1 ends up being near the high-resistance value, then the following circuit in Fig. 4 would be a better choice.

Performing the same function, this circuit allows the use of a lower gain phototransistor. It will also work with a high-gain phototransistor; however, it does require an additional component. The addition of Q3 to the original circuit in Fig. 2, inverts the output function

to allow the LED to light when a shadow falls on the phototransistor.

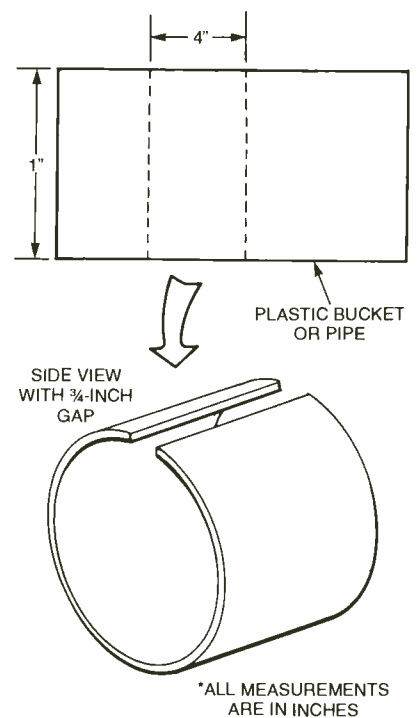

Fig. 5. Let's take the sunny-side approach to sundial building. Picture a round slice out of an opaque bucket or large plastic pipe, as shown above, with a slot cut through it, as shown.

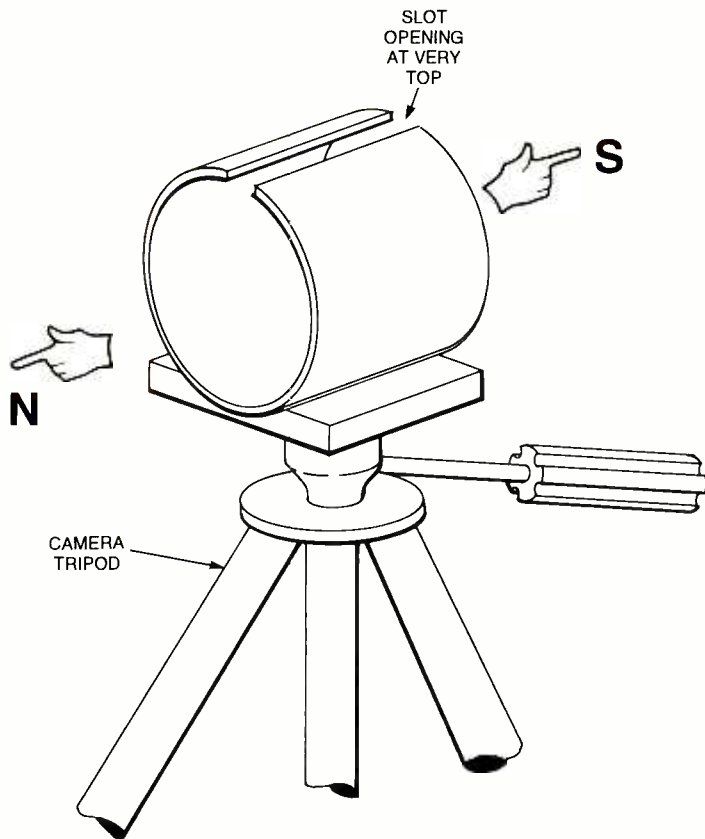

Fig. 6. To calibrate and mark each hour and half hour, mount the plastic circle on a camera tripod with the slot at the center of the top and the axis facing north and south.

It is easy to estimate the time between the hours on a sundial by the shadow's position between the hour markings; however, it is not so easy with the electronic version.

The shadow that falls on an area not seen by a phototransistor also does not light or turn off an LED. That means at some time between each hour the electronic sundial will not give a clue to the sun's actual position. To overcome this deficiency, a phototransistor can be placed on the half hour position between each hour—allowing a time display to within a half hour. Adding phototransistors and LEDs will increase the sundial's readout accuracy, and the low cost of phototransistors and LEDs makes it a reasonable option. Actually a total of 49 phototransistors and 49 LEDs will give a time readout at each quarter hour from 6 AM to 6 PM.

Another Path To Follow

After much study and woolgathering, I think the following sundial scheme will be an improvement over our first attempt. What is the opposite of the shadow cast by the gnomon? Sunlight of course! Let's take the sunny-side approach

to sundial building. Picture a round slice out of an opaque bucket or large plastic pipe, see Fig. 5, with a slot cut through it, as shown.

The slot is cut about $\frac{1}{4}$ -inches wide, in line with the axis of the circle. Pick a sunny day, take the cut circle out into the sunlight, and hold it in front of you with the slot positioned straight up. Face the north and align the circle due north, so that the sun casts a bright strip across the inside of the circle. Early in the AM the sun will cast its light very near the top left side of the circle, and in the late PM the strip of light will appear at the same spot on the opposite side of the circle. At noon the sun will cast a strip of light at the very middle of the circle.

To calibrate and mark each hour and half hour, mount the plastic circle on a camera tripod (as shown in Fig. 6) with the slot at the center of the top and the axis facing north and south. Actually when the circle is positioned properly, the only sun hitting the inside of the circle will be from the slot above. Just rotate the circle toward the north until only the light from the slot shows on the inner circle. At each hour and half hour from 6 AM to 6 PM, go out and make a

mark on the inside of the circle in the middle of the sun strip and the middle of the circle.

Once this is done, the locations for the phototransistors will all be marked. The actual width of the sun slot will depend on the placement and number of phototransistors used. The slot will cast a narrow light strip on the early and late hours and wider strips during the mid-day period. Some juggling of the phototransistors' positions and numbers will be in order to obtain the desired results. The number of phototransistors and LEDs used will determine the resolution of the displayed time.

The phototransistors will be positioned around the circle to correspond with the sun's exposure at a given hour, as shown in Fig. 7. The drawing shows only five positions, where as many as 49 phototransistors may be used to increase the readout resolution. It is also important that each phototransistor is positioned to face the incoming light. A general reference to the light-entry angle can be taken from Fig. 7. The inside of the circle should be painted a flat black to reduce any internal reflection that could be detected by other phototransistors not in the direct light path.

After all of the phototransistors are mounted and positioned correctly, both sides of the circle must be made light-proof. This can be accomplished with any opaque material of your choice. For weatherproofing, a drain hole can be drilled in the very bottom of the circle. Silicon rubber is a good material to use to seal out moisture around the phototransistors. This is an area where you will need to spend time in order to get the outdoor portion of the sundial up to snuff.

The Circuitry

The basic circuitry for the electronic sundial is just that, basic. There are several ways to approach the design. One is to use a multiple of the circuits shown in Fig. 2, with transistors turning on the LEDs, or to use a number of 4049 inverting CMOS buffers, as shown in Fig. 8. Either of these two methods will work, or any other scheme that performs the same function.

The use of CMOS 4049 ICs will cut down on the number of components needed and simplify construction.

In Fig. 8, the phototransistor detects the sunbeam, producing a high output at its emitter. This high at the input of the

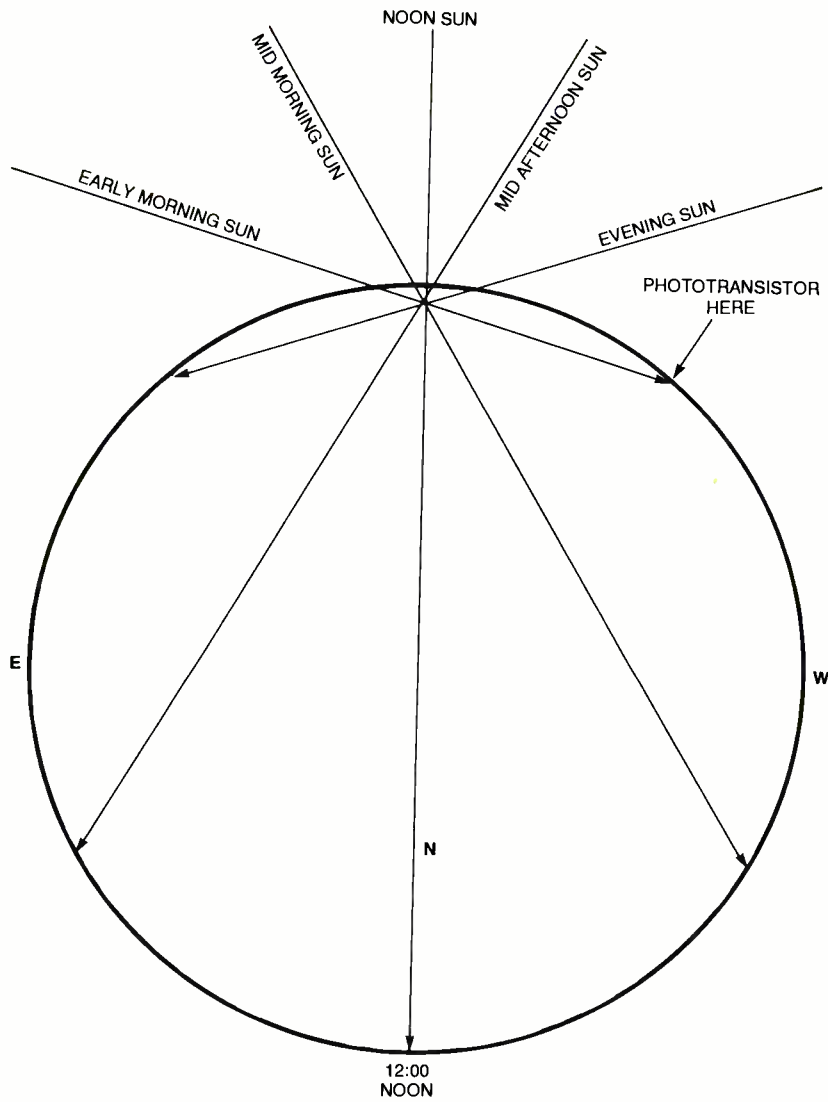
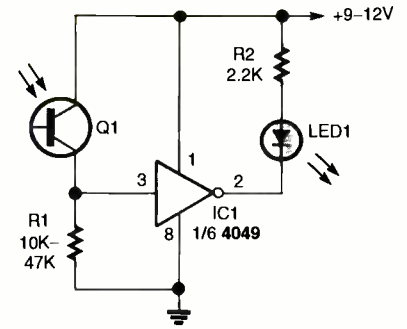

Fig. 7. The phototransistors will be positioned around the circle to correspond with the sun's exposure at a given hour. The drawing shows only five positions, where as many as 49 phototransistors may be used to increase the readout resolution.

4049 inverter produces a low at its output, lighting the LED. The remaining five inverters and their pin-out numbers are shown in the same figure. The circuit is duplicated for each time position and, to keep it simple, only a one position is shown.

The phototransistors used in my sundial experiments included a Mouser Electronic part #512-L14G1 and #512-

QSD124. Also, a few no-name, no-number types were tried and most would work. So I suggest trying a few of the inexpensive phototransistors and selecting the least expensive one that works. Actually building an electronic sundial will require more mechanical skills than electronic. But what other hobby offers so much diversity? Get out in the sunlight and build your own working elec-



4049 PIN OUT

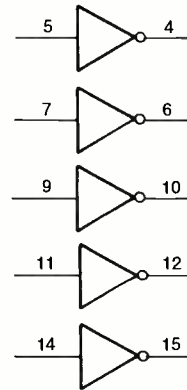

Q1 PHOTOTRANSISTOR, SEE TEXT

Fig. 8. Here the phototransistor detects the sunbeam, producing a high output at its emitter. This high at the input of the 4049 inverter produces a low at its output, lighting the LED.

PARTS LIST FOR THE 4049 CIRCUIT (FIG. 8)

SEMICONDUCTORS

IC1—4049 CMOS hex-inverting buffer IC

Q1—Phototransistor (see text)

LED1—Light-emitting diode, any type or color

RESISTORS

R1—(See text)

R2—2200-ohms, 1/4-watt, 5% resistor

tronic sundial and let me know how it turns out. Got to go for now....see you here next month. Cheers!!



While speeding treatments and cures for neuromuscular disorders, advances made by MDA researchers also have enhanced therapy prospects for heart disease, cancer, arthritis, Alzheimer's and AIDS.

Giving to MDA makes a world of difference.

MDA[®]

MUSCULAR DYSTROPHY ASSOCIATION
(800) 572-1717

USE THE FREE INFORMATION CARD FOR FAST RESPONSE

Ergonomic Pliers

Featuring spatulated handles molded from a flexible, non-slip material, the *Comfort Grip Pliers Set* (\$99) fits in the palm of the hand, reducing pressure and strain and improving power transfer. They are resistant to corrosive materials, including chloroethene, acetone, gasoline, oil, and brake fluid. The precision-machined cutting surfaces are designed for optimal cutting edge geometry. The three-piece set includes 10-inch multigrip pliers, 8-inch long-nose pliers with side cutter, and a 6.3-inch heavy-duty diagonal cutter.

SK HANDTOOL CORP.

9500 West 55th St.
Suite B
McCook, IL 60525
708-485-4574
www.skhandtool.com

CIRCLE 60 ON FREE INFORMATION CARD

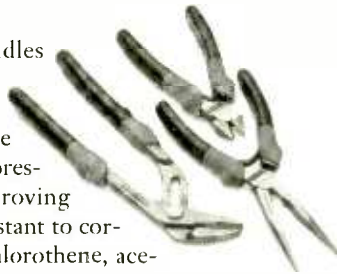

Motor Control

Ideal for farm equipment, gate controls, portable equipment carts, and hose and cord reels, the *WMC140 DC Motor Control* (\$75) is designed for use with battery-powered, brush-type permanent magnet DC (PMDC) motors requiring forward and reverse control. The control provides precise variable-speed operation, thermal overload shutdown, and adjustable current-limit fold-back to protect against excessive motor current from high starting or stall conditions.

WINLAND ELECTRONICS, INC.

1950 Excel Dr.
Mankato, MN 56001
507-625-7231
www.winland.com

CIRCLE 62 ON FREE INFORMATION CARD



SPL Meter

This miniature, high performance *Check Mate CM100 Sound Pressure Level Meter* (\$149.99) has a max/min function, level range display, AC signal output, and a resolution of .1 dB. It features an electret condenser microphone, an accuracy of ± 1.5 dB, A/C frequency weightings, fast and slow time weightings, an auxiliary AC signal output with a dynamic range of 50 dB, and a frequency range from 31.5 Hz to 8 kHz.



GALAXY AUDIO

601 E. Pawnee
Wichita, KS 67211
316-263-0642
www.galaxyaudio.com

CIRCLE 61 ON FREE INFORMATION CARD

Rolling Tool Organizer

Perfect for plant maintenance personnel, installers, and other professionals requiring light-duty tool transport, the *Rolling Tool Organizer Pro* (\$49.95) is a foldable rolling crate with 3-inch rubber wheels and a collapsible tote handle that extends to 39 inches. It also features a large interior compartment; a rugged 1800-denier removable liner with 58 outside pockets to organize tools; a custom pocket for cordless drills, bits, and tape measure; and a wide inside pocket.

JENSEN TOOLS

7815 South 46th St.
Phoenix, AZ 85044
602-453-2542
www.jensentools.com

CIRCLE 63 ON FREE INFORMATION CARD



Accessory Kit

Providing a complete starting selection of accessories, the *Model TLF3 Function Generator Kit* (\$79.95) eliminates the task of collecting cables and adapters to get started. Included in the kit are two BNC cable assemblies, one BNC breakout with miniature alligator clips, two miniflex IC clips, two microclip IC clips, a BNC in-series adapter, and more. All items are packaged in a convenient blister pack.

B&K PRECISION CORP.

22820 Savi Ranch Parkway
Yorba Linda, CA 92887
714-921-9095
www.bkprecision.com

CIRCLE 64 ON FREE INFORMATION CARD



Octave Band Analyzer

With built-in memory, the *Real-Time Octave Band Analyzer, Model 407790* (\$3499) stores up to 12,280 records in SLM mode and 1024 data points in 1/1 or 1/3 octave mode. The meter provides real-time analysis of noise from any source, monitors facility noise, stores the data for later reference and analysis, and provides noise-level statistics for internal and external audits. Stored data can be transferred to a PC via the RS-232 interface and analyzed with the included software. The meter spans 30 to 130 dB with high accuracy to ± 1.5 dB. It comes complete with a microphone cover, serial cable, batteries, screwdriver, and carrying case.

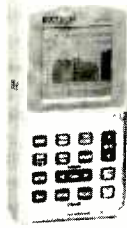

EXTECH INSTRUMENTS CORP.

285 Bear Hill Rd.
Waltham, MA 02451
781-890-7440
www.extech.com

CIRCLE 65 ON FREE INFORMATION CARD

Dual K Thermometer

With measurements ranging from -200 to 1999°F, -200 to 1360°C, or 70 to 1630°K, the *Easy View Type K Model EA10 Thermometer* (\$99) displays T1, T2, or T1-T2. Results are easily seen on the large, backlit LCD with low battery and overrange indications. The MIN/MAX function stores and recalls the highest, lowest, and average readings, while the timer function displays the elapsed time of the MIN and MAX. Other features include auto power off and an offset zero key to make relative measurements.

EXTECH INSTRUMENTS CORP.

285 Bear Hill Rd.
Waltham, MA 02451
781-890-7440
www.extech.com



CIRCLE 68 ON FREE INFORMATION CARD

Motor Controller

Designed to function as a versatile DC motor-control system for controlling one or two motors, the *Motor Mind C* (\$59) is ideal for use in small robotics projects for controlling two-wheel axles. The controller comes in a 40-pin DIP package with motor connections, mode settings, and control inputs. Three modes of operation are available, and each mode can be used to control one or two brushed DC motors. The current rating is 2.5A with no cooling and 4.0A with cooling, and over-current and over-temperature protection features are included.

SOLUTIONS CUBED

256 East First St.
Chico, CA 95928
530-891-8045
www.solutions-cubed.com

CIRCLE 67 ON FREE INFORMATION CARD

Function Generator

Offering a wide band of frequency in seven ranges, the *Model 2030 Function Generator* (\$325) comes with easy-to-use, well-marked, front-panel controls, and a large LED display. Complete with a built-in internal/external 6-digit frequency counter, it is perfect for a number of applications, including



audio response, vibration, servo system evaluation, ultra-sound measurements, basic industrial production line testing, and more.

GLOBAL SPECIALTIES

Highland Industrial Center
1486 Highland Ave., Unit 2
Cheshire, CT 06410
800-572-1028
www.globalspecialties.com

CIRCLE 66 ON FREE INFORMATION CARD

Socket Sets

Designed for the professional mechanic, the *Long Ball 7-Piece Fractional Hex Bit Socket Set* (\$87.74) allows up to a 30-degree angled entry for hard-to-reach areas. Made entirely of forged steel, the bit holders feature a through-hole design for faster change-outs of worn and damaged bits and a SuperKrome finish, which provides maximum corrosion resistance and easy clean up. Sizes in the set include $\frac{1}{8}$ -, $\frac{3}{16}$ -, $\frac{1}{4}$ -, $\frac{5}{16}$ -, $\frac{3}{8}$ -, $\frac{1}{2}$ -, and $\frac{5}{8}$ -inches.

SK HANDTOOL CORP.

9500 West 55th St.
Suite B
McCook, IL 60525
708-485-4574
www.skhandtool.com



CIRCLE 69 ON FREE INFORMATION CARD

NEW LITERATURE

McGraw-Hill Dictionary Of Scientific And Technical Terms, Sixth Edition

Edited by Sybil P. Parker
 McGraw-Hill
 2 Penn Plaza, 12th Floor
 New York, NY 1012
 800-2MCGRAW
 www.books.mcgraw-hill.com
\$150

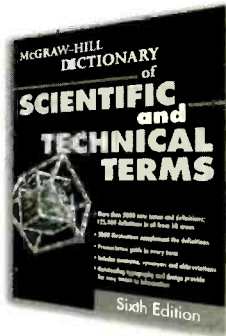

Keeping up with scientific terminology and technological vocabulary, this dictionary has over 105,000 terms, more than 122,600 definitions, and 3000 plus illustrations. This 2432-page book is an ideal reference for those in the scientific community, the general public, and high school and college students. A diskette is included, which contains a subset of entries.

Robots: Bringing Intelligent Machines To Life

by Ruth Aylett
 Barron's Educational Series, Inc.
 250 Wireless Blvd.
 Hauppauge, NY 11788
 800-645-3476
 www.barronseduc.com
\$23.95

Learn about the current state of computer and robot technology in this volume that covers Artificial Intelligence and building human-like robots. The author discusses the challenges inherent in teaching a machine to think and make decisions and the perfect blueprint for creating an ideal robot. Other topics include the life cycle of the present-day robot, raw materials and energy sources required for robot construction, and experimental progress in the field of self-designing robots.



PIC In Practice

by David W. Smith
 Newnes Press,
 Butterworth-Heinemann
 225 Wildwood Ave.
 Woburn, MA 01801
 781-904-2500
 www.bb.com
\$24.99

Based on popular short courses in the use of the PIC microcontroller, this book is a graded text formulated around practical exercises and hands-on experiences—ideal for professionals, students, teachers, and hobbyists. Useful at a variety of levels, it introduces applications using the 16F84 device and also includes sections on the 16C711, 12C508, 16F87X, and the latest 16F627 devices. Chapters cover analog-to-digital conversion, keypad scanning, radio transmitters and receivers, and programming, as well.

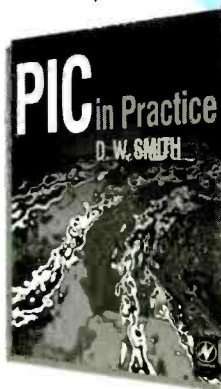

Master Handbook of Audio Production

by Jerry Whitaker
 McGraw-Hill
 2 Penn Plaza, 12th Floor
 New York, NY 1012
 800-2MCGRAW
 www.books.mcgraw-hill.com
\$39.95

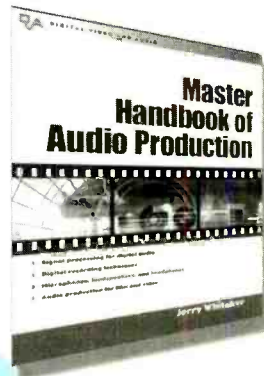

Covering the full range of modern audio techniques—from digital sound recording in the studio to sound for digital video and film—this book details essential equipment, recording equipment, and digital signal-processing techniques. Readers can learn how to select microphones and loudspeakers, produce sound for video and film, make high-quality studio recordings, and discover new audio design tools.

Electromagnetics Explained: A Handbook For Wireless/RF, EMC, And High-Speed Electronics

by Ron Schmitt
 Newnes Press, Butterworth-Heinemann
 225 Wildwood Ave.
 Woburn, MA 01801
 781-904-2500
 www.bb.com
\$34.99

Providing a comprehensive and practical understanding of electromagnetic fields and the principles necessary for circuit design at RF, this book is a helpful resource for analog and digital engineers alike. It offers further study of high-speed digital design issues, transmission lines, cross-talk, signal integrity, and high-frequency layout—based on familiar circuit theory and basic physics.

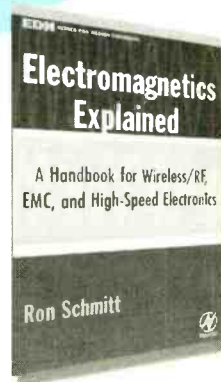

Final Cut Pro 3 Editing Workshop

by Tom Wolsky

CMP Books

1700 Fourth St.

Berkeley, CA 94710

800-788-3123

www.cmpbooks.com

\$49.95

Want to become a pro at image animation and special effects? This manual gives you first-hand experience in the art and technique of professional editing. Its 13 tutorials will help you develop a working knowledge of the principles and methods taught in film schools. Learn how to get your material into Final Cut Pro 3 (FCP3), work with audio and level control, enhance your projects, trim a sequence of shots, compress your finished product for Web and interactive media, and a whole lot more.

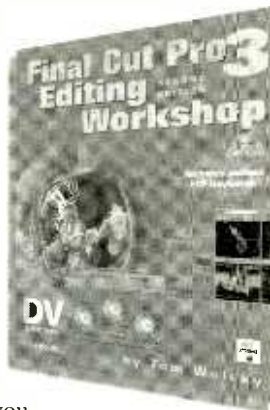

Small Tool Catalog

from Micro Mark

340 Snyder Ave.

Berkeley Heights, NJ 07922-1595

800-255-1066 or 908-464-2984

www.micromark.com

Free

This compact catalog is chock-full of handy tools and accessories, and each of them comes with a color photo and detailed description. Many featured items are on sale. Products include miniature power tools, hardware, paints and brushes, knife sets, sanders, drills, lighting devices, and more. Hobbyists can also find accessories for ship and railroad modeling, like architectural systems, dioramas, cutting tools, clamps, and manuals.



Electronics Catalog

from Smarthome

17171 Daimler St.

Irvine, CA 92614-5508

800-762-7846 or 949-221-9200

www.smarthome

Free

Offering products to help make your home more convenient, safe, and fun, this catalog showcases a wide array of high-tech gadgets and items. Smarthome technology makes it possible to use a universal remote to control TV and stereo equipment, automate lights and appliances, and program thermostats and security systems. Also featured are lighting-control devices,



phones and intercom stations, garden and pool accessories, and home-theater storage solutions.

Educational Products

from Kelvin

280 Adams Blvd.

Farmingdale, NY 11735

800-535-8469 or

631-756-1750

www.kelvin.com

Free

Incorporating a complete line of educational products for schools, this catalog is an ideal resource for teachers. It has a large selection of parts, kits, and trainers geared toward technology, science, and crafts. Many of these items stimulate interest and provide problem-solving challenges. Featured products include modeling systems, activity centers, lab equipment, photography and communications devices, robotics, art supplies, design kits, and much more.



Nano-Optoelectronics

Edited by Marius Grundmann

Springer-Verlag

175 Fifth Ave.

New York, NY 10010

800-777-4643

www.springer-ny.com

\$89.95

This book traces the quest to use nano-structured media for novel and improved electronics devices, starting with the invention of the heterostructure laser. Leading experts write about the fundamental concepts behind nano-optoelectronics, the material basis, physical phenomena, device physics, and systems. Readers can explore the sophisticated methods of material preparation and characterization that have been developed.



Poptronics®

SHOPPER[®]

800-308-4626 Check Our Website for our NEW LOCATION & NEW PRODUCTS **800-308-4626**

WIRELESS VIDEO LIPSTICK CAMERAS MONITORS **OVER 800 PRODUCTS IN STOCK!!** DIGITAL RECORDERS ANTENNAS MICRO CAMERAS

DIGITAL MONITORING & RECORDING SYSTEM



- ✓ TCP/IP
- ✓ MODEM
- ✓ LAN/WAN

PV-140A/B/C/D - \$299.95

The PV-140 Series turns your PC into a commercial grade digital security system in a few minutes. This incredible series integrates a color quad processor, multi-zone video motion detector, multiplexer, and a real time digital video recorder (DVR). By ordering addition cards, you can increase your surveillance up to 16 different cameras.



SOFTWARE INCLUDED!!!

System Requirements:

- Windows 98/ME/2000/XP
- Pentium III-550Mhz or higher with free PCI slot(s)
- 128 M3+ System Memory
- PCI/AGP bus graphics card (24 bit hi-color or 64 bit)
- Sound Card (optional)
- Hard Disk Space - 1 GB+ per camera; 10GB+ is recommended
- Microsoft DirectX or higher version
- CD-ROM / DVD-ROM device
- Cameras up to 1/2/4/8/12/16

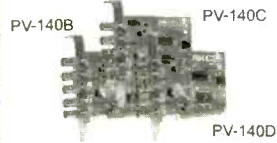

PV140 Card Configuration:

- 140A 1st four cameras/windows
- 140B 2nd four cameras/windows (expands to = 8 windows)
- 140C 3rd four cameras/windows (expands to = 12 windows)
- 140D 4th four cameras/windows (expands to = 16 windows)

Cards MUST be utilized in this order.

SAVE \$100
PV-140 PACK
 4 Pieces/One Pack
 \$1099.95

USB VIDEO CONVERTER

Additional Features-Call Today!!!

USB-01 The USB Video Converter acts as an interface for your analog video sources and converts analog output to digital for your computer. The USB Video Converter accepts high resolution SVHS video and standard composite NTSC video.



USB-01 \$89.95

MICRO BOARD CAMERAS



MB-780U
 B/W
 BOARD
 CAMERA
 \$29.95

20 DIFFERENT MODELS AVAILABLE

B/W PEN CAMERA WITH AUDIO

PENCAM is the newest member to our line of covert cameras. Its small, lightweight design allows this camera to slip into your shirt or coat pocket. It has audio and video capability making the PENCAM perfect for a number of applications.

Great Resolution!

PENCAM - \$225.95



NIGHT VISION W/AUDIO



3 MODELS AVAILABLE

26-0300 Night Vision Audio Monocular features a built-in Infrared Illuminator for viewing in complete darkness.
26-0300 \$349.95

5" WIRELESS OBSERVATION SYSTEM

Now you can enjoy peace of mind with our new wireless observation system. Each comes with a 5" wireless monitor & wireless camera. Just plug & play for perfect wireless video any time!

2.4GHz

Great for around the house, office or technical field work.



GW-2400SA \$379.95

1/3" COLOR OUTDOOR CAMERA

This camera merges the gap between bullet (lipstick) camera and full-size housing with camera. Unlike bullet (lipstick) cameras with limited features, this unit has many features only found on larger, "cased" cameras. The AV-48WC8 keeps the best part of the bullet/lipstick line in that they install quickly and come pre-assembled, ready for installation. Auto iris and vari-focal lens options are available upon request.



AV-48C8 \$235.95

We have 6 different configurations to meet your requirements for outdoor or indoor self-contained cameras. Industrial "O" Ring Sealed Aluminum Case

6 Configurations:

B/W: Regular, Auto Iris, Vari-Focal Lens
 Color: Regular, Auto Iris, Vari-Focal Lens



220x ZOOM CAMERA MODULE

Build your own speed dome or motor zoom camera with ease. The Polaris 220X camera module will fit right into your case easily. The life of the 220X motor is essentially 5 times longer than any other brand named camera available today.



AFZ-220X is compact and lightweight. This zoom camera will fit into a variety of applications.

AFZ-220X \$349.95

1/3" HIGH RESOLUTION DSP COLOR CAMERA

DX-7811S Our NEW Digital Signal Processing (DSP) Camera offers you a Day/Night Camera with Digital Zoom, Mirror Function, 470 lines of resolution, backlight compensation, gain control & low lux. An excellent addition to your current security system or a great beginning to a new system.

DX-7811S \$169.96



This camera has all the features of the brand names without the brand name price!

800-308-4626

WWW.POLARISUSA.COM

Polaris Industries, Inc.
We're On The Move!

Tech 404-872-0722/16 Fax 404-872-1038

CIRCLE 228 ON FREE INFORMATION CARD

AM & FM LOW POWER TRANSMITTER KITS

If you are interested in building quality low power transmitters for AM, FM Stereo, and Television transmission, see our website for more information. Kits covering the frequency range of 150 KHz to 1300 MHz. are available, for Amateur, experimental Part 15 uses, hobby, and radio control use.

NORTH COUNTRY RADIO

Visit our website www.northcountryradio.com

Sales: PO BOX 53 New Rochelle N.Y. 10804 Tel 914-235-6611

Technical: PO Box 200 Hartford NY 12838 Tel 518-854-9280

SEARCH & BUY ONLINE
www.mouser.com

MOUSER 
ELECTRONICS

166,000+
ELECTRONIC
COMPONENTS

CIRCLE 325 ON FREE INFORMATION CARD

FOR 26 EASY
WAYS TO HELP
SAVE THE
EARTH CALL
1-800-488-8887.

 A Public Service of
The Publishers

 Earth Share

HIGH QUALITY FM BROADCAST EQUIPMENT

- SINCE 1990 -

You know you want it! We've got it: LPFM & High Power, Stereo FM Transmitters, RF Amplifiers, Low Pass Filters, Antennas, Mixing Boards, Microphones, CD Players, Compressor/Limiters, Digital Reverbs, Automation Software, Studio to Transmitter Links, Emergency Alert Systems, RF Test Equipment, Kits, RF Parts, and much more. Best Prices. Highest Quality. Give Us A Call or Buy it Online...



www.progressive-concepts.com

305 SOUTH BARTLETT ROAD, STREAMWOOD, IL 60107

VOICE: (630)736-9822 FAX: (630)736-0353



Buy your transformers online
direct from **Toroid Corp.**

Standards:

www.toroid.com/standard.htm

Make-it-yourself kits

www.toroid.com/kits.htm

SERIAL LCDs

Serial LCDs work great with BASIC Stamps® and other microcontrollers. One-wire interface • simple serial protocol • low cost • high quality • in stock

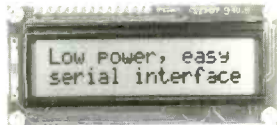

BPI-216N
 • 2x16 text LCD
 • 2400/9600 bps
 • \$45 (non-backlit)

SGX-120L
 • Mini graphics LCD
 • 2400/9600 bps
 • just \$99



Many other models available—see www.seetron.com!

Scott Edwards Electronics, Inc.
www.seetron.com • 520-459-4802

MEETING TOMORROW'S CHALLENGES TODAY

The men and women in the Navy's Seaman/Airman/Fireman Program are working for America, while learning valuable skills through on-the-job training. They're building solid futures, succeeding in a competitive, high-tech world and advancing as quickly as their abilities and performance allow. Find out more about the Seaman/Airman/Fireman Program, as well as other exciting Navy job opportunities, from your local Navy recruiter. This ad is brought to you as a public service of this newspaper.

Navy. Full Speed Ahead.

Coil Design and Construction Manual

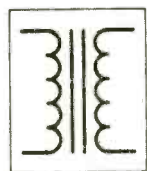

YOU CAN WIND YOUR OWN COILS?

There's no trick to it except knowing what you are doing. In a unique, 106-page book you can become expert in winding RF, IF, audio and power coils, chokes and transformers. Practically every type of coil is discussed and necessary calculations are given

with the mathematical data simplified for use by anyone. Get your copy today!

Mail coupon to:

Electronics Technology Today, Inc.
 P.O. Box 240 • Massapequa Park, NY 11762-0240

Please send me my copy of *Coil Design and Construction Manual* (BP160). I enclose a check or money order for \$8.99 to cover the book's cost and shipping-and-handling expenses. NY state residents must add local sales tax.

Name _____

Address _____

City _____ State _____ ZIP _____

All orders must be paid in U.S. funds only. Sorry, no orders accepted outside of USA and Canada. Please allow 6-8 weeks for delivery.

ET06

Be an FCC LICENSED ELECTRONIC TECHNICIAN

EARN MORE MONEY



Earn up to \$100 an hour and more!

The Original Home-Study course prepares you for the "FCC Commercial Radiotelephone License" at home in your spare time. This valuable license is your professional "ticket" to thousands of exciting jobs in:

- Communications
- Radio-TV
- Microwave
- Maritime
- Radar
- Avionics & more

You can even start your own business!

No previous experience needed! No need to quit your job or go to school. This proven course is easy, fast and low cost!

GUARANTEED TO PASS – You get your FCC License or your money refunded.

Send for FREE facts now!

Mail coupon today or call

(800) 932-4268 Ext. 240

www.LicenseTraining.com

COMMAND PRODUCTIONS

FCC LICENSE TRAINING - DEPT. 240

P.O. Box 2824 • San Francisco, CA 94126

Please rush **FREE** details immediately!

Name _____

Address _____

City _____ State _____ Zip _____

Graphic Interface with Touch screen control

Priced From
\$140.00
Qty 1

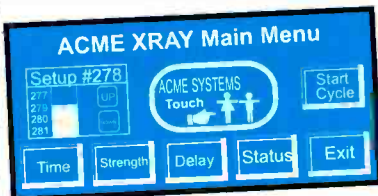

Easy Operator Interface through serial connection

Easy Interface with PC/104, 8051, 68HC11, PIC



Graphic display
Touch screen

Serial communication (RS-232C)
Eprom or Flash for screen storage
Only +5VDC power required
Easy to use development software
Create screens by PC paintbrush
Simple to place touch buttons software



Many Sizes Available

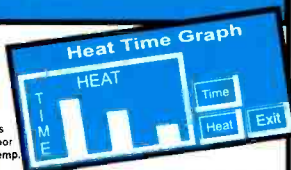

Embedded Computer Controller Also Available

Designtech Engineering Co.

2001 S. Blue Island Ave.
Chicago, IL 60608
Phone 312-243-4700
Fax 312-243-4776

www.designtechengineering.com

Microprocessor Hands-On Training

The PRIMER Trainer is a flexible instructional tool featured in a Prentice Hall textbook and used by colleges and universities around the world. Ruggedly designed to resist wear, the PRIMER supports several different programming Languages including Assembler, Machine Language, C, BASIC, and FORTH. A comprehensive Instruction Manual contains over 25 lessons with several examples of program design and hardware control. The Applications Manual provides theory and sample code for a number of hands-on lab projects.

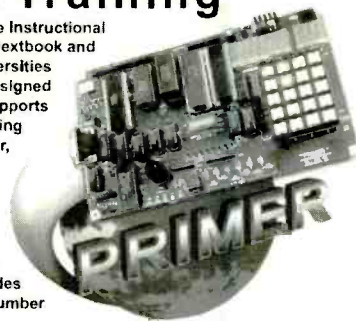

Application Projects Include:

- Scan Keypad input & Write to a Display
- Detect Light Levels with a Photocell
- Control Motor Speed using Back EMF
- Design a Waveform Generator
- Measure Temperature
- Program EPROMs
- Bus Interface an 8255 PPI
- Construct a Capacitance Meter
- Interface and Control Stepper Motors
- Design a DTMF Autodialer / Remote Controller

The PRIMER can be purchased as an unassembled kit (\$120) or as an assembled/tested kit (\$170). Upgrades provide battery-backed RAM and PC connectivity via an RS232 serial port (shown in picture). Additional options include a heavy-duty keypad (shown in picture) and a 9V power supply - see our website. Quantity discounts are available. Satisfaction guaranteed.

Since 1985
OVER
16
YEARS OF
SINGLE BOARD
SOLUTIONS

EMAC, inc.

Phone 618-529-4525 Fax 618-457-0110
2390 EMAC Way, Carbondale, Illinois 62901
World Wide Web: <http://www.emacinc.com>

The BEST is now Better!

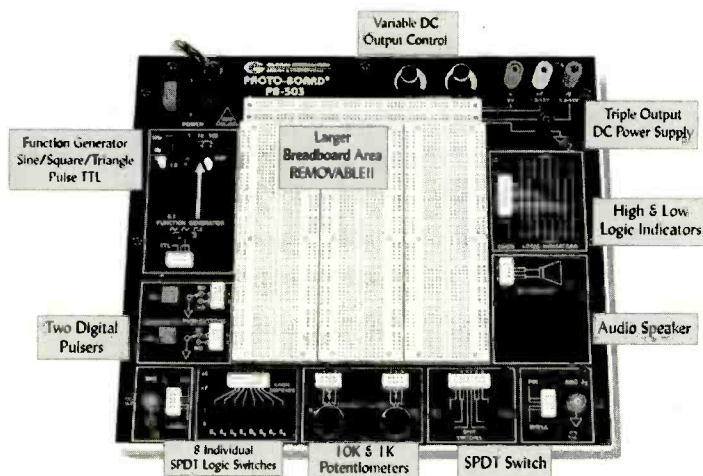

Feature-rich Circuit Design Workstation Ultra-affordable at just \$299.95

Portable Version Available for \$349.95

Our classic PB-503 the complete Proto-Board Design Workstation is newly improved. Enhancements Include: an 8-Channel Logic Monitor, High & Low Buffered Logic Indicators, 8 Selectable Logic Switches, and Removable Breadboard Socket Plate. This velcro-backed socket plate allows for greater circuit design flexibility; order extra to suit your needs.

Traditional instrumentation on the unit includes continuously variable Function Generator, Triple Output DC Power Supply, along with Switches, Digital Pulses, Potentiometers and an Audio Speaker. The highly functional PB-503 is built to last, with an industry best 3-year warranty along with a lifetime warranty on all breadboard sockets. Own the best! Order yours today.



GLOBAL SPECIALTIES
INSTRUMENTS

1486 Highland Avenue • Unit 2
Cheshire, CT 06410
1.800.572.1028
203.272.4330 FAX
www.globalspecialties.com

CALL TOLL-FREE

(800) 292-7711
Orders Only

Se Habla Español **Secure On-line Ordering @ cs-sales.com**

C&S SALES

CALL OR WRITE
FOR OUR
FREE

64 PAGE CATALOG!
(800) 445-3201

Digital Multimeters

Elenco Model M-1740



\$19.95

- 11 Functions:**
- Freq. to 20MHz
 - Cap. to 20µF
 - AC/DC Voltage
 - AC/DC Current
 - Beeper
 - Diode Test
 - Transistor Test
 - Meets UL-1244 safety specs

Elenco Model LCR-1810



\$89.95

- Cap. 0.1pF to 20µF
- Inductance 1µH to 20H
- Resistance 0.01Ω to 2,000MΩ
- Temperature -20°C to 750°C
- DC Vols 0 - 20V
- Freq. up to 15MHz
- Diode/Audible Continuity Test
- Signal Output Function

Elenco Model LCM-1950



\$65

- Large 1" 3/4" Digit LCD
- Autorangeing Freq. to 4MHz
- Cap. to 400µF
- Inductance to 40H
- Res. to 4,000MΩ
- Logic Test
- Diode & Transistor Test
- Audible Continuity Test

LCR Bridge

B&K Model 878



\$229

- Accurately measures capacitance, resistance, and inductance.
- Measures dissipation factor of capacitors and Q of inductors

Deluxe Soldering Stations

Elenco SL-5 Series

Electronically controlled, ideal for professionals, students, and hobbyists. Available in kit form or assembled.

Works w/ any iron! Turn any soldering iron into a variable iron.

Quantity Discounts Available



As Low As

\$24.95

Features:

- Cushion Grip Handle
- Soldering Iron (optional) with Grounded Tip for Soldering Static-Sensitive Devices. Easily Replaceable. Uses Long-Life, Plated Conical Tip.
- Heavy Steel, Non-Slip Base.
- Iron Holder Funnel - Reversible, left or right side.
- Steel Tray for Sponge Pad.
- Sponge Pad.

Test Equipment

Elenco Four Functions in One Instrument
Model MX-9300B

Features:

- One instrument with four test and measuring systems:
 - 1.3GHz Frequency Counter
 - 2MHz Sweep Function Generator
 - Digital Multimeter
 - Digital Triple Power Supply



\$450

Elenco 3MHz Sweep Function Generator with built-in 60MHz Frequency Counter
Model GF-8046

\$199.95

Generates square, triangle, and sine waveforms, and TTL, CMOS pulse.



GF-8025 - Without Counter **\$139.95**

20MHz Sweep / Function Generator with Frequency Counter Model 4040A

- 0.2Hz to 20MHz
- AM & FM Modulation
- Burst Operation
- External Frequency Counter to 30MHz
- Linear and Log Sweep



10MHz Model 4017A \$325
5MHz Model 4011A \$259
2MHz Model 4010A \$225

\$445
BK PRECISION

Elenco Handheld Universal Counter
1MHz - 2.8GHz
Model F-2800



\$99

Sensitivity:

- <1.5mV @ 100MHz
- <5mV @ 250MHz
- <5mV @ 1GHz
- <100mV @ 2.4GHz

Features 10 digit display, 16 segment and RF signal strength bargraph. Includes antenna, NiCad battery, and AC adapter.

C-2800 Case w/ Belt Clip **\$14.95**

Elenco RF Generator with Counter (100kHz - 150MHz)
Model SG-9500



\$225

Features internal AM mod. of 1kHz, RF output 100MV - 35MHz. Audio output 1kHz @ 1V RMS. SG-9000 (analog, w/o counter) \$119

Elenco Quad Power Supply
Model XP-581

4 Fully Regulated Power Supplies in 1 Unit



\$75

4 DC Voltages: 3 fixed, +5V @ 3A, +12V @ 1A, 1 variable: 2.5 - 20V @ 2A • Fully Regulated & Short Protected • Voltage & Current Meters • All Metal Case

Elenco Power Supply
Model XP-603



\$75

• 0-30VDC @ 3A Output
• 3A Fused Current Protection
• Current Limiting Short Protection
• 0.025Ω Output Impedance

Elenco 10Hz - 1MHz
Digital Audio Generator
Model SG-9300



\$225

Features built-in 150MHz frequency counter, low distortion and sine/square waves. SG-9200 (w/o counter) \$119

Ordering Information:

Model SL-5 - No iron. (Kit SL-5K) **\$24.95**

Model SL-5-40 - Includes 40W UL iron. (Kit SL-5K-40) **\$29.95**



Elenco Model SL-30

\$79.95

- Tip temperature changeable from 300°F (150°C) to 900°F (480°C).
- Temperature is maintained within ±10% of its preset temperature.
- The tip is isolated from the AC line by a 24V transformer.
- The tip is grounded to eliminate static charges.

SL-10 - Same as SL-30 w/o digital display **\$54.95**

Weller® Low Cost Soldering Iron
Model WLC100



- Variable power control produces 5-40 watts.
- Ideal for hobbyists, DIYers and students.
- Complete with 40W iron.

\$34.95

Elenco Oscilloscopes

Free Dust Cover and 2 Probes



S-1325 25MHz Dual Trace \$325
S-1345 40MHz Delayed Sweep \$549
S-1330 25MHz Delayed Sweep \$439
S-1360 60MHz Delayed Sweep \$725
S-1340 40MHz Dual Trace \$475
S-1380 100MHz Delayed Sweep \$895

Deluxe 29pc. Computer Service Tool Kit
\$36.95 Elenco Model TK-1200

Includes Soldering Iron, Solder, Long Nose Pliers, Diagonal Pliers, 11 PC Screwdriver Bit Set, Wire Stripper, IC inserter, IC Extractor, Screwdriver, Phillips Screwdriver, Desoldering Pump, and more!



Elenco Educational Kits

Model XK-150

Digital / Analog Trainer



\$89.95

- 830-pin Breadboard
- 8 Data Switches
- 8 LED Buffered Readouts
- Built-in Function Generator (sine and square wave)
- Built-in Clock Generator
- Variable Power Supply

OWI Model OWI-007

Robotic Arm Trainer



\$82.50

Model AK-700
Pulse/Tone Telephone Kit
Flashing Neon Lights
Great School Project

\$14.95



\$18.95

Model AK-780K

Two IC Radio Kit



\$9.95

Model RCC-7K
Radio Control Car Kit

\$27.95



\$12.95

Electronic Science Lab

Maxitronix 500-in-1 Electronic Project Lab Model MX-909

Everything you need to build 500 exciting electronic projects:

- Learn the basics of electronics. 500 different electronic experiments, special lighting effects, radio transmitter and receivers, sound effects, cool games and MORE!
- Includes built-in breadboard and an LCD.
- Explore amplifiers, analog and digital circuits plus how to read schematic diagrams.
- Includes 11 parts.
- Lab-style manual included.
- Requires 6 "AA" batteries.



MX-908 - 30C-in-1 Lab.....\$59.95
MX-907 - 20C-in-1 Lab.....\$44.95
MX-906 - 13C-in-1 Lab.....\$29.95
EP-50 - 50-in-1 Lab.....\$18.95

\$149

Guaranteed Lowest Prices C&S SALES, INC.

15 DAY MONEY BACK GUARANTEE

UPS SHIPPING: 48 STATES 5% (Minimum \$5.00)
OTHERS CALL FOR DETAILS
IL Residents add 8.25% Sales Tax

150 W. CARPENTER AVENUE
WHEELING, IL 60090
FAX: (847) 541-9904 (847) 541-0710

SEE US ON THE WEB

<http://www.cs-sales.com>



2 YEAR FACTORY WARRANTY

PRICES SUBJECT TO CHANGE WITHOUT NOTICE

Electronics & Computer Training

FREE
Course
Catalog!

Cleveland Institute of Electronics

No matter what your career goals may be, most employers still insist on an educational background. Cleveland Institute of Electronics (CIE) offers educational training in Electronics and Computer Technology that lead to Diplomas and Degrees.

Even if you have no experience in the high-tech workplace, CIE can give you the hands-on education you need to maximize your career potential. Experience a step-by-step program designed specifically for the independent study student.

Our patented teaching method allows you to complete each lesson at your own pace so you can *study at times that are most convenient for you!*

A Wide Range of Electronics & Computer Training Available!

You'll find many different CIE Career Courses ranging from our **Computer Programming** course to our **Electronics Technology with Laboratory** course to our most advanced program, CIE's **Associate in Applied Science in Electronics Engineering Technology**.

Every program includes all the tools, lab equipment and instructor support necessary to compete in the 21st century job market.

After successful completion of a Career Course, you'll receive a diploma. Continue in your studies and you can earn an Associate in Applied Science in Electronics Engineering Technology.

There are many other courses to choose from so you can get the exact job-training course that's right for you!

Build on what you already know!

You may be eligible to apply for advanced standing in CIE's A.A.S. Degree Program based on your previous military training or academic history.

Send for a FREE Course Catalog Today!

Fill out the form on this page or call CIE toll-free at (800) 243-6446 or visit us at www.cie-wc.edu and we'll send you a complete information package with our course catalog & tuition prices.



CIE 1776 E. 17th
Cleveland, OH 44114

Name _____

Address _____

Apt _____

City _____

State _____

Zip _____

Phone _____

e-mail _____

Check box for G.I. Bill Details:

Active Duty Veteran

PT30

Call 1-800-243-6446 for a FREE catalog or visit www.cie-wc.edu today!

CIRCLE 320 ON FREE INFORMATION CARD

RF Modules

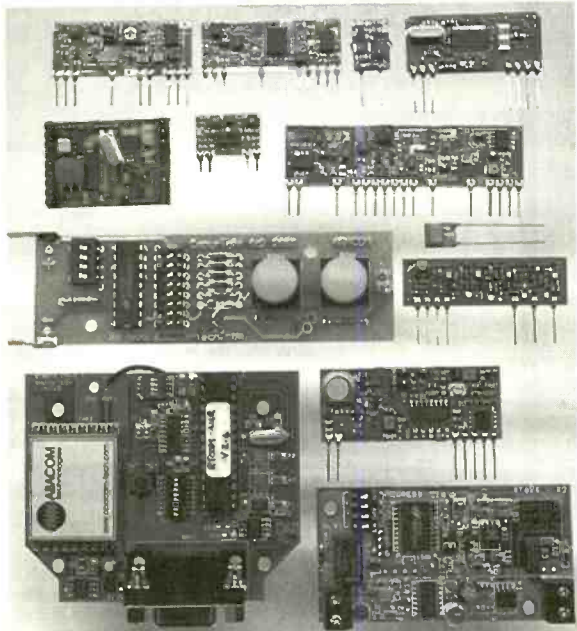

www.abacom-tech.com



Tel: +1(416)236 3858
 Fax: +1(416)236 8866
abacom@abacom-tech.com

\$62 PCBs

And our layout software is **FREE!**

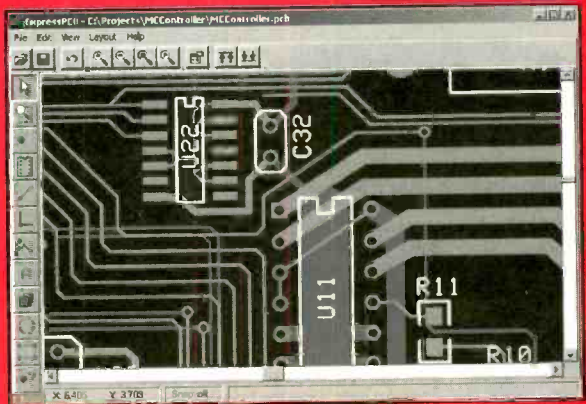

Download our **FREE** layout software
 Design your two-sided plated-through PCB
 Send us your design with just a click
 Receive your boards in a few business days

Select our MiniBoard service and get three top quality
 2.5" x 3.8" PCBs for \$62 – shipping included!



expresspcb.com



MECI 340 East First Street
 Dayton, Ohio 45402
 Your Electronics Value Company

Tons of Electronics

Get your **FREE** catalog today and discover some of the best deals in electronics. We have thousands of items ranging from unique hard-to-find parts to standard production components. Call, write or fax today to start your subscription to one of the most unique catalogs in the industry, filled with super values on surplus electronic and hobbyist type items.



Check out our 10,000 item on-line catalog <http://www.meci.com>

Order Toll Free Why pay more?
1-800-344-4465 Call today!
 Fax Order Line
 1-800-344-6324

CIRCLE 323 ON FREE INFORMATION CARD

Turn Your Multimedia PC into a Powerful Real-Time Audio Spectrum Analyzer

Features

- 20 kHz real-time bandwidth
- Fast 32 bit executable
- Dual channel analysis
- High Resolution FFT
- Octave Analysis
- THD, THD+N, SNR measurements
- Signal Generation
- Triggering, Decimation
- Transfer Functions, Coherence
- Time Series, Spectrum Phase, and 3-D Surface plots
- Real-Time Recording and Post-Processing modes

Applications

- Distortion Analysis
- Frequency Response Testing
- Vibration Measurements
- Acoustic Research

System Requirements

- 486 CPU or greater
- 8 MB RAM minimum
- Win. 95, NT, or Win. 3.1 + Win.32s
- Mouse and Math coprocessor
- 16 bit sound card

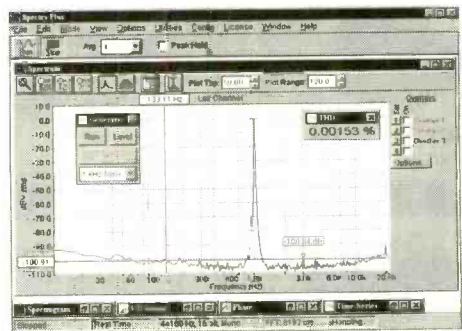

Priced from \$299

(U.S. sales only – not for export/resale)

DOWNLOAD FREE 30 DAY TRIAL!

www.spectraplus.com

PHS Pioneer Hill Software
 24460 Mason Rd.
 Poulsbo, WA 98370
 a subsidiary of Sound Technology, Inc.

Sales: (360) 697-3472



Spectra Plus
 FFT Spectral Analysis System

Fax: (360) 697-7717

e-mail: pioneer@telebyte.com

RAMSEY

GET THE NEW CATALOG TODAY!

New Kits, New LPFM, New Cameras
NEW! www.ramseykits.com



35 WATT LPFM STEREO TRANSMITTER



- ✓ 35W RF output, VSWR protected
- ✓ Automatic audio & power controls
- ✓ Digital synthesized PLL
- ✓ Full front panel control
- ✓ 110/220VAC, 12VDC operation

Whether your application is export or LPFM, the PX1 has you covered. From the over-rated continuous duty power supply & power amplifier to the 2 line vacuum fluorescent display, your station will be the easiest to setup and the most reliable for continuous operation. Full microprocessor controls provide a "virtual engineer". Check out www.highpowerfm for full details.

PX1 35W Professional FM Stereo Transmitter \$1,795.95

ELECTROCARDIOGRAM HEART MONITOR



- ✓ Visible and audible display of your heart rhythm
 - ✓ Re-usable sensors included; just like visiting the hospital!
 - ✓ Bright LED "beat" indicator
 - ✓ Monitor output for oscilloscope display
- Enjoy learning about the inner workings of the heart while covering the stage by stage electronic circuit theory of ECG/EKG systems. Be heart smart and learn at the same time!

ECG1 Electrocardiogram Heart Monitor Kit \$34.95
 CECG Matching Case & Knob Set \$14.95
 AC125 110 VAC Power Adapter \$9.95
 ECGP10 Replacement Reusable Probe Patches (10-Pack) \$7.95

PLASMA GENERATOR



- ✓ Generate 2" sparks to a hand held screwdriver!
 - ✓ Build your own plasma balls!
 - ✓ 25KV at 20 KHz from a solid state source!
- Generate really impressive sparks, build your own plasma ball, light fluorescent tubes without wires! From a solid state source, generate over 25KV at 20KHz for the most dazzling displays!

PG13 Plasma Generator Kit \$59.95
 PS12 14VAC Output Power Supply \$19.95

ION GENERATOR



- ✓ Generates negative ions with a blast of fresh air!
 - ✓ 7.5KV DC negative, 400uA - that's a lot of ions!
 - ✓ Steady state DC voltage, constant current, not pulsed!
- Learn the basics of ion repulsion by building this ion generator! Generate a continuous blast of fresh air charged with a ton of ions. Perfect for pollution and air freshening; just smell those ions! Solid state wind generation; you'll be amazed!

IG7 Ion Generator Kit \$59.95
 AC125 110 VAC Power Adapter \$9.95

TOUCH-TONE TONE GRABBER



- ✓ New-built-in RJ11 phone jack
- ✓ Large memory holds over 500 numbers
- ✓ Big bold 8 digit display, auto insertion of dashes
- ✓ New-output latch jack

Dialed phone numbers on the radio, repeater codes, control codes, anywhere touch-tones are used, you can read and store them! All new design for 2002. Capture those tones with the TG2!

TG2 Tone Grabber Tone Reader Kit \$59.95
 CTG2 Matching Case & Knob Set \$14.95
 AC125 110 VAC Power Adapter \$9.95

RCA TO XLR AUDIO CONVERTER



- ✓ Connect consumer outputs to XLR inputs
 - ✓ Left & right audio gain adjustments
- So you're trying to connect consumer audio outputs with RCA connectors (unbalanced) to XLR (balanced) inputs. Always a problem...Not anymore with the R2XL1!

R2XL1 Unbalanced to Balanced Audio Converter Kit \$49.95
 CR2XL Matching Case & Knob Set \$14.95
 PWR25 12VAC Power Adapter \$9.95

AUTOMATIC COLOR/BW IR CAMERA



- ✓ Color during the day, IR B&W at night!
 - ✓ Automatically turns on IR illumination!
 - ✓ Waterproof to IP57 standards!
 - ✓ Black anodized housing with universal mount
- Best of both worlds! This video camera is a waterproof COLOR camera during the day. When the light level drops, it automatically changes to B&W and turns on its built-in IR illumination, with 10 IR LEDs. Powered by 12VDC and terminated with a professional BNC connector. B&W only model

also available if color is not needed. Both in heavy anodized black housing.

CCD309 Color/B&W IR Waterproof Bullet Camera \$169.95
 CCD308 B&W IR Waterproof Bullet Camera \$109.95
 AC125 110 VAC Power Adapter \$9.95

MINI B&W CAMERA WITH IR ILLUMINATION



- ✓ Built in IR illumination!
 - ✓ Sees in total darkness!
 - ✓ Black aluminum housing with swivel bracket
- What a deal! This miniature B&W video camera has 6 high power IR LEDs built into it to provide illumination in total darkness! No need for external IR illuminators. Attractive black aluminum housing easily mounts at any angle with the built-in swivel bracket. Runs on 12VDC, and includes professional BNC output plug-in harness.

CCD303 Mini B&W IR Illuminated Camera \$59.95
 AC125 110 VAC Power Adapter \$9.95

Check out all our other new cameras at www.ramseykits.com!

PROFESSIONAL FM STEREO RADIO STATION



- ✓ Synthesized 88 to 108 MHz with no drift!
- ✓ Built-in mixer - 2 line inputs and one microphone input!
- ✓ High power module available for export use
- ✓ Low pass filter for great audio response

Our FM100 is used all over the world by serious hobbyists as well as churches, drive-in theaters, and schools. Frequency synthesized PLL assures drift-free operation with simple front panel frequency selection. Built-in audio mixer features LED bargraph meters to make setting audio a breeze. The kit includes metal case, whip antenna and built-in 110 volt AC power supply.

FM100 Super-Pro FM Stereo Radio Station Kit \$249.95
 FM100WT 1 Watt, Wired Export Version \$399.95

SYNTHESIZED FM STEREO TRANSMITTER



- ✓ All new design & features for 2002!
 - ✓ Fully adjustable RF output
- Our #1 kit for years has just gotten better for 2002! Totally redesigned, the FM25B has all the features you've asked for. From variable RF output, F connector RF output jack, line input, loop output, and

more. Includes case, power supply, whip antenna, audio cables.
 FM25B Synthesized FM Stereo Transmitter Kit \$129.95

AND...OUR FAMOUS MINI-KITS

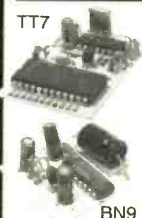

These are easy to build kits that can be used either stand-alone or as building blocks for more complex projects.

TS4 Tickle-Stick Shocker \$9.95
 BN9 Super Snoop Amplifier Kit \$8.95
 BL1 LED Blinky Kit \$3.95
 TD1 Tone Encoder/Decoder Kit \$6.95
 TT7 Touch Tone Decoder Kit \$19.95
 CPO3 Code Practice Oscillator Kit \$9.95
 UT5 Universal Timer Kit \$8.95



AMAZING DEVICES

NVENEVEN102

See and Order from Our "Action" Web Site at www.amazing1.com

Laser Window Bounce Listener

Powerful listening system, yet simple in operation. You shine a laser at a window and intercept the reflected beam with our ultrasensitive filtered optical receiver. Vibrations on the window from internal sounds and voices are now clearly heard. Range can be up to several hundred meters depending on laser power and optics used.

LWB99 Plans for 3 Laser Window Bounce Systems.....\$20.00
LWB6K Kit of 100' visible red for Science Project.....\$129.95

High performance modules require housing and simple alignment to make a field worthy LASER WINDOWBOUNCE unit. Shows test tone circuitry, optics and our lab method of a completed assembly
LWB90 Assembled receiver, 10 mw IR laser, collimator etc. \$449.95

PLASMA FIRE SABERS Kits, Parts and Accessories

Duplicates effect! In the motion picture epic of the century!

Specify blue, grn, pur, red or yel. Moving light appears to evaporate into space
Blades screw into handle for easy replacement

We stock all size and color blades, mauler adapters, tubes digital drivers, and parts for authentic designs. **Wireless interactive sound modules change tone with motion**

SAB18 Assembled with 15" Blade. \$39.95
SAB24 Assembled with 24" Blade. \$79.95
SAB24K Kit...\$59.95
SAB36 Assembled with 36" Blade. \$149.95
SAB36K Kit. \$129.95

Take Control!! Electronic Hypnosis

Electronic circuitry places subject under your control! Induces ALPHA relaxed mind states.

HYP2 Plans.....\$10.00
HYP2K Kit/Plans.....\$49.95
HYP20 Ready to Use.....\$69.95
MIND2 Plans for Mind Control.....\$15.00
MIND2K Kit/Plans.....\$49.95
MIND20 Ready to Use.....\$79.95

Pain Field Pistol

Caution! Do not aim at people!

Blast out rodents with high power ultrasonics. Handheld and battery operated with all controls.

Rental units available.

PPP1 Plans.....\$8.00
PPP1K Kit/Plans.....\$49.95
PPP10 Ready to Use.....\$79.95

Jacob's Ladder

A 1/2" arc expands to over 4' as it travels up the Jacobs Ladder evaporating in space.

- Adjustable arc control
- Uses safe high frequency
- Safety shock shut down
- Full 20" ladder length
- 110/220 vac 150 watts

JACK3K Kit.....\$149.95
JACK30 Ready to Use.....\$249.95

30" Spark Tesla Coil

Create a spectacular display of nature's own lightning. Many amazing experiments possible. See coil in action on our website!

BTC4 Plans.....\$20.00
BTC4K Kit.....\$899.95
BTC40 Ready to use.....\$1199.95

Smaller Version (8-10" Sparks)
BTC3 Plans.....\$15.00
BTC3K Kit.....\$349.95
BTC30 Ready to Use.....\$449.95

MINI TESLA COIL Lights 4' light tube!
MTC1 Plans.....\$5.00
MTC1K Kit.....\$19.95
MTC10 Assembled for 12 volts.....\$34.95

6 Transmitter Kits

- Super Sensitive Ultra Clear 1 Mile+ Voice Transmitter.
- 1 Mile+ Telephone Transmitter.
- Line Powered Phone Transmitter Never Needs Batteries!
- Tracking/Homing Beacon Beeping Transmitter
- Video/Audio Rebroadcaster 1 Mi.
- TV/FM Radio Disrupter. Neal Prank! Discretion Required

Includes Hints Using Wireless Devices
COMBOX Above 6 Kits/Plans.....\$59.95
COMBOP Above 6 Plans Only.....\$10.00

4 KV HV MODULE for hovercraft, plasma guns, antigravity, pyrotechnics. 12vdc input.
MINIMAX4.....\$19.95

Hover Board

28 pages of data related to the most revolutionary advance in transportation. Cutting edge R&D HOVER Plans and Data.....\$25.00

Anti Gravity

Float an object using anelectric force field. With handbook
GRA3 Plans/book.....\$20.00
GRA3K Kit Pwr Sup.....\$99.95
GRA30 Assembled above.....\$149.95

Information Unlimited PO Box 716 Amherst N.H. U.S.A. 03031 E-mail <info1@wavewizard.com>

1 800 221 1705 Orders/Catalogs Only! Fax 1 603 672 5406 Information 1 603 673 4730 Free Catalog on Request
Pay by MC, VISA, Cash, Check, MO. Add \$5.00 S&H Overseas Contact for Proforma

CIRCLE 220 ON FREE INFORMATION CARD

ELECTRONIX EXPRESS

Visit Our Website At <http://www.elexp.com>

<p>WELLER SOLDERING STATION - MODEL WLC 100</p> <ul style="list-style-type: none"> Variable power control (5 to 40 watts) Replaceable heating element Quality light-weight pencil iron <p style="text-align: right; font-size: large;">\$36⁹⁵</p>	<p>RSR TELECOMMUNICATIONS TRAINER</p> <p>HANOS-ON TELEPHONY, LAN, CATV EXPERIENCE WITH ONE SELF-CONTAINED UNIT</p> <p>T-Comm Trainer (TCM-100).....\$199.95 Lab Manual / Work Book.....26.95 Component and Supplies Kit.....37.95 Tool Kit.....119.95</p> <p style="text-align: right; font-size: large;">Only \$199⁹⁵</p> <p style="text-align: right; font-size: x-small;">MODEL TCM-100</p>
<p>LOWEST PRICE 20MHZ</p> <p>instek[®] OSCILLOSCOPE</p> <p>MODEL GOS-620 Dual Channel - 20MHZ (INCLUDES PROBES)</p> <p style="text-align: right; font-size: large;">\$299⁰⁰</p> <p>SCOPE PROBE 60 MHZ SWITCHABLE XT, X10</p> <p style="text-align: right; font-size: large;">\$12⁹⁵</p> <p>DIGITAL MULTIMETER 32 Ranges - 3 1/2 Digit MODEL MY-64</p> <p style="text-align: right; font-size: large;">\$27⁹⁵</p> <p>AC/DC Volt/Current, Res. Cap., Frequency. Rubber Molster Included</p>	<p>instek[®] FUNCTION GEN.</p> <p>WITH INT/EXT FREQ. COUNTER</p> <p>3 Mhz, Digital Display MODEL 8216</p> <p style="text-align: right; font-size: large;">\$199⁰⁰</p> <p>ALLIGATOR LEADS SET OF 10</p> <p style="text-align: right; font-size: large;">\$210</p> <p>SWITCHES Mini Toggle SPDT.....50¢ ea.</p> <p>SOLDERING IRON 3-WIRE HIGH PERFORMANCE #060501</p> <p style="text-align: right; font-size: large;">\$52⁵</p>
<p>PAD-234 DIGITAL/ANALOG TRAINER</p> <p>Complete portable workstation. Variable and fixed power supplies, function generator, digital I/O, rugged design, high impact case.</p> <p>Assembled Kit</p> <p style="text-align: right; font-size: large;">\$150⁰⁰ \$110⁰⁰</p>	<p>HIGH QUALITY TOOLS</p> <p>With Cushion Grips and Return Spring</p> <p>Needle Nose Pliers \$2⁹⁵ Wire Stripper \$1⁵⁰ Diagonal Cutter \$2⁹⁵</p> <p>DC POWER SUPPLIES</p> <p>MODEL HY3003 - DIGITAL DISPLAY Variable output, 0-30 VDC, 0-3 Amp</p> <p style="text-align: right; font-size: large;">\$89⁰⁰</p> <p>MODEL HY3003-3 - TRIPLE OUTPUT Two 0-30 VDC, 0-3 Amp variable outputs plus 5V 3A fixed. Digital Display.</p> <p style="text-align: right; font-size: large;">\$215⁰⁰</p>
<p>SOLDERLESS BREADBOARD</p> <p>830 tie points. MB102PLT model features 3 binding posts and aluminum backplate.</p> <p>Part No. 1-9 10+</p> <p>MB102 5.95 5.00 MB102PLT 8.95 8.00</p> <p>MOTION DETECTOR \$2 ea. - 10 For \$15</p> <p>LM555 10 Min.....22¢ ea. LM741 10 Min.....27¢ ea. 74LS00 10 Min.....18¢ ea. 7805 Regulator 10 Min.....30¢ ea. 2N3904 10 Min.....6¢ ea. PN2222 10 Min.....6¢ ea. Red LED T 1 1/4 10 Min.....6¢ ea. Green LED T 1 1/4 10 Min.....7¢ ea. Yellow LED T 1 1/4 10 Min.....8¢ ea. Photo Cell 10 Min.....65¢ ea. 100K Pot, 1" Shaft PC Mt. 10 Min.....15¢ ea.</p>	
<p>PRESS-N-PEEL</p> <p>PC Board Transfer Film</p> <p>PNP Blue 5 Sheet.....\$9.90 PNP Wet 5 Sheet.....9.90 PNP Blue 20 Sheet.....28.95 PNP Wet 20 Sheet.....28.95</p> <p style="text-align: right; font-size: large;">\$3⁹⁵</p>	
<p>RESISTOR KIT</p> <p>1/4 W 5% film. 5 pieces each of 73 values. 365 pieces total.</p> <p style="text-align: right; font-size: large;">\$3⁹⁵</p>	
<p>FREE CATALOG</p> <p>MORE Low-Priced Items In Our FREE 256-Page Catalog</p>	

TERMS: Min. \$20 + shipping. School Purchase Orders, VISA/MC, Money Order, Prepaid. NO PERSONAL CHECKS. NO CGD NJ Residents: Add 6% Sales Tax.

In NJ: 732-381-8020 365 Blair Road • Avenel, NJ 07001-2293
FAX: 732-381-1006 **800-972-2225** <http://www.elexp.com>
email: electron@elexp.com

CIRCLE 206 ON FREE INFORMATION CARD

STAMP VIDEO !!

LOW COST SINGLE CHIP VIDEO CONTROLLER



\$25 EVAL (1)
\$7.10 OEM (1K)

- Works with Stamp, z80, AVR, 8051, x86, PIC, etc.
- 8 col x 6 row alpha-numeric or 640 pixel graphic
- Includes high speed serial and parallel interfaces
- Drive CRT, TV, LCD with NTSC or VGA signal
- Source code examples in C, BASIC, Assembly

SINGLE CHIP COMPUTER \$7

- ZERO external components
- Built-in BASIC / Assembly
- RS232 program download
- 1K flash, 64ee, 3irq, 2timers
- 15 I/O bits, A/D comparator
- 20mips, faster than pic/8051
- 20 pin DIP part #MV1200



NEW! 8K SUPER CHIP
 40x the BASIC program space!
 -32 i/o, 12 irq, 3 timers, Bus
 -8K flash, 512ee, 512nvram
 -Watchdog with internal osc.
 -40 pin DIP part #MV8515
 oem(1k) \$7.10 eval(1) \$25.00

CREDIT CARD COMPUTER 2



New PLUG-N-GO, no cables/power supply to buy!
 Lo-power RISC cpu 10x faster than PIC, Z80, 8051
 4meg NV mem, ser, par, RTC, 4ch 12bit ADC, ISA bus
 Built-in BASIC, Assembly, C compiler included
 Friendly instruction set, unlike PIC or 8051
 CCC2 eval(1) \$75/oem(1k) \$21 CCC1 \$50/\$14



LO COST MINI-PC

Includes DOS, NV mem, ADC, RAM, clock, ISA bus
 Ports for serial, parallel, LCD, keyboard
 Program in Turbo C, BASIC, MASM, etc.
 Complete, no costly development kits required
 Lowest power lowest cost PC compatible as available
 XT: oem \$27 eval \$95 AT: oem \$55 eval \$195

SERIAL MINI-TERMINAL

RS232 terminal for Stamp, PC, Z80, AVR etc.
 -super low-current, powers from serial line
 -LED backlit LCD, visible in all conditions
 -115.2kbps, DB9 conn, simple commands
 -specify 20 customizable or 16 tactile keys
 eval(1) \$75, oem(1k) \$21.30, w/BASIC cpu \$27



640x480 VGA LCD \$27

Controller for most single/dual scan LCDs
 Works with lo-res (160x120, 320x240, etc.)
 Use with PC or SBC, standard VGA BIOS
 Source code demo shows VGA initialization
 Adaptable for other CPU's (i.e. Z80, HC11)
 oem(1k) \$27 evalkit(1) \$95 w/10" LCD \$195



STAMP DRIVE

Read / Write PC compatible hard
 disk, PCMCIA, & Compact Flash
 on stamp, 8051, pic, avr, z80, x86
 -up to 4 gigabyte capacity
 -low power, simple commands
 -RS232 @ 9600, 115.2k, 667k
 -\$95eval \$27oem, IDE version \$14

LIMITED TIME OFFER!

- FREE SERIAL EE
- FREE PLCC ADAPT.
- FREE ZIF SOCKET

\$95 PRINTER PORT PROGRAMMER

LOWEST COST, FASTEST, EASIEST TO USE!

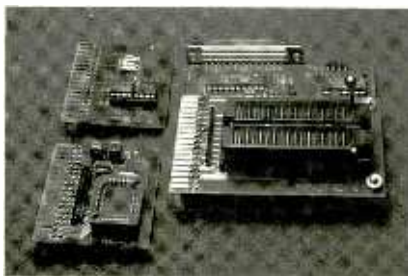

Does FLASH, EE, NVRAM, EPROM to 8m, (27080). Adapters for micros.
 Super small size! Perfect for notebooks or drive bay of desktop computer.
 WINDOWS and DOS software with script file ability to simplify operation.
 Higher yield and quicker programming than others. "Gang Bang" option.

WWW.STAR.NET/PEOPLE/~MVS

MVS Box 803
 Nash., NH 03060
 (508) 792 9507



5yr Limited Warranty
 Free Shipping
 Mon-Fri 10-6 EST

SERVING THE EMBEDDED
 COMMUNITY SINCE 1979!



ACTIVE

ELECTRONIC
COMPONENTS
DEPOT

www.activestores.com

YOUR LOCAL ONE STOP SHOP FOR ALL YOUR ELECTRONIC NEEDS!



Over 150,000 parts in stock!

We have the best names at the best prices for all your electronic projects!

- Electronic Components
- Test & Measure Equipment
- Chemicals
- Wire & Cable
- Soldering Supplies
- Hand Tools
- Books & Kits
- Datacom
- Prototyping
- Static Control
- and much more!



We now carry a wide selection of BASIC stamp products from Parallax!

Visit Active today!

- | | |
|-------------|---------------|
| BALTIMORE | MARYLAND |
| CAMBRIDGE | MASSACHUSETTS |
| CHERRY HILL | NEW JERSEY |
| CHICAGO | ILLINOIS |
| DETROIT | MICHIGAN |
| LONG ISLAND | NEW YORK |
| SEATTLE | WASHINGTON |
| WOBURN | MASSACHUSETTS |

Visit www.activestores.com for details on the store nearest you

Also 10 Locations in Canada

Join our **ACTIVEplus** Rewards Program today!



It's the free and easy way to earn points on every in-store purchase and **save big!***

*See us in store or online for more details

Sign up today and get



REWARDS PROGRAM

New memberships only. Points awarded on in-store purchases only.

100 BONUS POINTS

Computer Microscope

Capture Still Images or Motion Video!

Turn everyday objects into a fun learning experience! Connect to your PC with the USB interface to view specimens at 10X, 60X and 200X magnification. Capture single images, make movies and perform time-lapse photography. Save captured images as JPEG, BMP or AVI files. Add morphing and audio special effects with the bundled software package.

JDR part #: PT-MSCOPE

\$68⁹⁹

Email images to your friends!



Includes Cable Tester



\$99⁹⁹

UTP Tool Kit

Perfect for network or IS professionals

Kit includes a punch-down tool with 110-type blade and combo crimp/strip tool for RJ11/RJ45 connectors. The remote cable tester's modular 2-piece design tests pre-installed 10/100BaseT cables. Includes RJ45 connectors, cable boots and a carrying case.

JDR part #: PT-TKUTP

Bare-Bones PC

Motherboard, CPU, Case and Power Supply

System starter package includes an upright case with a pre-installed 230-Watt U/I/L approved power supply. The ATX motherboard comes pre-configured with a 533MHz Intel Celeron CPU and ball bearing cooling fan. Includes AGP 3D/2D graphics and 3D stereo sound.

JDR part #: PT-PKG533A



\$144⁹⁹ PKG

WOW!!

Shown with optional equipment installed.

GREAT DEAL!

\$84⁹⁹

CD-RW Drive

Add a Fast CD Burner to Your PC

Backup files, store images, transfer data and create music CDs with our internal IDE CD-RW drive. Save recording time with 40X write, 12X re-write and 48X read speeds. CD authoring software included makes recording CDs fast and easy.

JDR part #: PT-CDRW40X48

Hard Drive Bargains

IDE Drives from Major Manufacturers!

Increase your PC's storage capacity with these great deals from major manufacturers. These reliable IDE drives feature Ultra DMA/100 transfer rates and 5,400 RPM spindle speeds. Order yours today!

- | | | |
|----------------------|-------|---------|
| JDR part #: PT-HDD10 | | \$69.99 |
| JDR part #: PT-HDD20 | | \$74.99 |
| JDR part #: PT-HDD40 | | \$79.99 |
| JDR part #: PT-HDD60 | | \$89.99 |



30-Day Money-Back Guarantee 2-Year JDR Warranty Since 1979

JDR COMPUTER PRODUCTS

Call today for your FREE Catalog!

800-538-5000

www.jdrmicro.com

(c) 2002, JDR Computer Products. JDR Computer Products and the JDR logo are trademarks of JDR Microdevices, Inc. Prices do not include shipping charges or sales tax. Please call or visit our website to confirm charges. Prices are subject to change without notice and merchandise is subject to prior sale. Items pictured may only be representative. A complete copy of our terms and conditions of sale is available upon request!

PICmicro® PIC16F87x Series and ICD Book

Easy Debug'n



- Features of PIC16F87x microcontrollers
- In-circuit debugging using Microchip ICD
- Companion for our PIC'n book series
- 8.5x11 format. 72 pages. \$12.95

Table of Contents and Ordering Information On Web Site:

+ \$5 s/h in US. VISA, MC, AM, DS, MO. Check
CA residents please add 7.25% CA sales tax

PICmicro and MPLAB are trademarks of Microchip Technology Inc.

SQUARE 1 ELECTRONICS

P.O. Box 501, Kelseyville, CA 95451
Voice (707) 279-8881 Fax (707) 279-8883

We have been selling on the Internet since 1996. We will ship the day we receive your order or the next business day.

<http://www.sq-1.com>

PICmicro® BOOKS

Easy PIC'n - Beginner

\$29.95

- Programming Techniques
 - Instruction set, addressing modes, bit manipulation, subroutines, loops, lookup tables, interrupts
- Using a text editor, using an assembler, using MPLAB
- Timing and counting (timer 0), Interfacing, I/O conversion

PIC'n Up The Pace - Intermediate

\$34.95

- Serial communication - PICmicro to peripheral chips
- Serial EEPROMS
- LCD interface and scanning keypads
- D/A and A/D conversion - several methods
- Math routines

PIC'n Techniques - Intermediate

\$34.95

- 8-pin PICmicros
- Timer 1, timer 2 and the capture/compare/PWM (CCP) module
- Talking to a PICmicro with a PC using a terminal program
- Test equipment and data logger experiments

Serial PIC'n - Advanced

\$49.95

- Synchronous - bit-bang, on-chip UART, RS-232
- Asynchronous - I2C (Philips Semiconductor)
 - SPI (Motorola), Microwire (National Semiconductor)
- Dallas Semiconductor 1-Wire bus

October 2002, Poptronics

71

MODERN ELECTRONICS

Cable TV Descramblers

Buy 1 Descrambler,
Get the 2nd for

COPY RENTAL TAPES WITH OUR VIDEO STABILIZERS

- 30 DAY FREE TRIAL!
- FREE PRODUCT CATALOG!
- BEST DEALER PRICING!
- 100% MONEY BACK GUARANTEE



1/2 Price



1-800-906-6664

2609 S. 156th Circle • Omaha, NE 68130

<http://www.modernelectronics.com>



ORDERS: WWW.CONITEC.NET

**GALEP 4
UNIVERSAL
PROGRAMMER**

Introducing a pocket programmer
with true **Universal Output**

**\$333
COMPLETE KIT**



Latest generation pocket sized programmer uses ASIC universal pin driver technology. 1300+ device library, with lifetime free updates. Programs 8/16-bit EPROM'S, EEPROM'S, 0-Power RAM, FLASH, Serial EEPROM'S, GAL, PALCE,

microcontrollers such as 87/89xxx, PIC, AVR, ST62, etc. Low voltage devices down to 1.3V. No adapter required for DIL devices. 8 Hrs. operation on battery (AC charger included). Runs **WIN 98, NT, ME, 2000, XP** with Hex/Fuse Editor.

Remote control from other apps, (e.g. VisualBasic. Substitutes higher priced universal programmers e.g. ALL-11 (HIL0) or LAB-TOOL 48 (ADVANTECH) Providing virtually matching performance at only 1/3-1/5 the price. Info./Orders, call: **619-702-4420**



CONITEC DATASYSTEMS - 1951 4TH AVE, SUITE 301 - SAN DIEGO, CA 92101 - TEL: 619-702-4420 FAX: 619-702-4419

Lynxmotion, When you're tired of playing with toys!

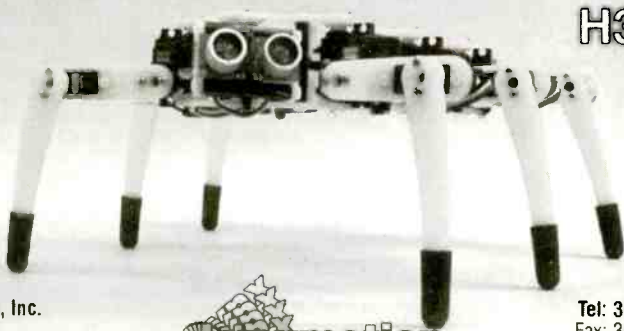

H3-KT

Lynxmotion, Inc.
PO Box 818
Pekin, IL 61555-0818
www.lynxmotion.com



Visit our website or ask for our free catalog!

Tel: 309-382-1816
Fax: 309-382-1254
sales@lynxmotion.com
tech@lynxmotion.com

Please give blood.

There's a life to be saved right now.

Call 1-800 GIVE LIFE



American Red Cross



Do You Repair Electronics?

- Repair Databases for TV, VCR, Monitor, UL Audio, FCC, and more.
- Over 76,000 records
- Private user forums
- Live on-line chat rooms

RepairWorld.com

Electronics Corp 1 Herald Sq Fairborn, OH 45324 (937) 878-9878

SINGERS! REMOVE VOCALS
Unlimited Free Backgrounds from Original Standard Recordings!
Thompson Vocal Eliminator™ VE-4 Free Brochure/Demo
24 Hour Demo/Info Line (770) 482-2485 - Ext 49
LT Sound Dept PE-1 7980 LT Parkway, Lithonia, GA 30058
Internet www.LTSound.com
Better Than Karaoke For Over 25 Years!

ALL ELECTRONICS CORPORATION

SHOP OUR ONLINE STORE
www.allelectronics.com

5MM BLUE LED SPECIAL

High-brightness blue LED. 1000 MCD. Water-clear in off state. Special price.



CAT# LED-86

\$1.75
each

10 for \$1.50 each
100 for \$1.15 each
1000 for 95¢ each

25 WATT POWER SUPPLY

Autec # UPS25-1002T

Input: 115v/1.5A or 230V/0.75A

Output:

5V @ 1.9A.

12V @ 1.6A.

25 Watt switching

supply mounted on an L-bracket,

9" x 2.27" x 2.25" overall. Standard three

prong IEC socket power input. On-Off rocker

switch. Molex-type connector output.

UL, CSA recognized.

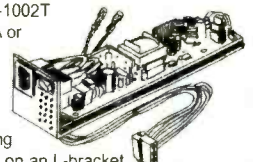

CAT# PS-251

\$4.25
each

10 for \$3.50 each

1 Farad 2.5 Volt Supercapacitor

PowerStor (tm) # B0810-2R5105

In addition to battery back-up

applications, these capacitors

can be used to provide short,

high-current pulses for

electronic and electro-

mechanical applications.



Features include: Extremely low ESR.

Ultra low leakage current - can hold a

charge for several weeks. Very high

charge-discharge cycle life. High usable

capacity - high energy that can be dis-

charge quickly.

0.33" diameter x 0.47" high.

0.16" (4mm) cut & bent pc leads.

CAT # CBC-125

10 for 85¢ each

100 for 70¢ each

\$1.00
each

ORDER TOLL FREE

1-800-826-5432

CHARGE ORDERS to Visa, Mastercard,
American Express or Discover

TERMS: NO MINIMUM ORDER. Shipping and handling for the 48 continental U.S.A. \$6.00 per order. All orders including AK, HI, PR or Canada must pay full shipping. All orders delivered in CALIFORNIA must include local state sales tax. Quantities Limited. NO COD. Prices subject to change without notice.

CALL, WRITE
FAX or E-MAIL
for our **FREE**

**96 Page
CATALOG**
Outside the U.S.A.
send \$3.00 postage.

MAIL ORDERS TO:
**ALL ELECTRONICS
CORPORATION**
P.O. Box 567
Van Nuys, CA 91408
FAX (818) 781-2653

e-mail allcorp@allcorp.com

High Tech Video System with Audio **Only \$119.00!!**
 Complete Package! Includes Two B/W Cameras with I.R. (night vision) & microphones
 One 5.5" B/W Monitor with Built in Switcher, Two pre-wired 60 ft hook-up cables
 Everything you need to be up & running in minutes with a high tech video system!!



- System Features:**
- *2 wide angle B/W cameras w I.R. & Sound
 - *5.5" B/W video monitor w built in switcher
 - *Two 60 ft. pre-wired cables
 - *View one or both cameras. Switching Time variable from 2 to 20 seconds
 - *Video easily hooks into a VCR

Aluminum Frame & Carrier!
 3 Cooling Fans **Best Choice! ONLY**
 Front Panel Door
 LED power indicator & HD activity **\$17.95**
 Keylock & Groundwire any qty.
 IDE Ultra DMA 66/100 & Ultra Wide
 SCSI models available



ALUMINUM HARD DRIVE RACKS/3 fans
 AMR2-3F IDE...\$17.95
 AMR2/UWSCSI...
 (UW SCSI).....\$23.95

Triple Output Bench Power Supply
 w four 3/12 digit LCD Displays



Output: 0-30 VDC @ 2 Amps x 2
 & 5V fixed @ 3 Amps x 1
 Input: 110VAC +/- 10%
CSI3002D-3....\$169.00
 (qty. 5+.....\$159.00)

Details at www.web-tronics.com
 under Test Equipment

2GHz RF Field Strength Analyzer
 • Frequency Range: 100KHz to 2.060MHz
 • Narrow Band FM (NFM), Wide Band FM (WFM), AM and Single Side Band (SSB) Modulated Signals May Be Measured
 • PLL Tuning System for Precise Frequency Measurement and Tuning
 • LED Backlight LCD (192x192 dots)
 • Built-in Frequency Counter
 • Hand-Held and Battery Operated
 • All Functions are Menu Selected
 • RS232C for PC Interface and Printer

ONLY \$1699



#3201

CTRL - D to bookmark this site

www.web-tronics.com

Don't forget the dash

Circuit Specialists Inc.

- Easy to Navigate
- Includes a Search Engine That Really Works
- New Items Added Constantly

In Business Since 1971

Intelligent Multi-Function Digital Counter (1.3GHz) **\$149.00!**
 Ch A: 10 to 100 MHz
 Ch B: 100 MHz to 1.3GHz
Micro-Controller Based Design
 An intelligent multi-function counter controlled by an 8-bit micro-controller with eight high bright LED display. Four measuring functions (frequency, period, total mode & self check) Also, a 10MHz OSC OUT feature.

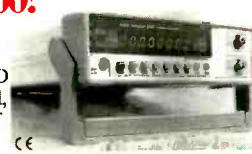

Extensive Details @ web site under TEST EQUIPMENT

Bullet CCD Cameras B&W and Color
 • Smart Rugged Metal Housing
 • Extremely Low Power Consumption
 • 12 Volt
 • CCD Area Image Sensor for Long Camera Life
 • Built-In Electronic Auto Iris for Auto Light Compensation
 • No Blooming, No Burning
 • 0.1 Min Lux Illumination (B&W), 1 Lux Min Lux Illumination (color)
 VMBLT1020 B&W, 21mm(D)x58.5mm(L) \$49.00 any qty.
 VMBLT1020W B&W Weatherproof, 21mm(D)x58.5mm(L) \$69.00 any qty.
 VMBLJC193W COLOR Weatherproof, 17mm(D)x88mm(L) \$109.00 any qty.



Intelligent DMM w RS-232 **\$44.50!**
 3999 Count Display
 Multi-Function Testing with Autoranging & manual operation
 hFE Test, Data Hold, Diode Test, Cont Test
 Backlight, Capacitance, DCV, ACV, DCA, ACA, Resistance, Temperature (#CSI345)
 ships w K-probe, rubber boot, RS-232 cable
 Software & test leads. Details @ web site

DC to AC Power Inverters!
150 watt up to 3000 watt models!

- 150w modified sine wave: \$29.95(G-12-015B)
 - 300w modified sine wave: \$39.95(G-12-030)
 - 150w pure sine wave: \$69.00(G-12-150S)
 - 300w pure sine wave: \$109.00(G-12-300S)
 - 800w modified sine wave: \$139.00 (G-12-800)
 - 1000w modified sine wave: \$179.00(G-12-10C)
 - 3000w modified sine wave(phase corrected), (G-12-300).....\$489.00
- See Our Website for DETAILED Specs.!



Our Most Sophisticated DMM **Now Only \$149**
 with RS-232 Interface & Software, 3-3/4 Digit, 4000 Count, Auto-Ranging with Analog Bargraph

- True RMS Mode
- 10MHz Frequency Counter
- Time Mode with Alarm, Clock, and Stop Watch
- Dual Display
- 10 Location Memory
- Min, Max, Avg and Relative Mode
- Decibel Measurement
- Cap and Ind Measurement
- Temperature Mode (C/F)
- K Type Temperature Probe Included
- Pulse Signal for Logic & Audible Test
- Continuity/Diode Test
- Logic Test
- Auto Power OFF/"Keep ON" Mode
- Fused 20A Input with Warning Beeper
- Back Light
- Data Hold/Run Mode
- Safety Design UL1244 & VDE-0411
- Protective Holster
- Silicon Test Leads

Reg. \$169
 More Details on our Web Site
PROTEK 506



Bench Digital Multimeter w RS232C Interface
 True RMS/AC voltage & current
 Digital & Analog Display
 3999 Counts & 42 Segment Bar graph
 Autorange & Manual Range
 Data Hold, Min/Max Relative Measurement
 Storage: Data Display/Recall
 Back Light
 ADP Measurement: 400mV+, 3% 10 Digit/1mV DC
 Continuity Test
 Diode Test
 RS232C standard interface
 AC or DC power
 Extensive Details @ WEB SITE
 Item# CSI9803R

Only \$99.00!
 any qty.



O'Scope Offer ONLY \$299
 30MHz! ONLY \$299!
 Industries Best Price!
 See web for specs

#OSC-1030

- Dual Channel
- Dual Trace
- Vert Trigger
- 1 Year C.S.I. Warranty!

Manufactured for CSI by a leading O.E.M. manufacturer. See our website for detailed specifications!



3000 Series Digital R/O Bench Power Supply
 • Low Cost Single Output • 3 Amp **New Lower Prices!** **AS LOW AS \$85**

High stability digital read-out bench power supply featuring constant voltage and current outputs. Short-circuit protection and current limiting protection is provided. Highly accurate LED accuracy and stable line regulation make the 3000 series the perfect choice for lab and educational use.

Line Regulation: 2x10⁻⁴ +1ma
 Load Regulation: 1 x 10⁻⁴ +5mv
 LED Accuracy: Voltage ±1% +2 digits
 Current ±1.5% +2 digits
 Wave Line Noise: ≤1mvrms
 Dimensions: 291mm x 158mm x 136mm

CSI3003: 0-30V/0-3amp Digital R/O Bench PS, 1x10⁻⁴+5mv Load Regulation \$89.00 5/\$85.00

CSI 5003: 0-50V/0-3 amp Digital R/O Bench PS, 1x10⁻⁴ +5mv Load Regulation \$109.00 5/\$99.00

See our web-site for many other power supply deals



New and Pre-Owned Test Equipment

New Equipment Specials

B+K Precision 2120B - 30 MHz Oscilloscope

- * FREE Model 117B Multimeter
 - * 2 Channel, Dual-Trace
 - * 30 MHz Bandwidth
 - * TV Triggering
 - * (2) Probes Included
- Sale Price \$339.00**

AVCOM PSA-37D - Spectrum Analyzer

- Satellite Downlink - Installation - Maintenance & Service*
- Band 1: 10 - 1750 MHz
 - Band 2: 3.7 - 4.2 GHz
 - Carrying Case Included
 - Line or Battery Powered
 - Built-in DC Block & Power for LNA/LNB's
- Sale Price \$2,395.00**

Instek GOS-6103 - 100 MHz Analog Oscilloscope

- 100 MHz Bandwidth
 - 2 Channel, High Sensitivity
 - TV Trigger - Signal Output
 - Cursor Readout
 - Time Base Auto-range
 - (2) Probes Included
 - 2 Year Warranty
- Sale Price \$899.00**

Leader LF 941 - CATV Signal Level Meter

- TV/CATV Coverage from 46-870 MHz
 - Video/Audio Carrier Measurements
- Sale Price \$489.00**

Wavetek Meterman HD160B Digital Multimeter

- Full Sealing Against Water, Chemicals, & Fluids
 - True RMS
 - Drop-Proof to 10 feet (3.3m)
- Sale Price \$159.00**

Pre-Owned Oscilloscope Specials

Tektronix	465	100 MHz	\$499.00
Tektronix	465B	100 MHz	\$649.00
Tektronix	475	200 MHz	\$749.00
Tektronix	475A	250 MHz	\$949.00

- Professionally Refurbished
- Aligned & Calibrated to Original Specifications
- The Industry Standard of Oscilloscopes
- 1 Year Warranty - The Longest Available!!!
- See Website for Complete Specifications

See us on the Web!
www.testequipmentdepot.com

We Buy Surplus Test Equipment

Test Equipment Depot

A FOTRONIC CORPORATION COMPANY

99 Washington St. Melrose, MA 02176
 (781) 665-1400 • FAX (781) 665-0780

e-mail: sales@testequipmentdepot.com

(1-800-996-3837)

TOLL FREE 1-800-99-METER



CIRCLE 322 ON FREE INFORMATION CARD

CONTROL MEASURE INPUT

RELAYS • LIGHTS • MOTORS
 TEMPERATURE • PRESSURE • LIGHT LEVELS • HUMIDITY
 SWITCH POSITIONS • THERMOSTATS • LIQUID LEVELS

MODEL 30 \$79



- PLUGS INTO PC BUS
- 24 LINES DIGITAL I/O
- 8 CHANNEL-8 BIT A/D/IN
- 12 BIT COUNTER
- UP TO 14K SMP/SEC

MODEL 45 \$189



- RS-232 INTERFACE
- 8 DIGITAL I/O
- 8 ANALOG INPUTS
- 2 ANALOG OUTPUTS
- 2 COUNTERS-24 BIT

MODEL 100 \$279



- 12 BIT 160 KHZ A/D
- 4 ANALOG OUTPUTS
- 3 TIMER COUNTERS
- 24 DIGITAL I/O

MODEL 150-02 \$179



- RS-232 INTERFACE
- TRMR, 20 AMPS
- 12 BIT A/D
- OPTO-ISOLATED
- COMPLETE DMM

MODEL 40 \$109



- RS-232 INTERFACE
- 28 LINES DIGITAL I/O
- 8 ANALOG INPUTS
- PWM OUTPUT

MODEL 70 \$239



- RS-232 INTERFACE
- 18 BIT A/D
- 5.5 DIGIT
- UP TO 60 SMP/SEC

Prairie Digital, Inc.

PHONE 608-643-8599 • FAX 608-643-6754

820 SEVENTEENTH STREET • PRAIRIE DU SAC, WISCONSIN 53578

CIRCLE 219 ON FREE INFORMATION CARD

Start A Career With High Wages, Excellent Benefits and Job Security!!

With UCANDO's extraordinary maintenance training programs you can quickly and easily enter a high paying field as a maintenance technician for a very small investment of time and money.

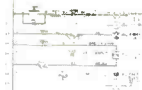

RC-M ONLY \$165 RC-M is a 15 hour training course on relay ladder logic systems. Includes a 5-part video and workbook. Great Value!

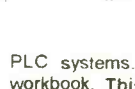

PLC-M ONLY \$198 PLC-M is a 32 hour training course on PLC systems. Includes (2) 4-part video's and workbook. This training is valuable.



HYD-M ONLY \$209 HYD-M is a 32 hour course on Fluid Dynamics. Includes (2) 4-part video's and workbook. This Module is a must.

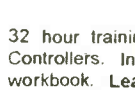

SC-M ONLY \$215 SC-M is a 32 hour training course on AC & DC Servo Controllers. Includes (2) 4-part video's and workbook. Learn everything you need about AC and DC servo Control Systems.



Electronic Training Videos: Basic Electronics, Digital Electronics, TV Repair, LASER and Fiber Optic training videos available at very affordable prices starting at **Only \$35.00 each.**

For information or to place an order call:

1-800-678-6113

www.ucando-corp.com

UCANDO VCR Educational Products Corp., Greenville, OH

FCC Course with Certificate

A Powerful 19 Lesson Self-Study Program on one CD!

FCC Exam Review Course

After completing this course you will be ready to take the FCC examination for a General Radiotelephone Operator License.

The General Radiotelephone Operator License is required to adjust, maintain or repair any FCC licensed radiotelephone transmitters in the aviation, maritime and international fixed public radio services. It is issued for the lifetime of the holder.

Through the years Cleveland Institute of Electronics (CIE) has been able to compile a great amount of information concerning the types of questions that the FCC include in their examinations.

Because of the extensive FCC sample questions in this course, you can look forward with confidence to passing the FCC exam particularly if you heed the hints given throughout the course.

Here's what you'll get!

19 FCC Lessons on CD ROM

Every lesson is presented in a clear and easy-to-understand format which makes learning this material fun and easy. After each lesson you'll take an exam. You can take it on-line or fill out one of the answer sheets we provide and mail it. After you finish the 19 lessons we'll send you a Certificate of Completion from CIE.

CIE Instructor Assistance:

Use our toll-free hot line to access our faculty and staff if you ever need assistance with your course work.

Priority Grading:

Your exams will be graded and sent back to you within 24 hrs.

Certificate of Completion:

Earn a Certificate of Completion that's suitable for framing.

Why is an FCC License so valuable?

An FCC license is an excellent credential for career advancement because it's proof of a certain level of electronics know-how. Because it is a federal examination, the FCC license with its implied knowledge is accepted by industry nationwide.



Lesson Topics Include:

- Modern Modulation Methods
- Receiving Equipment
- Batteries, Control Motors & other Power Sources
- Digital & Data Commun.
- Frequency Modulation
- Transmission Lines & Wave Guides
- Transmitters
- Antennas & Wave Propagation
- Monochrome & Color TV
- Microwave Comm. Systems
- Tuned-Stage Operation
- Suppressed - Carrier Modulation and Single
- Detection & Frequency Conversion
- Lasers in Communications & Industry
- Communications by Fiber Optics
- FCC Review Lessons Pt 1
- FCC Review Lessons Pt 2
- Pointers & Practices for Passing FCC G.C. Exam Pt 1
- Pointers & Practices for Passing FCC G.C. Exam Pt 2

Learn PC Repair



- PC Diagnostic Video
 - 200 + Page Training Manual
 - PC Assembly & Configuration Video
 - Micro-Scope Diagnostic Software (LE)
 - CD-ROM - contains videos and manual
- 02-020 \$99.95

Motor Controls 101

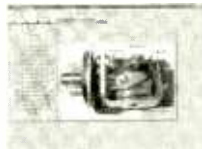

This CD ROM trainer uses pictures, sounds, animations & interactive circuits to teach you the basics of motor control. A Certificate of Completion may be printed on your printer if you achieve a passing score on the included test.

02-050 (not a CIE certificate) \$99.95

More CIE Certificate Courses

- AC/DC Electronics Course with Lab**
03-introb (39 graded lessons w/ cert) .. \$225
- Intro to Web Site Design**
01-M410 (10 graded lessons w/ cert) .. \$245
- Soldering Course with Lab**
01-SD01 (3 graded lessons w/ cert) \$95
- Programmable Controller Course**
01-SD01 (1 graded lesson w/ cert) \$65
- Digital Data Communications with Lab**
01-DD01 (11 graded lessons w/ cert) .. \$245

CIE Bookstore: 1776 E. 17th, Cleveland, OH 44114 • **800 321-2155** • **www.ciebookstore.com**

Shipping & Handling: \$0 - \$30 **\$2.75**, \$30.01 - \$50.00 **\$5.25**, \$50.01 - \$100.00 **\$11.75**, \$100+ **\$15.75** CA, HI & OH residents must add sales tax.

CIRCLE 320 ON FREE INFORMATION CARD



PCBexpress
www.pcbexpress.com

- No tooling charge!
- Lot charges start at \$80
- Simple order process
- Quickturn, low quantities

TWO SERVICES FOR CIRCUIT BOARDS



INSTANT ON-LINE QUOTES!
(No sign-up required)



www.pcbpro.com

- Quick Price Comparisons
- More options and added features
- Prototype & production quantities

Your own circuit boards from design through order are as easy as **PCB123**

- ✓ Download the **FREE** software.
- ✓ Design the circuit board you want.
- ✓ Get real-time pricing as you design.

We'll produce your small quantity circuit board order at an unbelievably low price, and we'll have it back to you in no time.

* Easy * Fast * Inexpensive



Visit us online today at www.pcb123.com—we make doing what you want as easy as 1,2,3.

Providing the complete circuit board solution, design through order.

QUICK and PAINLESS Programmable Robotics!

Ready for something different?



Co-Processor and Controller now separately available!

Blue Bell Design Inc.
www.bluebelldesign.com

SMT Prototyping Adapters

Snap-Apart™ Series

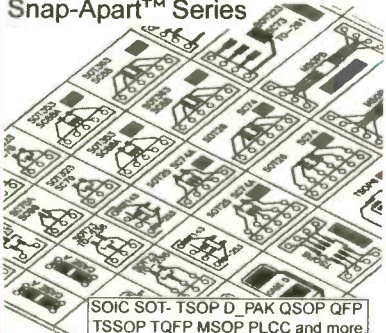

SOIC SOT- TSOP D_PAK QSOP QFP TSSOP TQFP MSOP PLCC and more.

Your design concepts become reality, fast. 5"x7.6" smooth grooved, green PCB's snap apart providing SMT adapters, .100" pin strips included. No pcb layout, no waiting, no adapter hunt for most patterns with these on hand. Details on these and more on website.

BELLIN DYNAMIC SYSTEMS, INC.
www.beldynsys.com (714) 630-8024

- Rapid Development Solutions for the Technical Professional -



...made easy.

www.microCommander.com

Scrambling News

915 NW First Ave., Suite 2902, Miami FL, 33136, 305-372-9427

Pay TV and Satellite Descrambling 2002 - New! - satellite and cable. Includes the latest information. \$19.95 plus \$1.75 shipping.

Hacking Digital Satellite Systems Video 2002 - New! - This 90 minute video focuses on the satellite television piracy business. \$29.95 plus \$ 3.50 shipping.

Scrambling News Online - Online service for those interested in satellite television news. \$59.95/year.

Pay TV and Satellite Descrambling Series CD-ROM - all 13 volumes over 300 pages, \$59.95 plus \$3.50 shipping.

Best Deal - Everything listed above for only \$99.95 plus \$3.50 shipping.

www.scramblingnews.com

Stepper Motor Book 

Easy Step'n

- For the experimenter.
- Determine surplus stepper motor specs using simple easy to build test equipment.
- Build microcontroller-based control systems (flow charts and code examples).
- Build stepper motor drive circuits.
- Mechanical design considerations.
- 8.5x11 format. 205 pages. \$34.95

Table of Contents: <http://www.stepperstuff.com>
+ \$5 s/h in US. VISA, MC, AM, DS, MO, Check
CA residents please add 7.25% CA sales tax

SQUARE 1 ELECTRONICS
P.O. Box 501, Kelseyville, CA 95451
Voice (707) 279-8881 Fax (707) 279-8883

<http://www.stepperstuff.com>

Top Secret Consumertronics
In business 25+ years - established professionals
www.tsc-global.com

Exciting Hi-Tech Survival Books, Manuals, Tapes

Stopping Power/ KW-HR Meters/VHS
Cellphone / Cordless / Pager Manuals
Voice Mail / Answ. Machine Security
Phone Color Boxes/ Caller ID,ANI Sec.
Fax Machine / PBX Security
Computer Sec./Hacker Files/Dirty2Doz
Internet Security / Frauds/Tracking
Beyond van Eck Tempest / VHS
Polygraph Secrets/Identity Theft Manual
Cons & Scams Databook / Placard Rep.
ATM/CreditCard/Check/MO Security
Mind Control / Under Attack! / EMBB
Radionics Manual/ Heal Thyself!
Stealth Tech. / High Voltage Devices
Social Engin./Ultimate Success Manual
Remote Office/ Casino Secrets - 100 more!

Catalog: Descriptions, Reg.Prices, Policies
Consumertronics
+\$6 S/H USA P.O. 23097, ABQ NM 87192
505-321-1034 - Printed Catalog \$3

Lone Star Consulting, Inc.

 8900 Viscount, #235
El Paso, TX 79925
915-474-0334

Descriptions, Prices, Policies:

www.lonestartek.net

SPECIAL PROJECTS HARDWARE

Unique - Original - Made-to-Order - Special Needs
Electronic - Computer - Phone - Energy - Security - Data Cards
Cars - RF - EM - Audio - Radionics - "Psychic" - Plans - more!
Power Meters Educational Modules ♦ Metal Detectors
Remote Controls ♦ KX Radar Emitter ♦ Audio Assistors
Lineman's Test Sets ♦ Bug/Tap Detectors /Blasters
Shriek Modules ♦ Stealth Paints ♦ Magnetometers
Neurophones ♦ Rifles ♦ Hieronymus ♦ Ultrasonic
Devices ♦ "Aura" Detectors ♦ TENS ♦ Jammers ♦ EMF
"Signature" Detectors ♦ Security Systems ♦ Data Card
Reader/Writers ♦ Unseen Presence Detectors ♦ Super
Conduct. Detectors ♦ Subliminal Devices ♦ Control
Signal Replicators ♦ Infrared Detectors ♦ Secret
Communicators ♦ Vortex Generators ♦ Levitators
Flash Blasters ♦ much more weird, wild & wacky stuff!

PIC Programmer Kits

Super Value!

\$16.95
+S&H \$4.95*

The P13PRO: can program up to 40 pin PICs including the popular 16F84 & 12C508 • Needs software (extra \$20) • Available assembled or starting from \$16.95 for the kit.

See www.electronics123.com for more info!
The PICALL programmer can also program ATmel AVR's in addition to the PICs it can program • Free software • PICALL programmer kit at \$69.95
See www.electronics123.com for more info!

Video Camera module Code:BB004

CMOS Camera Module, Black & White. Size: 0.63"x0.63"x0.59"H. Lens: f4.9, F2.8, EIA 320Hx240V. 0.6" DIL Package, 5 pins. Pin 3 is 1V p-p composite video (75 ohm) to monitor. \$36 + \$5 S&H

Running Lights kit Add \$6 or 8 triacs to drive light bulbs

8 LEDs with 10 push button selectable patterns. 8 speed levels! 80 combinations! \$16 + \$5 S&H

Toll Free: 1-888-549-3749 (USA & Canada)
Tel: (330) 549-3726. Request a FREE catalog or visit us at: www.electronics123.com for more products.
Amazon Electronics, Box 21 Columbiana OH 44408

SUPREME SURVEILLANCE

JUST PUBLISHED! The **EXTREME** Cover Catalog details virtually every surveillance system in the World Market today. From the FBI (and their superiors) latest anti-terrorist phone/computer/and video tools, to bargain basement devices no one knows about.

Complete specs and ordering information on hundreds of surveillance and investigative hardware and software products from 14 countries. Many, many new entries for covert audio and video supplies, computer busters, thru-wall viewers, night vision gear, fax interceptors, CIA designed lock defeaters, etc.

"Absolutely fantastic! A Techie's dream come true. No fluff, no filler, just raw spy meat. Whala meal!" - Kevin Murray, probably the top courier surveillance expert in the U.S. ECC, 8 1/2" x 11", ISBN 1-860-231-20-4, 437 pages, index. \$49.95

Intelligence Here
404 N. Mt. Shasta Blvd.
Mt. Shasta, CA 96067
Order by Phone: 866-885-8855
www.intelligencehere.com



Add \$8.00 (priority shipping) CA residents add 3% tax

Press-n-Peel Transfer Film PC Boards in Minutes

8.5" x 11" Shts.
* Or Photocopy
**Use standard household iron

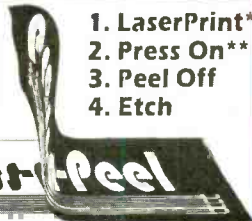

1. LaserPrint*
2. Press On**
3. Peel Off
4. Etch

Use Standard Copper Clad Board
20 Shts \$30/ 40 Shts \$50/ 100 Shts \$100
Visa/MC/PO/CK/MO \$4 S&H/Foreign Add \$7

Techniks Inc.

P.O. Box 463, Ringoes NJ 08551
ph. 908.788.8249 fax 908.788.8837
www.techniks.com

Visit Our E-Store On-Line!

PICmicro MCU Development Tools



EPIC Plus
PICmicro Programmer
\$59.95

Program PICmicro MCUs in BASIC!

DOS or Windows operation (includes Windows IDE software).
PicBasic Compiler - \$99.95
PicBasic Pro Compiler - \$249.95

Experimenter Boards

LAB-X1 for 40-pin MCUs (shown) - \$199.95
LAB-X2 for 28 or 40-pin MCUs - \$69.95
LAB-X3 for 18-pin MCUs - \$119.95



PICProto Prototyping Boards

\$8.95 to \$19.95

High-quality blank prototyping boards for PICmicro MCUs.

microEngineering Labs, Inc.

www.melabs.com
Phone: (719) 520-5323
Fax: (719) 520-1867
Box 60039, Colorado Springs, CO 80960

PCB Production

Double side—12¢ per in²
Four layers—20¢ in²
Six layers—32¢ in²
UL approved
(with solder mask, Silkscreen
Three weeks)

www.mylydia.com
MYLYDIA INC.

Call 1-800-MYLYDIA
E-mail: PCBSales@mylydia.com

**FIELD - STRENGTH
RECEIVER - METER** A High-Quality Electric Field Meter
So Sensitive It's Like a Wideband Receiver!



BROADBAND : 10 MHz to 4.5 GHz usable range
HIGHLY SENSITIVE : Detects "Cellular phones and "Bugs" at 20 ft. • 2.4 GHz "sealed" microwave ovens at 40 ft.
2 meter, 440 MHz transceivers FRS walkie talkies at 80 ft.
DUAL MODE : LINEAR - For measuring weakest signals
DETECTION : LOGARITHMIC - 1000:1 dynamic signal range
SENSITIVITY CONTROL : > 20 dB manually adjusted gain
80 HR. OPERATION (Approx.) : With 2 AA alkaline batteries

ANALOG METER and LED DISPLAYS : The LED display for distance and nighttime
SILENT VIBRATE MODE : Switchable vibrator for signal detection without direct viewing

Including shipping and handling
(CA residents add 8% Sales Tax) **\$89**

Alan Broadband Company Phone : (888) 369-9627
93 Arch Street
Redwood City, Ca. 94062 Fax/Phone: (650) 369-9627

www.zapchecker.com

PAIA

Theremin
The PAIA Theremax uses the same heterodyne principles as the original turn of the century instrument for classic tone and adds features made possible by modern ICs. Shown with optional pattern case.

£505K Kit \$89.75

FatMan Analog MIDI Synth
A complete music synthesizer with all the big bottom and phat sound that makes analog famous. 20 knobs and controls for real-time sound sculpting. Compatible with standard MIDI sources like keyboards or computers. Desktop case or rack panel available.

9308K Kit \$154.00

Check out <http://Paia.com> for schematics, tech details, firmware source files and more...
Synthesizer Modules, Guitar Effects, Mixers, EQs, Tube PreAmps, and dozens of kits for **ELECTRONIC MUSICIANS**

PAIA Electronics into@paia.com
3200 Teakwood Lane #05.340.6300
Edmond, OK 73013 fax #05.340.6378

PICMICRO TOOLS

ISP-PRO 3.0

All-in-one Programmer

- Uses PC Serial port (USB w/ adapter)
- Very Simple to use
- Free Software updates
- Complete with Windows IDE!
- Easy in-circuit programming
- Supports PIC, Schem, I2C and more!
- Firmware upgradeable!
- RJ-11 / 10 Pin Header
- Includes RJ-11 Cable

All for **\$59.95 Complete**

Solderless Development Boards
Develop your projects the easy way

- Complete Assembled Board
- In-Circuit Programmable (ISP)
- Solderless Bread Board
- Built in RS232 (w/ Mac232)
- Built in Power Connector
- Removable Oscillator
- Documentation
- Auto Disconnect for R51, R56, & R57
- Available in several models

Starting at \$49.95
Join our online PIC forums
tons of information and help FREE!!!
VISA • Master Card • American Express
Order Online or Call 1-734-425-1744
Basic Micro, 34391 Plymouth, Livonia, MI 48150
See more online at <http://www.basicmicro.com>

TIMELINE INC.

Over 16 years and 33,000 customers and still growing
<http://www.digsys.net/timeline>
• email: mraa@earthlink.net

240x64 dot LCD with built-in controller
AND 4021ST-EO. Unit is EL back-lit. \$29.95 or 2 for \$49.95 or OPTREX. DMF5005 (non back-lit) \$29.95 or 2 for \$49.95

240x128 LCD with built-in controller \$29.95 2 for \$49.95
256x128 LCD with built-in controller \$29.95 2 for \$49.95

Alphanumeric-parallel interface

16x1	\$5.00	16x2	\$5.00
20x4	\$8.00	40x2	\$7.00
40x4	\$15.00		

Certain models are backlit, call in for more info

Graphics and alphanumeric - serial interface

size	Mfg.	price	size	Mfg.	price
640x480 (backlit)	Epson	\$15.00	256x128	Epson	\$15.00
240x128 (backlit)	Optrex	\$15.00	240x64	Epson	\$15.00

57 WATT UPS SUPPLY \$19.00
(12V @ 2.2AMP BATTERY \$10.00) The outputs are +5 VDC @ 0.5A, +3.6 VDC @ 2.5A, +12 VDC @ .8A, -12 VDC @ .5A, and a battery charging output of 12 VDC @ 10A.

EMBEDDED 486 COMPUTER \$59.95 or 2 for \$109.00
Complete enhanced Intel 486SX-33 based computer in ultra small (9-7/8L x 6-5/8W x 3-1/8H) case.

NON - ENCLOSED TTL
5 inch Amber \$15.00 • 7 inch Amber \$19.00
• 9 inch Amber or Green \$19.00

5" COLOR MONITOR \$19.95 or 2 for \$29.95

2539 W. 237th Street Bldg. F, Torrance, CA 90505

Order desk: USA: (800) 872-8876 LATech. Info: (310) 784-5488 Fax: (310) 784-5750
Visit our website for more product listings. Email us your mailing address to go on our mailing list. <http://www.digsys.net/timeline>

VISION ELECTRONICS

Before After

◆ 1 Year Warranty
◆ Money Back Guarantee
◆ No Rolls/Jitters/Flickers/Fading

INTELESTAR

Buy 1 Unit, Get the 2nd for 1/2 Price

COPY RENTAL TAPES WITH OUR VIDEO STABILIZERS

1-800-562-2252

2609 S. 156th Circle • Omaha, NE 68130

<http://www.modernelectronics.com>

VISA AMERICAN EXPRESS

EZ-EP DEVICE PROGRAMMER - \$169.95

Check Web!! -- www.m2l.com

Fast - Programs 27C010 in 23 seconds
Portable - Connects to PC Parallel Port
Versatile - Programs 2716-080 plus EE and Flash (28F, 29C) to 32 pins
Inexpensive - Best for less than \$200

- Correct implementation of manufacturer algorithms for fast, reliable programming.
- Easy to use menu based software has binary editor, read, verify, copy, etc. Free updates via bbs or web page.
- Full over current detection on all device power supplies protects against bad chips and reverse insertion.
- Broad support for additional devices using adapters listed below.

Available Adapters

EP-PIC (16C5x 61.62x.71.84)	\$49.95
EP-PIC64 (62-5.72-4)	\$39.95
EP-PIC12 (12C50x)	\$39.95
EP-PIC17 (17C4x)	\$49.95
EP-51 (8751 C51)	\$39.95
EP-11E (68HC11 E/A)	\$59.95
EP-11D (68HC711D3)	\$39.95
EP-16 (16bit 40pin EPROMS)	\$49.95
EP-Z8 (Z86E02.3.4.6.7.8)	\$39.95
EP-SEE2 (93x.24x.25x.85x)	\$39.95
EP-750 (87C750 1.2)	\$59.95
EP-PEEL (ICT22v10 18v8)	\$59.95
EP-1051 (89C1051 2051)	\$39.95
EP-PLCC (PLCC EPROMs)	\$49.95
EP-SOIC (SOIC EPROMs)	\$49.95

Many Other Adapters Available

M²L Electronics
970/259-0555 Fax: 970/259-0777
250 CR 218 Durango CO 81301
CO orders add 7% sales tax
<http://www.m2l.com>

EZ-EP M²L ELECTRONICS
Los Angeles, California

The Pocket Programmer



INTRONICS, Inc.
The Pocket Programmer

The Best just got Better!!!

The Best portable programmer that uses the printer port instead of an internal card just got Better!! Now with easier to use Windows based software that programs E(E)prom, Flash & Dallas parts. 25/27/28 & 29 series from 16K to 8Mbit. Adapters available for MCU's 874X, 875X, Pic, Atmel, PLCC packages, Bi-Prom's, 40-Pin X16 Eproms, Rom Emulator to 32K X 8 (2716-27256) and More...

Only \$149.95

Same Name, Address & Phone # for 19 Years.... Isn't it Amazing ?

Intronics, Inc.
Box 13723 / 612 Newton St.
Edwardsville, KS 66113
Tel. (913) 422-2094 Add \$7.00 COD
Fax (913) 441-1623 Add \$6.00 Shipping
WWW.IN-KS.COM Visa/MC/Amex/Disc

spyoutlet.com

Security • Surveillance • Loss Prevention

Purchase your video cameras from one of the largest importers in the U.S.

- NEW weatherproof Bullet Cameras
- Spy Pinhole Cameras • Wireless Video
- PC Cards • Voice Changer
- Micro Recorders • Shotgun Mic
- Locksmithing • Bug Detectors
- NEW Phone Sentry Plus—defeats telephone tapping and taping
- UV Pens & Powder • Realtime 12 hr Telephone Recording System
- GPS Vehicle Tracking System

And much more • Quantity discounts

www.spyoutlet.com
Printed Catalog send \$5⁰⁰

SPY OUTLET 2468 NIA, FALLS BLVD
TONAWANDA NY 14150 (716) 695-8660

Poptronics®

SHOPPER

World's Smallest 68HC11 Microcontroller Modules!

MicroStamp11™



- telemetry
- microrobotics
- smart toys
- animatronics
- model railroading
- home automation

- tiny, light-weight (0.5 oz.)
- 1-inch x 1.4-inch 68HC11 module
- on-board 5V regulator
- 8MHz crystal (9.83MHz on Turbo version)
- choice of 8K or 32K EEPROM
- 32K RAM + 32K EEPROM on 64K version
- plugs into your breadboard like a DIP
- SCI (UART), SPI, Output Compares, Input Captures, hardware timer, pulse accumulator
- all 14 I/O lines and 2 interrupts brought out to versatile 20-pin connector
- program in BASIC, assembler, or C
- easy code-loading with Docking Module
- Starter Packages:*
- 8K EEPROM (#MS11SP8K).....\$49
- 32K EEPROM (#MS11SP32K).....\$77
- 32K EE+32K RAM (#MS11SP64K)...\$90

* includes MicroStamp11, manual, PC software (free-ware assembler, SBASIC compiler, MicroLoad utility, and sample programs), serial cable, Docking Module, and accessories.

Attention OEMs:

Embed MicroStamp11 modules into your product! only \$20 each (100-pc. price, 8K version)

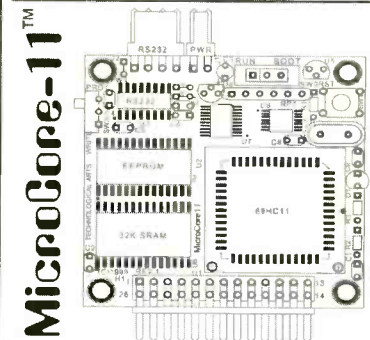

- tiny 2-inch x 2-inch 68HC11 module
 - 12 inputs/outputs plus 8 analog inputs
 - RS232, 5V regulator, 8MHz crystal
 - 32K SRAM plus 8K or 32K EEPROM
 - plugs into your breadboard like a DIP
 - easy programming from any PC
 - ideal for building MicroMouse robots
 - now available in Turbo version (9.83MHz)
 - 8K Starter Package #MC11SP8K.....\$68
 - 32K Starter Package #MC11SP32K.....\$93
- Motor driver boards, LCD/keyboard/keyboard interface & prototyping cards available

Technological Arts

Many other modules & accessories available. Visit our website at:
www.technologicalarts.com
sales@technologicalarts.com
TOLL-FREE: 1-877-963-8996
Phone: (416) 963-8996
Fax: (416) 963-9179
Visa • MasterCard • Discover • Amex

CLASSIFIEDS

BUSINESS OPPORTUNITIES

\$400 WEEKLY ASSEMBLING Electronic Circuit Boards/Products From Home. For Free Information Send SASE: Home Assembly-PT Box 216 New Britain, CT 06050-0216

CABLE TV

DISCOVER CABLE'S NEWEST BOXES! "DESCRAMBLES WHERE OTHERS FAIL" **LOWEST DEALER PRICES GUARANTEED.** 1-888-777-9123 1-888-675-3687

MISC. ELECTRONICS FOR SALE

T&M ELECTRONICS. Large variety of electronic parts since 1966. Visit our Web site at www.tandmelectronics.com

SMC ELECTRONICS - Surplus and refurbished electronic equipment including repair/replacement/experimenter parts and accessories. www.smcelectronics.com

SMART Battery Chargers - GPS Based Frequency Standard - Digital Frequency Synthesizer - surplus parts and more. www.a-engineering.com

PLANS-KITS-SCHEMATICS

Carl's Electronics - Hundreds of electronic kits, plus the latest in spy and surveillance. www.electronickits.com

Generate stereoscopic 3D video using cheap board cameras. 50-page booklet includes schematics, photos. Visit <http://stereo-video.home.att.net>.

SATELLITE

FREE Satellite TV Buyer's Guide. BIG Dishes - BIG Deals! Get the MOST free and subscription channels with C-band digital upgrade! **SKYVISION.** 800-543-3025. International 218-739-5231. www.skyvision.com

THE COLLECTED WORKS OF MOHAMMED ULLYES FIPS

#166—By Hugo Gernsback. Here is a collection of 21 April Fools Articles, reprinted from the pages of the magazines they appeared in, as a 74-page, 8½ × 11-inch book. The stories were written between 1933 and 1964. Some of the devices actually exist today.



Others are just around the corner. All are fun and almost possible. Stories include the Cordless Radio Iron, The Visi-Talkie, Electronic Razor, 30-Day LP Record, Teleglasses and even Electronic Brain Servicing. Get your copy today. Ask for book #166 and include **\$9.99 (includes shipping and handling)** in the US (First Class), Canada and Overseas (surface mail), and order from **CLAGGK Inc., P.O. Box 12162, Hauppauge, NY 11788.** Payment in US funds by US bank check or International Money Order. Allow 6-8 weeks for delivery. MA05

Gernsback Publications, Inc.

275-G Marcus Blvd. Hauppauge NY 11788

POPTRONICS® CLASSIFIED ADVERTISING ORDER FORM

Advertiser Information

Name _____
Company _____
Street Address _____
City/State/Zip _____
Telephone () _____
Signature (required on all orders) _____

Payment Information

Charge my: Master Card Visa Discover

Account No. _____

Exp. Date _____

- Full payment enclosed. Prepayment discounts offered for multiple insertions (except on credit card orders).
 Payment for first insertion enclose; additional payments will be made prior to closing dates. Prepayment discounts not available.

Do you want any special options? (where available)

- Boldface Type* Add 25% for entire ad Screened Background - Add 30%
 Special Heading - Add \$35.00

The first word of your ad and your name will be printed in boldface caps, at no additional charge. For individual boldface words, add .50c each.

In what month(s) would you like your ad to run?

- Entire year for publications selected above.
 Jan. Feb. Mar. Apr. May. June July Aug. Sep. Oct. Nov. Dec.

Here's how to calculate the cost of your Regular or Expanded-Ad Classified:

Rate X Numbers of Words + Rate for Boldface + Rate for Screened Background = Cost per Insertion X Number of Months = Cost

Magazine	Rate	x (min. 15)	+ Boldface (add 25%)	+ Screened + Background (add 30%)	= Cost Per = Insertion	x Number x of Months	= Cost
		x	+	+	=	x	=

Rates:

\$3.00 per word (New rate for renewals. New advertisers welcome.)

Minimum 15 Words

Here's how to calculate the total cost of your advertising:

Prepayment Discount:

(Full payment must accompany order, not applicable on credit card orders)

Prepay for 6 insertions in one magazine, 5% 12 insertions in one magazine, 10%

Subtotal _____

Less Prepayment Discount _____

TOTAL COST \$ _____

Please use a separate piece of paper to write your copy, or for any special instructions you may have.

HAVE A QUESTION? CALL: 1-631-592-6720 ext. 206

Fax signed orders with credit card information to : (631) 592-6723

GPI895

ADVERTISING INDEX

Poptronics does not assume any responsibility for errors that may appear in the index below.

Free Information Number	Page	Free Information Number	Page
- Abacom67	- Lone Star Consulting76
- Active Elec. Components71	- LT Sound72
- Alan Broadband Co.77	- Lynxmotion72
- All Electronics72	- M ² L Electronics78
- Amazon Electronics77	324 MCM ElectronicsCV2
- Basic Micro Inc.77	323 Mendelsons67
- Bellin Dynamic Systems76	296 Merrimack Valley70
- Blue Bell Design, Inc.76	- microEngineering Labs77
290 C&S Sales, Inc.65	- Modern Electronics72
283 CadSoft, Inc.11	325 Mouser Electronics62
233 Circuit Specialists73	- MyLydia, Inc.77
- CLAGGK, Inc.CV3, 32, 47	- North Country Radio62
- Classified Ads79	- PAiA Electronics77
- Classified Order Form79	275 Parts ExpressCV4
320 Cleveland Inst. of Electronics ..	.66, 75	- PCB 12376
321 Command Productions63	- PCB Express76
- Conitec Data Systems72	- Pioneer Hill Software67
- Consumertronics76	228 Polaris Industries61
- Designtech Engineering64	219 Prairie Digital74
- EDE Spy Outlet78	- Progressive Concepts62
- Elect. Tech. Today36, 41	263 Ramsey Electronics68
- Electronix72	- Scott Edwards Electronics63
206 Electronix Express69	- Scrambling News76
- EMAC, Inc.64	- Square 1 Electronics71, 76
- Engineering Express67	- Techniks77
- Global Specialties64	- Technological Arts78
220 Information Unlimited69	322 Test Equipment Depot74
- Intec Automation76	- Timeline, Inc.77
- Intelligence Here77	- Toroid Corporation62
- Intronics78	- UCANDO Videos74
- JDR Computer Products71	- Vision Electronics78

**When you buy products from
these advertisers, please tell
them you saw their ads in
Poptronics® magazine.**

ADVERTISING SALES OFFICES

Gernsback Publications, Inc.
275-G Marcus Blvd.
Hauppauge, NY 11788
Tel. 631-592-6720
Fax: 631-592-6723

Larry Steckler
Publisher (ext. 201)
e-mail: advertising@gernsback.com

Adria Coren
Vice-President (ext. 208)

Ken Coren
Vice-President (ext. 267)

Marie Falcon
Advertising Director (ext. 206)

Adria Coren
Credit Manager (ext. 208)

For Advertising ONLY EAST/SOUTHEAST

Marie Falcon
275-G Marcus Blvd.
Hauppauge, NY 11788
Tel. 631-592-6720 x206
Fax: 631-592-6723
e-mail: mfalcon@gernsback.com

MIDWEST/Texas/Arkansas/ Oklahoma

Ralph Bergen
One Northfield Plaza, Suite 300
Northfield, IL 60093-1214
Tel. 847-559-0555
Fax: 847-559-0562
e-mail: bergenrj@aol.com

PACIFIC COAST

Megan Mitchell
9072 Lawton Pine Avenue
Las Vegas, NV 89129-7044
Tel. 702-240-0184
Fax: 702-838-6924
e-mail: mmitchell@gernsback.com

**Subscription/
Customer Service/
Order Entry**
Tel. 800-827-0383
7:30 AM - 8:30 PM CST

www.poptronics.com

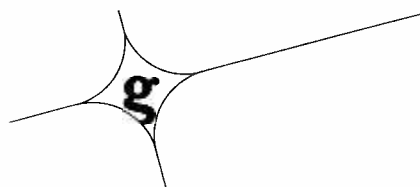

PARTS EXPRESS

ELECTRONICS & MORE
www.partsexpress.com

YOUR #1 SOURCE FOR AUDIO, VIDEO AND SPEAKER BUILDING COMPONENTS

FREE
316 PAGE
CATALOG



Dayton Loudspeaker Co.®

BR-1 2-Way Monitor System Kit

This high end 2-Way Monitor is based on our popular 1-1/8" Silk Dome Tweeter (#275-070) and 6-1/2" Woofer (#295-305). It was designed to provide a low cost, easy to build 2-Way system for the speaker building novice. The end result is a kit that can be built in a couple of hours and that has a sound that will rival systems costing two or three times its modest price! Overall, the system is smooth and detailed, with a wide soundstage that belies their smallish size. The tonal balance is on the warm side of neutral, which is pleasing with most types of music. The bass is also impressive for a system of this size. If you need more bass, we recommend using the #300-630 10" subwoofer to create a matching satellite/subwoofer combination. The cabinets are made of 5/8" MDF finished in an unobtrusive "black ash" vinyl laminate and include grills with black cloth. All driver holes are precision cut with a CNC for a perfect fit. The tweeter is flush mounted to reduce diffraction effects. *Note: This system is offered in kit form and can be assembled in about 2 hours. The crossover needs to be assembled so soldering skills are necessary. We've included a tutorial that thoroughly explains the theory and design process making this kit perfect for educational programs. Each kit includes everything needed to build 1 pair of speakers.*

System Specification: ♦Frequency response: 43-18,000Hz ♦SPL: 85dB 2.83V/1m ♦Power handling: 100 watts max ♦Cabinet dimensions: 14-1/4" H x 8-5/8" W x 11" D ♦Net system weight: 35 lbs.



6-1/2" Ceiling Speaker System

Don't let the low cost fool you! These great sounding ceiling speakers are ideal for adding music to the kitchen, den, bath, or patio! They feature a weather resistant 6-1/2" carbon fiber cone with a butyl rubber surround and a coaxial mounted 1" mylar dome tweeter. Perfect for high moisture environments. Retrofit design allows installation in both new and existing construction in just minutes. System includes removable steel mesh grills, built-in mounting brackets, hardware, and installation instructions.

Specifications: ♦Impedance: 8 ohms ♦Frequency response: 60-20,000 Hz ♦Power handling capability: 30 watts RMS/45 watts max ♦Sensitivity: 89 dB 1W/1m ♦Overall dimensions: 8-1/2" round x 2-3/4" deep ♦Net weight: 5 lbs. per pair.



#300-640

\$139⁸⁰
PAIR

250 Watt Subwoofer Amplifier With Remote Control

This high performance subwoofer amplifier allows you to adjust the volume and crossover frequency from the comfort of your favorite chair!

- Features:** ♦IR Remote Control ♦Remote mountable control panel ♦High power Class AB amplifier ♦Phase switch ♦Gold plated connectors ♦High pass filter for satellite speakers ♦Line Level Outputs ♦Auto On/Off

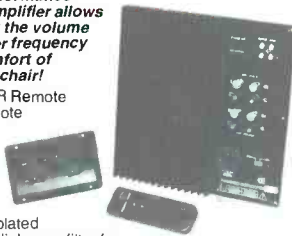

#300-793

\$137⁹⁰
(4-UP)

Dayton Loudspeaker Co.®

6-1/6" Treated Paper Cone Woofer

- ♦ ASV voice coil
- ♦ Vented pole piece
- ♦ Rubber surround



Specifications: ♦Power handling: 50 watts RMS/75 watts max ♦Voice coil diameter: 1-3/8" ♦Voice coil inductance: 1.40 mH ♦Impedance: 8 ohms ♦DC resistance: 6.0 ohms ♦Frequency response: 33-4,000 Hz ♦Magnet weight: 15 oz. ♦Fs: 33 Hz ♦SPL: 88 dB 1W/1m ♦Vas: 98 cu. ft. ♦Qms: 2.75 ♦Qes: .37 ♦Qrs: .33 ♦Xmax: 3.15mm ♦Net weight: 3 lbs.

#295-305

\$15²⁰
(4-UP)

3-1/4" Piezo Tweeter

- ♦Power handling: 50 watts RMS/75 watts max
- ♦Frequency response: 3,500-27,000 Hz
- ♦SPL: 94 dB



#270-011

95¢
(4-UP)

5" Ultra-Thin TFT-LCD Video Module

Complete color video display makes great personal rear seat TV screens. Works on a standard composite video signal from any VCR, video camera, or navigation system. Features high resolution, speedy response time, no radiation, low power consumption (less than 750mA), and wide view angle.

Only 1/2" thick

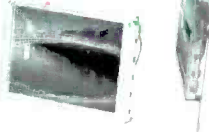

#205-013

\$119⁵⁵
(4-UP)

4" LCD Video Module

- ♦ High resolution
- ♦ 4" LCD flat screen color display module
- ♦ Works on a standard composite video signal from any VCR, video camera, video game or navigation system
- ♦ Ideal for mounting in seat backs or custom built enclosures



#205-050

\$89⁵⁰
(4-UP)

Speaker Surround Repair Kits

Don't throw away expensive loudspeakers just because the foam surround has dry rotted or has been punctured. With these new repair kits from Parts Express, you can save BIG bucks by repairing the foam surround and avoid costly loudspeaker replacements. Each kit contains supplies to repair two speakers and includes foam surrounds, plastic shims, four dust caps (two paper, two poly), a plastic bottle filled with 1 oz. of adhesive, 5 foam swabs for application of glue, and complete repair instructions.

Part #	Size	Price (1-3)	Price (4-UP)
260-915	6-1/2" kit	\$19.50	\$17.90
260-920	8" kit	21.90	18.95
260-925	10" kit	22.50	19.50
260-930	12" kit	23.90	20.90
260-935	15" kit	24.50	21.90
348-076	1 oz. bottle of speaker glue	5.95	5.25

DETAILED EASY TO FOLLOW INSTRUCTIONS!

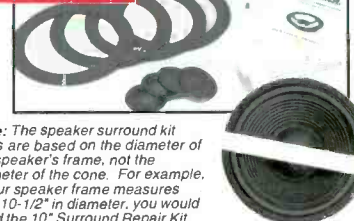

Note: The speaker surround kit sizes are based on the diameter of the speaker's frame, not the diameter of the cone. For example, if your speaker frame measures 10"-10-1/2" in diameter, you would need the 10" Surround Repair Kit.

LARGEST SELECTION OF SPEAKER DRIVERS IN THE COUNTRY!

Visit Us On The Web At
www.partsexpress.com
Or Call Toll Free
1-800-338-0531

725 Pleasant Valley Dr., Springboro, OH 45066-1158 KEY CODE: POM
Phone: 937-743-3000 ♦ FAX: 937-743-1677 ♦ E-Mail: sales@partsexpress.com

CIRCLE 275 ON FREE INFORMATION CARD

Electronics CD ROMs

PICmicro programming tools and CD ROMs



This great range of CD ROM learning resources will teach you all about electronic circuits and systems and how to design them.

Electronic Circuits and Components V2 provides an introduction to the principles and application of the most common types of electronic components and how they are used to form complete circuits. Sections on the disc include: fundamental electronic theory, active components, passive components, analogue circuits, digital circuits, fault finding and the Parts Gallery.

Digital Electronics V2 details the principles and practice of digital electronics, including logic gates, combinational and sequential logic circuits, clocks, counters, shift registers, fault finding and displays. The CD ROM also provides an introduction to microprocessor based systems.

Analog Electronics is a complete learning resource for this most difficult subject. The CD ROM includes the usual wealth of virtual laboratories as well as an electronic circuit simulator with over 50 pre-designed analog circuits which gives you the ultimate learning tool. The CD provides comprehensive coverage of analog fundamentals, transistor circuit design, op-amps, filters, oscillators, and other analog systems.

Electronic Projects is just that: a series of ten projects for students to build with all support information. The CD is designed to provide a set of projects which will complement students' work on the other 3 CDs in the Electronics Education Series. Each project on the CD is supplied with schematic diagrams, circuit and PCB layout files, component lists and comprehensive circuit explanations.

Robotics and Mechatronics is designed to enable those with little previous experience of electronics to build electromechanical systems. The CD ROM deals with all aspects of robotics from the control systems used, the transducers available, motors/actuators and the circuits to drive them. Full case study material (include the NASA Mars Rover, the Milford spider and the Furby) is used to show students how practical robotic systems are designed.

Digital Works is a highly interactive scalable digital logic simulator designed to allow electronics and computer science students to build complex digital logic circuits incorporating circuit macros, 4000 and 74 series logic.

CADPACK includes software for schematic capture, circuit simulation, and PCB design and is capable of producing industrial quality schematics and circuit board layouts. CADPACK includes unique circuit design and animation/simulation that will help your students understand the basic operation of many circuits.

Analog Filters is a complete course in filter design and synthesis and contains expert systems to assist in designing active and passive filters.

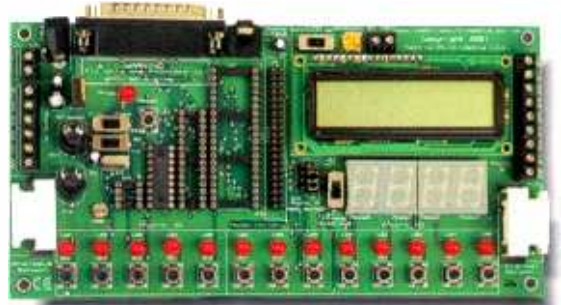

This flexible development board allows you to program 8, 18, 28, 40 pin PICmicro microcontrollers as well as test/develop code. All programming software is included and several resources which allow students to learn and program PICmicro microcontrollers are available - Flowcode, C for PICmicro microcontrollers and Assembly for PICmicro microcontrollers. A board is needed for the CD's below:



Flowcode is a very high level language programming system for PICmicro® microcontrollers based on flowcharts. Flowcode is a powerful language that uses macros to facilitate the control of complex devices like 7-segment displays, motor controllers, and LCD displays. The use of macros allows students to control highly complex electronic devices without getting bogged down in understanding the programming involved. Board not included.



The **Assembly for PICmicro microcontrollers** CD ROM (previously known as PICutor) contains a complete course in programming the PIC16F84 microcontroller from Arizona Microchip. The CD includes a full suite of tutorials starting at basic concepts and progressing complex techniques including interrupts. An IDE and all programming tools are included. Board not included.



The **C for PICmicro® microcontrollers** CD ROM is designed for students and professionals who need to learn how to program embedded microcontrollers in C. C for PICmicro MCUs also provides all the tools needed actually program a virtually any PICmicro - including a full C compiler and device programmer (via printer port). Although the course focuses on the use of the PICmicro® series of microcontrollers this CD ROM will provide a relevant background in C programming for any microcontroller. Board not included.

Order Form

Please allow 6 weeks delivery.

	Student / home version	Institution version
Electronic Ccts. & Comps. 2	\$50	\$99
Digital Electronics 2	\$50	\$99
Analog Electronics	\$50	\$99
Electronic Projects	\$75	\$159
Robotics and Mechatronics	\$50	\$99
Digital Works	\$50	\$99
CADPACK	\$75	\$159
Analog Filters	\$75	\$159
Assembly for PICmicros	\$50	\$159
C for PICmicros	\$50	\$159
Flowcode for PICmicros	\$50	\$99
PICmicro development board	\$159	

Postage - USA \$5 \$5
Postage - Canada \$10 \$10

Name: _____

Address: _____

Zip: _____ Phone: _____

Card Type: _____

Mastercard, Visa, or Discover only

Card number: _____

I have enclosed my check for \$: _____

Please charge my credit card for \$: _____

Signature: _____

Phone your order to us on:

631-592-6721

or send your order to:

CLAGGK Inc.
PO Box 12162
Hauppauge, NY 11788

Expire date

--	--	--	--



These institution versions have increased functionality, improved assessment and are licensed for use in schools and organisations.

Order online NOW from: www.poptronics.com

CL02