

Bring A Robot To LIFE!



Available
Exclusively at:

BARNES & NOBLE
BOOKSELLERS
www.bn.com

October 2001
ISBN 0-07-138787-0
\$59.95

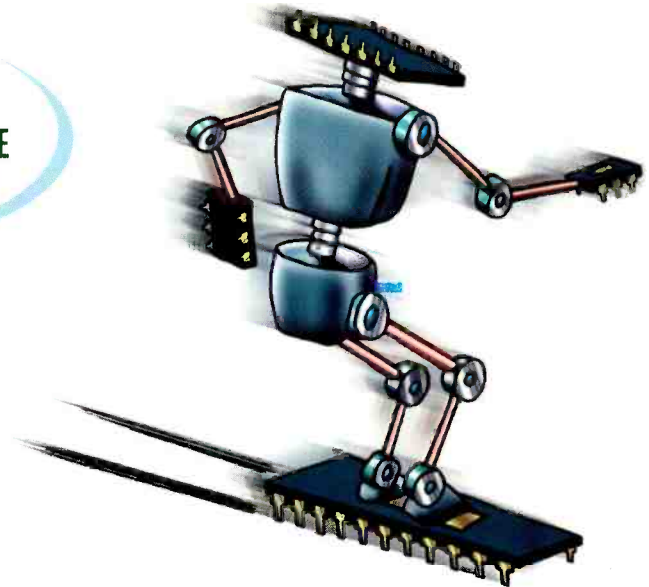

TAB Electronics

Build Your Own Robot Kit Created by Myke Predko and Ben Wirz

This incredibly simple-to-build robot will provide you with hours of enjoyment and a great platform on which to develop more sophisticated applications. The 9-volt battery powered robot is driven by dual electric motors and controlled by a Microchip PIC16C505 PICmicro Microcontroller. With two light sensors and wire "feelers" the robot is pre-programmed with the following "behaviors" built-in:

- Random Movement, change forward direction when an object is encountered
- "Photovore" – Seek out light
- "Photophobe" – Avoid Light
- "Maze Solver" – Follow Wall

Along with its basic control, the robot can be also be controlled by the infrared remote control included in the kit. With the addition of a BASIC STAMP BS2 Microcontroller (not included) customized applications can easily be built. The software code for the Basic Stamp applications is included on an accompanying CD-ROM along with assembly instructions and schematic and block diagrams.

99 inexpensive robotics projects...

The Robot Builder's Bonanza, 2E

Gordon McComb

This updated bestseller features fascinating field-tested projects and modular organization to make it easy to invent and build your own robots. You will find this heavily illustrated guide provides everything required to get started.

2001 • 753 pages
ISBN 0-07-136296-7
\$24.95



The easy way to master microcontrollers...

PIC Microcontroller Project Book

John Iovine

Offers hands-on directions for putting Microchip's RISC-based chips with up to 8K of memory to work. Starting with simple projects and experiments, this book leads you gradually into sophisticated programming techniques.

2000 • 272 pages •
ISBN 0-07-135479-4
\$29.95

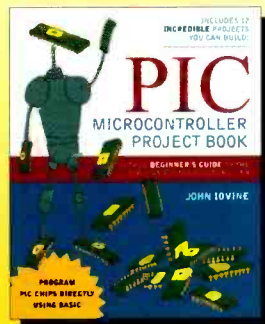

Explore the world of the nearly human...

Robots, Androids, and Animatrons, 12 Incredible Projects You Can Build, 2E

John Iovine

Presenting a new edition that details building 12 exciting robots, including walker robots, solar ball robots, speech-controlled robots, and much more! Ideal for the first time robot builder or the advanced hobbyist.

October 2001 • 275 pages
ISBN 0-07-137683-6
\$19.95

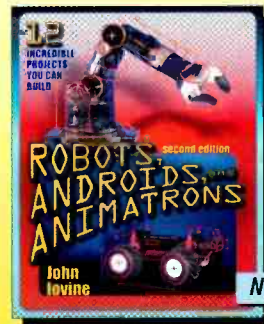

**Mc
Graw
Hill**

BARNES & NOBLE
BOOKSELLERS
www.bn.com

CIRCLE 143 ON FREE INFORMATION CARD

A Division of The McGraw-Hill Companies

Poptronics®

THE MAGAZINE FOR THE HANDS-ON ELECTRONICS ACTIVIST!

FEATURES

TALK TO THE WORLD FOR FREE!	John Carter and James Heidenreich	33
<i>Let the EchoBuster and iPatcher connect you to the world through the Internet.</i>		
OP-AMP AND COMPARATOR CHECKER	Charles Hansen	43
<i>Construct a handy testing board for your chips.</i>		

PRODUCT REVIEWS

GIZMO®		7
<i>See the latest handheld GPS units, DVD players, home-theater power distributors, and more.</i>		
HANDS ON REPORT		11
<i>DTI's 3-D LCD Display creates real depth three-dimensional imaging on your desktop.</i>		

DEPARTMENTS

PROTOTYPE		12
<i>Read all about an electronic drowning-detection system that can save lives.</i>		
TECHNOSCOPE	Elizabeth Jamison	21
<i>Get the skinny on fiber optics.</i>		
SURVEYING THE DIGITAL DOMAIN	Reid Goldsborough	23
<i>Let's examine the various optical storage options, as well as broadband access.</i>		
PEAK COMPUTING	Ted Needleman	26
<i>Printers are dropping in price and rising in performance.</i>		
SCIENCE: FACT OR FICTION	Brooke A. Berlin	28
<i>Wading through the conspiracies surrounding the Montauk and Philadelphia projects.</i>		
Q&A	Dean Huster	47
<i>Readers come before the Electronic Guru for answers.</i>		
ROBOTICS WORKSHOP	Scott M. Savage	51
<i>The navigational use of contactless-angular sensors is discussed.</i>		
SERVICE CLINIC	Sam Goldwasser	54
<i>Using simple circuits to protect your test equipment during high-voltage probing.</i>		
BASIC CIRCUITRY	Charles Rakes	57
<i>Get a "load" of these battery-testing circuits.</i>		

AND MORE

EDITORIAL	2	NEW LITERATURE31
LETTERS	3	POPTRONICS SHOPPER63
NEW GEAR	5	ADVERTISING INDEX90
YESTERDAY'S NEWS	16	FREE INFORMATION CARD90A

Poptronics (ISSN 1526-3681) Published monthly by Gernsback Publications, Inc. 275-G Marcus Blvd., Hauppauge, NY 11788. Second-Class postage paid at Hauppauge, NY and at additional mailing offices. One-year, twelve issues, subscription rate U.S. and possessions \$24.99; Canada \$33.15 (includes G.S.T. Canadian Goods and Services Tax Registration No. R125166280), all other countries \$33.99. Subscription orders payable in U.S. funds only. International Postal Money Order or check drawn on a U.S. bank. U.S. single copy price \$4.99. Copyright 2001 by Gernsback Publications, Inc. All rights reserved. Hands-on Electronics and Gizmo trademarks are registered in U.S. and Canada by Gernsback Publications, Inc. Poptronics trademark is registered in U.S. and Canada by Poptronix, Inc. and is licensed to Gernsback Publications, Inc. Printed in U.S.A. Postmaster: Please send address changes to Poptronics, Subscription Dept., P.O. Box 459, Mount Morris, IL 61054-7629

A stamped self-addressed envelope must accompany all submitted manuscripts and/or artwork or photographs if their return is desired should they be rejected. We disclaim any responsibility for the loss or damage of manuscripts and/or artwork or photographs while in our possession or otherwise.

As a service to readers, Poptronics publishes available plans or information relating to newsworthy products, techniques, and scientific and technological developments. Because of possible variances in the quality and condition of materials and workmanship used by readers, Poptronics disclaims any responsibility for the safe and proper functioning of reader-built projects based upon or from plans or information published in this magazine.

Larry Steckler, EHF, CET.
editor-in-chief and publisher

EDITORIAL DEPARTMENT

Chris La Morte, managing editor
Evelyn Rose, assistant editor
Brooke A. Berlin, editorial assistant

CONTRIBUTING EDITORS

Reid Goldsborough
Sam Goldwasser
Dean Huster
John Iovine
Elizabeth Jamison
Ted Needleman
Charles D. Rakes
Scott M. Savage
Teri Scaduto

PRODUCTION DEPARTMENT

Ken Coren, production director
Kathy Campbell, production manager
Michele L. Musé, prepress specialist

ART DEPARTMENT

Russell C. Truelson, art director
Michele L. Musé, graphic artist

CIRCULATION DEPARTMENT

Gina Giuliano, circulation manager

REPRINT DEPARTMENT

Maria Menichetti, Reprint Bookstore x235

BUSINESS AND EDITORIAL OFFICES

Gernsback Publications, Inc.
275-G Marcus Blvd.
Hauppauge, NY 11788
631-592-6720
Fax: 631-592-6723

President: Larry Steckler
Vice-President: Adria Coren
Vice-President: Ken Coren

SUBSCRIPTION
CUSTOMER SERVICE/
ORDER ENTRY
800-827-0383
7:30 AM - 8:30 PM EST

Advertising Sales Offices
listed on page 90

Cover by
Michele Lyn Musé

VISIT US ON THE INTERNET AT:
www.gernsback.com
or www.poptronics.com

Since some of the equipment and circuitry described in POPTRONICS may relate to or be covered by U.S. patents, POPTRONICS disclaims any liability for the infringement of such patents by the making, using, or selling of such equipment or circuitry, and suggests that anyone interested in such projects consult a patent attorney.

<mailto:popeditor@gernsback.com>

Maybe It Was A Mistake To Think...

Maybe it was mistake to think that the readership wouldn't mind something a little off the scale, such as "Radio Signals and The Great Pyramid." They would not grow into an anger-fueled fervor and erupt into cries of outrage. It was to be a catalyst plopped into the soup of mundane electronics.

Stuff like:

"Hey it runs on a 9-volt battery. It only costs three dollars. When you press this switch it beeps and this knob controls how fast it beeps. What's that? What does it do? Oh; it beeps."

Get the point?

So, I threw it into the mix. Oh, and mix it did. The calls came in steady—the letters, too. Did you know most retired engineers have the same vernacular as eighteenth century pirates? They called me names; they called the author names; they asked leading questions. Luckily my military training taught me how to maintain my bearing in times of interrogation. The situation grew grim, but there was a lesson learned—a vocal demographic of the readership likes their electronics straight up. That is, they don't want any tie between Physics and "New Age pseudo-science." All they want are components and electricity. According to *them*, the projects better follow all known laws of physics. If the authors plan on breaking standards, then they better have hard data backing up their claims and be willing to share all their findings with the masses. Unless these readers can build it "for real," they don't want to read about it.

And here is the verdict: *Unless I hear otherwise, that "stuff" won't be seen in these parts no more, ya hear!* It would be such a pleasure if everyone could open a copy of **Poptronics**, browse through the table of contents, and exclaim, "Awesome! Just what I wanted!" Well, we can't make all the people happy, all the time.. Needless to say, I won't ignore my core readership and dismiss them as big, mean skeptics (you big, blue "Meanies!"). In closing, let me say thanks. Thanks for the feedback in this grand PLL we call **Poptronics**.

In other news..."Robotics Workshop" has opened its doors once again. This time Scott M. Savage has the helm, and he plans to show our readers a thing or two about robotics. Mr. Savage joins the rest of our columnists who have brought you a wonderful November issue. Kick back, and crack us open. It's time for some electronics—the kind I hope you like.

Salutations,



Christopher La Morte
Managing Editor

Corrections for "Radio Signals and The Great Pyramid"

"Limestone is a sedimentary rock." "Poptronics shouldn't print speculative manuscripts without prima-facie evidence." Next time, I will get corporate to spring for an airline ticket so I can verify prototypes that are in operation. Well, seriously folks; here are just a sprinkling of letters that seemed to materialize from the aether onto my desk. For the record, I believe this is the highest volume of feedback ever received in such a short period of time.—Editor

Pseudo-Science Disappoints

I have been a loyal reader for five years. Every month I'm always glad to receive your periodical and enjoy sharing it with the VT students where I work. Unfortunately, your article "Radio Signals and the Great Pyramid" by B.K. Bayles wasn't up to standard. To suggest, even with reservations, that "the passages in the Great Pyramid were purposely constructed in order to provide a current path for massive amounts of energy" shocked me. The evidence doesn't support this silly theory. Please don't let the need for new subscribers entice you into printing pseudo-science. How Sandia National Labs and NASA can be in the same issue with B. K. Bayles, I don't know. Poptronics, please come back, I miss you.

I really enjoy your current selection of departments; Iovine, Goldwasser, Rakes, and others are doing a fine job. Please consider adding one more department—biography. Hugo Gernsback often looked into the lives of uniformed technicians in both the civilian and military arenas. Why not bring back this tradition, and once a month interview a scientist, engineer, or technician to see what their job is like and where they think the future will bring us. Just a thought.

Keep up the good work.
D. E. CHADBOURNE, CET
Ray Brook, NY

That is an excellent idea, sir. I think the readers would enjoy brief biographies of sci-

entists, inventors, and even some interesting hobbyists. Thanks for the feedback. I understand your dismay on the "Pyramid" article. We meant no harm.—Editor

Non-Fiction Goes Fiction

I am writing about the preposterous story about the Great Pyramid in the September issue of Poptronics. I assume you will get a lot of letters about this one. You say the author writes non-fiction books. Since this article is not factual, isn't it fiction? It is so outrageous that it wouldn't do even for an April issue.

The article abounds with outstanding errors, besides a lot of weird imagination. Some examples follow. Paramagnetism of stones has nothing to do with only existing at or above 76°F—specific heat is not measured in degrees anyway. Limestone is not an igneous rock! The imprinted magnetism of a rock does not tell its age. Sandstone is not formed as

described. "Sandstone rock will contain dirt and minerals"—well it had better, since that is what it is made of! Etc., etc.

"Radio frequency is 20Hz–20kHz," is true, but it is rarely thought of in such a low-frequency range, and it really has no obvious upper limit. Skin effect at such low frequencies is at best only a concept. What is meant by using alternating current instead of direct current to "carve" stone?

The fantastic story says to follow along with Fig. 2, but from there onward references are to lettered things while Fig. 2 has only numbered things. It seems you only printed part of a longer story as there are large gaps in its attempt at logic. Plus, I never did find out how the thing becomes an alternate source of energy.

My question is, why did you waste so many pages of Poptronics on such garbage??

KENNETH E. STONE
Cherryvale, KS

Perhaps I felt that the readers would be whipped into a frenzy of discussion on the topic of energy production using photovoltaic means. Actually, this did happen in some instances. However, other people seemed to be insulted and lashed out. That reminds me...I have to go smack my weather man! Thanks for the feedback, sir.—Editor

Scientific Exceptions

I am a regular subscriber to Poptronics and count on it providing me with scientific knowledge. I enjoy it very much.

However, I take exception to the September 2001 issue, which devoted eight pages of rambling-on about "Radio Signals and the Great Pyramid." I began to question the author's scientific acumen when, in the second sentence, she talked about "energizing the passages of the Great Pyramid with radio signals to build a triode amplifier and generate electricity."

I tried to read carefully a number of paragraphs thinking that I might be missing something. I could not find any logic anywhere. Even the diagram

KEEP IN TOUCH

We appreciate letters from our readers. Comments, suggestions, questions, bouquets, or brickbats ... we want to hear from you and find out what you like and what you dislike. If there are projects you want to see or articles you want to submit—we want to know about them.

You can write via snail mail to:

Letters
Poptronics
275-G Marcus Blvd.
Hauppauge, NY 11788

Sending letters to our subscription address increases the time it takes to respond to your letters, as the mail is forwarded to our editorial offices.

Our e-mail address can be found at the top of the column.

Of course, e-mail is fast.

All of our columnists can be reached through the e-mail addresses at the head of each column.

And don't forget to visit our Web site: www.gernsback.com.

looked phony. Is this some sort of April Fool's joke? If so, I give you credit. It is a good one.

JAMES L. BUCKWALTER, PE
Visalia, CA

I see, sir. No, this was no joking matter. It was a theory for scrutinizing readers. I believe the verdict is quite clear.—Editor

The Future Of Energy Production

I agree that photovoltaic solar energy has made great strides with many research avenues showing promise. There are lots of really interesting research approaches such as dye/TiO₂ and solar-heated vacuum thermionic emitters (nanoscale diamond pyramids!), as well as less far-out developments such as tailored multi-band material combinations of semiconductors and new production tweaks for amorphous Si cells. New Age fairy tales disguised as science disrespect the many people spending their careers advancing these solar technologies. Photovoltaics have crept within a factor of three or so (on a 1–10 scale) of being cost-competitive for electric power production. As energy demands increase, it seems inevitable that off-grid, localized power production will become a large factor in coming years.

In any case, I do agree that energy consciousness is important; and I would be happy to see articles connected with the electronics aspects of real-world solar electric/heating/cooling systems, or wind generator systems that people have installed in their homes and businesses. There are probably a number of interesting control and power-conversion issues that come into play.

ROB JARECKI
via e-mail

This is a response from Mr. Jarecki, after I replied to his initial letter. Let's take a look at some choice excerpts from his original correspondence.—Editor

“Will future essays discuss the antenna pattern considerations of Quija boards, or explain ghostbusting technology? I am not sure whether it bothers me more to think that your editorial staff is utterly scientifically naïve, or just cynically uncaring about the potential damage done by exposing the uninitiated to such misinformation. Please focus on the electronics circuit designs that make your magazine interesting, and don't risk alienating your core readership to pander to the lowest common denominator.”

Hmmm...if I wasn't so naïve, I'd say I was insulted. Luckily I'm cynical and uncaring, so insults just bounce off my dunce cap. Here would be my opportunity to retaliate, but to paraphrase Don Corleone: “Never let them know you're angry, Santino!” Instead, I replied as follows.—Editor

I am sorry if the “Pyramid” article insulted you in any way. We learn from our mistakes, and I have learned never to mix “New Age” logic with hard science. I have angered the gods of Physics. Yet, this article has generated the most feedback of any article in Poptronics.

In the future, I will keep with more conventional electronics. Here's a thought though: The initial theory of taking the Sun's rays and converting them to electrical energy is not a ludicrous idea. Renewable energies, whether wind, solar, tidal, biomass, etc., are going to have to become status quo within the next decade.

Maybe Bayles' “Pyramid” article will at least make us think about energy other than fossil fuels and archaic steam converters. On a 100 degree day in New York, when the ozone alerts are posted and one can barely see across the bay through the blue/grey haze, I often wonder, “Is there a better/cleaner mode of energy production/distribution?”

LA MORTE
At His Desk

P

FACTCARDS

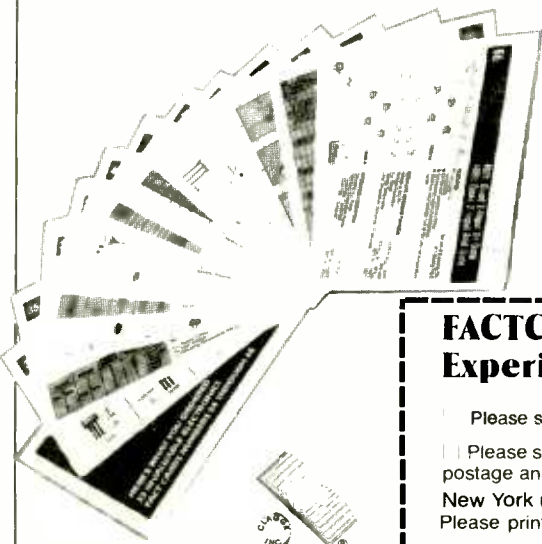

■ ALL YOU NEED to know about electronics from transistor packaging to substitution and replacement guides. FACTCARDS numbers 34 through 66 are now available. These beautifully-printed cards measure a full three-by-five inches and are printed in two colors. They cover a wide range of subjects from Triac circuit/replacement guides to flip-flops, Schmitt triggers, Thyristor circuits, Opto-Isolator/Coupler selection and replacement. All are clearly explained with typical circuit applications.

■ WANT TO EXPAND your knowledge of electronics? Do it the easy way

by studying the Electronics Fact Cards. Do you travel to and from your job each day? Drop a handful of cards in your pocket before you leave, and the bus becomes a schoolroom! At home, you can build some of the projects and not only have fun building and using them, but learn how they work at the same time.

■ YOU'LL BE AMAZED both at how rapidly you learn with these cards, and how easy it is to understand. These new cards are available right now. Don't miss out. Send your check or money order today.

Jampacked with information at your fingertips

FACTCARDS—Facts at your fingertips for Experimenters and Project Builders!

Please send one copy of FACTCARDS \$1.99. Shipping \$2.00 (U.S. and Canada only).
Please send _____ copies of FACTCARDS. Total cost is sum of copy price and First Class postage and handling cost multiplied by number of card sets ordered.
New York residents add sales tax to total cost of each order.
Please print _____ Allow 6-8 weeks for the material to arrive.

(Name) _____ Detach and mail today:
CLAGGK Inc.
P.O. Box 12162
Hauppauge, NY 11788
(Street Address) _____
(City) _____ (State) _____ (Zip) _____ All Payment must be in U.S. Funds!
BS168

USE THE FREE INFORMATION CARD FOR FAST RESPONSE

High-Accuracy Calibrator

You can now have automated lab calibration in a bench-top package with the high-accuracy 525A Temperature/Pressure Calibrator (\$3995). It has the multifunction adaptability to source amps, ohms, and volts with a 25-ppm (.0025%) accuracy. There is a simplified interface for automated calibration, and it can source and measure a complete range of industrial RTDs, ANSI, and international thermocouples. The calibrator also interfaces with MET/CAL Plus and GPIB software.

FLUKE CORP.

PO Box 9090
Everett, WA 98206-9090
888-308-5277 or 425-347-6100
www.fluke.com

CIRCLE 60 ON FREE INFORMATION CARD



Clamps To Measure Amps

General-purpose professional clamp-on meters, Models 511, 512, and 514 (\$129, \$159, and \$199, respectively) measure up to 1000 amps of AC current, AC and DC volts to 600 volts, as well as ohms, continuity and frequency. Model 511 is



average sensing, while the 512 and 514 provide true RMS measurement. Model 514 uses Hall sensor technology, providing DC and AC measurement up to 1000 amps.

AEMC INSTRUMENTS

200 Foxborough Road
Foxborough, MA 02035
800-3443-1391 or 508-698-2115
www.aemc.com

CIRCLE 62 ON FREE INFORMATION CARD

LCR Meter

This Passive Component LCR Meter (\$179) measures inductance and capacitance with a .7% basic accuracy and resistance with .5% accuracy. All measurements are displayed on a 4 1/2-inch digital, back-lit LCD. Test frequencies are provided at 120Hz and 1kHz. There are many extra features, such as a built-in test fixture, open and short zero, and auto power off. It can be powered by either a 9-volt battery or an AC adapter.



EXTECH INSTRUMENTS CORP.

285 Bear Hill Rd.
Waltham, MA 02451-1064
781-890-7440
www.extech.com

CIRCLE 61 ON FREE INFORMATION CARD

Non-Contact Activities

The CR2500 series of Hall Effect Current Transducers (\$91.51-\$108.94) range from 2 to 300 ADC and will output a DC signal proportional to a DC-current input signal. Designed for non-contact DC monitoring, they feature closed-loop sensing for accuracy and also 0-5 V_{DC} or 4-20 mA_{DC} outputs. The new design allows both surface and 35-mm DIN rail mounting. Operating from a 24-volt DC supply, the transducers can be used with battery chargers and systems, mobile applications, and DC motor drives.

CR MAGNETICS, INC.

544 Axminster Dr.
Fenton (St. Louis), MI 63026
636-343-8518
www.crmagnetics.com

CIRCLE 63 ON FREE



INFORMATION CARD

Computer Monitor Tester

A compact and versatile monitor tester, the VGA-Plus, Model # 269-001, (\$79) features 16 switch-selectable functions. Users can diagnose, repair, and test all VGA-type monitors, projectors, LCD displays, and other similar equipment without needing a computer. The unit is equipped with a DC power jack, runs on a 9-volt battery, and measures

2.25- × 2.18- × .65-inches.

JENSEN TOOLS, INC.

7815 S. 46th St.
Phoenix, AZ 85044-5399
800-426-1194
or 602-453-3169
www.jensentools.com



CIRCLE 64 ON FREE INFORMATION CARD

AC/DC In The Classroom

Ideal for industrial and commercial applications, the *AC/DC Power Supply, Model 1315* (\$285) is also suitable for educational purposes because of the many safety features. Both the input and output are protected against surges, the terminals are color-coded, and the rugged, metal case provides extra durability. There are separate outputs for either 0-25 V_{AC} or 0-25 V_{DC}, both at 5 amps. Other specifications include a <1-volt ripple and a ±10% regulation.

GLOBAL SPECIALTIES

Highland Industrial Center
1486 Highland Ave., Unit 2
Cheshire, CT 06410
800-572-1028
www.globalspecialties.com

CIRCLE 65 ON FREE INFORMATION CARD



Mama Said Knock You Out

Do you want to enhance the workmanship of projects with instrument panels, switches, keyways, and other data communications applications? The *Super Slug-Out Knockouts* (\$16 per piece), made of high-alloy tool steel, can withstand repeated punching of up to 10-gauge stainless steel. Its three-knife design splits the slug into three pieces, allowing for easy removal from the die. Pieces can be purchased individually, accommodating a range of 1/2-2-inch conduit, or in kits.

GARDNER BENDER

P.O. Box 3241
Milwaukee, WI 53201-3241
800-624-4320
www.gardnerbender.com

CIRCLE 67 ON FREE INFORMATION CARD



Non-Invasive, Two-Step Tracing

The *Tone Generator and Cable Tracer Kit, Model 262* (\$59) is designed for non-invasive tracing of telephone lines, troubleshooting automobile and computer wiring, and testing local area networks. This lightweight, hand-held, battery-powered kit is ideal for cabling technicians.

Its generator tests un-energized telephone lines (LAN cables) and can be connected to stripped wires, terminal panels, wall plates, and more. For identifying wires without piercing the insulation, there is a tracer that recognizes tones from up to 12 inches

B&K PRECISION CORP.

1031 Segovia Circle
Placentia, CA 92870-7137
714-237-9220
www.bkprecision.com
CIRCLE 66 ON FREE INFORMATION CARD

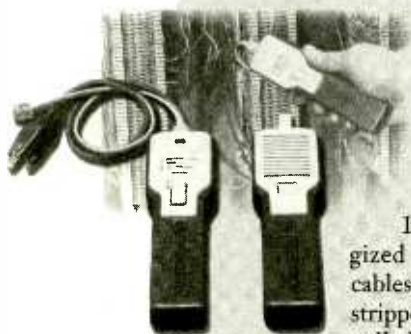

Wrap It Up

To help prevent such syndromes as carpal tunnel, the *PTX series of Ergonomic Wire Wrapping and Unwrapping Tools* (\$195) have many features to minimize repetitive stresses. Each one has a well-balanced construction, dual-finger short-throw trigger, and a long handle. With a high-power motor, the PTX responds quickly to the flick of a switch, handling 20-30 AWG wire.

JENSEN TOOLS, INC.

7815 S. 46th St.
Phoenix, AZ 85044-5399
800-426-1194 or 602-453-3169
www.jensentools.com

CIRCLE 68 ON FREE INFORMATION CARD



Give It the Brush Off

A high-speed continuity tester, the *SF10 Short Finder Brush* (\$39.95) has an ergonomic design that makes it easy to use for anyone in electronics. It comes with a pointed tip probe, as well as a stainless steel brush probe. The probes allow users to quickly locate shorts in complex electrical circuits, such as printed circuit card assemblies, IC sockets, and more.

WAVETEK METERMAN TEST TOOLS

PO Box 9090
Everett, WA 98206
877-596-2680

www.metermantesttools.com

CIRCLE 69 ON FREE INFORMATION CARD



GIZMO®

For more information go to page 90A

or e-mail: requests@berkshire-is.com

Convergent Component

The *DMC 100 Digital Media Center* (\$899) is an all-in-one interactive device for music, movies, the Internet, and more. It includes a DVD/CD player and a 30-GB hard drive, as well as broadband and dial-up Internet connectivity (with a \$9.95/month subscription to the ZapMedia service). The hard drive can store up to 10,000 MP3 or WMA (Windows Media Audio) tracks. It comes with a wireless keyboard and a programmable remote.



Big Ticket DVD Player

If you even considered purchasing Meridian's \$16,000 Model 800 DVD player, then the Model 596, yours for a mere \$4250, will seem like a bargain. It can handle DVD-Video, CD, VideoCD, and MP3 formats. The deck uses triple-buffering, de-jittering circuitry, and an output re-clocking stage said to maintain bitstream integrity. Component video, S-video, SCART (European), and composite video outputs are provided.

Meridian America, Inc., 3800 Camp Creek Parkway, Bldg. 2400, Suite 122, Atlanta, GA 30331; 404-344-7111; www.meridian-audio.com.

CIRCLE 52 ON FREE INFORMATION CARD



The Whole World In Your Hand

Harman Kardon, 250 Crossways Park Drive, Woodbury, NY 11797; 516-496-3400; www.harmankardon.com.

CIRCLE 50 ON FREE INFORMATION CARD

The *eTrex Venture* portable GPS device (\$194) offers a built-in worldwide database of cities. Information on hotels, dining, shopping, and entertainment can be downloaded from Garmin's Map-Source Points of Interest CD-ROM. Make a selection, and telephone and address will be displayed. Marine data, including buoys, lights, and wrecks, are also included.

Garmin International, Inc., 1200 East 151st Street, Olathe, KS 66062; 913-397-8200; www.garmin.com.

CIRCLE 51 ON FREE INFORMATION CARD



Monster Power Management

The two-outlet *Home Theater PowerCenter HT200* (\$59.95) is designed for areas where larger power strips are inconvenient and unnecessary—such as when one or two components are located some distance from the main home-theater system. It includes coax line protection for use with cable-TV or DBS satellite installations. Besides safeguarding components from surges and spikes, it filters noise.

Monster Cable, 455 Valley Drive, Brisbane, CA 94005; 415-840-2000; www.monstercable.com.

CIRCLE 53 ON FREE INFORMATION CARD



One for the Road

The 160-watt (40 × 4) *Jensen CH4001* automotive head unit (\$449.95) includes a four-disc magazine-style CD changer with 10-second electronic shock memory and an anti-shock mechanism that should deliver smooth sound even during rough rides. The Instaloc III digital tuner offers 18 station presets plus 12 auto station presets that

store the strongest stations when you're traveling. The single-DIN size unit has red illuminated control



buttons and a multi-color LCD.

Recoton Mobile Electronics, 2950 Lake Emma Road, Lake Mary, FL 32746; www.jensenaudio.com.

CIRCLE 54 ON FREE INFORMATION CARD

Wireless Weather Station

Monitor outdoor weather conditions in indoor comfort, with no wires, using the *Cable Free Modular Weather Station BHT-668A* (\$399.95). Four compact monitoring modules send RF signals to the base station, which displays readings from the barometer, self-emptying rain gauge, thermo-hygrometer, and ExactSet alarm clock, along with graphical weather forecasts for the upcoming 12 or 24 hours.

Oregon Scientific, Inc., 19861 SW 95th Place, Tualatin, OR 97062; 800-853-8883; www.oregonscientific.com.

CIRCLE 55 ON FREE INFORMATION CARD



Wall "Towers"

When performance is paramount, but tower speakers just won't fit, consider the *OWS-1* wall-mount speakers (\$319/pair). They feature Infinity's Ceramic Metal Matrix Diaphragm (CMMD) driver technology, said to deliver exceptional sonic accuracy. The slim-profile enclosures, available in either black or white finish and measuring just 4½ inches deep, work with any décor and are much easier to install than in-wall speakers.

Infinity Systems, Inc., 250 Crossways Park Drive, Woodbury, NY 11797; 800-553-3332; www.infinitysystems.com.

CIRCLE 58 ON FREE INFORMATION CARD



Road MP3

MP3 takes to the road with the *XP-MP3* portable MP3/CD player (\$240). The device comes with a car kit that includes DC and cassette adapter. It plays CDs and MP3-encoded CD-R/RW discs, displays ID3 tags, and offers a fixed/variable bit rate (32–320kbps), and can use rechargeable batteries.

Aiwa America, Inc., 800 Corporate Drive, Mahwah, NJ 07430; 201-512-3600; www.aiwa.com.

CIRCLE 57 ON FREE INFORMATION CARD



Advanced Gaming

Why trade in your beloved Game Boy Color for a new *Game Boy Advance* (\$99)? First, its 32-bit processor makes it dozens of times more powerful and allows it to display more than 500 times as many colors on its comparatively huge 2.9-inch LCD. Then there's the stereo and Dolby surround effects. Up to four Game Boy Advance units can be linked together for four-player gaming using a single multi-play-

er cartridge. Finally, the newcomer is backward compatible with all your favorite Game Boy Color titles.

Nintendo, 4820 150th Avenue NE, Redmond, WA 98052; www.nintendo.com.

CIRCLE 56 ON FREE INFORMATION CARD



Big-Screen HDTV + DBS

The *RCA Scenium HD65W20* (\$4499) is a 65-inch widescreen rear-projection HDTV set based on new LCoS (liquid-crystal on silicon) technology. It has a built-in all-format ATSC decoder and a built-in all-format DirecTV satellite receiver. It offers more than 1.5-million pixels of digital video resolution, a high-definition optical system, a high-gain dark-tint screen for 25% improved picture brightness, and Intellifocus auto convergence. Other features include NTSC twin-tuner PIP, V-Chip, and component video inputs to automatically adjust the scan rate for the connection of progressive-scan DVD players.

Thomson Multimedia, 10330 North Meridian St., Indianapolis, IN 46290; www.rcascenium.com.

CIRCLE 59 ON FREE INFORMATION CARD



USB Surge Protection

The *GE Under Monitor surge protector with USB Hub Model SU93973* (\$64.99) makes it easy to swap peripherals without rebooting. Designed to fit under a PC monitor, the device features one master power switch and four individual power switches on its front panel. Four corresponding USB ports are on the side, and on the back are five surge-protected outlets (one is unswitched, with continuous power).

Jasco; 800-654-8483; www.jascoproducts.com.

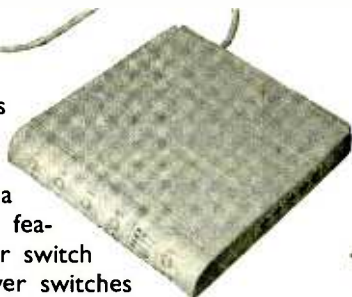

Wireless Communicator

Aimed at teens, the *Inter-tainment computer* (\$129) is a handheld device that provides wireless interactive gaming, instant messaging, e-mail, and Internet access via a link to a PC or Wireless Internet Gateway. Available in five translucent colors, it also includes personal organizer, address book, graphics editor, and music composer functions. Its 1 MB of memory can be upgraded to 16 MB.

Cybiko, Inc.; 630-529-1029; www.cybiko.com.



Shake, Rattle & Roll

Using NXT's SurfaceSound technology, the *Tremor S-150* desktop multimedia speaker system (\$149.99) provides big sound from a small package. The two satellite speakers feature a wide dispersion pattern for room-filling sound, while the powered subwoofer provides deep, rumbling bass for music or gaming. The system is rated at 75 watts total

RMS (150 watts peak). Both desktop stands and swivel bracket mounts are included. TDK Electronics Corp.; 800-835-8273 or 516-535-2600; www.tdk.com.



Affordable Laser Printer

The *ML-1210* (\$199) speeds through printing jobs at 12 pages per minute with a resolution of 600 dpi. It uses micro toner for sharper text and graphics and features a toner-save button said to reduce toner consumption by up to 40%. Equipped with both parallel port and USB interfaces, the printer is compatible with the iMac as well as Windows-based PCs.

Samsung Electronics America, Inc.; 888-887-8536; www.samsungusa.com.



Internet Radio Shelf System

The *FW-i1000* (\$499), when used with an always-on broadband connection, brings uninterrupted streaming digital audio from the Internet to a CD mini shelf system, with no need to "boot up" every time you want to listen to music. Stations can be sorted by genre, region, or language, and, when available, station name, artist, and title will be

displayed. The system can play back MP3 files stored on a PC and can be upgraded via the broadband connection when new Internet audio functions become available. The 220-watt system features a three-CD changer and Philips' power wOOx speaker technology for deeper bass.

Philips Electronics; 770-821-2715; www.philips.com.



CD ROM based resources for learning and designing

The internationally renowned series of CD ROMs from Matrix Multimedia has been designed to both improve your circuit design skills and to also provide you with sets of tools to actually help you design the circuits themselves.

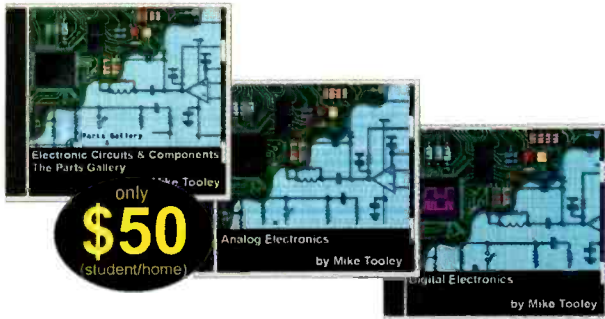

Electronic Circuits and Components provides an introduction to the principles and application of the most common types of electronic components and how they are used to form complete circuits. Sections on the disc include: fundamental electronic theory, active components, passive components, analogue circuits and digital circuits.

The Parts Gallery has been designed to overcome the problem of component and symbol recognition. The CD will help students to recognize common electronic components and their corresponding symbols in circuit diagrams. Quizzes are included.

Digital Electronics details the principles and practice of digital electronics, including logic gates, combinational and sequential logic circuits, clocks, counters, shift registers, and displays. The CD ROM also provides an introduction to microprocessor based systems.



Analog Electronics is a complete learning resource for this most difficult subject. The CD ROM includes the usual wealth of virtual laboratories as well as an electronic circuit simulator with over 50 pre-designed analog circuits which gives you the ultimate learning tool. The CD provides comprehensive coverage of analog fundamentals, transistor circuit design, op-amps, filters, oscillators, and other analog systems.

Electronic Projects is just that: a series of ten projects for students to build with all support information. The CD is designed to provide a set of projects which will complement students' work on the other 3 CDs in the Electronics Education Series. Each project on the CD is supplied with schematic diagrams, circuit and PCB layout files, component lists and comprehensive circuit explanations.



PICtutor and C for PICmicro microcontrollers both contain complete sets of tutorials for programming the PICmicro series of microcontrollers in assembly language and C respectively. Both CD ROMs contain programs that allow you to convert your code into hex and then download it (via printer port) into a PIC16F84. The accompanying development board provides an unrivaled platform for learning about PIC microcontrollers and for further development work.

Digital Works is a highly interactive scalable digital logic simulator designed to allow electronics and computer science students to build complex digital logic circuits incorporating circuit macros, 4000 and 74 series logic.

CADPACK includes software for schematic capture, circuit simulation, and PCB design and is capable of producing industrial quality schematics and circuit board layouts. **CADPACK** includes unique circuit design and animation/simulation that will help your students understand the basic operation of many circuits.

Analog Filters is a complete course in filter design and synthesis and contains expert systems to assist in designing active and passive filters.

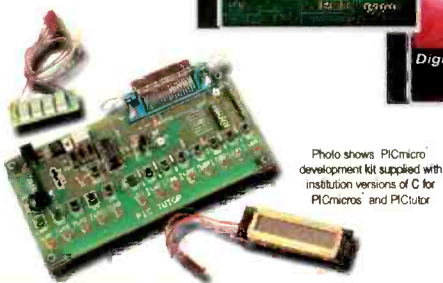

Photo shows PICmicro development kit supplied with institution versions of C for PICmicro and PICtutor

Shareware/demo CD ROM with more than 20 programs \$4.99 refundable with any purchase.

Order Form:

Please circle the products you would like to buy on the table below, calculate the total cost, fill in the rest of the order form and send it to us. NY residents add sales tax. Please allow 6 weeks for delivery.

	Student	Institution
Electronic Cts. & Comps.	\$50	\$99
Digital Electronics	\$50	\$99
Analog Electronics	\$50	\$99
Electronic Projects	\$75	\$159
PICtutor	\$179	\$350
C for PICmicros	\$179	\$350
Digital Works	\$50	\$99
CADPACK	\$75	\$159
Analog Filters	\$75	\$159
Postage - USA	\$5	\$5
Postage - Canada	\$5	\$5

Name: _____

Address: _____

Zip: _____ Phone: _____

Card Type: _____

Mastercard, Visa, or Discover only

Card number:

I have enclosed my check for \$: _____

Signature: _____

Please charge my credit card for \$: _____

Phone your order to us on:

631-592-6721

or send your order to:

CLAGGK Inc.

PO Box 12162

Hauppauge, NY 11788

Expire date:



CL02

Order online NOW from: www.poptronics.com



FROM NASA TO YOUR DESKTOP

Experience real depth 3-D without glasses.

Dimension Technologies, Inc. (DTI) has been researching and developing flat-panel, 3-D displays for over fifteen years. In 1993, DTI designed and constructed a fully functional, fully-animated holographic display for NASA. Now, after years of tweaking, DTI is offering its desktop flat-panel 2-D/3-D display to the public, starting at a cost of \$1699 for their 15-inch unit. Units can be ordered directly from DTI's Web site at www.dti3d.com. We had the chance to evaluate the pre-production unit, and here's what we found.

Amazing...Simply Amazing. The majority of us have seen three-dimensional images, either on a television with those red and blue glasses, or if you're a little grayer you may remember the blackish specs handed out at the cinema. Recent years have brought us many variations of virtual reality shutter-glasses for use on a home computer, but the *DTI 15-inch 2-D/3-D Display* is in a class all its own. The engineers at DTI have developed a new patented technology, called *Parallax Illumination*, which allows users to view real depth three-dimensional images without any headgear or glasses. Furthermore, this same device can be switched to a high-resolution 2-D display simply by pressing a button. This function is just one of the thirteen patented technologies that has been incorporated into the DTI LCD.

It only took ten minutes to hook up the LCD to my home system. A cable runs from the monitor to your computer's video card, another cable runs from the LCD to an available serial port, and finally, there is a power cable that plugs into the wall. A tutorial gently guided me through the simple viewing



Here is the 15-inch DTI LCD 2-D/3-D display. The screen offers incredible 3-D imaging, as well as high-resolution 2-D imaging. All for well under \$2000.

technique. For reasons explained later, the person viewing the screen must sit in a precise zone that is easily confirmed when a blinking LED mounted on the screen extinguishes. That's right, you guessed it! This unit has an optical sensor that detects if its user is seated properly in front of the device in order to experience the intended effect.

What's This About Parallax? The people of DTI have packed their Web site with tons of technical data that can be seen at www.dti3d.com, but what follows is a brief description of the process known as *Parallax Illumination*.

Humans have stereoscopic vision. Our two eyes are spaced approximately 2.5 inches apart (on the average), and each eye receives its own image of the environment. The left eye's image differs slightly from the right eye's image due to angular difference of the observation point.

A quick experiment to demonstrate the difference between the images is to sit in a chair and stare at an object on the wall, like a light switch, with both eyes open. Now, alternately close the right eye and then the left eye. Repeat this at about a frequency of twice per second. You should notice an apparent movement of the object.

(Continued on page 15)

LynX-10
HOME AUTOMATION KIT

- Software Included
- Use Existing Wiring
- Simple Inexpensive

1-800-928-5299 www.marrickltd.com

Don't lose sight of Glaucoma.



Introducing Robotics with Lego® Mindstorms™

For Robot Lovers. Shows how to build a variety of increasingly sophisticated computer-controlled robots using the brilliant Lego mindstorms Robotic Invention System (RIS). Covers the fundamental building techniques needed to construct strong and efficient robots. Explains to the reader how robot control programs may be simply constructed on their PC screens. Detailed building instructions are provided for all the robots featured. 270 pages, 7 1/2 x 10 5/7 in. **\$19.99.**

Plus \$2.45 shipping in U.S. Order from CLAGGK Inc., P.O. Box 12162, Hauppauge, NY 11788 **CLX1**

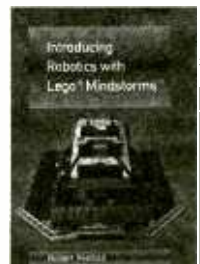

Business Buzz

CAMERA COLLABORATION

Matsushita and Leica Camera are collaborating in the development of digital still cameras that will be marketed under both Panasonic and Leica brand names starting in the third quarter of 2001. They will combine Panasonic's digital A/V technologies with Leica's expertise in optics. Panasonic has already used Leica lenses in some of its digital camcorders. The new digital still cameras will feature SD Memory Cards, making them easy to link with similarly equipped A/V devices.

TALKING TEXT

According to AT&T Labs, its Natural Voices Text-to-Speech is the most human-sounding computer-speech system in the world. David Offen, director of engineering for BeneTech, a nonprofit organization that develops technologies to meet social needs, such as online books for people with disabilities, agrees. "We rated 15 different synthesized speech systems. AT&T Labs' Text-to-Speech got the highest grade of them all," Offen said.

The two-part system consists of a text-to-speech engine that turns written words into natural-sounding speech, and the actual voices. Users can choose from a library of existing voice types, or develop a custom voice, to duplicate the sound of a company's celebrity spokesperson, for instance.

Potential customers include customer service companies that operate call centers, telemarketers, and travel or reservations systems. Other Natural Voices products are expected to follow, including speech products that will run on cell phones.

RADIO TO THE POWER OF X

With two geostationary satellites dubbed "Rock" and "Roll" positioned 22,000 miles above the earth, ready to beam digital radio signals to listeners coast to coast, XM Satellite Radio is ready to rock-n-roll. Its first receivers were scheduled to debut in September in San Diego and Dallas/Fort Worth, with 100 channels of music and talk radio available. National rollout is expected in November, just in time for the Christmas buying season. The subscription-based service will cost \$9.99 a month, with receivers starting at about \$250. Car, home, and portable devices will be available.

Poseidon Drowning-Detection System



The "Third-Eye" camera is an off-the-shelf Sony black-and-white CCD camera, optimized for underwater use.

You let your kids swim at the community pool, believing they are safe because the pool is staffed by well-trained lifeguards. Unfortunately, despite their best efforts, lifeguards cannot constantly monitor everyone in a crowded, noisy pool. Surface reflection and glare compound the problem. According to the Centers for Disease Control and Prevention, an average of six people drown in U.S. pools every day, and drowning is the second leading cause of injury-related deaths for American children. Many of these incidents occur at public facilities staffed with certified professional lifeguards. Furthermore, many nonfatal drowning accidents result in permanent injuries. For every person who drowns, four times as many people nearly drown. Finally, a drowning event can leave a lifelong mark on lifeguards who attempted an unsuccessful rescue.

Early Detection

The answer is not necessarily to hire more and better trained lifeguards. What is needed is the ability to detect and reach a drowning victim quickly. To prevent death or lifelong injury, resuscitation must be initiated as quickly as possible, ideally within 30 seconds.

Poseidon Technologies SA in Boulogne, France has developed a drowning-detection system, which features machine vision to identify swimmers in trouble. Machine vision, already used extensively in industrial automation applications, combines video cameras with computers into systems that can "see" and then make decisions based on what they see. In France, an estimated 1-2 people drown each week in public pools. The system was not designed to replace lifeguards, but to help them save lives and prevent injuries.

Machine Vision and Alarms

One of the challenges to applying the computer vision to outdoor pools was to develop machine-vision algorithms to image swimmers underwater. The big problem was the shadows from the natural lighting. This was solved by using computer stereo vision to discriminate volume and textures such as a swimmer versus a shadow or a light.

The Poseidon system uses a network of cameras located above and below the surface of the pool. The cameras are off-the-shelf Sony black-and-white CCD



Shown here is the display on the Supervision Workstation, which features a flashing light, a buzzer, and an easy-to-use touchscreen.

TYPE

cameras. The "Third-Eye" underwater camera units, optimized for underwater use, are sealed within the pool walls under the surface. Each unit's cameras have a combined field of vision of over 180 degrees to provide overlapping surveillance at the deep end of the pool. The cameras are networked to a central onsite processor that analyzes all the camera images in real time. Using machine-vision algorithms developed by Poseidon, the computer monitors the trajectories of swimmers and identifies suspicious situations, such as a slowly sinking or immobile victim, and triggers an alarm.

The alarm includes a flashing light and buzzer on the supervision workstation installed next to the pool. This command center for the system is naturally waterproof and has a touch-sensitive screen for easy use. Real-time video images are displayed and recorded immediately on a workstation monitor. The lifeguards also wear lightweight, water-resistant Poseidon pagers that provide both audible and vibration alarms. Poseidon gives the staff the coordinates of the swimmer within 10 to 15 seconds of a possible drowning event. With a range that extends more than 200 meters, the unit also displays the elapsed time since detection. There is an optional "After Hours Intrusion" mode that can detect swimmers when the pool is closed and send an alarm to the police or another security-monitoring station.

A Life Saved

The system at the Centre Aquatic Jean Blanchet in Ancenis, France has already been credited with saving a swimmer's life. A young man escaped serious permanent injury, or death, thanks to the rapid intervention by the lifeguards made possible by the Poseidon System. The Poseidon system has been in operation at the Ancenis pool since 1993.

Installation and Information

To date, 15 pools in France, the Netherlands, England, and Canada have been equipped with the Poseidon sys-

tem. This includes the 82- × 65-foot pool at the North Toronto Community Centre. Other installations in Sarasota, FL and Dedham, MA are in the works. The company plans to offer Poseidon to smaller pools, such as those at hotels and resorts.

For more information, contact Poseidon Technologies Inc., 100 Cummins Center, Suite 217C, Beverly, MA 01915; 866-342-0980; www.poseidon-tech.com. —by Bill Siuru **PT**

Virtual Therapy

More than 30 million Americans aged 15 to 54 suffer from some type of anxiety disorder—roughly half from fear of flying. In traditional treatments, the therapist spends several sessions familiarizing the patient with a real airplane. Only when the patient feels comfortable being on a stationary aircraft is an actual flight attempted. This course of treatment presents logistical problems and can be embarrassing for the fearful flyer.

Enter Virtual Reality (VR) therapy, the brainchild of Larry Hodges, a Georgia Institute of Technology professor of computing. He and his partner, Emory University professor of psychology Barbara Rothbaum, are co-founders of Virtually Better Inc., an Atlanta-based company that provides VR treatment and markets the licensed therapy programs to clinical psychology practices and hospitals. It costs \$15,000 to install a complete VR therapy system, which represents a tremendous drop in price from even a few years ago. Hodges credits the booming video game industry with part of that drop—3D graphics have become much cheaper. Many insurance companies have begun covering the cost of VR therapy, which usually requires between 7 and 15 office visits ranging from \$100 to \$200 a session.

In VR therapy for overcoming the fear of flying, the patient is seated in a darkened room in a chair that vibrates to simulate the motions of a plane. He wears a helmet-like, head-mounted display with earphones and separate

Research Notes

BEAT THE (ATOMIC) CLOCK

What keeps time more accurately than an atomic clock? The mercury-ion clock developed by a team of physicists at the National Institute of Standards and Technology is 1000 times more stable than today's best clocks. For instance, the NIST-F1 atomic clock, based on the natural atomic resonance of the cesium atom, is accurate to within one second in 20 million years. The new clock, based on energy transition in a single trapped (missing one electron) mercury ion, resonates much faster. While the NIST-F1 measures an atomic resonance of about 9 billion cycles per second, the mercury-ion device monitors an optical frequency of about 1 quadrillion cycles per second—so fast that it can be read only by an ultra-precise laser. You'd have to outlive the universe—hang around for some 15 billion years—to see it drift by even a second.

THE SCIENCE OF SPLAT

Researchers at Sandia National Laboratories, along with a consortium of eight U.S. companies including auto makers and aircraft engine manufacturers, are working to improve the fundamental scientific understanding of a new manufacturing technique called Cold Spray. Microscopic powdered particles of metal or other solids are injected into a supersonic jet of rapidly expanding gas and shot at a target surface. When the particles hit the substrate, they splat so hard they stick, just like bugs on a windshield. Consortium members plan to use the process to create tough new coatings on car- or aircraft-engine components made from lighter-weight composites, or to deposit layers of conductive metals onto substrates for use as heat-tolerant underhood auto electronics. The Cold Spray process might also be used as a low-temperature alternative to welding and to join chemically dissimilar materials with bonds that gradually transition from one material composition to another.

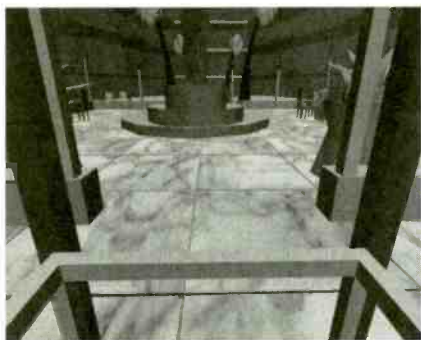

A virtual hotel lobby as viewed from a simulated glass elevator. This scene is one of several virtual-reality environments used successfully in treating subjects for fear of heights.

screens for each eye. A built-in head-tracking device feeds location and orientation data to the therapist's computer. Armed with that data, the computer knows which way the patient is looking and displays the appropriate visuals—the Atlanta skyline fading into the distance during takeoff, for instance. Although the 3D graphics are simple, when they are combined with the chair's vibrations, the roar of the engine during takeoff, and the therapist, playing pilot, announcing the flight's departure, the result is realistic enough that the patient feels immersed in the virtual scenario. A controlled study found that the VR method was as effective as traditional therapy in treating the fear of flying, and was more enjoyable for the patients.

Other VR therapy programs have been designed to treat fear of heights, storms, and public speaking. Veterans Administration hospitals in Boston and Atlanta are successfully using a Georgia Tech/Emory-created VR therapy program called *Virtual Vietnam* to treat veterans suffering from post-traumatic stress disorder. A program for people who are afraid of driving is under development, as is a "virtual house fire" that will be used by the Atlanta Fire Department to train and evaluate officers. **PT**

Attention, Drivers!

Everyone knows that it isn't safe to drive while tuning the radio, eating a Big Mac, talking on a cell phone, or reading the paper. In fact, the National Highway Traffic Safety Administration estimates that such distractions are involved in 20% to 30% of all accidents.

➤ Longer-Life Batteries

Scientists at Brookhaven National Laboratory have developed a new metal alloy that could significantly increase the life of rechargeable batteries. When used as an electrode in nickel/metal hydride (Ni/MHx) batteries, the alloy has a high capacity for storing charges, a long-lasting ability to be charged and recharged, and a high resistance to corrosion. Because it contains no expensive cobalt or toxic cadmium, it "is inexpensive and relatively environmentally benign," said John Reilly, head of the BNL research team.

The team was trying to understand the role played by cobalt and to find a way to replace cobalt with something less costly. While investigating several cobalt-free alloys, they accidentally discovered a combination of lanthanum, nickel, and tin with a very high storage capacity that didn't decay over many charge/discharge cycles. A slight, inadvertent change to the usual 1:5 lanthanum to nickel/tin combination, and the resultant changes in the alloy's structure, led to increased corrosion resistance and long-term energy-storage capacity. Batteries using the new alloy could eventually result in longer between-charge times for cell phones, laptops, and other portable gear. **PT**

Now Ford Motor Company has unveiled the VIRTTEX, or *Virtual Test Track Experiment*. The simulator allows researchers to study, in a controlled environment, how everyday driving tasks, such as swapping CDs, affect driver performance. The VIRTTEX "vehicle" rests atop six angled hydraulic pistons that allow it to move up to 11 feet to any side and tilt up to 20 degrees, duplicating actual forces experienced while driving.



A VIRTTEX occupant wears a laser head-set to track eye movement during a simulated drive on the virtual roadway.

The tests' main focus is on the use of mobile electronic devices while driving. Test drivers are asked to retrieve e-mail, use an electronic address book, or make a phone call, while coping with virtual traffic. The lab can simulate sudden,

unexpected actions by the surrounding virtual cars. Driver responses, both mental and physical, are examined. Because the tasks can be repeated indefinitely, VIRTTEX data can be used as the basis for scientific conclusions. The results of the study, which are expected to be published early in 2002, will be used to determine how Ford can incorporate electronic devices into vehicles without creating a safety risk. **PT**



MULTIMEDIA on the PC!

What is Multimedia? What can it do for you? It can do lots of nice things! This 184-page book helps you create your own multimedia presentation. Multimedia applications by people like you can revolutionize educational and business applications as well bring more FUN, FUN, FUN into your leisure computer activities.

Mail coupon to:

Electronics Technology Today, Inc.
P.O. Box 240
Massapequa Park, NY 11762-0240

Please send me my copy of *Multimedia on the PC* (PCP120). I enclose a check or money order for \$18.45 to cover the book's cost and shipping-and-handling expenses. NY state residents must add local sales tax.

Name _____

Address _____

City _____ State _____ ZIP _____

All orders must be paid in U.S. funds only. Sorry, no orders accepted outside of USA and Canada. Please allow 6-8 weeks for delivery.

MA02

HANDS-ON-REPORT

(continued from page 11)

As your right eye closes, the object jumps to the left and vice versa. This apparent movement is parallax. Using stereoscopic vision's natural parallax trait as a key, DTI developed a technique to obtain a stereo pair image of virtually any object. This image is comprised of two images—one from a left-eye perspective and one from a right-eye perspective—that are sent to the LCD screen.

The Secret Substrate. The real trick to depth-perception is the way the image is released by the LCD. Picture an LCD set at 1024 columns by 768 rows. The DTI display projects two images onto the pixel array. The left-eye image is assigned to all odd-numbered columns and the right-eye image is assigned to all even-numbered columns. Optical circuitry projects the image through the substrate, which causes the light to be projected as 1024 uniformly spaced vertical lines. Of the 1024 lines, 512 are for the right eye to receive and 512 are for the left eye to receive.

Imagine a lattice of light projecting from the screen and at a set point, the lines cross and enter their respective target. This precise point occurs at regular intervals, resulting in viewing zones where the blinking LED sensor extinguishes. So, when a person is at the right calculated angle and distance (just about over a foot away and centered), the screen suddenly comes to life with full 3-D depth. The truly amazing occurrence is that some programs not normally three-dimensional seem to be. The technicians at DTI explained that their driver tries its best to fill-in the missing effect, but companies like nVIDIA are collaborating with DTI for full 3-D support.

In A Nutshell. Overall, the performance of the DTI display was phenomenal. The screen can be integrated with a computer, dual video cameras, or even sonar and radar. Most home users will no doubt use the display for applications such as 3-D video games and

computer-aided design. The product worked as promised—three-dimensional viewing with no aids to the eyes. The price is right, at well under \$2000. I remember when the 19-inch SVGA were priced higher for standard support. Here, you get 2-D/3-D display capability together with the small footprint of a flat-panel LCD display.

For more information, contact DTI, 315 Mt. Read Blvd., Rochester, NY, 14611; 716-436-3530; e-mail: info@dti3d.com or circle 80 on the Free Information Card. **P**

ELECTRONIC GAMES

BP69—A number of interesting electronic game projects using IC's are presented. Includes 19 different projects ranging from a simple coin flipper, to a competitive reaction game, to electronic roulette, a combination lock game, a game timer and more. To order BP69 send **\$4.99 clearance (includes s&h)** in the US and Canada to **Electronic Technology Today Inc., P.O. Box 240, Massachusetts Park, NY 11762-0240.** US funds only. Use US bank check or International Money Order. Allow 3-8 weeks for delivery. **MA07**



**Frustration? No, thanks.
Fun? Yes, please.**

Satisfied customers - the key to our success

- ▶ that's why every new EAGLE version is based on the feedback from our customers
- ▶ that's why all our customers have access to our highly acclaimed, comprehensive support, free of charge
- ▶ that's why EAGLE has no hidden costs for libraries or modules which prove to be indispensable after purchasing
- ▶ that's why we really want customers to enjoy working with EAGLE
- ▶ that's why EAGLE is one of the top-rated programs for schematic capture and board layout



EAGLE 4.0

Schematic Capture • Board Layout
Autorouter

The leaders of the leading German electronics magazines selected EAGLE 4.0 as **Product of the Year 2000** in the category CAE/CAO

Windows

Linux

- Version 4.0 Highlights**
- New Library Management with Component Browser
 - Technology and Package variants for components
 - Design your own commands via User Language
 - Unlimited length for component names/values
 - Design Rules define pad/via dimensions and shapes
 - Net Classes for Autorouter and DRC
 - Minimum Autorouter grid: 0.02 mm
 - SMD pads can be rounded or round
 - Different pad shapes for Top, Bottom, or Inner layers



EAGLE 4.0 Light is Freeware!

You can use EAGLE Light for testing and for non-commercial applications without charge. The Freeware Version is restricted to boards up to half Eurocard format, with a maximum of two signal layers and one schematic sheet. All other features correspond to those of the Professional Version. Download it from our internet Site or order our free CD.

The Standard Version is suitable for boards in Eurocard format with up to 4 signal layers. The Professional Version has no such limitations.

http://www.CadSoftUSA.com
800-858-8355

Prices	Light	Standard	Professional
Layout		199\$	399\$
Layout + Schematic		398\$	798\$
Layout + Autorouter		398\$	798\$
Layout + Schematic + Autorouter	49\$	587\$	1187\$

Pay the difference for Upgrades

CadSoft Computer, Inc., 801 S. Federal Highway, Delray Beach, FL 33483
Hotline (561) 274-8355, Fax (561) 274-8218, E-Mail: info@cadsoftusa.com

November 2001, Poptronics



YESTERDAY'S NEWS

A PEEK INTO THE GERNSBACK ARCHIVES



Dateline: November 1941 (60 years ago)

Radio-Craft focuses on radio as a defense mechanism. The cover story retells an incident of a military information interception by an enemy radio station. It brings to light the importance of radio signals in modern warfare. A complementary article elaborates on how the NYA—an acronym for the National Youth Administration—trains men to work with radios on a national security level. Other features are about a 70-watt flexible amplifier, experimental photo-cell relay, and a compact kilowatt Xmitter. *(Radio would soon become a major aspect of wartime command and control. Today's armies rely heavily on electronic technology in order to achieve voice and data transmissions to and from the battlefield.)*

1900

1910

1930

1941

1950



1960

Dateline: November 1971 (30 years ago)

Radio-Electronics begins to highlight security systems with a cover title, "Stop Burglars With Electronics." One article helps readers choose the best alarm system to suit their own personal needs; a build-it-yourself \$5 vehicle alarm is included, along with one all-purpose multi-sensor system. While in today's world everything is digital, thirty years ago they were exploring photoelectric devices, infrared systems, Doppler frequency shifts, and ultrasonic detectors. Other articles talk about the use of inductors and how to build a scope-mountable camera. *(Thirty years has provided a major boost in security technology. Now simple proximity switches can be updated with video cameras and IR sensors, which have shrunk in size and cost.)*

1971

1980

Dateline: November 1991 (10 years ago)

Popular Electronics is a hobbyist's treasure trove of do-it-yourself information. With detailed step-by-step instructions, this issue shows you how to build a band-sweeper with the NE602 frequency converter, two different remote-controlled outlets for AC-power devices, a counter-surveillance monitor for catching unwanted bugs, and a music-synthesizing circuit. It includes experiments in galvanism—demonstrating basic electronics—and explores easier ways to get images from the computer screen to paper by examining the screen "dumping" process. *(Today, Gernsback still supports learning, experimentation, and discussion in the field of electronics.)*

1991

2000



Season's Greetings

Plug a Friend into

Poptronics[®]

*and Save \$44.89**

*This holiday season you can give an electrifying gift ... plug a friend into **Poptronics**[®] and brighten the whole new year! Whether electronics is your friend's livelihood or hobby, your gift will illuminate the whole spectrum of electronics throughout the coming year and provide a monthly reminder of your friendship.*

Poptronics[®] Magazine will keep your friend informed and up-to-date with new ideas and innovations in all areas of electronics technology ... computers, video, radio, stereo, solid-state devices, satellite TV, medical electronics, communications, robotics, and much, much more.

Poptronics[®] combines the best attributes of **Electronics Now** and **Popular Electronics**. It is the magazine for the hands-on electronics activist. We will be presenting articles on just about everything electronic—from satellite TV equipment to DVDs, gadgets and gizmos to energize your life, audio amplifiers, professional service features, PC-related projects, and much, much more.

PLUS: A selection of computer-oriented columns that explore the digital realm from the inner workings of a PC to the latest the Web has to offer. On the electronics side, there is something for everyone—from the beginner (Basic Circuitry and Q&A) to the expert. Whether your interest is fixing equipment (Service Clinic), tinkering with robots (Robotics Workshop),

or adventuring to the farthest reaches of electronics and science (Amazing Science)—**Poptronics**[®] takes you there.

SAVE \$44.89* ... OR EVEN \$89.78* ... For each gift of **Poptronics**[®] you give this holiday season, you save a full \$44.89* off the newsstand price. And as a gift donor, you're entitled to start or extend your own subscription at the same Special Holiday Gift Rate—you save an additional \$44.89*!

No need to send money ... if you prefer, we'll hold the bill till January, 2002. But you must rush the attached Gift Certificate to us to allow time to process your order and send a handsome gift announcement card, signed with your name, in time for the holidays.

So do it now ... take just a moment to fill in the names of a friend or two and mail the Gift Certificate to us in its attached, postage-paid reply envelope. That's all it takes to plug your friends into a whole year of exciting projects and new ideas in **Poptronics**[®]!

*Newsstand price—8 issues @ \$4.99 each
4 issues @ \$5.99 each

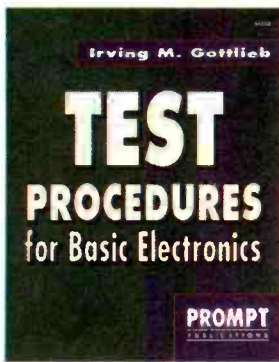

Test Procedures for Basic Electronics. #61063. – \$19.95
 Many useful tests and measurements are covered. They are reinforced by the appropriate basic principles. Examples of test and measurement setups are given to make concepts more practical. 7 3/8 x 9 1/4", 356 pp, paperback.

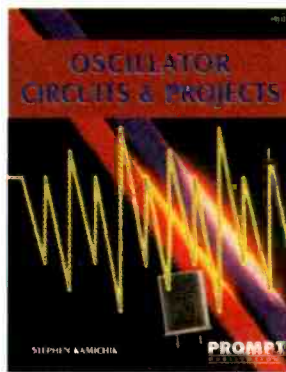

Oscillator Circuits and Projects. #61111. – \$24.95
 A Textbook and project book for those who want to know more about oscillator circuits. You can build and enjoy the informative and entertaining projects detailed in this book. Complete information is presented in an easy-to-follow manner. 7 3/8 x 9 1/4", 249 pp, paperback.

Build Your Own Home Lab. #61108 – \$29.95
 Shows you how to assemble an efficient working home lab, and how to make it pay its own way. Includes projects for creating your own test instruments too. 7 3/8 x 9 1/4", 249 pp, paperback.

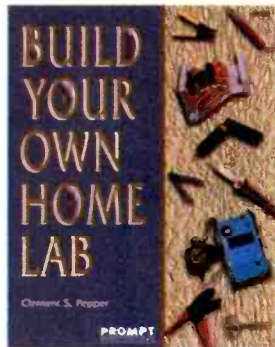

Troubleshooting and Repair Guide to TV. #61146. – \$34.95
 Repairing and troubleshooting a TV is very simple and economical with help from the information in this book. It is the most complete and up-to-date TV repair book available, with tips on how to handle the newest circuits. 8 1/2 x 11", 263 pp, paperback.

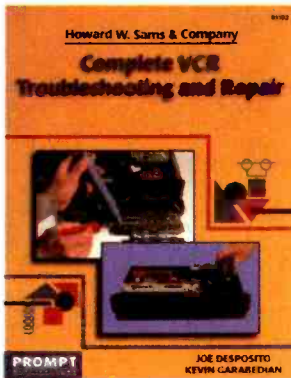
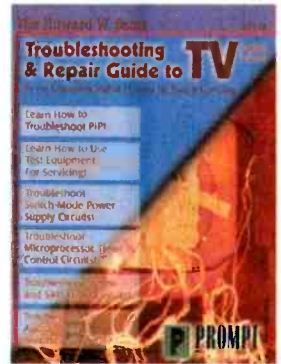

Complete VCR Troubleshooting and Repair. #61102. – \$34.95
 Though VCRs are complex, you don't need complex tools or test equipment to repair them. This book contains sound troubleshooting procedures that guide you through every task. 8 1/2 x 11", 184 pp, paperback.

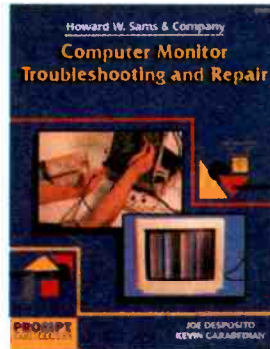

Computer Monitor Troubleshooting and Repair. #61100. – \$34.95
 This book can save you the money and hassle of computer monitor repair by showing you how to fix it yourself. Tools, test instruments, how to find and solve problems are all detailed. 8 1/2 x 11", 308 pp, paperback.

Wholesale & Discount Buyer's Guide #WD-1. – \$19.95
 Save up to 90% off list prices. Audio and video equipment and materials; electronic products and surplus; pro recording and specialty items; computers and components. Source listings include complete address, phone, fax, e-mail and website addresses. 8 1/2 x 11", 72 pp, paperback

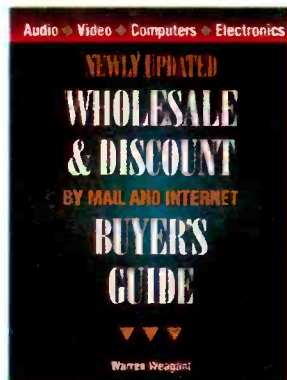

Joe Carr's Circuit Toolkit. #61181. – \$29.95
 Easy-to-build, useful circuits from Carr's workbench to you. They will spark new ideas in your day-to-day use of circuits and help solve frustrating problems. 256 pp, paperback. Contact Jim Surface.

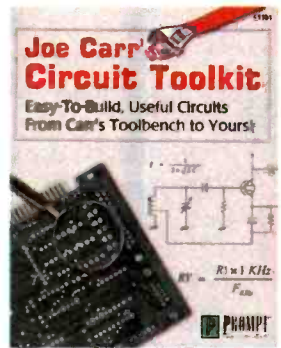

Please circle the products you would like to buy on the page above, calculate the total cost, include shipping charges, using in the form below and send it to us. Please allow 4 - 6 weeks for standard delivery.

Name: _____
 Address: _____
 Zip: _____ Telephone: _____
 I have enclosed my check for \$: _____
 Signature: _____

Please charge my credit card for \$: _____ Number:

Card Type: _____ Expiration Date:

Note: The delivery address and the address at which the credit card is registered must be the same.

Claggg Inc.
 PO Box 12162
 Hauppauge, NY 11788
 Tel: 631-592-6720
 Fax: 631-592-6723
 email: claggg@gemsback.com

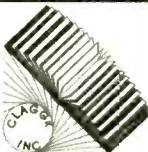

SORRY No orders accepted outside of USA & Canada No. of Books Ordered

SHIPPING CHARGES IN USA. CANADA ADD \$5.00

1 Book	\$ 5.00
2 Books	8.00
each add'l book	3.00
2 Day UPS	\$10.00 extra
Next Day UPS	\$20.00 extra

Total price of books.....	\$.....
Shipping (see chart).....	\$.....
Subtotal.....	\$.....
Sales Tax (NYS only).....	\$.....
Amount Enclosed.....	\$.....
All payments must be in U.S. funds!	

FINDING OUT ABOUT FIBER

In the 1990s, “fiber-optic cable” became a well-known catch phrase. Little did we know that what appeared to be a simple wire buried in the ground was in fact a subterranean super highway capable of transporting more information than we could imagine. Today, schools are connecting to one another with fiber, corporations are switching from copper wire to strands of glass, and video communication is surpassing previously impenetrable technological boundaries with the tremendous bandwidth that fiber-optic technology has to offer. The entire world is moving toward a fiber-friendly age—but what is a fiber-optic cable and how does it work?

For such a seemingly simple piece of equipment, the sheer amount of data that one strand of fiber-optic glass is capable of transporting is almost impossible to grasp. When one imagines a nearly invisible, hair-sized strand of stretched glass, it may appear that the data-transmission capacity is limited by its small size and delicate construction. This couldn't be further from the truth.

When asked for a simple, yet effective way to describe the capabilities of one strand of fiber-optic cable, Bob Grosh, Engineer for Realtime Learning Group, Inc., a national communications company, offered an insightful analogy. “Imagine a single drinking straw and that one telephone line has the bandwidth equal to the size of that straw. Now, take twenty-four more straws and put them in a bundle. Imagine that the drinking straw has grown to the size of a fire hose. We can now compare the fire hose to a T-1 line, which consists of 25 separate telephone lines. As we move up in bandwidth, we arrive at the DS-3 (703



Fiber-optic cable comes in many varieties as seen above. Drastic measures are taken to protect fragile glass fiber. An outer layer of PVC combines with a mesh tube of Kevlar surrounding the fiber to form a shield. The tips of the cable are then spliced to special connectors that allow the cables to be plugged into various transceivers and multiplexing equipment.

telephone lines), and our fire hose becomes much larger—to about the size of a standard culvert beneath a city street. Next in line is a 100-Mb circuit, which would be equivalent in size to that of a storm sewer. The actual bandwidth of fiber-optic cable, with the current technology available, would equal a pipe through which a Greyhound bus could pass. With possible future developments in the electronics that support this medium, the theoretical bandwidth of one strand of fiber is as large as a pipe wide enough to accommodate the moon.”

That's a lot of bandwidth.

So what exactly is this incredible technology that can boast virtually unlimited bandwidth? Simply put, fiber optics is the “...Science of transmitting data, voice, and images by the passage of light through thin, transparent fibers.”—*Encyclopedia Britannica*.

UNDERSTANDING FIBER OPTICS

Fiber-optic technology consists of three basic elements. According to Michael Vastag, Sr. Applications

Engineer with Corning Fiber, “All standard fiber is the same size and is comprised of the core, cladding, and coating. The core carries the light signals, the cladding keeps the light in the core, and the coating protects the actual glass. The core is composed of silica and germania, the cladding is pure silica, and the coating is a type of plastic called acrylate. From one piece of glass eight inches wide and a meter long, 300–500 km of fibers is produced.”

There are two types of fiber—single-mode and multi-mode. In single-mode fiber, the core, which the light travels through, is very narrow. This keeps the dispersion rate to a minimum, and there is little data loss. Imagine a heavy-set person walking through a narrow hallway. There is a single path for that person to follow. Since there is room for just one person at a time, he has no choice but to move forward. Single-mode fiber is capable of generating 40 Gb/sec (Gigabytes per second) or more and can transmit data over very long distances.

Single-mode fiber uses laser light, which has higher speeds and a narrower spectral width. With its higher power concentration and quality, laser light can be significantly higher in price and because of this, single-mode fiber tends to be more expensive than multi-mode. With high data rates, few splices/terminations, and easy upgradability, single-mode fiber is usually the best choice for long distances.

Multi-mode fiber (MMF) is different in structure than single-mode and cannot boast as high performance. Multi-mode fiber has a much larger core than single mode. This large inner canal allows easier connection and improved coupling efficiency. With the more spacious core, there is a higher

MULTIMODE	SINGLE-MODE
Large core size	Small core size
Easier to terminate and splice	More difficult to terminate and splice
LED light source, less expensive electronics	Laser light source, more expensive electronics
"Limited" bandwidth	"Unlimited" bandwidth
Low attenuation	Lowest attenuation
Distances up to a few km (300-500 km typical)	Very long distances
Lowest cost system for shorter links with many terminations	Best solution for high bandwidth longer links

rate of information loss due to light dispersion. Picture the heavy-set man. This time, he is walking through a wide tunnel, and there is enough room for other people to travel at the same time. They go in many different directions, bumping into each other as they zig and zag towards the end of the tunnel. Due to the collisions with one another, each person has dropped some of his belongings and has taken much longer to get through the tunnel.

"The larger the core, the more modes of light that can propagate; and the more modes, the greater the effects of pulse spreading due to modal dispersion. But, with multi-mode fiber, the larger core makes splicing much easier," explains Vastag.

Multi-mode fiber is ideal for shorter distances and is much less expensive than single-mode fiber because of ease of the connectivity and use of lower cost light sources. Applications include premise wiring, inter-building scenarios like computer networks and campus networks, telephony distribution, local area networks, and data transportation.

DEFINITIONS

According to a fiber-optics manual developed by Vastag, there are a few important definitions necessary to understand optical fiber—micron, types of communications systems, wavelength, index of refraction, mode, and optical characteristics.

Micron—A micrometer is a metric measure of distance. One micron = 1×10^{-6} meters or 0.000039 inches. One human hair is the equivalent of 50 microns.

Types of Communications Systems—There are two types of communications systems—digital (data ex-

pressed in digits) and analog (data represented by measurable quantities such as lengths, electrical signals, or voltage).

Wavelength—The length, in nanometers (nm), of one complete oscillation of a plane wave of light. Wavelengths ranging between 850–1625 nm are commonly used in optical communications.

Index of Refraction—Denoted by n , the ratio of the velocity of light in a vacuum to the velocity of light in a medium. $n = \text{Speed of Light (vacuum)} / \text{Speed of Light (medium)}$

Mode—The path in which light travels. Single-mode fiber supports only one mode. Multi-mode fiber supports many modes.

Optical Characteristics—Attenuation and dispersion are the two key optical characteristics. Both limit transmission length and dispersion limits speed (information-carrying capacity).

LEADER OF THE PACK

While copper wire is still hanging onto first place in the connectivity race, the myriad benefits of using fiber is quickly propelling this unobtrusive technology to the head of the pack. There are many reasons to use fiber, but, undoubtedly, the main benefit is transmission capacity. In a data-transmissions contest to see which technology can transport the most amount of information efficiently and clearly, optical cable wins every time. In the bandwidth arena, fiber is in a league of its own. Another benefit of fiber is that the data it transmits can travel for much longer distances without the need for regeneration of the signal, thus saving time and money (less hardware development/installation for regeneration sites).

The benefits of fiber don't stop with its bandwidth and range capabilities. The hardware itself is simple to upgrade, easy to install, secure, strong and flexible, and less expensive to maintain than copper systems. Fiber is also immune to electromagnetic interference, guaranteeing more accurate and consistent data transfer.

Upgradable—The only limiting factor to fiber-optic cable is currently available electronics; the fiber itself need not be replaced. With constant developments in transmitter and receiver capabilities, engineers continue to find new ways to tap into the unlimited bandwidth that fiber has to offer. Similarly to the vast areas of the human brain that remain unexplored, we are using only a small percentage of optical potential.

Ease of Installation—Fiber-optic cables are small in size and weigh less than copper wire. This makes for a much easier installation.

Immunity to EMI—Electromagnetic Interference (EMI) can cause copper-based systems to fail. Since fiber-optic cable is a dielectric (non-conductor of electricity), it is immune to EMI.

Secure Medium—Since optical fiber does not generate EMI and is very difficult to tap, it is secure and allows for privacy.

APPLICATIONS

With the incredible bandwidth capabilities of fiber-optic cable, there are a large number of applications suited for this technology. These include telephony, premise wiring systems, cable television, underwater applications (submarines), and utilities.

Telephony, which is a key application for fiber, uses optical cable for

(Continued on page 25)

The Progression of Optical Storage and Broadband Internet Access

Traditionally personal computers have used the physics of magnetism as the primary means of storing programs and data for later use. Floppy disks, hard disks, Zip disks, and backup tapes all work by magnetizing small areas on the surface of the disk.

In recent years magnetism has been complemented by optics as a storage mechanism. High-intensity light sources, such as lasers, burn information into the disc surface. (Disks that employ magnetism are spelled with a "k" at the end; discs that use optics typically end with a "c.")

An alphabet soup of optical technologies is available, including CD-ROM, CD-R, CD-RW, DVD-ROM, DVD-R, DVD-RAM, and DVD-RW, with even more on the way. You might think that making sense of these acronyms requires a Ph.D. Not necessarily, though it can be confusing. Here's a rundown.

THE COMPACT DISK

CD-ROM—This was the first popular optical disc technology used with PCs. CD-ROM (pronounced see-dee-rahm) stands for Compact Disc Read-Only Memory, which simply means your computer can read data from these discs, but can't write data back.

These discs hold 650 megabytes of data—a megabyte (MB) being approximately a million bytes, a byte being the equivalent of an alphabetical letter or a numeral. You can store 600,000

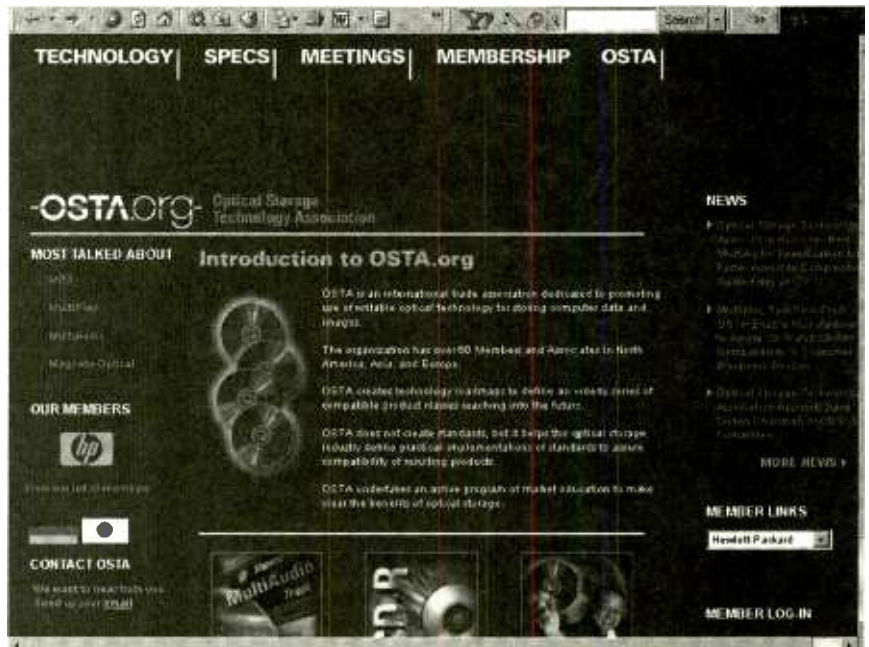

The URL for the Optical Storage Technology Association, an industry organization, serves as a fine research location for people who want to keep up to date with the rapid advances in optical storage.

typewritten pages on one of these discs.

Most computers today still come with CD-ROM drives—drives are the mechanisms that spin the discs—but this technology is being superseded.

CD-R—This is a newer technology that overcame CD-ROM's read-only limitation—CD-R stands for Compact Disc Recordable. Popular uses are copying music and archiving data.

The best feature of these discs is their low cost—20 cents in bulk. The

biggest limitation is that you can record data onto them only once. CD-R drives can read both CD-R and CD-ROM discs.

CD-RW—Standing for Compact Disc Rewritable, CD-RW overcame the write-once limitation of CD-R. You can rewrite and erase data multiple times. It's a technology that's becoming increasingly popular in new PCs, in many cases replacing Zip and tape backup drives.

CD-RW now has a cost advantage

ZONE

Products & Solutions | Download & Buy | Corporate | Service & Support | Partner Programs

THE BEST PERSONAL FIREWALL
Trusted by over 34 million users

ZoneAlarm Pro You Can Trust

New ZoneAlarm™ Pro v.2.6 is the award-winning personal firewall that automatically blocks known and unknown Internet threats, barricading your PC - and your network - from intruders and hostile attacks.

ENTERPRISE ENDPOINT SECURITY

Even with a firewall or VPN, your corporate network is only as secure as its most vulnerable endpoint.

The solution: ZoneAlarm Pro.

[Click here to find out more about securing the extended enterprise from hackers and Internet-borne threats.](#)

Zone Labs News

Zone Labs Joins Cisco AVID Partner Program

Visit and Zone Labs Form Strategic Alliance

Stay ahead of hackers.

ZoneAlarm Pro provides protection against Internet-borne threats. Compatible with Microsoft® Windows® 95/98/Me/NT/2000 and XP.

[Click here to download now.](#) [Click here for more info.](#)

Earn revenue from our Affiliate Program!

Got a web page? Put it to work! Promote ZoneAlarm Pro with a banner or text link and start earning cash.

2000 and 2001 Award Winner ZoneAlarm Pro

2000 and 2001 Award Winner ZoneAlarm Pro

ZoneAlarm FREE Download

POINT AND CLICK

Cogent Communications
www.cogentco.com

DirectPC
www.directpc.com

Earthlink
www.earthlink.com

Optical Storage Technology Association (OSTA)
www.osta.org

Zone Labs
www.zonelabs.com

Unless you need to buy immediately, your best bet is to wait to see which technologies are adopted over time by the major computer makers.

HIGH-SPEED ACCESS

As the Web becomes ever more laden with graphics, sound, animation, and video, the need for speed grows ever greater.

If you use the Web only occasionally, you probably don't need a high-speed modem. However, if you regularly use it for research or entertainment, you'll count your lucky megabits the day you get hooked up with a cable or DSL modem.

If you have high-speed access and are forced to return to dial-up access, as I was recently while on a trip, surfing the Web becomes entangling. You're stuck waiting for page after page to download. Using your browser seems like browsing through a magazine with the pages glued together.

For some time now, the biggest obstacle to high-speed Internet access, also called broadband access, has been scant availability. Many people who want it can't get it from their local cable or telecommunications companies because of the slow rollout of the underlying infrastructure.

UP-SHOTS AND DOWN-FALLS

Broadband customers face other problems as well. Partly as a result of the dot-com meltdown, the DSL industry has undergone an implosion, with big names such as Northpoint Communications and Flashcom filing for bankruptcy protection, limiting your choices.

Still, broadband use continues to

The folks at ZoneAlarm offer an excellent freeware firewall for home users. Commercial users, or home users seeking extra protection, can opt to buy the Professional version. This software firewall will beef up the security for your broadband Internet connection.

over Zip for backing up data or moving it from one PC to another. CD-RW drives cost twice that of Zip drives, but the discs themselves are ten times less expensive than the Zip discs and have two times more capacity.

The latest CD-RW drives are as fast in reading data as Zip drives and nearly as fast in writing data. They're faster than tape backup drives and more versatile. CD-RW drives can write to CD-R or CD-RW discs.

THE DIGITAL VERSATILE DISK

DVD-ROM—This is a technology that promised much, but never quite lived up to its potential. Standing for Digital Versatile Disk Read-Only Memory, DVD-ROM uses discs that are similar to CD-ROM discs, but typically hold seven to eight times more data.

Despite the greater capacity of DVD-ROMs, software makers have continued to distribute their programs primarily on CD-ROMs because of the ubiquity of CD-ROM drives. DVD-ROM drives can be useful for watching DVD movies on your PC or playing computer games.

DVD-ROM drives, like CD-ROM drives, can't record data, though they can read most types of CD and DVD discs. The speed ratings of DVD-ROM drives aren't comparable with those of CD-

ROM drives—a 12X DVD-ROM drive is faster than a 48X CD-ROM drive.

DVD-R—Similar to CD-R, this technology lets you record data onto discs, but only once. DVD-R discs currently have seven to eight times the capacity of CD-R discs, though both the drives and the discs are more expensive, with the discs costing about \$12 each. DVD-R drives can create CD-R discs and create or rewrite CD-RW discs.

DVD-RAM—This is a competing and incompatible technology. You can't read DVD-RAM discs with most other DVD drives and DVD-RAM drives can't create discs that can be read by CD-ROM drives or CD players, a big limitation compared with DVD-R.

DVD-RW—This technology lets you record, erase, and rerecord data. Since it's a new technology, it's expensive, with the discs costing \$20 to \$35 each. Some DVD-ROM drives can't read DVD-RW discs that have been written to multiple times.

Of the above technologies, CD-RW and DVD-ROM are versatile, compatible, and cost-effective choices. Regarding the newer DVD technologies, "it's impossible to call a winner," says Mary Craig, optical storage analyst for Gartner Dataquest, a market research firm in San Jose, CA.

grow, nearly doubling over the past year, according to market research company Cahners In-Stat. Excite@Home, the largest cable Internet service provider at www.home.net, is now the second most popular ISP behind AOL, according to StatMarket, another market research firm.

Yet not all people who have high-speed access are happy with it. Broadband service costs roughly two to three times more than dial-up service and that's a good deal considering that download speeds can be ten times faster. Unfortunately some broadband providers, including the well-regarded Earthlink, at www.earthlink.com, have raised prices recently as much as 25 percent.

Other problems include installation hassles and long wait times for service, which mirror problems encountered in the past with then high-speed ISDN service and cable TV service. Installation is typically much quicker with cable service, taking an average of five days compared to four to six weeks with DSL service, according to DVG Research.

My experiences with both cable and DSL service have been positive. Occasionally the ISP's e-mail or Web server goes down or service goes out completely. These problems are almost always fixed however, without my intervention, in a few hours. Cable access in general is faster, though it slows down more during peak evening hours.

Anecdotally, DSL users seem to report more installation and reliability problems than cable users, though cable users are exposed to more security risks, which makes DSL a better choice for businesses.

PROTECT YOURSELF IN THIS CHANGING WORLD

With either cable or DSL service, however, it's smart to take security precautions, including using a firewall program such as the well-regarded *ZoneAlarm*, at www.zonelabs.com. The software is still free despite the accelerating elimination of other free Internet products and services. A beefed-up pay version, *ZoneAlarm Pro*, makes sense if your PC is a part of a local-area network.

The desirability of high-speed Internet service in the minds of some has translated into its necessity, particularly for lower income people who want it but can't afford it. A number of advocacy groups and industry organizations contend that being a fully participating member of society requires broadband access to the Internet.

Some of the computer industry's biggest companies, including IBM, Intel, and Motorola, are lobbying for legislation that would subsidize broadband in inner city and rural areas. Grand comparisons are being made to the building of the interstate highway system and the rural electric system and even putting a man on the moon.

Despite the hyperbole, the argument for widespread broadband access to the Internet is compelling. Nevertheless, as with all government intervention in the marketplace, care needs to be taken to prevent this from becoming a boondoggle.

In the meantime, work in the private sector continues on access and even higher-speed Internet service.

DirecPC, at www.direcpc.com, recently introduced its Satellite Return service, which lets you both download data from a satellite and upload data back. The service can be a good choice if you can't get cable or DSL access.

Cogent Communications, at www.cogentco.com, is developing an all fiber-optic system that offers speeds of 100 megabits per second, which is about two hundred times faster than cable and DSL modems and one hundred times faster than typical business T1 connections. The cost: \$1000 per month.

Cogent is focusing its efforts initially on ten cities: its home city of Washington, D.C., plus New York, Chicago, Philadelphia, Dallas, Denver, Kansas City, Boston, San Francisco, and Santa Clara.

Reid Goldsborough is a syndicated columnist and author of the book *Straight Talk About the Information Superhighway*. He can be reached at reidgold@netaxs.com or <http://members.home.net/reidgold>.

P

TECHNOSCOPE

(continued from page 22)

long-haul trunk lines, inter-exchange trunks, and subscriber loops. The key advantages for using fiber for telephony is high capacity and long distance between repeaters.

Premise wiring—within and between buildings, to each floor, or to individual workstations—is another area for which fiber-optic cable is suited. Significant advantages to optical premise wiring include sufficient data capacity, immunity to EMI, and small

size and light weight of the equipment—making it much easier to handle.

Fiber-optic cable serves as the backbone between head-ends. The fiber makes it possible for cable companies to deliver hundreds of channels to the feeder, which will then supply from 20–2000 homes. Advantages are high bandwidth, improved reliability and fewer amplifiers, improved picture and a platform for future services like video-on-demand, interactive services, and HDTV (high-definition television).

Fiber optics in submarines allows

for total communications along coastal regions and between continents. With fiber, submarines now have a much higher data capacity and a long distance between amplifiers. As a result, their communications systems are much more dependable.

Other applications for fiber include utilities; sensors; fiber-optic gyroscopes; remote sensing; temperature, pressure, and movement gauging; and satellite ground systems. The potential capability of fiber is boundless and is growing exponentially every day.

P

SEE WHAT TAKES SHAPE. EXERCISE.

American Heart Association 

© 1992, American Heart Association

TERRIFIC PRINTING ON THE CHEAP

Printers are one peripheral that many users pay scant attention to. Generally, as long as whatever printer you have still works, you tend to just live with it. Most printers don't get replaced until the carriage jams, or it springs a leak. If you have any doubts, take a look at any office supply catalog, and you'll see hundreds of listings for ribbons for dot-matrix printers, which passed out of mainstream usage years ago.

The time has never been better to buy a new printer. Not only are prices less expensive than ever, but features are correspondingly greater than ever. In short, your printer dollar buys you more.

We've been playing around with some of the newest models. What's encouraging is that this column will take a look at a trio of offerings, for different kinds of users, none of which costs more than \$200. At that price, you're getting excellent print quality and some other high-end features.

SOMETIMES, YOU GET WHAT YOU NEED

If it's been a while since your last printer upgrade, you're going to be pleasantly surprised at what's now available. Picking the right unit, however, is much more a matter of matching your printing needs than it used to be. The three printers we looked at for this column all cost within \$50 of each other, but are very different kinds of units.

If most of the printing you have is still monochrome, in the form of reports and letters, a laser printer may

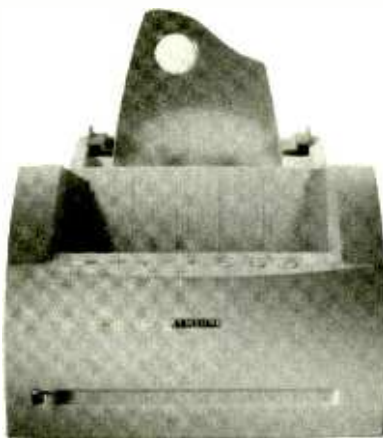

Samsung's ML-1210 is an affordable gateway to the laser printer market. Retailing at \$199, the ML-1210 features USB connectivity and true 600-dpi laser quality output

be your best choice. Lasers have traditionally been somewhat expensive, but from both a speed and cost-per-page standpoint, they offer excellent performance and value.

Now, even the purchase price has plummeted. When Brother introduced a \$300 laser printer years ago, it seemed that the printer would be pretty much the lower limit of this category. In fact, most of the laser printers introduced since, even by Brother, have cost more than this.

That's changed in the last few months. Mita introduced a \$199 laser printer last year, which quickly disappeared from the market when the company was acquired by Kyocera. Samsung was next on the market with a \$199 laser, its ML-4500. This was only on the market a few months when it was superseded by the ML-1210. Considering the \$199 retail price,

you're getting a great deal with ML-1210. Samsung rates the printer at 12 pages per minute in draft mode, and it actually spews paper just about that quickly. The previous under \$200 model was parallel only, but the ML-1210 also offers a USB port, which makes it really easy to connect. You have to install the driver through a separate install CD; and the printer will work with Windows, the Mac OS, or Linux.

PRINTERS: ONE ON ONE

Samsung's ML-1210 provides true 600-dpi laser quality and is a great value. It is not, however, the only printer in this space. Lexmark also just introduced a similarly priced and featured personal laser printer, the E-210. Unfortunately, our review unit arrived too late to include in this column.

What did arrive from Lexmark on time was the X83, also priced at \$199. We're not generally a big fan of multi-function peripherals (MFP), but the X83 may just change our mind. These units basically bundle an inkjet printer and a flatbed scanner into a single unit that has about the same footprint as just one of the peripherals. This makes an MFP an attractive choice when there's not much room, such as in a home office or a student's dorm room.

The problem comes in when the components are not anywhere as good as they would be if you bought them separately. It's sort of like the difference between buying a \$50 CD Boombox or a home audio center with a receiver and CD changer.

Lexmark's X83, to its credit, com-



LEXMARK X83

THE ALL-IN-ONE PRINT CENTER

KEY FEATURES

Color Printing

- 2400 x 1200 dpi print resolution in black and color
- Up to 12 ppm black and 6 ppm color

Color Scanning

- 600 x 1200 dpi resolution (up to 19,200 dpi enhanced)
- 48 bit flatbed scanner easily handles books, reports and more

ALL-IN-ONE SPECIFICATIONS

Printer:

Print Speeds: Up to 12 pages per minute black, 6 pages per minute color

Print Resolution: 2400 x 1200 dpi maximum resolution printing mode, 1200 x 1200 dpi high resolution mode, 600 x 600 dpi normal mode, 600 x 300 dpi draft mode

Paper Types: Plain, inkjet and photo paper, transparencies, labels, envelopes, index cards, greeting cards and iron-on transfers

Scanner:

Scanning Resolution: 600 x 1200 dpi (up to 19,200 dpi enhanced), 48 bit color (trillions of colors), 8 bit grayscale (256 levels of gray)

Copier:

Copy Speeds: 10 copies per minute black, 3 copies per minute color

Copy Quantity: 1-99 copies at one time

Zoom Range: Reductions to 25%, enlargements to 400%

BOX CONTENTS

- Lexmark™ X83 All-In-One Print Center
- High resolution color cartridge
- High resolution black cartridge
- User's guide with printer driver (CD-ROM)

Color Copying

- PC free copies up to 10 ppm black and 3 ppm color
- Reduction/enlargement capability from 25% to 400%

Faxing

- Easy scan to PC fax

Other Features:

Operating Systems: Windows 98, Win Me, and Win 2000

Drivers: X83 print driver software with cartridge ink gauge and job finishing functions (poster, booklet, duplex, n-up)

Monthly Volume: Up to 3,000 pages per month duty cycle

Connectivity: USB

Paper Handling: Input tray capacity – 100-sheet for paper, 25-sheet for transparencies, 10-sheet for envelopes; Output – 50 sheets

Paper Types: Wide range of media including envelopes, transparencies, card stock, paper labels, and papers up to 150 lbs.

Dimensions: 18.1" w x 14.2" d x 10.6" h (trays retracted) 18.1" w x 21.2" d x 12.4" h (trays extended)

Warranty: LexExpress™ one year exchange

Compliance: Energy Star



www.lexmark.com
1.800.539.6275

Lexmark and Lexmark with the diamond design are trademarks of Lexmark International, Inc. registered in the United States and/or other countries. LexExpress is a service mark of Lexmark International, Inc. All other trademarks are the property of their respective holders. Information in this document is subject to change without notice. ©2001 Lexmark International, Inc. 740 West New Circle Road, Lexington, KY 40505 Printed in the USA 5/01

X830001

Lexmark's X83 combines an inkjet printer capable of producing 2400- x 1200- dpi output on glossy photo paper, with a flatbed scanner that provides 42-bit color depth at a 600-dpi optical resolution.

Combines an excellent quality inkjet printer with a scanner of like capability. The printer can generate 2400- x 1200- dpi output on glossy photo paper, though it does take several minutes per page at this quality setting. You can also substitute a photo ink cartridge for the black ink. This gives you several additional shades of color and more photo-realistic output.

The scanner section offers 42-bit color depth and 600-dpi optical resolution. Lexmark has tightly tied the two components together so that the X83 also functions as a photocopier, even when the PC it is connected to is turned off. Copy speed, at a maximum of 10 ppm in black and 3 ppm in color, is not breathtaking. However, it sure beats having to dig up a batch of quarters for the photocopier down at the library when you need to make a copy.

Send a X83 back to school with your college students, and they may be able to cover tuition making copies for their dorm mates.

SOMETHING MORE CONVENTIONAL

If neither of the preceding printers rings your chimes, perhaps the new DeskJet 940c from Hewlett-Packard will do the trick. The DJ940c is actually the successor to HP's very popular DJ950 series. It uses the same REI technology to provide 2400- x 1200- photo-quality output on glossy paper. As with other printers in the 9XX model line, an automatic duplexer is available as an option. This fits on the rear panel of the printer and automatically flips the page after the front has been printed, so that the back of the page can be printed with no operator intervention

SOURCE INFORMATION

Hewlett-Packard Corporation
800-552-8500
www.hp.com

Lexmark
800-LEXMARK
www.lexmark.com

Samsung Electronics America
800-933-4110
www.samsung.com/usa

required. We've used this feature on other printers, and it's great if you often print brochures or other double-sided output.

HP rates the DJ940c at up to 12 ppm in monochrome and 10 ppm in color. That's for sparse pages printed in draft mode. Real-world printing goes much slower.

On the other hand, the DeskJet 940c has truly breathtaking color output reproducing digital photos on glossy paper. Plus, it doesn't need any special photo cartridges to do this. The DJ940c has both parallel and USB interfaces and comes with drivers for both Windows and the Mac OS. At only \$149, it's a terrific printer for home, small office, or student use. Our only criticism of the HP DeskJet 940c is that the warranty is only for 90 days. The warranties on the Lexmark X83 and Samsung ML-1210 printers are for a whole year.

LynX-10
HOME AUTOMATION KIT

- Software Included
- Use Existing Wiring
- Simple Inexpensive

1-800-928-5299 www.marrickltd.com

**Wireless & Electrical
Cyclopedia**

ETT1—Wireless & Electrical Cyclopedia \$4.99. Step back to the 1920's with this reprinted catalog from the Electro Importing Company. Antiquity displayed on every page with items priced as low as 3 cents. Product descriptions include: Radio components, kits, motors and dynamos, Leyden jars, hot-wire meters, carbon mikes and more. The perfect gift for a radio antique collector. To order ETT1, send \$4.99 (includes s&h) in the US and Canada to **Electronic Technology Today Inc., P.O. Box 240, Massapequa Park, NY 11762-0240.** US funds only. Use US bank check or International Money Order. Allow 6-8 weeks for delivery.

MA11

A Time-Travelers Time Line

Connecting The Philadelphia Experiment And The Montauk Project

By August 12, 1943, members of the United States Navy had finished wrapping large Tesla coils around the USS Eldridge, Navy Destroyer Escort 173, in the Philadelphia Harbor, Pennsylvania. What these men knew was that they were using the electromagnetic coils to test radar invisibility and stealth technology on ships with electric drives. By creating a rift in the time-space continuum, they planned on being able to further test and observe Einstein's Unified Field Theory (UFT) and the effects of electro-magnetic high-frequency waves on portions of the atmosphere (touched upon in last month's HAARP article). What these men did not know, nor anticipate, is that soon they would be discharged as mentally unfit, discredited, and disillusioned.

Sailing Through Time

The coils were activated, the ship and sailors aboard were engulfed in a pale haze of electromagnetic energy, and then, it all disappeared. Upon reappearance, surviving crewmembers were mentally and physically disoriented—some were burned, while others were literally soldered to the super-structure of the ship and planted into the bulkhead. Several could allegedly walk through walls; some never reappeared nor were ever seen again; and one, Duncan Cameron, jumped ship and landed in the future. Fragments of the event now remain scattered throughout the time continuum, appearing spontaneously in various places at different times. It has been leaked that classified Office of Navy Intelligence (ONI) files describe what the sailors saw and experienced first-hand. The incident was initially named Project Rainbow and ultimately renamed the Philadelphia Experiment.



All that is supposedly left of Camp Hero in Montauk, NY is this remnant of a WWII Sage-radar system used for coastal defense. The terrain of Montauk Point is an extremely rocky bluff overlooking the Atlantic Ocean. Speculators rumor that a nearby bunker leads downward into a hollowed subterranean mountain. Could this be an eastern Mt. Cheyenne?

Invisibility research began at the University of Chicago with the support of such well-known scientists as Dr. John Von Neumann and Emil Kurtenhauer. In 1933, the Institute of Advanced Studies at Princeton, New Jersey, was formed, and, in 1934, the invisibility project was relocated there. People such as Albert Einstein and John Hutchinson joined in the study, which was directed by Nicola Tesla until his resignation in 1942, though his affiliation remained strong through his inventions and ideas. Initial support came through the backing of the Massachusetts Institute of Technology (MIT), the Radio Corporation of America (RCA), and the Brookhaven National Laboratory (BNL).

Dr. John Von Neumann—a Hungarian-born mathematician who is well known as both the inventor of the modern computer and a collaborator on the Manhattan Project, which resulted in the first atomic bomb—directed the technical aspects of the Philadelphia Experiment. With particularly high

clearance, Von Neumann had access to the Nazi database of psychological research. With the conclusion of World War II, he continued to research what makes man's mind tick and why man could not be subject to interdimensional phenomena without extreme disaster.

Materializing Thoughts In The Underground

When the government would no longer support the invisibility research, the leaders went directly to the military for backing. Henceforth, Camp Hero, an abandoned and run-down Air Force Base at Montauk Point, the easternmost point on the southern fork of Long Island, NY, became the setting for many of these underground experiments, including the post-war research and tests of Von Neumann (known collectively as the Montauk Project). Von Neumann required the base particularly because it harbored a huge Sage-radar antenna, which emitted a frequency of approximately 420–470 MHz—the same frequency was believed required to enter man's conscious mind.

Eventually Von Neumann's work in the mind sciences brought results. According to speculative sources, human thoughts were being received by vacuum-tube radio receivers designed by Tesla, digitized and relayed into a computer, and stored as coded bits of information. Hardware was developed that allegedly amplified the bits of information enabling Dr. Von Neumann to hook a person up to a computer, have him/her think a thought, and create that thought into a reality—be that reality a person, place, or thing. The time-bending, history-altering possibilities were endless. It was an astonishing feat for a subject to be able to think an object into the present, but what would happen, for

instance, when a subject would think of an object yesterday?

It has been rumored that there was extensive extraterrestrial (ET) involvement in many of the secret operations and that the exchange of technology propelled the projects and furthered their growth. Using both this technology and the new-found power of manipulation, vortexes—openings in the atmosphere resembling a continuous flow of energy around an axis, also known as wormholes—were created in order to simultaneously link different times lines. This would prove critical in the connection between the Philadelphia Experiment and the Phoenix Project—one of the most important divisions of the Montauk Project.

Unleash The Beast

Dr. James F. Corum was utilizing Tesla's Egg of Columbus—an 1893 Chicago Columbian Exposition demonstration explaining the principle of the rotating magnetic field and the induction motor—while others at Montauk were preparing for the second major UFT experiment, both in hopes of replicating and improving the results of radar invisibility previously tested in the Philadelphia Harbor.

On August 12, 1983, exactly 40 years after the Philadelphia Experiment, a vortex was opened that linked the two time lines. However, the generator that was energizing the Tesla coils on the USS Eldridge prohibited the vortex from shutting—the outcome of which would have been complete devastation. Duncan Cameron—the sailor who jumped ship—and his brother, Ed Cameron, both Navy liaisons in the experiment, were convinced to go back in time to the USS Eldridge and destroy the generator keeping the vortex open and the ship in hyperspace.

These two experiments supposedly left an invisible temporal axis (or tunnel through time) in the Navy exercise space connecting the Philadelphia Harbor and Montauk Point. When some of the participants realized the dubious consequences of continuing with this line of experimentation, they conspired on a plan to halt activity. In late August, Duncan got hooked-up and was programmed to unleash an indescribable beast from his subconscious, which manifested, ravaged the laboratory, and literally destroyed the project. Afterwards, there was a series of major



Now that's a circuit breaker assembly! This photo was taken inside the radar tower at Montauk. The two modules at the lower right appear to be power supplies. A bare rack seems to be loaded with cables that once connected to numerous modules. The abandoned site suffers greatly from disrepair and pillaging.

debriefings and inevitable brainwashing.

Sightings And Speculations

Other projects continue, and there have been numerous reports of sightings at Camp Hero—people, suspicious construction on an “abandoned” site, and colored aurora-borealis-like streaks of light through the air. Many people feel that Camp Hero and the grounds surrounding it are shrouded in mystery and subterfuge. In a Web article by Jonathan Kosticky, he stated that Camp Hero, commissioned by the U.S. Army in 1942 (though some believe it was earlier), is considered to be one of the most valuable Cold War era artifacts. Its history of ownership is quite scandalous, considering that it was donated to New York State as a public park, while private areas have been retained and marked off by fences. Some land has been developed, and there are people who live within the outer boundaries. There has been discussion whether or not to continue development, though most of the land and water is polluted and contaminated. Many want to see the area restored, especially the 120-foot wide, 70-ton antenna, while many others want to see it just left alone to crumble under the weight of its own past.

What The Government Believes

The only information to be found on the official Navy Web site (www.navy.mil) is denial of supernatural occurrences. The Navy acknowledges that the allegations about the destroyer—that it was made invisible and teleported from Philadelphia Harbor to Norfolk, Virginia—do exist, though after extensive investigation of the Records in the Operational Archives Branch of the

Naval Historical Center, neither confirmation of the events nor naval interest has been found. The Web site gives the log of the USS Eldridge and states that it was never in the Philadelphia Harbor. It also gives the log of the SS Andrew Furuseth, whose crew supposedly observed the Eldridge in Norfolk, and states that the two ships were never in Norfolk at the same time. While the Navy does affirm that Einstein was a Bureau of Ordinance consultant, it disputes that Einstein's UFT was ever completed and that he was involved in researching invisibility and teleportation. Degaussing—wrapping electrical cables around a ship and sending currents through—was used to cancel out a ship's magnetic field, therefore making it invisible to the sensors of magnetic mines. However, the Navy disagrees that doing so made ships invisible to the human eye, radar, or underwater acoustic sensors.

Now This Is A Night Job

There are three significant men—Preston Nichols, Al Bielek (Ed Cameron), and Duncan Cameron—associated with the Montauk Project, two of whom—the Cameron brothers—are also connected with the Philadelphia Experiment. Other people played important roles in the development of the projects, such as Phil Schneider, an ex-government engineer involved in the building of underground bases and extraterrestrial intelligence experiments. The majority of the people connected to these covert operations claimed to have been brainwashed and robbed of their memories and some, such as Phil Schneider, are no longer alive.

Al Bielek was born Edward A. Cameron II, son of Alexander Duncan Cameron, Sr. and brother of Duncan Cameron, in 1916. The Cameron brothers were raised on Long Island and followed in the footsteps of their father by joining the Navy. After completing training for “Special Assignment” Navy personnel, they were assigned to the Institute of Advanced Studies at Princeton and worked on the invisibility study already underway. Ed and Duncan remained involved in the project through its completion and were on the USS Eldridge on August 12, 1943. After the ship returned to harbor, Duncan was never heard from again and Ed married, had a son, and transferred to Los Alamos, New Mexico. There, he was

arrested, charged with espionage—all charges were subsequently dropped—and transferred to Washington D.C. He never saw his family again.

Ed was washed of his memory, time-shifted, and placed with a family under the new identity of Al Bielek. Drafted into the Navy, he got a degree as an electrical engineer from the Newark College of Engineering and worked in that profession until 1998. He continued to work at Montauk with Duncan, who had stepped from the Eldridge to Montauk, without realizing their previous connection. Over time his (i.e. *Al's/Ed's—are we following this folks—Editor*) memories began to flood his consciousness, and he has spent recent years researching and speaking out. Duncan has what is considered “Swiss-cheese memory,” meaning that there are many holes in his memory. While specifics remain in darkness, he does remember being aboard the USS Eldridge and being a part of the projects at Montauk.

Preston Nichols was born in 1946 and grew up on Long Island. He received degrees in parapsychology, psychology, and electrical engineering. Going into Defense Electronics, he worked at both the Brookhaven National Laboratory (BNL) and the Airborn Instrument Laboratories (AIL)—a major Long Island military contractor previously run by the Eaton Corporations, but as of 1988, by the Department of Defense. According to Nichols, there are three branches of AIL—covert, commercial, and defense—with locations in such places as Farmingdale and Deer Park. Preston began his involvement with Montauk in 1968, specifically with the psychic aspects. He worked with Al on the chair used when interfacing the mind to a computer.

Siskel And Ebert Give...

Different entertainment outlets have tapped into the large market for sci-fi innuendo. The question you have to ask yourself is, what came first—the fact or the fiction? Are these people taking shreds of reality and turning them into fiction, or vice versa? Many skeptics (including those who also refuse to accept that there could be some truth behind the secret conspiracies of the government, military, and scientific technicians) simply dismiss all discussions of this sort as conspiracy-burdened

Sci-Fi. They are the people who turn to Hollywood, animation, and creation to find solace in the thought that what they see and hear is nothing more than someone's imagination. Still, other scientific skeptics (*like the majority of our readers—Editor*) would gladly adopt any theory under one simple condition—hard scientific proof based on correct facts. A string of allegations, rumors, and anecdotes does not make a scientific study.

While skeptics and believers duke it out, the media is reaping the spoils. Fox is currently in its fifth season of the show *Sliders*. Imagine yourself being able to slide through portholes and end up in parallel universes where the date is the same, you are the same, but everything else as you know it is different. The Sci-Fi channel shows re-runs of *Quantum Leap*, based on the principle of stepping into an accelerator and being able to travel back in time.

Sony Entertainment delivered the movie *Men In Black* to theaters across the world. With the ability to wipe out memories and create new ones with the push of a button (sound familiar?) and the cooperation of friendly aliens (wink, wink), two agents were able to monitor the immigration and emigration of extraterrestrial beings on Earth. In 1984 the *Philadelphia Experiment* was released as a movie, documenting the materialization and occurrence of the extraordinary disappearance and reappearance of the USS Eldridge and its crew.

There is an entire series of books (Sky Books publications) written by Preston Nichols with Peter Moon about the Montauk Project and related subjects—connections to other projects, people, and worlds. Other books are on the market, either focusing on the two projects or commenting on them. A plethora of Web sties can be found with interviews, photographs, and updated information.

Reprise: Strange Encounters

I recently met with Preston Nichols to gather and review information. Elaborating on the mechanics of the mind-alteration device that was built, he described how the vortex formed at the center of a particle accelerator and that a delta antenna surrounded the accelerator in a diamond-like configuration. He believes, through personal research, that there is still underground activity out at Montauk. Outfitting a small school bus with radio antennas, control boards, and

other needed equipment, he monitors such frequencies as those at the point and other FAA HAARP-like structures similar to the one in the Pine Barrens. Last summer he picked up frequencies of 400–435 megahertz at the point, a frequency used only by the military or aircraft. Considering the known locations of both on the island that are currently active, there is no reason for that frequency to be transmitted at that location.

Construction has taken place to expand the dilapidated underground lab; and where once there were six levels of operation, there are now eight. In the early '90s, large ten-foot squares of rock appeared at Montauk Point. When Preston and Peter Moon researched the occurrence, they found three possible answers, only one of which they found believable. The first theory was that a barge brought them in; unfortunately, there wasn't enough water to support a shipment of that capacity. Second was that they were brought in by truck, but when the two questioned people in the area, not a single witness could be found to support it. Finally, they found eyewitnesses that said that the earth practically opened up and the rocks were pushed out. Preston believes that they were cut from the ground to form the 7th and 8th layers and brought to the surface. When asked about the argument that construction isn't possible that far down because of the aquifer lining Long Island, he simply remarked that cement was a beautiful thing. On a similar note, when questioned about the controversy of ownership, Preston informed me that while the land is in fact state park land, their land rights only include the top two feet of land. The land beneath that is privately owned.

Preston continues to talk out, along with Al Bielek, Duncan Cameron, Stewart Swerdlow—one of the programmers of the Montauk boys—and others. As time continues, more information comes out, the holes fill in, and memories are completed. While many questions find answers, the mystery continues to intrigue. Every day there are more questions, some of which may never have answers. Whether you believe in these incredible occurrences or not, ask yourself do you believe in their possibility? What do you think? After all, it only takes one person's thought to change reality. P

NEW LITERATURE

Ham Radio Operator's Guide, Second Edition

by Carl Bergquist
 Sam's Technical Publishing
 5436 W. 78th St.
 Indianapolis, IN 46268
 800-428-7267
 www.samswebsite.com

\$29.95

In the past, it was more difficult to operate your own radio frequency. Now, with the FCC No-Code—Morse code, that is—Technician class, amateur radio operation has become a new favorite pastime. Explore sample test questions, on-air operations, and updated license requirements with this book, which is written from the point-of-view of a novice, while engaging the experienced mind. Learn about clubs, jargon, etiquette, and more.



Understanding The Linux Kernel

by Danile P. Bovet & Marco Cesate
 O'Reilly and Associates, Inc.
 101 Morris St.
 Sebastopol, CA 95472
 800-998-9938 or 707-829-0515
 www.oreilly.com

\$39.95

Take a guided tour through the Linux kernel and learn about maximizing efficiency, performing unusual applications, and the source code. Topics covered that are familiar to Unix programmers and users range from memory management and the Virtual and Second Extended Filesystem to inter-process communication (IPC) and program execution. Ways to become a true Linux hacker are outlined here.

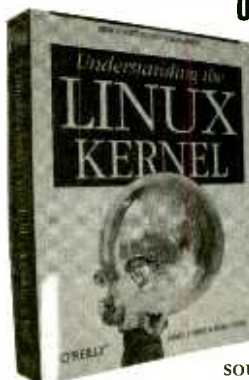

Antenna Zoning For The Radio Amateur

by Fred Hopengarten,
 K1VR
 ARRL
 225 Maia St.
 Newington, CT 06661
 888-277-5289
 or 860-524-0200
 www.ARRL.com

\$49.95

Throughout the years Ham radio operators have been shut down by legislation, regulation, and even war. Don't let today's ordinances, or intrusive neighbors, keep you from your passion. This book suggests techniques and strategies that Hams, or attorneys, can use to obtain an antenna-structure permit. Preparing you for what sorts of trouble you may encounter, the book guides you through the process of achieving your radio goals. There is even a section on regulation in Canada.



The Inventor's Notebook, Third Edition

by Fred Grissom & David Pressman
 Nolo
 950 Parker St.
 Berkeley, CA 94710-2524
 510-549-1976
 www.nolo.com

\$24.95

Inventors, educators, business advisors, and even attorneys can use this book to learn how to better organize the invention process and secure legal control of ideas. From documenting and evaluating development to assessing potential, necessary capital, and confident contacts, this book pays close attention to the details that make the difference. Be prepared to address the critical issues between you and your patent.



Comprehensive Programmable Power Supply Catalog

Sorensen
 9250 Brown Deer Rd.
 San Diego, CA 92121-2294
 800-525-2024
 www.sorensen.com

Free

This product catalog features the company's line of DC manual and programmable power supplies and electronic loads. The 56-page color catalog is a quick-reference guide, complete with product description and selection information, technical references, and custom services. Both individuals and dealers will find its contents useful.

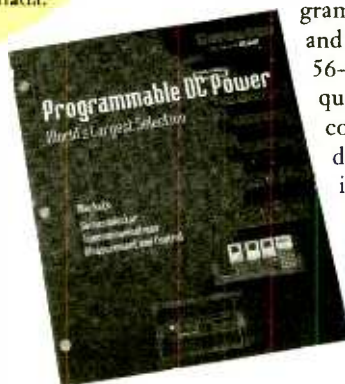

Fall 2001 Skyvision Catalog

Skyvision

1010 North Frontier Dr.
Fergus Falls, MN 56537-1023

800-500-9275

www.skyvision.com

Free

This catalog offers all the products anyone needs for satellite TV installation. It features big and small dish systems and parts, as well as tools, accessories, and books. Handy tech tips are scattered throughout the catalog. The company also provides replacement manuals for all kinds of analog and digital satellite TV equipment.



Programming Linux Games

Loki Software, Inc. with John R. Hall

No Starch Press

555 De Haro St., Suite 250

San Francisco, CA 94107

415-863-9900

www.nostarch.com

\$39.95



Whether you are a beginner or an expert, if you know that variety and innovation are the keys to successful computer game development and want to improve your ability to play and invent challenging Linux games, this comprehensive guide will take you through the process. Readers learn how to use Simple DirectMedia Layer (SDL) and gaming APIs, how to play sound effects and music, how to distribute their own game to the Linux community, and much more.

Mural Collection Brochure

Leviton

Manufacturing Co., Inc.

59-25 Little Neck Pkwy.

Little Neck, NY 11362-2591

800-323-8920

www.leviton.com

Free

This brochure showcases the company's line of residential grade Decora-style Mural Dimmers. Features and benefits for all models, along with applications,



ratings, and availability are all detailed within the pages. The models can be mixed and matched in order to create the perfect lighting ambiance specific to each individual's tastes.

USB Complete, Second Edition

by Jan Axelson

Lakeview Research

5310 Chinook Ln.

Madison, WI 53704

608-241-5824

www.Lvr.com

\$49.95

This second edition expands USB knowledge by teaching the four transfer types and three speeds of computer peripheral interfacing. Explaining what developers need to know about version 2.0 specifications and its new speed of 480 Megabits per second, the book also teaches about current controller chips and development tools. There is also information on device testing and how to debug application software and device firmware.

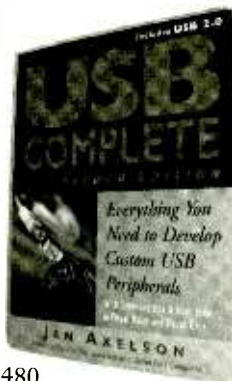

The Ultimate History Of Video Games

by Steven L. Kent

Prima Communications, Inc.

3000 Lava Ridge Court

Roseville, CA 95661

916-787-6972

www.primapub.com

\$18.95

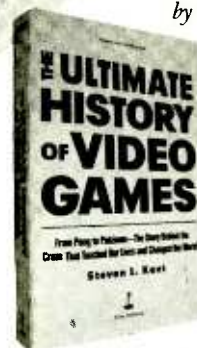

Journey through an era, which commenced with Atari, is currently infatuated with Sony Playstation2, and is guessing what the future will bring. Chronicling the passage of power from Pac-Man to Pokemon, this book divulges the inside secrets of electronic entertainment. There are interviews with the designers, programmers, and industry giants; insight into recent developments; and anecdotes on some of your favorite joystick-operated games.

Talk to the World for FREE!

JOHN CARTER AND JAMES HEIDENREICH

Some of the most rewarding construction projects center around communications. Whether it's a Ham transceiver or a fancy laser-based optical receiver, people like to build things that help them communicate. This article will lay out the plans for two unique devices: the *EchoBuster* and the *iPatcher*. Both of these devices can be used together to interface an ordinary telephone with your favorite Internet Talk application.

Choosing Your VoIP.

You're in for a real treat if you haven't tried any of the new Internet Talk applications. This is especially true if you've been paying through the nose to talk to a friend or relative for an extended period of time over the dial-up network here in the U.S. Those phone bills can be horrendous, no matter which long-distance carrier you use! If your friend or relative is in a foreign country, it gets compounded exponentially! Read on to find out how to drastically cut those costs and add some exciting features, instead of just simply talking one-on-one.

The fancy name for this new technology is Voice over the Internet Protocol (VoIP), and it has been around for many years. The first attempts to pass speech over the Internet left a lot to be desired, and only the truly dedicated technical people were willing to wade through the problems. We have seen considerable improvement in the voice quality and ease of use with each new software release, and some really exciting things are beginning to happen. Our Web site at www.jechtech.com/internet_talk.htm has links to many of these applications that will save you a lot of money on your telephone bills.

Each application uses its own proprietary algorithms to pass the audio over the Internet, and they each have their own unique set of features. They require

both ends to be using their software, so anyone you want to converse with must be running the same program. You should try several applications to see which one best meets your needs. All of the applications we've tried have varying degrees of help available to new users. The ones offering conference calls (a feature where numerous people are on the same call from different lines simultaneously) have special forums set up where there are volunteer users ready to help newcomers learn how to use the application. Imagine having someone in Sydney, Australia help you set up your latest talk application feature! It's amazing and we can only wonder what the future holds!

Our favorite PC-to-PC application is *Securi-Phone*

(www.securiphone.com/english). It has instant messaging (this lets you type messages and URLs back and forth) and file

transfer while you're talking, which lets you exchange pictures, MP3 files, or basically anything in digital format with the person you're talking with! The instant-messaging and file-transfer utilities also encrypt everything automatically, so all calls, messages, and files are handled securely. It also has a very small footprint of only half a megabyte and is very RAM efficient. If you are concerned about your privacy, then *SecuriPhone* is the product for you. *SecuriPhone* offers a trial before

you buy the program that can be downloaded for free. My mother and sister have cut their phone bills drastically by using *Securi-Phone*, since they talk at

least a half an hour every single day! Plus, they can swap pictures while they're talking! If you try *SecuriPhone*, add me to your contacts list so we can chat (my User ID# is 42350).

A Brief History. Early PC-to-PC applications typically cost a one-time fee of around \$50 and worked reasonably well, if you had the patience to set them up. The initial players were *iPhone* from Vocaltec and



***Let the EchoBuster and the iPatcher
be your link to free communication.***

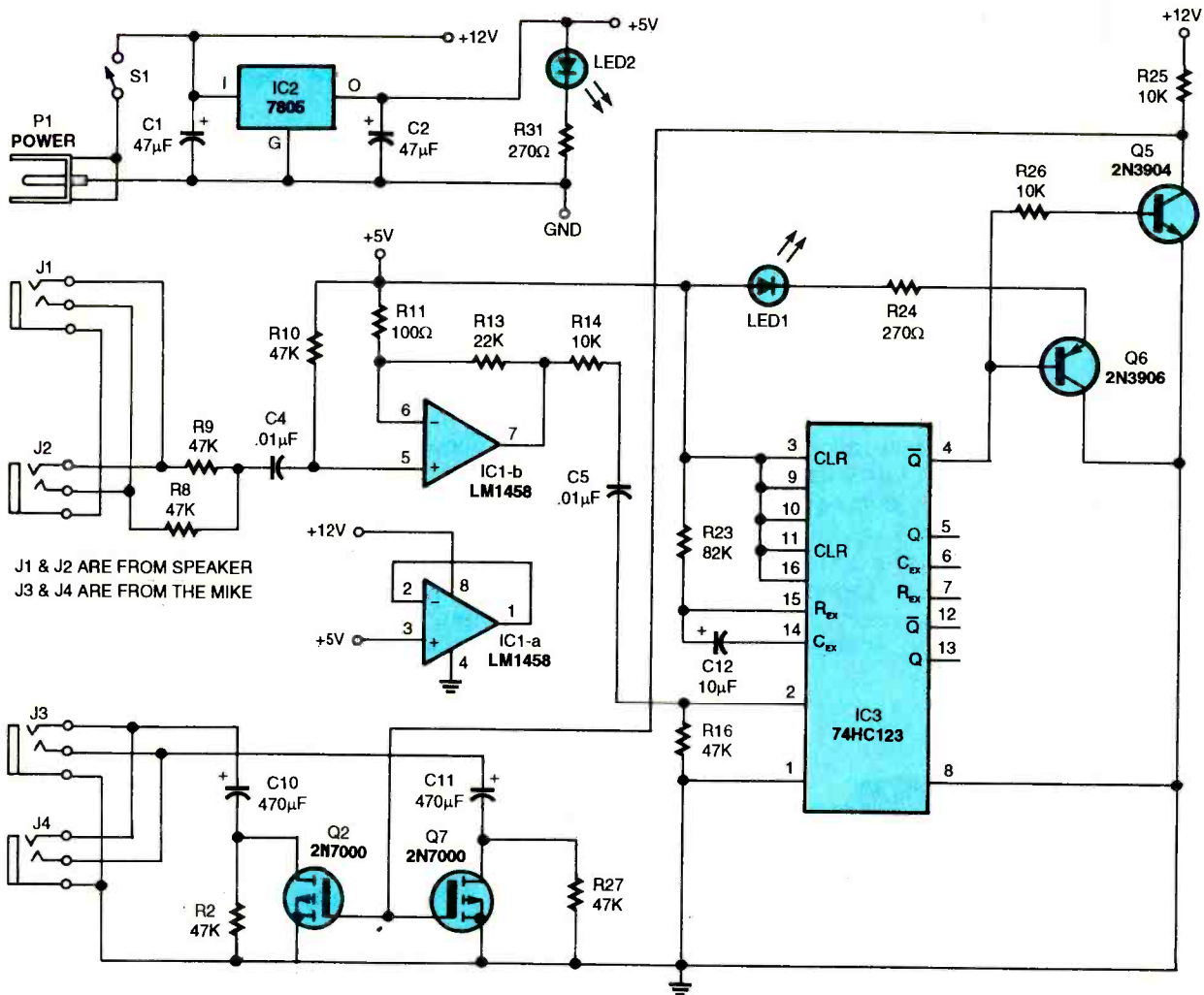

Fig. 1. This is the EchoBuster schematic diagram. Two chips are incorporated into the design; an LM1458 dual op-amp, and a 74HC123 dual retriggerable monostable multivibrator.

WebPhone from NetSpeak, along with some others that didn't capture much of the market. These applications saved their users literally thousands of dollars in toll charges. As of April 2001, there are many free PC-to-PC applications that are quickly gaining market share.

Initially, software and hardware problems made the audio quality poor, since it was sometimes choppy and unreliable. Faster servers, more bandwidth, and more efficient voice-coding algorithms were needed to speed things up. The software and hardware gurus have been hard at work on this; and improvements are being made daily, to the point where now even the most run-of-the-mill applications are getting very useable results. The audio will improve as the technology and the Internet evolves; and, since it is free, it really does deserve a try.

Second Applications. The next type of application for VoIP is the PC-to-Phone call. These applications allow you to call any standard telephone (USA and Canada) from your PC. Some even provide for international calls! The prominent player here is *DialPad*, with over 13 million subscribers and counting! They offer their service for free, and their banner advertisers pick up the tab. Some offer their service for a small per-minute fee instead of using advertising. Again, our Web site has the details. These applications are not fully developed yet because of bandwidth issues. Sometimes you can have a perfect conversation approaching true telephone quality, and other times it leaves a lot to be desired. However, it's free, so you're not out anything but your time. It's definitely worth looking into if the person

you want to talk with doesn't have a computer.

System Requirements. Each of these applications specifies what their minimum system requirements are for successful operation. Although they vary slightly, they all use the same basic technology and work with the same variables, so we can come up with a "generic" minimum as a starting point. The first consideration is the microprocessor speed, and the bogey here seems to be 166 Megahertz. So, if your computer isn't at least that speed, you will probably have less than acceptable results. The reason is quite simple. If it's not that fast, it simply cannot handle the "real time" flow of ones and zeros and put them back together in the form of an analog audio signal for you to hear and be heard. A good rule

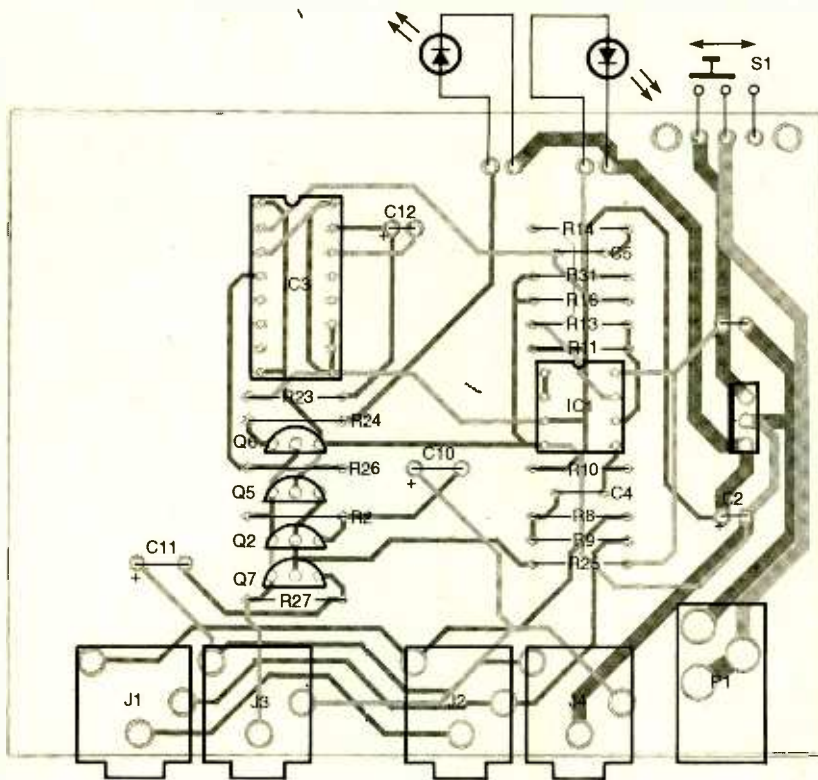

Fig. 2. Here's the parts placement diagram for the EchoBuster. Patience and a steady hand are required for soldering the components to the board.

of thumb for microprocessor speed for nearly all PC applications would be the faster, the better.

Next, your system needs to have a sound card. This takes all of those digital ones and zeros and converts them into an analog audio signal that comes out of your speakers. Conversely, it takes the analog signal generated by the microphone and converts it into the digital signal used by the computer. The standard here seems to be SoundBlaster; and if the specifications of your system state that their sound card is SoundBlaster compatible, you're OK.

Last, but not least, you need a modem. You folks with DSL or cable modems are home-free here, since their speeds are more than adequate. People on a Local Area Network (LAN) are in good shape as well, although there may be some firewall issues you have to deal with. Those of us stuck with the garden-variety dial-up modems need to take a closer look. A minimum connection speed of 28.8 Kilobytes per second seems to be good enough for normal-voice communications. If you're not sure

what your connection speed is, simply try the application and see how it works. Luckily for us, nearly all of the package systems sold today are multimedia machines and meet all of the above requirements right out of the box!

The Echo Problem. What do we mean by echo? User 1 talks into his microphone, which is sent over the Internet to User 2. User 1's voice (coming out of User 2's speakers) is picked up by 2's microphone and sent back to User 1. Hence, echo; and it can be very confusing to someone hearing it for the first time. Internet congestion adds some interesting effects (in the form of delay) on top of the echo as well, so suffice it to say, echo is bad and should be avoided.

To avoid this problem, most of these applications typically default to push-to-talk (PTT) operation similar to two-way radio. In the PTT mode, the microphone is muted when you're not "keying" it. Typically, they use either the space bar, CTRL key, or a function key as the PTT button. However, many of these applications have what is

called "hands-free" or "speakerphone" option so you don't have to hit any push-to-talk key. All you do is talk, and the software activates it for you automatically. It then becomes a vox (voice operated switch) type of operation, and it works quite well as long as you can deal with the dreaded echo problem.

Another solution to this echo problem is to use a headset or a handset, which doesn't allow the sound to get coupled back into the microphone. They both work well, but are somewhat restricting. Most people would much prefer to use their normal speakers and microphone instead. This is especially true if you want to have the whole family listen in during the conversation. So, if you use the application in the vox-mode with your speakers and microphone, you will soon see the effects of echo! If you have the volume set low enough or if you place the speakers far enough away from the microphone so the sound won't activate the vox, you can probably get by. It's a fine line at this point. Our solution is a device we call the *EchoBuster*. As the name implies, it fixes the echo problem by muting the microphone when there's audio coming out of the speakers. Refer to the *EchoBuster* section for more details on how to build your own.

Walk And Talk. OK, so now we've dealt with the basic problem of echo, but what if you'd like to get up and move to your easy chair during a conversation? If your easy chair is in the same room, all you do is turn up the volume a bit, get an extension cable for the microphone, and you're in business. If your easy chair is in a different room however, or you'd like to chat from the patio, you need to re-think it.

This is where the *iPatcher Internet Telephone Adapter* comes in. It does two basic things for your Internet Telephone experience. First, it deals with the echo problem by incorporating the echo-busting feature mentioned earlier, plus it lets you connect a dedicated telephone to your computer sound card. By "dedicated" we mean

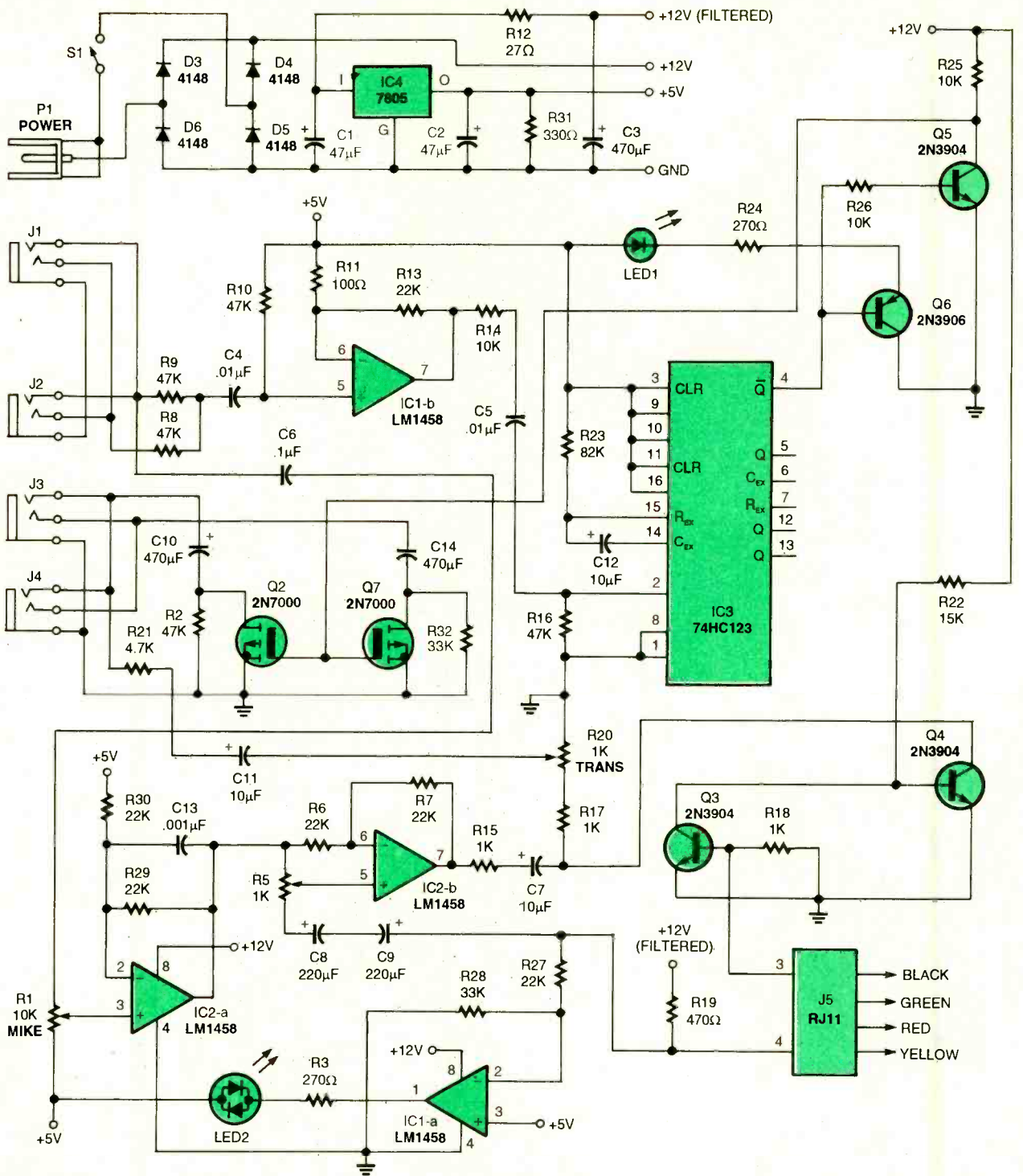

Fig. 3. This is the schematic for the iPatcher circuit. Notice the four-diode voltage-blocking circuit leading to voltage regulator IC4. A careful eye can see the EchoBuster circuitry is nested within the iPatcher.

that the phone will work only with the iPatcher and should NOT be connected to the regular telephone network. Note that this can be a cordless telephone that will allow you to roam around once the call is established. The reason we specify the phone must be dedicated to the iPatcher is because the FCC Rules (Part 68)

require certification of ANY device connected to the dial network. This certification can cost upwards of three to five thousand dollars—a sum we simply can't afford, hence, the disclaimer. If you want to use the phone on a regular phone line, simply unplug it from the iPatcher and plug it into your regular phone line receptacle (RJ-11 jack).

You can use a standard wired telephone with the iPatcher, as well as a cordless. Let's say you like talking to folks from one particular easy chair. It's convenient and familiar. So, you simply run a line from the iPatcher to your easy chair and connect up one of those cheap, corded telephones from Radio-Shack (part number 43-908). You

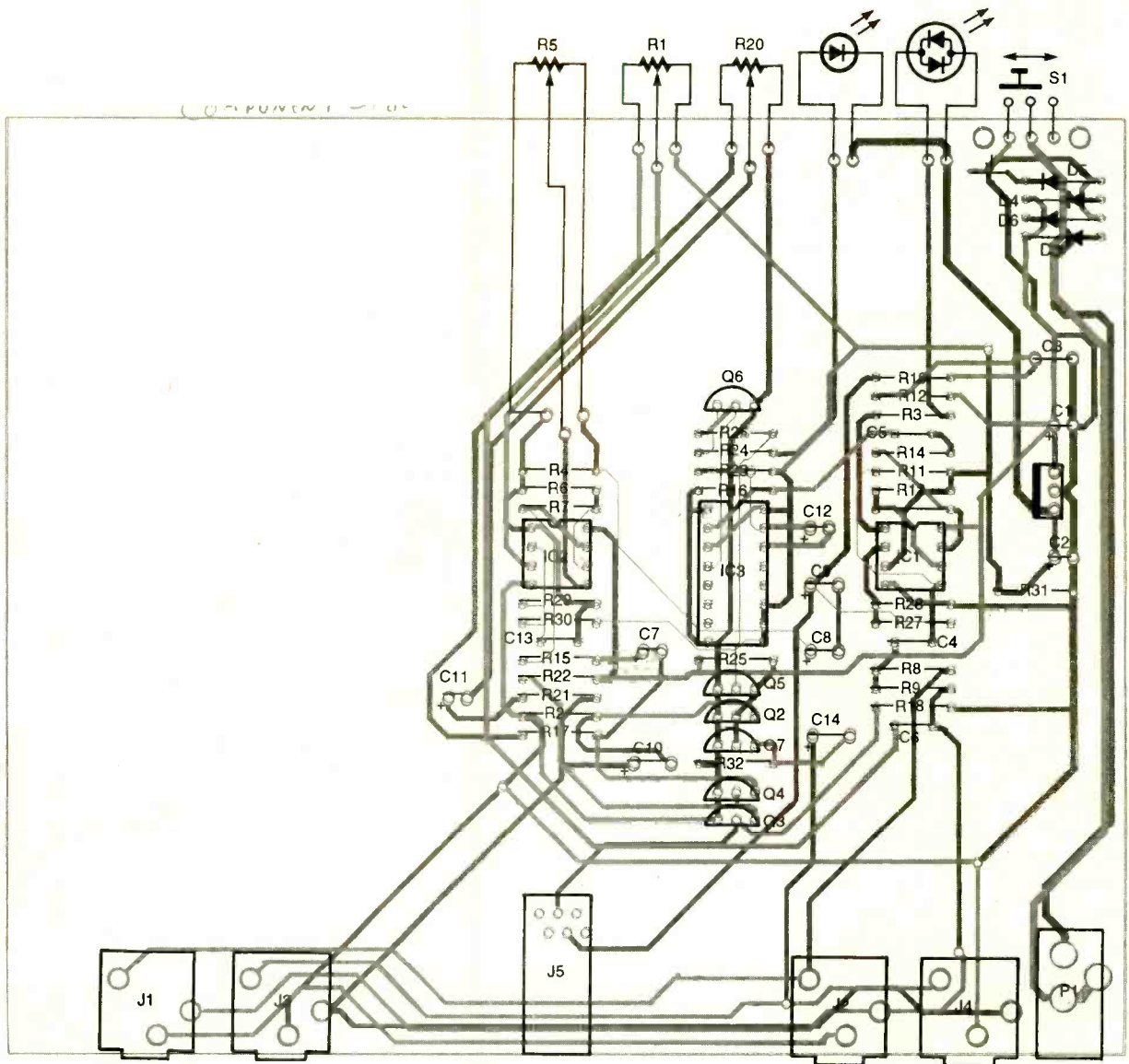

Fig. 4. Here is the parts placement for the iPatcher. Connector J5 is a standard RJ11 telephone jack.

must first establish the call from your computer, but once you've got them on line, simply say, "I'm going to my easy chair," and continue talking from there. Don't forget to hang up the call on your computer when you're finished.

As a side benefit, the iPatcher brings the speaker/mike jacks out from behind your computer to give you easy access for changing external speakers and microphones. Plug standard-patch cables into the sound card once and forget it. Sorry, that does mean bending over your computer one last time with a flashlight to make the initial connections, but you are home-free after that. Refer to the iPatcher section for details on how to build your own.

EchoBuster Theory Of Operation.

The EchoBuster achieves echo suppression by detecting audio on either the left or right speaker leads and then shunts the microphone signal to ground. To avoid chopping, due to audio peaks, a one-shot timer IC3-a (R23 and C12 determine the hold-off time) maintains this shunt for about 0.8 seconds after the last detected audio peak.

The regulator (IC2) and associated parts deliver a highly filtered 12 volts (+12 on the schematic) and 5 volts for the EchoBuster's electronics (see Fig. 1). The loop-through jacks (J1 and J2) couple the audio into an amplifier IC1b that amplifies the signal level to a point where

the triggering level of the one-shot timer, IC3, can occur. When the one-shot triggers, yellow LED1 illuminates, and amplifier Q5 drives the gates of the N-channel MOSFET microphone-shunting transistors Q2 and Q7. When the gates become high, the source-to-drain resistance of Q2 and Q7 becomes very low, which shunts the AC microphone signal at J3 and J4 to ground. Thus, received audio removes the microphone's signal and the echo caused by it. When the one-shot timer is not triggered, Q2 and Q7 look like an open circuit to the microphone signal.

Keep in mind that you should be using a stereo microphone plug with the EchoBuster. If you use a

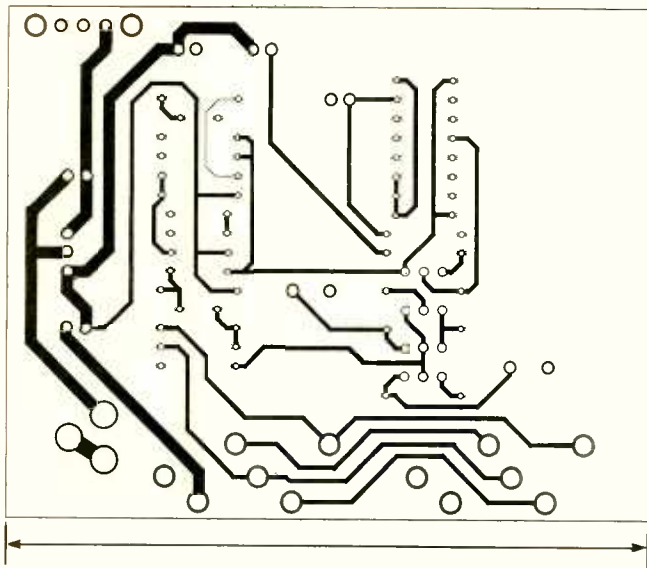

Fig. 5. This is a solder trace diagram for the EchoBuster's "solder side."

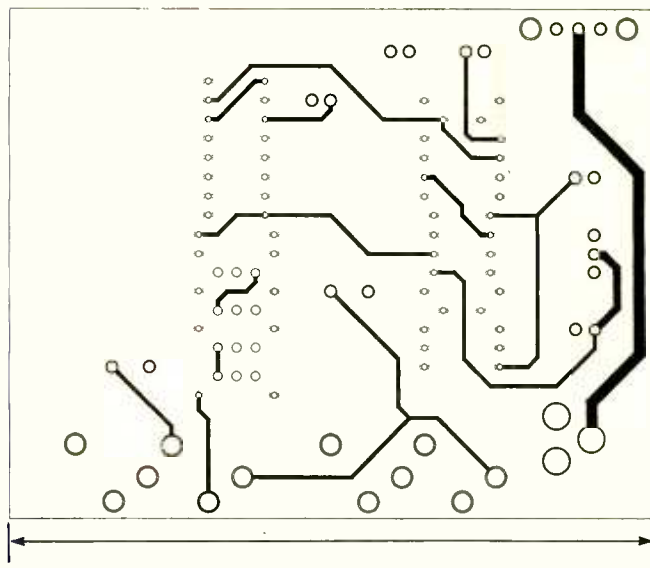

Fig. 6. This solder trace diagram shows the trace on the component side of the EchoBuster.

microphone with a mono jack on it, it will short the whole microphone circuitry to ground due to the way it is configured. A stereo plug has three contacts (tip, ring, and sleeve), while a mono plug has just the tip and sleeve contacts.

EchoBuster Construction. The parts layout for the EchoBuster is not critical. You can use standard perf board to build your own or you can order a printed circuit board from our Web page. Either way, use normal soldering and construction techniques to insure you have the proper components installed and that there are no solder bridges or wiring overlaps. Refer to Fig. 1 and Fig. 2 to insure you have everything laid out properly. If you want to make your PC boards for this project, you can download the plot files for the top and bottom of the board. The top is at www.jechtech.com/echo-top.pdf, and the bottom is at www.jechtech.com/echo-bottom.pdf. Figures 5 and 6 are the foil patterns for the solder side and component side, respectively. You can get the Acrobat Reader 5 for free from <http://www.adobe.com/products/acrobat/readstep2.html>.

Once you have the unit wired, you should do some preliminary testing. Plug in the AC adaptor (12 V_{DC} at 200 mA). Switch the power switch to the "ON" position. The green power LED should come on,

and you may or may not see the yellow (Mute) LED flash on power-up. Measure the input voltage at pin 1 of Q1 to make sure it falls in the range of between +12–18-volts DC as measured to ground. Now, check the output of the regulator Q1 to make sure it is +5 V_{DC} as measured to ground.

Speakers. Make sure the jacks are firmly plugged into their respective jacks, since it will not work properly if they are not fully seated. Again, make sure your microphone has a stereo-type jack (tip, ring, and sleeve) and NOT a mono (tip and sleeve only) jack. Now, run your Internet Talk Application for further testing. First, observe the yellow (Mute) LED. It should light when there is audio coming out of your speakers. If it doesn't light up, then increase the level of the audio coming out of the sound card by going to your Playback mixer-control panel and moving the slider up. We are assuming you are using amplified speakers, which have a volume control on them as well. So, in order to keep the volume at a comfortable level, you may have to turn the speaker volume down to compensate for the increased input level.

If the yellow LED stays on either all the time or nearly all the time, then you should back the sound card output down. What we're looking for is the light to come on

PARTS LIST FOR THE ECHOBUSTER

SEMICONDUCTORS

- IC1—LM1458 dual op-amp
- IC2—7805 voltage regulator
- IC3—74HC123 dual op-amp
- LED1—Light-emitting diode, yellow
- LED2—Light-emitting diode, green
- Q2, Q7—2N7000 FET
- Q5—2N3904 NPN transistor
- Q6—2N3906 PNP transistor

RESISTORS

- (All resistors are 1/4-watt, 5% carbon-film units.)
- R2, R8–10, R16, R27—47,000 ohms
 - R11—100 ohms
 - R13—22,000 ohms
 - R14—10,000 ohms
 - R23—82,000 ohms
 - R24, R31—270 ohms
 - R25, R26—10,000 ohms

CAPACITORS

- C1, C2—47 μF, electrolytic
- C4, C5—.01 μF
- C10, C11—470 μF
- C12—10 μF, electrolytic

ADDITIONAL PARTS AND MATERIALS

- J1–J4—1/2-inch stereo jack (Mouser 1613507)
- S1—Power switch (Digi-Key EG1917)
- Power pack (12 VDC/200 mA); two (2) interconnect cables 1/2-inch stereo on each end; case with front and rear panels

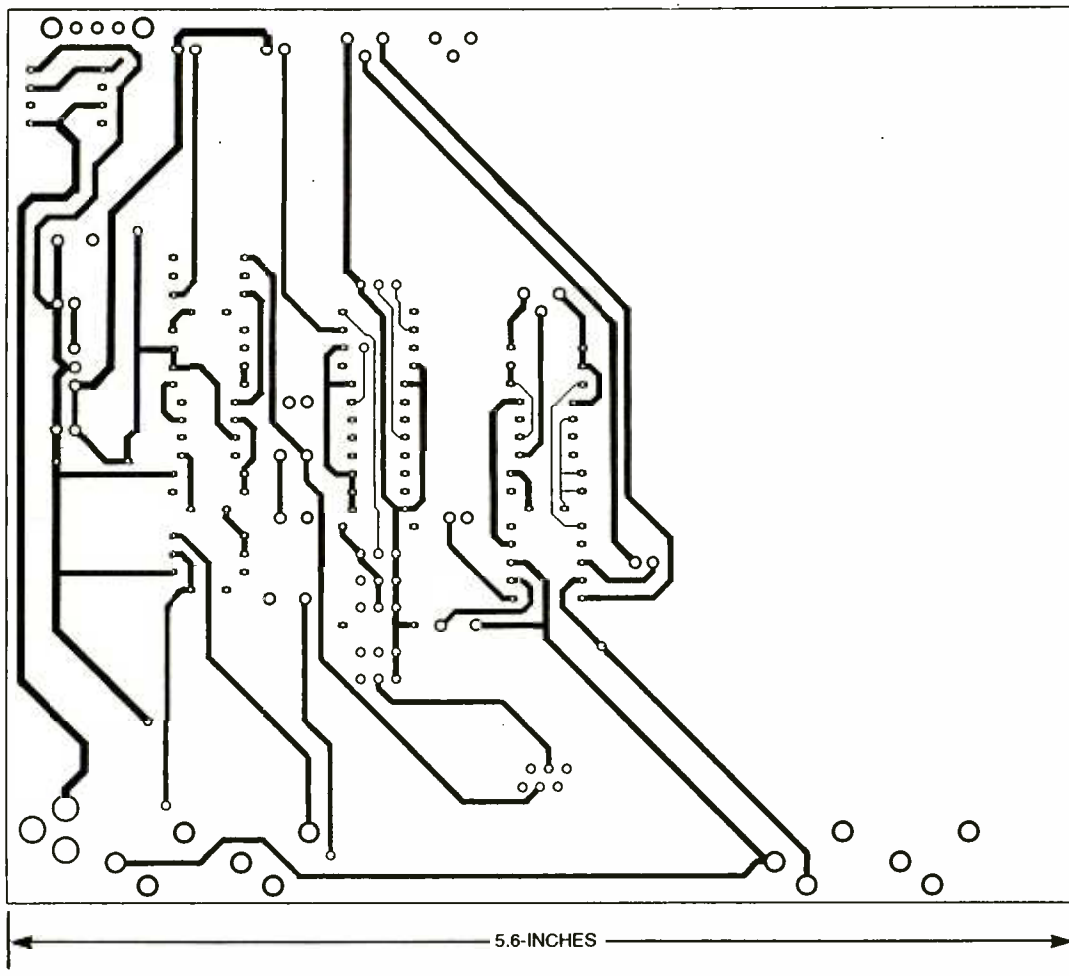

Fig. 7. The iPatcher's "solder side" trace is shown above.

only when there is audio coming out of the speakers. It should go out when there is no audio there. You should be able to reach a good compromise between the sound card output level and a comfortable listening level using these two level controls.

Now you need to configure the microphone using the Record Control Panel of Windows. Double-click on the small, yellow speaker icon in your task bar at the bottom of your screen. This should bring up the Play Control Panel with the various audio controls. Make sure there is a check mark in the MUTE box at the bottom of the microphone control. Without a check mark in this box, any audio going into the microphone will automatically come out of the speakers like a karaoke machine, and that is not what we want to happen. Set the microphone level slider up to about 75% of full scale.

While you're there, click on the Advance button of the microphone and make sure there is a check mark in the Mike Boost (20 db) box.

If you don't have the small, yellow speaker icon on your task bar, you can find the control panel by going to the Windows START function in the task bar (lower-left side of the screen).

If you are still unable to find it, consult your sound card documentation to find out how to access these controls.

When the yellow (Mute) LED is on, that means the microphone is being effectively shut off so that it can not pick up the audio and send it back down the microphone lead to your sound card which ends the echo problem. Keep in mind that while the Mute light is on anything you say into the microphone will NOT be sent out since it is muted. It won't take long to get the hang of it, and using the EchoBuster will become second nature to you.

iPatcher Theory Of Operation. The iPatcher achieves echo suppression by detecting audio on either the left or right speaker leads and then shunts the microphone signal to ground. To avoid chopping, due to audio peaks, a one-shot timer (R23 and C12 determine the hold-off time) maintains this shunt for about 0.8 seconds after the last detected audio peak.

In Fig. 3, diodes D3-D6 form a polarity-guard circuit, which enables the use of any polarity 12-V_{DC} supply. The regulator and associated parts deliver a highly filtered 12 volts (12V filtered on the schematic), and 12 volts and 5 volts for the iPatcher's electronics.

Speaker lead audio is coupled by loop-through jacks J1 and J2 into an amplifier IC1-b that amplifies the signal level to a point where the triggering level of the one-shot timer, Q3, can occur. When the one-shot triggers, yellow LED1 illuminates, and amplifier Q4 drives the

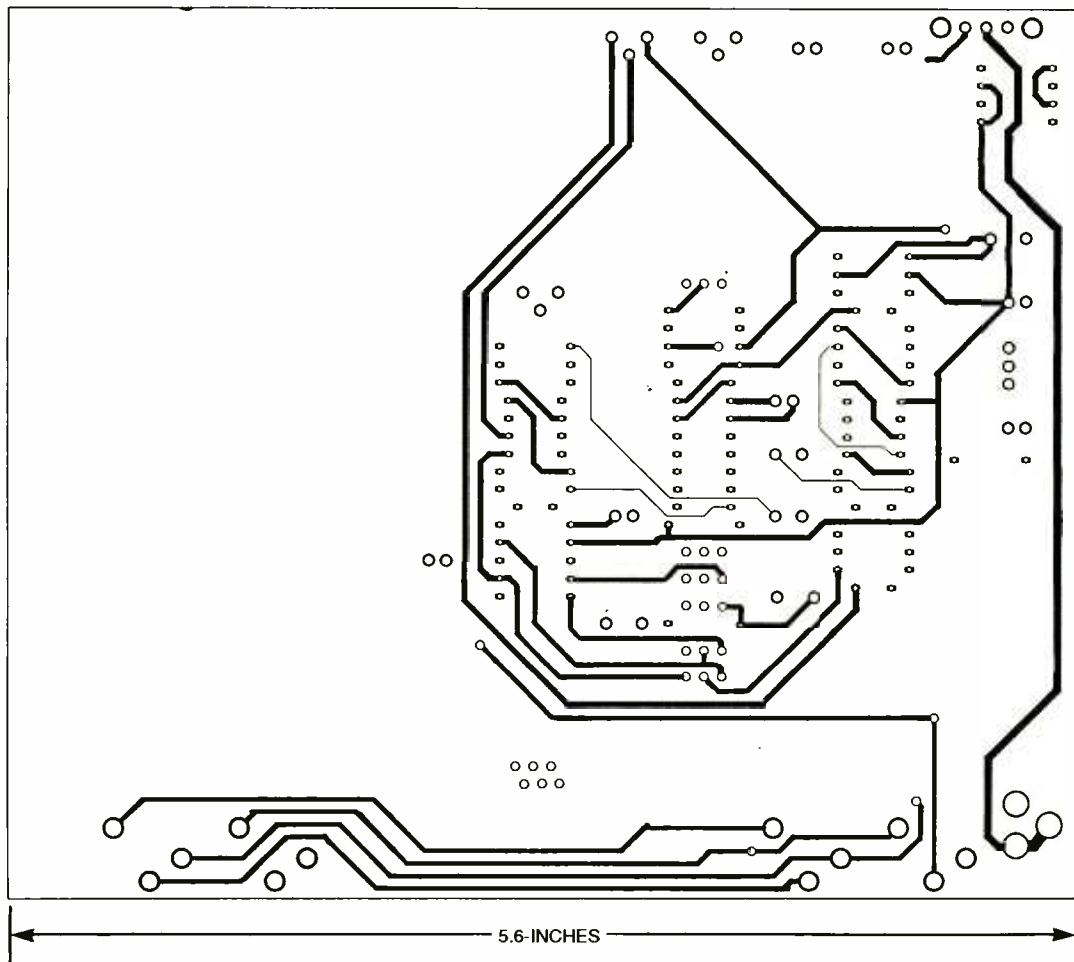

Fig. 8. This is the component side solder trace for the iPatcher.

gates of the N-channel MOSFET microphone shunting transistors Q2 and Q7. When the gates become high, the source-to-drain resistance of Q2 and Q7 becomes very low, which shunts the AC microphone signal at J3 and J4 to ground. Thus, received audio removes the microphone's signal and the echo caused by it. When the one-shot timer is not triggered, Q2 and Q7 look like an open circuit to the microphone signal.

Audio from the speakers is sent to the telephone, J5, an RJ-11 jack, through volume control pot R1, amplifier IC2-a, and to the telephone earpiece via C8 and C9. Resistor R19 provides loop current, and comparator IC1-a provides on-hook and off-hook indications for tri-color LED2. The speaker signal is also applied to a hybrid IC2-b that attenuates this signal by about 30 dB. Note that this attenuation is in the path to the sound card's microphone input, J3 and J4. Resistor R5 is adjusted so that

the output of the hybrid (IC2-b, pin 7) is minimized for speaker lead audio. Applying a 1-kHz sine wave to J1 or J2 and adjusting R5 until the AC signal at pin 7 is minimum can make the adjustment. This effectively reduces echo before the one-shot timer's trigger level is reached.

The telephone mouthpiece signal goes through C8 and C9 and through (without attenuation) the hybrid. Adjustment R20 sets the transmit level to the sound card's microphone input. When the phone is off the hook, telephone loop current flows through R19, through the telephone, and then through the base-emitter junction of Q3. Transistor Q3's collector is low, which cuts off Q4. Contrarily, when the phone is on the hook, Q3 is off and Q4's base-emitter junction is forward biased by R22. This causes Q4 to stop any speaker audio from reaching the mike leads.

iPatcher Construction. Figure 3 shows the schematic of the

iPatcher, and Fig. 4 is the iPatcher parts layout. If you are going to use breadboard, you can place the components wherever it's convenient, since parts placement is not critical. If you want to save yourself those headaches, you can order a bare printed circuit board from our Web site. Observe all of the standard construction practices and check your work for solder bridges before applying power. If you want to make your own PC boards, the plot files for the iPatcher are available at www.jechtech.com/ipatcher-top.pdf and www.jechtech.com/ipatcher-bottom.pdf. Figures 7 and 8 are foil patterns for the solder side and component side, respectively. You can get the Acrobat Reader 5 for free from <http://www.adobe.com/products/acrobat/readstep2.html>.

Testing Your Completed iPatcher. Plug the 12-volt DC power pack into the power jack on the rear of the iPatcher. The red MODE LED

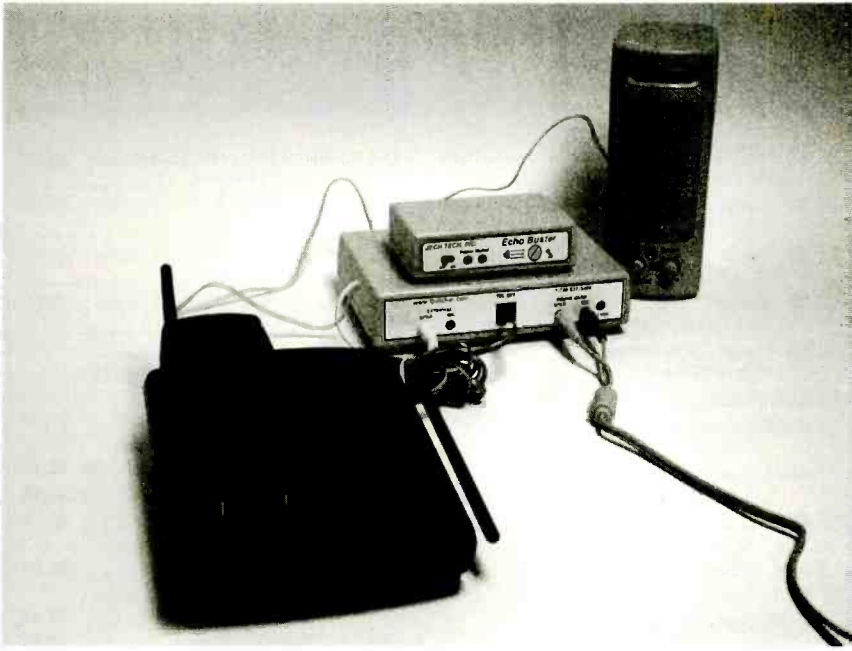

The EchoBuster and iPatcher are shown above. A cordless phone is attached to J5 of the iPatcher.

should light with the power switch set to the ON position. The yellow (MUTE) LED may flash briefly on power up. Measure the voltage from pin 1 to ground of the 7805 (IC4) to insure it is between 12-18-volts. Then, check the voltage on pin 3 of Q1 to insure that it is 5 volts. If you don't get these voltages, then you must determine what the problem is before proceeding. It

could be due to a defective regulator (7805), solder bridges between the foil tracings, or a defective power pack. Once these voltages appear to be within range, you're ready to move on to the next phase.

Using The iPatcher. Hook the iPatcher up to your phone and PC's soundcard. Make sure all of the plugs are firmly seated into their

respective jacks. Also, make sure the plug on the external microphone you are using is a stereo plug (tip, ring, and sleeve) and not a mono plug with just the tip and sleeve. If you use a microphone with a mono jack, it shorts out the microphone completely, due to the way the jacks are wired. Now set R5 (the on-board potentiometer) to mid-range.

With everything set up, run any application that outputs audio to the speakers. This can be a music CD or a .wav file playing on the Windows Recorder. The yellow LED should light up when there is audio coming out of the speakers. Start and stop the audio to see if the LED turns on and off with the audio on and off. If not, you need to troubleshoot the circuitry of IC1-b (LM1458) and IC3 (74123A), along with Q5 and Q6, to determine what the problem is. Pick up the telephone and see if you hear the audio there. Now adjust the RECV pot on the front of the iPatcher for a comfortable level in the telephone set.

Most of you will be using amplified external speakers and you can adjust the output level using the gain controls on the speakers. Keep in mind that there is also a

PARTS LIST FOR THE iPATCHER

SEMICONDUCTORS

IC1, IC2—LM1458, dual op-amp
 IC3—74HC123, dual retriggerable monostable multivibrator
 IC4—7805, voltage regulator
 LED1—Light-emitting diode, yellow
 LED2—Light-emitting diode, tri-colored
 D3-D6—1N4148 silicon diode
 Q2, Q7—2N7000 FET
 Q3-Q5—2N3904 NPN Transistor
 Q6—2N3906 PNP Transistor

RESISTORS

(All resistors are 1/4-watt, 5% carbon-film units, unless otherwise noted.)

R1—10,000-ohms potentiometer (Mouser 323-409-10K)
 R2, R8-R10, R16—47,000 ohms
 R3—220 ohms
 R4—Not Used
 R5—1000-ohms potentiometer (Digi-Key DJA13CT-ND)
 R6, R7—22,000 ohms

R11—100 ohms
 R12—27 ohms
 R13, R27, R29, R30—22,000 ohms
 R14, R25, R26—10,000 ohms
 R15, R17, R18—1000 ohms
 R19—470 ohms
 R20—1000-ohms potentiometer (Mouser 323-409V-1K)
 R21—4700 ohms
 R22—15,000 ohms
 R23—82,000 ohms
 R24—270 ohms
 R28, R32—33,000 ohms
 R31—330 ohms

CAPACITORS

C1, C2—47 μ F, electrolytic
 C3—470 μ F, electrolytic
 C4, C5—.01 μ F
 C6—.1 μ F
 C7—10 μ F, electrolytic
 C8, C9—220 μ F, electrolytic
 C10, C14—470 μ F, electrolytic

C11, C12—10 μ F, electrolytic
 C13—.001 μ F

ADDITIONAL PARTS AND MATERIALS

J1-J4—1/4-inch stereo jack (Mouser 1613507)
 J5—RJ-11 phone jack
 P1—Coaxial jack (Digi-Key CP-002A)
 S1—Power switch (Digi-Key EG1917)
 Power pack (12 VDC/200 mA); two (2) interconnect cables; 1/4-inch stereo on each end; case with front and rear panels

Note: Printed circuit boards, complete kits, and assembled and tested units are available on our Web site at www.ipatcher.com. You can call us at 800-631-0349 to place a credit card order.
 JECH TECH, INC., Attn: iPatcher, 13962 Olde Post Road, Pickerington, OH 43147

level control on the sound card, which can affect output levels as well, and that these two controls (sound card and speaker) work independently of one another. The RECV control on the iPatcher only affects the audio level in the telephone ear-piece.

You are now ready to run whatever Voice over the Internet application you want to use the iPatcher with. I will use DialPad as an example, keeping in mind that this applies to any application you're using. Set the SEND pot on the front of the iPatcher to mid-range. Place a test call to someone as you normally would. Once the party answers, pick up the phone and talk normally. Watch the yellow LED to make sure it comes on when the other party is talking. If it doesn't light, you probably need to increase the level of the audio coming out of the sound card. If it comes on and stays on, you need to reduce the incoming audio level. Click once on the yellow speaker icon in your task bar and move the slider up or down to get the desired level.

If the person you called can't hear you, turn the SEND control on the iPatcher clockwise to increase the level. You may have to increase the microphone level on the Play Control Panel from 75% to full scale to achieve the proper level.

That completes the setup, and you're ready to start enjoying your Internet conversations with the freedom to roam around while talking. **P**

THE COLLECTED WORKS OF MOHAMMED ULLYSES FIPS

#166—By Hugo Gernsback. Here is a collection of 21 April Fools Articles, reprinted from the pages of the magazines they appeared in, as a 74-page, 8 1/2 x 11-inch book. The stories were written between 1933 and 1964. Some of the devices actually exist today. Others are just around the corner. All are fun and almost possible. Stories include the Cordless Radio Iron, The Visi-Talkie, Electronic Razor, 30-Day LP Record, Teleyeglasses and even Electronic Brain Servicing. Get your copy today. Ask for book #166 and include \$9.99 (includes shipping and handling) in the US (First Class), Canada and Overseas (surface mail), and order from **CLAGGK Inc., P.O. Box 12162, Hauppauge, NY 11788**. Payment in US funds by US bank check or International Money Order. Allow 6-8 weeks for delivery.



MA05

Poptronics

REPRINT BOOKSTORE

- | | |
|---|---|
| <input type="checkbox"/> 229 Popular Electronics (1999 back issues) \$5.00
Write in Issues desired _____ | <input type="checkbox"/> 218 Electronics Now (1998 back issues) \$5.00
Write in Issues desired _____ |
| <input type="checkbox"/> 228 Popular Electronics (1998 back issues) \$5.00
Write in Issues desired _____ | <input type="checkbox"/> 217 Electronics Now (1997 back issues) \$5.00
Write in Issues desired _____ |
| <input type="checkbox"/> 227 Popular Electronics (1997 back issues) \$5.00
Write in Issues desired _____ | <input type="checkbox"/> 216 Electronics Now (1996 back issues) \$5.00
Write in Issues desired _____ |
| <input type="checkbox"/> 226 Popular Electronics (1996 back issues) \$5.00
Write in Issues desired _____ | <input type="checkbox"/> 215 Electronics Now (1995 back issues) \$5.00
Write in Issues desired _____ |
| <input type="checkbox"/> 225 Popular Electronics (1995 back issues) \$5.00
Write in Issues desired _____ | |
| <input type="checkbox"/> EH96 Experimenters Handbook (1996) \$5.00 | |
| <input type="checkbox"/> EH95S Experimenters Handbook
Summer Edition (1995) \$5.00 | |
| <input type="checkbox"/> EH94S Experimenters Handbook
Summer Edition (1994) \$5.00 | |
| <input type="checkbox"/> EH94W Experimenters Handbook
Winter Edition (1994) \$5.00 | |
| <input type="checkbox"/> EH94 Experimenters Handbook (1994) \$5.00 | |
| <input type="checkbox"/> EH93 Experimenters Handbook (1993) \$5.00 | |
| <input type="checkbox"/> HH95S Hobbyists Handbook
Spring Edition (1995) \$5.00 | |
| <input type="checkbox"/> HH95F Hobbyists Handbook
Fall Edition (1995) \$5.00 | |
| <input type="checkbox"/> HH94S Hobbyists Handbook
Spring Edition (1994) \$5.00 | |
| <input type="checkbox"/> HH94F Hobbyists Handbook
Fall Edition (1994) \$5.00 | |
| <input type="checkbox"/> HH93 Hobbyists Handbook (1993) \$5.00 | |
| <input type="checkbox"/> HISTORY Crystal Radio History, Fundamentals
& Design \$10.95 | |
| <input type="checkbox"/> XTAL Crystal Set Handbook \$10.95 | |
| <input type="checkbox"/> XTALPRO Crystal Set Projects \$14.95 | |
| <input type="checkbox"/> XTALBLD Crystal Set Building \$15.95 | |
| <input type="checkbox"/> POP96 POPtronix Hobbyist Handbook (1996) \$5.00 | |
| <input type="checkbox"/> POP97 POPtronix Exper Handbook (1997) \$5.00 | |
| <input type="checkbox"/> Radiocraft 1993 Projects for Hobbyists \$5.00 | |
| <input type="checkbox"/> 219 Electronics Now (1999 back issues) \$5.00
Write in Issues desired _____ | |

REPRINTS REPRINTS

- | | |
|---|---|
| <input type="checkbox"/> 174 Electronics Cartoons (The Best of) \$1.99 | <input type="checkbox"/> 173 From Not-Working to Networking
Troubleshooting Local-Area Networks \$2.99 |
| <input type="checkbox"/> 172 33 Bench-Tested Circuits \$1.99 | <input type="checkbox"/> 171 36 Time Tested Circuits \$1.99 |
| <input type="checkbox"/> 170 High-Voltage Project for Fun and
Science Book 1 \$2.99 | <input type="checkbox"/> 170A High-Voltage Projects for Fun and
Science Book 2 \$2.99 |
| <input type="checkbox"/> 169 Think Tank (133 Circuits) \$1.99 | <input type="checkbox"/> 169A Think Tank Vol. 2 \$1.99 |
| <input type="checkbox"/> 168 Fact Cards (#34-66) \$1.99 | <input type="checkbox"/> 168C Fact Cards (#67-99) \$1.99 |
| <input type="checkbox"/> 168D Fact Cards (#100-132) \$1.99 | <input type="checkbox"/> 167 Designing With IC's \$2.99 |
| <input type="checkbox"/> 166 Collected Works of Mohammed Ulyses
Fips (62 pages, April Fools Collection) \$6.99 | <input type="checkbox"/> 165 How to Repair CD Disc Players \$2.99 |
| <input type="checkbox"/> 164 Modern Electrics (April 1908) \$1.99 | <input type="checkbox"/> 160 New Ideas - 42 Circuits \$1.99 |
| <input type="checkbox"/> 159 Low Frequency Receiving Techniques
Building and Using VLF Antennas \$2.99 | <input type="checkbox"/> 158 Electro Importing Co. Catalog
(Circa 1918) \$2.99 |
| <input type="checkbox"/> 157 All About Kits \$1.99 | <input type="checkbox"/> 156 How To Make PC Boards \$1.99 |
| <input type="checkbox"/> 154 How To Repair VCR's \$1.99 | |

To order any of the items indicated above, check off the ones you want. Complete the order form below, include your payment, check or money order (DO NOT SEND CASH), payable to and mail to Claggk Inc., Reprint Department, P.O. Box 12162, Hauppauge, NY 11788.

Please allow 4-6 weeks for delivery. No COD's!
To place a credit card by phone, Visa Mastercard or Discover only. You can also order and pay by e-mail. Contact Claggk@gernsback.com for details.

CALL: 631-592-6721

To use your Visa, Mastercard or Discover, complete the following:

Bill my Visa Mastercard Discover 

Card No. _____

Exp. Date _____

Signature _____

MAIL TO: Claggk Inc.
Reprint Bookstore, P.O. Box 12162, Hauppauge, NY 11788.

SHIPPING CHARGES IN USA & CANADA

Up to \$5.00	\$2.00	\$30.01 to 40.00	\$6.00	Overseas Orders must contact
\$5.01 to \$10.00	\$3.00	\$40.01 to 50.00	\$7.00	CLAGGK for shipping charges.
\$10.01 to 20.00	\$4.00	\$50.01 and above	\$8.50	
\$20.01 to 30.00	\$5.00			

Total price of merchandise \$ _____

Shipping Charge (see chart) \$ _____

Subtotal \$ _____

Sales Tax (New York State Residents only) \$ _____

Name _____ Total Enclosed \$ _____

Address _____

City _____ State _____ Zip _____

CL01

Op-Amp and Comparator Checker

CHARLES HANSEN

Weed out faulty chips before they fail.

Introduction. This project allows you to take advantage of surplus circuit board and IC grab bag bargains. It will perform a quick and highly reliable test for the majority of single, dual, and quad op-amps as well as for the LM339 and LM311 comparators.

The *Op-Amp and Comparator IC Checker* described here tests industry-standard single, dual and quad op-amps, as well as quad op-amps with the RC4136 pinout arrangement (RC4136, TL075, OP-09). It also has provisions for testing the LM311 comparator and the LM339 quad comparator. It will not, as presently designed, test dual 14-pin op-amps like the 747, transconductance op-amps such as the CA3080, or Norton current feedback op-amps such as the LM3900 and CA3401. These could easily be accommodated by adding additional suitably connected test sockets, however.

How it Works. As shown in the schematic diagram (Fig. 1), power for the Checker is supplied to power jack J1 by a 9-V_{AC}, 500-mA AC plug-in power adapter. I recycled an adapter from a non-working video game, but the adapter in the parts list is an equivalent.

Since there is no on-off switch provided, be sure to unplug the AC adapter power supply before removing or installing an IC for test and wait until the LEDs go out. Alternatively, you can add a DPDT power switch to the checker, between capacitors C1 and C2 and the test sockets. The 9-V_{AC} adapter is dual half-wave rectified by D1 and D2 to provide a ± 12 -V_{DC}

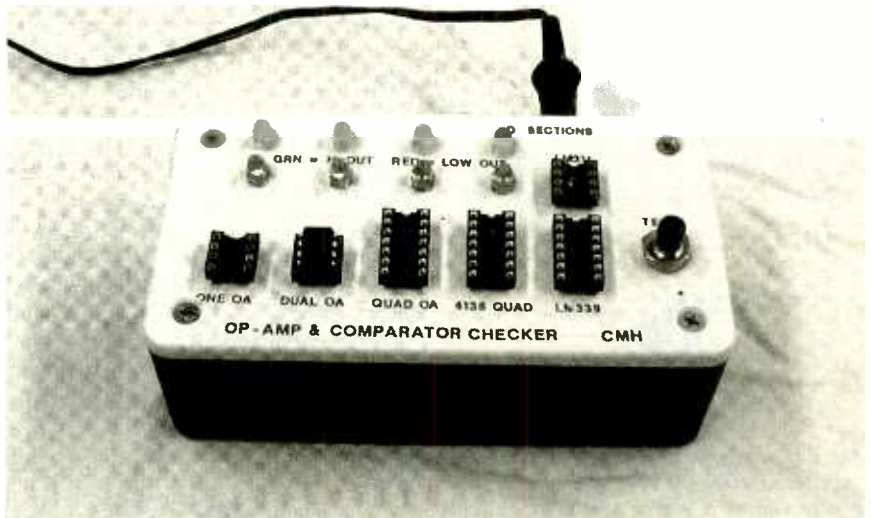

dual supply for the Checker circuitry. Capacitors C1 through C4 filter the DC supply.

The operation of the Checker can be described by means of an op-amp plugged into the single op-amp test socket, SO1. The schematic for this op-amp is shown in Fig. 2. The Checker operates by performing an open-loop test with each op-amp connected as a comparator. The +12-V_{DC} supply will be applied to pin 7 and the -12-V_{DC} supply will be applied to pin 4. Inverting-input pin 2 is grounded. The non-inverting input test signal is derived from a voltage divider consisting of R1, R2, and R3, which provides approximately -1 V_{DC} at pin 3. The C5 capacitor provides filtering for the input test signal to remove power-supply ripple.

Output pin 6 is connected to anti-parallel-connected red and green light-emitting diodes LED1

and LED2, in series with current-limiting resistor R4. If the op-amp is working properly, the -1-V_{DC} input voltage at pin 3 will drive output pin 6 to -12 V_{DC}, causing red LED1 to conduct.

Pressing switch S1 will remove the short across R3, changing the divider ratio so that approximately +1 V_{DC} appears at pin 3. The positive voltage at pin 3 now drives output pin 6 to +12 V_{DC}, causing red LED1 to go out and green LED2 to conduct. If this does not occur, it is highly likely that the IC under test is faulty.

The test method for the dual and quad op-amps is the same, except additional input and output connections are wired to these sockets. Depending on how many op-amp sections are contained in the IC under test, one to four LED pairs will be active in the test. The schematics for dual and quad op-

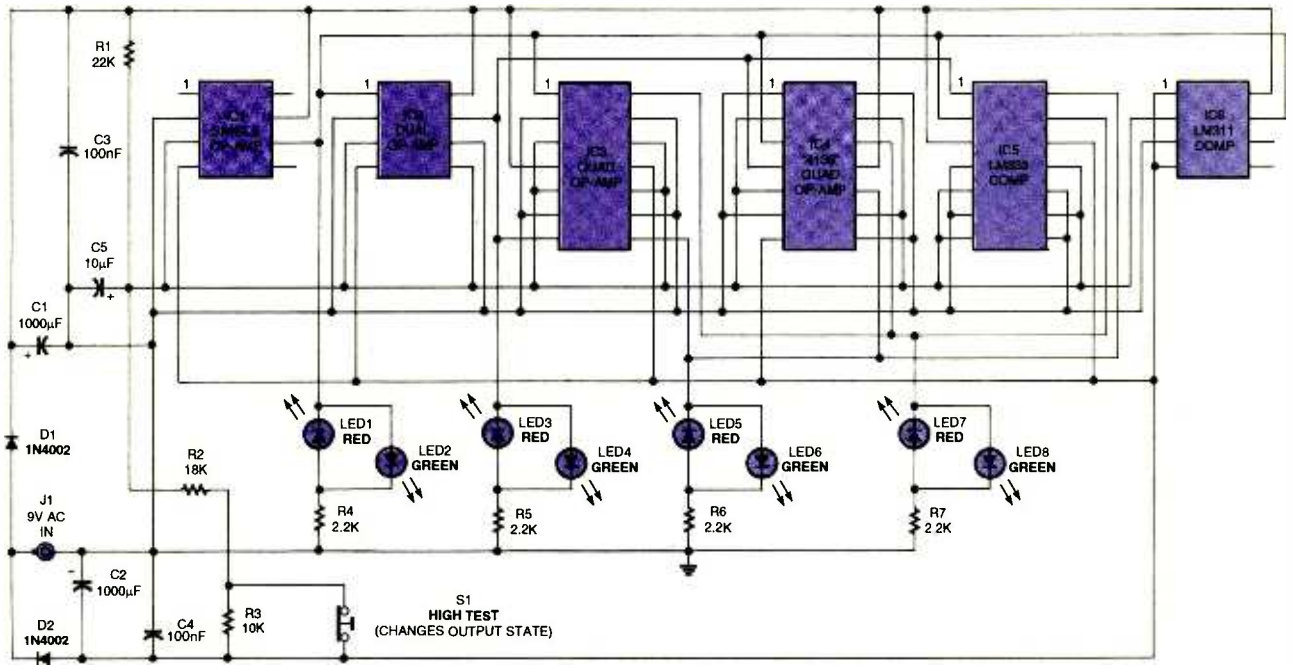

Fig. 1. The schematic above is for the Op-Amp and Comparator Checker. The only ICs required will be the units under test. Eight LEDs are used as visual indicators.

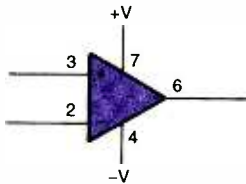

Fig. 2. Here is a basic schematic for an op-amp chip. Notice there are two voltage inputs; one positive and one negative.

amp connections for sockets SO2 through SO4 are shown in Figs. 3 to 5.

The test for comparators is simpler. The NPN open-collector output stage of the LM339 can only sink current. There is no active output source capability to drive the green LEDs. The output stage of the LM311 can be connected to either sink or source current, but SO6 is

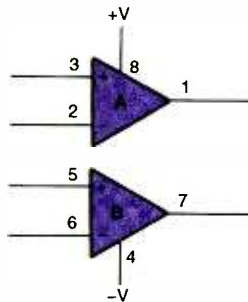

Fig. 3. Here is a basic dual op-amp. One amp works on a negative supply voltage, while the other amp runs on a positive supply voltage.

connected in the sink configuration in the Checker for consistent operation of the red LEDs. Since the comparators will only sink current, the red LEDs will initially be illuminated and will go out when the

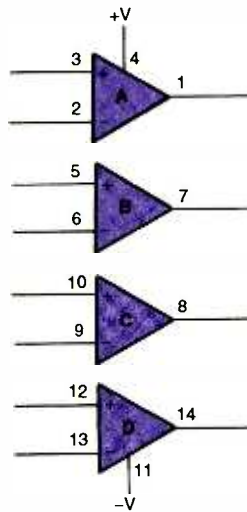

Fig. 4. A quad op-amp is shown above. Each pair shares one supply voltage.

TEST switch is pressed. The schematics for comparator sockets SO5 and SO6 are shown in Figs. 6 and 7.

The input test voltage is kept to ± 1 VDC to prevent any latch-up of FET-input op-amps and to ensure the IC under test is indeed providing voltage gain as evidenced by

LED illumination. The high-gain open-loop test method will allow testing of op-amps such as the NE5534, which are not unity-gain stable.

Construction. The IC test sockets and the LEDs are mounted on the project enclosure cover and interconnected by wire-wrap. Switch S1 is also mounted on the cover. An enclosure must be selected with sufficient room for the perf board or PC board and chassis-mounted

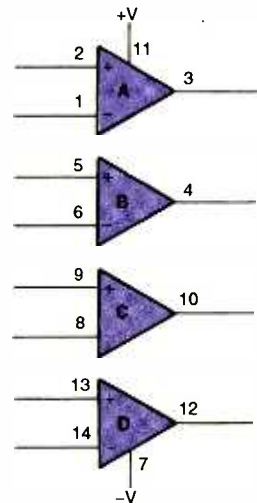

Fig. 5. Here are the pin-outs for RC4136, TL075, and OP-09 style op-amps. The configuration is similar to standard op-amps, but the pin numbers differ.

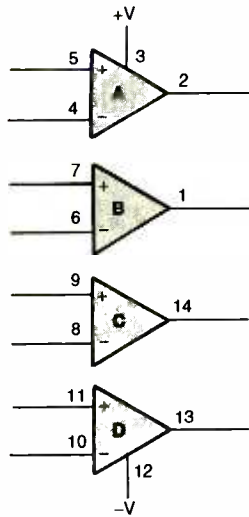

Fig. 6. The schematic above shows the pin-outs for an LM339 comparator. Note its similarity to a quad op-amp.

components. There must be enough depth available for the IC socket leads in the cover to clear the circuit board in the base of the enclosure. A 2½ × 4¾ × 1¾-inch enclosure was used for the prototype, and any excess length on the socket leads was clipped off after wiring was completed.

A 0.1-inch grid perf board was clamped to the cover and used as a drilling template for the sockets and LED leads. A number 58 twist drill (0.042-inch diameter) is required to drill the holes in the cover. After painting and lettering the cover, the sockets were installed and held securely in place with a drop of hot glue.

The power-supply board in the prototype was built on a wire-wrapped perf board, but a PC-board layout is also provided in Fig. 8. The circuit layout is not critical. Figure 9 shows the parts layout and wiring to parts located off the PC board.

In keeping with good assembly practice, install the least sensitive

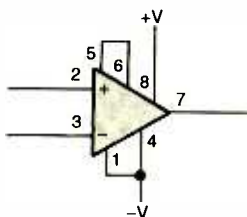

Fig. 7. The LM311 comparator has an output sink built into its design. This device resembles an op-amp with a control loop.

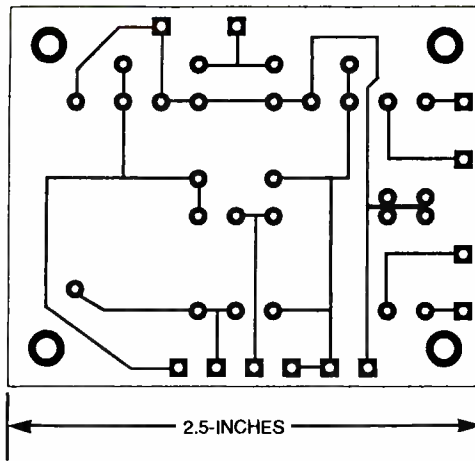

Fig. 8. This simple foil pattern can be used to etch a PCB. As always, the components can be breadboarded or connected via copper hook-up wire.

parts first, followed by the more sensitive parts. All four PC-board mounting holes have sufficient clearance for a 4-40 screw with flat washer. In the prototype, ⅜-inch plastic spacers were used to mount the power-supply board low in the enclosure near the power jack. The PWB is designed for this same mounting method.

Next, solder in the passive parts (resistors, then capacitors). Finally, install the diodes. Double-check the orientation of the polarized components.

Testing. After construction, connect the AC power adapter and measure each test socket for proper connection of the +12- and -12-V_{DC} power supplies, which may measure higher with no loading on the power supply. Confirm that -1-V_{DC} test voltage exists at each non-inverting input socket pin. Press S1 and verify that the test voltages change to +1 V_{DC}. Finally, connect each output pin alternately to the -12 and +12 supply voltage and verify that first the red LED lights and then the green LED.

Using the Checker. Unplug the AC adapter power-supply plug and allow several seconds for the power-supply capacitors to discharge before removing or installing an IC for test. **DO NOT INSTALL TWO ICs AT THE SAME TIME.** Since all similar section outputs in each test socket are wired in parallel, there is nothing except the devices internal resistances to limit the current if one device has failed and opposing polarities appear at the parallel-connected outputs.

(Continued on page 61)

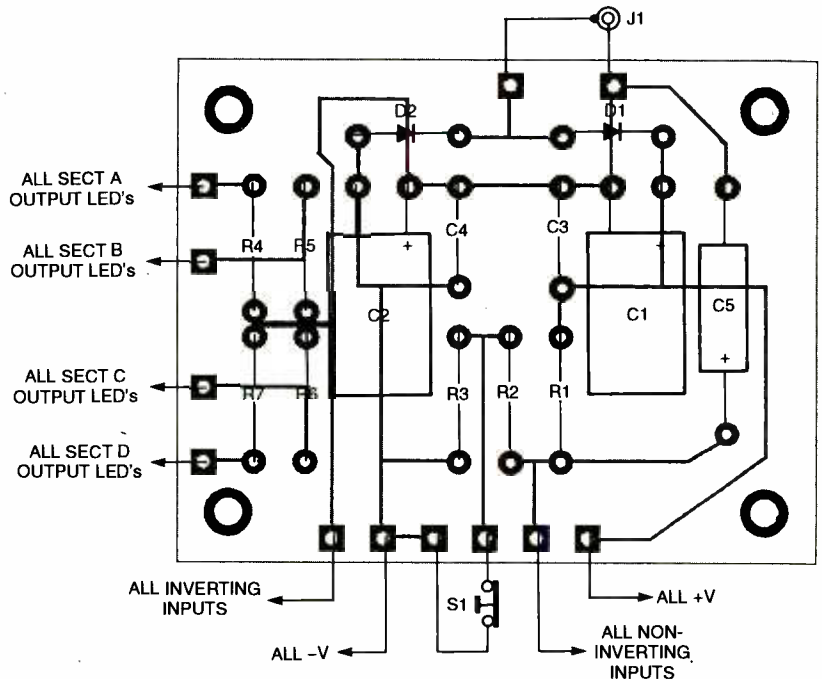

Fig. 9. If a PCB method is adopted, then this parts placement diagram will be useful.

ELECTRONIC TECHNOLOGY TODAY INC.

P.O. Box 240 • Massapequa Park, NY 11762

INVENTORY BLOWOUT SALE



* ALL CANADIAN CHECKS MUST CLEAR THROUGH AN AMERICAN BANK

BP07	100 Radio Hookups	\$3.00	BP317	Practical Electronic Timing	\$6.99
BP36	50 Circuits Using Germanium, Silicon & Zener Diodes	\$2.99	BP320	Electronic Projects for Your PC	\$5.99
BP44	IC 555 Projects	\$5.99	BP322	Circuit Source Book 2	\$6.99
BP56	Electronic Security Devices	\$3.99	BP329	Electronic Music Learning Projects	\$6.99
BP64	Semiconductor Technology Elements of Elect Book 3	\$5.99	BP332	A Beginners Guide to TTL Digital ICS	\$6.99
BP74	Electronic Music Projects	\$3.99	BP333	A Beginners Guide to CMOS Digital ICS	\$6.99
BP76	Power Supply Projects	\$3.99	BP334	Magic Electronic Projects	\$6.99
BP78	Practical Computer Experiments	\$2.99	BP355	A Guide to the World's Radio Stations	\$7.99
BP80	Popular Electronic Circuits	\$3.99	BP359	An Introduction to Light in Electronics	\$6.99
BP103	Multi-Circuit Board Projects	\$2.99	BP367	Electronic Projects for the Garden	\$6.99
BP109	The Art of Programming the IK ZX81	\$3.99	BP370	The Superhet Radio Handbook	\$6.99
BP112	A Z-80 Workshop Manual	\$5.99	BP371	Electronic Projects for Experimenters	\$6.99
BP114	The Art of Programming the 16K ZX81	\$3.99	BP374	Practical Fibre-Optic Projects	\$6.99
BP115	The Pre-Computer Book	\$2.99	BP378	45 Simple Electronic Terminal Block Projects	\$6.99
BP124	Easy Add-On Projects for the Spectrum, ZX81 & ACE	\$3.99	BP379	30 Simple IC Terminal Block Projects	\$6.99
BP143	An Intro to Programming the Atari 600/800 XL	\$2.99	BP384	Practical Electronic Model Railways Projects	\$6.99
BP148	Computer Terminology Explained	\$2.99	BP385	Easy PC Interfacing	\$6.99
BP154	An Introduction to MSX Basic	\$3.99	BP391	Fault-Finding Electronic Projects	\$6.99
BP156	An Introduction to QL Machine Code	\$3.99	BP392	Electronic Project Building for Beginners	\$6.99
BP187	A Prac Ref Guide to Word Pro Amstrad PCW8256/PCW8512	\$7.99	BP393	Practical Oscillator	\$6.99
BP190	More Advanced Electronic Security Projects	\$3.99	BP396	Electronic Hobbyists Data Book	\$7.99
BP194	Modern OPTO Device Projects	\$3.99	BP401	Transistor Data Tables	\$7.99
BP232	A Concise Introduction to MS-DOS	\$3.99	BP411	A Practical Intro to Surface Mount Devices	\$6.99
BP256	An Intro to Loudspeakers and Enclosure Design	\$3.99	BP413	Practical Remote Control Projects	\$7.99
BP264	A Concise Advanced User's Guide to MS-DOS	\$3.99	BP416	Practical Alarm Projects	\$6.99
BP272	Interfacing PCS and Compatibles	\$5.99	BP439	Troubleshooting Your PC	\$8.99
BP290	An Intro to Amateur Communications Satellites	\$5.99	PCP107	Digital Logic Gates and Flip-Flops	\$10.99
BP297	Loudspeakers for Musicians	\$6.99	PCP112	Digital Electronics Projects for Beginners	\$10.99
BP299	Practical Electronic Filters	\$6.99	PCP114	Advanced MIDI Users Guide	\$10.99
BP302	A Concise User's Guide to Lotus 1-2-3 Release 3.1	\$5.99	ETT1	Wireless & Electrical Cyclopedia	\$4.99
BP304	Projects for Radio Amateurs and S.W.L.S	\$5.99			

PRICES DO NOT INCLUDE SHIPPING & HANDLING. ALL SALES ARE FINAL, NO RETURNS

ORDER FORM

Book No.	Title	Price	No. of Copies	Cost

Name _____
 Address _____
 City _____ State _____ Zip _____

If you wish to use a Credit Card:

MasterCard Visa Expire Date /

Card No. _____

Signature _____

Allow 6-8 weeks for order to be fulfilled.

Please return this order form to:
ELECTRONIC TECHNOLOGY TODAY, INC.
 P.O. Box 240
 Massapequa Park, NY 11762-0240



SHIPPING COSTS				Total Amount \$	
\$0.01 to \$5.00	\$2.00	\$20.01 to \$30.00	\$5.00	30% off	Subtotal
\$5.01 to \$10.00	\$3.00	\$30.01 to \$40.00	\$6.00	Local NY State Sales Tax	Add shipping cost (see table)
\$10.01 to \$20.00	\$4.00	\$40.01 to \$50.00	\$7.00		TOTAL COST \$
\$50.01 and above	\$8.50				

Telephone Orders: If you wish to place your credit-card order by phone, call 631/592-6720. Automated order taking system functions 24 hours a day. Have your credit-card ready. Sorry, no orders accepted outside of U.S.A. and Canada, New York State Residents must add applicable sales tax. Offer expires 12/21/01. ET11

Thanks

The instant I opened up the August 2001 issue, I noticed the same thing that reader Ed King noticed: The bell circuit of Fig. 3 has no clapper. It's missing the ground. I looked back in the copy I sent in, and sure enough, no ground. For some reason, it didn't make it from my "scribble schematic" to the electronic version. The junction of Q1 emitter, C1, and R2 should be grounded, i.e., connected to the negative terminal of the power supply. Thanks for your note, Ed.

Rippling the Caps

Q In "Q & A," September 2000, there's a statement regarding voltage regulator design that says, "Excessively large ripple levels can burn out a filter capacitor." I would like to know what that means. Does this have to do with peak ripple exceeding the maximum voltage rating of the capacitor?—S. B., via e-mail

A Let's use a typical half-wave 60-Hz "linear" supply as an example for exploring this area. Suppose that we have a perfect 33-microfarad filter capacitor in our circuit. At 60 Hz, the capacitive reactance, X_c , of the capacitor will be $1/(2\pi fC)$ or about 80-ohms. At first one would say that if the ripple level on this supply was 40 volts, we would have $\frac{1}{2}$ amp of current through the capacitor and that would be 20 watts of power being dissipated by the cap. Now, don't forget that being a perfect cap, this is 20 watts of reactive power; and any power that is apparently "consumed" by the cap is just dumped back into the circuit at a later date, so no power is actually consumed.

No capacitor is perfect. Capacitors tend to have a very high resistance in parallel with that capacitance, which we call leakage. Also, there is a small inductance in series with the capacitance that is caused by the leads; as well as, a small series resistance made up of the leads and plate material, which we call effective series resistance (ESR). Therefore, an ideal capacitor has infinite leakage resistance, zero inductance, and zero

ESR. Some capacitor types are better than others when it comes to perfecting these individual characteristics.

A problem can occur if the cap develops (or initially has) a high ESR—a quantity that we normally want to be as low as possible. If the ESR increases to 10 ohms, we'll effectively have 10 ohms plus the X_c of 80 ohms in series, which is about 90 ohms total resistance. This will allow a current of about 440 milliamperes to flow through that series resistance and being resistive, it will dissipate about 2 watts in the form of heat. Two watts of heat in a little bitty 33-microfarad, 63-volt capacitor could heat it up and cause it to vent or even burst. By the way, I know that I was very liberal by simply adding the X_c and ESR together to arrive at a total resistance. In reality that would be incorrect, but for illustration, it gives us a figure that's close enough without presenting a course in RC circuits.

On-Site Education

Q Now that I've seen the other general electronics forums on the Internet, are there any educational sites out there where one can learn electronics?—D. S., Marion, VA

A Strangely enough, here I am an electronics instructor and I've never researched that topic. I suppose that's because I don't allow unilateral student access to the Internet in the classroom. I've found that the legal liability to which I'm exposed in this day and age of litigation more than offsets the benefits that it would provide.

I have run across a few sites that may be of help to you. Howard Sharp's Twisted-Pair site has a few tutorials (www.twisted-pair.com), as does Ian Purdie's (www.electronics-tutorials.com).

A couple of schools have some curriculum "on the air." Hazelwood School (Missouri) has a science department section (www.hazelwood.k12.mo.us/~grichert/sciweb/applets.html) and Sault College of Applied Arts and Technology has an engineering site that is under development. There, only three subjects in digital-logic systems are active at this time

(http://scorpion.saultc.on.ca/faculty/~ed/EL_N115main.htm).

Although it's not a tutorial *per se*, you can download a crippled Karnaugh map program at <http://puz.com/sw/karnaugh> and find a wire table at www.drzyzgula.org/bob/text/fr.tom/awg.txt.

The various electronics forums offer a lot in the form of questions and answers. Browsing through those can be very educational, although you do have to watch out for erroneous posts which could be misleading. Even my posts aren't always sterling. Those forums were discussed in the "Q & A" column in the July 2001 issue. In addition to those forums, there are several in the Yahoo groups covey:

http://groups.yahoo.com/group/General_Electronics, <http://groups.yahoo.com/group/electronics>, and <http://groups.yahoo.com/group/aus-electronics>.

Also, you can go to www.yahogroups.com and search for "electronics" because there are a lot more forums than those.

As an example of the educational value of a forum, check out our own Gernsback Forum at www.gernsback.com/HyperNews/get/forums/ElectronicBench.html. There, thread #3578 has a lot of great information on soldering from guys that have been doing it for a long time.

Decibels and Gain

Q At an Internet site, I was reading about antenna gain where it said that a 3-decibel (dB) gain is a two-fold increase in power, 6 dB is a four-fold increase, and 9 dB is an eight-fold increase. Suppose that I have a transmitter that has a 5-watt output into a standard dipole antenna. Does that mean that if I feed an antenna with a 6-dB gain, I'll have 20 watts coming out of the antenna?—P.C., New Iberia, LA

A Well, yes and no. An antenna gets its "gain" by taking as much of the signal as possible and concentrating it in one or more directions. A standard AM clear-channel broadcast station has 50 kilowatts (KW) of power. A station such as KMOX in St. Louis, located such that

the audience is distributed evenly in all directions from the station, has a single transmitting tower so that the signal is radiated in an omnidirectional pattern, or a full circle. The 50 KW of power is sent out in all directions. Compare this to station WWL just east of you in New Orleans which has two towers. The phasing of the two towers causes the most signal to be broadcast to the north, just a little bit less to the east and west and very little to the south, since Gulf shrimp and the residents of Coatzacoalcos are not likely to pay any attention to WWL's radio ads. For all practical purposes, WWL's antenna will have some gain by focusing all of the transmitter power through a radiation pattern of only 270 degrees versus all 360 degrees of an omnidirectional pattern.

The gain of an antenna then depends upon eliminating radiation in some directions and concentrating it in others. A half-wave dipole, with radiation in two directions, is usually considered the standard by which other antennas are measured, having a declared gain of 0 dB. A Yagi antenna, using reflectors and directors, tends to reduce emission from the "rear" and "sides" of the antenna and concentrate it to the "front." The more directors (elements in front of the driven element) the Yagi has, the narrower the angle of radiation from the front and the more concentrated that radiation will be at the point to which the antenna is aimed. All of the power going into the antenna is being concentrated in one small area. It's just like comparing a flashlight lamp with no reflector versus one with a reflector. They both put out the same amount of light. It just seems that the lamp is brighter with the reflector because all of the light output is being concentrated in one direction rather than everywhere. A 3-watt lamp appears to have the same brightness as a 12-watt lamp when installed in a flashlight, meaning that the flashlight provides a four-fold increase or a 6-dB gain in light concentration.

Yes and no. Yes, it appears that you are putting out four times more power if the antenna has a 6-dB gain—if you're right in the cross-hairs of the antenna. No, the actual power being radiated is the same because you're eliminating the radiation from the rear and sides of the antenna and simply concentrating that radiation toward the front.

WWL wants to do this to slightly increase their coverage area where their

listeners are. An amateur radio operator wants high directivity so that he can punch a lot of signal out to the one person with whom he's communicating without unnecessarily interfering with the communications of others on the same frequency who are located off in a different direction.

Don't forget that the same antenna for transmitting is often used for receiving and in that application, the gain and directivity attributes still apply. In the receive mode, the antenna is "hotter" and rejects signals from directions other than where it is pointed.

HOW TO GET INFORMATION ABOUT ELECTRONICS

On the Internet: See our Web site at www.poptronics.com for information and files relating to **Poptronics** and our former magazines (**Electronics Now** and **Popular Electronics**) and links to other useful sites.

To discuss electronics with your fellow enthusiasts, visit the newsgroups sci.electronics.repair, sci.electronics.components, sci.electronics.design, and rec.radio.amateur.homebrew. "For sale" messages are permitted only in rec.radio.swap and misc.industry.electronics.marketplace.

Many electronic component manufacturers have Web pages; see the directory at www.hitex.com/chipdir/, or try addresses such as www.ti.com and www.motorola.com (substituting any company's name or abbreviation as appropriate). Many IC data sheets can be viewed online: www.questlink.com features IC data sheets and gives you the ability to buy many of the ICs in small quantities using a credit card. You can also get detailed IC information from www.icmaster.com, which is now free of charge although it formerly required a subscription. Extensive information about how to repair consumer electronic devices and computers can be found at www.repairfaq.org

Books: Several good introductory electronics books are available at RadioShack, including one on building power supplies.

An excellent general electronics textbook is *The Art of Electronics*, by Paul Horowitz and Winfield Hill, available from the publisher (Cambridge University Press, 800-872-7423) or on special order through any bookstore. Its 1125 pages are full of information on how to build working circuits, with a minimum of mathematics.

Also indispensable is *The ARRL Handbook for Radio Amateurs*, comprising over 1000 pages of theory, radio circuits, and ready-to-build projects, available from the American Radio Relay League, Newington, CT 06111, and from ham-radio equipment dealers.

Back issues: Copies of back issues of and past articles in **Electronics Now**, **Popular Electronics**, and **Poptronics** can be ordered on an "as available basis" from Claggg, Inc., Reprint Department, P.O. Box 12162,

As a side note, remember that every time the power is doubled, you get a 3-dB increase. It's interesting that an amateur radio operator can inexpensively double his power from 8 watts to 16 watts, an increase of only 8 watts, and will have a 3-dB gain. If KMOX were legally allowed to double their power to 100KW, an increase of 50KW, it would cost them a lot of money and still be only a 3-dB gain. At a receiver location, if both stations were being received at the same strength, both will have appeared to have increased their signal by an equal amount.

Hauppauge, NY 11788; Tel: 631-592-6721. To ensure receipt of the correct material, readers must supply complete information on the article or issue that they wish to buy.

Poptronics and many other magazines are indexed in the *Reader's Guide to Periodical Literature*, available at your public library. Copies of articles in other magazines can be obtained through your public library's interlibrary loan service; expect to pay about 30 cents a page.

Service manuals: Manuals for radios, TVs, VCRs, audio equipment, and some computers are available from Howard W. Sams & Co., Indianapolis, IN 46214; (800-428-7267). The free Sams catalog also lists addresses of manufacturers and parts dealers. Even if an item isn't listed in the catalog, it pays to call Sams; they may have a schematic on file which they can copy for you.

Manuals for older test equipment and ham radio gear are available from Hi Manuals, PO Box 802, Council Bluffs, IA 51502, and Manuals Plus, 130 N. Cutler Dr., N. Salt Lake, UT 84054.

Replacement semiconductors: Replacement transistors, ICs, and other semiconductors, marketed by Philips ECG, NTE, and Thomson (SK), are available through most parts dealers (including RadioShack on special order). The ECG, NTE, and SK lines contain a few hundred parts that substitute for many thousands of others; a directory (supplied as a large book and on diskette) tells you which one to use. NTE numbers usually match ECG; SK numbers are different.

Remember that the "2S" in a Japanese type number is usually omitted; a transistor marked D945 is actually a 2SD945.

Hamfests (swap meets) and local organizations: These can be located by writing to the American Radio Relay League, Newington, CT 06111; (www.arrl.org). A hamfest is an excellent place to pick up used test equipment, older parts, and other items at bargain prices, as well as to meet your fellow electronics enthusiasts—both amateur and professional.

Counter Schematic

Q I am looking for a schematic or service data for a Fordam 550-Mhz frequency counter. Any help would be appreciated.—J. T., via e-mail

A I think that the spelling of your “manufacturer” is probably “Fordham,” Fordham Radio Supply, 260 Motor Pkwy., Hauppauge NY 11788-5134. After doing a quick search through my manuals sources (“Q & A,” February 2001), I did find three Internet manual sites that may have what you need. They all list a counter as “Fordham 550,” and it may be your best shot. It appears that it may include service information, but you’ll want to verify that with the vendor before you order. Here are the three sites: www.manualsplus.com, www.w7fg.com, and www.sarrio.com. The manual is running around \$15–20.

One of the problems with inexpensive items of test equipment is that they are imported somewhere from Asia and then relabeled with the vendor’s (e.g. Fordham) brand name. If you look through several catalogs, you begin to see signal generators, counters, and all-in-one test instruments that look like twins, but have different manufacturer names. Usually what you get with one of these is an Operators Manual and no other information. If you’re very lucky, there might be a schematic diagram included that would require a microscope to read. Rarely will you find a parts list or a calibration procedure.

Some big-name test equipment manufacturers imported equipment like this for their “pond scum” line of equipment, targeted to less-sophisticated or financially-disenfranchised customers. They all quit doing that when they realized that even they couldn’t get support from their Asian suppliers. For those of you contemplating the purchase of new test equipment, let this be a “heads up.” You get what you pay for. Yes, that new Asian counter or function generator is dirt cheap, but you may have no help available if it ever needs repair or adjustment.

Sources for Parts

Q I just got interested in building electronic circuits about a month ago. I’ve been reading up on everything I can. Do you have any must-reads for the electronic hobbyist

beginner? Also, I got the idea to shop at thrift stores and pick up old electronic devices and strip them for parts. Is this worthwhile or are electronic components cheap enough to purchase? If nothing else, I figure it would give me training in soldering and desoldering.—J. H., via e-mail

A In my nail-biting, cliffhanger July episode of “Q & A,” I provided my bibliography and with the books listed in the main sidebar, it should provide a lot of good theory for you. I don’t know that tearing apart boards provide that much appropriate practice, even in desoldering, for the object in harvesting components from a board is to save the component. That’s just the opposite goal of true desoldering for board repair where you want to save the board. Completely different techniques are used. However, that is a good source for parts and is economical as long as you’re considering your time to be free. Rather than buying the salvage material, why not check with television and computer repair shops around town to see if they have any discards that they’d be willing to donate to a beginner?

Salvage is how I’ve gotten the bulk of my components. Older boards that are just covered with integrated circuits (ICs) look tempting for stocking your parts drawers, but consider that you’ll only use but one or two ICs per board and that may be a few years down the line. Liberating ICs from their native homes is difficult enough that you might consider putting an ID number on each board, inventorying all the ICs on each, and recording this in a book. Then store the boards in a box and put it out of the way. When you need an IC, look it up on your record, retrieve the board, remove that one IC, scratch it off your inventory, and put the board back into the archive. You’ll save a lot of time that would otherwise be spent desoldering ICs that you’ll never use.

Negative Logic

Q In active-high TTL logic, what voltage represents true and what voltage represents false?—T. B., New Zealand

A This is a bit of a double-sided question here, so let me approach the answer from two directions. Remember that for the most part, there are only two voltages in a digital or binary system—a low voltage and a high voltage. In gen-

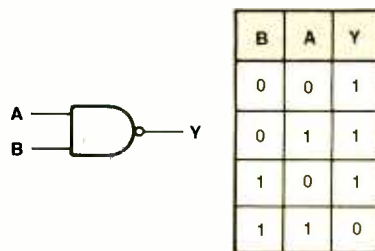

Fig. 1. A 74LS00 NAND gate as conventionally drawn in a data book or most schematics has “active HIGH” inputs.

eral, TTL is what is known as a positive-logic system and the vast majority of today’s designs use positive logic. In a positive-logic system, the more-negative-less-positive (which I’ll call “lower”) voltage represents a logical zero, or LOW, which is often labeled “false.” A less-negative-more-positive (“higher”) voltage represents a logical one, or HIGH, which is often labeled “true.”

In TTL, a logical LOW (false) is anything under 0.8 volts and a logical HIGH (true) is anything over 2.0 volts. The domain between 0.8–2 volts is undefined. Some chips will treat a voltage in that undefined window as a HIGH and some won’t deal with it at all.

In your question, you use the term “active-high logic.” I might add that “active HIGH” means that an input’s function (reset, load, or set, etc.) is initiated when the input goes to a logical HIGH. “Active LOW” means that an input’s function is initiated when the input goes LOW. For instance, the “parallel load” function of a 74LS193 is active LOW, and the chip will parallel load data when that input goes LOW; on the other hand, the “master reset” input of the 74LS193 is active HIGH, and that chip will reset when that input goes HIGH. On the traditional symbols for logic devices, an active LOW input or output is represented by an inverting “bubble” on the logic line and an active

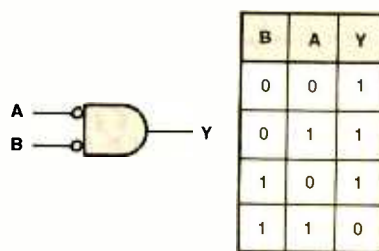

Fig. 2. A 74LS00 DeMorgan NAND gate has “active LOW” inputs and has the identical truth table of the NAND gate in Fig. 1 and, in fact, may be one of the gates from the same 74LS00 package.



B		A		Y	
0V	LOW	0V	LOW	5V	HIGH
0V	LOW	5V	HIGH	5V	HIGH
5V	HIGH	0V	LOW	5V	HIGH
5V	HIGH	5V	HIGH	0V	LOW

Fig. 3. A 74LS00 chip operates as a NAND gate in the positive-logic system for which it was designed.

HIGH has no inverting bubble.

DeMorgan gate equivalents are the gate representations of this "active HIGH" and "active LOW" designation. A 74LS00 NAND gate, as presented in a standard TTL data book, has the symbol and truth table shown in Fig. 1. The 74LS00 DeMorgan NAND gate and its associated truth table are shown in Fig. 2. Notice that both of these NAND gates may actually be within the same 74LS00 chip. The only difference between the two is how the schematic symbols are drawn and how we perceive their operation.

In the case of the standard NAND gate in Fig. 1, we see that if "A" is HIGH and "B" is HIGH, the output will go LOW. All other input conditions will give you a HIGH. In the case of the DeMorgan NAND of Fig. 2, if "A" is LOW or "B" is LOW, then the output will go HIGH. All other input conditions will give you a LOW. The truth tables are the same.

We look at the traditional NAND gate and see how HIGHS at the input affect the output; we also see that when the inputs are satisfied, the output goes LOW (it has an inverting bubble). We see how LOWs at the inputs affect the output of the DeMorgan NAND gate (the inputs have inverting bubbles); and we also see that when the input conditions are satisfied, the output will go HIGH (it has no inverting bubble). Gates are drawn either way on a schematic to help technicians understand how various logic lines and gates will be affected. Not all schematics will use DeMorgan

gates—you'll notice that until this date of publication (which I'm sure will live in infamy in the eyes of the editors), you didn't see a DeMorgan gate in the pages of **Poptronics** or any of its predecessors.

Many people confuse an "active LOW" input with "negative logic." "Active LOW" is not negative logic. Negative logic, which is obviously the opposite of positive logic, is when a logical HIGH is assigned when the output of the logic device is at a more negative voltage, and a logical LOW is when the output goes to a more positive voltage. The 7400-series TTL devices were assigned positive logic action where +5 volts (the more positive voltage) is a HIGH and 0 volts (the more negative level) is a LOW. Had it been assigned the function of negative logic, a LOW would have been +5 volts while a HIGH would have been 0 volts.

However, just to confuse the issue (and this is trivial stuff, so ignore it if you want), the 7400-series can be used in a negative logic system. You keep the normal +5 volts on the Vcc pin and ground on the ground pin (if you reverse those, you'll destroy the chip), but the logic assignments for the gates get switched around. A 7400 positive-logic NAND gate has a NOR function in negative logic; a 7408 positive-logic AND gate has an OR function in negative logic; a 7432 positive-logic OR gate has an AND function in negative logic; a 7402 positive-logic NOR gate has a NAND function in negative logic. XOR in positive logic becomes

XNOR in negative logic; XNOR in positive logic becomes XOR in negative logic. Inverters are still inverters and buffers are still buffers in either system. Luckily, negative logic systems are little but history.

Figure 3 shows how a 74LS00 will act if we assign "LOW" and "HIGH" to the logic levels in its normal positive logic system. Figure 4 shows how that same gate will act if we do the same thing in a negative logic system.

As far as using TTL or CMOS logic in a negative logic system, electrical performance will be identical. The choice of using negative or positive logic seems to me to be more of a philosophical decision based upon logical preferences. Negative logic always seemed backward to me, a person who wants "positive," "true," "up," "right," "correct," "logical HIGH," "yes" and "truth-justice-and-the-American-way" to be logical synonyms while "negative," "false," "down," "left," "wrong," "logical LOW," and "anarchy" to be an opposite set of logical synonyms (i.e., the two groups are antonyms).

Writing to Q&A

As always, we welcome your questions. Please be sure to include:

- (1) plenty of background material,
- (2) your full name and address on the letter (not just the envelope),
- (3) and a complete diagram, if asking about a circuit; and
- (4) type your letter or write neatly.

Send questions to Q&A, **Poptronics**, 275-G Marcus Blvd., Hauppauge, NY 11788 or to q&a@gernsback.com, but do not expect an immediate reply in these pages (because of our backlog). We regret that we cannot give personal replies. Please no graphics files larger than 100K. P



B		A		Y	
5V	LOW	5V	LOW	0V	HIGH
5V	LOW	0V	HIGH	5V	LOW
0V	HIGH	5V	LOW	5V	LOW
0V	HIGH	0V	HIGH	5V	LOW

Fig. 4. A 74LS00 chip operates as a NOR gate if it is used in a negative-logic system. It is very important to note that even though the assignment of LOWs and HIGHs are reversed, Vcc and ground connections to the 74LS00 chip remain the same whether in a positive- or negative-logic system.



Plant Trees

Contactless Angular Measurement

Recently, I was building a robot for a competition that needed the ability to go down a hallway without running into the wall. Simple. I walk down hallways every day, and I very rarely run into the wall. However, the robot is effectively blind, which changes things considerably. Just how does one get the robot to *see* when it is parallel to the wall and heading straight down the hallway, versus not parallel and heading for the wall?

After contemplating various methods and considering that the competition penalizes the robots for touching the wall, I decided that the robot would need to detect its angle with respect to a wall without actually touching the wall. This would enable the robot to correct its course while in motion and while staying in the middle of the hallway. If, for some reason, the robot finds itself more than 20 degrees off, it could stop, spin until parallel to the wall, and then resume movement.

The question now was how to get distance detection sensors arranged in such a way that they would be able to detect the angle.

Positioning The Sensors

The first idea I had on positioning the sensors was to place two sensors on my robot, one pointing to the right and one pointing to the left, as shown in Fig. 1. With these in place, the robot can quickly determine if it is in the center of the hall. Using this information, it can determine if it needs to turn right or turn left. This was a fast solution, but it did not detect if the robot was parallel to the wall, which left this problem: If the robot is in the center of the hall, but not parallel to the wall, the robot would make the assumption that it needs to go in a straight line when it really needs to turn.

The next idea was to move the two sensors out in front of the robot. This would detect if the front of the robot

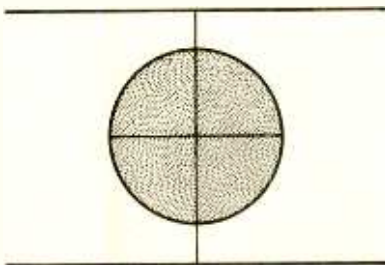

Fig. 1. When the robot is sitting in the middle of the hall, both sides will be the same distance from the wall.

needed to move to the left or to the right. While this appeared to be a better solution, it still left the same problem.

The solution was to place one sensor on the front of the robot facing towards one side and a second one on the back of the robot facing towards the same side. This would detect how far the back of the robot was from the wall and how far the front was from the wall. Using this method, the sensors would provide two different distances if the robot were not parallel to the wall.

As shown in Fig. 2, when the robot is parallel to the wall, both of the sensors return the same reading because they are the same distance from the wall.

However, when the robot is at an angle from the wall as shown in Fig. 3, one of the sensors will return a larger reading than the other.

By using a little trigonometry, the angle between the robot and the wall could be determined. To derive this

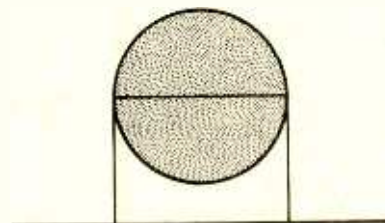

Fig. 2. When the robot is sitting parallel to the wall, both the front and the back are the same distance from the wall.

angle, the ratio of the difference between the two measurements to the walls and the distance between the two sensors are used in an Arctangent calculation—Arctangent(Y/X).

A Quick Lesson In Trigonometry

Arctangent is defined as the angle (A) that corresponds to a specific ratio created by dividing the length of the side opposite the angle (Y) by the length of the side adjacent to the angle (X). An Arctangent diagram is shown in Fig. 4. Arctangent literally means “the Arc (angle) of the Tangent (Ratio).”

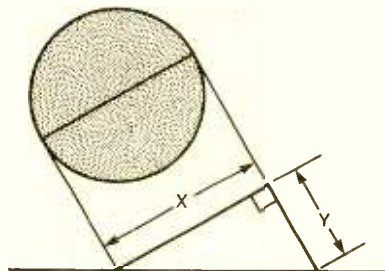

Fig. 3. When the robot is sitting at an angle to the wall, the front and back are different distances from the wall.

A mathematical comparison chart of Arctangent and Sine is shown in Fig. 5. The chart is marked off in 10° ticks, spanning a total of 360°, where the left side is 0° and the right side is 360°. Most of you should already know what a Sine wave looks like and, therefore, should be able to pick out the Sine wave on the chart. However, the Arctangent wave looks totally different. It starts out flat and then decreases sharply, flips to the top of the chart, and then sharply declines back to a flat line.

Notice that that closer to 0°, the flatter the slope on Arctangent is. I already decided that if the robot's course-correction angle is more than 20°, the robot should stop, turn, and then resume. This meant that I only needed a formula for in-motion course correction that was

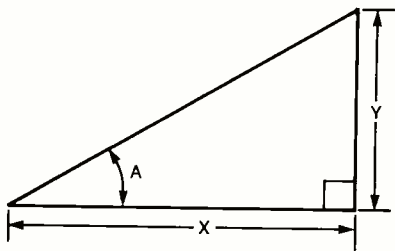

Fig. 4. Arctangent is the angle (A) that corresponds to the ratio of the length (Y) divided by the length (X).

concerned with the first 20° of Arctangent.

Figure 6 shows a zoom-in of the first 20° of the chart shown in Fig. 5. Since the first 20° of Arctangent is so flat, it is possible to substitute a constant value for the Arctangent function altogether.

The ratio that is needed for Arctangent to return 20° is 0.364. To determine the value to use as the constant, the angle of 20° is divided by the ratio, which yields a constant of 55. The actual formula is:

$$20/0.364 = 54.95$$

where 54.95 is rounded to 55. By using 55 as a constant, the formula:

$$\text{Degrees} = 55 * (Y / X)$$

can be substituted for the formula:

$$\text{Degrees} = \text{Arctangent}(Y / X)$$

for angles under 20°.

To verify that the formula with the constant would work in place of the formula with Arctangent, the two formulas were computed with both 20 and 10 degrees:

$$\text{Arctangent}(0.36397) = 20^\circ \text{ and } (55 * 0.36397) = 20.01835$$

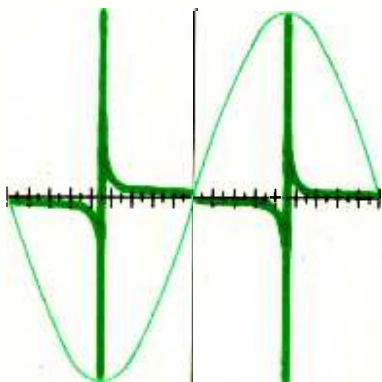

52 Fig. 5. Arctangent and Sine.

$$\text{Arctangent}(0.17633) = 10^\circ \text{ and } (55 * 0.17633) = 9.69815$$

Despite a small error rate, these formulas are essentially equivalent and therefore the formula with the constant can be used.

Using The Sharp GP2D12 Infrared Distance Sensor

Now that we have the formula to use, the next step is to get the numbers into it. The distance sensor I selected was the Sharp GP2D12 Infrared Distance Sensor.

This sensor determines the distance between itself and an item placed in front of it. It has a limited range of 80cm (2.6 feet), but for the requirements of the competition, this would be more than adequate. The sensor reports the distance by returning a non-linear analog voltage that can be read by an analog-to-digital converter. The problem with the non-linear result that it returns is that the ratios will wind up not being correct for the trigonometric calculations. What is needed is a way to make the result linear. The OOPic II shown in the sidebar has a software object called oIRRange, which takes the non-linear reading from the Sharp GP2D12 and converts it into a linear distance reading of 64 steps per foot.

To connect the Sharp GP2D12 to the OOPic, one Analog-to-Digital I/O Line is used as shown in Fig. 7. The OOPic's +5-volt power can be used for one GP2D12. Since two or more will put a strain on the OOPic's voltage regulator, you will need a larger voltage regulator. A capacitor in the value of 4.7µF is placed between the sensor's output voltage and the ground.

To use a Sharp GP2D12 in an OOPic program, the oIRRange Object must be created and configured as shown in Listing 1.

"Dim IR As New oIRRange." This line initializes a new instance of the oIRRange object and names it "IR". This object knows how to read the Sony GP2D12 and convert its result to a distance of 64 steps per foot.

"IR.IOLine = 1." This line instructs the IR object to use I/O line number 1. On an OOPic, I/O line 1 can be found on the 40-Pin connector on pin 7.

"IR.Operate = cvTrue." This line instructs the IR object to start taking readings. Once the object is operating, any time that IR.Value is used anywhere

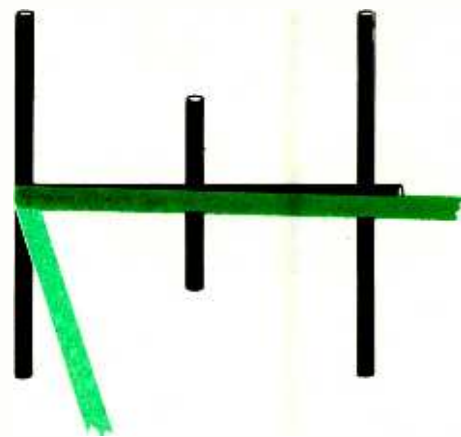

Fig. 6. The first 20° of Arctangent and Sine.

in the program, such as in a formula, the current distance measurement is returned.

Measuring The Angle

A test jig was made to test the angle of the robot in reference to the adjacent wall. It was constructed using two GP2D12s that were mounted on a strip of wood 10.125 inches apart (see photo).

The distance between the sensors of 10.125 inches was chosen, because my robot was 10 inches in diameter and the GP2D12s were going to be mounted on the outside edges. Since the oIRRange objects return distance in 64 steps per foot, a value that represented the distance between the sensors measured in 64 steps per foot would also be needed to properly calculate the required ratio. The distance between the sensors can be converted by multiplying the distance of 10.125 by (64/12), which calculates the distance between the GP2D12s in 64 steps per foot. The resulting value was 54. Referring back to Fig. 2, the distance between the sensors is the X-value, so 54 is plugged into the formula:

$$[\text{Degrees} = 55 * (Y / X)]$$

which results in a formula of

```

LISTING 1
Dim IR As New oIRRange
Sub main()
  IR.IOLine = 1
  IR.Operate = cvTrue
  ' At this point, any time that IR.Value is read,
  ' it will be the current distance measurement.
End Sub

```

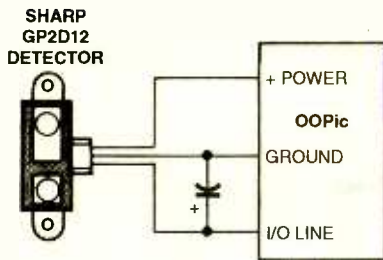



Fig. 7. Hookup diagram for connecting a Sharp GP2D12 to an OOPic.

$$[\text{Degrees} = (55 * (Y / 54))]]$$

This formula can be reduced by dividing 55 by 54. The result of 55/54 is 1.0185, which can be rounded to 1 and plugged back into the formula:

$$[\text{Degrees} = (Y * 1)]]$$

This, of course, can be reduced to a formula of:

$$[\text{Degrees} = Y]$$

The difference between the two distances obtained from the two oIRRange objects is calculated simply by subtracting the two values. (FrontDistance -

BackDistance) This number is the Y-value in the formula. After plugging this in, the formula for determining the angle to the wall works out to be:

$$[\text{Degrees} = \text{FrontDistance} - \text{BackDistance}]]$$

That sure was a lot of work to come up with a calculation that simple.

Don't assume that this reduced formula will work for all cases. It relies on a coincidental relationship between the two values that are used in the original trigonometric formula. The 1st -value that is required for this coincidence was the 64 steps per foot that the oIRRange object returns. The 2nd was the distance between the sensors of 10.125 inches. If you take the time to work the math back the other way, you will discover that the optimal distance between the sensors is 10.3125 inches; however, this change makes the result only 2 hundredths of a degree more accurate.

Displaying The Results

To see the calculations in operation, I wrote the program shown in Listing 2 that displayed both positive and negative angles as positive numbers. A value of 128 was added into the formula to make the negative numbers show up as positive numbers, resulting in the following calculation:

$$[\text{Degrees} = 128 + \text{Front Distance} - \text{Back Distance}]]$$

With this calculation, a reading of 128 is now considered parallel to the target.

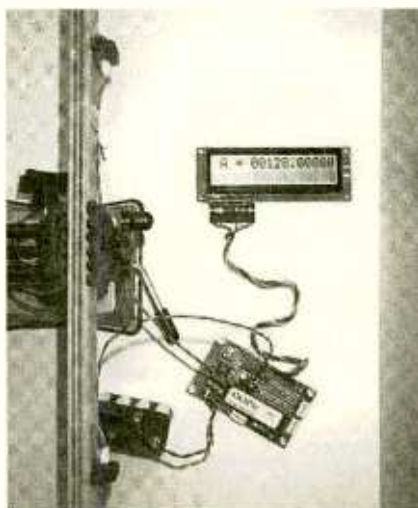

The test jig configured with 2 Sharp GP2D12s parallel to a wall.

NEW PRODUCT RELEASE

The OOPic has been enhanced to make robotic control easier. The OOPic II has over 30 **new** built-in functions (objects) to control hardware, such as stepper and DC motors; and read sensors, such as IR Distance detectors, compasses, and flame detectors. New objects and enhancements to existing objects have also been made to the OOPic's unique virtual circuit feature. In addition to the



The OOPic II has a large number of robotic sensor software objects, including one that reads the Sharp GP2D12.

objects, a new bank of memory has been added for variable storage space. Like its predecessor, the OOPic II has a multi-tasking operating system and an Object-Oriented language to simplify the task of controlling the hardware in your project. The OOPic II is 100% code-compatible with the original.

Next Month

Next month, we will discuss how to control the motors on the robot in such a way that they correct the robot's course based on the angle. In that article, Magnevation's Dual PWM board will be used to control two DC Motors that will move the robot down the hall.

On the Web

Both the OOPic and the Sharp IR Distance Detector are available from Acroname Robotics at www.acroname.com. LCD modules are available from BGMico at www.bgmico.com. More information on the OOPic can be found at: www.oopic.com. Information on Magnevation's Dual PWM board can be found at www.magnevation.com. 

Great consumer information is a shoe-in with our free Catalog. Call toll-free 1 (888) 8-PUEBLO or go to www.pueblo.gsa.gov.

LISTING 2

' Note: This program uses Version 4.00 of the OOPic compiler.

' Instructions for connecting the LCD can be found at: www.oopic.com/lcd.htm.

Dim LCD As New oLCD
Dim FIR As New oIRRange
Dim BIR As New oIRRange

Sub main()

Call IOSetup

Do

LCD.Locate(0,0)

LCD.String = " A = "

LCD.String = STR\$(128+FIR-BIR)

Loop

End Sub

Sub IOSetup()

' This routine sets the IO lines that are used.

LCD.Iogroup = 3 'IO group used for nibble out to LCD

LCD.Nibble = 1

LCD.IOLineE = 27

LCD.IOLine.RS = 26

LCD.Operate = cvTrue

FIR.IOLine = 1

FIR.Operate = cvTrue

BIR.IOLine = 2

BIR.Operate = cvTrue

End Sub

Basics Of High-Voltage Probe Design

BOX: The devices described in this article involves the use of materials and substances that are hazardous to health and life. **DO NOT** attempt to implement or use the information contained in this article unless you are experienced in the construction and safety considerations that apply to high-voltage devices of this nature. Although all possible measures have been taken to ensure the accuracy of the information presented, Gernsback Publications Inc. is not liable for damages or injuries, misinterpretation of directions, or the misapplications of information.

There are all sorts of times when being able to determine the value of a high-voltage DC source is desirable. Most multimeters have a maximum range of 750-1000 volts. (One exception is the workhorse Simpson 260, which has a 5000-volt range). Whether testing a TV with a dim picture, a HeNe laser power supply that does not work quite right, or troubleshooting some home-built, high-voltage project, the ability to measure 10, 20, 30, or more kV can come in handy. This month we deal with the design of simple HV probes that can be used to safely extend the range of either an analog or digital multimeter.

Warning

The microwave oven is perhaps the most dangerous equipment you are likely to encounter around the house. The high-voltage (up to 5000 volts) along with the high-current (1 amp or more) availability make this an instantly lethal combination. It is highly recommended that **NO** measurements be made on a powered microwave oven. Only after the plug has been pulled and its high-voltage capacitor has been safely discharged should you even think about touching or probing anything. Most troubleshooting can be done with an ohmmeter at most.

See the document "Troubleshooting and Repair of Microwave Ovens" at my Web site, www.repairfaq.org, for more information. By comparison, other consumer electronic equipment, like TVs and monitors, are tame. While still very dangerous, they don't have quite the deadly quality of the microwave oven!

Read the document "Safety Guidelines for High Voltage and/or Line Powered Equipment" at my Web site before attempting to work with high-voltage systems. High voltage can jump amazing distances when you least expect it. The direct or indirect consequences of this can ruin your entire day or a whole lot more.

Basic Considerations

CAUTION: DMMs may not be particularly forgiving of voltages on their inputs exceeding their specifications. Auto-ranging DMMs may be even more likely to blowout as they are selecting the correct range—if there even is one. Depending on your electrical and mechanical components, the chance of excess voltage due to arc-over, leakage, or component breakdown may be a major consideration. My analog VOM has survived many close encounters with HV. You should not assume the same for the typical low-cost or even expensive DMM. There is a reason for the high cost of commercial HV probes—these kinds of factors are incorporated (hopefully) in their design.

A simple high-voltage probe for a DMM or VOM may be constructed from a pair of resistors. This is suitable for DC measurements, but without compensation, will have an unknown AC response due to the very high impedance and stray capacitance forming a filter—low-pass or high-pass depending on the amount of stray capacitance and input capacitance of your meter or scope. However, this simple design is sufficient for the majority of consumer electronics work, which are mostly DC measurements. I have not characterized the AC response of this probe design. However, if there is AC riding on your high voltage, it may mess up your readings if there is no compensation provided as it may act as a high-pass filter.

To design the voltage divider, you must take the input impedance of the meter into account. There is a minor, but significant, difference between DMMs and VOMs.

DMM: Z-in is usually constant, often 10M ohms.

VOM: Z-in is the voltage range (full scale) times the ohms/volt rating of the meter.

Figure 1 shows the basic circuit: R1 together with R2 parallel to R3 form a voltage divider where R3 is the internal-resistance of the DMM or VOM on the scale for which the probe is designed.

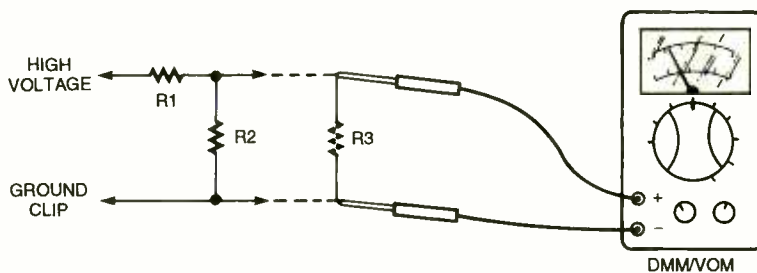

Fig. 1. This is a basic circuit for protecting your multimeter from some high voltages.

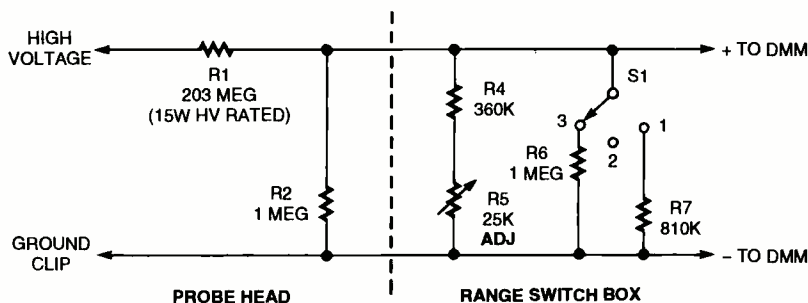

Fig. 2. Here is a home-built HV probe switch selectable to use a VOM or DMM. It is comprised of a probe head circuit and a range switch-box circuit.

While R2 is not strictly needed, it is recommended that it be included and approximately equal to the Z-in of the meter on the scale you will be using. The reason to include R2 is to insure that high voltage can never reach the meter. The ground clip should be securely connected to the metal chassis of the device being tested—the frame of a microwave oven or CRT grounding/mounting strap of a TV or monitor—before it is powered up. Both R1 and R2 should be located in the probe head.

The only difficult part is locating a suitable resistor for R1 that has high enough resistance and is physically long enough so that arc-over is avoided. However, don't expect them to pay much attention to you for an order of five resistors! It may be possible though, to obtain free samples if you explain what you're doing—and their lawyers don't get involved! If this doesn't work out, electronics surplus outfits occasionally come up with odd lots of strange components, such as these, and they even show up on eBay from time to time.

The high-value, high-voltage resistor can also be constructed from several equal lower-value resistors in series if they are all approximately the same size. Another possibility is salvaging the focus-divider networks from dead fly-backs or TV/monitor voltage-multiplier assemblies. Even if the unit was discarded as being faulty, where there are no internal shorts in the HV rectifier or resistive network itself, the entire unit can be used intact.

In addition to basic safety precautions when working around high voltages, some form of equipment protection should be considered to provide an arc-over path to ground, should there be arcing over the surface of the resistor as well as if the resistor should somehow

decrease in value. There is no telling what can happen under less-than-ideal, damp, or dirty conditions.

A "corona," "arc," or "discharge" ring could be placed around the resistor near the low-voltage end securely connected to the ground cable. The idea is that any arcing over the surface should find this as its destination before obliterating your meter.

A variety of devices could be placed across R2 to limit the maximum voltage present in the event of a breakdown. Suitable devices include neon light bulbs (NE2s without resistors); zener, avalanche, or ordinary diodes; or other semiconductor junction devices. Traditional surge suppressors like MOVs and Tranzorbs may work, but their off-state impedance may be too low compared to R2. The neon bulb is good, since its impedance is essentially infinite until its breakdown of 90 volts or so is reached. In some cases, these devices will be destroyed (semiconductors may short), but they will have served their protective function and are a small price to pay to prevent you and your meter from being blown up.

Frequency Response

Probe compensation similar to that used on oscilloscope probes can be implemented. However, the determination of the capacitor values is beyond the scope of this article. To put it simply, the ratio of the capacitance C1:C2 (where C1 is across R1 and C2 is across R2 parallel to R3) needs to be equal to the ratio of R2 parallel to R3 to R1 (or equivalently, to the inverse of the voltage-divider ratio). Capacitor C2 includes the stray capacitance and input capacitance of the meter or scope probe. The capacitor across R1 would need to sustain the HV, so that is another complication. Since a 10x scope-probe usually

has an input impedance of 10M, the same design as used for the DMM would work with a scope. Although I have not pursued this issue, it sounds like based on the ratio (1000:1 would mean that C1 would need to be extremely small, probably smaller than the stray capacitance of the R1 and the associated wire) you would need to add a capacitance for C2 and to make sure that there will be enough stray capacitance such that no physical C1 will be needed.

If you are only interested in DC measurements, putting a 0.1 μ F capacitor across R2 should smooth out any 50/60 Hz or higher-frequency ripple.

The implementation of full-probe compensation is left as an exercise for the motivated student.

Here are some simple high-voltage probe design examples.

50,000-Volt Maximum Using A 10-Megohm Z-In DMM

By my rule above, I will select R2 to be 10 megohms. Fine adjustment of calibration could be made by making R2 out of a combination of a fixed resistor and a multiturn pot.

To minimally load the circuit under test, R1 should be as high as practical. Practical here means low enough so that leakage over its surface is not a problem and so that a reasonable voltage can be developed across R2 parallel to R3 and high enough so that loading of the equipment being tested will not change the readings by more than a few percent.

Placing R2 parallel to R3 yields 5 megohms. Selecting R1 to be 4995 megohms will give a 1000:1 ratio so that 50,000 volts will read out as 50 volts on the DMM. A measurement of 4995 megohms is high enough that loading of a 250-megohm focus network should not be an issue (5%). A ratio of 1000:1 is easy to remember. You could go to something higher if loading is still a concern, but then leakage current over the surface of R1 becomes an even greater concern. Even 5000 megohms is about as close to an open circuit as you can get—any contamination whatsoever will change the calibration significantly. You may find that using a resistance around 1000M will result in less of a problem and accept the circuit loading that this value implies.

For all practical purposes, you can use 5000M instead of the exact value of 4995M. The error of about 0.1 percent

will be less than the error spec of most portable DMMs and much less than the error spec of any VOM. Plus, you probably aren't going to risk your expensive precision-bench multimeter on this lunacy anyhow!

50,000-Volt Maximum Using A 30K Ohm/V VOM

This is a little more complicated than you need to pick a range and then calculate the Z-in for that range. For example, for the 100-volt range of a 30K ohm/V VOM, the Z-in will be 3 megohms. For the same 5000-megohms R1 and 10-megohm R2, you would get a reading of 23 volts (roughly) on the 100-volt scale for a 50-kV input. The divide ratio in this case is about 218.

It is a simple matter to determine a scale and an R2, such that the actual high-voltage measurement is easily calculated from the meter reading. What you want is the ratio of R1 to R2 parallel to R3 to be a nice round number. Note that switching ranges will produce some peculiar behavior due to this current division between R2 and R3. A unique R2 must be selected for each range of interest. You are already using nearly the maximum sensitivity of the meter, and switching to a lower range will only slightly change the position of the needle unless you construct a range switch box as shown in Fig. 2.

In reference to Fig. 2:

S1—SPDT center off toggle switch.

All resistors except R1 are 1/2-watt, 2 percent.

50,000-volt maximum based on the particular R1 I had laying around (1000:1-voltage division).

S1-1 is RadioShack DMM on 3, 30, or 300-volt scale (10M Z-in).

S1-2 is VOM, 25-volt scale (30K ohm/V, 750K Z-in).

S1-3 is VOM, 100-volt scale (30K ohm/V, 3M Z-in).

Modifications to use a higher-value R1 are straightforward.

Simple Circuit

I have constructed a high-voltage probe from the surplus-bleeder resistor from a defunct video terminal. For the probe tip, I used a discarded probe from a VOM. The resistor and probe tip were mounted inside an insulating plastic tube with R2 included at its base. A ground cable with an alligator-clip provided the connection to the chassis.

There was a second pair of wires with banana plugs connected to the meter via a switchbox, which could select between a DMM or a couple of different scales on a VOM. Potting the entire HV head is a good idea to minimize the possibility of arc-over. Remember that 50,000 volts can jump several inches (two inches in dry air approximately). See above text for other suggestions on equipment/you protection (which is not shown).

This circuit uses only a 203-megohm high-voltage resistor. Since the internal resistance of a typical focus-divider network is 200–300 megohms, this probe would obviously load such a circuit excessively.

Calibration

Unless you have a calibrated HV supply, a working TV for which you have the service manual makes a good starting point. The proper high-voltage is usually specified to within 5–10%. If you have a line-transformer based HV supply (e.g., neon sign transformer, rectifier, or capacitor), then this would be pretty accurate based on your power-line voltage. For a DMM with a constant input resistance, you can use a low voltage (like a few hundred volts) on a lower range and extrapolate for the HV range. However, for a VOM, you cannot use this technique, since changing ranges also changes the parallel resistance of R2 parallel to R3. You are already using nearly the full sensitivity of the meter.

Wrap-Up

If you will be making HV measurements regularly, by all means invest in a real HV probe for your multimeter. What is described above can be built and used safely, but probably won't have the accuracy, consistency, or frequency response of a good commercial probe. Aside from purchasing a new HV probe, these do show up surplus as well as on eBay, possibly at greatly reduced prices. Even if a model isn't available for your particular multimeter (which is likely), it should be possible to adapt almost any commercial probe to work with it, requiring at most a scaling factor when taking a reading.

There is some additional information on HV probe construction, frequency compensation, and commercial HV probes on my Web site, www.repairfaq.org. As always, I welcome questions, comments, and corrections (via e-mail only please, sam@repairfaq.org).

VCR Cross Reference

**NOW Find the right Part
for your VCR**

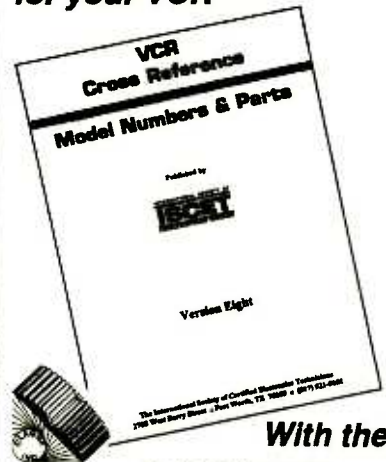

With the

ISEET VCR

CROSS REFERENCE

This 172-page reference contains both model and part-number cross-references updated as of Feb, 1997.

VCR's are made in a few factories from which hundreds of different brand names and model numbers identify cosmetically-changed identical and near-identical manufactured units. Interchangeable parts are very common. An exact replacement part may be available only a few minutes away from you even though the manufacturer supplier is out-of-stock. You may be able to cannibalize scrap units at no cost!

The ISEET VCR Cross Reference is pre-punched for standard loose-leaf binding. . \$29.95 includes shipping in the United States for each Reference.

Claggk Inc.

VCR CROSS REFERENCE OFFER

P.O. BOX 12162

HAUPPAUGE, NY 11778

Name _____

Business _____

Address _____

City _____

State _____ Zip _____

Phone _____

Enclose \$29.95 for the Eighth Edition of the ISEET VCR Cross Reference including shipping for each Reference in the United States. All other countries add \$5.00 (surface mail).

The total amount of my order is \$ _____
Check enclosed—do not send cash.
or please charge my credit card.

Visa MasterCard Exp. Date ____/____/____

Card No. _____

Signature _____

New York State residents must add applicable local sales tax to total. US funds only. Use US bank check or International Money Order. **CB02**

BASIC CIRCUITRY

mailto: basiccircuitry@gernsback.com

CHARLES D. RAKES

MORE BATTERY-TESTING CIRCUITS

Here we are again, ready to continue our battery-testing adventure. Last visit we covered a few voltage-monitoring circuits along with loading methods. We're going to start this session off with a simple pulsed on/off battery-life testing circuit, followed by a slightly more complex pulsed system with many additional timing features. Then, we'll move on to constant-current discharge circuits, which just may be the very best method for meaningful life testing comparisons.

Our first on/off load-testing circuit is shown in Fig. 1. A 555 IC timer is connected in a simple low-frequency astable oscillator circuit with the on/off rate

controlled by R4 and S1. The timing may be varied from several cycles a second to many seconds a cycle. The two loads are switched across the test batteries by Q1 and Q2.

The circuit is not adaptable for testing single 1.5-volt cells; however, two 1.5-volt batteries may be operated in series and tested. Of course, the batteries must be the same make and age when testing. Almost all batteries with output voltages of over 3 volts are made up of two cells or more to obtain the labeled output voltage. The ever popular 9-volt alkaline battery contains six 1.5-volt cells connected in series to develop an output of 9 volts.

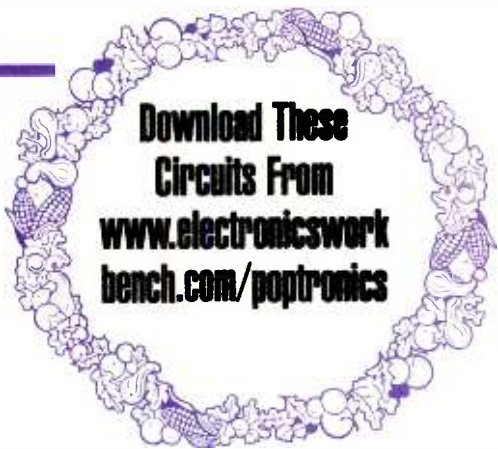

PARTS LIST FOR THE PULSED LOAD TESTER (FIG. 1)

SEMICONDUCTORS

Q1, Q2—2N2222A NPN transistor
IC1—555 timer IC

RESISTORS

(All resistors are 1/4-watt, 5% units.)
R1—R3—1000-ohm
R4—1-megohm potentiometer

CAPACITORS

C1—1.0- μ F, 25-WVDC, electrolytic
C2—10- μ F, 25-WVDC, electrolytic
C3—100- μ F, 25-WVDC, electrolytic
C4—.1- μ F, ceramic disc

ADDITIONAL PARTS AND MATERIALS

S1—SP3P rotary switch
S2—SPST switch
Batteries and load resistors, see text

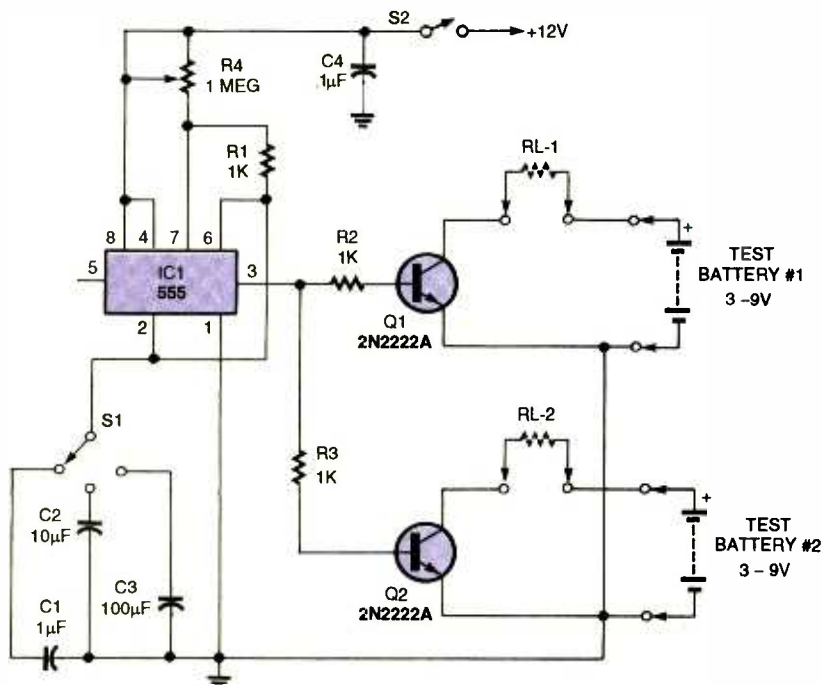

Fig. 1. This simple circuit uses a 555-timer chip and a low-frequency astable oscillator circuit controlled by R4 and S1. Be sure the batteries are from the same manufacturer when testing.

Each time the 555's output at pin 3 goes high, both Q1 and Q2 go into saturation, switching RL 1 and RL 2 to ground. This places the loads across the batteries. The low collector-to-emitter saturation voltage has very little effect on testing batteries of 3 volts and greater. Playing with the value of R1 can vary the circuit's on/off percentage some. The fastest on/off rate is when S1 is in position 1 and R4 is near its minimum resistance value—the opposite is true for the slowest on/off rates.

An improved circuit, with a precision variable on/off timer feature, is shown in Fig. 2.

The same basic 555 oscillator circuit we just looked at in our first circuit

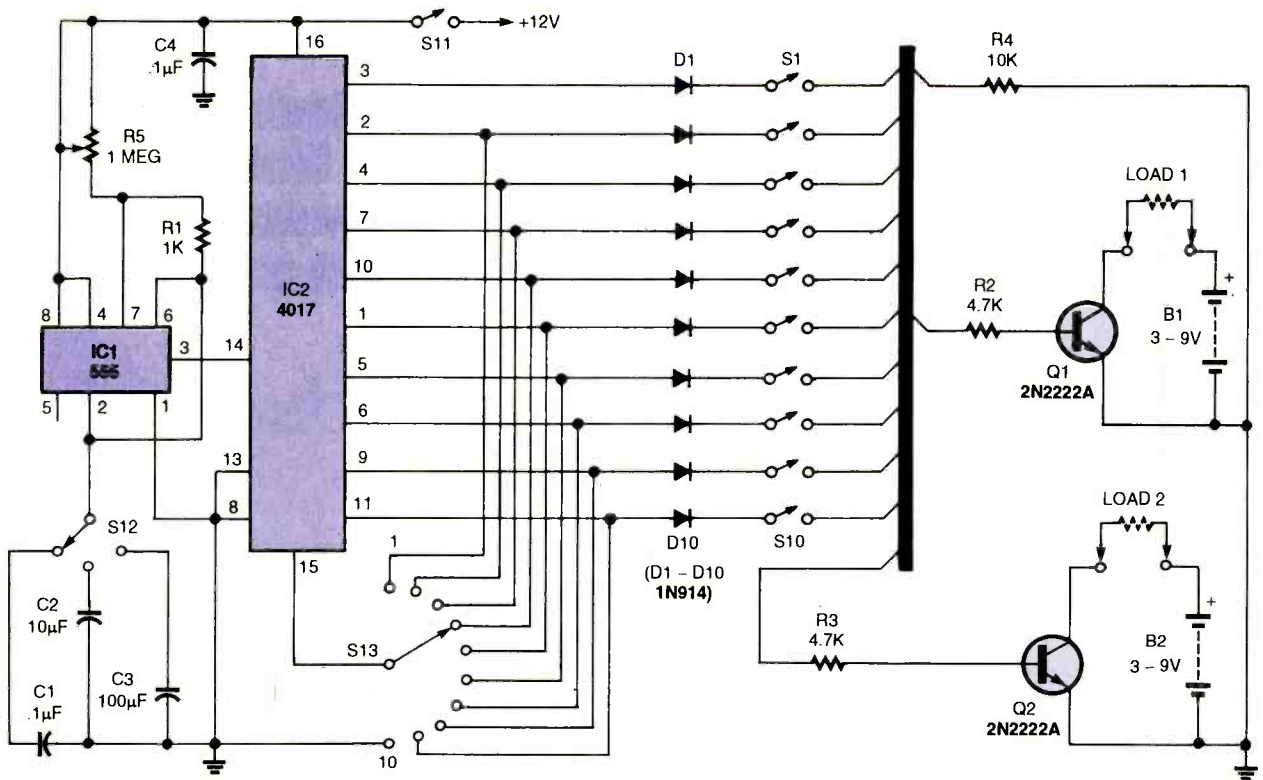

Fig. 2. This circuit incorporates a 4017 divide-by-ten counter into the circuit from Fig. 1. Switch S13 controls the cycle frequency by setting the number of steps before the cycle is repeated. Position ten will connect pin 15 to ground, which will cause a continuous test of all ten steps.

PARTS LIST FOR THE IMPROVED ON/OFF TEST CIRCUIT (FIG. 2)

SEMICONDUCTORS

- Q1, Q2—2N2222A NPN transistor
- IC1—555 timer
- IC2—4017 decade counter IC
- D1-D10—1N914 silicon diode

RESISTORS

- (All resistors are 1/4-watt, 5% units.)
- R1—1000-ohm
 - R2, R3—4700-ohm
 - R4—10,000-ohm
 - R5—1 megohm potentiometer

CAPACITORS

- C1—1.0- μ F, 25-WVDC, electrolytic
- C2—10- μ F, 25-WVDC, electrolytic
- C3—100- μ F, 25-WVDC, electrolytic
- C4—.1- μ F, disc ceramic

ADDITIONAL PARTS AND MATERIALS

- S1-S11—SPST switch
- S12—SP3P rotary switch
- S13—SP10P rotary switch

serves here as a clock-pulse generator for the 4017 divide-by-ten counter. Each time the 555's output goes positive, the 4017's output goes forward one step. This continues for ten sequential steps, which produces a positive output at each of the 4017's outputs. All other outputs are low, with only one high at a time. A

good analogy is a single-pole rotary switch with ten positions. Our circuit basically does the same thing electronically, which is easier, faster, and definitely more reliable.

The 4017's ten outputs are isolated from each other with coupling diodes, D1-D10. These diodes keep the 4017's

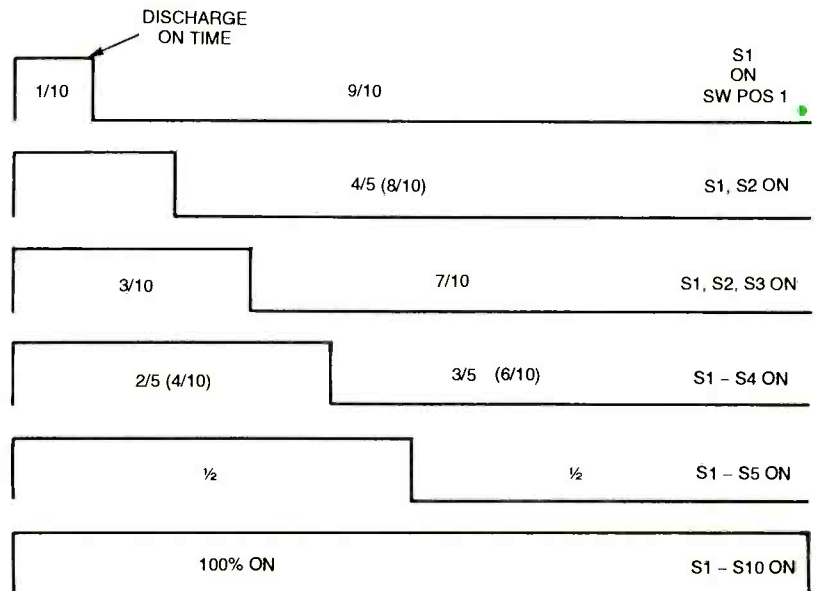

Fig. 3. Here are the waveforms that should appear at the output bus. When all the switches are closed, a steady high will be present.

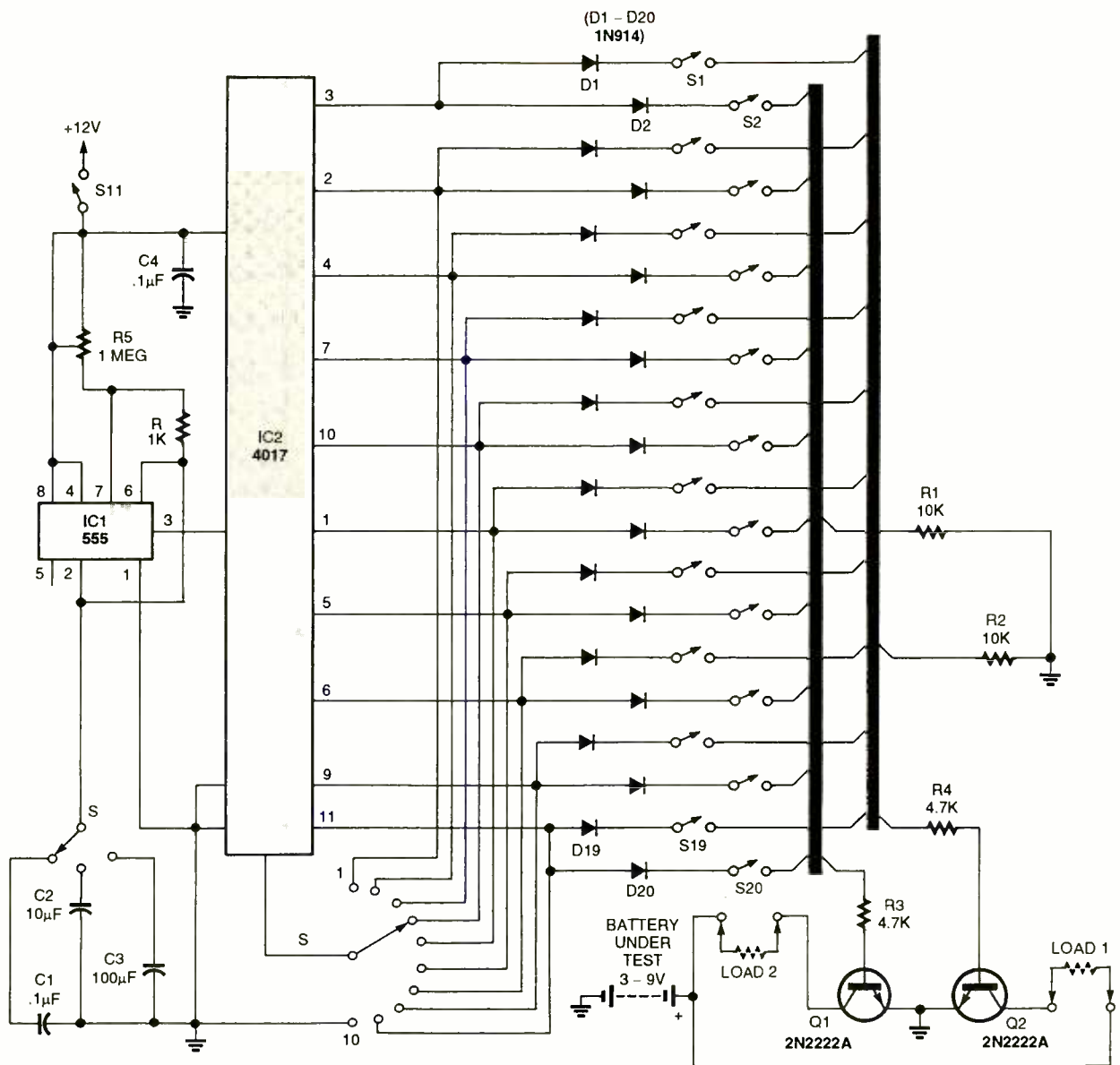

Fig. 4. This version of the circuit allows two loads to be tested in a timed sequence. Notice each pin of the 4017 has two diodes—one for each load.

PARTS LIST FOR THE MORE COMPLEX TESTER (FIG. 4)

SEMICONDUCTORS

D1-D20—1N914 silicon diode
Q1, Q2—2N2222A NPN transistor

ADDITIONAL PARTS AND MATERIALS

S1-S20—SPST switch
R1, R2—10,000-ohm, ¼-watt, 5% resistor
R3, R4—4700-ohm, ¼-watt, 5% resistor

activated output from feeding its positive voltage back into the other nine low outputs. The diodes also allow any or all of the outputs to be switched on to drive the load-switching transistors, Q1 and Q2.

Pin 15 of the 4017 determines how many steps the counter will take before repeating the sequence. Returning pin 15 to circuit ground allows the counter to step through all ten positions.

The drawing in Fig. 3 illustrates how the waveform appears at the output buss. This positive-output pulse drives Q1 and Q2 on, placing the load resistors across the batteries during this time period. The following outputs are true when S13 is in position 10. Closing S1

produces a positive output for 1/10th of the total cycle time, which is the same time period as a single clock pulse. With S1 and S2 closed, the output pulse is twice as long and so on and on until all switches (S1-S10) are closed for a 100% on time.

The position of S13 determines the number of steps that occur before the cycle is repeated. In position 1 the output makes single steps over and over at the clock rate. All other outputs are out of the loop. Position 2 allows two steps to occur and then repeat. In the 10th position, the output moves through ten steps and then repeats over and over as long as power is applied.

The reasoning behind all these vari-

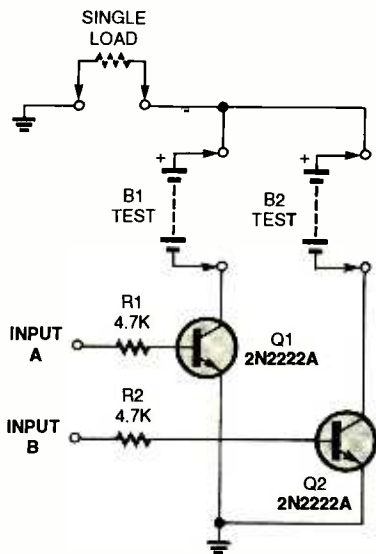

Fig. 5. Here is an add-on circuit for Fig. 4. A single load can be applied to two batteries, but not at the same time. Using the same load to test each battery should give a more accurate measurement.

PARTS LIST FOR THE SINGLE-LOAD CIRCUIT (FIG. 5)

Q1, Q2—2N2222A NPN transistor
 R1, R2—4700-ohm, 1/4-watt, 5% resistor
 B1, B2—Test batteries

able test parameters is to have the ability of simulating a real-world load to the batteries under test.

If two different makes of batteries are being compared, it is very important that both loads are operated with identical on/off timing. Almost every application that is battery-powered offers a unique load.

The incandescent light bulb used in the majority of flashlights is just one example. The flashlight bulb is definitely a resistive load; however, it is in no way a simple fixed-value resistor. The initial turn-on current of a typical bulb is several times its normal operating current. The resistance of a lamp is very low with no current flowing. The bulb's resistance rises to a much higher value when rated voltage is applied. Only batteries with a low internal resistance should be used to power this type of load. Any device that has a DC-operated motor also demands a higher output current to start the thing moving. One of the most demanding popular devices around today is the digital camera. They eat batteries three times a day and go to

bed hungry. Battery-operated clocks and other low-current demanding devices are often powered by a single 1.5-volt alkaline battery or a small-size, long-life lithium battery.

Now we'll get back to some examples using our versatile battery-life tester. A battery-operated device that demands maximum current for only a short portion of its total operating time is difficult to simulate with a fixed resistor load, but it's a relatively easy job for our tester. Switch S13 to position 10, close S1, and connect the batteries to the test terminals. Select the desired load resistance (take a look at last month's column) and connect it to the load terminals. Do the same for both load 1 and load 2. This set-up will apply the load to the batteries for 1/10th of the total cycle time. Setting the 555 oscillator to a one Hertz per second would place the batteries under load for one second and off for nine seconds. If more on time is desired, switch on S2 or more of the output switches. A much slower repetition rate may be in order. Slowing the clock down to one Hertz per minute will give a ten-minute platform for the load testing. Study the device's load demands and try to match it as closely as possible with the tester's timing adjustments. Use one of the battery voltage-monitoring circuits offered in our last visit.

Expanding The Possibilities

A slightly more complex version of the life tester is shown in Fig. 4, which allows two different loads to be applied to the batteries in a timed mode. Two sets of isolation-diode strings and switches are provided to allow setting up the load circuit for two separate load resistors. Also not shown is a duplicate-output circuit, which includes Q1, Q2, R3, R4, and the load resistors. Now two batteries may be tested at the same time.

Here's how the test circuit may be set up to apply a heavy initial start-up load, followed by a lower-value operating load. Set S13 (see Fig. 2) to position 10 and close (Fig. 4) S1, S4, S6, S8, and S10. These settings will apply the heavy load (load 1) for 1/10th of the time and the lighter load (load 2) for the remaining 9/10th of the time. Components S11, S12, S13, and R5 of Fig. 2 operate the same way in Fig. 4.

One Load, Two Batteries

Another add-on circuit, see Fig. 5,

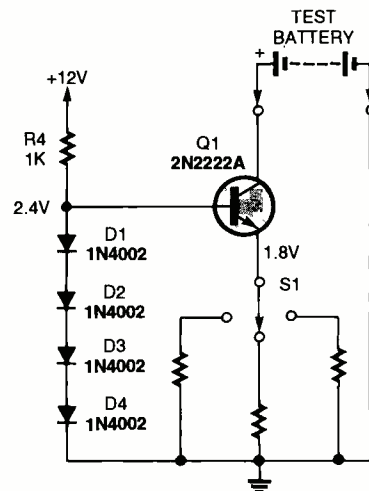

Fig. 6. Using Ohm's Law, one can calculate the required values of resistors R1, R2, and R3 within this constant-current test circuit. The four silicon diodes in series provide a voltage reference for Q1's base.

PARTS LIST FOR THE CONSTANT-CURRENT CIRCUIT (FIG. 6)

Q1—2N2222A NPN transistor
 D1-D4—1N4002 silicon diode
 S1—SP3P rotary switch
 R1-R3—See text
 R4—1000-ohm, 1/4-watt, 5% resistor

for the tester in Fig. 4 allows a single load to be applied to two different batteries during a life-test period. Of course, both batteries cannot be connected to the single load at the same time. Just connect input "A" in Fig. 5 to buss 1 in Fig. 4 and "B" to buss 2. The odd-numbered switches in Fig. 4 operate buss 1, and the even-numbered switches operate buss 2. Never have a single output of the 4017 switched to both inputs of the transistors at the same time. As long as only one switch per output is on, you're ok.

Here's one reason to use a single load on both batteries with our time-sharing circuit. The load can now be any device the batteries are normally used to operate. Using the same load for each battery can insure a fair jury in determining which battery is best suited for the test load. Using power Darlington transistors in place of Q1 and Q2 will allow test currents over one amp. You can use either a 2N6043 or a 2N6059 (both are Darlington transistor) for higher load currents.

The timing circuit can be set to a

very low clock rate, which will allow the load to be operated in a near normal manner. A flashlight is a good load for alkaline batteries and can be cycled off and on at a very slow rate. Set the circuit's clock to about one pulse per minute and switch S3, S5, and S7 on for setting up output buss 1. Switch on S14, S16, and S18 for output buss 2. This set up will operate the flashlight from test battery B1 for three minutes and then be turned off for two minutes and on for three minutes with test battery B2. This sequence will be repeated as long as power is applied to the test circuit.

Jacking Up The Current Demand

Using a constant-current load on the

test batteries will speed up the testing process. A fixed-resistor load only draws the maximum test current for a short time. As the battery voltage begins to drop, the resistor receives less current, which allows the battery to loaf along during the remainder of the test. A constant-current load demands the same output current from the battery regardless of its output voltage.

Figure 6 shows a simple constant-current circuit that is suitable for battery-load testing. The test currents using the 2N2222A transistor should be no higher than about 50 mA. Four 1N4002 silicon diodes are connected in series and serve as a voltage refer-

ence for Q1's base. The voltage at the base of Q1 is about 2.4 volts, and the voltage at the emitter is about 1.8 volts. The constant-current load level is set by the value of Q1's emitter resistor. Using Ohm's Law ($R = E/I$) will give us the needed resistor value to set each switch position for a desired load current. A 10-mil load requires a 180-ohm emitter resistor. A 50-mil load current would require a 36-ohm resistor. Any current value in between is easily determined by the above formula.

It's time to close for this visit, but tune in again next month. We'll continue with the constant-current testing and testing rechargeable batteries as well. P

OP-AMP

(continued from page 45)

Install a single op-amp such as a 741 in SO1, and reconnect the power

adapter. Red LED1 should be on. Press S1 and LED1 should go out and green LED2 should go on.

PARTS LIST FOR THE OP-AMP AND COMPARATOR CHECKER

SEMICONDUCTORS

- D1, D2—1N4002 silicon diode
- LED1, 3, 5, 7—Light-emitting diode, red
- LED2, 4, 6, 8—Light-emitting diode, green

RESISTORS

(All fixed resistors are 1/4-watt, 5% units, unless otherwise noted.)

- R1—22,000-ohm
- R2—18,000-ohm
- R3—10,000-ohm
- R4-R7—2200-ohm

CAPACITORS

- C1, C2—1000- μ F 25v, aluminum

- electrolytic capacitor
- C3, C4—100-nF, ceramic disc
- C5—10- μ F 12-volt, aluminum electrolytic capacitor

ADDITIONAL PARTS AND MATERIALS

- J1—3.5-mm power jack, or jack to mate with selected 9-V_{AC} adapter
- S1—Normally-closed push-button switch (RS 275-1548)
- SO1, SO2, SO6—8-pin DIP IC socket
- SO3, SO4, SO5—14-pin DIP IC socket
- 9-V_{AC}, 500-mA wall plug-in adapter (JAMECO 10129 or equivalent), printed-circuit materials, project enclosure, wire, solder, hardware, etc.

Disconnect the power, remove the IC in SO1, and repeat the above procedure for a dual op-amp such as the 1458 in SO2. Red LED1 and LED3 should be on initially, followed by green LED2 and LED4 when S1 is pressed.

Next, repeat for a quad op-amp such as an LM324 in SO3 and then a 4136 quad op-amp in SO4. In each case, all four red LEDs will initially be lit, followed by all four green LEDs when S1 is pressed.

Repeat for the comparators—the LM339 in SO5 and then the LM311 in SO6. As described earlier, only the red LEDs will be functional and will go out when S1 is pressed. The LM311 will illuminate only LED1. The LM339 will illuminate all four red LEDs. P

IT'S NOT WORTH THE WEIGHT.



For better health and fitness,
exercise.

American Heart Association 

© 1992, American Heart Association

RETAILERS THAT SELL OUR MAGAZINE EVERY MONTH

Arizona

Elliott Elec. Supply
1251 S. Tyndell Ave.
Tucson, AZ 85713

California

All Electronics
14928 Oxnard Street
Van Nuys, CA 91411

California Electronics
221 N. Johnson Ave.
El Cajon, CA 90202

Electronics Plus, Inc.
823 4th St.
San Rafael, CA 94901

Electronics Warehouse
2691 Main Street
Riverside, CA 92501

Ford Electronics
8431 Commonwealth Ave
Buena Park, CA 90621

HSC Electronics
5681 Redwood Drive
Rohnert, CA 94928

HSC Electronics
4837 Amber Lane
Sacramento, CA 95841

Halted Specialties Co.
3500 Ryder Street
Santa Clara, CA 95051

Kandarian Electronics
1101 19th Street
Bakersfield, CA 93301

Mar Vac Electronics
2001 Harbor Blvd.
Costa Mesa, CA 92627

Mar Vac Electronics
1759 E. Colorado Blvd.
Pasadena, CA 91106

Mar Vac Electronics
4747 Holt Blvd.
Montclair, CA 91763

Mar Vac Electronics
5184 Hollister Blvd.
Santa Barbara, CA 93111

Mar Vac Electronics
2537 Del Paso Blvd.
Sacramento, CA 95815

Mar Vac Electronics
2000 Outlet Center Dr. #150
Oxnard, CA 93030

Mar Vac Electronics
12453 Washington Blvd.
Los Angeles, CA 90066

Metro Electronics
1831 J Street
Sacramento, CA 95814

Orvac Electronics
1645 E Orangethorpe Ave.
Fullerton, CA 92631

Sav-On Electronics
13225 Harbor Blvd.
Garden Grove, CA 92643

Colorado

Centennial Elec. Inc.
2324 E. Bijon
Colorado Springs, CO
80909

Connecticut

Cables & Connectors
2315 Berlin Turnpike
Newington, CT 06111

Illinois

Tri State Elex
200 W. Northwest Hwy.
Mt. Prospect, IL 60056

Maryland

Mark Elec. Supply Inc.
11215 Old Baltimore Pike
Beltsville, MD 20705

Massachusetts

Electronic Hook-Up
104 Main St.
Milford, MA 01757

"You-Do-It" Electronics
40 Franklin Street
Neeham, MA 02494

Michigan

Purchase Radio Supply
327 East Hoover Avenue
Ann Arbor, MI 48104

The Elec. Connection
37387 Ford Road
Westland, MI 48185

Minnesota

Acme Electronics
224 Washington Avenue N.
Minneapolis, MN 55401

Missouri

Gateway Electronics
8123-25 Page Blvd.
St. Louis, MO 63130

New Jersey

Lashen Electronics Inc.
21 Broadway
Denville, NJ 07834

New York

LNL Distributing Corp.
235 Robbins Lane
Syosset, NY 11791

T&M Elec. Supply, Inc.
472 East Main Street
Patchogue, NY 11772

Unicorn Electronics
Valley Plaza
Johnston City, NY 13790

Ohio

Parts Express
725 Pleasant Valley Drive
Springboro, OH 45066

Oregon

Norvac Electronics
7940 SW Nimbus Avenue
Beaverton, OR 97005

Texas

Computers Electronics Etc.
110 E. Medical Center Blvd.
Webster, TX 77598

Electronic Parts Outlet
3753 B Fondren
Houston, TX 77063

Tanner Electronics
1301 W Beltine
Carrollton, TX 75006

Washington

Supertronix Inc.
16550 W. Valley Hwy.
Tukwila, WA 98188

*Barnes & Noble • B. Dalton • Crown Books • Tower Books • Super Stand
Borders Book Store • On Cue • Hastings • Media Play • Walden Book Store
Just About Every Major Book Store!*

**If you'd like to sell our magazine in your store, please circle 180 on free
information card or Contact Gina Giuliano at (631) 592-6720 ext 215**

Poptronics®

SHOPPER

POLARIS CAN SUPPLY YOU WITH ALL OF TODAY'S HOTTEST VIDEO TECHNOLOGY!

CALL OR GO ON-LINE TO ORDER YOUR FREE VIDEO CATALOG - 100's OF PRODUCTS - MICRO CAMERAS - WIRELESS VIDEO - LIPSTICK CAMERAS - DIGITAL VCR's
WEB CAMERA WITH BUILT-IN PAN/TILT/ZOOM CONTROLS WEATHERPROOF DIGITAL STORAGE CAMERA



Compact Web Camera For Online Image Monitoring and Delivery Over The Internet

Featuring a built-in Web server, powerful 10x zoom, pan/tilt, and alarm input/output capability, all in an ultra-compact unit. These Web cameras can be installed virtually anywhere and deliver high-quality images to the Internet for real-time monitoring or broadcast. Better yet, these cameras can be controlled and monitored via a standard Web browser, making it ideal for a wide variety of applications.
 Size: 122mm x 82mm x 97mm.

- ☛ Ultra-compact, all-in-one web camera with built-in web server
- ☛ Monitoring and camera control possible via web browser
- ☛ 10x optical zoom and multi-angle pan/tilt capability
- ☛ 10Base-T interface for direct connection with network
- ☛ Alarm In/Out function for automatic surveillance
- ☛ Three different security levels

The SWC-40R combines a black & white video camera, digital image storage, video motion detection and an alarm interface in a compact, vandal proof enclosure. It is unique as it offers a complete CCTV surveillance system within a single compact enclosure.

- ☛ All-in-one CCTV system
- ☛ Built-in digital image storage
- ☛ Programming and image retrieval by remote control
- ☛ Built-in video motion detection

NO TAPES!

SWC-40R \$849.95

Dimensions 5" x 4" x 4.5"



"YOUR WEB BROWSER IS YOUR REMOTE EYE!"

The FlexWatch acts as an internet camera server. No software needed in order to view your video. All you need is a web browser such as Internet Explorer or Netscape. FlexWatch includes many special functions including video quality control, pan/tilt/zoom interface and network configuration. All of them are controlled by the web browser. Features 4 video inputs - 3 external.

FLEXWATCH-100 - CALLS



CONTROL PAN / TILT AND ZOOM REMOTELY OVER THE INTERNET!

LIVE VIDEO!

COLOR & B/W SUBMERSIBLE CAMERAS

CAN SEE UNDER WATER!



B/W version comes with attached 80 meter cable (color-20 meter). Built-in white LED's give this camera a 15 meter infrared range. Heat resistant glass and water resistant design allow for rugged applications.

VIDEO CAMERA HEAD CAN BE SUBMERGED UP TO 100 FEET!

SUBCAM-BW (B/W) - \$249.95
SUBCAM-CL (COLOR) - \$299.95

5" COLOR WIRELESS OBSERVATION SYSTEM



ADD UP TO 3 ADDITIONAL CAMERAS!

Now you can enjoy peace of mind with our new wireless observation system. Comes with 5" wireless color monitor and a wireless color camera. Just Plug-&-Play! Perfect for around the house or office.

2.4GHz GW-2400S - \$379.95

MICRO VIDEO HEAD "SNAKE" CAMERA

Incredibly small micro head color camera incorporates a CCD chipset. (Not CMOS). Fully adjustable focus from 0.5 inches to infinity. Automatic Iris for varying light levels.



VIDEO HEAD IS ONLY 7mm IN DIAMETER!

MH-SCO1 \$479.95

6.4" COLOR TFT-LCD MODULE
TFT MONITORS AVAILABLE FROM 2.5" - 15"



Back Side of Module
HIGH RESOLUTION!

Our new 6.4" Color TFT Module can be used for a variety of purposes such as; custom automotive dash installations, video phone, door phone, boat installations, covert ultra-compact surveillance packages, security and more.

Dimensions
TFT-64M - \$319.95 1.5"(W) x 1.75"(H) x 0.5"(D)

2.4 GHz A/V TRANSMITTING MODULE



4 CHANNELS!

2.4 GHz

Makes any camera wireless! Excellent for hobbyist / remote control airplanes.

2.4GHz 4 channel video transmitting module with audio capability / power switch and antenna.

MPX-2400 - \$89.95

Dimensions
2.4GHz RECEIVER GFR-5002 - \$119.95
 1.5"(W) x 1.75"(H) x 0.5"(D)

COVERT COLOR SPY CAMERA



It's small sleek indestructible design and pinhole lens allow for various applications and simple installation. Comes equipped with a RCA JACK for easy connection to TV monitor or VCR. Great for covert use in any-place imaginable.

25mm(W) x 17mm(D) **CM-550CP - \$79.95**

-MICRO BOARD CAMERAS- MANY MODELS IN STOCK TO CHOOSE FROM!



MB-1250HRP
Hi-Res Color Pinhole
5.0mm Lens
1.27" x 1.27"
\$109.95

WEATHERPROOF CAMERA



Color Camera
 400 TV Lines
 Automatic Iris
Hi-Res Color Lipstick Camera
 Length: 2.6"
 Diameter: .785"
WP-300C - \$159.95

MONITOR UP TO 4 VIDEO CAMERAS SIMULTANEOUSLY THRU YOUR INTERNET CONNECTION OR OVER YOUR MODEM!



MOTION DETECTION - ALARM RECORDING - NOTIFICATION!

- ✓ TCP/IP Highlight an area on your video screen, and the PV-140 will inform you via modem thru your telephone or pager if there is movement in that highlighted area while recording to your hard disk.
- ✓ MODEM
- ✓ LAN/WAN

PV-140...4 Input Digital Video Card...\$299.95

POLARIS INDUSTRIES 800-752-3571 470 Armour Drive NE • Atlanta GA 30324-3943 Tech 404-872-0722 • Fax 404-872-1038 WWW.POLARISUSA.COM

CIRCLE 228 ON FREE INFORMATION CARD

Turn your hobby into a career!

Be an FCC LICENSED ELECTRONIC TECHNICIAN!



Earn up to \$100 an hour and more!

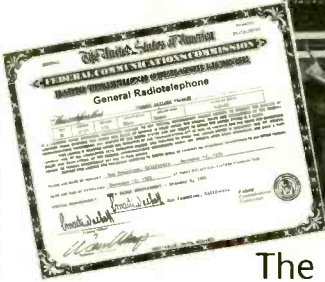

The Original Home-Study course prepares you for the "FCC Commercial Radiotelephone License" at home in your spare time. This valuable license is your professional "ticket" to thousands of exciting jobs:

- Communications
- Radar
- Maritime
- Microwave
- Radio-TV
- Avionics & more

You can even start your own business!

No need to quit your job or go to school. This proven course is easy, fast and low cost!

SEND FOR FREE FACTS NOW!

Mail coupon today or call

(800) 932-4268 Ext. 210

Visit our Website: www.LicenseTraining.com

COMMAND PRODUCTIONS

FCC LICENSE TRAINING - DEPT. 210
P.O. Box 2824 • San Francisco, CA 94126-2824
Please rush FREE details immediately!

Name _____

Address _____

City _____ State _____ Zip _____

CIRCLE 321 ON FREE INFORMATION CARD

Turn your PC into a 16-bit Storage Scope spectrum analyzer, and digital multimeter!

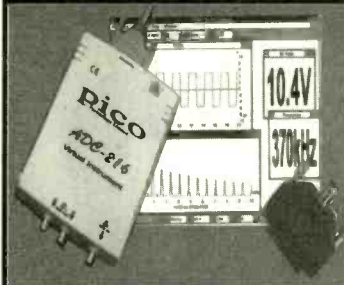

Turn your PC or laptop into a sophisticated storage scope & spectrum analyzer & multimeter. Display on large screen! Print in color! 100MS/s 8-bit, 1.2MS/s 12-bit or 333kS/s 16-bit versions. Great for test depts, schools. Input to Excel. LabView/NT drivers. High precision not high cost! Models from \$95 - \$799!

DrDAQ
science lab in a box!

great for science fairs!

DrDAQ is a sophisticated digital data-logger that plugs into a PC and comes with sensors for light, sound, pH and temp. Lots of suggested science experiments included which can be done from software supplied. Spectrum analyzer/scope/meter all at once! DrDAQ from only \$99!

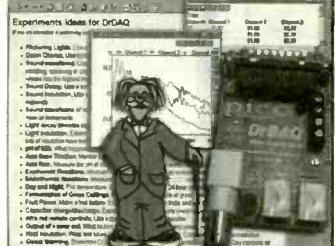

www.saelig.com

RS232-422/485 converters, self-powered, opto-isolated I2C adapter boards for PC communication with I2C bus Mini dataloggers for events, voltages, pressures, etc. Enviromon temperature and environment netwk logger Thermocouple and thermistor adapters for PC ports. BASIC-programmable BASIC-TIGER controller modules JANZ CANbus boards - from Germany's leader! SMD adaptor boards for prototyping with any SM parts!



Saelig Company

www.saelig.com saelig@aol.com
716-425-3753 • 716-425-3835 (fax)

1-888-7SAELIG

SERIAL LCDs

Serial LCDs work great with BASIC Stamps® and other microcontrollers. One-wire interface • simple serial protocol • low cost • high quality • in stock

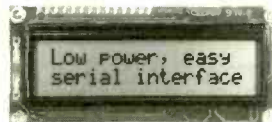

BPI-216N

- 2x16 text LCD
- 2400/9600 bps
- \$45 (non-backlit)

- **SGX-120L**
- Mini graphics LCD
- 2400/9600 bps
- just \$99



Many other models available—see www.seetron.com/

Scott Edwards Electronics, Inc.
www.seetron.com • 520-459-4802

Electronic Kits



What You Want.....
Today!™



You Must Provide this Source Code to Receive Discount Pricing

POP91

call toll free

1-800-543-4330

fax toll free

1-800-765-6960

customer service call toll free

1-877-626-3532

www.mcmelectronics.com

Visit our website for other gift ideas.

- Audio Products
- Books
- Cameras
- Car Audio and Security
- Computer Accessories
- Games
- Headphones
- Home Theater
- Joysticks
- Personal Electronics
- Radios
- Receivers
- Test Equipment
- Tools
- Tool Boxes/Cases
- More

for the Holidays

ELENCO Solder Station Kit

Build your own solder station with variable temperature control. Electronically controlled from 5 to 40 watts. Includes heavy-duty soldering iron. A special solder practice project is also included to help you achieve good soldering techniques. A great two-for-one project. Mfr. #SL5-40K.

Order # 80-4400 Reg. ~~\$30.29~~

Only! **\$24.95**



ELENCO Digital Multimeter Kit

This easy to build meter kit is perfect for any training program or hobbyist. Features include: •3½ digit LCD display •18 ranges •Transistor test •Diode test •Overload protection •Includes test leads and detailed manual Specifications: •DC voltage ranges: 200mV, 2V, 20V, 200V, 1000V •AC voltage ranges: 200V, 750V •DC current ranges: 200µA, 2mA, 20mA, 200mA, 10A •Resistance in ohms: 200, 2K, 20K, 200K, 2M •Dimensions: 2.9" (W) x 5" (L) x 1" (D)

Order # 80-4770 Reg. ~~\$25.29~~

Only! **\$21.95**



ELENCO 500-in-1 Electronic Project Lab Kit

Learn the basics of electronics and put your knowledge to work creating 500 different electronic experiments, special lighting effects, radio transmitter and receivers, amazing electronic sound effects, cool games and more. Includes built-in breadboard for easy wiring and connection of components and an LCD indicates the information during the experiments in process. Build your knowledge by exploring amplifiers, analog and digital circuits plus how to read schematic diagrams. Includes transistors, transformers, diodes, resistors, capacitors, phototransistors, integrated circuits, speaker, earphone, LEDs, LED digit display and a fact-filled, illustrated, lab-style manual. Requires six "AA" batteries (not included). Mfr. #MX-909.

Order # 80-5050 Reg. ~~\$184.79~~

Only! **\$159.95**



ELENCO Digital/Analog Trainer

A low cost, full-function digital/analog trainer that meets the needs of electronic training programs. Rugged, high impact molded case with flow-thru cooling to ventilate the power supply. Specifications: Digital: •Eight data switches •Two no bounce logic switches •Eight LED readouts, buffered •Clock frequency 1Hz, 1KHz, 100KHz and 60Hz •Clock amplitude 5V p-p square wave Analog: •Function generator - sine and square wave •Frequency adjustable in two ranges from 200 to 4KHz •Amplitude 4V p-p sine wave, 12V p-p square wave General: •Two power supplies •Two undedicated potentiometers 1Kohm and 100Kohm •One breadboard with 830 tie points including two bus strips •Dimensions: 11" (L) x 11" (W) x 2" (H) •Mfr. #XK-150

Order # 80-4395 Reg. ~~\$100.99~~

Only! **\$89.95**



ELENCO Radio Controlled Car Kit

The purpose of this project is to expand your understanding of basic transmitters, receivers and electronic switching theories. Your Turbo King Car will be built from the ground up. You'll learn about gears, motors, printed circuit boards and integrated circuits from our detailed assembly and training manual. You will construct each section, explore the circuitry and troubleshoot it. The completed car features seven remote functions, flashing top light and single channel operation. The remote control is included. Requires four "AA" and one 9V battery (not included).

Order # 80-4415 Reg. ~~\$32.29~~

Only! **\$27.95**



GFX AM/FM Headphone Radio

•Rugged sports design for outdoor use •AM/FM receiver •Foam swivel earpads for comfortable fit •Adjustable headband with rear safety strap •Flexible whip safety antenna •Requires two "AA" batteries (not included) •Mfr. #AHP3500RS

Order # 80-4225 Reg. ~~\$10.09~~

Only! **\$8.99**



Source Code: POP91

Prices effective October 1 through December 29, 2001.

CIRCLE 324 ON FREE INFORMATION CARD

A Premier Farnell Company

The Standard for checking Capacitors in-circuit



Good enough to be the choice of Panasonic, Pioneer, NBC, ABC, Ford, JVC, NASA and thousands of independent service technicians.

Inexpensive enough to pay for itself in just one day's repairs. At \$179, it's affordable.

And with a 60 day trial period, satisfaction guaranteed or money-back policy, the only thing you can lose is all the time you're currently spending on trying to repair all those dogs you've given up on.

CapAnalyzer 88A

Available at your distributor, or call 561-487-6103

Electronic Design Specialists

www.eds-inc.com

Locate shorted or leaky components or conditions to the exact spot *in-circuit*

Still cutting up the pcb, and unsoldering every part trying to guess at where the short is?

\$179



Your DVM shows the same shorted reading all along the pcb trace. LeakSeeker 82B has the resolution to find the defective component. Touch pads along the trace, and LeakSeeker beeps highest in pitch at the defect's pad. Now you can locate a shorted part only a quarter of an inch away from a good part. Short can be from 0 to 150 ohms

LeakSeeker 82B

CIRCLE 210 ON FREE INFORMATION CARD

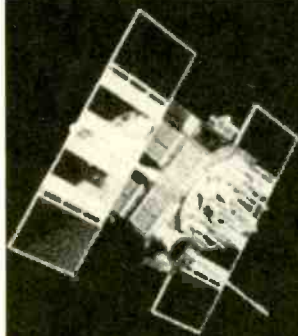

The only GPS electronics trainer on the market!

Graymark[®]'s GPS-101TM

Now you can use the technology of the global positioning system, to deliver a motivating and comprehensive electronics program to your students. Our kit uses GPS technology to teach your students analog and digital circuits, using low level components. The kit includes all necessary hardware, CD's and instructions and provides from 20 to 40 hours of classroom course work.

Graymark[®] International, Inc.

(800) 854-7393

[Http://www.graymarkint.com](http://www.graymarkint.com)

"1st in Electronics, 1st in Quality & Service."



Learn PC Repair!

The Ultimate Self-Paced PC Assembly and Repair Course

This is the simplest, easiest and most complete course on how to understand, assemble, and diagnose PCs available today. It contains all the text, videos and diagnostic software you'll need to succeed.

Self-Study Course Manual

The manual is a self-study workbook that will enable you to quickly teach yourself all about computers, how they're put together and how to keep them working. Just follow the step-by-step instructions on each page.

At the end of the course you'll know how to build a PC and install & configure Microsoft Windows.

Call **(800) 321-2155**

Videos

The two videos included contain over 3 hours of the Micro 2000 engineering team teaching everything from the basics of PC assembly all the way to using the MicroScope software to troubleshoot them! Watch the pro's in action as they build a completely functional Pentium system with all the major peripherals.

Software

This course includes a Limited Edition version (25 uses) of the award winning MicroScope Diagnostic Software. Use it to build your own PC (computer not included), upgrade it and troubleshoot any problems.

www.ciebookstore.com



Only \$99.95
Complete Course

Product # 02-020

Course includes:

- 200 + Page Training Manual
- PC Assembly & Configuration Video
- PC Diagnostic Video
- Micro-Scope Diagnostic Software (LE)
- CD-ROM - contains videos and manual

CIE Bookstore: 1776 E 17th Cleveland, OH 44114

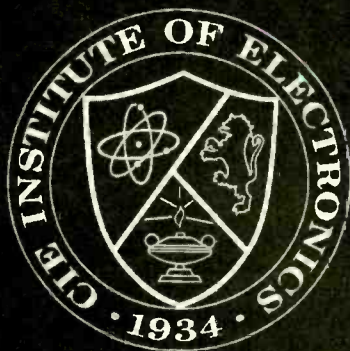

It's almost like being paid to study.

Earn an Associate Degree in Electronic Engineering Technology...

Put your knowledge of electronics to work for you. CIE offers the most comprehensive Associate Degree program offered in electronics. Best of all you study at your own pace with the full resources of CIE just a phone call or a click of a mouse away.

It's Comprehensive and Unique. You Pay for Only the Time You Use!

You won't find a better school than CIE if you want to accomplish your goals without pesky time restrictions (commuting, 8 hour class days, etc.) at CIE you study at your own pace, even an accelerated pace. And if you're like most readers of this magazine, your electronics background can help you receive your degree in less than the maximum 8 terms allowed. Finish sooner and you can save thousands of dollars in tuition. It's almost like being paid to study.

Get all the details on CIE's Associate Degree Program, World College's Bachelor Degree Program and CIE's 10 Career Courses today!



Free Course Catalog!

(800) 243-6446

www.cie-wc.edu

For a FREE Course Catalog on all of our Programs send to CIE: 1776 E. 17th St., Cleveland, OH 44114-3679 or visit www.cie-wc.edu PT30

Name: _____
Address: _____
City: _____
State: _____ Zip: _____
Phone: _____
E-mail: _____

CIRCLE 320 ON FREE INFORMATION CARD

RAMSEY

GET THE CATALOG TODAY!
Over 100 NEW products!
www.ramseykits.com



SYNTHESIZED FM STEREO RADIO STATION

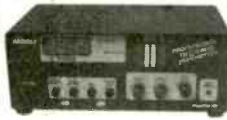

- Synthesized 88 to 108...no drift!
- Built in mixer - 2 line inputs and one microphone input!
- High power module available for export use
- Low pass filter for great audio

Our FM100 is used all over the world by serious hobbyists as well as churches, drive in theaters, and schools. The kit includes metal case, whip antenna and built-in 110 volt AC power supply.

FM100	Super-Pro FM Stereo Radio Station Kit	\$249.95
FM100WT	1 Watt, Wired Export Version	\$399.95

SYNTHESIZED FM STEREO TRANSMITTER



Professional quality rock stable synthesized transmitter. Dip switch settable for any frequency between 88-108 MHz. Strappable for high power output for export applications. Our most popular kit. Start your own radio station today with the FM25!

FM25	Synthesized FM Stereo Transmitter Kit	\$129.95
------	---------------------------------------	----------

FM STEREO TRANSMITTER



Great entry level FM broadcast kit. Thousands in use. Handy for sending music through house and yard, ideal for school projects too - you'll be amazed at the exceptional audio quality! Runs on 9V battery or 5 to 15 VDC. Add matching case and whip antenna set for great pro look.

FM10A	Tunable FM Stereo Transmitter Kit	\$34.95
CFM	Matching Case and Antenna Set	\$14.95
FMAC	12V DC Wall Plug Adapter	\$9.95

RF WIRELESS LINK MODULES



- SAW Resonators for high stability - NO Drift!
- Powerful +10 dbm output
- Range up to 600'
- 433 MHz license-free band
- Sensitive superhet receiver with RF LNA
- Stable over full 3-12 VDC range
- Optional on-board 12 bit encoder/decoder using Hitec HT12 series chips, Quarter not included!

RXD433	433 MHz Receiver/Decoder Mod., Assembled	\$26.95
TXE433	433 MHz Transmitter/Encoder Mod., Assembled	\$24.95
RX433	433 MHz Data Receiver Mod., Assembled	\$21.95
TX433	433 MHz Data Transmitter Mod., Assembled	\$19.95

THE CUBES! MINIATURE VIDEO TRANSMITTERS

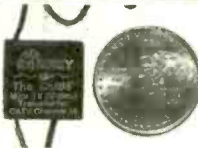

Wireless crystal clear reception, yet smaller than a quarter! Transmits color or B&W with fantastic quality almost like a hard wire connection to any TV or VCR tuned to cable channel 59. Crystal controlled for no frequency drift with performance that equals law enforcement models that cost hundreds more! Basic 20mW unit goes up to 300' while the

high power version can virtually double that range! Fully assembled and tested, and ready to go. Powered by a standard 9V battery. Name that Quarter!

C2000	Video Cube, Factory Assembled & Tested	\$89.95
C20Q1	High Power Version, Assembled & Tested	\$129.95

INFRA-RED VIDEO CAMERA ILLUMINATOR



Lets video cameras "see in the dark". Invisible light source to us, but lots of light to CCD B&W cameras! Illuminates the area just like light, yet cannot be seen. Draws 180mA at 12 VDC. 110VAC power adapter available.

IR1	Infra-Red Camera Illuminator Kit	\$24.95
AC125	12VDC Power Supply	\$9.95

ELECTRONIC PROTOTYPING SOFTWARE

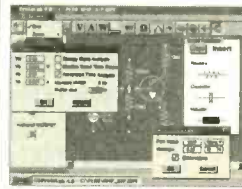

Priced for the hobbyist!

You can create and test AC and DC circuits minutes after installing this package on your PC. Start from scratch, or from the included library of pre-designed circuits. Drag and drop placement from a complete list of active and passive components. Test using a complete list of virtual instruments, Oscilloscope, voltmeter, ohmmeter, ammeter, and watt meter.

PLAB4	Electronic Prototype Software, Win95/98	\$49.95
-------	---	---------

ANALOG-DIGITAL PORTABLE LAB STATION



The COMPLETE analog-digital lab station in one. Includes function generator, clock output, power supplies, level switches, pulsers, pots, LEDs and a LARGE breadboarding area all in one! Includes a custom molded case as shown. Used through the world at universities, technical schools, and R&D labs. Available in "Learn as you Build" kit form or factory assembled and tested. A great buy either way!

ML200	Lab Station, Kit	\$155.95
ML200WT	Lab Station, Factory Assembled & Tested	\$225.95

CABLE WIZARD CABLE TRACER



Did you ever have to identify the "other end of that cable"? No more "ohming it out" with the Cable Wizard. Simply connect the wizard transmitter to one end of the cable and use the receiver to sniff out the other end. It's as simple as that! The transmitter sends a pulsating 2 KHz signal down the cable which is heard when the receiver is close to the cable. Works with any cable including coax, telephone pairs, ethernet and more. Equipped with an RJ45 for all telco connections and clip leads for single wire connections.

WCT20	Wireless Cable Tracer Kit	\$39.95
WCWT	Matching Case Set for Transmitter & Receiver	\$29.95
WCT20WT	Factory Assembled & Tested WCT20	\$99.95

SPEEDY PERSONAL SPEED RADAR GUN



This low cost microwave radar uses the same principle found in police units costing thousands more. This has been the number one Science Fair project for years. Direct digital readout in miles/hour, kilometers/hour, or feet/second. An earphone jack allows you to actually hear the Doppler frequency shift of moving objects. Our detailed manual not only guides you through construction, but covers

the how's and why's of speed radar theory. Learn while you build. Uses two 13 oz coffee cans for the antenna (not included) and runs on 12 VDC.

SG7	Speedy Personal Speed Radar Kit	\$99.95
AC125	12VDC Power Supply	\$9.95

AND...OUR FAMOUS MINI-KITS



These are easy to build kits that can be used either stand alone or as building blocks for more complex projects.		
TS4	Tickle-Stick Shocker	\$9.95
BN9	Super Snoop Amplifier Kit	\$8.95
BL1	LED Blinky Kit	\$3.95
TD1	Tone Encoder/Decoder Kit	\$6.95
TT7	Touch Tone Decoder Kit	\$29.95
CPO3	Code Practice Oscillator Kit	\$9.95
UT5	Universal Timer Kit	\$8.95

RAMSEY
ELECTRONICS, INC.

793 Canning Parkway
 Victor, NY 14564
 716-924-4560
sales@ramseykits.com



Order Today! 800-446-2295
www.ramseykits.com

CONTROL RELAYS • LIGHTS • MOTORS

MEASURE TEMPERATURE • PRESSURE • LIGHT LEVELS • HUMIDITY

INPUT SWITCH POSITIONS • THERMOSTATS • LIQUID LEVELS

MODEL 30 \$79



- PLUGS INTO PC BUS
- 24 LINES DIGITAL I/O
- 8 CHANNEL
- 8 BIT A/D / Fd
- 12 BIT COUNTER
- UP TO 14K 5AMP/SEC

MODEL 45 \$189



- RS-232 INTERFACE
- 8 DIGITAL I/O
- 8 ANALOG INPUTS
- 2 ANALOG OUTPUTS
- 2 COUNTERS-24 BIT

MODEL 100 \$279



- 12 BIT 100 MHZ A/D
- 4 ANALOG OUTPUTS
- 3 TIMER CENTERS
- 24 DIGITAL I/O

MODEL 150-02 \$179



- RS-232 INTERFACE
- TRMS, 20 A.MPS
- 12 BIT A/D
- OPTO-ISOLATED
- COMPLETE DMM

MODEL 40 \$109



- RS-232 INTERFACE
- 28 LINES DIGITAL I/O
- 8 ANALOG INPUTS
- PWM OUTPUT

MODEL 70 \$239



- RS-232 INTERFACE
- 18 BIT A/D
- 5.5 DIGIT
- UP TO 60 I.MP/SEC

Prairie Digital, Inc.

PHONE 608-643-8599 • FAX 608-643-6754

20 SEVENTEENTH STREET • PRAIRIE DU SAC, WISCONSIN 53578

CIRCLE 219 ON FREE INFORMATION CARD

Graphic Interface with Touch screen control

Priced From
\$140.00
Qty 1

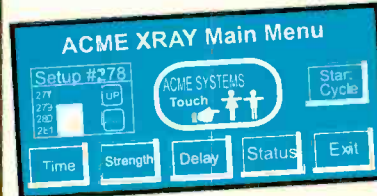

Easy Operator Interface
through serial connection



Easy Interface with PC/104, 8051, 68HC11, PIC

**Graphic display
Touch screen**
Serial communication (RS-232C)
Eprom or Flash for screen storage
Only +5VDC power required
Easy to use development software
Create screens by PC paintbrush
Simple to place touch buttons software



Many
Sizes
Available

Designtech Engineering Co.

2001 S. Blue Island Ave,
Chicago, IL 60608
Phone 312-243-4700
Fax 312-243-4776

Many Types
Indoor, Outdoor
Factory, Ext. Temp.
CCFL, LED
Available

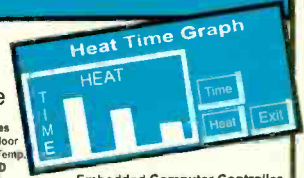

Embedded Computer Controller
Also Available

www.designtechengineering.com

Smart Battery Charger

New &
Improved



FOR GEL-CELLS or LEAD ACID BATTERIES.

Features: Precision temperature tracking voltage reference & three mode charging sequence. Standard kit is for 12V @ 1/2 or 1 Amp, user selectable. Can be connected to the battery indefinitely, will not overcharge. Weighs 2 pounds and measures 4"W x 5 1/2"D x 2 1/2"H. Finished enclosure included in kit.

Complete Kit Only \$59.95
Assembled & Tested \$79.95

CA residents add 7.50% sales tax. S&H: \$6.50 (insured)
Foreign orders add 20%. For more info: www.a-aengineering.com

A & A Engineering

2521 W. La Palma #K • Anaheim, CA 92801
(714) 952-2114 • FAX: (714) 952-3280

Do You Repair Electronics?

Repair Databases for
TV, VCR, Monitor, UL
Audio, FCC, and more.

- Over 76,000 records
- Private user forums
- Live on-line chat rooms

RepairWorld.com

Electronix Corp 1 Herald Sq, Fairfield, OH 45324 (937) 978-9878

PCB Services

From Concept to Production

Schematic Development
Fast Proto boards
Production boards
Plastic molding
Metal cases
Assembly

Making your designs
Affordable!



(800)259-0774
WWW.CTechindustries.com

EZ-EP DEVICE PROGRAMMER - \$169.95

Check Web!! -- www.m2l.com

Fast - Programs 27C010 in 23 seconds

Portable - Connects to PC Parallel Port

Versatile - Programs 2716-080 plus EE

and Flash (28F,29C) to 32 pins

Inexpensive - Best for less than \$200

- Correct implementation of manufacturer algorithms for fast, reliable programming.
- Easy to use menu based software has binary editor, read, verify, copy, etc. Free updates via bbs or web page.
- Full over current detection on all device power supplies protects against bad chips and reverse insertion.
- Broad support for additional devices using adapters listed below.

Available Adapters

EP-PIC (16C5x,61.62z,71,84)	\$49.95
EP-PIC64 (62-5,72-4)	\$39.95
EP-PIC12 (12C50x)	\$39.95
EP-PIC17 (17C4x)	\$49.95
EP-51 (8751 C51)	\$39.95
EP-11E (68HC11 E/A)	\$59.95
EP-11D (68HC711D3)	\$39.95
EP-16 (16bit 40pin EPROMS)	\$49.95
EP-Z8 (Z86E02,3,4,6,7,8)	\$39.95
EP-SEE2 (93x,24x,25x,85x)	\$39.95
EP-750 (87C750, 1.2)	\$59.95
EP-PEEL (ICT22v10, 88v8)	\$59.95
EP-1051 (89C1051,2051)	\$39.95
EP-PLCC (PLCC EPROMs)	\$49.95
EP-SOIC (SOIC EPROMs)	\$49.95

Many Other Adapters Available

M²L Electronics

970/259-0555 Fax: 970/259-0777
250 CR 218, Durango, CO 81301
CO orders add 7% sales tax
<http://www.m2l.com>

EZ-EP
M²L ELECTRONICS
Los Angeles, California



electronic components

MOUSER ELECTRONICS

(800) 346-6873

www.mouser.com

ONLINE FEATURES

- Ordering
- Product Search
- Catalog
- Spec Sheets
- Product Availability

sales@mouser.com

1-800-346-6873

MOUSER ELECTRONICS

A **ut** COMPANY

www.mouser.com

CIRCLE 205 ON FREE INFORMATION CARD

November 2001, Poptronics

VISION ELECTRONICS

BEFORE AFTER

- No Rolls/Jitters/Flickers/Fading
- Works on all TV's, VCR's, Beta, & Cable
- Gold Video Connectors & Cables Included
- 1 Year Warranty
- Money Back Guarantee

FREE CATALOG!

COPY RENTAL TAPES WITH OUR VIDEO STABILIZER

1-800-562-2252 2609 S. 156th Circle • Omaha, NE 68130
www.modernelectronics.com

Data Acquisition and Control

The ADR series of interfaces allow control of analog, digital and relay I/O via RS232 or RS485. Visit the web site for specs, applications and programs in VB, C, BASIC etc. (705) 671-2652

www.ontrak.net
Ontrak Control Systems Inc.

SINGERS! REMOVE VOCALS

Unlimited, Low Cost, Instantly Available Background Music from Original Standard Recordings! Does Everything Karaoke does. Better and gives you the Thompson Vocal Eliminator. Free Brochure & Demo Tape. LT Sound Dept PE 7988 LT Parkway, Lithonia, GA 301058 Internet: <http://www.LTSound.com> 24 Hour Demo/Info Request Line (770) 482-2485 - Ext 49 When You Want Something Better Than Karaoke!

Antique Electronic Supply

6221 S. Maple Ave. Tempe, AZ 85283
www.tubesandmore.com
NOS, Parts, Supplies, Books, Speakers, Transformers, Grill Cloth, and MORE!
Ph: 480.820.5411 • Fax: 480.820.4647, or 800.706.6789

Poptronics® SHOPPER

The Pocket Programmer

INTRONICS, Inc.
Edwardsville, KS
The Pocket Programmer

The Best just got Better!!!

The Best portable programmer that uses the printer port instead of an internal card just got Better!! Now with easier to use Windows based software that programs E(E)prom, Flash & Dallas parts. 25/27/28 & 29 series from 16K to 8Mbit. Adapters available for MCU's 874X, 875X, Pic, Atmel, PLCC packages, Bi-Prom's, 40-Pin X16 Eproms, Rom Emulator to 32K X 8 (2716-27256) and More...

Only \$149.95

Same Name, Address & Phone # for 19 Years.... Isn't it Amazing ?

Intronics, Inc.
Box 13723 / 612 Newton St.
Edwardsville, KS 66113
Tel. (913) 422-2094 Add \$7.00 COD
Fax (913) 441-1623 Add \$6.00 Shipping

WWW.IN-KS.COM Visa/MC/Amex/Discover

MECI 340 East First Street Dayton, Ohio 45402
Your Electronics Value Company

Tons of Electronics

Get your FREE catalog today and discover some of the best deals in electronics. We have thousands of items ranging from unique hard-to-find parts to standard production components. Call, write or fax today to start your subscription to one of the most unique catalogs in the industry, filled with super values on surplus electronic and hobbyist type items.

FREE CATALOG!

Checkout our 10,000 item on-line catalog <http://www.meci.com>

Order Toll Free Why pay more? Call today!
1-800-344-4465 Fax Order Line 1-800-344-6324

ROBOTS, ROBOTS, ROBOTS...

ROBOT STORE

FEATURING MUSCLE WIRES

STUFF For Robots, Bots, and More!
Robotic Kits, Home, Office

Robot Kits, Programmable Robots, LEGO® Robots, Living Robots, Muscle Wires®, Home and Office Robots, Electronic Kits & More!

Request our FREE 48 page catalog with over 300 items!

www.RobotStore.com
800-374-5764

Mondo-tronics Inc.
PMB-N, 4286 Redwood Hwy, Dept. 171
San Rafael, CA 94903
ph 415-491-4600 fx 415-491-4696
info@robotstore.com

YOUR LOCAL ONE STOP SHOP FOR ALL YOUR ELECTRONIC NEEDS!

Over 5,000 products on display for you to browse through, including:

- Electronic Components
- Test Equipment • Soldering Supplies
- Chemicals • Tools • Wire & Cable
- Books • Datacom • Prototyping
- Static Control and much more!



ACTIVE 8 Locations across the US!

BALTIMORE
TEL: (410) 863-0070
FAX: (410) 863-0075
active.baltimore@future.ca

CHERRY HILL
TEL: (856) 424-7070
FAX: (856) 424-7722
active.cherry.hill@future.ca

DETROIT
TEL: (734) 525-0153
FAX: (734) 525-1015
active.detroit@future.ca

SEATTLE
TEL: (425) 881-8191
FAX: (425) 883-6820
active.seattle@future.ca

CAMBRIDGE
TEL: (617) 864-3588
FAX: (617) 864-0855
active.cambridge@future.ca

CHICAGO
TEL: (847) 640-7713
FAX: (847) 640-7613
active.chicago@future.ca

LONG ISLAND
TEL: (631) 471-5400
FAX: (631) 471-5410
active.long.island@future.ca

WOBURN
TEL: (781) 932-0050
FAX: (781) 933-8884
active.woburn@future.ca

- Shop where the pro's shop for professional service, from a truly knowledgeable staff.
- Great Student Discounts.
- Fast delivery available!
- All the latest from the top manufacturers:

FLUKE Chemtronics

IDEAL Weller

Xcelite NTE alpha

MG Chemicals Tektronix

- Ask about our ACTIVEplus Rewards Program - NEW!

FREE CHIPLIFTER

Mention this ad in store & receive a FREE chiplifter!

(ACT # 86A09 valued at \$1.99.) One gift per customer, while quantities last.



ACTIVE

ELECTRONIC
COMPONENTS
DEPOT

www.activestores.com

CIRCLE 267 ON FREE INFORMATION CARD

Turn Your Multimedia PC into a Powerful Real-Time Audio Spectrum Analyzer

Features

- 20 kHz real-time bandwidth
- Fast 32 bit executable
- Dual channel analysis
- High Resolution FFT
- Octave Analysis
- THD, THD+N, SNR measurements
- Signal Generation
- Triggering, Decimation
- Transfer Functions, Coherence
- Time Series, Spectrum Phase, and 3-D Surface plots
- Real-Time Recording and Post-Processing modes

Applications

- Distortion Analysis
- Frequency Response Testing
- Vibration Measurements
- Acoustic Research

System Requirements

- 486 CPU or greater
- 8 MB RAM minimum
- Win. 95, NT, or Win. 3.1 + Win.32s
- Mouse and Math coprocessor
- 16 bit sound card

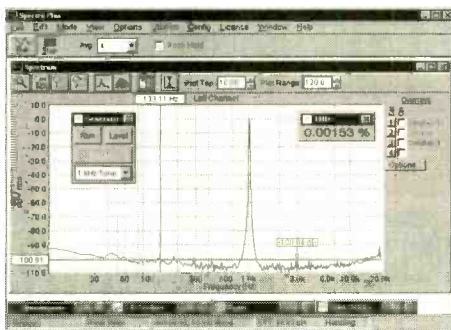

Priced from \$299

(U.S. sales only - not for export/resale)

DOWNLOAD FREE 30 DAY TRIAL!

www.spectraplus.com

PHS Pioneer Hill Software
24460 Mason Rd.
Poulsbo, WA 98370
a subsidiary of Sound Technology, Inc.



Spectra Plus
FFT Spectral Analysis System

Sales: (360) 697-3472

Fax: (360) 697-7717

e-mail: pioneer@telebyte.com

Call Today And
SAVE! Unbeatable
PRICES!

CABLE TV

**DESCRAMBLERS
CONVERTERS • FILTERS
VIDEO STABILIZERS**

- FREE** ▶ 30 Day Trial
- FREE** ▶ Product Catalog
- FREE** ▶ 1 Year Warranty

100% MONEY BACK GUARANTEE



Let us point you in
the right direction ...

Arrow
Technologies
Omaha, Nebraska

**TOLL FREE
1-800-554-ARROW**

1-800-554-2776

http://www.arrowtek.com



CALL TOLL FREE
(800) 292-7711
Orders Only
 Se Habla Español

C&S Sales

Look For Other
 Monthly Specials
 On Our Website

Excellence in Service

www.cs-sales.com

D/A Trainer

Elenco Model XK-700

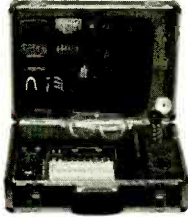

\$195

Elenco's advanced designed Digital/Analog Trainer is specially designed for school projects. It is built on a special PC board for maximum reliability. It includes 5 built-in power supplies, a function generator with continuously variable sine, triangular, and square waveforms. All power supplies are regulated and protected against shorts. The trainer is mounted in a professional technician tool case made of reinforced metal with heavy-duty handles and locks.

Soldering Stations

Weller Low Cost Soldering Iron
 Model WLC-100



\$34.95

- Variable power control produces 5-40 watts.
- Ideal for hobbyists, DIYers and students.
- Complete with 40W iron.

Weller Soldering Station
 Model WES50



50 watts of controlled power - designed for continuous production soldering.

\$119

Deluxe Electronic Soldering Station

Elenco SL-5 Series

Electronically controlled, ideal for professionals, students, and hobbyists. Available in kit form or assembled.



As Low As
\$29.95

Ordering Information:

- Model SL-5 - No iron. (Kit SL-5K) **\$29.95**
- Model SL-5-40 - includes 40W UL iron. (Kit SL-5K-40) **\$35.95**

*** Limited Time Offer ***
 FREE SP-1A Solder Practice Kit w/ Kit Order!



Features:

- Cushion Grip Handle Soldering Iron (optional) with Grounded Tip for Soldering Static-Sensitive Devices. Easily Replaceable. Uses Long-Life, Plated Conical Tip.
- Heavy Steel, Non-Slip Base.
- Iron Holder Funnel - Reversible, left or right side.
- Steel Tray for Sponge Pad.
- Sponge Pad.

Generators & Counters

B&K 20MHz Sweep/Function Generator with Frequency Counter
 Model 4040

- 0.2Hz to 20MHz
- AM & FM modulation
- Burst Operation
- External Frequency counter to 30MHz
- Linear and Log sweep

\$425



- 10MHz Model 4017 **\$319**
- 5MHz Model 4011 **\$249**
- 3MHz Model 4003 **\$205**

BK PRECISION

Four Functions in One
 Elenco Model MX-93003



Features:

- One instrument with four test and measuring systems:
- 1.3GHz Frequency Counter
- 2MHz Sweep Function Generator
- Digital Multimeter
- Digital Triple Power Supply - 0-3V @ 2A, 5V @ 2A, 15V @ 1A

\$450

Elenco Handheld Universal Counter
 1MHz - 2.8GHz
 Model F-2800



\$99

Features 10 digit display, 16 segment and RF signal strength bargraph. Includes antenna, NiCad battery, and AC adapter. C-2800 Case with Belt Clip **\$14.95**

Elenco RF Generator with Counter
 (100kHz - 150kHz) Model SG-9500



Features internal AM mod. of 1kHz. RF output 100MV - 35MHz. Audio output 1kHz @ 1V RMS.

\$225

SG-9000 **\$119.95**
 (analog, w/o counter)

Elenco Sweep Function Generator
 w/ built-in frequency counter Model GF-8046



\$195.95

This sweep function generator with counter is an instrument capable of generating square, triangle, and sine waveforms, and TTL, CMOS pulse over a frequency range from 0.2Hz to 2MHz.

GF-8025 - Without Counter **\$139.95**

Kit Corner

over 100 kits available

Quantity Discounts Available

Elenco Model RCC-7K

Radio Control Car Kit

\$29.95

- Fun & Easy to Assemble
- 7 Functions
- Radio Control Transmitter Included
- Also available as Model AK-870 (No Soldering) **\$24.95**



Elenco Model AK-700

Pulse/Tone Telephone Kit

\$15.95



Ideal School Project

Action Lab Kit

Model MX-902

- Safe, Solderless, Educational, and Fun!
- Easy-to-read, Illustrated, Lab-Style Manual Included.
- Requires 2 "AA" Batteries
- Build your own operating motor - It's easy, it's fun, it's Safe!
- For Ages 10 and up.

\$24.95



Elenco Model AM-780K

Two IC Radio Kit

\$11.95

Also available:
 Model AM/FM-108K
 AM/FM Radio Kit
\$29.95

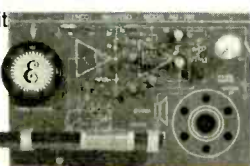

OVI Model OVI-007

Robotic Arm
 (Wired Control)

Teaches the basic robotic sensing and locomotion principles while testing motor skills.

\$55.95

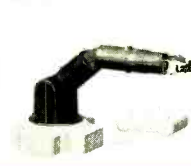

Elenco Digital

Multimeter Kit

Model M-2665K

- Extra large 1 1/4" x 2 1/2" LCD display area.
- 34 ranges - includes capacitance, transistor testing hrs., diode testing
- 20A AC/DC current
- Overload protected

\$49.95



Guaranteed Lowest Prices

UPS SHIPPING: 48 STATES 5%
 OTHERS CALL FOR DETAILS
 IL Residents add 8.25% Sales Tax

C&S SALES, INC.

150 W. CARPENTER AVENUE
 WHEELING, IL 60090
 FAX: (847) 541-9904 (847) 541-0710

15 DAY MONEY BACK GUARANTEE
2 YEAR FACTORY WARRANTY



PRICES SUBJECT TO CHANGE WITHOUT NOTICE

SAME DAY SHIPPING
Secure on-line ordering

C&S Sales

Excellence in Service

CALL OR WRITE FOR OUR FREE
64 PAGE CATALOG!
(800) 445-3201

Elenco Oscilloscopes

Free Dust Cover and 2 Probes

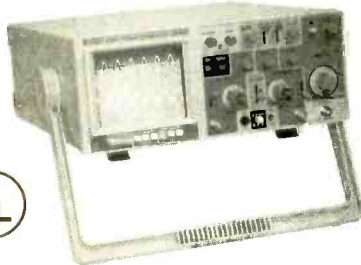

S-1325	25MHz	Dual Trace	\$325
S-1330	25MHz	Delayed Sweep	\$439
S-1340	40MHz	Dual Trace	\$475
S-1345	40MHz	Delayed Sweep	\$569
S-1360	60MHz	Delayed Sweep	\$725
S-1390	100MHz	Delayed Sweep	\$895

DIGITAL SCOPE SUPER SPECIALS

DS-203	20MHz/10Ms/s Analog/Digital	\$695
DS-303	40MHz/20Ms/s Analog/Digital	\$850
DS-603	60MHz/20Ms/s Analog/Digital	\$950

Quantity Discounts Available

Digital Multimeters

Fluke 79III



\$195

Features analog bargraph, automatic touch hold, diode test, continuity beeper, fused current inputs, lead resistance compensation, ohms, and true RMS.

Elenco LCR & DMM Model LCM-1950



\$69

- Large 1", 3 3/4 digit LCD
- Autoranging frequency to 4MHz
- Capacitance to 400µF
- Inductance to 40H
- Resistance to 4000MΩ
- Logic Test
- Diode & Transistor Test
- Audible Continuity Test

Elenco Model M-1740



\$34.95

- 11 Functions
- Freq. to 20MHz
- Cap. to 20µF
- AC/DC Voltage
- AC/DC Current
- Beeper
- Diode Test
- Transistor Test
- Meets I.L. 1244 safety specs.

Model M-2760 - \$19.95
(9 functions)

Dual-Display LCR Meter w/ Stat Functions B&K Model 878



\$225

Auto/manual range
Many features with Q factor
High Accuracy

Elenco LCR Meter Model LCR-1810



\$99.95

- Capacitance .1pF to 20µF
- Inductance 1µH to 20H
- Resistance 0.1Ω to 2000MΩ
- Temperature to 750°C
- DC Volts 0 - 20V
- Frequency up to 15MHz
- Diode/Audible Continuity Test
- Signal Output Function
- 3 1/2 Digit Display

Elenco DMM Kit Model M-1005K



\$19.95

- 18 Ranges
- 3 1/2 Digit LCD
- Transistor Test
- Diode Test
- Training Course

M-1000B (Assembled) \$15.95

Project Labs

Elenco 50-in-1 Electronic Playground Model EP-50

Easy-to-build experiments teach you the operation of over 500 electronic circuits. Fully assembled, includes all the parts needed. No tools or soldering required! Build these exciting circuits: finger touch lamp, magnetic bridge, voltmeter, morse code alarm, electronic noisemaker, electronic kazoo, electronic keyboard, transistor radio, radio announcer, metal detector, and many more. 76 page manual teaches you about voltage, current, resistors, capacitors, transistors, diodes, transformers, speakers, and antennas. Requires one 9V battery.



\$19.95

Maxitrix 300-in-1 Electronic Project Lab Model MX-908

\$48.95

Everything you need to build 300 exciting electronic projects:

- A Transistor Radio
- IC Organ
- Burglar Alarm
- Delayed Timer
- Electronic Game
- Optical Volume
- Multiplier
- Multiple Counter
- Digital Light Dimmer
- Tone Burst Generator
- Audio Signal Tracer
- Electronic Candle
- Voice Level Meter
- and many, many more!



• Easy-to-read, illustrated, lab-style manual included.

Maxitrix 500-in-1 Electronic Project Lab Model MX-909

\$170

Everything you need to build 500 exciting electronic projects:

Learn the basics of electronics and put your knowledge to work creating 500 different electronic experiments, special lighting effects, radio transmitter and receivers, amazing electronic sound effects, cool games and MORE! Includes built-in breadboard for easy wiring and connection of components, and an LCD (Liquid Crystal Display) indicates the information during the experiments in process.

• Fact-filled, illustrated, lab-style manual included.



Elenco Quad Power Supply Model XP-581

\$79.95



4 Fully Regulated DC Power Supplies in 1 Unit
4 DC voltages: 3 fixed - +5V @ 3A, +12V @ 1A, -12V @ 1A
1 Variable - 2.5 - 20V @ 2A

Elenco AC/DC Variable Power Supply Model XP-800

The XP-800 is a high current power supply with 3 variable outputs. Choose from either 0-120VAC @ 2A, 0-20VAC @ 7A, or 0-28VDC @ up to 10A. The precision LED displays allow for exact readout of volts and current. The XP-800 is ideal for Principles of Technology experiments in schools or it can be used as a bench power supply in OEM labs.



\$325

Elenco Power Supply Kit Model XP-720K

\$54.95

- 1.5VDC - 15VDC @ 1A
- -1.5VDC - -15VDC
- 5VDC @ 3A
- 6.3VAC @ 1A & 12.6VAC center tapped @ 1A



XP-720 Fully Assembled
\$85

Elenco DC Power Supply Model SPL-603 3A 0-30VDC

\$79.95

The SPL-603 is a solid-state DC power supply providing the exact output voltage no matter what current you use. Output fully protected from overload.



Tool Kits

Elenco Deluxe Electronic Tool Kit Model TK-3000 **\$79.95**

A professional technician service tool kit in a metal reinforced tool case with heavy-duty handle and locks. A removable, double-sided pallet handles most of the tools listed below with more room for tools and parts in the lower half. A special ramp in the tool case will lock your meter of choice in place.

- Tools included in case:**
- Deluxe Soldering Iron
 - Soldering Iron Stand
 - Diagonal Pliers
 - Long Nose Pliers
 - Deluxe Wire Stripper
 - Solder Ease Kit
 - 3 pc. Nut Driver
 - Precision Screwdriver Set
 - Screwdriver Slotted 3/16"
 - Screwdriver #1 Phillips
 - IC Extractor
 - Solder Pump
 - Safety Goggles
 - Pocket Screwdriver
 - Solder Tube
 - and Solder Wick.

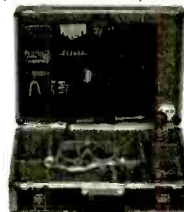

Elenco Deluxe 26pc. Computer Service Tool Kit Model TK-1200

Includes everything you need to service today's computers. Tools include deluxe soldering iron, 5" needle nose pliers, reversible star bits T10, T15, reversible bit nut drivers 3/16" and 1/4", deluxe wire stripper, IC extractor, and more!

\$39.95



Xcelite® PC Repair Kit Model 99-SPC

- Ideal for repairs on all PCs
- Anti-static chip tools protect from ESD damage.
- Convenient roll-up pouch.

\$34.95



Guaranteed Lowest Prices

UPS SHIPPING: 48 STATES 5%
OTHERS CALL FOR DETAILS
IL Residents add 8.25% Sales Tax
SEE US ON THE WEB

C&S SALES, INC.

150 W. CARPENTER AVENUE
WHEELING, IL 60090
FAX: (847) 541-9904 (847) 541-0710
www.cs-sales.com

15 DAY MONEY BACK GUARANTEE
2 YEAR FACTORY WARRANTY



PRICES SUBJECT TO CHANGE WITHOUT NOTICE

CIRCLE 290 ON FREE INFORMATION CARD

PIC'n Books

LEARN ABOUT PIC MICROCONTROLLERS



See Table Of Contents: <http://www.sq-1.com>
Secure Online Ordering Is Available

PIC is a trademark of Microchip Technology Inc.

SQUARE 1 ELECTRONICS

Voice (707) 279-8881 Fax (707) 279-8883

<http://www.sq-1.com>

RF Data Modules

AM Transmitter



- Sub Miniature module
- SAW Controlled
- No adjustable components
- Low current - 2.5mA
- Supply 2.5-12Vdc
- 418MHz or 433MHz
- Range up to 300ft
- CMOS TTL data input
- 7 x 11 x 4mm³
- AM-TX1-xxx \$12.60

AM Receiver



- Compact Hybrid Module
- Very stable
- CMOS/TTL output
- Patented Laser Trimmed
- 5Vdc, 0.8mA (HRR6)
- 2kHz data rate
- Sensitivity -105dBm
- 38 x 12 x 2 mm
- AM-HRR6-xxx... \$16.33

FM Transceiver



- Only 23 x 33 x 11mm
- Up to 40,000bps data rate
- Up to 450ft. range.
- 5V operation
- 418MHz or 433MHz FM
- 5V CMOS logic interface
- Fast 1mS enable
- Power saving feature
- Carrier Detect output
- BiM-xxx-F \$87.36

RS232 Transceiver



- 3wire RS232 interface
- 19.2Kbps half duplex
- 418MHz or 433MHz FM
- 7.5-15Vdc, 20mA
- TX/RX Status LED's
- Up to 400ft. range
- 1/4 wave ant. on board
- User data packetizing
- 58 x 40 x 15mm
- CYPHERNET \$139.30

AM Transmitter



- Range up to 250ft.
- SAW controlled stability
- Wide supply range 2-14V
- CMOS/TTL input
- Low current, 4mA typ.
- Up to 4kHz data rate
- Small, 17 x 11mm
- AM-RT5-xxx \$12.10



ABACOM TECHNOLOGIES



tel: (416)236 3858
fax: (416)236 8856
www.abacom-tech.com
MasterCard / VISA

The BEST is now Better!

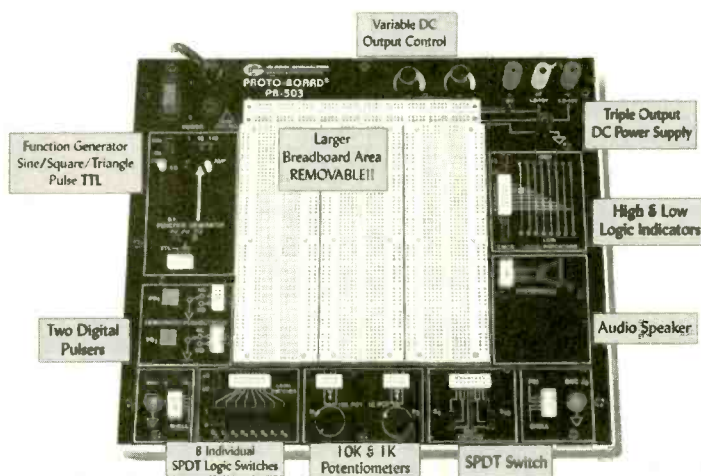

Feature-rich Circuit Design Workstation
Ultra-affordable at just \$299.95
Portable Version Available for \$349.95

Our classic PB-503 the complete Proto-Board Design Workstation is newly improved. Enhancements Include: an 8-Channel Logic Monitor, High & Low Buffered Logic Indicators, 8 Selectable Logic Switches, and Removable Breadboard Socket Plate. This velcro-backed socket plate allows for greater circuit design flexibility; order extra to suit your needs.

Traditional instrumentation on the unit includes continuously variable Function Generator, Triple Output DC Power Supply, along with Switches, Digital Pulses, Potentiometers and an Audio Speaker. The highly functional PB-503 is built to last, with an industry best 3-year warranty along with a lifetime warranty on all breadboard sockets. Own the best! Order yours today.



GLOBAL SPECIALTIES
INSTRUMENTS

1486 Highland Avenue • Unit 2
Cheshire, CT 06410
1.800.572.1028
203.272.4330 FAX
www.globalspecialties.com

World's Smallest 68HC11 Microcontroller Modules!

MicroStamp11™



- telemetry
- microrobotics
- smart toys
- animatronics
- model railroading
- home automation

- tiny, light-weight (0.5 oz.)
- 1-inch x 1.4-inch 68HC11 module
- on-board 5V regulator
- 8MHz crystal (9.83MHz on Turbo version)
- choice of 8K or 32K EEPROM
- 32K RAM + 32K EEPROM on 64K version
- plugs into your breadboard like a DIP
- SCI (UART), SPI, Output Compares, Input Captures, hardware timer, pulse accumulator
- all 14 I/O lines and 2 interrupts brought out to versatile 20-pin connector
- program in BASIC, assembler, or C
- easy code-loading with Docking Module
- Starter Packages: *
 - 8K EEPROM (#MS11SP8K).....\$49
 - 32K EEPROM (#MS11SP32K).....\$77
 - 32K EE+32K RAM (#MS11SP64K)...\$90

* Includes MicroStamp11, manual, PC software (free-ware assembler, SBASIC compiler, MicroLoad utility, and sample programs), serial cable, Docking Module, and accessories.

Attention OEMs:

Embed MicroStamp11 modules into your product! only \$20 each (100-pc. price, 8K version)

MicroCore-11™

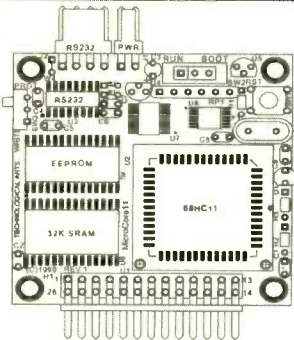

- tiny 2-inch x 2-inch 68HC11 module
- 12 inputs/outputs plus 8 analog inputs
- RS232, 5V regulator, 8MHz crystal
- 32K SRAM plus 8K or 32K EEPROM
- plugs into your breadboard like a DIP
- easy programming from any PC
- ideal for building MicroMouse robots
- now available in Turbo version (9.83MHz)
- 8K Starter Package #MC11SP8K.....\$68
- 32K Starter Package #MC11SP32K.....\$93
- Motor driver boards, LCD/keypad/keyboard interface & prototyping cards available

Technological Arts

Many other modules & accessories available. Visit our website at:

www.technologicalarts.com
sales@technologicalarts.com
TOLL-FREE: 1-877-963-8996
Phone: (416) 963-8996
Fax: (416) 963-9179
Visa • MasterCard • Discover • Amex

MODERN ELECTRONICS

CABLE TV DESCRAMBLERS



- ★ FREE CATALOG!
- ★ BEST DEALER PRICING!
- ★ DISCOUNTED PRICING!
- ★ 30 DAY FREE TRIAL!
- ★ 100% MONEY BACK GUARANTEE

**COPY RENTAL TAPES WITH
OUR VIDEO STABILIZER**

1-800-906-6664

2609 S. 156th Circle • Omaha, NE 68130

www.modernelectronics.com



Build Your Own Intelligent Robot, We Make It Easy!

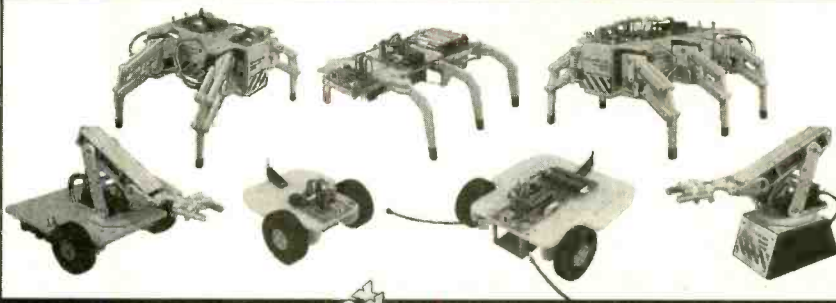

Lynxmotion, Inc.
PO Box 818
Pekin, IL 61555-0818
www.lynxmotion.com



Visit our website or ask for our free catalog!

Tel: 309-382-1816
Fax: 309-382-1254
sales@lynxmotion.com
tech@lynxmotion.com



One tree can make
3,000,000 matches.



One match can burn
3,000,000 trees.

ELECTRONIC MILITARY SURPLUS



FAIR RADIO SALES

WEBSITE: fairradio.com
E-MAIL: fairradio@fairradio.com
PHONE: 419-227-6573
FAX: 419-227-1313
1016 E. Eureka - Box 1105
Lima, OH 45802
VISA, MASTERCARD, DISCOVER
Address Dept. ES

2KW SOLA REGULATOR



Sola CVS 2000
Watt Constant
Voltage
Transformer pro-
vides a very well
regulated sinus-
oidal waveform
that is isolated
from variations and disturbances in
the input voltage. Also provides isola-
tion and step-up/step-down to allow
for various input/output voltages.
Input 95-130/175-235/190-260/380-520
60Hz Output 120/240VAC 60Hz
2000VA. 17.8x11.4x9.6, 115 lbs sh.
Unused, \$250.00 ea, 2 / \$450.00

Allow money for shipping.

**SEND FOR OUR
2001 CATALOG !!**

Radios - Test Equipment - Tubes - Antennas

HARMONY

A PARTNERSHIP WITH A HEALTHY LAND

The earth has always provided food, water, and all that we need. Today, as in the past, American Indians recognize the importance of keeping the earth healthy. Give back to the earth. Call for your free action packet.

1-800-THE-SOIL

United States Department of Agriculture
Natural Resources Conservation Service



LOG ON TO FORT777.COM

Come & Visit Fort777.com Now!

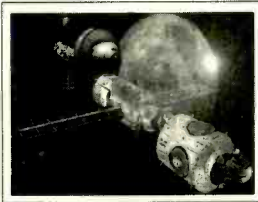

Come and take a look at all the great products we've got for you at Fort777.com - and they're all at incredibly low prices even if you only want one piece. Just click Product Index to find all the things you need. While you're there take a look at the Novel and read all about the Fort777 of the future. Make Fort777 your first choice and start saving NOW!

Electronic Components

When you want electronic components, visit Fort777.com. We've got large ranges of all the most popular items you'll need. Check out our Resistors, Capacitors, Connectors, Relays, Potentiometers, Fuses, LEDs, Neons, Lampholders, Diodes, Rectifiers, Crimp Terminals, Suppressors, Buzzers, Fuseholders, Clips, Audio, Computer and Telephone Cords and much, much more.

We've got specialty items as well and our range is growing all the time. Take a look at our special offers and click on Star Buys to see our latest hottest items. There are lots of new things happening all the time at the new Fort777.com so come back and visit us regularly then you won't miss any of our great specials. With our low prices you can buy for your friends and save on freight costs. Orders over US\$150 we pay the freight.

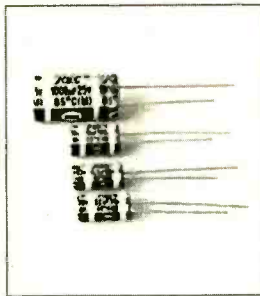

Only Top Quality Components



You can rely on the components you'll get from Fort777.com. We only buy direct from the best factories. All our components are fully specified and are the same each time you buy. You can pay much more for these very same items by buying from our competitors. But if you want the best parts at the best prices, come to Fort777. The choice as always is yours.

Low Cost Movies That Play On Your DVD Player



Never before sold in US, but now you can buy near-DVD quality video CDs that will play on your DVD player. We've got lots of the latest movies, top movies released over the last few years and classics. Prices are around one third the regular price for DVDs. These discs are 100% legal product, produced under license from the studios. Visit Fort777.com and find out more about how we can do it and check out all your favorite movies.



and drawing if it's pcb mounted. So now you can check out all the specs on line to find the exact part you need. Just click on More Info to see all the details and don't forget to scroll right to the bottom of the page to see the entire specification. In the More Info product screen, you will see a large picture of the product so that you can be absolutely certain that you've got the exact item you need. Take a look at Fort777 right now!

It's All At Fort777.com

When you need the best quality components and the best prices, you need to visit Fort777.com. Use the menu buttons, search function or index to quickly find the parts you need. Every item has a color picture and full description, specification

ITEMS SHOWN HERE AND ON THE WEBSITE [HTTP://WWW.FORT777.COM](http://www.fort777.com) ARE ONLY AVAILABLE FROM THE WEBSITE

No minimum order quantity. Prices are valid for one piece/pack. Freight charged extra.

*The address below is for returns and servicing:

FORT777.COM NORTH AMERICAN SERVICE AGENTS, FRONTIER ENGINEERING
 628 S. SUNSET ST., LONGMONT, CO 80501 * email: sales@fort777.com

**More Features
More Power
Less Money**

Ivex Complete Power Tools include: WinDraft P350 Schematics, WinBoard P350 PCB Layout, Ivex Spice Standard Simulation and Gerber Viewer together in a complete, affordable package.

Ivex Complete Plus includes everything in the Complete package plus 650 pin versions of WinDraft and WinBoard with Ivex Spice Advanced.

Ivex 650 pin versions have no feature limitations like other low cost products on the market. Fast expert technical support, free 24 hour Knowledge Base on the web, and professional full-featured tools have made Ivex the preferred choice for designers.

For larger designs use these Ivex Products:

WinDraft unlimited \$495
WinBoard unlimited \$495

Ivex Complete Electronics CAD Package

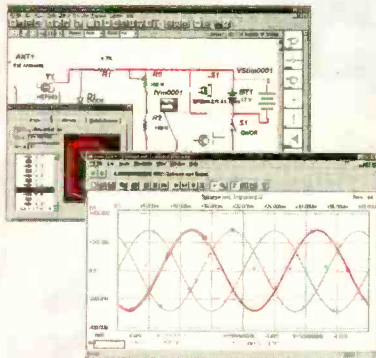

Advantages

Full-feature tools
17,000 Schematic parts
Part edit & model making
Part Search
Bill of Materials with Sort & Spreadsheet output
Hierarchy for large designs
ERC (electrical rules check)
15 Netlist outputs
7 Analysis Types
Spice Advanced includes 14 analyses
16 PCB layers
0.01 micron grid resolution
Advanced DRC
Micro via
Gerber & NC Drill report
24 hour FREE Technical Support Internet Knowledge Base
No hardware protection lock!
New: Schematic DXF output

Ivex Complete

Schematics
Simulation
PCB Layout
Gerber Viewer

\$350

Ivex Complete

Plus

P650 Schematics
Adv. Simulation
P650 PCB Layout
Gerber Viewer Plus

\$550

Free board quote

pcbCite.com

The Internet source for PCB manufacturing

Visit the Ivex web site for complete product information and download full function demos.

www.ivex.com

Tel: (503) 531-3555 e-mail: sales@ivex.com

IVEX™
DESIGN
INTERNATIONAL

ADV8_4

Test Equipment

From \$99.00



ATC modules provide for affordable pc based testing
DSO, DVM, Spectrum Analyzer, Data Logging
O-Scope I and **O-Scope II** Single and dual channels
Serial a protocol analyzer software package
DFA 5 low cost differential amplifier

Standalone digital oscilloscopes from **HiRel** and **TPI**

Pico Technology LTD leads in low cost pc based modules for test and data logging. Units to 100MSPS. 8 to 16 bits, 1 to 22 channels. Environmental monitoring. Science education with **DRDAQ**. Pricing from \$99

Allison Technology Corporation

2006 Finney Vallet Rd. Rosenberg, TX 77471

PH: 800-980-9806 or 281-239-8500, FAX 281-239-8006

<http://www.atcweb.com> atc@atcweb.com

Start A Career With High Wages, Excellent Benefits and Job Security!!

With UCANDO's extraordinary maintenance training programs you can quickly and easily enter a high paying field as a maintenance technician for a very small investment of time and money.



RC-M ONLY \$165 RC-M is a 15 hour training course on relay ladder logic systems. Includes a 5-part video and workbook. **Great Value!**

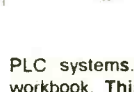

PLC-M ONLY \$198 PLC-M is a 32 hour training course on PLC systems. Includes (2) 4-part video's and workbook. **This training is valuable.**



HYD-M ONLY \$209 HYD-M is a 32 hour course on Fluid Dynamics. Includes (2) 4-part video's and workbook. **This Module is a must.**

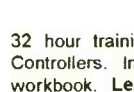

SC-M ONLY \$215 SC-M is a 32 hour training course on AC & DC Servo Controllers. Includes (2) 4-part video's and workbook. **Learn everything you need about AC and DC servo Control Systems.**

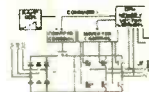

Electronic Training Videos: Basic Electronics, Digital Electronics, TV Repair, LASER and Fiber Optic training videos available at very affordable prices starting at **Only \$35.00 each.**

For information or to place an order call:

1-800-678-6113

www.ucando-corp.com

UCANDO VCR Educational Products Corp., Greenville, OH

Miniature Transmitters and Receivers

2 Button / 3 Channel Transmitter



RF300T

1....\$22.95
5....\$19.95 ea
10...\$16.95 ea

RF300XT

1....\$25.95
5....\$22.95 ea
10...\$19.95 ea

- 300' (XT), 150' (T) Range
- Frequency: 318 MHz
- 59,049 Settable Security Codes
- 12 Volt Battery and Keychain Included
- Current Draw: 4.8 ma
- Fully Assembled in Case
- Dimensions: 1.25" x 2.0" x .5"
- Push both buttons for the 3rd Channel
- Slide Button Cover Included

4 Button / 15 Channel Transmitter

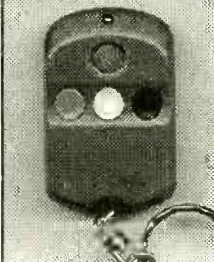

RF304XT

1....\$27.95
5....\$24.95 ea
10...\$21.95 ea

- 250' Range
- Frequency: 318 MHz
- 6,561 Settable Security Codes
- 12 Volt Battery and Keychain Included
- Current Draw: 4.6 ma
- Fully Assembled in Case
- Dimensions: 1.35" x 2.25" x .5"
- Push combination of buttons to achieve up to 15 channels

2-4 Data / 3-15 Channel Receivers



**RF300RL
RF300RM**

1....\$27.95
5....\$24.95 ea
10...\$22.95 ea

**RF304RL
RF304RM**

1....\$29.95
5....\$26.95 ea
10...\$23.95 ea

- Compatible with 300/4 Transmitters
- 11-24 volts DC Operating Voltage
- 13 ma. Current Draw
- Latching (L) or Momentary (M) Output
- Kits Available (subtract \$5.00 ea.)
- Dimensions: 1.25" x 3.75" x .5"
- 2 (300) / 4 (304) Output Data Lines
- Binary to Dec / Hex Converter can achieve up to 15 channels

- Alarm Systems
- Garage / Gate Openers
- Lighting Control

- Magic Props
- Medical Alert
- Monitoring Systems

- Industrial Controls
- Surveillance Control
- Motor Control

- Schematics Available
- Receiver Board Layout Available
- Custom Design Consulting Available

Visitect Inc.

(510) 651-1425 Fax: (510) 651-8454
P.O. Box 14156, Fremont, CA 94539

Email: Support@Visitect.Com
Visa / Mastercard, COD

CIRCLE 224 ON FREE INFORMATION CARD

Enclosed Switching Power Supplies



Triple Output Supplies
100w, 5v/12v/-5V
as low as \$44.00
100w, 5V/12V/-12V
as low as \$44.00

Single, Dual & Triple Output Models

Single Output Supplies

(5V, 12V, 15V, 25V)

25 watt series AS Low as \$20.55 ea.

60 watt series AS Low as \$27.95 ea.

150 watt series AS Low as \$42.95 ea.

Dual Output Supplies

100W, 5V/12V

100W, 5V/24V

...as low as \$38.00

50W, 5V/24V

...as low as \$27.00ea.

UL Approved

See Our Web Site for Details

Removable Hard Drive Rack

For IDE/Ultra DMA Hard Drives

We Sold Over 14,000 in 1998!

ONLY \$14.95 any qty.
This product can be used with any 3-1/2" IDE hard drive up to 1" high. It includes an electronic keylock for safe removal and insertion. Made of ABS 707 fireproof plastic. Use this product to protect sensitive hard drive data, take your hard drive between work and home or even set up different users with their own hard drives that they physically insert every time they use a PC. Other models available from C.S.I. include RH10 series and RH20 series, which are interchangeable within the same interface design (IDE or SCSI). Other Models are Available. See www.web-tronics.com under "hard drive and accessories" for more details and pictures.



#RH-10C-IDE

Removable Hard Drive Rack with Auto Door and Cooling Fan

ONLY \$18.95 any qty.

- Auto door on the outer frame
- ABS material of outer frame, High efficiency cooling fan
- Worldwide patent pulling function handle
- CE Approved
- Coating iron bottom cover
- For IDE interface
- For 1" high 3.5" HDD
- Not compatible with our RH10 & RH20
- Compatible with our RH17-IDE model.



#MR-27

Mini CCDs (B/W & Color)

Sensational NEW Design for Small Observation Cameras. Smaller and Better!

- Ultra Miniature Design
- Black & White Versions Only 25mm x 25mm
- Color Versions Only 32mm x 32mm
- Available in Standard Lens or Pinhole Lens
- All include Pre-Wired Cable Harness for Video & Power
- 12V Regulated Power Supply Required (120mA typical power consumption)
- 0.1 LUX Rating (B/W), 1 LUX (color)
- CCD Area Image Sensor for Long Camera Life
- Back Light Compensation Circuit
- Built-In Electronic Auto Iris Lens



LOWER PRICES

- VMCW-H11A 32mmx32mmx30mm, Color CCD with standard lens, pre-wired cabling, 12V DC Power \$139.00 / \$129.00 5 or more
- VMCW-H12A 32mmx32mmx19mm, Color CCD with pinhole lens, pre-wired cabling, 12V DC Power Input \$139.00 / \$129.00 5 or more
- VMPS-718A 25mmx25mmx30mm, B/W CCD with standard lens, pre-wired cabling, 12V DC Power Input \$59.00 / \$49.00 5 or more
- VMPS-250A 25mmx25mmx15mm, B/W CCD with pinhole lens, pre-wired cabling, 12V DC Power Input \$59.00 / \$49.00 5 or more
- VCC-3232 32mmx32mmx30mm, CMOS COLOR, std lens, see web for specs \$79.00 / \$72.00 5 or more

Detailed Specs on the Web

2GHz RF Field Strength Analyzer

- Frequency Range: 100KHz to 2,060MHz
- Narrow Band FM (NFM), Wide Band FM (WFM), AM and Single Side Band (SSB) Modulated Signals May Be Measured
- PLL Tuning System for Precise Frequency Measurement and Tuning
- LED Backlight LCD (192x192 dots)
- Built-In Frequency Counter
- Hand-Held and Battery Operated
- All Functions are Menu Selected
- RS232C for PC Interface and Printer

ONLY \$1989

#3201



- Easy to Navigate
- Includes a Search Engine That Really Works
- New Items Added Constantly

In Business Since 1971

CCD B&W Board Cameras

- ASIC CCD Area Image Sensor
- Extremely Low Power Consumption
- 0.5 Lux Min Illumination
- Built-In Electronic Auto Iris for Auto Light Compensation

Detailed Specs on the Web



LOWER PRICES

- VM1030PA-B 30mmx30mmx25mm, Pinhole lens, 12V \$39.00 any qty.
- VM1030A 30mmx30mmx26mm, Standard lens, 12V \$39.00 any qty.
- VM1035A 42mmx42mmx25mm, Standard lens, 12V with back light compensation \$49.00 any qty.
- VMCB21 44mmx38.5mmx28mm, with 6 infra-red LEDs, 12V \$49.00 any qty.
- VM1036A 32mmx32mmx25mm, Standard lens, 12V, reverse mirror image feature \$49.00 any qty.

Bullet CCD Cameras B&W and Color

- Smart Rugged Metal Housing
- Extremely Low Power Consumption
- 12 Volt
- CCD Area Image Sensor for Long Camera Life
- Built-In Electronic Auto Iris for Auto Light Compensation
- No Blooming, No Burning
- 0.1 Min Lux Illumination (B&W), 1 Lux Min Lux Illumination (color)

Detailed Specs on the Web



LOWER PRICES

- VMBLT1020 B&W, 21mm(D)x58.5mm(L) \$54.00 any qty.
- VMBLT1020W B&W Weatherproof, 21mm(D)x58.5mm(L) \$79.00 any qty.
- VMBLTJC19BW COLOR! Weatherproof, 17mm(D)x88mm(L) \$139.00 any qty.

COLOR CCD Mini Board Cameras

- Low Power Consumption
- 1 Lux Illumination
- Internal Synchronization
- 12Volts
- 400 TV Lines
- Built-In Electronic Auto Iris for Auto Light Compensation

Detailed Specs on the Web



PRICE REDUCTION

- VM3010PA 33mmx33mmx18mm, Pinhole lens \$99.00 any qty.
- VM3011-A 45mmx40mmx24mm, Standard lens, single board \$89.00 any qty.
- VM3010-A 33mmx33mmx32mm, Standard lens \$99.00 any qty.

DC to AC Power Inverters!

- 150w modified sine wave: \$29.95(G-12-015B)
- 300w modified sine wave: \$39.95(G-12-030)
- 150w pure sine wave: \$69.00(G-12-150S)
- 300w pure sine wave: \$109.00(G-12-300S)
- 800w modified sine wave: \$139.00 (G-12-800)
- 1000w modified sine wave: \$179.00(G-12-100)
- 3000w modified sine wave(phase corrected), (G-12-300).....\$489.00



See Our Website for DETAILED Specs.!

Our Most Sophisticated DMM

- with RS-232 Interface & Software, 3-3/4 Digit, 4000 Count, Auto-Ranging with Analog Bargraph
- K Type Temperature Probe Included
- Pulse Signal for Logic & Audible Test
- Continuity/Diode Test
- Logic Test
- Auto Power OFF/"Keep ON" Mode
- Fused 20A Input with 0Warning Beeper
- Back Light
- Data Hold/Run Mode
- Safety Design UL1244 & VDE-0411
- Protective Holster
- Silicon Test Leads

NOW ONLY \$149 Reg. \$169

More Details on our Web Site



PROTEK 506

BEST DEALS! NOW OFFERING Dish Network & Direct TV

Great Equipment & Service See Our Website for our

Incredible Offers! Also Great HDTV Prices!

O'Scope Offer ONLY \$299 30MHz! ONLY \$299! Industries Best Price! See web for specs



- Dual Channel
- Dual Trace
- Vert Trigger
- 1 Year C.S.I. Warranty!

#OSC-1030

3000 Series Digital R/O Bench Power Supply

Low Cost Single Output 3 Amp High stability digital read-out bench power supply featuring constant voltage and current outputs. Short-circuit protection and current limiting protection is provided. Highly accurate LED accuracy and stable line regulation make the 3000 series the perfect choice for lab and educational use.

AS LOW AS \$89



- Line Regulation: 2x10⁻⁴ +1ma
- Load Regulation: 1 x 10⁻⁴ +5mv
- LED Accuracy: Voltage ±1% +2 digits
- Current ±1.5% +2 digits
- Wave Line Noise: ≤1mvrms
- Dimensions: 291mm x 158mm x 136mm

- CSI3003: 0-30v/0-3amp Digital R/O Bench PS, 1x10⁻⁴+5mv Load Regulation \$99.00 5/\$89.00
- CSI 5003: 0-50v/0-3 amp Digital R/O Bench PS, 1x10⁻⁴ +5mv Load Regulation \$129.00 5/\$119.00

AMAZING DEVICES

NVEN220010DD

See in Action video on our web site at www.amazing1.com

Ion Ray Guns

Star Wars Technology Directs Energy

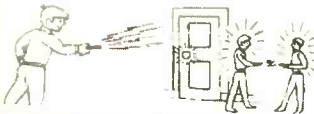

Star Wars Technology Demonstrates Weapons Potential. Force Fields, IonMotors, Antigravity etc **Projects electric shocks without contact!!** Conduct many weird and bizarre experiments. Handheld battery operated and easy to operate.

- IOG7/9 Plans..... \$10.00
- IOG7K Kit/Plans..... \$99.50
- IOG70 Assembled/Tested..... \$149.95
- Higher Powered Device**
- IOG9K Kit/Plans..... \$129.95
- IOG90 Assembled/Tested..... \$199.95

Shocker Trigger Ignitor

Variable 20,000 volt pulser used for laser flash tube, spark gap and pyro ignitor, garden pest shocker, electric fence, snake venom removal etc. 12 volt battery operation.

- TRIG1K - Kit/Plans..... \$29.95
- TRIG10 - Lab Assembled..... \$49.95

Cybernetic Ear!

Provides that "extra edge" for many listening applications. Enhances 3 to 4x of normal. **CYBEREAR..... \$19.95**

Mini TESLA Coil

Lights up a 4' fluorescent tube-all without any contact!! Yet only 3" tall!!

Ultrasonic Painfield Generators

For property and personal protection. Four transducer matrix intensifies and concentrates effect on target area.

- PPF4 Plans..... \$20.00
- PPF4K Kit..... \$199.95
- PPF40 Ready to use..... \$299.95

3 Mi Voice Transmitter

Crystal clear. Many applications. Easy to build

- FMV1 Kit and Plans..... \$39.95

Body Heat Telescope

Detects living bodies over 300' Heat leaks etc. Built in chopper and sens control

- BHT6 Plans..... \$10.00 BHT6K Kit..... \$99.95
- BHT60 Ready to use..... \$149.95

Ultra Bright Green Laser

30 to 50x brighter than most red pointers!! Full 5 mw range in excess of 6000 feet!! Operates for hours from 2 "AAA" batteries

Low Cost 100,000 Volt DC Supply

Amateur experimenters source of HVDC for many applications

- 100,000 volts at 2ma
- Built in dry filled multiplier.
- Operates on 12vdc or 115vac

Combo Tesla Coil, Jacobs Ladder, Plasma Tornado

Amazing and bizarre effects turn a normal light bulb into a spectacular plasma display!! With adjustable frequency control. Safe 12vdc input

- TCL5 Plans..... \$8.00 TCL5K Kit/Plans..... \$59.95
- TCL50 Assembled and Tested..... \$99.95

Mass Driver

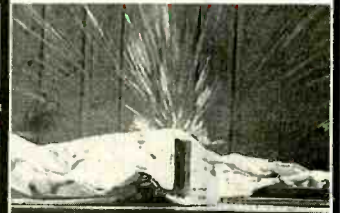

Above photo shows burst impact of Mass Driver

Can Crusher

A can is crushed into the shape of an hour glass demonstrating the awesome power of magnetics. Very popular demo in science museums as users get to crush and keep their own can. **Kids love this!!**

Wire Exploding

Generate pyrotechnical explosive blasts for many applications. Create a new artistic concept. Uses our unique high energy pulser shielded explosion chamber

HEP9 High Energy Pulser...\$20.00

Plans pack Includes above MASS1 Mass driver, CANCRU1 Can crusher and WIREXPL0D1 Wire exploder/Blast art plans. We stock all parts, kits and completed units for the above items.

Above HEP9 pulser is used for : EMP / HERF Generation, Build a Rail or Coil Gun, Electrothermal Gun, High Power Pulsed Laser, Mass Warping etc etc

Mind&Brain Controllers

Incredible device Turbo charges memory, Boost mental powers, Controls stress, Speeds up healing processes and Uncover hidden potentials. High quality unit with many features.



- BWPLUS-APOLLO Ready to use. \$179.95
- BWII- EINSTEIN Lower cost unit.. \$129.95

Information Unlimited PO Box 716 Amherst N.H. U.S.A. 03031

1 800 221 1705 Orders/Catalogs Only! Fax 1 603 672 5406 Information 1 603 673 4730 Free Catalog on Request
Pay by MC, VISA, Cash, Check, MO, Add \$5.00 S&H. Overseas Contact for Proforma

CIRCLE 220 ON FREE INFORMATION CARD

New and Pre-Owned Test Equipment

New Equipment Specials

B+K Precision 2120B - 30MHz Oscilloscope

- * FREE Model 117B Multimeter
- * 2 Channel, Dual-Trace
- * 30 MHz Bandwidth
- * TV Triggering
- * (2) Probes Included

Sale Price \$339.00

AVCOM PSA-37D - Spectrum Analyzer

- Snellite Downlink - Installation - Maintenance & Service**
- Band 1: 10 - 1750 MHz
- Band 2: 3.7 - 4.2 GHz
- Carrying Case Included
- Line or Battery Powered
- Built-in DC Block & Power for LNA/LNB's

Sale Price \$2,395.00

Instek GOS-6103 - 100 MHz Analog Oscilloscope

- 100 MHz Bandwidth
- 2 Channel, High Sensitivity
- TV Trigger - Signal Output
- Cursor Readout
- Time Base Auto-range
- (2) Probes Included
- 2 Year Warranty

Sale Price \$899.00

Leader LF 941 - CATV Signal Level Meter

- TV/CATV Coverage from 46 - 870 MHz
- Video/Audio Carrier Measurements

Sale Price \$489.00

NEW! Fluke 187 - Digital Multimeter

- Basic DC Accuracy of 0.025% at 50,000 Count
- True-RMS AC, AC+DC, dBm, & dBV

Sale Price \$319.00

Pre-Owned Oscilloscope Specials

Tektronix	465	100 MHz	\$499.00
Tektronix	465B	100 MHz	\$649.00
Tektronix	475	200 MHz	\$749.00
Tektronix	475A	250 MHz	\$949.00

- Professionally Refurbished
- Aligned & Calibrated to Original Specifications
- The Industry Standard of Oscilloscopes
- 1 Year Warranty - The Longest Available!!!
- See Website for Complete Specifications

See us on the Web!
www.testequipmentdepot.com

We Buy Surplus Test Equipment

Test Equipment Depot

A FOTRONIC CORPORATION COMPANY

99 Washington St. Melrose, MA 02176

(781) 665-1400 • FAX (781) 665-0780

e-mail: sales@testequipmentdepot.com

(1-800-996-3837)

TOLL FREE 1-800-99-METER

CIRCLE 322 ON FREE INFORMATION CARD



SINGLE CHIP COMPUTER

- ZERO external components
 - Built-in BASIC / Assembly
 - RS232 program download
 - 1K flash, 64ee, 3irq, 2timers
 - 15 I/O bits, A/D comparator
 - 20mips, faster than pic/8051
 - 20 pin DIP part #MV1200
- oem (1k) **\$1.99**
eval (1) **\$7.00**



- NEW! 8K SUPER CHIP**
40x the BASIC program space!
- 32 i/o, 12 irq, 3 timers, Bus
 - 8K flash, 512ee, 512nvram
 - Watchdog with internal osc.
 - 40 pin DIP part #MV8515
- oem(1k) \$7.10 eval(1) \$25.00

CREDIT CARD COMPUTER



New PLUG-N-GO, no cables/power supply to buy!
Lo-power RISC cpu 10x faster than PIC, Z80, 8051
256k NV mem, ser, par, RTC, 4ch 50khz ADC, ISA bus
Built-in BASIC/Assembly, other compilers avail.
Friendly instruction set, unlike PIC or 8051
oem (1k) price 14.20 eval kit (1) \$50.00

PC WATCHDOG CARD

No More Hangups!

Reboots PC on hardware/software hang
3 versions: RESET, TIMER, PHONE
reset version oem \$21.30, eval kit \$75

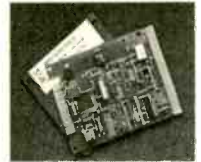

LO COST MINI-PC

Includes DOS, NV mem, ADC, RAM, clock, ISA bus
Ports for serial, parallel, LCD, keyboard
Program in Turbo C, BASIC, MASM, etc.
Complete, no costly development kits required
Lowest power lowest cost PC compatible available
XT: oem \$27 eval \$95 AT: oem \$55 eval \$195

PC SOLID STATE DISK



Replace mechanical drives with faster, more reliable, more secure solid-state.
Use FLASH, NVRAM, UV EPROM.
Both DIP and PCMCIA versions from 32Kbyte (PCM1) to 1Gigabyte (PCD2) starting at \$14.20 oem (1k) \$50.00 eval (1)

640x480 VGA LCD \$27

Controller for most single/dual scan LCDs
Works with lo-res (160x120, 320x240, etc.)
Use with PC or SBC, standard VGA BIOS
Source code demo shows VGA initialization
Adaptable for other CPUs (i.e. Z80, HC11)
oem(1k) \$27 eval kit(1) \$95 w/10" LCD \$195



SERIAL MINI-TERMINAL

RS232 terminal for Stamp, PC, Z80, AVR etc.
-super low-current, powers from serial line
-LED backlit LCD, visible in all conditions
-115.2kbps, DB9 conn, simple commands
-specify 20 customizable or 16 tactile keys
eval(1) \$75, oem(1k) \$21.30, w/BASIC cpu \$27



STAMP DRIVE!!

Read / Write PC compatible hard disk, PCMCIA, & Compact Flash.
RS232 to ATA drive adapter for Stamp, 8051, AVR, PIC, Z80, x86
ANY controller, big or small:
-up to 4 gigabyte capacity
-low power operation 5v 2ma
-simple software commands
-baud rates up to 115.2kbps
-S14 IDE & S21 ISA/104 versions

oem(1k) **\$27**
eval kit(1) **\$95**

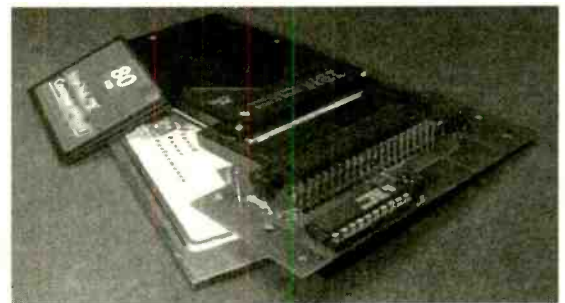

WWW.STAR.NET/PEOPLE/~MVS

MVS Box 803
Nashua, NH 03060
(508) 792 9507



5yr Limited Warranty
Free Shipping
Mon-Fri 10-6 EST

SERVING THE EMBEDDED COMMUNITY SINCE 1979!

CABLE TV REMOTES BLOW-OUT SALE

We carry all models

50pc.	100pc.	500pc.	1kpcs.
\$3.50	\$3.25	\$2.75	\$2.50

Rebellion-3 125ch. Converter		
12pc.	50pc.	100pc.
\$50.00	\$47.00	\$44.00

Magnavox Universal Remote Controls		
12pc.	50pc.	100pc.
\$4.50	\$4.00	\$3.75

Call Today Globaltech 1-(800)-582-5116
View Our On-Line Display Catalog at:
www.globaltechdistributors.com

SMART CARDS

Complete system! Program your own smart card applications in easy to use BASIC!



Tool Kit comes complete with:

- Security Systems
- Time Cards
- Emulation
- Access Control - Home, Auto
- Robotics Programming
- DATA Security

Complete system *or only \$79.95

We accept
VISA • MasterCard • American Express

To Order Call 1-800-773-6598 Worldwyde.com,
33523 Eight Mile Rd #A3-261, Livonia, M. 48152
Visit us online <http://www.worldwyce.com>

SCRAMBLED VIDEO



THE CLEAR SOLUTION

Model VSG-RFDL
.....RESTORES LOST VIDEO

R.C. Distributing Company
P.O. Box 552 South Bend, IN 46624
Phone (219) 233-3053 Fax (219) 289-1566
www.rcdistributing.com

spyoutlet.com

Countersurveillance - Electronic Devices

Purchase your video cameras from one of the largest importers in the U.S.

- NEW Underwater Bullet Cameras
- Spy Pinhole Cameras starting at \$79⁰⁰
- Wireless Video • Voice Changer
- Micro Recorders • Shotgun Mic
- Locksmithing • Bug & Phone Tap Detectors • Phone Call Register
- UV Pens & Powder • Realtime Telephone Recording Systems:
- 12 Hour \$125⁰⁰ • GPS Vehicle Tracking System (nationwide)
- And much more

www.spyoutlet.com
Printed Catalog send \$5⁰⁰

SPY OUTLET 2468 NIA FALLS BLVD
TONAWANDA NY 14150 (716) 695-8660

CONTROL IT

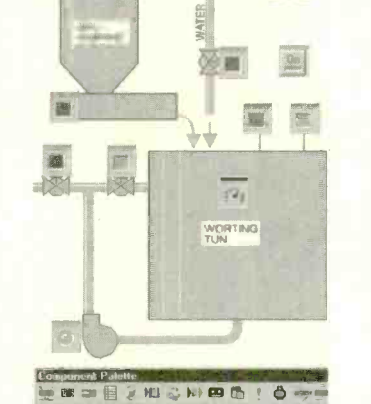

Intec Automation Inc.
www.micromanager.com

PIC Programmer Kits

Super Value!
\$16.95 + S&H \$4.95
The P16PRO can program up to 40 pin PICs including the popular 16F84 & 12C508 • Needs software (extra \$20) • Available assembled or starting from \$16.95 for the kit.
See www.electronics123.com for more info!
The PICALL programmer can also program Atmel AVR's in addition to the PICs it can program • Free software • PICALL programmer kit at \$69.95
See www.electronics123.com for more info!

Video Camera module

Code:BB004

CMOS Camera Module, Black & White, Size: 0.63"x0.63"x0.59"H.
Lens: f4.9, F2.8, EIA 320Hx240V.
0.6" DIL Package, 5 pins. Pin 3 is 1V p-p composite video (75 ohm) to monitor. \$36 + \$5 S&H

Running Lights kit

Add \$6 for 8 triacs to drive light bulbs
8 LEDs with 10 push button selectable patterns. 8 speed levels! 80 combinations! \$16 + \$5 S&H

Toll Free: 1-888-549-3749 (USA & Canada)
Tel: (330) 549-3726. Request a FREE catalog or visit us at: www.electronics123.com for more products.
Amazon Electronics, Box 21 Columbiana OH 44408

PAiA

Theremin
The PAiA Theremax uses the same heterodyne principles as the original turn of the century instrument for classic tone and adds features made possible by modern ICs. Shown with optional lectern case.

FatMan Analog MIDI Synth
A complete music synthesizer with all the big bottom and phat sound that makes analog famous. 20 knobs and controls for real-time sound sculpting. Compatible with standard MIDI sources like keyboards or computers. Desktop case or rack panel available.

Check out <http://Paia.com> for schematics, tech details, firmware source files and more...
Synthesizer Modules, Guitar Effects, Mixers, EQs, Tube PreAmps, and dozens of kits for **ELECTRONIC MUSICIANS**
PAiA Electronics info@paia.com
3200 Teakwood Lane 405.340.6300
Edmond, OK 73013 fax 405.340.6378

Lone Star Consulting, Inc.

8900 Viscount, Suite 235
El Paso, TX 79925
915-474-0334
Descriptions, Prices, Policies:

www.lonestartek.net
SPECIAL PROJECTS HARDWARE

- Unique - Original - Made-to-Order - Special Needs
- Electronic - Computer - Phone - Energy - Security - Data Cards - RF - EM - Audio - Radionics - "Psychic" - Plans - more!
 - Power Meters Educational Module ♦ KK Radar Emitter Lineman's Test Set ♦ Bug & Tap Detector ♦ Blaster Shriek Module ♦ Stealth Paint "Elixer" ♦ Audio Assistor Multi-Use Magnetometer ♦ Omnimax Tens Stimulator Radionics Rife ♦ Neurophone Device ♦ Ultrasonic Stimulator ♦ Ultrasound Shrieker ♦ Ultrasonic Detector Harassing EMF Jammer ♦ EMF "Signature" Detector "Aura" Detector ♦ Super Conductor Detector ♦ Unseen/Unknown Presence Detector ♦ Subliminal Mixer/Amp Infrared Detector ♦ Secret Communicator ♦ Levitator Flash Blaster ♦ 6th. Sense Communicator • many more!
- *TECHNICAL "LIFE COACHING" *WEBSITE DESIGN SERVICES

NEW Easy-PC For Windows

Schematic & PCB Layout CAD

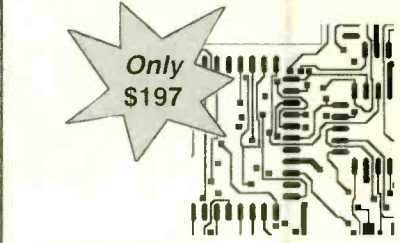

- True Windows interface
- True Windows 32 bit application
- Schematic and PCB Design as standard
- Intelligent Cut, Copy and Paste - internal & external
- Multi-level Undo and Redo
- Forward design changes - Schematic to PCB
- Integrated Autoplacement
- Integrated Shape based AutoRouter (Optional Extra)
- Shape based copper pour and split power planes
- And now version 4.0 with many new features!!

Call Ohio Automation (740) 596 1023
www.numberone.com

CABLE BOX SUPPLIERS

**VISION MASTER PLUS
W/UNIVERSAL FORMAT
STABILIZERS PICTURE
WORKS ANY SYSTEM!**

"DEALERS WELCOME"
★ **LOW, LOW PRICING** ★
1-888-777-9123
1-888-675-3687

Scrambling News

915 NW First Ave., Suite 2902,
Miami FL, 33136, 305-372-9427

Pay TV and Satellite Descrambling 2002 - New! - satellite and cable. Includes the latest information. \$19.95 plus \$1.75 shipping.

Hacking Digital Satellite Systems Video 2002 - New! - This 90 minute video focuses on the satellite television piracy business. \$29.95 plus \$ 3.50 shipping.

Scrambling News Online - Online service for those interested in satellite television news. \$59.95/year.

Pay TV and Satellite Descrambling Series CD-ROM - all 13 volumes over 300 pages, \$59.95 plus \$3.50 shipping.

Best Deal - Everything listed above for only \$99.95 plus \$3.50 shipping.

www.scramblingnews.com



**Black Feather
ELECTRONICS**
Visit our Website
www.blkfeather.com

- ▶ 4400 S. Robinson Avenue
- ▶ Oklahoma City, OK 73109
- ▶ FAX: (405) 616-9603
- ▶ Email: blkfea@aol.com

Or call & order today:
1-405-616-0374

PCB Production

Double side—12¢ per in²
Four layers—20¢ in²
Six layers—32¢ in²
UL approved
(with solder mask, Silkscreen
Three weeks)

**FREE Quote for 8-12L
PCB & membrane switch**
MYLYDIA INC.

Call 626-292-2686
Fax: 626-292-2689
E-mail: tj2@ix.netcom.com

PICmicro MCU Development Tools

Experimenter Boards

LAB-X1 for 40-pin MCUs (shown) - \$199.95
LAB-X2 for 28 or 40-pin MCUs - \$69.95
LAB-X3 for 18-pin MCUs - \$119.95



**EPIC Plus
PICmicro Programmer**
\$59.95

Program PICmicro MCUs in BASIC!

DOS or Windows operation (includes Windows IDE software).
PicBasic Compiler - \$99.95
PicBasic Pro Compiler - \$249.95

PICProto Prototyping Boards

\$8.95 to \$19.95

High-quality blank prototyping boards
for PICmicro MCUs.



microEngineering Labs, Inc.



www.melabs.com

Phone: (719) 520-5323

Fax: (719) 520-1867

Box 60039, Colorado Springs, CO 80960

SCINTILLATING!

Who Are You? The Encyclopedia of Personal Identification. Insider information directly from the FBI and Customs, top graphic artists, offshore attorneys, master thieves, and professional sharks. *Who Are You?* details ID theft schemes (and prevention), how to create great documents on a home computer, get a new driver's license (suspension? No problem), open offshore or US bank accounts w/o an SS number, acquire the world's best ID, second passports, phony credit cards, read vehicle tags, much, much more. Sources, sites, suppliers, tips, tricks and techniques. 352 pages \$44.95.

Covert Catalog 2000 The latest, hands-on source guide for law enforcement goodies, electronic surveillance, covert video, counter measures, entry equipment, weapons, tracking systems, computer surveillance, and more. Exact order info from suppliers in 13 nations! 220 Pages. \$39.95.

ORDER BOTH BOOKS — SUBTRACT \$10!!

Intelligence Here
404 N. Mt. Shasta Blvd.
Mt. Shasta, CA 96067
Order by Phone: 866-885-8855
www.intelligencehere.com



Add \$6.00 (priority shipping). CA residents add 8% tax

CABLE SECRETS!!!

**Build your OWN cable
box "test" devices!**

Why pay \$100.00 or more for a "test" device that someone else made? Make your own! Includes complete source code and plans for the most commonly used cable boxes. *Unlock all of the channels on your box!*

Or start your own lucrative business!

Complete source code \$79.95
Code for individual boxes \$29.95

DSS SECRETS — Vol. 2

Step-by-step instructions on programming your own DSS access card. *Unlock all channels on your own card!* This is the most current information on the market! Includes software, plans, and hardware sources. Book & CD-ROM.

DSS Secrets Vol. 2 \$49.95

VISA • MasterCard • American Express

To order, call **Worldwyde @ 1-800-773-6698**

33523 Eight Mile Rd. • A3-261 • Livonia, MI 48152

Visit us on the web at www.worldwyde.com

Solar Panels

160 mW / Sun 8 Cells

200pc \$2.⁰⁰_{ea} 2Kpc \$1.⁸⁰_{ea} 20Kpc \$1.⁷¹_{ea} 200Kpc \$0.⁸⁵_{ea}

Battery Holders

AA Singles, and Dual Side by Side

200pc \$0.⁴⁰_{ea} 2Kpc \$0.³⁶_{ea} 20Kpc \$0.³⁴_{ea} 200Kpc \$0.¹⁷_{ea}

LED's

High Intensity HPWT-DL00

Similar to Lumex type SSL-LX30448SYC

200pc \$0.⁵⁰_{ea} 2Kpc \$0.⁴⁵_{ea} 20Kpc \$0.⁴³_{ea} 200Kpc \$0.²¹_{ea}

Call 1-847-612-2739

Top Secret Consumertronics

In business 25+ years - established professionals

www.tsc-global.com

Exciting Hi-Tech Survival Books, Manuals, Tapes

Stopping Power Meters \$29	Polygraph Secrets \$29
SPM Demo VHS Tape \$29	Identity Theft Manual \$29
KW-HR Meters \$29	Credit Card Security \$29
Gas & Water Security \$19	Check & M.O. Security \$29
Beyond Phone Color Boxes \$29	ATM Manual \$39
Cellphone/Cordless Guide \$39	Mind Control \$29
Pager (Beeper) Manual \$29	Under Attack! \$29
Caller ID & ANI Security \$29	EM Brainblaster \$29
Voice Mail Security \$29	Radionics Manual \$29
PBX Security \$25	Heal Thyself! \$29
Fax Machine Security \$29	Ultimate Success Manual \$29
Computer Security \$39	Stealth Technology \$29
Hacker Files (3 HD Disks) \$39	High Voltage Devices \$29
Social Engineering \$29	Secret & Survival Radio \$29
Cons & Scams Databook \$29	Secrets of Solderless BBs \$29
Internet Security \$29	The "Goldfinger" \$19
Internet Frauds Databook \$29	Casino Secrets \$29
Internet Tracking/Tracing \$29	Government Land Grab \$19
Beyond Van Eck Tempest \$29	Rockets Red Glare \$29
Van Eck Demo VHS Tape \$29	...much more in Catalog!

Check, MO, VISA, MC - add \$5 S/H (US, Canada)
Printed Catalog: \$1 with order, \$3 w/o (descriptions, policies)

Order Today! Consumertronics
P.O. Box 23097, ABQ, NM 87192
505-321-1034 Fax: 505-275-5637

Home Automation



World's Largest Source for Home Automation!

- Voice Control
 - Gadgets & Motorized Devices
 - Home Theater
 - Phones & Intercoms
 - X10 & Lighting Control
 - Home Security & Surveillance
 - Home Networking & Structured Wiring
- and Much More...

800-SMART-HOME

www.smarthome.com

Free 144 pg. Color Catalog!

Dealers/Resellers ask about our SmartHome PRO Dealer Program 800-949-6255



EPROM+

A device programming system for design, repair and experimentation

- ◆ EXCEPTIONAL POWER FOR THE PRO
- ◆ EASY-TO-USE FOR THE NOVICE
- ◆ INCLUDES STEP-BY-STEP TUTORIAL

Here's what you get: A rugged, portable programming unit including the power pack and printer port cable both of which store inside the case. A real printed user and technical manual which includes schematic diagrams for the programming unit plus diagrams for all technology family adapters.* Comprehensive, easy-to-use software which is specifically designed to run under DOS, Windows 3.1, 95 and 98 on any speed machine. The software has features which let you **READ, PROGRAM, COPY and COMPARE** plus much more. You have full access to your system's disk including **LOADING and SAVING** chip data plus automatic processing of **INTEL HEX, MOTOROLA S-RECORD and BINARY** files. For detailed work the system software provides a full screen **buffer editor** including a comprehensive **bit and byte tool kit** with more than 20 functions.

Broad device support: **FIRST GENERATION EPROMS** (2708, TMS2716*, 25XX) **SECOND GENERATION EPROMS** (2716-28C080, 40 AND 42 PIN EPROMS* (27C1024-27C160) **FLASH EPROMS** (28F, 29C, 29EE, 29F), **EEPROMS** (2816-28C010), **NVRAMS** (12XX, X2210/12) **8 PIN SERIAL EPROMS*** (24, 25, 85, 93, 95, 80011A) **PLUS ERI 400/M58657* AND ER5901 BIPOLAR PROMS*** (72S/82S), **FPGA CONFIGURATORS** (17CXXXX) **MICROCONTROLLERS*** (874X, 875X, 87C5XX, 87C75X, 89C5X) **ATMEL MICROS*** (8-40) PIN 89CX051, 89SXXXX (AVR) 90SXXXX **PIC MICROS*** 8, 18, 28, 40 PIN (12CXXX-16CXXX, 16FX, 17C) **MOTOROLA MICROS*** (68705P3/U3/R3, 68HC705, 68HC711)

\$289

REQUIRES SNAP-IN ADAPTER (ORDER FACTORY DIRECT OR BUILD YOURSELF) \$5.00 SHIPPING + \$5.00 C.O.D. 1 YEAR WARRANTY - 30 DAY MONEY BACK GUARANTEE VISA MASTERCARD* AMEX

ANDROMEDA RESEARCH, P.O. BOX 222, MILFORD, OH 45150
(513) 831-9708 FAX (513) 831-7562 website - www.arlabs.com

TiePieScope HS801

PORTABLE MOST

Reliability



- 50 MHz ARBITRARY WAVEFORM GENERATOR-
- 100 MHz STORAGE OSCILLOSCOPE-
- 50 MHz SPECTRUM ANALYZER-
- 6 DISPLAY MULTIMETER-
- 200 DAYS TRANSIENT RECORDER-

The HS801: the first 100 Mega samples per second measuring instrument that consists of a MOST (Multimeter, Oscilloscope, Spectrum analyzer and Transient recorder) and an AWG (Arbitrary Waveform Generator). This new MOST portable and compact measuring instrument can solve almost every measurement problem. With the integrated AWG you can generate every signal you want.

A user defined toolbar with which over 50 instrument settings quick and easy can be accessed is offered by the versatile software. An intelligent auto setup allows the inexperienced user to perform measurements immediately. Through the use of a setting file, the user has the possibility to save an instrument setup and recall it at a later moment. The setup time of the instrument is hereby reduced to a minimum.

Analyzing signals is done with an 8 bit resolution and a maximum sampling speed of 100 MHz. The input range is 0.1 Volt full scale to 80 Volt full scale. The record length is 32K/256K samples. The AWG has a 10 bit resolution and a sample speed of 25 MHz.

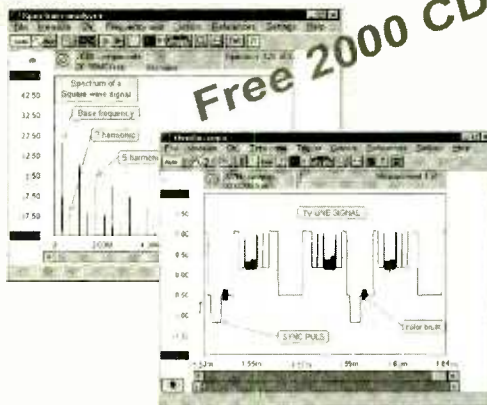

Free 2000 CD

Convince yourself and download the demo software from our web page: www.tiepie.nl. When you have questions and / or remarks, contact us via email: support@tiepie.nl. The HS801 is delivered with a user manual, two probe's, Windows and DOS software.

US dealer:
Feedback Incorporated: Tel 800-526-8783;
Fax 919-644-6470; www.fbk.com

Outside US:
TiePie engineering, P.O. BOX 290, 8600 AG SNEEK,
The Netherlands.
Tel: +31 515 415 416 Fax: +31 515 418 819
Web: www.tiepie.nl

Thanks to you, all sorts of everyday products are being made from the paper, plastic, metal and glass that you've been recycling. But to keep recycling working to help protect the environment, you need to buy those products.

BUY RECYCLED.



AND SAVE.

So look for products made from recycled materials, and buy them. It would mean the world to all of us.

For a free brochure, write *Buy Recycled*, Environmental Defense Fund, 257 Park Ave South, New York, NY 10010, or call 1-800-CALL-EDF.

ENVIRONMENTAL DEFENSE FUND



Microprocessor Hands-On Training

The PRIMER Trainer is a flexible instructional tool featured in a Prentice Hall textbook and used by colleges and universities around the world. Ruggedly designed to resist wear, the PRIMER supports several different programming Languages including Assembler, Machine Language, C, BASIC, and FORTH. A comprehensive Instruction Manual contains over 25 lessons with several examples of program design and hardware control. The Applications Manual provides theory and sample code for a number of hands-on lab projects.

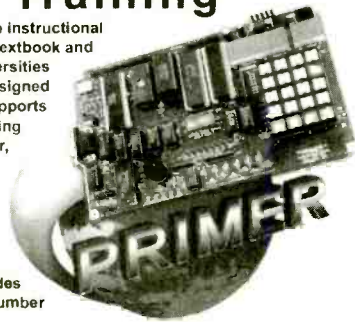

Application Projects Include:

- Scan Keypad Input & Write to a Display
- Detect Light Levels with a Photocell
- Control Motor Speed using Back EMF
- Design a Waveform Generator
- Measure Temperature
- Program EPROMs
- Bus Interface an 8255 PPI
- Construct a Capacitance Meter
- Interface and Control Stepper Motors
- Design a DTMF Autodialer / Remote Controller

The PRIMER can be purchased as an unassembled kit (\$120) or as an assembled/tested kit (\$170). Upgrades provide battery-backed RAM and PC connectivity via an RS232 serial port (shown in picture). Additional options include a heavy-duty keypad (shown in picture) and a 9V power supply - see our website. Quantity discounts are available. Satisfaction guaranteed.

Since 1985
OVER
16
YEARS OF
SINGLE BOARD
SOLUTIONS

EMAC, inc.

Phone 618-529-4525 Fax 618-457-0110
2390 EMAC Way, Carbondale, Illinois 62901
World Wide Web: <http://www.emacinc.com>

\$59 PCBs

And our layout software is **FREE**

- 1 Download our board layout software
- 2 Design a 2-sided circuit board 2.5" x 3.8"
- 3 Send us your layout over the Internet
- 4 We ship you 3 excellent quality boards with plated-through holes for \$59 (shipping included)

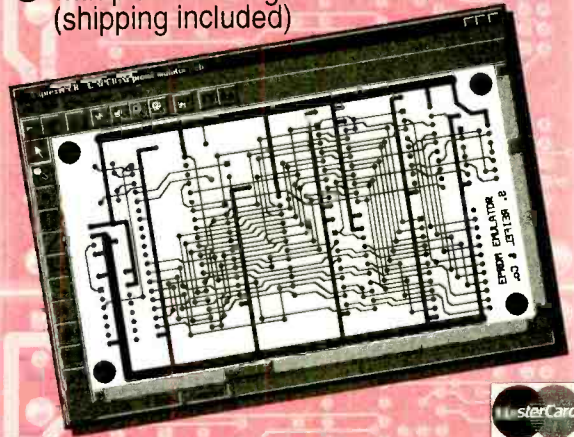

www.expresspcb.com



2539 W. 237th Street, Bldg. F, Torrance, CA 90505
Order desk only: USA: (800) 872-8878 CA: (800) 223-9977
L.A. & Technical Info: (310) 784-5488 Fax: (310) 784-7590
www.digisys.net/timeline • email: mrao@earthlink.net

TIMELINE INC.

Over 15 years and 33,000 customers and still growing

Minimum Order: \$20.00 Minimum shipping and handling charge \$5.00. We accept cashiers checks, MC or VISA. No personal checks or COD's. CA residents add 8.25% sales tax. We are not responsible for typographical errors. All merchandise subject to prior sale. Phone orders welcome. Foreign orders require special handling. Prices subject to change without notice. 20% restocking fee for returned orders.

LIQUID CRYSTAL DISPLAYS

240x64 dot LCD with built-in controller.
AND 4021ST-EO. Unit is EL back-lit. \$49.⁰⁰ or 2 for \$89.⁰⁰ or OPTREX. DMF5005 (non back-lit) \$39.⁰⁰ or 2 for \$69.⁰⁰
20 character x 8 line 7/4" x 2 3/8" The built-in controller allows you to do text and graphics.

240x128 LCD with built-in controller: \$49.⁰⁰ or 2 for \$69.⁰⁰
256x128 LCD with built-in controller: \$49.⁰⁰ or 2 for \$69.⁰⁰

Alphanumeric—parallel interface

16x1.....\$5.00	20x2.....\$7.00	32x2.....\$6.00
16x1 (lg. char.).....\$8.00	20x4.....\$8.00	40x1.....\$6.00
16x2.....\$5.00	20x4 (lg. char.).....\$10.00	40x2.....\$8.00
16x2 (lg. char.).....\$10.00	24x2.....\$7.00	40x4.....\$15.00
16x4.....\$8.00	32x4.....\$7.00	4x2.....\$4.00

5V power required • Built-in C-MOS LCD driver & controller • Easy "microprocessor" interface • 96 ASCII character generator
Certain models are backlit, call for more info.

Graphics and alphanumeric—serial interface

size	Mfr.	price	size	Mfr.	price
640x480 (backlit)	Epson	\$15.00	320x240	Epson	\$20.00
640x400 (backlit)	Panasonic	\$10.00	256x128	Epson	\$15.00
640x200	Toshiba	\$10.00	240x128 (backlit)	Optrex	\$20.00
480x128 (backlit)	ALPS	\$ 8.00	240x64	Epson	\$15.00
480x128	Hitachi	\$ 6.00	160x128	Optrex	\$15.00

6" VGA LCD 640X480, Sanyo LMDK55-22 \$15⁰⁰

9.4 inch color active matrix LCD. Toshiba LTM09C011 **\$49⁰⁰**

9.4 inch monochrome displays. Sharp LM64P70 or LM64P723 **\$29⁰⁰**

MONITORS

Non-Enclosed TTL

Comes with pinout. 12V at 1.4 Amp input • Horizontal frequency 15KHz • Ability to do 40 and 80 column.
5 inch Amber \$19.00 • 7 inch Amber \$19.00
9 inch Amber or Green \$19.00

5" COLOR MONITOR \$25.⁰⁰

- Flat Faceplate • 320 x 200 Dot Resolution • CGA & Hercules Compatible
- 12 VDC Operation • 15.75 KHz Horiz. Freq. • 60 Hz Vert. Sync. Freq.
- Open Frame Construction • Standard Interface Connector • Degaussing Coil included • Mfr. Samtron

2 for \$39⁰⁰

HACKER CORNER

57 WATT UPS SUPPLY \$39.⁰⁰ (COMES W/ 12V @ 2.2AMP BATTERY)
Unit designed to provide uninterrupted DC power in the event of loss of the primary 110 / 220 VAC supply. It utilizes a 12 V sealed lead acid battery as a source of power until the AC supply can be restored. It is a versatile unit which can be used in a number of different applications. The outputs are +5 VDC @ 6.5 A, +3.6 VDC @ 2.5 A, +12 VDC @ 8 A, -12 VDC @ .5 A, and a battery charging output of 12 VDC @ 10 A. The DC outputs are terminated in in-line connectors which interface with standard motherboard and drive connectors. Possible applications include: Robotics, scientific sensing and recording, Linux devices attached to Ethernet or Internet links, etc...

• The unit is small enough (2" x 3.5" x 8.5") to be contained in a standard PC enclosure, in place of the regular power supply - interfacing directly with the motherboard - providing an uninterrupted power supply • It can function as a DC - DC power supply furnishing multiple outputs using a 12 VDC input • The 10 Amp, 12 VDC output can be used as a battery charger with any AC input from 100 -240 V • The unit is a versatile 57 watt DC power supply providing +5 and 3.6VDC as well as +/- 12VDC.

EMBEDDED 486 COMPUTER \$79.⁰⁰ 2 for \$149⁰⁰

Complete enhanced Intel 486SX-33 based computer in ultra small (9.7xL x 6.5xW x 3.1xH) case. Ideal for embedded operations or as a second computer. Features include: • One 16 bit ISA slot • 3 serial ports plus dedicated printer port • Parallel optical coupled adapter port • Built in IBM PC/AT keyboard port • On board VGA video and port • Uses standard SDRAM up to 32 MB • BIOS is PC/AT compatible

Unit has a backup Ni-Cd battery system in case of power failure (5 min. backup time) and lockable front cover to prevent floppy drive access. Mounting / interface provisions for standard 3.5" laptop floppies and 2.5 inch hard drives. Comes with very comprehensive manual.

CELL SITE TRANSCIVER \$29.⁰⁰ 2 for \$49⁰⁰

These transceivers were designed for operation in an AMPS (Advanced Mobile Phone Service) cell site. The 20 MHz bandwidth of the transceiver allows it to operate on all 666 channels allocated. The transmit channels are 870.030-889.980 MHz with the receive channels 45 Hz below those frequencies. A digital synthesizer is utilized to generate the selected frequency. Each unit contains two independent receivers to demodulate voice and data with a Receive Signal Strength Indicator (RSSI) circuit to select the one with the best signal strength. The transmitter provides a 1.5 watt modulated signal to drive an external power amplifier. Channel selection is accomplished with a 10 bit binary input via a connector on the back panel. Other interface requirements for operation are 26 VDC (unregulated) and an 18.990 MHz reference frequency for the digital synthesizer. The units contain independent boards for receivers, exciter, synthesizer, tunable front end, and interface assembly (which includes power supplies and voltage-controlled oscillator). Service manual, schematics and circuit descriptions included.

POS & BAR CODE

MAGNETIC CARD READER \$15.⁰⁰

Includes: • 20 character dot matrix display with full alpha-numeric capability • keypad with full alpha-numeric entry • separate 7.5 VDC/0.5 Amp power supply • standard telephone interface extension cord • lithium battery and flat cone speaker.

HP bar code wand (HBCS 2300) \$19.00



CONITEC DATASYSTEMS

TOP PERFORMANCE in a small package:
Europe's best selling multi-programmer!

Top of the line multi-programmer in sub-\$500 category. From 20% to 80% market share in Germany in 6 years. 1300+ device output and growing fast. Europe-wide sales 30%-60% mkt. share in 6 years. Minimal, 3% return quota for hardware defects. Replaces all low priced dedicated programmers e.g. PIC only or GAL only units. GALEP III also substitutes higher priced universal programmers e.g. ALL-11 (H.C.) or LAB-TECH (48-BIT/ADVANTEC H.). It provides virtually matching performance at only 1/3-1/5 the price.

Programs 8-bit and 16-bit EPROMs, EE-PROMs, 0-Power RAMs, Flash, Serial EEPROMs / GAL, PALCE, ATF12700, 89xxx, PICT 2/16/17Cxx / All DIL devices **without adapter!** Lightning fast parallel data transfer (27C 256 read 2 sec., prog. 8 sec!). Supports HEX, JEDEC and binary formats, with integrated hex and fuse map editor. Fully Windows compatible incl. Win 2000 / NT. Browse 1300+ supported devices on Conitec's website: www.conitec.com. 90%+ of the listed devices require no adapter!

GALEP III (cable, belt, and recharger) **\$333.00**
 PICC adapt. / 8-bit EPROMs / 16-bit EPROMs / GALs each \$129.00

GALEP-III
 Pocket Multi-programmer

CONITEC DATASYSTEMS - 1951 4th Avenue, Suite 301 - San Diego, CA 92101 - Tel: 619-702-4420 - Info/Downloads/Orders: WWW.CONITEC.COM

American Heart Association
 Fighting Heart Disease and Stroke



Research gave him a future

Support Research

Paperback Books

GREAT BOOKS AT BUDGET PRICES

100 RADIO HOOKUPS
 -#7-\$3.00

First published in May, 1923 this popular booklet went into reprint editions nine times. It is packed with circuits, theory, antenna installation and tips on consumer radio receivers that were popular in the early 1920's. Antique radio buffs and those inquisitive about the early days of radio will find this booklet an exciting, invaluable and excellent reference into the minds of early-day radio listeners. Sorry, we cannot honor the original 25-cent cover price.

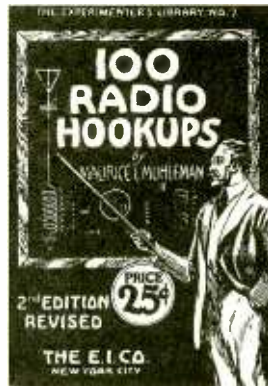

GUIDE TO THE WORLD'S RADIO STATIONS
 -BP355-\$7.99

An easy-to-read guide for the casual listener and top notch QSL getter! The Guide is an essential reference work designed to steer the listener around the ever more complex radio bands. Listings cover world-wide shortwave stations with a special emphasis on international broadcasts in English. Medium and long-wave listings are also included for the US, Canada, European, Middle and Near East, and North Africa regions.

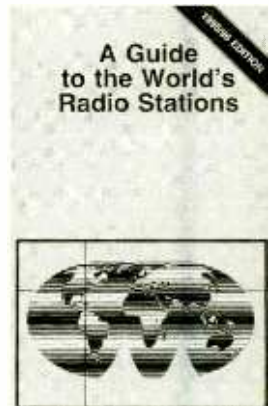

PRACTICAL ELECTRONIC MODEL RAILWAY PROJECTS
 -BP384-\$6.99

Provides a number of useful but reasonably simple projects that include a constant voltage controller, automatic signals, steam whistle sound effect, two-tone horn sound effect, automatic chuffer, and a full chapter that covers how to use a computer to control a model railway layout, including controllers and signaling systems. Helps make your model railway a state-of-the-art system.



WIRELESS & ELECTRICAL CYCLOPEDIA
 -ETT1-\$4.99

A slice of history. This early electronics catalog was issued in 1918. It consists of 176 pages that document the early history of electricity, radio and electronics. It was the "bible" of the electrical experimenter of the period. Take a look at history and see how far we have come. And by the way, don't try to order any of the radio parts and receivers shown, it's very unlikely that it will be available.

ELECTRONIC TECHNOLOGY TODAY INC.
 P.O. BOX 240, Massapequa, NY 11762-0240

Name _____
 Address _____
 City _____ State _____ Zip _____

SHIPPING CHARGES IN USA AND CANADA

\$0.01 to \$5.00	\$2.00
\$5.01 to \$10.00	\$3.00
\$10.01 to 20.00	\$4.00
\$20.01 to 30.00	\$5.00
\$30.01 to 40.00	\$6.00
\$40.01 to 50.00	\$7.00
\$50.01 and above	\$8.50

SORRY No orders accepted outside of USA & Canada

Total price of merchandise	\$ _____
Shipping (see chart)	\$ _____
Subtotal	\$ _____
Sales Tax (NYS only)	\$ _____
Total Enclosed	\$ _____

All payments must be in U.S. funds!

Number of books ordered

Introducing the New **ATOM** !

More Powerful than the Basic Stamp® 2p

The "ATOM®"



Get more out of your stamp projects! More commands, faster code execution, built in hardware, real time graphical code debugging, no more 2k program size limits, interrupt driven hardware and software features, multitasking, enhanced math capabilities and much more!

The OEM "ATOM®"

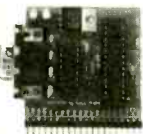

The New ATOM is fully pin compatible and software compatible with the Basic Stamp 2p® but with more power and features! Use all your existing hardware and software! All this for only \$59.95 Complete!

Built in Hardware:

- 3 10 bit A/D Converters
- 2 Capture and Compare
- Internal Adjustable Vref
- + / - External Vref
- 2 PWM
- UARTS
- I2C. SPI
- 3 Timers
- Interrupts External & Internal
- 256 Bytes of Data eeprom
- Over 256 Bytes of RAM

Software Features:

- Free Software
- Graphical Debugging
- More Software Commands
- 32 Bit Integer Math
- 32 Bit Floating Point Math
- Easy to use code editor
- BS2p Compatible Syntax
- Firmware upgradeable
- Unlimited Support
- Free Software Upgrades
- Plus much more!

Visit us online at <http://www.basicmicro.com>

Basic Stamp is a registered trademark of Parallax Inc.

Order online 24 hours 7 days a week visit <http://www.basicmicro.com>
Order by phone M-F, 9am to 5pm EST 1-734-425-1744
Master Card • Visa • American Express

Program PICmicros in Basic !



With our easy to use Basic Compiler. Convert easy to write BASIC programs into files that can be directly run on a PICmicro. PICmicro Basic provides a seamless Windows environment, you can write, debug and compile your BASIC program, all with one Windows application! Full Basic Stamp 2 Compatibility! Starting at \$99.95

PICmicro Programmer

Program PICmicros, Seevic SX, I2C. Microchip ICD compatible! Firmware upgradeable! Includes Windows IDE program software! Only \$59.95

With optional ZIF adapter PICSTART Plus equivalent only much faster!

PICSTART Plus and PICmicro are registered trademarks of Microchip



40 Pin ZIF Adapter

Intelligent ZIF adapter (ISP-PRO). Programs all supported PICmicros from one position! Optional case available for complete unit. Only \$69.95

Complete unit with ISP-PRO and Case Only \$129.95



Solderless Prototype Boards



The 2840 and 0818 solderless prototyping boards are designed for in-circuit programming. See code changes on-the-fly.

Choose our 2840 board for 28/40 pin PICmicros or the 0818 board for 8/18pin PICmicros. Includes RS-232 circuit, regulated power, solderless I/O connector and prototyping area. Prototyping has never been easier! Starting at only \$59.95

Getting Started Kits

Programming PICmicros has never been easier! Kits come with everything to get started! Test code changes on-the-fly without unplugging or switching cables! Starting at \$159.95

Kit Shows Includes:

- PICmicro Basic
- 2840 Dev. Board
- ISP-PRO
- Power Supply
- Serial Cable
- 10Mhz Resonator
- PIC16F476



BASIC MICRO INC.

Microcontrollers Made Easy!®

Hackers Goldmine

Worldwyde.com specializing in hard to find information

We Accept: VISA • Master Card • American Express

To Order Call 1-800-773-6698 (M-F 9am to 5pm EST)
Send Money orders to: Worldwyde.Com,
33523 Eight Mile Rd #A3-261, Livonia, MI, 48152

Order online or view our catalog at <http://www.worldwyde.com>

Electronic Kits & Projects

(Assembled or Kit)

Miniature FM Transmitter	\$11.95
FM Stereo Transmitter (Hi-Fi)	\$29.95
Deluxe Car Alarm System	\$24.95
Digital LED Thermometer	\$20.95
16 Melody Generator	\$12.95
Telephone FM BUG	\$12.95
10 LED Stereo VU-Meter	\$13.95
Digital Timer w/ LED Display	\$21.95
5 Watt Amplifier	\$12.95
50 Watt Stereo Power Amp	\$30.95
0 to 30v - 2mA to 1.5A Reg.	
DC Power Supply	\$29.95
5 to 15v - 1A Reg. DC Supply	\$15.95
Robotic Voice Imitator	\$13.95
Special All Kits Above Only.....	\$239.95

Satellite and Cable TV



Satellite Piracy \$59.95
Secrets of DISH Vol.2 .. \$59.95
Secrets of Free Cable .. \$29.95

Satellite and Cable TV piracy is at an all time high! Find out how it is being done and what the Satellite and Cable TV companies are doing about it! Sources covered for DS3, DISH and Cable TV

Component Shop

PICmicro's starting at	\$6.00
Serial Cables Only	\$4.95
Power Supply Only	\$8.95
Wire Kits Only	\$17.95

Misc parts from LEDs to Cables and more all available at our one stop shop!

Come see our online one stop component shop at <http://www.worldwyde.com>

Programmers

ALLPIC.....\$89.98
Program PIC, ATMEL, SX and serial eeproms. Assembled with 40 pin ZIF



Smart Card Toolkit



- Security Systems
- Time Cards
- Emulation
- Robotics
- And More!

Tool Kit comes complete with:

- SmartCard Programmer
- Developer Software Package
- User Manual in printed form
- 3 Blank Smart Cards

All For Only \$79.95

PlayStation® 2 Secrets

PlayStation® 2 Secrets \$29.95
Learn the secrets of PlayStation® 2 MOD chips and how PlayStation® backups are made.

PSX2 ModChip Source Code \$49.95
(Test your own backups)

PSX2 Kit \$74.95
(Source Code & PSX2 Book, Plus 1 blank chip)

Books & CD Software

Hackers Anarchy Cook Book 2000	\$39.95
Scams & Schemes (3 Vol Set)	\$24.95
Internet Fraud	\$19.95
Identity Fraud	\$19.95
Palm Utilities 2001 CD	\$14.95
Palm Games 2001 CD	\$14.95
Arcade Emulator Heaven 2001 CD	\$39.95
Game Cracker CD	\$29.95
AAA Credit Secrets	\$29.95

Hackers Corner

The Hack & Crack Bible Vol.1	\$29.95
The Hack & Crack Bible Vol.2	\$39.95
Hack & Crack Master Gold CD Vol.1	\$29.95
Hackers Tool Kit CD	\$24.95
Forbidden Knowledge Vol.2	\$14.95

We offer a wide selection of material on hacking!
Visit us online at <http://www.worldwyde.com>

ALL ELECTRONICS CORPORATION

SHOP OUR ONLINE STORE
www.allelectronics.com

150 Watt Power Supply

Cherokee International # MQT154A1
Input: 100 - 240 Vac, 3 Amp
Outputs: +5 Vdc @ 26 A, 3.3 Vdc @ 8 A,
-12 Vdc @ 1 A, +12 Vdc @ 6 A.

Switching power supply.
Aluminum enclosure
on three sides.

8" x 4.25" x
1.5." Line
and load
regulation.

Current
limiting. Voltage
adjustment. Overvoltage setting.
Remote sensing. UL, CSA.

CAT # PS-155

\$10⁵⁰
each

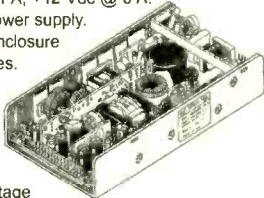

330 uF 400 Vdc Snap-in Cap

BHC Aerovox # ALC10D1001DF

-10 +30%. 1.4" diameter x
2" high. 0.4" pin spacing.

CAT # EC-3341

\$2⁵⁰
each



30 Watt Stereo Amplifier

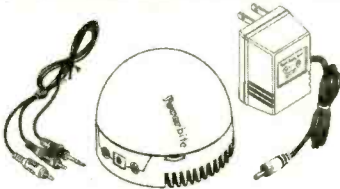

Powerbite © personal stereo amplifier. Boost the power of your computer, personal CD player, portable TV or video game, any audio device with a line level output. This ergonomically designed desktop amplifier provides 30 (15 x 2) Watts of power for a clean, full sound that can be played through bookshelf or larger speakers. Trackball-like volume control. Tone control. LED power indicator. Includes wall-mount power supply and stereo mini-to-RCA cable to connect to audio source. New units in retail display packaging. Speakers not included. **CAT# PBA-30**

\$25⁰⁰
each

case of 12 for
\$20.00 each

ORDER TOLL FREE
1-800-826-5432

CHARGE ORDERS to Visa, Mastercard,
American Express or Discover

TERMS: NO MINIMUM ORDER. Shipping and handling for the 48 continental U.S.A. \$6.00 per order. All others including AK, HI, PR or Canada must pay full shipping. All orders delivered in CALIFORNIA must include local state sales tax. Quantities limited. NO COD. Prices subject to change without notice.

CALL, WRITE
FAX or E-MAIL
for our **FREE**

96 Page
CATALOG
Outside the U.S.A.
send \$3.00 postage.

MAIL ORDERS TO:
ALL ELECTRONICS
CORPORATION
P.O. Box 567
Van Nuys, CA 91408
FAX (818)781-2653

e-mail allcorp@allcorp.com

CLASSIFIEDS

BUSINESS OPPORTUNITIES

\$400 WEEKLY ASSEMBLING Electronic Circuit Boards/Products From Home. For Free Information Send SASE: Home Assembly-PT Box 216 New Britain, CT 06050-0216.

CABLE TV

CABLE TV Descramblers. One-piece units. Scientific Atlanta, Jerrold, Pioneer, and others. Lowest Prices Around. **Precision Electronics** Houston, TX Anytime. 1-888-691-4610

DESCRAMBLERMANIA! SAVE 80% ALL UNIVERSAL CABLE DESCRAMBLER CONVERTER MODELS! INDIVIDUAL AND BULK SALES! 1-800-246-0434 www.cableboxcentral.com

TESTCHIPS, masterfiles, all makes/models, lowest prices around! Dealers, Wholesale, Retail, testchips_1@excite.com, <http://www.angelfire.com/movies/testchips/index.htm> 1-888-322-3886

MISC. ELECTRONICS FOR SALE

T&M ELECTRONICS. Large variety of electronic parts since 1966. Visit our Web site at www.tandmelectronics.com

PLANS-KITS-SCHEMATICS

Carl's Electronics - Hundreds of electronic kits, plus the latest in spy and surveillance. www.electronickits.com

SATELLITE EQUIPMENT

FREE Satellite TV Buyer's Guide. Best Products - Lowest Prices - Fastest Service! Dish Network, DirectTV, C/Ku-band, including 4DTV. Parts- Upgrades - Accessories! **SKYVISION** - 800-543-3025. International 218-739-5231. www.skyvision.com

Poptronics®

SHOPPER

From Not-Working to Networking!

Troubleshooting Local-Area Networks!

Now, complete for the first time in one detailed booklet!

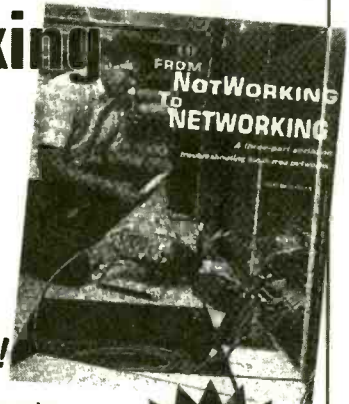

Gain a fuller knowledge of network fundamentals and how they developed from the early days of main frames, from XNS to Ethernet technology, the OSI stack for interconnecting different computers, basic and specialized test instruments, etc. Several tough LAN case histories brings you from theory to the practical side of troubleshooting.

ONLY \$4.99

CLAGGK Inc., Reprint Bookstore
P.O. Box 12162, Hauppauge NY 11788

Please rush my copy of "From Not-Working to Networking." I enclosed payment of \$4.99 which includes shipping charges. U.S.-First Class, Canada and Overseas-Surface Mail.

Name _____

Address _____

City _____ State _____ Zip _____

All Payments must be in U.S. funds. Send check or money order payable to CLAGGK Inc.—do not send cash or stamps. New York State residents add applicable sales tax. Allow 6 to 8 weeks for delivery

RBS02

Gernsback Publications, Inc.

275-G Marcus Blvd. Hauppauge NY 11788

POPTRONICS® CLASSIFIED ADVERTISING ORDER FORM

Advertiser Information

Name _____
 Company _____
 Street Address _____
 City/State/Zip _____
 Telephone () _____
 Signature (required on all orders) _____

Payment Information

Charge my:
 Master Card Visa Discover
 Account No. _____
 Exp. Date _____
 Full payment enclosed. Prepayment discounts offered for multiple insertions (except on credit card orders).
 Payment for first insertion enclose; additional payments will be made prior to closing dates. Prepayment discounts not available.

Do you want any special options? (where available)

- Boldface Type* Add 25% for entire ad Screened Background – Add 30%
 Special Heading – Add \$35.00

The first word of your ad and your name will be printed in boldface caps, at no additional charge. For individual boldface words, add .50¢ each.

In what month(s) would you like your ad to run?

- Entire year for publications selected above.
 Jan. Feb. Mar. Apr. May. June July Aug. Sep. Oct. Nov. Dec.

Here's how to calculate the cost of your Regular or Expanded-Ad Classified:

Rate X Numbers of Words + Rate for Boldface + Rate for Screened Background = Cost per Insertion X Number of Months = Cost

Magazine	Rate	x	Number of Words (min. 15)	+ Boldface (add 25%)	+ Screened Background (add 30%)	=	Cost Per Insertion	x	Number of Months	=	Cost
_____	_____	x	_____	_____	_____	+	_____	x	_____	=	_____

Rates:

\$3.50 per word

Minimum 15 Words

Here's how to calculate the total cost of your advertising:

Prepayment Discount:

(Full payment must accompany order, not applicable on credit card orders)

Prepay for 6 insertions in one magazine, 5% 12 insertions in one magazine, 10%

Subtotal	_____
Less Prepayment Discount	_____
TOTAL COST \$	_____

Please use a separate piece of paper to write your copy, or for any special instructions you may have.

HAVE A QUESTION? CALL: 1-631-592-6720 ext. 206

Fax signed orders with credit card information to : (631) 592-6723

GPI895

ADVERTISING INDEX

Poptronics does not assume any responsibility for errors that may appear in the index below.

Free Information Number	Page	Free Information Number	Page
- A&A Engineering69	139 JamecoCV3
- Abacom74	- LT Sound70
267 Active Electronic Components ..	.71	- Lone Star Consulting, Inc.82
- All Electronics88	- Lynxmotion75
- Allison Technology Corp.78	- M ² L Electronics69
- Amazon Electronics82	324 MCM Electronic65
- Andromeda Research84	- Marrick Ltd.11
- Antique Electric Supply70	143 McGraw-Hill CompanyCV2
- Arrow Technologies71	323 Mendelsons70
- Black Feather Electronics83	296 Merrimack Valley Systems81
290 C&S Sales, Inc.72	- microEngineering Labs83
283 CadSoft, Inc.15	- Modern Electronics75
- Carl Taylor Inc.83	- Mondo-tronics70
233 Circuit Specialists79	205 Mouser Electronics69
- CLAGGK, Inc.10, 20	- MyLydia83
320 Cleveland Inst. of Electronics67	- Ohio Automation82
321 Command Productions64	- Ontrak Control Systems70
- Conitec Data Systems86	- PAIA Electronics82
- Consumertronics83	- Pioneer Hill Software71
- C-Tech Industries69	228 Polaris Industries63
- Designtech Engineering Co.69	219 Prairie Digital69
- EDE Spy Outlet82	- RC Distributing Co.82
210 Electronic Design Specialists66	263 Ramsey Electronics68
- Elect. Tech. Today46	- Saelig Co. LLC.64
130 Electronic WorkbenchCV4	- Scott Edwards Electronics64
- Electronix69	- Scrambling News83
- EMAC Inc.85	- Smarthome.com84
- Engineering Express85	- Square 1 Electronics74
- Fair Radio Sales75	- Technological Arts75
- Fort777.com76	322 Test Equipment Depot80
- Global Specialties74	325 Timeline, Inc.85
- Globaltech Distributors82	217 Tie Pie Engineering84
212 Graymark International66	- UCANDO Videos78
220 Information Unlimited80	- Vision Electronics70
- Intec Automation82	224 Visitect, Inc.78
- Intelligence Here83	- Walter Malecki83
- Intronics70	- World Wyde82, 83, 87
- IVEX Design77		

ADVERTISING SALES OFFICES

Gernsback Publications, Inc.
275-G Marcus Blvd.
Hauppauge, NY 11788
Tel. 631-592-6720
Fax: 631-592-6723

Larry Steckler
 Publisher (ext. 201)
 e-mail: advertising@gernsback.com

Adria Coren
 Vice-President (ext. 208)

Ken Coren
 Vice-President (ext. 267)

Marie Falcon
 Advertising Director (ext. 206)

Adria Coren
 Credit Manager (ext. 208)

For Advertising ONLY EAST/SOUTHEAST

Marie Falcon
 275-G Marcus Blvd.
 Hauppauge, NY 11788
 Tel. 631-592-6720 x206
 Fax: 631-592-6723
 e-mail: mfalcon@gernsback.com

MIDWEST/Texas/Arkansas/ Oklahoma

Ralph Bergen
 One Northfield Plaza, Suite 300
 Northfield, IL 60093-1214
 Tel. 847-559-0555
 Fax: 847-559-0562
 e-mail: bergenrj@aol.com

PACIFIC COAST

Megan Mitchell
 9072 Lawton Pine Avenue
 Las Vegas, NV 89129-7044
 Tel. 702-240-0184
 Fax: 702-838-6924
 e-mail: mmitchell@gernsback.com

**Subscription/
 Customer Service/
 Order Entry**
 Tel. 800-827-0383
 7:30 AM - 8:30 PM CST

www.poptronics.com

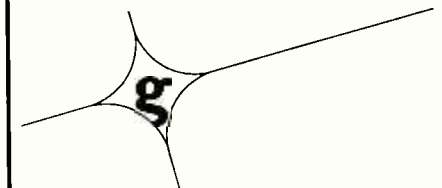

JAMECO[®]

ELECTRONICS

Over 6,000
Quality Products!
99.7% Availability



Your Best Source

for **New and Out-of-Production**
Electronic Products at Value Prices

We Stock a Broad Selection of...

- ◆ Electronic Components
- ◆ Power Components
- ◆ Computer Products
- ◆ Communication Products
- ◆ Tools & Test Equipment
- ◆ Accessory Hardware
- ◆ Sensors ◆ Books ◆ Kits

Visit our website

www.jameco.com/pop

Receive a Full-Color Catalog

FREE!

Call toll free
or sign-up on
our website
for your
complimentary copy.



Mention **VIP#PO3**

1 (800) 831-4242

The world's most popular electronics simulation software just got better! **WHY settle for second best?**

***FREE**

Virtual Lab with Poptronics Circuits

Check out the circuits from recent issues, including this month's!
Tweak the circuits and see the instruments respond instantly.

Download the Multisim demo with pre-built Poptronics circuits from www.electronicworkbench.com/poptronics

BEST PRODUCT! BEST PRICE!

Electronics Workbench is recognized around the globe for developing highly advanced, yet easy-to-use electronics software. Over 150,000 users tell us that they have completed projects using Electronics Workbench in less time than it takes to even install other programs.

And now we've just released Version 6.2! If you've never tried electronics simulation, this is your chance - you can now have your very own virtual lab! Work on your own or create circuits together with others across the country - live on the internet. Start with the **FREE** Electronics Workbench/Poptronics demo and then take advantage of this best price ever when you buy. Tried other products? You owe it to yourself to experience what only the market leader can offer - there is no comparison. And if you own earlier versions of Electronics Workbench, call us now for upgrade pricing starting at just **\$149!**

Multisim Highlights

- ▶ Advanced schematic capture
- ▶ Intuitive auto & manual wiring (no toggle)
- ▶ Change circuits while simulating
- ▶ Mixed-mode SPICE analog/digital simulation
- ▶ Built-in symbol and component editor
- ▶ Parts organized into bins (no alpha lists)

Don't settle for a program that has less than:

- ▶ 6,000 parts in component database
- ▶ 9 virtual instruments & 8 powerful analyses
- ▶ Interactive design on the Internet
- ▶ OLE integration with Excel/MathCAD

multisim V6.2

Schematic Capture & Simulation

~~\$399~~ **\$299**

ultiBOARD

Powerful PCB Layout

~~\$399~~ **\$299**

or get **BOTH** products for **\$498**

Limited Time Offer
BEST price ever!

Ultiboard Highlights

- ▶ Powerful & easy-to-use PCB layout & editing
- ▶ Reroute while move (full rubberbanding)
- ▶ Built-in autorouter
- ▶ Real-time design rule check
- ▶ Automatic net highlighting (selective)
- ▶ Density histograms/placement vectors

Don't settle for a program that has less than:

- ▶ 3,000+ library of footprint shapes
- ▶ Capability for boards of any shape, up to 50"x50"
- ▶ 32 layers support
- ▶ 1 nanometer internal resolution

To order, or to find out why our products are the most popular in the industry, call **1-800-263-5552** or visit www.electronicworkbench.com (**FREE** demo available)



Electronics
WORKBENCH

CIRCLE 130 ON FREE INFORMATION CARD

www.americanradiohistory.com