

THE PROFESSIONAL MAGAZINE FOR ELECTRONICS AND COMPUTER SERVICING

ELECTRONIC^{T.M.}

Servicing & Technology

December 1998

Brightness control and retrace lines

Replacement parts/servicing information sourcebook

Where is test equipment headed?

Test equipment showcase



Sharp Video Cassette Recorder Models VC-H902U, VC-H906U, VC-H907U

U.S. \$3.50

12>



7 25274 86667 0

**we deliver
timely solutions,
every day.**



Working harder for you.

When you need help right away, call Philips Smart Parts. We're working hard to make sure your customers are completely satisfied. Call us today for all your parts, accessories, and service aids. **Call 800-851-8885.**



PHILIPS

Circle (120) on Reply Card

Let's make things better.

ELECTRONIC

Servicing & Technology

Volume 18, No. 12 December, 1998

Contents

FEATURES

**6 Troubleshooting techniques:
Brightness control and retrace
lines**

by Homer Davidson

When troubleshooting a TV set, it's always helpful if you can make a mental connection between the symptoms and the parts of the circuitry that might cause those symptoms. In this article, the author explores a number of symptoms involving screen brightness, and helps readers make mental connections between those symptoms and the circuits within the set that's creating those symptoms.

**10 Replacement parts/servicing
information sourcebook**

by the ES&T Staff

In this era of throwaway consumer electronics and private branded products, it's often difficult just to determine the manufacturer behind a brand name product. Sometimes, it's harder still to find service literature and replacement parts to fix a product even after you've figured out who made it. This annual article provides a number of information tools, and updates address listings for some of those hard-to-find parts and service manuals.

22 Mechanical subsystems servicing
by the ES&T Staff

These days, if an electromechanical products, such as a VCR, camcorder, or CD player, malfunctions, it's almost always something in the mechanics. This article provides the reader with some tips on approaching those mechanical problems.

24 Test equipment showcase
by the ES&T Staff

This special advertising section is a way

to provide information to readers about test equipment in a way that is not ordinarily possible. Advertisers in this special section have been given additional space to tell readers about their company and products. We invite readers to see what these companies have to say.

46 Upgrading a personal computer
by John Kull

As PC prices have fallen, so have individual component prices, and that means upgrading can be a good option for your customers. Even though the price of a new PC has fallen, in many instances an upgrade is still a better alternative to purchasing a new PC. This article, one of a series, will look at some popular upgrades and how to accomplish them.

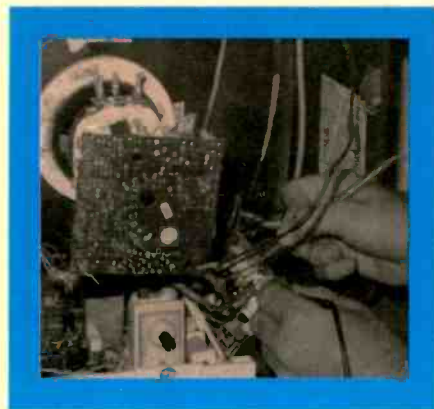

page 6

DEPARTMENTS

- 2 Editorial
- 4 Literature
- 5 Calendar
- 21 Test Your Electronics Knowledge
- 29 Profax
- 45 Books
- 58 Photofact
- 59 Products
- 62 Classified
- 63 Reader's Exchange
- 64 Advertisers' Index



page 10

ON THE COVER

A consumer electronics product operates in such a way that when it fails, the service technician requires a broad array of test equipment to determine what's gone wrong. This test equipment showcase offers readers an in depth look at the offerings and operations of some test equipment manufacturers. (Photo courtesy of Sencore)



page 22



Question
What is the
most important
component
to any
repair job?



electro dynamics, inc.

Leading The Way in the USA™

7 Oser Avenue, Hauppauge, NY 11788-6808

NATIONWIDE TOLL FREE PHONE:
1-800-I-AM-NICE (800-426-6423)

NATIONWIDE TOLL FREE FAX: 1-800-873-2948

International Phone: 516-496-4400

International fax: 516-496-4166

Circle (63) on
Reply Card

EDITORIAL

The troubleshooting process

To the uninitiated, the troubleshooting process must seem mysterious. The technician observes the symptoms, perhaps twiddles a few knobs, pauses for a moment, appears to be deep in thought, then turns the unit off. Next, he opens the unit up, connects leads of a mysterious looking box with numbers on the front, observes the values displayed. Next, he might turn the unit on and connect yet another mysterious box, this one with a screen on the front like a miniature TV and spend some time observing the squiggles on the screen, then connect it to some other place inside and make some more observations.

Once he has done that to his satisfaction, the technician might get a look on his face that suggests he has come to a conclusion, go and get some kind of part, desolder the old one, solder in the new one, then turn the TV set on, to find that it now operates.

Knowledge is the magic

To someone who sees a consumer electronics product, say a TV set, as nothing but this mysterious device that plucks pictures and sounds out of the air and reproduces them in his living room, and who still hasn't learned to program the VCR to tape a show while he's not home, the fact that anyone could possibly understand such a complicated piece of equipment well enough to determine why it's not working right, and fix it is magic.

Of course, those of us who have studied electronics, and consumer electronics in particular, and so have at least a rudimentary knowledge of how those products work, realize that it's not magic. Troubleshooting is nothing more, or less, than applying a broad, deep, knowledge of the construction and operation of the products in a logical manner.

In the case of electronics products, the troubleshooting process seems even more like magic because of the abstruse nature of the operation of the circuitry. It takes a considerable amount of study and contemplation simply to gain any kind of grasp of what's going on in an electronic circuit. The whole thing is very abstract. While there are analogies in electronic circuits to things in the physical world, those only become useful to someone who has studied electronics for a while.

If you think about it in those terms, in some respects, the process of diagnosis of electronic circuits seems arcane even compared to medical diagnosis. Anyone with any knowledge of mechanical things can get a grasp of such things as the heart as a pump, and the veins as pipes or hoses, and can understand high or low blood pressure. If there's a problem with that part of the body, most non-medical people can quickly learn enough to get an idea of what's going on. But with electronics, there's really no quick frame of reference.

If you've ever tried to explain a problem in a consumer electronics product to a non-technical person, you understand frustration. You try to explain that it's a capacitor. Well, what does a capacitor do? Then you find you're involved in trying to



explain what would really take hours to explain — if the listener cared enough. Which they usually don't.

Becoming a better troubleshooter

Every technician would like to become a better troubleshooter. There are two things that any technician can do to become more efficient at troubleshooting. One is to continue to study electronics. Spend as much time in school, and reading books and magazines on the subject as he can. The broader and deeper a technician's knowledge of the operation of electronic circuits and components is, the more likely that he'll possess that one tidbit of information that will help repair the product that's on his bench.

The other thing that a technician can do is to become more methodical, more orderly in his troubleshooting. So many of us fall into that trap when starting a diagnosis, that we're pretty sure what the problem is, so we go there only to find out that that doesn't seem to be where the problem lies. Then we jump to some other point and soon find out we've gotten into a horrible muddle, mentally.

Write things down

It's really a little far-fetched, perhaps, because we're all in a hurry, and we have to get the job done quickly, and besides, this problem is soooooo obvious, but a very good way to begin a diagnosis would be for the technician to write on a piece of paper an exact description of the symptom or symptoms. Then below that, to write what the possible causes of that problem are, then to number them in order of the relative likelihood that that is the cause.

Then below, that, record the identification of every test point checked for voltage, resistance, waveform, and what was found there. Come to think of it, that's not too different from the method teachers use to teach technicians in the lab. Only in that case, the teacher, or the book, tells the prospective technician what places to check and what results to expect.

Yes, this type of approach is time consuming, and perhaps cumbersome. But when you've found yourself wrestling with a tough dog, and losing, and you've almost forgotten your own name, never mind what the original problem was, that piece of paper with a list of what you know so far can help you get your train of thought back on the track.

You may find you've written a book

By following procedures such as this, you will eventually have a great deal of documentation of your own that will further reinforce your troubleshooting ability. By skimming through your own notes from time to time, you may relearn some things that you would otherwise have forgotten forever. Some things that just might help you with that next service job.

Mike Conrad Penam

Answer The right part at the right price ...

**At Electro Dynamics, Inc.
our most important commodity
is supplying our customers with
the correct component for their
repair job. We carry a full line of
schematics and service manuals
for the world's leading manufacturers
of consumer electronic equipment.**

Our Success Depends Upon Your Success.



electro dynamics, inc.

Leading The Way in the USA™

7 Oser Avenue, Hauppauge, NY 11788-3808

NATIONWIDE TOLL FREE PHONE:

1-800-I-AM-NICE (800-426-6423)

NATIONWIDE TOLL FREE FAX: 1-800-873-2948

International Phone: 516-496-4400

International fax: 516-496-4166

Circle (64) on
Reply Card



Fall 1998 full-line catalog:

Contact East introduces its 292-page catalog of new tools and test instruments for engineers, technicians, hobbyists, and general purpose users. Featured are quality products from brand name manufacturers for testing, repairing, and assembling electrical and electronic equipment. New Product Highlights include Tektronix' TX-DMM Series of True RMS DMMs with built-in RS-232 interface, Weller's electronically-controlled Silver Series soldering station, and Erem "2200 Series" ergonomic cutters and pliers. Also featured is a full selection of DMMs and oscilloscopes, power supplies, solder/desoldering equipment, heat guns, precision and hard-to-find hand tools, cordless power tools, measuring instruments, ESD protection products, adhesives, and custom made tool kits.

Circle (90) on Reply Card

Catalog supplement

An extensive selection of advanced surface mount and thru-hole PCB components and hardware are detailed in a new 16-page catalog supplement available from Keystone Electronics. Ten product groups, including surface mount tape and reel packaging availabilities, are described. They are: coin cell holders; retainers and clips; vertical 20-mm coin cell holders; surface mount battery clips; SMT and thru-hole test points; PC fuse clips and holders; auto blade fuse hold-



ers; computer brackets; PC screw terminals; "F" connectors; modular PC terminal blocks; SMT stereo jacks and color keyed PC phono jacks; as well as, universal serial bus sockets and "Firewire" sockets and plugs. The supplement provides complete product details with comprehensive technical information, specifications, mechanical and electrical ratings, engineering drawings, illustrations, photographs; and in the case of the computer brackets, a complete master worksheet.

Circle (91) on Reply Card

Full line catalog

Cal-Chip Electronics offers their new 132-page full line catalog which features

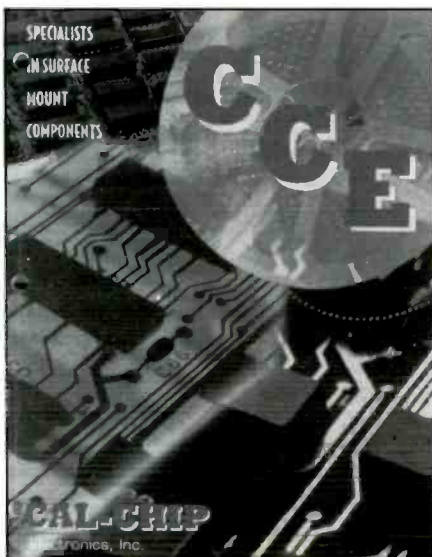

Components catalog and internet features

Jameco Electronics has just released a new catalog and updated website. The 140-page catalog features thousands of ICs, components, tools, test equipment, and computer products for OEMs, engineers, educators, and service/repair technicians. More than 300 new products have been added, including refurbished Macintosh computers and peripherals, vacuum tubes, 100BaseTX Ethernet products, LEDs, LED displays, headers, terminal blocks, and more.

Circle (93) on Reply Card

over 30 series of capacitors, thermistors resistors, and inductors. Suited for a wide range of computer, communications, automotive, audio, commercial, and industrial applications, capacitors featured in the new literature are available in dielectrics of COG(NPO), X7R, Z5U, and Y5V in a wide range of capacitance values and tolerances. Among the capacitors included are full lines of stacked PEN film, ceramic, tantalum, and discoidal chips. Surface mount aluminum electrolytic capacitors, resistor arrays, thick film chip resistors, chip inductors, thermistors, and ferrite beads are also described. Chip capacitors, resistors, and inductors are available in sizes ranging from 0402 to 2512.

Circle (92) on Reply Card

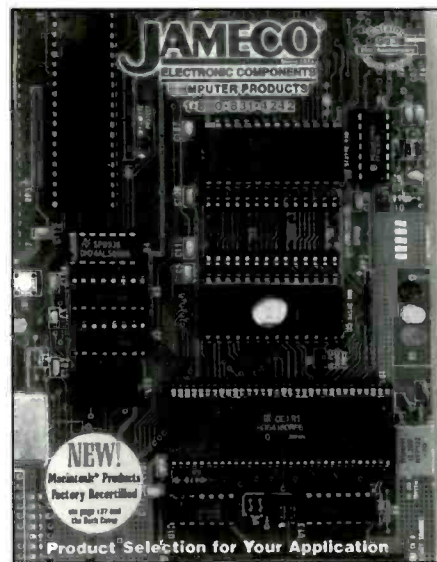

Electronic Servicing & Technology is edited for servicing professionals who service consumer electronics equipment. This includes service technicians, field service personnel and avid servicing enthusiasts who repair and maintain audio, video, computer and other consumer electronics equipment.

EDITORIAL

Nils Conrad Persson, *Editor*
(Internet e-mail: cpersedit@aol.com)
Alycia Nichol森, *Associate Editor*
(Internet e-mail: kirstieest@aol.com)
Richard S. Moseson, *NW2L, On-Line Coordinator*

CONSULTING EDITORS

Homer L. Davidson, *TV Servicing Consultant*
Victor Meeldijk, *Components Consultant*
John E. Shepler, *Audio Consultant*
Sam Wilson, *Electronics Theory Consultant*

PRODUCTION

Elizabeth Ryan, *Art Director*
Barbara McGowan, *Associate Art Director*
Edmond Pesonen, *Electronic Composition Mgr.*
Dorothy Kehrwieider, *Production Manager*
Emily Kreutz, *Assistant Production Manager*
Pat Le Blanc, *Phototypographer*

BUSINESS

Richard A. Ross, *Publisher*
Sal Del Grosso, *Accounting Manager*
Ann Marie DeMeo, *Accounting Department*
Catherine Ross, *Circulation Manager*
Melissa Kehrwieider, *Operations Manager*
Jean Sawchuk, *Data Processing*
Denise Pyne, *Customer Service*

SALES OFFICE

Electronic Servicing & Technology
21704 SE 35th Street, Issaquah, WA 98029
Tel.: 425-557-9611 Fax: 425-557-9612

Evelyn Garrison, *Director of Advertising*
Emily Kreutz, *Sales Assistant*

EDITORIAL CORRESPONDENCE:

P.O. Box 12487
Overland Park, KS 66212
913-492-4857



Electronic Servicing & Technology (ISSN 0278-9922) is published monthly by CQ Communications, Inc., 25 Newbridge Road, Hicksville, NY 11801. Telephone 516-681-2922. Periodical postage paid at Hicksville, NY 11801 and additional offices. Statement of Ownership, Management and Circulation, October 1, 1998. Electronic Servicing & Technology, 25 Newbridge Road, Hicksville, NY 11801. Publication #0278-9922. Issued monthly, subscription price \$26.95 per year (12 issues). Publisher: Richard A. Ross; Editor: Nils Conrad Persson; owned by CQ Communications, Inc. Stockholders: Richard A. Ross, Alan M. Dorihtoffler. Circulation (Average of Preceding 12 Months): Net Press Run 20,050. Sales Through Dealers and News Agents 1,123. Mail Subscriptions 17,141 Total Paid 18,264 Free Distribution 366. Total Distribution 18,630 Copies Not Distributed 350. Returns from News Agents 1,070. Total 20,050. Circulation (single issue nearest filing date): 19,735. Sales Through Dealers and News Agents 1,612. Mail Subscriptions 16,534. Total Paid 18,146. Free Distribution 339. Total Distribution 18,485 Copies Not Distributed 350. Returns from News Agents 900. Total 19,735 s/Richard A. Ross, Publisher. Entire contents copyrighted 1998 by CQ Communications, Inc.
Printed in the United States of America.

Postmaster: Please send change of address to Electronic Servicing & Technology, 25 Newbridge Road, Hicksville, NY 11801.

ES&T Calendar

Int'l. Cons. Electronics Show (CEMA)
January 7-10, 1999
Las Vegas Convention Center
and Hotels
Las Vegas, NV
CEMA (VA): 703-907-7600
www.cemacity.org

Western States Conference
(Regional Associations Conference)
Feb. 18-20, 1999
Queen Mary
Long Beach, CA
Bob Lunn (AZ)
Phone/Fax: 602-943-0596
Lunnct@aol.com

1999 All Service Convention
March 10-14

Radisson Resort Parkway Hotel
Orlando, FL

Sponsoring Associations:

Professional Service

Association — PSA

Electronics Technicians

Association — ETA

Florida Electronic Service

Association — FESA

Satellite Dealers Association —

SDA ETA

604 N Jackson, Greencastle, IN 46135

765-653-8262

Fax: 765-653-4287

e-mail: eta@indy.tdsnet.com

web site: <http://www.eta-sda.com>

Tri-States Annual State Convention '99

March 11-14, 1999

Hood River Inn

Hood River, OR

Mike McCray (OR)

503-288-5356

Fax 503-288-0359

mmccray@cowboyz.com

Electronic Distribution Show: EDS '99
May 18- 20, 1999
Educational Programs May 17th
Las Vegas Hilton Hotel
Las Vegas, NV

National Professional Service
Convention
August 2- 7, 1999
(Trade Show August 4 and 5)
Hotel Intercontinental
Dallas, TX

PCS 99
September 22-24, 1999
New Orleans, LA
703-739-0300

Consumer Electronics Manufacturers
Association (CEMA)
2500 Wilson Blvd
Arlington VA 22201-3834
703-907-7600
<http://www.cemacity.org>

Electronic Distribution Show
Corporation
222 South Riverside Plaza, Suite 2160
Chicago, IL 60606
(312) 648-1140
Fax: (312) 648-4282
<http://www.edsc.org/>
eds@edsc.org

NESDA
2708 W. Berry
Fort Worth TX 76109-2356
817-921-9061
Fax: 817-921-3741
<http://www.nesda.com>

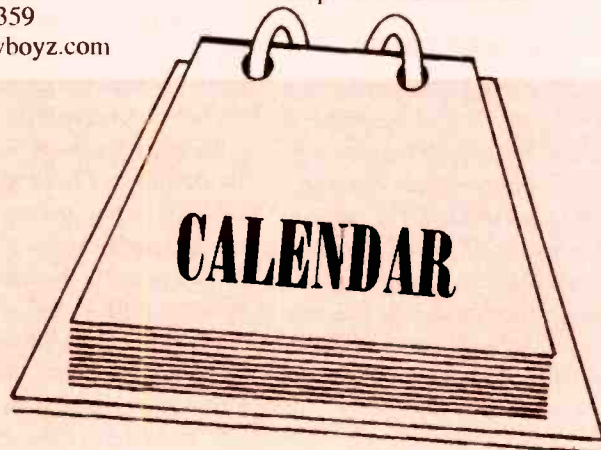

Troubleshooting techniques: Brightness control and retrace lines

by Homer L. Davidson

If you should encounter a TV set that has the problem of improper brightness, no brightness, or brightness control problems with retrace lines, you can be pretty sure that whatever is causing the problem is located within the video output and picture tube circuits. The symptoms might be no raster, no brightness, low brightness, no video/no brightness, no video/bright screen, intermittent brightness, and no control of brightness. In older TV receivers, absence of brightness or a dark picture resulted from poor heater connections of the picture tube.

The most common retrace line symptom is the case in which you observe a retrace line at the top of the picture. Other retrace line problems include a bright picture with retrace lines, bright raster and retrace lines, retrace lines within a normal picture, and retrace lines at the bottom of the picture.

In older sets, white retrace lines were caused by improper boost voltage as a result of defective components in the boost voltage source (Figure 1). Improper boost voltage within a Sanyo PR-7001 chassis was caused by a defective electrolytic capacitor C1203 (4.7 μ F). This voltage source provides boost voltage (+203V) to the color output transistors and pin 9 of the CRT. If this voltage is not correct, the result may be a bright screen with retrace lines.

No raster/no brightness

If the symptom is a black screen with no picture at all, suspect that the problem might be caused by either a high voltage source or a low voltage source that's producing the incorrect voltage. The electron gun assembly in the CRT will not produce a raster if the filament (heater) is not receiving the correct voltage. If you suspect that this might be the cause of a dark screen, look to see if there is light at the

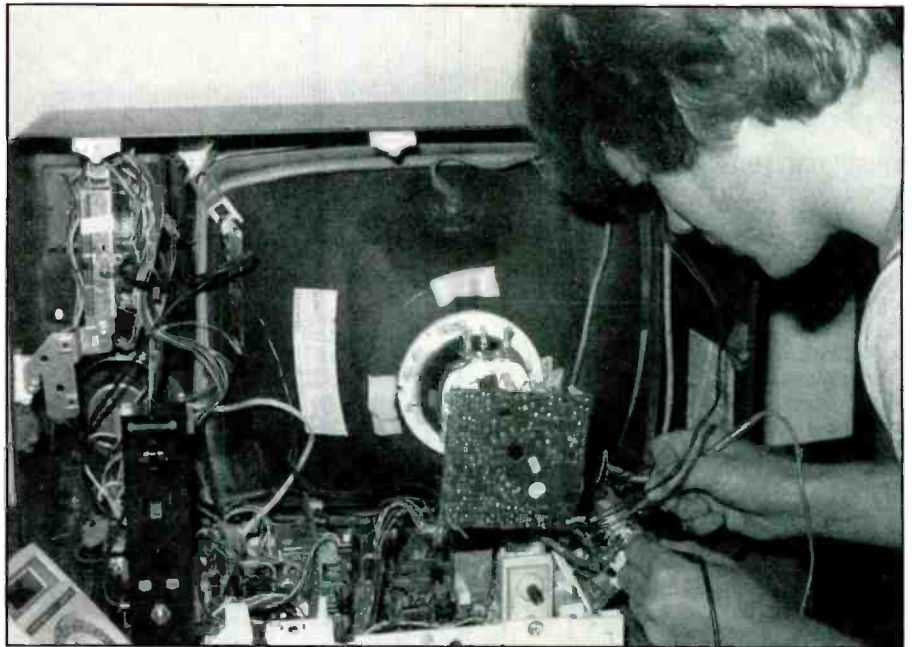

Figure 1. Accurate voltage measurements are a vital step in diagnosing brightness-related problems in the video voltage source circuits.

end of the CRT. If you see light, this means that the filament is operating. Absence of light here may mean that the filament is not receiving the correct voltage. Improper focus voltage can prevent the tube from presenting a raster. Poor video signal at the cathode terminals is another cause that can prevent a raster appearing, even with the correct voltage applied to the picture tube.

If you don't see a cheery glow from the picture tube filament, check it for continuity. If the filament checks out, resolder the heater terminals on the CRT board.

Measure the high voltage at the CRT anode button. Check to see that all of the voltages at the picture tube socket are within specification. Make sure that the focus voltage at the focus terminal varies between 3.5KV and 5.5KV. The higher value may be as high as 7.8KV on larger picture tubes. If in doubt, test the picture tube with the tube tester.

If the screen is dark and you've checked all of the voltages operating the picture

tube, then all signs point toward possible problems in the video circuits.

No video/no brightness

The picture tube is dark and you've checked the high voltage and all of the other picture tube voltages and they're all reasonably close to the values on the manufacturer's literature. What next? The most likely suspect is problems within the video circuits. Check the video output and second video transistors. Improper video supply voltage can produce a no video-brightness symptom as a result of leaky diodes and open filter capacitors. Check for open coils within the video circuits.

Don't overlook the possibility that the problem is caused by poor filament connections. Gently twist the CRT socket and notice if the filaments began to light up. Resolder the heater connections. If the problem is not cured, replace the CRT socket and harness assembly.

An Emerson ECR210 portable came in with no brightness-no video symptom.

Davidson is a TV servicing consultant for ES&T.

After all CRT voltages were checked and found to be normal, I scoped the video output circuits. The video amp Q202 was leaky. I replaced it with a universal replacement transistor (Figure 2). This solved the problem. Also, check D201 and D203 in the base circuit of Q202 for leakage. In another one of these sets, a leaky D202 within the 11.88V power supply to IC501 caused the same symptom.

Dark picture/low brightness

A poor or weak CRT gun assembly can cause a weak or dark picture. If the picture is dim and you've checked voltages to the CRT and found them to be within specification, check all three color guns for weak conditions. Improper high voltage to the picture tube elements can cause a dark or weak picture. Often, if the high voltage is too low, the raster will pull in at the sides. Check the video output and luminance circuits when the picture tube and corresponding circuits are normal.

If the voltage of the voltage source that supplies the video circuits is lower than normal, this condition can cause low brightness and a dark picture. If you find this voltage to be lower than normal, check for open or dried up electrolytic capacitors and leaky diodes in the supply circuit. Measure all resistors on the CRT board for correct resistance. Another possible cause of an intermittent dark picture might be a defective delay line within the luminance buffer amp circuits. A leaky luma amp can cause a dark raster.

One customer complained of low raster and a poor picture on his RCA F27159WN portable TV. The symptom suggested that the picture tube was weak. I tested the CRT. It appeared normal. I then measured the voltages on the video and luminance buffer transistors. These checks indicated low voltage at the emitter of transistor Q2901. The transistor tested normal in the circuit, however. Upon checking the 12V source for low voltage, I found the output voltage on Q4106 was normal (Figure 3). Further checks revealed that CR4118 was leaky. I replaced this component with a universal diode, part number NTE125. This corrected the problem.

No video/bright screen

If the symptom is absence of video, but the screen is bright, check the PIX-IF IC.

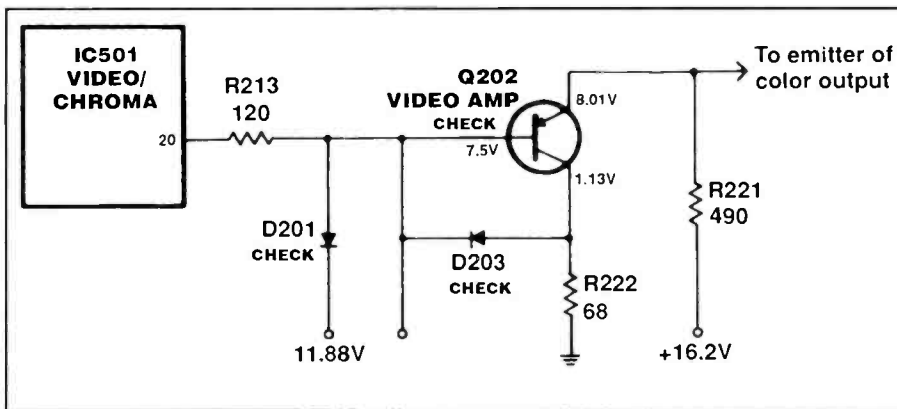

Figure 2. In this Emerson ECR210, replacement of leaky video amp (Q202) solved the no video/no brightness symptom. I also checked diodes D201 and D202.

If this IC is defective, replace it. Test the pulse shaper, brightness limiter, luminance buffer, and video output transistors for leakage. Do not overlook the possibility that the cause of this problem is a defective delay line.

Scope the video and output amps for a video signal. Trace the video signal to the video/chroma IC. If you find video signal at the input, but there is no output, insert a video signal at the input terminal. Now scope the output that feeds to a video drive or output IC and finally to the CRT. Suspect a defective IC or improper supply voltage if there is no video output. Scope each video output transistor in turn for video signal. When you reach a point at which the video signal becomes lost, suspect that that stage is defective.

Measurements revealed that there was no video in a GE CTC168 chassis. I scoped the video and luminance circuits and measured voltages in the luminance circuits. I noticed that the voltage at the

emitter terminal of the luminance buffer transistor (Q2906) was low. I tested Q2906 in the circuit and found high leakage between the base and emitter terminals (Figure 4). I also replaced R2924.

Intermittent raster and brightness

Any of a number of faults can cause the raster to become intermittent: incorrect heater voltage, incorrect screen or anode voltage, or a defective picture tube. Sometimes the chassis might operate for hours before failing. Careful voltage and scope tests can help solve the intermittent raster problem. In older sets that exhibit intermittent brightness accompanied by a bright screen, replace the noise canceller and pulse shaper transistors.

Incorrect heater voltage at the CRT socket produces most intermittent raster problems (Figure 5). The heater voltage is developed using a separate winding of the flyback transformer. As a preliminary check, simply tap the CRT socket to see

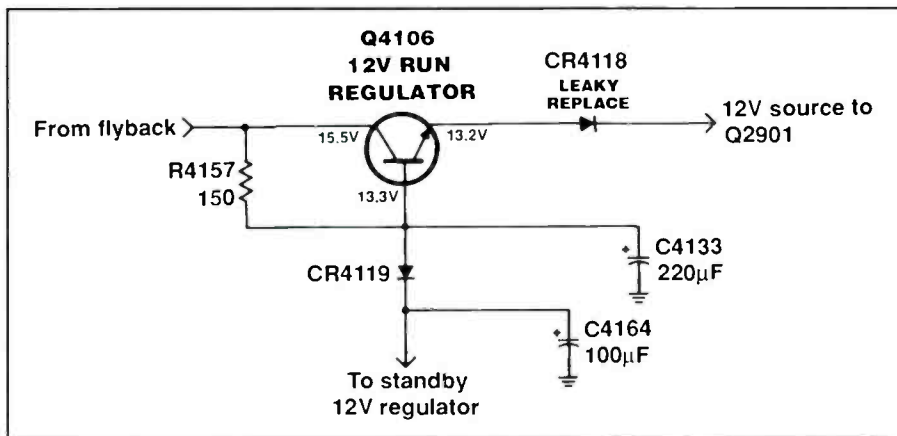

Figure 3. A dark picture and poor video was the problem in this RCA F27159WN portable TV. The problem was caused by leaky diode CR4118 in the 12V run voltage source.

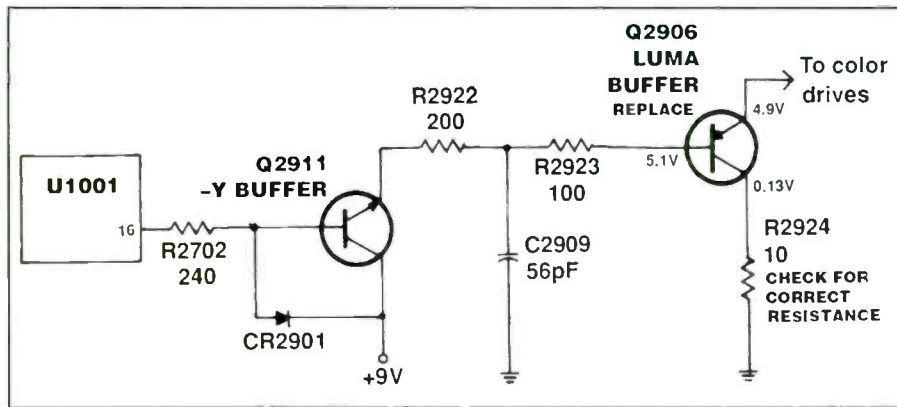

Figure 4. In this GE CTC168 chassis, leaky luma buffer transistor (Q2906) resulted in no video and a bright screen.

caused by a failure in the video circuit that prevents normal brightness control. In some cases, the brightness is so great that the brightness control cannot reduce it to normal. Excessive brightness that cannot be adjusted is seldom caused by the picture tube. In such a case, look for defects in the video circuits. Check to see if the CRT screen-grid and control-grid dc voltages are too high or too low. Measure CRT cathode voltages to see that they are sufficiently positive. Test these voltages first to find which is incorrect, and then check the video circuits.

Improper brightness control can be caused by a shorted picture tube, incorrect element voltage, or incorrect control-signal voltage. Determine if the CRT or circuits are defective using the tube tester and voltage measurements. Suspect a defective luminance, video or output circuit with normal CRT and voltages applied to the picture tube. In the older TV chassis, a defective video and pedestal clamp transistor caused brightness problems.

Check for a change in resistors found in the ABL, brightness limiter, luma, and video amp transistors. Suspect a shorted or leaky second or third video amp transistor when the brightness can't be controlled and you see retrace lines. Excessive brightness can be caused by a defective component within the video supply source. Check for incorrect voltages on the picture tube, when the brightness cannot be turned down and you see retrace lines at the top of the picture.

if the intermittent raster acts up or goes away. Move the socket around. Poor plug fittings or bad picture tube socket can cause the intermittent heater voltage. Resolder all CRT socket connections when the brightness is intermittent and the picture is of one certain color. Faced with these symptoms, it's best to replace the entire socket and harness assembly. Another cause of intermittent high brightness in older sets is that service switch contacts have become corroded.

Intermittent picture problems such as a flashing picture, retrace lines, loss of one or two colors, and no video, can be caused

by a defective picture tube socket. Blow out the dust collected within the spark gaps of the socket. In some instances, the picture will become excessively bright and then the chassis shuts down. Replace the defective socket on the CRT board.

An intermittent brightness symptom was noted in an RCA CTC157 chassis. Checks revealed that the delay line was defective. Replacing the defective delay line (DL2701) solved the brightness problem (Figure 6).

Can't control the brightness

Uncontrollable brightness can be

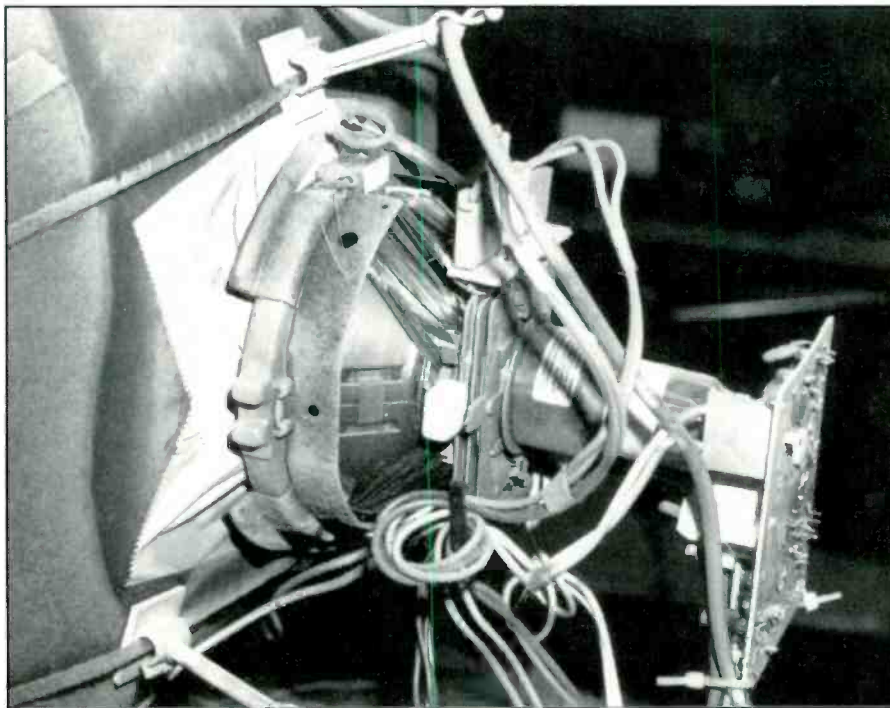

Figure 5. Intermittent raster and brightness can be caused by poor connections of the picture tube socket on the CRT board.

Retrace lines at the top

Defective component in the luminance, vertical or picture-tube circuits might be the culprit when you see several white lines at the top of a picture that has normal-brightness. Often these lines are seen when the brightness is turned down. If the picture is extremely bright and cannot be turned down and there are retrace lines at the top, suspect incorrect voltages on the picture tube. A leaky video output transistor can cause the same problems.

Composite video includes sufficient amplitude of blanking pulses to eliminate the retrace lines under normal conditions. However, slight compression of the video can remove part of the blanking-pulse amplitude, allowing white retrace lines to be seen. To prevent lines from occurring,

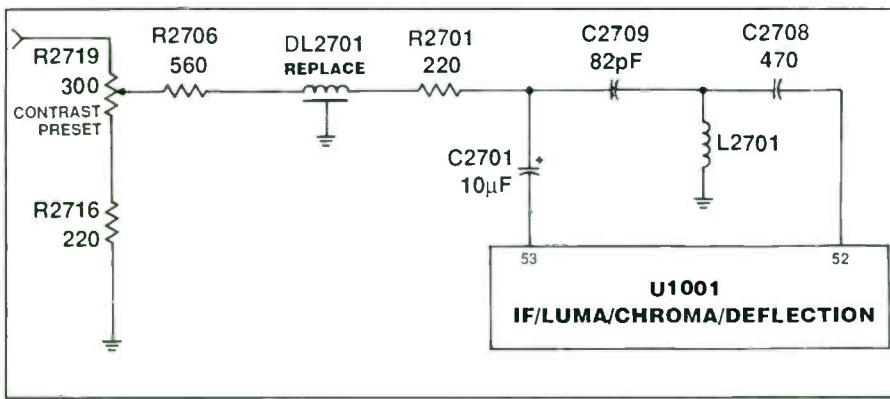

Figure 6. Replacement of a defective delay line (DL2701) in this RCA CTC157 chassis cured an intermittent and flashing picture.

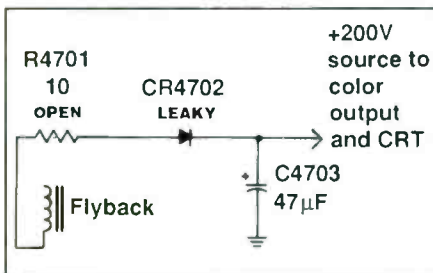

Figure 7. Retrace lines at the top of the picture in another RCA CTC157 chassis were caused by a burned R4701 and leaky CR4702.

vertical-retrace blanking pulses are fed to the correct video stage. When a defect in these components occurs, the white lines can be seen on the screen. Make sure the screen-grid voltage is not set so high that it causes white retrace lines.

A defective color output transistor can cause retrace lines in the picture. Of course, these retrace lines will be in color, indicating which of the color-output stages is defective. Improper boost voltage applied to the color-output transistors

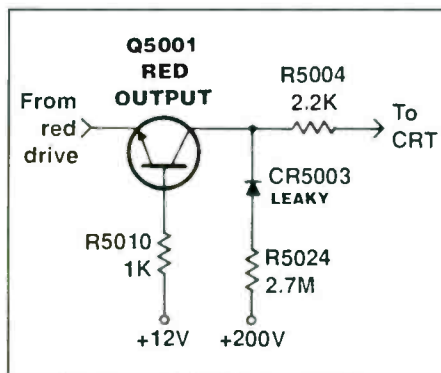

Figure 8. A bright screen with retrace lines in this RCA CTC159 chassis was produced by a leaky CR5003 diode in the collector circuit.

and CRT can cause retrace lines at the top. Check for open coils and resistors in the voltage supply source.

In one RCA CTC157 that was brought into the service center, the brightness could not be reduced enough to eliminate retrace lines. Since defective boost voltage has been the cause of many symptoms of high brightness and retrace lines at the top of the screen, I measured the B+ boost voltage at the collector terminal of the red output color transistor. The voltage was very low. Upon checking the 200V source, I found that R4701 (10Ω) was burned open, and diode CR4702 was leaky (Figure 7). Replacing the 10Ω resistor and the diode solved the problem of excessively bright screen and retrace lines.

Bright picture/retrace lines

Retrace lines can be the result of a shorted picture tube or defective luminance and color output circuits. High brightness with retrace lines can be caused by a defective CRT socket. Improper adjustment of screen and bias controls can result in retrace lines over the whole screen. A defective picture tube can have an extremely bright raster with retrace lines. High brightness and retrace lines with a defective picture tube can cause high voltage and chassis shutdown in the latest TV chassis.

Suspect a defective IF/Video/Luma/Deflection IC whenever you notice retrace lines in the picture. Also, check for open diodes and filter capacitors in the power source that feeds the vertical output IC. Suspect leaky diodes within the base circuit of the luminance buffer transistor if

the screen is bright and there are retrace lines. It's a good idea to also check for a leaky luma buffer amp or video output transistors in the case of this symptom.

In one RCA CTC159 I worked on, the screen was excessively bright, and there were retrace lines. I observed waveforms in all video stages with the oscilloscope. Everything looked normal. When I checked the color-output stages, I found that diode CR5003 in the collector circuit of the red output transistor (Q5001) was leaky. Q5001 tested normal (Figure 8). I replaced CR5003 solving the problem of a bright screen and retrace lines.

Conclusion

When you suspect that brightness or video problems are caused by problems in the video or CRT circuits, scope the video and CRT circuits using a broadcast signal, or a dot-bar generator signal. Take critical voltage and resistance measurements to locate a defective video, luma transistor, or IC. Suspect a leaky IC if the supply voltage is quite low. Check for a defective component in the power supply with an improper voltage source. ■

ELECTRONICS TECHNICIANS AUSTIN, TEXAS

Sears Customer Network is an industry-leading provider of PC, electronics, and home appliance repair information. Our new state-of-the-art technology/call center in Round Rock is now completed, and we have a seat with your name on it. We offer stable year-round employment with no slow seasons. Ongoing training on all the latest products is provided. We offer competitive compensation and a benefits package that includes medical, dental, 401(k), stock purchase plan, and tuition reimbursement.

Relocation assistance provided. If you can repair consumer home electronics including TV's, VCR's, and camcorders, fax or mail your job history to:

Sears Customer Network
1300 Louis Henna Boulevard
Round Rock, Texas 78664
1-800-531-5953 Ext. 14248 E.O.E.
Fax: 512-248-7935

RESUMAIL IT!
www.maxserv.com
www.resumail.com

SEARS
Home Services
Customer Network

Replacement parts/servicing information sourcebook

by the ES&T Staff

There was a time, back when television sets and other consumer electronics products were relatively expensive items, that the products were manufactured by the company whose name was on the product, sold through a distributor to the retailer, and ultimately to the consumer. As long as products were handled that way, finding sources for service literature and replacement parts when they needed service was a relatively easy procedure.

Nowadays, in many instances TVs, VCRs, and many other consumer electronics products are handled like so many jelly beans. Some factory in Korea, Taiwan, Singapore, or other offshore country, churns out product. Some entrepreneur travels to that factory, buys a carload of product, puts it on a ship bound for the west, and, voila, one day very low priced units show up in a discount store. The consumer buys the product, and when it fails, brings it to his local service center expecting it to be repaired.

Now the problem begins for the service manager. Who made the set? Do they have a presence in this country and can he go somewhere to get service literature and parts? Sometimes the answer is yes. That's good. Sometimes the answer is no. That's not so good.

In the case when the answer is no, the service center may still be able to deter-

mine the identity of the company that actually built the product. That company may or may not be able to provide service literature on the unit in question. If the product is identical to one sold by the company under their own brand name, the company may be willing to furnish service literature for the similar brand product. On the other hand, they may not make a product anything like that orphan brand, and may have left it up to the company that bought the product to generate service literature.

In the first instance, you're in luck and will be able to fix the product. In the second instance, unless you can locate the company that imported the sets, and they have service literature to sell, you'll have to service the product without a manual, or return it to its owners.

Other factors that make service difficult

These are only a few of the factors that make it difficult for the average service center to locate and obtain service literature and replacement parts for some products. Some of the other reasons are:

- Companies move, and after a set amount of time the post office doesn't forward mail.

- Some companies are small and have a very low profile in the marketplace, so they're just hard to locate.

- Many private brands of consumer electronics products have little or no support.

- An offshore manufacturer may sell and support products in the U.S. for a period of time and then leave the market. In some cases these companies will have sold their stocks of replacement parts to a distributor in the U.S., but how do you know to whom?

- Some companies don't wish to have independent service companies service their products, so they refuse to provide service literature and replacement parts to the independent.

What are some of the clues?

If you encounter a product that has an unfamiliar name and no other information, such as an address or phone number to help you determine its origins, you may still be able to find out how to locate its manufacturer or distributor. Two pieces of information that can help make such an identification are the FCC (Federal Communications Commission) ID number and the UL (Underwriters Laboratories) code number.

Here's some help

Because consumer electronics servicing presents so many difficulties in simply locating replacement parts and service information, each year in the December issue, we publish a replace-

1999 International

CES

THE SOURCE FOR CONSUMER TECHNOLOGIES

Please send me a copy of the 1999 International CES Directory, as mentioned in **ES&T**.

Enclosed is a check for \$25.00, Payable to the Consumer Electronics Show.
(For **ES&T** readers only.
Regular value is \$100.00.)

Print Copy CD Rom

Name _____

Company _____

Address _____

City _____ State _____ Zip _____

Phone _____ Fax _____

E-mail _____

Mail to: CES, Attn: CES Registration
2500 Wilson Boulevard, Arlington, VA 22201-3824

FCC ID numbers

Code Prefix	Manufacturer	Code Prefix	Manufacturer
A26	Alpine	AKC	Superscope Inc.
A6R	Yamaha	AKE	Marantz Co Inc.
A3D	NEC	ALA	Wells Gardner Electronics Corporation
A3L	Samsung	ALI	Kenwood USA Corporation
A7R	Orion	ANV	Capetronic Int'l Corporation
AAL	Phone Mate	API	Harman Kardon Inc.
AAO	Radio Shack	ARS	AOC Int'l of America Inc.
AAV	Midland International Corporation	ASH	Akai
ABL	Hitachi	ASI	Victor Company of Japan
ABW	JC Penney	ATA	Sharp
ABY	Motorola	ATO	Zenith Electronics Corporation
ACA	Yorx Electronics	ATP	Advent Corporation
ACB	Phonotronics	BBO	Cobra
ACJ	Matsushita	BCG	Apple Computer
ADF	Carterfone	BEJ	Goldstar
ADT	Funai	BGB	Mitsubishi
AES	Uniden	BO7	Sanyo Fisher
AEZ	Sanyo	BOU	Philips
AFA	Fisher	C3K	Microsoft
AFL	Sharp	C5F	Daewoo
AFR	Curtis Mathes	CKL	Hyundai Electronics
AGI	Toshiba	CNT	Compaq Computers
AGV	Montgomery Ward	E0Z	Shintom
AHA	RCA	E2K	Dell Computer
AIH	Litton Microwave Cooking Products	F67	Ampex
AIX	Sylvania	FOD	Packard Bell
AJD	Pioneer Electronics Corp.	G9H	Thomson Consumer Electronics
AJU	GE	GBU	3M
AK8	Sony	GQ8	Acer

Figure 1. Every VCR, personal computer, cordless telephone, and microwave oven must carry an FCC ID number. The first three characters of that ID uniquely identify the manufacturer of the product. This is a listing of manufacturer vs FCC ID number prefix, alphanumerically by code.

ment parts and servicing information sourcebook that provides service companies with several tools to help them overcome these problems. This sourcebook is published annually because so many changes take place within a twelve month period that the list is largely out of date by the time a year has gone by.

This sourcebook contains the following sections:

- A list of suggested references
- A list of FCC (Federal Communications Commission) ID number prefixes that identifies the manufacturer of any product that bears an FCC ID number.
- An identification for the website for the FCC. At this site, you can browse and search for manufacturer identification for a given FCC ID number. At one point, it was possible for visitors to this site to download records that contain FCC ID numbers vs. company name, address, etc. At the moment, this capability seems to no longer be in effect.
- An updated list of UL (Underwriters' Laboratories) ID numbers.

- An updated list of manufacturers with addresses and telephone numbers.

Finding replacement parts

Here's a list of references that are useful in tracking down the manufacturer, or parts distributors. We think that every electronics servicing facility should have them:

Consumer Electronics Replacement Parts Source Book

Consumer Electronics Manufacturers Association,
Electronic Industries Association
2500 Wilson Boulevard
Arlington, VA 22201

This document costs \$8.00, including shipping and handling

Electronic Industry Telephone Directory (Or some equivalent)

Harris Publishing Company
2057-2 Aurora Rd.
Twinsburg, OH 44087-1999
216-425-9000

This will cost around \$50.00 (Or you might be able to get a copy free from your distributor.)

The Howard W. Sams and Company Annual Photofact Index

Available from your distributor, or directly from

Howard W. Sams & Company
2647 Waterfront Parkway East Drive
Indianapolis, IN 46214-2041
800-428-7267

Consumer Electronics Show (CES) Directory

Electronic Industries Association
Consumer Electronics Group
2500 Wilson Blvd.
Arlington, VA 22201
703-907-7500

The CES directory includes over 1,000 manufacturers, brand names, products, and key personnel. The best way to get a copy of this directory is to attend the Consumer Electronics Show in Las Vegas, January 7 through January 10, 1998. It comes with the price of attendance. For further information about CES, write to the address above, or call the listed number and ask for CES Registration.

FCC ID numbers

Manufacturer	First 3 Characters of FCC ID	Manufacturer	First 3 Characters of FCC ID
3M	GBU	Mitsubishi	BGB
Acer	GQ8	Montgomery Ward	AGV
Advent Corporation	ATP	Motorola	ABY
Akai	ASH	NEC	A3D
Alpine	A26	Orion	A7R
Ampex	F67	Packard Bell	FOD
AOC Int'l of America Inc.	ARS	Philips	BOU
Apple Computer	BCG	Phone Mate	AAL
Capetronic Int'l Corporation	ANV	Phonotronics	ACB
Carterfone	ADF	Pioneer Electronics	AJD
Cobra	BBO	Radio Shack	AAO
Compaq Computer	CNT	RCA	AHA
Curtis Mathes	AFR	Samsung	A3L
Daewoo	C5F	Sanyo	AEZ
Dell Computer	E2K	Sanyo Fisher	BO7
Fisher	AFA	Sharp	AFL
Funai	DT	Sharp	ATA
GE	AJU	Shintom	E0Z
Goldstar	BEJ	Sony	AK8
Harman Kardon Inc.	API	Superscope Inc.	AKC
Hitachi	ABL	Sylvania	AIX
Hyundai Electronics	CKL	Thomson Consumer Electronics	G9H
JC Penney	ABW	Toshiba	AGI
Kenwood USA Corporation	ALI	Uniden	AES
Litton Microwave Cooking Products	AIH	Victor Company of Japan	ASI
Marantz Co Inc.	AKE	Wells Gardner Electronics Corporation	ALA
Matsushita	ACJ	Yamaha	A6R
Microsoft	C3K	Yorx Electronics	ACA
Midland International Corporation	AAV	Zenith Electronics Corporation	ATO

Figure 2. To make it easier for readers who may be interested in locating the FCC ID prefix of a particular manufacturer, here is the same information presented in Figure 1, alphabetically by manufacturer name.

If you can't get to the show, limited numbers of copies of the directory will be available from the above address. Limited quantities of the CES Show directory will be available at a reduced price to **ES&T** readers who send in the coupon in this issue. Quantities are limited, but the EIA/CEMA will fill as many orders as possible.

A VCR model number and parts reference

Another invaluable reference is published by the International Society of Certified Electronics Technicians (ISCET): a VCR model number and parts cross reference. The Eighth Edition of the VCR Cross Reference Manual is available in both paper and software editions from ISCET.

The software allows the user to search by manufacturer for model numbers and description for part numbers, and a sub-search by manufacturer and part description is also a feature of the program. The editing sequence for parts shows all the substitutes for the part entered.

The cross reference, which lists equivalent model numbers among brands and equivalent part numbers among brands, is now available from ISCET. This three-hole punched, 144-page, expanded edition includes more than 6,000 parts and 1746 models. About 50 brands are covered in the manual, including RCA, GE, Panasonic, Quasar, JC Penney, Canon, Magnavox, Philco, Sylvania, and others. Typically, this manual would enable a user to repair say, a Canon VCR with a Panasonic part, using RCA service data. The price of the paper version was originally \$29.95, plus \$3.00 shipping. It is now on sale, until December 30, 1998, for \$17.95, plus \$3.00 shipping. The software version on 3-1/2 inch floppy diskette is \$39.95 plus \$3.00 shipping.

The Cross Reference book or disk can be ordered from ISCET. The address is 2708 West Berry, Fort Worth, TX 76109; Telephone: 817-921-9101.

This two-part reference will help any servicing organization that services VCRs to cross reference among different brands

made by the same manufacturer. Part 1 of this reference will allow the user to determine when he has a product in for servicing, if it's possible that it's identical, or almost, to a product for which he already has a service manual. Part 2 of the reference cross references parts, so that if you can't find a part number for a product you are servicing, you may find that you have it on hand under a different part number for another manufacturer's product.

The FCC ID number can help you find a manufacturer

Most consumer electronics products, carry clues as to who the manufacturer is. An FCC ID number, for example, appears on every VCR and computer, and any other product that might generate electromagnetic interference. The first three characters of this number, letters, or a combination of letters and numbers, identifies the manufacturer of the product. If a technician is faced with a product on the bench whose name he doesn't recognize, and if it bears an FCC ID number, he may

UL listing number to VCR manufacturer (Unofficial)

UL Number	Manufacturer	Brand Names
146C	Goldstar	
153L	NEC	
16M4	Samsung	Supra, Multitech, Unitech Tote Vision, Cybrex, GE, RCA, Sears
174Y	Toshiba	Sears
238Z	Hitachi	RCA, GE, Penny, Pentax
270C	Sony	
277C	JVC	
282B	Sharp	
289X	Emerson	
333Z	Symphonic	Teac, KTO, Realistic, Multitech Funai, Porta Video, Dynatech, TMK
336H	RCA	
347H	NAP	
43K3	Kawasho	
403Y	Fisher/Sanyo	Realistic, Sears
436L	Quasar	
439F	JVC	Zenith, Kenwood, Sansui
444H	Zenith	
44L6	TMK	Emerson, Lloyds, Broksonic
504F	Sharp	Wards, KMC
51K8	Portavideo	
536Y	Mitsubishi	Emerson, Video Concepts, MGA
540B	GE	
570F	Sony	Zenith
623J	Sampo	
628E	Samsung	MTC, ToteVision
679F	Panasonic	RCA, GE, Magnavox, Quasar, Canon, Philco
723L	Sanyo	
727H	Hitachi	
74K6	Funai	
781Y	NEC	Dumont, Video Concepts, Vector, Sears
828B	Panasonic	Olympus
843T	Magnavox	
86B0	Goldstar	Realistic, JC Penney, Tote Vision, Shinton, Sears, Memorex
873G	Mitsubishi	
41K4	Portland	

Figure 3. The UL listing number on a consumer electronics product identifies the manufacturer who made it. Here's a partial listing of UL numbers vs. manufacturer.

look the number up in a list of such numbers and determine who the manufacturer was, and find their street address and telephone number.

This is a very helpful bit of information, but it might, or might not, yield the information that the technician needs. For starters, the name of the manufacturer might or might not be the same as the name on the product. The address and telephone number in the FCC database might be up to date, or it might not. The information in the database is the information that was current when the manufacturer provided the communications interference information concerning the product to the FCC.

And now, at least for the time being, it might or might not be possible to obtain

this information easily from the FCC. In the past, the FCC had a voice number that a citizen could call. Once the call went through, the caller would provide the person who answered with the ID number and ask for the name and address of the manufacturer. The individual who answers would relay your question to the bulletin board via a computer terminal and will then relay the information it provides to you.

As I understood it when I contacted the FCC in October, this voice method of obtaining manufacturer information from an FCC ID number is no longer available.

Another method of obtaining manufacturer information from an FCC ID number was to call a number in the DC area from your computer, which would

connect the computer to a bulletin board operated by the FCC. Then by going through a series of steps, the caller could determine the manufacturer of a product that bore a particular FCC ID number. When I called the FCC in October, I was told that the computer bulletin board is no longer in operation.

Currently, the FCC operates a website from which it is possible to obtain a great deal of information about the FCC and its operation. Not too long ago, it was possible not only to look up FCC ID numbers, but to download the entire database. This was a .dbf file, compressed into a .zip file. You could unzip the file and load it into any compatible database program and search for any information you might need. On my most recent trip to the FCC website, it was not possible to download this information. A notation said that it was hoped that they would be able to offer the database for downloading in the future.

Even more troubling, on my most recent visits I was not even able to look up individual FCC ID numbers on the web. I sent an e-mail to the address that was shown on the home page of the FCC site to see if I was perhaps not using it properly, or if there are problems that might be rectified soon, but have not received an answer to that e-mail.

This article lists a number of FCC ID number three-character prefixes and the name of the manufacturer of the products that bear that number. We have added some numbers over and above those that were included in our previous list in the December 1997 issue.

A private company has downloaded this information and makes it available in the form of a compact disc. The address and telephone number for this company are:

M.I. Technologies:
3310 E. Peterson Road
Troy, OH 45373
937-335-4560

A recent telephone call to that company indicates that the information that exists in that listing is quite current.

Identification using the UL manufacturer's code number

Another source of manufacturer identification information is the Underwriters Laboratories code number. The manufacturer of every product submitted to UL for certification is assigned a code num-

Original Manufacturer	UL listed code	FCC listed code
Akai	186Z	ASH
Fisher/Sanyo	403Y	AFA
Funai	333Z, 51K8	ADT, EOZ, BFY
Goldstar	86BO	BEJ
Hitachi	238Z	ABL, AHA
JVC	439F	ASI
Matsushita	679F	ACJ, AIX, AJU
Mitsubishi	536Y	BGB
NEC	781Y	A3D, E74
Orion-Emerson	44L6, 722	A7R
Philips	645Y	BOU
Samsung	16M4, 414K	A3L
Sharp	504F	ATA
Sony	570F	AK8
Toshiba	174Y, 84X7	AGI, G95

This is a FCC and UL guide to original VCR manufacturer that was published in the Taiko replacement video head guide July 6, 1994.

ber that identifies who the manufacturer is. Figure 3 is a partial list of UL numbers and the manufacturers they represent.

Locating the manufacturers

It's not unusual for a servicing organization to have some difficulty finding the address and telephone number of a manufacturer of a product for which they need to order parts, even when the manufacturer is well known. Figure 4 is a listing of manufacturers, gleaned from the

Consumer Electronics Replacement Parts Sourcebook, the NESDA Professional Electronics Yearbook, ES&T reader correspondence, many telephone calls by the ES&T staff, and other sources.

Information sources close to home

Those of you who are located in a city that has a good library system have a ready source of information available free. For example, the ES&T staff regularly call the local library for informa-

tion. References that they have available include the Thomas Catalog, a book called "Companies and their brands," and one called "Brands and their companies." And they're always pleased to receive a call for this kind of information. It's what they're there for. Try giving the reference librarian in your local library a call next time you have a question about who makes what brand of TV or VCR, or similar questions.

Look on the internet

Nowadays, another good way to find information on a company is to search for it on the worldwide web. It's pretty much hit-or-miss, but this approach might just help you find the information you need. To find information on a company this way, just use whatever browser you ordinarily use, enter the name of the company that you want to search for, in quotes. Start by using the simplest search string, for example just the name of the company, without the word "Company," or "Inc."

And if you don't find any information at first, see if there are any other names that you might search under. For example, if you don't find anything under "Philips," try Magnavox, or vice versa.

Here are URLs for a couple of useful sites that list businesses:

<http://www.companiesonline.com/>
<http://www.hoovers.com/>

Replacement Parts Source

Acoustic Research (AR)

(Now owned by Recoton)
 527 Stone Rd
 Benicia, CA 94510
 707-748-5930
 e-mail: ab-tech@worldnet.att.net

Action TV

(American Action TV)
 100 Exchange Place
 Pomona, CA 91768
 909-869-6600
 909-869-5545
 This company sells through truck stops and discount stores.

Adcom Service Corporation

11 Elkins Road
 East Brunswick, NJ 08816
 908-390-1130

AIWA America Inc.

800 Corporate Drive
 Mahwah, NJ 07430-2048
 201-512-3600

Akai American, Ltd. — See Mitsubishi

Alpine Electronics of America, Inc.

19145 Gramercy Place
 Torrance, CA 90501
 310-326-8000 • 800-421-2284

Altec Lansing Consumer Products

PO Box 277
 Milford, PA 18337
 717-296-4434 • 800-258-3288

AmPro Corporation

(Replacement parts for Kloss Novabeam and Videobeam)
 5 Wheeling Ave.
 Woburn, MA 01801
 Sales: 617-932-4800 • 800-556-7733

AOC International

311 Sinclair Frontage Rd.
 Milpitas, CA 95035
 408-956-1070

Apple Computer

1 Infinite Loop
Cupertino, CA 95014
408-996-1010

Aristo Computers Inc.

6700 SW 105th Ave., Suite 300
Beaverton, OR 97008
503-626-6333

Atari Games Corp.

675 Sycamore Drive
Milpitas, CA 95035-7430
408-434-3700

Audio Technica U.S., Inc.

1221 Commerce Drive
Stow, OH 44224-1744
330-686-2600

Audiovox Corp.

150 Marcus Drive
Hauppauge, NY 11788-3723
516-231-7750

Barcus-Berry, Inc (Division of BBE)

5381 Production Drive
Huntington Beach, CA 92649
714-897-6766 • 800-233-8346

Blaupunkt Service

2800 South 25 Ave.
Broadview, IL 60153
800-266-2528

Canton Electronics Corporation, Inc.

1723 Adams St NE
Minneapolis, MN 55413
612-706-9250

Casio Inc.

570 Mt. Pleasant Ave.
Dover, NJ 07801-1620
973-361-5400

Channel Master

1315 Industrial Park Drive
Smithfield, NC 27577-6024
919-695-9286

CIE America, Inc. (C. Itoh)

2701 Dow Ave
Tustin, CA 92780-7209
714-573-2942

Citizen America Corp.

831 S Douglas St Suite 121
El Segundo, CA 90245-4965
310-643-9825

Clarion Corporation of America

661 W. Redondo Beach Blvd.
Gardena, CA 90247-4201
310-327-9100

Columbia Data Products

1070b Ranier Drive
Altamonte Springs, FL 32714-3846
407-869-6700

COMPAQ Computer Corp.

20555 State Highway 249
Houston, TX 77070
281-370-0670

Connecticut Microcomputer

PO Box 186
Brookfield, CT 06804
203-740-9890 • 800-426-2872

Curtis Mathes Corp.

100911 Petal St.
Dallas, TX 75238
214-503-8880

Daewoo Electronics Corp. of America

120 Chubb St.
Lyndhurst, NJ 07071
201-460-2500

Dell Computer Corp.

1 Dell Way
Round Rock, TX 78682-7000
512-338-4400
Sales, Parts and Warranties:
800-426-5150

Denon Electronics

222 New Road
Parsippany, NJ 07054
973-575-7810

Design Acoustics

Division of Audiosphere
Technologies
25 Esna Park Drive
Markham, Ontario L3R 1C9
Canada
905-474-9130

Emerson Radio Corp.

9 Entin Road
Parsippany, NJ 07054

Epson America, Inc.

20770 Madrona Ave.
Torrance, CA 90503-3777
310-782-0770

**Solder Equipment BLOWOUT!**

while supplies last

Weller Portable Desoldering Station (DS600)

part# 4835 395 17204
was \$569.00 now \$499.95

Den-on Desoldering Tool w/stand (SC7000Z)

part# SC7000Z + part# 08-00-00 (stand)
was \$399.95 now \$329.95

Weller MicroTouch Precision Soldering Station (MT1000)

part# 4835 395 17272
was \$769.00 now \$599.95

Philips Solder Station (SBC345)

part# 4822 395 10163
was \$89.95 now \$74.95



SmartParts
Genuine Philips Parts...The Intelligent Choice

Fujitsu Ten Corp. of America
National Service Headquarters
19600 South Vermont St.
Torrance, CA 90502
310-327-2151 • 800-423-8161

Funai USA Corporation
(Also Symphonic)
100 North Street
Teterboro, NJ 07608-1202
201-288-2063

GE Appliances/Microwave Products Dept.
Appliance Park
Bldg. 4106
Louisville, KY 40225
502-452-4311

Gemini, Inc.
103 Mensing Way
Cannon Falls, MN 55009
507-263-3957

GoldStar Electronics Int'l, Inc.
See LG Electronics

GoVideo
7835 East McClain Drive
Scottsdale, AZ 85260
602-988-3400

Grundig/Lextronix Inc.
3520 Haven Ave., Unit L
Redwood City, CA 94063
800-872-2228

Harmon Kardon, Inc., JBL, Infinity
80 Crossways Park Drive
Woodbury, NY 11797
516-496-3400

Hitachi Home Electronics (America), Inc.
3890 Steve Reynolds Rd.
Norcross, GA 30093
770-279-5600

International Jensen/Recoton
2950 Lake Emma Rd
Lake Mary, FL 32746
407-333-8900

JVC Service & Engineering Co. of America
Division of U.S. JVC Corp.
107 Little Falls Rd.
Fairfield, NJ 07004-2105
973-808-9279

Kawasho International
(Kawasho is no longer importing TV sets into the U.S., but some parts and service information is available from:)
Factory Service
PO Box 747
Buffalo, NY 14240
716-856-1612
Kawasho flybacks are also available from:

Electro Dynamics
(General line distributor)
135 Eileen Way
Syosset, NY 11791
800-426-6423

Kenwood U.S.A., Corp.
National Parts Department
2201 E Dominguez
Long Beach, Ca 90801
310-549-7810

Kloss Video Corp.
See Ampro Corp.

Kyocera Electronics, Inc. (Printers)
2301 Cottontail Lane
Somerset, NJ 08873
732-560-3400

LG Electronics
(Formerly Goldstar Electronics)
201 James Record Rd.
PO Box 6166
Huntsville, AL 35824-0166
800-243-0000

Luxman
Division of Alpine
19145 Gramercy Place
PO Box 2859
Torrance, CA 90509
310-326-8000

Marantz USA
440 Medinah Rd.
Roselle, IL 60172
630-307-3100

Matsushita Services Co.
20421 84th Avenue South
Kent, WA 98032
800-833-9626

Mattel, Inc.
See INTV

Midland Consumer Radio
1690 North Topping
Kansas City, MO 64120
816-241-8500

Mitsubishi Electronics
Parts Department
6100 Atlantic Boulevard
Norcross, GA 30071-1305
800-553-7278

NAD (USA) Inc.
633 Granite Court
Pickering, Ontario
Canada L1W 3K1
416-831-6333

NEC Technologies Inc.
Consumer Electronics and Computer Products Divisions
1255 Michael Drive
Wood Dale, IL 60191-1094
630-860-9500

Nikko
AVS Technologies
2100 Trans-Canada Highway South
Montreal, Quebec
Canada H9P-2N4
514-683-1771

Nintendo of America
4820 150th Avenue NE
Redmond WA 98052
800-447-8373

Okidata
532 Fellowship Road
Mount Laurel, NJ 08054
800-OKIDATA

Onkyo U.S.A. Corp.
200 Williams Drive
Ramsey, NJ 07446
201-825-7950

Orion Sales Inc.
11 Union Drive
PO Box 10
Olney, IL 62450
618-392-7000

Ortofon, Inc.
65 East Bethpage Rd.
Plainview, NY 11803
516-454-6570

Panasonic Services Company

20421 84th Ave South
Kent, WA 98033
206-395-0819

Penney, J.C.

National Parts Center
6840 Barton Road
Morrow, GA 30260
800-933-7115

Philips Consumer Electronics Company

Philips Service Company
PO Box 555
401 Old Andrew Johnson Highway
Jefferson City, TN 37760
615-475-8869

Pilot Audio Video Systems

Information available on this company is that it went out of business in about 1989. For a while some parts were available through Curtis Mathes, but now there is no source of parts or service literature for Pilot. If any readers have other information, please let us know. (See Electroponic).

Pioneer Electronics Service, Inc.

1925 East Dominguez St.
PO Box 1760
Long Beach, CA 90801
~~310-746-6337~~ 1-800-421-1606

Proton Corporation

13855 Struikman Road
Cerritos, CA 90703
310-404-2222

Radio Shack

Business Products Support Services
1600 One Tandy Center
Fort Worth, TX 76102
817-390-3011

Ricoh Corp.

3001 Orchard Pkwy.
San Jose, CA 95134
408-432-8800

Rotel of America

290 Larkin Street
Buffalo, NY 14220-8089
800-543-0471

Runco International

2463 Tripaldi Way
Hayward, CA 94545
510-293-9154

Sampo Corporation of America

5550 Peachtree Industrial Blvd.
Norcross, GA 30071
404-449-6220

Samsung Electronics America, Inc.

Service Division
One Samsung Place
Ledgewood, NJ 07852
201-691-6200

Sansui Electronics Corp.

Parts Department
17150 South Margay Avenue
PO Box 4687
Carson, CA 90746
310-604-7300

Sanyo-Fisher (USA) Corp.

Consumer Electronics Sales Div.
21350 Lassen St.
Chatsworth, CA 91311
818-998-7322
For Service: SFS Corporation
1200 West Artesia Blvd.
PO Box 9038
Compton, CA 90224-9038
310-537-5830

Scott, H.H. Inc.

5601 Westside Ave.
North Bergen, NJ 07047
201-662-2000
Parts/Technical Literature:
H.H. Scott, Inc.
State Route 41 & County Rd. 100W
Princeton, IN 47670
800-695-0095

SDI Technologies

(Formerly Soundesign Corporation)
800 Federal Blvd.
Carteret, NJ 07008
908-855-0220

Sears

800-225-2864

Sharp Electronics Corp.

Sharp Plaza
PO Box 650
Mahwah, NJ 07430-2135
201-512-0055
National Parts Center
1300 Naperville Drive
Romeoville, IL 60441
708-759-8555

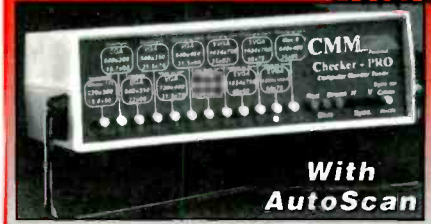
CMM**Monitor Test Equipment****Checker Pro NEW!****With AutoScan**

There is a Computer monitor tester you have been asking for. Sweep rates to 15-64kHz, MGA, CGA, VGA, lots of MACs, even video (mono), **GRAY SCALE**, quick push button operation, "Energy Star" testing, and more. AC or Battery.

PRICE: \$499.95**Checker 12e**

Now you can repair and test Computer monitors with ease. With sweep rates up to 64Khz., eight step gray scale, white screen, single color mode, Mac II, EGA, CGA support, you can run almost ANY PC monitor. And it is EASY to use. Color front panel displays show just what you should see. Don't let its' small size fool you. It is the most powerful handheld available, and it supports ALL basic VGA modes (some don't). It is suitable for bench or field operations. Battery or AC operation.

PRICE:\$295**Checker TV Pro & TV Jr.**

The TV Pro is just the tool for your repair bench. It provides Video, S-Video, and RF outputs. It also has the most important pattern, GRAY SCALE! You can't set up a color TV without it. All with NTSC standards and COMPLEX sync. The RF output also includes an audio tone and STEREO signaling. With colorbars, gray scale, crosshatch, with dots, you can set and test quickly.

Checker TV Pro...PRICE: \$499.95

The TV Jr. is a small NTSC video generator, with colorbars, crosshatch with dots, white, red, blue, green, and black screens. Small enough to fit in your pocket, powerful enough to drive the largest projection TV!

Checker TV Jr...PRICE: \$129.95**Computer & Monitor****Maintenance, Inc.**

1-800-466-4411 • 770-662-5633

<http://www.computermonitor.com>

Circle (61) on Reply Card

Sherwood/Inkel Corporation

14830 Alondra Blvd.
La Mirada, CA 90638-5730
714-521-6100

Shintom West Corp. of America

20435 S. Western Ave.
Torrance, CA 90501
310-328-7200

Shure Brothers, Inc.

222 Hartrey Avenue
Evanston, IL 60202-3696
708-866-5732

Signet

4701 Hudson Drive
Stow, OH 44224
216-688-9400

Sony Corp. of America/

Sony Service Company
Sony Drive (T1-12)
Park Ridge, NJ 07656
201-930-1000

Sony National Parts Center

8281 N.W. 107th Terrace
PO Box 20407
Kansas City, MO 64153
816-891-7550

Soundcraftsmen, Inc.

2200 S. Ritchey St.
Santa Ana, CA 92705
714-556-6191

Sparkomatic Corporation

Routes 6 & 209
Milford, PA 18337
717-296-6444

Studer Revox America, Inc.

1425 Elm Hill Pike
Nashville, TN 37210
615-254-5651

Symphonic Corp.

(Also Funai)
100 North St.
Teterboro, NJ 07608
201-288-2606

Tandberg

Fields Lane, Bldg 2
Brewster NY 10509
914-277-3320

Tandy National Parts

900 East Northside Dr.
Ft. Worth, TX 76102
817-870-5600
800-442-2425

Tatung Company of America, Inc.

2850 El Presidio St.
Long Beach, CA 90810
310-637-2105
310-979-7055

TEAC Corporation of America

7733 Telegraph Rd.
Montebello, CA 90640
213-726-0303

Technics

See Matsushita

Teknika Electronics Corp.

A subsidiary of Fujitsu, Ltd.
Parts Department
353 Route 46 West
Fairfield, NJ 07004
201-575-0380

Teledyne

See Acoustic Research

Thomson Consumer Electronics

600 N. Sherman Drive
Indianapolis, IN 46201
317-267-5000

Thomson Consumer Electronics

Distributor and Special Products
Division
2000 Clements Bridge Rd.
Deptford, NJ 08096
609-853-2525
For Servicing Literature:
TCE Publications
10003 Bunsen Way
Louisville, KY 40299
502-491-8110

Toshiba America Consumer Products Inc.

National Parts Center
1420-B Toshiba Dr.
Lebanon, TN 37087
800-345-9785

Tote Vision

969 Thomas St.
Seattle, WA 98109
206-623-6000

Unisonic Products Corp.

16 West 25th Street
New York, NY 10010
212-255-5400

Videonics

1370 Dell Ave.
Campbell, CA 95008
408-866-8300

V-M Corporation

The Voice of Music
305 Territorial
PO Box 426
Benton Harbor, MI 49023
616-925-8841

This company no longer manufactures products, but manufactured large numbers of turntables under their own name, and for use in audio products of other manufacturers. If you ever need parts for a turntable that has 857 for the first three digits of the serial number, this is the company to contact. If you have any parts for these turntables, V-M corporation would like to talk to you about buying them.

Wells-Gardner Electronics Corp.

2701 North Kildare Avenue
Chicago, IL 60639
312-252-8220

Yorx Electronics Service Center

302 S Service Road West
High Hill, MO 63350
314-585-8817

Zenith Data Systems

2150 East Lake Cook Road
Buffalo Grove, IL 60089
708-808-4584

Zenith Sales Company

1000 Milwaukee Avenue
Glenview, IL 60025-2493
847-391-8738 or 8941

Figure 4. Sometimes it's difficult to find parts or servicing information for a product, even if you know who the manufacturer is. This listing, gleaned from the Consumer Electronics Replacement Parts Sourcebook published by EIA/CEG, the Professional Electronics Yearbook & Directory published by NESDA/ISCET, and information otherwise developed by the **ES&T** staff, will provide you with some parts and technical literature sources for some products.

Test Your Electronics Knowledge

by J.A. Sam Wilson

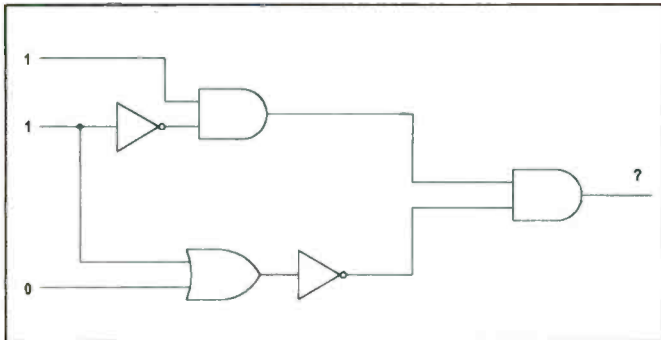

Figure 1.

1. $2 + 3 \times 7 + 4 - 14 \div 2 = ?$

2. Can you solve this basic problem:

$$\begin{array}{r} 6 \\ \hline 2 \quad 2 \\ 3 \quad 3 \end{array} =$$

3. \overline{M} means _____

4. What is the output logic level of the gate circuit in **Figure 1**?

5. The inputs to an EXCLUSIVE NOR are M and N. Write the Boolean algebra output.

6. Phrone Smedge decided to rewind a single-layer coil having a #22 wire size with wire having a #16 wire size. He was careful to make the coil with the same dimension. The rewound coil didn't have the same inductance. Why?

7. A volt is:

- A. A unit of force that pushes electrons through a circuit.
- B. A unit of work per charge.

8. Is the following statement correct? A coulomb is a charge equal to the sum of the charges of 6.28 electrons.

- A. Correct
- B. Not correct

9. To change from milliunits to microunits,

- A. Multiply by 1000
- B. Divide by 1000

10. With 200 microvolts across a resistor and a current through the resistor of 2×10^{-6} amps, the resistance must be _____.

(Answers on page 60)

Wilson is the electronics theory consultant for FS&T.



The Professional
**Electronics
Technicians
Association**
and the **Satellite Dealers
Association**

Certified Satellite/ Antenna Technicians

Four types of recognition for technicians engaged in small and large satellite dish installation, rooftop antennas and video distribution are available from ETA and SDA. Write for a free brochure (or circle your reply card).

THE ANTENNA BOOKS #1 & 2

These two new study guides have all the information your need to become an expert in providing customers with the best reception, interconnection and signal distribution methods. They are written by multiple authors, each with years of experience. They contain quizzes at the end of each chapter, plus an overall practice test similar to that used for the actual certification exams in these categories. Both Antenna Books can be ordered from ETA-SDA for \$44 (incl S & H)

Join the **Antenna Experts Group** and SDA for just \$25 and get a free listing in the AEG page on the ETA-SDA Web Site.

765-653-4301 - 765-653-8262 Fax

602 N Jackson

Greencastle, IN 46135

<http://www.eta-sda.com>

e-mail: eta@indy.tdsnet.com

Circle (76) on Reply Card



**Join the Thousands
of Professionals
Who Are Reaping
the Rewards Today**

**Joining the NCA is your best choice for securing
your future in the computer industry.**

As a trade association of over 2,000 professional VARs, the NCA is having the impact that no one company can have alone. As an association member, you'll now be able to share ideas and be armed with the tools that can reverse the trend of high operating costs and low revenues. These cooperative efforts will continually strengthen and help secure your place in the computer industry for many years to come. In addition to becoming a professional member of the NCA, your benefits include the following:

Toll-Free HelpLine

Certification Programs

OEM Software Opportunities

Professional Reference Guide

Educational Programs

Product Search Program

Equipment Leasing Services

Telecommunication Services

Credit Card Services

Financial Services

Equipment Rentals

Travel Services

Specialized Product Programs

Media Replication Services

Investment Services

Seminar Training Programs

Extended Warranty Programs

Technical Support References

Recycling Programs

Monthly Newsletter

Web Hosting Services

NCA Logo and Decal

Certificate of Membership

Membership ID Card

Please contact the National Computer Association to receive complete applications.

◆ **800.615.6224** ◆

◆ National Computer Association ◆

13555 Automobile Blvd ◆ Suite 240 ◆ Clearwater, FL 33762

nca@gte.net ◆ www.nca-net.com

Circle (78) on Reply Card

Mechanical subsystems servicing

by the ES&T Staff

The electronics circuitry in today's consumer electronics products have become so reliable that they seldom fail. Failures in the electronics circuitry tend to occur either when the product is very new, very old, or when the product has been subjected to abuse, such as when lightning strikes either the power line, or the antenna, or cable.

As an example, I own a hi-fi stereo VCR that has seen a great deal of use over the past seven or eight years. The electronics circuitry has never had a problem. Parts of the tape transport mechanism, however, became somewhat worn and it became necessary to clean it, replace brakes, and a few belts. It was almost as good as new after that work.

In sum, when a malfunction occurs in one of today's electromechanical consumer electronics products: VCR, CD player, DVD, personal computer, or camcorder, the problem is most likely to have occurred in the mechanical portion.

Evaluating the mechanical portion of a unit

Troubleshooting the mechanical portion of a product has one advantage over troubleshooting the electronic portion: you can, at least in most cases, see what's going on. For example, if there's a problem with the picture produced by a VCR, you can take the case off, put in a tape (not a good tape you'd like to keep) and play it. If you see the tape is curling at the top or at the bottom, you know that some of the guides need to be adjusted. If the tape is not being wound on the takeup reel, you know that there's a problem there.

In fact, probably one of the best investments in time for a technician who is servicing, or wants to service, some particular type of product, is to sit down with one of these products opened up, and the technical and service manuals in hand, put in a tape or disc, and run the unit through its paces, making particular note of when certain levers move, belts turn, etc. Then, try to imagine what kinds of problems might occur: what would happen if the pivot

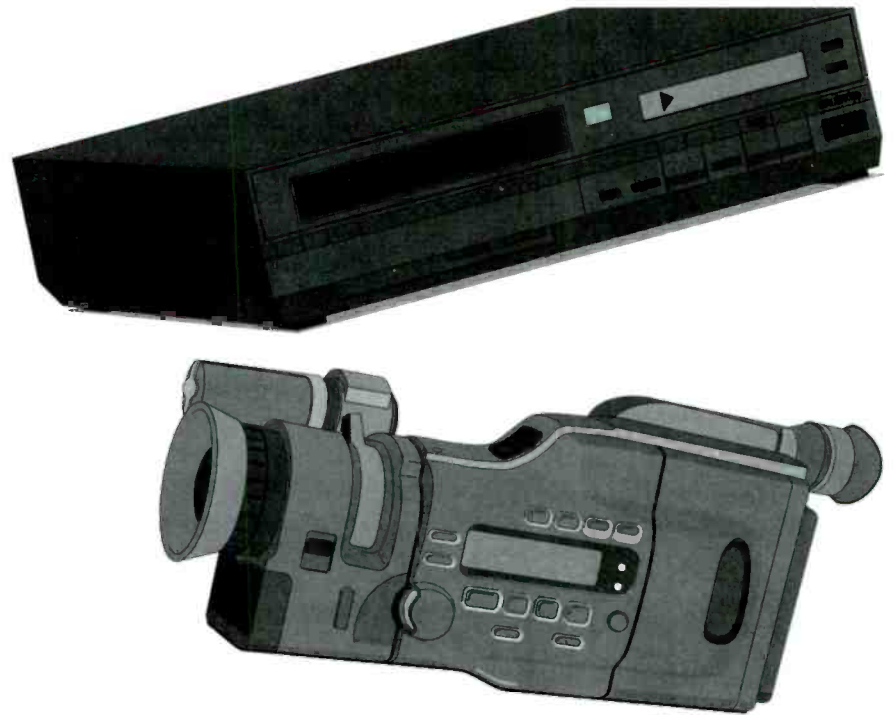

point on that lever became worn, or if that belt started slipping, or if that gear lost a few teeth. With that kind of mental picture available, it would improve the likelihood that the technician would be able to quickly find the source of the problem.

The correct tools

It's always tempting to try to save a few bucks by using common tools to do the work that the manufacturer says will require specialized tools; such as to use a standard pair of pliers or screwdriver to remove and replace snap rings. But that approach is false economy.

You might indeed be able to save a little money in tools by doing this, but at what cost? At best, it might only cost you a little more time to get the work done. At worst, use of the wrong tool, in some cases, might result in damage to the product that the technician would then have to repair, in addition to the original problem.

If the service center plans to perform service on large numbers of a given type of product over a period of years, the cost per unit of purchasing the proper tools

should become relatively small, and the improvement in productivity will more than make up for the cost.

And if the service center doesn't plan to service significant numbers of units, it might be best to limit work on these products to routine cleaning, and to contract either with another local service center, or a service depot, to perform the more involved service, and mark up their cost as a handling fee.

Lighting and magnification

Another important consideration in servicing mechanical subsystems is to make sure that lighting is adequate. Actually, it's almost impossible to have too much light when you're servicing any portion of a consumer electronics product. It's amazing how many kinds of faults can hide in the darkness: hairline cracks, worn mechanical components, binding mechanisms, dried out or cracked rubber parts. Pour a little light in there, and many problems that have been hiding jump right out so you can see them.

It's best to have good area lighting to

illuminate the servicer's work area to start with, then to have strong task lighting to light up the product being serviced. In addition, however, it's very helpful to have some kind of small spot light that can be shined directly into those dark cracks and crevices.

Moreover, many faults are not visible to the unaided eye, even with the best lighting. Every service position should have magnification available. What type of magnifier depends on the type of product, and the preferences of the technician. Magnifier lamps are useful for a number of seeing tasks in servicing, but the lamp might get in the way in some situations. The best situation would be to have a magnifying glass, or lamp for some tasks, but to also have a pair of magnifying glasses or goggles when a glass or lamp might be in the way.

Lubrication

One of the reasons that mechanical components wear out is failure of the lubrication. The grease or oil gets forced out of the joint, or it just breaks down and the part begins to wear. When a technician is servicing an electromechanical

product, he should have on hand all of the lubricants recommended by the manufacturer, and of the correct type as specified by the manufacturer.

If the correct lubricant isn't available, it's tempting to just leave it out, or to use some kind of substitute. But the lubricants specified by the manufacturer are engineered to be compatible with the materials that they lubricate, and to provide protection from wear for the maximum length of time. Using no lubricant, or the wrong lubricant, could cause accelerated wear, and premature failure of the unit.

It's also tempting to put too much lubricant. That can lead to accumulations of dirt at lubricated joints, or even splashing or dripping of lubricant onto parts that are not meant to be lubricated.

Good mechanical servicing practice

Good mechanical servicing is largely just good common sense. Use the right tool for the job, have the service literature on hand, make sure lighting is adequate, and follow the manufacturer's specifications on cleaning materials and methods, and lubrication. Cutting corners can result in inefficiency, or worse. ■



Your Ticket to SUCCESS

More than 40,000 technicians worldwide are Certified Electronics Technicians. IS CET offers Journeyman certification in Consumer Electronics, Industrial, Medical, Communications, Radar, Computer and Video. For more information, contact the International Society of Certified Electronics Technicians, 2708 West Berry Street, Fort Worth TX 76109; (817) 921-9101.

Name _____
 Address _____
 City _____
 State _____ ZIP _____

- Send material about IS CET and becoming certified
- Send one "Study Guide for the Associate Level CET Test." Enclosed is \$14.95 (includes postage/handling). TX residents — include 8.25% sales tax.

ES&T

Circle (77) on Reply Card

Call today for your FREE catalog!

B&D Enterprises

PO BOX 460 • MAIN & LIBERTY — RUSSELL, PA 16345

FACTORY AUTHORIZED SEMICONDUCTOR DISTRIBUTION FOR:

SANYO NEC SanKen Shindengen

(AND MANY OTHERS!)



MEMBER



REDUCED PRICES ON 1000'S OF ITEMS

ORDER TOLL FREE!

1-888-815-0508

TECH SUPPORT 814-757-8300

FAX 814-757-5400

BUSINESS HOURS: 8:00 AM - 7:00 PM EST

Visit our Web Site at www.bdent.com

MINIMUM ORDER ONLY \$15.00
C.O.D. ACCEPTED

(Cash or Company Checks Only)



Circle (60) on Reply Card

When a technician is faced with a consumer electronics product that malfunctions, unless it an extremely simple problem, he is going to need test equipment. In most cases, the technician takes an overall look at the problem and on that basis makes a preliminary judgement. No picture, no sound: probably power supply problems. Everything seems ok, except that the picture is a horizontal line: probably in the vertical section.

Once the technician has made a preliminary diagnosis, then he needs the test equipment to narrow it down. He'll need a DMM to check voltages and resistances, and an oscilloscope to observe waveforms. Maybe he'll need a capacitor tester and/or an ESR meter.

The test equipment

As consumer electronics products evolve and improve, and as more and more products are added to the mix, the service center has to change and grow to keep up with those changes. On the other hand, the basic principles of electronics don't change, and some of the test equipment in use by service centers today will still be in use for years to come. The DMM and the oscilloscope, and other test instruments and accessories, such as the variable transformer, the isolation transformer, and the bench power supply, are just as necessary as they ever were to the serious consumer electronics technician. In other words, the arsenal of test equipment required by the technician gradually and continually grows.

But even as the requirements for newer test equipment are arising, the old standby items of test equipment are evolving and being improved.

For example, while today's technicians require oscilloscopes and test meters and other old standbys just as much as they did 10 or 20 years ago, in many cases the test equipment they require has to be more sophisticated than before. In other words, because the products that the technicians face are so much more sophisticated than they once were, the test equipment must also be more sophisticated.

Some things to consider

The value of a piece of test equipment to the technician depends on a number of factors:

- Ease of use
- Capability
- Accuracy
- Support by the manufacturer
- Versatility

Purchasing guidance is important

The more features that a product offers, the more difficult it becomes to compare features in order to know what product to buy. Anyone who has ever agonized over making a wise purchase in today's environment knows how true that is.

Fortunately, a consumer electronics service center has access to a number of resources that can help them chose from the many test products offered by the many manufacturers. There are, for example, the catalogs offered by the test equipment manufacturers themselves. Most of these provide details of the features offered by each of the products in the company's line. Not only that, but many of the manufacturers have a treasure trove of information on how to connect the equipment, and how best to use it to achieve accurate results. Even better, in some cases, are the catalogs offered by distributors and by companies that rent or lease test equipment. They list products that are offered by a number of manufacturers within each price level, which makes comparison somewhat easier.

The test equipment purchase decision

When a service center buys a piece of test equipment, it would be best if the purchase was considered in detail before the decision is made. Unfortunately, that doesn't always happen. For example, when it's decided that the service center needs a new oscilloscope, the service manager may perform some research on the products and prices, and then send out a purchase order for an oscilloscope.

Most purchases done in this manner

turn out fine, but sometimes the organization learns too late that the unit isn't quite what they need. For example, it may not have the required features to service some new consumer product that they will soon begin servicing. In other cases, the service center realizes that the expensive new piece of test equipment has far more features than they'll ever need, and the money tied up in it could be used elsewhere. You occasionally see some of those items listed in Readers' Exchange in this magazine.

Just as with any purchase, the use to which the test equipment will be put should be carefully studied.

The checklist

Before a service center buys a piece of test equipment, it might be useful to check the candidates against a list such as this:

- What products will this equipment be used to test (now and in the near future)?
- What bandwidth is needed?
- Single-channel, or multichannel?
- Is waveform storage needed?
- Will this be used at the bench only, or on site as well?
- Does this scope need to have on-screen readout of waveform parameters?
- Can this purchase be cost justified as a time and effort saver?

Getting to know the suppliers

Because the decision to purchase a piece of test equipment is so important, the more you know about the manufacturers or suppliers, the better informed your decision will be.

This special advertising section "Test Equipment Showcase," was conceived as a way to help bring more information about test equipment providers to readers. Every advertiser in this section has been given additional space to tell readers something about their company, or to help readers understand the value and use of that company's products.

We invite you to read what these companies that sell test equipment have to say about themselves and their products. ■

Philips Service Solutions Group

PO Box 555
401 E. Old Andrew Johnson Highway
Jefferson City, TN 37760
Toll Free Phone: 800-851-8885
Toll Free Fax: 800-535-3715
Marketing: 423-475-0740 or
423-475-0437

Philips Service Solutions Group is dedicated to providing you and your customers with timely solutions to all of your replacement parts, accessories and service aid needs. We stock over 30,000 different replacement parts, and offer a complete line of Magnavox Accessories as well as Sencore test equipment and Chemtronics chemicals. From Computer Monitor Analyzers and Video Generators to Spray lubricants and cleaners, *we have it all*. We will match anyone's advertised price on Sencore and Chemtronics products, and we offer the most competitive price on Magnavox Accessories of anyone in the service industry.

Easy to Do Business With

Courteous and knowledgeable phone representatives are available Monday through Friday from 8am to 8pm EST, and on Saturday from 8am to 5pm EST. Our professionally trained phone representatives are ready to take your order or assist you in a variety of ways.

Rated #1 in the Industry

Philips Service Solutions Group surveys its Authorized Servicers throughout the country asking them to rate our level of service compared to the top ten consumer electronic manufacturers. All manufacturers are rated in seven (7) service related categories as well as an overall rating. The Philips Service Solutions Group has consistently received a #1 rating in every category, including Service Parts Support.

National Parts and Sales Center

• **Order-Entry:** Our order entry department is one of the best in the industry according to customer opinions. It is staffed with well-trained representatives who are willing and able to place your order promptly, as well as provide pricing and availability information for the products you are interested in. To reach our order entry department, please call 1-800-851-8885 and select option 1.



• **Customer Service:** All customers are encouraged to contact our customer service department with any questions or issues with orders, parts, accessories, service aids, accounts, or returns. Our knowledgeable representatives are trained to resolve most issues while you are on the line. To reach our customer service department, please call 1-800-851-8885 and select option 2.

Making Things Better by Reducing Our Price to You

In our effort to continually *make things better*, Philips Service Solutions Group is reducing pricing on Accessories and Service Aids in order to be more competitive and get you more for your money. This reduction will be effective January 1999 and will affect our most popular items like Surge Protectors, Universal Remotes, Audio-Video Accessories, and Servicing

Chemicals. Additionally, we'll match anyone's advertised price on the same exact accessory or service aid, period; so don't hesitate to call us today!

Same Day Shipping and Two Day Delivery

Philips continues to offer same day shipping for 97% of all orders received by 5pm EST. Additionally, your order should be delivered within two business days virtually anywhere within the continental United States.

Inventory Availability

Philips Service Solutions Group prides itself on inventory available, measuring its orderfill percentage to insure that orders are filled at 95% or better every day. This means that you will have your order on-time with fewer backorders, and that will allow you to provide the best service support possible to your customer.

Pomona Electronics

1500 E. Ninth Street
 Pomona, CA 91766
 Phone: 909-623-3463
 Fax: 909-629-3317
www.pomonaelectronics.com

Pomona Electronics has the broadest line of test accessories in the world, for applications ranging from test labs to field service and plant maintenance, repair and operation. The company has consistently been at the forefront of innovative product design and development for the past 50 years, providing test engineers and field service technicians with the tools necessary to keep pace with the constantly changing technologies they encounter.

Today, Pomona Electronics offers nearly 8,000 products, including banana plugs, coaxial cables, oscilloscope and DMM probe kits and accessories, IC test clips, boxes, connectors and test leads. This broad product line is designed to provide the best equipment available for a wide range of test and interconnect applications. In the lab or in the field, design

engineers and technicians must be able to safely and accurately access the product, component or device. The electrical interface must be reliable and the connection must be strong and continuous for accurate readings. Pomona's products are designed and built to provide accurate results every time.

Pomona's products are recognized worldwide as being of the highest quality, dependability and reliability, and the new products introduced this year continue that tradition. A completely redesigned line of DMM accessories that comply with the industry's newest safety standards, both UL and IEC1010-2-031, also incorporate the latest in ergonomic design and high tech materials for enhanced comfort and durability. The expansion of the company's Minigrabber® and Minipincer®

test clips offer increased comfort, reliability and precision as well as improved access to tight test points and hard-to-reach areas. The introduction of the Precision Electronic Probe, designed for use with a variety of tip points, sets a new industry standard for accessibility and accuracy for any testing configuration.

Building on their legacy of industry leadership in product development and global distribution, the company also sets the highest standards for customer service. Technical and product information is available 24 hours a day, seven days a week, via the company's web site, located at <www.pomonaelectronics.com>, or the "Pomona Access" Fax-On-Demand program at (800) 444-6785, which includes more than 1500 technical documents. The toll-free technical support line (800) 241-2060 continues to provide individual service to customers with specific product or application questions. Information on the company's entire range of products is also available in the 1998 full line catalog.

Pomona Electronics is located at 1500 E. Ninth St., Pomona, California 91766; Tel. (909) 623-3463; Fax (909) 629-3317. Pomona Electronic's line of test accessories is available through the company's global distribution network. Call today for a free catalog. ■

FIFTY YEARS LATER, POMONA STILL MAKES TEST ACCESSORIES WORTH THEIR WEIGHT IN GOLD.

Pomona's IEC1010 designed probes assure optimum durability and performance. They're the perfect end to any test connection. Worth their weight in gold.

The Pomona MDP Banana Plug has been an industry standard nearly as long as we have. Yes, those gold plated jacks do the job.

Pomona offers industry's finest quality test leads with the latest in high tech materials, including silicone wire for longer service life. Rated to 1000V, 10A, CAT III, P2.

Famous for their accurate "all pins" contact, Pomona's DIP test clips make testing the newest chips faster, easier. Gold plated contacts make them precious time savers.

The best solution for small, hard-to-reach connections. Pomona's new MiniGrabber® Test Clip Patch Cords provide golden test results and are rated to 1000V.



www.ittpomona.com

Visit us on the web for complete details or request a copy of the new 1998 Pomona Catalog.

ITT Pomona Electronics
 AN ITT CANNON COMPANY

ITT Pomona Electronics 1500 E. Ninth Street Pomona, CA 91766-3835 Tel: (909) 623-3463 Fax: (909) 629-3317

Circle (66) on Reply Card

LG Precision

13013 East 166th Street
 Cerritos, CA 90703-6227
 Phone: 562-404-0101
 Fax: 562-921-6227
 e-mail: lgpa@pdc.net
 Website: www.oscilloscope.com



LG Precision

LG Precision was founded in Korea in 1976. Since its establishment, LG Precision has grown significantly in the Test and Measurement marketplace.

It has expanded with a wide selection of Analog and Digital Storage Oscilloscopes, Frequency Counters, DC Power Supplies, Digital Multimeters (Handheld and Bench-Top), Function Generators, and Audio Oscillator.

In 1998, LG Precision made significant upgrades in its products line, such as launching high performance 2.7GHz Spectrum Analyzer and portable digital 100MHz Oscilloscope. The SA-7270 is a high performance and state-of-the-art designed spectrum analyzer providing 2.7GHz wideband range, a bright large-scale LCD screen, convenient menu operation, memory function, etc. The OS-310M is a 100MHz Digital Oscilloscope with built-in Digital Voltmeter. It is designed for field service and bench operations as well.

The new triple output DC power supply GP-4303TP and the 5MHZ Functions Generator with built-in frequency counter FG-7005C have recently joined LG Precision's products line.

LG Precision runs its U.S. office to provide effective customer service in U.S. and Canadian market places. It is conveniently located in Cerritos, California and carries sufficient inventory and technical support for immediate response to customer requirement. LG Precision provides detailed information about the products on the internet. Welcome to visit the website at <www.oscilloscope.com> and conveniently download specifications and pictures. ■

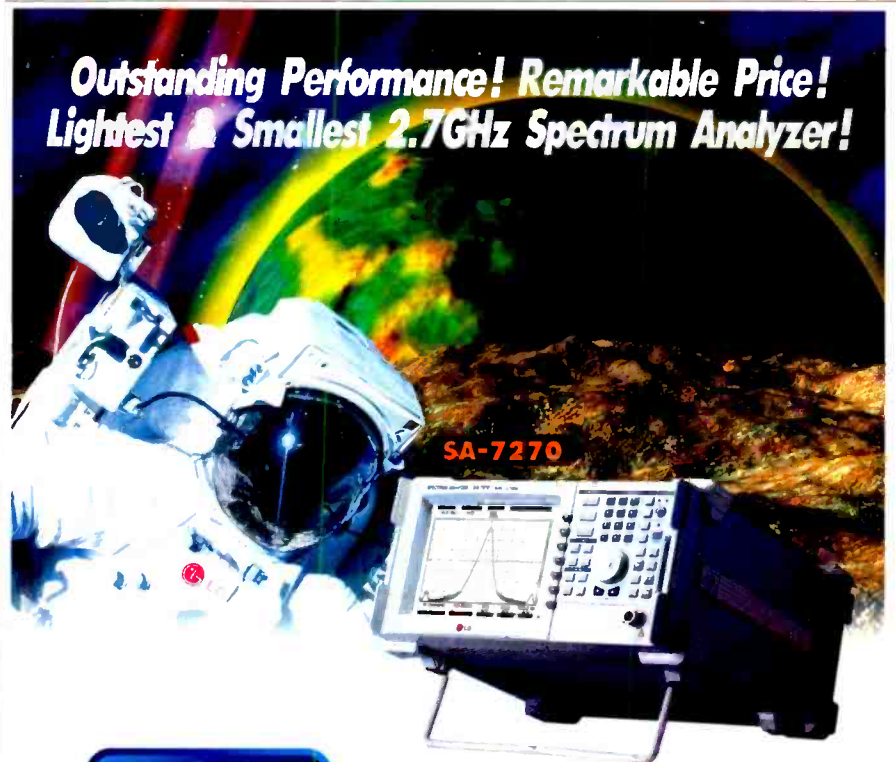

**Outstanding Performance! Remarkable Price!
 Lightest & Smallest 2.7GHz Spectrum Analyzer!**

SA-7270

Other Products



OS-310M



OS-5100RA



The pinnacle of high-technology New 2.7GHz Spectrum Analyzer from LG Precision

Through its extensive investment in R&D, LG Precision is introducing 2.7GHz Wideband Range Spectrum Analyzer. State of the spectrum analyzer SA-7270 possesses sophisticated design and functions such as a wideband range measuring capacity of 2.7GHz, a compact design and the most up-to-date features including the use of rechargeable batteries enabling field use.

- ▶ Measurement of 2.7GHz Wideband Range Frequency!
- ▶ Large-scale 7.4" LCD Screen
- ▶ Compact Design, Portable Size
- ▶ Use of batteries is possible as well as the dual use of AC and DC
- ▶ Convenient MEMORY Function
- ▶ Full Synthesizer Mode



LG Precision

13013 E. 166th. St. Cerritos, CA 90703
 Tel: (562) 404-0101 Fax: (562) 921-6227
 e-mail: lgpa@pdc.net
 Internet Homepage: www.oscilloscope.com

MCM Electronics

650 Congress Park Drive
Centerville, OH 45459

Phone: 800-543-4330

Fax: 800-765-6960

www.mcmelectronics.com

MCM Electronics, Your Source For Service Parts and Accessories

For over 20 years, MCM has been a leading supplier to the electronics service industry. Stocked are literally thousands of repair parts used in all aspects of consumer electronics repair. As authorized distributors for Denon, RCA/GE, Panasonic, Technics, Quasar, Philips/ECG and Magnavox, we have the exact replacement items you need. For the bench, we stock a broad selection of tools and technician aids from trusted names like Chemtronics, Tech Spray, Caig, Xcelite, Crescent, Wiha, Weller, Ungar and Hakko. Our extensive selection of test equipment includes Tenma, Fluke, B&K Precision, Hitachi, Sencore, Leader, Triplett, Simpson and Tektronix.

Discover The MCM Electronics Difference

MCM publishes two full-sized catalogs annually. The latest issue boasts over 3,000 new products, featuring semiconductors, repair parts, and accessories. In all, MCM stocks over 40,000 items essential to the service industry. Sales flyers are mailed regularly featuring specially priced items and new product additions, keeping the customers up to date on the latest products.

Superior Customer Service

All MCM staff is trained to answer calls in a fast, friendly and efficient manner. All sales representatives are well-trained professionals who can provide immediate information on stock availability and pricing. They are available Monday through

Friday 7:00 a.m. to 9:00 p.m. EST, and Saturday 9:00 a.m. to 6:00 p.m. EST. Faxed orders are also accepted 24 hours a day, seven days a week. MCM's highly trained electronics technicians are available Monday through Friday to answer product questions. With a separate toll-free Tech Line, customers can receive prompt answers to their questions by calling 1-800-824-TECH (8324). Our website, www.mcmelectronics.com allows customers with Internet access the ability to place orders, make technical inquiries and get the latest information on special purchases and closeouts.

Fast Delivery From Two Distribution Facilities

MCM is committed to providing superior customer service. Distribution centers are strategically located near Reno, NV and Dayton, OH. This enables fast delivery at ground rates throughout the U.S. In addition, with over 40,000 items stocked, 99% of all orders are shipped within 24 hours. In fact, all in stock orders received by 5:00 p.m. (your time) are shipped the SAME DAY! For more information and a free catalog, call 800-543-4330, in Dayton, OH, call 937-434-0031. ■

Prices effective December 1, 1998 thru January 15, 1999

MCM Electronics® Exclusive!

TENMA® DMM with Logic Function

3½ digit DMM provides all of the functions you see in more costly meters, plus transistor h_{FE} measurement and logic test. Call MCM today and receive this meter with its included protective holster for this incredible low price. Regular price \$65.95.

- AC/DC voltage measurement to 600V with up to 100µV resolution
- Resistance measurement in ranges from 200ohm-2000Mohm
- Capacitance measurement in ranges 2nF-20µF
- 2.5/second sampling rate
- 10Mohm input impedance

Technicians have come to know MCM as the undisputed leader in supplying the service industry. Our 20+ years experience, selection of over 40,000 stocked items and same day shipping have set the standards for our industry nationwide. Get the complete MCM picture. Call today and request our free catalog.

1-800-543-4330

fax 1-800-765-6960

www.mcmelectronics.com



When ordering please provide
CODE: ES107

Order #72-4025
Only

\$29⁹⁵



FREE CATALOG!



MCM ELECTRONICS®
850 CONGRESS PARK DR.
CENTERVILLE, OH 45459
A PREMIER FARNELL Company

Hours: M-F 7 a.m. - 8 p.m., Sat. 9 a.m. - 6 p.m. EST.

CODE: ES107

Circle (70) on Reply Card

Sencore, Inc.

3200 Sencore Dr.
Sioux Falls, SD 57107
Phone: 605-339-0100
1-800-SENCORE (736-2673)
Fax: 1-605-339-0317

Doug Bowden →
Executive Vice President/Owner
Sencore Electronics



The Service Industry and Sencore – Past, Present and Future

Greetings from Sioux Falls, South Dakota, Sencore's home now for 20 years. Wow, it doesn't seem that we've been here that long! Sencore was founded in Chicago by my father, Herb Bowden, 49 years ago. Herb ran Sencore as its CEO and owner until five years ago, when my brother Al and I purchased the business. In talking to Herb about this article, we both agreed with Bob Dylan, "The times, they are a changin'" - and these changing times bring both opportunities and challenges to all of us dedicated to the service industry.

In this article I am going to talk about the past, present, and future of our industry. Yes, I say **our** industry, because Sencore has been right there with you from the beginning, while many of our competitors have come and gone.

The Past

As recently as 1985, there were approximately 45,000 active electronic Service Centers.

The Present

Between 1985 and 1997, the number of active electronic Service Centers shrunk to an all-time low of only 13,666, with 2,356 Service Centers going out of business in 1997 alone.

Sencore and the Future

Phew ... what a difference only 13 years makes! Ron Sawyer of the Professional Service Association discusses this downsizing trend and many of its causes in his report, *Our Annual Report on the Service Industry* (Professional Service Association News, Summer, 1998) and has kindly given his permission to reprint excerpts from his report. Take it away Ron...

"...it has long been expected that the industry would continue to downsize to a point where the demand for service would equal the number of surviving service centers on a national basis."

"If you are not watching what you are doing as a manager...then you will probably become one of the statistics.

You need to manage your business like you have never done it before"

"There is business out there to keep you profitable, but you need to think differently in order to find it."

"You should be looking for new areas of service..."

Our Annual Report on the Service Industry, Professional Service Association News, Summer, 1998, Used with Permission

During my conversation with Ron we shared notes on these changes and trends that have so dramatically altered the face of our industry, especially in the last five years. The central theme in Ron's PSA News report and other expert industry sources is that the market will downsize and equalize, resulting in a strong network of Service Centers and new opportunities. These opportunities are available today for those that will:

1. Get better at what they do now - plain and simple
2. Diversify into new areas of service

This means that to succeed you must:

- Seek out new service work
- Be trained on these new service opportunities
- Be trained on how to run your business more efficiently
- Be efficient and effective and able to quickly identify and accept repairs that will make you money and reject those that will not
- Not allow tough dogs to eat up your profits
- Not allow yourself to go another day without accurate technician productivity and business performance information
- Jump into the year 2000 with electronic service information
- Decide what you're going to do with HDTV

So how does a 50-year old company like Sencore respond to these changes...drop you like a hot potato and move on? No! We have chosen to seize the opportunities pointed out in Ron Sawyer's report and adapt and adjust to ensure that Sencore will be there to meet your needs in the future.

In the year 2000 Sencore will celebrate its 50th anniversary serving the needs of the Consumer Electronics Service Industry. Starting in 1951 with my father, Herb Bowden, a pioneer with Admiral television in launching television in the United States, we have served this industry with time saving, profit building products. I'm proud to say that in all those years, we have not forgotten that only when you succeed, can we succeed.

With our commitment to be your "Total Service Solution" company, Sencore is uniquely positioned to meet all your business needs. Just take a look at a few of the products and services we've introduced over the past 2 years:

- Sencore introduces all new monitor repair training program at the factory, in your area, on-site, and on CD-ROM
- Sencore introduces all new Windows(r) on the Workbench and business management training seminars available in 1999
- Sencore introduces the HA2500 universal horizontal analyzer - troubleshoot and isolate any horizontal defect in record time
- Sencore introduces the all new patented LC103 ReZolver in-circuit capacitor and inductor analyzer
- Sencore introduces the Sencore LITE line of general instruments that provide cost effective solutions to your general test equipment needs
- Sencore Introduces Windows(r) based business management software that helps you better manage your service business
- Sencore works with Manufacturers on Interactive Service Manuals - Sencore's TechDisc
- Sencore introduces and ships the HDTV995 HDTV player (which means that when the time is right we'll deliver a HDTV signal generator designed and built with you in mind)

We gave 110% in the Past, we're giving 110% in the Present, and I promise we will give you, our valued customer, 110% in the Future!

Who is on the Sencore team...

Did you know that over 10,000 active Service Centers today own Sencore? In fact over 6,000 Service Centers own 4 or more Sencore instruments.

If you don't own Sencore I personally invite you to call us and try out our innovative solutions to your toughest servicing problems. We have been here for the industry for over 50 years and I am confident in saying that you need not look anywhere else.

Join the Sencore team and let's succeed together in the year 2000 and beyond.

Howard W. Sams & Company

2647 Waterfront Parkway East Drive
Indianapolis, IN 46214-2041

Phone: 800-428-7267

Fax: 800-552-3910

Website: <http://www.hwsams.com>



Howard W. Sams & Company is proud to be celebrating over 50 years as the nation's leading technical publisher. Since its inception in 1946, Sams has seen its product offerings expand and diversify, so that today, Sams boasts the most complete lineup of technical documentation, services, and publications found anywhere.

Over 50 years ago, Howard Sams was the first company to recognize that the increasing popularity of home entertainment electronics meant a corresponding demand for reliable service documentation. This insight gave birth to the first PHOTOFACT® which presented concise technical information to help service technicians repair specific makes and models of radios. Televisions soon were added to the product line, followed by computer equipment and then VCRs, further enhancing Sams' ability to provide complete, consistent, high-quality repair information to service technicians.

Today, Howard Sams is the nation's largest provider of aftermarket service data for the television and VCR repair industry in the form of the PHOTOFACT® and VCRfacts®, through subscription services, as well as through electronics distributors. Research shows that 95 percent of the companies providing aftermarket repair service for color televisions use Sams technical data.

While PHOTOFACT® provided the foundation for Howard Sams' rise to the top of the technical publishing industry, it is only a portion of what the company publishes today. Sams currently offers a complete line of service products, distributor catalogs, technical books, copy service, and custom manuals for a wide range of clients.

Created in 1991, PROMPT® Publications has grown to become one of the top technical imprints in the nation and one of Sams' brightest stars. Concentrating its efforts on technical books designed both for the novice and the experienced electronics technician, PROMPT® published over 60 books in its first five years, with another 28 scheduled to go to press this year.

Each and every PROMPT® book provides a clear understanding of the principles involved in the installation, maintenance, and performance of electronic devices that have become such a large part of our everyday lives. Some of PROMPT's bestselling titles include *The Component Identifier and Source Book*, the *Semiconductor Cross Reference Book*, the *IC Cross Reference Book*, and the *Tube Substitution Handbook*. Each of these replacement and substitution part guides contain thousands of part numbers, type numbers, and other identifying numbers, and are backed by Sams' decades of research and data.

Sams' photocopy service is another element of the company's business that provides invaluable information to its customers. With a library of hundreds of manufacturers covering a wide range of product lines and thousands of models, Sams can provide service documentation on most any product, including TVs, VCRs, FAX machines, computers, microwave ovens, antique radios, plus much more.

This diverse product line coverage makes Sams your one-stop source for test equipment, replacement parts, and troubleshooting information. PROMPT® has over 15 titles dedicated to these practical topics, and Sams' service data was designed to make troubleshooting and repair quick and easy for technicians.

Since its very creation, Howard W. Sams & Company has been setting the standard by which every other technical publisher is judged. Many have tried, but few have succeeded in matching the level of quality and customer satisfaction that Sams provides with every one of its products. Sams is now taking its half-century of technical expertise into the next generation, once again forging the path that other publishers will try to follow. To receive more information on any Sams products or services, please call 800-428-7267. ■

A **Bell Atlantic** Company
Howard W. Sams

Buy PHOTOFACT®
in brand-name specific sets!

Introducing...
Branded PHOTOFACT Sets

You can now buy PHOTOFACT® grouped by manufacturer brand name. Get an average of 25 PHOTOFACT® folders, covering over 50 models and spanning several years, all for just \$139.95 per set. Choose from RCA, Zenith, Sony, JVC, GE, and all major manufacturers, including off-shore brands.

Visit your local distributor or call

800-428-7267

for details on Sams' new

Branded PHOTOFACT® Sets.



Find out which manufacturers are covered, along with the years, models, and chassis included in each Branded PHOTOFACT® Set.

Circle (119) on Reply Card

Electronic Design Specialists

4647 Appalachian Street
 Boca Raton, FL 33428
 Phone: 561-487-6103
 www.eds-inc.com

Electronic Design Specialists is a maker of specialty test equipment designed specifically to help electronic technicians troubleshoot electrical problems as quickly as possible. All test equipment is designed by David T. Miga, CET, who is both an electronic engineer and a servicing technician.

Dave started EDS eleven years ago with the now-famous SemiAnalyzer 59C, which he designed originally for himself to increase his output as a service technician. After other technicians saw the amount of help the SemiAnalyzer was providing and asking Dave to custom-build them their own units, EDS was born. Used by the military, fortune 500 companies, individual service technicians, and many technical trade schools and colleges, the SemiAnalyzer was just the first

in a series of unique test solutions to aid various technical specialties.

Following the SemiAnalyzer was the Bus Line Tracer, which located shorted and leaky components to their exact location on the PC board, the Teletester series, which simulated two telephone lines for repairing answering machines and faxes, and the MicroAnalyzer, which was designed to help microwave oven technicians check all parts in-circuit under high-voltage load.

At the St. Louis convention in 1996, EDS introduced the LeakSeeker 82A, which like the Bus Line Tracer, locates the exact location of shorted or leaky components, although the LeakSeeker is a digital, automatic version of the Bus Line Tracer, with many more capabilities. For 1997, EDS introduced the world's best

and fastest in-circuit electrolytic capacitor checker, the CapAnalyzer 88.

Dave uses the basic idea that a service technician simply needs to know if a component is good or bad, and doesn't need to be confused by electrical statistics that only an engineer could care about. (Look in the "used test equipment" section to see evidence of "purchase overkill"). Therefore, all EDS equipment is reasonable priced, designed to check components quickly in circuit, with calibrations to determine component condition as good or bad, based on Dave's 25 year service experience. The CapAnalyzer 88 reflects this approach by automatically discharging the capacitor, checking for shorts or DC leakage, then checking high-frequency ESR, quickly alerting the technician by both beeping and indicating the condition of the capacitor....all within three seconds.

As the electronic service repair industry heads into the twenty-first century, Dave will keep on thinking of new products that make it easier for the consumer electronics technician to make a profitable living in repairing today's and tomorrow's complex electronics. Dave invites all technicians to call or write to him regarding their ideas for test solutions they would like to see in the EDS test equipment lineup. ■

CHECK CAPACITORS IN-CIRCUIT WITH 100% ACCURACY IN 3 SECONDS---GUARANTEED*

Automatically discharges capacitor, checks for DC leakage (DCR) and beeps below your preset value, measures ESR on LED bar and beeps from 1 to 5 beeps for values from good to bad.

- ONE-HANDED GOLD-PLATED TWEEZER PROBE
- HANDY 3-COLOR CHART SHOWS TYPICAL READINGS
- 20 SEGMENT LED METER DISPLAYS ESR FROM 0.1 TO 20 OHMS
- PORTABLE, RUNS ON AAA BATTERIES



CapAnalyzer 88 \$179

FIND THE EXACT LOCATION OF ANY SHORTED OR LEAKY COMPONENT IN SECONDS-GUARANTEED*

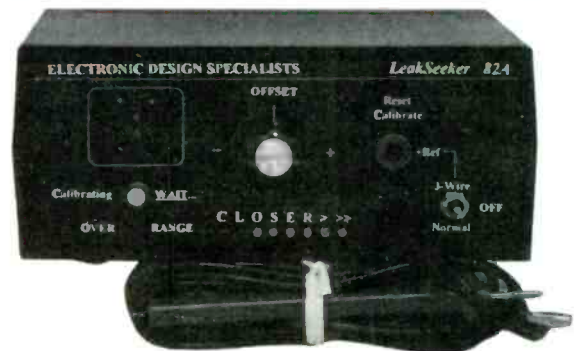

Stop cutting up the PCB and unsoldering each suspicious part to check out of circuit because your ohmmeter can't handle the job. Simply touch LeakSeeker's probe to any solder pad along the trace showing the short, and listen for the highest beep, 'cause that's exactly where the bad part is!

LeakSeeker can find components that other equipment can't, because it has a range from zero to 150 ohms, with a resolution of 0.001 ohms. You would need a six-digit DVM to do what LeakSeeker 82A can do.

LeakSeeker 82A \$179

* 60 DAY TRIAL PERIOD WITH MONEY-BACK GUARANTEE. AVAILABLE AT YOUR FAVORITE DISTRIBUTOR. THREE YEAR WARRANTY PARTS & LABOR FREE TELEPHONE SUPPORT

ELECTRONIC DESIGN SPECIALISTS (561) 487-6103

we make test equipment designed to make you money.



The Electrical Engineering Handbook Second Edition; A Volume in the Electrical Engineering Handbook Series, by Richard C. Dorf, CRC Press, 2,752 pages, hardcover, \$115.00

The first edition of *The Electrical Engineering Handbook* provided breadth and depth of coverage in an engineering reference work. Now this classic has been substantially revised and updated to include the latest information on all the important topics in electrical engineering today. Every electrical engineer should have an opportunity to expand his or her expertise with this definitive guide.

The second edition features:

- More contributions from leading authors, professors, and researchers in electrical engineering
- 15 new chapters and 24 new articles
- Definitions of nearly 2,000 terms
- New software applications in each section of the book
- Nearly 3,000 pages filled with tables, formulas, and definitions
- Extensive cross-referencing and indexing system.

CRC Press LLC, 200 Corporate Blvd., N.W.,
Boca Raton, FL 33443-19868

Building Network Management Tools with Tcl/TK by Dave Zeltserman and Gerard Puoplo, Prentice Hall, hardcover, \$48.00

Prentice Hall PTR has added to its network management publications with the recent release of *Building Network Management Tools with Tcl/TK*, by Dave Zeltserman and Gerard Puoplo. This publication is a new addition to the Prentice Hall Series in Computer Networking and Distributed Systems.

Tcl/TK is exceptionally well suited for building tools for network troubleshooting, device monitoring, network inventory, and configuration. This book presents a foundation of routines demonstrating fundamental concepts, then walks through construction of five robust applications of response time monitoring, network discovery, IP path tracing/diagnostics, Web-based status monitoring, and RMONv2 configuration. Through extensive code examples supported by the authors' Website, these expert developers

for Cisco, Digital, and 3Com show how to script powerful custom network management tools and Web-enable network management applications with Tcl/TK.

Simon & Schuster Education Group, One Lake Street,
Upper Saddle River, NJ 07458

ES&T Presents the Test Equipment Guide, by ES&T Magazine, Prompt Publications, 288 pages, paperback \$18.95

Compiled from articles and prefaced by ES&T's editor, this book will provide hands-on information for anyone interested in electronics and product repair. *Test Equipment Troubleshooting & Repair* includes the latest information on how to choose the best equipment, how to build test equipment and accessories, how to set up the ideal service bench, and how to put together a practical technician's tool kit. A special chapter also discusses surface mount technology and how to test its components. The knowledge gained from these chapters will help to make readers work more effectively and economically. The list of featured writers includes some of ES&T's brightest stars like Homer Davidson, Conrad Persson, Vaughn D. Martin, Brian Phelps, and others.

PROMPT Publications, 2647 Waterfront Parkway E. Drive,
Indianapolis, IN 46214

The Digital Signal Processing Handbook; A Volume in the Electrical Engineering Handbook Series, by Vijay K. Madisetti and Douglas B. Williams, CRC Press, 1,776 pages, hardcover, \$129.95

The field of digital signal processing (DSP) has spurred developments from basic theory of discrete-time signals and processing tools, to diverse applications in telecommunications, speech and acoustics, radar, and video. *The Digital Signal Processing Handbook* provides a remarkable reference offering theoretical and practical information to the audience of DSP users.

This immense compilation outlines both introductory and specialized aspects of information-bearing signals in digital form, creating a resource relevant to the expanding needs of the engineering community. It also explores the use of computers and special-purpose digital hard-

ware in extracting information or transforming signals in advantageous ways. Impacted areas presented include: telecommunications, computer engineering, acoustics, seismic data analysis, DSP software and hardware, image and video processing, remote sensing, multimedia applications, medical technology, radar, and sonar applications.

This authoritative collaboration, written by some of the foremost researchers and practitioners in their fields, comprehensively presents the range of DSP — from theory to application, from algorithms to hardware.

Features:

- Presents the scope of DSP topics in engineering, computer science, design and marketing, and academics;
- Enables an immediate, perceptive, and thorough exposure to the knowledge, experience, and writing of leading engineers, researchers, and scholars;
- Serves as a reference text for classrooms or for professional education courses in digital signal processing;
- Provides information, background material, technical details, and introductions to standards and software;
- Assesses the current and future of DSP applications in speech and acoustics, video, radar, and telecommunications.

CRC Press LLC, 200 Corporate Blvd., N.W.,
Boca Raton, FL 33431-9868

Test Procedures for Basic Electronics, by Irving M. Gottlieb, 356 pages, paperback \$16.95

Many useful tests and measurements are covered in this book, and the emphasis is always on the deployment of commonly available instruments, rather than laboratory types. Test procedures and measurements are reinforced by the appropriate basic principles, and examples of test and measurement setups are given to make concepts more practical. Students, hobbyists, and professionals will find the whats and whys of obtaining useful results, whether they are repairing a modern CD player or restoring an antique radio. Other topics covered include DC resistance, voltage and current, and semiconductor devices.

PROMPT Publications, 2647 Waterfront Parkway E. Drive,
Indianapolis, IN 46214

Upgrading a personal computer

by John Kull

As personal computer prices have fallen so have individual component prices, and that means upgrading can be a good option for your customers. Even though the price of a new PC has fallen, in many instances an upgrade is still a better alternative to purchasing a new PC. This series of articles will look at several popular upgrades and how to accomplish them.

Each article will present background information on each device involved in the upgrade and discuss the process involved. The final section will present a step by step procedure and troubleshooting section. This article will discuss replacing the main hard drive, adding a second drive, and adding a CD-ROM drive to the system.

Talk to the customer

The first step in considering any upgrade is to talk to your customer and find out what they hope to accomplish and decide if an upgrade is the best option for them. If they have a 386 or 486 running at less than 100MHz, a new system may be the way to go. However, if they are satisfied with the system's performance, and are simply outgrowing their hard drive, then an upgrade is a much better option than a new system. Perform a cost analysis of the proposed upgrade versus a new system purchase and let your customer decide which he or she prefers.

Before we discuss any particular personal computer upgrade, let's examine some things that are common to any hard drive or CD-ROM upgrade: Cables, Connectors and Jumpers.

Cables and connectors

Whether installing a hard drive, CD-ROM or a motherboard you must deal with the interconnect cabling. PC's utilize ribbon cables for the connections between a device and controller and Molex style connectors with larger wiring for the power connections. Let's start with the ribbon cables.

PC systems use ribbon cables with two

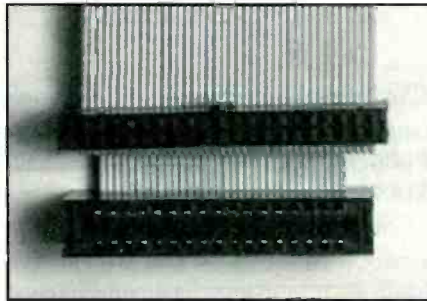

Figure 1. If updating an older personal computer system with certain types of drives it may be necessary to purchase an adapter that changes the edge card connector to a pin header type or simply install a new cable.

different styles of connectors. The pin header style is a rectangular connector that mates with a set of vertical pins on a plug in circuit board or motherboard. These connectors are typically on the "controller" end of the cabling and on IDE CD-ROM'S and hard drives.

The edge-card style is a rectangular connector with a slot in the center designed to slide onto the edge of a circuit board. Edge card connectors are found on 5 1/4" disk drives and on some specialized hardware. If updating an older system that includes one of these types of drives, it may be necessary to purchase an adapter that changes the edge card connector to a pin header type or simply install a new cable (Figure 1).

IDE hard Drives and CD-ROM drives use a forty-pin ribbon cable. The cable will have two or three pin header style connectors on it. A cable with two connectors is used for a single drive installation and a cable with three connectors is used to install two hard drives on the same IDE "channel."

Floppy drives require a thirty-six-pin ribbon cable for installation. This cable is available in several variations depending on the type of drives you are installing. The controller end of the cable always uses a thirty-six-pin header style connector, while the drive connectors may be pin header or edge card type or a combination of both types of connectors.

Once you have selected the proper

cable, you must insure that it is connected properly. The problem with the pin header type of connector used in PCs is that they can easily be installed backwards; fortunately, without serious consequences. The task of inserting the cable properly is made easier by a color-coded ribbon cable. All interconnect cabling used with PCs utilize a colored stripe on one edge of the ribbon cable (usually solid red, blue or dashed red or blue,) to indicate the "pin-one" edge of the cable. The connector is attached to the corresponding "pin-one" end on the disk drive, CD-ROM, or controller connector (Figure 2).

Identifying pin one

The method for identifying the pin-one end of the device can vary depending on the location of the connector. If the connector is located on a plug-in circuit board or on the motherboard it will typically have a silk screen legend near the connector with a numeral 1 or 2 indicating the pin one end, or a numeral 39 or 40 (35 or 36 for the floppy drive) indicating the opposite end of the connector. If no legend is present, examine the solder side of the circuit board for the presence of a square solder connection. This square connection indicates pin one.

If none of these methods prove useful you can usually find a drawing included with the documentation for the particular circuit board or motherboard.

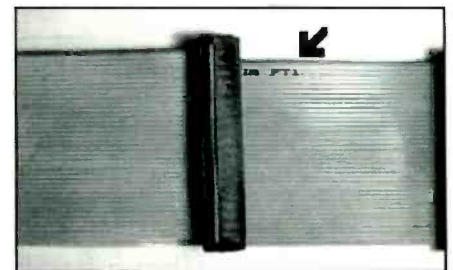

Figure 2. All interconnect cabling used with PCs utilizes a colored stripe on one edge of the ribbon cable (usually solid red, blue or dashed red or blue,) to indicate the "pin-one" edge of the cable. The connector is attached to the corresponding "pin-one" end on the disk drive, CD-ROM, or controller connector.

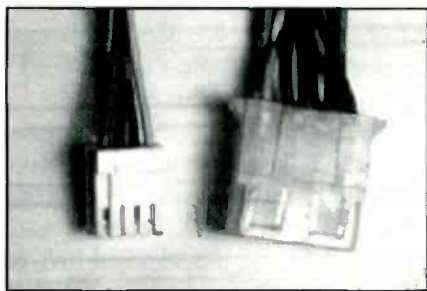

Figure 3. The hard and floppy drives use two different four-pin connectors for power. The larger of these two connectors has beveled edges for insuring proper insertion while the smaller connector has a key on one side to insure proper insertion.

Identifying pin one on a hard drive or CD-ROM can vary depending on the manufacturer. Not all drive manufacturers use silk screen labeling. Typically the pin one end of the cable is toward the power connector on the drive. If in doubt check the documentation. If you have no documentation for the drive, a good source is the World Wide Web. All major drive manufacturers maintain websites with hard drive specifications and drawings for all the drives they manufacture - new and old. (See Resources section at the end of the article.)

The floppy drives use both the pin header and the edge card connectors. The 5.25" drives utilize the edge card connector that contains a "key" or notch in the connector to insure proper insertion. The mating connector can only be inserted one way. The drive itself may also contain silk screen information like the hard drives. The 3.5" drives present a little more of a challenge. They utilize a pin header connector and do not seem to follow any standard as far as cable orientation. I have seen drives with connector orientation in either direction! Again as in the hard drives look for the silk screen legend or a square solder pin for indication of pin one.

Power connectors

The last set of connectors we need to discuss are the power connections. Power connectors for all devices emanate from the system's power supply. All system devices require power to operate. This sounds pretty basic, but forgetting to connect the power is a mistake often made during upgrading that can lead to some serious head scratching when you start

receiving error messages like "hard drive controller failure or hard disk error." PC's utilize three different styles of connectors for power connection to system devices and the motherboard.

Two six-pin connectors supply power to the motherboard. The connectors contain a combination of colored and black wires and are keyed to ensure they are not installed backward. However there is no mechanism to insure they are not interchanged with each other. When installed correctly the black wires will be facing each other on each connector. If the connections are reversed the power supply will be shut down upon start up and the PC will appear dead.

The hard and floppy drives use two different four-pin connectors for power. A larger four pin Molex style connector for hard drives and 5.25" floppy drives, and a smaller four pin connector for 3.5" floppy drives and some hard drives. The larger connector has beveled edges for insuring proper insertion while the smaller connector has a key on one side to insure proper insertion (Figure 3).

Some common interconnect problems

Even the best technician in the world can still encounter some common problems with interconnect cabling. Let's discuss some of the common problems and how to recognize them. I alluded to the most common problem in upgrading earlier in the article: The pin header connector and mating cable. The most common mistake is inserting the cable backward. If the cable is inserted backward the device will not work. If it is a hard drive, the system will usually give an error message upon boot-up, such as "hard drive controller error or disk error." Keep in mind you must orient the cable properly on both the drive and controller end. A reversed cable on either end will lead to error messages.

Another common mistake is missing a couple of pins or a whole row of pins when inserting the cable onto the mating connector. When inserted properly the connector should install smoothly. If you feel resistance when inserting the connector remove it and check for proper insertion. An improperly inserted cable can bend the pins of the connector so you may need to straighten them with needle-nose pliers or tweezers. A key point here is proper light-

ing. The inside of a PC case can be rather dark, even in a well-lit room. A magnifying lamp and additional lighting can aid in proper insertion. Or, if you are performing an on sight upgrade, be sure to include a flashlight in your toolkit.

The large power connectors typically do not present many problems. They often fit snugly to the device, so removing them can sometimes be difficult. Grasp the connector with your thumb and forefinger and rock the connector back and forth to remove it. When reconnecting the connector, observe the beveled edges for proper insertion. Slide the connector on until it stops.

The smaller connectors are also keyed to prevent them from being inserted backward. However, like the pin header connectors, these can be installed so that one pin is missed or unconnected. When the connector is installed in this manner, it effectively shorts a power supply voltage to ground. Fortunately, for unlucky technicians, PC's utilize switching power supplies with short circuit protection. The result of this mistake is an apparent "dead" system. The power supply will not start up if one of its outputs is grounded. If your system appears dead, check for incorrect or reversed connections on the motherboard or disk drive power connections.

Jumper connector

PC's use a system of small connectors and plugs known as "jumpers" to set different options on hardware devices. A jumper is a simple switch. Two or more pins are arranged in rows or groups and assigned special functions within the hardware device. A particular option or feature is turned on, or enabled, by insert-

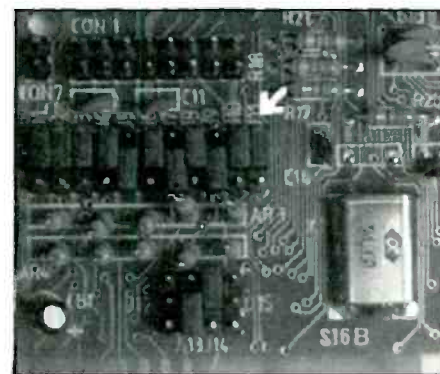

Figure 4. A jumper's function and settings may be silk screened on the circuit board, contained in separate documentation, or both.

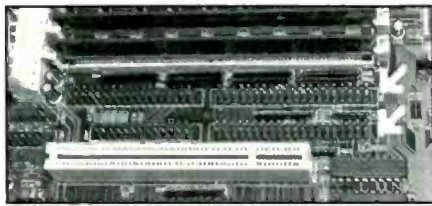

Figure 5. Systems with one IDE channel on the motherboard may be upgraded by adding a second channel as part of a sound card or separate stand alone IDE card.

ing, moving, or removing a jumper. The jumper plug simply shorts across two pins to enable or disable a function. Jumpers are found on various controller cards, motherboards, CD-ROMS and hard drives. The Windows 95 "Plug and Play" standard has made an industry move away from hardware jumpers in favor of software setup. Jumpers are currently still in use on hard drives, CD-ROMS, motherboards, and on older hardware designed prior to the plug and play standard. Jumper pins may be alone in units of two or three pins, or may be in groups consisting of two or three rows of pins. Jumper pins are typically assigned numbers labeled from top to bottom left to right. A jumper's function and settings may be silk screened on the circuit board, contained in separate documentation, or both (Figure 4).

Hard drive installation

With any upgrade, it's always a good idea to do some planning and discuss the options with your customer before beginning the project. Most people need a new hard drive because the old drive is defective or is full. If a customer is happy with the performance of the existing drive and just needs more space, adding an additional drive is a quick and easy solution, taking as little as a half an hour to complete. However, if the customer would like to replace the existing drive with the new drive and still use the old drive, this requires that all existing software be transferred to the new drive; a process that can take much more time than just adding a drive. Be sure your customer understands the difference and the time involved and increased cost involved.

Another point to discuss is drive performance. The hard drive is responsible for storing all data and applications and transferring that data from the drive to

RAM memory and other devices. The performance of the hard drive has a huge impact on system performance. A system can contain the fastest microprocessor and lots of memory, but still grind to a halt as it sends data to and from the hard drive. Do not overlook the effect the hard drive has on overall system performance. Like all other system components, the hard drives of today have improved greatly.

Hard drives have two main specifications that influence performance: *access time* and *transfer rate*. The access time is the average amount of time it takes to access data on any point on the disk surface. Current hard drives boast access times in the 9msec to 12 msec ranges. Older drives operate at slower rates.

The transfer rate is the most important specification and is defined as the rate at which data is transferred from the drive to the motherboard. The transfer rate is specified in megabits per second and is a best case figure. A hard drive cannot operate at its maximum transfer rate at all times. This figure usually represents a burst, or short term sustained transfer. The type of interface used to connect the hard drive to the system limits the maximum transfer rate. Older 386 and 486 systems use the ISA expansion bus that limits the maximum transfer rate to 2Mbits to 3Mbits per second. Pentium systems use the PCI bus, which can allow newer hard drives to attain rates up to 16Mbits to 33 Mbits per second.

The IDE drive

The most common type of drive used in home PC's is the IDE, also know as ATA or AT Attachment. The drive connects or attaches (thus the term AT attachment) to the AT expansion bus via the motherboard or plug in card. The IDE (ATA) drives have continued to improve over time. Following is a brief history of the IDE (ATA) drive.

First came the original IDE drive. This created a boon to the hard drive industry and also simplified installation. The drive connected to the system with a single 40-pin cable (versus two cables for the MFM/RLL/ESDI types.) Original IDE drives were limited to a maximum size of 512Mbytes due to a combination of limitations in the drive, motherboard, BIOS, and the DOS operating system. (DOS 3.3 limited the size to 32MB, DOS 4.0 raised

it to 128MB, and later extensions raised it to 2 GB. A more detailed discussion on disk/partition limitations is examined in the section on drive partitions.)

EIDE or Fast ATA provided a solution for the 512Mbyte limit when used with a compatible motherboard or controller BIOS. In addition, EIDE added increased performance over the Standard IDE, but remained backward compatible with older hardware. The EIDE specification also began implementation of a "secondary" IDE channel for connection of additional IDE devices, which now included CD-ROM drives, tape backup units, and ZIP drives.

Ultra DMA/33 or Ultra ATA is the latest version of the IDE specification. It provides for theoretical data transfers at 33Mbits per second. Like EIDE, it requires a special adapter card or motherboard BIOS to take full advantage of its features. Ultra DMA/33 is backward compatible with older hardware.

Hard drive prices, specs and installation

Hard drive prices and specifications are constantly changing. Discuss all the available options with your customer and recommend the drive that will give them maximum performance and storage but still fit within their budget.

Hard drive installation can be divided into two sections: hardware and software installation. The hardware installation consists of setting jumpers, connecting the ribbon cables, and physically installing the drive in the system case. The software installation involves running the CMOS setup program, partitioning the disk, formatting the disk, and finally software installation or transfer.

Hard drive hardware installation

First, let's look at the hardware portion of hard drive installation. This article



Figure 6. If you are adding a new drive to a system that contains a drive, you can make it the Master or the slave. The existing drive will need to be changed accordingly.

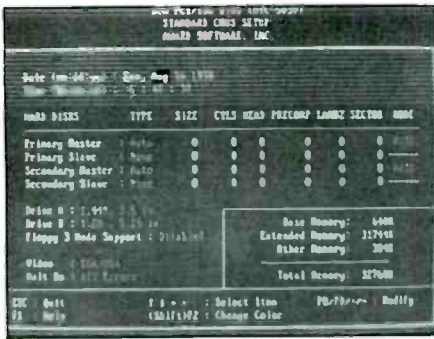

Figure 7. Once the drive is mounted you can attach the ribbon cable to the drive and controller, observing the “pin one” rule on both ends. Then connect the four-pin power cable. This is the finally step in the hardware installation process. Finally, before applying power to the system, double check all ribbon cable and power connections you have made.

assumes you will be installing an IDE hard drive. IDE stands for *Integrated Drive Electronics*, which means the controller electronics are part of the drive itself instead of on a separate card. This concept can be somewhat confusing since we will discuss connecting the drive to the controller. Actually, a better term to use is host adapter. While the card is often called a controller, it simply provides a means of getting the signals onto the computers expansion bus and does not actually control the drive. Most IDE “controllers” are now built into the motherboard so connection of the controller cable is made directly to the motherboard. However, in some installations a separate card may be used.

Motherboards manufactured within the last two to three years usually contain two IDE controller “channels” for connection of IDE devices. The channels are designated primary and secondary, and can each support two devices. Systems with one IDE channel on the motherboard may be upgraded by adding a second channel as part of a sound card or separate stand alone IDE card (Figure 5).

In a typical installation, the hard drive is located on the primary channel and the CD-ROM and other devices are on the secondary channel. The secondary channel is typically used for the slower system devices, such as the CD-ROM and tape backup units. If a slower device, such as the CD-ROM, is placed on the same channel as the hard drive it can actually degrade the performance of the hard drive. This same problem can occur with

two hard drives on the same IDE channel. Unless the interface you are using supports independent timing for the master and slave drives (usually set by jumpers on the drive if supported,) it is usually better to connect the “slower” devices to the secondary IDE channel. This is an important thing to keep in mind when a customer elects to keep their older hard drive in their system. IDE drives operate in three different configurations: Single, Master and Slave. (Some manufacturers define the master and single configurations as one.) If the drive is the only drive connected to the ribbon cable it is considered a “single” configuration. If two drives are connected on the same cable, the first drive is considered the “Master” and the second is the slave. Since IDE drives have built in controller electronics, both drives cannot be the controlling or master drive. Therefore the first drive in the chain is considered the “master” or controlling drive and the second is the “Slave” or listening drive. The master and slave configurations are set with jumpers on each individual drive. Jumper setting is the first step in installing a new drive. Consult the drive’s documentation or the manufacturers web site for the jumper settings. If you are adding a new drive to a system that contains a drive you can make it the Master or the slave. The existing drive will need to be changed accordingly (Figure 6).

After completing the jumper setting the drive can physically be installed in the system case. System cases contain both 3.5” and 5.25” mounting bays for mounting hard, floppy and CD-ROM drives. These bays can have external openings for floppy drives and CD-ROM’S and internal bays for hard drives. The internal bays are usually part of a removable cage that aids in hard drive mounting. With a 3.5” bay the drive can be directly attached with two screws on each side, while a 5 1/4” bay requires the drive be installed in an adapter frame prior to mounting.



Figure 8. If any partitions already exist on a drive you will need to delete them if you wish to create new ones or resize them.

Once the drive is mounted you can attach the ribbon cable to the drive and controller, observing the “pin one” rule on both ends. Then connect the four-pin power cable. This is the finally step in the hardware installation process. Finally, before applying power to the system double check all ribbon cable and power connections you have made (Figure 7).

Software setup

The motherboard CMOS RAM stores the computers hardware setup information. The CMOS setup program is a special piece of software contained in the system motherboard BIOS chip that allows you to enter information to be stored in the CMOS RAM. Any time a hard drive, floppy drive or system memory is added or removed the CMOS setup program must be ran to update the information in the CMOS RAM. When the PC boots up, the CMOS Ram is read and the system hardware is tested based on the information in the CMOS. If any errors are detected, they are reported and the user is usually given the option or directly taken to the CMOS setup screen.

The CMOS setup program can be activated during startup when the message is displayed usually stating “Hit Del to Run Setup.” (The technique or keystroke sequence may vary slightly depending on the manufacturer of the BIOS program. The look and feel of the program will also vary depending on the manufacturer. Some manufacturers use a graphical interface to give it a “windows” look and some are text based. The important thing to keep in mind is the *function* of the setup program, which is to update the systems hardware configuration information, is the same regardless of the manufacturer.) The program usually contains a “Standard CMOS” setup for entering hard and floppy drive information, date and time changes, and memory size information.

Several advanced menu options allow changing various features of the motherboard, such as setting up on board I/O ports, turning on and off memory testing and running system diagnostics. In this section we are only concerned with the “Standard CMOS” settings.

Specifying drive geometry

When installing a hard drive we must provide the CMOS with the parameters.

Hard Drive Installation - Step By Step

I. Hardware Installation

1. Check/Set drive jumpers for proper installation. Refer to the documentation supplied with the drive for information on jumper settings. If no documentation is available, check the manufacturers website. Note: Determine master/slave configuration and set jumpers on each drive accordingly. The master drive is the first drive in the chain when two drives are connected on the same controller cable.

2. Install drive and connect 40-pin cable to controller and drive. Remember that pin one on the cable end connects to pin one on the drive and controller.

3. Connect four-pin power cable to drive.

II. Run CMOS Setup Program

1. Restart the system. Start the setup program by pressing the Del key when you see the message, "hit Del to run setup."

2. Select the "Standard CMOS setup" option from the main menu (Figure S1).

3. Set hard drive type for new drive to "auto." If "auto" is not available set drive type to "user defined" and enter drive parameters.

4. Press the Esc key to return to the main menu.

5. Select "Write to CMOS and exit," and answer yes to the prompt. If you do not follow this procedure your changes will not be saved and your system will not recognize the new hard drive!

III. Partition and Format Drive -

1. Restart your system using the "boot" floppy.

2. At the command prompt type FDISK and press Enter.

3. Select option 4 to examine the disk to see if any partitions or logical drive exist. If the drive has existing partitions or logical drives, decide if they will serve the customers purpose. If not, remove them with the appropriate selections on menu item 3, Delete partition or logical drive. Partitions and logical drives must be deleted in the following order: Logical drives, extended partition, and finally the primary partition. Remember that once a partition is deleted all data in that partition is lost! If you need to resize a partition without losing data, then use a commercial program such as Partition It or Partition Magic.

4. Create a primary partition.

a. Select Create DOS partition or Logical DOS Drive and press Enter.

b. Select Create primary DOS Partition and press Enter.

c. At the next prompt answer yes if creating a single partition, no if creating an extended partition.



Figure S1. After you've installed the new hard drive, run the CMOS Setup Program. To do this, start the setup program by pressing the Del key when you see the message, "hit Del to run setup," and select the "Standard CMOS setup" option from the main menu.

d. From main menu select "make partition active" and select partition 1.

e. Press Esc to return to the main menu.

f. Continue to step 5 if creating an extended partition; otherwise move to step 6.

5. Create an extended partition and logical DOS drives.

a. Select Create DOS partition or Logical DOS Drive and press Enter.

b. Select Create Extended DOS Partition and press Enter

c. Accept the remaining size for the partition and press Enter

d. Press Esc and you will be directed to the logical drive screen. (If the logical drive prompt does not appear automatically, select "create logical drives in the extended partition" from the create partition menu.)

e. Use the entire disk space to create a logical drive or create multiple drives as needed.

f. Press Esc to return to the main menu.

g. Press Esc to reboot system.

6. Format the partitions:

a. At the A:\> prompt type Format C: /s and press Enter.

b. A message will appear indicating all data will be lost. Press Enter to continue.

c. After formatting is complete you can enter an optional volume label: and subsequent logical drives.

e. At the A:\> prompt type Format X: and press Enter. Substitute applicable drive letter.

f. A message will appear indicating all data will be lost. Press Enter to continue.

g. After formatting is complete you can enter an optional volume label.

7. Run snacks or commercial diagnostic program to "verify integrity" of disk.

8. Install operating system and/or data.

9. Verify proper operation of system and test various applications for errors.

or geometry information about the hard drive. The three important parameters of a hard drive are cylinders, heads and sectors, usually abbreviated cyl, hds, and sec.

This information is usually provided by the hard drive manufacturer on a separate piece of documentation or printed on a label attached to the drive.

Most new systems also support automatic detection of hard drive parameters and use a system known as Logical Block Addressing, or LBA to refer to specific

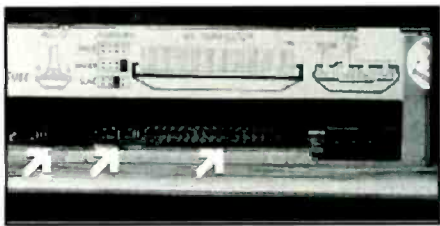

Figure 9. Once all connections are made the unit is ready for software setup. Double check all connections before returning power.

sectors on the drive. This is the best and easiest method and is invoked by selecting the "auto" option for hard drive type. This will cause the drive to communicate with the CMOS and transfer the proper settings. If you know the parameters of the hard drive you can also manually enter this information by selecting the "user defined" option for hard drive type.

When you are satisfied everything is correct, exit the standard CMOS setup menu and select "save changes and exit." This is the most important step. The changes will not be saved if you simply exit the program.

Partitioning and formatting the disk

Now we are ready for the next software phase: Partitioning and formatting the disk. All hard drives must contain at least one division, or partition. A partition is a division of the drive set aside for a particular operating system. Early versions of the DOS operating system were designed for a maximum hard disk size of 32 megabytes. If a drive was installed that was larger than 32 megabytes the amount of space over 32 megabytes was assigned to a separate Extended Partition. This extended partition was assigned a separate drive letter and treated as a separate hard drive.

Throughout the history of the PC, the maximum disk/partition size has been extended and the limits reached, and then exceeded. Combinations of limitations of the operating system and the motherboard BIOS have been the major stumbling blocks. DOS version 4.0 allowed partition sizes up to 128 megabytes. Later revisions extended the limit to 2 gigabytes. Although the operating system could support larger drives, the BIOS, which provides low level disk service to the operating system, had its own limits. The next

major hurdle was the 512-megabyte limit. To install a drive larger than 512 required a special hard drive controller card, or a motherboard with an updated BIOS or a special software driver program. Newer motherboards were then manufactured with updated BIOS software and a special controller card was no longer necessary.

Windows 95 supports disks/partitions up to 2 gigabytes. Windows 95B adds FAT 32 that can support disks up to 4 terabytes. The most recent limitation is again in the motherboard BIOS software with a limit of 8.4 gigabytes. Again the solution is a motherboard with an updated BIOS or special software drivers. BIOS upgrades provide the best solution. Fortunately, many new motherboards now have BIOS chips that can be upgraded with a floppy disk or via software downloaded from the Internet. These BIOS chips are known as FLASH ROMS.

Primary partition

The primary partition is the partition where the boot files of the operating system are located. This is the partition the computer uses to boot, or load the operating system into the computers RAM memory. The extended partition is an additional partition or division on the drive that extends the size of the original partition. An extended partition can be further divided, if desired, into multiple divisions called logical drives. A logical drive is treated as a separate hard drive by the operating system. If the extended partition is created, but not divided further, it is also considered a logical drive. In addition, a drive may contain non-DOS partitions for other operating systems.

In a two drive system both drives may contain a primary partition, but only the master drive can have an active partition, making it the bootable drive. In addition, if both drives contain a primary partition, DOS assigns these partitions first. Extended partitions are assigned drive letters after the primaries. This can cause confusion when adding a second drive to a system that contains a primary and extended partition on the original drive. If another drive is added with a primary and secondary partitions the drive letters will change as follows: Original drive primary partition will be assigned "C," second drive primary will be assigned "D," original drive extended will be assigned "E," second drive extended will be

assigned "F." Sound confusing? What's worse, any shortcuts or file entries referring to the original "D" partition will be invalid because "D" has moved to "E"!

Fortunately, there is a solution. When installing a new drive in a system that has an existing drive with multiple partitions, do not create a primary partition on the new drive, only create extended partition (s.) To accomplish this, the existing drive must be present when creating partitions on the new drive.

Why multiple partitions?

If a hard disk does not contain multiple operating systems, and adding drives with partitions can cause new headaches, why create multiple partitions on a drive? The answer lies in the method used to store data on the disk. The current DOS and Windows 95 operating systems use a method of file storage known as FAT 16. At a low level, disk space is divided into units called sectors. The FAT 16 system groups the sectors in an integral number known as a cluster. The cluster is the minimum space, or allocation unit set-aside for each file in a partition.

A special table on the disk, the File allocation table (FAT), keeps track of the clusters that each file has in use. FAT 16 uses both 8 bit and 16 bit numbers in managing the drives sectors and clusters. By design, as the size of the partition gets larger, the cluster size is increased. A 1-gigabyte drive for instance allocates a minimum of 32 kilobytes for each new file when it is created, even if the file is only several kilobytes in size! The result of this design is a lot of wasted space on a large hard drive. (On average around 30 to 40 megabytes per 1 gigabyte of disk space.)

You can minimize this wasted space by creating multiple partitions on a hard drive. By reducing the partition size to 512 megabytes, the cluster size is reduced to 16 kilobytes. Of course you don't want to make the partitions too small that you quickly fill it up. Another advantage to partitioning is drive organization. A single partition can be created for data or applications and in a network environment single partitions can be given restricted access.

Windows 95B and Windows 98 solve the problem of wasted space with a new FAT system known as FAT 32. FAT 32 uses all 32-bit numbers for the sectors and cluster numbering. As a result FAT 32

uses smaller cluster sizes, which reduces waste and increases the maximum disk size to 2 terabytes!

FDISK is the DOS program used to create, delete, and change partition size. FDISK is located in the DOS directory (command directory in Win95/98.) It is a simple to use, but a destructive program! Once a partition is created or deleted, any data previously stored on the drive is lost and cannot be recovered. Commercially produced software such as Partition Magic and Partition It, allow partitions to be resized on existing drives without destroying data. These programs can also handle converting partitions from FAT 16 to FAT32 and vice versa.

Adding a hard drive to a Windows 95/98 PC

If adding a hard drive to a system with Windows 95B/98 installed, use the FDISK program that is included with Windows 98. This version of FDISK is designed to work with FAT 32. Older versions of FDISK are not compatible with FAT32. When running FDISK on a system with FAT 32, a message will appear upon entering the program indicating the advantages and disadvantages of using FAT 32: "Your computer has a disk larger than 512 MB." This version of Windows includes improved support for large disks, resulting in more efficient use of disk space on large drives, and allowing disks over 2 GB to be formatted as a single drive. *Important:* If you enable large disk support and create any new drives on this disk, you will not be able to access the new drive(s) using other operating systems, including some versions of Windows 95 and Windows NT, as well as earlier versions of Windows and MS-DOS. In addition, disk utilities that were not designed explicitly for the FAT32 file system will not be able to work with this disk. If you need to access this disk with other operating systems or older disk utilities, do not enable large drive support. Do you wish to enable large disk support (Y/N)? (Editors note— The previous paragraph was copied directly from the Microsoft program FDISK.)

Inform your customer of both the advantages and disadvantages to using FAT 32 and assist them in making an informed decision. This is especially true when upgrading to Windows 98 which includes FAT 32. If they upgrade to '98

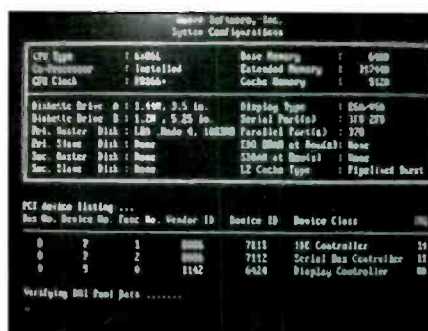

Figure 10. On bootup the computer shows the "system configuration display." This is a chart displayed prior to the message "Starting MS-DOS or Starting Windows 95 The chart displays the system setup information contained in the CMOS memory. By observing this screen at bootup, (press the pause key to freeze the display) you can determine whether the system has detected the hard drive or CD-ROM drive just installed.

and decide they don't like it, and they installed FAT 32, they must convert back to FAT 16 to return to '95. Unfortunately, this is not possible with the FAT conversion utility included in WIN 98. A better solution is to install Windows 98 without FAT 32. After the customer has decided '98 is for them, they can elect to convert to FAT 32 with a third-party program like Partition IT, or Partition Magic, which include FAT converting utilities

Is the new hard drive the main drive?

If the new drive will be the main hard drive in the system you will need to start the system with a bootable diskette that contains the FDISK program. If you do not have a bootable diskette you can easily create one under DOS or Windows 95/98. (See the step by step procedure at the end of this section.) If the new drive will be a second hard drive, you can perform the steps below from an MS-DOS window under Windows 95/98.

Once the bootable disk is created, you are ready to run FDISK on the new hard drive. Before running FDISK, decide the number of partitions and the size of each. To run FDISK, boot the system with the boot floppy and type FDISK at the prompt. FDISK presents a simple menu of options for creating, deleting, and displaying the partitions on a drive. If you are installing a second drive in a system, FDISK will have a fifth menu option for selecting the drive you wish to work with. Each menu item is selected by pressing

the number key associated with it and following the succeeding menus and prompts. Before creating any partitions on a drive, select option four to display the existing partition information. If any partitions already exist on a drive, you will need to delete them if you wish to create new ones or resize them. (Figure 8)

The primary partition is created first. FDISK will prompt you to use the entire available disk space for the partition and make it active. If you are only creating one partition, select yes and follow the prompts. Accept the default sizes for the partition and the process is completed. Insert your boot disk and restart.

Multiple patterns

If creating multiple partitions, enter the amount of disk space you wish to use in percent or megabytes. Entering a percent is much easier than calculating exact megabyte sizes if you are trying to divide the disk evenly. After the primary partition is created, select option two and make the partition active. Setting the partition active makes it the bootable partition. If you forget to make a partition active, the drive will not boot.

Next, create the extended partition. The extended partition will use the remaining space on the drive, unless you are reserving space for another operating system. When prompted, accept the default size for the partition. The partition size should equal the remaining space. After the extended partition is created, you will be prompted to create logical drives within the extended partition. (If the logical drive prompt does not appear automatically, select "create logical drives in the extended partition" from the create partition menu.) The extended partition can be further divided if desired into multiple logical drives or it may be assigned as a single logical drive.

After all partitions have been created and logical drives assigned, return to the main FDISK menu and select option four to display the partition information. Examine the information and verify that everything is set correctly. Press "Esc" and you will be prompted to reboot your system. Insert the boot disk and restart

Drive formatting

The next step is drive formatting. Formatting a disk creates the directory and File allocation table structures that

CD-ROM Installation Step by Step

I. Hardware Installation

1. Check /Set drive jumpers for proper installation. Refer to the documentation supplied with the drive for information on jumper settings. If no documentation is available, check the manufacturer's website. In most configurations the default setting of "slave" will function properly.
2. Install drive and connect 40-pin cable to controller and drive. Remember that pin one on the cable ends connects to pin one on the drive and controller. Install CD-ROM on "secondary" controller channel if present.
3. Connect four-pin power cable to drive

II. Run CMOS Setup Program

1. Restart the system. Start the setup program by pressing the Del key when you see the message, "hit Del to run setup."
2. Select the "Standard CMOS setup" option from the main menu.
3. Set Primary Slave or Secondary Slave for "auto" detection depending on configuration.
4. Exit to main menu and select "save changes and exit."
5. Reboot system and install software:
 - a. WIN 95/98 - no additional software required unless customer will need access to CD-ROM drive in MS-DOS mode.
 - b. DOS/WIN 3.X - Run software installation program or install files manually.
 - c. Reboot system and test operation.

the operating system uses to store data on the disk. If the drive will be the primary drive in the system, we can also copy the system files necessary to boot the computer from the hard drive during the format process. If the disk has multiple partitions, the primary partition and each extended partition/logical drive must be formatted individually. To format the primary partition, type `FORMAT C: /S`. Each additional logical drive is formatted by typing `format X:` where X is the logical drive letter assigned to the drive. The "/S" portion is only required for the bootable partition. This is a command line switch that indicates the system files will be copied during the format.

After all partitions are created and formatted, the drive is ready to store data. Before using the drive for the first time run a hard disk diagnostic program such as Windows 95's "SCANDISK." SCANDISK will test the disk surface for errors and mark any bad areas in the FAT so they will not be used for data storage.

If the drive is replacing an existing drive, the software on the original drive must be copied to the new drive. Transferring data to the new drive can be accomplished in many ways. If the sys-

tem contains a backup device such as a tape drive or other backup device, the original drive can be "backed up" and then "restored" to the new drive. Commercial software packages such as Drive Copy and Disk Clone can make the process of transferring one drive to another a simple process. Or you can copy all files from one drive to another with DOS. The DOS XCOPY command can copy all files and directories from one drive to another. XCOPY copies all files except hidden and system files. To copy hidden and system files, the files hidden and system attributes must be cleared. After the files are copied, the attributes can be reset. This process can be tedious but requires no additional software to accomplish.

Installing a new drive as the primary boot drive also presents the opportunity to perform a "clean" install of the Windows operating system. After years of adding and deleting software, a Windows installation can become damaged or corrupted, leading to poor system performance. If the software is simply copied or transferred to the new system, all the problems get transferred right along with it. By installing the operating system from scratch, many of these prob-

lems are eliminated. Of course, this process comes with a price: All application software must be reinstalled and configured; a sometimes long and tedious process. Discuss the system's current performance with the customer and recommend a clean install to improve performance if they are experiencing system problems or have deleted a lot of software improperly. Adding a new primary drive is also a good time to upgrade or install a new operating system.

After all software has been transferred, reboot and test the system. Run various applications and verify they operate normally. See the associates box for a summary of the hard disk installation procedure in a step by step format.

IDE CD ROM drive installation

The CD-ROM drive is treated much like a hard drive for installation and setup, with a few differences. The main differences have to do with setup under Windows 95 versus DOS/WIN3.X. CD-ROM drives utilize jumpers for setting configuration. Like a hard drive, the CD drive can be set as a master or slave. CD-ROM's are typically shipped with the jumpers set for a slave configuration. This configuration will work for most installations. The IDE CD-ROM can be placed on the same cable with a hard drive, or on a separate cable attached to the secondary IDE channel. As mentioned earlier, newer systems have two IDE channels each that can support two IDE hard drives, CD's, tape drives, and other devices. If the system you are installing the CD in has two channels, it is recommended that you utilize the secondary channel for the CD drive, due to its slower timing in relation to the hard drive.

CD-ROM drives can also come packaged with a multimedia "kit." These drives often have a proprietary interface that is designed to function only with the supplied hardware card. If these types of drives are connected to a standard IDE interface, it will not function properly and may cause other problems with the system. If using a drive with a proprietary interface card, it may be necessary to disable the secondary IDE channel on the system. Check the kit's documentation for details.

Once the jumpers are set properly, the drive can be mounted in the system case. CD-ROM's will mount in a 5-1/2" drive

bay. A word of caution here: In some installations the drive may fit tightly in the mounting bay, and can bind the drive tray when it opens and closes. Try another bay or figure out where the problem lies and correct it. Attach the ribbon cable, observing the pin one rule, and attach the power connector.

If the system contains a sound board and speakers, analog audio output is provided from the CD to connect to the sound board's CD audio input. Connection is made with a small audio cable included with the CD-ROM drive. Once all connections are made, the unit is ready for software setup. Double check all connections before returning power to the system (Figure 9).

Invoke the CMOS setup program during bootup. Select standard setup from the main menu. Set the primary slave or secondary slave setting to "auto," depending on what configuration you chose for the drive. Note: The CD-ROM can function as a slave device on the secondary controller without a master device present. Exit to the main menu and save the changes. Reboot the system and observe the start up messages. You should see the system display a message indicating it detected the CD-ROM drive. This may also be part of table, displayed during bootup, indicating all the devices and configurations detected.

The CD-ROM like many PC peripherals was an add on device, developed many years after the PC was designed. Like other add on devices it requires a special software component known as a device driver to allow it to work with the DOS/WIN 3.X operating system. The device driver is a small program loaded by the PC's CONFIG.SYS file during the PC boot up process. In addition to the device driver, the CD-ROM also requires another program, typically loaded in the AUTOEXEC.BAT file, MSCDEX.EXE. The MSCDEX.EXE program allows DOS/WIN to access the CD-ROM as though it is a hard drive, since the CD-ROM stores information in a different format than a hard drive.

The device driver software is usually provided as part of the CD-ROM package when purchased. The software is usually installed by a small installation program that copies the needed files to the systems hard drive and updates the CONFIG.SYS and the AUTOEXEC.BAT

files. If the drive did not come with installation software, the files can be installed manually using the DOS copy command and editing the CONFIG.SYS and AUTOEXEC.BAT files with the DOS editor or Windows notepad utility. Driver software may also be downloaded from the manufacturers website. Once the driver software is installed and the personal computer system is rebooted, the CD-ROM installation is complete.

The Windows 95/98 installation is much simpler than the DOS/WIN 3.X installation. Windows 95/98 has device drivers built into the operating system to support the CD-ROM drive, so no additional software is needed unless specified by the manufacturer documentation. After you have completed the hardware and CMOS setup, the drive will be functional under Windows 95/98.

Note: If your customer uses Windows 95/98 "MS-DOS Mode" for games or other applications that require a CD-ROM drive, the DOS/WIN 3.X drivers *will need* to be installed.

Troubleshooting

As with any upgrade, problems can arise. Follow a systematic step by step logical process just as you would any electronic device. Ask yourself the question, "what was the last thing I did before the problem occurred?" The answer to this question will usually point you in the right direction. The PC itself can also provide some clues when troubleshooting. One useful piece of information the PC provides on bootup is what I call the "system configuration display." This is a chart displayed prior to the message "Starting MS-DOS or Starting Windows 95 (Figure 10). The chart displays the system setup information contained in the CMOS memory. By observing this screen at bootup, (press the pause key to freeze the display) you can determine whether the system has detected the hard drive or CD-ROM drive just installed.

A system boot floppy is essential when installing the bootable hard drive. The end of this section contains step by step procedures for creating a boot floppy for troubleshooting and setup. Commercial software is also available to simplify hard drive installation, troubleshooting and data transfer.

The following list should indicate the

most common installation and setup problems you may encounter and some possible corrective action.

Hard drives

The following are some typical problems that may arise, during hard drive installation and suggested solutions.

Problem: System displays message at bootup, "HDD Failure, Hard Disk Controller Failure," or similar message.

Solution: Usually caused by reversed cable, incorrect jumper setting or no power connected to drive. Check power connection. Check that 40-pin ribbon cable is properly attached on BOTH ends, observing the pin-one rule. Be sure jumpers are set properly. If two drives are present on one cable, the first drive should be set to master and the second set to slave. A single drive should always be set to single or master.

Problem: The personal computer system will not boot from hard drive. Error message(s) "No Operating System, or "boot Disk Error, Insert boot Disk and Press any Key to Continue."

Solution: Primary partition not set active or operating system not installed properly. Boot system from a boot floppy and run FDISK. Check/Set primary partition to active. Format hard disk with "/S" switch or use the DOS SYS (SYS C:) command to transfer the computer operating system to the hard disk.

Problem: System displays message "invalid media type" or "invalid drive specification" when trying to access the hard disk partition from DOS.

Solution: "Invalid media type" indicates the disk has not been formatted. Format the disk. "Invalid drive specification" indicates the operating system is not detecting the hard drive. Run FDISK and select option 4 to examine the drive. If an extended partition has been created, it will not be recognized by DOS/WIN unless a logical drive has been created to identify it. Create a logical drive(s) as needed to solve his problem.

Problem: "Error reading fixed disk" or "no fixed disks present" error message when trying to run FDISK.

Solution: Hard drive is not installed properly. Check Jumpers, cables, and power connection. Check CMOS setup for proper drive parameters (CYL, HDS and SEC, or "Auto")

Problem: System appears dead after hard drive installation.

Solution: Controller cable connected improperly. Check controller cable for "missed pins." See section on cable errors in cables and connector section.

Problem: Hard drive not recognized when system is booted from a floppy disk.

Solution: If new hard drive has FAT 32

on it and system is booted with a floppy created under Windows 95, the drive will not be recognized. Recreate the boot floppy with a system that has Win 95B or Win 98 or use the DOS "SYS" command from a system that has Win 95B/98.

Problem: Full size of hard drive/partition is not recognized.

Solution: BIOS or operating system

limitation. See below for possible solutions. 512 megabyte limit — BIOS limitation, enable logical block addressing (LBA) in hard drive setup, update BIOS/motherboard, install EIDE controller card, or use special software such as Disk Manager. 2 gigabyte limit — Limitation of Windows 95. Drives larger than 2 gigabytes and less than 8.4 gigabyte must be separated into partitions of 2 gigabytes or less. Windows 95B/98 raises limit to 2 terabytes, but runs into the next BIOS limitation at 8.4 gigabytes. 8.4 gigabyte — BIOS limitation. Update BIOS/motherboard, or install special software such as Disk Manager.

Problem: There's an error message on the screen, "No ROM Basic."

Solution: System could not find a bootable device in the system. If booting from a floppy during hard drive setup, check disk on another system. If the error message appears during hard drive booting check the following:

1. Power and cable connections
2. Run FDISK and verify the primary partition has been set to active. If the partition is active an "A" will appear in the

World wide web resources

The World Wide Web provides an enormous resource for electronics and computer information. The following manufacturers and related sites will assist in hard drive setup and troubleshooting.

Manufacturers

- www.seagate.com — hard drive manufacturer, website includes drive info, software downloads, and products.
- www.maxtor.com — hard drive manufacturer, website includes drive info, software downloads, technology index, and FAQ section.
- www.westerndigital.com — hard drive manufacturer, website includes drive info, software downloads, tech support message boards, FAQ, and troubleshooting sections.
- www.fujitsu.com — PC/Peripheral manufacturer, website includes products info, software downloads and step by step troubleshooting.
- www.quantum.com — Peripheral manufacturer, website includes hard drive and other product manuals, application notes, FAQ, and helpful "white papers" on various drive related topics.
- www.samsungelectronics.com — Consumer electronics manufacturer, website includes info on all products including hard drives.

BIOS manufacturers

- www.ami.com — American Megatrends, a motherboard BIOS company, website includes BIOS error codes, utilities, and BIOS upgrades.
- www.award.com — Award Software, a motherboard BIOS company, website includes BIOS tech support, FAQ, and upgrades. NOTE: Award technologies recently merged with Phoenix technologies another BIOS manufacturer.
- www.firmware.com — Micro firmware, a distributor for PC ROM BIOS upgrades and software. Website includes Y2K test utility for PC BIOS.

General hard drive info and help

- www.webopedia.com — an on-line PC terminology encyclopedia and search engine. Search by keyword for a PC related topic including hard drive installation and FAQ's. Provides additional links to related topic.
- www.pcquide.com — another great PC information resource.

Hard disk related software

- www.quarterdeck.com — software manufacturer, makers of Partition IT, Disk Clone, and other PC and Hard drive utility/troubleshooting software.
- www.powerquest.com — software manufacturer, makers of Partition Magic, Drive Copy, and Drive Image hard disk utility software.
- www.microhouse.com — software and technical information company, makers of Drive Pro, Image Cast, and EZ Drive installation products, as well as the famous Microhouse technical manuals and CD-ROM based technical libraries.
- www.ontrack.com — software manufacturer and data recovery specialists. makers of Disk Manager hard drive installation software. Disk manager software may be purchased directly from On-Track and is also included as an OEM version with the purchase of hard drives from many different manufacturers including Seagate and Quantum.

ELECTRONIC COMPONENTS

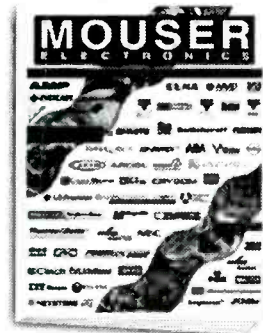

Visit our web site!
www.mouser.com

Subscribe, download, or
view catalog online!

- Over 78,000 Products
- More than 145 Suppliers
- Same Day Shipping
- No Minimum Order

800-992-9943

817-483-6828 Fax: 817-483-6899
catalog@mouser.com

958 North Main St., Mansfield, TX 76063

Circle (69) on Reply Card

PHOTOFACTS

EMERSON

TC2556D4065

FUNAI

F4819T 4073

GE

VG2044 (sim to) VCR-304

VG4064 VCR-304

JVC

C-13910 4071

C-13911 4071

MITSUBISHI

CS-27205 4074

CS-27205C 4074

PANASONIC

AEDP303 4070

ANEDP303 4070

AREDP303 4070

ASEDP303 4070

ATEDP303 4070

CT-27G3UW 4070

CT-27G3W 4070

CT-27G13DW 4070

CT-27G13UW 4070

CT-27G13W 4070

CT-27S6CW 4070

CT-2754SCW 4070

QUASAR

AMDC304 4076

AMDP304 4076

TP1322DW 4076

TP2011DW 4076

RCA

CTC197AK2 4066

F27683GYFE1 4066

VR347 VCR-304

VR525 VCR-304

SHARP

CK27S30 4067

CK27S40 4067

27K-S300 4067

27K-S400 4067

27NL20 4069

TOSHIBA

CF30F40R 4075

TAC96324075

WHITE-WESTINGHOUSE

CN-2001 4068

WTV-12505 4068

ZENITH

A13P02D4077A27A11D 4072

CN-1151 4077

GA14P02D 4077

LGA29A11GM 4072

status window. If no partition is active, change it to active with menu option 2, make partition active. 3. Reboot system with floppy and rewrite master boot record with the following command: FDISK /mbr and press enter.

4. Copy system files to the hard drive with the boot disk. Type SYS C: and press the Enter key.

5. Repartition and reformat hard drive.

CD-ROM troubleshooting

Problem: Error messages displayed during bootup "no drives found or no valid CDROM device drivers found."

Solution: These errors are generated by the DOS based device driver software and indicate the software could not detect the CD-ROM drive. Check jumpers, cable, and power connections. Reboot the system and observe the BIOS Configuration screen at bootup to see if CD-ROM was recognized. If CD is not recognized, run CMOS setup and verify proper setting of CD position. (For example primary slave, secondary slave)

Problem: System appears dead after CD-ROM installation.

Solution: Controller cable connected improperly or CD-ROM drive uses a proprietary interface. Check controller cable for "missed pins." (See the section on cable errors in cables and connector.) If cabling checks out OK, remove CD-ROM and try starting system again. If system returns to normal, CD drive is defective or uses a proprietary interface. Drives that use a proprietary interface typically connect to a sound card or stand alone interface card.

Problem: The CD-ROM drive is accessible in Win 95, but when system is run in "MS-DOS" mode, the CD-ROM drive cannot be accessed.

Solution: DOS device drivers must be loaded for CD-ROM access in WIN 95/98 "MS-DOS Mode." Run installation software or manually install device drivers and modify CONFIG.SYS and AUTOEXEC.BAT files.

Making a bootable floppy disk

The purpose of the boot floppy disk is to start the computer and load the basic operating system files necessary to access the hard drive for setup, maintenance, and

troubleshooting. A system boot floppy or emergency disk can be created under DOS or Windows 95.

DOS/WIN3.X:

1. Boot the computer normally to the DOS prompt.

2. Insert a blank floppy disk in the "A" floppy drive.

3. Type Format C: /S (This will format the disk and copy the operating system files to it, making it a "bootable disk.")

4. Copy the following files to the floppy using the syntax: Copy C:\DOS\FILENAME.XXX A: substitute the following filenames for FILENAME.XXX: FORMAT.COM, SYS.COM, FDISK.EXE, SCANDISK.EXE, CHKDSK.EXE. You may also want to include other utility programs for advanced troubleshooting. (If you prefer, drag and drop the files using Windows explorer.)

5. Copy a generic CONFIG.SYS and AUTOEXEC.BAT file. Also add CD-ROM device drivers and MSCDEX.EXE if you require access to a CD-ROM drive on the system you are troubleshooting. If you experience difficulty fitting all the files on a floppy disk, create a separate boot floppy with the CD-ROM files for CD-ROM support.

WIN 95/98

1. Click on the start button, then select settings, then click on control panel. Double-click on "Add/Remove Programs." Select the "Startup Disk" tab and click on the "Create Disk" button.

2. Follow the prompts and WIN 95/98 will create a "startup disk." This disk will contain all the files previously discussed in the DOS section and additional files for advanced troubleshooting. As mentioned in the DOS section, add a generic CONFIG.SYS, AUTOEXEC.BAT file and CD-ROM device drivers as needed.

Conclusion

PC upgrading can be a challenging and sometimes frustrating experience. Like any other consumer product, a good working knowledge of the device is essential to successfully repairing and maintaining it. An organized work area, the proper hand tools and software tools are also essential to performing the job efficiently and effectively. Chances are you already use a PC in your business, why not add them to the devices you service? ■



Dual-display digital multimeters

B&K Precision announced the Models 2880A and 2890 high-performance, dual-display DMMs. Both models are handheld, offering true RMS measurements. Both models offer RS-232 computer interface and in-depth, long-term signal analysis utilizing the dual display.

Other features of both units include two user-selectable operating resolutions (4,000/40,000 counts), voltage to 1000Vdc/750Vac, current to 10A, a dual-display offering the frequency to 200kHz with ac signal measurement, resistance to 40M Ω , capacitance to 9,999 μ , and diode check and continuity. Both meters also include user-friendly features such as Data hold, relative mode (display the difference of a set input to subsequent inputs), and MAX/MIN/AVG of an input with an elapsed timer counting the time to the event.

The 2880A offers True, while the 2890 provides both ac and ac+dc True RMS readings. Additional features of the 2890 include a frequency counter, temperature, conductance, square wave output duty cycle, pulse width, and a 1mSec. peak hold glitch capture feature.

Circle (95) on Reply Card

Digital multimeter accessories

Fluke has added two new probes and two test lead sets to its popular family of digital multimeter test tool accessories. The 80K-15 Electronic Air Cleaner Test Probe is an accessory which extends the

voltage measurement capability of most digital multimeters up to 15kV and is intended for measuring the output voltage in low energy environments such as electronic air cleaners.

The Fluke i2000 flex Current Probe is a flexible, ac current probe recommended for current measurement on large and difficult-to-reach conductors.

The Basic TL80 electronic test lead kit consists of two test leads and accessories.

The Deluxe TL81 electronic test lead kit consists of all the items in the Basic TL80 kit (except for the vinyl case) plus two modular test leads and accessories.

Circle (96) on Reply Card

Magnifier lamp

The new Vision Lite 2000 from the O.C. White Co., with a dimmable fluorescent illuminated magnifier, is now available with a 4-diopter lens (2x magnification) as well as the standard 3 diopter (1.75x). The higher magnification will give users better control of assembly and inspection applications where very small parts or high precision (as in fine pitch SMT assembly) require a higher level of vision magnification and clarity. The unit uses new state-of-the-art microchip-controlled ballast technology that allows it to be dimmable from 100% down to 25%, so that highly reflective surfaces can easily be seen.

Circle (97) on Reply Card

Magnifier

The Magni-Focuser from Edroy, a vision-aid that enhances close-up work, has recently added two new features: the product is now available with a light and/or a bifocal lens. The magnifier features an adjustable, contoured padded vinyl headband that offers the user adjustable fit. It is lightweight, comfortable, washable and can be worn over glasses. Its high-impact, non-corrosive ABS plastic front lens unit is not only shatter resistant, but scratch resistant as well. And since there is no center post, the field of vision is never obstructed. The lens plate chosen is supplied with each model. Additional interchangeable units are available to compliment varying degrees of magnification and working distances.

Circle (98) on Reply Card

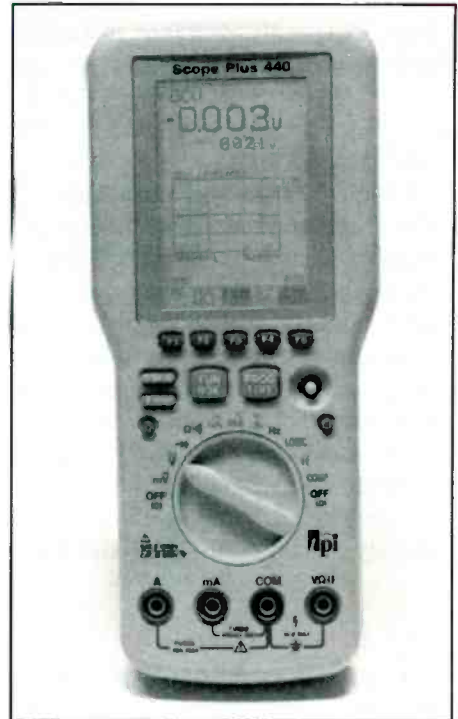

Oscilloscope plus true RMS DMM

Test Products International introduces a new hand-held oscilloscope with True RMS DMM capabilities. The 440 Scope Plus offers all the features of a DMM and allows the user to view actual waveforms.

The unit is designed for multiple applications in industrial plant maintenance and process control environments. Users can view industrial signals such as motor controls, UPS, switching power supplies, and PLC controls with the 1 MHz dc bandwidth. Noise spikes, glitches, and intermittents are captured with a 25 megasample per second sampling rate. The product also features continuous autoset, which automatically determines the correct vertical and horizontal settings to deliver optimum waveform viewing. The "real time" display is continually updated, insuring information won't be lost. Other features include cursor measurements, flexible triggering including glitch capture, roll mode, frequency counter, and an optional RS-232C port.

Circle (99) on Reply Card

Pocket LCR meter

An LCR meter, Model 381820 from Extech, displays a wide range of measurements for inductance (2mH to 20H), capacitance (2nF to 200 μ F), and resis-

tance (200Ω to 20MΩ) on a 0.5" 1999 count LCD with overrange indication. Includes battery and test leads.

Circle (100) on Reply Card

Contact cleaner

T.A. Emerald Industries announces the release of Puretronics. The product is a precision contact cleaner that effectively and safely cleans electronic components and equipment. It removes oils, greases, grime, dirt, silicones, and fluxes and other contaminants in helping to achieve optimum level of cleanliness. The material is quick evaporating, leaves zero residue, and its low odor formula is safe on plastics and metal materials. It is ozone friendly containing no CFCs or HCHs.

Circle (101) on Reply Card

Hand-held color analyzer

A new color analyzer from Sencore allows the user to confidently measure color and luminance levels on all CRTs. The CP290 "ColorPro" Hand-Held Color

Analyzer is compact and portable for white balance testing and alignment, wherever the display is located. The analyzer is simple to use, menu-driven, and provides total control at your fingertips.

The unit provides fast, accurate chromaticity measurements over a wide range of luminance on all CRTs. You get industry standard measurement units and display modes, sync-locked measurements requiring no external sync, and a bright (easy-to-read) LED screen.

Circle (102) on Reply Card

Portable desoldering system

PACE introduces the new ST 105P, a portable version of the ST 105 self-contained digital desoldering system. Useful for field repair and service, the compact unit fits into most standard tool cases. The product incorporates the manufacturer's Auto Snap-Vac feature, which provides a minimum vacuum on-time for improved desoldering performance, reduced maintenance, and extended tip life. Included is

an extractor holder that flips and locks into place for travel and a heat resistant, static-dissipative silicon rubber holder for extra tips, a cleaning sponge, and tip tool. Additional features include a quiet vacuum pump, new backlit illuminated LCD, and kickstand for easier programming and viewing.

Circle (103) on Reply Card

High pressure propellant

A new high-pressure propellant from Stoner, new GUST Air Duster removes dust and dirt from delicate or hard-to-clean surfaces using a clean, filtered, moisture-free, high pressure propellant that won't scratch or harm glass, computers, tools, plastics, rubber, or appliances when used as directed. The product contains DustexII, a colorless, odorless, non-ozone depleting propellant. The duster can be used in the repair of personal computers, stereos, TVs, and VCRs that may be faulty due to dust build up.

Circle (104) on Reply Card

Test Your Electronics Knowledge

Answers to test (from page 21)

1. In mathematics, multiplication and division take precedence over addition and subtraction. So the problem becomes:
 $2 + 21 + 4 - 7 = 20$

Here are additional rules you should know: material in parentheses and under a radical must be done first.

2. The answer is "no." The determinant in the denominator becomes $(2 \times 3) - (3 \times 2) = 0$. You cannot divide by zero. The basic determinant is solved by subtracting the product of the ups from the product of the downs.

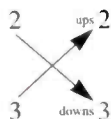

3. Not M

4. Write the logic level at the output of each gate, and note that there is a logic level 0 at the input of the right-hand AND. That makes the output zero. (Figure 2)

5. Output = $M N + \bar{M} \bar{N}$

6. With the larger wire size, he couldn't get as many turns per inch, so the inductance was lowered.

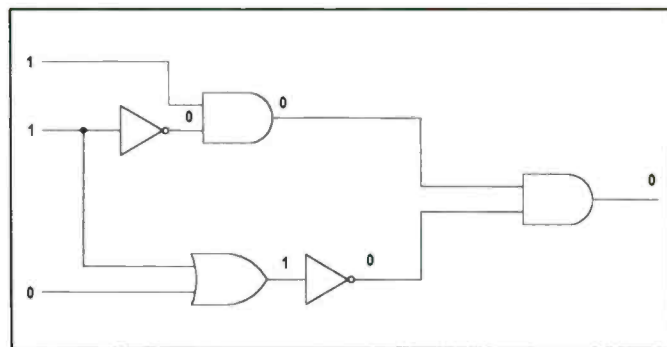

Figure 2.

7. B (by definition)

8. B — The number is 6.24×10^{18} electrons — often given as 6.25×10^{18} (it depends on how many decimal places are used). An electron has a charge of 1.6×10^{-19} coulombs. Take the reciprocal of that number to get the number of electrons per charge.

9. A (By definition)

10. 100Ω (by Ohm's law)

ES&T BOOK SHOP



ES&T Presents Computer Troubleshooting & Repair
Features information on repairing Macintosh computers, a CD-ROM primer, and a color monitor. Also included are hard drive repair tips and computer diagnostic software.
61087\$24.95

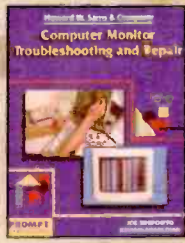

Computer Monitor Troubleshooting & Repair
Learn the basics of computer monitors with chapters on tools and test equipment, monitor types, special procedures, how to find a problem, and how to repair faults in the CRT.
61100\$34.95



1998 Computer Monitor Tips
Includes over 2,000 troubleshooting and repair tips listed by manufacturer name and model number featuring such major names as Apple, Gateway, Compaq, IBM, and Dell.
61160\$49.95



ES&T Presents the Test Equipment Guide
Includes the latest information on how to choose the best equipment, how to build test equipment and accessories, how to set up the ideal service bench, and how to put together a practical tool kit.
61089\$24.95



Complete VCR Troubleshooting & Repair
In addition to troubleshooting procedures, this book contains nine detailed VCR case studies, each focusing on a particular model of VCR with a very specific and common problem.
61102\$34.95



Electronic Troubleshooting & Servicing Techniques
The premiere guide for hobbyists, technicians, and engineers to a variety of troubleshooting tests, measurement procedures, and servicing techniques.
61107\$29.95



ES&T Presents TV Troubleshooting & Repair
Presents important and new information that will make it possible for technicians, students, and electronics hobbyists to service TVs faster, more efficiently, and more economically.
61086\$24.95



Complete Projection TV Troubleshooting & Repair
Covers everything from the basics of projection circuits, tools and test equipment, TV types, safety procedures and measurements, to the finely detailed repair techniques.
61134\$34.95



In-Home VCR Mechanical Repair & Cleaning Guide
Regular VCR maintenance is critical to prolonging the life of your equipment, and this book shows readers the tricks and secrets of the trade using just a few small hand tools.
61076\$24.95



Troubleshooting & Repair Guide to TV, Second Edition
The most comprehensive, complete, and up-to-date television repair book available, with tips on how to troubleshoot the newest circuits in today's TVs.
61146\$34.95



Complete Camcorder Troubleshooting & Repair
Contains sound troubleshooting procedures beginning with the external parts of the camcorder, then narrowing the view to gears, springs, pulleys, lenses, and other mechanical parts.
61105\$34.95



Power Supply Troubleshooting & Repair
Designed to provide technicians with a better understanding of how switched-mode power supplies operate. It also provides practical, useful procedures to follow when troubleshooting power supplies.
61138\$24.95

YES! I want to learn from the experts. Rush me my book(s) right away!

Please add \$4 shipping & handling. **FREE shipping & handling for orders \$50 and over.**

Please make your check or money order payable to: **Electronic Servicing & Technology**

U.S. and possessions - add \$4 shipping/handling. **FREE S/H on orders \$50 and over.** Foreign - shipping/handling charges are calculated by order weight & destination. A \$4 credit will be applied for Foreign orders over \$50.

**To Order Call
516-681-2922**

Qty	Order#	Description	Price	Total Price
Shipping/Handling				
New York Residents add applicable sales tax				
Total				

Name _____

Address _____

City _____

State _____

Zip _____

MC/VISA/AMEX/Discover # _____

Expires _____

Form of payment: MC VISA AMEX Discover Check Money Order

Please mail your orders to: **Electronic Servicing & Technology, 25 Newbridge Rd, Hicksville, NY 11801-9962 FAX- 516-681-2926**

CLASSIFIED

Classified advertising is available by the word or per column inch.

By-the word. \$1.65 per word, per insertion, pre-paid Minimum charge is \$35 per insertion. Initials and abbreviations count as full words. Indicate free category heading (For Sale, Business Opportunities, Miscellaneous, Wanted). Blind ads (replies sent to ES&T for forwarding) are \$40 additional. No agency discounts are allowed for classified advertising by the word. Contact Alycia Nicholzen at 516-681-2922 to place your classified ad (by-the-word). Mastercard, VISA, American Express and Discover are accepted for FAX or mail orders.

Per column Inch (classified Display): \$235 per column inch, per insertion, with frequency discounts available, 1" minimum, billed at 1/4" increments after that 10" maximum per ad. Blind ads are \$40 addition. Reader Service Number \$25 additional to cover processing and handling costs. (Free to 4-inch or larger ads.) For more information regarding classified display advertising please call 516-681-2922. Optional color (determined by magazine) \$150 additional per insertion.

Send your order, materials and payments to:

Electronic Servicing & Technology, 25 Newbridge Road, Hicksville, NY 11801
Attn: Classified Department Ph: 516-681-2922 FAX: 516-681-2926

FOR SALE

SERVICE TIPS for FREE!!! ***** That's right it's **FREE!!** **PROFESSIONAL BOARD LEVEL & COMPONENT LEVEL REPAIRS** for TV's, VCR's, Projection TV's, CAMCORDER's, CD Players, Audio and other repairs on computer disk. **ADD** your own repair tips. **PRINT** out repair tips. **BACKUP** & save Your repairs. Want to share your own repair tips? If you do, we will send you **FREE** Updates!!! Ask about our **TIP EXCHANGE** policy. For IBM compatible computers with a hard drive and some Apple Macs. **Get your FREE Stage 1 SERVICE TIPS PROGRAM Now!!! ***** FREE CALL — CALL NOW!!! CALL 1-800-215-5081. *******

SERVICE TIPS **45,000 technical SERVICE TIPS. SERVICE TIPS THE ONLY NESDA APPROVED TECHNICAL TIPS PROGRAM available for WINDOWS/DOS at \$199.95 (plus s&h). 1-800-621-8477**

TEST EQUIPMENT FOR SALE: REASONABLE PRICES SENCORE, TEKTRONIX, HP and MUCH MORE. View complete list at: <http://www.astglobal.com> or contact: **AST GLOBAL ELECTRONICS.** Voice: 888-216-7159; Fax 814-398-1176; e-mail: ales@astglobal.com

NAP Tuner 340309. RCA Tuner TCHRIA or TCCRIA and more. Snowy picture? Will rebuild for \$25.00, Free Shipping. **Tip Top TV & VCR,** 18441 Sherman Way, Reseda, CA 91335, 818-345-1974.

WinSTIPS!— over 73,000 current Service tips from **KD T-V, NEDSA,** & over 600 contributors! 380 brands (TV, VCR, Computer Monitor, Microwave, Camcorder, Audio, Misc.) Add your tips. Tip exchange. Print tips. Symptom/Info/Cure Search. VCR cross. Sams similar-model cross. Finest ORIGINAL data. One-button update from web. Advanced Multiple Search, One-button e-mail in your tips! Windows 95/98 **\$149.95.** (CD or Web download). Dos **\$89.95 (Diskettes).** Free Registerable Demo: <http://www.kdtviwe.com> updated monthly. **KD T-V 514 3rd St. Aurora, IN 47001. TOLL FREE 1-888-KD-STIPS.** All c/cards. Ken Hull C.E.T.

((**36,000 REPAIR TECH-TIPS**)) **STEP-UP OPPORTUNITY.** You may purchase our Windows **95/98** CD data-base only, 1987 thru Nov 98 for **\$99.00** or Paper Format in (5) manuals for **\$150.00.** If you are satisfied with our product, you may have your purchase applied to our full membership of **\$350.00** with Telephone Tech Support — FCCID Cross-Reference Manual — Tip informer magazine, 6-month updates of 2,000 repairs at reduced cost. **"GET TO THE BOTTOM LINE PROFITABLY."** CALL TODAY and speak to service center owner and technician **ED Erickson, NESDA MEMBER** and past president of the (Professional Electronics Assn. of South Florida) **800-474-3855** or 954-349-2455.

FOR SALE

SENCORE, TEKTRONIX, HEWLETT PACKARD (all models). We **BUY, SELL, & TRADE.** Please call **"CHOICE ELECTRONICS"** for all of your test equipment needs. Complete financing options available. Call 1-800-609-0677, 605-361-6386 ask for Lance Tople.

FURTHER PRICE REDUCTION. Diehl Mark III \$49, Diehl Mark V Horizontal circuit tester \$169. New. Conductive coating for remote control keypads \$9.99 ppd. **WEEC,** 2411 Nob Hill Road, Madison, WI 53713. 608-238-4629, 608-273-8585.

TV CASE HISTORIES: Volume 7 with 3,045+ histories. Satisfaction assured. Only \$59 (plus \$3.25 shipping). Over 8,100 books and supplements sold with only 1 returned for a refund! **Mike's Repair Service,** P.O. Box 217, Aberdeen Proving Ground, MD 21005. Same mailing address 34+ years. Send SASE for samples. 410-272-4984, 1-800-2-FIX TVS 11am-9pm. (<http://www.netgsi.com/~mikesrs>).

Factory service data, used-Sams, books, vintage parts. AG Tannenbaum, Box 386, Ambler, PA 19002. 215-540-8055, fax 215-540-8327, **On-line catalog: www.agtannenbaum.com.**

SENCORE SC3100 100Mhz Dual Trace Oscilloscope. Low Hours \$1500.00. Call 609-799-4457 or e-mail Displaydr@aol.com

TEST EQUIPMENT BOUGHT & SOLD: OSCILLOSCOPES, ETC. 925-706-0177. **FAX: 925-706-0156.**

IN-CIRCUIT CAPACITOR ESR TESTER — Find bad caps FAST and RELIABLY with the new Capacitor Wizard in-circuit ESR Tester! Great for monitors, switching power supplies, TVs, etc. Only \$179.95. MC/VISA. **Independence Electronics Inc., 800-833-1094, www.awiz.com.**

SENCORE SC3100 Scope, \$200.00. CM 2125 Computer Monitor Analyzer, \$2000.00. PR 57, \$500.00. CR 70-CRT Analyzer and Restorer, \$500.00. TF46, \$290.00. B&K Precision 5200 Transistor Tester, \$200.00. All equipment is new with probe manuals and boxes, Contact Hugh at 718-257-3790 or (fax) 718-927-1937.

HORIZONTAL OUTPUT STAGE ANALYZER- Test and isolate problems in the H.O.S.A. and its interdependency loop in 10 minutes or less. Must see demo training video available, a great troubleshooting aide that's very educational which is created by an EE engineer with over 30 years of experience. H.O.S.A. is \$175.00 (satisfaction guaranteed) and the video is \$10.00. No need to spend thousands on other analyzers. Prices include S & H or for free information. send to: Luz Research Corp. P.O. Box 350875, Miami, FL 33135, 305-642-6438.

CLASSIFIED

BUSINESS OPPORTUNITIES

CONSUMER ELECTRONICS SERVICE BUSINESS/BUILDING. Centrally located in Connecticut, well established. Authorized for major brands. Some financing available. 860-828-6448.

VIDEO SALES SERVICE. Established, profitable, 100K Inventory. One Person operation. Retiring. \$35K, Houston, Texas. 281-495-1683.

SERVICE CENTER FOR SALE: Great opportunity in the corner of Tri-state area. Offers outstanding growth potential for the right person. High growth area, low rent. High traffic volume, audio-video-cam-corder-office products repairs. Proven business, yearly revenue increases. Phone: 864-882-6580. Ask for Ian.

BUSINESS OPPORTUNITIES

CENTRAL FLORIDA TV/ELECTRONICS Business/Building. Heart of the retirement area. 36 years (75K). Owner retiring. 941-385-0359.

NORTHWEST MONTANA CONSUMER ELECTRONICS/MOBILE RADIO BUSINESS. Shop plus house. Good one man operation. 13 years (150K). Owner retiring. 406-675-0618.

WANTED

WANTED:USED TEST EQUIPMENT. TURN IDLE OR EXCESS EQUIPMENT INTO CASH. AST GLOBAL ELECTRONICS. Voice: 888-216-7159; Fax 814-398-1176; e-mail: sales@astglobal.com.

READERS' EXCHANGE

Readers' Exchange is a free service.

The following restrictions apply to Readers' Exchange:

- Only individual readers may use Readers' Exchange, and items must be restricted to those that are ordinarily associated with consumer electronics as a business or hobby. If you're in business to sell the item(s) you want to offer for sale, the appropriate place for your message is in a paid advertisement, not Readers' Exchange.
- Readers' Exchange items must be restricted to no more than three items each for wanted and for sale.
- All submissions must be typed or printed clearly!

Send your Readers' Exchange submissions to:

Readers' Exchange, Electronic Servicing & Technology, 25 Newbridge Road, Hicksville, NY 11801

FOR SALE

Sams Photofacts #1, Jan.46 to #2466, March 86 complete. \$300.00. B&K Solid state sweep/marker generator model 415, original box and manuals. \$250.00. Sencore TV-VTR-MATV and video analyzer meter model VA48, like new. \$300.00. Sencore AC Powerite model PR57. \$300.00. B&K Precision model 1460 triggered sweep oscilloscope. \$200.00. Sencore model DV58 microranger, AC, DC, AC volt, peak to peak. \$400.00. Sencore Model LC53 z-meter capacitor, inductor analyzer. \$400.00. Sencore CB51 cb auto performance tester. \$50.00. Sencore YF33 yoke and flyback ringer tester. \$50.00. Sencore TF26 transistor tester, touch tone cricket. \$50.00. Contact: Wallace Huffman, 219-453-4811.

Sencore dual trace oscilloscope model SC 3080. B&K transistor tester model 510 and other test equipment. \$1500.00 plus shipping. Contact: Ken, 760-949-1435.

Many models, many brands of service manuals. Will sell all together, will not separate. Contact Donnie Dillon, 540-345-8131 or e-mail tscen-ter@aol.com.

Various radios, TV's, antennas, tubes, capacitors, oscilloscopes, testing equipment and repair books and manuals. Many schematics and repair manuals, many first editions. Contact: 412-881-5414 for more information.

Sencore VC-93 VCR analyzer, \$1400.00 with manual, test cables, test tape, original box and packing. Excellent condition. Contact Robert Gray, 810-497-5223 or 810-739-2748 after 6 p.m.

TEK THS720A digital scope. \$1750.00. Contact: Kim, 612-869-4963.

VCR test equipment, \$300.00. Beltron 808A picture tube checker. \$400.00, microwave oven test equipment. \$350.00. Bird wattmeter Model 4431 with 7 elements. \$400.00. Contact Martin Wiedenbeck, 7773 Akron Rd., Lockport, NY 14094 or call 716-434-7395.

Sencore VC93 all VCR analyzer, \$1200.00, like new with connectors and manual. Contact: Kanshie Mathis, 512-785-2547.

Craig 3202 pioneer tape player stereo 4-1. Sams Photofact folders. Contact: Anne Bichanich, 15 1/2 West Lake St., Chisholm, MN 55719.

Fluke 5 -inch oscilloscope, 25 Mhz dual channel. \$275.00 with manual. RCA Master VoltOhmyst WV87A, large 7 inch meter face. \$ 75.00 with probes. Two Sony black and white TV cameras with electronic viewfinder and 200mm lenses and suitcases, \$125.00 for both. Shipping not included. Contact: Maurer Television 29 South 4th St., Lebanon PA 17042 or 717-272-2481 or e-mail radiobks@aol.com.

WANTED

Service information for ITT Schaub-Lorenz stereo 5501 hi-fi radio/cassette. Contact: John Phipps, 1412 Navaho Trail, St. Charles, MO 63304.

Mitsubishi TV CS2669 preamp, IC#M51014L control panel. Contact: 810-774-1230.

Complete cassette deck assembly for a Pioneer deck model CT-9R. Contact: Helwig Electronics at 505-253-4732 or e-mail at dene.helwig@mailcity.com.

Operating manual for Model 650 Precision apparatus tube tester. Xerox copy o.k. Contact: Richard Gilman, P.O. Box 633, King City, CA 93930, 831-385-9248.

Flyback CTC 108 RCA Part No. 1455854-501. Contact: George Fogelman, 1201 Idlewild, El Paso, TX 79925, 915-778-0997.

Sylvania TV Model RNE602SL02, chassis 26C611 (85). Need system controller processor IC1000, designated 612498-1. Contact: 614-899-9049.

Apple I, Altair, Seelni-8H, Mark-8, Altair, Heath, Brämiac, Geniac, Edmund. Audio computers. Nakamichi T-100 or similar all-in-one unit. Technics turntable and EPA arms, tube amplifiers and limiters, Urei, Fairchild, Pultec, Cinema Engineering. Display oscilloscopes (Pioneer SD-1100, JVC MM-4) tapes, decoders, encoders, turntables, cartridges, literature, etc. Contact: Kim, 612-869-4963.

Curtis Mathes TV chassis C87-6 run 01 model A2529RC in working condition. Contact: Richard or Bob, 209-582-2083 or 209-587-0748 (fax).

Camcorder part units, service manuals and any other camcorder repair parts or items. Contact: Sherman, 818-991-2228 or 818-991-3326 (fax).

TUBES • TUBES • TUBES
World's Largest Range
 Over 2,000 Types, Domestic & Foreign
UP TO 85% OFF Ask for price list
 International Components Corporation
 Toll Free 800-645-9154 • N.Y. State 516-293-1500
 107 Maxess Road, Melville, New York 11747

Circle (85) on Reply Card

Do You Repair Electronics?

Repair Databases for TV, VCR, Monitor, UL Audio, FCC, and more.

- Over 76,000 records
- Private user forums
- Live on-line chat rooms

RepairWorld.com

Electronics Corp 1 Herald Sq. Fairborn, OH 45324 (937) 878-9878

Circle (62) on Reply Card

ULTIMATE HOME SHOP

Complete tools for metal & woodworking

Starting at **\$995** Easy to use Versatile Affordable
FREE CATALOG Call today!

Call 1-800-345-6342 or write: Dept. ES7 PO Box 1517, Ann Arbor, MI 48106-1517

Circle (74) on Reply Card

SBS DIRECT
STORE-TRAK
#1 Service Software
 • Most Affordable
 • Easiest to use
Call for info and free gift!
 (888) 377-8771
 www.sbsdire.com

Circle (72) on Reply Card

The nation's one stop from **a to z**
Critronics
 a iwa Panasonic DENON PHILIPS FISHER RCA SANYO SHARP JVC SONY MAGNAVOX ZENITH
 1-800-638-3328
 1-800-888-FAXD

Circle (75) on Reply Card

National Computer Association
 The National Computer Association is the Professionals' Choice for securing a future in the computer industry. We make the computer industry a better place for our members to work by uniting together and working to reverse the trend of high overhead and low profits.
 Please See Our Ad on Page 21 or Visit Our Website at www.nca-net.com
1-800-615-6224

ADVERTISERS' INDEX

Company	Page Number	Reader Service Number	Advertiser Hotline
B & D Enterprises	23	60	888/815-0508
Computer Monitor & Maintenance	19	61	800/466-4411
Electro Dynamics, Inc.	2,3	63,64	800/426-6423
Electronic Design Specialists	44	65	561/487-6103
Electronics Technicians Assoc.	21	76	765/653-4301
Electronix Corporation	64	62	937/878-1828
ITT Pomona Electronics	26	66	909/623-3463
International Components Corp.	64	85	800/645-9154
Iscet	23	77	817/921-9101
L.G. Precision	39	68	562-404-0101
MCM Electronics	40	70	800/543-4330
Mouser Electronics	57	69	800/992-9943
NCA/National Computer Assn.	21,64	78	800/615-6224
Philips Service Solutions Group	IFC,17	120,79	800/851-8885
SBS Direct	64	72	800/603-9000
Sams & Company, Howard	43	119	800/428-7267
Sears Home Services	9	73	800/531-5953
Sencore	IBC	1	800/736-2673
Smithy Company	64	74	800/345-6342
Thomson Consumer Electronics	BC	67	800/336-1900
Tritronics, Inc.	64	75	800/638-3328

We'd like to see your company listed here too. Call Evelyn Garrison at 425-557-9611 or Fax her at 425-557-9612 to work out an advertising program tailored to suit your needs.

What's Your Best Servicing Value?
 The magazine that makes money for you - **ELECTRONIC**
 Servicing & Technology

Each month, **ES&T** brings you how-to service articles on TVs...VCRs... Computers... CD players... Microwaveovens... Audio products and more. It's the information you need to do your job everyday.
 Regular columns and special features from experts will make you more efficient - and more profitable - in no time. Plus, our monthly PROFAX, a FREE 8-page pull-out of popular TV, VCR and computer schematics, makes **ES&T** an even greater value.

1-year, (12 issues) \$26.95	2-years, (24 issues) \$49.95
1-year Canada/Mexico \$36.95	2-years, Canada/Mexico \$69.95
1-year Foreign Air Post, \$44.95	2-years Foreign Air Post, \$85.95

Electronic Servicing & Technology
 25 Newbridge Road, Hicksville, NY 11801 • Phone: 516-681-2922 • FAX: 516-681-2926

Your Total Service Solution In 1999 & Beyond



**Team Sencore
110% Dedication**



Herb Bowden
Founder Of Sencore
Electronics 1951-
Sencore News 1982

Extra Effort has been Sencore's driving force from the beginning, and it's still the foundation of the company today! When we ran the "Extra Effort" advertisement in 1982, we delivered our customers innovative designs, greater productivity, better service, enhanced technical support, and fast, reliable service.

In 1999, Team Sencore continues its' 110% dedication to making the extra effort for our customers. As Your Total Service Solution manufacturer of electronic test equipment, nobody works harder to save you time and effort on the job. Our innovative product designs have revolutionized the electronic repair industry. Our service after the sale is second to none. Back all that with our lifetime workmanship guarantee and our 30-day money back guarantee, and you'll see that Sencore is Your Total Service Solution in 1999 and beyond!

Circle (1) on Reply Card

SENCORE

3200 Sencore Drive • Sioux Falls, SD 57104
1-800-736-2673 • www.sencore.com

Video Heads

Pick A Number Any Number

When you're looking for a replacement head, *SK Series* is way *ahead* of the competition.

SK Series replacement video heads cross over to 4,500 different models and 68 different brands.

And when you're in need of any exact semiconductors, belts, tires, flyback transformers or video replacement parts, we have them too.

But we don't stop there.

Every *SK Series* product comes with the quality assurance and accuracy you expect from all Thomson products.

For more information on *SK Series* products, contact your nearest Thomson Distributor.

SK Series...The parts you need to do the job. "Trust me!"



THOMSON CONSUMER ELECTRONICS

SK
Series

Circle (67) on Reply Card