

THE PROFESSIONAL MAGAZINE FOR ELECTRONICS AND COMPUTER SERVICING

ELECTRONICTM

Servicing & Technology

July 1997

Dealing with satellite TV

Servicing EEPROM problems in RCA televisions



Servicing home office products

Thomson Consumer Electronics, Inc.
Video Cassette Recorder
Model no. VR71HF

U.S. \$3.50



7 25274 86667 0

WORLD WIDE FORCE

Be More
Productive
with **FORCE's**
New Internet
Subscription
Service.

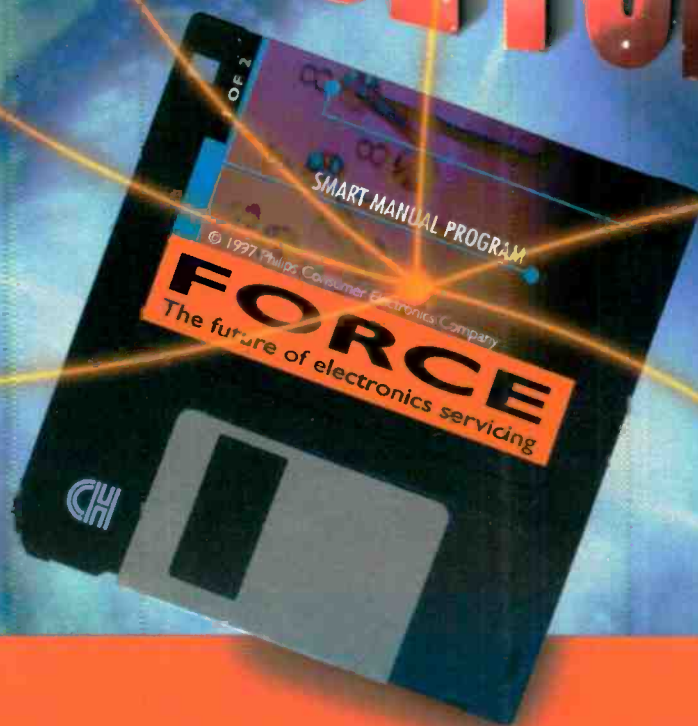

Now you can get **FORCE**—the innovative computer software with diagrams, parts information, troubleshooting tips and more—from anywhere in the world! Just use **FORCE's** new Internet subscription service and download service manuals and updates when you need them. It'll save you time—and give you the program that'll make a world of difference in your productivity.

For complete information call **(423)475-0393** today.

401 E. Old Andrew Johnson Highway, P.O. Box 555, Jefferson City, TN 37760 • e-mail: force.support@knox.pcec.philips.com

NPSC 9
Vegas
Booth 40

Let's make things better.



PHILIPS

Circle (117) on Reply Card

ELECTRONIC

Servicing & Technology

Volume 17, No. 7 July 1997

Contents

FEATURES

- 10 Satellite TV systems servicing:
Dealing with satellite TV**
By The ES&T Staff
DSS systems in homes may range from simple to complex. Outside service technicians who perform in-home service should have a familiarity with these systems to help troubleshoot problems when they encounter a DSS system.
- 20 Servicing EEPROM problems in RCA televisions**
By Bob Rose
EEPROMS literally control every function in some RCA televisions. For this reason it is important to learn how to troubleshoot and repair EEPROM related problems.
- 24 The ten criteria for selecting an electronics aerosol cleaner**
By Mike Sauer
There are ten basic selection criteria that a service center should review before selecting an aerosol cleaner. This article explores those criteria.
- 40 Servicing home office products: Servicing laser printers**
By Jeff Teets
This is the first in a series of articles that will explore whether to and how to service laser printers.
- 42 Anti-frustration indexes**
By Roger D. Redden
One frustration servicicers face is searching for elusive information

that is needed to finish a repair. Setting up indexes that keep track of the information you have can save you a lot of time and hassle.

- 46 Troubleshooting receiver circuits**
By Tom Jones
This article will consider the common types and uses of rf test equipment, circuits of a receiver, and the use of test equipment to verify operation as well as troubleshoot radio frequency circuits.

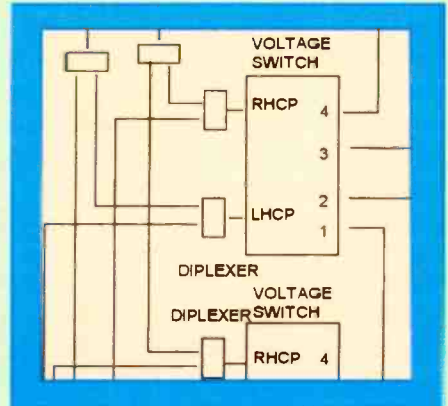

page 10

DEPARTMENTS

- 2 Editorial**
- 4 News**
- 8 Products**
- 19 Books**
- 29 Profax**
- 39 ES&T Calendar of Events**
- 56 Photofact**
- 57 Test Your Electronics Knowledge**
- 58 What Do You Know About Electronics?**
Keep your expertise honed.
- 60 Literature**
- 62 Classified/Reader's Exchange**
- 64 Advertisers' Index**



page 24

ON THE COVER

Thinking about servicing home office equipment? There are, of course, some differences between servicing consumer electronics equipment and home office equipment, but in the main you'll find that you'll be using substantially the same test equipment and techniques, and replacement parts. (Photo courtesy Parts Express.)

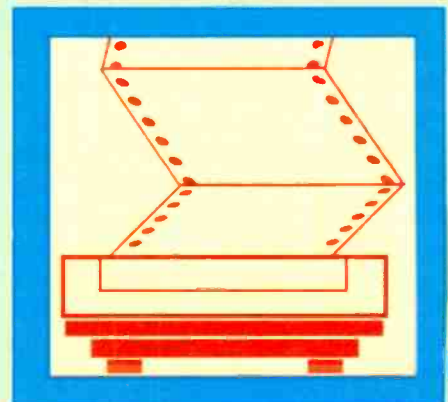

page 40

It's about time

I woke up this morning to the beeping of my electronic alarm clock. Shortly thereafter, I could hear the gurgling of the coffee perking, and began to smell the aroma wafting through the house. The coffee pot is on a timer and starts perking whenever I program it to. It made me think about how greatly our modern electronics products and time are tied together.

For example, the creation of a picture on a TV screen depends on synchronizing oscillator circuits in the television set with the incoming signal so that the electron beams are striking the phosphors on the screen at precisely the right instant. If something happens to the oscillator circuits or the synchronizing signal, the picture on the screen is reduced to a meaningless jumble, or rolling.

Think about the waveform on the screen of an oscilloscope. It's truly a picture, in time, of the behavior of a varying voltage. If the waveform on the screen is a sinusoid, it's easy to appreciate the fact that this is a voltage that's varying smoothly over time. A square wave, on the other hand, changes abruptly from one level to the other instantaneously.

And think about that RC time constant curve. The charging of a capacitor occurs over time in a very characteristic manner. Changing the value of either the resistor or the capacitor changes the time required to charge the capacitor to full charge, or to discharge it completely.

Computers require precise timing to bring data in, to manipulate it, and to get the data back out again in a form that's usable to the humans.

But time figures importantly in consumer electronics service for other reasons than the time dependence of the circuitry. Unfortunately, in consumer electronics service, as in so many other professions these days, time seems to become distorted. For example, even as consumers become more demanding and not only want their products fixed, they want it done now, it becomes more and

more difficult for a service technician to get the job done at all.

The product to be serviced may be one that's totally unfamiliar: it has a brand name that no one has ever heard of before and it has unfamiliar-looking circuits. That means that the service center has to spend time researching the origin of the product, and these days that's no mean feat. The search can become quite long and arduous. First the searcher looks in some of the obvious places: the Electronic Industry Telephone Directory, the Thomas Register, the CES Show Directory, perhaps a search of the internet.

If that fails to turn up any useful information, the next step might be to check the FCC ID number against the FCC's listings to see if that turns up any useful information. There are at least a couple of problems here. One is that unless the product is one that is a potential cause of radio-frequency interference, it is not required to have an FCC ID number. Another problem is that the FCC ID number only identifies the manufacturer. If the product was manufactured for another company, that company will not be listed. And in most cases, when a manufacturer makes a product for another company, it disavows any responsibility to supply service literature.

Now even if you're lucky enough to identify the company whose name is on the product, you may still find that they're not located in the U.S. Now the problem becomes how do you contact that company to get service literature.

Then even if you're lucky enough to locate the company whose name is on the product and get service literature, you have to study the schematic diagram, decide how to go about troubleshooting the unit. And then once you have isolated the problem, and ordered the required replacements for any defective parts, you have to wait for them to be delivered to you. They may be in stock at some distributor. Or, they may be available from

stock from the company's U.S. location. Or, if you're not so lucky, you might have to wait for parts from an overseas location. In the worst case, they might even be on back order from the manufacturer.

Time is further distorted for electronics service in this country by the constant changes and technological advances taking place in consumer electronics. Not only do service centers have to provide good service and find the occasional hard to find product manufacturer, it has become a constant challenge to keep up with a rapidly expanding product base, and continually advancing technology. The time spent in any kind of educational programs needed to keep up with these advances is, of course, time well spent. But it is, in fact, time spent, and takes away from the time that a service center needs to spend on its primary area of concern; servicing consumer electronics products.

Fortunately, some of the new products, notably the computer, make it possible for us to find ways to save a little of the time that we would otherwise lose. For example, software like service center management programs saves time in the recording and retrieval of data, as well as connecting us to the vast information resources of the internet. And fax machines let us send and receive information in written form as quickly as we can talk on the telephone, thus speeding the ordering of service literature and parts. Of course each of these modern miracles required us to spend more time to learn about them.

Time has always figured importantly in the lives of people concerned with electronics service, and it always will. We can only hope that with the passage of time that servicers and the manufacturers of the products they service will find ways to disseminate information to minimize the amount of time it takes to acquire it and act on it.

Nile Conrad Penner

If you repair these ...

Exact Semiconductors

You need them. We have them.

Over 1,700 different stock numbers.

We have the exacts you need for the brands you service. And we're adding new stock numbers everyday.

All with the quality you've come to expect from SK Series and Thomson Consumer Electronics.

For more information, contact your Thomson Distributor.



We can supply you with these ...

2SB688	2SC1809	2SC2621	2SC331
2SB709A	2SC1815		2SC331
2SB716	2SC1815Y		2SC332
2SB718	2SC1826		2SC333
2SB754	2SC1844		2SC338
2SB766	2SC1845	2SC2690	2SC339
2SB817	2SC1906	2SC2705	2SC339
2SB829	2SC1921	2SC2720	2SC339
2SB851	2SC1923	2SC2735	2SC339
2SB861	2SC1941	2SC2773	2SC340
2SB870	2SC1942	2SC2810	2SC340
2SB871			2SC341
2SB874	2SC1969	2SC2857	2SC341
2SB876	2SC1986	2SC2878	2SC342
2SB885			2SC342
2SB885	2SC2021S	2SC2909	2SC342
2SB886	2SC2026	2SC2911	2SC342
2SB908	2SC2027	2SC2912	2SC345
2SB914	2SC2058	2SC2921	2SC345
2SB961	2SC2060	2SC2928	2SC345
2SB1114	2SC2063	2SC2979	2SC346
2SB1172	2SC2073	2SC3026	2SC346
2SB1172B	2SC2086	2SC3038	2SC346
2SC1209	2SC2120	2SC3039	2SC346
2SC1210	2SC2167	2SC3040	2SC348
2SC1213	2SC2168	2SC3042	2SC348
2SC1222	2SC2209	2SC3070	2SC348
2SC1308	2SC2229	2SC3090	2SC350
2SC1318	2SC2230	2SC3117	2SC350
2SC1335	2SC2233	2SC3148	2SC351
2SC1342	2SC2236Y	2SC3150	2SC352
2SC1359	2SC2238	2SC3153	2SC355
2SC1383	2SC2240	2SC3157	2SC356
2SC1384	2SC2271	2SC3158	2SC361
2SC1398	2SC2274	2SC3163	2SC366
2SC1403	2SC2274K	2SC3170	2SC366
2SC1413	2SC2291	2SC3175	2SC367
2SC1413A	2SC2309	2SC3180	2SC367
2SC1417	2SC2310	2SC3180N	2SC368
2SC1445	2SC2314	2SC3181	2SC368
2SC1475	2SC2328	2SC3181N	2SC368
2SC1507	2SC2336	2SC3182	2SC371
2SC1509	2SC2344	2SC3198	2SC372
2SC1583	2SC2362	2SC3203	2SC373
2SC1623L5	2SC		2SC374
2SC1627	2SC		2SC378
2SC1678			2SC378
2SC1685			2SC379
2SC1730			2SC380
2SC1740	2SC		2SC380
2SC1740S			2SC384
2SC1741			2SC385
2SC1755	2SC2581	2SC3300	2SC385

THOMSON CONSUMER ELECTRONICS



Circle (113) on Reply Card

CEMA announces industry conference on product returns

The Consumer Electronics Manufacturers Association (CEMA) announces that it is sponsoring a major cross-industry conference to help suppliers and retailers discuss ways to cut the high costs associated with product returns on September 23 in Dallas. This one-day, cross-industry forum will give suppliers and retailers an in-depth look at the reasons for product returns, original consumer research on why products are returned, different types of return practices, and creative solutions that suppliers and retailers are using to help reduce their product returns. It will also feature a speaker from the Federal Trade Commission (FTC) on what the government allows to be sold as "new".

Co-sponsors of the conference representing over 5,000 suppliers and 4,000 retailers include the American Hardware Manufacturers Association (AHMA), the Association of Home Appliance Manufacturers (AHAM), the National Housewares Manufacturers Association (NHMA), the National Kitchen and Bath Association (NKBA), The North American Retail Dealers Association (NARDA), and the Professional Audio-Video Retailers Association (PARA).

"Product returns is a major issue affecting many institutions," proclaimed Gary Shapiro President of CEMA. "Returns of hard goods are as high as 20 percent of products sold, costing the industry billions of dollars. This forum allows retailers and suppliers to discuss creative solutions and practices."

"Our members are very concerned about how best to deal with a consumer who has decided to return a product," said Elly Valas of NARDA. "They [members] have been struggling for years about how to work closely with their vendors, and this conference will open the dialogue with both ends of the [retail] delivery channel. CEMA and its members have taken a leadership role in defining solutions and practices."

The day long conference will be held in

Dallas, TX at the Omni Dallas Park West, and registration fees will be \$450 for sponsoring/co-sponsoring association members and \$550 for non-members.

CEMA launches new consumer electronics magazine

The Consumer Electronics Manufacturers Association announces its plans to launch *Consumer Electronics Vision*, a new bi-monthly, four-color magazine for its members and the consumer electronics industry at large. With the tagline, "The First Source for Retailers and Manufacturers", the mission of *Consumer Electronics Vision* is to tackle the tough business issues facing both retailers and manufacturers. CEMA is best positioned to address these issues with its forefront market research.

With the first issue, published in April, *Consumer Electronics Vision* planned to report on activities that will impact the businesses of retailers and manufacturers - consumer electronics legislation, engineering developments, marketing trends and statistics, training and education, and trade shows. The initial readership of 15,000 will comprise retailers, manufacturers, financial and marketing analysts, and CEMA members.

"Our mission is to grow the consumer electronics industry. CEMA performs the most in-depth and credible market research in the industry. We fight on Capitol Hill and in regulatory agencies to push public policies favorable toward the industry. We develop engineering standards for new products and technologies. We create one of the world's foremost training programs for both manufacturers and retailers. And we manage and produce the largest annual marketing and trade event showcasing consumer electronics products. These business issues and actions need the proper communications vehicle to inform the industry. *Consumer Electronics Vision* is that vehicle," said Gary Shapiro, CEMA president.

The May/June issue will highlight trends in digital cameras and camcorders, the integrated home systems market, dig-

ital audio radio, the transition of Hong Kong to China, Internet access fees and managing customer product returns, among other business topics.

Free to qualified subscribers only, *Consumer Electronics Vision* will not accept advertising from outside the association during 1997 and will act as one of the main marketing vehicles for CEMA. The magazine will create a visual identity foundation for CEMA's other marketing materials and publications.

Individuals who wish to be put on the magazine's circulation list should contact Lisa Clayton at 703-907-7626 for a qualification form. The form can also be downloaded from CEMA's website at www.cemacity.org.

CEMA is a sector of the Electronic Industries Association (EIA), the 73-year-old Arlington, Virginia-based trade association representing all facets of electronics manufacturing. CEMA represents U.S. manufacturers of audio, video, accessories, mobile electronics, communication equipment information products and multimedia products.

CEMA-sponsored TV/PC interface meeting a success

Over 40 representatives of the television, personal computer and associated industries participated in the first major effort to develop an industry standard for the interface between large screen televisions and personal computers.

Sponsored by the Consumer Electronics Manufacturers Association (CEMA), the meeting was held May 13th at Thomson Consumer Electronics headquarters in Indianapolis, and brought together industry engineers to start the development process of interface standards that will ultimately ensure that electronics products are compatible and thus more consumer-friendly.

The participants decided, as their first goal, to develop a family of standards that would allow interconnectivity between high-resolution operability sources and display units, using point-to-point local connections. As a result of the meeting,

ELECTRONIC

Servicing & Technology

Electronic Servicing & Technology is edited for servicing professionals who service consumer electronics equipment. This includes service technicians, field service personnel and avid servicing enthusiasts who repair and maintain audio, video, computer and other consumer electronics equipment.

EDITORIAL

Nils Conrad Persson, *Editor*
(Internet e-mail: cpersedn@aol.com)
Kirstie A. Wickham, *Associate Editor*
(Internet e-mail: kirstieest@aol.com)
Richard S. Moseson, *NW2L, On-Line Coordinator*

CONSULTING EDITORS

Homer L. Davidson, *TV Servicing Consultant*
Victor Meeldijk, *Components Consultant*
John E. Shepler, *Audio Consultant*
Sam Wilson, *Electronics Theory Consultant*

PRODUCTION

Elizabeth Ryan, *Art Director*
Barbara McGowan, *Associate Art Director*
Edmond Pesonen, *Electronic Composition Mgr.*
Dorothy Kehrwieler, *Production Manager*
Emily Kreutz, *Assistant Production Manager*
Pat Le Blanc, *Phototypographer*

BUSINESS

Richard A. Ross, *Publisher*
Diane G. Klusner, *Associate Publisher*
(Internet e-mail: dianekest@aol.com)
Frank V. Fuzia, *Controller*
Catherine Ross, *Circulation Manager*
Melissa Nitschke, *Operations Manager*
Jean Sawchuk, *Data Processing*
Denise Pyne, *Customer Service*

SALES OFFICE

Electronic Servicing & Technology
76 N. Broadway, Hicksville, NY 11801
516-681-2922; FAX 516-681-2926

Diane G. Klusner, *Director of Advertising*
Emily Kreutz, *Sales Assistant*

EDITORIAL CORRESPONDENCE:

P.O. Box 12487
Overland Park, KS 66212
913-492-4857



National Electronic Service
NESDA
Dealers Association, Inc.
Member, Electronic Servicing
Dealers Association

Electronic Servicing & Technology (ISSN 0278-9922) is published 12 times a year by CQ Communications, Inc. 76 N. Broadway, Hicksville, NY 11801. Telephone (516) 681-2922. Periodical class postage paid at Hicksville, NY and additional offices. Subscription prices (payable in US dollars only): Domestic—one year \$26.95, two years \$49.95. Canadian—one year \$36.95, two years \$69.95. Foreign Air Post—one year \$44.95, two years \$85.95. Entire contents copyright 1997 by CQ Communications, Inc. Electronic Servicing & Technology or CQ Communications, Inc. assumes no responsibility for unsolicited manuscripts. Allow six weeks for delivery of first issue and for change of address. Printed in the United States of America.

Postmaster: Please send change of address notice to Electronic Servicing & Technology, 76 N. Broadway, Hicksville, NY 11801.

CQ Communications, Inc. is publisher of CQ The Radio Amateur's Journal, Popular Communications, CQ Radio Amateur (Spanish CQ), CQ VHF, CQ Contest, and Electronic Servicing & Technology.

Wavetek. The Way Value Is Measured.

For the best values in digital multimeters everyone is turning to the Wavetek XT Series. Each of these full-function DMMs measures voltage, current, resistance, and also a set of additional electrical or electronic properties you work with every day. Inductance. Capacitance. Frequency.

Temperature. There is an XT Series DMM right for you. With oversized character displays, these DMMs are as easy to read as they are to use. All have fully-fused current inputs and input warning beepers to protect you and the meter. Each comes with safety test

leads and are approved to IEC1010-1 safety standards. Our commitment to reliability and high quality is backed by the industry's only "No Hassle" warranty program. If your XT Series meter requires warranty service, your local dealer replaces it immediately. Call today for full details and the names of your local Wavetek distributors. You'll find that when it comes to Wavetek performance and price, nothing else measures up.



27XT A unique combination of DMM and component checking in a single meter.	23XT Electronic and electrical test functions for general duty and HVAC/R.	25XT A full C-meter in a DMM, and more! Ideal for APX cell-phone & antenna matching component inspection.	28XT A thermometer + DMM for HVAC/R, building or plant maintenance.	85XT A precision True-RMS reading DMM, ideal for equipment like copiers.	LCR55 Full-function LCR, extra test features for "best-buy" in a component checker.
<ul style="list-style-type: none"> • Inductance • Capacitance • Logic • Frequency 	<ul style="list-style-type: none"> • VAC Safety Tester™ • Temperature • Transistor • Logic 	<ul style="list-style-type: none"> • Full Capacitance 0.1pF to 20nF • Capacitance Zeroing & Test Slots 	<ul style="list-style-type: none"> • Temperature • Capacitance • Frequency • Max-Hold 	<ul style="list-style-type: none"> • 4 1/2 digit Accuracy • True-RMS • Frequency • Duty Cycle 	<ul style="list-style-type: none"> • Inductance • Capacitance • Resistance • Transistor • Dual Diode

Accessories include current clamps, RF & HV probes, temperature converters, holsters, boots and carrying cases.

Wavetek Corporation
9145 Balboa Avenue, San Diego, CA 92123
(800) 854-2708



four engineering working groups were proposed: one to assess current technology, one to act as liaison to other standard-making bodies, one to look at multi-level systems operations problems, and one to study overall architecture issues.

Gary Shapiro, president of CEMA, stated, "We are extremely pleased to bring our members together to implement and expedite the convergence of intelligent entertainment and home information products through the creation of a comprehensive family of standards. CEMA has a long history of working with member companies and interested parties to help develop technical standards that ultimately benefit the consumer, and computer manufacturers are an integral part of this convergence."

Participating companies at the meeting were: Bell Atlantic, Bose, CEMA, Compaq, Connector Industry Consulting Group, Echelon, Hitachi, IBM, Intel, Matsushita, Microsoft, Mitsubishi, NEC, Philips, Pioneer, Samsung, Sharp, Sony, Thomson, Toshiba, V-Tech, VESA, Zenith, and Zilog.

The group planned its next two meetings, to be held in June in Chicago, and September in Denver. Specific dates and locations will be announced. Contact George Hanover at CEMA at e-mail: george@eia.org for more information.

CEMA joins forces with Internet access coalition to block unfair charges

Working to ensure the affordability of Internet access for consumers, the Consumer Electronics Manufacturers Association (CEMA) announced today it will become an active member of the Internet Access Coalition. The Coalition is fighting attempts by some telephone companies to impose "access charges" against Internet access providers. CEMA shares the Coalition's concern that additional charges would be passed on to consumers, thus inhibiting consumer Internet use.

"We can not allow local telephone companies, which already gain substantial revenues from PC modem connections, to impose further financial burden on U.S.

consumers," said Gary Shapiro, CEMA president. "In this exciting digital age, when our members are producing Internet-accessible TVs, phones, pagers, and computers, we must work with the Internet Access Coalition to ensure that all consumers can enjoy affordable access to the wonders of the Net."

In a ruling issued December 24, 1996, the Federal Communications Commission (FCC) tentatively decided not to allow the phone companies to assess new charges. The FCC is currently seeking comments on its tentative decision.

The Commission has also requested public comment on the need for local telephone companies to provide alternatives to voice telephone switches for handling data traffic. The Internet Access Coalition supports the creation of competition to spur the deployment of technologies such as ADSL (Asymmetric Digital Subscriber Line) or HDSL (High bit rate Digital Subscriber Line) that can provide high-speed Internet access to consumers while eliminating any potential burden on local voice telephone networks.

CEMA joins the following high-tech companies and associations as members of the Internet Access Coalition: America Online, Inc.; American Electronics Association; Apple Computer, Inc.; Business Software Alliance; Compaq Computer Corp.; Compuserve, Inc.; Dell Computer Corp.; Digital Equipment Corp.; EarthLink Network, Inc.; Eastman Kodak Company; GE Information Services; IBM Corp.; Information Technology Association of America; Information Technology Industry Council; Intel Corp.; Internet Service Providers and Users Association; Microsoft Corp.; Netscape Communications Corp.; Novell, Inc.; Oracle Corp.; Software Publishers Association; Sun Microsystems, Inc.; Voice on the Net Coalition.

PC users seek audio entertainment, CEMA survey shows: On-line preferences also revealed

Based on a new survey showing that 62 percent of multimedia PC users play

audio CDs on their CD-ROM drives (up from 18 percent in 1994), the Consumer Electronics Manufacturers Association (CEMA) foresees a substantial opportunity for PCs to mature as audio entertainment products.

"This survey reveals a mixed bag of results for the multimedia industry," said Gary Shapiro, CEMA president. "While many PC users are now taking advantage of some nontraditional functions of their PCs, such as listening to audio CDs, there remains a clear field of opportunity for online audio and surround-sound. It is also interesting to note that, despite the increased use of the PC as a CD player, the use of home CD players among multimedia PC households remained steady."

CEMA's survey shows that 67 percent of multimedia PC owners use separate detached speakers with their computer, while 20 percent use speakers built into the monitor. Of those with separate detached speakers, there exists virtually no surround-sound penetration — 91 percent indicated that they use only two speakers. There is, however, interest (31 percent) among all PC users in enjoying a surround-sound experience when playing audio CDs and/or games from the PC.

Among owners of personal computers with a modem, 69 percent subscribe to a commercial online service and 36 percent subscribe to an Internet Service Provider (ISP). When browsing the Internet, online users choose to connect through an Internet Service Provider (41 percent) as opposed to 23 percent who choose to use a commercial online service.

Multimedia programs on the Internet such as RealAudio and Macromedia Shockwave are far from reaching mass market status. The survey shows that 55 percent of online PC users have never heard of RealAudio, while 66 percent have yet to hear about Shockwave.

CEMA's survey results also demonstrate Microsoft's lightning-quick market penetration of its operating systems and Internet browser. Sixty-four percent of non-Apple computer users indicated they use the Windows 95 operating system

(just 16 months after its introduction). Meanwhile, 56 percent of online users say they have the Netscape Navigator browser installed on their personal computer, with Microsoft's Internet Explorer gaining ground with 37 percent.

The survey was conducted in December, 1996 among 500 multimedia personal computer owners. It has a margin of error of ± 3 points.

Copies of this CEMA survey are available from the CEMA Market Research department. Contact Todd Thibodeaux, e-mail: toddt@eia.org.

NASM's expanded educational congress offers something for everyone

NASM's 42nd Educational Congress to be held at the Fairmont Hotel in Dallas, TX beginning October 12, 1997 will offer a newly developed and greatly expanded

program compared to that organization's past annual conferences.

This year's theme "Taking Bold STEPS: Strategic Techniques for Excellence in Product Support" reflects the association's dedication to providing the service management industry with high quality educational sessions and programs in one location.

Some of this year's program changes will include the following:

- Expanded workshop presentations from 9 to 12 educational sessions in the following tracks: Evolving Technology, Systems and the Virtual Office; Benchmarking practices to Improve Performance and Effectiveness; Internal and External Practices to Add Value and Satisfy Customers; People Relationships and Practices for Customer Effectiveness.

- High Quality Post Congress Seminar: Again, ASQC and NASM will partner at this year's educational congress to offer

"Baldrige Award Self-Assessment Training for Service Organizations" beginning on Thursday, October 16, 1997. This highly interactive seminar will teach attendees how to use the Baldrige Award criteria to Diagnose and Improve the quality management system in their service organization.

- By Popular Demand SMI Unit I Program: The University of Wisconsin's Service Management Institute will offer its Unit I: Managerial and Leadership Skills for the Service Manager from October 14-16, 1997 at the congress site. This brings the high quality long-standing program into the mid south area for the convenience of NASM members and their employees.

For more information, contact NASM Headquarters at: 1030 West Higgins Road, Suite 109, Hoffman Estates, IL 60195; 847-310-9930; fax: 847-310-9934; website: <http://www.nasm.com>. ■

PTS Electronics

Supplying the World of Electronics

NPSC 97
Vegas
Booth 1006

PTS Support

PTS has been supporting the electronic service industry for over three decades. By providing quality TV replacement Tuners and Mainboards, PTS has become a source you can rely on. Thousands of TV Tuners, Chassis, Mainboards, and Modules are in stock and available for immediate delivery. PTS stocks and services over 40 brands of direct replacements. PTS is a valuable resource which will keep you competitive in today's electronics industry.

COMPUTER
Service On Monitors,
Printers,
System Boards

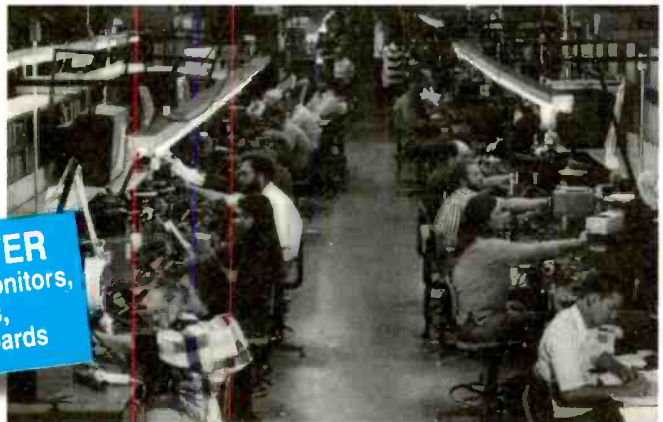

The Nation's Largest Inventory of TV Tuners and Mainboards

CORPORATE HEADQUARTERS

INDIANA
BLOOMINGTON
800-844-7871
TOLL FREE
800-844-3291
FAX

COLORADO
ARVADA
800-331-3219
TOLL FREE
303-422-5268
FAX

CALIFORNIA
TUSTIN
800-380-2521
TOLL FREE
714-258-0315
FAX

Circle (74) on Reply Card

Multimeter

Wavetek Corporation introduces the new Model 25XT DMM and C-Meter combination, an addition to the company's line of XT Series testers.

The meter includes functions of volts, ohms, amps and full capacitance ranges from 200pF to 20mF, transistor testing, and frequency to 40kHz.



In addition to its core measuring capabilities, the unit is enhanced with a combination of features including max/data hold, stray-capacitance zero adjustment knob, easy-to-read oversized characters, auto-off, wide measuring ranges, fully-fused current inputs, safety test leads and input warning beeps.

Circle (100) on Reply Card

On-line technician services

TechsWeb is a new electronic repair subscription service from *Electronix Corporation* that allows users unlimited, on-line access to over 75,000 repair problem/solution and informational databases. Information is updated twice weekly.

The service features include private newsgroups, live on-line chats with other technicians, Hot Tip bulletin board, and links to most consumer electronics manufacturers. The problem/solution databases include TV (16,000+ records), VCR (10,000+), Computer Monitor (1,300+), and Audio (2,000+).

There are also pages with frequently asked repair questions, reference guides, etc. To subscribe you need Internet access and an e-mail account.

Circle (101) on Reply Card

Soldering equipment analyzer

A miniature soldering equipment analyzer, the G310 with all of the capabilities and accuracy of larger units is available from *Hexacon Electric Company*. Its small size makes it portable so that it can be used to test any soldering equipment at any location - any time.

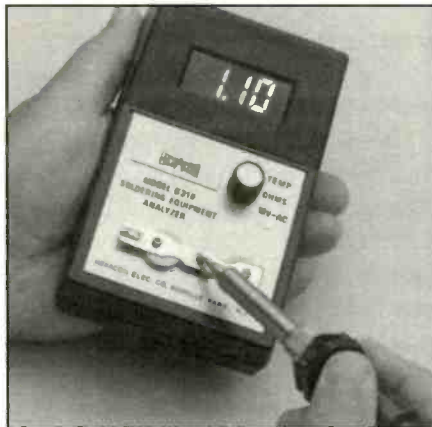

The analyzer operates on a 9V battery and comes equipped with a storage case.

All test results are digitally displayed on the unit and an interface port for chart recording or a data logger is also provided, if permanent test records are desired.

With the iron at full heat, the unit will test tip temperature, ESD resistance and voltage leakage. It can also be used for bench solder pots and soldering machines. Optional thermocouple probe and test leads are available for testing solder pots and soldering machines.

Circle (102) on Reply Card

Software for multifunction counter

Fluke Corporation introduces Fluke-View 160 software for Windows for Fluke's 164 MultiFunction Counter. The new software provides waveform analysis and paperless recording of up to 10 signals simultaneously, and documents and archives the waveforms, together with values and logging records.

The software runs on Windows 3.1 and Windows '95, and connects to a standard PC communication port via an optically isolated RS-232 cable. It reads graphical data from the counter's display in pixel format as bit-mapped graphics. The software also reads numerical measurement data to generate high-resolution vector graphics that can be analyzed, logged, zoomed-in and scaled. Both graphs and numerical data can be saved, retrieved, printed and ported to other software,

including word processors, spreadsheets, and presentation programs.

Circle (103) on Reply Card

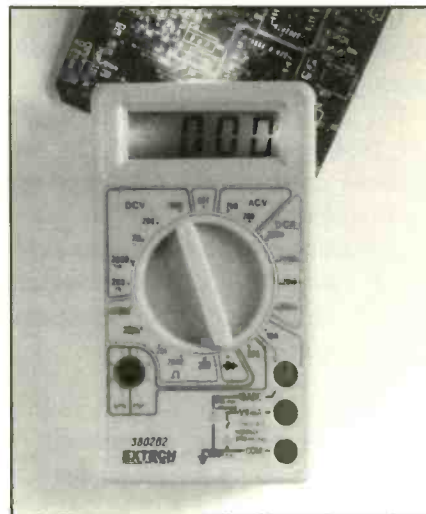

Multimeter flashlight

Extech's Mini Multimeter Flashlight, Model 380202, with backlit LCD and built-in flashlight enables measurements in hard to see or dark areas. The 3 1/2 digit LCD (± 1999 counts) automatically indicates polarity. A rotary switch is used to select voltage, current, and resistance ranges plus transistor and diode checks. The meter measures current with a resolution from 0.1 μ A to 10mA. Overload protection and indication are provided for voltage, current (200mA), and resistance. Complete with 9V (for DMM) and 2 AA (for flashlight) batteries and test leads.

Circle (104) on Reply Card

Low-profile IC test clips

ITT Pomona Electronics' newest low profile IC test clips allow easy connection of test instruments to the industry's latest high density TQFP (thin quad flat package) and SQFP (small quad flat package) surface mounted devices.

Model 6150 (110-pin), 6151 (144-pin) and 6152 (176-pin) test clips provide spring loaded contacts spaced at 0.5mm to assure positive electrical contact with each pin tested. Mechanical fingers specifically designed to hold on to thin TQFP chips assure positive retention in both vertical and horizontal positions. The patented clip design enables the user to test an on-board, surface mounted device (SMD) while the host board is inserted into a standard-spaced computer

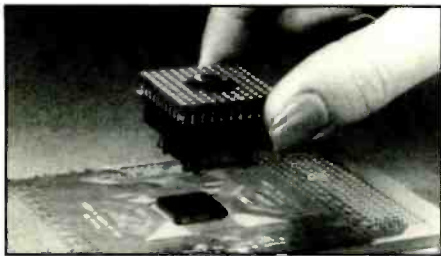

or system slot. Signals can then be sampled during normal system operation.

Circle (105) on Reply Card

Data acquisition modules

Data acquisition modules from *B&B Electronics* can receive signals from up to eight external sensors, control various devices and output analog voltages. The compact modules plug easily into DB-25 serial ports. Applications include monitoring sensors and controlling process and test equipment, and monitoring and controlling ON/OFF states.



RS-232 and RS-485 modules have the ability to interface seven A/D channels, two digital input channels, one digital output channel, and four channels of 8-bit D/A outputs. Only four commands are needed to control the modules. For applications where long wire runs are required or a lot of line noise may be encountered, there are two current loop models which output a 4-20mA current.

Circle (106) on Reply Card

Servicing program will be accessible via the Internet

Philips announces that beginning in July the FORCE computer system, which gives service technicians instant access to TV and PTV diagrams, components, circuits, known faults, parts information, troubleshooting tips and more will be accessible through the Internet, allowing

service techs to download current and past manuals and upgrades on their computer.

With an Internet subscription, a service technician can have access to manuals and upgrades, at the push of a button, and within as few as 10 minutes.

According to Mark Blevins, Philips' software production supervisor, who was formerly a service technician and a service engineer, "When you use this software it's easy to navigate around and troubleshoot complex machines. It's like having a guy who's been doing it for 20 years sitting right next to you."

"What makes this an invaluable tool for service techs is that it was designed by service techs for service techs," said Chet Dunn, Philips' manager of software development.

Getting used to using this electronic information isn't hard, according to Blevins. New and current users are supported by software tutorials and constant phone support. Once the Web site is up, full-service support will be available through the site.

Manuals are updated on an as-needed basis, and then the information is made immediately available on the Web, which makes the information more current than that of paper manuals, according to Blevins.

Downloading and updating files doesn't take long, according to Dunn, because the software condenses the manuals into very small files so they can be updated individually. This makes updating a very quick and easy process."

In the first phase of the program, which begins in June, subscribers will receive manuals and upgrades through their e-mail addresses. Then, in July, it will be accessible through FORCE's Web site.

A user provides an authorization number, and then can download current subscriptions, including back issues to 1990, as often as needed.

In order to get a year-long Internet subscription one needs only to purchase the software and pay a minimal annual subscription fee.

Circle (10) on Reply Card



Sony revolutionizes product repair with ESI, Electronic Service Information system!

The ESI system is a CD ROM collection that contains virtually all the information you need to repair Sony Consumer Products sold in the United States since 1991. The system allows for instant access to model accessories, product features and specifications, owner's and service manuals, schematic diagrams (except audio products), parts information and pricing, and more!

No more lost or misfiled bulletins, manuals, or microfiche, all the service information you now need, is at your fingertips with Sony's ESI!

For more information
contact the Sony World Repair Parts Center at
(816) 891-7550 ext. 33

SONY

Circle (80) on Reply Card

Satellite TV systems servicing: Dealing with satellite TV

By the ES&T Staff

Because of the economics surrounding DSS, it's possible that many service centers will never install a DSS system, or service one. However, with the number of these systems being sold to consumers, it is highly likely that an outside service technician will encounter a TV that's connected to a DSS system. When that occurs, a passing familiarity with the basics of a DSS sys-

tem and some of the variations might help a service technician determine whether the problem lies in the TV set, or somewhere else in the system. For that reason, we present this article on DSS.

Don't be confused if you also encounter the abbreviation SMATV (satellite master antenna television). That term simply describes a privately-owned system that receives signals from any combination of

satellite, cable and broadcast antenna, and distributes them throughout a building. The term applies to a home, as well as those institutions with which we normally associate the abbreviation SMATV: an apartment complex, a hospital, or a motel.

SMATV

A home SMATV system receives signals from broadcast, cable and satellite

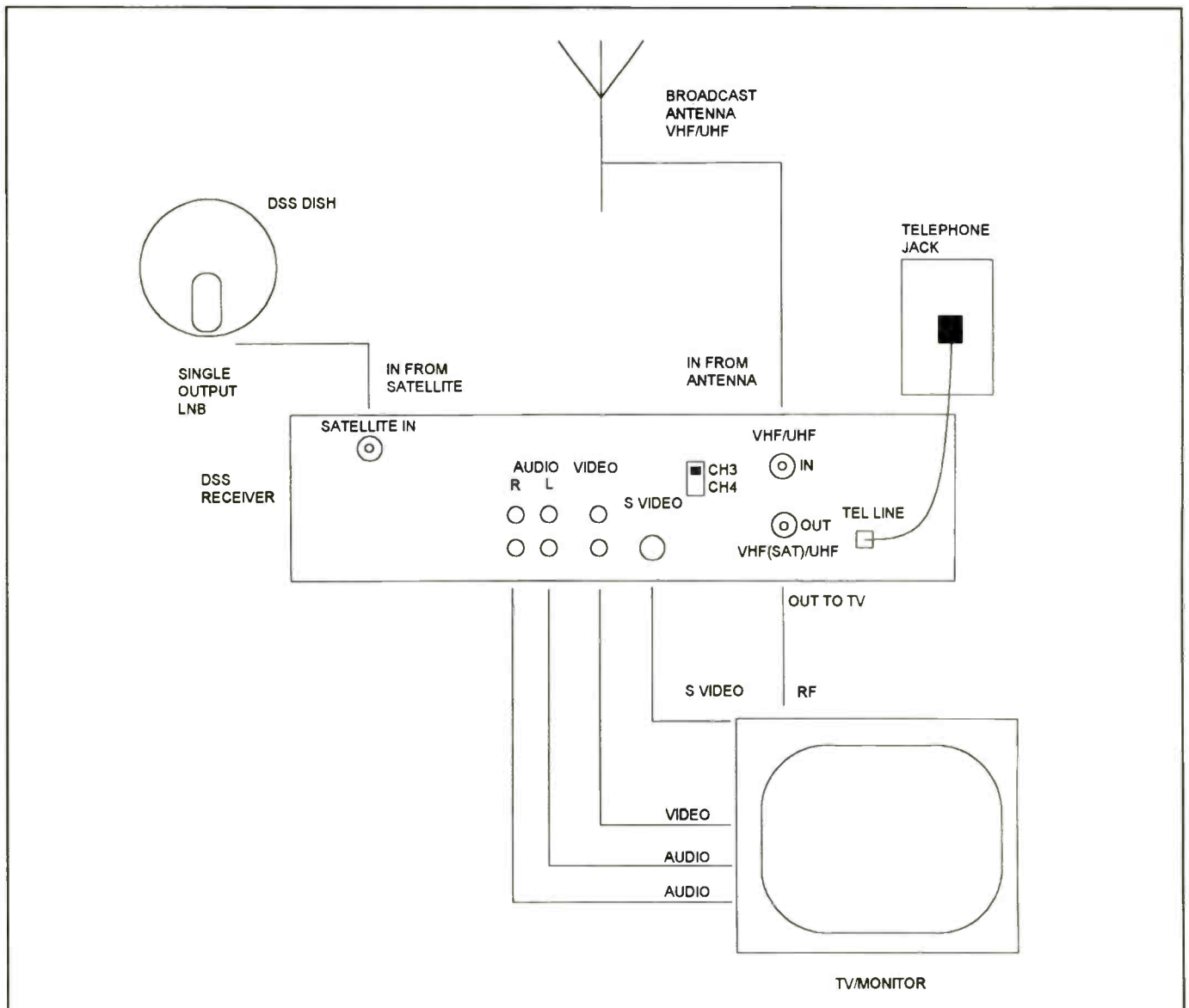

Figure 1. Single TV/Single Output LNB/Single Receiver.

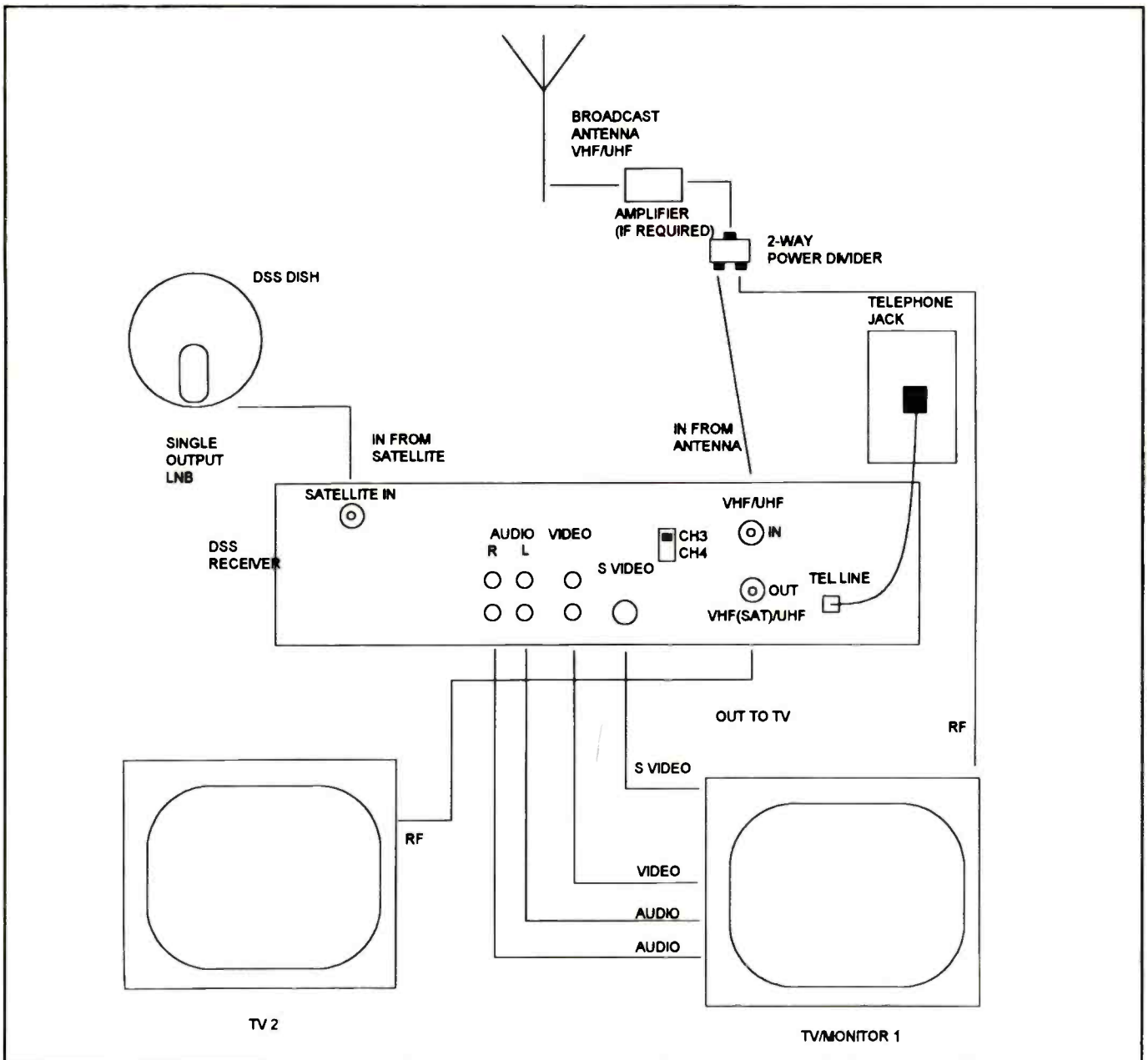

Figure 2. Dual TV/Single Output LNB/Single Receiver.

systems and distributes them throughout the house, where they may be received on any of a number of TV sets or VCRs. The wiring for these systems is coaxial cable. If the system was properly installed, every location served will be able to record or display a clean TV program. The system consists of these sections:

- the head end
- the distribution portion (cabling and connection distribution devices), and
- the receiver.

The head end

The head end is the place where the signal from the satellite is collected over a

relatively large area (the dish) and focused onto the antenna. The resulting signal is conducted to the low-noise block converter (LNB), which selects an entire block of signals and changes the frequency range to a lower frequency range (down converts it) from the satellite frequency to frequencies used by the DSS system. This block of signals is then delivered via the distribution wiring to the receiver called the "integrated receiver/decoder" (IRD).

Polarization of satellite TV signals

In order to understand what goes on in a DSS system, it is necessary to under-

stand a little about the characteristics of the signals that they are dealing with. Satellites transmit many TV signals (channels) to the surface of the earth at the same time. Each channel consists of a range of frequencies, just as is the case with broadcast TV here on earth. In order to conserve radio-frequency spectrum, these channels are tightly packed together. If some kind of method were not employed to prevent it, the adjacent channels would interfere with each other.

Interference is avoided by the application of "polarization" to the signals. Alternate adjacent channels are polarized in opposite directions. One group, or block,

of channels is circularly polarized in a clockwise direction. This is called "right-hand circularly polarized" (RHCP). The alternate channels that lie between these RHCP channels are circularly polarized in the counterclockwise direction. These signals are said to be "left-hand circularly polarized" (LHCP).

Types of LNBS

There are two types of LNB: a single-

output LNB and a dual-output LNB. We'll start with the single output LNB.

Selecting a block of channels on a single-output LNB

The LNB is controlled by a dc voltage that is applied from the receiver, as selected by the user. This allows the LNB to select either the block of channels that is RHCP, or the block of channels that is LHCP. A voltage of 13Vdc sent to the

LNB selects the RHCP channels, and a voltage of 17Vdc sent to the LNB selects the LHCP channels.

In the case of a single-output LNB, a receiver connected to the DSS system can only receive half of the channels available from the satellite at one time. If the viewer wishes to view programs on the oppositely polarized channels, he will have to select that block of channels, then tune in one of the channels from that

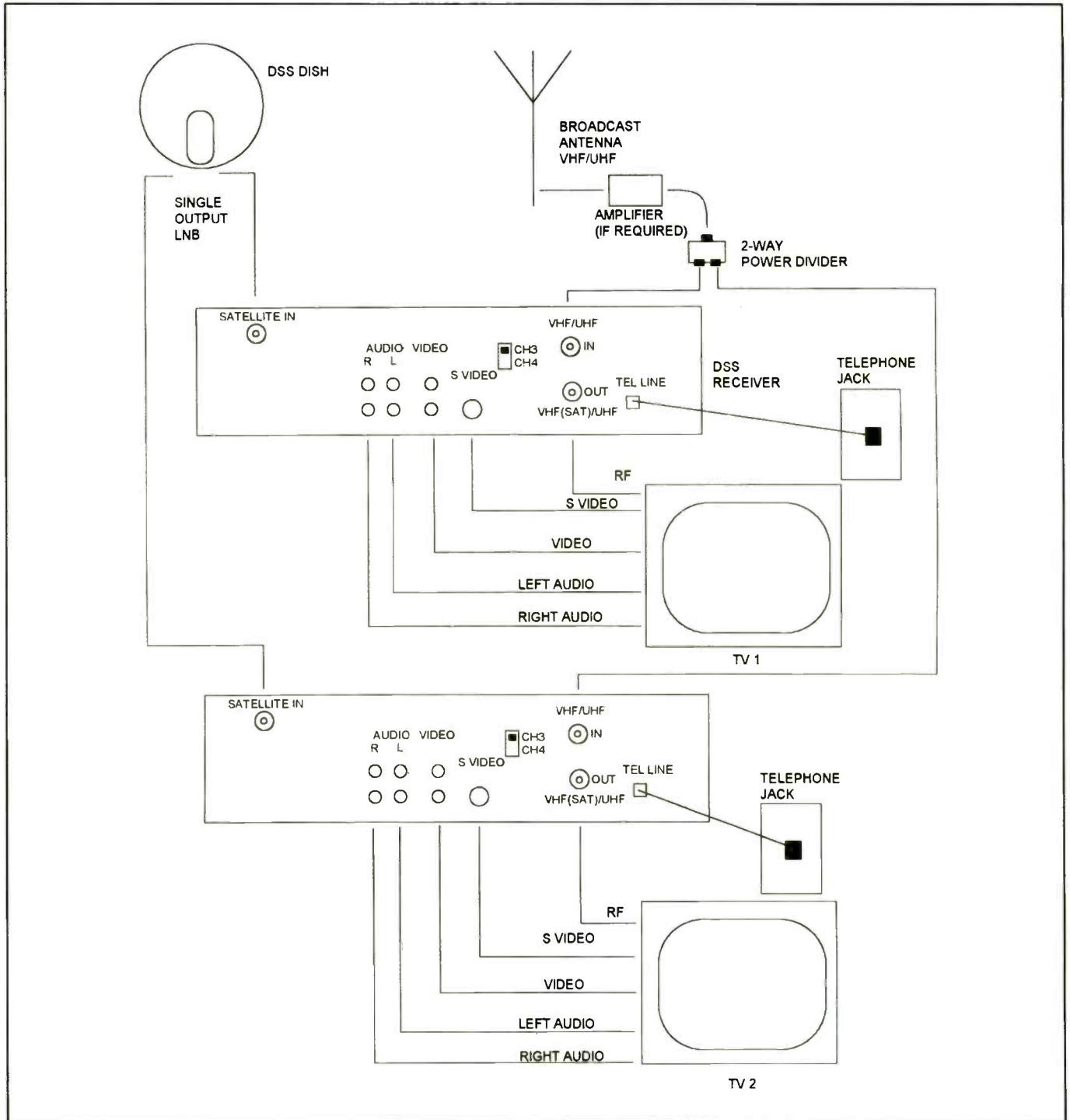

Figure 3. Dual TV/Dual Output LNB/Dual Receiver.

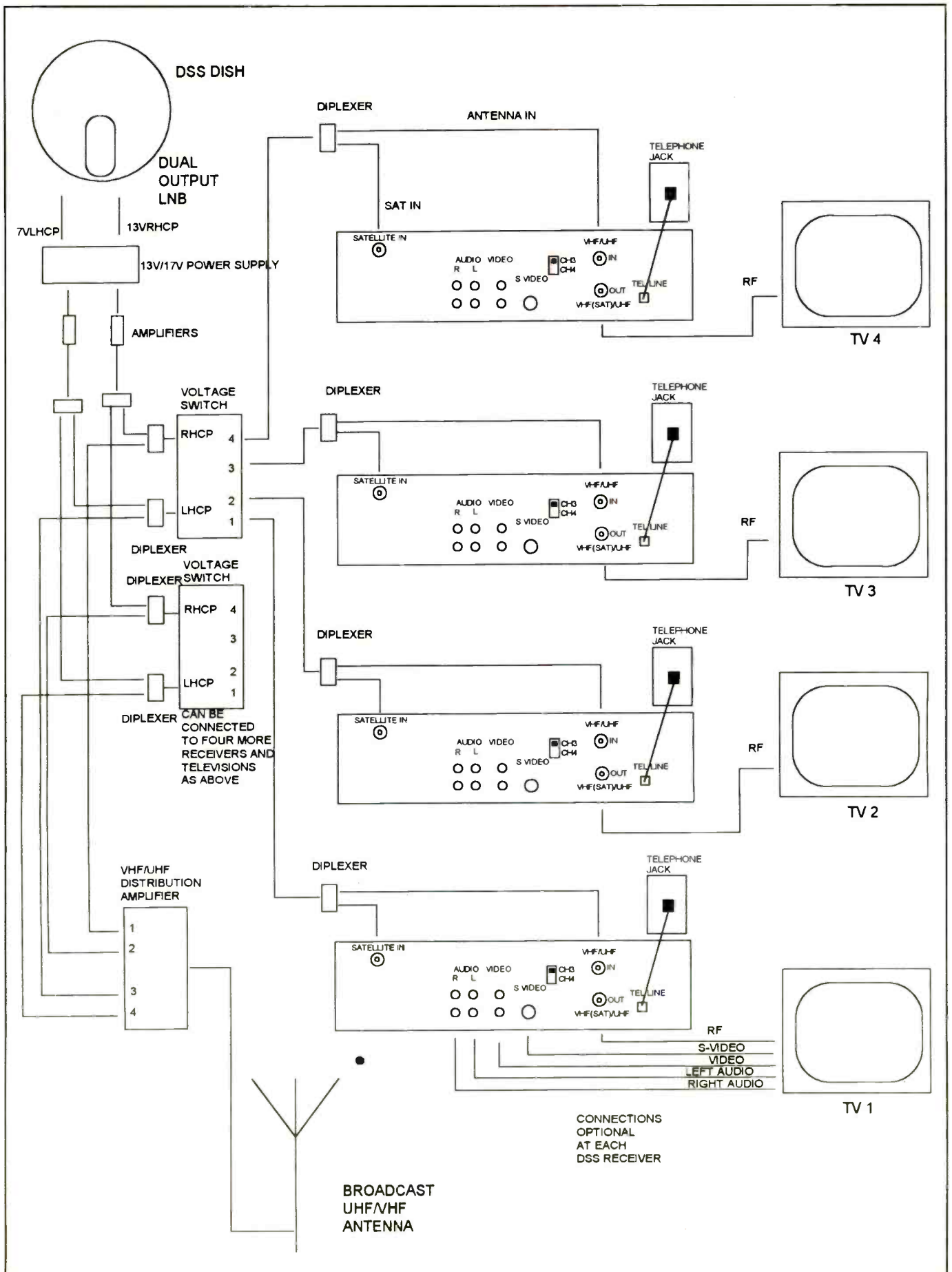

Figure 4. Multiple TV/Dual Output LNB/Multiple Receiver with two Voltage Switches.

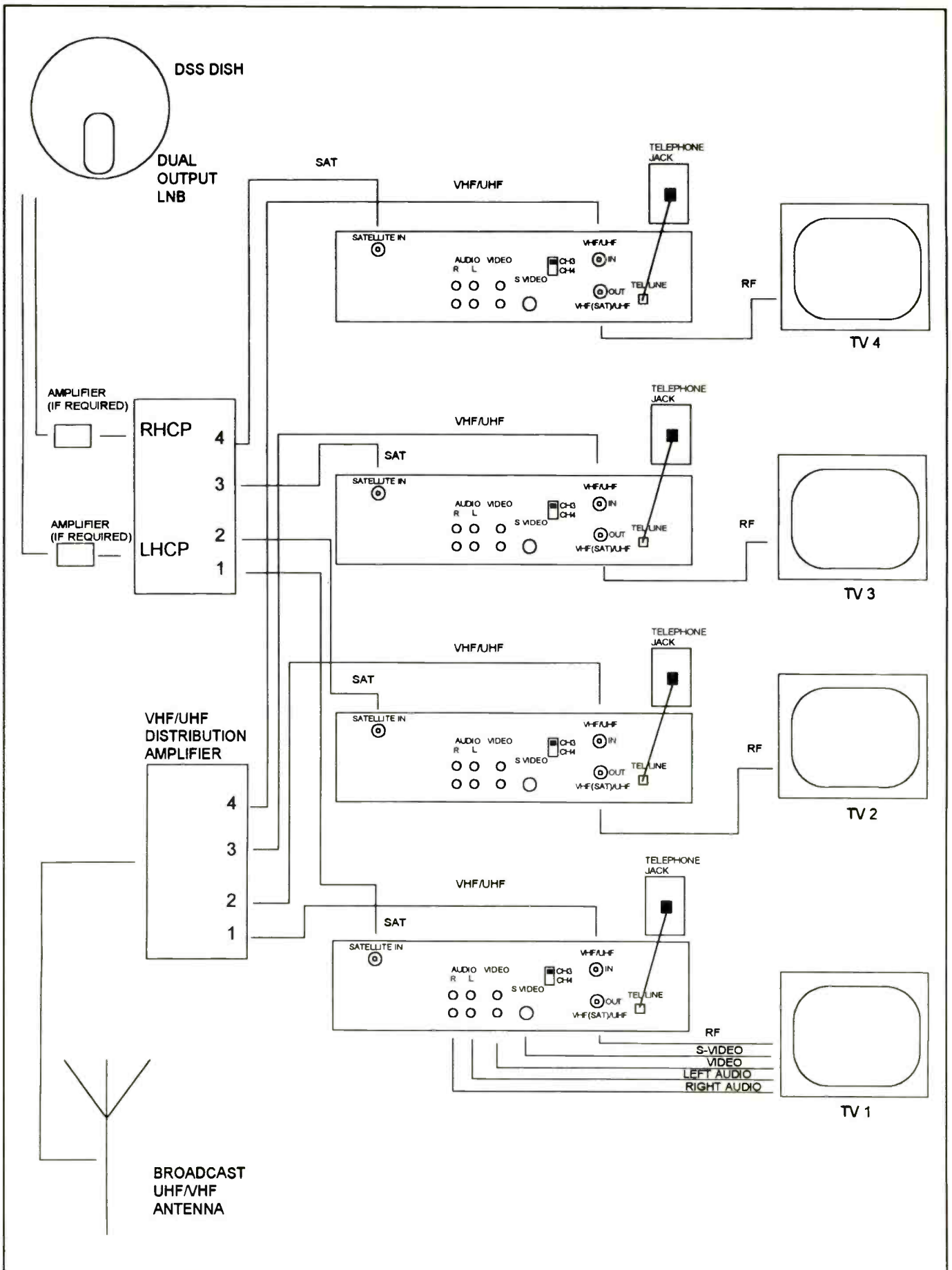

Figure 5. Multiple TV/dual Output LNB/Multiple Receiver with Voltage Switch and separate VHF/UHF Distribution System.

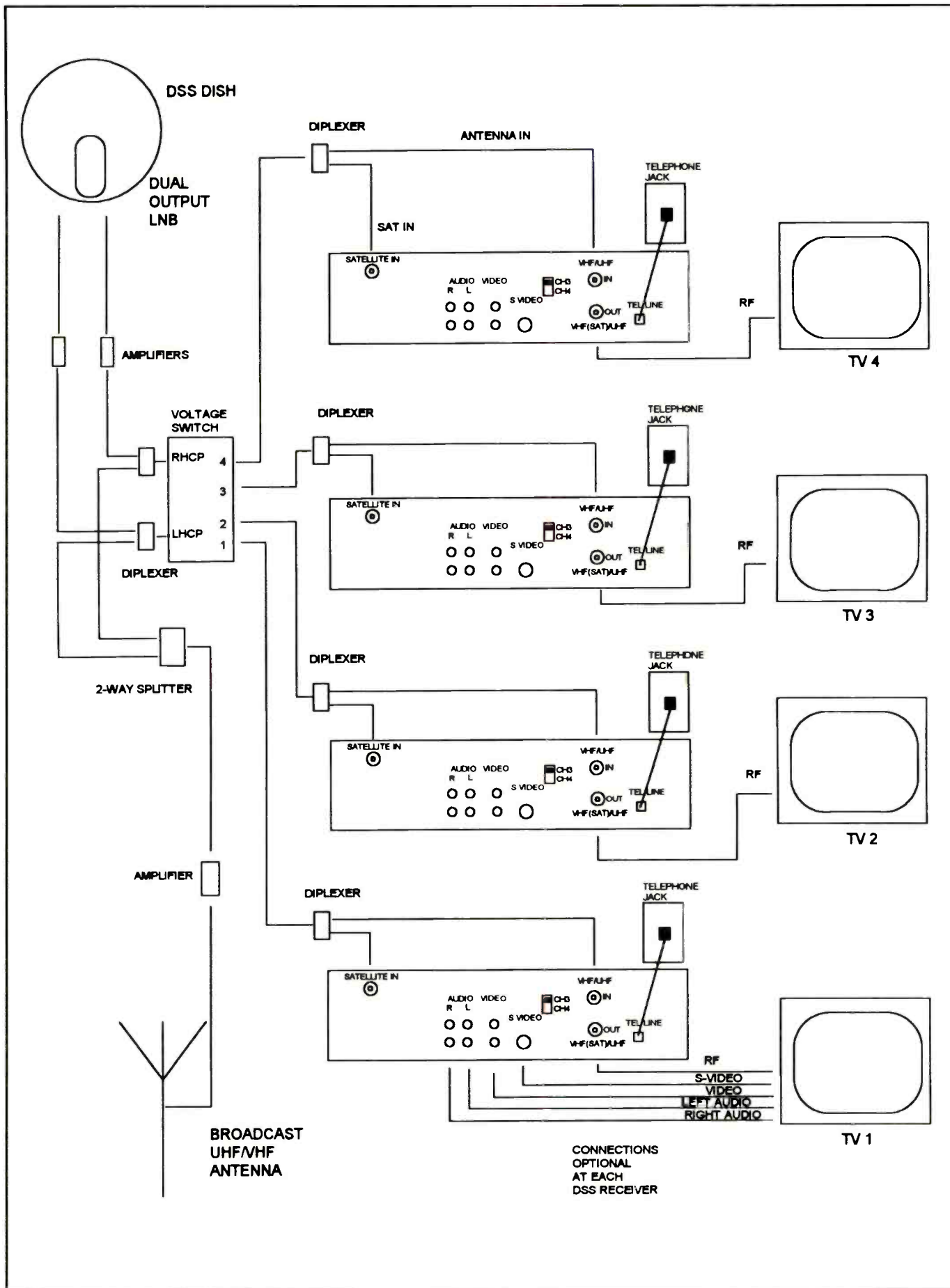

Figure 6. Multiple TV/Dual Output LNB/Multiple Receiver with Voltage Switch and diplexers.

SPECIAL NPSC 97 CONVENTION OFFER

Receive **FREE** our latest **VOLUME UPDATE** WITH 357 additional **SERVICE TIPS** when you purchase the program.

21,391 SERVICE TIPS FOR JUST \$169.95

STAY AHEAD OF YOUR COMPETITION!

Technicians worldwide know **SERVICE TIPS IS THE MOST VALUABLE PIECE OF EQUIPMENT YOU CAN OWN TODAY.**

"Service Tips is the only program I use." — Gary Thompson, Thompson TV

"An outstanding program that has paid for itself in no time." — Ron Purkhiser, Ron's Video Repair

"I love this program, no service center should be without it!" — Danny Garris, Garris Radio & TV

SERVICE TIPS with over 117 **CURRENT** Manufacturers/Brands is unlike any other tips program you may own or have seen. The **SERVICE TIPS** program contains **ACTUAL TECHNICIANS** findings and is **SUPPORTED** by its **CREATORS & APPROVED** BY **National Electronics Service Dealers Association.**

FOR MORE INFORMATION CALL 1-800-621-8477

Electronic Software Developers, Inc.

NESDA Corporate Member
826 South Main Street

South Farmingdale NY 11735
e-mail us at esd@pb.net or

Visit our Website at: www.pb.net/vcrtips

Circle (84) on Reply Card

Service the **JUMBO** and **PROJECTION TV's** with One **MAN**



* TAKE CHASSIS ONLY
* AVOID CABINET DAMAGE

* CONSERVE SHOP SPACE
* SAVE MANPOWER AND TRUCKING

Method used by Sears, N.A.P., Sony, Mitsubishi, GE/RCA, Sharp, Toshiba, Emerson, Samsung and other major manufacturers.

More than twenty years; over 50,000 test jigs are now in use.

TELEMATIC'S TEST JIG SYSTEM

Quick to hookup...Easy to use...
For all popular makes and models

The Telematic Test Jig System is designed to facilitate TV chassis trouble-shooting without the need for bringing the cabinet and picture tube to the shop. With the trend toward larger—27-, 30- and 35-inch—picture tubes and projection sets, a test jig is needed more than ever!

Telematic

DESIGNERS & MANUFACTURERS
OF COLOR T.V. TEST JIGS AND
ADAPTORS

108-02 Otis Avenue 718-271-5200
Corona, NY 11368 718-271-5738 (Fax)

Circle (82) on Reply Card

block. With such a system, if there were more than one TV set in the house, they would be able to be tuned to different channels, but both channels would have to be in the same block of channels.

Dual output LNBs

A dual-output LNB solves the problem of limiting all TVs in a home to one block of channels at a time. With a dual-output LNB, one IRD can be connected to each output, and can independently select either the RHCP block or the LHCP block of channels. Thus with a dual-output LNB, two TV sets at different locations in the home may be tuned to view the same channels, different channels within the same block, or two different channels from two different blocks.

Connecting more sets

It is possible to connect more TV sets by adding voltage switches, and, if necessary, installing amplifiers. It is possible to install four, or even more, TV sets, each tuned to a different channel.

The distribution system

The distribution system consists of the cables, splitters, voltage switches and signal outlets. This system allows the signals received from all sources, satellite, cable and/or broadcast antenna to be distributed throughout the home.

The receiver (IRD)

The SMATV receiver is more correctly called the IRD or integrated receiver/decoder. Keep in mind that everything received via a DSS system is encoded to prevent reception of signals by someone who has not paid for them. Thus the receiver must not only receive the signal, but decode it as well.

Connection to broadcast antenna or cable

DSS systems don't carry any local programming. If the owner of such a system is to receive local programming, the system will have to have a connection to either a cable system or a broadcast antenna capable of receiving signals from the local television stations.

System configuration

Depending on what type of SMATV system the customer has installed in the

home, a service technician may encounter a relatively simple distribution system, or a complex one. Depending on the symptom(s) exhibited by one or more sets, the technician may be able to determine if the problem is in the set, or somewhere in the distribution system.

For example, if all TV sets but one are operating fine, the problem is likely in the set itself, though it could conceivably be in that portion of the distribution system. The cause of this symptom could be confirmed by simply substituting one set for another. If all sets are having the same problem on a block of channels, on the other hand, it would very likely be caused by the LNB or the IRD.

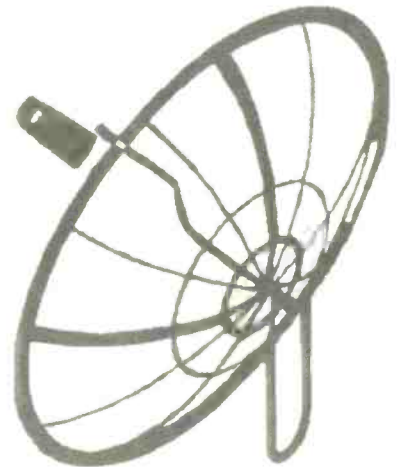

Versatility incurs complexity

Unfortunately, some of these systems can become quite complex, and therefore, it becomes more difficult to determine where the cause of a particular problem lies. Back in the old days, it was easy. There was one signal source, the antenna, and one TV. These days a home may be served by an antenna, a cable system and a satellite receiving system. And the signal may be received by many TV sets and/or VCRs. In addition, the system may also use internal signal sources such as VCRs or laser disc players.

As a result of this complexity, the process of troubleshooting the system, or any display device connected becomes more complex as well. The more a service technician knows about the signal delivery system, as well as the display devices connected to it, the easier it will be to service any of it.

The accompanying illustrations show the number of ways in which a DSS system may be connected. ■

Digital Storage Oscilloscopes, by Ian Hickman, Newnes, 208 pages, paperback \$39.95

Digital storage oscilloscopes have long since completely supplanted analog storage oscilloscopes and have reached a degree of sophistication and performance which enable them to rival the most advanced real time oscilloscopes. In this comprehensive handbook, Ian Hickman describes how they work and how to use them to the best advantage.

The book contains an Introduction, Digital storage oscilloscope fundamentals; Digital storage oscilloscope modes of operation; Input circuitry; Digitizing; Triggering; Signal processing; Displays and display technology; Digital sampling oscilloscopes; Accessories for use with digital storage oscilloscopes; Using digital storage oscilloscopes; Glossary; Appendix; Manufacturers of digital storage oscilloscopes and their agents.

Newnes, 313 Washington Street, Newton, MA 02158-1626

Inside PC Card: CardBus and PCMCIA Design, by Faisal Haque, Newnes, 254 pages, hardcover \$49.95

This new designer's guide to PCMCIA covers Release 2.1 and PC Card '95, offering both design and software implementation examples. The book offers the first detailed look at CardBus and multi-function PC Cards.

PC Card (or PCMCIA) technology allows computers to interface with each other using less space than conventional interfaces. Currently, most applications are in the personal computing market, to enhance peripherals capabilities. As the industry changes, the applications will grow outside of the PC arena, into areas such as medical instrumentation and digital cameras, where peripheral expansion was previously unavailable.

The contents include: PCMCIA overview; PC card: The 16-Bit Bus, CardBus: The 32-Bit Bus; Interface and configuration issues; Multi-Function cards; PCMCIA Software: An overview; PC card mechanical issues; Designing PCMCIA hosts; and Designing PCMCIA cards.

Faisal Haque is Design Engineering Manager at Baynetworks in Santa Clara, CA and has been involved in PCMCIA design for the past four years. He is currently the chair of the PC Card ATA Working Group and has contributed to the 1995 PC Card Standard.

Newnes, 313 Washington Street, Newton, MA 02158-1626

Audio Power Amplifier Design Handbook, by Douglas Self, Newnes, 256 pages, paperback \$29.95

This is a detailed guide to the theory and practice of audio power amplifiers, from the elegantly simple mathematics of the differential pair to the practicalities of bolting down power transistors without breaking them. Based on a large body of original research and twenty years of experience, this work provides the first authoritative exposition of power amplifier design and operation. It shows that much of the conventional wisdom is quite wrong, and supplies practical solutions to many intractable design problems.

The book includes the first complete explanation of the sources of power amplifier distortion, shows how they can be eliminated or minimized, and gives detailed information allowing power amplifiers to be designed and constructed, with performance figures that would have been thought impossible a few years ago. It also includes an unusually detailed and lucid account of the operation of negative feedback in amplifiers, making it an excellent text for teaching as well as a key source for design engineers.

Douglas Self is Chief Design Engineer at Soundcraft Electronics, a major audio manufacturing company.

Newnes, 313 Washington Street, Newton, MA 02158-1626

Filter Design, by Steve Winder, Newnes, 256 pages, paperback \$56.95

Why do most books on filters contain so much mathematical complexity? Because the authors are trying to show how clever they are? This book is written for a purpose—to cut through the guff and show readers how to design effective and working electronic filters. The book has kept math to a minimum; is a practical design guide, and was written by an experienced practicing designer.

The book's contents include: Filter applications; Frequency response characteristics; Poles, zeros and modern network theory; Lowpass filters; Highpass filters; Bandpass filters; Bandstop filters; Diplexer filters; Phase shift networks (all-pass filters); Selecting components for filters; Analog filter design software; Transmission lines as filters; Filters for phase locked loops; Filter integrated circuits; Introduction to digital filters using DSP; and the Index.

Newnes, 313 Washington Street, Newton, MA 02158-1626

Safest And Most Effective Restoration!



Easily Test And Restore CRTs With The Most Complete Tests Available For Added Profit And Security!

The Safest And Most Effective Restoration Techniques Available

- The multiple levels of restoration guarantee the safest possible restoration
- Six levels of "Progressive Restoration"
- Self-limiting shorts removal function
- Three times the restoration range of other testers

We'll prove it!

Compare the new CR7000 to your current CRT tester.

Call 1-800-SENCORE

for a free 10 day trial.

SENCORE

3200 Sencore Drive, Sioux Falls, SD 57107

Direct: (605)339-0100 Fax: (605)339-0317

Circle (77) on Reply Card

Servicing EEPROM problems in RCA televisions

By Bob Rose

EEPROMs (electrically erasable programmable read only memories) have been around for several years. If you are like me you paid them no attention, because until the advent of the CTC 175-177 family of television sets, EEPROMs caused very few problems. I remember one CTC 169 chassis that had a host of really odd problems. The cause was an unstable 5V supply to the EEPROM. I remember a Zenith TV that used a 9-1130 module. It had raster but no picture and no sound. The problem was a lightning-damaged EEPROM.

Rose is an independent consumer electronics business owner and technician.

Thanks to RCA, "EEPROM" has become a widely discussed (and cursed) topic.

Typical EEPROM problems

What are some of the problems EEPROMs cause in the newer RCA televisions? Remember that there are *no* mechanical adjustments in these sets. Literally *every* function is controlled by the EEPROM. When this tiny chip does not function, the set will not function.

No start-up

Obviously, several things can cause a no-start condition. I have found that excluding power supply problems, the EEPROM causes most no-start conditions. I

suggest the following procedure for isolating this problem. First, check pin 8 of the EEPROM for a good, clean, 5V. If the 5V is there, use an oscilloscope to check pins 5 and 6 for any logic activity. If you find activity (assuming that you have not touched any of the controls and that the set has been plugged in for several minutes) chances are good that you have a defective EEPROM.

Remember that when the set is first plugged in, the system control processor attempts to shake hands with the EEPROM and the tuner control IC. When the processor gets acknowledgment, clock and data activity cease. If the processor does not receive its handshake from the

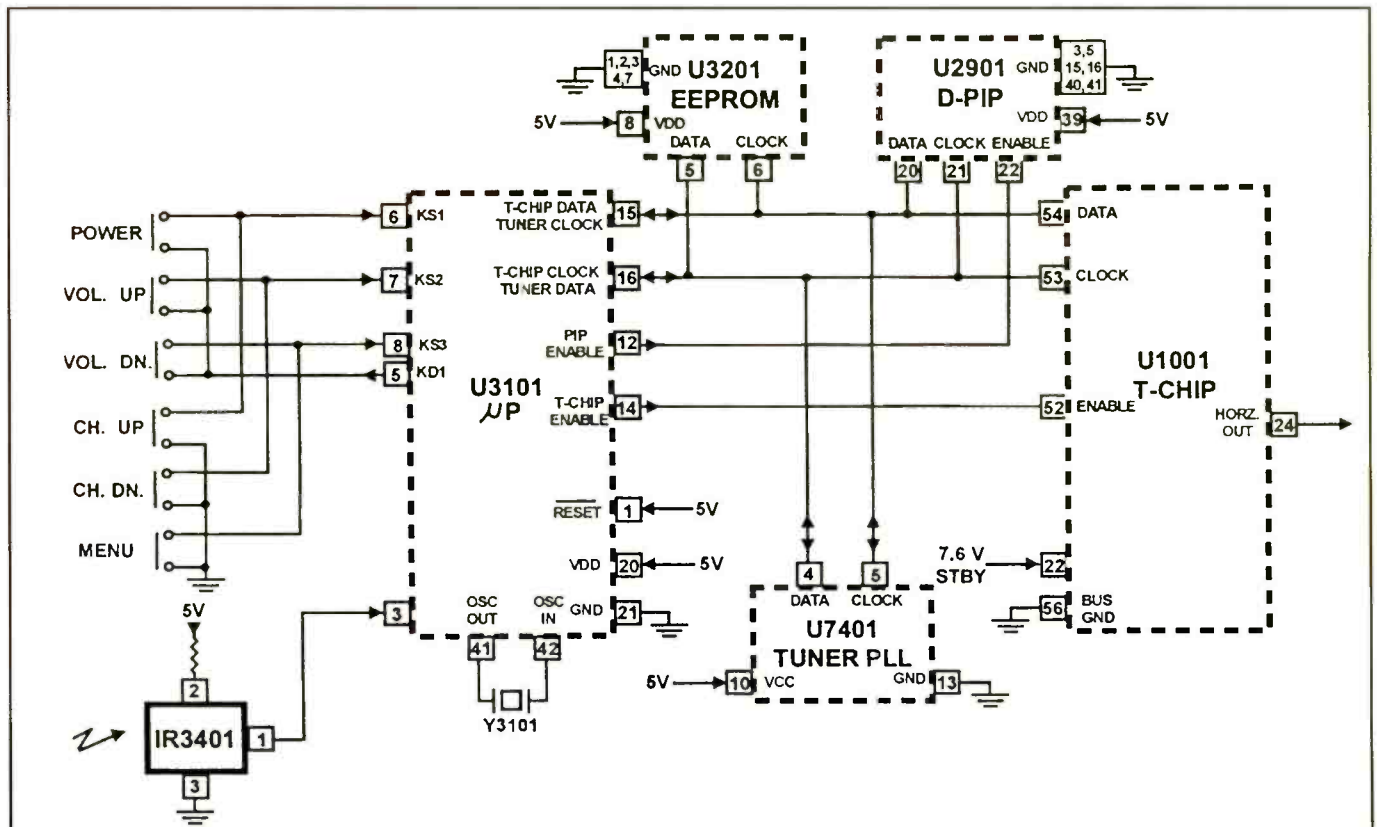

Figure 1. Every function is controlled by the EEPROM.

Accurately Test All CRTs!



CR7000 "BEAM-RITE"
CRT Analyzer & Restorer

**Test All CRTs, Including:
Computer Monitors, Video
Displays, Televisions,
Projection TVs, Scopes, and
special application CRTs—**

- The CR7000 now has full dynamic range to test older CRTs and the new ones
- The most accurate and thorough tests of any tester
- Full bias ranges with a sliding "good/bad" scale
- Exclusive "Lo Level" and "High Level" emission tracking
- Detects all gun element shorts or leakage

We'll prove it!

**Compare the new CR7000
to your current CRT tester.
Call 1-800-SENCORE
for a free 10 day trial.**

SENCORE

3230 Sencore Drive, Sioux Falls, SD 57107
Direct: (605)339-0100 Fax: (605)339-0317

Circle (78) on Reply Card

Service Adjustment Parameters

Parameter Number	Parameter	Value Range	Suggested Value
01	Horiz. Frequency	00-31	Approx. 11
02	Horiz. Phase	00-15	Approx. 11
03	EW DC (pincushion)	00-15	Approx. 07
04	EW Amplitude	00-07	Approx. 03
05	Vert. DC (centering)	00-15	Approx. 08
06	Vertical Size	00-31	Approx. 24
07	Red Bias	00-127	Begin at 23
08	Green Bias	00-127	Begin at 20
09	Blue Bias	00-127	Begin at 27
10	Red Drive	00-63	Begin at 36
11	Green Drive	00-63	Begin at 32
12	Blue Drive	00-63	Begin at 27

Table 1. The EEPROM contains data that controls the adjustment of 12 service parameters. The third column lists the range of values for each parameter. I arrived at the suggested values in the fourth column by observing the actual value of each of the parameters on a number of sets that were operating properly and taking an average of those observed values.

EEPROM, clock and data activity continue. Of course if you find activity on pins 5 and 6 after the set has been plugged in for a while, the problem could be elsewhere, but that really is not likely. To save time, and time is precious for a tech, simply replace the EEPROM (Figure 1).

No audio

The EEPROM-related problem that I encounter more than any other is in the audio. A customer will bring one of these sets in and complain either of no audio, or very little audio, even when the volume is set at its highest level. When you encounter this weak audio problem, check pin 29 of the microprocessor for an active high. If the logic level at the pin is high, wick it out. If audio returns, the problem is with the EEPROM.

The reason for this problem is that the EEPROM contains data that mutes the speaker to prevent an audible pop at turn-on and turn-off. A ground fault created by

a poor tuner wrap connection corrupts this data and causes the EEPROM to send "audio mute" information to the microprocessor at all times.

Some techs solve the problem by first repairing the tuner wrap (never replace an EEPROM without first repairing the tuner wrap) and then removing resistor R1915 in the audio mute circuit. When you perform this procedure the audio returns to normal and you don't have to replace and reprogram the EEPROM.

RCA will quickly tell you that this is not an "approved" servicing procedure. They will tell you to use another procedure to restore audio without replacing the chip EEPROM:

1. disconnect ac from the chassis,
2. unsolder pin 8 of the EEPROM,
3. use a pick to short pin 8 to the pad, temporarily restoring B+,
4. plug the set in and turn it on,
5. remove the pick, and therefore the short circuit,

Chassis Alignment Parameters

Parameter Number	Parameter	Value Range	Suggested Value
14	PLL Tuning	00-63	31
15	4.5 MHz Trap	00-07	04
16	Video Level	00-07	03 to 05
17	FM Level	00-15	07
18	B+ Trim	00-15	07
19	RF AGC Ch.6	00-31	Begin at 00
20	RF AGC Band 1	00-31	Begin at 00
21	RF AGC Band 2	00-31	Begin at 00
22	RF AGC Band 3	00-31	Begin at 00
23	D-PIP Chroma		
24	D-PIP Tint		
25	D-PIP Bright		
26	D-PIP Contrast		
27	Factory Tint	00-63	

Table 2. This is a list of the "chassis alignment" parameters for these sets. Again, the fourth column lists an average of the values I observed on working sets.



WIN A FREE

DeoxIT Maintenance Kit

Visit our Web Site at:
<http://www.caig.com>

See DeoxIT on Page 26

6. use the menu function to select speaker on-off,
7. turn the speaker back on, and,
8. unplug the set and resolder the pin.

Either of these procedures solves the problem, and the technician is spared the need to replace the EEPROM.

No vertical deflection

Another frequently-encountered problem that may be caused by an EEPROM-related fault is absence of vertical deflection. The customer brings a set into your shop complaining that the only picture he can get is a line across the middle of the screen. You confirm the problem and proceed to fix it. But you really don't find anything wrong, except that there's no vertical drive out of the T-Chip. All voltages are correct, but you have no vertical drive out of the T-Chip.

Before you change the T-Chip, do yourself a favor and change the EEPROM. It's a lot easier to change an 8-pin chip than a 64-pin one. Chances are that the EEPROM is at fault anyway.

If you look at parameter 06 (refer to Table 1), you will see that vertical size is set by that value. A ground fault, for example, can reset that parameter to 0. The result is absence of vertical deflection. I have on some occasions accessed service parameter 06 by entering the service mode, carefully counting the value range to 76, counting the parameter change to 06, toggling the value up and down, and restored vertical deflection. It's worth a try.

No video

The last problem to be considered here is absence of video. You are confronted with a dim raster and no hint of video. You check voltages and waveforms and find nothing wrong, except you don't have even the hint of a picture. Before you troubleshoot the tuner or replace the T-chip, try replacing the EEPROM.

Programming the EEPROM

Let's assume that you have replaced that pesky little IC. What do you do next?

Electronic Tuner Alignment Parameters			
Parameter Number	Parameter	Value Range	Suggested Value
100	Ch. 2 Secondary	00-63	32
101	Primary	00-63	27
102	Single	00-63	17
103	Ch. 6 Secondary	00-63	63
104	Primary	00-63	53
105	Single	00-63	40
106	Ch. 14 Secondary	00-63	63
107	Primary	00-63	62
108	Single	00-63	63
109	Ch. 17 Secondary	00-63	48
110	Primary	00-63	62
111	Single	00-63	62
112	Ch. 18 Secondary	00-63	47
113	Primary	00-63	44
114	Single	00-63	45
115	Ch. 13 Secondary	00-63	63
116	Primary	00-63	44
117	Single	00-63	56
118	Ch. 34 Secondary	00-63	63
119	Primary	00-63	44
120	Single	00-63	57
121	Ch. 37 Secondary	00-63	63
122	Primary	00-63	44
123	Single	00-63	55
124	Ch. 48 Secondary	00-63	51
125	Primary	00-63	51
126	Single	00-63	37
127	Ch. 50 Secondary	00-63	43
128	Primary	00-63	38
129	Single	00-63	23
130	Ch. 51 Secondary	00-63	30
131	Primary	00-63	33
132	Single	00-63	44
133	Ch. 57 Secondary	00-63	28
134	Primary	00-63	30
135	Single	00-63	38
136	Ch. 63 Secondary	00-63	26
137	Primary	00-63	26
138	Single	00-63	34
139	Ch. 76 Secondary	00-63	28
140	Primary	00-63	24
141	Single	00-63	32
142	Ch. 83 Secondary	00-63	29
143	Primary	00-63	26
144	Single	00-63	34
145	Ch. 93 Secondary	00-63	31
146	Primary	00-63	28
147	Single	00-63	35
148	Ch. 110 Secondary	00-63	29
149	Primary	00-63	27
150	Single	00-63	34
151	Ch. 117 Secondary	00-63	29
152	Primary	00-63	27
153	Single	00-63	34
154	Ch. 125 Secondary	00-63	24
155	Primary	00-63	25
156	Single	00-63	32

Table 3. This is a list of the electronic tuner alignment parameters for these sets. As in Tables 1 and 2, the fourth column lists an average of the values I observed on working sets.

You are faced with the necessity of programming it, and that's what makes the service procedure difficult and somewhat time consuming.

Accessing the service mode

After installing the new chip, you first

have to put the TV into the service mode. To do this, depress and hold down the menu button and press the power-on and volume-up controls in that order. The TV then enters the service mode.

There are three levels of adjustment. Each level has its own pass number. De-

press the volume-up button on the set or the remote control until the number on the right side of the screen reads "V 76." Use the channel-select buttons on the TV or on the remote control to access the parameter you want to adjust.

For example, the first adjustment will be horizontal frequency. The new EE-PROM has all values set to mid-range. The TV will come on, but the horizontal will not be at the correct frequency. Use channel-up to select "P01." Be very careful while making this adjustment. If you run the value too high or too low, the horizontal frequency will be so far off that the set will shut down.

Use the channel-down function to step the parameter down *one step at a time* until the picture drifts slightly from side to side (the sync is killed when you select P 01). When you exit this parameter the picture will be stable and you can proceed with the rest of the alignment. I have found that setting this value to approximately 11 works best.

Once you have stepped through the twelve parameters, the value number on the right side of the screen resets to 0. Use the volume-up function to set this number to 77. On reaching 77, the parameter on the left side of the screen becomes 14. Parameters 14 through 27 are called "Chassis Alignment Parameters."

When you complete these alignments, V resets to 00. Use the volume-up function to set the number to 78. The "P" number becomes 100, and you have entered the tuner alignment level. At this level, you must step through and align parameters 100 through 156 in order to get the tuner to function as it should.

Service adjustment parameters

After you have set the horizontal frequency, you can proceed with the rest of these alignments. How do you do that? Well, RCA goes through a lengthy alignment procedure in its technical training manual on these sets. Of course their procedure works, but there is a quicker way. Some of these adjustments are common-sense adjustments. You should have no problem with any of them. I accessed several working TVs, extracted the parameter values I found, and averaged them. I use these values to program the EE-PROMs I install, and I find that in almost all instances they work perfectly. These values are recorded in Tables 1 through 3. If they don't work for you as they are,

they will at least give you an excellent place to begin. You may want to do as I have done and compile your own list.

Chassis alignment procedures

The second level is what RCA calls "chassis alignment." If you consult their training manual you will find an exact alignment procedure, but I find that if I use my values (Table 2) I achieve substantially the same results. At least I have an excellent place to begin.

Electronic tuner alignment parameters

Tuner alignment is the most tedious procedure. You are supposed to monitor the rf agc voltage at pin 12 of the T-Chip as you adjust each parameter for minimum agc voltage while you attenuate the applied test signal appropriately. RCA manufactures a signal generator (TAG-001) that works quite well.

The TAG001 is a handy piece of equipment to use. It has a built-in step attenuator, and it is controlled by the same remote that controls the television. You use the remote to change channels on the set while it is in the service mode. The channels on the TAG001 simultaneously change. One remote controls both instruments.

It is very handy, but also costs about \$130.00. In reality, you can use any generator that has a minimum 100-channel capability and has a signal attenuator. For example, a series of articles in *Sencore News* describes how to use that company's equipment to align these tuners.

Perhaps I need to underscore the fact that you *must not* attempt the alignment procedure by using an off-the-air signal. It simply cannot be done.

But there is an easier way. After doing it RCA's way on more than one occasion, I decided to try it my way. "My way" consists of using the values in Table 3. I have found that using these values almost always puts the tuner in good alignment. It certainly saves time. I have found that I can complete the job in less than 30 minutes (if I take the time to drink a cup of coffee). It need not be the daunting job it may appear to be at first sight.

Suggested literature

If you want to do additional research, I suggest two publications by RCA: CTC 175/176/177 Technical Training Manual and CTC 177/178 Troubleshooting Guide. Several articles in *Sencore News* were also useful. ■

Easily Test And Restore CRTs!



CR7000 "BEAM-RITE"
CRT Analyzer & Restorer

Easily Test And
Restore CRTs With The
Most Complete Tests
Available For Added
Profit And Security!

The Easiest To Use CRT Tester On The Market - Guaranteed

- Simply connect one of the six supplied adapters to test virtually all new CRTs without adjusting setup switches
- All three guns of color CRTs are tested, and results displayed, simultaneously
- All gun tests are displayed with interpretation-free "Good/Bad" results

We'll prove it!

Compare the new CR7000
to your current CRT tester.
Call 1-800-SENCORE
for a free 10 day trial.

SENCORE

3200 Sencore Drive, Sioux Falls, SD 57107
Direct: (605)339-0100 Fax: (605)339-0317

Circle (79) on Reply Card

The ten criteria for selecting an electronics aerosol cleaner

By Mike Sauer

Most product service involves the use of chemicals. In consumer electronics service for example, a typical procedure might include lubricating moving parts and controls, cooling one or more components with coolant spray, and cleaning potentiometers and circuit boards.

Before it was recognized that certain classes of chemicals, most notably CFCs, had a serious adverse effect on the environment, there was an array of chemicals for these purposes. These chemicals could be used for cleaning just about any electronics component or circuit board without any fear of them causing damage. They were chemically inert, had favorable toxicity, caused no damage to plastics, cleaned well and left no residue. Unfortunately, they were found to cause deterioration of the ozone layer, or to otherwise adversely affect the environment, and were banned. Since then, chemical manufacturers have conducted research to develop chemicals that would replace those that are no longer available.

Aerosol cleaners for service

Typically, aerosol cleaners are the products of choice for doing manual, low volume electronics rework and repair. Technicians usually prefer aerosols which are effective cleaners, fast drying, and safe on plastics and elastomers. Because of this, aerosol solvents are usually the cleaners of choice. Aqueous and semiaqueous formulas typically don't have desirable attributes in aerosol form, if they can be made into an aerosol at all. Most are slow drying and may not flush under components or into tight tolerance areas effectively.

So how do you select an aerosol cleaner? It's easy. There are ten basic selection criteria you should review before you select an aerosol cleaner for your elec-



tronics application. Not all of them may apply to you, but they should all be important considerations.

Flammability

Does it matter whether you use a flammable product? If flammability is not a concern, several aerosol cleaning solvents are available that have excellent performance as flux removers and cleaner/degreasers. Products based on hydrocarbons and other chemistries are among those available on the market. If flammability is a concern, consider new hydrofluoroether (HFE) based cleaners. HFEs

from 3M company were introduced at the beginning of February of this year. When blended, HFE based products can have excellent solvency.

Material compatibility

Determine if the boards in the products you service are populated with sensitive components. Most are. If you have water sensitive components, or components with plastic content, as most boards do, solvents are your best choice. Banned products like CFC-113 had excellent compatibility. Now, certain hydrocarbon-based solvents and new HFE-based

Sauer is Senior Product Manager for aerosols and liquids with Chemtronics.

cleaners are among your best choices for plastic compatibility and safe cleaning of water-sensitive components.

Fast drying

In addition to being plastic safe and nonflammable, banned CFC-113 based aerosol cleaners were fast drying. Most rework and repair cleaning must be fast. To have to wait on a cleaner to dry is unacceptable. Certain hydrocarbon-based solvents and new HFE-based cleaners are very fast drying.

Deep cleaning ability

Look for cleaners that demonstrate good wetting properties. This means that the solvent will be able to flow under surface mount components and into other tight tolerance areas to flush out flux residue and other soils. Left uncleaned, residues can result in board or component damage. Most solvent-based cleaners including the new HFE-based cleaners have excellent wetting and low surface tension properties to flush tight tolerance areas clean.

Water-based and certain semi-aqueous cleaners are less able to flush tight toler-

ance areas clean. They typically have high surface tensions and fair to poor wetting ability. Solvents are typically the best choice for deep penetrating cleaning.

Odor

Aerosol cleaners for electronics applications might have practically no odor, or they might be pungent. Determine what you find acceptable by trying different products. A lot will depend on your ventilation. Alcohol and hydrocarbon-based cleaners tend to have a stronger ethereal odor, while new HFE-based solvents have practically no odor at all.

Cleaning effectiveness

Determining the best cleaner for your application can be tedious. If you are removing flux and ionic contamination, hydrocarbon based cleaners and aerosol/brush systems may be the best choice. Try several products to determine their cleaning effectiveness, and if they leave a white residue. Cleaning effectiveness will depend on the type of flux used, and how encrusted it is. A brush clean aerosol or aerosol with acid brush can clean even the most encrusted flux.

Toxicity

Aerosol cleaners have a wide range of toxicity levels, depending on the chemical contents and the blend. It is important to evaluate the MSDS before you evaluate the product. The MSDS should provide enough information on toxicity and other attributes to allow you to make an informed decision about whether or not to try the product. For example, some firms have restrictions on the allowable exposure limits for a cleaner. If this is an important selection criterion, determine a level that you will not go below and evaluate your current and new cleaning products against that.

Regulatory issues

CFC (chlorofluorocarbon) aerosol cleaners have already been regulated out of use in the U.S. So, before you decide on a new aerosol cleaner, determine if there is any potential of it being phased out. For example, if you were evaluating a CFC-based product back in 1995, you might have discovered that CFC production would be phased out effective January 1996. There is no reason to specify a product that is regulated, scheduled

Only Micro Care Brings Control Back to the Benchtop.

NEW! FEATURING OS-120



New! VeriClean and the Trigger Grip™, affordable process control.

Whether you're manufacturing sophisticated aerospace components or repairing basic circuit boards, you need a cleaner that gives you process control. And with increasingly tough environmental regulations, you need a cleaning fluid that's here to stay.

Get long term process control with new VeriClean™. This remarkable new cleaner gently lifts away rosin and "no clean" fluxes, light oils, many adhesives and even cured solventless silicone conformal coatings. Made from new VOC exempt OS-Fluids, it's a great choice in California or anyplace with tight air quality rules. Lastly - and unlike some "new" chemistries being pushed in the market today - it's completely ozone safe and affordable!

Find out how VeriClean can give you the long-term process control you need. Call Micro Care today.

www.microcare.com or email at info@microcare.com



Old style cleaning, a process out-of-control.



Control Is Everything

MICRO CARE CORPORATION 1-800-638-0125 34 RONZO ROAD BRISTOL, CT 06010-7792 USA • 860-585-7912 • FAX 860-585-7378

IMPROVE CONNECTOR PERFORMANCE & RELIABILITY

DeoxIT™

- Improves Conductivity
- Reduces Noise & Intermittents
- Deoxidizes, Cleans & Protects
- Improves Signal Quality
- Reduces RFI, Wear & Abrasion

"Corrosion problems on very sensitive connectors have been an annoying problem for us. We have tried many products without success until we tried CAIG's DeoxIT & ProGold. DeoxIT & ProGold are the only products that have worked perfectly. We highly recommend them." **XEROX CORP.**

"People call us daily asking for recommendations of potentiometer cleaners and lubricants. Most everyone has tried something lesser than CAIG and upon using what we authorize the results are always positive, sometimes bordering on miraculous. We here at RANE Corporation use CAIG products exclusively on all our service units. We endorse and recommend using only CAIG products in our production units." **RANE CORP.**



16744 West Bernardo Dr., San Diego, CA 92127-1904
 TEL: 619 / 451-1799 FAX: 619 / 451-2799
 E-Mail: caig123@aol.com URL: <http://www.caig.com>

1-800-CAIG-123



Circle (63) on Reply Card

Test Your Electronics Knowledge

(Answers to the quiz -from page57)

1. The equation you searched your mind for is:
 $L_T = L_1 + L_2 + 2L = 4L_1$
 That makes $L_T = L_T + L_1 + 2L = 4L_1$. So, the total inductance is 4 times the inductance of either inductor. (I had to search the books for this one.)
2. No increase. Power with no modulation equals power with 100% modulation.
3. $P = I^2R$ (solve for I) The allowable current is 50 mA.
4. power factor. A power factor of 1.0 is ideal.
5. $I^2 = P/R$ (solve for I) $I = 5$ amperes
6. There is an impedance mismatch between the transmission line and load (output) impedance.
7. Not correct. It is the even harmonics that are suppressed - assuming the circuit is properly balanced.
8. Copper loss, hysteresis loss, and eddy current loss.
9. Not correct. The output frequency is twice the input frequency.
10. Correct. Electrostatic coupling is also called capacitive coupling. The Faraday shield eliminates capacitive coupling between the primary and secondary windings.

for phase out, or has a strong potential for being phased out. Select an aerosol cleaner that you can use for the long term. One of the newest solvents on the market, HFE-based cleaners have all of the performance of the old CFC-113 based products, and are not regulated. These chemicals are a good choice for long term use.

Availability in aerosol and liquid

Evaluate whether you need a cleaner for both aerosol and liquid applications. For most rework and repair applications, cleaning is very manual. Aerosol cleaners are ideally suited for this environment. However, certain applications in the rework area, and throughout the facility, may require liquid solvents for ultrasonic or vapor degreaser cleaning. Standardizing to one cleaner for liquid and aerosol applications is advantageous for several reasons. Technicians who need a cleaner don't have to guess which one to use: they are all the same MSDS, and technical information becomes standardized across both aerosol and liquid products. Finally, technicians have the opportunity to become comfortable and adept at knowing and using one solvent for all of their different applications, as opposed to guessing each time they have to use an aerosol, spray system, or vapor degreaser.

Overall value

To determine the overall value of the aerosols you use or are evaluating, determine which of these criteria are important to you. You should select at most three criteria. Rigorously evaluate your current aerosol cleaners against these criteria to allow you to determine whether these products are the best choice for your applications. You may find that you have made trade-offs on features such as plastic compatibility because there were no other cleaners available.

Now there are new HFE-based aerosol products that offer an combination of features that most electronics facilities want in a cleaner. These new products are plastic safe, nonflammable, and fast drying. However, not all HFE-based aerosols clean effectively. A few questions of your distributor, or chemicals manufacturer, should help you select the right HFE-based cleaner for your applications. And remember, HFEs are not regulated and will be around for years to come. ■

ES&T Calendar

Internationale Funkausstellung/
USA Pavillion
August 30-September 7, 1997
Berlin, Germany
540-372-1414

PSC 97 (Pers. Communications
Industry Association)
September 10-12, 1997
Dallas, TX
703-739-0300

CTIA Breakaway '97
September 18-20, 1997
San Diego, CA
702-268-1818 ext. 310

CES Mexico
October 8-10, 1997
Mexico City Mexico
Sponsored by EIA/CEMA
703-907-7620

ASEA (AZ) Annual State Convention
October 10-12, 1997
Casa Grande, AZ
602-937-3241
e-mail: Lunnct@aol.com

NASM 42nd Educational Congress
October 12-16, 1997
Dallas, TX
847-310-9930

Personal Computer & Electronics Expo
October 16-19, 1997
Uniondale, LI, NY
800-886-8000

Networks Expo Dallas/Windows World
October 29-31, 1997
Dallas, TX
201-346-1400, ext. 145

TeleCon XVII (ABC/Applied Business
teleCommunications)
November 5-7, 1997
510-606-5150

'98 International Consumer Electronics
Show
January 8-11, 1998
Las Vegas, NV
703-907-7600

Home Automation Show & Conference
February 25-27, 1998
Orlando, FL
203-840-5482

NESDA 48th/ISCET 28th/NIAS 6th
Annual
August 10-15, 1998
Kissimmee, FL
817-921-9061

PCS 98
September 23-25, 1998
Orlando, FL
703-739-0300

Personal Computer & Electronics Expo
October 15-18, 1998
Uniondale, NY
800-886-8000
516-889-6000

PCS 99
September 22-24, 1999
New Orleans, LA
703-739-0300

Your Nationwide Source for OEM Replacement Parts & Accessories!

4 Locations

NPSC 97
Vegas
Booth 309



FOX INTERNATIONAL LTD., INC.
23600 AURORA ROAD • BEDFORD HEIGHTS, OHIO 44146

Call for
your FREE
FOX Catalog!

Exclusive

Emerson
DISTRIBUTOR

SONY

Matsushita
Panasonic - Quasar - Technics

SANYO

RCA

ILLINOIS
(312) 254-4381
Manager
Mark Schueing

NEW YORK
(516) 694-1354
Manager
Janice Meindl

OHIO
(216) 439-8500
Corporate
Headquarters

TEXAS
(972) 231-1880
Manager
Larry Burns

TOSHIBA

SAMSUNG
ELECTRONICS

FISHER



NAP - North American Philips
Magnavox - Philco - Philips - Sylvania

HITACHI

ORDER TOLL FREE
800-321-6993

CONTACT US ONLINE:
CompuServe: 102467,1777
America Online: FOXINTL@aol.com
Internet <http://www.fox-international.com>

24-HOUR FAX LINE
800-445-7991

Servicing home office products: Servicing laser printers

By Jeff Teets

Diversification is a word that is being spoken about more and more frequently in the service industry. Service centers that specialize in one particular product line are becoming an endangered species. One avenue of opportunity shrouded in mystery and misconception is the servicing of laser printers. Is there money to be made? Can I buy parts? Do I need to be an authorized service company? Is it difficult to repair a laser printer?

These are just a few of the questions I have been asked at trade shows and conventions. This three-part feature will cover the ins and outs, and the hows and whys of laser printer servicing. Don't wait for part three to be published before you ask questions. Write, fax, e-mail any questions you may have and we will share them with the readers of *Electronic Servicing and Technology*.

Introduction

As you read this article, you will notice that I continually talk about the "engine" of the laser printer, not the specific make and model of the printer. In most cases, you do not need to be concerned with who the manufacturer of the printer is. Instead, you need to know the identity of the manufacturer of the "engine" around which the laser printer is built.

The fact is that there are only a dozen or so companies that produce engines that are used in desktop laser printers. These engines are then sold to manufacturers such as Hewlett Packard, Apple, QMS, and more, who then place their own system board in the engine of the laser printer, and voila, there is a new laser printer.

As just one example, more than 246 different models of laser printers use the very popular Canon SX engine. So don't think that you need hundreds upon hundreds of different sources for parts. All that is needed is a simple cross-reference chart to tell

Jeff Teets is Vice President of Laser Wizard, a laser printer service company, and co-inventor of the LaserTest printer diagnostic device. Teets owns 27 patents.

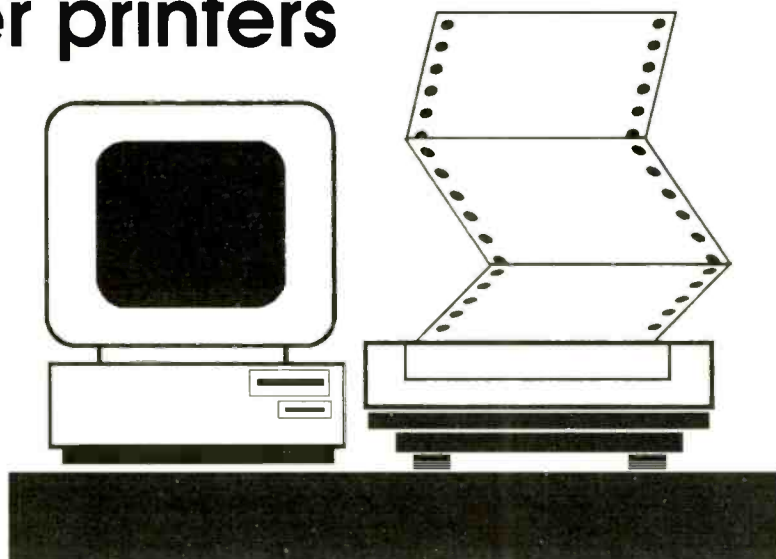

you what engine a laser printer uses. Ninety-five percent of the time when a service technician services a laser printer, it is the engine that is the problem. For this reason, you only need to be fluent in servicing a half dozen laser printer engines in order for you to be able to service hundreds of makes and models of laser printers.

The market

Even before you begin to consider adding laser printer service to your product line, you must ask yourself one question: "How great of a market is there?" The numbers may surprise you. In 1995, more than five million laser printers were sold in the United States alone. Of this five million printers, 64% are networkable. "What is the significance of this?" you may ask. Keep in mind that networkable laser printers are not disposable laser printers. Because prices of these printers start at \$1,200, users are more willing to spend several hundred dollars to have their printer repaired than those whose printers only cost them a few hundred dollars to buy. Also keep in mind that a laser printer that is used on a network is the Achilles' heel of a company. If that laser printer goes down it will take an entire department or even company with it. Let me ask you, how good is a computer that you can't print from?

In order for us to look into the future of laser printer service, we must look to the

past. Dot matrix printers were replaced by inkjet printers, and letter-quality daisy-wheel printers were replaced by laser printers. So, what is on the horizon that will replace laser printers. Nothing.

Printer manufacturers are not searching for new technology to replace the laser imaging system. Instead, they are working to improve print quality, print speed, and even to utilize this system to produce color prints for very low per-page cost.

In short, the laser printer imaging system is here to stay for some time. The future for this equipment is vast and, in turn, provides a great opportunity for the laser printer service technician.

Outdated equipment

We all know that the computer industry is changing by the second. It seems that we no more than finish setting up our newly purchased computer to discover it is obsolete. Does the laser printer industry advance with such alacrity? Yes; new models of laser printer are being introduced with greater regularity. Yet unlike older computer equipment, most older laser printers can still work with today's advanced software. This greatly reduces their obsolescence.

Quality

One other very interesting fact about the development of the laser printer is quality. In most cases, the construction of

older laser printers is clearly better than that of today's laser printers. This superior quality does not come without a price. Laser printers of yesterday were far more expensive than today's.

For example, Hewlett Packard's LaserJet Series II printer was an eight page per minute printer, had a resolution of 300DPI (dots per inch), 512kBytes of memory and was designed to be the workhorse of the industry. Introduced in 1987, this printer sold for \$2,500. Today, the new Hewlett Packard LaserJet 5 is the closest comparison. Equipped with 2M-Bytes of memory, 42 internal fonts, and capable of printing 12 pages per minute, this printer is far (logically) superior to the old HP II and sells for only \$1,400. Even though the new HP 5 laser printer has far more bells and whistles than the older HP II, this machine is not nearly as rugged as its predecessor.

This shift in quality has created a surge within the laser printer service industry. Both the older, more rugged, laser printers, and the newer, less durable, printers, need the skilled hands of the laser printer technician. Even though newer, more technically advanced printers are declining in price, it surprises me how many people are willing to spend the money to have their old faithful laser printer repaired. In some cases they feel that putting \$300 into servicing a laser printer that cost them \$2,500 is a bargain. Others are simply passionate about their laser printer. They don't like change, and feel that their printer has worked this long without needing service, and they reason that now that it is repaired it will last another three or four years.

The difference

OK, so you know that there are only a handful of companies that make the engines for laser printers. You know that there is a huge market for laser printer service, and that people depend greatly on this equipment. You also know that the laser imaging system is going to be around for quite some time. What you don't know is how difficult (or not) it might be to add servicing of these products to the line of products you service.

Let me be truthful. This article is written to inform, not to sell, so I won't sugarcoat it. In a laser printer, electronics, mechanics and a photoconductive process all must work together in perfect har-

mony in order for the laser printer user to produce crisp, clear print. A seemingly simple problem such as a paper jam may be caused by any one of these three areas.

If a technician has a full understanding of the operation of the laser printer's components, and possesses the ability to think a problem through, he should have very little problem servicing this equipment. Some have coined the phrase "Theory of Operation" to describe this method of troubleshooting. Next month in this mag-

azine we will describe the *theory of operation* method of troubleshooting.

Until the next installment in this series of articles on servicing laser printers, take a second look at that university, hospital or business center, and ask yourself how many laser printers might be in that building. To give you an idea, a drug company that Laser Wizard services has over two thousand laser printers in one location. I'll let you do the math on the implications of that one. ■

OVER 36,000 STOCKED!

MCM

ELECTRONICS®

Unsurpassed quality and service!



CAIG
LABORATORIES, INC.

CaiLube™ MCL
Moving Contact Lubricant

Designed for moving contact surfaces, this lubricant replenishes the lubrication lost on surfaces cleaned with solvents. Ideal for faders, switches, potentiometers or any mechanisms with sliding surfaces.

Price effective July 1 through August 8, 1997.



MCM Order #	Mfr. #/ Description	(ea.)
200-205	MCL5S-H6/ 10% solution 5 oz. spray	\$8.99
200-205	MCL100S-L2/ 100% solution 2 cz. spray	11.99
200-207	MCL5MS-H6/ 10% solution 15g mini spray	4.99
200-203	MCL100L-25C/ 100% solution 25 ml needle dispenser	14.99



TENMA®
Satellite Meter
\$119.00

Features polarization indicator, 900-2050MHz frequency range, 2KHz-20KHz audible tone, LNB current measurement to 500mA and LNB voltage measurement to 25VDC. Voltage output for LNB switchable 13V/18V. Includes rechargeable Ni-Cad battery and AC adaptor.
MCM Order #72-6281

Authorized Original Parts Distributor

PHILIPS / **MAGNAVOX** / **ECG**
Semiconductors

RCA / **GE** / **Panasonic**

1-800-543-4330
www.mcmelectronics.com

FREE CATALOG!



See Us At the NESDA Show in Las Vegas, Booth #301 and #303



MCM ELECTRONICS®
650 CONGRESS PARK DR.
CENTERVILLE, OH 45459
A PREMIER FARNELL Company

SOURCE CODE:
ES96

Circle (72) on Reply Card

Anti-frustration indexes

By Roger D. Redden

Electronic servicing is an occupation replete with frustrations. One of those frustrations is a futile search to find the information you require to proceed with the repair.

Typically, repair work begins by verifying the symptoms and doing a thorough visual check. If you complete these steps without finding the problem, and you are unfamiliar with the product, you need a schematic. It's true you might beat the odds and make the repair without one, but

you're likely to spend considerable time doing it. Unfortunately, it's also possible to spend considerable time trying to find a schematic you know you have.

If you have a complete set of manufacturer's literature for the product, the search should be short. Likewise, if the Sams index shows the product and you have a complete set of Photofacts, the search is quickly over.

Both of these circumstances assume that the schematic you want is stored in its proper place, not left with another product being worked on. But if your service center has an eclectic assortment of

service literature, acquired by buying a schematic when one was needed, then an unsuccessful search may leave you wondering, "Is this one I don't have, or do I have it and have I simply overlooked it?"

Is it on the list?

The obvious solution is to keep a list of the literature you own next to your indexes. This eliminates getting out of your chair if you don't have the schematic diagram; which may appeal to you the way it does to me. But more importantly, you don't waste time on unnecessary search-

Redden is owner and operator of a consumer electronics service center.

M=Manufacturer; P=Profax; S=Sams Photofact
IC lists often incomplete due to lack of space.

Brand	Chassis/model	Data ID
EMERSON		
EME	ECR2100 (Vert. mounted chassis at left of CRT)	S 2647
EME	TC4253 ICS:M50442,LA7911,AN5156, AN5512, 78012,AN5265	S 2713
HITACHI		
HIT	3267E VCR	P 3087
HIT	35UX70, 80 (CZ57, CZ58) C. TV	P 3146
MAGNAVOX		
MAG	25C6 TUN. BDS: TS9,TS10 ICS:473-1,471-1,472-1,412-2, 477-2,444-1,476-1.PS2021,126-1,449-1	S 2457
MAG	25,26,27P1 TUN:340313 ICS:TDA4504,TBA120,TEA5582, TDA1013.TMP47C634,X2444, 612479.6N136,MC34065, CNX35,LA7831,TDA3569	S 2741
RCA		
RCA	CTC51-CTC115 FIELD SERVICE GUIDES	M
ZENITH		
ZEN	B1908,20,26,92,96, MODS:9-155, 9-291 (MAIN, 9-181 SIM.), 9-351(SWEEP). TUN:175-2253, 175-2265, 176-809A	S 2532
ZEN	B3932,36,52 See B1908 above	S 2532

List 1. These excerpts from my service literature index illustrate some helpful information that can be added to such an index.

SERVICING, TIPS, IDEAS to improve servicing, three pages of them. FEB 92 P42
 SERVICING, TRANSFORMERS, see TRANSFORMERS.
 SERVO SYSTEMS, closed loop motor control, proper amount of feedback. AUG 94 P62
 SERVO SYSTEMS, control signals. MAR 94 P21
 SERVO SYSTEMS, general explanation of. FEB 94 P56
 SERVO SYSTEMS. Explanation using VCR system as general example. Block diagrams, how a Hall effect device works as a sensor, the comparator stage and amplifier stage. APR 94 P24
 SERVO SYSTEMS. see also VCRs, SERVOS.
 SIGNALS, DIGITAL PROCESSING for audio, A/D conversion, other uses. NOV 91 P57

List 2. A block of entries from my main index of **ES&T** magazine used to illustrate one use of such an index.

es, or risk squandering money on duplicate literature.

If you decide to make a list, don't waste time including schematics older than you're likely to use, but do make a note on your list that older schematics were omitted, just in case. It's surprising what you can forget if a year or so goes by before you see that old chassis you thought you'd never see again.

My first list was on lined paper with plenty of blank lines for flexibility to add new entries, and done in pencil so it was easy to delete unwanted items. If you noticed in the last sentence, the computer word "delete" replaced the perfectly good word "erase". Now you can probably guess where this list is headed.

A big step forward in making it easy to alter a list is putting the list on a computer, using a word processor or text editor. But once the list is on the computer, using the computer for routine checks of the list may or may not be best. If your computer is next to your bench and usually on, it may be quicker to use the computer to search the list. But I'm not set up that way, and for the fairly short list I have, I find I can usually scan a printout quicker than I can fire up the computer, load the list, and key in the proper search word. The downside of a printout is having to print an updated one periodically.

Should you index?

The list is useful and easy to make, but if your service literature is fairly limited, you may want to consider something that requires more time and effort to make.

"Fat chance," you say?

Well, don't be hasty. Suppose you had an index that saved you from looking in other indexes, and more important, saved you from buying another schematic. Would that be worth considering?

Rearrange the above list and fatten it up, and you have the index I'm proposing. It's most valuable for those who have relatively small, random collections of service literature, and pointless for those who have complete sets of Sams or manufacturer's literature. Also, it nearly demands to be done on a computer, as a handwritten index soon becomes overcrowded and unreadable as new information is added.

Further, you need to realize that you may spend up to ten minutes on each entry before it's completed. Multiply by ten the number of schematics you think you would include when estimating whether the benefits of the index are worth the effort. (This time estimate is based on each entry containing most of the added information detailed below. The entry time decreases as the amount of added information decreases.)

List 1 contains selected excerpts from my personal index. As you can see, unlike a list of the service literature you own, which would be in order by number or year, the index is in alphabetical order by brand, and model or chassis. Also, there is extra value because of the various notes. For example, the first Emerson entry reminds me that if I'm working on a set, including a non-Emerson brand, that has the chassis mounted vertically to the left of the CRT, this Emerson schematic might work with that chassis.

The second Emerson entry shows as many of the ICs in that chassis as I could fit on the line. If the set I'm working on contains all of those ICs, it may be similar regardless of the brand name.

The Magnavox entries also show the ICs, and the tuner control boards. Since different chassis sometimes use the same tuner control boards, you may be able to match the tuner control board of one schematic with the main board of another

schematic diagram. Result: one less schematic to buy.

The RCA entry reminds me of what's in the RCA field guides I have. The first Zenith entry shows the tuners and modules in the schematic, which again sometimes allows repairing a different model without buying a new schematic. The second Zenith entry has added listings of models that have very different letters or numbers, so you don't overlook them. Model numbers differing only in the last two digits are listed after the commas in each entry to save space on the index.

Similar sets

Anytime you find a set that is the same or very similar to what's covered by one of your schematics, you naturally want to add that brand, chassis, and schematic identification to your index. Or if you work on a Wards set that the FCC or UL codes (as discussed before in **ES&T**) indicate was made by Sharp, put "Sharp?" in your index next to the Wards model. When you work on a Sharp that looks familiar but you don't have a schematic, scan your index for a "Sharp?" and you just might find it. If you manage this often enough, saving the price of new literature each time, it will repay the time you spend on the index.

Anything you think will be useful can be added to your index, which is both the value and the challenge of it. I went to the trouble of typing up a Profax index and inserting entries from it in order by brand. Now this combined index is the only place I have to look to see if I have a schematic for a product. I try to update all of the entries every month or two to keep the index current.

A few tips

Making the index is pretty straightforward, but a few tips might help jump-start your thinking about it. You could get by

Cases, TV (symptoms/cures, tips)

RCA CTC175/177: VERTICAL, black band at top after warmup—tuner shield connection. NOV 96 P11
RCA CTC176: POWER supply (switching). Explanation of circuit operation and general troubleshooting tips. OCT 93 P19
RCA CTC177: VERTICAL low or intermittent—C4505, 220uf, bad. MAY 95 P22
RCA CTC186/187: SOUND drops out while in the SAP mode—replace C1609 with 47uf, 25V capacitor (193043, and add 100k SMD across C1609. (Resistor numbered R1628, pt. no. 192084.) Not needed after sets with serial number 429000000 and higher. MAY 95 P32

Cases, VCR

EMERSON VCR755: COLOR missing and head-switching LINE near center of screen, no signal on pin 17 of IC4001—IC4001, sync separator, bad. Quick test for headswitching given. JUN 90 P49
FISHER, VARIOUS: Many develop problems with drive idler or loading belt. Suggests that both be replaced when service done. MAY 89 P58
FISHER IDLER pulleys, easier method of replacing. APR 90 P51
FISHER IDLER wheel, removing when there is no cutout in metal chassis. Idler wear may be due to Hall effect (lessened with washer), no ball bearings, only one tire instead of two. NOV 89 P38

List 3. Two blocks of excerpts from the case histories indexes, TV and VCR respectively, that were extracted from the main ES&T index.

without it, but a word processor or text editor that can sort by lines is a real help. My word processor doesn't have this function, so I used the E editor in DOS ver. 6.1. I set tabs at 1, 9, and 68 for brand, chassis, and data ID to keep these columns straight. Of the brands I entered, there were no duplications among the first three letters, making that an adequate abbreviation for sorting. If there were duplications, you could add one more letter to one of the duplicates to make the sort work properly.

When first typing in the list, I kept all information for one entry on a single line for proper sorting, as shown in the second line of the Emerson example. After I completed typing all entries, I had the computer sort them. Then I went back and added the underlined brand heading and

additional lines of information where more space was required, such as the Zenith entries.

If you have a word processor or text editor that can sort paragraphs, then you don't need to worry about the one line limit when sorting. This will speed things up. If you're comfortable with setting up a simple database, that will be even more effective. I didn't have a database program when I first made this index.

Another index

This magazine, *Electronic Servicing & Technology*, contains an enormous amount of information when the accumulation of a number of years are considered. Let's say, conservatively, that each issue has 25 pages of useful or interesting articles. That's 25 x 12, or 300

pages a year. In 9 years that's the equivalent of a 2700 page book. Although the annual indexes the magazine prints each January are helpful, if you want to find some particular information within 2700 pages, it's not efficient to have 9 different indexes, with some of them categorizing items differently. One thorough index, arranged alphabetically by subjects, would be nice. I've compiled an index that I think at least approaches that.

My original intention was to make a simple alphabetical index using one or two words for each entry. But that proved inadequate, because I might want an article with details, and when I pulled the referenced article it was a general overview, or maybe the opposite. So I added information about length and level of detail where it seemed necessary. But then, even when I found a detailed article as desired, the details weren't always the ones I wanted. So, I enlarged many of the entries into abbreviated abstracts. Then I added cross-references to related subjects I might otherwise overlook.

The index grew. And grew. Like an alien creature in a science fiction movie, it began to suck up my life! Ok, that's an exaggeration, but it gobbled my spare time in big gulps.

The outcome of the loss of my spare time was a nine-year index, not perfect of course, but useful. List 2 shows an excerpt from my main index which will illustrate how an index makes it easier to benefit from the magazine.



Store Management Software

Designed Exclusively For
Electronics & Appliance Sales & Service Stores

STORE-TRAK, Release 3.22

An easy-to-use menu-driven system that organizes every aspect of your business more effectively, using state of the art programming technology.

Turnkey Hardware/Software Systems Available!
Financing Options!

Eliminates Paperwork & Filing ✦ Detailed Business Summaries ✦ Fully Networkable

1-800-603-9000 Ext. 99
123 N.W. 13th Street, Suite 213 Boca Raton, Florida 33432
<http://www.sbsdirect.com>



Circle (76) on Reply Card

Studying in depth

Let's say that you want to study a particular technical area in depth, say servo circuits. For a general overview of servo circuits, you would look under the category "SERVO SYSTEMS," as shown, and find five entries. The first four list the month, year, and page to find articles of a general nature about servos. The fifth entry refers you to "VCRs, SERVOs", where you would find a list of articles specifically about VCR servos.

If you read the articles listed in both sections of the index, all 15 of them, you will be nearly guaranteed to have a better understanding of servos. Of course, you will also have tired eyes.

Another use of the index is to determine if any articles in the magazines offer specific help on a piece of equipment you are working on. The main index lists symptoms and cures, or cases, for specific brands and chassis of different types of equipment. That's good enough where only a page or two of entries contain specific information about the product being worked on. But where the list is fairly long, as for TVs and VCRs, something else is needed. So, I extracted a separate index, arranged by brand, which lists specific symptoms and repairs. This index of about 23 pages often eliminates the need to read through articles while in the process of a repair. List 3 shows two short excerpts from this index.

If no specific answer is found in this auxiliary index, looking under the TVs, or VCRs categories in the main index may direct you to articles with useful circuit theory or troubleshooting methods, or one that will start your thoughts on the right path.

Currently my indexes cover the issues from 1/88 through 12/96. It does not index Book Reviews, Buyer's Guide, News, New Products, Photofact, or Literature. Nevertheless, it totals 100 pages of about 60 lines each. I didn't keep a record, but I'm confident I've spent more than 500 hours on it. Weighing that amount of time against the index's benefits, it's clearly not a cost-effective project.

The easy way

If you want the index of schematics you own, you obviously have to do it yourself. A nine year index of the editorial content of this magazine, on the other

hand, does not need to be unique to each person. My index may serve you as well as one you would make yourself. If you think so, I can supply a 1.2M or 1.44M IBM compatible disk containing files of my indexes of the magazine. The indexes are contained either in two larger files, one about 250k and one about 80k, or in 7 divided files under 64k each. The larger files are easier to use if your machine and software allow them. The files are ASCII text files and should load in most text editors or word processors that will import ASCII files. I could also supply either the 7 divided files or the 2 larger files, but not both, on a 360k disk.

Or, if you don't have a computer, I can send a dot-matrix printout, 50 pages printed on both sides, punched for 3-ring binder. This is a draft mode printout, which is legible but not great printing. It costs more because of the paper, extra shipping, and about an hour and a half of my time to print it.

For a copy of my index, please send a check or money order to Roger Redden, 4274 Grandview Rd, Beaver, WV 25813, and state the type of disc (360k, 1.2M, 1.44M) that you require, and for a 360k disc, which set of files (large or small) you need. The cost for the disk is \$10, including shipping. The cost for the dot-matrix printout is \$17. That's probably about two to three cents an hour for the time you would spend to make a comparable index.

Watch the day flow

Paying careful attention to where the minutes (sometimes hours) of your days go may reveal how you can invest a block of time once to prevent the daily loss of lots of little chunks of time, and the frustrations that produces. Either a list or an index of your schematics may be such an investment. Like any investment, the benefits must be weighed against the costs, whether measured in time or money.

As for ignoring my own advice about weighing the costs when making the magazine index, my excuse is initial ignorance, aggravated by a character flaw of obsessive stubbornness. But you, as the logical and reasonable person this was written for, have no character flaws, and will always apply advice to perfection, regardless of inconsistencies in the source. Don't you agree? ■

CMIM Monitor Test Equipment

Checker 12e



Now you can repair and test Computer monitors with ease. With sweep rates up to 64KHz., eight step gray scale, white screen, single color mode, Mac II, EGA, CGA support, you can run almost ANY PC monitor. And it is EASY to use. Color front panel displays show just what you should see. Don't let its' small size fool you. It is the most powerful handheld available, and it supports ALL basic VGA modes (some don't). It is suitable for bench or field operations. Battery or AC operation.

PRICE: \$295

Checker Jr.



Looking for a SMALL battery operated monitor test pattern generator that will fit in your pocket? The Checker Jr. is it. It displays a very useful 64 color pattern. You can evaluate size, focus, linearity, color tracking, and balance. It operates in the 640 x 480 mode (31.5KHz x 60Hz.), and is very easy to use. Use it anywhere.

PRICE: \$99.95

Checker VI



Need to check-out or burn-in multiple monitors? The Checker VI is the tool you need. It is a stand-alone (no computer required) 6 output test pattern generator. You can run 1 to 6 monitors from the small (1" x 5" x 6") Checker VI. It operates in the 640 x 480 mode, displaying an 8 x 8 8-color pattern which shifts every 3 minutes to reduce screen burn.

PRICE: \$249

Computer & Monitor Maintenance, Inc.

1-800-466-4411 • 770-662-5633
<http://www.computermonitor.com>



Circle (64) on Reply Card

Troubleshooting receiver circuits

By Tom Jones

At one time, electronics equipment could clearly be divided by function, such as audio, video, computer, and radio. Nowadays, you are likely to find circuits from all of these categories inside one box. The modern technician needs to be increasingly knowledgeable about RF circuits in order to repair new wireless systems such as alarms, remote repeaters, video and intercoms, and General Mobile Radio Service (UHF/FM band) transceivers used for personal and family use. A look at the general theory and troubleshooting techniques for a generic radio receiver will help troubleshooters who encounter any type of equipment using radio frequency (rf) technology. The repair techniques also apply to television, high speed computer circuits, home automation, citizens band, and cellular radio, etc.

Actually, if you have performed thorough testing on audio amplifiers or television you will find similarities to rf circuit testing. Tests such as frequency response, gain, distortion and spectrum analysis are all performed to check tuned circuits and rf stages.

We will consider the common types and uses of rf test equipment, circuits of a receiver, and the use of test equipment to verify operation as well as troubleshoot radio frequency circuits.

Rf test gear summary

The following is a listing, and explanation of the various types of test equipment that is typically used in troubleshooting an rf receiver.

- *Signal or frequency generator.* This unit provides a stable frequency used for signal injection. A "mini transmitter" capable of generating required modulation at a single frequency and also able to generate multiple or "sweep" frequencies very rapidly across a selected band.

- *Rf demodulator probe.* This probe connects to an oscilloscope or DVM and provides an indication of the rf voltage at the measuring point. Also called rf detector or rf probes, they are basically a diode

Figure 1. This is the block diagram of a typical rf receiver. →

and capacitor arrangement which rectifies the rf and charges a capacitor to the peak value of the rectified waveform. The dc charge on the capacitor allows frequency limited test equipment to detect a representative value of the rf signal. Choose a probe that has the required frequency response and a small turn on voltage to allow measurement of the relatively weak RF signals in receivers.

- *Frequency counter.* This is used to measure assorted frequencies in the receiver as well as to verify the output frequency of the frequency generator. Frequency counters with both 50Ω and high impedance inputs are desirable. A display hold feature which freezes the last readout also saves time during receiver servicing. When measuring sensitive circuits, an in-line 120K to 330K resistor may be necessary to decrease loading effects if the counter lacks a high impedance input.

- *Spectrum analyzer.* These can be purchased as complete units or a less expensive probe type unit may be used with an oscilloscope or computer system. Their purpose is to provide an on-screen representation, in the frequency domain, of the amplitude of rf present at a particular point in the circuit. Any mention of the rf probe in the remainder of this article is also applicable to the spectrum analyzer.

- *Rf millivoltmeter.* This voltmeter is capable of measuring small voltages in the rf region. Most DVMs are bandwidth limited to frequencies well below the radio frequency region.

- *Communications analyzer/monitor.* If you repair radios on a full time basis you undoubtedly already have one of these. The capabilities of all the previously mentioned equipment and more reside in these units. Suffice it to say, the analyzer can be used almost anywhere in the receiver to generate or check signals.

Receiver overview

In Figure 1, passing rf waves set up sympathetic oscillating currents in the

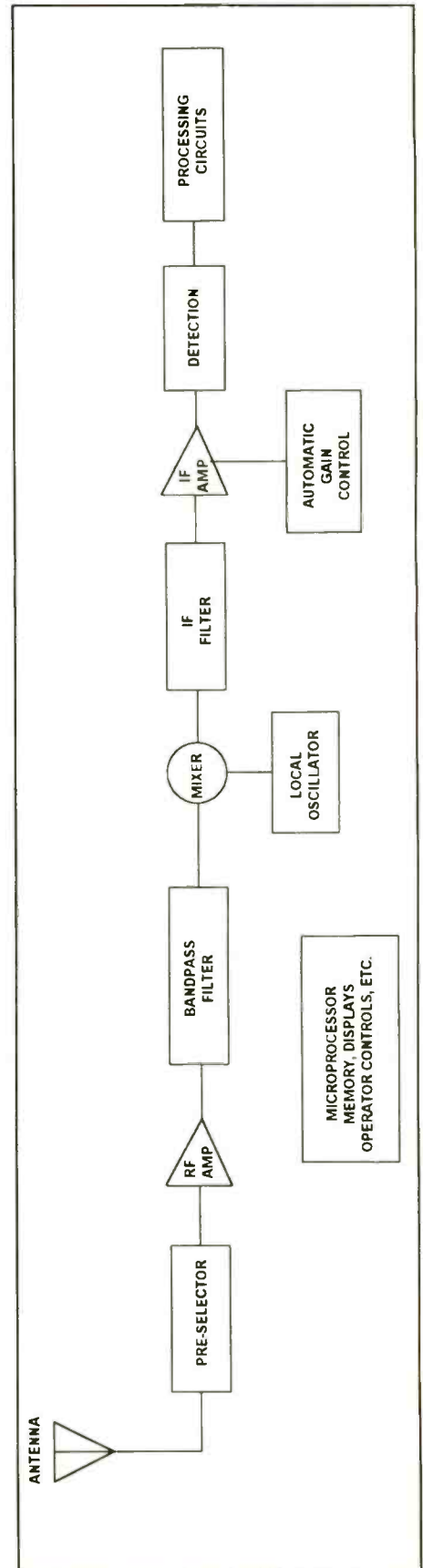

Jones is electronics applications engineer at Enercon Industries, Menomonee Falls, WI.

PROMPT
PUBLICATIONS

A Bell Atlantic Company
Howard W. Sams

Presenting books that have the answers you need.

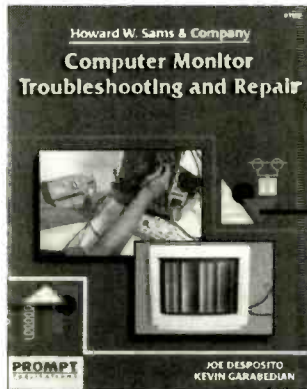

\$29.95

Computer Monitor Troubleshooting and Repair by Joe Desposito & Kevin Garabedian

With the ever increasing number of computers in homes, offices, and schools, the demand for computer repair information has exploded. Manufacturers' service data is nearly impossible to find, especially for computer monitors. *Computer Monitor Troubleshooting and Repair* is the only book of its kind on the market today, and covers safety procedures, tools and test equipment, monitor circuits, faults in the CRT, troubleshooting tips, and more.

Complete VCR Troubleshooting and Repair by Joe Desposito & Kevin Garabedian

This book contains sound troubleshooting procedures beginning with an examination of the external parts of the VCR, then narrowing the view to gears, springs, pulleys, belts, and other mechanical parts. It also shows how to troubleshoot audio and video circuits, special effect circuits, video heads, and power supply circuits. *Complete VCR* also contains nine VCR case studies, each focusing on a particular model of VCR with a specific problem.

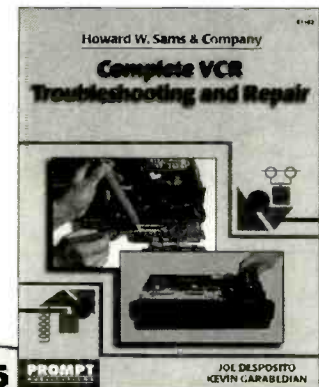

\$29.95

NPSC 97
Vegas
Booth 109

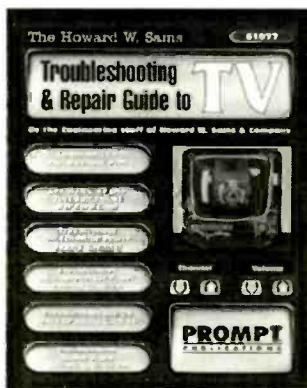

\$29.95

Troubleshooting & Repair Guide to TV by Howard W. Sams & Company

Sams' *Troubleshooting & Repair Guide to TV* is the most complete and up-to-date television book available. Included in its more than 300 pages is complete repair information for all makes of TVs, timesaving features that even the pros don't know, comprehensive basic electronics information, and extensive coverage of TV symptoms. This book is the first truly comprehensive television repair guide published in the 90s.

Call today for more
information and the name of
your local Sams distributor.

800-428-7267

Circle (119) on Reply Card

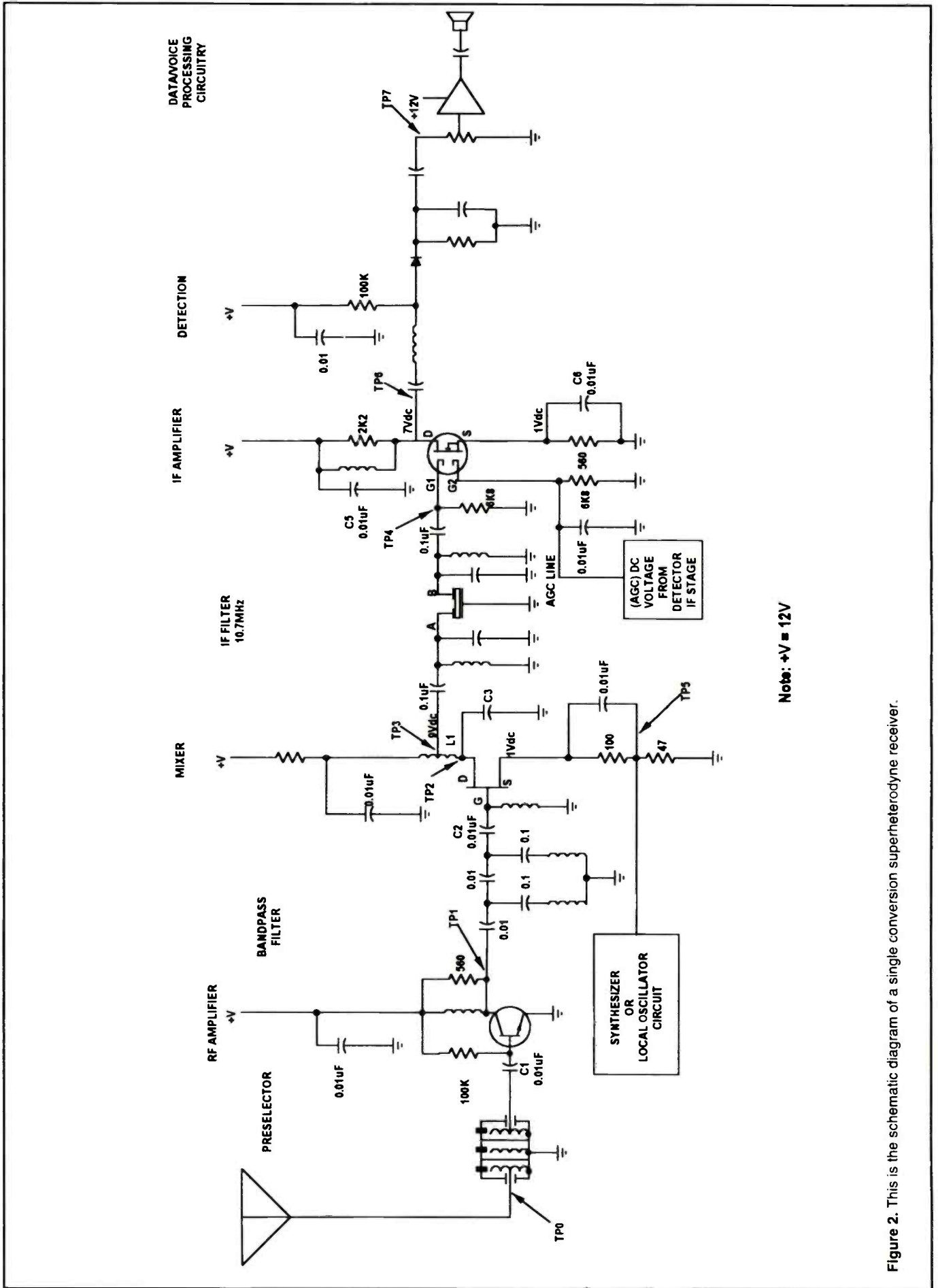

Figure 2. This is the schematic diagram of a single conversion superheterodyne receiver.

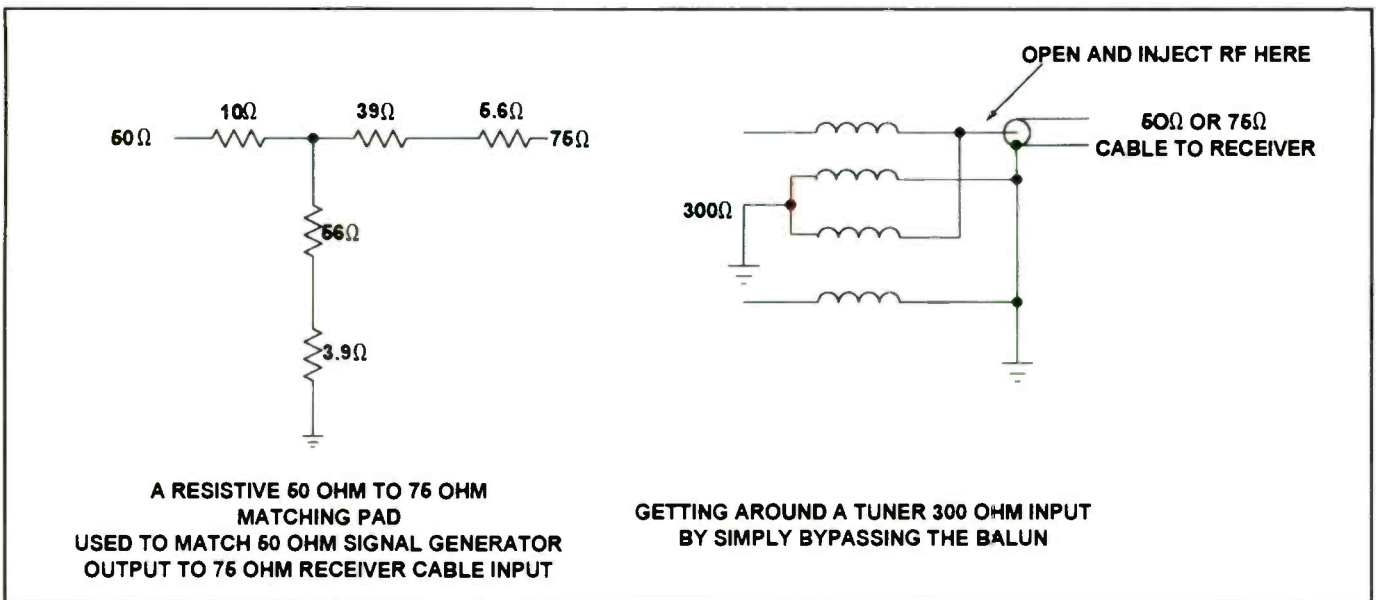

Figure 3. Using a simple interface circuits such as these, it is possible to adapt a signal generator to consumer receiver inputs.

antenna. The desired frequency range is selected by the pre-selector tuned circuits, amplified by the rf amplifier and again passed by the bandpass filter before arriving at the mixer. The mixer beats or heterodynes the microprocessor-selected local oscillator rf signal with the pre-

selected incoming antenna signal to produce, among other frequencies, an intermediate frequency (if). The desired resultant frequency from the single conversion mixing process is selected by the if filter and amplified by the if amp before the detection circuit recovers the voice or

data and passes it on to the processing circuits for use by the operator, etc.

The automatic gain control (agc) circuit feeds a gain control signal to the if or other radio circuits to sustain reception during moderate rf overloads. Large input signals would otherwise tend to drive ac-

DALBANI
The Ultimate Selling Source

CATALOG 17

HITACHI RCA SANYO
DALCO SONY FLUKE
SONY FLUKE
DAEWOO GOLDSTAR
SABENSUNG Toshiba Allegro
SOLIDEX 3M
JBRD SABA
EVEREADY PYRAMID
DURACELL
ENERGIZER
EMERSON MAGNA/OX
NAP
PARALISE
JBC
UCANDO
Xcelite Weller
JTB Products

CALL TOLL FREE
1-800-325-2264

\$3.95

A Picture is Worth
30,000 Items

FREE 248 PAGE CATALOG
1-800-325-2264

4225 N. W. 72nd Ave.
Miami, Florida 33166
TEL : (305) 716-1016
FAX : (305) 594-6588

Your Benefits-Our Mission



- **NCA Professional Reference Guide CD**
CD comes with quarterly upgrades with thousands of parts and accessories. "Point and Click" to find all your computer needs from our **wholesale distributors**. "Search and Print" capabilities.
- **Quarterly Newsletter on CD**
Keep up with current computer events, learn about hot new products, and read about all the latest shows.
- **HelpLine 800**
Our listing of hundreds of industry support contacts alone, is worth the cost of your membership.
- **Enhanced Business Services**
A unique variety of business services. *The power is in membership.*
- **NCA "Members Only" Web Page**
Exclusive access to NCA's WebSite with the latest industry news and gossip. This is the place where members share solutions and trade tips
- **Trade Show Updates**
You'll be given calendars of all major trade shows, and be eligible for special show discounts on hotels, rental cars and many other perks.
- **Use of NCA Logo**
All members have full use of the NCA logo for advertising.

Please contact the National Computer Association to receive complete applications.

◆ 800.615.6224 ◆

National Computer Association • 1355 Automobile Blvd., Ste 240 • Clearwater, FL 34622
nca@gte.net • www.nca-net.com

Circle (65) on Reply Card

Circle (71) on Reply Card

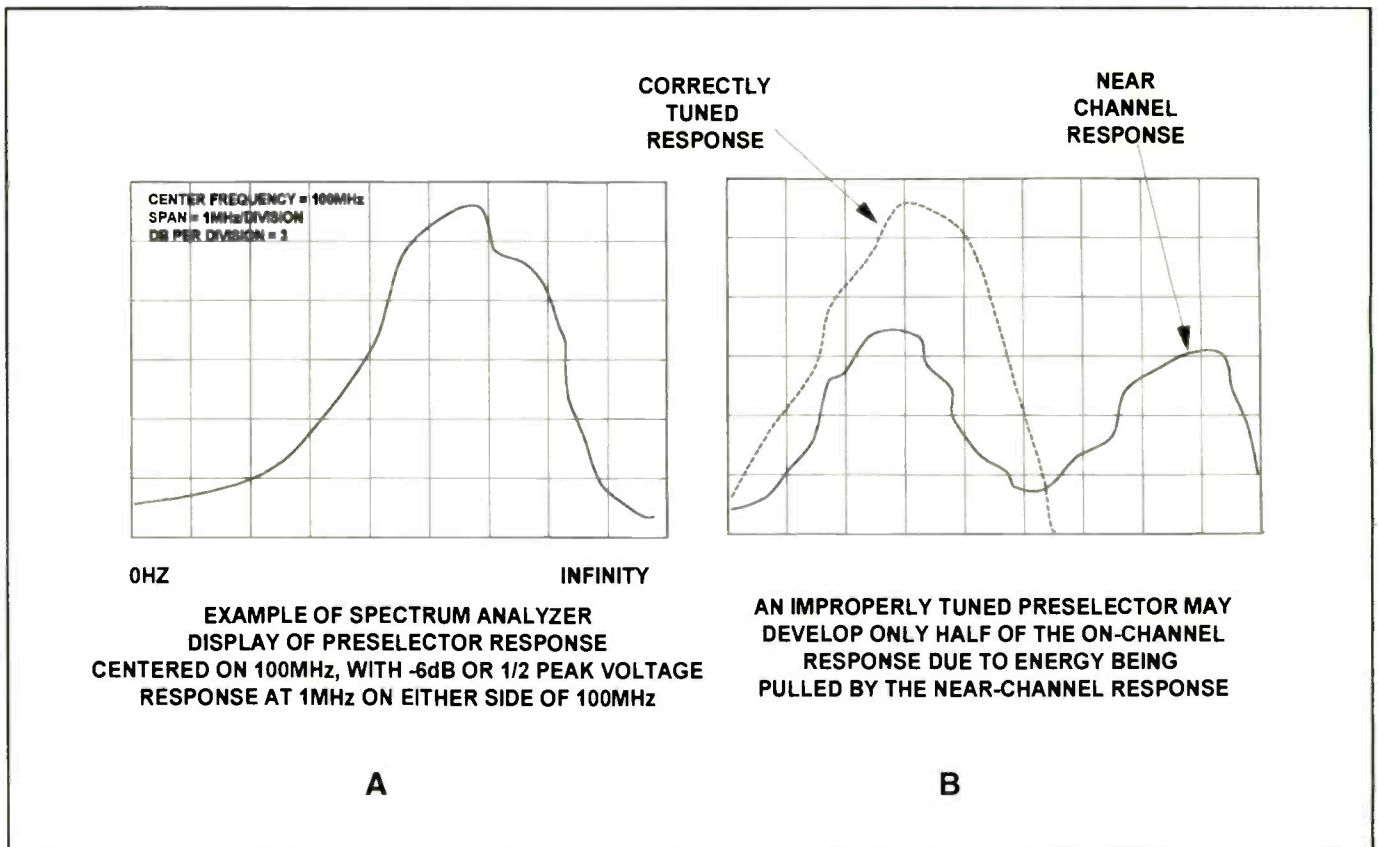

Figure 4. For multi-frequency receivers, you can test the pre-selector stage by injecting, at TPO, a swept frequency over the bandpass range of the stage and observing the output at TP1 with the spectrum analyzer.

tive stages into saturation and therefore distort the recovered data or audio. Additional rf amplifiers, filters, processing circuits, local oscillators, and if injection frequencies, etc., were left out of the drawing for the sake of clarity.

Testing and troubleshooting stage by stage

In this section, each basic stage of the receiver (Figure 2) is analyzed using test equipment and failure analysis on discrete stages. Integrated circuits that perform the same or multiple functions are now widely used. This article will deal with circuits that are based on discrete components, rather than with integrated circuits so that more troubleshooting information may be presented.

The antenna

If the antenna is an integral part of the receiver, you can inject an input signal by coiling a wire from the signal generator around the antenna (TP0). One note of caution, use the lowest injection signal amplitude necessary to gain a measurable output at TP1. Additionally, a simple re-

sistance check between the "hot" (hot is rf terminology for signal voltage) antenna and "cold" (no signal) receiver chassis or common does not constitute a valid antenna check unless you first determine if the input connection at the receiver is dc or ac coupled and if the antenna itself has a tuned circuit or coil which might provide a dc return to the chassis. In our receiver, the antenna is dc coupled to the chassis by the input coil in the pre-selector and will indicate a dc short on an ohmmeter, yet appear as a higher impedance to the incoming radio waves.

If the antenna is defective, inject a signal into the antenna input jack on the receiver to verify operation of the rest of the circuits. If the radio has an rf input connector, connect the signal generator via the input connector using shielded cable to prevent introduction of spurious radiation. Automobile radios and consumer radios will require some capacitance or a resistive matching arrangement in line with the antenna input and signal generator to match to their non-standard impedance (Figure 3).

Other problems with antennas/cables include coaxial shields coming loose, or

making connection with only one or two strands of the outer braid. While this fault will not show up with a simple resistance test, overall receiver sensitivity will usually be reduced due to increased noise entering the system. Look for corroded connectors and areas where water has leaked into the coaxial or other type of cable. Also check for dents in cables which will cause impedance discontinuities which decrease signal transfer.

The pre-selector

For multi-frequency receivers, test the pre-selector stage by injecting, at TPO, a swept frequency over the bandpass range of the stage and observing the output at TP1 with the spectrum analyzer (Figure 4A). If you do not have sweep capability on your rf generator, then simply inject signals at selected frequencies of interest and observe the relative outputs for nearly identical amplitudes using the rf probe or rf millivoltmeter.

If the receiver is single frequency, tune the pre-selector stage for a peak at the frequency of interest, however, you should also check other frequencies either side of the channel in case the preselector has

two response peaks or modes (Figure 4B).

Since there are no active devices between the antenna and the output of the pre-selector, the amplitude of the signal generator can be turned up relatively high to provide a readable signal for a demodulator probe, etc., by observing the response at a point before the rf amplifier (at C1 for example).

Unless the coils have already been disturbed, they seldom "detune," except in the case of dirt or small metal fibers causing a short somewhere on the coil. Often, simply blowing out the coil with air will dislodge any foreign matter. Other failure modes include cracked ferrite tuning cores and sometimes an open or high resistance solder connection on the coil. These faults are caused by mechanical stresses on the coil, or attempts by others to tune using a jewelers screwdriver or other improper tuning tools. Defective coils result in improper tuning response of the stage, and can also be found by simply tapping on the coil and listening for low frequency crashing and crackling sounds in the speaker.

If using a spectrum analyzer and sweep

generator, and performing touch up tuning, simply tune each coil a few turns each way and look for an improvement in response. Resist the temptation to keep turning to get it all from one coil, but instead go to the next coil and do the same thing, alternating between all the coils until you obtain the correct response.

If the pre-selector is way off from its normal response, turn all tuning slugs all the way in or out and then only turn the slugs in the same direction until final touch up tuning. Start with the coil farthest from the antenna, turn about three turns, go to the next one and turn three turns, and work your way to the antenna input, return to the farthest coil, turn three more times, etc. Obviously, do not turn past the point where the signal starts to drop off. Common rf coils are highlighted in Figure 5A.

A poor solder connection or a slightly open connection between, for example, the tuning coil and ground, or a pre-selector cavity and ground, will allow an rf signal to still pass but at a greatly reduced amplitude. This might show up as an extreme loss of receiver sensitivity. So,

always check, and perhaps resolder pre-selector connections, before considering "touch-up" tuning!

The varactor pre-selector circuit of Figure 5B is more difficult to troubleshoot. Assuming that there are no direct shorts, that the varactors (also called varicaps) are identical, and that the coil section has been checked out; clamp the tuning line voltage with the circuit shown in Figure 5B. Bridge one of the varicaps with a very small capacitance (picofarad range), check the resultant swept frequency response, and then remove the capacitor and use it to bridge the other varicap and check response. Swept responses which are not nearly identical would indicate a defective varicap. It would be prudent to replace both varicaps in that.

Rf amplifier and bandpass filter

The RF amplifier should be suspected if TPI indicates no output even with a signal capacitively coupled (0.1uF) from the signal generator to the transistor base with C1 disconnected. Remove the transistor and perform resistance checks on the other components for further isolation if



The Professional
Electronic Technicians Association
and the **Satellite Dealers Association**

Join Us

CET Certification - FCC License Exams

At all cities and military bases. Study materials on disk, paper and video. Free retake if you do not pass CET 1st time. Test Review available. **Option areas:** Consumer, Industrial, Computer, Satellite, Biomed, Radar, Wireless and Telecommunications, RF Video Distribution, Fiber Optics, Customer Service, Satellite Installation.

Employment Help

Join ETA-SDA. Send your resume - We can help. Employers: Call us for highly skilled Certified Electronics Technician staff workers.

Membership includes Technical Tips; Technician Assn News journal, Employment assistance; Help line, Technical and business monographs; Seminars on site or via satellite; Participation on tech committees for CET and skills standards. Leadership training; Annual Convention; Student Chapters; Industry recognition; Networking; discounts and a lot more.

THE ASSOCIATE CET Exam Books

New Study Guides for the Associate Level CET exams. Book 1 contains 248 sample CET Exam Quiz questions and answers. Multiple CET authors. Book 2 different sample quizzes - latest exam topics plus complete listing of over 380 CET exam test sites. Written by CETs, electronics instructors and working technicians. Great study material for every professional electronics technician.

317-653 4301

602 N Jackson

Greencastle, In 46135

<http://www2.fwi.com/~n9pdt/eta.html>

Circle (85) on Reply Card

Panasonic Services Company

Kent, Washington

Panasonic
National Parts Center

Matsushita Services Company

has changed it's name to:

Panasonic Services Company

The source for original Panasonic, Quasar and Technics brand replacement parts and accessories.

See us in Las Vegas at NPSC '97

Call 800-545-2672 for your closest Distributor.

20421 84th Avenue South
Kent, WA 98032

(800) 833-9626
(800) 237-9080 fax

Circle (81) on Reply Card

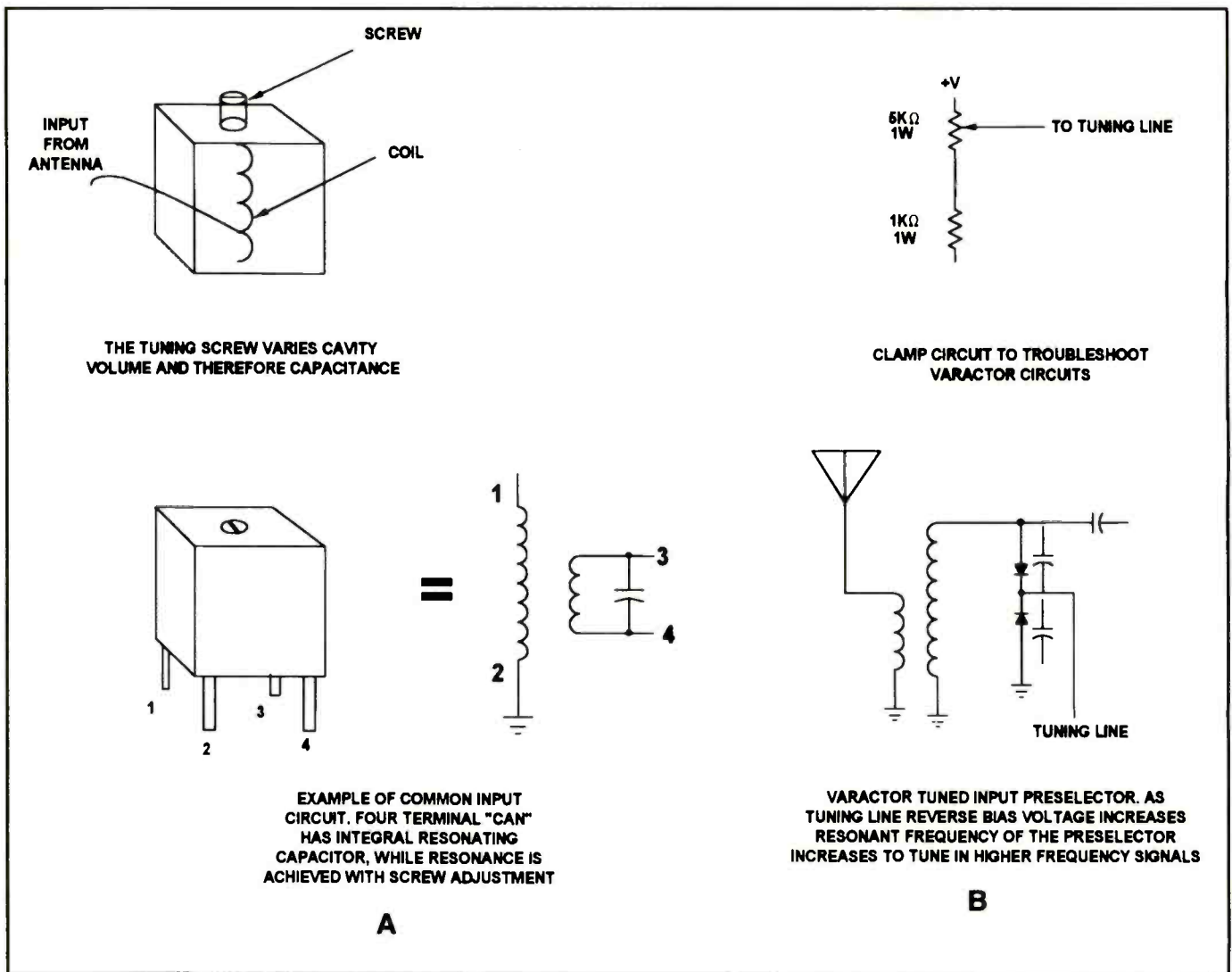

Figure 5. Tuned circuits may be tuned in a variety of ways. These drawings show the use of several methods: variable inductance, variable capacitance, and caractor diodes to achieve tuning of the circuit.

necessary. In most instances, the active device will be the component that causes failure in this circuit.

The discrete bandpass circuit was included to show how to isolate faults in this type of circuit. Use signal injection. The capacitors are very reliable, as well as the coils. If there is a failure in this circuit, it will usually be an open capacitor. Signals at this point are usually less than 1mV, so an rf voltmeter or spectrum analyzer can be used here to check for loss of signal. Again, since there are no active stages in the bandpass filter, you can increase the signal generator output level to gain a usable measurement with an RF probe by injecting at TP1.

A suspected open capacitor can be bridged with a new one to confirm a defective part. Unsolder the side of C2 next to the coil on the gate of the N-channel depletion FET to ensure that the coil is

not loading down the filter circuit. If "chip" capacitors are used, they sometimes open at the connection to the metal endcap. Push down on the chip capacitors with your fingers to see if the receiver comes back to life. Otherwise, use a known-good capacitor to temporarily bridge the suspected defective capacitor.

Mixer and local oscillator system

This particular receiver uses a 10.7MHz if, and so the output expected from the mixer should contain a 10.7 MHz component, among the other harmonics generated in the mixing process. Inject a steady signal at the exact desired receive frequency, from the signal generator into TP0 and using a frequency counter or oscilloscope check the waveform at TP3 for a signal at 10.7 MHz.

On some receivers, this will not be pos-

sible if the mixing process is marginal and the 10.7MHz difference frequency is not much stronger than the other mixing products. L1 and C3 resonate near 10.7-MHz on this receiver. Otherwise, you would be observing the 10.7 MHz if at the output of the crystal filter, at TP4.

If the local oscillator has an adjustment, it would be made at this time by adjusting for exactly 10,700,000Hz at TP4 using a frequency counter. If the radio has a frequency synthesizer, the reference crystal frequency would be adjusted for exactly 10.7MHz. TP5 would be used to observe the local oscillator frequency, and presence of signal could be detected with the RF probe or frequency counter. (As a reminder, the spectrum analyzer or communications monitor may be used throughout all the steps we will go through in this procedure).

Troubleshooting the mixer circuit is

relatively straightforward. The mathematical difference between the two frequencies at TP0 and TP5 should appear at TP3 or TP4. Other than defective components around the mixer, the other cause of trouble may be distorted waveforms, caused by spurious frequencies present at TP5. There may be a filter of some sort between the local oscillator and mixer circuit to counteract this problem.

The coil on the gate of the FET is used to provide a dc return for the bias circuit and an open or short here would cause a low output from the mixer.

A non-sinusoidal waveform viewed on a scope at TP4 can also be caused by the input frequency not being within the pass-band of the ceramic or crystal filter. As the frequency varies away from 10.7MHz one alternation of the sinewave will become distorted. Always check the input frequency before deciding that the filter is defective.

On this receiver, coil L1 would be adjusted for a maximum amplitude 10.7MHz signal at TP4. If there is no output from the filter, remove the filter and bypass it with a 0.1uF capacitor. If there still is no output, odds are one of the impedance matching components (capacitor or coil) connecting the filter input and output is defective.

Most ceramic resonators are designed with input and output impedances that are identical, usually from 300Ω to 3KΩ. Also, coupling and bypass capacitors used in this frequency range are likely to be opened, not shorted or leaky. Refer to Figure 6 for the essential theory of the mixing process, which allows either positive or negative portions of the RF input signal to pass to the output, generating the sum and difference frequencies.

If amplifier

The RF probe or scope can be used here to check the voltage at TP4 and TP6. Look for a voltage gain of anywhere from 5 to 20 in the if amplifier.

If the stage has no gain, measure the terminal voltages of the N-channel depletion dual-gate MOSFET. In this stage, as gate 2 (G2) voltage decreases below the source voltage the signal at TP6 decreases due to less MOSFET current and therefore less signal voltage developed across the drain load. Therefore, the AGC voltage can be clamped to various dc voltages

to check for varying gain from the MOS-FET. If there is weak gain from the MOS-FET, check the source lead with the scope for presence of signal.

A signal more than a few mV here indicates that the rf bypass capacitor (C6) is open. Likewise, check the drain rf bypass capacitor (C5) for a very small, or better yet, non-existent signal voltage. Always check the AGC circuit before assuming defective if amplifiers.

Detection and audio or data processing

The detector circuit here is a simple amplitude modulation detector. This is essentially the same circuit that is built into the RF probe, except for the time constant of the RC circuit. Since an amplitude modulated rf signal is symmetrical about its axis, the value averaged over one cycle is zero. The rectification process in the diode captures the original phase relationships of the carrier and sideband waveforms which occur during modulation at the transmitter. The time constant of the resistor and capacitor respond to, and recover, the original audio or data modulation information. Nowadays, detection is accomplished by an integrated circuit, whether it be AM, FM or some other form of modulation.

The circuits previous to TP6 are common to AM, FM, CW, and SSB radio.

Audio or data should be observed at the output of the detector circuit. Detector problems usually show up as distorted audio. Also, simple AGC circuits derive input from the detector stage and can also cause distorted audio symptoms. A shot from a can of freeze spray on audio and AGC components can often help locate defective components.

Other circuits

The microprocessor provides the interface between the operator and the radio receiver, performing such duties as illuminating channel indicators, determining local oscillator injection frequencies, interpreting switch/knob position, etc.

General troubleshooting pointers

As with most forms of troubleshooting, a technician must have the right diagnostic tools to effectively and efficiently repair radio frequency receivers.



DA-1

Computer Monitor Distribution Amplifier

- 10 monitor outputs
- 200MHz Bandwidth
- Rack Mountable
- Operates in any mode
- One year warranty

FREE!

Diagnostic/Burn-in software and all eleven VGA cables to get you rolling. You can't find a better offer!

Only \$299.95
ACM Company
 516-395-4862



Circle (62) on Reply Card

PARTS EXPRESS



Reg. \$149.95
SPECIAL \$129.95
 Order #ES-390-706

Computer Monitor Tester

This compact device can quickly and easily troubleshoot, test, and align computer monitors, without the need for a separate computer. Test MDA, CGA, EGA, VGA (640 x 480), SVGA (800 x 600), 8514 (interlaced), SVGA (1024 x 768), and high resolution monitors. Generates the following video test patterns: color bars, cross hatch, dots, color raster (white, red, green, blue), and windows. Two video connectors are provided: a digital/TTL 9 pin and an analog 15 pin. Net weight: 3/4 lb.

CALL TOLL FREE: **1-800-338-0531**

To receive our 244 page full line catalog, use source code ESM when ordering.

340 E. FIRST STREET, DAYTON, OHIO 45402-1257
 PHONE: 937-222-0173 FAX: 937-222-4644
 E-MAIL: sales@parts-express.com
 HOME PAGE: http://www.parts-express.com



Circle (73) on Reply Card

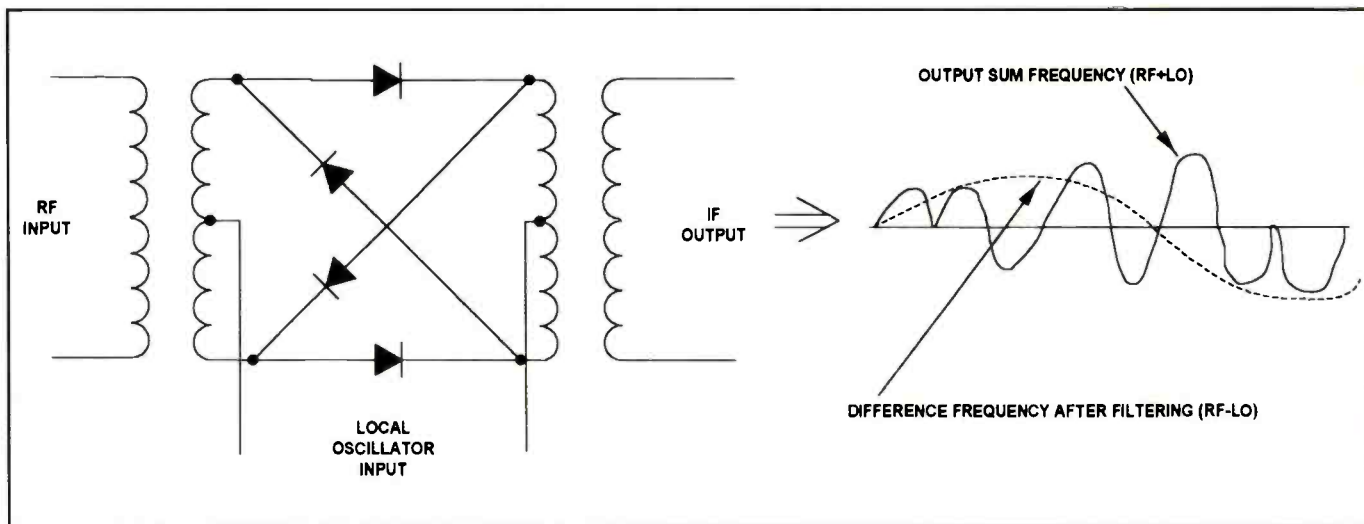

Figure 6. In the double balanced mixer arrangement, shown here, the circuit output signal (if output) varies in amplitude (gain is less than 1) by the amount of frequency difference between the local oscillator (LO) and the rf signal. The rf and LO signals are cancelled to the extent that the circuit is balanced, leaving only sum and difference frequencies in the output. The intermediate frequency (if) output will have a filter to select the desired harmonic, usually the difference frequency.

Receivers tend to have more mechanical parts (like tunable coils, crystals, etc.) which can fail, and more temperature sensitive circuits. For example, a coil with a tuning slug at either extreme of its range exhibits a greater inductance change with temperature than does a coil with the tuning slug nearer mid-range.

The local oscillator or frequency synthesizer are the heart of the unit, and so are a good place, after power supplies, to initially check. Key checks here should not only be frequency but that they are stable, with no noise on the control lines

to varactor diodes in tuning circuits or voltage controlled oscillators.

The next circuit function to check is in the detection area. This is a good point at which to split the receiver's circuits in two, as well as an injection area for audio signals to confirm that the audio or data processing circuitry is working. Next inject at the if stage. Remember to also verify the agc circuits. Finally, verify operation of the receiver front end circuits, and resist the urge to tweak coils, they seldom fail. Keep in mind, to, that microprocessor failures are very rare.

Seventy percent of the receiver problems I have repaired are defective active components, cold solder joints, poorly soldered rf shields and covers, and voltage controlled oscillators with control voltages out of tolerance due to defects in the synthesizer circuitry. Most of the low receiver sensitivity problems were caused by poor solder connections on enclosed tuned circuits to ground and other ground related problems. Poor ground related connection problems increase as frequency of operation extends into the UHF and microwave region. ■

PHOTOFACTS

CROSLEY

CT1922C1243855
19E6193855

JCPENNEY

NC-36A3851
685-07703851
685-07883851
685-2715-003851
685-2716-003851
27153851
27163851

MAGNAVOX

TP2795C1013852
TP3273C1023849
27W503-00AA3852
32V501-00AA3849

MITSUBISHI

CK-323083850
CS-273053845
CS-322073850
CS-323073850

PHILIPS

13E6063854
13P220C1213854
13P220C1223854
13P220C1233854
27PS75C23843
27V5013843

RCA

CTC175C3844
CTC187AJ3848
F19202WNTX13844

F19203BKTX13844
F25674GYFE13848
F25674GYJX13848
VR501BVCR-287
X19150SGTX1384

SONY

KV-20V603847
SCC-J84H-A3847
SCC-J93E-A3847

ZENITH

SY0955X3853
SY1949Y3846
SY1949YM3846

Test Your Electronics Knowledge

By J.A. Sam Wilson



1. Assume that two inductors L1 and L2 are connected in series and the coefficient of coupling is unity. If the two inductors have equal inductance, and their fields are in phase, what is the inductance of the combination?

2. An AM station is 100% modulated. What is the increase in output power compared with no modulation?

3. A certain resistor has a power rating of 25 watts and a resistance equal to 10K. What is the maximum allowable current in milliamperes?

4. The actual power consumed in an RLC circuit divided by the product of V and I is called _____.

5. Calculate the antenna current that flows when an AM transmitter delivers 250W to an antenna with an antenna resistance of 10Ω.

6. A certain 2-wire transmission line has a 50Ω capacitive reactance at its input terminals. What is wrong?

7. Is the following statement correct? With push-pull amplification the odd harmonic frequencies are suppressed.

8. Name three kinds of losses in iron-core transformers. (Assume perfect coupling between the windings.)

9. Is the following statement correct? In a transmitter "doubler" circuit the output voltage is twice the input voltage.

10. Is the following statement correct? A Faraday shield in a power transformer is for eliminating (or greatly reducing) electrostatic coupling.

Wilson is the electronics theory consultant for ES&T.

(Answers to Quiz on page 26)

FREE DEMO 20,000 Technical TIP Repairs

FREE DEMO

TV's, VCR's, Projection TV's, CAMCORDER's, CD Players, Audio & other repairs organized in an EASY to use Computer Program:

The TECHNICAL TIP REPAIR program.

- PROFESSIONAL BOARD & COMPONENT LEVEL REPAIRS.
- ADD your own repairs.
- PRINT repairs.
- BACKUP & save your own repairs.

Have your own tips? Ask about our TIP EXCHANGE policy with FREE Updates. Works on IBM compatible computers with a hard drive (Also works on some Apple Macintosh computers). NEW VERSION works in DOS, WINDOWS 3.1 & WINDOWS '95.

FREE SHIPPING

HIGHER INTELLIGENCE SOFTWARE, INC.



60 Farmington Lane
Melville, NY 11747
1-800-215-5081

Circle (83) on Reply Card

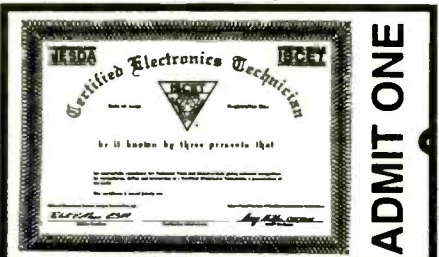

Your Ticket to SUCCESS

More than 40,000 technicians have gained admittance worldwide as certified professionals. Let your ticket start opening doors for you. ISCED offers Journeyman certification in Consumer Electronics, Industrial, Medical, Communications, Radar, Computer and Video. For more information, contact the International Society of Certified Electronics Technicians, 2708 West Berry Street Fort Worth TX 76109; (817) 921-9101

Name _____

Address _____

City _____

State _____ Zip _____

Send material about ISCED and becoming certified

Send one "Study Guide for the Associate Level CET Test."

Enclosed is \$10 (inc. postage).

What Do You Know About Electronics?

Keep your expertise honed

By J.A. Sam Wilson

You are one of the top technicians in the country. I know that because you subscribe to **ES&T** magazine. Since you are a top technician, there are other things I know about you. Here is your profile.

You get 100% of the questions in "Test Your Electronics Knowledge" correct. You read "What Do You Know About Electronics." You belong to both ETA and ISCET (you probably attend their conventions). And, finally, you like apple pie.

Allow for some error in your profile.

As a top technician, you are completely trained in electrical and electronics theory. However, you know that it is always a good idea to review your knowledge of basic theory.

Some questions and answers

Recently I ran across a book published by ARCO Publishing Company. Copyright 1967. It is titled "Questions and Answers For Electricians." That may be a little bit away from the electronics field, but electronics training will likely carry a technician through the test questions I have selected. I chose only the questions that deal with basic theory and math.

Have a go.

1. If there is no way to change the frequency of the supply (or mains) you can speed up a 3-phase synchronous motor by
 - a. connecting a shunt across the field circuit of the motor.
 - b. connecting a shunt against the line leads of the motor.
 - c. connecting a shunt across the series field motor.
 - d. it is not possible to change the speed.The answer is d.

The speed of a synchronous motor depends solely upon the frequency of the ac supply. If you can't change that frequency (and usually you can't) then you can't change the speed.

You may remember from studying basic theory that big companies keep a large synchronous motor running on the roof of their building. In that application the motor is used for power factor correction. The power used by the company is equal to $V \times I \times \text{power factor}$. The power factor is equal to the cosine of the phase angle between the voltage and current. A power factor of 1 means that the voltage and current are in phase. Since companies can pay a heavy penalty for having a phase angle between the voltage and current, they take pains to keep them in phase.

2. To determine directly whether all finished wire installations possess resistance between conductors, and between conductors and ground, use
 - a. a power measurement.
 - b. short circuits between the conductors and between the conductors and ground.
 - c. an ohmmeter.
 - d. a megger.The answer is d.

Of course, you want infinite resistance between conductors and between the conductors and ground. An ohmmeter cannot be used to test insulation because it only applies a few volts during a measurement. A megger applies a sufficient voltage level to test for insulation breakdown.

3. Which of the following values is a candle power?
 - a. Light equal to the intensity from a standard candle
 - b. 2.7 candelas
 - c. 5.6 lumens
 - d. Light equal to the intensity from a 1W light bulb.The answer is a.

Technicians working in electronics are familiar with optoelectronics. Candle power is a basic unit of light intensity in that technology.

4. The percentage of total time during which an electrical device carries current is called
 - a. ampere-hour X 100

- b. power factor X 100
 - c. duty factor X 100
 - d. percent time constant X 100.
- The answer is c.

Another way of describing duty cycle is to call it the on time divided by the total time. That is just another way of saying the same thing. Multiplying by 100 gives it the percent value. Without multiplying by 100, the quotient (on time divided by total time) gives the duty factor.

5. A conductor providing a connection between equipment (and its circuit) and earth is called
 - a. a circuit A conductor
 - b. a circuit B conductor
 - c. a ground conductor
 - d. an earth conductorThe answer is C.

Actually, answers c and d are both correct if you consider that the British call grounding a circuit "earthing" a circuit. However, this is a test taken in the good old USA, so we will stick with choice c.

As you know, the most difficult measurement is 0V, that is ground potential. There is a story that is often told about people being electrically executed on the operating table. As that story goes, one medical electronics company called one voltage 0V, and another company called a different voltage 0V (ground). The two voltages were not actually equal to 0V.

When the patient on the operating table was connected to monitoring equipment using the two different voltages as ground, he was executed.

I'm not going to swear to the accuracy of that story, but it does bring up an interesting point. Do you have several different test instruments on your work bench? If so, some experts tell us they should be strapped together. In other words, a ground strap should be used to interconnect all of the ground points together.

There is another point to be brought out. If you are using a coaxial cable to connect signals between instruments, you are supposed to connect the ground braid to *one* of the instruments. Otherwise, an ac

Wilson is the electronics theory consultant for ES&T.

current can flow through the braid that will interfere with the signal (of course, that won't happen if your instrument grounds are strapped together).

6. Insulation is defined as a material that has a resistance

- a. of $1k\Omega$.
 - b. of $10k\Omega$.
 - c. of $100k\Omega$.
 - d. high enough to separate two circuits.
- The answer is d.

That seems to be a little vague to me, but I don't think that any definite value of resistance could be used. I know that an insulation that can separate two dc circuits might not work for two rf circuits.

When Thomas Edison installed his power company in downtown New York City, he had to run his dc power lines beneath a street. The lines were insulated with a material called gutta percha.

Soon crowds of people gathered on the sidewalks to see the "dancing horses." The electricity was leaking through the surface of the pavement and into the horses' shoes. The horses were trying to get all their legs into the air at the same time. The gutta percha insulation that Edison used would have been sufficient for a lower value of voltage.

So, insulation can also depend on the amount of voltage involved. Incidentally, Edison changed the insulation.

7. When you use electricity from a power company, they send you a bill for your use of

- a. power.
 - b. current.
 - c. energy.
 - d. electricity.
- The answer is c.

You pay for kilowatt-hours (KWHR). In other words, you pay for power x time. Power multiplied by time gives energy.

8. The "load" of a generator actually refers to its

- a. power output.
 - b. voltage.
 - c. current delivered.
 - d. watt-hours.
- The answer is c.

Here we encounter a healthy difference of opinion. When we say a battery or generator is heavily loaded, we mean it has to deliver a high current. A battery or gen-

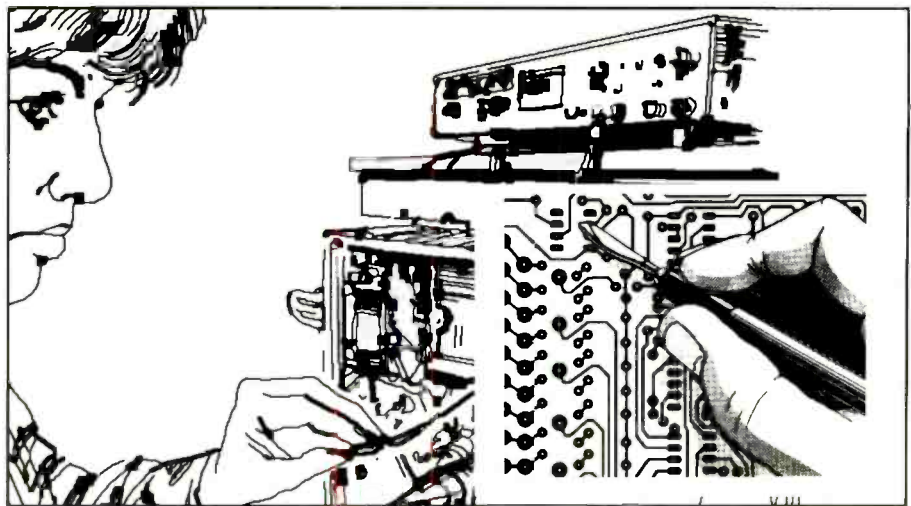

erator can deliver a voltage all day and not be loaded. This may be a difference between the fields of electricity and electronics (the book gives all of the choices as being correct).

There is confusion in electronics between the terms "load" and "load resistance." Some authors insist on saying that the current is delivered to the "load," when they mean "the current is delivered to the load resistance."

This may be like the term RMS power. Someone who knew nothing about electricity determined that RMS voltage multiplied by RMS current equals "RMS power." Actually, there is no such thing as RMS power. The term is meaningless.

When you multiply RMS voltage by RMS current, you get *average power*.

$$\text{RMS Volts} \times \text{RMS Amps} = \text{Average Power}$$

$$V\sqrt{2} \times A\sqrt{2} = (V \times A)\sqrt{2}$$

which is average power.

The term "RMS Power" would seem to mean that you divide the power by $\sqrt{2}$. That doesn't make sense.

While electricity and electronics may seem to some to be completely different fields, they in fact have a lot in common. The more a technician knows about both fields, the better he'll be able to understand the theory and to do his job. ■

IF YOU NEED IT... WE HAVE IT!



**SEE US AT
NPSC '97
VEGAS - BOOTH #1007**

ORIGINAL REPLACEMENT PARTS & ACCESSORIES

SONY KENWOOD Panasonic RCA
Quasar TOSHIBA Technics
ONKYO SAMSUNG PROSCAN

THE HERMAN ADVANTAGE

- All In-Stock Orders Placed Before 4:00 PM EST Are Shipped the Same Day.
- FREE or DISCOUNTED Air Freight Program
- RAPID RESPONSE to All Research Requests.
- PROFESSIONAL Customer Service Representatives to Serve Your Every Need.
- CONSOLIDATE YOUR BUYING and purchase all the major lines from ONE SOURCE.
- NO MINIMUM ORDER.

**PHONE: 800-938-4376
FAX ORDER LINE: 800-938-4377**

Test Equipment, Tools, Soldering Equipment, Chemicals, and Service Accessories

BK PRECISION GoldStar FLUKE HAKKO
HITACHI KENWOOD LEADER
VALVEK GC 3M Weller Xcelite

7350 HERMAN WAY, MIAMI, FL 33122
Internet E-Mail Address: info@hermanelectronics.com

VISIT US ON THE WEB AT HERMANELECTRONICS.COM

Master catalog

The latest 268-page, full-color Jensen Master Catalog listing of products for the electronics industry, is now available. It lists tool kits and cases, hard-to-find specialty tools and other items for technicians and engineers.



Among the new items featured are a pair of tool kits available, one for electronics equipment service, and the other with inch and metric tools for servicing domestic and foreign equipment.

A wide range of test instruments is also offered, including the new SIMMCheckII Advanced Memory Module Tester, an infrared temperature measuring device, and an instrument for measuring loop current in telephone systems.

Circle (25) on Reply Card

Electronic components and computer products catalog

Jameco Electronics has recently released a new catalog with more than 5,000 ICs, components, tools, test equipment and computer products for OEMs, engineers, educators and service/repair technicians. The free 132-page catalog features 300 new products, including transistors, relays, switches, capacitors, fans, power supplies, ESD safe soldering equipment, motherboards, controller cards and more.

Circle (26) on Reply Card

Service aids catalog

Philips Service Company has published a catalog that features their line of service aids. The 45-page catalog contains everything from general hand tools to test equipment to chemicals, etc. The brands are B&K, Xcelite, Chemtronics, and Philips' own Force software.

Circle (27) on Reply Card

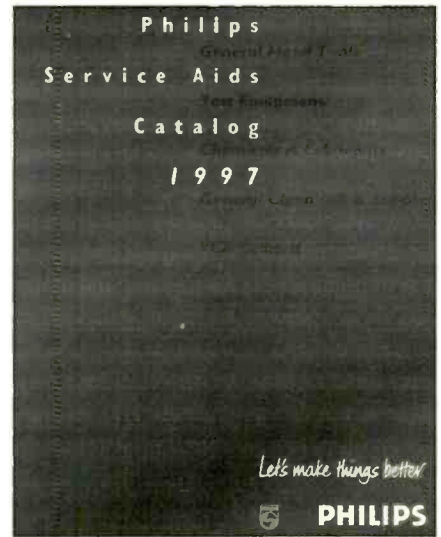

**Large enough to serve you -
small enough to know you!**

Your one stop for major brand name electronic parts, accessories, supplies, tools and literature.

1306 Continental Drive • Abingdon, MD 21009-2334

1-800-638-3328

1-800-888-FAXD

orders placed by 4pm EST
ship same day



Visit our home page at

<http://www.tritronicsinc.com>

Or e-mail us at tritronics@aol.com

Call and ask about our on-line ordering system

Dragnet



authorized parts, accessories and literature distributor for:

CASIO SANYO SFS (NAP) RCA SHARP DENON

Quasar aiwa PROSCAN Optonica PHILCO PHILIPS

Emerson Matsushita FISHER SCOTT SYLVANIA

THOMSON Panasonic HITACHI MAGNAVOX Technics

3M BLACK WATCH BK PRECISION Channel Master

Chemtronics

Flex ELECTRONICS

SK Series

PRB LONG

RITE OFF

XTRONIX

Circle (86) on Reply Card

July 1997

Electronic Servicing & Technology 61

CLASSIFIED

Classified advertising is available by the word or per column inch.

By-the word. \$1.65 per word, per insertion, pre-paid Minimum charge is \$35 per insertion. Initials and abbreviations count as full words. Indicate free category heading (For Sale, Business Opportunities, Miscellaneous, Wanted). Blind ads (replies sent to ES&T for forwarding) are \$40 additional. No agency discounts are allowed for classified advertising by the word. Contact Kirstie Wickham at 516-681-2922 to place your classified ad (by-the-word). Mastercard, VISA, American Express and Discover are accepted for FAX or mail orders.

Per column Inch (classified Display): \$235 per column inch, per insertion, with frequency discounts available, 1" minimum, billed at 1/4" increments after that 10" maximum per ad. Blind ads are \$40 addition. Reader Service Number \$25 additional to cover processing and handling costs. (Free to 4-inch or larger ads.) For more information regarding classified display advertising please call 516-681-2922. Optional color (determined by magazine) \$150 additional per insertion.

Send your order, materials and payments to:

Electronic Servicing & Technology, 76 N. Broadway, Hicksville, N.Y. 11801 Attn: Classified Department
Phone: 516-681-2922 FAX: 516-681-2926

FOR SALE

Service tips. Over 16,000 Quality tips. KD T-V and 30 NESDA and other Professional Servicers. 200 brands, TV-VCR-CM-MWO-CC-Audio-Misc. Diskette database \$39.95. New version monthly. Finest Original Data! Power record adding feature! Alphabetized symptoms! Upgrade \$29. Annual subscription (12 disks) \$12.50/mo. **KDTV 514 3rd St. Aurora, IN 47001. 812-926-4321.** All c/cards. Send your tips for **FREE UPGRADE.**

IN-CIRCUIT CAPACITOR ESR TESTER - Find bad caps FAST and RELIABLY with the new Capacitor Wizard in-circuit ESR Tester! Great for monitors, switching power supplies, TVs, etc. Only \$179.95. MC/VISA. **Independence Electronics Inc., 800-833-1094, www.awiz.com.**

INVENTORY REDUCTION SALE!: TEST EQUIPMENT PRICES SLASHED UP TO 60%. LIMITED TIME OFFER. VIEW COMPLETE LIST AT WEB SITE "a-mall.com" or call NOW to receive list by fax or mail. AST GLOBAL MARKETING. Voice: 888-216-7159; Fax: 814-337-7920 e-mail: astmrktg@wrench.tollcity.net.

Service Literature bought and sold. Previously owned VCR, Sams, Ham, test equipment manuals. Call, fax, or write with your wants. **IDC Electronics, 3471 West Broadway Ave., N. #252, Robbinsdale, MN 55422. Phone/fax 612-588-6898. E-mail: fallen-idceworldnet.att.net.**

Desoldering & Soldering Station OK Model SA1201-115. Never used, cost \$856.00. Will sell for \$350.00. Also, **oscilloscope H.P. 1725A 275MHz** for \$700.00. Call NY, **914-236-4773.**

*******FREE ZENITH REPAIR TIPS*******
SAVE \$\$\$ Repair Zenith TV modules found in over 1,000 models, 1983-1995. Symcure manual shows you how. \$79.95 or send SASE for **FREE** samples. **TVPRO, 807 Queen Palm Lane, Sarasota, FL 34243.**

FURTHER PRICE REDUCTION. Diehl Mark III \$49, Diehl Mark V Horizontal circuit tester \$169. New. Conductive coating for remote control keypads \$9.99 ppd. **WEEC, 2411 Nob Hill Road, Madison, WI 53713. 608-238-4629, 608-273-8585.**

SENCORE, TEKTRONICS, HEWLETT PACKARD (all models). We **BUY, SELL, & TRADE**. Please call "**CHOICE ELECTRONICS**" for all of your test equipment needs. Complete financing options available. Call 1-800-609-0677, ask for Lance Tople.

NAP Tuner 340309 RCA Tuner TCHRIA or TCCRIA. Snowy picture? Will repair for \$25.00, Free Shipping. **Tip Top TV & VCR, 18441 Sherman Way, Reseda, CA 91335, 818-345-1974.**

FOR SALE

Electronic Software Developers offers 21, 391 Service Tips with the latest volume update FREE. See our display ad page 16.

CRT ADAPTER KIT - Hooks your CRT tester to ALL picture tubes. Win the "socket war". Obsolete proof! \$59.00. **DANDY 2323 Gibson, Muskogee, OK 74403. 918-682-4286.**

Computer monitor service information. Windows Tech-Tips service program. Over 700 monitor schematics, ESR in-circuit capacitor tester. Visa, MC, Amex. **MI Technologies Inc., 513-335-4560, Fax 513-339-6344. E-mail: mit335@bright.net, Web: http://www.bright.net/~mit335.**

TEST EQUIPMENT BOUGHT & SOLD: OSCILLOSCOPES, ETC. 510-706-0177. FAX: 510-706-0156.

((32,000 REPAIR TECH-TIPS)) WE - ARE - TECHNICIANS!
TEST our **FULL DATABASE** of repairs in **CD FORMAT, DOS** or **WINDOWS** for **ONE WEEK** in **YOUR SERVICE CENTER** for \$20.00. If satisfied, you may join our membership for an additional \$330.00. Over **2,384 members World-Wide** and growing. Our membership price has been the same for the past 6 years and will remain the same in the future. "**FREE**" 48 Page Member Magazine "THE TIP INFORMER", "**FREE**" Emergency Tech-Assist Telephone Line, "**FREE**" FCC-ID Cross-Reference Manual, "**FREE**" Service Center Forms, **Semiannual updates of 2,000 new repairs in four - 3" Paper Manuals or Computer, CD, DOS or True Windows** in which you may enter your own repairs, edit or tag any report or press one key and printout selected or all repairs on a particular Model or Chassis. "**GET TO THE BOTTOM LINE PROFITABLY**" CALL and speak to a Service Center Owner and Technician **ED Erickson, NESDA MEMBER** and past president of the (**PROFESSIONAL ELECTRONICS ASSN. OF SOUTH FLORIDA**). You and your technicians will be glad you did! Remember, labor is your largest expense. **800-474-3588 or 954-349-2455, TV-Man Tech-Tips, Inc. 2082 Augusta, Weston, Florida 33326.**

TV CASE HISTORIES: Booklet with 2,825+ histories. Satisfaction assured. Only \$56 (plus \$3.00 for priority mail). **Mike's Repair Service, P.O. Box 217, Aberdeen Proving Ground, MD 21005.** Same mailing address 33 years. Send SASE for samples. 410-272-4984, 1-800-2-FIX TVS 11am-9pm. (or at <http://www.netgsi.com/~mikesrs>).

SERVICE DATA & HARD TO FIND PARTS previously-owned SAMs, manufacturers data, books, FREE catalog. **AG Tannenbaum, Box 386, Ambler, PA 19002, 215- 540-8055, fax 215- 540-8327.**

20,000 Technical Tip Repairs - Higher Intelligence Software. See display ad page 55.

CLASSIFIED

FOR SALE

SAMS PHOTOFACTS: Consecutive from 1100-2830, over 1,700 folders, all for \$1,500.00 plus shipping. Call Mark, 908-685-4180.

BUSINESS OPPORTUNITIES

ESTABLISHED BUSINESS. Owner retiring. Electronics business since 1965 in commercial building for \$295,000 or purchase business opportunity and continue with long term lease for \$50,000. Lots of old tubes for antique radios and TVs. Call Margaret Odegard, Associate Broker, Prudential Northwest Properties 503-256-1234 or 503-243-3912.

BUSINESS OPPORTUNITIES

Electronics Service Center! Very Well Established, Excellent location in Suffolk County(NY). Steady flow of work. Call for details. Eves - 516-395-4236.

WANTED

WANTED: USED TEST EQUIPMENT. AST GLOBAL MARKETING: Voice: 888-216-7159; Fax: 814-337-7920, e-mail: astmrktg@wrench.tool-city.net

**TO ADVERTISE IN THE CLASSIFIEDS
CALL 516-681-2922 OR FAX 516-681-2926**

READERS' EXCHANGE

Readers' Exchange is a free service.

The following restrictions apply to Readers' Exchange:

- Only individual readers may use Readers' Exchange, and items must be restricted to those that are ordinarily associated with consumer electronics as a business or hobby. If you're in business to sell the item(s) you want to offer for sale, the appropriate place for your message is in a paid advertisement, not Readers' Exchange.
- Readers' Exchange items must be restricted to no more than three items each for wanted and for sale.
- All submissions must be typed or printed clearly!

Send your Readers' Exchange submissions to:

Readers' Exchange, Electronic Servicing & Technology, 76 North Broadway, Hicksville, New York 11801

FOR SALE

Sencore PR57 Powerite, variable isolation transformer and safety analyzer. New, never used, \$295.00. Contact: Pete 616-429-1182.

Sylvania and RCA modules. B&K substitution master #2902 and tubes. Contact: Ann Bichanich, 15 1/2 W. Lake Street, Chisholm, MN 55719, 218-254-4421.

Sencore SC3100 Auto-Tracker Auto. 100MHz waveform/circuit analyzer, \$2750.00. Sencore SG80 AM/FM Stereo analyzer, \$2450.00. Both brand new in box. Contact: Jim, 888-532-8007 (toll-free), Fax 707-259-8010.

Sencore TVA92 and VG91, 1995 models with cables, manuals, and schematics. Excellent condition, little use, \$3500.00. Contact: 208-678-1782.

Sams AR-Auto Radio Books, Approximately 90 for \$150.00 plus shipping. Mostly low numbers, must take all. Radio Electronics Magazine from early 1950's for \$90.00 plus shipping. Sams PF Reporter from 1960's, 78 volumes, \$150.00 plus shipping. Contact: Maurer TV Sales, 29 South 4th Street, Lebanon, PA 17042, 717-272-2481.

Sencore SC61 waveform analyzer, excellent condition, cables and manuals, \$1100.00 plus shipping. Buy it and get Sencore TF166, Sencore SS105 and Zenith 852-241 for free. Contact: Christopher Marquette, 860-449-8607.

Sencore VC93 VCR tester/analyzer. All manuals and probes. Excellent condition, hardly used, \$1200.00 or best offer. Contact: Tom Dunnigan, 617-935-9432.

Sencore SC3100 Auto Track \$1,800.00; Sencore VA48 Video Analyzer \$250.00; Sencore SC61 Scope \$750.00; Sencore SG165 Stereo Analyzer \$300.00; Sencore VG91 Video Generator \$1,200.00; Sencore TVA92 TV Analyzer \$1,100.00; Sencore VC93 VCR Analyzer \$1,000.00. AST GLOBAL MARKETING: Voice: 888-216-7159; Fax: 814-337-7920. e-mail: astmrktg@wrench.toolcity.net

TV, VCR, camcorder, audio: parts, accessories, components, test jigs, test tapes, training tapes, training tips, etc. Accumulated by a warranty authority service center for over 10 years. Need to sell! Will take best offer! c/c accepted. Payment arrangements can be accepted. Contact: Lance Tople, 800-609-0677 or fax 605-361-6386.

WANTED

Sanyo Beta VCR model VCR6800. Need one good carriage assembly that will fit model. Will pay reasonable amount. Contact: All-Tronics Video and Audio, 22111 Route 130, Cinnaminson, NJ 08077, 609-829-0054. E-mail: alltroni@ix.netcom.com.

IC LA-4250 or ECG 1386. Contact: David A. Tabor, Tabor TV & Appliance, 300 SE. Central Avenue, Killdeer, ND 58640. 701-764-5017.

Grundig TV (multi-system), brought over from Europe, model T55-340/90 service manual. Contact: Sidney Karam, 228 Victoria Road, Units, Dartmouth, NS Canada B3A 1W7. Call collect, 902-466-0061 (mention Grundig).

Oscilloscope CRT tube for HP 1740A, or HP1740A for parts. Contact: Minsoo Kim, 1979 Lonsdale Avenue, North Vancouver, British Columbia V7M2K3, Canada, 604-985-3490 (phone/fax).

Mitsubishi main printed circuit board in repairable condition for model CS-2656R or CK-2602R. Contact: Peter A. Letizia, PO Box 1043, Hopewell Jct., NY 12533. Call or fax 914-221-2788, e-mail: TRICO76@aol.com or Petercoe@aol.com.

WANTED: USED TEST EQUIPMENT. AST GLOBAL MARKETING: Voice: 888-216-7159; Fax: 814-337-7920, e-mail: astmrktg@wrench.tool-city.net

Schematic for Unitech (Samsung) VCR model SSV-1000, and a drum motor or PC motor block for an Akai VCR model VS-555 UM. Classic VCR CVP-3500, need service manual. Contact: Daniel, 250-338-6575.

Phileo 25C 537 p/n G12442-1 MPV (IC-1000) NAPT chips. Philco E34-C4 p/n 15-31015-13, need tuner prescaler. Zenith p/n 221-160. Used OK. not over \$10.00 each. Contact: W. Worley, 305 Hickory Bend Road, Enterprise, AL 36330, 334-347-5281.

TUBES • TUBES • TUBES

World's Largest Range

Over 2,000 Types, Domestic & Foreign



UP TO 85% OFF

Ask for price list



International Components Corporation

Toll Free 800-645-9154 • N.Y. State 516-293-1500
107 Maxess Road, Melville, New York 11747

Circle (69) on Reply Card

The Ultimate WWW Service Site

www.electronix.com

The One-Stop Service Site
for Electronic Technicians

Electronix Corp 313 W Main St Fairborn, OH 45324
(513) 878-1828 Fax (513) 878-1972 sales@electronix.com

Circle (66) on Reply Card



The WWW
Site With
the Chemistry
that's Right
for You!

See our other ad on page 25

<http://www.microcare.com>

DELPHI
INTERNET™

Get online
with
ELECTRONIC
Servicing & Technology
on Delphi!

To sign up dial **1-800-365-4636**
with your computer & modem, and enter
ELECTRONIC at the signup password
prompt! You can find CQ VHF Magazine in
the Radio & Electronics Forum (GO RADIO).

Circle (99) on Reply Card



If you're planning a move in the near future, don't risk missing an issue of ES&T Please give us 6-8 weeks notice if you're planning on changing your address. Just write your new address and mail it, WITH YOUR SUBSCRIPTION MAILING LABEL, to:

Electronic Servicing & Technology
76 North Broadway, Hicksville, NY 11801

National Computer Association, Inc.

The National Computer Association brings together computer professionals to promote matters of importance to you. We want to make the computer industry a better place for our members to work, while increasing the confidence of the public that buys from them.

Please See Our Ad on Page 51
or Visit Our Website at www.nca-net.com

1-800-615-6224

ADVERTISERS' INDEX

Company	Page Number	Reader Service Number	Advertiser Hotline
ACM Company	55	62	516/395-4862
CAIG Laboratories	22,26	63	800/CAIG-123
Computer & Monitor Maintenance	45	64	800/466-4411
Dalbani Corporation	51	65	800/325-2264
Delphi Internet	64	99	800/365-4636
Electronic Servicing & Technology Books	60		800/853-9797
Electronic Software Developers, Inc	16	84	800/621-8477
Electronics Technicians Association	53	85	317/653-4301
Electronix Corporation	64	66	513/878-1828
Fox International	39	67	800/321-6993
Herman Electronics	59	68	800/938-4376
Higher Intelligence	57	83	800/215-5081
ISCET	57		817/921-9101
International Components Corp.	64	69	800/645-9154
MCM Electronics	41	72	800/543-4330
Microcare Corporation	25,64	70	800/638-0125
NCA/National Computer Assn.	51,64	71	800/615-6224
PTS Corporation	7	74	800/844-7871
Panasonic Services Company	53	81	800/833-9626
Parts Express	55	73	800/338-0531
Philips Software Development	IFC	117	423/475-0393
Philips Service Company	IBC	120	800/851-8885
SBS Direct	44	76	800/603-9000
Sams & Company, Howard	49	119	800/428-7267
Sencore	19,21, 23,BC	77,78 79,1	800/SENCORE
Sony Technical Services	9	80	816/891-7550
Telematic	16	82	718/271-5200
Thomson Consumer Electronics	3	113	800/336-1900
Tritronics	61	86	800/638-3328
Wavetek	5	97	800/854-2708

We'd like to see your company listed here too. Call Diane Klusner at 516/681-2922 or E-Mail her at dianekest@aol.com to work out an advertising program tailored to suit your needs.



SALES OFFICE

PHONE (516) 681-2922

FAX (516) 681-2926

**Smart
Accessories**
The Intelligent Choice

Dumb Accessory

Smart Accessories



Do the Smart Thing. Sell Philips Accessories and Make More Money Now.

When you sell Philips Smart Accessories you're really using your head. That's because Smart Accessories give your customers all the extras they want—while adding a little extra to your bottom line.

So, get on top of the game and call the Philips Sales Center to order Philips Smart Accessories—your one-stop shop for parts, accessories and service aids. Anything else just isn't very smart.

To place your order call **1-800-851-8885** today.

401 E. Old Andrew Johnson Highway, P.O. Box 555, Jefferson City, TN 37720 • Fax 1-800-535-3715

**NPSC 97
Vegas
Booth 401**

Let's make things better.

Circle (120) or Reply Card



PHILIPS

Streamline Your Service Center!

Service Assistant¹⁶
by Sencore

NPSC 97
Vegas
Booth 601

The First Fully Integrated, Windows™ Based Business Management Software System That's Guaranteed To Streamline Your Repair Processing By 50% Or More For Increased Profits And Productivity!

Service Assistant is the only fully integrated business management tool for today's electronic service center. From customer drop off to customer pick-up, Service Assistant gives you a complete tracking system that allows you to quickly monitor the status of any job, as well as assist you in managing your entire service operation, including;

- Windows™ Based Operation
- Technician Productivity
- Accounts Payable
- Purchasing & Check Printing
- Full Data Import/Export
- Service Call Scheduling
- Time Spent On Repairs
- Accounts Receivable
- Complete Inventory Processing
- And Much, Much More

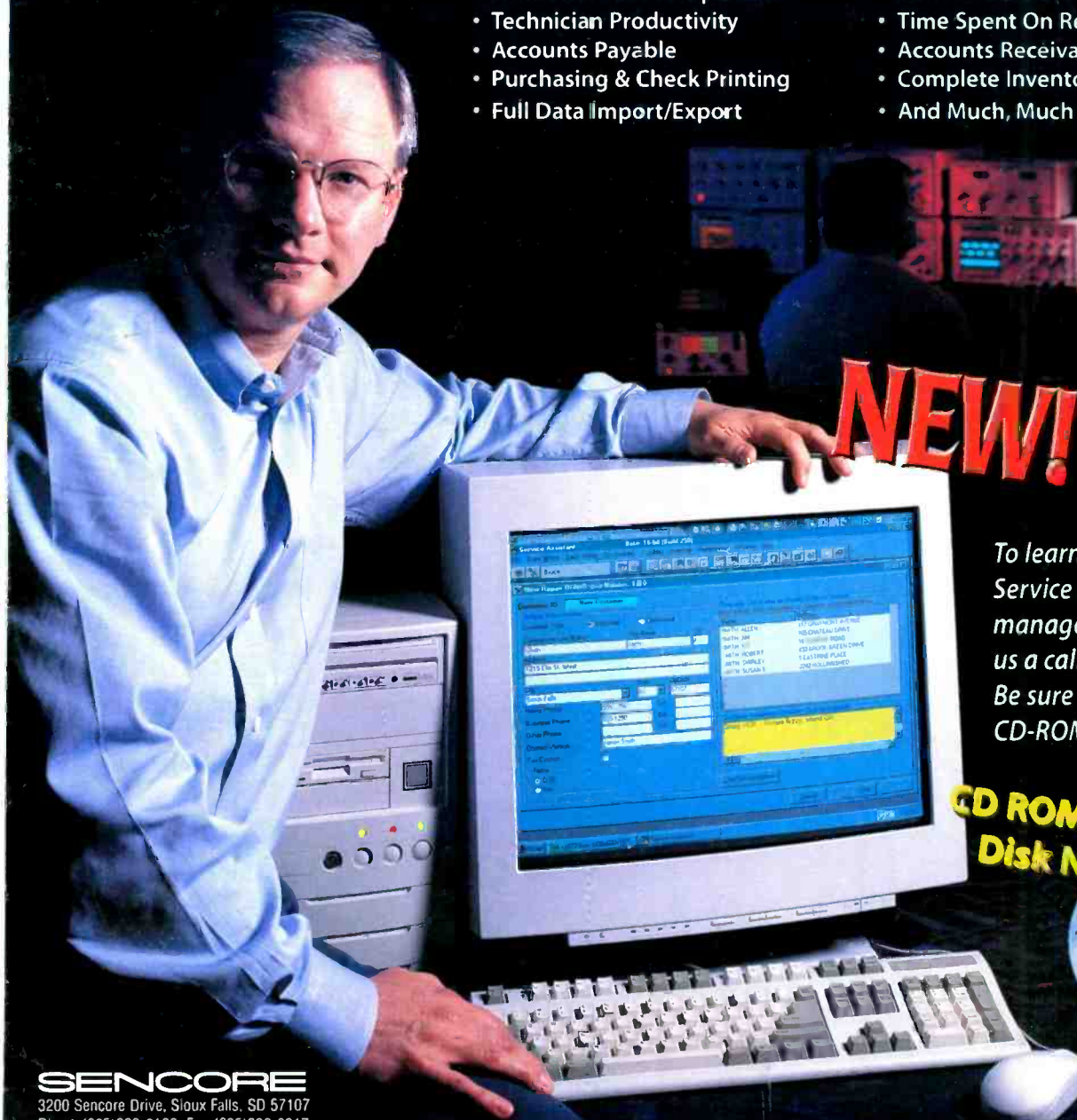

To learn more about the New Service Assistant business management software, give us a call at **1-800-SENCORE**. Be sure to ask about our CD-ROM demonstration disk.

CD ROM Demonstration Disk Now Available!



SENCORE
3200 Sencore Drive, Sioux Falls, SD 57107
Direct: (605)339-0100 Fax: (605)339-0317

Circle (1) on Reply Card