

THE PROFESSIONAL MAGAZINE FOR ELECTRONICS AND COMPUTER SERVICING

ELECTRONIC^{T.M.}

Servicing & Technology

September 1992/\$3.00

Servicing high and low circuits in RCA's CTC 110 chassis

Working with microcomputer display technology

Choosing a multimeter for today's
electronic troubleshooting

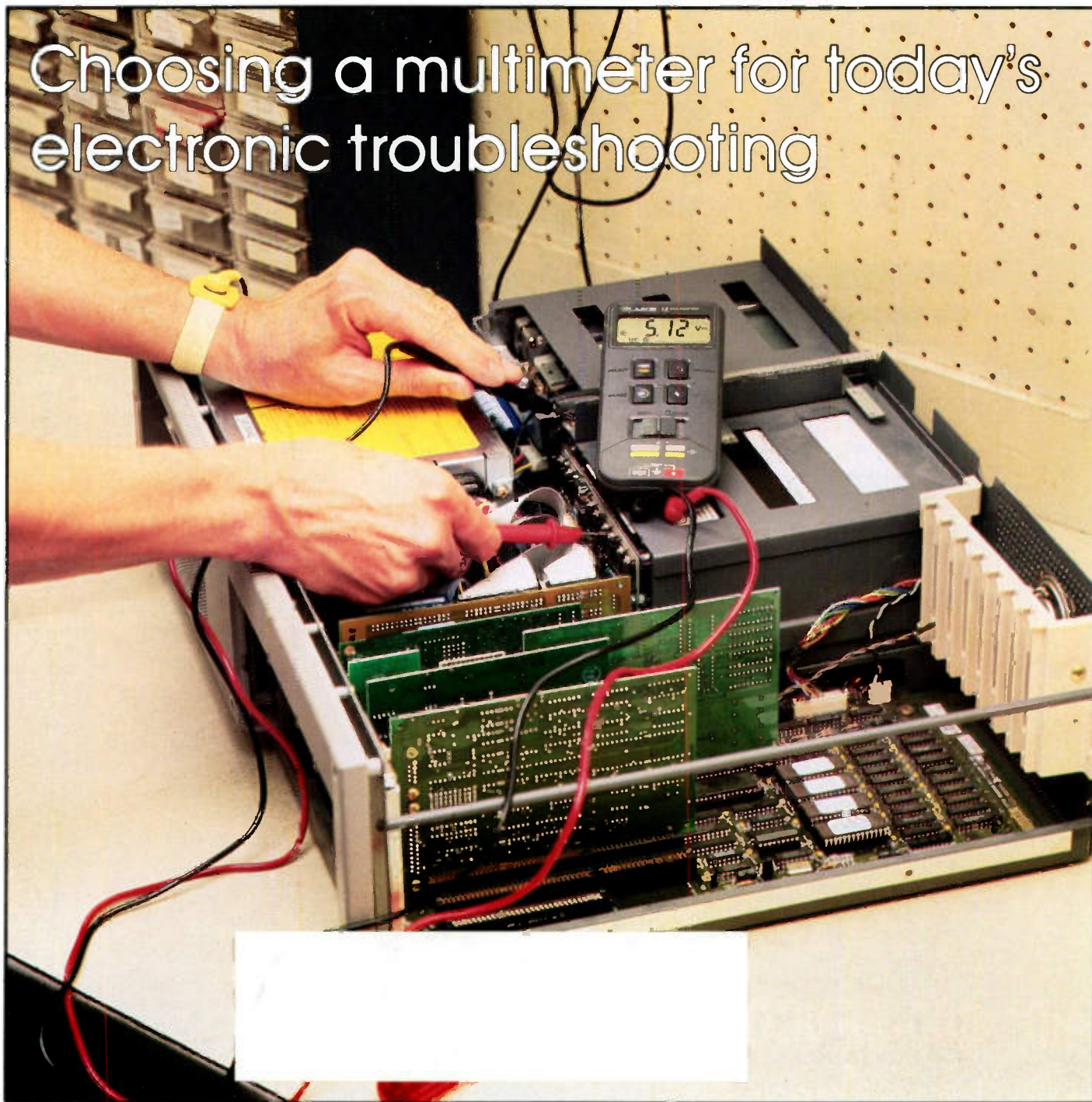

Twice The Power In One Video Analyzing System!

New!

Finally, there is a full featured, compatible, and complementary analyzing system specially designed by servicers for servicers. This new system provides over twice the analyzing power of any combination of non-integrated instruments you can find. At Sencore, we call it the "Tech Choice System".



Introducing The TVA92 TV Video Analyzer

Now Everything You Need To Isolate TV Defects, Troubleshoot Start-up/Shut-down Problems, And Test Expensive Components. Plus, Accurately Estimate TV Repair Cost.



And, Introducing The VG91 Universal Video Generator

A Complete All Channel RF/IF/MTS Universal Video Generator Designed To Performance Test And Isolate Defects In Any NTSC Video System!

Circle (57) on Reply Card

You can custom design your bench to fit your individual analyzing needs and add to the package as your business needs grow. Plus, with Sencore's exclusive commitment to the service industry, you are assured that your system investment will protect your business with additional income and upcoming complementary instruments.

Call 1-800-SENCORE (736-2673) ext. 731

SENCORE

THE CHOICE

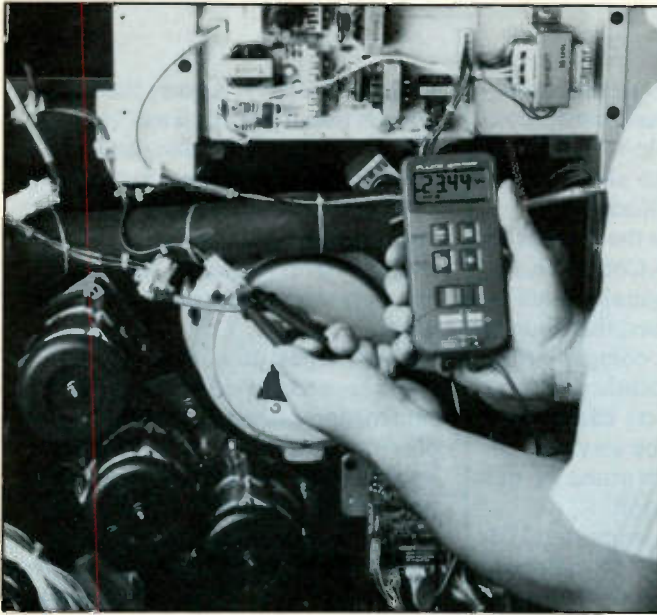

page 15

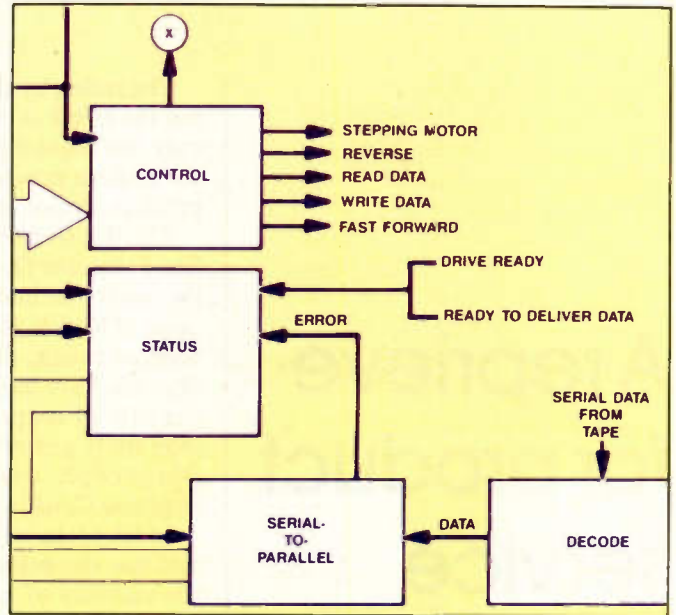

page 56

FEATURES

- 8** **Equipment and methods for PC board servicing**
By Bob Kral
This article focuses on the instruments required for today's PC board troubleshooting. This article will give you a better idea of the type of equipment best suited for your organization.
- 15** **Choosing a multimeter for today's electronic troubleshooting**
By Bob Greenberg
As many technicians know, the techniques of troubleshooting electrical and electronic equipment have changed significantly in the last 15 years. Read this article to help choose the right tool for you.
- 19** **A homemade isolation transformer to cure H-K shorts**
By R.D. Redden
Many service technicians encounter a TV set with a heater to cathode (H-K) short. By reading this article you will be able to make yourself an isolation transformer which will allow you to restore the set to almost perfect operation.

- 20** **Servicing high and low voltage circuits in RCA's CTC 110 chassis**
By Homer L. Davidson
The horizontal switch, trigger, inverter and driver circuits in the CTC107, CTC108, and CTC109, are all identical to the same portions of the CTC110. Once you've learned to deal with the high-voltage and low-voltage circuits in the CTC110, you'll be able to use this knowledge on the other sets as well.
- 26** **Microcomputer Display Technology**
By John A. Ross
This article will provide you with vital information on CGA video cards and monitors. Even though many users have progressed to higher resolution monitors, many of the older type displays are still around and require servicing.
- 60** **Making tools out of unusual raw materials**
By Sheldon Fingerman
Many technicians with a little ingenuity have a favorite tool that they themselves have designed. Read this article and see how you can turn certain items into a number of different helpful gadgets for electronic servicing.

- 4** Literature
- 6** News
- 31** Profax
- 49** Tell us about your success story
- 50** Successful servicing
- 53** Test Your Electronics Knowledge
- 54** Computer Corner
Computer motherboard repairs
- 56** What Do You Know About Electronics?
Mass-storage continued
- 62** Audio Corner
Tricks enhance audio performance
- 63** Products
- 64** Books
- 66** Readers' Exchange
- 68** Advertisers' Index

ON THE COVER

The nature of electronics servicing continues to change, and this influences the nature of the test equipment used in servicing. Much field service has shifted to outright circuit board replacement. The technician is only interested in verifying whether a particular signal or voltage is present. A low cost handheld digital multimeter is frequently adequate for this task. (Cover photo courtesy of John Fluke Manufacturing Co.)

THE PROFESSIONAL MAGAZINE FOR ELECTRONICS AND COMPUTER SERVICING

ELECTRONIC
Servicing & Technology

DEPARTMENTS

- 2** Editorial

A reprieve for product service

On June 8, 1992, the United States Supreme Court ruled 6 to 3 in the case of Image Technical Services, Inc., et al vs Eastman Kodak that a manufacturer may not force someone who buys one of its products to purchase another of its products or services.

You may remember that in the editorial in this magazine in October 1991, we reported that a California company named Image Technical Service (ITS), which services office equipment, had sued Eastman Kodak Co. in an attempt to force Kodak to sell replacement parts to them.

Back in 1985, ITS was servicing Kodak equipment such as microfiche readers and microfilm equipment. ITS became so successful in competing with Kodak's own service organization that Kodak halted sales of replacement parts to independent servicers throughout the U.S. A lawsuit brought by ITS and others was thrown out by a federal judge in San Francisco. Subsequently, an appellate panel ordered it back for trial. The Supreme Court had agreed to hear Kodak's appeal for dismissal.

The ruling by the Supreme Court, has the effect in this case that Kodak may not require people who bought their office products to also buy the product service from Kodak.

This decision returns the case to the San Francisco District Court. This is the court that had originally ruled in favor of Kodak. However, that court's original ruling, that a company that does not have monopolistic power in the sale of its products can't have monopoly power in the servicing of that product, was overturned by the Supreme Court's decision.

Much of the work in support of ITS and this successful fight to maintain the viability of independent service was performed by the California State Electronics Association (CSEA) and the National Electronic Sales and Service Dealers Association (NESDA), and benefited all independent servicers. NESDA's financial contribution to this effort has been repaid through large donations by some of its members, but CSEA is still facing a large bill.

Because this effort benefited all independent service, it only seems right that all independent service organizations help to pay for the effort. If you'd like to contribute to this effort, you can contact one of the organizations named below.

National Electronic Servicing Dealers Association (NESDA)
2708 W. Berry Street
Ft. Worth, TX 76109
817-921-9062

California State Electronics Association (CSEA)
10564 Progress Way, Suite E
Cypress, CA 90630
714-827-4986
Fax: 714-827-5630

We've just gotten bigger

Count the pages in this issue. You'll note that there are eight more pages than we have been publishing in Electronic Servicing & Technology. Future issues will be this size. We've increased the page count for a number of rea-

sons. For starters, readers have complained that there just wasn't enough "meat" to the magazine, and we've been listening. For another reason, consumer electronics servicing and the products serviced have changed dramatically over the years. At one time, products serviced consisted of TV and radio.

Over the past decade or so manufacturers have added video games, VCRs, camcorders, laser disc players, CD players, satellite TV and more. Even an eight page increase is not in proportion to the increase in products serviced, but it's a start, and it will enable us to publish 13 percent more articles every month, to help service technicians do the difficult work of product servicing.

A special schematics issue

Something else we're doing to make this magazine an even better value for readers is to publish a special issue once a year, in addition to the twelve regular monthly issues that we publish each year.

Readers have told us over and over again that the two biggest problems that they face are finding servicing information and finding replacement parts. This special extra issue will consist of nothing but schematic diagrams of TVs, camcorders, VCRs, plus a listing of manufacturers, with addresses and telephone numbers that will help readers locate sources of replacement parts.

These schematics will be all new, not published in regular issues. And they will be more complete than the diagrams we ordinarily publish in a monthly issue. For example, the schematic diagrams for a single camcorder took 12 pages, but this will help those technicians who have not been exposed to camcorder schematics to be able to see all of the circuitry instead of just a portion of it.

This issue will be sent to all current subscribers, and everyone who subscribes in the next 12 months.

Nile Conrad Pearson

LIFE SAVER

Handheld NTSC Pattern Generator LCG-412B

That's what an enthusiastic user calls it. Carries it in his pocket for on-the-spot checks of color monitors in hospitals and operating theaters. A truly portable source of NTSC test signals, the LCG-412B provides baseband video, VHF and UHF.



- ★ Phono jack delivers *baseband video* into standard *75Ω* loads
- ★ F connector delivers *VHF and UHF*
- ★ AC adapter jack for bench use or 6 "AA" cells for field use
- ★ Slide rule dial spots *VHF and UHF* channels
- ★ Intercarrier sound at *1 kHz* for TV and VCR audio checks
- ★ Full-field color bars *real NTSC* not NTSC "type"
- ★ Crosshatch and dots to converge color monitors and TV sets
- ★ Corner marker for correct yoke connections — vital for large-screen projectors
- ★ 100% white raster or fully-saturated red, green and blue for beam-landing checks

Leader
is a Major Supplier to the
Professional Video and
Broadcast Industries

Call toll free
1 800 645-5104
In NY State 516 231-6900

LEADER
FOR PROFESSIONALS WHO KNOW
THE DIFFERENCE

Leader Instruments Corporation, 380 Oser Avenue, Hauppauge, New York 11788
Regional Offices: Chicago, Dallas, Los Angeles, Atlanta. In Canada call Omnitrion Ltd., 416 828-6221

Circle 47 For Product Information Only

Circle 46 For Product Information and Demonstration.

EIA/CEG promotes career opportunities with "The Power Profession: Your Career As An Electronics Technician"

It's graduation time . . . what's the next step to pursue a successful and respected career?

According to "The Power Profession: Your Career as an Electronics Technician," there are great career opportunities in the field of consumer electronics and product servicing.

A new publication released by the Product Services Department of the Electronic Industries Association's Consumer Electronics Group (EIA/CEG), "The Power Profession" is designed for students at the secondary level, as well as for educators and counselors. It contains industry statistics, information regarding vocational training programs and information about pursuing a career as an electronics technician.

"There is a world of opportunity in the field of consumer electronics for a service technician," says Don Hatton, staff vice president, EIA/CEG Product Services. "The demand is out there. Consumers are investing in more and more electronics products, and as a result, there is an increasing need for technicians to service those products."

The booklet states that, according to the U.S. Department of Labor, employment opportunities for electrical/electronics technicians are expected to grow 34%, and technician careers in data processing equipment will grow 60% by the year 2005.

Circle (97) on Reply Card

Conformal coating removal bulletin

A new technical bulletin is offered by Dynaloy which addresses the chemical removal of conformal coatings. The 6-page bulletin outlines specific chemical removal techniques for polyurethane, silicone, acrylic, epoxy, parylene, and UV-cured type conformal coatings from printed circuit boards and other substrates. Also included in the bulletin are two, full-page solvent selection guides that list recommended solvents and approximate removal times for many manufacturers' conformal coatings.

Circle (98) on Reply Card

Tool kit, test equipment

Techni-Tool announces their 240 page Catalog 42, with easy to follow icons, is filled with more than 18,000 items from over 850 manufacturers. You can find anything you need from electro mechanical and assembly devices to electronic, telecommunication and field service tool kits. They also carry a full-line of items for aerospace production, computer maintenance and the fast growing field of surface mount technology. Also offered is a complete line of ESD, static control and clean room items.

Circle (99) on Reply Card

1992 edition of the U.S. Consumer Electronics Industry in review available

The Consumer Electronics Industry has had a great impact on both the way Americans spend their leisure time and the way they become aware of events unfolding around the world.

98% of all American households own at least one TV, and more than 60% own two or more. 77% own a VCR, 94% own an audio system, and 46% own a telephone answering device.

This information and more is available in the 1992 edition of the *U.S. Consumer Electronics in Review: Entertainment and Education — Yesterday, Today and Tomorrow*, which provides an introduction to one of America's most dynamic and innovative industries. Compiled by the Electronic Industries Association's Consumer Electronics Group, this annually-updated profile and history of its rapidly-changing industry, estimated at \$47 billion at retail, traces the development of consumer electronics by product, categories such as video, audio, home information equipment, accessories, assistive devices and more.

In addition, this authoritative source of information contains useful statistics on industry-wide sales trends, product by product. All data were compiled by the Electronic Industries Association's Marketing Services Department, which has developed comprehensive statistical reporting programs for over three decades.

Circle (100) on Reply Card

THE PROFESSIONAL MAGAZINE FOR ELECTRONICS AND COMPUTER SERVICING

ELECTRONIC

Servicing & Technology

Electronic Servicing & Technology is edited for servicing professionals who service consumer electronics equipment. This includes service technicians, field service personnel and avid servicing enthusiasts who repair and maintain audio, video, computer and other consumer electronics equipment.

EDITORIAL

Nils Conrad Persson, *Editor*
Jeffrey Uschok, *Assistant Editor*

CONSULTING EDITORS

Homer L. Davidson, *TV Servicing Consultant*
William J. Lynott, *Business Consultant*
Victor Meeldijk, *Components Consultant*
John E. Shepler, *Audio Consultant*
Sam Wilson, *Electronics Theory Consultant*

PRODUCTION

Elizabeth Ryan, *Art Director*
Barbara Terzo, *Assistant Art Director*
Susan Reale, *Artist*
Edmond Pesonen, *Electronic Composition Mgr.*
Dorothy Kehrwieler, *Production Manager*
Emily Kreutz, *Production*
Pat Le Blanc, *Phototypographer*
Florence V. Martin, *Phototypographer*

BUSINESS

Richard A. Ross, *Publisher*
Jonathan C. Kummer, *Associate Publisher*
Dorothy Kehrwieler, *General Manager*
Frank V. Fuzia, *Controller*
Catherine Ross, *Circulation Director*
Melissa Kehrwieler, *Data Processing Manager*
Carol Licata, *Data Processing*
Denise Pyne, *Customer Service*

SALES OFFICE

Electronic Servicing & Technology
76 N. Broadway, Hicksville, NY 11801
516-681-2922; Fax, 516-681-2926

Jonathan Kummer, *Advertising Manager*
Emily Kreutz, *Sales Assistant*



Member, Electronic Servicing Dealers Association



ASSOCIATION FOR SERVICE MANAGEMENT INTERNATIONAL

EDITORIAL CORRESPONDENCE

P. O. Box 12487
Overland Park, KS 66212
913-492-4857

Electronic Servicing & Technology (ISSN 0278-9922) is published monthly by CQ Communications, Inc., 76 N. Broadway, Hicksville, NY 11801. Telephone (516) 681-2922. Second class postage paid at Hicksville, NY and additional offices. Subscription prices (payable in US dollars only): Domestic—one year \$24, two years \$40. Foreign countries—one year \$30, two years \$52. Entire contents copyright 1992 by CQ Communications, Inc. Electronic Servicing & Technology or CQ Communications, Inc. assumes no responsibility for unsolicited manuscripts. Allow six weeks for delivery of first issue and for change of address. Printed in the United States of America.

Postmaster: Please send change of address notice to Electronic Servicing & Technology, 76 N. Broadway, Hicksville, NY 11801.

CQ Communications, Inc. is publisher of CQ The Radio Amateur's Journal, Popular Communications, ComputerCraft, CQ Radio Amateur (Spanish CQ), CQ Amateur Radio Equipment Buyer's Guide, CQ Amateur Radio Antenna Buyer's Guide, Popular Communications Communications Guides, and Electronic Servicing & Technology.

The DMM our customers designed.



Before we built the new generation Beckman Industrial Series 2000 DMMs, we asked people like you what you *really* want.

You want more. More test and measurement capabilities. More troubleshooting features. All in an affordable hand-held DMM. The Series 2000 features the widest range Frequency Counter in any professional DMM, a full-range Capacitance Meter, True RMS measurements, Intermittent Detection, 50ns Pulse Detection, and Peak Measurement capabilities. Plus, the Series 2000 is the only meter to offer autoranging Min/Max recording and relative modes.

You want a DMM that's easier to use. The Series 2000's display is 25% larger, with bigger digits and backlighting for easier reading, even in the worst light. Plus the fast 4 digit display provides the high resolution needed for adjusting power supplies and generators down to 1mV. And only the Series 2000 features a menuing system for fast, simple feature access.



Made in the USA

The Beckman Industrial Series 2000, priced from \$209 to \$279 offers you the best performance for your dollar. Look again at these features:

- 4 Digit, 10,000 Count Resolution
- Basic Accuracy to 0.1%
- True RMS, AC or AC on DC
- 0.01 Ω Resolution
- Automatic Reading Hold
- 1ms Peak Hold
- Fully Autoranging Relative and Min Max Modes
- Intermittent Detector
- UL1244, IEC1010 Design
- Three Year Warranty

The Series 2000 offers the most solutions for your everyday test and measurement needs. The only DMMs designed by the people who use them. You.

For more information on these new DMMs call (outside CA) 1-800-854-2708 or (inside CA) 1-800-227-9781. Beckman Industrial Corporation, 3883 Ruffin Rd., San Diego, CA 92123-1898.



Beckman Industrial™

An Affiliate of Emerson Electric Co.

Specifications subject to change without notice.
© 1992 Beckman Industrial Corp.

Fiber optic installer referral network

Fotec, Inc. the Boston-based fiber optics test equipment company, is expanding its referral network for fiber optic installers. The network provides potential fiber optic users with an extensive list of fiber optic installers throughout the USA, from which they can choose an installer for their network.

Fotec began referring customers to installers informally many years ago," according to Jim Hayes, Fotec founder and President. "We had many customers who were contractors doing fiber optics installations, so we just gave their names to end users needing their services. Two years ago, we formalized the network on a fee basis to participating installers and began publishing a list of 150 contractors who participated. The program has been so popular, we are now expanding the service to all contractors involved in fiber optics at no cost to them and we are considering holding an annual training conference for our network members."

Contractors interested in being list-

ed with the Fotec Fiber Optic Installer's Network should contact Louise Downing, Network Coordinator, at 800-537-8254 to obtain a qualification questionnaire. End users interested in hiring fiber optic installers can contact the Fotec sales department at 800-537-8254 to request a copy of the current listing. For more information on the program itself, contact Jim Hayes at 800-537-8254.

New SDA officers announced

The following were elected to serve during the 1992-1993 year in the Satellite Dealer's Association (SDA): Gary Moller, CSI, Owner of Satellite System Sales, 1077 Fresno, Hot Springs, SD, was elected Chairman. He is 56 years old and served as Technical Committee Officer during SDA's first year.

Vice Chairman is Larry Hulsey of Hulsey and Hulsey, 2800 Browns Ferry Rd., Gainseville, GA. Larry served as External Affairs Officer during SDA's first year.

The Secretary position remains with David White of Mid OH Satellite in

Dublin, OH. Address is 7780 Strathmora, 43015.

Treasurer position also is taken by a second term officer: Mr. Roger Duquette of TWR Satellite, 218 Keddy St., Springfield, MA 01109.

Conference Committee Chairman is Mark Booth, CSI, of North American Satellite Associated, Rt 11, Box 11, Lake Charles, LA, 70601.

1993 Technical Committee Officer is Gary Cope, owner of Ohio Valley Micro-Cablevision, 145 Oak Meadow Dr., Pataskala, OH 43062.

Zoning Committee Officer is Greg Woods, owner of the Satellite Shop in Whitetown, IN. Address is: Rt 1 Box 307, 46075.

Additional officers rounding out the new Board of Directors are the Presidents of three of the affiliated state associations not already represented in other officer positions: They are: Joseph Lester, Lester's Satellite, 13412 Darrow Rd in Vermillion, OH. Karl Mavis, CET, Mavis Communications, PO Box 282, Auburn, IN. Harold Richard, Sat-Com of Louisiana, 943 E. Simcoe, Lafayette, LA. 70501.

All Nine Most-Used Measurements, By One Multimeter: DM-38!



Ideal for field, lab and shop. Measures capacitance, frequency, logic, transistor hFE, AC/DC voltage and current, resistance, semi junctions and continuity. 3-3/4 digit with peak hold, 0.5% accuracy. At 900 Philips ECG distributor locations or call 1-800-526-9354.



Philips ECG



PHILIPS

Circle (52) on Reply Card

ECG® Replacement Parts And Tools Fit 31 VCR Brands.



New catalog covers RF modulators, VHS and Beta heads, idler wheel assemblies, pinch rollers, belts, opto-sensing devices and more. All meet or exceed OEM specs. Lists over 2400 crosses. Service aids include test cassettes, jigs, tools, cleaning materials.

Ask for a copy at 900 Philips ECG distributor locations or call 1-800-526-9354.



Philips ECG



PHILIPS

Circle (53) on Reply Card

The above officers will serve until the 1993 annual satellite convention, planned again for New Orleans in June or July. Elections took place at the July 8-11 1992 ETA/SDA national convention, Clarion Hotel, New Orleans, LA.

Seminar and handbook explain VXI instrumentation standard

National Instruments announced today a new free seminar and accompanying 92-page seminar handbook titled "An In-depth Seminar on the VXIbus Instrumentation Standard." In both seminar and handbook, the company summarizes the development history of VXI, covers such topics as VXI backplanes and protocols, and explains how test engineers can combine embedded or external VXI hardware and software products to build smaller test systems with improved performance over conventional test systems.

The three-hour seminar and handbook are divided into several sections, VXI Specification, VXI System Configurations, and VXI Software. The VXI Specification section includes topics such as VXI module sizes, mainframe and extension requirements, programming requirements, and different types of VXI devices. VXI System Configurations explains the different system control options - embedded PC-based control, distributed control with embedded real-time computers, GPIB control, and external VXI controllers consisting of off-the-shelf PCs and workstations with the MXIbus high-speed interface. This section also describes how to design multiple-mainframe VXI systems. VXI Software explains the importance of software selection of designing a VXI system and educates readers about the advantages and disadvantages of specialized versus open software packages.

Electronics technician competition winners

Sharp Electronics recently named the seven winners of its Consumer Electronics Master Technician Competition, recognizing them as the best Sharp consumer service technicians in the nation.

The winners from the television/LCD (Liquid Crystal Display) projec-

tor service category were: Peter Mayerhoffer and Christopher Gerrick of Electra-Sound, Inc. in Parma, OH, Michael Emmons of Norman's Electronics in Chamblee, GA and Rick Jones of Jones TV in Jonesville, LA. The winners from the VCR/camcorder category were: Stan Redwine of Norman's Electronics in Chamblee, GA, Ted Phelps of American Consolidated Electronics in Indianapolis, IN and Kurt Schweiker of Tandy Corporation in Bethlehem, PA.

The competition comprised three phases. In the first phase, the participants of the competition were nominated from Master Service Stations and selected servicing dealers. Up to four technicians from each of these service organizations could be nominated to participate - a maximum of two technicians each for the television/LCD projector and VCR/camcorder service categories. Phase two involved a written test given in 12 cities. ■

"You need it? PTS has it!"

PTS Electronics has the nation's largest inventory of modules, motherboards, chassis, and projection TV chassis.



More professionals call PTS for all major makes of Projection TV chassis, modules, and motherboards than any other source. PTS Electronics was founded by TV technicians in 1967 as a

tuner rebuilding company. We have grown and adapted to meet the needs of today's technicians. Today, PTS Electronics is the #1 source for all leading brands of modules, motherboards, and chassis. And we still do tuners!



Thousands of chassis, modules and motherboards are in our giant warehouse, in-stock for immediate delivery. Ask about overnight shipping and nationwide distributors.



Call PTS toll free. We will instantly check the nation's largest computerized in-stock inventory. We're able to say "We've got it!", more than any other supplier.

PTS Electronics

CALL PTS TODAY! 800-844-7871 800-331-3219

EAST

PTS Electronics Corporation
5233 37 South,
Bloomington, IN 47402

WEST

PTS Electronics Corporation
4941 Allison St., #11,
Arvada, CO 8002

Equipment and methods for PC board servicing

By Bob Kral

It wasn't long ago when only a few pieces of test equipment were needed (and available) for repairing electronic equipment. Electronic paleontologists will tell you most test benches were stocked with an oscilloscope, VOM, power supply, function generator, frequency counter, and perhaps a dinosaur or two, including a tube tester. Whether you were a design engineer or service technician, you probably used the same type of equipment.

Time and evolution very quickly drove many pieces of test equipment to extinction, and did the same with many service establishments.

From 1977 to 1987, 90% of the one- and two-man TV service centers mysteriously disappeared. Or was it mysterious at all? The complexity and diversity of electronics increased dramatically.

Erstwhile "tube jockeys" were forced to troubleshoot at the component level. It became impossible for one man to know enough to expertly troubleshoot a wide variety of products. Integrated circuits proliferated, which slowed troubleshooting. Turnaround time lengthened, and it became less expensive to buy a new piece of equipment than to have the old one repaired. The experience, education, and equipment became inadequate for the task at hand.

This scenario is indicative of very real dilemmas faced today by service establishments. If the technical staff and test equipment has been more or less fixed, and the equipment coming in for servicing is changing, what new instruments or people are needed in order to continue to service products profitably at a price customers are willing to pay? The answer is not the same for all establishments.

This article will focus on the instruments required for today's PC



Figure 1. Low-cost functional IC testers can work in-circuit or out-of-circuit. A functional tester is being used here to troubleshoot a microprocessor-based board.

board troubleshooting. It will examine standard bench instruments, analog signature analysis, and functional automated test equipment (ATE), including card edge testing, functional IC testing, bed-of-nails testing, and emulation testing. Each method's technical strengths, shortcomings, and costs will be discussed. Time, experience, and education needed to set up the equipment and perform the tests will be presented. This article is intended to give you a better idea of the type of equipment best suited for your organization.

Basic bench instruments

Traditional test equipment, including oscilloscopes, signal generators, and multimeters, are useful for isolating problems to a specific stage or section of a malfunctioning electronic product. Inexpensive additions to this

standard assortment of equipment may include a logic probe, pulser probe, IC comparator, and logic monitor.

An IC comparator is a simple device that compares an IC, in-circuit or out-of-circuit, to a known good IC. Because of their limited capabilities, IC comparators have been displaced to a great extent by low-cost functional testers, ranging as low as \$3,000, depending on their capabilities (Figure 1).

A functional tester compares the IC under test to its truth-table, stored in the tester's memory, automatically indicates pass or fail, and identifies failed pins. In other words, it tests the *function* of the IC. Known-good ICs are therefore not required.

Using an IC comparator and logic monitor, along with an oscilloscope, DMM, and pulser probe, is the least expensive way in terms of equipment cost, to troubleshoot digital circuits.

Kral is Marketing Product Manager for B&K Precision

The nature of discrete logic circuits requires that the technician work forward through the unit, rather than backward: if an IC near the beginning of a logic path is malfunctioning, and is not capable of changing logic outputs, none of the ICs that follow will show changing logic states.

Of course, an IC must be operating if the technician is to check it. If logic states are not changing, false test results may be generated, which may lead the technician to incorrectly suspect that another IC is defective.

If the technician suspects that an IC may be malfunctioning due to a problem earlier in the circuit, he should use the logic monitor to determine whether logic states are changing as they should. If the clock speed of the IC is very fast, the monitor's LEDs may appear to be constantly lit, and an oscilloscope must be used to check the outputs.

It is not usually necessary to test every IC in a malfunctioning circuit (with a schematic or block diagram, the process can be focused on a few suspect ICs). Nevertheless, troubleshooting complex logic circuits with simple basic equipment is time consuming, and the required skill level is high. These instruments are inadequate if a service establishment routinely encounters boards packed with integrated circuits or if the personnel turnover rate is high.

Analog signature analysis

For establishments engaged in PC board repair, an "analog signature analyzer" (Figure 2) is a useful low-cost addition that will speed troubleshooting significantly.

The analog signature analyzer is probably the only low-priced piece of equipment that can be used universally on all components. Digital ICs, analog ICs, custom ICs, capacitors, resistors, diodes, or transistors can all be checked. However, it is a qualitative tool. A known good board must usually be available, at least to learn typical signatures, or until someone in the technical staff develops enough experience to feel comfortable without the good board on hand.

Analog signature analysis is effective for troubleshooting PC boards or components with power off. An ac signal is applied to the device under test, and a graph is then displayed that shows how current varies as a function of the applied voltage.



Figure 2. Signature analyzers can be used without known good components for comparison. This is especially true when testing discrete components out-of-circuit

Figure 3 shows this V/I relationship for several common components. These signatures will be different if the components are tested in-circuit, connected to other components. Figure 4 shows the signatures of common combinations of components. For ICs or discrete components in circuit, the component under test is usually compared directly to a known good component.

Catastrophic failures are easy to spot. Shorts appear as vertical lines, while open circuits appear as horizontal lines. However, marginal components are more difficult to identify. Signatures of good components are crisp with sharp corners. Signatures of defective components are usually distorted.

Through experience, many technicians are able to recognize defective components' signatures at a glance, without a known good component signature for comparison. This is especially true when checking discrete components out of circuit. However, time is needed to learn the technique, and to become comfortable with it.

Analog signature analysis equipment varies in cost from \$1000 to \$5000 or more. The better equipment allows the technician to select from a wide range of test voltages and frequencies. This feature is absolutely necessary in order to be able to test a wide range of components.

Some signature analyzers allow storage of known-good signatures on a personal computer, and provide report generation and record keeping

capabilities. If your universe of PC boards is somewhat repetitive, computer storage of good signatures allows even inexperienced technicians to troubleshoot quickly and effectively using the analyzer.

The shortcoming of the signature analyzer is discovered when testing ICs. It is not a functional tester. Variations between manufacturers (and manufacturing processes) of the same IC can often lead to differences in pin signatures, even though the ICs may be functionally equivalent and operating normally.

The cost of a signature analyzer is reasonable, but time will be required to learn the technique. Most technicians can learn to spot catastrophic failures in a matter of minutes. Marginal components will be more difficult to pinpoint; it will become easier only through experience. While experience (training) is essential, the skill level required to troubleshoot PC boards using analog signature analysis is minimal.

Functional automated test equipment (ATE)

Another method of testing in the service arena is functional ATE. This form of test generally requires greater capital investment but provides greater diagnostic capabilities, data storage facilities, and process consistency. One of the primary goals of automating the test process is increased throughput.

With proper application of func-

tional ATE this goal can be achieved and, through automation and user-friendly interfaces, with lesser skilled operators. Functional ATE for service falls into three main categories: functional IC testing, card-edge testing, and bed-of-nails testing.

A powerful combination of equipment is an analog signature analyzer combined with a functional IC tester (Figure 5). Functional IC testers are used to verify the functionality of each individual integrated circuit on a PC board. Most functional IC testers interface to the device under test (DUT) via some sort of clip-type adapter. This type of interface is not only quite reliable, it is also flexible and cost-effective.

A functional IC tester has an internal library of IC's. It tests an IC by applying all possible combinations of inputs and checking the IC's outputs. Out of circuit, the test is nearly fool-proof, limited only by the pin count of the tester and the scope of its library. In circuit, there can be problems if an IC is hard wired in such a way that the IC tester cannot execute the IC's standard truth table.

This problem can be circumvented if the functional tester has a "learn" mode. In a "learn" mode, the tester's IC clip is affixed to the IC in-circuit on a known good board, and the truth table responses are learned in-circuit. This truth table can then be stored in memory, and recalled whenever that

IC has to be tested on that particular board. This is invaluable when a service organization does a lot of repetitive testing.

This method of testing greatly simplifies the programming effort, shortens the test development or modification cycle, and increases the flexibility of the test instrument. Prices for functional IC testers have become much more affordable, ranging from about \$3,500 on the low-end to about \$75,000 on the upper-end. Some very capable service-oriented testers can be found in the \$15,000 to \$30,000 range (Figure 6).

More advanced IC testers have the ability to electrically isolate the DUT from other components in the circuit. Back driving and guarding, the two techniques most often employed, are useful because they help to eliminate the need to remove components from the PC board during test.

Back driving consists of applying a current limited, high current stimulus to the device inputs, forcing them to the desired digital state ("1" or "0"); this capability is absolutely essential for testing common circuit configurations where the outputs of one device are connected to (driving) the inputs of the DUT. This technique will not damage the ICs and has been proven safe when applied in short, limited durations. Usually, 250mA to 500mA is enough to effectively back drive most circuit configurations.

Guarding involves driving a point (or points) to a specific level for the duration of a particular test. This technique is useful when testing PC boards that have clocks or bus structures. The guard can be used to override a clock signal or to enable/disable ICs on a bus (See Figure 7). While guarding is commonly found on more expensive IC testers, the complexity of today's PC boards is making this capability nearly essential.

Card-edge functional testing involves placing various stimuli on the input connector of a PC board and sensing the corresponding output response at the proper output points. This test method is relatively simple to use, but the level and accuracy of the failure diagnostics is usually dependent on the sophistication of the programmed test software. To achieve more accurate diagnostics, an experienced programmer with intimate circuit knowledge is required.

Recently, failure detection that combines card-edge testing with guided-probe analysis has been introduced to facilitate faster and more accurate card-edge PC board analysis. Card-edge testers will generally range in price from \$35,000 on up, with the lower cost testers requiring more extensive programming to achieve higher fault coverage.

Bed-of-nails ATE testing (Figure 8) refers to a custom-made test fixture which has hundreds of "nails" (spring

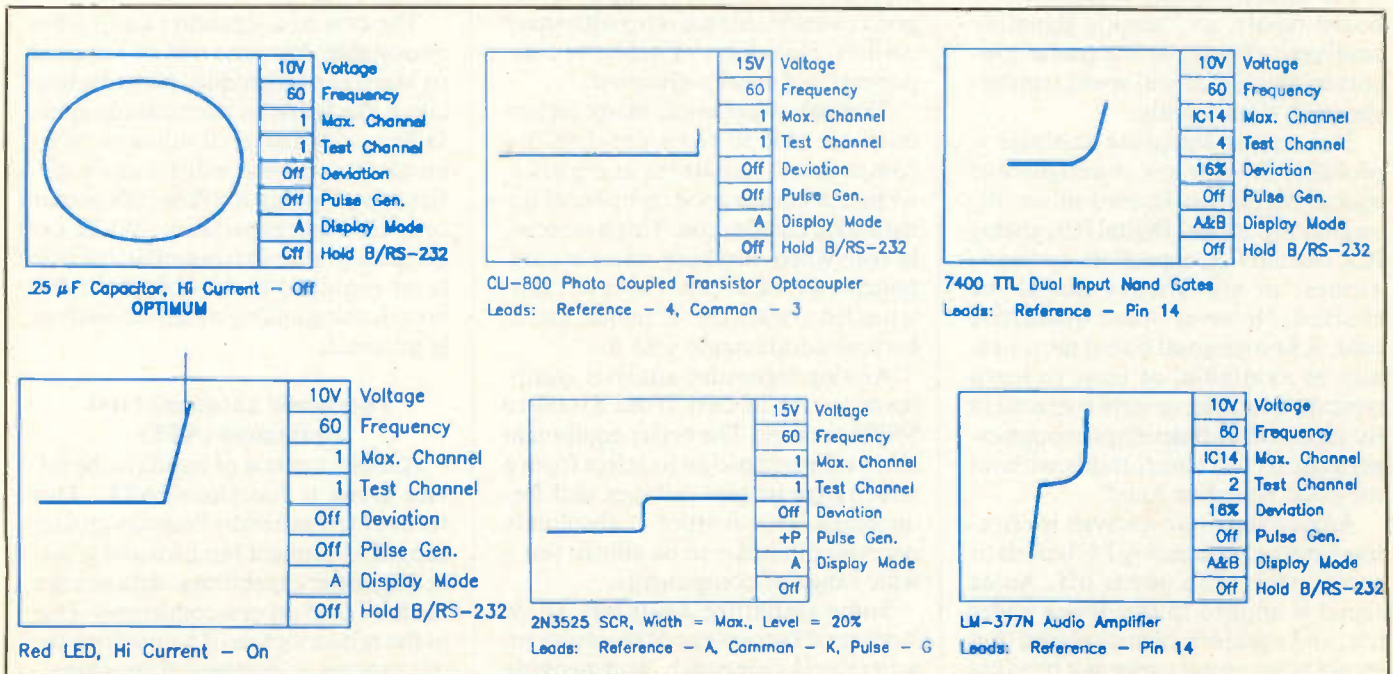

Figure 3. Typical V/I signatures for common components.

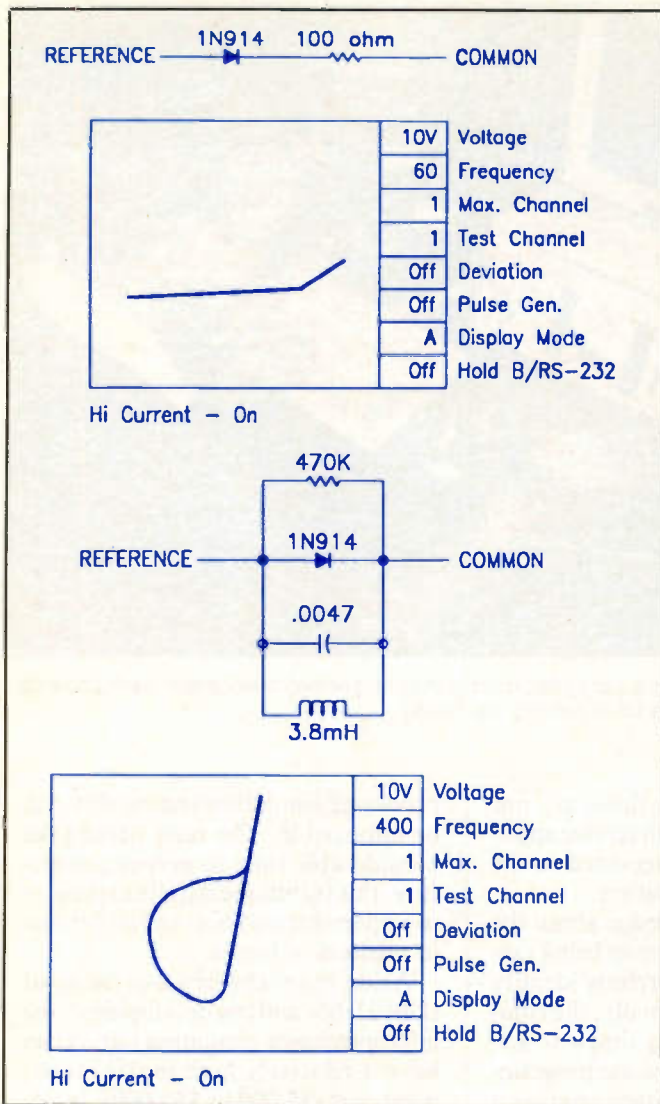

Figure 4. Typical signatures for combinations of components.

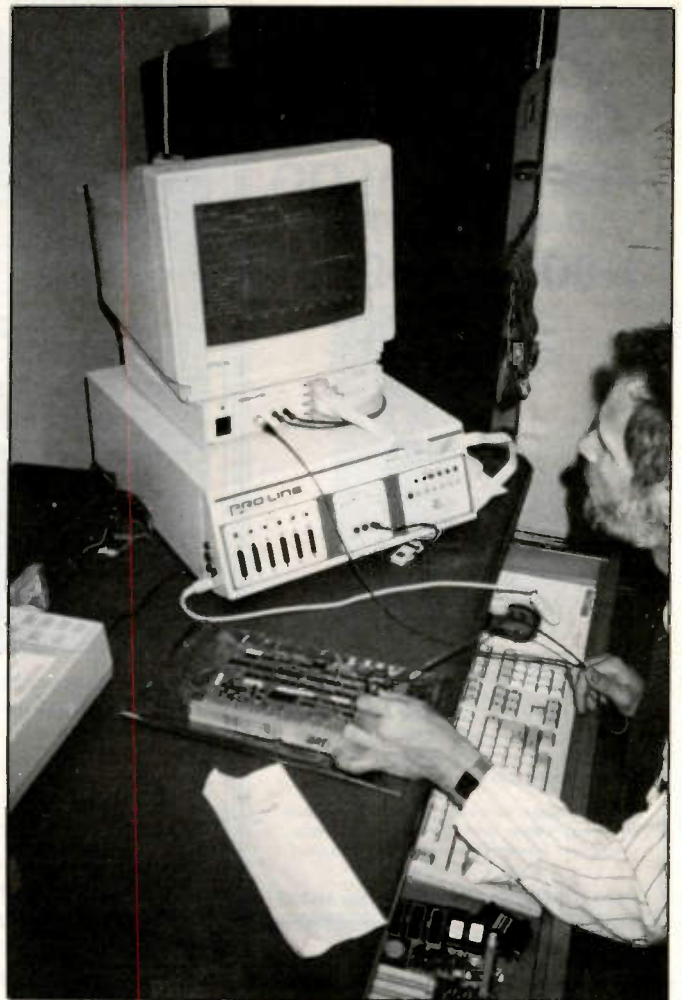

Figure 5. Functional testing and signature analysis combined can be very effective for troubleshooting; in this instance, for an A to D converter for a process control application.

loaded probes) that contact solder pads on the underside of the PC board under test. The PC board is held in place on top of the bed of nails fixture by a vacuum. The pins are wired to connectors that plug into the test system.

Bed-of-nails testing combines many of the advantages of card-edge testing and functional IC testing, while increasing the level of automation and often reducing test times. The main drawbacks to this form of ATE testing is the capital investment/support costs and the relative reduction of flexibility.

While the cost of the tester itself is quite substantial (\$50,000 and up), the required fixturing is also costly (\$500 and up per product) and often difficult to modify. Additional disadvantages, such as higher programming costs and greater test development times, are also frequently encountered due to the level of program sophistication in-

involved. This test philosophy works most effectively in high volume applications, especially those in which the service organization (captive or third party) can use the equipment, fixturing, and/or programming which has already been developed and is (or was) used by the manufacturer for production testing.

Emulation testing

Though not as popular as they once were, emulation testers are sometimes employed in service applications (Figure 9). They can be very useful for troubleshooting microprocessor-based PC boards; they usually cannot be used to troubleshoot PC boards that don't have a microprocessor (or microcontroller). In general, an emulator replaces the component which it is capable of emulating, provides stimuli to the surrounding circuitry, and

monitors various points associated with a bus and its related components. The two types of emulation testers that are most commonly used for service testing are microprocessor emulators and ROM emulators.

Microprocessor emulation is probably the most popular emulation technique. In general, an interface pod replaces the microprocessor in the unit under test and executes instructions to exercise various other functions outside of the microprocessor kernel (microprocessor, clock, and bus interconnections). A microprocessor emulator is most effective in locating memory failures, and can also be programmed to perform extensive tests of I/O devices as well.

Another advantage to microprocessor emulation is that testing is performed at higher speeds, which enables the diagnosing of timing interrela-



FREE CATALOG
CALL TOLL FREE
1-800-338-0531



Parts Express is a full-line distributor of electronic parts and accessories, geared toward the consumer electronics industry and the technical hobbyist. We stock an extensive line of replacement parts for TV and VCR repair. Call for your FREE 148 page catalog today.

Free catalog is sent via bulk mail. For express delivery, please send \$2.50 to cover 1st class postage. Foreign destination customers send \$5.00 to cover postage.

340 E. First St., Dayton, Ohio 45402

Circle (51) on Reply Card

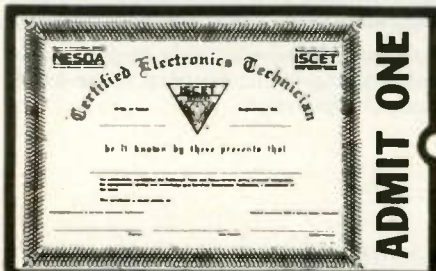

Your Ticket To

SUCCESS

Over 28,000 technicians have gained admittance worldwide as certified professionals. Let your ticket start opening doors for you.

ISCTE offers Journeyman certification in Consumer Electronics, Industrial, Medical, Communications, Radar, Computer and Video. For more information, contact the International Society of Certified Electronics Technicians, 2708 West Berry Street, Fort Worth, TX 76109; (817) 921-9101.

Name _____
Address _____
City _____
State _____ Zip _____

Send material about ISCTE and becoming certified.

Send one "Study Guide for the Associate Level CET Test." Enclosed is \$10 (inc. postage).



Figure 6. Functional testers can speed troubleshooting of microprocessor-based boards. The board being tested is from gaming machinery.

tion faults, although these are not typically encountered in service applications. Failures are reported to the operator for interpretation.

Considerable knowledge about the unit under test and the tests being executed is required to correctly identify the failed device(s). Usually, the emulation tester is relatively simple to set-up and operate, but the tester programming and post-test analysis requires a highly skilled technician or engineer.

Various situations arise, such as soldered-in microprocessors or PC boards with multiple processors, which make implementation of micro-

processor emulation testing difficult or impossible. The tests often take considerable time to execute, therefore, this technique is quite expensive to implement and best suited for low to medium volumes.

Aside from the obvious costs of skilled labor and test development, the microprocessor emulation testers can have a relatively high initial investment cost (\$5,000 to \$50,000); in addition, a dedicated interface pod (\$500 to \$2500 each) is often required for every different microprocessor encountered.

ROM emulation is employed by re-

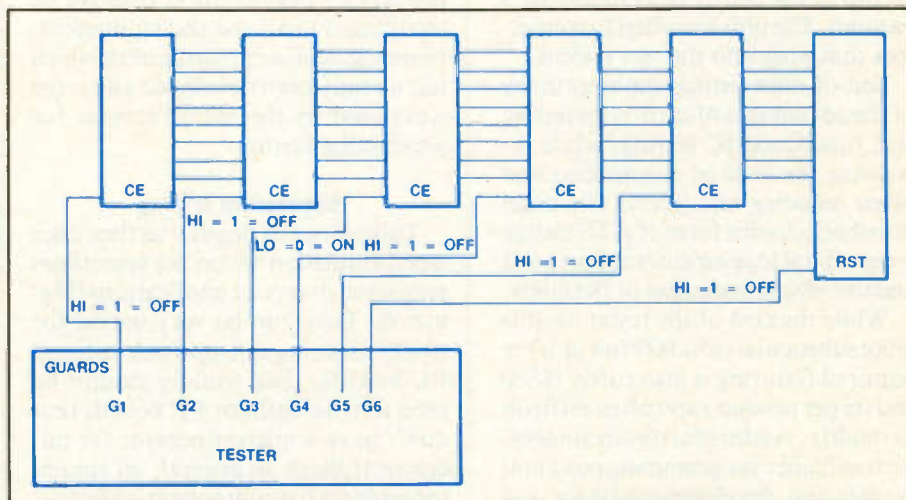

Figure 7. Guards can be placed at key locations (reset, chip enable pins) to electrically isolate the IC in-circuit.

moving the ROM containing the permanent instruction set for the microprocessor and replacing it with the emulator interface. The tester can then be used to direct the microprocessor to exercise various functions typically under its control (memory access, I/O addressing, data processing, bus inquiries, etc.) while the tester (or operator) monitors and verifies those activities.

ROM emulation is most useful in situations where an organization is faced with repairing products in which the microprocessor is soldered in place. ROM emulators are quite flexible since a change to a different microprocessor merely requires a corresponding change in software.

One disadvantage of ROM emulation is that the microprocessor kernel must be operational. Another disadvantage is that, like microprocessor emulation, this test technique requires extensive program development, extensive knowledge about the tester, and extensive knowledge about the circuitry of the UUT. ROM emulation testers range in price from \$3,000 to \$20,000 and are best suited for low to medium volume testing of very complex circuits.

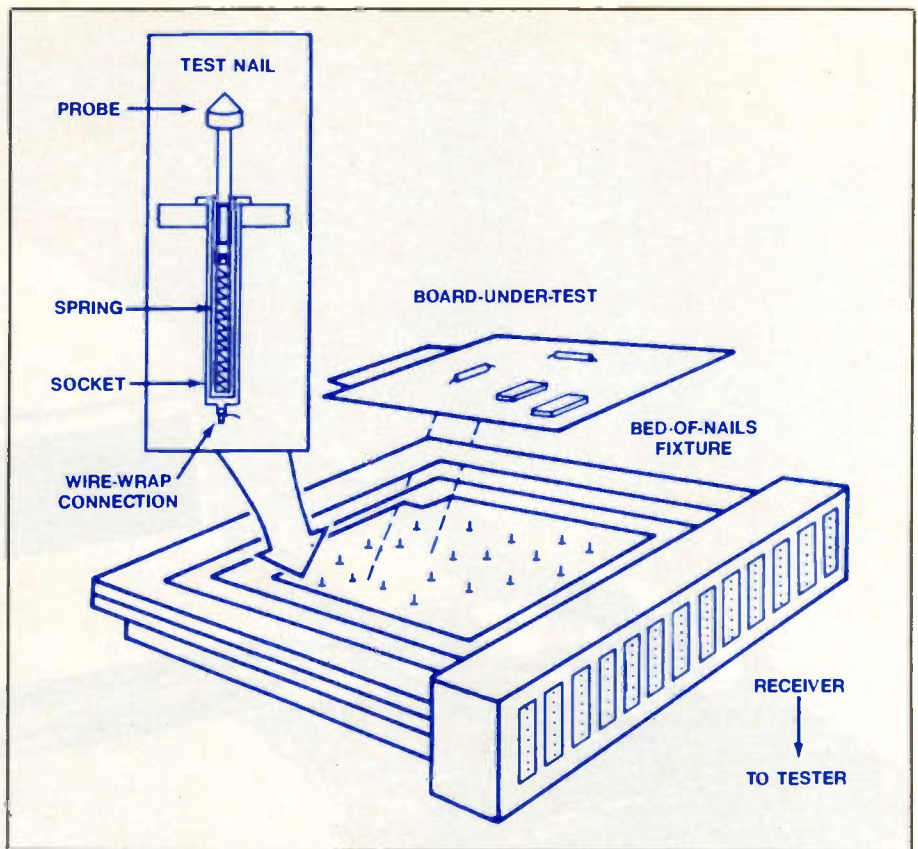

Figure 8. "Bed-of-nails" test fixture. (Courtesy Genrad).

Conclusions

The final decision regarding which diagnostic technology is best must take into account the present and future nature of your operation. Board variety and volumes, and staffing requirements must be considered. The higher the volume of boards, and lower the variety, the more automated testing will pay off.

For example, assume that you are servicing a board with 50 ICs and a microprocessor bus. Assume the boards are coming in at the rate of 100 per month. A low-cost ATE system involves a much higher initial investment (Figure 10).

The ATE equipment costs more to buy and install. However, at 100 boards per month, repairs are much cheaper (Figure 10). Cost savings are realized by saving time and using less-skilled labor. Throughput is increased, freeing time to do more work and take on more business. In the scenario of Figure 10, a service shop must handle at least 19 boards (of the single variety) per month in order for ATE to be worthwhile.



"The SEMIANALYZER is the most complete test equipment on the bench"-R. Hohl, GMC, MI
\$399 3 YEAR WARRANTY
MADE IN THE USA

- CHECKS AND IDENTIFIES SEMICONDUCTORS IN CIRCUIT
- MEASURES VOLTAGE BREAKDOWN, LEAKAGE, NOISE OF CAPACITORS, SEMICONDUCTORS, NEONS, LEDS, SWITCHES
- SIGNAL TRACER WITH ALC AND 3½ DIGIT DC VOLTMETER
- OPTIONAL PLUG-IN IR REMOTE CONTROL TESTER PROBE

* THE SEMIANALYZER SPEEDS UP SERVICE ON TV AND VCR - AJS TV-SAT-VCR Service, IA

FIX MICROWAVE OVENS?



First timers or experienced servicers will find them EASY and PROFITABLE WITH THE

MICROANALYZER 76
 3 YEAR WARRANTY MADE IN THE USA

\$329

- CHECKS HV DIODE, CAPACITOR, TRIAC, MAGNETRON.
- ALSO TESTS TRANSFORMER, TRANSISTORS, MOSFETS. Includes article "How To Repair Microwave Ovens"
- MEASURES UP TO 5000V AC OR DC IN 2 RANGES.

60 DAY SATISFACTION OR MONEY-BACK GUARANTEE

SOUTHGATE ELECTRONICS (305) 720-4497

275 Rock Island Rd., N. Laud., FL 33068



Circle (58) on Reply Card

- A - Microprocessor/ROM pod
- B - Sync module
- C - Sync module adapter
- D - ROM module
- E - Cable

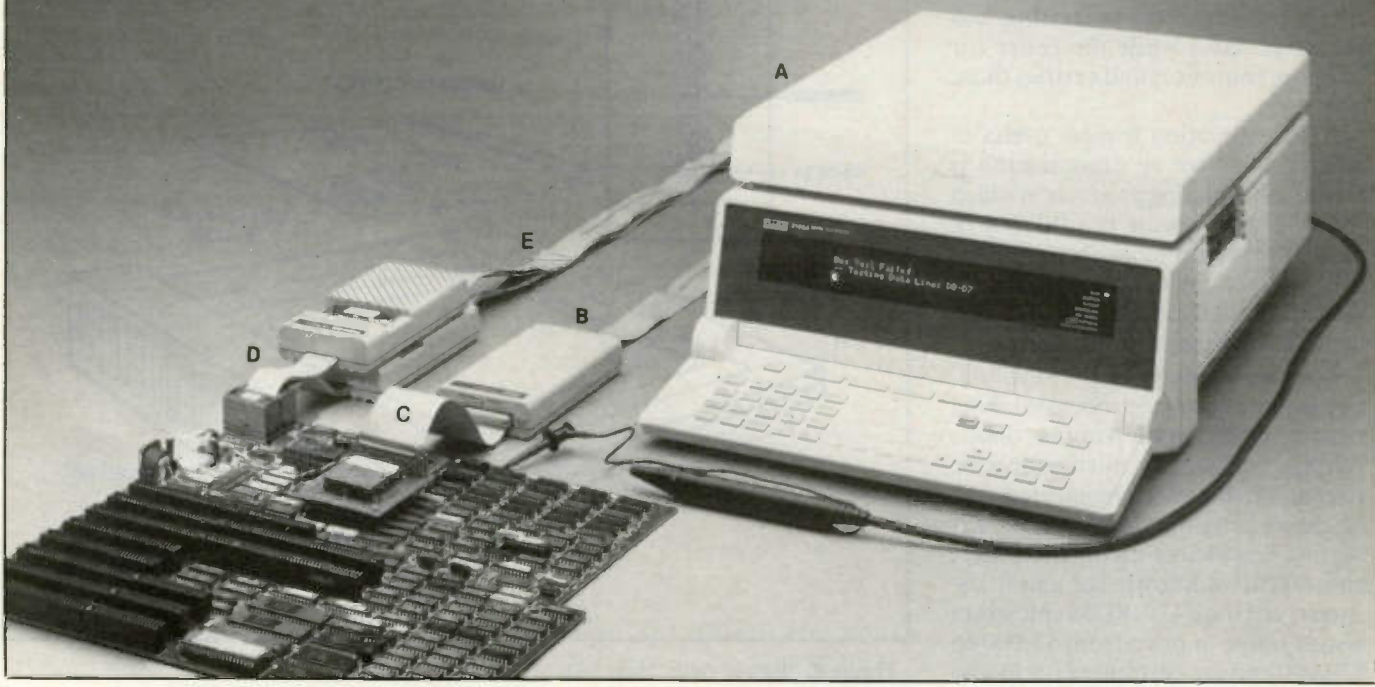

Figure 9. A complete microprocessor/ROM emulation system, shown connected to a board for servicing (courtesy John Fluke).

To Order Back Issues

Send \$3.50 Per Issue (Check, Money Order, Mastercard, VISA, And AMEX).

Send All Correspondence To:

CQ Communications
76 North Broadway
Hicksville, NY 11801

Or Call
516-681-2922
FAX 516-681-2926

ORDER YOUR BACK ISSUES TODAY

	LOW-COST ATE	STANDARD INSTRUMENTS
FIXED COSTS		
Cost of instrument(s)	\$20,000	\$5,000
Cost to set-up system		
Hours required	80 hrs	0 hrs
Hourly rate	\$20.00	\$0
Total labor cost	\$ 1,600	\$0
TOTAL FIXED COSTS	\$21,600	\$ 5,000
ANNUAL COST OF BOARD REPAIR		
Boards per month	100	100
Hours per board	0.5	4
Hours per year	600	4800
Hourly rate	\$12.00	\$20.00
Total labor cost	\$ 7,200	\$ 96,000
TOTAL FIRST YEAR COSTS	\$28,800	\$101,000

Figure 10. Cost analysis for a board with 50 ICs and a microprocessor bus that requires guarding.

Each time you get a new type of board in, you will have to program the ATE machine to test that board. Therefore, if you are servicing 200 boards per month, and each board is differ-

ent, ATE will not be cost-effective. It will, in fact, be the most costly and least desirable test methodology.

It pays to research your test equipment needs thoroughly. ■

Choosing a multimeter for today's electronic troubleshooting

By Bob Greenberg

The techniques of troubleshooting electrical and electronic equipment have changed significantly in the last 15 years. Today, almost every piece of hardware has a built-in microprocessor, resulting in more and better products with significantly more utility. But this is a mixed blessing. From offices to the manufacturing floor, workers have become dependent upon sophisticated microprocessor-based products. When they fail—and eventually they will—work literally comes to a standstill while impatient workers wait for the harried service person to make repairs.

Compounding the problem is the increasing volume and variety of field-service diagnostic equipment. Service technicians are stretched to the limit to work faster and more efficiently. As a result, in many cases service in the field has become a matter of on-site replacement of sensors, relays, switches, and circuit board subassemblies.

Replacement vs adjustments

Because the nature of electronics servicing has shifted to outright replacement instead of adjustment and setting, in many cases the service technician is interested only in verifying whether a particular signal or voltage is present. This, in turn, has changed the requirements for testing capability and accuracy. A low-cost (under \$100) handheld digital multimeter is frequently the tool of choice among field service technicians.

Choosing the right tool

Since verifying power supplies and the input/output components of a system occupies a great deal of the technicians's DMM measuring time, choos-

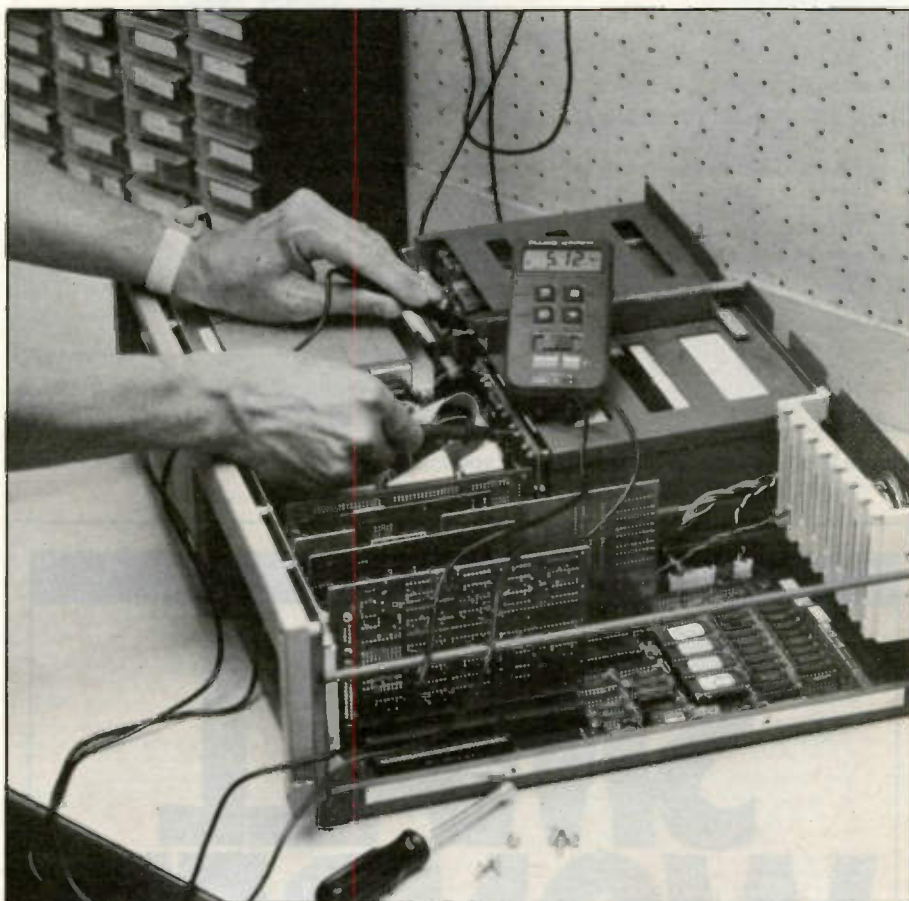

Figure 1. Because of the modular nature of many of today's electronics products, and the need to get products such as this personal computer back in operation quickly, technicians frequently use resistance checks to determine what circuit board is causing the problem. That board is then replaced with a good board, and the bad board is sent to a depot to be refurbished.

ing the right tool can make the job faster and easier. Front-line, on-site electronic checks as described above require less sophisticated test capabilities than would be needed for more complex, adjustment type service. Fewer features mean simplified use and lower cost.

But while many low-cost meters are available, a technician should look beyond mere price when evaluating a multimeter. The service technician

should look for an instrument that offers a core set of the most-needed measurement capabilities, and evaluate which optional features may be desirable. Durability, ease of use, and input protection for safe operation should also be considered.

Core Features

The core features needed to find most hard faults and do first-line checks include ac and dc volts to 600V;

Greenberg is Senior Product Planner, Service Equipment Group, John Fluke Mfg. Co., Inc.

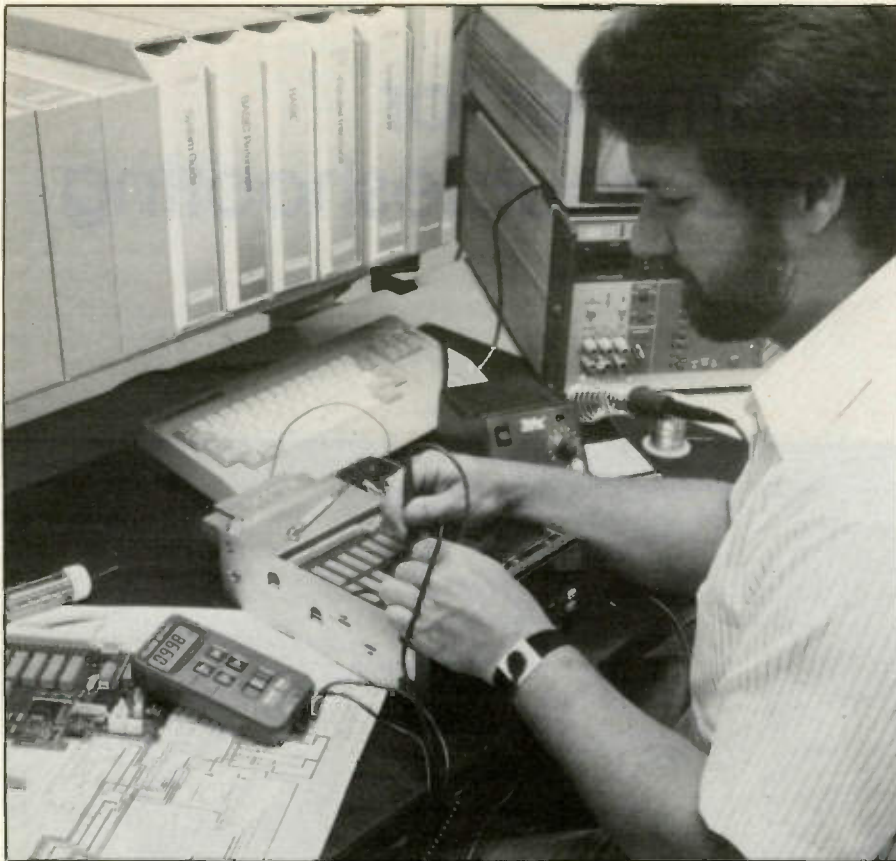

Figure 2. This technician is using the dc voltage function of the DMM to make sure that the voltage coming from the logic supply is correct.

resistance up to $40M\Omega$; continuity function to verify if a connection between two points has any opens or shorts; and diode test capability to verify whether a diode is good, open or shorted.

Current measuring capability is not an essential feature because most troubleshooting problems are, in fact, solved by measuring volts and resistance. However, a meter should have input protection to at least 600V to guard against mistakes when measuring power sources. This protection can prevent damage to the meter or to the electrical/electronic system being tested, and in extreme cases can even prevent injury to the user.

The speed of the continuity-measurement function varies from meter to meter. At a minimum, this function should be able to measure shorts and opens lasting $250\mu\text{sec}$. Some meters can measure transitory defects as brief as $250\mu\text{sec}$, and may offer a continuity capture function to automatically record them. The capture function eliminates the need for a second technician to be present to read the display.

In addition, a continuity beeper is a desirable addition to continuity check function, because it's faster to listen for an audible tone than to stop and read a display.

Displays may be autoranging, manual ranging, or both. The autoranging display is helpful when the magnitude of the parameter to be measured is not known. With autoranging, the meter automatically selects the appropriate display range. When the magnitude is known, or when the same measurement will be made repeatedly, manual ranging is more than adequate, and even makes the display a little faster than autoranging.

Optional Features

Capacitance measuring capability, while not essential, is highly desirable: capacitors are a notorious source of system failure. Anyone servicing down to the component level in the field or on the bench will find this feature useful. Look for a capacitance measuring specification in the range of $0.001\mu\text{F}$ to $400\mu\text{F}$.

Depending upon the user's skill and the type of problems he or she is called upon to service, additional features may be desirable and/or necessary. For example, Min/Max is useful for troubleshooting intermittent problems. This capability automatically

SMALL WONDER

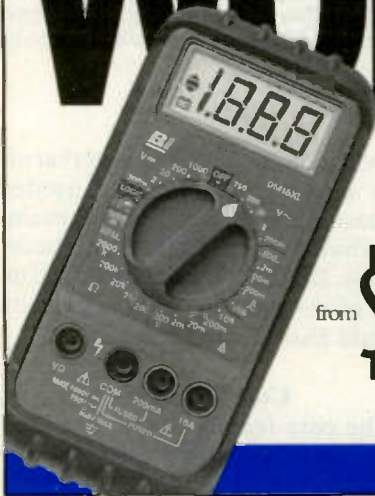

Small size to fit your pocket. Small price to fit your pocketbook. Large functionality to fit your work. The Pocket Series. A small wonder.

from **\$39.95**

BITM

Circle (41) on Reply Card

records the highest and lowest resistance or voltage reading over the measurement period. With Min/Max, the user can leave the meter connected to the system for several days if necessary, and need not be present to read the display.

A Min/Max function can be coupled with a timestamp feature that records the times when the minimum and maximum occurred. This feature enables the user to correlate surges and sags with external events. For example, a power glitch may occur at 8:00 a.m. every day, which happens to be the time that a 300hp chiller goes on-line. Without Min/Max and the timestamp, the technician would have to be present over the entire measurement period to make this correlation.

Innovative Features

With most DMMs, when checking back and forth between continuity and voltage (or ohms and voltage), the technician must change test leads and switch the meter from one setting to another. This repeated switching is not only inconvenient and time consuming, but if the user forgets to make the change the meter could be damaged.

However, two low-cost DMMs are available that eliminate these hassles. They are the Models 11 and 12 of the Series 10 family of DMMs from John Fluke Mfg. Co., Inc. These two meters offer a feature called the V Chk function, which automatically switches the meter between measuring ohms, continuity, and voltage, without requiring the user to change switches or test leads.

This feature automatically switches to voltage measurement as soon as it detects more than 4.5V on the line and displays ac or dc volts, whichever is greater. This allows the user to check the outputs of any power source or power supply connections, including ac and dc power sources, battery chargers, and 5V, 12V, and 24V power supplies for control systems without changing settings.

Although such a feature is useful, there is a warning to keep in mind: the input impedance of the meter in this mode is a low 2k Ω . While this will cause no problem to power sources or the output of most power supplies, if this feature were used to measure ohms or continuity in active electronic circuitry, the 2K Ω input impedance could overload the circuit, resulting in

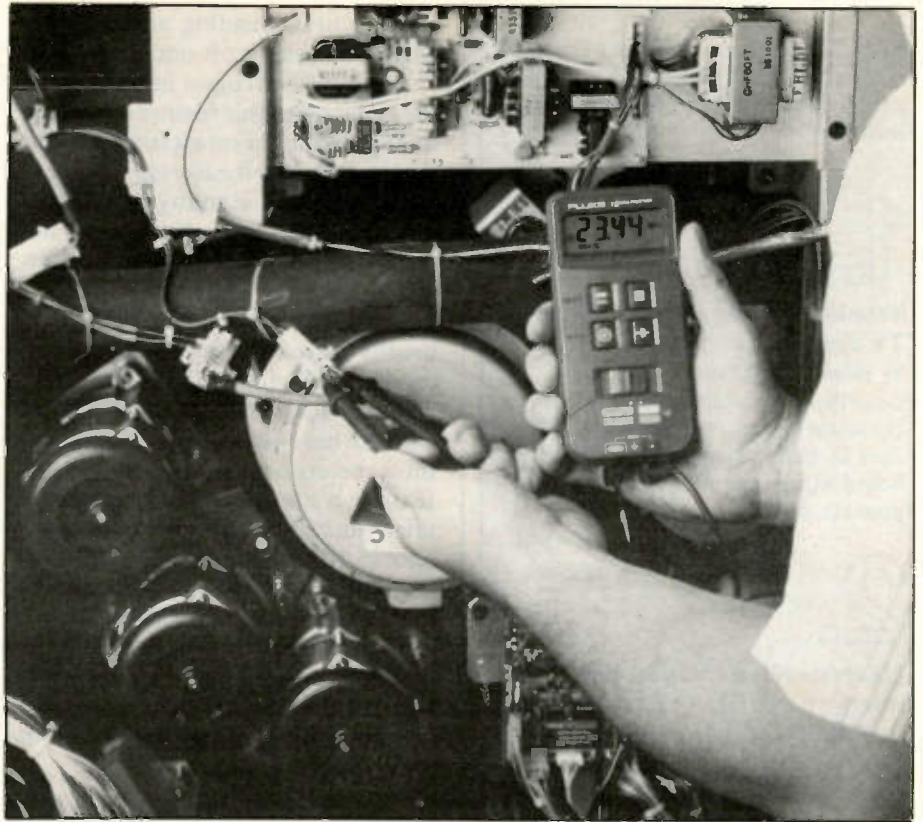
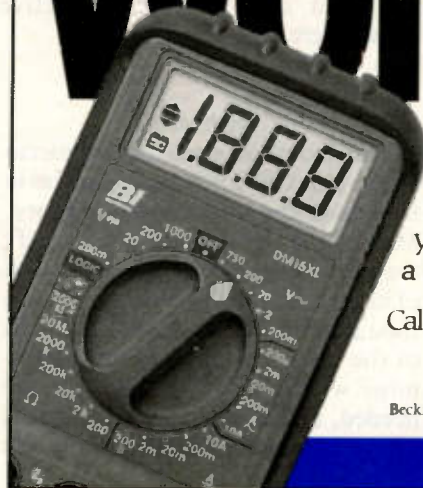

Figure 3. A multimeter with a Min/Max function is useful for troubleshooting intermittent problems, as in this copier. This capability automatically records the highest and lowest resistance of voltage reading over the measurement period. With Min/Max, the user can leave the meter connected to the system for several days if necessary.

NO WONDER



Because it's from Beckman Industrial. The new Pocket Series from the people who have proven you don't have to pay a fortune for a top quality meter.

Call (800) 854-2708, (800) 227-9781 in CA.

Beckman Industrial™

An Affiliate of Emerson Electric Co.
Beckman Industrial Corporation, San Diego, CA 92123-1898.

Circle (42) on Reply Card

ES&T for October will be packed with articles of interest to consumer electronic and computer servicing technicians, including:

1.

Troubleshooting the intermittent TV chassis

by Homer Davidson

Describes some of the problems that can cause intermittent problems in TV sets, such as faulty components, faulty pc board wiring, thermally sensitive components, etc.

2.

Understanding compact disk interactive (CDI) — Part 2

by Marcel Riolland

This is part two of an article that describes for the servicing technician the design, construction and operation of CDI.

3.

Working with microcomputer display technology — Part Three

by John A. Ross

This article continues the discussion of personal computer displays.

4.

Making oscilloscope trace photographs

by Vaughan Martin

This article describes in detail the types of camera equipment and film that may be used to photograph oscilloscope waveforms for record purposes.

5.

Troubleshooting of projection TV HV power supplies

by Robert M. Russell, CET/CSM
National Service Manager,
Curtis Mathes

This article describes service procedures, troubleshooting tips and corrective action recommended when there's a problem in the HV power supply of a Curtis Mathes projection TV set.

an inaccurate reading and possibly damaging the circuit under test.

The low (2 k Ω) input impedance of the meter when this feature is invoked does provide an interesting benefit that is useful for measuring voltage in both main and standby power systems: the ability to distinguish between real voltage and phantom voltage arising from leakage sources. Leakage with other energized circuits, usually caused by a fault in the system, can make it difficult to determine whether a particular circuit does or does not have voltage present. Because these meters have, in addition to this feature, a standard voltage-measurement function with high input impedance (5 M Ω for ac volts, 10 M Ω for dc volts), the problem can be solved by measuring the voltage with both functions and comparing the results. If the V Chek reading is significantly lower than the standard voltage reading, the voltage is most likely phantom, not real.

Other Features

There are other, less-critical features that vary among meters, but should not be overlooked by the technician when evaluating which one offers the utility and value desired. Size (is it truly "handheld"?), ease of use (i.e. pushbuttons, slide switches vs. rotary switches, etc.), durability to withstand day to day use (or abuse), life expectancy, and cost of ownership beyond purchase price (i.e. battery life, warranties, etc.) are also factors that should be considered.

Any accessories, such as test leads and probes, should be of high quality, and readily available and affordable when they need replacing. Inquire about any convenience items such as tilt stand, carrying case, protective holster, etc.

Conclusion

The electronic/electrical technician on the front lines has many choices in DMMs in the under-\$100 category. Making the right choice can simplify the job, without costing a great deal of money. The field-service technician should carefully evaluate the demands of the work he/she performs, determine what testing capabilities are needed, and then match those needs with the multimeter that will serve him or her best.

Differentiating Between Resistance and Continuity Beeper/Diode Test Functions

Back in the good old days, there was no distinction between resistance (ohms) measurements and continuity measurements. To verify the continuity of a circuit, a technician would typically measure the resistance across two connections. If the value was close to zero, the technician assumed the connection was good.

Alternatively, a technician who had to make a number of continuity checks might hook up a light bulb and battery — or a bell and battery — and connect them to the circuit under test. If the bulb lit up or the bell rang, the technician assumed the connection was good.

When digital voltmeters first began appearing on the scene, they, too, had just an ohms range. As with analog instruments, this range served double duty, being used for both resistance measurements and continuity checks.

Later, as solid state components became more popular, the need arose for a diode test range. Since diode tests involve measuring the voltage drop across the diode junction, it made sense to use the ohms range for this function as well. So now the ohms range was used for three purposes: resistance measurements, continuity checks, and diode tests.

Eventually, the continuity check function evolved into a continuity beeper, since it was faster to listen for an audible tone than to stop and read a display. If the voltage dropped below a specified value, the beeper would sound, alerting the technician to the presence of an open or short.

The continuity beeper function also was tied to the ohms range initially. But with the increasing presence of electronics in electrical equipment, extremely brief continuity intermittents began to appear. These breaks were too brief to be captured by ohms measurements, which generally cannot detect opens or shorts lasting less than 250 μ sec.

To solve this problem, instrument manufacturers began to split off the continuity check/diode test functions from the ohms range. By making these separate functions, they were able to use a high-speed comparator for continuity checks, allowing the detection of extremely transitory opens and shorts.

A homemade isolation transformer to cure H-K shorts

R.D. Redden

A bright red, green or blue screen with retrace lines often means a heater to cathode (H-K) short in the CRT. When TVs used 60Hz to power the CRT filament, we bypassed this problem by installing a large, heavy isolation transformer for the filament. Now that filaments are powered by the high-voltage transformer, isolation transformers are small and light. And it's easy to wind your own. The materials for the ones I make cost me under two dollars, and I can wind one in about five minutes.

Actually, the first isolation transformers I used were free. Some TV sets used toroid transformers of about 1-1/2 to 2 inches in diameter near the ac input as a line choke. I snipped these out of junked sets and they worked well as isolation transformers. But like most good freebies, they seem to have become scarce.

Toroid cores are not all the same. The core material affects the permeability and thus the inductance for the same number of turns on similar sized cores. I wanted a small, light core that would require few turns of wire. Ocean State Electronics (800-866-6626) has a wide selection of cores. Their stock number FT82-75 has a permeability of 5,000, allowing 14 turns of No. 22 wire to produce about $500\mu\text{H}$ to $550\mu\text{H}$ of inductance.

I use GC hookup wire, which has a rather thick coating of insulation. Such thick insulation may not be necessary, but I wanted to be sure a CRT arc would not cause a short in my isolation transformer.

Wiring the transformer is easy. Just cut two 18-inch lengths of the No. 22 hookup wire. You can use the same color and mark one wire for the primary, but a different color for each wire is better. Stretch the two wires side by side and slide a core to about the center of the two wires. Make fairly tight turns around the core, alternately doing 2 or 3 turns on each side

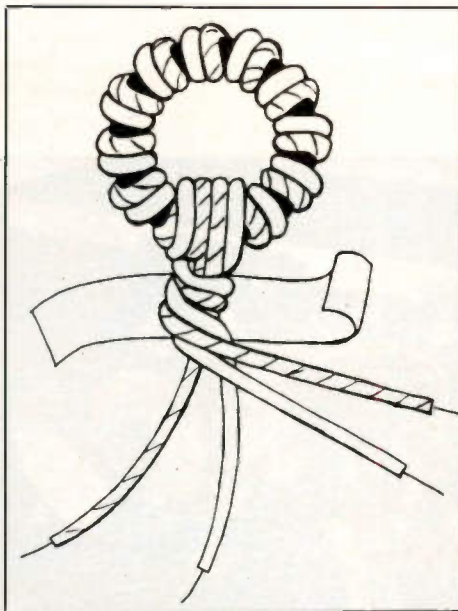

Figure 1. If you encounter a TV set with a heater to cathode (H-K) short, an isolation transformer such as this one, that you can make yourself, will allow you to restore the set to almost perfect operation.

of the starting point. (All doubled turns are the same direction, but starting in the middle of the wire means less wire to thread through the core).

You should be able to just fit 12 turns on the core in a single layer. Then make one more turn with each set of wires in a second layer for a total of 14 turns. Give the ends a twist next to the core and wrap a little tape around the twist to hold it together. You should have about two inches of wire left over for external hookup. See Figure 1.

I needed to answer three questions about the transformer before using it. Did it cause an excessive load on the HVT? Did it supply enough current for the filaments? Would it cause distortion of the TV's picture?

Since the voltage going to the primary of the isolation transformer is shaped like the retrace pulse that is its source, calculating the current drawn by the isolation transformer with its secondary open (no load current) would be difficult. But by leaving the secondary open and hooking the pri-

mary to the filament supply from the HVT of a used 19-inch set I had, I could monitor the B+ current to the horizontal output transistor and check for the additional load current caused by the isolation transformer. I found the current increased from 0.315A to 0.316A, or 0.317A (the last meter digit fluctuated). This increase of only 1mA to 2mA did not seem excessive.

Still monitoring the horizontal output current, but with a test pattern on the TV and the contrast and brightness turned to maximum, I got a reading of 0.625A, whether the filament was powered directly or through the isolation transformer. I was not able to see any difference in the brightness or contrast of the picture whether the isolation transformer was installed or not. This indicated that enough current was being supplied for the filaments. Of course, if there had actually been a H-K short, there would have been some slight smearing of the video due to the short.

I also checked the filament waveform from the HVT with a scope. It was a 28V pulse with a small dip in the center of the peak. With maximum brightness/contrast of the set, I could see no difference in either waveshape or amplitude whether or not the isolation transformer was installed, another indication of no excess loading on the HVT.

The point of the transformer, of course, is to allow the dc voltage of the filaments to be the same as that of the cathode to which the filament is shorted so as not to pull the cathode's voltage low. So if a filament pin is grounded on the CRT socket board, you may have to cut a strip out of the foil going to the grounded filament pin.

Only the secondary of the isolation transformer should hook to the filament pins. The primary of the isolation transformer goes to the filament leads from the HVT, either the actual wires, or their connections on the CRT socket board. The transformer is so light that it can be mounted by taping it to a low voltage wire from the CRT socket. ■

Redden is owner and operator of a consumer electronics service center.

Servicing high and low voltage circuits in RCA's CTC110

By Homer L. Davidson

Many of the problems encountered in the CTC110 chassis are the same problems that occur in the CTC107, 108 and 109 chassis. This is not surprising, considering that the horizontal switch, trigger, inverter and driver circuits in all of these sets are identical, using discrete transistors. The horizontal output and flyback circuits are also common to all of these sets and feature high voltage diodes built into the HV winding of T402 (Figure 1). The voltage feeding the horizontal output (114V) and oscillator circuits (19.91V) in these sets comes from an SCR101 regulator voltage supply.

Keeps blowing fuses

As with most TV sets, if you find that F101 (5A) fuse is blown, likely causes are leaky or shorted bridge diodes, leaky SCR101 or Q412 or a defective flyback. To determine the cause of a blown F101, first remove the horizontal output transistor (Q412) from the circuit to eliminate the horizontal output and flyback circuits. A 100W bulb may be connected in place of the fuse, if desired, to limit the current and act as an indicator of the amount of current being drawn. Of course you'll have to shunt the remote relay if the chassis is operated by a remote control in order to use the light bulb.

A shorted power supply or leaky horizontal output circuit will draw excessive current, resulting in a bright light bulb. When the leaky component is removed, the light bulb will dim. If the light dims after Q412 is removed, there is a leaky component in the horizontal output or flyback circuits. If the bulb remains bright after Q412 is removed, suspect leaky diodes in the low voltage power supply.

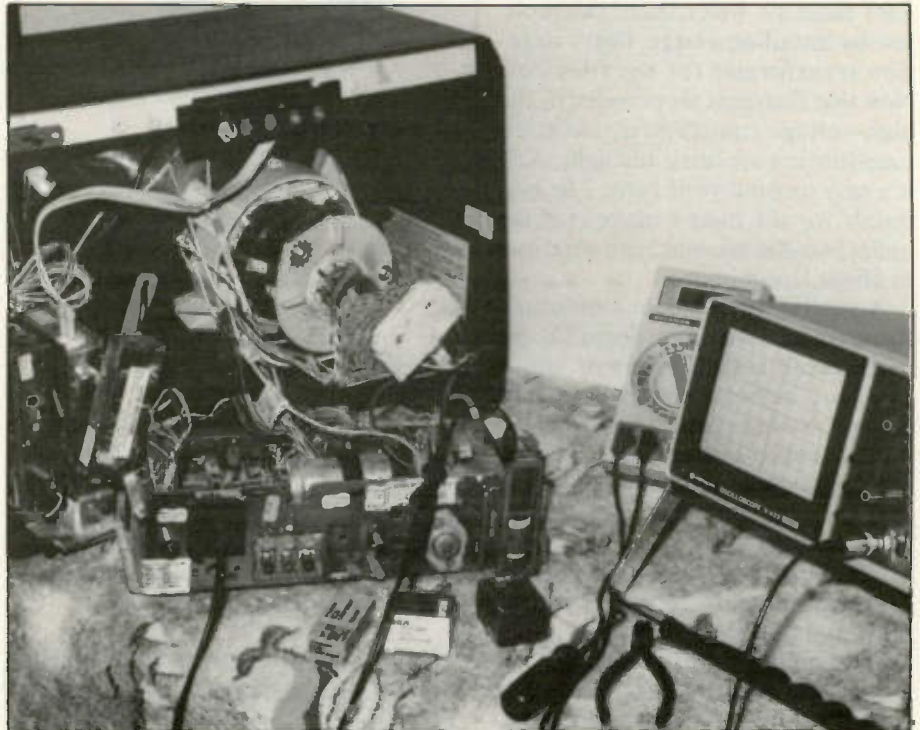

Figure 1. The oscilloscope and DMM are useful instruments in servicing TV high voltage and low voltage circuits.

In some cases only one silicon rectifier in the power supply is shorted, while in other cases you may find two or more. Lightning damage may destroy all four diodes. RF101 (2.5 Ω) may be found open when power supply diodes are shorted. These components can be replaced with 2.5A replacements.

An SCR101 that is shorted between anode and cathode may blow the fuse and damage L106. Carefully check L106 for shorted or burned windings any time SCR101 is shorted. If the horizontal output transistor (Q412) is too warm or extremely hot, this may be a sign that L106 is damaged.

Can't shut off TV chassis

When the symptom is that the set can't be shut off, your first suspicion

is that the remote control transmitter or module is defective. The only way to turn off the set when this problem occurs is to unplug it from the power line. Sometimes, the chassis will come on when plugged into the receptacle, and at other times it will come on with the remote control unit.

When you encounter this problem, notice if the sides of the picture are pulled in or if, as occurs in a few cases, the only picture on the screen is a trapezoid water falls. If either of these screen conditions is present when you can't turn off the set, go directly to the low voltage circuits. Measure the B+ voltage at C105 (Figure 2). This capacitor is easy to locate as it is clamped to the back metal part of the chassis.

The normal voltage should be around 162V to 165V. If the voltage

Davidson is a TV servicing consultant for ES&T.

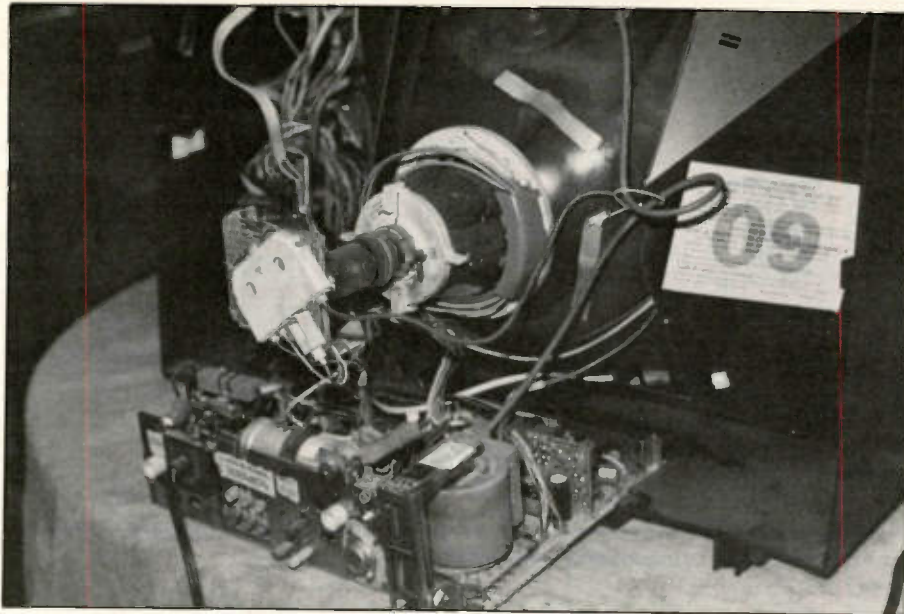

Figure 2. Check the low voltage circuits with a voltage measurement at Capacitor C105. This electrolytic capacitor is at the top rear of the metal chassis.

is under 130V, suspect an open or dried out filter capacitor C105 (600 μ F). To determine if this capacitor is the cause of the problem, simply shunt another 600 μ F or greater capacitor with correct working voltage across C105. In three different chassis this dc voltage had decreased from 165V to around 130V, producing the above symptoms (Figure 3).

Raster, no HV, no sound

When the symptom is a dead set, determine if the chassis will not start up or if it shuts down after it is turned on.

A chassis with a defective HV system may shut down after a few seconds. When you turn on the set, notice if the HV comes up by listening for the expansion noise caused by the deflection yoke. The screen may be black or show signs of some light when the chassis shuts down with either chassis or HV shut down.

If you suspect HV shut down, remove the collector terminal of x-ray latch transistor Q414. This transistor may also be removed from the circuit when you encounter HV shut down symptoms. Connect the set through a

variable line power transformer and gradually increase the voltage to determine if excessive HV is the cause of shutdown.

Double check the dc voltage applied to the horizontal output transistor (114V). In this particular CTC110 Chassis, the voltage was high at 132.5V. The voltage at the SCR101 regulator was 159.V. I assumed that SCR101 was normal with a voltage drop across it (Figure 4). Also, the flyback transformer emitted a low squealing noise.

Since the collector voltage was higher than normal, the flyback transformer and circuits were assumed to be okay. A quick scope check at the base of Q412 and the collector terminal of the horizontal drive transistor (Q411) revealed that there was no waveform, indicating an absence of horizontal drive pulses.

The dc voltage at the collector of Q411 was only 4.3V and R428 was quite warm. I shut the chassis down and checked Q411 for leakage and open tests. Q411 tested normal, indicating absence of drive waveform. Resistor R428 (5.6K Ω) will run warm when there is no drive pulse at the base of the driver transistor.

To determine if the horizontal oscillator circuits are operating, you can check waveforms, perform in-circuit transistor tests, or inject a dc voltage to the oscillator circuits. In this case, I turned off the set, disconnected it from the power line, and applied +20V from an external power supp-

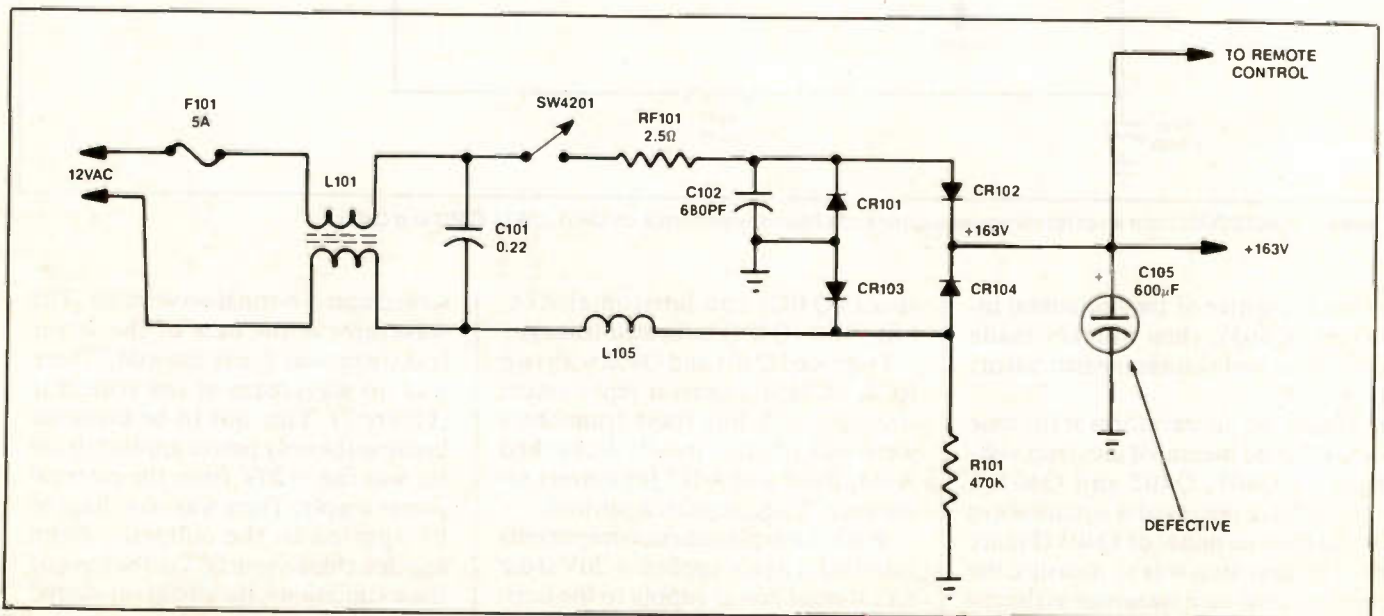

Figure 3. You may not be able to turn off the remote CTC110 TV chassis if C105 is defective.

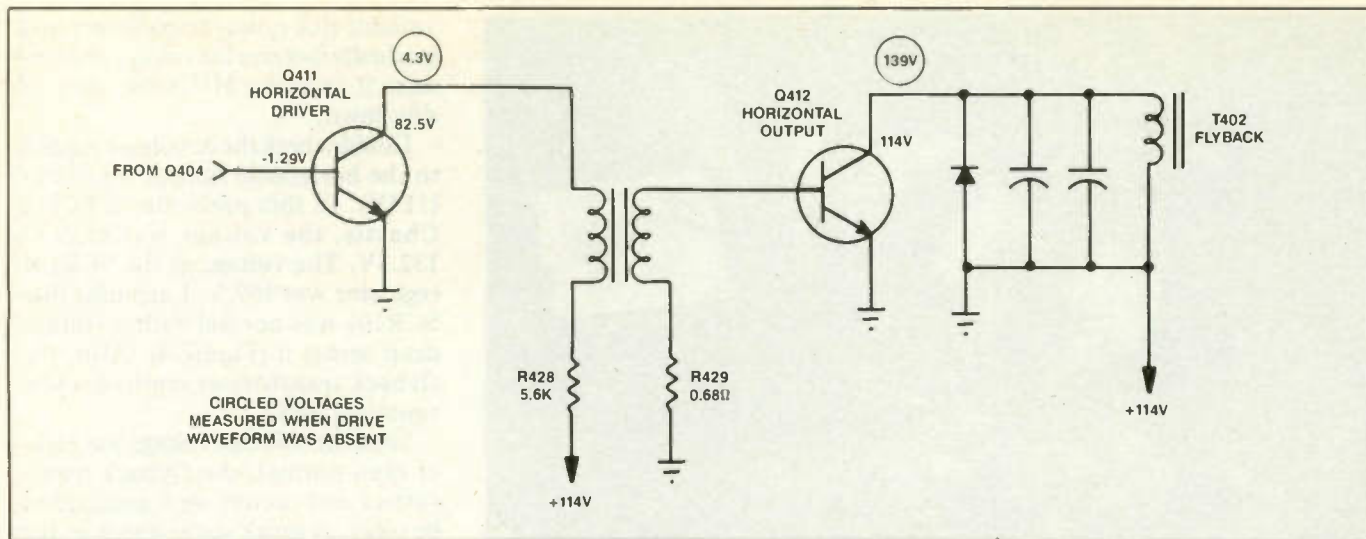

Figure 4. High collector voltage on Q412 indicated an open transistor or improper drive waveform.

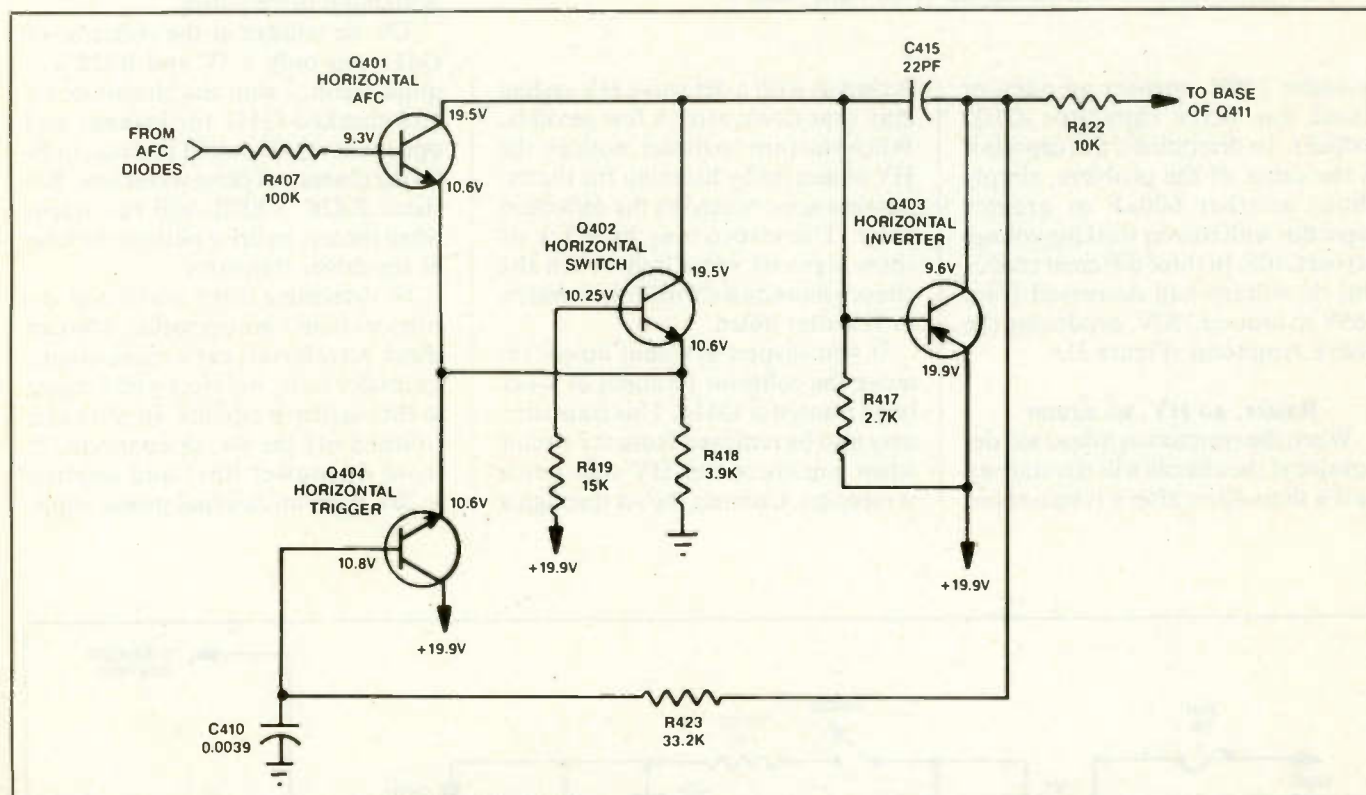

Figure 5. Inject 20Vdc from an external power supply and observe waveforms on Q401, Q402, Q403 and Q404.

ly to the emitter of the horizontal inverter (Q403), then quickly made waveform and voltage measurements (Figure 5).

I observed no waveform at the base of Q403, and measured incorrect voltages on Q401, Q402 and Q404. I should have observed a square wave at the base terminal of Q403 (Figure 6). The next step was to measure the resistances of each transistor in the circuit. Both the horizontal switch tran-

sistor (Q402) and horizontal AFC transistor (Q401) indicated leakage.

I replaced Q401 and Q402 with two RCA SK3854 universal replacement transistors. While these transistors were out of the circuit, I checked R418, R419 and R417 for correct resistance. They appeared normal.

With the replacement components installed, I again applied +20V from an external power supply to the horizontal oscillator circuits. Now I ob-

served nearly normal waveforms. The waveform at the base of the driver transistor was fairly normal. There was no waveform at the collector (Figure 7). This was to be expected because the only power applied to the set was the +20V from the external power supply. There was no voltage to be applied to the collector from another chassis source. On the basis of these conditions, the circuits appeared normal.

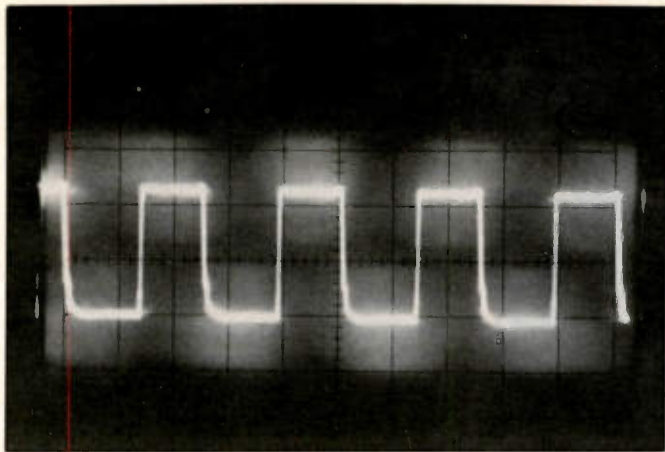

Figure 6. You should observe a square wave at the base of horizontal switch transistor (Q403), if horizontal circuits are normal.

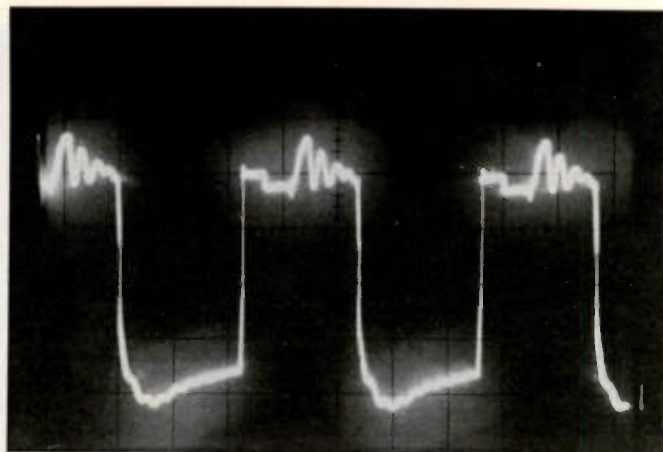

Figure 7. The correct waveform found at the base of the horizontal driver transistor (Q411) looks like this.

After soldering the collector terminal of the latch transistor back into the circuit, I applied power to the chassis. It worked as it should. When XT2 and XT1 terminals were shorted, the chassis shut down, indicating the HV shut down circuits were normal.

No raster, no HV, squealing transformer

In another CTC110 chassis, the same symptoms occurred, accompanied by a squealing flyback. The dc voltage at the collector terminal of Q412 was high at 139V with only 4.3V at the collector of driver transistor (Q411). Q411 was tested in the circuit and appeared leaky. A resistance measurement from collector to ground showed a direct short. The shorted Q411 was replaced with original part number 146851.

Resistor R428 (5.6K Ω) had changed resistance and was burned. After replacing Q411 and R428, I applied power to the chassis. It operated, but shut down again after only one half hour. Again, Q411 and R428 felt warm, but tested good (Figure 4).

It was possible that additional damage occurred in the horizontal driver circuits, or another trouble existed in the chassis. Again, R428 was checked and appeared normal. R427, R437, C432, C413 and C412 checked normal in the circuit.

Perhaps a change in resistance of the secondary circuits of R401 might be at fault. I measured the resistance of both the primary and the secondary windings of T401. The resistance of the primary winding measured 96.7 Ω . I almost failed to consider this component as a possible cause of the prob-

lem. Then it occurred to me that it was possible that the primary winding might have been damaged when Q411 was shorted and R428 had changed in resistance.

The primary resistance according to the schematic should measure 100 Ω . Is it possible that a difference of 3.3 Ω caused the chassis to shut down after operating a few minutes? Another meter measured the primary resistance at 97 Ω . I measured the resistance of T401 in another RCA CTC108 chassis for comparison. It measured 101 Ω . Assuming that the lower resistance in the T401 primary in the set that was malfunctioning indicated a defective

transformer, I replaced it. After this component was installed, the TV operated perfectly on the bench for two days and was subsequently returned to the owner.

Keeps destroying Q412

The horizontal output transistor (Q412) may be damaged if there is insufficient drive, a leaky transistor, a leaky yoke circuit, a shorted damper diode, or a leaky flyback transformer. When you replace Q412 and it's immediately destroyed when you turn on power to the set, suspect a defective horizontal output transformer.

First, make sure that the horizontal

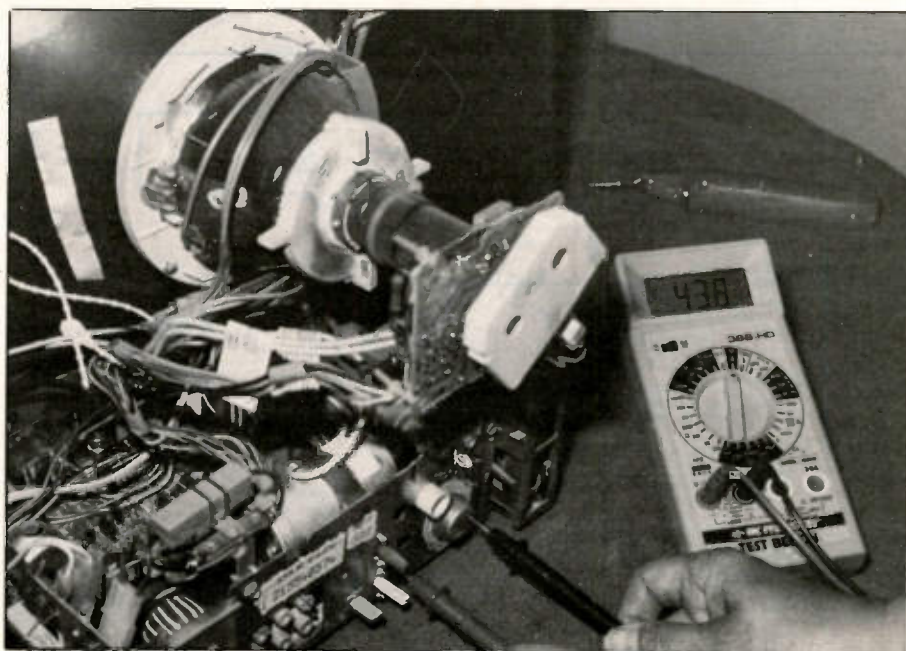

Figure 8. A diode check between collector (metal) body of Q412 and ground may indicate the condition of the damper diode. Extremely low resistance indicates a leaky Q412 or damper diode (CR405).

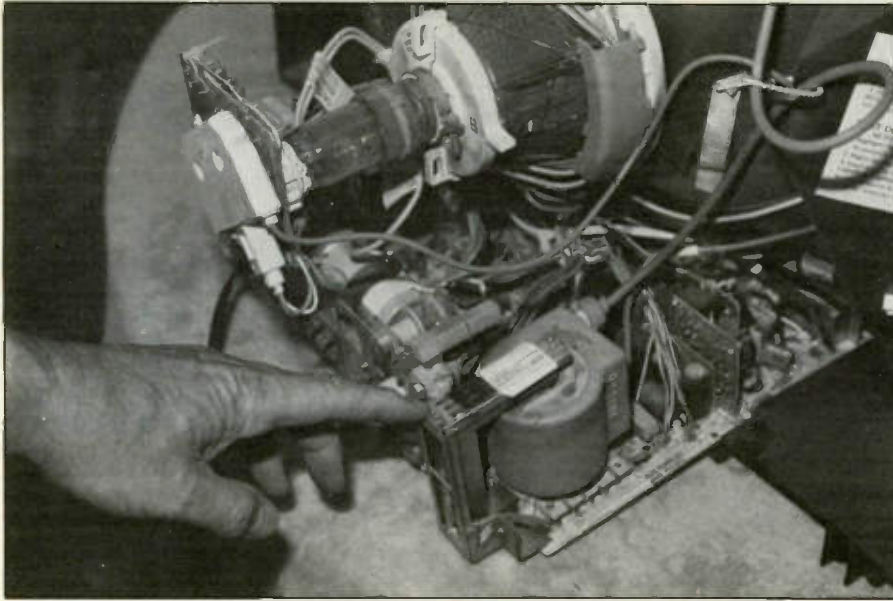

Figure 9. The leaky flyback may cause low voltage at the output transistor and absence of horizontal output waveform. A normal horizontal output pulse can easily be seen by holding scope probe near the flyback.

oscillator, driver and output circuits are normal. Then apply an external 20V source to the inverter, switch and trigger circuits, and check the horizontal oscillator circuits. Check waveforms up to the horizontal driver transistor Q411.

Test Q411 in the circuit with a transistor tester, or the junction test of the diode scale of the DMM. Remember,

resistor R428 (5.6K Ω) will run warm if there is no drive voltage supplied to Q412. Check the resistance of R428, T401 and R437.

Next, check for overloading in the horizontal output circuits. A leaky damper diode (CR405), C417 or C434 may result in damage to the horizontal output transistor. Remove the red lead of the deflection yoke to deter-

mine if the yoke circuits are loading down the output circuits (Figure 8). Do not overlook the possibility that a burned L106 is the cause of a damaged Q412.

The flyback transformer may be checked by slowly raising the line voltage via a variable voltage power line transformer and monitoring the dc voltage at the collector with waveform on the base terminal of Q412. If Q412 begins to appear warm when 60Vdc to 80Vdc is applied, suspect a leaky flyback transformer. Check the horizontal output transistor to confirm that the horizontal oscillator is operating.

Although the base waveform may not appear as in the schematic, check the waveforms upon base and collector of driver transistor (Q411). If very little waveform is found next to the flyback, either the transformer is leaky or components tied to the secondary windings are overloading the horizontal output circuits.

Usually, an overloaded circuit within the scan-derived voltage of a flyback takes a little time before shutting down the chassis. The HV comes up, the raster may appear or the yoke expands indicating high voltage is present. Replace the suspected flyback transformer when Q412 runs warm with no horizontal waveform and 60Vdc to 80Vdc applied (Figure 9).

Shut down problems

Most problems that cause shut-down originate in the horizontal and HV circuits. High voltage shut down may be caused by a defective component within the x-ray latch circuits (Q413). Check for excessive voltage at the anode of the CRT. Short terminals XT1 and XT2 together to see if this causes the chassis to shut down. To prevent HV shut down long enough to diagnose the cause of the problem, remove x-ray latch transistor (Q414) from the circuit, then repair the excessive high voltage problem.

Excessive brightness followed by chassis shut down may be caused by a shorted gun in the CRT. If you suspect this to be the case, remove the picture tube socket then turn on the set to see if the chassis shuts down. Often, firing in the gun assembly indicates a defective CRT or a cracked glass gun assembly. Excessive brightness followed by chassis shut down within a few seconds may be caused by open re-

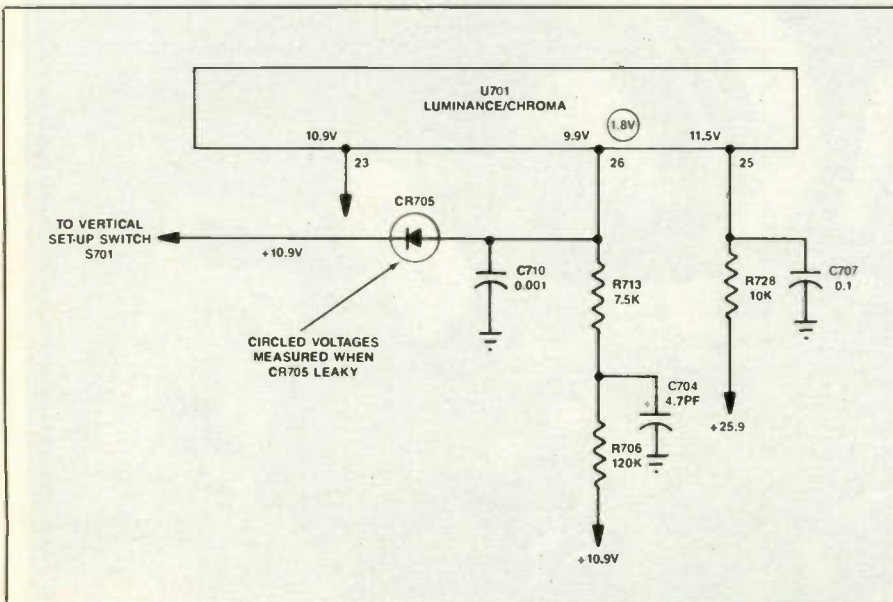

Figure 10. The unusual excessive brightness and shut down problems were caused by a leaky diode (CR705) in the luminance/chroma circuits instead of horizontal, high voltage or flyback circuits.

sistor R125 (4.7Ω) in the scan-derived boost voltage circuit. Do not overlook dirt in the spark gaps of the CRT socket. Internal arcing of the screen and focus assembly (R5015) has caused chassis shut down.

An overloaded or leaky flyback transformer (T402) has been another cause of many shut down problems in these chassis. Poor soldered or socket connection of SCR101 have caused chassis shut down. Suspect transistors Q411 and Q412 when these sets shut down unexplainably. If horizontal switch transistor Q402 is intermittent, this may cause shut down. If the problem is intermittent start up and shut down, suspect poor soldered connections of driver transformer T401. To correct this problem, resolder all board connections and check the primary for correct resistance (100Ω). Open Q412 may cause a no-start-up problem. Remove the transistor from the circuit for accurate tests.

Unusual bright screen followed by shut down

The raster on one of these sets that was brought in for service became excessively bright then the chassis shut down. Brightness was not controllable. At times retrace lines were found at the top of raster before shut down. In a set that exhibits these symptoms, the picture tube, the high voltage circuits, or the flyback may be defective.

In several CTC107 and CTC109 chassis, these symptoms were caused by a defective luminance-chroma IC (U701) and related circuits. In one such case, I initially suspected the flyback, but I did not want to change the flyback before checking all other components that might be the cause. I injected 25V at the 25.9V source, but this did not indicate that the supply pin of U701 was leaky (Figure 10). So I decided to replace U701 with original part number (146858).

This did not correct the problem, as the chassis shut down in 5 seconds. Upon checking the schematic, I found that two different sources are fed to U701 (10.9V and 25.9V). I checked all voltages beyond the junctions where both external voltage sources were fed to the respective circuits of the luminance-chroma IC. The voltage on pin 26 was only 1.8Vdc. It should be around 9V. All other voltages were normal.

I measured the resistance between pin 26 and chassis ground. It measured 998Ω. For comparison, I measured the resistance between the same two points on another RCA CTC109 chassis sitting across the bench. In this case, I measured over 7.5KΩ. The cause of the low resistance could be a leaky C710 or C704. When I checked C710, I read the same leaky measure-

ment. I tested C110 with one lead disconnected, but the capacitor tested normal.

A closer check of the schematic revealed a diode (CR705) in the circuit of pin 26. When CR705 diode was removed from the circuit it tested leaky. Replacing CR705 with a universal ECG177 diode solved the unusual brightness shut down problem. ■

NOW!! MORE MONITORS
NOW!! COMPONENT SOURCES

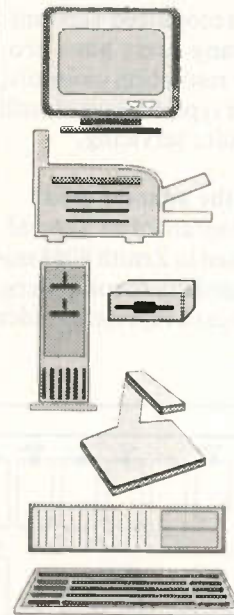

Resolve™

MONITOR REPAIR DATABASE

Save time with the Resolve monitor repair database. Access 624 repairs on 51 monitors, (VGA, EGA, CGA and Mono), including sources for semiconductors and magnetic components.

ResolvePlus updates add repairs, monitors and data every three months.

Add the ResolveRite editor to enter your own data or create new databases on any product you repair.

The Resolve system gives you monitor repair data while organizing and protecting your own data.

Call for FREE Demo Disk
1-800-999-0304

ResolveRite, Resolve & ResolvePlus are Trademarks of AnaTek Corporation.



PO Box 1200 / 4 Limbo Lane / Amherst, NH 03031

Circle (40) on Reply Card

FACT

PHOTOFACT® provides up-to-date documentation needed to repair most brands and models of televisions.

- **PHOTOFACT®** is inexpensive. At only \$42 per month your PHOTOFACT® subscription will provide documentation for at least 14 different models and chassis each month. Manufacturers' data for as many sets could cost up to \$630.
- **PHOTOFACT®** is easy to get. Call your authorized Sams distributor or our toll-free number to order single copies or to begin your PHOTOFACT® subscription.

Phone 1-800-428-7267

(Ask for Operator SW)

Sams. The Technician's Best Resource.



Howard W. Sams & Company

2647 Waterfront Parkway,
East Drive
Indianapolis, Indiana
46214-2041

Circle (56) on Reply Card

Working with microcomputer display technology

Part Two—CGA video cards and displays

By John A. Ross

All art for this article was provided courtesy of Zenith Data Systems

Previous articles, discussed Hercules and RGBI video cards and displays. This article will cover CGA video cards and monitors. The article separates both the video card and the mon-

itor into easily recognized sections. Even though many users have progressed to higher resolution monitors, many of the older type displays are still around and require servicing.

Looking at the adapter card

Figure 1 is a diagram of a CGA video output card used in Zenith 8088 microprocessor-based microcomputers. Even though the card represents older

technology, it demonstrates how signal action within the CPU affects the monitor display. The card works with both monochrome and color monitors and uses a non-interlace format.

Along with power supply components, the card contains circuitry for addressing, reading and writing to the video RAM, color selection circuitry, mode selection circuitry, a character generator, color video encoder and

Ross is a technical writer and a microcomputer consultant for Ft. Hays State University, Hays, KS

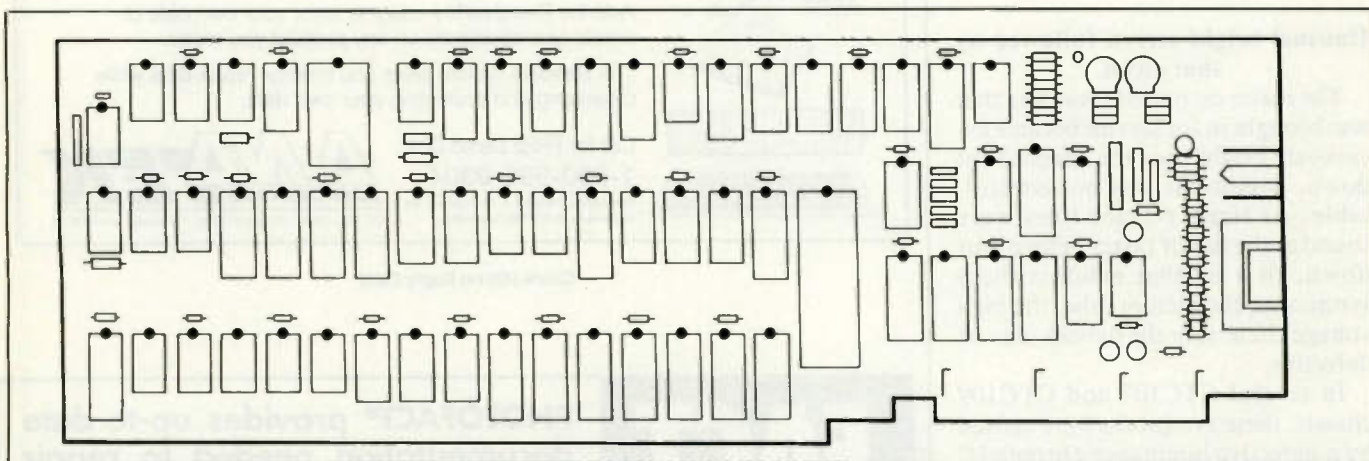

Figure 1A. This is the layout of a CGA video output card used in Zenith 8088 microprocessor-based microcomputers. It helps to demonstrate how signal action within the CPU affects the monitor display.

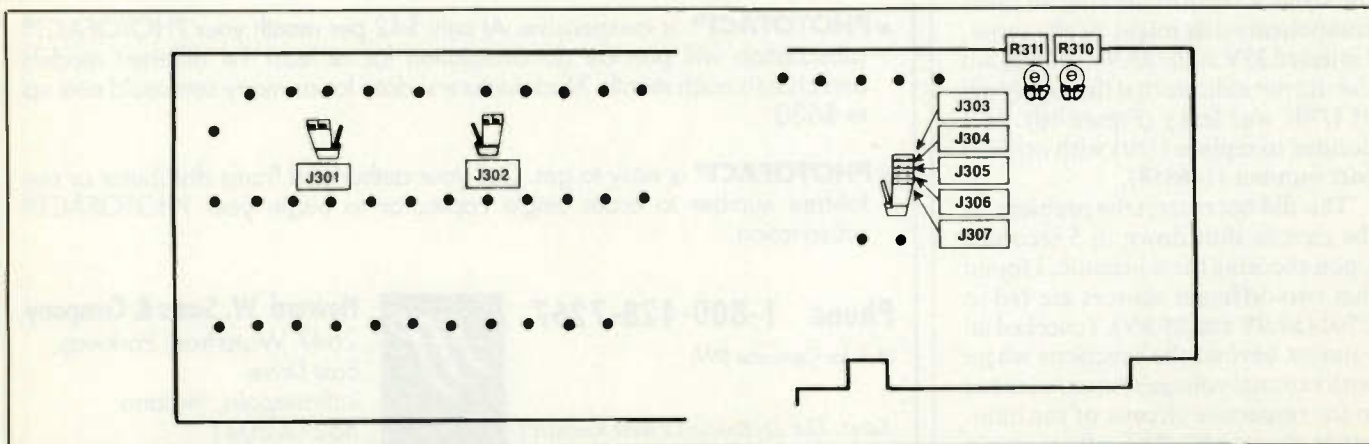

Figure 1B. Video problems in a Zenith CGA monitor may be caused by a number of jumpers or components on the video card. This is an illustration of all of the possible positions for all jumpers on the CGA video output card.

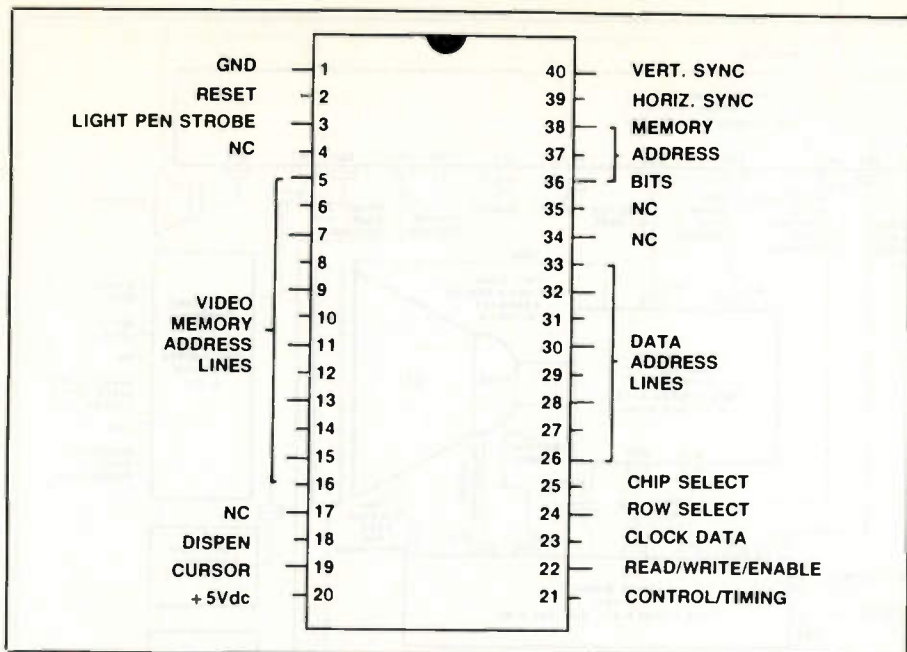

Figure 2. Within the CRT Controller IC, nineteen registers define the display and control parameters of the monitor.

video output circuitry. In addition, the card includes circuitry needed for generating timing and control signals.

Video card power supply circuitry

Several components on the adapter card connect the card with system power supplies. Capacitors C362, C363, C364 and filter L301 decouple the +5Vdc voltage from the system bus. This voltage becomes the operating supply voltage for the video output transistors and TTL devices located on the card.

Signal action and the CRT controller

U348, a data transceiver, directs data to the card from either the system bus or from the video I/O channel bus. A signal from pin 15 of U338, the PAL address decoder, establishes the direction in which the data should travel. When the XCVRD signal is low, the data transfers from the card data bus to the system data bus. When the signal goes high, data transfers from the system data bus to the video data bus.

Data arriving onto the video data bus then goes to the CRT Controller IC, U235. The CRT Controller provides the drive signals for the CRT. Also, other signals going to and from the controller interface it with the system microprocessor, the video RAM, character generator logic, and the monitor. Signals such as chip select, register select, read/write, ena-

ble, clock and reset allow the card and system to communicate.

At pin 18 of the CRT controller, the DISPEN or display enable signal goes high when a video signal at the CRT becomes active. The DISPEN signal acts as a video blanking signal because it becomes low during the vertical and horizontal retrace. Figure 2 shows a diagram of the CRT controller and the associated signals.

Registers

Within the CRT Controller IC, nineteen registers define the display and control parameters of the monitor. Software applications set the hexadecimal addresses for the registers, while the address register acts as a pointer to the addresses of the remaining registers, which are set up as mode select and status registers. The CPU loads the write-only address register directly.

Status registers designate the horizontal and vertical retrace. Parameters set within the registers determine the horizontal and vertical sync frequencies. The character clock, or the total number of displayed and undisplayed characters minus one, fixes the horizontal sync frequency.

Each horizontal sync pulse references to the leftmost character position displayed on the scan line. Vertical sync pulses have a duration of sixteen scan lines. These pulses use the topmost character position on the

The ZVM-130 CGA Video Monitor

Key Specifications for the ZVM-130:

Text Capacity	25 lines of 40 characters
Display Resolution . . .	250 horizontal lines x 240 vertical lines (non-interlaced) 480 lines (interlaced)
Inputs	NTSC standard composite video
Bandwidth	2.5 MHz
Scan Frequency	15.734 kHz horizontal 60 Hz vertical

Figure 3. These are the specifications for a ZVM-130 CGA monitor formerly produced and sold by Zenith Data Systems.

screen as a reference point.

Aside from setting the vertical and horizontal retrace, the status registers establish cursor characteristics and the addresses for the screen memory. This occurs through establishing the least significant and most significant bits of the character font byte. In addition the contents of the registers determine if the cursor will blink or move, and define the screen memory address that contains the displayed first character of the top-left corner of the raster.

At pin 56 of the controller, the PCURSOR, or cursor enable signal, exists as a result of the register settings and allows the definition of the cursor on the screen.

The mode select registers set the alphanumeric and graphics mode and the display format, and determine whether to use either monochrome or color signals. Changes within the mode select registers allow scrolling of raster contents or positioning of the cursor on the screen. If another video board is used with the system, the mode select registers route the output of the added board to the output of the resident video board.

Timing signals for the CRT controller and the Video RAM arrive from U111, the timing generator. Additionally, the timing generator controls memory access between the CPU and the CRT controller. U309, the composite color generator, processes and sends the color and mode select infor-

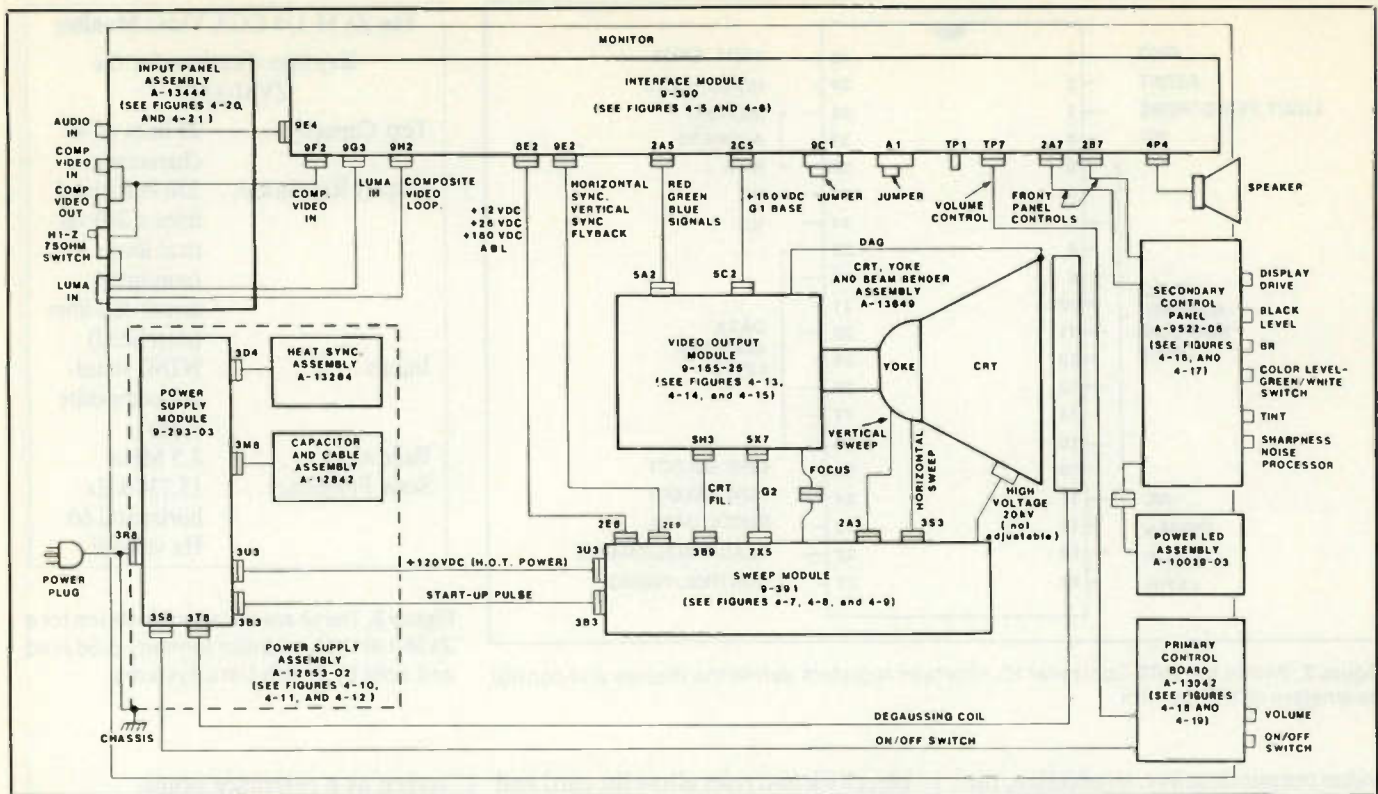

Figure 4. A block diagram of the ZVM-130 monitor listing the major assemblies. As the diagram shows, you can consider the monitor as consisting of four basic sections: the power supply assembly, the video output board, the sweep module and the interface module.

mation plus the composite video information signal to the video output circuitry. U340 and U341 make up the video output circuitry on the video card.

Video RAM action

U331 and U332 make up the 16K Byte storage banks. The video RAM stores the attribute and character bytes. Video RAM address bytes are derived from the multiplexing of signals originating at the CRT controller and found on lines MA1 through MA10. Graphic and alphanumeric displays cause the video RAM circuitry to function in different ways during the read cycle.

A graphics display causes the allocation of 16K of video RAM space for the graphics characters. An alphanumeric display leaves 8K of RAM available for attribute storage while 8K stays available for character storage.

During the alphanumeric data read cycle, these video RAM segments alternately output two bytes of data. When the write-enable signal at pin 11 of U318, a quad NAND gate, goes high, and the RAMG signal goes low, one byte is read as an attribute data byte.

When the NRFSH or refresh signal at pin 18 of U335, an octal buffer, goes

low, the multiplexed output of U326, U327, U333 and U334 supplies two bits of data to the video memory A0 through A7 address bus. Each memory circuit latches onto an address byte

when the row-address select signal goes low.

When the column-address select signal at pin 3 of U353, a Quad positive (continued on page 41)

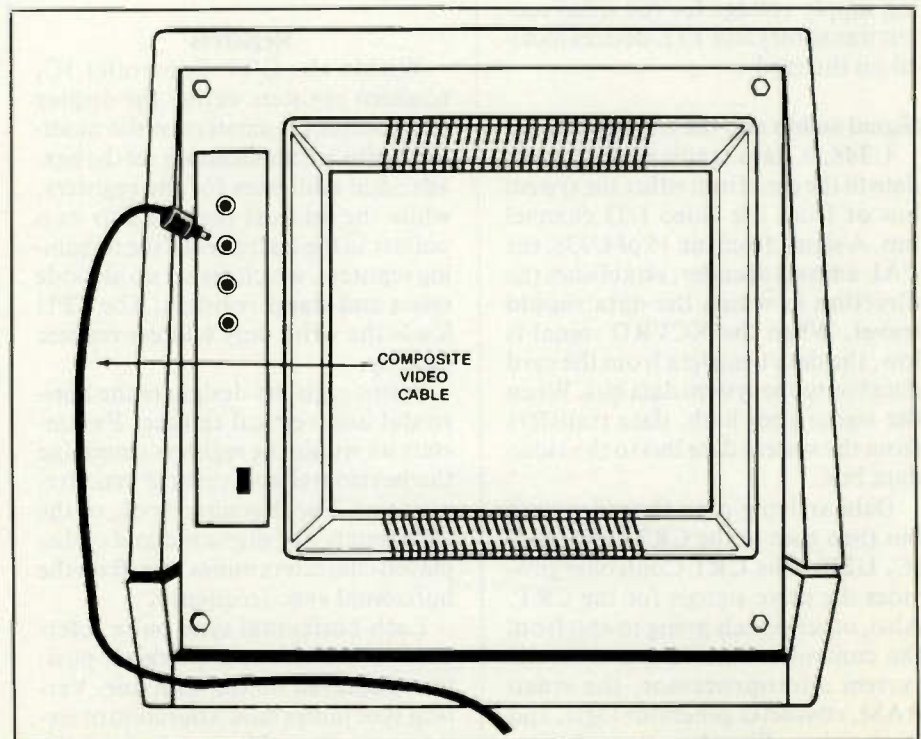

Figure 5. A video input connector connected to the graphics card in the computer supplies the composite video signal to the interface module.

SEPTEMBER 1992

Thomas Consumer Electronics
 Color TV Model No. TX82

Profax
 Number

3092

TUNER SCHEMATIC

Product safety should be considered when component replacement is made in any area of an electronics product. A star next to a component symbol number designates components in which safety is of special significance. It is recommended that only exact cataloged parts be used for replacement of these components.

Use of substitute replacement parts that do not have the same safety characteristics as recommended in factory service information may create shock, fire, excessive x-radiation or other hazards.

This schematic is for the use of qualified technicians only. This instrument contains no user-serviceable parts.

The other portions of this schematic may be found on other Profax pages.

TUNER SCHEMATIC

Product safety should be considered when component replacement is made in any area of an electronics product. A star next to a component symbol number designates components in which safety is of special significance. It is recommended that only exact cataloged parts be used for replacement of these components.

Use of substitute replacement parts that do not have the same safety characteristics as recommended in factory service information may create shock, fire, excessive x-radiation or other hazards.

This schematic is for the use of qualified technicians only. This instrument contains no user-serviceable parts.

The other portions of this schematic may be found on other Profax pages.

All integrated circuits and many other semiconductors are electrostatically sensitive and require special handling techniques.

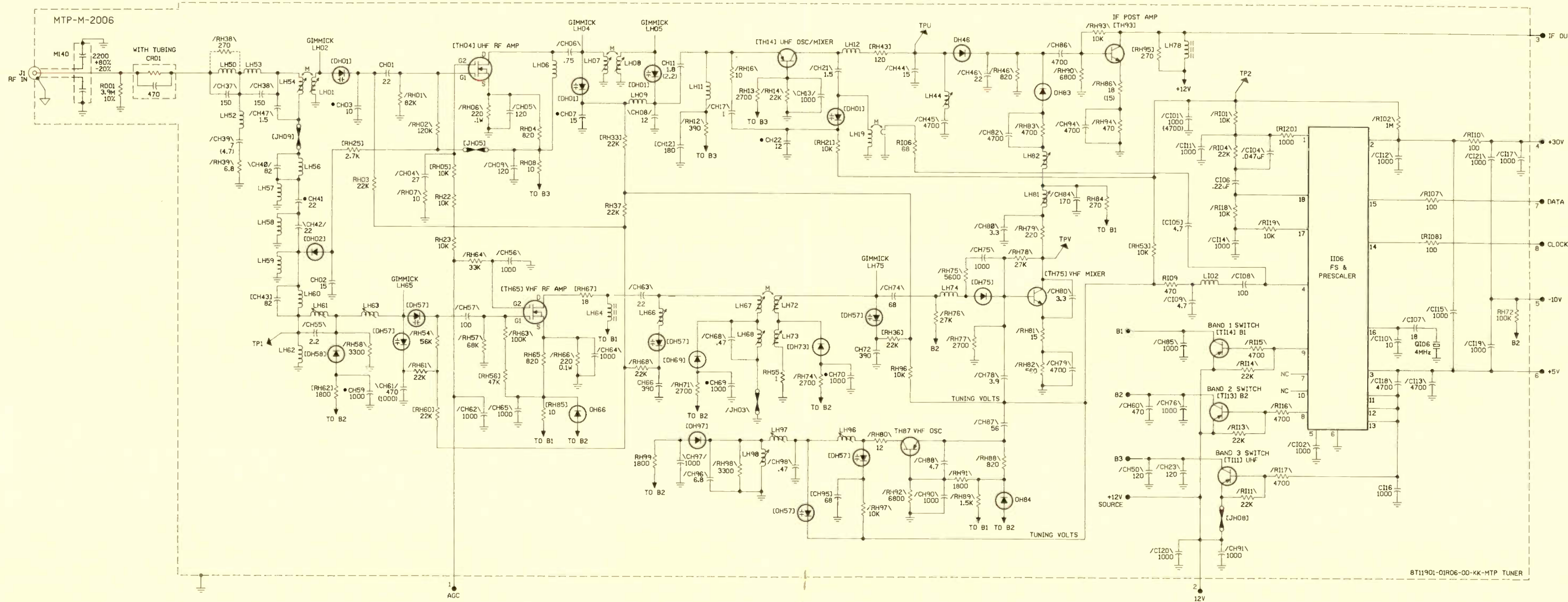

ALL INTEGRATED CIRCUITS AND MANY OTHER SEMICONDUCTORS ARE ELECTROSTATICALLY SENSITIVE AND REQUIRE SPECIAL HANDLING TECHNIQUES DESCRIBED UNDER "ELECTROSTATICALLY SENSITIVE (ES) DEVICES" IN THE SAFETY AND SERVICING PRECAUTIONS PUBLICATION.

PRODUCT SAFETY NOTE: COMPONENTS WITH A (*) HAVE SPECIAL CHARACTERISTICS IMPORTANT TO SAFETY. BEFORE REPLACING ANY OF THESE COMPONENTS, READ CAREFULLY THE PRODUCT SAFETY NOTICE IN THIS SERVICE DATA. DO NOT DEGRADE THE SAFETY OF THE SET THROUGH IMPROPER SERVICING.

- SCHEMATIC NOTES**
- ALL CARBON FILM RESISTORS ARE 0.25W UNLESS OTHERWISE SPECIFIED.
 - RESISTANCE VALUES IN OHMS (K=1000) 5% TOLERANCE.
 - CAPACITANCE VALUES ARE IN pF EXCEPT AS INDICATED.
 - UNLESS OTHERWISE SPECIFIED ALL CAPACITORS ARE 50V.
 - (*) INDICATES SERVICE TEST POINT (TP).
 - () INDICATES A FLAT SURFACE MOUNTED COMPONENT. (RESISTORS ARE 0.125W, 1206 SIZE CHIP)
 - (/) INDICATES A 0005 "MINI CHIP" COMPONENT. (RESISTORS ARE 0.0625W EXCEPT AS INDICATED.)
 - (•) INDICATES A TUBULAR-SHAPED CHIP COMPONENT.
 - (/) INDICATES A TUBULAR-SHAPED MINI-CHIP COMPONENT. (RESISTORS ARE 0.0625W EXCEPT AS INDICATED.)
 - A) ⊥ DENOTES CHASSIS GROUND.
 - B) ⊥ DENOTES ISOLATED GROUND.

SIGNAL SCHEMATIC

Product safety should be considered when component replacement is made in any area of an electronics product. A star next to a component symbol number designates components in which safety is of special significance. It is recommended that only exact cataloged parts be used for replacement of these components.

Use of substitute replacement parts that do not have the same safety characteristics as recommended in factory service information may create shock, fire, excessive x-radiation or other hazards.

This schematic is for the use of qualified technicians only. This instrument contains no user-serviceable parts.

The other portions of this schematic may be found on other Profax pages.

All integrated circuits and many other semiconductors are electrostatically sensitive and require special handling techniques.

SIGNAL SCHEMATIC

This schematic is for the use of qualified technicians only. This instrument contains no user-serviceable parts.

The other portions of this schematic may be found on other Profax pages.

All integrated circuits and many other semiconductors are electrostatically sensitive and require special handling techniques.

Product safety should be considered when component replacement is made in any area of an electronics product. A star next to a component symbol number designates components in which safety is of special significance. It is recommended that only exact cataloged parts be used for replacement of these components.

Use of substitute replacement parts that do not have the same safety characteristics as recommended in factory service information may create shock, fire, excessive x-radiation or other hazards.

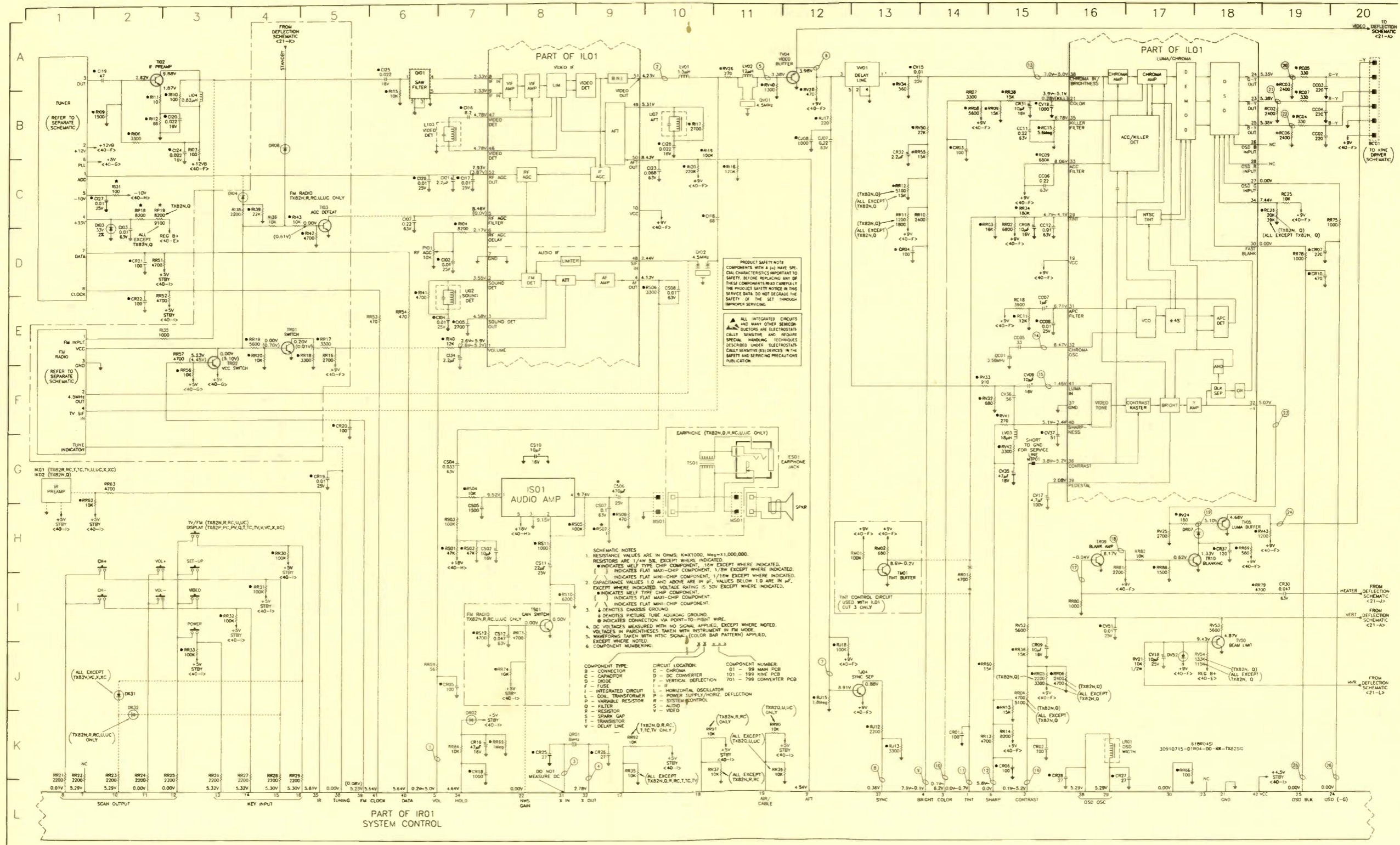

DEFLECTION SCHEMATIC

Product safety should be considered when component replacement is made in any area of an electronics product. A star next to a component symbol number designates components in which safety is of special significance. It is recommended that only exact cataloged parts be used for replacement of these components.

Use of substitute replacement parts that do not have the same safety characteristics as recommended in factory service information may create shock, fire, excessive x-radiation or other hazards.

This schematic is for the use of qualified technicians only. This instrument contains no user-serviceable parts.

The other portions of this schematic may be found on other Profax pages.

All integrated circuits and many other semiconductors are electrostatically sensitive and require special handling techniques.

DEFLECTION SCHEMATIC

Product safety should be considered when component replacement is made in any area of an electronics product. A star next to a component symbol number designates components in which safety is of special significance. It is recommended that only exact cataloged parts be used for replacement of these components.

Use of substitute replacement parts that do not have the same safety characteristics as recommended in factory service information may create shock, fire, excessive x-radiation or other hazards.

This schematic is for the use of qualified technicians only. This instrument contains no user-serviceable parts.

The other portions of this schematic may be found on other Profax pages.

All integrated circuits and many other semiconductors are electrostatically sensitive and require special handling techniques.

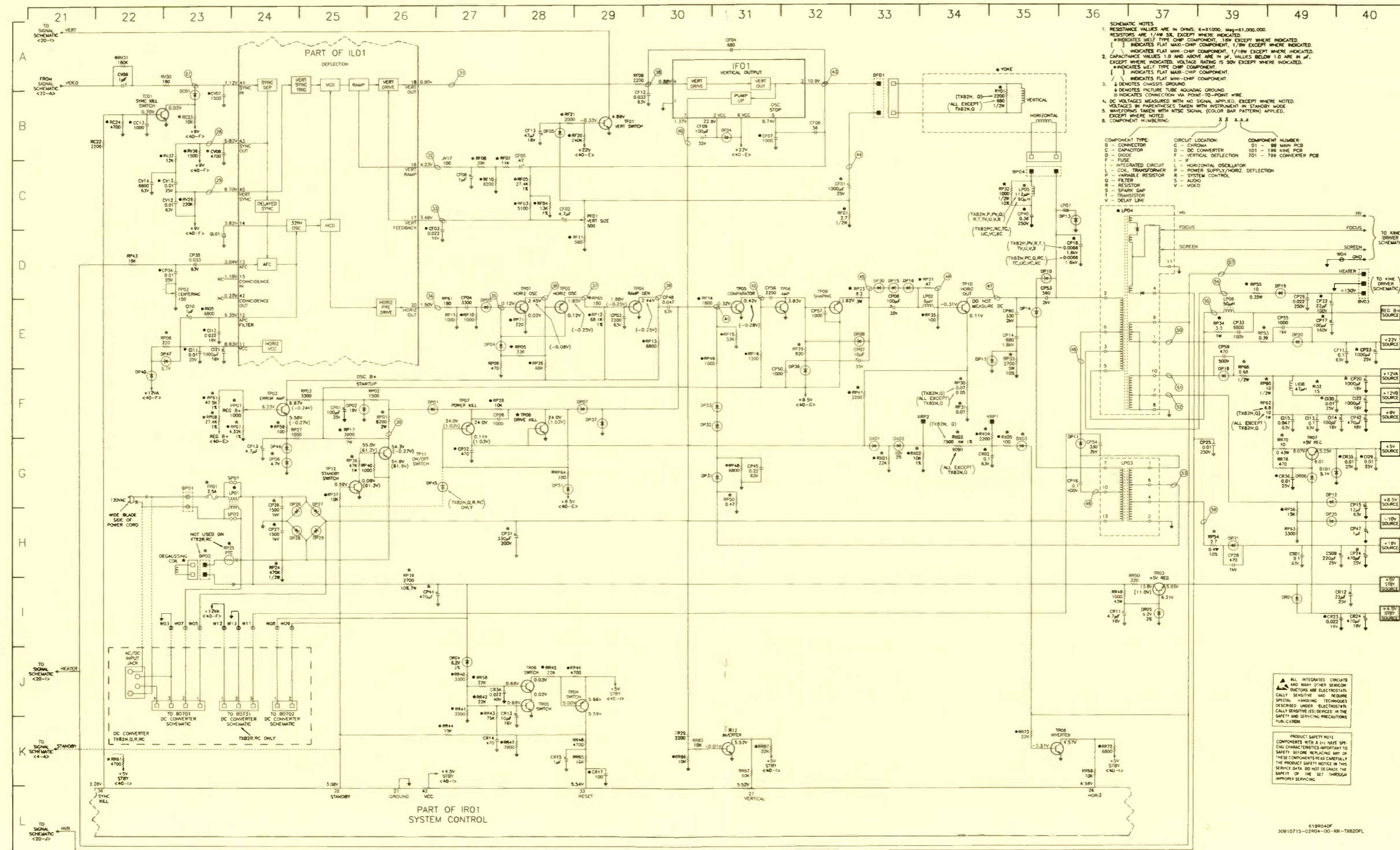

Thomas Consumer Electronics Color TV Model No. TX82

DC-DC CONVERTER SCHEMATIC

Product safety should be considered when component replacement is made in any area of an electronics product. A star next to a component symbol number designates components in which safety is of special significance. It is recommended that only exact cataloged parts be used for replacement of these components.

Use of substitute replacement parts that do not have the same safety characteristics as recommended in factory service information may create shock, fire, excessive x-radiation or other hazards.

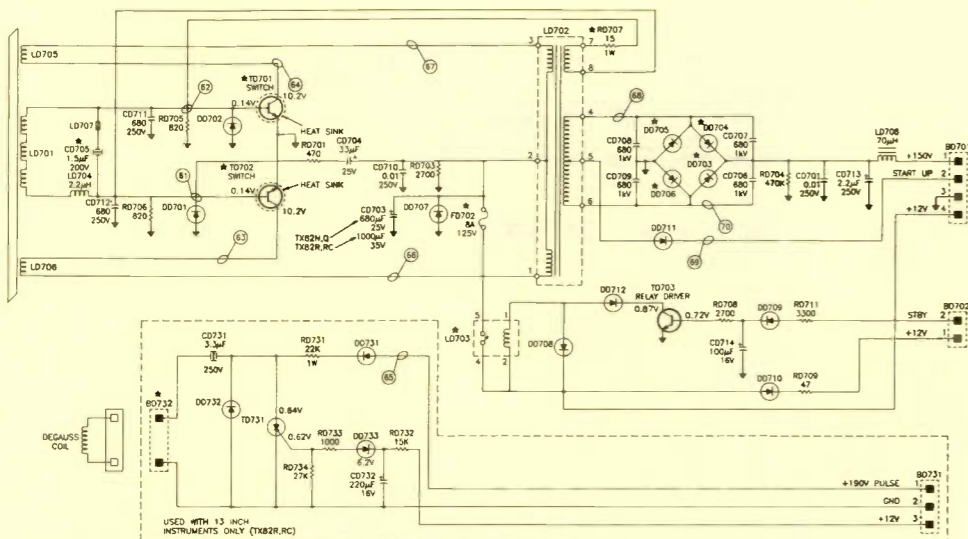

- SCHEMATIC NOTES: 1. RESISTANCE VALUES ARE IN OHMS, K=X1,000, M=X1,000,000. RESISTORS ARE 1/4W 5% EXCEPT WHERE INDICATED. ... 6. COMPONENT NUMBERING.

621R04DC 3091D715-04R04-00-KK-TX822C

REMOTE TRANSMITTER (CRK50/52/52) SCHEMATIC

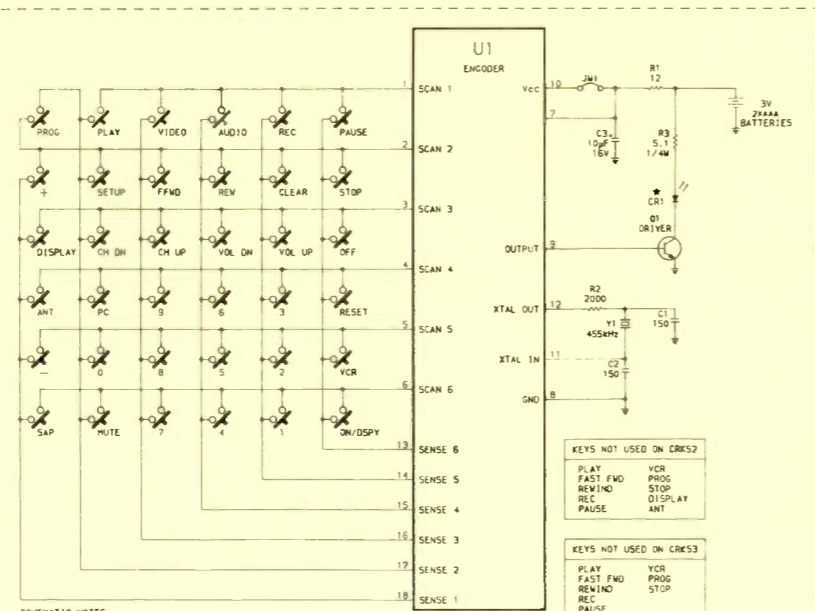

- SCHEMATIC NOTES: 1. ALL RESISTORS ARE 1/4W, 5% TOLERANCE UNLESS OTHERWISE SPECIFIED. 2. RESISTANCE VALUES IN OHMS, K=X1,000. 3. CAPACITANCE VALUES 1.0 AND ABOVE ARE IN PF. CAPACITANCE VALUES BELOW 1.0 ARE IN PF UNLESS OTHERWISE SPECIFIED. ALL CAPACITORS ARE 50V UNLESS OTHERWISE SPECIFIED.

6159001-00R01-00-JK-CRKS2/S3

KINE DRIVER SCHEMATIC

This schematic is for the use of qualified technicians only. This instrument contains no user-serviceable parts.

The other portions of this schematic may be found on other Profax pages.

All integrated circuits and many other semiconductors are electrostatically sensitive and require special handling techniques.

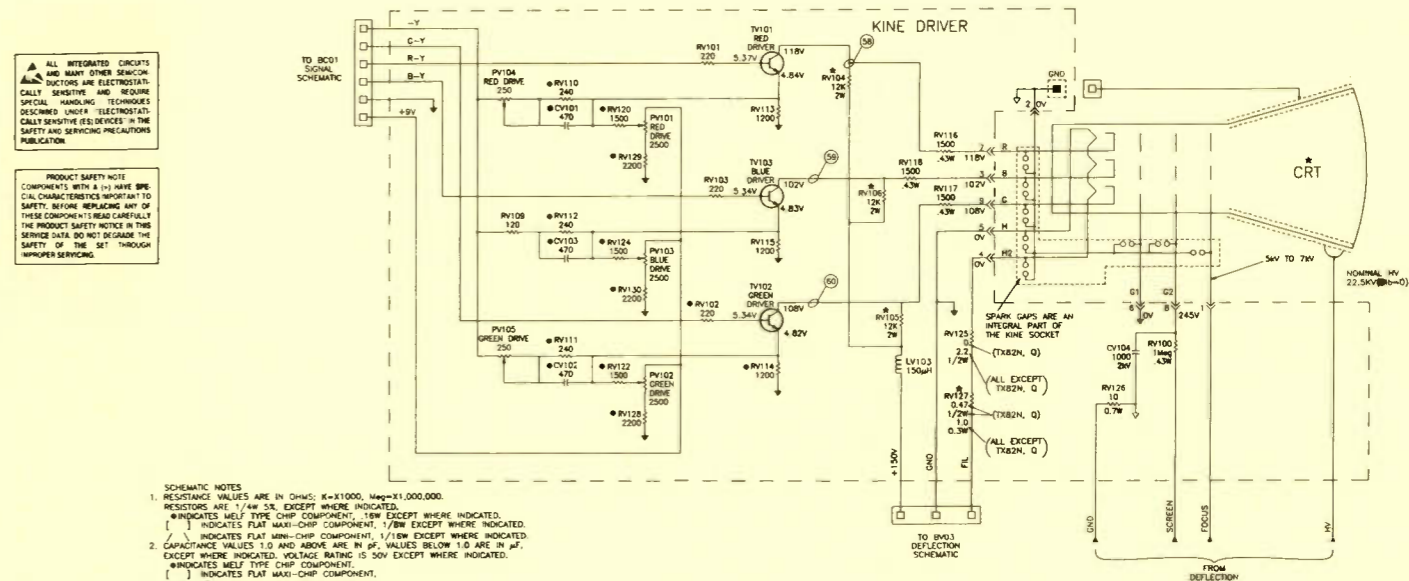

- ALL INTEGRATED CIRCUITS AND MANY OTHER SEMICONDUCTORS ARE ELECTROSTATICALLY SENSITIVE AND REQUIRE SPECIAL HANDLING TECHNIQUES DESCRIBED UNDER 'ELECTROSTATICALLY SENSITIVE DEVICES' IN THE SAFETY AND SERVICE PRECAUTIONS PUBLICATION. PRODUCT SAFETY NOTE: COMPONENTS WITH A (*) HAVE SPECIAL CHARACTERISTICS IMPORTANT TO SAFETY. BEFORE REPLACING ANY OF THESE COMPONENTS READ CAREFULLY THE PRODUCT SAFETY NOTICE IN THIS SERVICE DATA. DO NOT REGARD THE SAFETY OF THE SET THROUGH WHOLESALE SERVICING.

- SCHEMATIC NOTES: 1. RESISTANCE VALUES ARE IN OHMS, K=X1,000, M=X1,000,000. RESISTORS ARE 1/4W 5% EXCEPT WHERE INDICATED. ... 6. COMPONENT NUMBERING.

Table with 3 columns: COMPONENT TYPE, CIRCUIT LOCATION, COMPONENT NUMBER. Lists various components like connectors, capacitors, diodes, etc.

FM CONVERTER SCHEMATIC

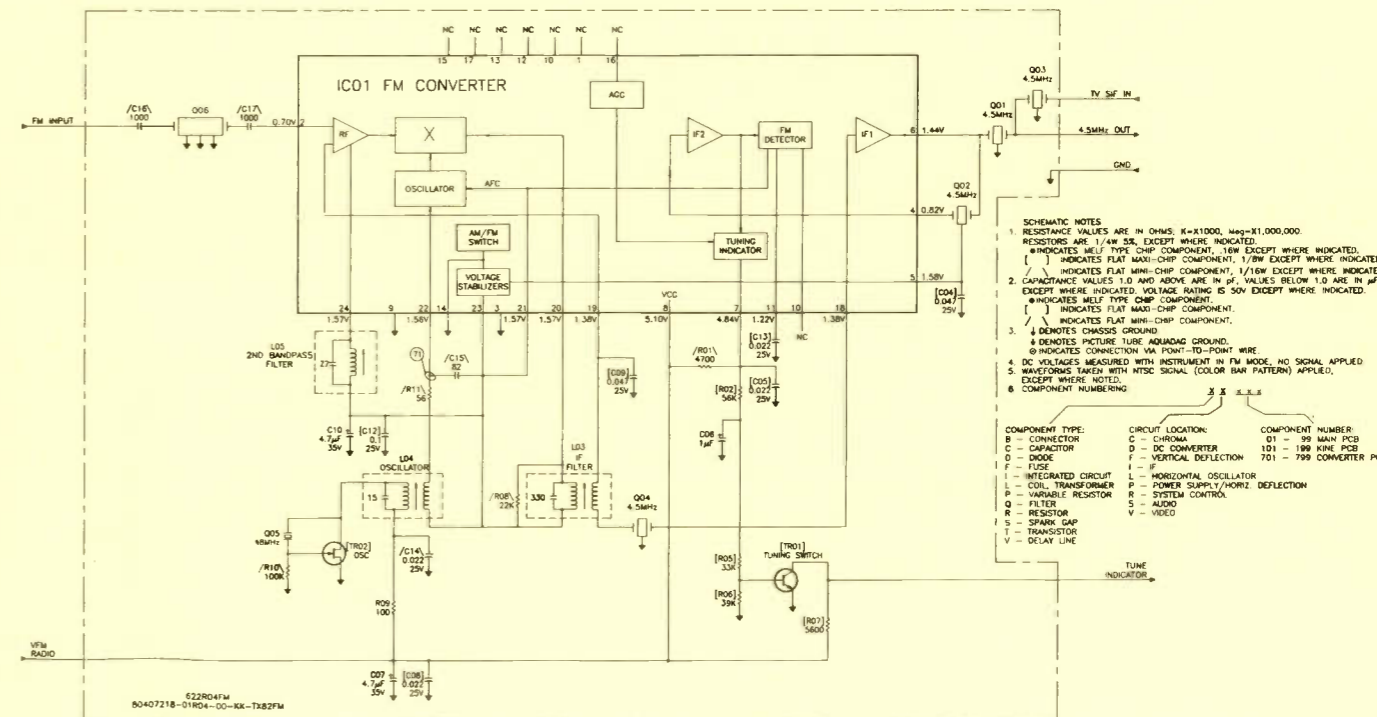

- SCHEMATIC NOTES: 1. RESISTANCE VALUES ARE IN OHMS, K=X1,000, M=X1,000,000. RESISTORS ARE 1/4W 5% EXCEPT WHERE INDICATED. ... 6. COMPONENT NUMBERING.

622R04FM 60407218-01R04-00-KK-TX82FM

9-293
 8
 9-293-01
 8
 9-293-02

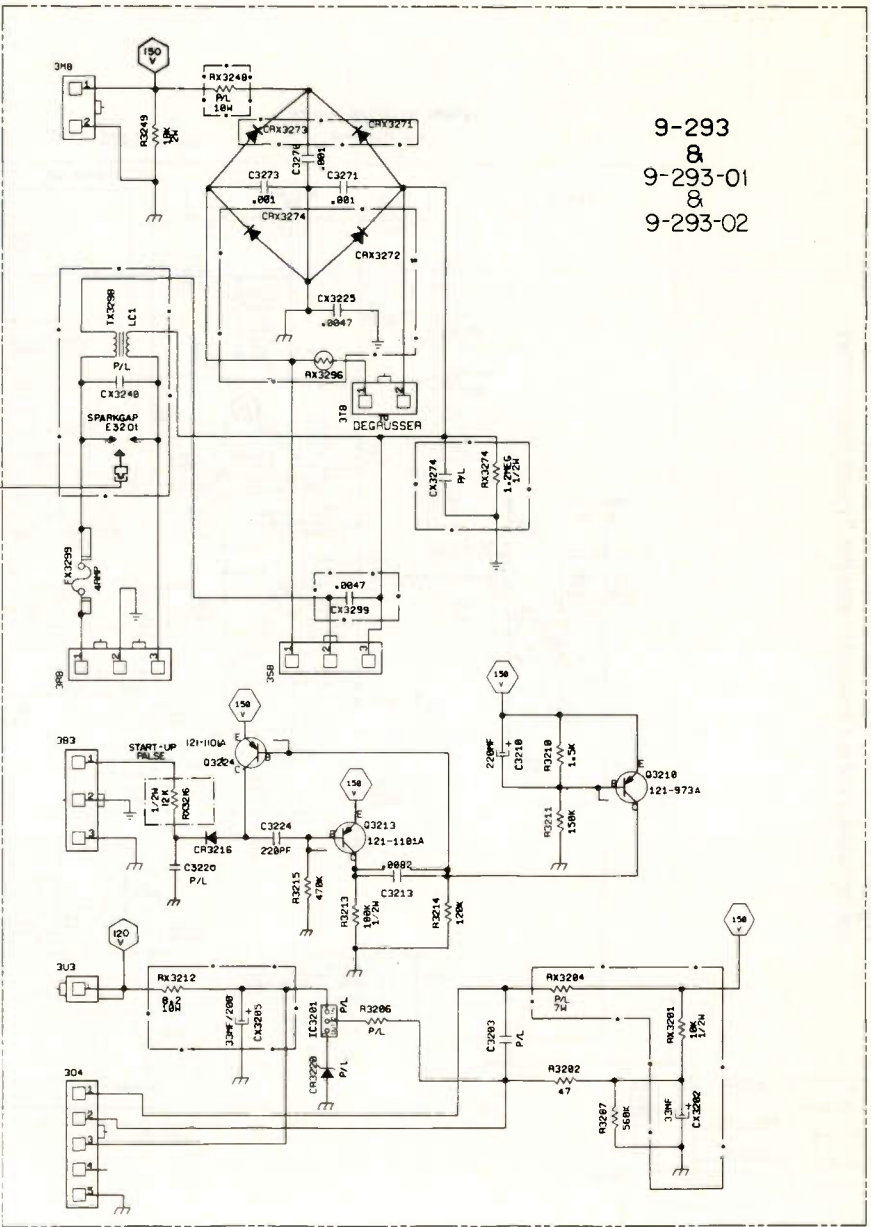

SCHEMATIC FOR
 9-293 & 9-293-01 & 9-293-02
 SERIES PASS POWER SUPPLY

CIRCUIT REFERENCE DESIGNATOR	PART NUMBER	VALUE	MODULE
C3249	22-7819-10	470MF 200V	9-293 & -01
C3249	22-7819-11	680MF 200V	9-293-02

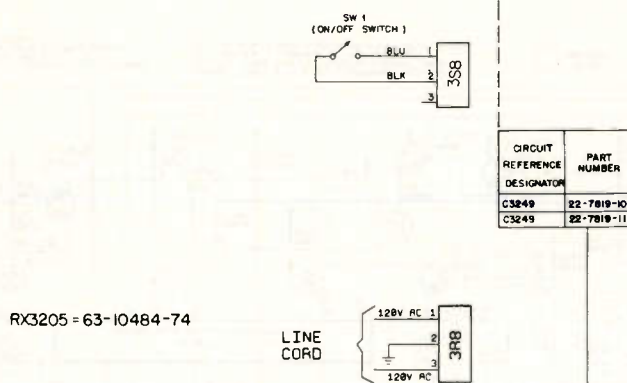

RX3205 = 63-10484-74

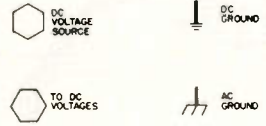
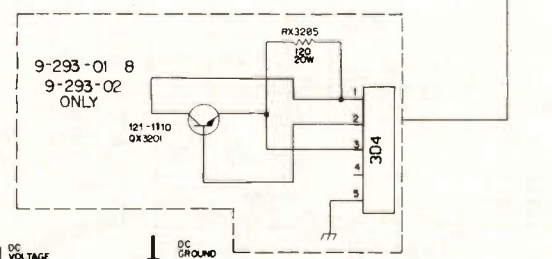
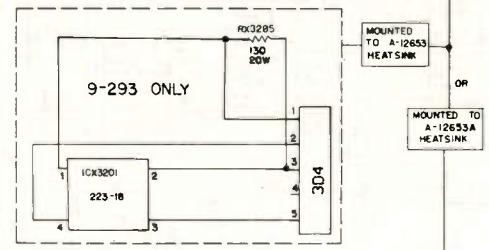

NOTES:
 1. RESISTORS ARE 1/4 WATT, 5 PERCENT TOLERANCE UNLESS OTHERWISE SPECIFIED.
 2. CAPACITORS ARE IN MICROFARADS UNLESS OTHERWISE SPECIFIED.

NOTES: (VALUE TAGS WITH SPECIAL MEANINGS)
 A. P/L = SEE PARTS LIST FOR APPLICABLE USAGE.
 B. JUMPER = JUMPER WIRE USED INSTEAD OF NORMAL PART
 C. PROV = PROVISION FOR A PHYSICAL PART IN THE LAYOUT ONLY.

Figure 6. Schematic of the power supply for the ZVM-130 monitor.

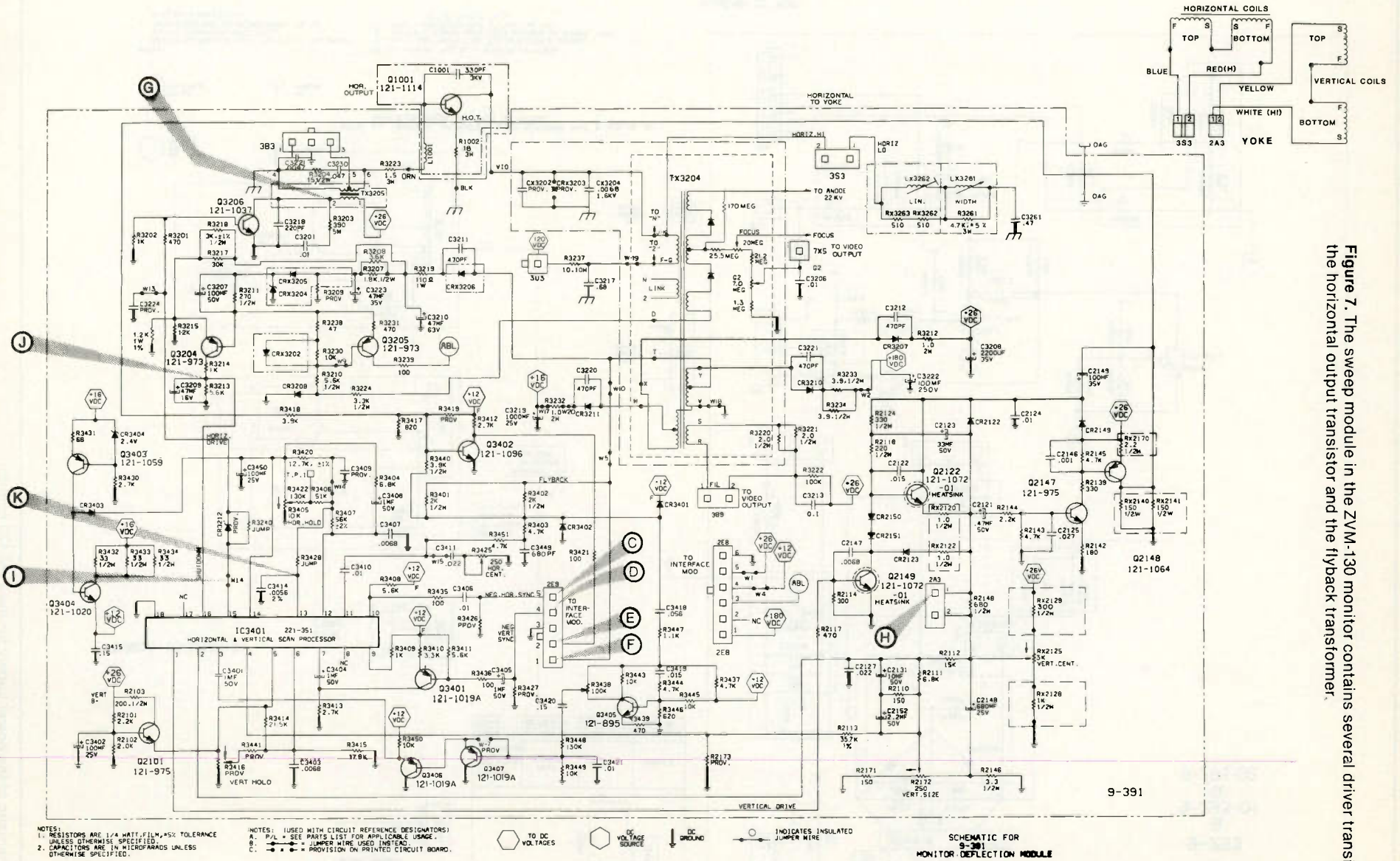

Figure 7. The sweep module in the ZVM-130 monitor contains several driver transistors, the horizontal output transistor and the flyback transformer.

NOTES:
 1. RESISTORS ARE 1/4 WATT, 5% TOLERANCE UNLESS OTHERWISE SPECIFIED.
 2. CAPACITORS ARE IN MICROFARADS UNLESS OTHERWISE SPECIFIED.

NOTES: USED WITH CIRCUIT REFERENCE DESIGNATORS)
 A. P.V. = SEE PARTS LIST FOR APPLICABLE USAGE.
 B. - = JUMPER WIRE USED INSTEAD.
 C. - = PROVISION ON PRINTED CIRCUIT BOARD.

TO DC VOLTAGES
 DC VOLTAGES SOURCE
 DR GROUND
 INDICATES INSULATED JUMPER WIRE

SCHEMATIC FOR
 9-391
 MONITOR DEFLECTION MODULE

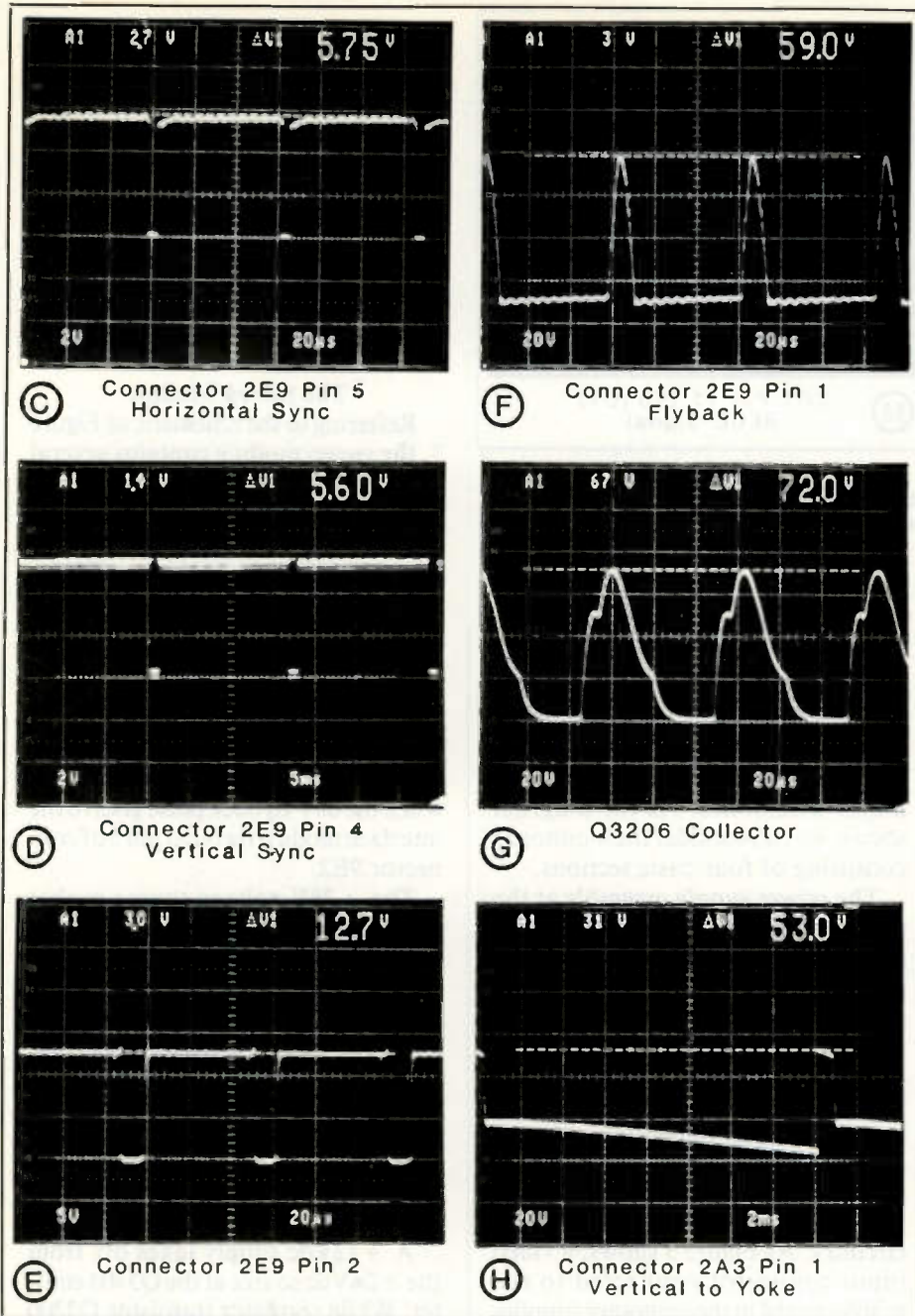

Figure 8. Horizontal and vertical sync and the drive signal waveforms observed in a ZVM-130 monitor.

OR gate, becomes active, the video RAM devices latch onto a second address byte from lines VMA1 through VMA6 of the video memory address bus. Character and attribute data bytes become stored at the addressed memory location.

With a low RAMG signal, the tri-state buffer, U330, transfers data from the video RAM data lines to the data bus during the read cycle. An active ROMG signal causes the other byte to address the character generator read-only memory. In turn, the ROM supplies a character data byte.

The write and refresh cycles remain the same for either the alphanumeric or graphic modes. With the memory write signal at pin 2, U340, a hex inverter, drives the signal at pin 11 of U318, a quad NAND gate, to a low condition. This action provides a write enable signal for the video RAM. Additionally, the digital active low state at pin 18 of U318 "turns on" the tri-state buffer, U329. Data transfers to the video data bus. Refreshing the data stored in the memory locations prevents the loss of the data.

Refresh or NRFSH signal pulses

from pin 16 of the gate array go to pin 4 of U318 and to the video RAM multiplexers. A low NRFSH signal sends the signal at pin 6 of U318 high. With a high level at pin 6, the binary counter, U336, supplies the tri-state buffer, U337, with a byte of data. With that action, the addressing of a specific row within the video RAM occurs. To refresh the row of data, the RAS, or row-address strobe signal, goes low.

Character generator operation

Screen memory and character generation require two sets of signals. Lines MA0 through MA13 serve as screen memory address output lines. These fourteen lines let the controller address the 16KBytes of video memory. Lines RA0 through RA4 work as the raster address signals for character generation logic.

A ROM character generator provides selectable characters from patterns stored within the ROM. Four sets of characters generate 256 possible characters through the 7 x 7 double-dot and the 5 x 7 single dot width character dot set. Character generator logic determines which scan line of a character row functions. Scan line counts range from zero to 31 per character row. Each scan line count becomes a part of the horizontal sync rate.

Troubleshooting the video card

Video problems may be caused by a number of jumpers or components on the video card. See Figure 1B for an illustration of all of the possible positions for all jumpers on this card. Following are many of the video problem symptoms and possible causes:

Problem: Characters on the left side of the raster display off the screen.

Causes: 1. Incorrect setting of jumper 302 on the video card. 2. Defective quad multiplexer, U341.

Problem: Loss of horizontal synchronization.

Causes: 1. An incorrectly positioned jumper 305. 2. A defective hex inverter, U340. 3. A bad hex inverter buffer, U349.

Problem: Loss of vertical synchronization (rolling or poor vertical linearity).

Causes: 1. Mis-set jumpers 302, 303 and 313. 2. Defects in U340, U341 or U349. In all instances, check the input and output signals of the CRT controller.

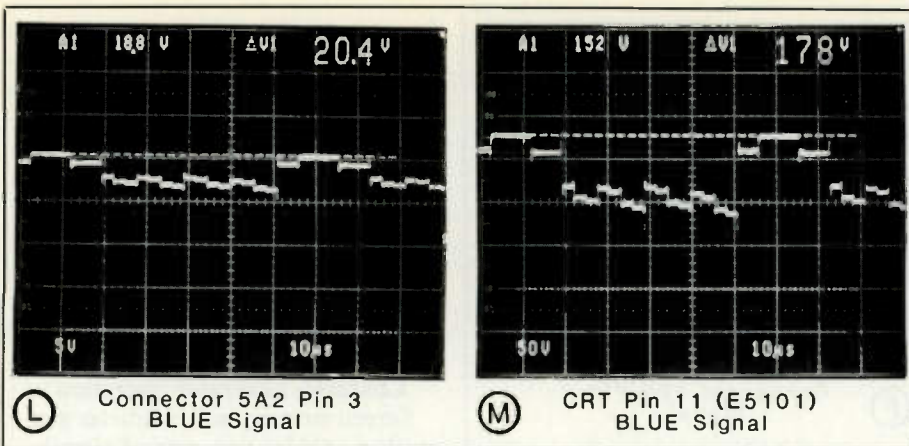

Figure 9. Output signals from the video output module go directly to the CRT socket. Red, blue, and green signals enter the module at connector 5A2 and travel to the individual red, blue, and green video output transistors. Shown here are the waveforms observed at the connector and the CRT socket.

Problem: Mismatched colors and lowered intensity.

Causes: 1. Defects in the dual 4 to 1 multiplexers (U327, U334, U333). 2. Defective video memory ICs. 3. Defective resistor pack, RP306. 4. Defective CRT controller. 5. Defective tri-state buffer, U345. 6. Defective octal flip-flop, U330. 7. Defective quad multiplexer, U342.

Problem: Incorrect background color.

Causes: Defective U326, U327, U330, U333, or U334.

Problem: Cursor does not blink.

Causes: A bad CRT controller.

Problem: Loss of video dots in graphics mode.

Causes: Defects in U324, U325, U326, a dual 4 to 1 multiplexer, or U327, another dual 4 to 1 multiplexer.

Problem: Display of wrong data while in video mode.

Causes: 1. Malfunctions in octal flip-flop, U330. 2. Defective video RAM ICs. 3. Defective 4 to 1 multiplexer U334.

Problem: Display of random characters and attributes across the raster.

Causes: 1. Internal defects in U319, an eight-bit latch. 2. Defective U323, U326, U327, U328, U330, U333 or U334. 3. Defective video RAM devices.

Problem: 1. White raster or a displayed wrong font.

Causes: 1. Defective switch 301 and the CRT controller. 2. Defective CRT controller. 3. Defective video RAM, U326, U327, U330, U333 or U334.

The ZVM-130 CGA monitor

Figure 3 lists the specifications for a ZVM-130 CGA monitor formerly produced and sold by Zenith Data Systems. Figure 4 shows a block diagram of the monitor and lists the major assemblies. As the diagram shows, we can consider the monitor as consisting of four basic sections.

The *power supply assembly* at the top of the diagram provides regulated dc power supply voltages needed to generate the horizontal and vertical drive voltages.

The *video output board* connects the CRT to the video output signals. The *sweep module* provides the low dc signal voltages, deflection voltages and the high voltage for the CRT. A separate *interface module* contains part of the vertical and horizontal sync circuitry. As Figure 5 shows, a video input connector connected to the graphics card in the computer supplies the composite video signal to the module.

The power supply assembly

As with many of the televisions that Zenith produced in the 1980's the ZVM-130 monitor relies on molex connectors for the board interconnections.

Referring to the schematic of the power supply assembly of Figure 6, the line voltage supply ties to the power supply assembly through connector 3R8. A fuse provides overcurrent protection against overcurrent problems. Connector 3S8 is the tie point for the ac line switch. Diodes CRX3271 through CRX3274 make up a bridge rectifier with ac ground used as a reference.

Of the two positive dc voltages de-

veloped on the power supply assembly, the +150Vdc supply reaches its full potential first. This supply provides the start-up pulse for the sweep module. Without the start-up pulse that allows the horizontal oscillator to operate and drive the horizontal output transistor, Q1001, no high voltage can develop. +120Vdc derived from the +150Vdc supply provides power for the horizontal output transistor.

The Sweep Module

Referring to the schematic of Figure 7, the sweep module contains several driver transistors, the horizontal output transistor and the flyback transformer. The flyback, TX3204, supplies +180Vdc, +26Vdc, +12Vdc, the CRT filament voltages, the 22kV CRT high voltage, the focus voltage, the G2 voltage and the 60V flyback pulse.

Three voltages, +180Vdc, +26Vdc and +12Vdc, are applied to the interface module through connector 2C5, while the 60V flyback pulse goes to the interface module through pin 5 of connector 9E2.

The +26V voltage source pushes the horizontal oscillator into operation. Diode CR3224 rectifies ac current from the secondary winding of start up transformer T3201. Diode CR3219 shunts the negative alternations of the signal to ground and leaves only the positive half-wave alternations as a supply for the oscillator, which is part of IC3401, the sync processor. From the oscillator, the horizontal signal goes to pin 5 of IC3401.

A +12Vdc supply takes off from the +26Vdc source at the Q3404 emitter. While regulator transistor Q3200 supplies +12.7Vdc through its emitter, current flowing through diode CR3205 produces a voltage drop across a voltage divider made up of resistors R3203 and R3202. Any change in the +12vdc output voltage from the regulator transistor is detected by transistor Q3201. The detector connects to the center of the voltage divider.

If the output voltage decreases, the current flowing through the divider resistors and the voltage at the base of Q3201 also decreases. Because Q3201 conducts less current, the voltage at the base of Q3200 increases and drives the transistor harder. The output voltage at the emitter of Q3200 then increases back to its necessary level.

If the output voltage rises above +12.7Vdc, the opposite conditions

occur. Current through the divider resistors and the voltage at the base of Q3201 increases. When Q3201 conducts more current, the voltages at the base and emitter of Q3200 decrease.

After it is generated by the power supply assembly, the horizontal drive signal goes to connector 3G3 of the sweep board. From the connector, the signal becomes applied to forward driver transistor Q3206, reverse driver transistor Q3209, and transformer T3205. The output voltage of the

transformer goes to the horizontal output transistor through connector 3R3.

Sync signals found on the sweep module

The composite signal connects to the base of transistor Q3404 through pin 2 of connector C. Some overvoltage protection for the transistor comes from the combination of capacitor C3462 and zener diode CR3409. From the emitter of Q3404, we can trace the

composite signal to pin 27 of the sync processor. After processing, the signal is driven from pin 16 of the IC to the base circuit of Q3405. The signal then becomes applied from the collector of Q3405 to each of the drive level adjustment potentiometers.

Along with processing the composite drive signals, IC3401 also processes the vertical and horizontal sync signals. With either positive or negative vertical sync, the signal is applied from pin 2 of connector E to the base of

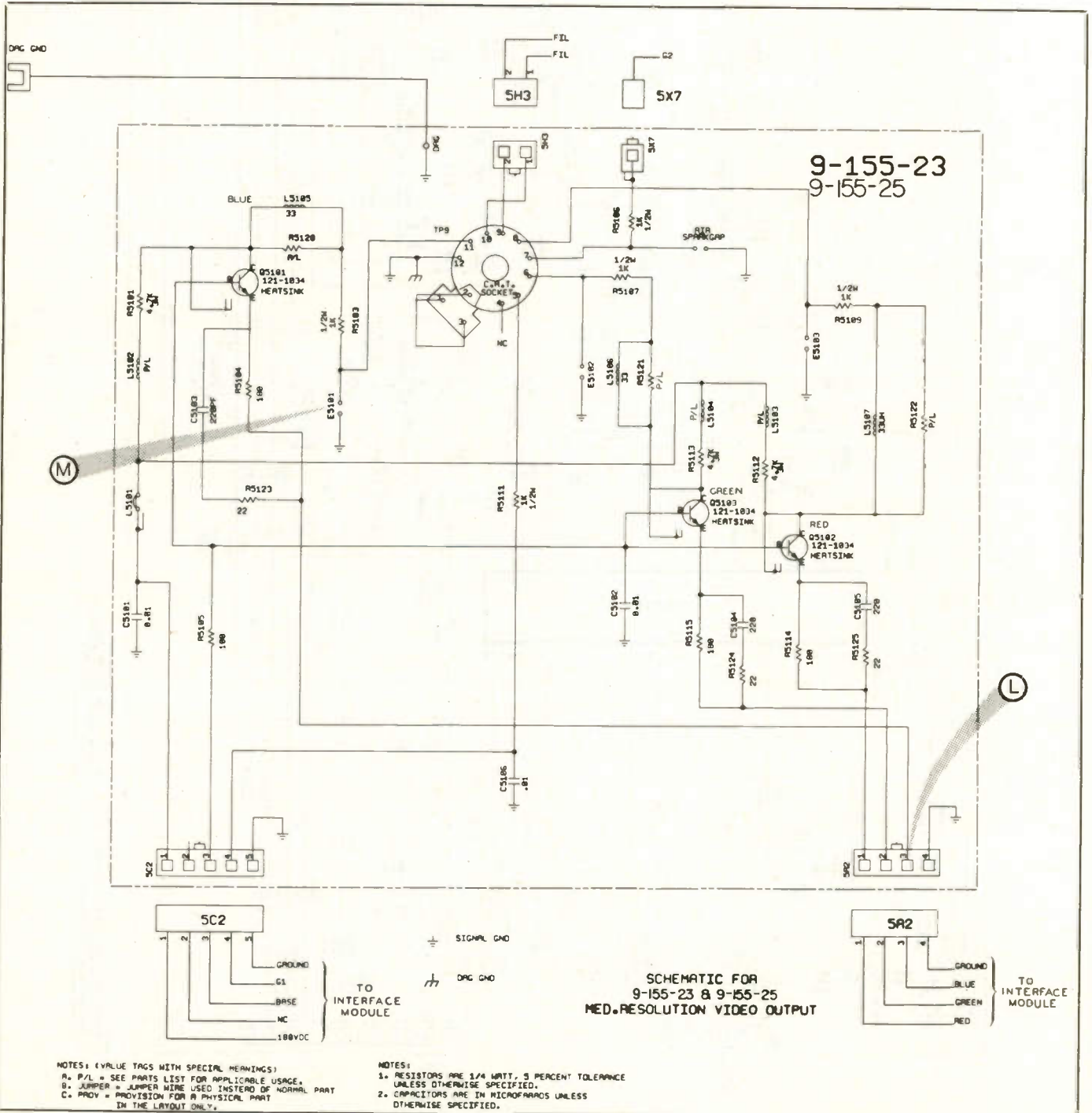
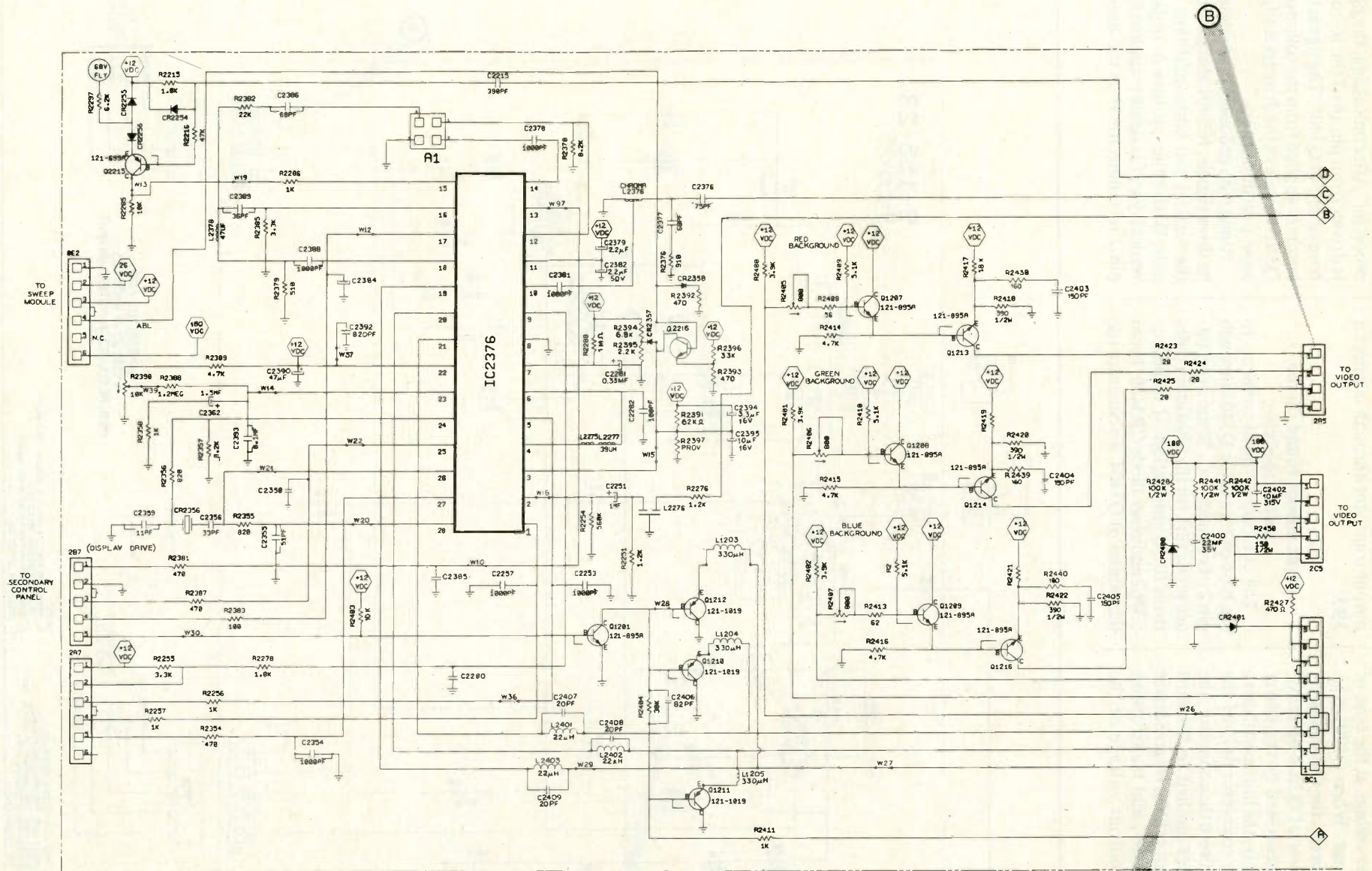

Figure 10. The red, green and blue output transistors on the video output module are Q5102, Q5103 and Q5101, respectively.



NOTES:

1. RESISTORS ARE 1/4 WATT, 5 PERCENT TOLERANCE UNLESS OTHERWISE SPECIFIED.
2. CAPACITORS ARE IN MICROFARADS UNLESS OTHERWISE SPECIFIED.

NOTES: (VALUE TAGS WITH SPECIAL MEANINGS)

- A. P/V - SEE PARTS LIST FOR APPLICABLE USAGE.
- B. AMPER = AMPERE WIRE USED INSTEAD OF NORMAL PART.
- C. PROV - PROVISION FOR A PHYSICAL PART IN THE LAYOUT ONLY.

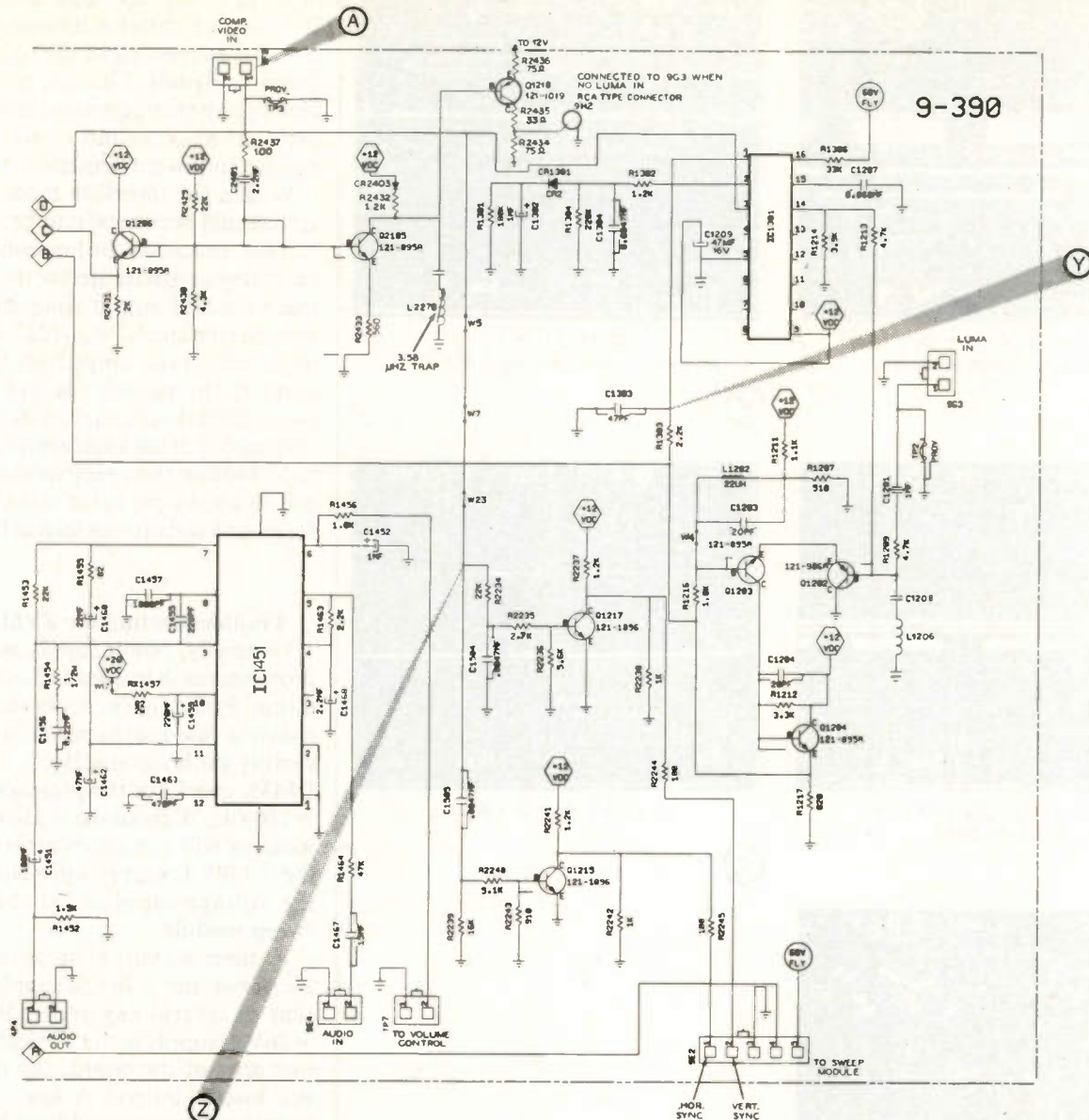

Figure 11 In addition to interfacing the signals from one module to another, the interface module also develops the red, green and blue signals for the video output module. This module also contains circuitry required for generating the horizontal and vertical sync.

Q3401. Once the signal has become inverted, it goes to the base of Q3402 and then to pin 28 of the sync processor circuit.

Pin 1 of connector E supplies either positive or negative horizontal sync signals to the base of Q3403. As seen with the vertical sync signal, the common emitter transistor inverts the signal before it goes to the base of an emitter follower. From the collector of the emitter follower or Q3404, the signal then goes to pin 27 of the integrated circuit.

Aside from the horizontal oscillators and sync processing circuitry, IC3401 also contains other key cir-

cuits. The sync processor IC includes the horizontal automatic phase control, horizontal output driver, vertical oscillator and the vertical output driver. The vertical output present at pin 14 of the IC drives a pair of vertical output transistors, Q2101 and Q2102.

The vertical output signal goes from these transistors to connector 3G3 and on to the sweep assembly. In addition, the horizontal sync signal from pin 5 of the connector also goes through the 3G3 connector and to the sweep assembly where it drives the horizontal output transistor. Figure 8 shows photographs of horizontal and vertical sync and the drive signal waveforms.

The video output module

Output signals from the video output module go directly to the CRT socket. Red, blue and green signals enter the module at connector 5A2 and travel to the individual red, blue and green video output transistors. Figure 9 shows the waveforms seen at the connector and the CRT socket. As shown in the Figure 10 schematic, the respective transistors are Q5102, Q5103 and Q5101.

All voltages on the video output module originate on other modules. The sweep module supplies the CRT filament voltage at connector 5H3, the G2 voltage at connector 5X7 and the

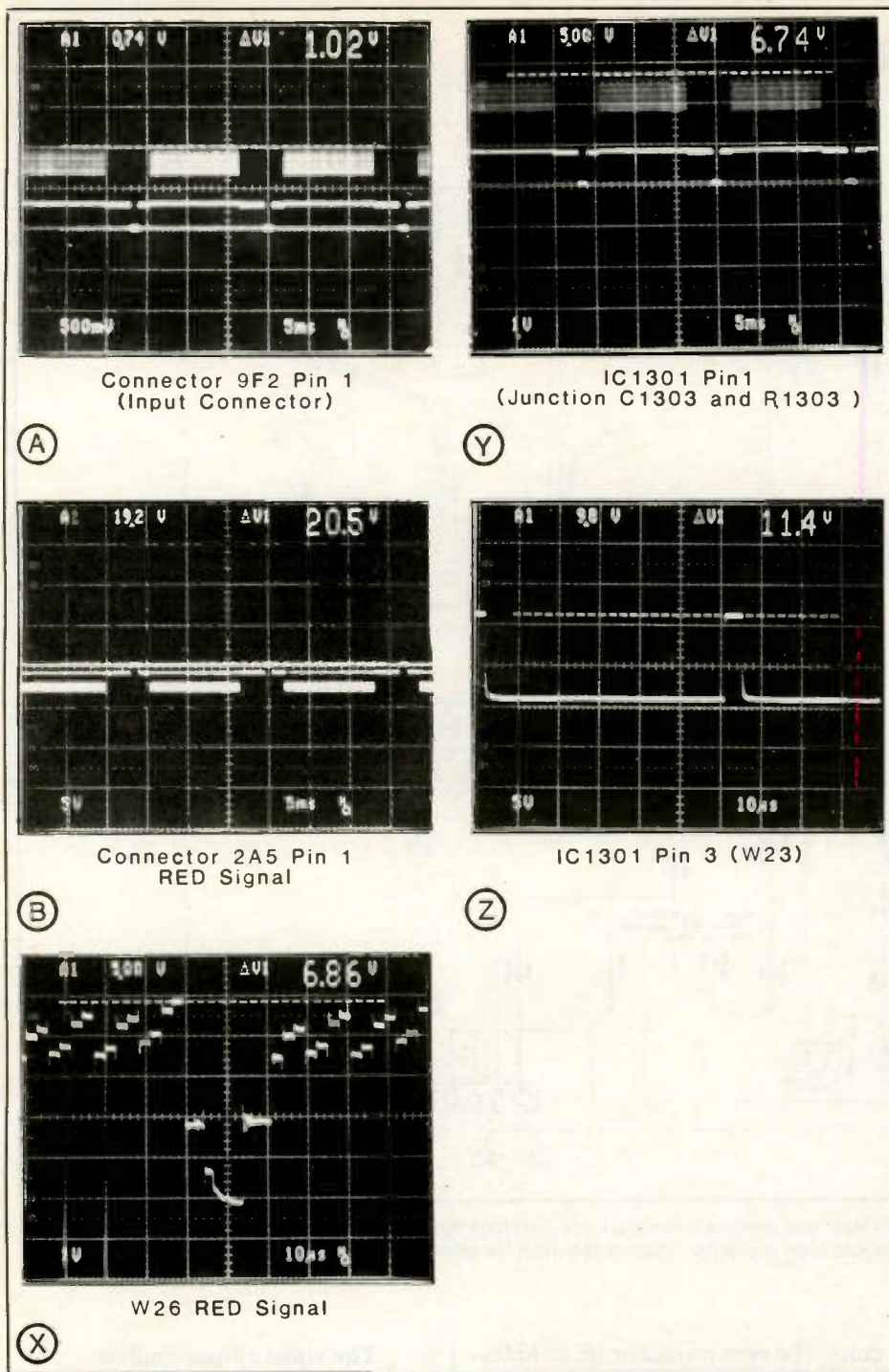

Figure 12. The color signal waveforms found at IC1301 on the interface module. IC1301, processes the horizontal and vertical sync signals.

focus voltage. The interface module supplies the +180Vdc transistor supply voltage, the G1 voltage and the horizontal output transistor base drive voltage.

The interface module

Figure 11 is the schematic for the interface module. Aside from interfacing the signals from one module to another, the interface module also develops the red, green and blue signals

for the video output module. In addition, the interface module contains circuitry required for generating the horizontal and vertical sync signals for the sweep module. As you may suspect, those signals are derived from the composite video signal.

The composite video signal enters the module at pin 1 of connector 9F2. Wiring ties the connector to the input panel assembly and the external composite video input jack. From the con-

ductor, the video signal goes to IC2376, the chroma/luminance circuit, for processing of the red, green and blue signals. The red, green and blue signals then progress through individual background controls and emitter follower transistors.

Within the interface module, the vertical and horizontal sync processor, IC1301, processes the horizontal and vertical sync signals. Before the signals reach the 9E2 output connector, the vertical sync amplifier, Q1217, and the horizontal sync amplifier, Q1215, amplify the signals for use by the sweep module circuitry. Sync signals flowing out of the interface module go to IC3401 on the sweep module. Figure 12 shows the color signal waveforms and waveforms seen at IC1301.

Troubleshooting the ZVM-130

Generally, power supply assembly problems result in a dead monitor condition. Preliminary checks should include the fuse and the power supply assembly molex connectors. Using a DMM, check for the presence of the +150Vdc. Without the +150Vdc, the monitor will not achieve start-up. If the +150Vdc supply is present, check the voltage supplies listed for the sweep module.

As the schematic of the sweep module shows, the +26Vdc supply is present in several key areas. With no +26Vdc supply in the vertical deflection area of the board, the monitor will lose its output. A low +26Vdc supply will cause problems with the vertical height and linearity. Since the +12Vdc supply ties to the sync processor, also trace +12Vdc line when experiencing sync problems.

In the past, Zenith Data Systems reported problems with ZVM-130 monitors losing horizontal sweep because of bad solder connections. Check the connections at coils L1 and L2. The high current through those coils sometimes generates enough heat to unsolder the connections. In addition, the high current caused by the open solder joints can cause resistors R1 and R2 to open.

Next time

In the next installment, we'll talk about another type of graphics adapter and monitor. As we look at EGA displays, we'll study how the signals affect the video display. ■

Tell us your success story

By Conrad Persson

The past two decades have been a difficult period for consumer electronics servicing businesses. A number of forces have combined to make it more and more difficult to stay in business. The proof of that is the remarkable number of businesses that have failed during this twenty-plus year span. In his article "Equipment and methods for PC board servicing," in this issue, Bob Kral mentions that in that span, many servicing businesses have gone belly up, and mentions some of the reasons why.

Many service businesses that were in operation in the early 70's are still healthy and thriving. Why did some businesses fail while others survived, and some positively thrived? It would appear that those that did in fact make it through hard times, and are now not only healthy but extremely successful, are the ones that saw the handwriting on the wall and began to make the changes necessary to stay in business.

One of the things that some service businesses did to survive was to diversify. TVs became more reliable, and at the same time more difficult to service. And, contrary to the experience of the economy as a whole, the products, the TVs, stereos, and as they entered the market the VCRs, camcorders and CDs continued to drop in price. Because of this economic reality, many service centers have said "my biggest competition is the price of a new product."

With 19-inch TVs selling for under \$300.00, some VCRs selling for under \$300.00, and CD players selling for less than \$100.00 to a few hundred dollars, the service centers are limited to a fraction of that amount as to how much they can charge to service a product.

As the price of new products dropped, some sales and service businesses changed to service-only, because of the low margins available on sales of the products. In many

cases, small sales and service companies were paying more to buy product from the manufacturer at wholesale than the mass merchandisers, with their tremendous buying power, were charging the end user.

Many service businesses diversified into service of other products, such as video games, computers and other home office equipment. In addition, these businesses began to specialize, by having each technician concentrate on specific classes and brands of products. It is really no longer possible for a single individual to be able to service all brands and all products. They are just too numerous and too complex.

Those service centers that have successfully changed the direction of their business are generally only too happy to share some of that information with their fellow service centers. We're sure that many readers of *ES&T* will be able to benefit from the advice of service centers that have made the changes necessary for their continued survival.

With this issue, *ES&T* inaugurates a new department: Successful Servicing. In it, we will bring you information about successful service businesses that have made changes that have made it possible for them to survive and prosper even in a difficult economy. The first of these will be Frick Electronics of Independence, MO.

We would like to invite our readers to participate in this department. If you have made changes to your service business, such as by adding new high-tech products to the list of products that you service, and that has allowed you to go from hard times to new levels of success, let us know. We'd be delighted to tell readers about the reasons for your success.

Or if you know of a service business that has recently turned things around by making some important changes, tell us about it so we can contact them and get their story.

We would welcome your story written in your own words. If your service company has faced problems such as

the ones that we mention above, and the ones that have been overcome by Frick Electronics, and you have taken steps that have turned things around and kept the business healthy and thriving, that information may help other service businesses that are trying to keep their heads above water. If you'd like to tell other service companies how you survived when companies all around you were going out of business, please send us text and photos and we'll publish them in an article similar to the one here.

We're particularly interested in stories about service businesses that have either survived, become successful, or become more successful, by expanding the scope of their servicing to include products that are either entirely new, or products that are not the traditional consumer electronics products. This range of products includes such things as personal computers, monitors, printers, facsimile machines, telephone answering machines, video games.

Send your story to:

Conrad Persson
Editor
Electronic Servicing & Technology
PO Box 12487
Overland Park, KS 66212
913-492-4857

If your submission is accepted, we'll publish it, and besides gaining the recognition of other service companies, you will be helping other service businesses overcome their problems.

The article you send should be between three and six double-spaced typewritten pages. Photos should be 4X5 or larger. For your information, the photos that accompany this article were shot by an amateur photographer with a good quality 35mm single-lens reflex camera using 400-speed black and white film. All the lighting for the photos is standard indoor lighting typically found in a service facility.

Let us hear from you! ■

Successful Servicing

Frick Electronics updates line of products serviced, gets back on track to success

Tim Frick started Frick Electronics around 20 years ago. Tim's wife Susan has been part of the business since the beginning. Today, Frick Electronics, Independence, MO, is a successful consumer electronics service center. Tim Frick is President of the company, and Susan is Business Manager.

In the early years, during the 70s, Frick was successful, servicing mostly TVs and audio equipment. Their good work and effective business practices led to their becoming authorized for a number of product manufacturers.

The company continued to be successful for a number of years, but gradually, business began to fall off. It was the same problem that has been faced by thousands of consumer electronics servicing businesses. The problem has a number of components.

For one thing, the products themselves went through a number of changes. Vacuum tubes, which were inherently and notoriously unreliable failed often, and failures of these components usually accounted for several service calls on a product in any year.

As vacuum tubes were replaced first



Figure 1. When faced with declining business in servicing of traditional consumer electronics products, Frick Electronics, in Independence, MO, diversified into servicing of other products, such as video games and home office products. Business has never been better.

by transistors and then by integrated circuits, the number of service calls on an average TV set dropped from several per year to one every five or ten years.

The introduction and refinement of printed circuit technology gradually replaced point to point wiring in consumer electronic products, which dramatically reduced the labor cost of



Figure 2. Susan Frick, on the left, in the reception area of Frick Electronics. A sign on the wall informs customers that Frick serviced Nintendo Games and provides a listing of the price of each service procedure.



Figure 3. Dot matrix printers such as the one on the service bench are highly reliable, but even they do fail, and require service. In this case, the printer wasn't faulty, but had to be reconfigured via the soft keys on the front to do what the owner wanted it to do.



Figure 4. The technician at this bench is servicing a TV set, but it is evident that there is a computer monitor on the bench waiting service. Monitors are somewhat different than TV sets, but they are similar enough that learning to service monitors is a comfortable experience for a qualified TV technician. There are millions of computer monitors in homes in this country, a significant opportunity for service centers.

building a product. Other production automation techniques combined with the automation of circuit wiring, causing the prices of the products to not only not increase, but to actually decrease, while inflation was causing the prices of other consumer goods to rise steadily.

During the same time period, the mass merchandising companies began to appear. Their tremendous buying power increased the downward pressure on the price of consumer electronics products. With all of these occurrences lowering prices on products, it

became more attractive in many cases for the consumer to discard a product that had developed a problem than to have it serviced.

Enhancing the consumer's tendency to discard a product rather than to have it fixed was the fact that in the several years that they owned the product, the manufacturers had so improved the new products, with such things as remote controls, cable ready, stereo audio, second audio program, higher fidelity audio, that consumers were generally ready to buy a more modern, fuller featured set anyway.

Even though they were good, and by most measures successful, the Fricks saw their business first stagnate and then contract. They began to look around for new directions to move in, new products to service. They knew that they had to make some changes, but weren't sure what changes to make.

Benefiting from the experience of others

Recognizing that other service businesses had faced the same problems and while many had failed or were on the verge of failing, many had made some kinds of corrections that had revitalized their businesses. The Fricks joined the National Electronics Service Dealers Association through the Kansas City affiliate.

By associating with other service professionals who were in the same boat, they began to learn of ways in which other service centers were able to increase their business in spite of problems in the economy, and the problems peculiar to the service business. Frick Electronics adopted some of those techniques to their own business.

One of the areas Frick Electronics decided to explore was office equipment. In 1986 as the increasing reliability and decreasing price of consumer electronics products continued to erode their business, even as they added more and more brands, Frick Electronics decided to branch out into the servicing of the growing field of computers.

This move into the office product



Figure 5. More and more consumers are buying computers for the home to do all kinds of tasks; from word processing and finance tracking to playing computer games. Servicing of these computers can provide a good source of revenue for the service center that is farsighted enough to recognize this opportunity.



Figure 6. Nintendo video games represent a relatively new class of products that need servicing. Here a technician at Frick refurbishes a Game-Boy unit. This procedure includes replacing certain specified components that tend to wear or fail, and is done at a fixed price.

servicing area came about as a result of the good servicing work that Frick had already been doing on audio and video for one of the major manufacturers. As this manufacturer began to introduce personal computers and related products onto the market, they solicited their authorized service centers to service these products. Frick decided to enter the personal computer servicing field.

Once Frick was successfully servic-

ing these products, they decided to talk to the manufacturer about allowing them to service their industrial computers; that is the higher end personal computers that are used in management information systems. Frick Electronics now services those products as well.

Servicing printers and copiers
Once started in servicing computers and monitors, Frick Electronics also

decided to enter the field of computer printer service. In order to get up to speed on printers, they sent one of their techs to a school where he learned to service dot-matrix, daisy wheel and laser printers. With a technician on staff who was competent to service printers, Frick decided to solicit laser printer servicing business from other manufacturers. The company now services many different brands of laser printers.

Copiers, which are similar in principle to laser printers, seemed like a likely product on which to exercise the skills that their technicians had acquired in entering laser printer servicing, so Frick Electronics went after that business. It wasn't long before Frick had added copiers to the growing list of products that they service.

Servicing facsimile

Frick Electronics then began looking to service other office products. At about the same time, facsimile was beginning to appear in more and more offices and homes. Frick sent a technician to a generic fax servicing course offered by a major manufacturer. This course provided the technician with skills to service any kind of fax equipment.

Video games

Frick has also become authorized to service Nintendo video games in the Kansas City area, and these ubiquitous products have provided a substantial amount of business for the company.

Non-traditional products are substantial part of product mix

Servicing of products other than those that have been traditionally considered to be consumer electronics products is now 20% of Frick's business.

Try it, you might like it

If you are facing problems similar to those faced, and faced down, by Frick Electronics, it might be in your best interests to look around, talk to other service businesses, attend a meeting of a servicing association, and think seriously about servicing some products other than the products traditionally serviced by consumer electronics service companies. It just might be the medicine your bottom line needs. ■

Looking to challenge your building skills?

Want to explore beyond Amateur communications?

Well here's the publication for YOU!

COMMUNICATIONS QUARTERLY, the journal of communications technology. You are invited to become part of an elite group of Radio Amateurs and technical professionals as a subscriber. Circulation will be strictly limited.

This new quarterly publication has been put together with YOU in mind. Articles will explore, in-depth, areas that no Amateur Magazine is currently covering.

State-of-the-art electronics like direct synthesis, digital signal processing, and computer control are fully investigated and explained so that you can take advantage of these new technologies. COMMUNICATIONS QUARTERLY articles cover high speed data communications, the latest in antennas using computer designed models, plus much more. Articles examine many areas of professional electronics in a way that trade publications can't. Insights into areas that are only whispered about are normal fare. A major effort is made to show how applications can be translated into Amateur Radio operations.

Each quarterly has approximately 100 pages of technical material; advertising is limited. Articles flow from page to page, without the interruption of ads placed in the middle. The open layout accentuates each author's work and lets you make notes, calculations, or comments for later reference. Graphs, photos, computer program listings, and charts are presented in an easy-to-use format. COMMUNICATIONS QUARTERLY is printed on a high-quality stock and "perfect bound" (square backed). It is such a valuable resource, you'll want to file each copy away in your technical archives for future reference. In fact over time, you'll find much of what is presented in COMMUNICATIONS QUARTERLY will become the standard in the Amateur and professional communications field.

Act now. Subscribe today!

1 year 29.95 Foreign—1 year \$39.95 Foreign Air Mail 1 year \$ 60.95
2 years \$56.95 2 years 76.95 2 years 118.95

Name _____ Call _____

Address _____

City _____ State _____ Zip _____

Check Money Order MasterCard VISA Amex

Card No. _____ Expires _____

Signature _____

Mail to: CQ Communications, Inc.
76 North Broadway, Hicksville, NY 11801
Phone: 516-681-2922/FAX: 516-681-2926



Test your electronics knowledge

By Sam Wilson, CET

This is another test that gives you definitions. Your job, if you decide to accept it, is to select the term or terms that match the definitions. There are more terms than definitions.

Terms

- | | |
|-----------------------------------|--------------|
| 5 Printer Spooler Response | 4 WAN Hold |
| 3 Propagation Delay Time Constant | 2 IEEE NESDA |
| 1 Interrupt Coriolis | 7 C Digital |
| Mirroring MAD | 8 Unix |
| 9 LAN | 10 SAD |
| | 6 Bandwidth |

Definitions

1. A signal that suspends a program

temporarily. It transfers control to the operating system when input or output is required.

2. What is the name of a professional engineering organization that sets networking standards.

3. The time necessary for a signal to travel from one point on a circuit to another is called _____.

4. A network covering a large geographic area. It may include packet-switched, public data, and value-added networks.

5. Software that sends a file to a shared printer over a network even when the printer is busy. The file is saved in temporary storage and then printed when the printer is available.

6. A measure of the information capacity of a transmission channel.

7. A programming language used by professional programmers to write applications software.

8. An AT&T-developed multitasking, multiuser operating system for mini-computers that has enjoyed popularity among engineering and technical professionals.

9. An assembly of computing resources, such as PCs and printers, linked by a common transmission medium such as coaxial cable or twisted-pair wiring.

10. A fast-acting diode used for protection against an overvoltage condition. (This is about a computer power supply component.)

(Answers on page 61)

Wilson is the electronics theory consultant for ES&T.

Improve Your Form.

3-Part

A continuous feed form used for customer c.o.d. service or parts/accessory sales receipts (N3CN). Not for warranty billing. Computer generated software to be available soon.

5-Part

Available in snapout (N5SN) or continuous feed (N5CN). Matching fields with N3SN, except for customer estimate and receipts. For warranty billing.

7-Part

A universal snapout form (N7SN) designed for both customer service c.o.d. and manufacturer warranty billing. Compiles fully with the requirements of state and local ordinances, including California.

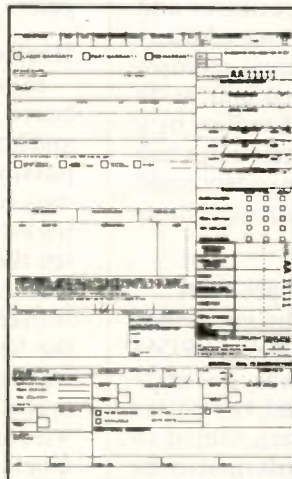

Discounts

Carbonless NESDA Forms are available to NESDA members at additional savings. For pricing information and samples, or information regarding other NESDA membership benefits, write to NESDA, 2708 W. Berry St., Ft. Worth, TX 76109; or call (817) 921-9061.

The NESDA Form

NESDA, 2708 W. Berry St.
Fort Worth TX 76109
Phone: (817) 921-9061

Presenting the New TENMA Video Pattern Generators from MCM Electronics



MCM introduces the new Tenma NTSC and Portable Pattern Generators! These new low cost generators are ideal for any service application. The NTSC Generator produces 14 patterns including NTSC color bars, with or without -IWQ. The Portable Pattern Generator produces ten patterns and is perfect for most field service technicians. For more specifications, see page 12 in catalog 29 and call today!

To order, or to request a FREE catalog
Call Toll Free: 1-800-543-4330
or Fax 1-513-434-6959



MCM ELECTRONICS
650 CONGRESS PARK DR.
CENTERVILLE, OH 45459-4072
A PREMIER Company

ES-68

Circle (48) on Reply Card

Computer motherboard repairs

By T.V.Kappel

Computer motherboards of the ISA, EISA, and MicroChannel variety do not have a great number of failures. These boards usually have relatively low voltage and current requirements and consequently don't experience the expansion and contraction due to heat that causes so many problems in electronics.

This doesn't mean that there are no failures, just that they are few and far between. That's more or less the good news. The bad news is that when they do fail they are almost always intermittent and are usually temperature sensitive. This, of course, means that they are "dogs" and are often difficult to locate and repair.

Most of the problems that will be encountered will be caused by intermittent components that are acting up and will not, usually, be caused by the soldered connections on the motherboard. This doesn't mean that solder joint problems don't happen. This possibility should always be checked and eliminated. It's surprising how often that just soldering the suspicious connections on a motherboard will correct and repair the unit.

No matter what the symptoms are, however, before you finally arrive at the motherboard and begin troubleshooting you should have checked the power supply, the board edge connections, and all externally connected boards and devices and positively eliminated the possibility that the problem originated in one of those sections. Most problems in a computer occur in one of those areas.

Once you have for all practical purposes exactly, absolutely, positively isolated the problem to the motherboard, roll up the oscilloscope, the heat gun, the can of coolant, the heat

blanket, and schematic, if you're lucky enough to have one. This could, and probably will be, a tough dog problem.

Check the socketed chips

The most likely causes of problems are the socketed chips on the motherboard. These chips become loose through expansion and contraction due to the heat build up inside the case itself. Push against these chips and sometimes they will reseat with a little popping sound as they connect firmly with the socket.

The pins on these chips can also oxidize while they're clamped and seated in the socket. The expansion and contraction moves the chip to an oxidized area and creates a resistive connection and possibly an intermittent. Carefully pull and remove these chips and clean the chip legs of any oxidation, but be doubly careful here as this often complicates the problem.

Improper static procedures and handling of chips have caused many of them to fail. One recent multiple problem repair involved bad ROM chips due to improper handling by a previous technician. These chips had to be replaced before the system could be started and the original intermittent problem resolved.

Using ROM POST products

It should probably be mentioned here that there are a number of "ROM POST" (read-only memory power on self test) test boards and kits on the market. These are often touted to check dead motherboards right to the component and they often do work and save you time. If you repair a large number of computers or have a large organization, these troubleshooting aids might be invaluable time savers and production aids.

These products are expensive, however, and you should check them thoroughly to make sure they perform the

tests adequately and as advertised. If it's a mail order house, make sure they have a return-if-unsatisfied policy. Then when the unit arrives, make sure it is tested the minute it comes out of the box.

If you service a large number of the same model of computers, contemplate purchasing a backup set of ROMs if they are available. If they are not, burn a back-up set for troubleshooting purposes. Now the law here is confusing and we certainly don't want to break the law. If you are allowed to make a back up set of ROMs for a computer you own for archival and testing purposes then do so. If not, then don't. But, they definitely can be a handy test device especially if other service technicians or even just plain curious owners get their hands on the machines to fool around with before they bring them in for bench repair. Now, back to the problem of intermittent motherboard repairs.

Heat may be the cause of the problem

In most cases the defective motherboard will be tested outside of a case and hooked up to a power supply and possibly even a video device and a monitor. This, of course, will allow the board to run much cooler and often the temperature related problem will not show up. Use a heat gun or a blanket to cover the board to build up the heat and troubleshoot the unit when it begins to act up. Now this is pretty basic stuff, but often patience, wisdom, and a can of coolant will quickly isolate and solve a potentially difficult problem.

ROM chips do fail, but not very often. CPU chips fail, but also not very often. What fails most of the time are the small chips that have big jobs to do and ones that must constantly work or switch fast. These chips work hard, generate heat in the process, and fail accordingly.

Kappel is Telecommunications Engineer for the District Library, Instructional Technology Services, for the Alburquerque, NM, Public Schools.

Clock oscillators, clock dividers, flip-flops, and other chips associated with the timing of the computer have caused a number of intermittent problems. The erratic changing of the timing to integrated circuits can make the component receiving these pulses appear defective. If these chips are suspected, check the clock pulses using the high frequency oscilloscope. Monitor them while using the heat gun and the can of coolant. This can save ordering expensive IC's only to find out the problem still exists.

The value of a good library

Without a schematic, defective oscillator chips can be difficult to locate and interpret. A good set of IC chip specification sheets are worth their weight in gold. Buy these books and stick them on the shelf. A good reference library will increase production and improve overall profits. One quick and good trick here is to see if a suspected chip's replacement is listed in your favorite semiconductor replacement guide, like the ECG guide. The chip layouts here can often show you which pins to monitor on the original component in the computer under test.

On some of the old original single-board computers like the Commodore, the Atari, or the Radio Shack computers, the troubleshooting procedure was always to check the power

supply, then the RAM chips, and finally the clock pulses. This is still a good procedure even with today's faster and much more complicated motherboards.

Carelessness may have been the cause of the problem

The new breed of computer motherboards often have many of the functions and chips that used to be relegated to add-in bus boards. Video, serial and parallel ports, elaborate audio circuits, and others can now be found on these motherboards. These functions are often protected by buffer chips and these buffer chips are often damaged by plugging and unplugging cables to the associated ports. This is quite often done with the computer on and the external machine on the other end of the cable powered on as well.

Static, accidentally grounding pins, and hooking cables to the wrong ports are common causes of failures on these new motherboards. Here is one place where loop back cables and test devices can definitely help you. The oscilloscope can help here as well. Monitor and test each line for proper output. The scope will provide a much better picture than a breakout box ever will with its little blinking diodes.

Motherboard problems can be the most difficult problems to solve. Watch the time invested in troubleshooting one. The cost of a new board is quite often relatively cheap and



troubleshooting time is definitely not. Board repair is a challenge. Board replacement is an easy cop out.

There is a challenge to a technician's ability to solve these tough dog problems. It's so easy to get involved and lose all track of time with the challenge. If the motherboard problem proves that difficult then replace it. It is often the most economical and wise repair in today's business and profit environment. But, you can still give it one heck of a good shot before you call the new board in as the solution. ■

If You Knew How Much TENTEL Gauges Improve VCR Repair - You'd Already Have Them!

More confidence in repairs being done right the first time. Peter Kosovlch

Peko TV- Milwaukee, WI

Bench time has been cut in half! Fred Jolley

Beverly, N.J.

Don't know how we managed as long as we did without the gauges. Peggy Miller

Miller's Elect's-Butler, PA

Stop guessing about sources of video streaking, tracking problems, flagging video, tape edge damage, video head wear, tape "eating" problems, and other VCR problems. 9 out of 10 VCR malfunctions are due to mechanical problems that can easily be diagnosed with TENTEL gauges. Electronic methods just don't work for guide height, tape tension, torques, video head wear, spindle height, tape edge damage, and other critical measurements.

TENTEL's 4 universal, powerful test instruments allow YOU to do 28 different mechanical measurements; including a method to determine video head wear in microns, to help decide if older VCR'S are even worth repairing.

Call today for information on the lease to own program that puts the power of these tools in your shop for about \$67 a month. Less than one VCR per month, yet you'll use this equipment on every VCR you do, and know it's been done right! Isn't it time to **Stop guessing**, and do VCR repair better and faster. **Trial and error wastes time and doesn't find pending problems.** Often there are 2 or 3 other problems along with each major problem. Can you find them now?? We can! Your satisfaction is 100% guaranteed!

CALL TOLL FREE: 1-800-538-6894 / 916-939-4005
TENTEL 4475 Golden Foothill Pkwy. El Dorado Hills, CA 95630

Circle (60) on Reply Card



What do you know about electronics?

Mass storage-continued

By Sam Wilson, CET

In the previous issue I gave details of a telephone interview with Ron. Ron is a mathematician and computer expert who works at the Space Center on Florida's East Coast. We have been discussing *mass storage*. Specifically, we have been talking about the use of magnetic tape as a backup system for mass storage. This is my second call to Ron.

Sam: Hi Ron! This is Sam.

Ron: Hi Sam. I haven't seen the magazine with our conversation. Is it out yet?

Sam: It isn't out yet. It will be about six weeks before it is in the magazine because I am writing several articles ahead.

Ron: Good! You didn't use my name did you?

Sam: No Ron! You told me not to use your name in my articles.

Ron: Good! What do you want to talk about this time?

Sam: Well, during our last conversation we were interrupted because you had an appointment. How about starting with the ways the digital information is put on the tape? Do you still have the illustrations I sent?

Ron: Yes. OK, in a typical application multiple records and multiple files are stored on a single tape. Between each record there is usually a section of unmagnetized tape called an *inter-record gap* and an unmagnetized area between each file called an *end of file gap* or *interblock gap*. The gap represents a waste of valuable storage space. It is possible, with certain types of tape recordings and relatively small files or

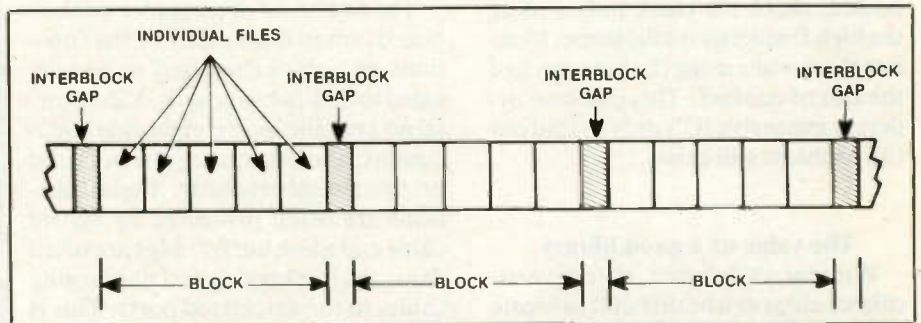

Figure 1. In magnetic tape data storage, to reduce the problem of space wasted in gaps, the technique called *blocking* shown here is often used.

records, that as much as 90% of the tape can be wasted with those gaps.

The gaps are necessary. This is a mechanical and electrical procedure. When you are searching for certain records within a file, or, certain files on a magnetic tape, there must be some means of identifying the end of a record or the end of a file. Also, there must be a way of identifying the beginning of file or the beginning of record.

To reduce the problem of space wasted in gaps, a technique called *blocking* is often used. This technique is illustrated in Figure 1. It involves placing several files between the blocks. Each file is a complete set of data. For example, it could be a ten page report or twelve individual letters.

When serial data is recorded it is necessary to identify the beginning and end of each byte. This is in addition to marking the start and end of a record within a file and the start and the end of each file.

Coded signals are usually used to identify the first and last bits of a byte.

As an example, a serial-coded data format is shown in Figure 2.

Figure 3 shows an example of data storage of specific interest. Note that there are three binary ones represented by spaces. This is considered wasted space, especially if the same data can be recorded in a more efficient manner.

One of the ways to accomplish this is called *Non Return to Zero*, or *NRZ*. It is illustrated in Figure 4. In this case the three logic bits are stored in sequence without the necessity of a zero-level gap between each one.

The NRZ is accomplished by using timing mark sequences to indicate the beginning of each bit. The mark sequences can be generated by software.

Sam: OK. So the data is put on the tape in the form of ones and zeros. Talk to me about how the digital signal from the tape goes into and out of the computer.

Ron: Data on a tape recording is slow

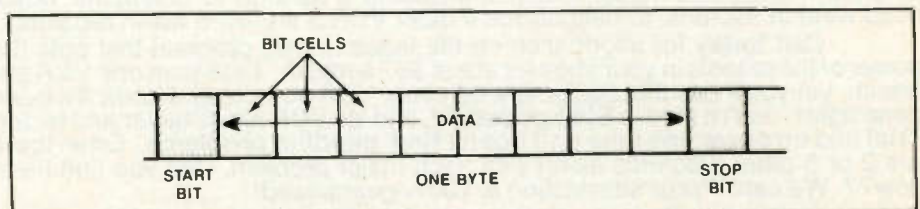

Figure 2. Coded signals, such as shown here, are usually used to identify the first and last bits of a byte.

Wilson is the electronics theory consultant for ES&T.

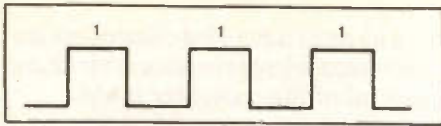

Figure 3. Spaces between data bits stored on a magnetic tape are wasted space.

compared to the ability of the computer to process data. It would be very undesirable to have the computer wait while a lot of the information is retrieved from a tape, or until the tape system can record all of the data from the computer.

To get around this problem *buffers* are used. A buffer is an electronic memory that can take all of the information from a tape file and hold it for the computer to use. Using this method the computer can retrieve the information at high speeds. Likewise, a buffer can be used to hold all of the computer information to be stored on tape. In some systems the buffer may be a part of the computer RAM that is *dedicated* to (reserved for) mass storage data.

When all of the data is stored in the buffer a signal is sent to the computer which then processes the data. The computer does not have to wait while

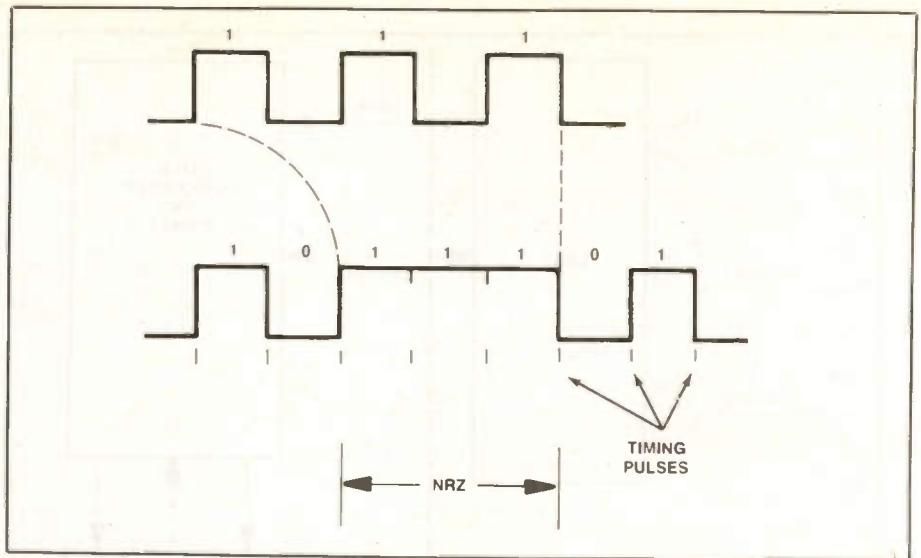

Figure 4. Wasted space on a magnetic tape used to store data can be reduced by using a technique called Non Return to Zero (NRZ).

the tape moves through the machine to store or retrieve data. Instead, it can be busy doing some other kinds of work until all of the data is in the buffer.

Buffers are also used with other types of mass storage devices. They are often part of a *Controller* system or subsystem. In a typical mass storage system the computer turns the job of

data management over to the controller.

The simplest type of controller directs data from memory onto a tape cassette, and out of the tape cassette into the computer. The controller controls motor operations such as fast forward, motor ON and motor OFF, and the direction of tape movement.

Come Out of the Dark.

Shed some light on your managerial skills with the Certified Service Manager exam from NESDA, the association dedicated to sales and service dealers and technicians. For a **FREE** practice test and some answers to *your* questions, just send the following to NESDA:

Name _____

Address _____

City _____ State _____

Zip _____

Phone _____

National Electronics Sales &

NESDA

Service Dealers Association

2708 W. Berry St.
Ft. Worth TX 76109
(817) 921-9061

ATTENTION CAMERA TECHS!

NOW MORE AFFORDABLE THAN EVER!

\$499

**Model TR100 CB
Camera Light Box
with Transparencies**

- (2) 3200° Kelvin Lamps (meets mfr. specs.)
- 7-Bar color transparency
 - 11-step gray scale transparency
- Transparencies mounted in acrylic with optical scratch-resistant surface
- 1 year conditional guarantee
- Optional Transparencies Are Also Available

The method most manufacturers recommend

NUTRONIX, Inc.

P.O. Box 7103, Sterling Hts., MI 48078
(313)726-1278

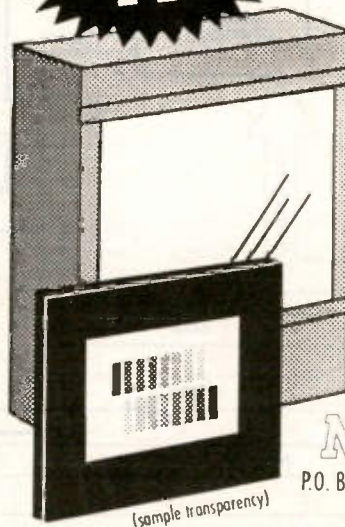

Circle (49) on Reply Card

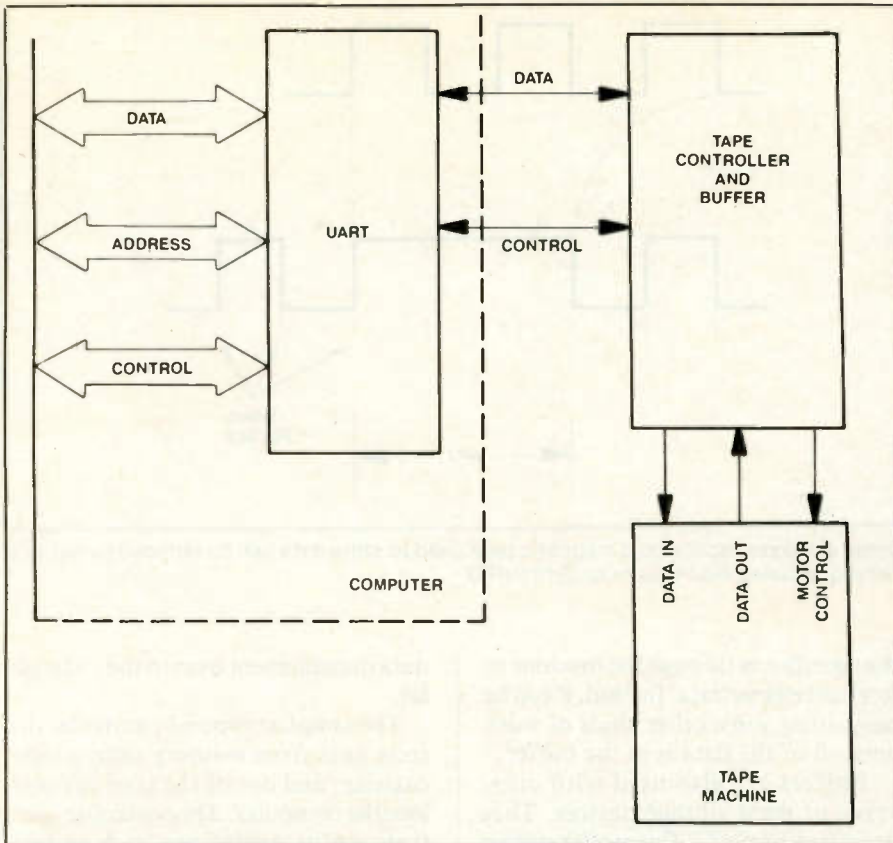

Figure 5. In a typical computer mass storage system, the computer turns the job of data management over to a controller.

The most advanced controllers are dedicated microprocessors that share control of the computer RAM.

Sam: I have sent a block diagram of a controller. Do you want to discuss that drawing?

Ron: The drawing (Figure 5) shows a very simple tape controller - sometimes referred to as *tape interface*. In this example there are only three controls: write, read and motor operation.

The UART (Universal Asynchronous Receive/Transmit) receives the data in parallel form from a parallel data bus. The data is converted into serial form in the controller and delivered to the cassette during a write period.

During a read period the serial data is read from the tape, converted to parallel data in the controller, and then delivered to the computer.

A clock signal is used to add bit-timing pulses and to regulate the speed of the motor.

The computer chooses the tape system by delivering a coded signal to the address decoder. Data to be written on

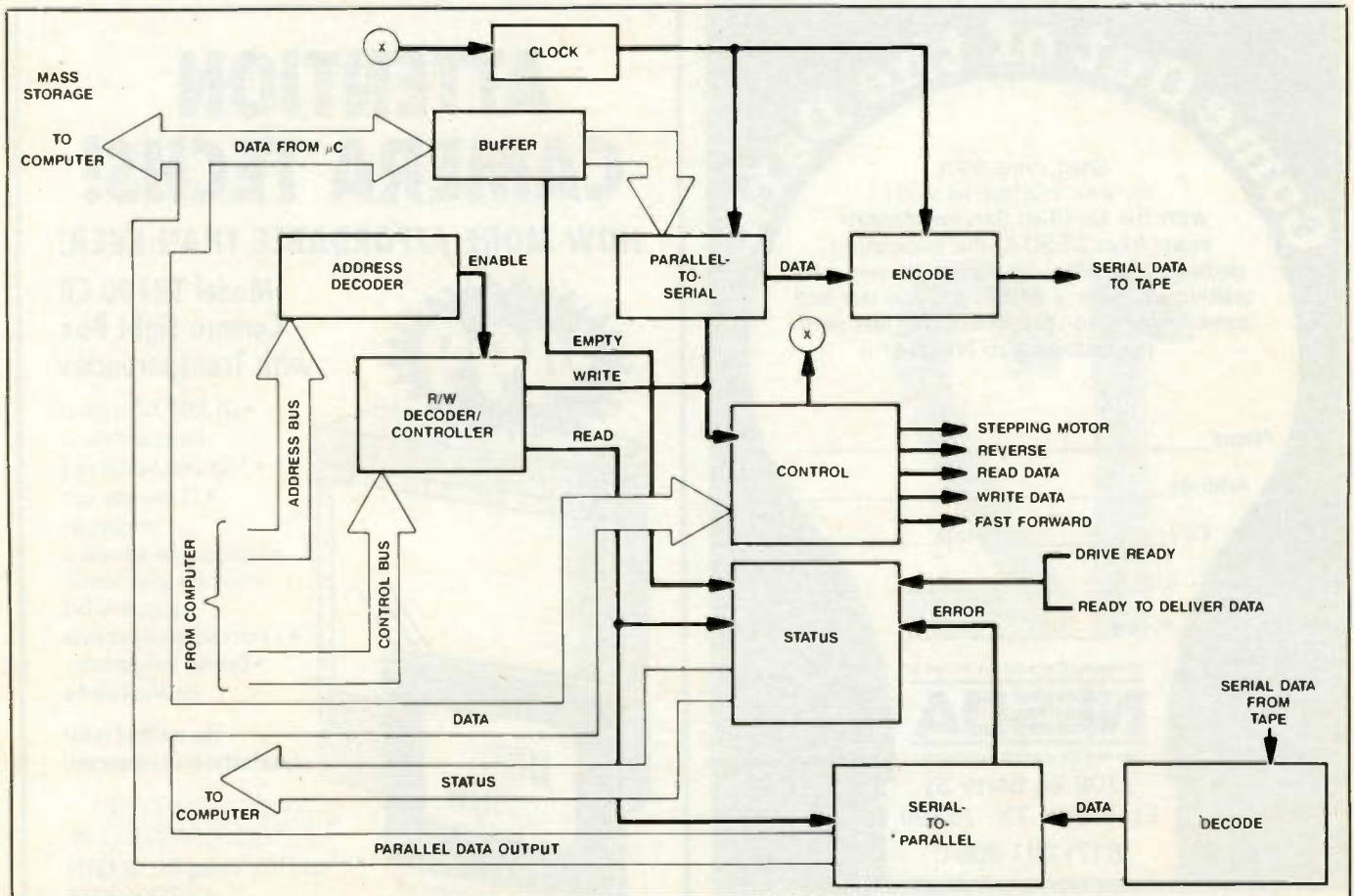

Figure 6. Most practical computers have more complex tape controllers than the one shown in Figure 5. Here is an example.

the tape comes directly from the system RAM, and data taken from the tape is stored directly in the system RAM. So this system employs Direct Memory Access (DMA). Read and write functions are selected by a keyboard signal.

Modern tape controllers (for tape backup and mass storage) are made with Very Large Scale Integration (VLSI) technology. They combine several stages into a single integrated circuit. Since there are fewer external connections the reliability is greater and the cost of fabricating the system is reduced.

A more advanced tape controller (Figure 6) receives parallel data from the microcomputer peripheral input/output (PIO), processes it, then delivers it in serial form to the tape write head. Also, it processes serial data from the read head and delivers it to the microprocessor in parallel data form. Remember that the controller uses DMA for handling data traffic directly to and from the memory.

At the top of the block diagram there is clock section. It receives a timing signal from the computer control section. The clock output signal from the computer control section. The clock output pulses are necessary in order to mark the start of bits for an NRZ recording.

In this system, the input data comes from the computer and it is delivered to the buffer. The buffer is needed for data storage because the microcomputer can read and write data faster than the tape recorder can use it.

Parallel data is delivered from the buffer to a *Parallel-to serial converter*. This circuit is similar to the one used internally in a computer to take parallel data from the microprocessor and deliver it to the serial port. One output from the buffer goes to the *control circuit*.

The control circuit is like the traffic cop for signal control. It keeps the computer informed of the status of recording and playback. As an example, it acts upon a signal that comes from the buffer to indicate that the buffer is empty and ready to receive more data. Then the controller tells the computer to send more.

Pay careful attention to the output signals from the control circuit. If there is anything wrong with the system a technician can use knowledge of those signals to determine if various parts of the system can operate properly.

There is a signal from the buffer that goes by way of the controller. It indicates that the buffer is full and cannot accept more data. The controller stops the computer from sending more data.

Returning to the parallel-to-serial circuit, the serial data output goes to an *encoder*. Remember that the serial data bytes must be marked so that the start of a byte and end of a byte can be identified. The encoder provides those markings.

Signals on the address bus select the controller. If the system is *memory mapped* the address bus considers the controller to be just another form of memory. Signals on the control bus determine whether the system is writing (storing information) or reading (retrieving information).

Sam: Well Ron, I think I'll have to continue this discussion in the next issue. So far it has been good information on tape backup systems.

Ron: Remind me to start with the status circuit next time. And, Sam....

Sam: I know what you are going to say: Don't put your name in the article. Right?

Ron: Right!

Sam: Relax! I will keep your name out of it! So long.

Ron: So long. ■

Again, thanks to Lou Frenzel for his permission to use some of this material.

Organize and Protect Your Copies of **ELECTRONIC** Servicing & Technology

Now there's an easy way to organize and keep copies of your favorite magazine readily available for future reference.

Designed exclusively for ES&T by Jesse Jones Industries, these custom-made titled cases and binders provide the luxury look that makes them attractive additions to your bookshelf, desk or any location in your home or office.

Whether you choose cases or binders, you'll have a storage system that's durable and well organized to help protect your valuable copies from damage.

Electronic Servicing & Technology
Jesse Jones Industries, Dept. EST
499 East Erie Avenue, Philadelphia, PA 19134

Please send _____ cases; _____ binders

Enclosed is \$ _____

Charge my: (Minimum \$15)

American Express

Visa

MasterCard

Diners Club

Card # _____

Exp. Date _____

Signature _____

Charge Orders Call TOLL FREE 7 days, 24 hours 1-800-825-6690

Print Name _____

Address _____

No P.O. Box Numbers Please

City/State/

Zip _____

PA residents add 7% sales tax

SATISFACTION GUARANTEED

Quantity	Cases	Binders
One	\$ 7.95	\$ 9.95
Three	\$21.95	\$27.95
Six	\$39.95	\$52.95

Add \$1 per case/binder postage and handling. Outside USA \$2.50 per case/binder. (U.S. funds Only)

Making tools out of unusual raw materials

By Sheldon Fingerman

Most of us have a favorite tool that we designed or modified ourselves. Maybe it's a miniature pair of pliers. Maybe it's something we've modified for a special purpose. Whatever, the old saying "necessity is the mother of invention" has always applied to the benches and toolkits of just about every technician I know.

My previous employer's favorite tool was not some newfangled digital scope, nor was it the latest in DVM technology. It was his famous "green stick." I don't know where it came from, but we fixed more intermittent problems with this little green stick than everything we had on the bench. I'm not even sure what it was made of. Plastic? Fiberglass? It was about six inches long, 1/8th of an inch in diameter, with a well worn point on each end. And it was green.

We poked, probed, and prodded circuit boards until they begged for mercy. On items that had hinged circuit boards we could use it to hold the boards out of the way, much like the metal rod that holds the hood of your car up. I even fabricated a few springs by winding stiff wire around it.

When I decided to go out on my own I was not only able to get my hands on the latest diagnostic equipment, but I even found my own version of the green stick. I actually found it in a catalog. It was also about six inches long, as big around as a pencil, and flattened on two sides. It had a point on one end, and a chisel tip on the other. It also had a small notch cut on one side of the chisel tip, great for snatching wires and the edges of circuit boards. OK, it wasn't green, but it had been preshaped, and it wouldn't roll off the bench. The day it arrived I knew this was destined to become my favorite tool.

Fingerman is an electronics and computer consultant and servicing technician.

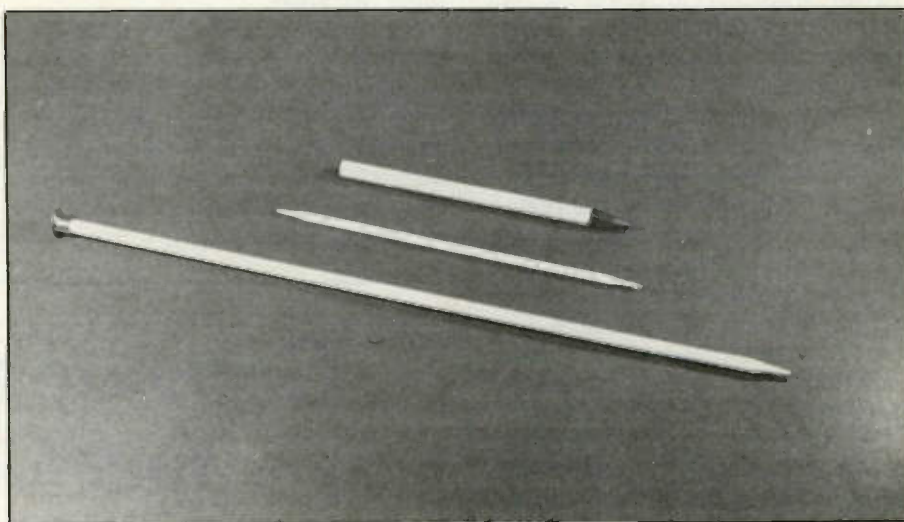

Figure 1. With a little ingenuity, you can turn plastic knitting needles (shown here, with a ballpoint pen at top to show relative size) into a number of different helpful gadgets for electronic servicing.

All was well until it disappeared one day. I'm not sure but I think I left it at a service call. Even though I went back, looked everywhere, and pretty much turned my bench upside down, it was nowhere to be found. To make

matters worse I couldn't find another anywhere.

Why not make one?

My only answer was to actually make another one. But out of what?

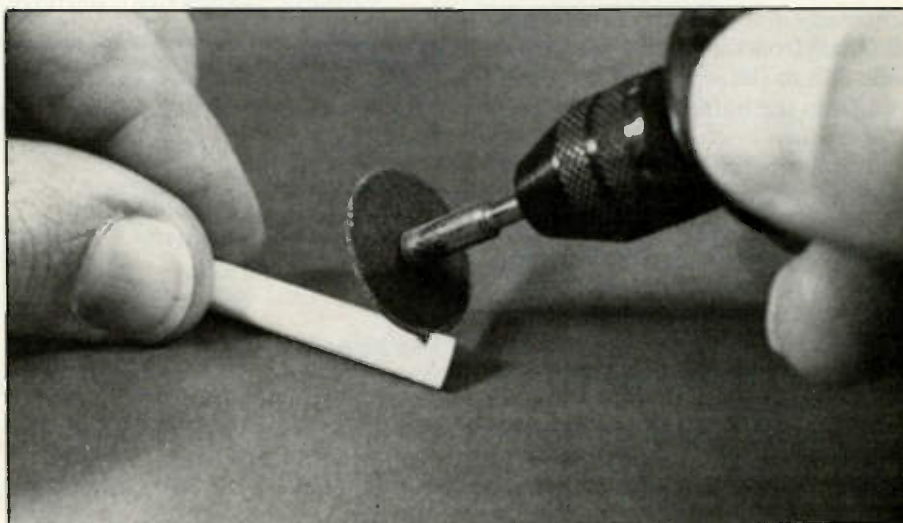

Figure 2. A hand grinding tool makes the job of shaping go fast, but any type of file or knife will do.

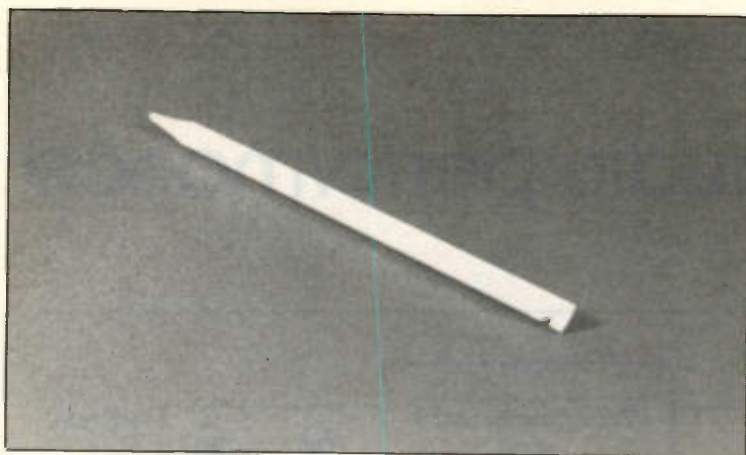

Figure 3. The finished product has a point on one end, a chisel tip on the other end, and a small notch on one side of the chisel tip for snatching wires and the edges of circuit boards.



Figure 4. Any mistake you make, or leftover knitting needles can be used for other purposes, such as this prop rod that's holding a circuit board in a good service position. The nonconductive material assures that there will not be any accidental short circuits.

The only material I could find was wood. A lousy substitute for what was once my favorite tool. An alignment tool served as a substitute for awhile, but it just didn't work out.

Well, there's another saying. "Behind every great man there's a woman." Lucky for me my girlfriend is into crafts. While on a shopping spree one day, after having thoroughly checked out the entire power tool section, I wandered over to the crafts section of the department store looking for her.

I soon found myself mesmerized by a plastic crochet needle. (See Figure 1.) It appeared I was onto something here. It was soon after that I struck the mother lode. Plastic knitting needles. Some of them looked just like the old green stick, except they weren't green. They also came in an incredible variety of sizes. Nonconductive, lot's of sizes, easy to modify, and dirt cheap. What more could I ask for?

The following day I was back at my bench armed with a wide assortment of knitting needles. They even came 2 to a pack: one to use, one to lose. Already having a point at one end, one of the larger needles only had to be cut and shaped to duplicate my old friend. Using a hand grinding tool (see Figure 2), a file, and some emery paper, it didn't take long. My favorite tool was back.

The next time you're shopping, a trip to the crafts section, or crafts

store, could be more valuable than you're usual stroll through the hardware. You may find that one of those crochet needles will come in handy one day. The smaller, double pointed knitting needles can be used right out of the pack. And, the larger needles can be shaped into a variety of tools.

Some suggestions:

The tips of the smaller needles can be filed into just about any type of alignment tool you can imagine. If you use a hand grinding tool, be prepared for a lot of dust.

The larger needles have metal caps on one end. You can cut them off or pull them off, just get them off because they are conductive.

The needles are quite smooth. You may want to use some fine emery paper to give them a better grip. (See Figure 3).

Don't be afraid to experiment. Your mistakes are great for supporting circuit boards or any other use you can come up with. And finally, many of the needles and hooks you will find are made of aluminum. They may have some uses other than knitting, but keep looking for the plastic ones. (See Figure 4).

So, don't be embarrassed to explore the "knitting" section of your department store. If you don't have a favorite tool now, you may just find one in a very unlikely place. ■

Answers to TYEK

(from page 53)

1. Interrupt - Interrupts have priority levels, and higher-order priority interrupts come first in processing.
2. IEEE (Institute of Electrical and Electronics Engineers).
3. Propagation delay.
4. WAN (Wide Area Network)
5. Printer spooler
6. Bandwidth - Strictly speaking, bandwidth is the difference, expressed in Hertz (Hz), between the highest and lowest frequencies that the channel can handle.
7. C
8. Unix
9. LAN (Local Area Network)
10. SAD (silicon avalanche diode). For more information see page 45 of the November 1991 issue of *ES&T*.

Tricks enhance audio performance

By John Shepler

We know that sound perception is so subjective that instruments don't always tell the whole story. For instance, one portable radio can sound much richer than another, yet response and distortion tests show that the better specs belong to the worse sounding set. How can that be?

The sound of smaller radios is largely determined by the design of the entire system and mostly by the speaker and enclosure. Much of the richness that is perceived comes from reverberation and resonances through the case. A booming low end makes the sound fuller and it helps the mask mid and high frequency distortion. The sound seems to come deeper from within the loudspeaker.

You can run some simple experiments to prove this. Try hooking various types and sizes of loudspeakers through the earphone jack. Note the change in sound quality. The better speakers, especially without enclosures, often sound worse. Some of the really good acoustic suspension speakers sound terrible because the amplifier doesn't have enough power to drive the speaker without severe distortion.

Portable radio designers use every trick they can think of to improve the perceived quality of their product. A type of stereo effect can be produced by a mono radio by using large and small speakers on opposite sides of the radio. This splits the frequency band so that low frequency instruments, such as drums, are primarily reproduced by the larger speaker on one side of the radio. Higher frequency instruments, such as cymbals, are most transmitted by the smaller speaker on the other side. On some songs, the stereo effect can actually sound quite good.

Another simple trick is the "wide" versus "normal" stereo switch. This is easy to implement with a switch that simply reverses the phase to one of the speakers. Normally, stereo speakers

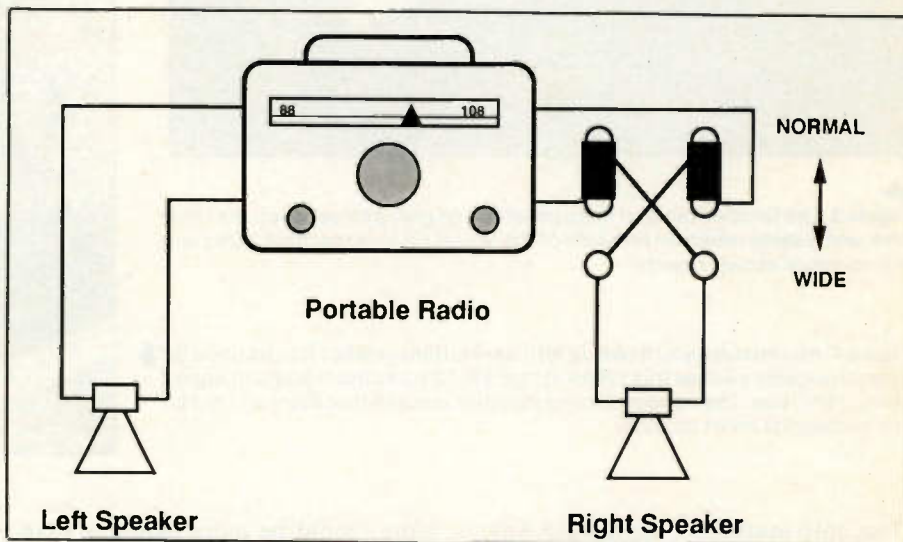

Figure 1. "Wide" stereo switch

are driven in phase so that mono materials drives the cones in the same direction at the same time. This puts singers, commercials, and other mono material squarely between the speakers. Reversing the phase causes the speakers to cancel each other so that the portion of the stereo stage between them disappears. The effect sounds wider because the sound is pushed out to the speaker location rather than mixing in the middle. This just goes to prove that sometimes technically incorrect actually sounds better. Figure 1 shows the hookup you can try with any stereo setup.

Car audio systems have their own tricks for sounding great. These systems are designed to enhance the performance of the overall perceived sound rather than optimizing any particular component. Some years ago, I remember being astounded by how horrible \$300.00 Ford and GM car radios, especially the AM band, sounded through earphones on the bench. Put them back in the vehicle and they sounded terrific. Those rear deck 6x9 speakers reverberating through the trunk made all the difference.

Home stereo systems offer less opportunity for this type of acoustic manipulation. The receiver is separate

from the speakers and is rated on its own performance, notably power output, distortion, frequency response, separation, and RF performance. Speakers are almost all sealed wood boxes with subtle increases in transparency as you go up the range in price.

Most audio manipulation on home setups is done with parametric and graphic equalizers, pointing out how much perfectly flat component frequency response is really worth. Speaker placement does make a big difference. One long-time trick has been to stand the speakers in the corners of the room to gain extra bass response by using the walls as a sounding board.

Another trick that adds richness to the sound is adding electronic reverberation with a separate control unit. The older ones use a spring and acoustic transducers to provide the delay. Newer designs use digital techniques such as BBD (bucket brigade devices) or DSP (digital signal processing). A small amount of reverb gives that rich sounding concert hall effect heard on live albums.

Superb sound to the consumer isn't always the same as perfect technical specifications. Sometimes the ear can be tricked. ■

Shepler is an electronics engineering manager and broadcast consultant. He has more than twenty years experience in all phases of electronics.

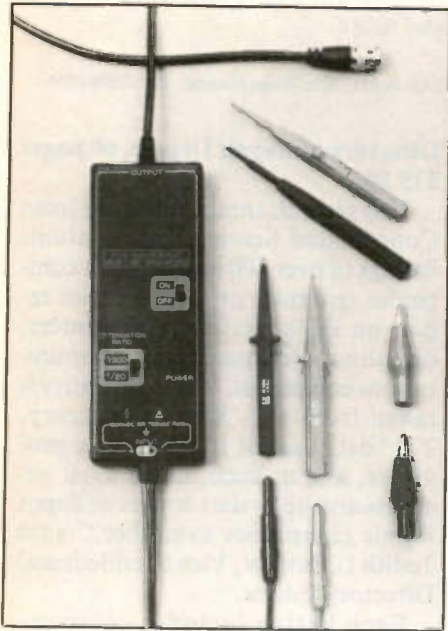

VCR service/repair kit
Techni-Tool now has a VCR Service/Repair kit for the service technician. Packed in zipper pouch, the 21 piece kit will permit trained VCR service technicians to repair, align and adjust almost every type of equipment on the market.

Circle (93) on Reply Card

ESD safe workbenches
Jensen Tools Inc. introduces their heavy duty ESD-safe workbenches. With an undercarriage made of heavy gauge steel, welded and bolted together, these benches will support 1000 lbs of distributed weight. Optional instrument shelves feature the same quality



construction and will bear up to 500 lbs. All units have baked-on blue enamel finish, white Formica tops, and are coated with a special static-dissipative laminate. The benches are offered with or without ESD protection. They are available in a choice of styles and with a wide selection of optional drawers and accessories.

Circle (94) on Reply Card

Digital industrial multimeter
Amprobe Instrument announces the introduction of their model AM-1200 digital industrial multimeter. Features include: circuit protection on all ranges, over range indication, auto zero on all ranges, easy to use single rotary switch, LCD display, low battery indicator, large recessed 3 1/2 digit annunciated and much more.

Circle (95) on Reply Card



Compact multimeters
B&K Precision introduces four new compact, low-cost "Tool Kit" DMMs. These multifunction DMMs offer 0.5% dc accuracy. These DMMs feature functions to help professional technicians, installers, and even homeowners. All measure current and voltage, resistance, and test diodes. Some models also measure capacitance, frequency, temperature and logic level, and check transistors. All of these DMMs measure current to 10A, and have large 3 1/2 digit LCD readout. A continuity beeper is also featured. They are drop resistant, fused, have transient and overload protection, and are backed by a one-year warranty. The model 2703 measures voltage, resistance and dc current. The Model 2704A adds ac current, capacitance, and transistor tests. The Model 2706 adds a temperature measurement function. The Model 2707 is similar to the 2704, but features a built-in frequency counter and logic probe functions.

Circle (96) on Reply Card

Differential oscilloscope probe
Test Probes Inc. introduces its active differential oscilloscope probe, model ADF15, for measurement of two points in a circuit without the necessity of ground reference. The two different input signals are processed in one probe on one scope channel. The design permits the oscilloscope to be grounded for safety while the measurements are made without isolation amplifiers. This also eliminates errors caused by the differences between two amplifiers and two probes. The probe is intended for differential measurements in switching power supplies, motor controllers employing thyristors and power MOSFETS, and similar devices. It makes accurate measurements of small differences even in the presence of very high common mode voltage.

Circle (92) on Reply Card

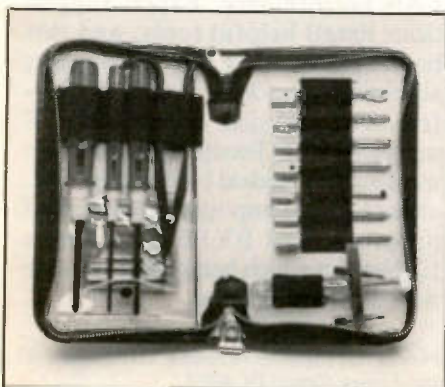

Memory Management For All Of Us, By John M. Goodman, Ph.D. Prentice Hall Computer Publishing, 1,137 pages, \$29.95.

Those who demand the most from their PC's memory capabilities need "Memory Management for All of Us." This book delivers answers for creating an efficient PC environment and for exploiting the computer's memory and disk-caching capabilities to their fullest.

Geared toward users who are not content to work with computer memory limitations, this book teaches readers to successfully navigate a computer system and get the most from it. Users are taught how to thoroughly understand a PC's memory, what tools are best to use, and how they impact the memory process.

The book is written for those who want or need to become proficient memory managers. After an integral walk through all the basic concepts and principles of memory management, readers learn the specifics for getting hardware and software to work together at top speed and efficiency. They receive suggestions for add-ons, hardware, software, and shareware products that may make the job easier.

This book teaches users how to utilize clever strategies for troubleshooting and avoid many common problems. The wealth of information found in "Memory Management for All of Us" keeps users referring to the book time and time again.

Prentice Hall Computer Publishing, 11711 North College Ave., Carmel IN 46032.

Enhanced Batch File Programming, Second Edition, By Dan Gookin, 341 pages, Paper, \$34.95 (Includes 3-1/2 inch floppy disk with over 80 batch files, and dozens of utilities).

Now updated to cover DOS 5 and windows, Enhanced Batch File Programming, Second Edition features new techniques that the reader can use to boost the power of the computer operating system using batch files. The author's clear concise explanations and practical examples make even the most complete tasks easy to understand. The book shows how to write custom batch file utilities using C and assembly language, simplify disk operation, file manipulation and

menu and screen control, expand batch files using third party utilities, create stand alone COM programs, run the system and launch applications via batch files.

Windcrest/McGraw-Hill, Blue Ridge Summit, PA 17294-0850.

Theory and Applications: Intel and Motorola Microprocessors, By M. Rafiquzzaman, 468 pages.

Focusing throughout on fundamental concepts, this text provides an overview and insights into the full range of today's typical 8-bit, 16-bit, and 32-bit microprocessors and microcomputers. Content highlights include: The basics of microprocessors, with coverage of typical programming languages and practical applications, such as personal computers and robotics, fundamentals of microcomputer architecture, software concepts of typical microprocessors, including addressing modes, typical instructions and assemblers, details of architecture, instruction sets, I/O and system design associated with 8085, 886, and 68000, respectively. A summary of interfaces standards such as IEEE 488, S-100, RS-232 and current loops, and practical applications for two detailed system design examples using the 8-85 and 68000.

Simon and Schuster Business and Professional Group
17111 North College Ave., Carmel IN 46032.

The Encyclopedia of Electronic Circuits, Volume 4, By Rudolf F. Graf and William Sheets, 729 pages, \$29.95.

This fourth edition of the Encyclopedia of Electronic Circuits offers hundreds of schematics for the most up-to-date electronic circuits, straight from the drawing boards of industry leaders such as Motorola, Texas Instruments, General Electric, RCA and National Semiconductor.

Easy to use, this giant collection of original circuits is tightly organized and includes an extensive index to all of the circuits presented in the book, as well as for the circuits found in each of the previous three editions.

Included are descriptions of automotive circuits, alarm and security circuits, computer-related circuits, audio

circuits, ultrasonic and video circuits and more.

TAB Books, Blue Ridge Summit, PA 17294-0850.

Directory of Repair Depots, 60 pages \$75.00.

This seventh annual directory from Coordinated Service, Inc. contains listings of over 400 independent companies currently providing depot repair on PC's, peripherals, printers, disk drives, terminals and communications equipment. "This Directory is taken from our 'Service Sourcery, Too' data base of 10,000 service providers, and as such, is the most accurate and up to date source of depot repair companies available," said Judith L. Sawyer, Vice President and Directory Editor.

Each listing includes company name, address, contact, phone and FAX numbers. Also listed are types of equipment serviced; turn around time and pricing policies. There is also an index by manufacturers so that users can quickly find a source for their service needs.

Coordinated Service, Inc., P.O. Box 1260, Littleton, MA 01460.

Introduction to Networking, By Barry Nance, Prentice Hall Computer Publishing, 408 pages, \$24.95.

This comprehensive book/disk set introduces users to Local Area Networks (LANs). Beginning with LAN definitions and progressing to usage fundamentals, readers quickly learn the basics of buying and using networks. This book explores such popular products as NetWare, OS/2 LAN Server and LAN Manager, NetWare Lite, LANtastic, acquainting users with all major networking products.

The book addresses software and hardware products that help improve LAN performance. Expert suggestions detail helpful tools, and this book teaches users how to manage, administer and keep LANs trouble-free. The free disk includes BYTE magazine LAN Benchmarks that help users select the ideal LAN; Que-Mail, an easy-to-use pop-up electronic mail program, and BYTE magazine's LANexpert which helps users evaluate network requirements.

Prentice Hall Computer Publishing, 11711 North College Avenue, Carmel IN, 46032.

If you enjoy Amateur Radio, you'll enjoy CQ.

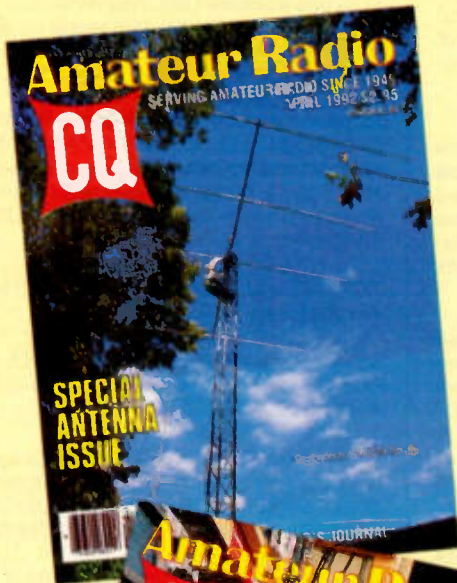

It's a different kind of ham magazine. Fun to read, interesting from cover to cover, written so you can understand it. That's CQ. Read and enjoyed by over 90,000 people each month in 116 countries around the world.

It's more than just a magazine. It's an institution.

CQ also sponsors these thirteen world famous awards programs and contests: The CQ World Wide DX Phone and CW Contests, the CQ WAZ Award, the CQ World Wide WPX Phone and CW Contests, the CQ World Wide VHF WPX Contest, the CQ USA-CA Award, the CQ WPX Award, the CQ World Wide 160 Meter Phone and CW Contests, the CQ Five Band WAZ Award, the CQ DX Award, and the highly acclaimed CQ DX Hall of Fame. Accept the challenge. Join the fun. Read CQ.

Also available in Spanish language edition. Write for rates and details.

SUBSCRIBE TODAY!



The Radio Amateur's Journal
76 North Broadway
Hicksville, NY 11801

Please start my CQ subscription with the next available issue.

Enclose payment or charge information with order.
Term and Rate (check one):

	USA	VE/XE	Foreign
1 Year	<input type="checkbox"/> 22.95	<input type="checkbox"/> 25.	<input type="checkbox"/> 27.
2 Years	<input type="checkbox"/> 43.	<input type="checkbox"/> 47.	<input type="checkbox"/> 51.
3 Years	<input type="checkbox"/> 63.	<input type="checkbox"/> 69.	<input type="checkbox"/> 75.

Paid by: Check Money Order VISA MasterCard
 American Express



Card Number:

--	--	--	--

Allow 6-8 weeks for delivery of first issue

Name _____

Street _____

City _____

State or Country _____ Zip _____

Reader's Exchange has been reinstated as a free service.

The following restrictions apply to Reader's Exchange:

- Only individual readers may use Reader's Exchange, and items must be restricted to those that are ordinarily associated with consumer electronics as a business or hobby. If you're in business to sell the item(s) you want to offer for sale, the appropriate place for your message is in a paid advertisement, not Reader's Exchange.
- Readers Exchange items must be restricted to no more than three items each for wanted and for sale, and may be no more than approximately four magazine column lines in length (about 20 words).

Send your Reader's Exchange submissions to:

**Reader's Exchange
Electronic Servicing & Technology
76 N. Broadway
Hicksville, NY 11801**

FOR SALE

Hakko 700 soldering/desoldering station. Variable temperature, self-contained vacuum pump. With extra tips. Works great. \$450.00. *Larry Sirignano, Audio Service, 191 Bantam Lake Rd., Bantam CT, 06750. 203-567-5801.*

Sencore CM2000, 4 mos. new, with all adapters, ext. cable 10KV probe, protective cover, balance of mfr's. Original warranty, \$2875.00 incl. shipping. *Call Steve, 309-243-5550.*

Sencore SG165 AM-FM stereo analyzer with cables and manual. \$500.00. *Curt Hancock, 518 2nd St., Mt. Vernon, IA 52314.*

Digital capacitor tester: tests to 20,000 M μ F new for \$45.00. Multitester tests up to 6M Ω new for \$10.00. Auto radio stereo power booster new \$15.00. *Joe Oracki, 350 E Northern Parkway, Baltimore, MD 21206. 410-254-0284.*

Schematic/service info for: (1) Hallicrafters S-108 Short-wave receiver and two non-linear systems (NLS) Model FM-7 0-60MHz Frequency Counters. *Rick Menzel, 901 Hickory, Sandpoint, ID 83864. 208-265-4247.*

Nutronix model TR100 CB camera light box with transparencies, used twice, \$300.00. B&K Model 1270 vectorscope, never used, \$850.00. *Smith's TV service, 901-285,6967.*

800 new tubes; 900 Sams 1100-2100: 300 AP auto manuals to 312, Zenith modules. Make offer. *H. Browne, Box 453 Onancock, VA. 23417 or call 804-787-4064.*

Sencore CB41 CB tester \$85, Sencore CB49 Analyzer/Performance tester \$300.00, Sencore PS148 oscilloscope/vectorscope \$200.00. Never used. *Tony Satullo, 1219 Souter, Troy MI 48083.*

VA62A with VC63 and NT64 \$2700.00, Tentel tape tension Gauge, \$275.00, like new. *Call Tom 803-647-1002.*

Retiring send large SASE for test equipment list. Also tubes sold individually only. Send SASE. *Maurer TV, 29 South 4th St., Lebanon PA 17042.*

Complete set of Tentel alignment tools, used 3 mos. \$100.00. B&K Precision Model 1249A NTSC Gen \$60.00. B&K Precision Model 2005 RF Signal generator \$50.00. All o.b.o. Out of business. *Russ Hasty, 1148 Ovray, Grand Junction, CO, 81501, 303-245-2554.*

Zenith service literature 1976 to 1992. Clean \$1500.00. Sencore CB42 analyzer with 178 Sams C.B. facts \$500.00. TV and Radio tubes most in original boxes 1500.00. Part of set of Sams Photofact maybe 1500.00. Some old some dirty all for \$250.00. *Dales TV, RT 1 Box 236, Mtn View, MO, 65548. 417-934-6655.*

Sams Photofacts set #1000 to 1700. \$1.00 each of all \$560.00 Wyse monitor, Model WY-50 and keyboard \$70.00 plus shipping. *Lien Nguyen, 2373 Pruneridge Ave., #3 Santa Clara, CA 95050.*

Diehl Mark III scanner \$100.00 (includes shipping) with manual. GE HVXFMRS, EP77X44, \$40.00. EP77X55 \$60.00. *Elmer Wieland 237, Talbot Dr., Bedford, OH 44146 216-232-8653.*

PTV Magnavox reflection module A10038B002, Power supply module for Magnavox APW096-003 \$75.00 a piece. PTV ASG014 video bands for Magnavox \$50.00, PTV Yokes 362107-3 \$20.00. And a 19C5 Magnavox chassis with MC2 tuner \$75.00. Much more. *Eugene Otto 419-523-6680.*

1500 tubes in boxes. Sell all or part. Send S.A.S.E. for list. *John Reynolds, 1942 Sandalwood Lane, Fort Collins, CO 80526. 303-484-2715.*

TV Modules and parts, now 8 page list. Electrolytic and misc. capacitors for Radio, TV motors, etc., 10 pages. Send SASE for each set and specify group. *Chuck Vaccaro, 708 Booth Ln., #E, Amber, PA 19002-5014. 215-646-3641.*

B&K CRT tester and restorer excellent condition 6 months old with manuals and adaptor sockets \$440.00. *Call Gus at 416-354-5465.*

Emerson model VCR 754 parts. Clock, timer, PC board, audio and erase heads, complete drum assembly. Reel and loading motors. *Nathan Jackson, Rt. 1, Box 483 Gayesville, AL 35973.*

Like new. Sencore VC93 asking \$1600.00 plus shipping if interested please call *Tom Engle, 708-837-1028.*

WANTED

Schematic or service information on Pioneer Ampl. Model SX 780. Will pay for copy. *G. Lopez, 1280 S.W. 131 Pl., Miami, FL 33184.*

Tripler for a KV-1201 Sony T.V. part #8-983-835-95. *Ken Williams, 511 Spring Street, Peoria, IL 61603.*

Western Electric 9A phono pickup head in good condition with or without repeating coil and equalizer switch. Also, associated pre-WWII vertical transcriptions. *D.G. Piacentini, 12 Joyce Rd. Plainview, NY 11803.*

Macintosh computer discontinued models 128, 512K plus schematics and troubleshooting, Apple manuals, and books. Also source for Sony 400/800K drive parts. *J. Wegner, Jr. P.O. Box 262, Glendale, CA 91209.*

Schematic and troubleshooting chart for EICO early Model 232 tube tester VTVM. Also schematic and troubleshooting chart for Precise Model #660. Color Bar generator. *Gerard O'Gara, 11 Craigh Lane, Levittown NY 11756. 516-731-4025.*

7JP4 CRT in Motorola TV Model VT71 (1948). *Jim Hightower, 602-831-6212.*

Service manual for Technics Model SA-727 (FM/AM stereo receiver). *John Taylor, 804-779-3307.*

Books on signal generators for radio repair, also books on radios for radio repair. Any type will do. Also Riders manuals. *Daniel Seidler 3721 W 80th Street Chicago, IL 60652. 312-284-8221.*

RCA Yoke Model 119060 for old B&W TV Mod. NJ009 Please state price and condition (If used). *H.L. Hemken P.O. Box 8753, Chula Vista, CA 91912. 619-691-0576*

Service schematic and operation manual for a RCA oscilloscope Model WO-505A. Copies or original. *James Thurman, 160 Clinton CR, Jackson, MS 39209. 601-922-7889 after 6:00 p.m.*

High voltage rectifier ECX-B0085-C for a Bohsei TV Model No. TC-700. *B&B Electronic Service, 2230 North 55th Avenue., Hollywood, Florida 33021.*

Flyback transformer ORION FB-120 for a TMK model 750C portable color TV, needed, desperately. *Carlos Urbina, 410 E. Hillside Apt., 317, Laredo TX 78041.*

Service manual for Harley Davidson model 19-HTTLV VCR/TV Combo will copy and return. *Chapman TV, 3601 West Eighth Street, Cincinnati, OH 45205.*

Information on where I can purchase an AN247 (ECG1173) V1F/AGC IC for a Panasonic CT326. *P. Sayers, Box 297, Aylesford, NS Canada BOP 1C0.*

Magnavox video camera power supply part #V80027BK01 or schematic of such. *Fedon TV - 12 E. Penna Ave., Pen Argyl, PA 18072 215 863-5560.*

1600 VCR symptoms/cures by make/model. Print out \$45.00, IBM disc -\$85.00. *VCR tune up center, 43 James Ave, Redwood City, CA 940063. Ask for Philip Tyre.*

B&K 1040 and 2040 CB analyzers, IFR two way radio analyzers. *Ben Metigor 9405 Mirror Pond Dr., Fairfax, VA 703 978-6737.*

Classified advertising is available by the word or per column inch.

By-the-word: \$1.65 per word, per insertion, pre-paid. Minimum charge is \$35 per insertion. Initials and abbreviations count as full words. Indicate free category heading (For Sale, Business Opportunities, Miscellaneous, Wanted). Blind ads (replies sent to ES&T for forwarding) are \$40 additional. No agency discounts are allowed for classified advertising by the word. Contact Emily Kreutz at 516-681-2922 to place your classified ad (by-the-word). Or send your order, materials and payment to Emily Kreutz, Electronic Servicing & Technology, 76 North Broadway, Hicksville, NY 11801.
Per Column Inch (Classified Display): \$235 per column inch, per insertion, with frequency discounts available. 1" minimum, billed at 1/4" increments after that 10" maximum per ad. Blind ads are \$40 additional. Reader Service Number \$25 additional to cover processing and handling costs. (Free to 4-inch or larger ads.) For more information regarding classified display advertising please contact Jonathan C. Kummer at 516-681-2922. Optional color (determined by magazine) \$150 additional per insertion.

FOR SALE

REPAIR MANAGEMENT SOFTWARE: for IBM PC's. Repair tracking, inventory, reports, billing, maillist, more. Demo disk \$15. CAHILL ELECTRONICS, PO Box 568, Kingston, NH 03848. 603-642-4292 9-92-2t

REDUCED 85%, Diehl Mark 111 scanner \$79. Diehl Mark V scanner \$199. New. Restore remote control keypads with our conductive coating \$8.99 ppd. WEEC, 2805 University Ave., Madison, WI 53705. 608-238-4629, 608-233-9741. 12-91-tfb

YOUR CONDUCTIVE SOLUTION Super thin liquid allows effective rejuvenation of rubber conductive pads on remote controls/keypads. Will layer for decreased resistance. Detailed Instructions/hints included. \$35.00 MC/Visa. COD add \$4.00. 1-800-742-8165 Ext 10. 9-92-1t

VHS-VCR Repair Solution Sets I, II, III, IV, V, VI, VII. Each contains 150 symptoms and cures, updated cross reference chart, free assistance, \$11.95 each, all seven \$69.95. Schematics available. Visa/MC. Eagle Electronics, 52053 Locks Lane, Granger, IN 46530. 6-92-7t

TV VCR Service near new pier & ocean. Oldest shop in Huntington Beach California. Retiring can help you get started. 714-846-1591. 8-92-2t

THE ONLY ANSWER TO REPAIRING ELECTRONICS PROFITABLY (This should have been done years ago) **GET SMART!** Someone somewhere has already repaired the next repair **YOUR BEST TECHNICIAN**, who's training you have paid for **JUST LEFT TODAY!** **YOU'RE THE BOSS** and now you have put on your old rusty technician's cap. **TODAY YOUR BANK** sent you three NSF checks your customers graciously gave you, and you don't have time to chase them down to collect, **THEY LEFT TOWN. IT'S TAKING YOU LONGER** to assess the repairs and your customers are now coming to collect their units. You promised to give them a **FREE** estimate, but you just realized you don't have a schematic or time to do it. **NOW YOU ARE DOING NIGHT REPAIRS** because during store hours the phone rings off the hook with nuisance questions about settling VCR clocks and you have parts to order, bills to pay and service literature to file. **CIRCUIT CITY JUST MOVED IN** and your wife says there's no money in repairs. **FRIEND!! YOU DEFINITELY HAVE AN EMERGENCY!!** Spend \$350.00 **NOW & RECEIVE A MILLION AND ONE HALF DOLLARS VALUE IN TECH-TIPS.** 10,000 Technician Tech-Tips, 1987-through 1992 with annual updates of approximately 2000 tips for \$100.00 per year. **I CAN ASSURE THESE TECH-TIPS ARE NOT DUSTY OLD REPAIRS YOU'LL NEVER SEE.** Send \$15.00 for Computer or Paper Demo. Overnight. AMEX/MC-VISA, CHECKS & COD. **TV-MAN SALES & SERVICE** 8614 SR-84 Ft. Lauderdale, FL 33324 305-474-2677. 6-92-1tb

ATTN. VCR SERVICERS: 1600 VCR symptoms/cures by make and model printout \$45. IBM disk \$85. VCR Tune-Up Center, 2610 Bay Road, Redwood City, CA 94063. VISA, Mastercard on phone orders. 1-800-777-7883. 9-92-4t

VCR SERVICE LITERATURE: AVOID COSTLY DUPLICATION. Over 1000 models cross referenced, mostly mechanical. Model/Chassis to Base Model, or Model to Mechanical Deck Family, or Brand to Brand Model Number. Sample: Magnavox VR9625ATO to Panasonic PV-3720. Sample: JC Penney 686-5831 to JVC HR-D171U. Send \$9.95 to GOODCO, P.O. Box 921032, Norcross, GA 30092. 9-92-1t

SENCORE VA-62 with VC-63 also SC-61 waveform analyzer like new with manuals \$2,500 each or all for \$4,500. 803-272-2607. Ask for Cliff. 9-92-1t

PHOTOFACTS: Folders and specialized books; AR, CB, CM, HTP, MHF, SD, TR, TSM, VCR. A.G. Tannenbaum, P.O. Box 100, E. Rockaway, NY 11518. 516-887-0057. 9-92-1t

MY TELEVISION SERVICING INSTRUMENTS: Dual-scope, Counter, Generators. Send SASE. Dan Pancoast, 154 Bala Drive, Somers Point, NJ 08244. 9-92-1t

TV TOUGH DOGS 300 symptoms and cures. Send \$10.95 to Davis TV, 11772 Old Fashion Way, Garden Grove, CA 92640. 9-92-1t

BUSINESS OPPORTUNITIES

TV/VCR TECHNICIAN needed in Bozeman, Montana. University town is an excellent place to raise children. Long established company can provide an excellent living. 406-728-5054 ask for Bob. 8-92-2t

I AM LOOKING TO BUY: TV/VCR repair shop in busy New York area or get into working partnership. Bogdan, P.O. Box 22555, Brooklyn, New York 11222. 9-92-1t

Manufacturers Parts and Literature Directory

This monthly section is sponsored by manufacturers to help you find the parts and technical literature needed to service their equipment. Call them for replacement parts or for the name of their nearest distributor.

Hitachi Home Electronics 401 W. Artesia Blvd. Compton, CA 90220 800-HITACHI	Mitsubishi Electronics America 5757 Plaza Drive Cypress, CA 90630 800-553-7278 fax 800-825-6655	NEC Technologies 1255 Michael Drive Wood Dale, IL 60191 800-366-3632
Panasonic 50 Meadowlands Parkway Secaucus, NJ 07094 800-545-2672	Philips ECG 1025 Westminister Drive Williamsport, PA 17701 800-526-9354 fax 800-346-6621	Quasar 50 Meadowlands Parkway Secaucus, NJ 07094 800-545-2672
Technics 50 Meadowlands Parkway Secaucus, NJ 07094 800-545-2672	Thomson Consumer Electronics 2000 Clements Bridge Road Deptford, NJ 08096 800-257-7946 fax 800-524-1498	Zenith Electronics Corp. 1900 N. Austin Avenue Chicago, IL 60634 312-745-2000

Call Jonathan Kummer at 516-681-2922 to reserve space in this special section.

**GUARANTEED
LOWEST
PRICES!**

FREE CATALOG

908-381-8020

FAX: 1-908-381-1572

**ELECTRONIX
EXPRESS**

**365 BLAIR ROAD
AVENEL, NJ 07001**

Circle (43) on Reply Card

TUBES • TUBES • TUBES

World's Largest Range

Over 2,000 Types, Domestic & Foreign

UP TO 85% OFF Ask for price list

International Components Corporation
Toll Free 800-645-9154 • N.Y. State 516-293-1500
105 Maxess Road, Melville, New York 11747

Circle (45) on Reply Card

*For fast, accurate service,
please remove the peel off
label used to address your
magazine, and attach it to
the Reader Service Card,
the Address Change Card
or to any correspondence
you send us regarding
your subscription.*

**Tech's
Guide
To
Pricing**

**"Sperry Tech's
Pricing Guide"**

Updated new 6th edition...a
framework for setting rates
that apply to Hi-Tech
products...a formula that
guarantees SUCCESS!
Call Toll Free for details
1-800-228-4338

Circle (59) on Reply Card

**THE SOURCE . . . for quality
Electronic Parts & Accessories.**

*"We'll get your parts to you
as fast as you need them!"*

Call today and ask about our
PREMIUM DELIVERY and for your
FREE copy of our catalog . . .

1-800-558-9572

or for 24 hour ordering call FAX 414-473-4727

"First in Quality, Service and Delivery"

**PREMIUM
PARTS+**
ELECTRONIC COMPANY

P.O. Box 28 • Whitewater, Wisconsin 53190

Circle (54) on Reply Card

Advertisers' Index

Company	Page Number	Reader Service Number	Advertiser Hotline
Anatek	25	40	800/999-0304
Beckman Industrial	5,16, 17	41,42, . . . 23	800/854-2708
Electronix Express	68	43	908/381-8020
Fluke Manufacturing, John	BC	4	800/87FLUKE
Hitachi Home Electronics	67	800/545-2672
Iscet	12	817/921-9101
International Components Corporation	68	45	800/645-9154
Leader Instruments	3	46,47 . . .	800/645-5104
MCM Electronics	53	48	800/543-4330
Mitsubishi Electronics America	67	800/553-7278
NESDA	53,57	817/921-9061
Nutronix	57	49	313/939-4710
PTS Corporation	7	50	812/824-9331
Panasonic	67	800/545-2672
Parts Express	12	51	513/222-0173
Philips ECG	6	52,53 . . .	800/526-9354
Premium Parts +	68	54	800/558-9572
RCA/Thomson Consumer Electronics	IBC	55
Quasar	67	800/545-2672
Sams & Company, Howard	25	56	800/428-7267
Sencore	IFC	57	800/SEN-CORE
Southgate Electronics	13	58	305/720-4497
Sperry Tech	68	59	800/228-4338
Technics	67	800/545-2672
Tentel	55	60	800/538-6894
Thomson Consumer Electronics	67	800/257-7946
Zenith Electronic Corporation	67	312/745-2000

We'd like to see your company listed here too. Contact Jonathan C. Kummer to work out an advertising program tailored to suit your needs.

SALES OFFICE

THE PROFESSIONAL MAGAZINE FOR ELECTRONICS AND COMPUTER SERVICING

ELECTRONIC

Servicing & Technology

**76 North Broadway
Hicksville, NY 11801
(516) 681-2922
FAX: (516) 681-2926**

Jonathan Kummer
Associate Publisher

Emily Kreutz
Sales Assistant

PUNCH IT UP!

Punch up replacement semiconductor information quickly and easily on your PC, with Thomson Consumer Electronics' cross-referencing software:*

SK CROSS

The SK Cross program, from Thomson, gives you an item-by-item description directly next to the SK Series Semiconductor part number. Unlike other software that either provides no description or, at best, hides the description at the bottom of the screen.

Advantages include:

- Ability to scroll through entire cross-reference
- Descriptions next to part numbers
- Technical notes below descriptions
- Transistor complements, matched pairs, matched complementary pairs listed in description

In seconds, you can find the perfect replacement for over 235,000 of the most commonly specified transistors, diodes, rectifiers and integrated circuits from a selection of more than 3,600 replacements. All are fully warranted and most are available for immediate delivery.

Complete the coupon or call your local SK distributor today to order!

*SK Cross software operates on any IBM-PC or compatible that has 640K of RAM, at least 12 megabytes of hard disk space and 3.5" or 5.25" floppy disk drives.

THOMSON CONSUMER ELECTRONICS

2000 Clements Bridge Road/Deptford, NJ 08096-2088
Circle (55) on Reply Card

Please send the following number of copies of SK Cross software on the size disks indicated.

_____ 3.5" (1.2M) at \$5.00 each (SKG202DK1)
_____ 5.25" (360K) at \$7.50 each (SKG202DK2)

Enclosed is my check or money order for \$ _____

Name _____

Company _____

Address _____

City _____

State _____ Zip _____

Phone () _____

Please allow 3 to 4 weeks for delivery.

The Fluke 79: More Of A Good Thing

More high-performance features. More advanced measurement capabilities. More of the vital information you need to troubleshoot even the toughest problems — with both analog and digital displays.

Meet the latest, greatest member of our best selling 70 Series II family — the new Fluke 79 digital multimeter.

It picks up where the original family left off. In fact, it's a quantum leap forward — in performance, value and affordability.

It's got the features you'd expect from Fluke. Including high resolution. Fast autoranging. Patented, automatic Touch Hold®. A quick continuity beeper. Diode test. Automatic self-test. Battery-conserving sleep mode. And it's just as rugged and reliable as the rest of the 70 Series II family. Easy to operate, too — with one hand.

And thanks to the Fluke 79's proprietary new integrated circuit technology, that's only the beginning. When it comes to zeroing in on tough electrical problems, the Fluke 79 leaves the competition behind:

Hz

Frequency: The Fluke 79's built-in frequency counter lets you measure from below 1 Hz to over 20 kHz. And while you view frequency on the digital display, the analog bar graph shows you AC voltage. So you can see if potentially hazardous voltage is present.



Fast 63-segment analog bar graph: The Fluke 79's bargraph moves as fast as the eye can see, updating at a rate of 40 times per second to simulate the functionality of an analog needle. You get the high speed *and* high resolution you need to detect peaking, nulling and trending.



Capacitance: No need to carry a separate dedicated capacitance tester; the Fluke 79 measures capacitance from 10 pF to 9999 µF.



Actual Size

40Ω

Lo-Ohms range: Our proprietary Lo-Ohms function lets you measure resistance as low as 0.01 ohms. High noise rejection and a test lead Zero Calibration function make the Fluke 79 ideal for detecting small resistance changes.

SMOOTHING

Smoothing™: Our exclusive new Smoothing mode gives you a stable digital readout for unstable signals — by displaying the running average of eight readings. No more jitter or "digit rattle" due to noisy signals.

Get a good thing going: To put more meter to work for you — at a price that works for you, too — head for your nearest Fluke distributor. For the name of your nearest distributor, or for more product information, call 1-800-87-FLUKE.

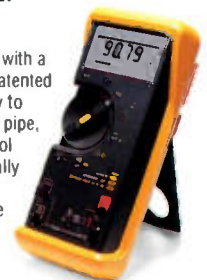

The Fluke 79 comes with a yellow holster and patented Flex-Stand™ — easy to hang from a door or pipe, clip onto a belt or tool kit, or stand at virtually any viewing angle. There's even storage space for test leads.

Fluke 79 Series II

\$185*
4000 Count Digital Display (9999 in Hz, capacitance, and Lo-Ohms)

63-segment Analog Bar Graph

0.3% Basic DC Voltage Accuracy

Automatic Touch Hold

Diode Test, Audible Continuity Beeper

Autoranging, Manual Ranging

Holster with Flex-Stand

Frequency Counter to over 20 kHz

Capacitance, 10 pF to 9999 µF

Lo-Ohms Range with Zero Calibration

Smoothing

700 Hours Battery Life (alkaline)

3-Year Warranty

* Suggested U.S. list price

FLUKE AND PHILIPS
THE T & M ALLIANCE

John Fluke Mfg. Co., Inc. P.O. Box 9090, M/S 250E Everett, WA 98206. © Copyright 1991. Prices and specifications subject to change without notice. Ad no. 00172.

FLUKE®

Circle (4) on Reply Card