

THE MAGAZINE FOR CONSUMER ELECTRONICS SERVICING PROFESSIONALS

# ELECTRONIC<sup>T.M.</sup>

Servicing & Technology

JUNE 1992/\$3.00

Working with microcomputer display technology - Part II

Speed up common VCR adjustments

## Test equipment update



# The Rising Star In VCR Servicing— A New Dimension!

Introducing The Service Industry's Only  
Dedicated VCR Analyzer!

- Isolate video from servo defects!
- Pinpoint capstan and cylinder servo defects!
- Eliminate the guesswork associated with replacing video or audio Hi-Fi heads; before you order the new heads!
- Troubleshoot all VCR formats with the same procedures and confidence every time!



For More Information On The Patented  
VC93 All Format VCR Analyzer  
Call 1-800-SENCORE ext. 502

Circle (20) on Reply Card

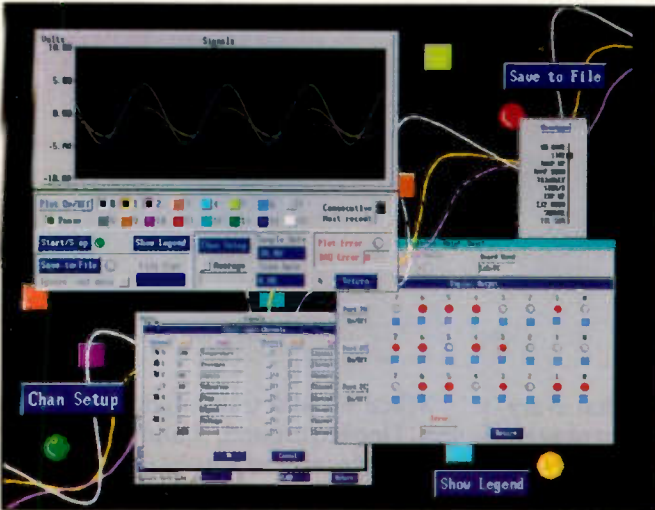

page 13

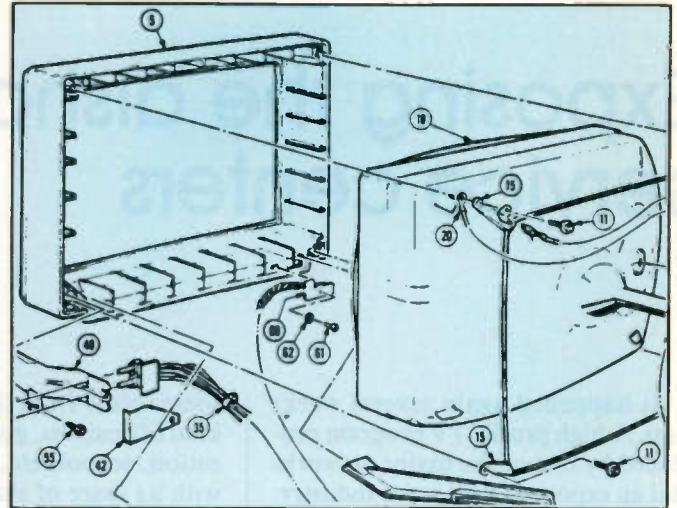

page 40

## FEATURES

- 6 Test equipment update**  
*By the ES&T Staff*  
While all of the advances and changes have been taking place in electronics in the past several years, test equipment and accessories have not been standing still.
- 8 Measurements can only be as accurate as your connections**  
*By James Heighway*  
Making good measurements depends largely on making good connections between the instrument and the test point or points.
- 13 Measurement and Instrumentation: The 1990s**  
*By John M. Graff*  
More powerful computers have combined with instrumentation software packages to result in computer-based test instruments that can be designed for specific test procedures.
- 17 How to speed up common VCR adjustments**  
*By the ES&T Staff*  
Many technicians do not understand the purpose of each

- 20 Selecting the right oscilloscope probe**  
*By Bill Hansen*  
This article shows that for accuracy, and to avoid wasting hours of your time, you want to make your probe as transparent to the system as possible.
- 22 Troubleshooting CD motor circuits**  
*By Homer L. Davidson*  
Motor malfunctions may be difficult to diagnose because of the variety of possible causes. This article describes the operation of each motor in a CD player.
- 40 Working with microcomputer display technology Part II—Hercules and RGBI Displays**  
*By John A. Ross*  
Although computer video display technology has undergone rapid change, many of the older video display adapters and monitors are still in use. This article will acquaint readers with Hercules and RGBI monitor and video card operation.

- 4 News**
- 5 Literature**
- 27 Profax**
- 39 Products**
- 46 Video Corner**  
The video printer
- 48 What Do You Know About Electronics?**
- 50 Business Corner**  
Use a newsletter to inform customers
- 52 Audio Corner**  
Simplified surround sound
- 54 Test Your Electronics Knowledge**
- 55 Books**
- 58 Readers' Exchange**
- 59 Classifieds**
- 60 Advertisers' Index**

## ON THE COVER

Consumer electronics servicing begins with a careful diagnosis of the problem. As the products to be serviced become more sophisticated and complex, the more sophisticated the test equipment must be, and the diagnostic skills of the technician. (Photo courtesy ITT Pomona)

## DEPARTMENTS

- 2 Editorial**

# Exposing the dishonest service centers

It happened again several weeks ago. A high profile TV program produced by one of the major networks did an expose of the service industry. One segment about the consumer electronics business provided significant evidence that there are crooks in the business who are more interested in turning a quick buck than in doing a good job of servicing people's products.

It's nothing new. There have been exposes of the consumer electronics service business by network TV shows, local TV shows, newspapers over the years. They conclude something that most of us who are associated with the business are only too aware of: that there are indeed dishonest practitioners in the consumer electronics servicing business.

It's a subject that's a little hard to come to grips with. You find yourself asking questions like: Who are these guys? Are they service people who are just a little (or a lot) dishonest? Or are they crooks who have decided to practice their criminal way of life by getting into the service business and stealing every penny they can?

In all probability, there are both kinds of dishonest servicing organization: the one that never really intended to try to give customers any kind of value for money, and the one that is basically a good business organization, but that somewhere along the way succumbed to temptation.

It really doesn't matter which of the two kinds of dishonesty is practiced by a given organization, in the final analysis, the customer is being cheated, and the profession in general gets a black eye.

The honest service organizations out there, I'm sure that includes most of the people reading this, can take

some solace from the fact that every kind of business, government organization, school, etc., etc., has to live with its share of sharp operators.

Take a look for example at the savings and loan scandal. Recent analyses of this colossal mess suggest that this was a deliberate raid on the public treasury by many dishonest people in the industry, aided and abetted by a number of public officials. This is thievery that will eventually cost the taxpayers of the U.S. billions of dollars.

Even more staggering is a headline I read on one of the news magazines lately that suggests that health care fraud bids fair to cost all of us even more in the long run than will the savings and loan mess.

What can an honest service organization do in the face of these exposes and the suspicion it generates? Stand tall. Be proud. And most important, keep doing business in the most scrupulously honest and ethical manner possible.

Sometimes it does seem as though it's an uphill battle, but to quote an old phrase, virtue is its own reward. Here's an example from another profession that tends to have a bad reputation: automatic transmission service.

On occasion when I have called the Better Business Bureau about a particular automatic transmission service organization, they have suggested that I exercise care in dealing with them. The standard practice of many of these organizations seems to be to automatically drop the pan and look for problems. That costs at least fifty bucks, and if they find problems, the customer's reaction would normally be to have any suggested service done rather than have the transmission butted back up and go through the expense a second time at a later date.

When I had a transmission problem, I looked around, found a service center I was almost absolutely certain I could trust and brought my car in for the service.

When I received a call from the service center a couple of hours later, I knew that I had made a good choice. The technician on the other end of the line asked me to described the symptoms, because he hadn't been able to get the car to do the things I had described. That told me that he was performing a thorough diagnosis and that I could expect him to fix the problem, not try to sell me on an unnecessary overhaul.

To make a long story short, I had a minor leak outside of the transmission that they were able to fix completely for about fifty bucks without tearing anything apart. Any time a friend or acquaintance mentions transmission problems to me, I send him to this place. From the crowd of cars I see outside the shop every time I go by, he's doing very well. And he's recommended by a major automobile association.

The crooks in any profession are a bother. They cause hurt to the reputations of all the good, honest practitioners who form the majority. The best way to deal with the problem is to remain scrupulously honest, help to expose and eliminate the sharp operators, support reasonable consumer protection legislation, join associations that establish standards of technical and business excellence, and be proud to be a member of a profession whose purpose is service to others. ■

*Nile Conrad Pearson*

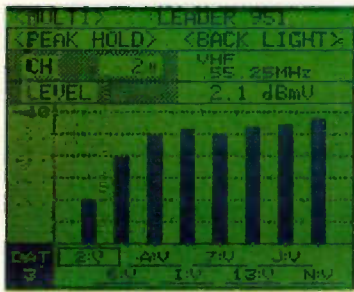

Multi-Channel Bargraph Eases Comparison of Channels

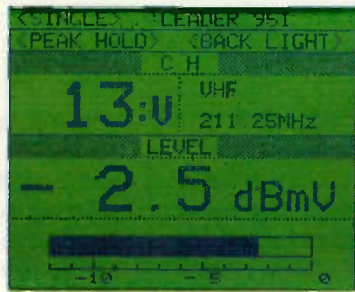

Single Channel Display Includes Digital and Analog Readouts

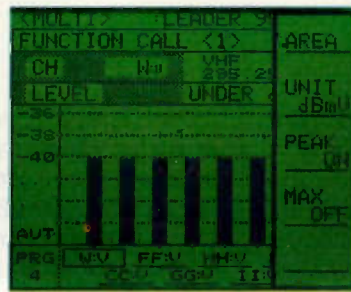

Pop-up Menus For Entry To Special Functions

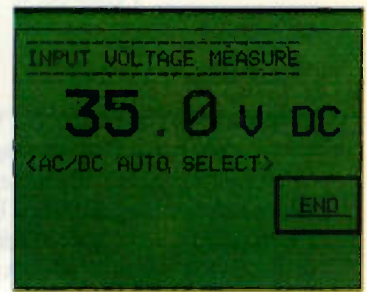

Auto Select AC/DC DVM

# AUTO CHANNEL SEARCH

## NEW CONCEPT IN CATV LEVEL METERS MODEL 951



Now there's no need to preset or manually tune through all the channels. Let the Model 951 do an **auto channel search** for active channels in your region. The unit will detect 32 active channels and display them segmented by frequency from four data storage registers that can be saved as data results or as programs for future measurements.

Start measuring right away

without channel listings or charts. The 951 can be used in both simple and sophisticated operation modes.

For **simple operation** use four buttons in the MEASURE section. Measurements will be displayed with auto-ranging and scaling. Or you can program the unit with pop-up menus with soft key selection to guide you through the unique features and functions to facilitate

custom programmed measurements.

Call toll-free  
**1 800 645-5104**

In NY State  
**516 231-6900**

**LEADER**  
FOR PROFESSIONALS WHO KNOW  
THE DIFFERENCE

Leader Instruments Corporation, 380 Oser Avenue, Hauppauge, New York 11788  
Regional Offices: Chicago, Dallas, Los Angeles, Atlanta. In Canada call Omnitronix Ltd., 416 828-6221

### Zenith-AT&T digital HDTV system begins ATTC testing

The all-digital high-definition television system developed by Zenith Electronics Corp. and AT&T began testing this week at the Advanced Television Test Center here. The Zenith-AT&T system, digital spectrum compatible HDTV, is the third of five HDTV systems to undergo the eight-week battery of tests.

Results of the tests will go to the FCC Advisory Committee on Advanced Television Services, which is expected to recommend a system to the Federal Communications Commission. Following field tests of the recommended system, the FCC is expected to adopt the new broadcast standard in 1993.

"We've been preparing the system for a long time and now we're ready," said Wayne Luplow, Zenith's division vice president of research and development, advanced television systems. "The Zenith-AT&T engineering team has worked to get peak performance from our system. We're very optimistic about the tests."

According to Arun Netravali, A&T Bell Labs research director and HDTV project manager, a critical element of the system's ability to produce superb pictures is its powerful video compression algorithm. "We're convinced that this system delivers the best HDTV pictures," he said.

This approach includes four-level and two-level coding. It identifies and transmits the most important image data in the two-level mode - actually a series of zeros and ones. The remainder of the picture is sent in four-level mode - actually a series of zeros, ones, twos and threes.

Information sent in four levels assures high-definition video and compact disc sound quality. The two-level system takes over when the receiver is far from the transmitter, as in the far fringes of a broadcast area. The two-level system retains a high-quality video and audio at the fringes. Bi-rate coding also extends coverage area in major cities, where interference between transmitters can be strong.

DSC-HDTV offers a combination of video compression technology and 787.5-line progressively scanned images. This results in 1,575 horizontal

picture lines every one-thirtieth of a second, for higher resolution HDTV images than competing systems based on 1,15 or 1,050 lines. Progressive scanning eliminates jagged edges and other artifacts that degrade picture performance of interlace-scanned HDTV images.

### Video products sales increase over February 1991

Spurred on by strong sales of VCR decks, camcorders and laserdisc players in February 1992, sales of video products rose 4.2% over February 1991, according to statistics released today by the Electronic Industries Association's Consumer Electronics Group (EIA/CEG).

EIA figures reveal that the United States consumer electronics manufacturers produced \$7.1 billion worth of goods in 1991, 11.6% over the 6.4 billion worth of goods produced in this country in 1990.

Sales to dealers of all video products have grown 11.6% during the first two months of this year, which is consistent with preliminary data released this week for the nation's largest retailers by The Wall Street Journal. The data shows that sales rose between 7 and 9% in February 1992 over February 1991. This gain in retail sales comes on the heels of a 3.9% increase in sales in January 1992, a month in which several closely tracked economic indicators showed increases, including housing starts and the index of leading economic indicators.

Sales of VCR decks in February 1992 rose 3.9% over February 1991, and have grown 36.5% year-to-date. For the first two months of 1992, VCR decks sold at an annual rate in excess of 13 million units.

Camcorder sales increased 8.5% in February 1992, the highest ever February sales for this product category. Sales of compact camcorders were particularly strong, rising 35%. Sales of laserdisc players, spurred by the increasing number of movies and other programs available on laserdisc, increased 11% in February 1992, and have risen 78.6% during the first two months of this year.

Although February 1992 sales of color televisions fell 7.1% from February 1991 figures, it is important to

note that sales have dropped just 1.4% during the first two months of 1992. Some of the decline can be traced to shifting consumer preferences for large screen televisions, as evidenced by the continued strength in sales of TV's 30 inches and larger, which grew 56% in February 1992.

Sales of big screen TV's were also likely to be bolstered by the recent Olympic games, according to a new study from Sharp Electronics. The study, conducted for Sharp by the Gallup Organization, showed that 28% of consumers shopping for a new television considered the Olympics a "major influence" in their decisions to purchase a large screen television.

### NPEC '92 technical seminars

Technical seminars at the National Professional Electronics Convention (NPEC) offer valuable information on the latest consumer electronics products and their components. A dozen workshops led by instructors and manufacturer trainers are free to convention registrants. NPEC 92 will be held August 3rd thru August 8th at the Worthington Hotel in Fort Worth, TX.

Electronics Industries Association (EIA) microprocessor and compact disc schools and a pair of Hitachi camcorder seminars are among this year's featured events. The 3-day microprocessor schools covers theory of microprocessors, input/output operations, multiplexed display, and digital to analog conversion. The 2-day compact disc school includes a CD overview and demo, A/D processing, D/A processing and dequantization, oscilloscope techniques, mechanical familiarization, optical systems, laser characteristics, MPV control, adjustments, and troubleshooting. Both schools are limited to 24 students.

Hitachi's Ray Furlong will lead two camcorder schools covering Hitachi's new VM4400 and VM 5400 series chassis. Hands-on training delves into the mechanics of assembly and disassembly. Alignment procedures using AT class computers are also covered. Each seminar is limited to 20 participants.

Additional seminars and their manufacturer sponsors are: Sencore switch

*(continued on page 57)*

# ELECTRONIC

Service & Technology

Electronic Servicing & Technology is edited for servicing professionals who service consumer electronics equipment. This includes service technicians, field service personnel and avid servicing enthusiasts who repair and maintain audio, video, computer and other consumer electronics equipment.

## EDITORIAL

Nils Conrad Persson, *Editor*  
Jeffrey Uschok, *Assistant Editor*

## CONSULTING EDITORS

Homer L. Davidson, *TV Servicing Consultant*  
William J. Lynott, *Business Consultant*  
Victor Meeldijk, *Components Consultant*  
John E. Shepler, *Audio Consultant*  
Sam Wilson, *Electronics Theory Consultant*

## PRODUCTION

Elizabeth Ryan, *Art Director*  
Barbara Terzo, *Assistant Art Director*  
Susan Reale, *Artist*  
Dorothy Kehrwieler, *Production Manager*  
Emily Kreutz, *Production*  
Pat Le Blanc, *Phototypographer*  
Florence V. Martin, *Phototypographer*

## BUSINESS

Richard A. Ross, *Publisher*  
Jonathan C. Kummer, *Associate Publisher*  
Dorothy Kehrwieler, *General Manager*  
Frank V. Fuzia, *Controller*  
Catherine Ross, *Circulation Director*  
Melissa Kehrwieler, *Data Processor*  
Denise Pyne, *Customer Service*

## SALES OFFICE

Electronic Servicing & Technology  
76 N. Broadway, Hicksville, NY 11801  
516-681-2922; Fax, 516-681-2926

Jonathan Kummer, *Advertising Manager*  
Emily Kreutz, *Sales Assistant*



Member, Electronic  
Servicing Dealers  
Association

## EDITORIAL CORRESPONDENCE

P.O. Box 12487  
Overland Park, KS 66212  
913-492-4857

Electronic Servicing & Technology (ISSN 0278-9922) is published monthly by CQ Communications, Inc., 76 N. Broadway, Hicksville, NY 11801. Telephone (516) 681-2922. Second class postage paid at Hicksville, NY and additional offices. Subscription prices (payable in US dollars only): Domestic—one year \$24, two years \$40. Foreign countries—one year \$30, two years \$52. Entire contents copyright 1992 by CQ Communications, Inc. Electronic Servicing & Technology or CQ Communications, Inc. assumes no responsibility for unsolicited manuscripts. Allow six weeks for delivery of first issue and for change of address. Printed in the United States of America.

Postmaster: Please send change of address notice to Electronic Servicing & Technology, 76 N. Broadway, Hicksville, NY 11801.

CQ Communications, Inc. is publisher of CQ The Radio Amateur's Journal, Popular Communications, ComputerCraft, CQ Radio Amateur (Spanish CQ), CQ Amateur Radio Equipment Buyer's Guide, CQ Amateur Radio Antenna Buyer's Guide, Popular Communications Communications Guides, and Electronic Servicing & Technology.

## Literature

### Service training schedule announced

Philips Service Company today announced its service training schedule through July 1992. The updated course schedule features seven new classes, including a two-day course on Power Supply Service #2 (C128). This updated schedule reflects service technicians' demand for information on various specialized topics. The course also covers the S1/4, T1 and PTV 380 chassis power supplies with hands-on labs and troubleshooting.

The T1 series chassis features a new switching mode power supply with special control from a new IC. The circuitry for this new power supply is covered in detail, along with hands-on lab sessions.

An RCA CTC168 chassis is used for the fourth project in this training program. Its design presents special considerations when servicing these power supplies to the component level. Troubleshooting this chassis is given much consideration in this training course.

Other new courses scheduled during the six-month period include Advanced PC Repair, Fundamentals of Color Camcorders, and VCR Operating Systems. In addition, seven other courses will be taught at various training centers through the end of July. These include MS-DOS 5.0 (Operating System and Hardware Familiarization), Computer Monitor Repair, Power Supply Service #1, 8mm Camcorder Repair, Update VCR Technology, Compact Disc-Interactive and Compact Disc-Digital Audio.

Circle (26) on Reply Card

### Catalog features guide to power protection

A new catalog of power protection products, featuring a detailed guide to power protection, has just been published by Perma Power Electronics, Inc.

The eight-page guide and catalog begins with an explanation of the variety of power problems that can adversely affect the performance of computers and peripherals, as well as other sensitive electronics products, such as modems, telephones, fax machines and VCRs. The guide also includes descriptions of the three basic types of power protection: surge suppression, voltage regulation and UPS (uninterruptible power supplies).

Each section explains the applications best suited for each type of protection, as well as what features and specifications to look for when selecting a device.

The catalog section describes the company's full line of power protection products. Included are specifications and applications information on surge suppressors for computers, peripherals and for other equipment connected to telephone, data and antenna lines; power control centers; automatic voltage regulators; and UPS power systems for standalone PCs and local area networks.

Circle (27) on Reply Card

### 1992 product catalog

Parts Express announces the release of their 148 page, 1992 catalog. Parts Express is a full-line distributor of electronic parts and accessories geared toward the consumer electronics industry and the technical hobbyist. They stock an extensive line of electronic components including speakers and audio accessories for home and car, CATV and VCR repair parts and accessories, semiconductors, tools and technical aids, computer accessories, chemicals and solvents, telephone products, wire, connectors, instructional books and videotapes, and arcade game parts.

Circle (28) on Reply Card

### EIA standards and publications catalog

A comprehensive, new, 108-page catalog of all standards, specifications, and other publications of the Electronic Industries Association (EIA) and its affiliated groups has just been published. It is available without charge from Global Engineering Documents, Irvine, CA, exclusive distributor of EIA documents and publications.

The EIA catalog includes publications of the Telecommunications Industry Association (TIA), the Joint Electron Device Engineering Council (JEDEC), the EIA Tube Engineering Advisory Panel (TEPAC), and other bodies in the EIA group. Approximately 1,000 publications are listed; and all available from Global Engineering Documents the same day as ordered. ■

Circle (29) on Reply Card

# Test equipment update 92

## Introduction

As anyone who has been in consumer electronics servicing for any length of time knows, the instruments used for servicing have changed dramatically over the years. Early meters, for example, were large, bulky, simple voltmeters, ammeters and ohmmeters that were of limited precision and presented a heavy resistive load to the circuit under test. Today the technician commands digital multimeters that can measure not only volts, amps and ohms, but capacitance, solid-state junctions and more. And they can be slipped into a pocket and carried anywhere.

Oscilloscopes, too, have evolved. Early scopes were narrow bandwidth instruments that had limited triggering capability, only a single channel, difficult to read graticules, and other limitations that made them, although essential in service testing, extremely limited in their applications. Today's oscilloscopes are available in bandwidths well beyond that required for TV servicing, are cable of multiple channels, have on-screen parameter readout and much more.

Over the past few years, a great deal has taken place that has changed not only test instruments, but the idea of test instruments. In the past, test instruments were analog devices. That is, the electrical parameter was directly converted into some kind of mechanical analog, or equivalent, so that it could be observed. For example, in a voltmeter, the voltage might be converted into a magnetic field that was used to deflect a pointer. In an oscilloscope, the signal to be viewed is applied more or less directly to the deflection plates surrounding the CRT, and the amount of deflection of the beam is proportional to the magnitude of the signal.

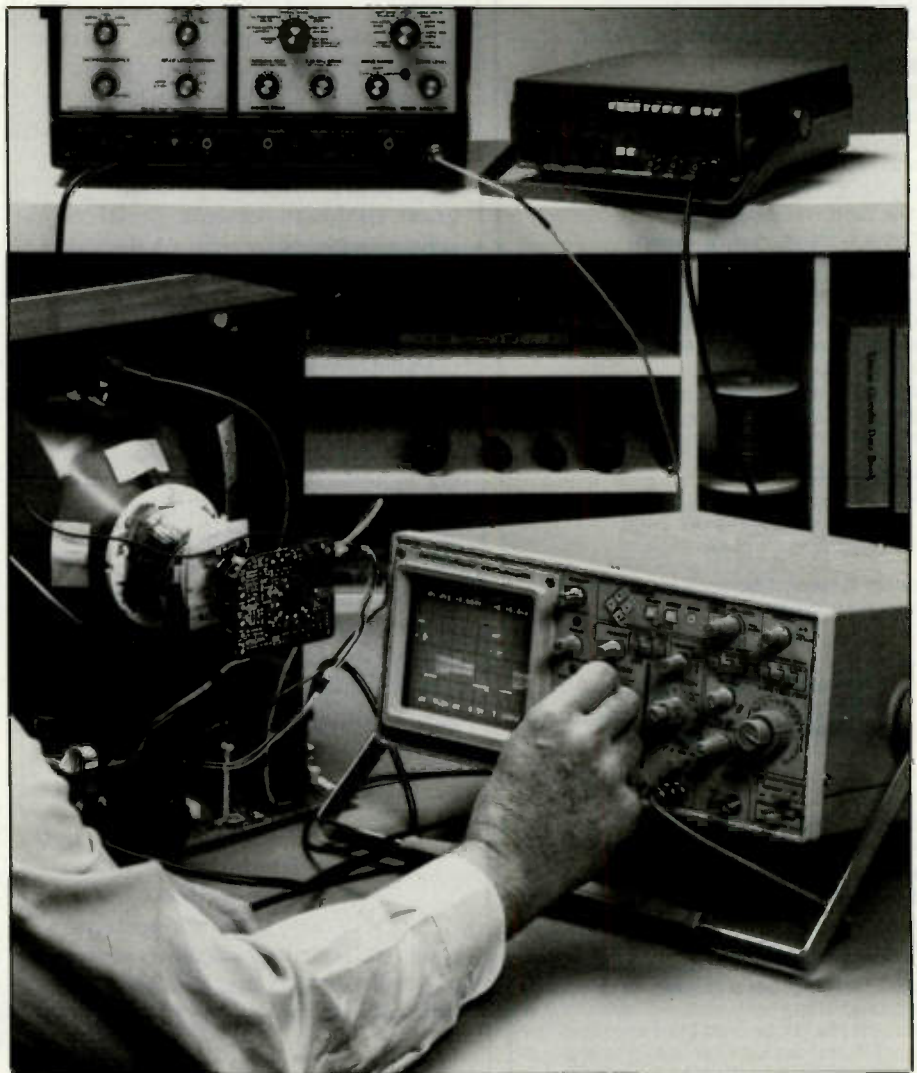

### The digital revolution

Many test devices made today are still based on the analog principle. It still works very well. But the availability of computers and computer products has made possible an entirely new way to design and build test instruments. With the computer based in-

struments of today, products such as digital storage oscilloscopes (DSOs), the signal observed by the operator of the instrument is no longer simply a visual analog of the signal being monitored by the oscilloscope.

The original signal has been sampled by the oscilloscope and converted



from its analog representation into a series of binary digits. This series of digits is then manipulated by the test instrument's circuitry, and converted into an analog representation of the original signal that is observed on the screen.

There are a number of advantages of such a piece of test equipment. Some disadvantages as well, of course. Among the advantages is the fact that the digital representation of the signal can easily be stored and observed at a future time. It can be stored temporarily in the unit's internal memory, or it can even be recorded on a magnetic disc or tape for an indefinite length of time.

But not only can the digitized information be manipulated or stored, it can be transmitted to another location for manipulation and evaluation.

#### Computers as test equipment

While manufacturers of traditional test equipment saw the value of incorporating computers in their products, other manufacturers perceived that the opposite approach would also work, and so began to design and manufacture peripherals, add-in circuit boards and software that could be used to turn a personal computer into a test instrument.

This approach required a peripheral device that would be used to sense the parameter of interest: current, voltage, etc. and convert it into a digital signal. This digital signal is then manipulated by the computer; in some cases by a special add-in circuit board, and in some cases just by the computer's own circuitry; and displayed on the computer monitor.

#### What does the future hold?

The article in this Update entitled "Measurement and instrumentation: a vision for the 1990s," is one view of the near-term future of test instruments, based on the state of the art of test equipment and computers today.

Most of the instrumentation described in this article is largely applicable to engineering and scientific research, and so has limited applicability to consumer electronics servicing, for the present at any rate. It is,

however, an important application of computers to testing, and anyone who uses test instruments on a daily basis, as do technicians, should be aware of this direction being taken by testing technology.

#### Making connections

While test instruments are constant-

ly getting more useful, and more accurate, they don't do much until they are connected to the circuits that are to be tested. This requires connectors and test leads. The other two articles in this update provide information on understanding and choosing test probes and connectors for the particular application. ■

## "You need it? PTS has it!"

**PTS Electronics has the nation's largest inventory of modules, motherboards, chassis, and projection TV chassis.**



More professionals call PTS for all major makes of Projection TV chassis, modules, and motherboards than any other source. PTS Electronics was founded by TV technicians in 1967 as a

tuner rebuilding company. We have grown and adapted to meet the needs of today's technicians. Today, PTS Electronics is the #1 source for all leading brands of modules, motherboards, and chassis. And we still do tuners!



*Thousands of chassis, modules and motherboards are in our giant warehouse, in-stock for immediate delivery. Ask about overnight shipping and nationwide distributors.*



*Call PTS toll free. We will instantly check the nation's largest computerized in-stock inventory. We're able to say "We've got it!", more than any other supplier.*

# PTS Electronics

**CALL PTS TODAY! 800-844-7871 800-331-3219**

#### EAST

PTS Electronics Corporation  
5233 37 South,  
Bloomington, IN 47402

#### WEST

PTS Electronics Corporation  
4941 Allison St., #11,  
Arvada, CO 8002

Circle (6) on Reply Card

# Measurements can only be as accurate as your connections

By James Heighway

In the last few years, a variety of sensitive instruments have been introduced to the test and measurement market, particularly digital multimeters. Many of these new meters are both more accurate and less costly than those available earlier.

However, despite the potential for performance improvement these new tools offer, it's important for users to remember that making good measurements depends largely on making good connections between the meter and the test point or points.

In other words, the most sensitive meter in the world won't provide accurate readings if the clip or probe that connects it to the point being measured isn't selected and used properly.

Because of economic considerations, instrument manufacturers can't supply every connector the user may need over the life of the instrument. Typically, the user should plan on investing in additional leads and connectors designed for the specific application.

This article will examine the steps involved in ensuring quality connections, such as understanding the differences between connectors and choosing the most appropriate connector for the application. Proper soldering and crimping techniques will be reviewed, and recent innovations in connector design will be discussed.

## Making quality connections

Every electrical connection has two ends: the working (user interface) end and the instrument end. From the perspective of the working end, there are basically three elements involved in making a quality connection:

## Mechanical Properties

### Strength of Connection

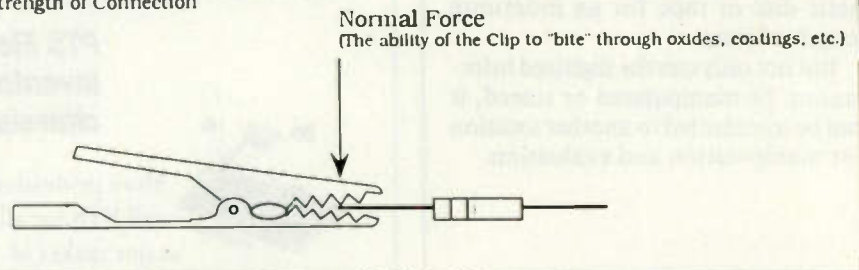

Figure 1. Strength of connection

- Establishing electrical contact with the test point or points through oxides, platings, dirt, insulation, solder masks, etc. This may require the user to clean, scratch off, pierce, peel back, or otherwise remove the material that separates the connector from the test point.
- Keeping the working end of the connection in continuous contact with the point of measurement. Obviously, if the connection is constantly pulling loose, or the connector comes in contact with other devices or equipment, the user will have to waste time making re-connections, and the data obtained may not be totally reliable.

Every quality connection must combine sufficient normal (perpendicular) force (See Figure 1), which provides the "bite" needed to penetrate oxides, coatings, etc., with adequate mechanical "grip" to prevent the connector from pulling away from the test point due to its own weight.

For alligator, plunger and DIP clips, the spring provides the necessary bite. When using a test prod, the user provides the "bite" by applying pressure to the tip of the prod.

- Making the connection safely. Con-

stantly stopping to reconnect loose leads is not just annoying, it's also potentially hazardous, particularly when working with high voltages.

To minimize these dangers, always read the connector and instrument manufacturers' safety recommendations before beginning testing and follow them scrupulously.

To prevent shock hazards, burns from overheated connectors, etc., don't attempt to remove insulators/safety shrouds unless the manufacturer specifically states that the procedure is safe. Finally, confirm that the connector has sufficient current carrying capacity for the application.

It's also critical to ensure the electrical and mechanical integrity of the link between the working end of the probe, clip or connector assembly and the wire lead that connects it to the instrument end. Although many connectors are offered with the wire lead already attached to the connector assembly, highly-specialized applications may require assembly.

## Assembly methods

A variety of techniques can be used to make the connection between the tip and the wire lead:

Heighway is President of Mueller Electric Company.

• **Spot welding** — Although spot welding is a very fast method of making quality electrical connections, the set-up time and expense of the necessary equipment means it's generally not practical for assembling a small number of connectors.

• **Brazing and soldering** — Like spot welding, brazing and soldering, when done properly, make a fine electrical connection. Both use high temperature to melt a dissimilar metal (brass or steel for brazing, a combination of tin and lead for soldering) to link the connector to the lead wire. However, these techniques call for far less equipment, so they're more economically feasible for low volume use.

• **RF (radio frequency) welding** — This type of welding is often used for assembling BNCs, and, like spot welding, is appropriate for high volume work. Essentially, a coil pumps RF power into the connector assembly and lead wire. This power creates a "skin effect" that excites the molecules of the outer layers of the parts so that they melt together.

• **Riveting/eyeletting the wire to a clip** — This technique is often used by manufacturers for producing high volumes of clip and lead assemblies. Essentially, the end of the lead is inserted in a hole in the clip, then an eyelet is inserted into the hole and mechanically compressed, attaching the wire firmly to the clip.

• **Crimping** — Like soldering and brazing, crimping the wire to the connector assembly is appropriate for many low volume applications. When done correctly, it also provides a sound mechanical connection and high electrical integrity.

One of the fastest, most effective crimping techniques is simply to cut away the insulation at the end of the lead wire, fold the wire back over the insulation, insert the wire into the connector assembly, then crimp the end of the connector around the exposed wire and insulation.

#### **Various combinations of these techniques may sometimes be used.**

Safeguarding the connection Once the electrical connection has been established, the user may need to include several additional steps to minimize the opportunities for mechanical disruption and prevent shock hazards while the connector is in use. One of the most important safeguards is to seal the connection against oxidation

to prevent corrosion, usually by adding some form of insulation.

The use of proper strain relief techniques is also critical to making lasting connections. A strain relief separates the external forces or environment from the internal mechanical and electrical connections. When a crimped connection has good strain relief built in, the connection offers high reliability without the need for additional strain relieving techniques.

An unprotected soldered connection is easily damaged, however. Some of the solder may wick up the lead, stiffening a portion of the wire. Later, when the lead is flexed, the point where the stiffened and unstiffened sections meet is exposed to additional stress, and the lead may break. To prevent these problems, connector manufacturers must often add molded strain reliefs to protect their soldered connections.

#### **The connection at the instrument end of the lead**

While instrument end connections require the same mechanical and electrical properties as those at the working end, the user generally has less freedom of choice here, because the type of connector required is fixed by the instrument manufacturer. The most common types of instrument end connectors are banana plugs and BNCs, but other types of connections may be required for highly-specialized applications, such as nanovoltmeters.

Usually, making the instrument end connection involves little more than verifying that the test lead is plugged firmly into the proper jack. However, it's important to ensure that the test lead being used is of sufficiently high quality to provide the level of accuracy needed.

Many low-resolution DMMs, for example, may come equipped with inexpensive test leads that would be adequate for simple tests but that would be less than sufficient if plugged into a high sensitivity instrument. Even expensive meters may not include all the leads needed for specialized applications such as low impedance testing, etc. •

Also, before plugging in the test lead, inspect the connector to make sure it is in good condition. This warning is especially important when using banana plugs, because some older designs are susceptible to deformation damage after use. Don't attempt to

smash a banana plug back into shape. Replace it if it seems to jiggle or rattle around within the jack.

#### **Characteristics of the lead wire**

The performance characteristics of the lead wire or cable that connects the working and instrument ends of the connector are also important. Obviously, the lead must provide sufficient current carrying capacity for the application.

In addition to the electrical properties it provides, the composition of the conductor can affect how easy the lead is to use during testing. For example, "ultra-flex" leads have a main conductor consisting of 384 strands of soft drawn copper wire, which can help prevent tangling.

The type of insulation material used will affect the lead's thermal resistance. Silicon rubber insulation is an excellent choice for both low temperature (-100C) and high temperature (300C) applications. Shielded leads or cables may be necessary for applications that require isolating the connection from magnetic effects or electrostatic noise.

#### **Alligator clips — the general-purpose solution**

The alligator clip and its almost infinite variations continue to be among the most popular forms of general-purpose connectors used today. The first alligator-type clips were designed nearly 85 years ago by Mueller Electric. Before this period, clips and connectors were usually home-grown, special-purpose designs developed by the user. In the succeeding decades, the design, manufacture and reliability of alligator clips have steadily improved.

As connector manufacturers created variations on the basic design of the alligator clip, new applications have evolved. The popular DIP (dual in-line package) clip is essentially a plastic alligator clip that's equipped with anywhere from eight to more than 100 test pins, depending on the IC for which it is intended.

The crocodile clip is another variation on the alligator clip, but made with long jaws with nesting teeth for use in close quarters. The teeth are designed to provide solid contact along the length of the jaw.

For electrical applications, there are few practical, cost-effective alterna-

tives to the all-purpose alligator clip. They offer good current carrying capacity and dissipate heat well; their jaws easily expand to fit a variety of different sizes from screws and wires to large bus bars without the need to change the clip itself.

While there's hardly a scientist, engineer or technician anywhere who hasn't used alligator-type clips for making electrical or electronic connections, there is also an almost unlimited range of mechanical applications for these items, such as downrigger fishing apparatus, dental bib holders, ski clothing, name tags, etc.

### Clip materials

Depending on the requirements of the particular application, alligator clips can be fabricated from a number of materials and protected with a variety of platings. Steel and copper are the most commonly-used clip materials.

Steel is relatively inexpensive compared with copper. While it offers excellent durability and long life and it's especially well-suited for mechanical applications, steel is not as good a choice electrically as a copper clip, particularly for low level measurements. For electrical test and measurement work, the high conductivity of copper clips makes them well worth the higher price tag. A variety of copper alloys are available for specialized applications.

### Clip plating materials

Over the last eighty years or so, a variety of different platings have been used for alligator clips. Lead was once a common plating material because of its excellent oxidation resistance. However, changing Environmental Protection Agency (EPA) regulations on the use of lead have made these clips a thing of the past.

For many years, cadmium was the non-noble plating of choice for high end applications because of its excellent oxidation resistance and soldering properties. However, cadmium has also fallen into disfavor with the regulatory agencies.

Tin plating, while it offers good electrical properties, has a very brief shelf life and poor durability. Tin develops a heavy layer of oxide when exposed to moisture, so its applications are limited to environments

where the temperature and humidity can be strictly controlled.

Noble metals such as gold, platinum and palladium resist oxidation, solder well, and provide excellent electrical performance for low level measurement applications, but command a premium price. For example, a gold electroplated clip can cost ten times as much the same part without the plating.

Nickel plating offers good electrical performance. It develops a relatively robust oxide layer that requires high temperatures and an aggressive rosin flux to solder it. However, it solders well if the user follows the correct procedures. (For further information, see the "Soldering Tips" sidebar.)

Although solid copper clips are excellent conductors, copper-plated steel clips provide no higher current carrying capacity than unplated steel clips. However, some connector manufacturers add copper plating simply to make buyers think they are getting a solid copper item. For all except the lowest end applications, a solid copper clip is a better value than a copper-plated one.

Zinc provides an attractive, inexpensive tarnish-resistant plating for steel clips but adds little or nothing in terms of durability.

### Clip selection considerations

Some users may occasionally find it difficult to use alligator clips effectively. In most cases, problems of this type are the result of using the wrong clip for the job. When choosing a clip, it may be helpful to keep the following criteria in mind:

- Match the size of the clip to the application. It can be next to impossible to prevent shorts, inadvertent contacts, etc. if the clip is too large for the device or lead to which it is attached. Conversely, don't attempt to force a tiny clip onto a thick bus bar. It's better to take a few minutes to switch to a properly-sized clip rather than waste time reattaching clips that are constantly slipping off.
- Make sure the clip has sufficient clamp strength, so the weight of the clip itself won't act as a lever to pull itself loose. Clamp strength is usually a function of the size of the clip.
- Select a clip with an appropriate jaw configuration for the device to which

it will be attached. Take advantage of the clips designed for specific uses. For example, the jaw configuration of the 41C plier-type battery clip was designed specifically for attachment to side- and top-mounted auto battery terminals.

- Look for clips developed for specialized applications — The right clip can reduce testing time significantly. For example, the 50C has a beryllium copper piercing needle, so it allows for making quick connections to insulated wires, for applications such as telephone line testing.

If frequent configuration changes will be necessary, choose a connector designed to reduce set-up time. Clips are available with a variety of different lead connection schemes besides the traditional screw, crimp, and solder connections. For example, threaded steel barrels make it easy to connect any threaded male test lead, while banana plugs can easily be inserted in unthreaded barrels.

### Clips engineered for a wide range of applications

As versatile as alligator-type clips are, they obviously aren't suitable for every application. A wide range of clip designs have evolved to meet specific needs. For example, plunger clips have been around for many years.

However, as the electronic applications have changed from wirewrap chassis to printed circuit boards, engineers have required ever-smaller J-hook and plunger clamp clips to make difficult connections to delicate component leads and terminals quickly and easily.

Similarly, Kelvin clips are designed for making four-wire resistance measurements. The jaws of a Kelvin clip are electrically isolated from each other when open and shorted to each other through the component lead under test when closed. One jaw provides a current path for the source while the other provides a current path for the sense.

### Test probes and prods

Many of the selection criteria for hand-held test probes and prods are very similar to those for clips. These tools are often constructed of brass because it is a good current conductor with a low voltage drop across the contact point.

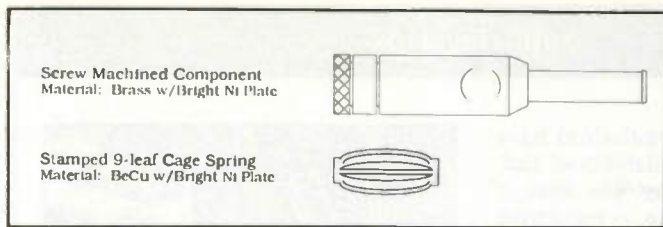
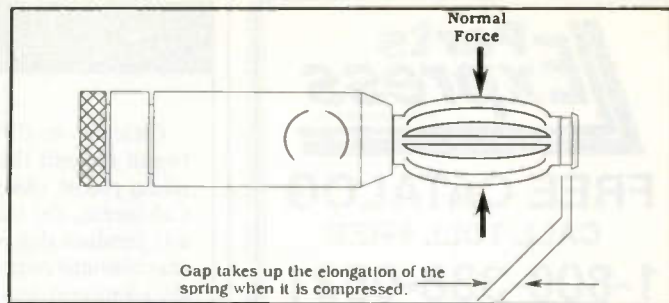

Figure 2. A nine-leaf design



However, since brass is a relatively soft material, probes are often equipped with sharp stainless steel points to allow the user to penetrate oxides or insulation more easily. These points also make it easier to work with minute leads and test points. In many cases, probes are equipped with banana jacks to simplify changing probes or leads quickly.

The growing awareness of the importance of testing safety has led probe manufacturers to engineer improved safety features into their products, such as molded shock collars/guards and safety shrouds to reduce the risk of contact with voltage-carrying parts. Probe bodies are generally molded of thermoplastics such as ABS, polyvinyl chloride

### The next generation of connection products

(PVC), polyamide materials, etc.

As instruments become increasingly sensitive and electronic components continue to shrink in size, ensuring good connections becomes both more important and more difficult. To meet these challenges, designers have developed a variety of new connectors for high temperature and card-edge applications.

They continue to explore the potential of heat-resistant plastic insulators that won't absorb moisture and that offer higher chemical resistance for use in corrosive or other aggressive environments. New methods of electrical shielding within leads and connectors are making it possible to reduce

signal interference due to noise to negligible levels.

Even long-accepted connector designs offer opportunities for improvement. For example, after repeated insertions and removals, the industry-standard four-leaf banana plug will deform. The result is often a plug that fits too loosely into the jack, so contact is annoyingly intermittent. An improved nine-leaf design (See Figure 2) was developed to prevent this problem.

Note that the nickel-plated beryllium copper cage spring is slightly shorter in length than the center barrel that holds it. This allows the spring to expand when it is compressed by being pushed into the jack, instead of deforming.

## ECG® Flyback Transformers Fit 39 TV/Monitor Brands.



Direct replacements for color and monochrome television and computer monitors—83 ECG types cross to 200 manufacturer's part numbers. Ask for our catalog/cross-reference at 900 Philips ECG distributor locations or call 1-800-526-9354.



Philips ECG



PHILIPS

Circle (8) on Reply Card

## 45 ECG® Ni-Cad Batteries Fit Camcorders, Cordless Phones And More.



Rechargeable replacement batteries and packs for cordless phones and camcorders cover 99 brands, 1,000 part numbers. Power for memory backup, radio-controlled model vehicles, too. Ask for catalog. At 900 Philips ECG distributor locations or call 1-800-526-9354.



Philips ECG



PHILIPS

Circle (9) on Reply Card

**Parts Express**  
International Inc.

**FREE CATALOG**  
CALL TOLL FREE  
**1-800-338-0531**



Parts Express is a full-line distributor of electronic parts and accessories, geared toward the consumer electronics industry and the technical hobbyist. We stock an extensive line of replacement parts for TV and VCR repair. Call for your FREE 148 page catalog today.

Free catalog is sent via bulk mail. For express delivery, please send \$2.50 to cover 1<sup>st</sup> class postage. Foreign destination customers send \$5.00 to cover postage.

340 E. First St., Dayton, Ohio 45402

Circle (7) on Reply Card

**ISCET**  
**VCR**  
**Cross Reference**  
VCR Model Number Cross Reference  
and VCR Parts Cross Reference

**3rd Edition.** Contains both model- and parts- number cross-references for more than 180 additional parts, and almost 50 brand names. **\$35.00** plus shipping **\$ 3.00**

**One 3½" disc,** or  
 **Two 5¼" 360K discs.**  
Version 4.0, for IBM PC AT/XT or compatibles. Requires hard drive and DOS 2.1 or greater. **\$69.95** plus shipping **\$ 2.00**

**Special Combo Offer.**  
Your choice of discs, plus 3rd Edition VCR Cross Reference. **\$95.00** plus shipping **\$ 3.00**

Allow 4-6 weeks delivery when using personal checks or VISA and MasterCard. Money orders and cashiers checks processed immediately.

Amount \_\_\_\_\_ VISA  MasterCard   
Card No. \_\_\_\_\_ Exp \_\_\_\_\_  
Name \_\_\_\_\_  
Business \_\_\_\_\_  
Address \_\_\_\_\_  
City \_\_\_\_\_ State \_\_\_\_\_ Zip \_\_\_\_\_  
Phone \_\_\_\_\_ Member  ISCET;  NESDA  
Texas residents multiply dollar value by 7.75% for taxes.  
Foreign shipments please add international postage.  
Send to: ISCET, 2708 W. Berry St., Ft. Worth TX 76109

**Soldering Tips**

Changes in EPA regulations have begun to limit the availability of cadmium plated clips today. The State of California, for instance, is registering any product shipped within its borders that contains cadmium. Because of this, the connector industry is searching for alternative platings to replace cadmium's versatility and convenience.

A growing number of connector manufacturers are turning to zinc and nickel electroplating. Both of these metals develop a more robust surface oxidation than cadmium, so soldering is more difficult.

Overall, the most effective soldering techniques call for using the right temperature, with a soldering tip that covers the largest contact area possible with as much pinpoint accuracy as possible. Speed is critical; if high heat is applied to an area for too long a time, it spreads throughout the metal being soldered and can discolor it or remove some of the metal's plating.

Here are some guidelines for soldering zinc-plated and nickel-plated connectors:

- Use a highly activated solder with a rosin core, such as Kester 44 flux core. The rosin core will clean metal surfaces to improve the solder's bonding ability.
- Use high quality 60/40 or 63/37 composition tin/lead solder of the proper diameter, usually 1/32" to 1/16". Normally, the smaller diameters work best. Larger solders tend to produce a bigger mass that cools the clips and connections being bonded. Cooler temperatures inhibit a good bond.
- Use a soldering station with adequate power, accurate temperature control, and fast thermal recovery. Standard pencil tip irons without temperature controls produce unsatisfactory results; they can't

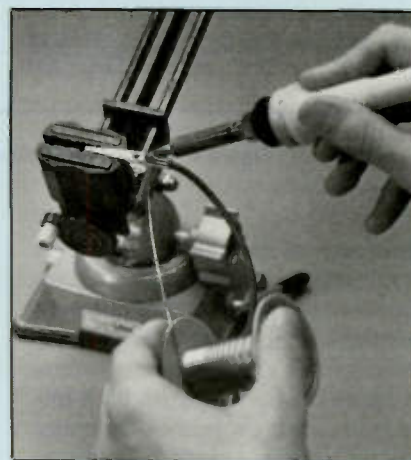

heat the clip or connection quickly enough, creating bonding problems or producing excessive solder masses.

**Recommended soldering temperatures:**

- Tin plated clip - 575F
- Copper plated clip - 650F
- Nickel plated clip - 675F
- Copper clip - 700F
- Zinc plated clip - 800F

Use a heavy-duty tip of the appropriate size and keep it properly tinned. Be sure the wire to be soldered has a fresh, clean surface exposed. Sometimes, the tinning is so good in very finely stranded wire that it can act as a wick, making soldering difficult.

Under extreme surface oxidation conditions, it might be advantageous to break the oxidation with a larger amount of solder, then to remove the excess with a desoldering braid. This has the effect of pre-tinning the surface.

The "wiping" action created when the spring expands into the gap continually self-cleans the electrical contacts, improving the plug's long-term reliability and performance. The nine-leaf design also provides a larger contact area between the plug and jack.

Changes in international equipment standards are also having a major impact on connector design. As instrument makers strive for ISO-9000 quality certification, connector technology must adapt to keep up with the new

performance standards.

Long-established electronic equipment standards such as UL 1244 and IEC-348 are being replaced by the evolving IEC-1010 standard that's already gained acceptance throughout Europe.

Although no one can predict exactly what the connection technology of the 21st century will be like, users can be confident it will offer significant improvements in both measurement accuracy and testing efficiency. ■

# Measurement and Instrumentation: The 1990s

By John M. Graff

During the 1970s and 1980s, several key standards emerged that will have a major impact on instrumentation in the 1990s. Some were conventional industry standards such as RS-232, GPIB, and VXI; others were de facto standards such as the IBM PC and the Macintosh. Together, these standards significantly simplify the development and reduce the cost of quality measurement and instrumentation systems.

One vision for instrumentation in the 1990s begins with a generalized model for instrumentation systems. This generalized system model includes GPIB instruments, plug-in data acquisition boards, VXI instruments, and RS-232 instruments, and is based on industry-standard computers, operating systems, and programming tools.

## Software is the key

The key to this instrumentation system model is the software. Instrumentation software packages should be able to easily integrate any or all of these four hardware instrumentation options into a single system. The software should support all aspects of an instrumentation system, including data acquisition and control, data analysis, and data presentation.

With this type of software you can build your own instruments to exactly match a particular application. Taking advantage of this new opportunity, however, means that the buyer can no longer assume that details concerning the signals and computation are

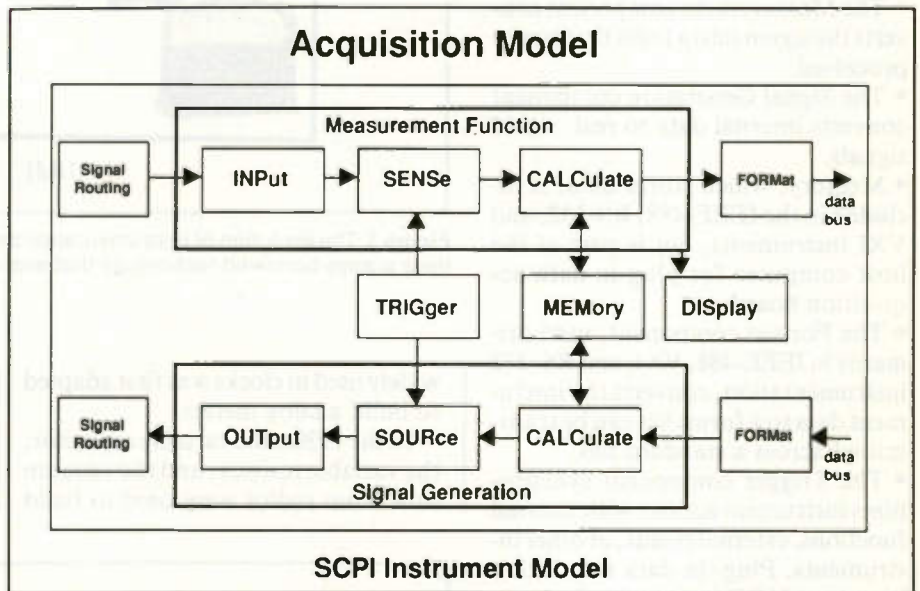

Figure 1. The SCPI generic model defines the internal components of instruments that are used as part of an instrumentation system.

automatically handled by the instrument vendor.

## A model for instrument components

The Standard Commands for Programmable Instruments (SCPI) standard contains a generic model for the

internal components of instruments that are used as part of an instrumentation system, as shown in Figure 1. This model summarizes all that has been learned about the components of an instrument.

SCPI uses this model to describe the

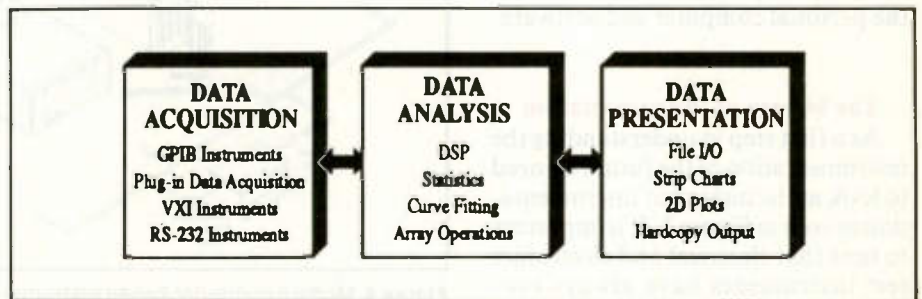

Figure 2. The basic model of an instrumentation system supports GPIB instruments, plug-in data acquisition boards, VXI instruments, and RS-232 instruments. The key to this model is software that supports all aspects of an instrumentation system, including data acquisition and control, data analysis, and data presentation.

Graff is Corporate Marketing Manager for National Instruments.

functional components of a generic instrument and then defines specific commands that are used for each of these components. Depending on the type of instrument, some of the functional components of the generic instrument model may not apply.

### The components of the SCPI instrument model

The following list describes the function of each component of the SCPI generic instrument model:

- The Signal Routing component controls the connection of a signal to the instrument's internal components.
- The Measurement component converts the signal into a form that can be processed.
- The Signal Generation component converts internal data to real-world signals.
- Memory, which stores data, is included in the IEEE-488, RS-232, and VXI instruments, but is part of the host computer for plug-in data acquisition boards.
- The Format component, used primarily in IEEE-488, VXI, and RS-232 instrumentation, converts the instrument data to a form that can be transmitted across a standard bus.
- The Trigger component synchronizes instrument actions with internal functions, external events, or other instruments. Plug-in data acquisition boards and VXI instruments have sophisticated trigger capabilities because of technologies such as the Real-Time System Integration (RTSI) bus on some data acquisition boards and the added trigger signals defined by the VXI specification.

The generalized model for an instrumentation system, shown in Figure 2, mixes off-the-shelf instruments, which have components defined by the SCPI model, with computation, analysis, and presentation provided by the personal computer and software.

### The history of instrumentation

As a first step in understanding the instrumentation of the future we need to look at the history of instrumentation as seen in Figure 3. It is important to note that electrical and electronics test instruments have always borrowed freely from contemporary technology that was widely used elsewhere. In the 19th century, for example, the jeweled movement that was

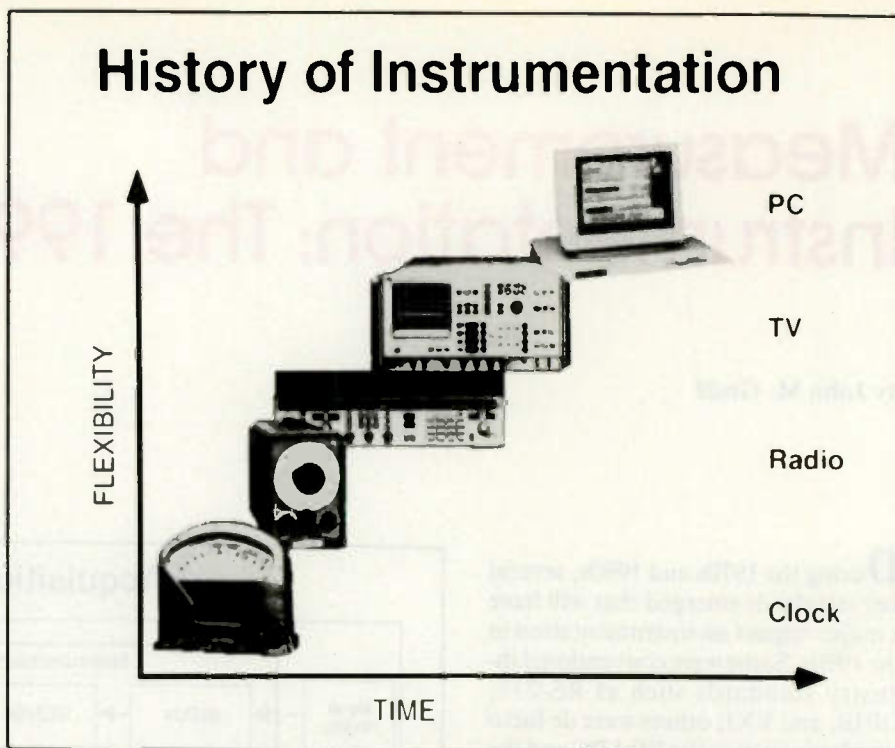

Figure 3. The evolution of instrumentation over the last 100 years shows that instruments have always borrowed technology that was widely used elsewhere.

widely used in clocks was first adapted to build analog meters.

In the 1930s, the variable capacitor, the variable resistor, and the vacuum tube from radios were used to build

the first electronic instruments. Display technology from the television has contributed to modern oscilloscopes and analyzers.

Finally, modern personal compu-

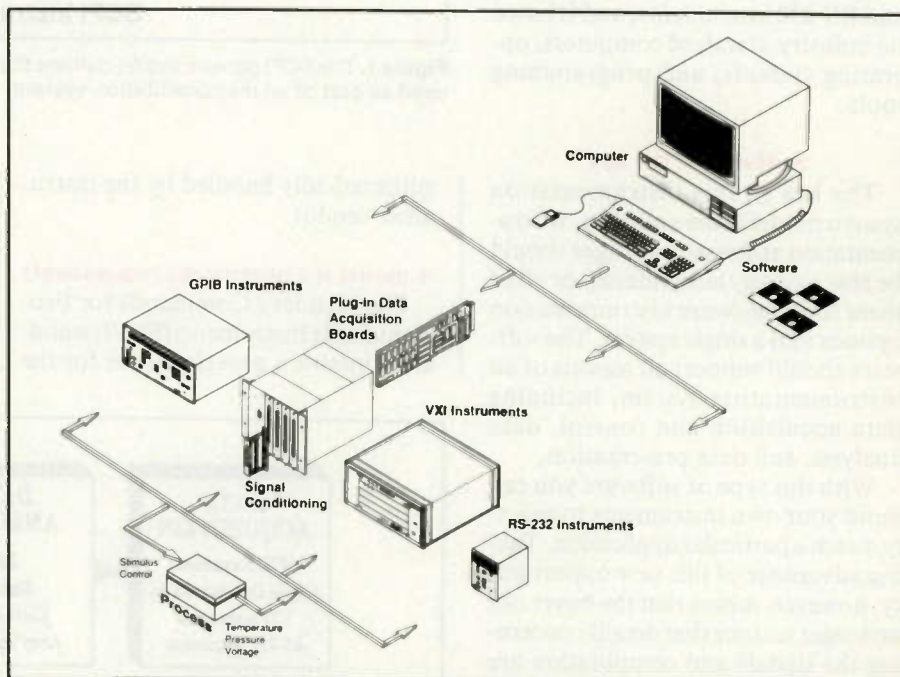

Figure 4. Modern computer-based instrumentation systems, whether for data acquisition or test and measurement, require a number of hardware and software components. Someone selecting the tools for building a custom system, should evaluate a vendor who follows an open architecture and industry standards philosophy to ensure that all components will be compatible and to ensure that the system can be updated in the future as new technologies become available.



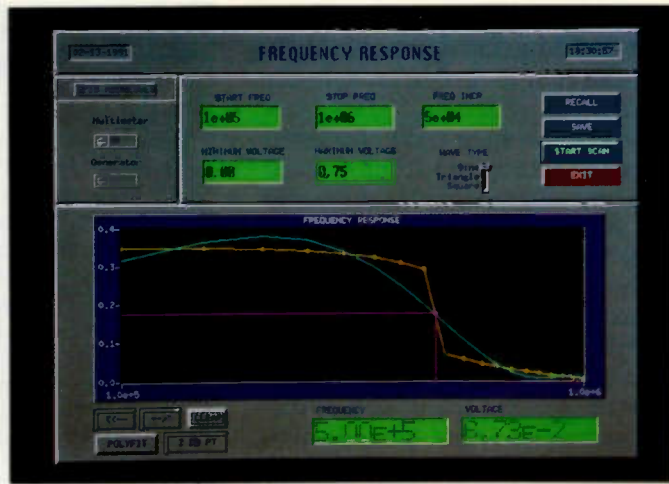

Figure 5a and 5b. Based on industry-standard languages, this software provides a flexible set of libraries to customize programs for a wide variety of instrumentation applications.

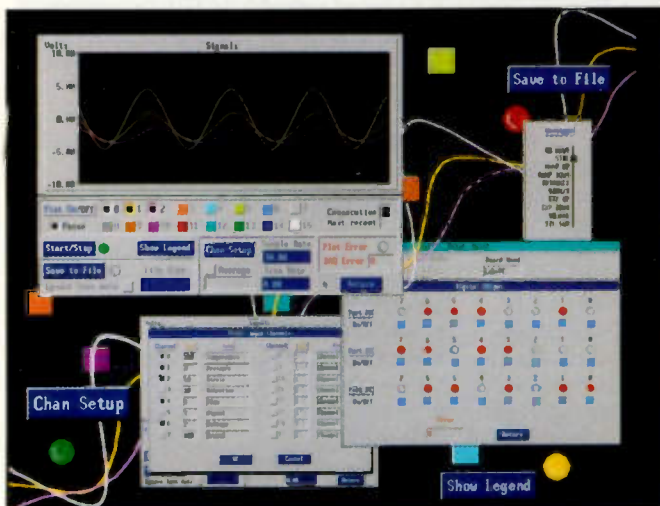

Figure 6. DAQware is a program that was developed using Lab-Windows libraries. DAQWare is a ready-to-run package for operating the National Instruments PC plug-in data acquisition boards.

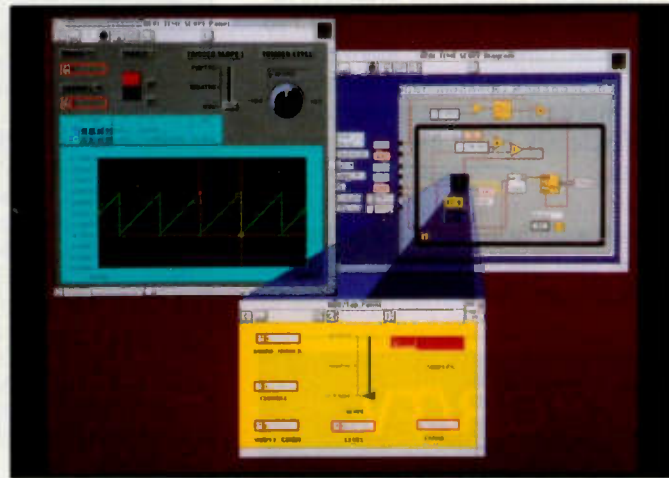

Figure 7. Using Instrumentation software, you build your instruments directly on the computer screen.

ters have high-performance computation and display capabilities. This technology has been adapted for use with instrumentation, and will be used to an even greater extent in the future.

### The evolution of computers in test equipment

The first computerized instrument systems of the 1960s were difficult to build because they required custom hardware interfaces and low-level assembly language programming. The GPIB standard for instrument-to-computer connection and programming was a tremendous achievement, and laid the foundation on which instrument systems would be built for the next 20 years.

In addition, the BASIC programming language was a significant contribution to programming technology

that would grow along with instrumentation through the 1970s and 1980s. Recently, further improvement was made for software with the introduction of SCPI. SCPI simplifies programming instrumentation by defining a single, hierarchical command set for all types of instruments regardless of the manufacturer.

In the 1980s, digitizers and computer plug-in data acquisition boards became widely accepted. These instruments are versatile because the ultimate instrument functionality of the system is determined by the computation done on the data rather than by some fixed function of the instrument. During the 1980s, PCs were equipped with computational engines powerful enough to be turned into sophisticated measurement instruments by software that contains the analysis and display

functions traditionally available only in stand-alone instruments.

### A new way of building instruments

One focus in the 1990s will be on instruments that can explicitly meet the specialized requirements of individual applications; instruments that are easy to configure and use, and precisely fit the user's measurement needs; instruments that provide in-depth analysis and presentation of results, and that seamlessly integrate the user's general-purpose computer and other tools. These instruments of the 1990s must keep pace with technology and adapt quickly as measurement needs change.

Ideally, in the 1990s, each scientist, engineer and technician would have a custom instrument for every measurement he or she performs. Imagine that you could just snap your fingers and

an instrument salesman would show up at your door with an inexpensive instrument custom-designed specifically for you. You would already know how to use it, it would be easily connected to your signal or process, and it would have extensive analysis capabilities to give you the exact information you need. Your efficiency and productivity would be tremendous, as shown in Figure 4.

Personalized instruments for each of us would be a great breakthrough, but is this concept practical? Currently, specialized stand-alone instruments are expensive and time-consuming to produce. And with the millions of engineers, scientists and technicians in the world, the number of custom instruments we would need far surpasses the thousands available today. How could we possibly build so many instruments? The answer is to have powerful, intuitive development tools that a test equipment user can use to efficiently build his own instruments.

#### Software brings it all together

The cost associated with software development has been the major stum-

## VCR/TV Service Centers

Discount Parts  
FREE CATALOG

Call Toll Free

1-800-223-3205



## Electronix

Corporation

313 W. Main St. Fairborn, OH 45324

Ph: 513-878-1828 Fax: 513-878-1972

Circle (15) on Reply Card

## A glossary of instrumentation terms

**Bus** - The group of conductors that transfer specialized types of data among the individual sections of a computer system. Typically, a bus is the expansion vehicle to which I/O or other devices are connected through expansion slots. Buses are characterized by the number of bits of data they can transfer during a single clock cycle, such as 8-bit or 16-bit.

**RS-232** - A communications protocol that defines the specific lines and signal characteristics used by serial communications controllers to standardize the transmission of serial data between devices. RS-232 was originally designed for communications between computers and modems through the serial port of the computer, but now it is often used for instruments. The transfer rate of the RS-232 is measured in baud, or bits per second. Transfer rates range from 300 baud to 19.2 kbaud or more.

**GPIB** - General Purpose Interface Bus, the standard bus used for controlling electronic instruments with a computer. Originally developed by Hewlett-Packard and first called HP-IB (Hewlett-Packard Interface Bus), the bus standard was adopted by IEEE in 1978 and became known as the ANSI/IEEE Standard 488-1978. An update to their standard is known as ANSI/IEEE Standard 488.2-1987. GPIB is an 8-bit parallel bus that can transfer data at a maximum rate

of 1 Mbytes/sec. GPIB has 8 data lines, 3 handshake lines, 5 interface management lines, and 8 ground lines housed in a round flexible cable. One GPIB-equipped computer system can have maximum cable length of 20 meters and control up to 15 instruments.

**VXI** - VME eXtensions for Instrumentation. A high-performance backplane bus used on the VMEbus designed to accommodate high-performance processor and instrumentation modules. Combines ease-of-use and interoperability of GPIB systems with the high-speed (40 Mbytes/sec) transfer capabilities of the VMEbus. VXI systems can be controlled by external computers via the GPIB; by a custom VXI-based embedded CPU; or by an external computer linked to the VXI backplane via the MXIbus (Multisystem eXtension Interface) cable.

**SCPI** - Standard Commands for Programmable Instrumentation; an extension of IEEE-488.2 that standardizes the ASCII command used to program instruments. All SCPI instruments with the defined functions are programmed with a specified command set, regardless of manufacturer. SCPI was defined and adopted by a group of major instrumentation manufacturers, including National Instruments, Hewlett-Packard, and Tektronix.

bling block in the way of user-designed instruments. Although the software is clearly the major challenge, it must not be considered the problem. In fact, to make this vision of instrumentation in the 1990s a reality, the software should be considered the instrument. Test equipment software packages are designed to simplify the construction of modern instrumentation systems.

For those who are already comfortable programming with BASIC or C, instrumentation software packages equip these standard programming languages with all the necessary tools for building instruments. An interactive development program, contains integrated drivers for all types of acquisition hardware, high-level instrument drivers for specific instruments, front panels for automatic code generation, and analysis and digital signal processing (DSP) functions for per-

forming specialty processing (Figures 5a and 5b and 6).

The software package illustrated in Figure 7 integrates a complete block diagram programming language with drivers for all types of acquisition hardware, high-level instrument drivers for specific instruments, analysis and DSP functions, hooks to link in traditional programming code, and an advanced user interface.

By building on the experience of the past and technology of the future, we can satisfy the needs of a wide range of industries and applications, ranging from acquisition and control to automated test equipment and advanced test and measurement. Digitizers, PCs, and powerful software will create the next rapid change in the growth of instrumentation. Every user will be empowered with the tools needed to efficiently build their own instruments. ■

# How to speed up common VCR adjustments

By the ES&T Staff

**W**hy are many VCR servicers ignoring alignment checks? It seems that there are two reasons. First, many do not understand the purpose of each adjustment because the brief instructions in the service literature do not explain how each affects the VCR's performance. Second, many find the procedures too time consuming because several pieces of test equipment must be used with an assortment of leads, operating instructions and tolerances.

This article will help you understand VCR alignment better by looking at three of the VCR adjustments that cause the biggest questions for VCR

*Adapted with permission from the Sencore News, Nov/Dec 1990, Issue 151*

servicers. The article will explain what each adjustment does in the circuit and then describe how to make each measurement and adjustment.

## Setting head-switch timing

All VCR alignment instructions require adjustment of the head-switching signal. Here's a description of what the head-switch signal is all about. The VCR circuits produce a visible horizontal noise bar when they switch from one video head to the other. If the circuits switched between heads halfway between vertical sync pulses, the picture would have a noise bar right in the middle of the screen (Figure 1). Or, if the circuits switched during vertical sync, the TV receiver would show rolling or vertical jitter.

To prevent these problems, the cir-

cuits switch the heads during the last few lines of each vertical field. This places the noise at the very bottom of the screen, often below the viewable picture. The switching happens three or four horizontal lines before vertical blanking to prevent sync problems.

The "Head Switch" (sometimes called the "Head PG" or the "Head Shifter") adjustment changes the timing of the head-switch square wave relative to vertical sync. Some VCRs have only one control that affects the timing during playback. Others have two controls; one for recording and one for playback. Still others have three controls; one affecting the position of the positive recording transition, the second affecting the position of the negative transition, and the third affecting playback timing. All

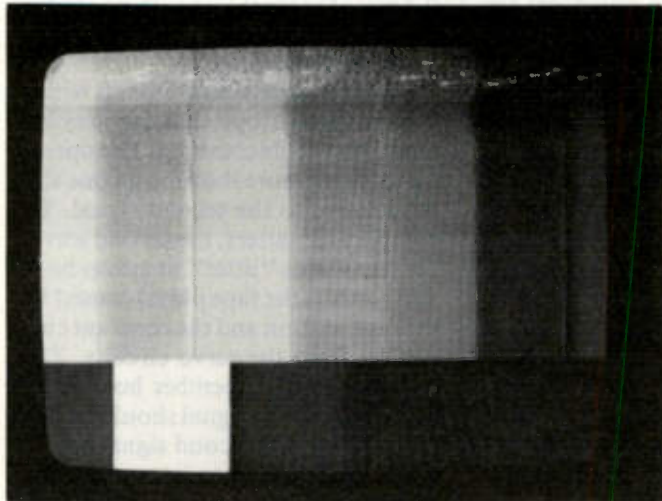

Figure 1. A tear appears on the picture if the VCR switches between heads at the wrong time.

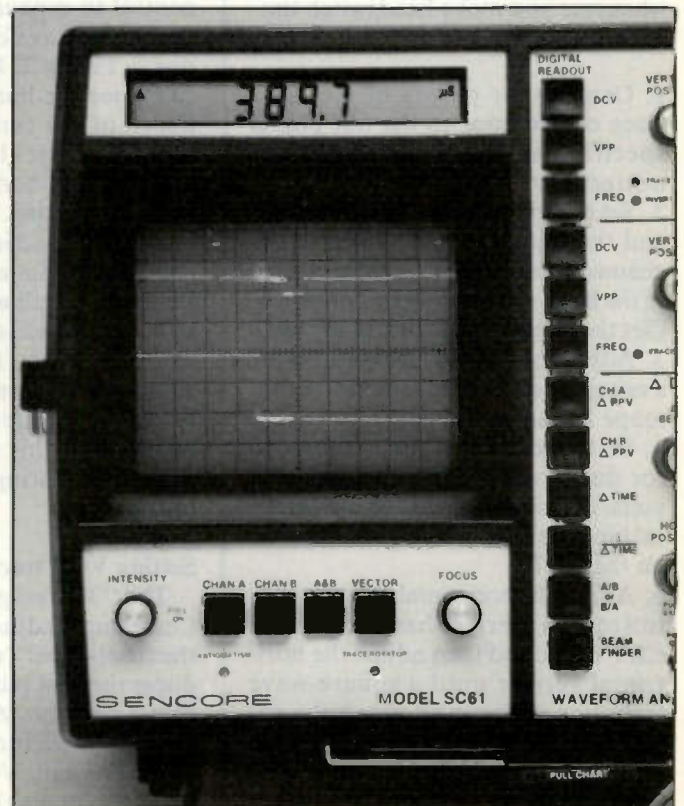

Figure 2. With the oscilloscope trace expanded, the waveform will follow the head switching alignment instructions.

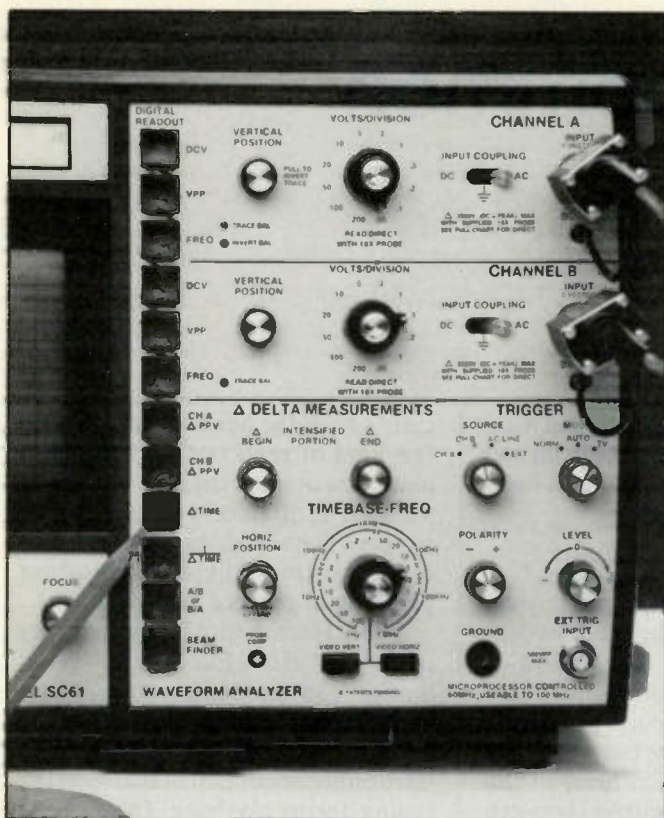

Figure 3. To adjust the VCR so that "Tracking" control produces the best picture when set to its center position, it is necessary to adjust the delay between a square wave and a pulse. To do this, you may count graticule divisions on the scope face. If your scope has delta time readout, you may simply adjust the oscilloscope delta time controls to highlight the position of the signal that is of interest.



Figure 4. To adjust the record current level, you can measure its value by counting scope graticules. Here the cyan bar is selected by the oscilloscope's delta PPV function. Now all the technician has to do is to adjust the circuit until the digital display shows the correct level.

three types use identical alignment procedures.

Refer to the following instructions whenever you make headswitch timing adjustments.

1. Connect the probes of the dual-trace oscilloscope to the test points specified in the VCR alignment instructions.
2. Set the trigger mode switch to auto and the trigger source switch to the channel to which you have the source of the head-switching signal connected. (Set the trigger level control to zero.)
3. Adjust the oscilloscope controls for a sweep rate of 1msec. Set the oscilloscope for normal sweep.
4. Set the controls of the oscilloscope for dual-trace mode and adjust the volts/division controls for each vertical input until both waveforms appear on the CRT.
5. Adjust the horizontal position control to view the right-hand edge of the CRT trace, and then adjust the horizontal vernier until a square-wave transition and vertical sync pulse appear at the right edge of the waveforms.
6. Adjust the horizontal position control until the square-wave transition

lies on the CRT's center, calibrated, graticule line.

7. Manipulate the horizontal position control to expand the waveform ten times. The waveform will look like the one in Figure 2. Notice that you can easily see the horizontal sync pulses ahead of the vertical sync interval. Simply adjust the VCR control so there are 3.5 horizontal lines before vertical blanking. If your oscilloscope has an add function it is even easier to compare the timing of the two signals. Follow the oscilloscope's operating instructions to add the two input signals together. Now, the head-switching squarewave causes a "jog" to appear in the composite video signal. Most people find this makes comparison easier than placing one waveform next to the other.

#### Setting VCR tracking adjustments

The "Tracking Fix" or "Tracking Centering" adjustment insures that the front-panel Tracking control produces the best picture when set to its center position. Adjustment procedures vary, according to the specific VCR. For most VCRs, the correct delay is the interval between a square-

wave at one test point and a pulse at a second test point. Some Panasonic VCRs, for example, need a delay of 0.4 msec for machines with two video heads but need a delay of 7.3 msec for four-head machines.

Making these measurements with a conventional scope calls for very attentive graticule counting. The operator must measure the time on one signal relative to the second signal. To complicate matters, the second waveform contains "jitter" (it moves back and forth as the tape plays) caused by the tape motion and the constant correction from the servo circuits. The operator must remember how many little squares one signal should be displaced from the second signal on the CRT, while trying to interpolate the average position of the moving signal.

If your oscilloscope has some kind of delta time function this measurement will be easier (Figure 3). The delta time function provides accurate time measurements directly on the waveform. You don't have to multiply switch settings or count CRT graticule markings. The results are accurate, whether the horizontal sweep speed is in the "Cal" or the uncalibrated

mode. Parallax errors or interpretation errors between the two signals don't cause problems either because the delta time function marks the waveform itself, instead of requiring the operator to align waveform segments with the CRT graticule.

To measure time, follow the oscilloscope's instructions for making this measurement.

To measure the delay between two signals, you adjust the position of the beginning of the delta bar, on an on-screen cursor, until it just touches the transition in the first waveform. Then adjust the end of the delta bar, or second cursor, until it just touches the transition in the second trace and read the digital readout or on-screen readout to see the time delay between the signals.

#### Setting record current adjustments

A few millivolts of measuring error become critical when adjusting the Chroma and Luminance Record Current controls. The typical signal level for Chroma Recording Current is only 30mV. The Luminance Record Current has a level of around 100mV.

These two adjustments determine whether the VCR will record a clean signal. If the signals are too large, the video heads will saturate the tape, causing a noisy picture or incorrect colors during playback. If the signals are too small, the tape will have a poor signal-to-noise ratio.

Two things complicate the adjustment of these controls. First, the trigger circuits of many scopes have difficulty locking to the composite video signal. Second, this procedure involves measuring the peak-to-peak voltage level of a small part of the complete signal, meaning careful counting of graticule divisions.

If your scope has an internal sync separator, or an external sync separator unit, you will be able to lock onto the video sync pulses and hold the waveforms in perfect synchronization. If your scope has a Delta PPV function, use it for these adjustments.

Just as with the Delta Time measurements (covered earlier), this function activates the intensified delta bar controlled by the delta begin and delta end controls, or the oscilloscope's on-screen cursors. Adjust the controls until the delta bar or the cursors just cover the part of the waveform the alignment instructions says to measure.

To adjust the Chroma Record Current control, display the signal at the horizontal sync rate. Next, highlight the cyan bar (Figure 4) of the chroma bar sweep pattern or NTSC split field video pattern from a video signal generator (both video patterns produce the same result).

For the Luminance Record Current, display the signal at the vertical sync rate, and highlight the vertical

sync interval. Then simply adjust the VCR circuits until the digital readout shows the correct peak-to-peak amplitude.

#### Alignment gets easier with practice

You can see why it's important to check the alignment of the internal VCR controls. Some will need minor touch-up, while others will need full adjustment. ■

If YOUR CUSTOMERS  
Ever Want To See  
Their PALMCORDERS  
Working Again, BETTER  
Send Us \$59.95\*

\*Plus shipping and handling

Here's the deal; if you want to free those Palmcorder and Quarterback models that are being held ransom by servicing headaches, send us \$59.95\*. In exchange, we'll release to you the PR-15 Palmcorder Training Program, the latest in our "Tech Talk" training series. The PR-15 features a 37-minute videocassette and 143-page training manual designed to train service technicians on the Panasonic Compact VHS Movie models PV-10/20/40 and Quasar models VM500/505/508. The video covers disassembly, basic troubleshooting, and reassembly, while the manual contains theory of operation as well as circuit descriptions. Both come housed in an attractive binder.

#### Don't Worry, You Can Trust Us

Matsushita training products are backed by over 10 years of experience in the service training field. No other company does as much to compile historical service data for Panasonic and Quasar products than Matsushita. And nobody knows them better than us.



#### Ordering Is Easier Than Paying Ransom

Don't worry, we don't want your cash in unmarked bills. Just send us a check or money order for \$67.95 (includes shipping and handling) or \$72.15 if ordering from NJ (includes shipping, handling and sales tax.) You can even use your VISA, MasterCard or Discover card with our 24 hour faxline. Please be sure to include all shipping, credit card information, and signature with your order, and allow 3-5 weeks for delivery.

At this price, you're not really paying a ransom, you're making an investment in your future.



**PR-15**  
**The Palmcorder Training Program**  
by Matsushita  
(Briefcase not included)

Technical Services Division · 50 Meadowland Parkway, Secaucus, NJ 07094 · Fax 201-392-4100

Circle (5) on Reply Card

June 1992 *Electronic Servicing & Technology* 19

# Selecting the right oscilloscope probe

By Bill Hansen

When you're troubleshooting a device with an oscilloscope — a TV, microwave oven, CD player, or microprocessor system, you should reduce the amount of noise or distortion introduced onto the circuit. You must be sure the waveform produced on the scope is an accurate signal from the device under test (DUT), and does not contain errors that you've introduced. In effect, the link between the DUT and the scope should be invisible.

Unfortunately, all probes introduce a load to a circuit or DUT. The wrong probe, one not designed to handle today's higher frequency microprocessor signals, can introduce a load, that changes the system's function or stops it altogether. The wrong probe can mask the very problem you're looking for. For accuracy, and to avoid wasting hours of your time, you want to make your probe as transparent to the system as possible. Putting a low-frequency probe on a high-frequency system guarantees problems.

## A 60MHz probe can't measure a 200MHz signal

Most oscilloscopes used in the service field have bandwidth of less than 60MHz. Today's microprocessors, used in everything from personal computers to VCRs and TVs to copier machines, often operate at well above this frequency. Obviously, if you're trying to look at a 200MHz waveform on a 60MHz scope, it won't look like the waveform on the schematic diagram. What might not be as obvious, though, is that you also cannot use a probe designed for 60MHz and obtain an accurate 200MHz waveform, even if your scope is rated at that level. The scope/probe "system" will operate properly at the frequency of the weakest link.

Oscilloscope probe suppliers usual-

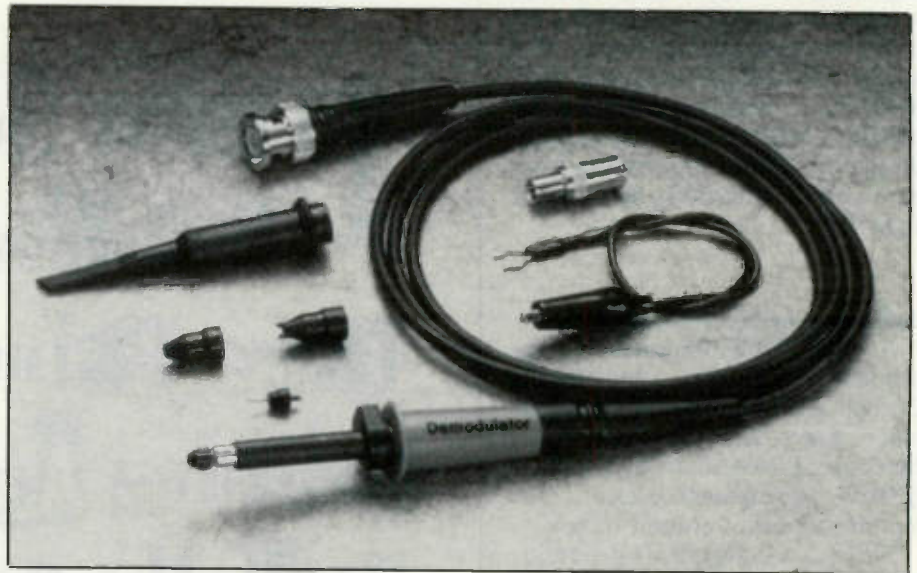

Figure 1. High frequency, modular, oscilloscope probe kit, showing various accessories supplied as standard. Three adjustable trimming circuits for impedance compensation are located directly behind the BNC scope connector.

ly offer a variety of probes with bandwidths, attenuations, capacitive/resistive loadings, and compensations to match your testing needs (Figure 1). The bandwidths generally range from 100MHz to 300MHz (there are higher ones, if necessary) and attenuation values from X1 to X100. For RF detection, there are even special probes designed for use with a scope with 10M $\Omega$  input, and up to 800MHz bandwidth.

In general, a probe that is rated for a lower bandwidth than the frequency of the signal that you're trying to display will not provide a good trace or an accurate measurement. A probe rated for a higher bandwidth than the frequency you're facing will provide a true signal.

## How to select the right probe

So, how do you select the right scope probe for your needs? Do you

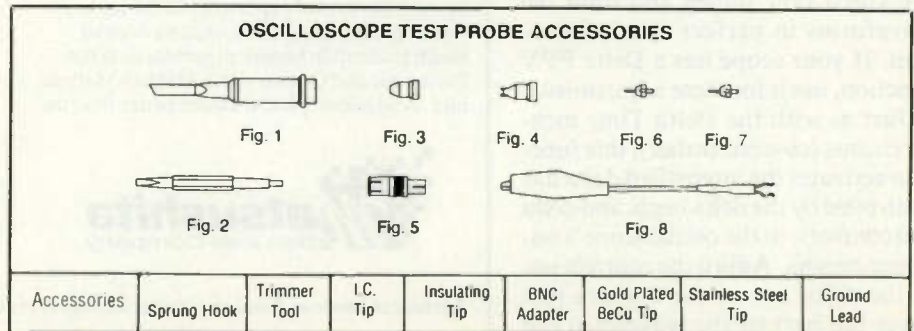

Figure 2. Line drawings and captions of typical replacement parts for scope probe kits.

Hansen is the Engineering Manager for ITT Pomona

Oscilloscope Probes		
MODEL	Use with the Following Popular Oscilloscopes	
4550A	Beckman, Hitachi, Kikusui Leader	All Models 200, 1021, 1041, 1060, 1100, 2100R, LCD-100, LBO-313, -315, -323, LBO-325, -516, -518
5792	Tektronix Beckman, Hitachi, Kikusui	T201, 222 All Models
5795	Tektronix Beckman, Hitachi, Kikusui Hewlett Packard Leader	300 Series All Models 1715, 1740 Series, 1950A, 5200A/D, 54112D, 54501A 3060D, LBO-2060
5800	Tektronix	T201, 222
5803	Tektronix Beckman, Hitachi, Kikusui Hewlett Packard Phillips  Leader	300 Series All Models 1715, 1740 Series, 1805A, 1809A, 1950A, 1980A, 54501A, 54510A 3050, 3052, 3055, 3057, 3065, 3070, 3206, 3215, 3217, 3219, 3256, 3266, 3267, 3280, 3285, 3286, 3302, 3305, 3308, 3310, 3311, 3315, 3320, 3335, 3350, 3355, 3365, 3375 3060D, LBO-2060
5809	Hewlett Packard Phillips	1720 Series, 54201 3290, 3295, 3296, 3323
5812	Tektronix	485, 2465, 7A42

Figure 3. Probe kit selector guide by oscilloscope brand/model.

need flexibility for a wide variety of applications, or just for one use? There are several things to consider.

First, choose a probe with a bandwidth at least equal to the scope's bandwidth. If possible, choose a probe with a bandwidth three to four times the frequency you expect to commonly measure. Just remember, the higher the rated bandwidth capability, the higher the cost of the probe.

Second, get a probe with the correct attenuation. A X1 (no attenuation) probe allows the scope to accurately present small signals (100mVpp) at a low frequency that may be lost if attenuated. It is also the lowest cost alternative. A X10 probe offers the best balance for general purpose testing. Its improved input impedance will not load the DUT as does a X1 probe, and the X10 attenuation allows for accurate waveforms between 100mVpp and 400Vpp.

If you always work on high-power copier circuits, get a probe with high attenuation that will bring the signal down to a level that your scope can accept (X100 attenuation). If your work varies, you might want to consider a probe with switchable X1-X10 attenuation. This probe offers the best of both worlds at small to medium voltages.

Consider accessories. Can you replace or interchange different tips: for ICs, BNC connectors, gold plated or stainless steel tips, ground leads, etc.? If the cable or the probe head get dam-

aged during use, can you replace part of it without having to buy an entirely new probe assembly? A modular probe offers these advantages (Figure 2). Of course, you want to be sure that the probe physically matches your scope, but today most scopes use BNC connectors, as do most probes.

Most oscilloscope manufacturers provide probes with the scopes. Be sure that what you have is not just the minimal probe to get by, nor an expensive one that is overrated for your needs. Most scope manufacturers sell accessories, such as probes, but you

should study the market before just purchasing their suggested replacement. Possibly consider a supplier that specializes in test accessories. They can most likely provide the parts quicker and at a lower cost than the scope's manufacturer. They may also have those unique accessories that suit your overall testing needs (Figure 3).

Good probes are not inexpensive. But the first time you waste four or five hours troubleshooting a problem that's masked by an incorrect probe, you've just wasted more than the cost of the best probe on the market. ■

**WATCH FOR**



**BUSINESS CORNER**

This exclusive monthly column will show you how to run your service operation more efficiently and profitably.

You'll learn about

- building customer satisfaction
- writing service contracts
- marketing your services



## To Order Back Issues

Send \$3.50 Per Issue (Check, Money Order, Mastercard, VISA, And AMEX).

Send All Correspondence To:

**CQ Communications**  
76 North Broadway  
Hicksville, NY 11801

Or Call  
**516-681-2922**  
FAX 516-681-2926

# Troubleshooting CD motor circuits

By Homer L. Davidson

Servicing compact disc player motor circuits can be made easier if you know what each motor does and what circuit controls the motor operation. You'll need an oscilloscope and a digital multimeter for servicing a CD player, but these are usually found on a technician's service bench (Figure 1). When trying to diagnose problems in RF, operation control and processor control circuits, the schematic diagram is a must.

As in any electronics troubleshooting, it's usually easiest to determine the cause of the problem when the product is completely dead. Intermittent operation, motor shut down or loop circuit malfunctions may be more difficult to service, and may require several more hours of service time. Motor malfunctions may be difficult to diagnose because of the variety of possible causes: the motor may be defective, it may be receiving improper applied and drive voltages, servo control and signal processing circuits may prevent the various motor operations.

## The various motors

A typical CD player has three motors. The tray or loading motor pushes out and pulls in the loading disc tray when the open/close switch is pushed. This dc loading motor reverses direction when the drive voltage applied to the motor terminals is reversed. Pressing the Open switch causes the tray loading mechanism to come out so the operator may load or unload a disc. Pressing the Close switch causes the loading tray to pull in to play.

Once the loading motor has moved the tray to its closed position, the disc or turntable motor rotates the disc to play it. This disc motor shaft is directly connected to the turntable or platform in which the disc is placed. The loading motor, on the other hand, may be belt



Figure 1. The oscilloscope, digital multimeter, capacitor tester and schematic diagram are required for servicing of CD players.

or gear driven. The disc motor is always mounted vertically, while the loading and slide motors may be mounted either vertically or horizontally. In top loading and portable CD

players, the disc is inserted and the door is closed manually, so there is no loading motor (Figure 2).

The slide or sled motor moves the laser pickup assembly to track the

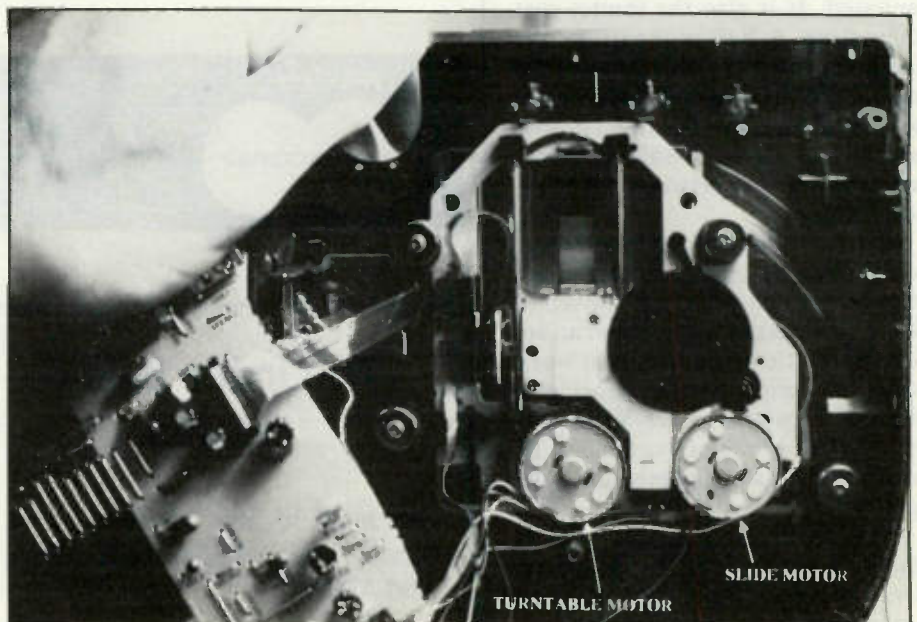

Figure 2. In top loading and portable compact disc players, only a disc and sled motors are found, as in this Sony portable. There is no loading motor.

Davidson is a TV servicing consultant for ES&T.



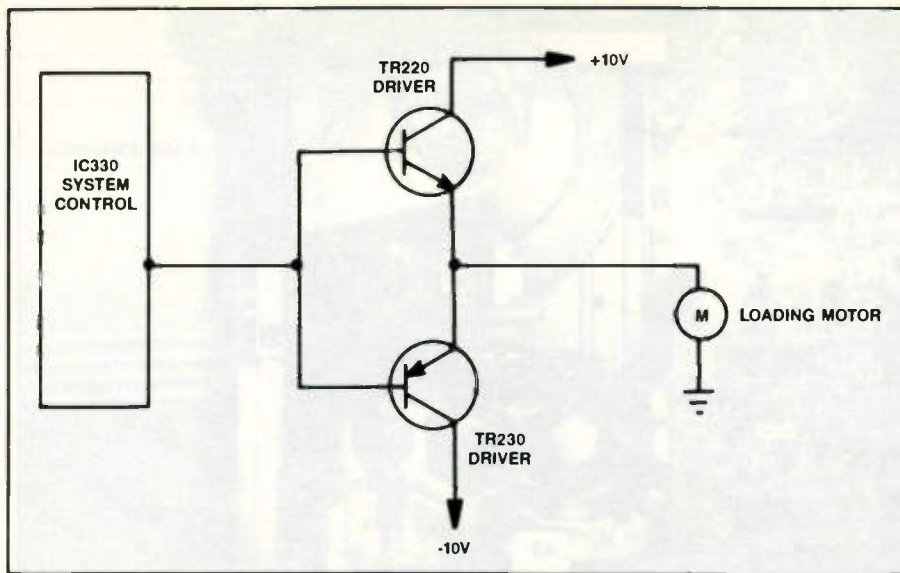

Figure 3. A typical transistor driver loading motor circuit.

digitally-encoded music on the disc. This motion is from the center to the outer rim of the revolving disc. This motor may drive the worm gear drive assembly via a rubber belt or directly through a set of gears. In some players, the slide or feed motor moves the laser pickup in an arc or radial motion across the CD. The slide motor may have a fast forward and reverse mode operation.

#### Safety precautions

There are some safety precautions that should be observed when you're servicing a CD player. Power line voltages are present, of course, but the laser beam adds an additional hazard to the technician. Never look directly at the laser beam while servicing the CD player. It could damage your eyesight. Keep a disc on the turntable at all times while you have the interlock defeated. Some technicians cover the laser diode with aluminum foil. Of

course you may observe the laser beam from a distance, to check the focus and tracking operation search upon the CD. But never look directly down on the open optical lens assembly. Remember, the optical lens assembly is located under the rotating disk. Protect your eyes.

#### The loading motor

The loading or tray motor, sometimes called the carriage motor, moves the CD tray in and out for loading and unloading the disc. The motor pulley may be belt or gear driven. Often the plastic tray is driven by a plastic gear box next to the tray assembly. At the same time, the loading gear may raise and lower the clamp assembly. The clamp assembly raises upward as the tray is loading. When the tray closes with the disc, the clamp assembly provides pressure on the CD, holding it in position.

The loading motor is controlled by

the system control IC, through a balanced driver transistor or IC components. Early CD players employed driver transistors, while you'll find loading driver IC circuits in the latest models as shown in Figure 3. When a motor fails to operate, or doesn't operate properly, in-circuit transistor tests and careful voltage checks of control circuits determine if the cause of the problem is a defective motor, transistor or signal processor.

Whenever you encounter a loading motor malfunction in a CD player that uses ICs, suspect a defective driver IC or system control IC if the motor checks normal. In the DC player shown in Figure 4, the open/close signal from the system control IC, IC301, controls the loading motor drive circuit. The control signal is applied to pins 5 and 6 of IC 301 with the output control voltage applied to the motor from terminals 2 and 10.

Check for voltage across the loading motor terminals when the open/close switch is engaged. Improper voltage at the motor may indicate a defective driver IC. Measure the voltage at supply terminal 8. Low or no voltage here may indicate a leaky driver IC or a defective low voltage source. The voltage polarity at the loading motor changes with open or closed positions (5V to 10V).

#### Spindle or turntable motor

The spindle, turntable or disc motor directly rotates the disc at a speed of 500rpm when the laser pickup is at the center, and slows to approximately 200rpm when the laser pickup is at the outer rim of the disc. The speed of rotation of the disc is continuously reduced in this manner as the laser pickup moves from the center to the outside edge of the disc so that the speed of the digital music information on the disc moves past the laser pickup at a constant linear velocity.

The disc motor is located directly under the clamp assembly. The vertically-mounted spindle motor spins the disc in the horizontal plane, while the laser pickup assembly is moved on rails from and to the turntable assembly (Figure 5).

The circuit that controls the spindle motor may consist of transistors and/or IC components. The spindle motor control circuit is a dc-operated CLV (constant linear velocity) motor circuit. Constant linear velocity means that the speed of the motor is constant-

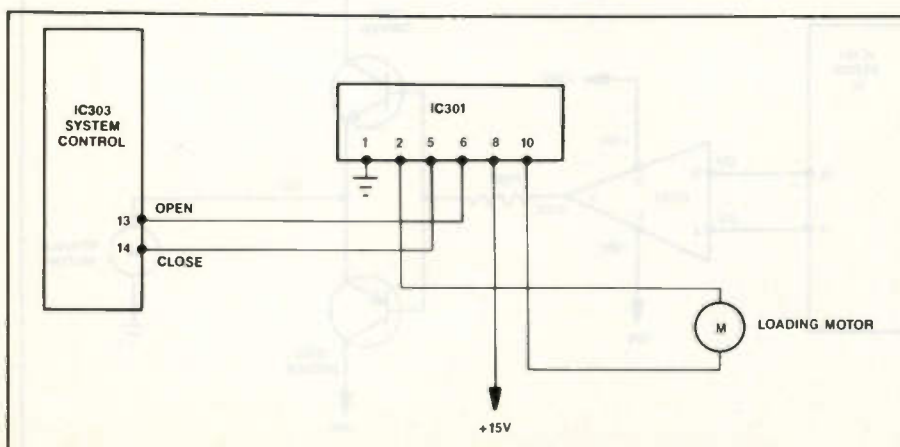

Figure 4. In the latest CD players, the loading motor may have an IC driver.

ly reduced as the pickup assembly travels on its rails from the center of the compact disc to the outside edge, such that the linear speed of the disc past the pickup always remains the same. The CLV system may consist of a PLL circuit for extracting clock signals for controlling the motor. The spindle motor may be driven from balanced transistors or IC driver circuits (Figure 6).

If the spindle motor fails to operate, check the motor continuity with the ohmmeter. If this value measures open, the motor is bad. If the motor appears to be sound, measure voltage applied to the spindle motor terminals. If there is no voltage, check transistors Q101 and Q102. Measure the dc voltage applied to each transistor. Suspect a leaky IC103 if voltage is low at pin 4 or 5. Determine if signal is present at pins 2 and 3 of IC103 when there is no disc movement. Remember, before the disc or turntable motor operates, RF signal must be present from the pickup assembly.

#### Sled motor

The sled motor (also called a slide, carriage or feed motor) moves the optical assembly across the disc from the inside to the outside rim of the CD. In older players, the feed motor moves the laser assembly in an arc or radial motion across the CD. Usually, this motor assembly, which slides the laser pickup assembly along two bars, is gear driven (Figure 7).

In some models, the sled motor shaft has a pulley that is connected by a belt to a pulley that drives a worm gear to slowly move the pickup assembly. The carriage, or optical assembly, will not move if the belt is broken or loose. If the optical assembly moves erratically, inspect the belt for cracks and oil spots. A gummed up track or poor meshing of gears is another possible cause of erratic movement. If you observe this problem in a CD you're servicing, clean off rails with alcohol and a lint-free cloth.

Monitor the voltage at the slide motor terminals. Check continuity of the motor with low ohm range of ohmmeter. Take voltage measurements at the pins of the sled driver IC or transistors. Check each transistor with in-circuit tests. Slide motor circuits are similar to the loading motor circuits. The slide or feed motor is found off to one side of the rail assembly.

You may have to remove the clamp

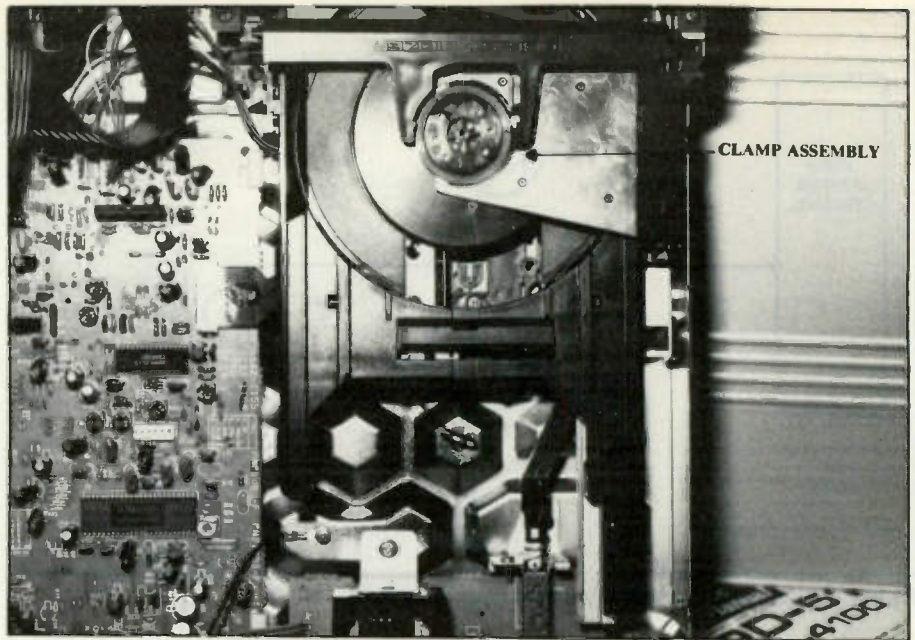

Figure 5. The spindle, turntable or disc motor is found under the clamp assembly in the CD player.

assembly to gain access to the feed motor. The carriage motor may be mounted upon a motor base with a small pulley. Some feed motors are mounted directly to the metal chassis. Check the motor pulley, worm gear and track assembly for erratic or no pickup movement.

#### Mechanical or electronic problems

Other possible causes of erratic operation of the tray or loading motor are lack of adequate lubrication of the plastic track or a dirty spring switch. A dirty or worn close/open or tray switch may cause the tray to open and not close. Broken plastic teeth or foreign objects within the track assembly may clog up the movement of the

tray. Clean off all leaf switches with alcohol and a cleaning swab, then slide a piece of cardboard back and forth between switch contacts. This may burnish the contacts.

Inspect the worm gear of the slide motor assembly for gummed up oil and dirt accumulation. Notice if the plastic feed motor gear has broken or worn teeth. Check the rail assembly for dry or corroded spots. Clean the assembly with alcohol and cleaning fluid, then wipe it with an oily cloth. Clean up the worm gear drive belt with alcohol and replace if it's cracked or shows signs of slipping.

The spindle is directly driven with-

*(continued on page 37)*

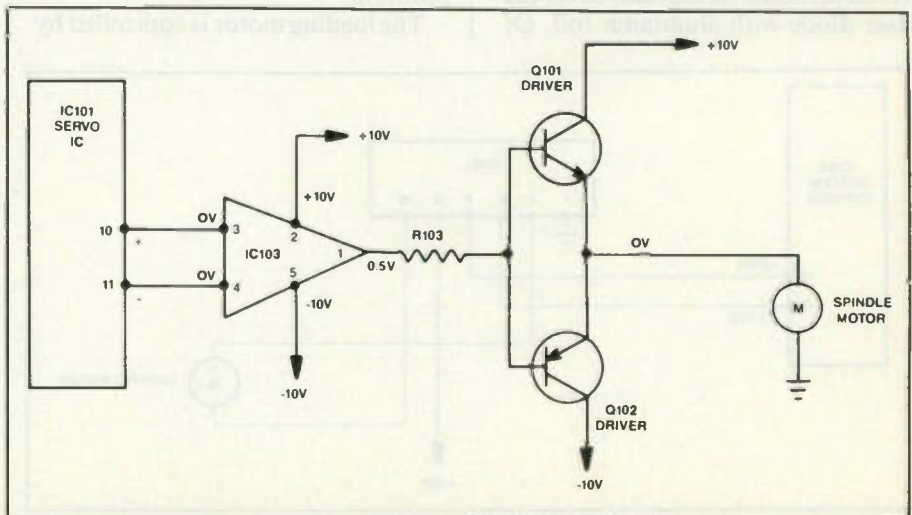

Figure 6. Typical block diagram of a spindle, turntable or disc motor dc drive circuit.

JUNE 1992

**Profax Number**

**HITACHI**  
VT-M231A/M240A/M241A/M240AW No. 3265E VCR .....3089

**SYSTEM CONTROL SCHEMATIC DIAGRAM**

Product safety should be considered when component replacement is made in any area of an electronics product. A star next to a component symbol number designates components in which safety is of special significance. It is recommended that only exact cataloged parts be used for replacement of these components.

Use of substitute replacement parts that do not have the same safety characteristics as recommended in factory service information may create shock, fire, excessive x-radiation or other hazards.

This schematic is for the use of qualified technicians only. This instrument contains no user-serviceable parts.

The other portions of this schematic may be found on other Profax pages.

**SYSTEM CONTROL SCHEMATIC DIAGRAM**

This schematic is for the use of qualified technicians only. This instrument contains no user-serviceable parts.

The other portions of this schematic may be found on other Profax pages.

All integrated circuits and many other semiconductors are electrostatically sensitive and require special handling techniques.

Product safety should be considered when component replacement is made in any area of an electronics product. A star next to a component symbol number designates components in which safety is of special significance. It is recommended that only exact cataloged parts be used for replacement of these components.

Use of substitute replacement parts that do not have the same safety characteristics as recommended in factory service information may create shock, fire, excessive x-radiation or other hazards.

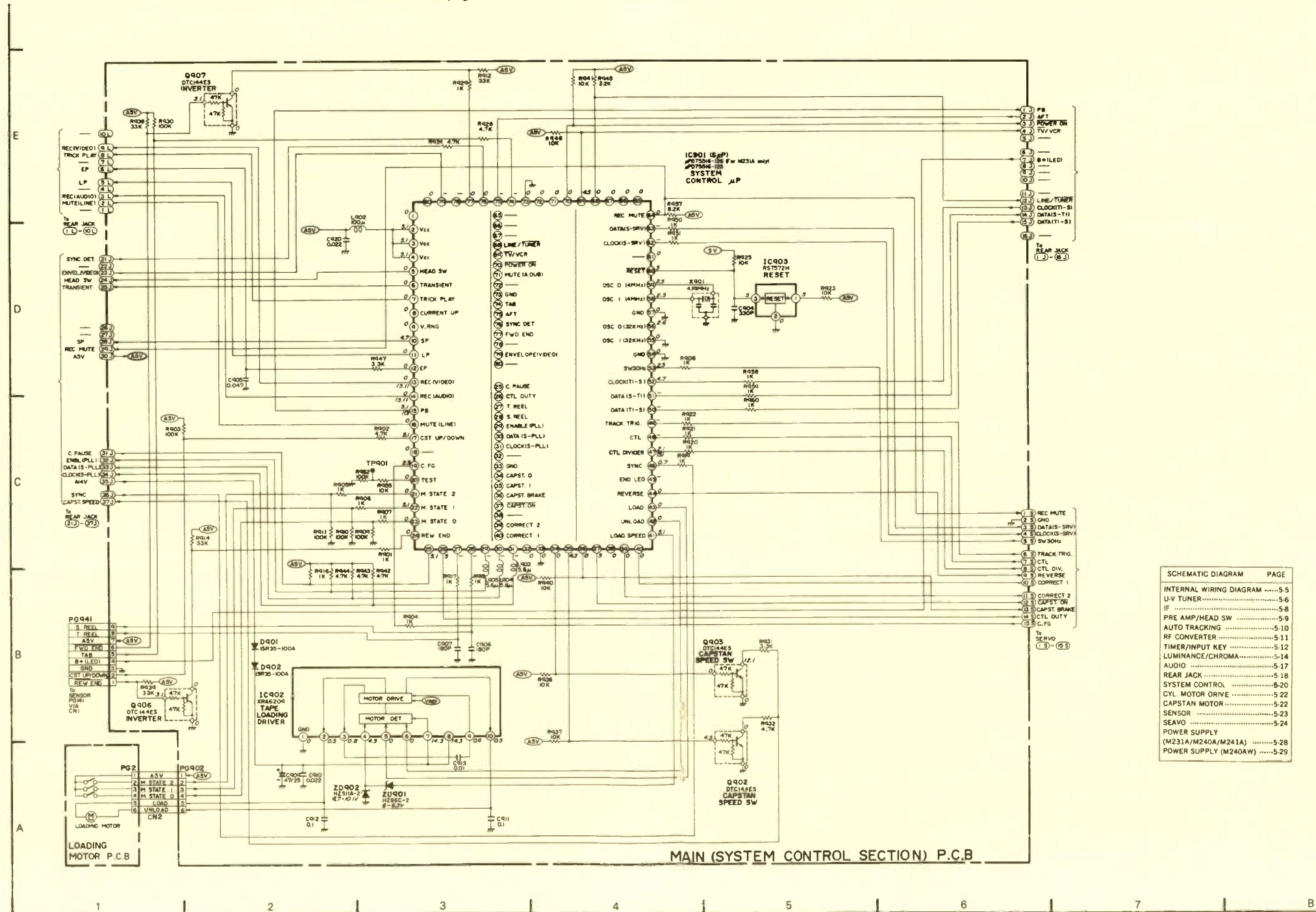

SCHEMATIC DIAGRAM	PAGE
INTERNAL WIRING DIAGRAM	5-5
U-V TUNER	5-6
IF	5-8
PRE AMP/HEAD SW	5-9
AUTO TRACKING	5-10
RF CONVERTER	5-11
TIMER/INPUT KEY	5-12
LUMINANCE/CHROMA	5-14
AUDIO	5-17
REAR JACK	5-18
SYSTEM CONTROL	5-20
CYL MOTOR DRIVE	5-22
CAPSTAN MOTOR	5-22
SENSOR	5-23
SEAVO	5-24
POWER SUPPLY (M231A/M240A/M241A)	5-28
POWER SUPPLY (M240AW)	5-29

LUMINANCE/CHROMA SCHEMATIC DIAGRAM

Product safety should be considered when component replacement is made in any area of an electronics product. A star next to a component symbol number designates components in which safety is of special significance. It is recommended that only exact cataloged parts be used for replacement of these components.

Use of substitute replacement parts that do not have the same safety characteristics as recommended in factory service information may create shock, fire, excessive x-radiation or other hazards.

This schematic is for the use of qualified technicians only. This instrument contains no user-serviceable parts.

The other portions of this schematic may be found on other Profax pages.

All integrated circuits and many other semiconductors are electrostatically sensitive and require special handling techniques.

LUMINANCE/CHROMA SCHEMATIC DIAGRAM

Product safety should be considered when component replacement is made in any area of an electronics product. A star next to a component symbol number designates components in which safety is of special significance. It is recommended that only exact cataloged parts be used for replacement of these components.

Use of substitute replacement parts that do not have the same safety characteristics as recommended in factory service information may create shock, fire, excessive x-radiation or other hazards.

This schematic is for the use of qualified technicians only. This instrument contains no user-serviceable parts.

The other portions of this schematic may be found on other Profax pages.

All integrated circuits and many other semiconductors are electrostatically sensitive and require special handling techniques.

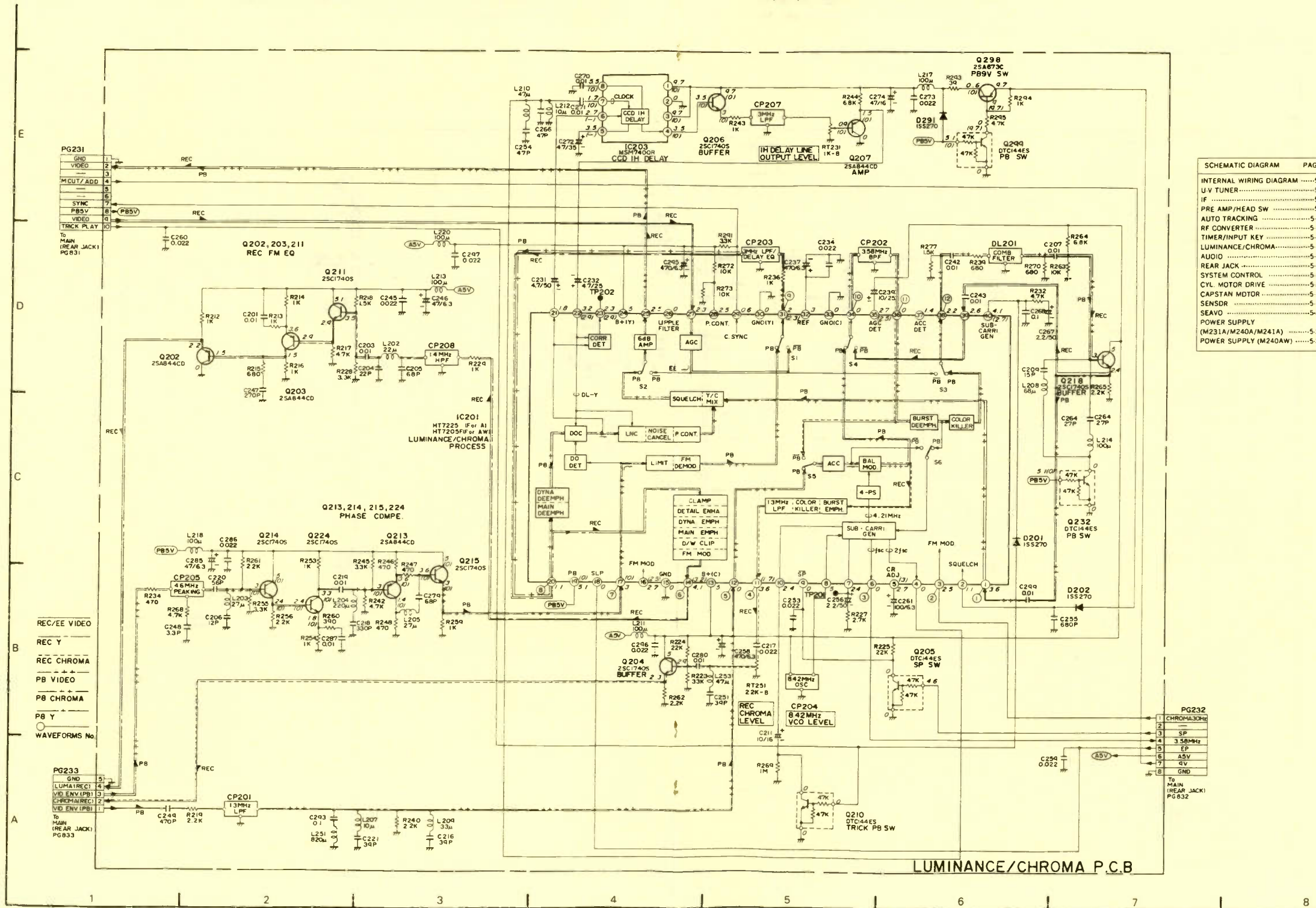

SERVO SCHEMATIC DIAGRAM

Product safety should be considered when component replacement is made in any area of an electronics product. A star next to a component symbol number designates components in which safety is of special significance. It is recommended that only exact cataloged parts be used for replacement of these components.

Use of substitute replacement parts that do not have the same safety characteristics as recommended in factory service information may create shock, fire, excessive x-radiation or other hazards.

This schematic is for the use of qualified technicians only. This instrument contains no user-serviceable parts.

The other portions of this schematic may be found on other Profax pages.

All integrated circuits and many other semiconductors are electrostatically sensitive and require special handling techniques.

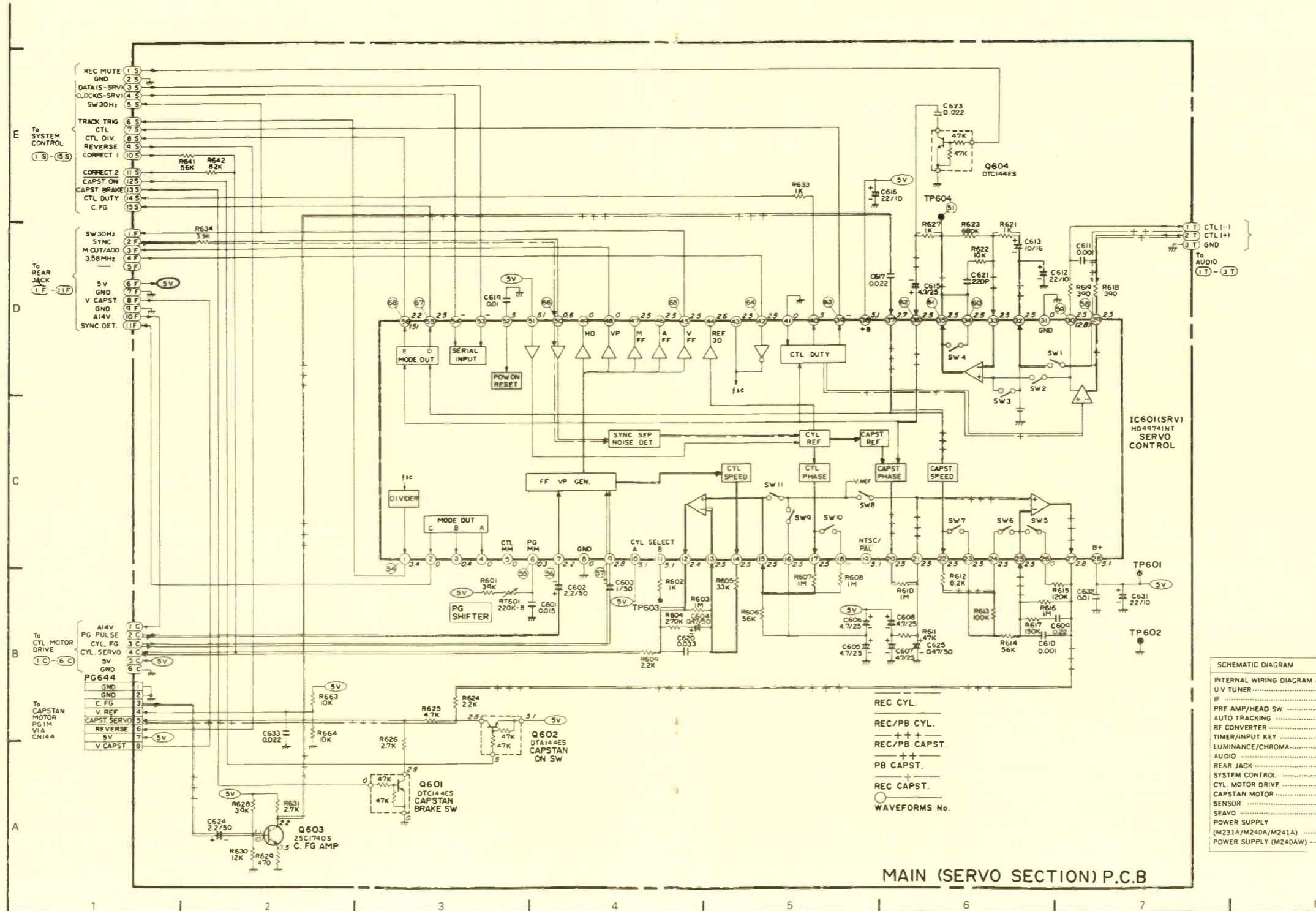

SERVO SCHEMATIC DIAGRAM

Product safety should be considered when component replacement is made in any area of an electronics product. A star next to a component symbol number designates components in which safety is of special significance. It is recommended that only exact cataloged parts be used for replacement of these components.

Use of substitute replacement parts that do not have the same safety characteristics as recommended in factory service information may create shock, fire, excessive x-radiation or other hazards.

This schematic is for the use of qualified technicians only. This instrument contains no user-serviceable parts.

The other portions of this schematic may be found on other Profax pages.

All integrated circuits and many other semiconductors are electrostatically sensitive and require special handling techniques.

HITACHI  
VT-M231A/M240A/  
M241A/M240AW  
NO. 3265E VCR

JUNE 1992

Product safety should be considered when component replacement is made in any area of an electronics product. A star next to a component symbol number designates components in which safety is of special significance. It is recommended that only exact cataloged parts be used for replacement of these components.

Use of substitute replacement parts that do not have the same safety characteristics as recommended in factory service information may create shock, fire, excessive x-radiation or other hazards.

This schematic is for the use of qualified technicians only. This instrument contains no user-serviceable parts.

The other portions of this schematic may be found on other Profax pages.

All integrated circuits and many other semiconductors are electrostatically sensitive and require special handling techniques.

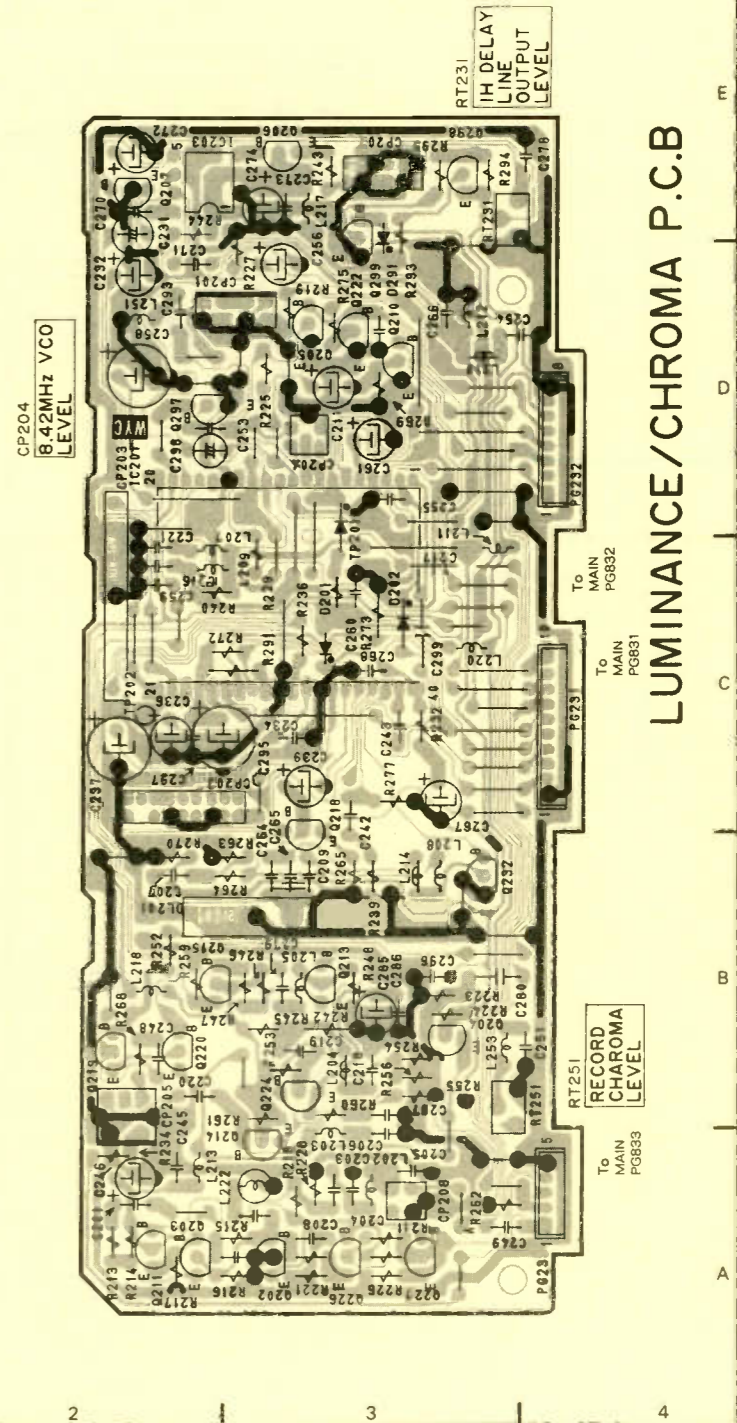
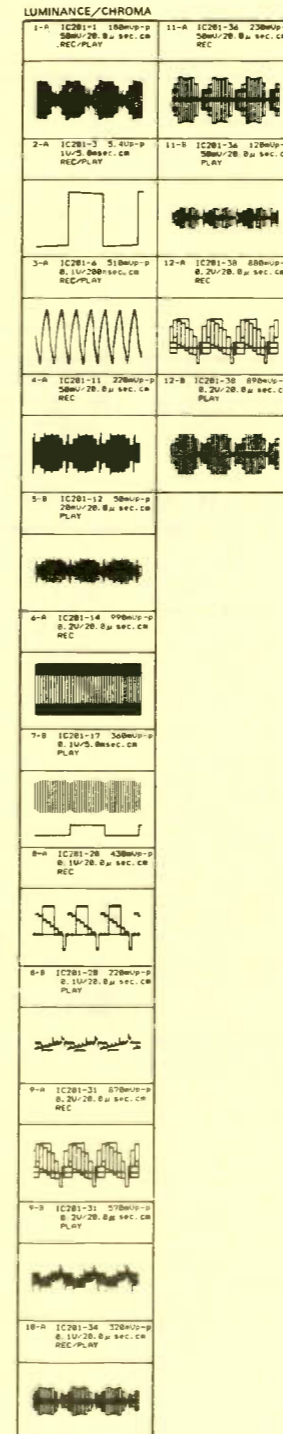
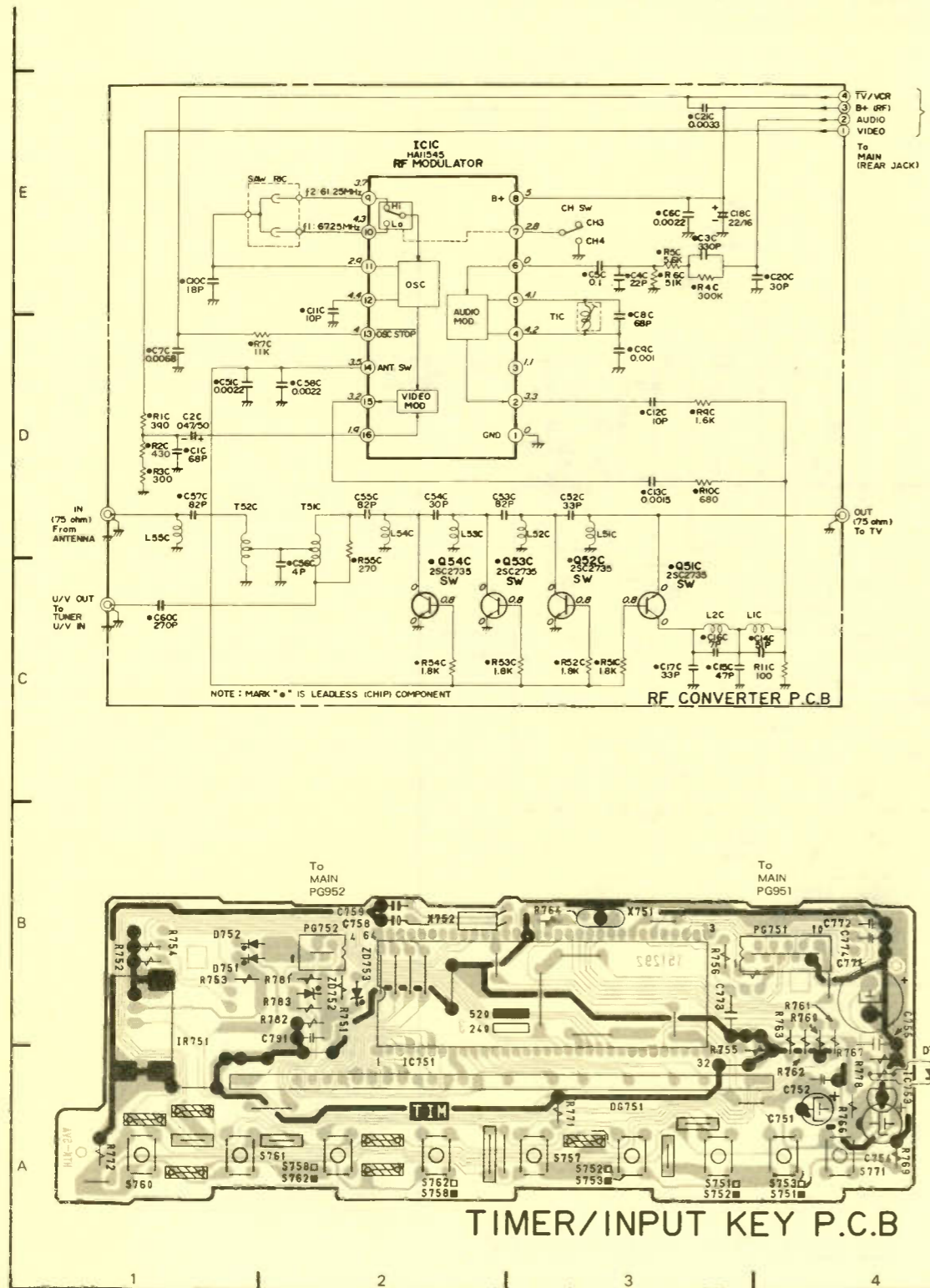

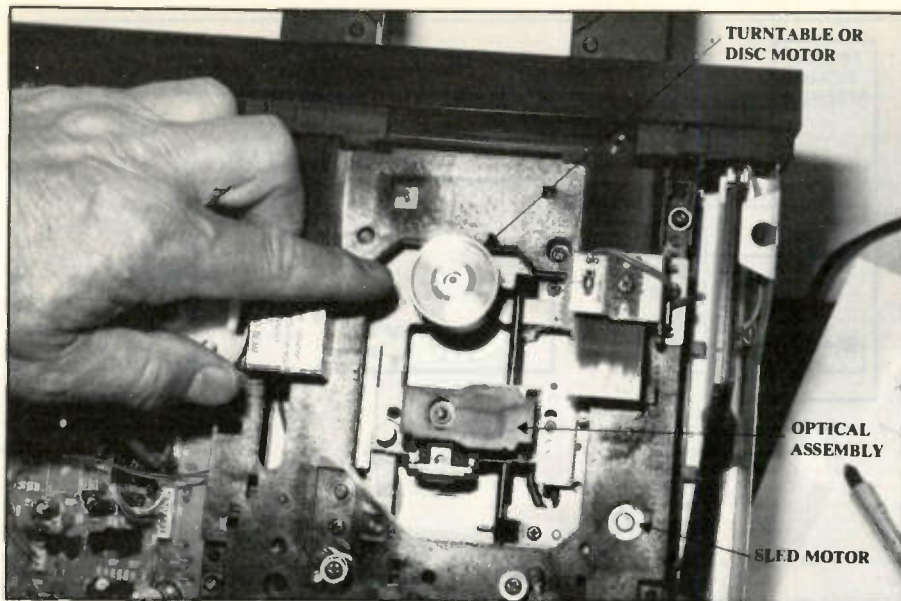

Figure 7. The slide or carriage motor is located to the side of the pickup optical assembly and the turntable motor at the other end in this Sanyo CP-500 CD player.

out any pulleys or belts. Erratic motion or slowing down of the spindle motor may indicate a defective motor, driver IC or signal processor. If this is a portable or top loading CD player, do not overlook the possibility that the problem is caused by a dry or sluggish keeper assembly that presses against the disc.

**Dead, no movement**

One Realistic CK-3000 CD player would operate on batteries but not from the power line. I checked all silicon diodes in the power supply in-circuit. Diode D903 was leaky, so I replaced it (Figure 8). When I turned the unit back on, both D903 and D904

became warm.

Upon checking the regulator circuits, I found Q901 leaky and Q902, Q903 and Q904 were normal. I replaced Q901 with a 25D1406Y transistor. While Q901 was out of the circuit, I tested C903 and D905. D905 was leaky so I replaced it. Sometimes, when leaky or shorted diodes are found, the primary of the transformer may be open. Always check the power transformer windings before giving an estimate or ordering parts.

**Intermittent loading**

Sometimes the tray would come out and other times the tray would stay out and not return when the open/close

switch was engaged in a Pioneer PD-7010 CD player. At first I suspected that the tray assembly was binding, or that a foreign object might be preventing movement of the loading tray. Cleaning up the tray assembly did not help, however.

Next I cleaned the motor belt with alcohol and cloth and checked to make sure it was still sound. There was no slippage between the motor pulley and gear assembly. The dc motor operated normally when voltage was present.

I then considered the possibility that the close and open switch was dirty. When I applied extra pressure to the switch button, the tray moved each time. I sprayed cleaning fluid down into the open/close switch assembly. Now, the tray would open and close with only normal pressure on each operation. Excessively dirty or malfunctioning leaf and contact switches should be removed and thoroughly cleaned, and, if necessary, replaced.

**Turntable rotates then stops**

The turntable motor would start to rotate and then quit in an Alpine 5900 auto CD player. I noticed that the laser focus-tracking assembly was hunting. The loading motor would load and unload. Sound was heard for a few seconds. This indicated the power supply and mechanical control processors were functioning.

Although both the turntable and loading motors are fed from the same mechanism control, IC508, the loading motor is controlled by a dc voltage while the turntable motor is controlled by an RF signal.

Since the disc motor would operate for a few seconds and then shut down, I decided to monitor the RF signal after the RF amplifier. I connected the scope to TP (RF), out of pin 3 at RF amp/signal processor IC 652 (Figure 9). I started the player and momentarily observed a weak RF signal before the player stopped. Again, the unit was started with the same results.

Either IC652 was defective, or the power supply was defective, or the signal from the optical pickup assembly was incorrect. I checked the signals at pins 5 and 6 of IC652 in turn on the oscilloscope, and observed a noisy signal which would then disappear.

I held an infrared indicator in front of the laser beam and did see light, which indicated that signal was pres-

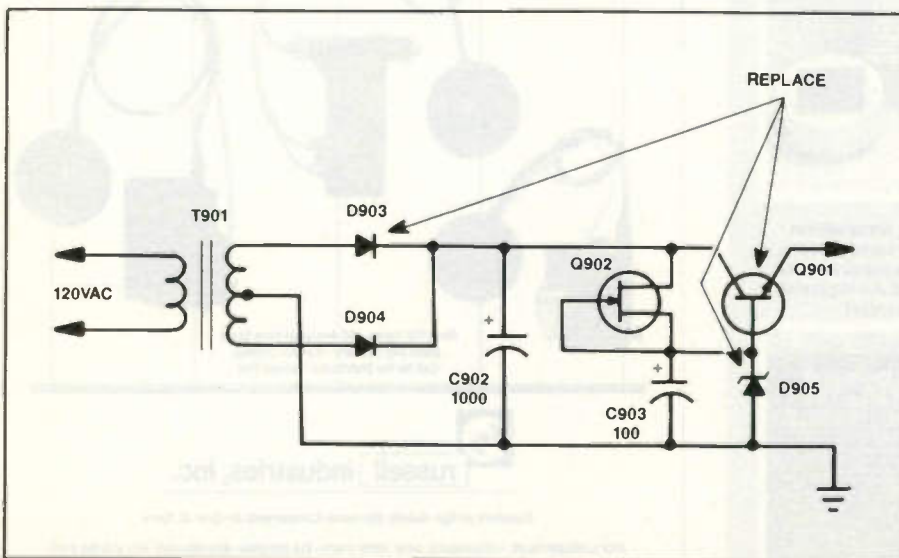

Figure 8. Silicon diode D903, transistors Q902 and Q901, and zener diode D905 were found defective in the low voltage power supply of a Realistic CK-3000 CD player.

ent. I could not determine if the signal was of the correct intensity, however, as I did not have an infrared light meter. I assumed that because the diodes in the pickup head did emit infrared they were normal.

Supply voltage (+ 5.2V) at pins 24 and 25 were normal. Voltages at pins 1, 21 and 22 were not. Close visual inspection of the solder joints at the pins of IC652 revealed that at some time it had been replaced. It was possible that IC652 had been damaged during replacement.

I ordered a replacement for IC652, a CX20109 RF Amp/Signal Processor. When the replacement arrived, I carefully soldered it in place. When I turned the unit on, the CD player played continuously without shut down. A check with the scope showed that the RF eye pattern at the test point (TP) and pin 3 was normal.

### Conclusion

When a CD motor fails to operate, use voltage and continuity tests to determine if the problem is in the motor or the drive circuits. Scope the mechanism and servo control processors for correct drive signals.

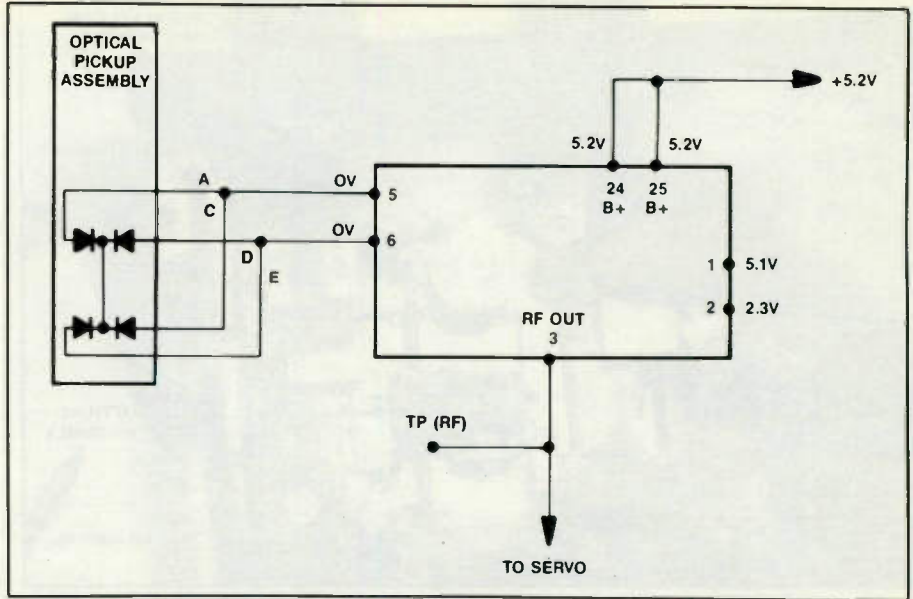

Figure 9. A defective RF amp/signal processor (IC652) in an Alpine 5900 auto CD player caused intermittent shutdown.

If a defective motor has to be replaced, use an exact replacement. Check the polarity of motor wires before soldering. Replace the motor pulley or turntable at the exact same height as the old one. If the disc or turntable motors are not installed at

the correct height, you may end up with a weak eye pattern. Some motors have spacers provided for exact pulley mounting. Do not apply too much pressure on mounting screws of disc motor to prevent diminished eye patterns. ■

## MCM Proudly Introduces New Caig Laboratories Lubricants, Cleaners and Preservatives.

New

**CAIG**  
LABORATORIES, INC.



Caig Laboratories has been manufacturing quality lubricants, preservatives and cleaners since 1956. Caig's popular Cacon and Cramolin-based products are used extensively in the lubrication, preservation and cleaning of all metal contacts... Including gold! Caig's newest line of reformulated and improved sprays, pastes, wipes and lubricants are available from MCM today!

Call MCM today for high-quality problem solving service aids!

For more information and a FREE catalog, Call Toll-Free 1-800-543-4330 or FAX 1-513-434-6959



**MCM ELECTRONICS**  
650 CONGRESS PARK DR.  
CENTERVILLE, OH 45459-4072  
A PREMIER Company



SOURCE NO. ES-66

## The Industry's Most Complete Line of Flyback Transformers.

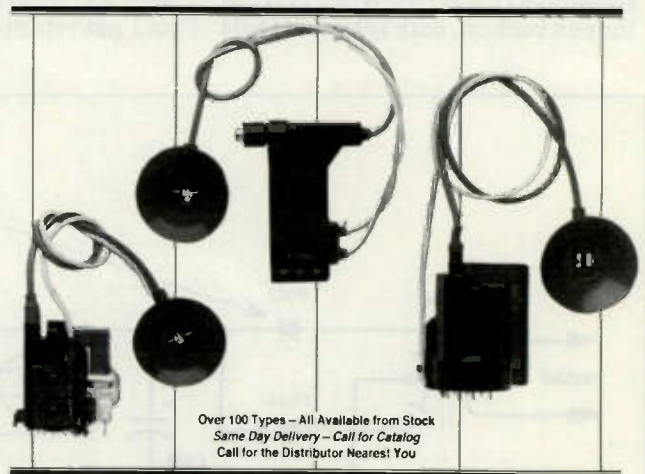

Over 100 Types - All Available from Stock  
Same Day Delivery - Call for Catalog  
Call for the Distributor Nearest You



A DIVISION OF

**russell industries, inc.**

Suppliers of High Quality Electronic Components for Over 30 Years

3000 LAWSON BLVD. • OCEANSIDE, NEW YORK 11572 • 516-536-5000 • 800-645-2202 • FAX 516-764-5747





**LAN system tester**

Beckman Industrial has introduced the TMT-10 Signal Injector for Local Area Network and Telecommunication wiring system certification. The TMT-10 provides accurate system testing for both unshielded twisted pair LAN and TELECOM Wiring Systems. The unit indicates whether a twisted or flat pair cabling system will serve as an efficient, effective data transmission media. It also allows user testing of the twisted pair cable on the spool prior to installation, and also performs a comprehensive six function test complete with certification printout on the cabling system once it is installed.

Circle (30) on Reply Card

**AC/DC current transducer**  
Amprobe Instruments introduces



the model CT 600 ac/dc. The CT 600 when used in conjunction with a digital volt meter (DVM) will measure ac and dc current up to 600 amps. Features include coil/cord with output banana plugs, function/range select switch, dc zero adjust knob, overload protection; 800 amps ac/dc and frequency response; ac 40-400Hz.

Circle (31) on Reply Card

**Fume extractor**

Pace Inc. introduces the new MINI-2 Fume Extractor which removes harmful and irritating fumes from the work environment. This portable system has a powerful 1000 watt motor and a specially designed combination filter which houses both

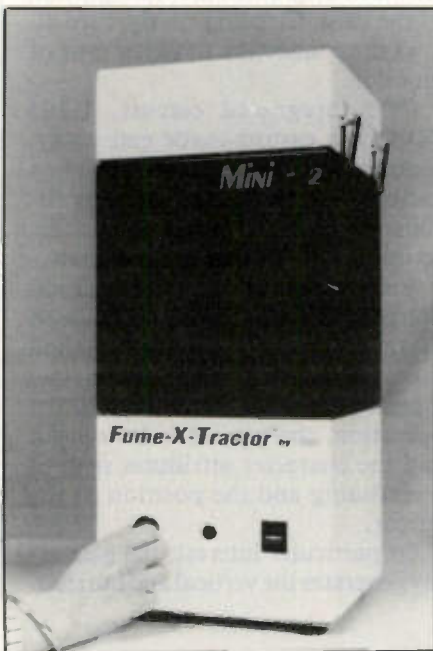

HEPA and carbon elements. Filter condition is constantly monitored and a warning light will indicate when a filter change is required. The MINI-2 is designed for applications requiring intermittent use such as field service or research and development facilities. The MINI-2 is supplied with quick-fit inlet ports which allow easy attachment of up to extractor arms.

Circle (35) on Reply Card

**Ionizer tester**

The Ionizer Tester from Chapman is a hand held charge plate monitor



which gives a quick, reliable evaluation of ionizer performance at the work bench, without removing the ionizer for extensive laboratory evaluation. The unit includes a case with belt loop, grounding cord, and instructions.

Circle (36) on Reply Card

**Modular BNC test lead kit**

Probe Master Inc. has developed a test lead kit containing a unique universal test lead with 9 plug-in accessories. This kit is a new concept that allows the technical user to select any number of accessories and snap them together for accessing difficult to reach high density circuitry. For exam-



ple IC's wire-wrap pins, terminals and other miniature components. The kit is optionally available in several lengths of RG58C/U or RG174/U shielded cable from 24" to 72". Plug-in accessory leads are 6" long with gold plated male pins.

Circle (37) on Reply Card

# Working with microcomputer display technology

## Part Two—Hercules and RGBI Displays

By John Ross

A previous article described how video display technology for microcomputers has progressed from monochrome-only displays to displays that show an infinite number of colors. Many of the "older" video display adapters and monitors are still in use. This article will discuss Hercules and RGBI monitor and video card operation.

### Signals from the adapter card

In many instances, a single video adapter card can provide the signals needed for either Hercules or RGBI video. The ZVM-1240 Hercules monitor used as an example in this article arrived as a part of a larger Zenith system package. Most 8088-based Z-159 microcomputers included a combination video/floppy controller card.

Figure 1 is a layout diagram of this

Ross is a technical writer and a microcomputer consultant for Ft. Hayes State University, Hays KS.

complete card. The integrated circuits used for video signal operations are marked. Figure 2 is a schematic diagram of the video circuitry. Figure 3 is a block diagram of the video portion of the card. Circuitry on the card allows the connection of either type of monitor.

One integrated circuit, U205 (PVC2), a custom-made gate array, contains both the video mode registers and the video mode compatibility circuits. Figure 2 lists the pin-outs and descriptions of the gate array signals.

Video mode registers hold information needed for displaying an image on the face of the CRT. That information involves selecting the appropriate memory for either Hercules or RGBI operation, the type of video output and the character attributes such as underlining and the position of the cursor.

Of particular interest, the gate array generates the vertical and horizon-

tal drive signals for the monitor. The vertical output signal from the gate array depends on an input signal labeled as the CMNTR or color monitor signal (pin 26). (See Figure 4).

If the CMNTR signal has a digital low status, the vertical signal also has a low status and produces sixteen horizontal scan periods. A digital high CMNTR signal causes the vertical signal to go high and produce only three horizontal scan periods. Likewise, the status of the CMNTR signal determines the pulse width of the horizontal drive signal outputted from the gate array.

Ultimately, the CMNTR signal depends on the state of another input signal called the CPUAD signal (pin 15). A combination of high CPUAD and a low CMNTR signals indicates the connection of a monochrome monitor. With both signals high, a color monitor is attached to the microcomputer.

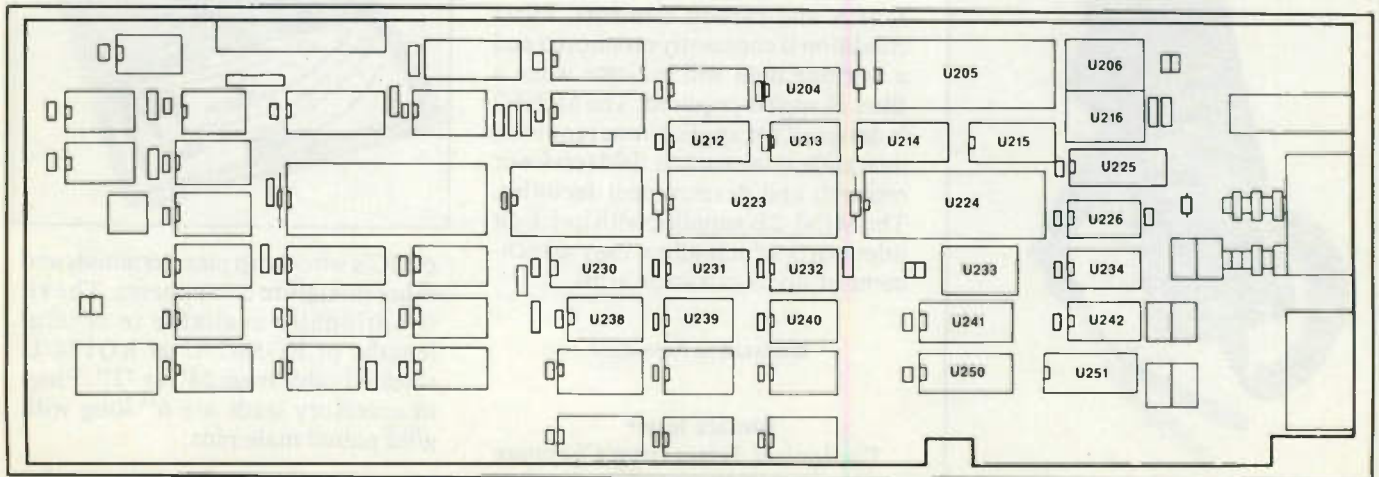

Figure 1. Component layout for the floppy video controller card.

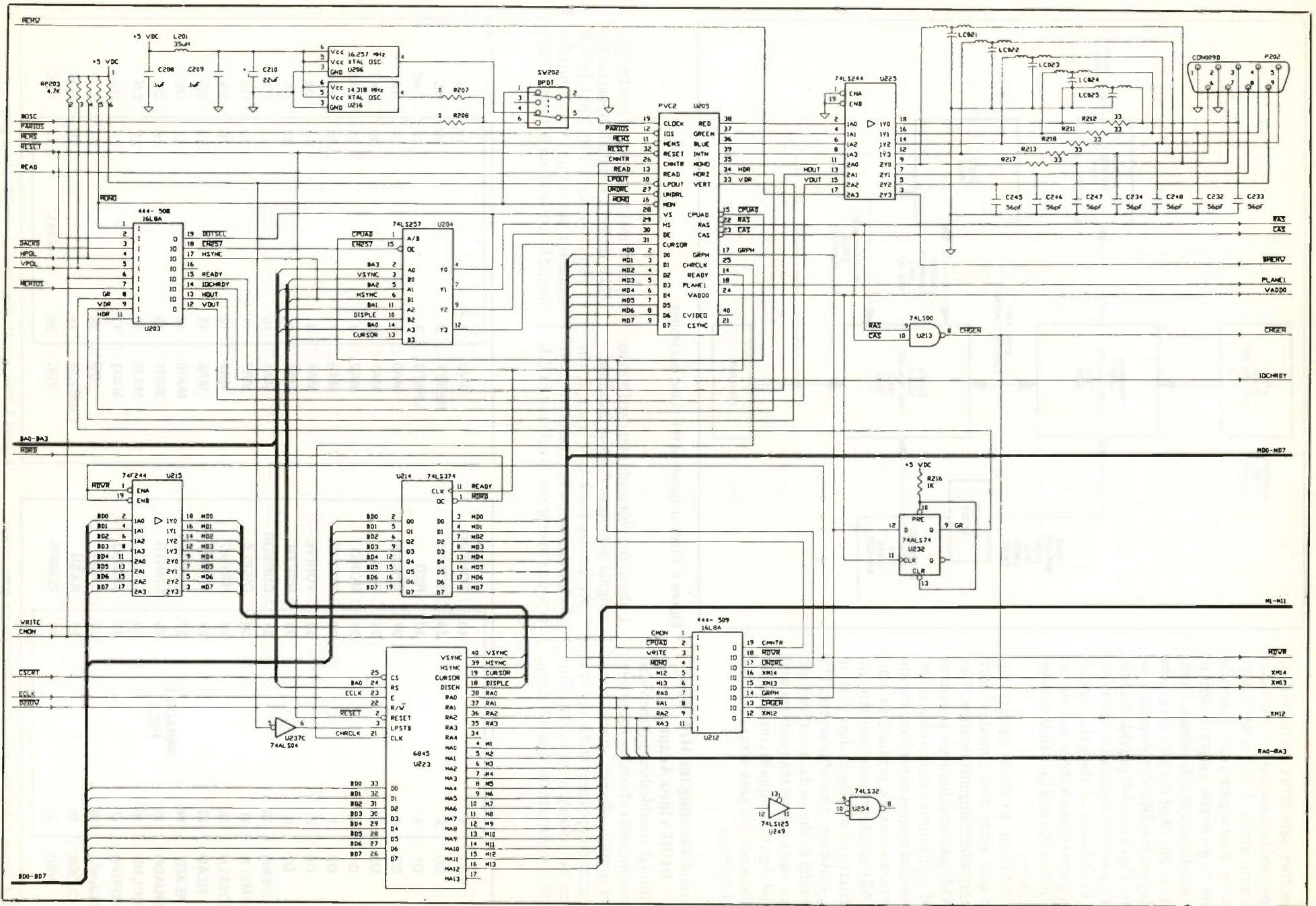

Figure 2. Schematic drawing of the floppy/video controller card video circuitry.

Another gate array on the video/floppy card acts as a raster controller. This gate array, U223 (6845), also known as a slave gate array, shown in Figure 5, generates cursor position, sync and display enable signals. Coming from pin 18 of the gate array, the display enable (DE) signal updates the screen. Pins 39 and 40 provide the horizontal and sync signals for the monitor. Processing of the sync signals takes place through input and output multiplexer ICs and the primary video gate array.

In addition to those signals, the slave gate array also contains video memory addressing information. Two DRAMs and one character generator ROM temporarily store video information that arrives either from the microprocessor or the primary gate array. All this information translates into patterns of displayed dots that, in turn, make up video characters. The remainder of the card consists of logic arrays and various transceivers and multiplexers that support communication between the gate arrays and the video memory.

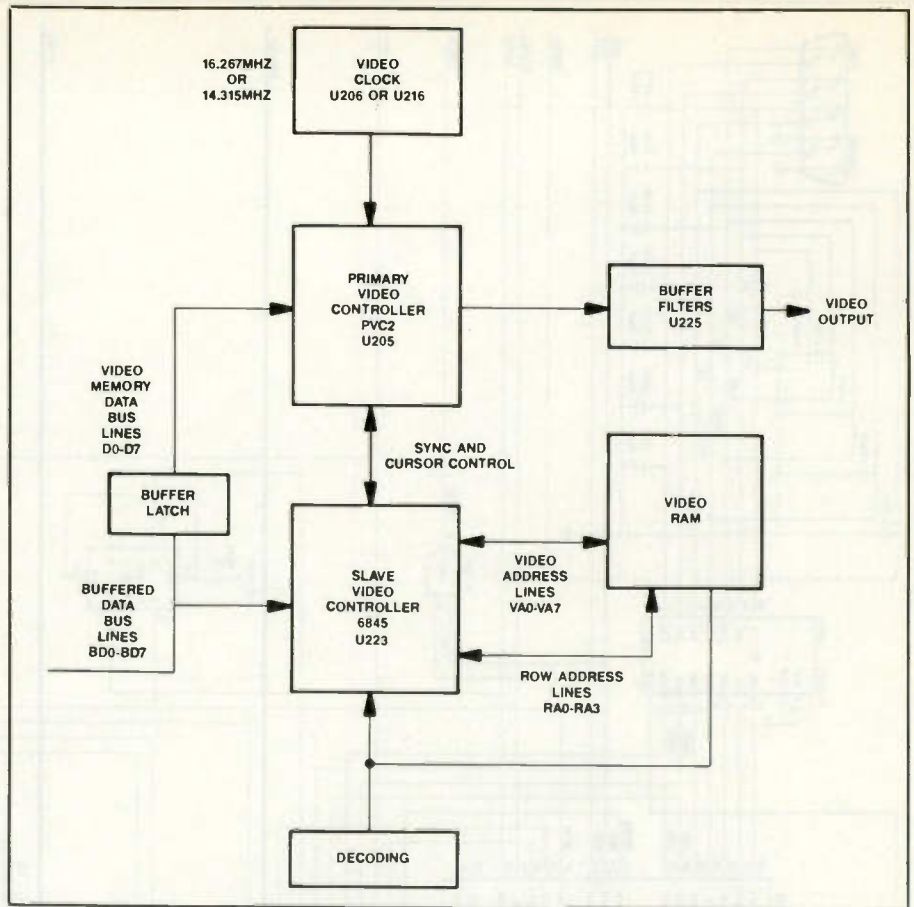

Figure 3. Block diagram of the video controller

### Troubleshooting the Hercules/ RGBI Video Adapter

Although troubleshooting the video adapter includes checking for proper power supply voltages, shorts, burned or open components and leaky electrolytic capacitors, most of the effort should concentrate on signal tracing.

Indeed, the video adapter card acts as a signal generator for the monitor.

Referring back to Figure 2, the clock signals must be present for proper video operation. While the ECLK

signal shows at pin 23 of multiplexer U223, the BCLK signal appears at pin 11 of multiplexer U240. The CLOCK signal for the entire video controller should be active at pin B20 of the video

VDD	1	40	COMPVD
D0	2	39	INTENS
D1	3	38	RED
D2	4	37	GREEN
D3	5	36	BLUE
D4	6	35	MONO
D5	7	34	HDRIVE
D6	8	33	VDRIVE
D7	9	32	RSETN
LPENN	10	31	CURSOR
MEMSLN	11	30	DISPLE
IOSELN	12	29	HSYNC
READ	13	28	VSYSN
READY	14	27	ROW12N
CPUADN	15	26	CMNTR
COLMD	16	25	CHRCLK
GRPHVD	17	24	VADDO
PLANE1	18	23	CASN
CLOCK	19	22	RASN
VSS	20	21	COMPS

PARADISE  
PVC2

GND	1	40	VS
RESET	2	39	HS
LPSTB	3	38	RA0
MA0	4	37	RA1
MA1	5	36	RA2
MA2	6	35	RA3
MA3	7	34	RA4
MA4	8	33	D0
MA5	9	32	D1
MA6	10	31	D2
MA7	11	30	D3
MA8	12	29	D4
MA9	13	28	D5
MA10	14	27	D6
MA11	15	26	D7
MA12	16	25	CS
MA13	17	24	RS
DE	18	23	E
CURSOR	19	22	R/W
VCC	20	21	CLK

6845

Figure 4. Pin-outs for the video controller primary gate array.

Figure 5. Pin-outs for the video controller slave gate array.

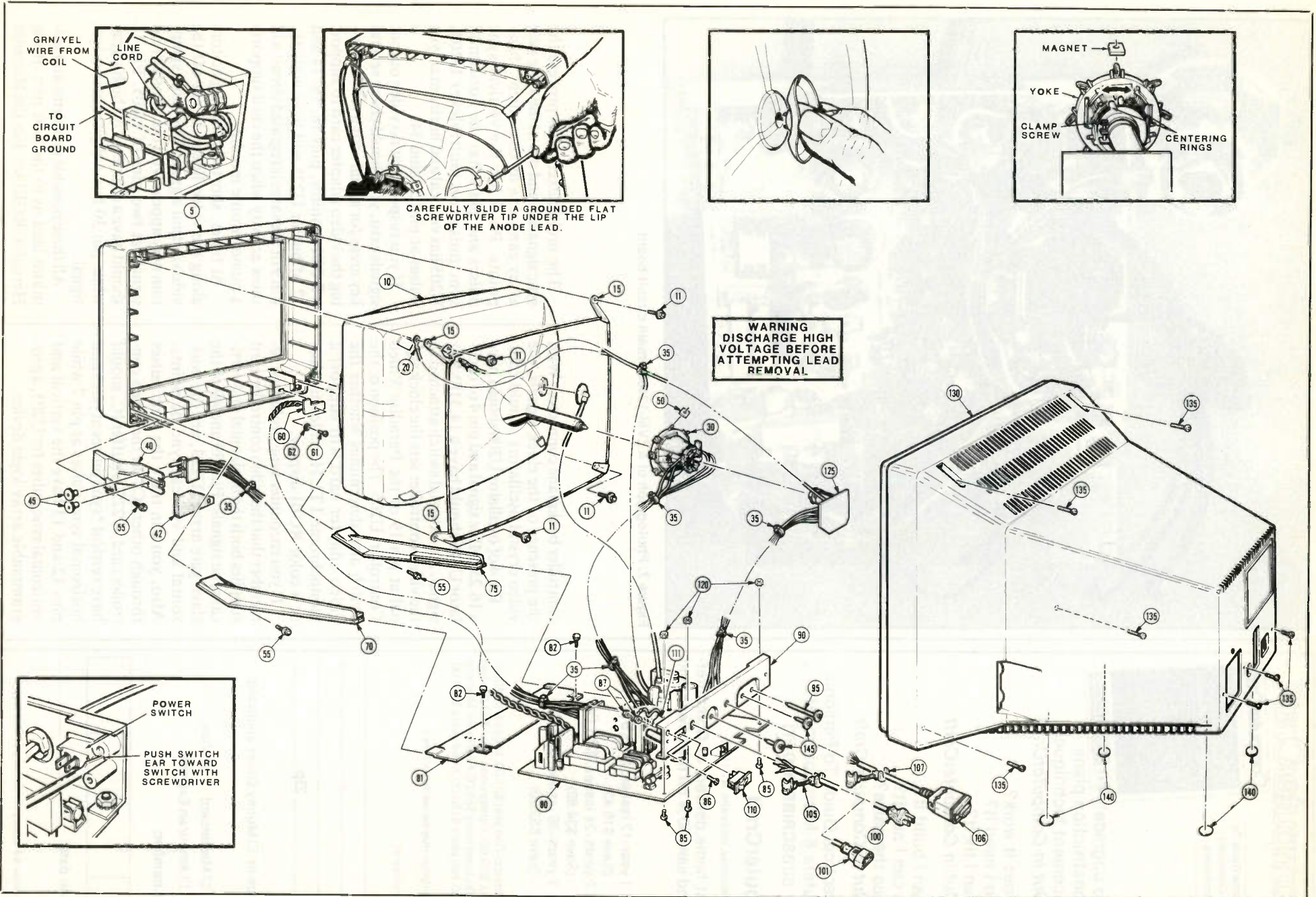

Figure 6. Exploded view of a Zenith data systems ZVM-1240 Hercules monitors.

# ComputerCraft

The Practical Guide To  
Personal Computers  
& Microcontrollers



How to upgrade!  
Full construction plans  
Enhancement techniques  
Find Out in ComputerCraft

How does it work?  
Why do I need it?  
How can I fix it?  
Find Out in ComputerCraft

How can I build it?  
Where can I buy it?  
Who has the parts?  
Find Out in ComputerCraft

The Practical Guide To Personal  
Computers & Microcontrollers  
**SUBSCRIBE TODAY!**

## ComputerCraft

76 North Broadway, Hicksville, NY 11801

Get fast home delivery of Computer-Craft and save 50% on the newsstand price!

- 1 year-12 issues: \$18.97  
(Save \$16.43)
- 2 years-24 issues: \$36.00  
(Save \$34.80)
- 3 years-36 issues: \$53.00  
(Save \$53.20)

Canada/Mexico-One year \$21.00, two years \$40.00, three years \$59.00; Foreign-one year \$23.00, two years \$44.00, three years \$65.00. Foreign Air Mail-one year \$76.00, two years \$150.00, three years \$224.00.

(Your subscription may be tax deductible.)

(Please print clearly)

Name \_\_\_\_\_  
Street \_\_\_\_\_  
City \_\_\_\_\_  
State \_\_\_\_\_ Zip \_\_\_\_\_

Check or  Money Order enclosed

Bill to  Mastercard  Visa  
 American Express

Account number:

--	--	--	--

Expiration date: \_\_\_\_\_

Note: Allow 6-8 weeks for delivery of first issue.

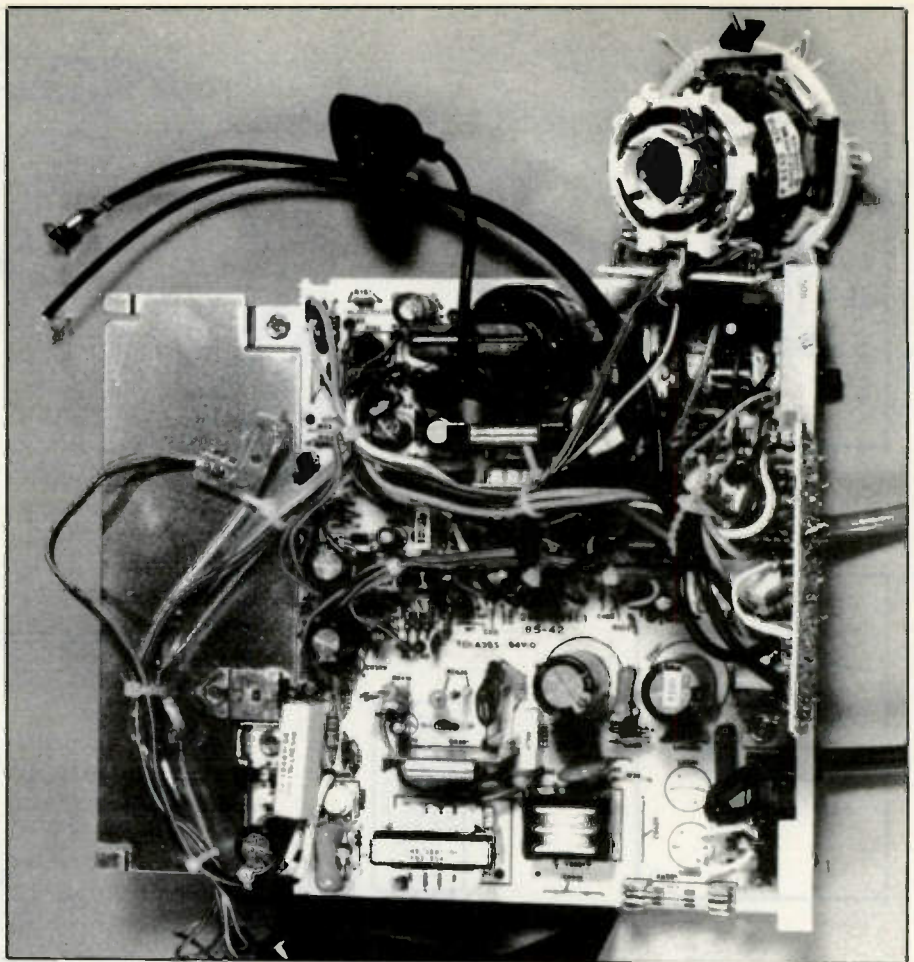

Figure 7. Photograph of a ZVM-124000 main circuit board.

controller backplane connector. With the presence of the clock signals, the video crystal oscillators should run.

Pin 4 of oscillator U206 should have a 16.257MHz signal and pin 4 of oscillator U216 should have a 14.318MHz signal. An external switch attached to the video controller sets the clock signal at pin 19 of the Paradise Video Controller, U205. The position of the switch also determines whether the video adapter card will support a monochrome TTL Hercules monitor or a color RGBI display.

If you encounter sync problems, remember that the video controller card supplies both the horizontal and vertical sync signals. Pins 39 and 40 of the slave gate array, U223, are the horizontal and vertical sync tie points. Also, you can trace the sync pulses through other ICs on the video controller card. U225, a buffer IC, should have vertical \*sync pulses at pin 5 and horizontal sync pulses at pin 7 while pins 12 and 13 have the vertical and horizontal sync pulses for U203, a programmable array logic device.

The multiplexers that process the sync signals in and out of the slave gate array can serve as convenient check points. Pin 7 has the vertical sync pulses and pin 9 has the horizontal sync pulses on multiplexer U204. U205 has vertical and horizontal sync pulses at pins 33 and 34.

If you suspect that no video output signals exist, you should check several key areas for signal activity. When using the video adapter card to support a RGBI monitor, pins 18, 16, 14 and 12 of buffer U225 will have activity. Pin 9 of the same integrated circuit will show activity when the card supports a monochrome monitor.

At times, shorted filter capacitors along the video lines will cut off the video output signals. The same symptom may appear with the wrong or no signals at two pins of U205. Pin 12 should have a digital active high signal while pin 30 has a digital active low signal.

All these possible problems and solutions lead us to the next part of the Hercules/RGBI set. For the Hercules

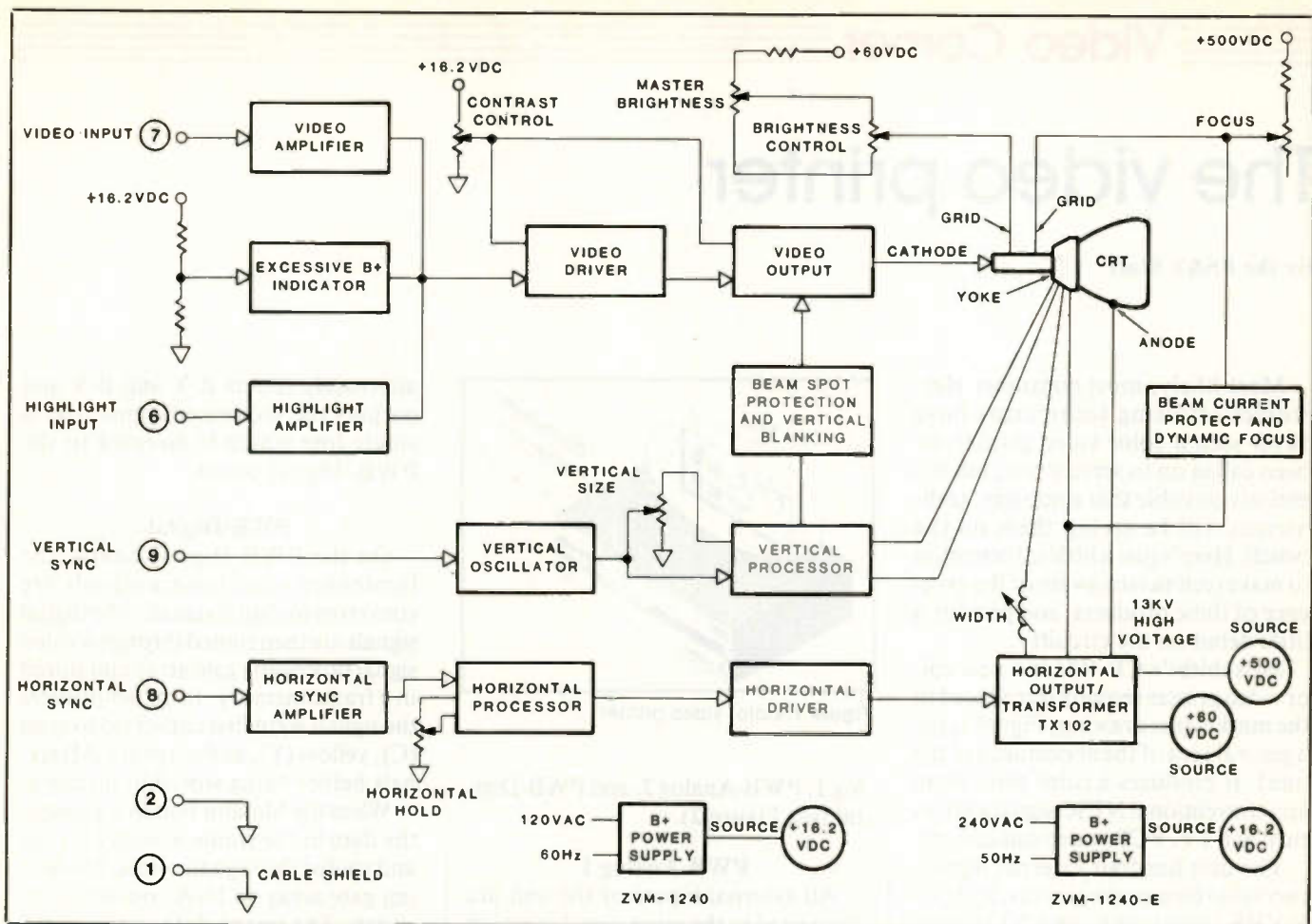

Figure 8. Diagram of the Hercules monitor.

part, a monochrome monitor serves as an example. An RGBI color monitor example completes the analysis.

### The Hercules Video Display

While the advent of VGA monochrome monitors has caused Hercules monitors to fade from the marketplace, many older microcomputer systems still use Hercules graphics. As a text and graphics display, the Hercules graphics adapter and monitor supplanted the earlier text-only MDA graphics. Additionally, the Hercules combination retained the 720 horizontal and 320 vertical scan lines seen with the monochrome graphics. To keep that resolution, the Hercules graphics display uses a horizontal sync frequency of 18,432Hz and a vertical sync frequency of 49.82Hz.

Most Hercules monitors resemble monochrome television receivers and feature a one-board main chassis. Figure 6 is an exploded view of a Zenith ZVM-1240 Hercules monitor. As we move through the analysis of Hercules signal operation, we'll use the

ZVM-1240 as an example. Figure 7 illustrates the main circuit board of the Zenith monitor.

Figure 8 is a block diagram of the Hercules monitor. Moving from top to bottom, the block diagram shows two video input signals, the vertical and horizontal sync signals and the power supply connections.

### Tracing Hercules monitor video signals

Both video signals are TTL-level, positive-polarity input signals. While the video signal feeds through a resistor to the base of the video driver amplifier, Q201, the highlight signal flows through a resistor to the base of the highlight amplifier, Q203. The two driver transistors amplify and invert the input signals.

Both signals then combine at the base of the collector of Q201, the video driver amplifier transistor. A contrast control tied to the base of Q204, the video output transistor, controls the signal current through Q202, the video amplifier, and the video output

transistor by varying the output base voltage. From there the amplified signals drive the cathode of the CRT.

As you would suspect, troubleshooting the video signal section of the Hercules monitor concentrates on the three transistors in the section. If the video amplifier, highlight amplifier or video output transistors become defective, the monitor will lose its video processing. Nevertheless, defects in other areas can also cause a "has raster, but no video" condition. If diode CR103 which connects between the flyback and the 60V power supply opens, the monitor will lose its video output. Also, an excessively high B+ voltage can kill the video signal.

A future installment of this article will describe how to trace sweep signals and high and low voltages in Hercules monitors. Also covered will be some basics of RGBI video.

*All figures courtesy of Zenith Data Systems.*

# The video printer

By the ES&T Staff

Most likely, most consumer electronics servicing technicians have never seen a color video printer, or been called on to service one, but it's entirely possible that some day, technicians will be seeing them on the bench. Here's just a little information to make technicians aware of the existence of these products, and provide a little detail on the circuitry.

Mitsubishi's CP-10U is a new color video printer recently introduced to the market (see drawing, Figure 1, for a general idea of the appearance of the unit). It produces a color print from any conventional NTSC signal source, such as a TV, VCR, video camera, etc.

The unit has four external inputs, two video (composite) inputs, and two S-VHS (separate C and Y) inputs. There is one video input and one S-VHS input on the front of the unit. The second video and S-VHS inputs are on the rear of the unit. There is also one video output and one S-VHS output on the rear of the unit for monitoring the output of the printer.

The normal print consists of one complete frame (two fields) producing a high-resolution picture. The printer is also capable of producing a print from one field only. This is advantageous when there is rapid motion in the picture.

The print is 4 by 3½ inches and is centered on a 6 by 4 inch sheet of paper.

The printer can print not only a single print on a sheet of paper, it can also print four or sixteen prints on a single sheet of paper.

## The signal path through the printer circuitry

The main signal path is through three main circuit boards: PWB- Ana-

*Adapted from an article in the Expander, February 1991, a monthly publication published by Mitsubishi for their authorized service centers.*

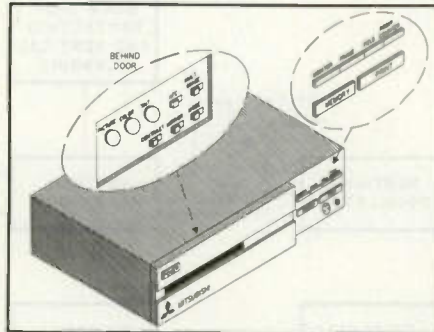

Figure 1. Color video printer

log 1, PWB-Analog 2, and PWB-Digital (see Figure 2).

## PWB-Analog 1

All external inputs of the unit are connected to the input signal selection circuitry on the PWB-Analog 1 circuit board. The selection of input signal is automatically controlled by internal switches in the two S-VHS inputs and the front video input. When a source is connected to a specific input, that input is automatically selected by the input selection circuitry.

The selected input signal then takes two paths. One path is through the output signal selection circuitry to the S-VHS and video outputs so the signal source can be monitored. The second path followed by the selected signal brings it to the comb filter circuitry.

If the signal source is separate luminance (Y) and chroma (C), from a S-VHS input, the signals are routed directly to the outputs of the comb filter circuitry. When the signal source is composite video (combined chroma and luminance), the Y and C components of the signal are separated and directed to their respective outputs of the comb filter.

The Y signal is amplified, processed and is applied to the digital circuitry on the PWB-Digital circuit board. The chroma signal from the comb filter is decoded, producing R-Y and B-Y color difference signals.

The R-Y and B-Y signals are applied to an R-Y/B-Y switching circuit which

alternately selects R-Y and B-Y and outputs the sequenced signal over a single line which is directed to the PWB-Digital board.

## PWB-Digital

On the PWB-Digital board, the luminance and chroma signals are converted to digital signals. The digital signals are then routed through a video signal processing gate array and stored in a frame memory. In earlier printers the signals were first converted to cyan (C), yellow (Y), and magenta (M) signals before being stored in memory.

When the Monitor button is pressed, the data in the frame memory is read and routed through the video processing gate array to D/A converter circuitry. The image data is converted back to analog Y, R-Y and B-Y signals and is directed via PWB-Analog 2 and PWB-Analog 1 to the monitor outputs of the unit.

When the user adjusts the brightness, color or tint of the monitor image, these changes are made in the video processing gate array as the memory is being read. The actual data in the memory is not altered.

When the Print button is pressed, the data is read from the frame memory, any changes entered by the user in the monitor mode are performed in the video processing gate array, and the signal is directed to the print gate array.

The print gate array converts the Y, R-Y and B-Y data to yellow, cyan and magenta drive signals that drive the thermal printing head. To perform the signal conversion, the print gate array must analyze all data for each individual horizontal line. To make this possible, the data for each horizontal line is temporarily stored in a line memory and then processed by the print gate array to form the appropriate Y, C and M signals.

The drive signals from the print gate array are then routed through thermal head drive circuitry to the thermal head to print the desired image.



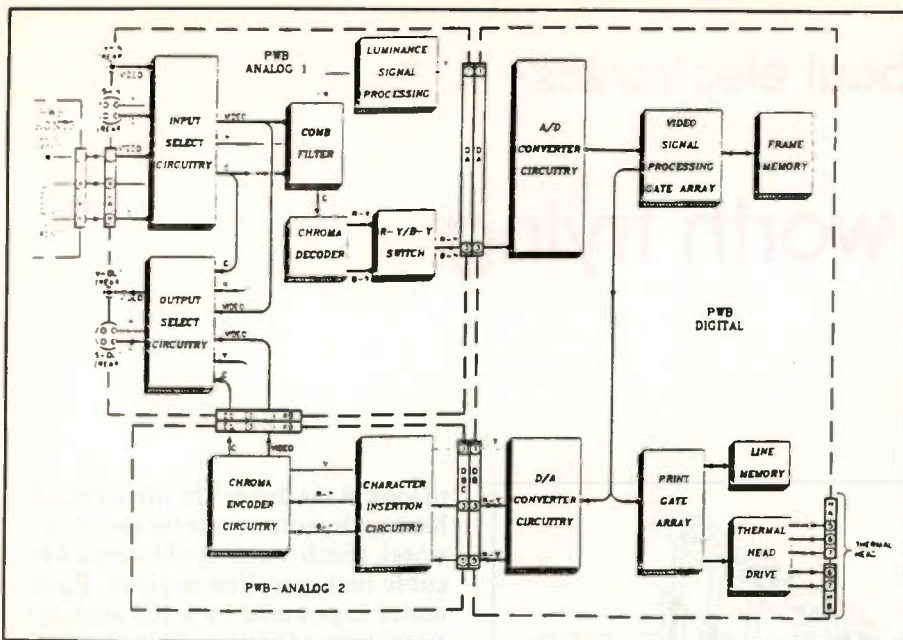

Figure 2. CP-10U PWB signal path

### PWB-Analog

When monitoring the stored image, the Y, R-Y and B-Y signals from the PWB-Digital are directed through character insertion circuitry on the PWB-Analog 2. The character insertion circuitry is used to insert titles (if

desired) or error codes if necessary in the monitor signals. The outputs of the character insertion circuitry are applied to chroma decoder circuitry which generates the luminance, chroma and composite signals that are directed to the S-VHS and video outputs via the PWB-Analog 1. ■

# SAVE TIME

*For fast, accurate service, please remove the peel off label used to address your magazine, and attach it to the Reader Service Card, the Address Change Card or to any correspondence you send us regarding your subscription.*

WATCH FOR

BUSINESS CORNER

## ELECTRONIC

Servicing & Technology

You'll learn about

- building customer satisfaction
- writing service contracts
- marketing your services
- hiring technicians.

## If You Knew How Much TENTEL Gauges Improve VCR Repair - You'd Already Have Them!

More confidence in repairs being done right the first time. **Peter Kosovitch**

**Peko TV- Milwaukee, WI**

Bench time has been cut in half! **Fred Jolley**

**Beverly, N.J.**

Don't know how we managed as long as we did without the gauges. **Peggy Miller**

**Miller's Elect's-Butler, PA**

Stop guessing about sources of video streaking, tracking problems, flagging video, tape edge damage, video head wear, tape "eating" problems, and other VCR problems. 9 out of 10 VCR malfunctions are due to mechanical problems that can easily be diagnosed with TENTEL gauges. Electronic methods just don't work for guide height, tape tension, torques, video head wear, spindle height, tape edge damage, and other critical measurements.

TENTEL's 4 universal, powerful test instruments allow YOU to do 28 different mechanical measurements; including a method to determine video head wear in microns, to help decide if older VCR'S are even worth repairing.

Call today for information on the lease to own program that puts the power of these tools in your shop for about \$67 a month. Less than one VCR per month, yet you'll use this equipment on every VCR you do, and know it's been done right! Isn't it time to Stop guessing, and do VCR repair better and faster. Trial and error wastes time and doesn't find pending problems. Often there are 2 or 3 other problems along with each major problem. Can you find them now?? We can! Your satisfaction is 100% guaranteed!

**CALL TOLL FREE: 1-800-538-6894 / 916-939-4005**

**TENTEL 4475 Golden Foothill Pkwy. El Dorado Hills, CA 95630**

Circle (13) on Reply Card



# What do you know about electronics?

## A challenge worth trying

By Sam Wilson, CET

Some people like riddles and puzzles. I don't, but I know some of our readers do. Here is an easy one for them. A man has 20 horses and three stalls. He doesn't want to put an even number of horses in a stall. He thinks it is bad luck. So, how does he divide the horses so that every horse is in a stall? (Answer at the end of this article.)

### If you can't solder it, you can't unsolder it

If you thought soldering and unsoldering surface mount components was a challenge, think about press-fit connectors like the one shown in Figure 1. They are gas tight and very easily assembled.

One slight problem - it may take two men and a boy to get one loose. (That assumes it could be necessary to get one loose.)

The manufacturer says the connectors are ideal for resistor networks and other pluggable components.

Alright - readers who like a challenge - what do you suggest for replacing a "pluggable component?"

### Speaking of a challenge... Here is a true story

Don't let anyone tell you that opportunities in electronics are drying up. Recently, I was given a design problem that \$160,000 worth of engineering hadn't been able to solve. The number was given to me by the general manager of the company involved. Let me carry you through the design and solution.

Ron - On the phone: I just bet a guy \$100.00 that you can solve a problem in two hours that they haven't been able to get solved since 1974!

Sam - Two hours?!

Ron - The problem is to remove a 15 kilohertz annoying sound in their

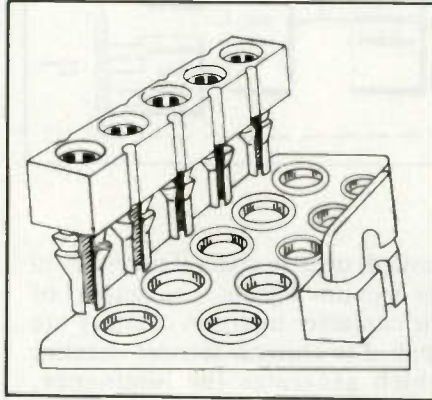

Figure 1.

product. I'll pick you up in 40 minutes.

I assumed a large pillow would kill the sound. Maybe a little cotton stuffed into the cracks.

Ron was so excited about the bet he forgot to tell me how much I would get. I decided to ask for \$50 of the \$100 bet. He arrived in 35 minutes.

### At the company

General Manager - Actually, we aren't worried about the annoying sound. We are trying to manufacture a remote-controlled golf cart. We bought the patent in 1974. It works OK on level ground but it won't go up hills. We've spent over \$160,000 on that problem.

Sam (with a one-track mind) - Does it make a 15kHz sound when it tries to go up a hill? (I'm not going to pass up a chance at \$50 if I can help it.)

General Manager - (Disregarding my question): The last engineer we hired said we need to convert from 12V to 24V for each drive wheel and change the motors, That is going to be expensive and time consuming, but, I guess that's what we'll have to do. The cart weighs over 250 lbs.

He took us out to the company lab

to look at the drive. The drive system has two dc motors - one for each drive wheel. (Each motor could start a 440 cubic inch gasoline engine). Each motor is powered by a 105 ampere-hour lead acid battery. We go back to the General Manager's office.

I pointed out that he should be able to drive the cart up a vertical wall with the equipment he is using. I said he didn't need 24V and new motors for each wheel.

General Manager - Could you make it work with 12V?

Sam - Yes.

General Manager - If you can show me you are right I'll make you an offer you can't refuse.

Note: That is not the same as offering me money. Suppose he is holding a gun. "Get out of my office or I'll shoot" is an offer I couldn't refuse.

### The next day

I looked at the controller output on an oscilloscope and found that the motor controller is delivering pulses to the motors. A quick measurement showed that the maximum duty cycle is less than 50%. In other words the motor is actually getting power less than 50% of the time.

I designed the simple circuit of Figure 2 to deliver power to the motor 100% of the time. The schematic is for the drive circuit of one wheel. At saturation the power amplifiers can deliver nearly the full battery current to one motor. I know the circuit is over-designed, but, I didn't want to take any chances that the cart would die on a Japanese golf course.

A technician built my circuit for one wheel. When the input was adjusted to maximum voltage three full-size men could not hold the cart from climbing a 40% incline with only one wheel driving. Remember, that is by driving only one of the two wheels.

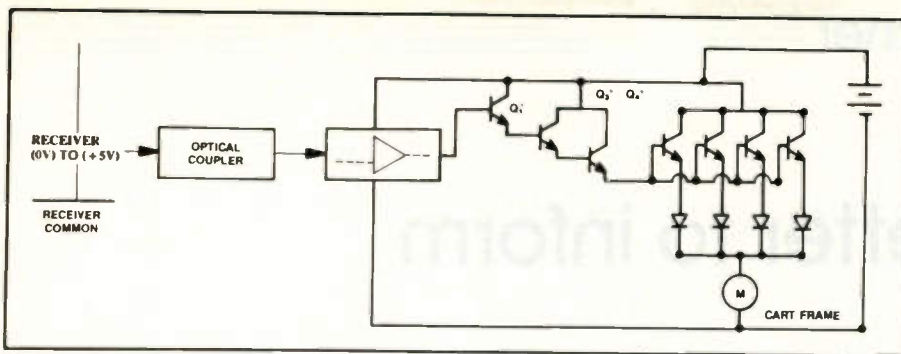

Figure 2.

The final design was to be for driving two wheels. Now, I'm ready for that offer.

General Manager - I'd have to see it with two wheels driving. This guy has more turns than a swamp eel. I decided not to go any further. Two days later I went back for some tools I had left. He asked me to go to his office.

General Manager - I have an appointment to demonstrate the cart in Japan in two weeks. Could you get the cart ready by that time?

Sam - Easily.

General Manager - If you can do that I'll fix it so that you never have to worry about money the rest of your life. (Norma explained that could mean he was going to have me hypnotized and programmed not to worry about money.)

Your royalties on this job alone will be over \$200,000 a year. Also, I'll hire you as an engineer at \$60,000 a year. That is called "Threatening a man with prosperity."

Sam - I'll tell you what. Give me \$8 an hour. I'll have the cart ready in 8 days. Take the \$8 an hour out of my future royalties and salary.

General Manager - I'm not going to give you a penny! I've already paid over \$160,000 to get this thing to work. I won't spend one cent more!

So, I left. If he wouldn't give me \$320 a week he would never give me \$200,000 plus \$60,000 a year. Also, I knew he was not to be believed when he offered to hire me as an engineer. I don't know anything about how to run a train. I have filed a Disclosure document with the United States Patent Office. It gives details of my cart drive and other pertinent design features.

When I get my verification from the patent office I am going to try to sell Ron 50% of the rights for fifty dollars.

### Older than older

In a previous issue I extended congratulations to a Missouri publication called TESA of St. Louis. That publication has not missed an issue in 40 years of service.

In response to that article I got two very nice letters from Illinois. The writers are: Lyle T. Green and Thomas M. Vann??? (Thomas: send me your name - printed or typed - and I'll find some way to get it into this column. That's a promise!)

I am very sorry that I could not decode the complete last name of the second writer but the letter came from Vans TV Sales and Service in Des Plaines, IL.

Both writers informed me that a publication called *The Word* was started by Frank J. Moch and has been in operation for 42 years. I am very impressed. Congratulations to *The Word*.

According to the letter writers, there have been only two editors since that

publication was started: Frank Moch, and, the present editor George Weiss. Mr. Weiss is the present Executive Director of ES&T.

Lyle T. Green sent a copy of *The Word*. It is a very impressive publication.

Note: TESA send me copies of their publication. At one time I was getting 20 publications a month! I am still getting four.

Does anyone else want to jump in here with news of your publication?

### A very funny criticism

Recently a reader of this column sent a criticism written by a person who has a monthly column in a mid-western publication. That writer was trying to convince his readers that my article titled "Why Johnny Can't Understand Capacitors," is not based on fact.

After a discussion complete with misinformation he makes his statement: Did you get that? A capacitor can operate with a vacuum between the plates. It doesn't need to have a dielectric.

Thanks to the reader who sent that. He doesn't want his name given.

I wonder if anyone besides me wrote to explain to him that a vacuum IS a dielectric!

Answer to the riddle: He put 11 horses in one stall and 9 horses in another stall. Nothing was said about having to use all three stalls! (now do you see why I don't like riddles and puzzles?).

Sell to nearly 30,000  
consumer electronics  
servicing professionals . . .

**ELECTRONIC**  
Servicing & Technology

- ES&T magazine readers buy test equipment, replacement parts, tools, servicing manuals, virtually every kind of electronics servicing related product.

- ES&T readers budget nearly \$230 million a year for test/measurement equipment for their facilities. With 77% directly influencing the selection of products for their facilities.

- ES&T readers service all types of consumer electronics products. Including personal computers, VCRs, CDs, TVs and other audio/video equipment.

Call or write today for your ES&T media kit.

76 N. Broadway • Hicksville, NY 11801 • (516) 681-2922 • FAX (516) 681-2926

# Use a newsletter to inform customers

By the ES&T Staff

What kinds of products do you service? What brands are you authorized for? Do you offer any unusual or unique services? Do you sell accessories? Do your customers and potential customers know these things?

The world of consumer electronics has changed so much over the past few years, and continues to change at such a rapid pace that you may be providing service on products that no one even had in their homes just a few years ago. Have you told the people in the

local community about that? How can you inform your customers of what you're doing that's new?

Of course, there's advertising in the newspapers and the yellow pages. It works well and brings in customers. And of course there's your storefront and signage, which should reflect unambiguously the kinds of service you provide and the products you accept for service. And if you have trucks or vans there's a good place to advertise your message to the world.

## Direct communication

All of the above avenues to getting the word out to the customers and potential customers are good, but another avenue that is being used by successful service business is the newsletter. For example, Gerry McCann of McCann Electronics in Metairie, LA, publishes a newsletter from time to time. (See Figure 1). He calls it "A periodic update, made available to our clients, regarding Consumer, Commercial and Computer Elec-

### The McCann Electronics Newsletter

100 Division St. Metairie, La. 70001 504-837-7272 FAX 504-834-1014

February 1992

A periodic update, made available to our clients, regarding Consumer, Commercial and Computer Electronics Services and Products.

#### Floppy Drawers



Computers must spawn floppies. Every place we find a computer, we find a collection of boxes and a lot of loose floppy disks all around the desks and the shelves and the room. A normally neat area becomes cluttered with colorful boxes and plastic things to the point of creating confusion. Now someone has created a floppy storage drawer that holds 150 floppies and has a lock on front and stacks atop each other neatly. With inside dividers, they are just the thing we normally neat folks have been needing. The 3.5" floppy version holds 150 disks. The 5.25" floppy version holds 180 disks. They also hold CD Rom disks and DC2120 data tapes. We have a good supply of these cabinets at \$9.00 each.

#### Videotape Bulk Lots

We stock short lengths of VHS videotape for quantity users. These come in 15 and 30 minute lengths. Commonly used in making multiple copies for teaching, commercials and any short length event, the cartons contain 50 tapes and come with no tags and sleeves. The brand is FUJI, the quality is great, and the cost is very attractive.

#### Computer Sound

Normally a personal computer and great sound are not mentioned in the same sentence. The new Sound Blaster Professional computer interface card sets a standard in combining software and sound. This \$295.00 item has a 4 Watt per Channel Amp built in, but works best when connected to a nice stereo system. Never before have we had such full software control of fade in, fade out, pan, volume, left/right channel steering and Mic mixing. Special chip synthesizers create 22 voices. Upgrading to a computer talking real words with ASCII text translation software supplied with the Sound Blaster Pro is fascinating. Powerful programming, serious music compositions and just fun creating rhythms are plenty reasons to buy this new dimension to a computer.

#### Decks, Flies and Videotape



Having a sales meeting that could use a little pizzazz? Have you been tasked with developing an educational program for incoming personnel? Do you need to attract your audience's attention but your presentation won't even attract flies? We now have a skilled computer animation technician on duty and ready to come to the rescue. Let us create presentation flair for you. Phone and ask for Rain at our MultiMedia Desk.

#### Bigger Picture

A move is on to use larger Computer monitors. Most VGA monitors have 14 inch screens. We are now stocking 17 inch Super VGA Monitors because of the demand. 17 inch is about one third larger area than 14 inch. If you have poor eyesight or just get very strained after a few hours in front of the 14 inch, come visit and see the difference larger text can make. The tiny and finer typefaces look much clearer. And prices have now become almost reasonable.



#### New Product



Minolta has reinvented the opaque projector. This new device is to be used in a presentation or a classroom environment. Pages of text and pictures, even from a book in full color, can be projected onto a large screen. We have experimented with one in our conference room, and a great 6 foot high by 9 foot wide display can be viewed. It even allows us to place a printed circuit board on the glass surface and examine the tracings enlarged and in full color on the screen. This projector would be appreciated when showing off graphics and pictures where true color reproduction makes a difference. Phone and ask for Jack at the MultiMedia Desk. Demonstrations at your conference site are available by appointment.

#### Used Equipment

We have a few pieces of demonstration sample computer equipment that is in used but good condition. One is an ALR EISA Tower with both 1.2 and 1.4 meg floppies, a 330 Meg ESDI Hard Drive, four Megs of Ram, a 512k Video card and a Viewsonic 6 Non Interlaced .28 VGA Color Monitor for \$3,500.00. Another item is a Canon LBP-8 Mark III Laser Printer in nearly new condition with only about 40,000 copies logged. The full sized Laser Printer includes scalable fonts and 1.5 Megs of Ram for \$750.00. The Newsletter you are reading has been produced on this printer.

#### Mardi Gras Video



Remember some basic rules of Videotaping during Mardi Gras time. Check your batteries, always have at least two fully charged. (We stock the best selection of original equipment brand Camcorder batteries in the city.) Always bring a plastic bag to cover the camera with in case it rains during the parade. At night always get near a good bright street light or a lighted sign. During daytime parades always get on the side of the floats with the sun behind you. And always keep the strap around your shoulder. *Dropped camcorders are big trouble.* Be careful the lens doesn't get hit and scratched by flying beads and doubloons. Use only camcorder quality videotape, the pictures of the kids marching in the band and the Uncles on the floats will be in the family for years. (We have plenty of stock and a special on Camcorder quality VideoTape this month - timely huh?)

tronics Services and Products." He uses it for a number of messages.

For example, a recent issue, February 1992, mentions floppy disks and the way they create clutter in the computer area. The solution offered is a floppy disk storage drawer that holds 150 floppies. Thus the newsletter offers the reader a solution to a common problem, which the company happens to have for sale.

The same newsletter describes an unusual, if not unique, service to be offered by an electronics service center. The company has on staff a skilled computer animation technician who can help any client or potential client produce a professional computer presentation program.

Another service provided in this issue of the newsletter is advice on videotaping the festivities at Mardi Gras. It offers suggestions on protecting the camcorder from damage and the elements, recommends ways to get in position to get the best results for both daylight and nighttime shots. This kind of service generates goodwill. But, in addition, the same item also lets readers know that they can pur-

chase both batteries and videotape for their camcorders at McCann Electronics.

**Neat/clean, not fancy**

This newsletter isn't fancy. It's printed out very simply, cleanly and neatly on a laser printer (which the newsletter also points out is for sale), and every item is brief and to the point. It's also illustrated with some eye catching computer-generated visuals.

A newsletter such as this not only offers specific products and services to the customers (in keeping with his professional image, McCann calls them "clients"), it offers the company another opportunity to put its name and image in front of the people who are consumers of the products and services offered, so that when they are ready to buy, they'll think of the company that published the newsletter.

A newsletter, such as this one, cannot only keep your company's name in front of the current and potential customers, it can let them know about specific products and services offered by your company. ■

**BIG PROFITS IN VIDEO REPAIR!**

**WORK FROM HOME-EARN \$85 HR!**

With the tens of millions of VCRs and Camcorders in use, there currently is a **serious shortage** of trained techs to perform cleaning and repair jobs on these popular devices... Learn how you can start your own highly profitable, **Home-Based** video servicing business... And since up to 95% of all VCR and Camcorder malfunctions are due to a simple **mechanical or electro-mechanical** failure, you need not spend months or even years of complicated study before starting paid, **professional service work!**



Train at Home in your Spare Time!

Let Viejo's Training Program show you how!

CALL TOLL-FREE

**1-800-537-0589**  
or mail coupon today!

**VIEJO PUBLICATIONS, INC.**

4470-107 Sunset Blvd., Suite 600  
Dept. VK Los Angeles, CA 90027

Yes! Rush me your **FREE OPPORTUNITY KIT** today!  
(Check appropriate box)

- VCR Repair
- Camcorder Repair
- Advanced VCR Repair
- Fax Machine Repair

Name \_\_\_\_\_

Address \_\_\_\_\_

City/State \_\_\_\_\_ Zip \_\_\_\_\_

Dept. EST

Circle (14) on Reply Card

**Improve Your Form.**

**3-Part**

A continuous feed form used for customer c.o.d. service or parts/accessory sales receipts

(N3CN). Not for warranty billing. Computer generated software to be available soon.

**5-Part**

Available in snapout (N5SN) or continuous feed (N5CN). Matching fields with N3SN,

except for customer estimate and receipts. For warranty billing.

**7-Part**

A universal snapout form (N7SN) designed for both customer service c.o.d. and manufacturer warranty billing. Complies fully with the requirements of state and local ordinances, including California.

**Discounts**

Carbonless NESDA Forms are available to NESDA members at additional savings. For pricing information and samples, or information regarding other NESDA membership benefits, write to NESDA, 2708 W. Berry St., Ft. Worth, TX 76109; or call (817) 921-9061.

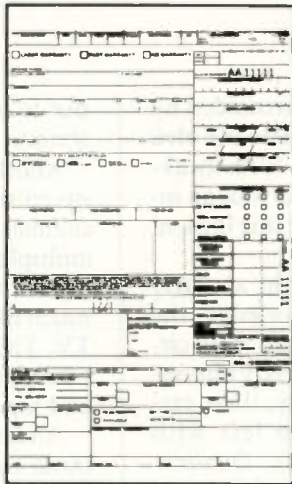

**The NESDA Form**

NESDA, 2708 W. Berry St.  
Fort Worth TX 76109  
Phone: (817) 921-9061



Resolve your Monitor Repair requirements quickly and easily with

**Resolve™**  
MONITOR REPAIR SERVICE DATABASE

Resolve is a PC monitor repair history database. Simply specify the monitor and select from Resolves symptom list for that monitor, and repair details are displayed in order of repair frequency. Now you can eliminate needless troubleshooting and dead ends. The original release includes over 425 repairs on monitors produced by 21 manufacturers. Upgrade subscription customers will receive quarterly updates with additional repairs, new manufacturers and updated information and repairs.

**Included in Release 1.0 of Resolve:**

- |                |              |         |
|----------------|--------------|---------|
| ACER           | IBM          | SAMSUNG |
| AMDEK          | LEADING EDGE | SAMTRON |
| CASPER         | MITSUBISHI   | SPERRY  |
| COMPAQ         | NEC          | TATUNG  |
| CTX            | PACKARD BELL | XTRON   |
| EPSON          | PRINCETON    | ZENITH  |
| EVERVISION     | GRAPHICS     |         |
| Honeywell Bull | RELISYS      |         |

Call for FREE Demo Disk 1-800-999-0304



Circle (1) on Reply Card

# Simplified surround sound

By John Shepler

Surround Sound is the latest audio magic to be incorporated into many consumer stereos and TV sets. More and more receivers now have Dolby Surround and Dolby Pro Logic circuits built-in. While these new technologies from Dolby Labs use digital delays and other sophisticated logic to bring the theater experience into the living room, did you know that there is a very simple form of surround sound that you can add inexpensively to any stereo receiver or TV?

Surround sound has its roots in Quadraphonic audio, a hot technology of the early 70's that has faded into obscurity. Quadraphonic, or Quad, as it was called, was an attempt to expand the stereo experience into three dimensions.

In a very good stereo system, you cannot tell where the speakers are. With a single sound source, like a table radio, your ears can easily tell exactly where the sound is coming from. You are said to "localize" the source of the audio. It's harder to localize stereo sound because each speaker contributes amplitude, frequency, and phase information that mixes in the center of the room to create what sounds like a stage, or a wall-of-sound. You hear the singers and the instruments spread between the speakers and even beyond them.

Unfortunately, you can still tell which direction is toward the stereo stage. The speakers are generally spread against one wall of the listening room. You cannot hear any sounds coming from the ceiling, floor, or behind.

Quadraphonic sound added two speakers and two more channels of audio. It was double stereo with the

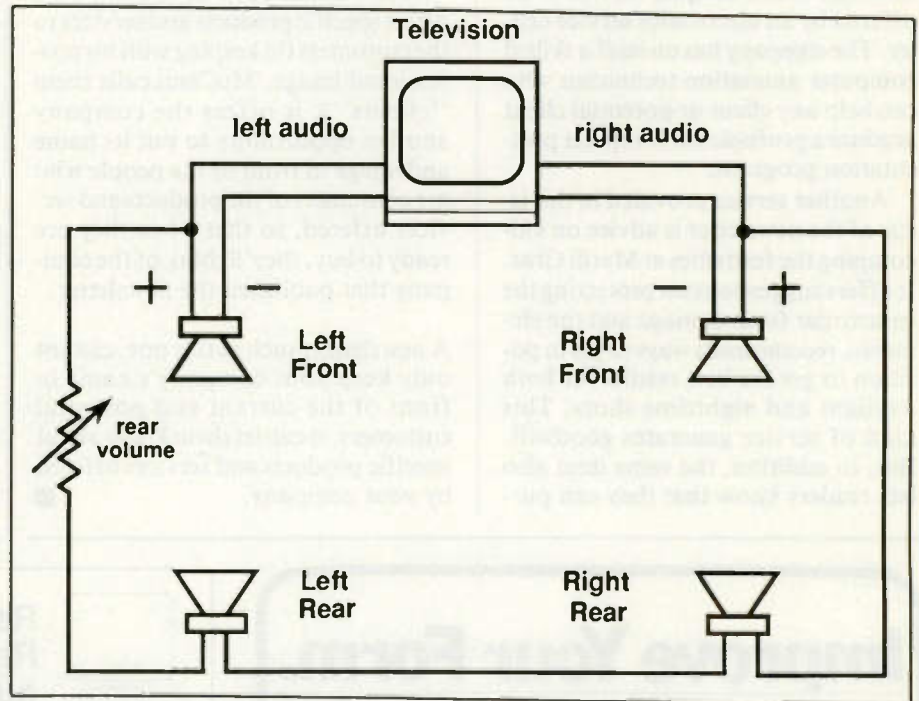

Figure 1. Simple surround sound

listener in the center, surrounded by speakers. This is also where the idea of surround sound arose. With speakers in front of and behind you, an instrument can sound as if it is located anywhere in the room.

As anyone who bought an early Quad system will acknowledge, the sound of a recorded freight train circling the room makes a pretty impressive demo. Unfortunately, these early investors have been left with something of a curiosity. Quadraphonic stereo requires special source material that contains the four channels. This material never became very popular and was soon discontinued.

One way to get quad audio is to produce a tape with four channels. This can be done with a special tape head for cassette or reel to reel decks. This method provides excellent separation,

but is not compatible with normal stereo.

Another technique is to keep the stereo standard formats as the front channels and add the rear channels by multiplexing them onto tape or records with a high frequency carrier, much like broadcast stereo and MTS TV. This takes special decoders and, of course specially recorded records and tapes.

An interesting scheme came out of those early Quad experiments in the surround sound. It was discovered that there is extra phase information in normal stereo material that can be extracted as the difference between the left and right speaker audio. This L-R signal can be fed into a set of rear speakers to produce a simple and very inexpensive surround effect.

Figure 1 shows the hookup. It

Shepler is an electronics engineering manager and broadcast consultant. He has more than 20 years experience in all phases of electronics.

works for TV, FM, and recorded stereo. Notice that the speakers are wired in series and connected across the plus connections of the front left and right speakers. The series pot adjusts the volume level of the rear speakers, which is kept fairly low.

The quality of the L-R speakers is far less critical than the main speakers because the extra sound is only for background ambiance. In fact, you can even eliminate one of the rear speakers and have a single speaker for surround sound ambiance.

Is this the same as Dolby Surround? No. Dolby Surround is a patented system using filtering and a digital time delay to enhance the spatial effect. A more sophisticated scheme, Dolby Pro Logic uses digital logic circuitry to determine which direction is the strongest and instantaneously adjusts the volume to that channel. In addition, Dolby processing of the original soundtrack improves the L-R information for a fuller sound.

Still, it's nice to know that you can very simply provide your customers with an introduction to surround sound until they are ready to step up to the more sophisticated receivers.

# Test your electronics knowledge

## Answers to the quiz

(from page 54)

The terms are in the same order as the definitions. The last three terms are not related to any of the definitions.

1-A. RS-232

2-B. Node

3-C. Access method

4-D. Modem (Modulator-Demodulator)

5-E. ASCII (American Standard Code for Information Interchange)

6-F. Byte

7-G. Attenuation

8-H. Asynchronous transmission

9-I. Frame

10-J. Assembly language

11-K. Flow control

12-L. Address

M. Bead Ledge

N. Fasterous Loader

O. ECMA (European Computer Manufacturer's Association)

## SAVE YOUR COPIES OF **ELECTRONIC**

Servicing & Technology

CASE

These custom-made titled cases and binders are ideal to protect your valuable copies from damage.

They're designed to hold a year's issues (may vary with issue sizes), constructed with reinforced board and covered with durable leather like material in (color), title is hot-stamped in (gold/silver).

cases are V-notched

for easy access, binders have special spring mechanism to hold individual rods which easily snap in.

BINDER



Cases: 1—\$7.95 3—\$21.95 6—\$39.95  
Binders: 1—\$9.95 3—\$27.95 6—\$52.95

Electronic Servicing & Technology

Jesse Jones Industries, Dept. EST  
499 East Erie Avenue, Philadelphia, PA 19134

Enclosed is \$\_\_\_\_\_ for \_\_\_\_\_ Cases:

Binders. Add \$1 per case/binder for postage & handling. Outside USA \$2.50 per case/binder (US funds only).

PA Residents add 7% sales tax

Print

Name \_\_\_\_\_

Address \_\_\_\_\_

No P.O. Box Numbers Please

City \_\_\_\_\_

State/Zip \_\_\_\_\_

CHARGE ORDERS (Minimum \$15): Am Ex, Visa, MC, DC accepted. Send card name, #, Exp. date.

Call TOLL FREE 7 days, 24 hours 1-800-825-6690

**SATISFACTION GUARANTEED**

# Fox International

23600 Aurora Rd. - Bedford Hts., Oh. 44146

**RCA**

Original Oem Parts In Stock For

**SANYO**

**Panasonic TOSHIBA SONY**



**Quasar**

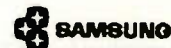

**Technics**



**SANSUI**



**SHARP**

*Emerson*

## CALL TOLL FREE

800-321-6993

800-445-7991

Order Line

Fax Order Line

For a **FREE** Subscription to our catalog mail this coupon to:  
Fox International • 23600 Aurora Rd. • Bedford Hts., Oh. 44146

Name \_\_\_\_\_ Phone # \_\_\_\_\_ - \_\_\_\_\_ - \_\_\_\_\_

Business Name \_\_\_\_\_

Address \_\_\_\_\_

City \_\_\_\_\_ State \_\_\_\_\_ Zip \_\_\_\_\_

Circle (2) on Reply Card

June 1992 *Electronic Servicing & Technology* 53

# Test your electronics knowledge

By Sam Wilson, CET

This is a very tough quiz based upon computer terminology. Anyone who can identify three or more terms is a very high-level computer person. In any event, it is a good way to learn computer terms.

There are 15 computer terms identified by letters of the alphabet. Write the letter that identifies the term beside the related definition below. There are more terms than definitions, so, be careful.

## Computer terms

- A. RS-232
- B. Node
- C. Access Method
- D. Modem (Modulator-Demodulator)
- E. ASCII (American Standard Code for Information Interchange)
- F. Byte
- G. Attenuation
- H. Asynchronous Transmission

Wilson is the electronics theory consultant for ES&T.

- I. Frame
- J. Assembly Language
- K. Flow Control
- L. Address
- M. Bead Ledge
- N. Festerous Loader
- O. ECMA (European Computer Manufacturer's Association).

## Definitions

1. An Electronic Industries Association (EIA) specified set of interface standards that dictates how asynchronous devices such as PCs and terminals communicate over telephone wire. It is based on a 25-pin architecture that permits 19.2 Kbps data transfers.

2. A point of connection on a network especially a point at which a terminal or PC is located.

3. The method used by networked stations to determine when they can transmit data on a shared transmission medium.

4. A device that converts digital signals to analog signals and vice versa and that changes them from/to their assigned frequencies for transmission over coaxial cable. It is used in broadband networks.

5. A system for representing alphanumeric data using 7-bit data codes. It and EBCDIC are the two most widely used data codes.

6. A unit of consecutive binary digits (for example, an 8-bit or 16-bit \_\_\_\_\_).

7. The decrease in magnitude of the power of a signal transmitted over a wire, measured in decibels per kilometer. As \_\_\_\_\_ increases, signal power decreases.

8. Data transmission in which the interval between transmitted characters may be of unequal length. Start and stop bits at the beginning and end of each character control data transmission and timing.

9. A group of bits that make up an elementary block of data to be sent over a communications channel. Usually, a \_\_\_\_\_ contains its own control information, including the transmission address and data for error detection.

10. A low-level programming language whose statements are similar in form to the machine language of a computer. Because programs written in \_\_\_\_\_ "speak" directly to the hardware, they are extremely compact, efficient, and fast.

11. A hardware or software mechanism employed in data communications to turn off the transmission when the receiving station is unable to store the data it is receiving.

12. The unique identity of a station or network.

(Answers on page 53)

## MOVING?

If you're planning a move in the near future, don't risk missing an issue of *Electronic Servicing & Technology*. Please give us 6-8 weeks notice if you're planning on changing your address. Just write in your new address below and mail this coupon,

WITH YOUR  
SUBSCRIPTION MAILING  
LABEL, to:

Name \_\_\_\_\_  
Address \_\_\_\_\_  
City \_\_\_\_\_  
State \_\_\_\_\_ Zip \_\_\_\_\_

**ELECTRONIC**  
Servicing & Technology

Subscriber Services  
76 N. Broadway  
Hicksville, NY 11801



**Understanding data communications, By Gilbert Held; 368 pages; \$24.95.**

Understanding Data Communications takes the vast, complex world of computers and condenses it for the layperson. This uses plain English and illustrations to explain how various computer hardware and software components work and communicate. An overview of data communications introduces readers to the basics and how they are connected to the real world. This volume discusses database services, information utilities, electronic bulletin boards, and other up-to-the-minute technologies. These concepts and principles are accompanied by a thorough look at the world of digital communications. Here, the book spells out the advantages and disadvantages of local area networks, packet networks, and network design and management.

The book is arranged somewhat like a textbook, with chapters that start and end with a summary, plus a short multiple-choice quiz on each chapter's contents.

Prentice Hall Computer Publishing 11711 N. College Ave., Carmel IN 46032

**Hands-on Resource To Understanding Automotive Electronics; By William B Ribbens, Ph.D.; 392 pages; \$24.95.**

Automotive electronics changed a great deal during the 80's and early 90's. Understanding Automotive Electronics, Fourth Edition, brings electronics buffs up to date on the latest technology.

This volume explores electronic engine control and the development of all-new automotive subsystems. Readers discover step-by-step, self-paced tutorial lessons that introduce the most vital areas of electronics within the auto environment. They learn how and why electronic circuits and devices now replace what used to be mechanical and pneumatic.

Packed with essential reference material and illustrations this book helps readers define the systems approach to control and instrumentation, understand how sensors and actuators operate, discover the latest digital engine control techniques, understand the

elements of automotive instrumentation and diagnostics, and look into the future of automotive electronics systems.

Prentice Hall Computer Publishing, 11711 North College Ave. Carmel, IN 46032.

**The Modern Oscillator Circuit Encyclopedia, By Rudolf F. Graf; TAB Books, 192 pages, \$12.95 paper.**

This encyclopedia offers the largest number of up-to-date oscillator circuits available anywhere in a single, low-cost source. This special-focus encyclopedia gives engineers, technicians, students and hobbyists fast, easy access to more than 250 practical, ready-to-use oscillator circuits that represent the latest developments in circuit technology. This volume covers the whole spectrum of oscillator circuits including: Audio, burst, sine-wave, Colpitts, Wien-bridge, bias, multivibrators, crystal, RF, TTL, code and function generators.

Organized by application for easy reference, the circuits are in their original form to prevent any possible transcription errors. The schematics are accompanied by a brief explanation of how each circuit works, and the original source for each circuit is cited for readers who want additional information.

TAB Books Blue Ridge Summit, PA 17294

**A Passion For Technology, By Gibson Research Company; Gibson Research Corp; \$24.95.**

This five volume set is a collection of enhanced articles first published in Steve Gibson's TechTalk column in InfoWorld magazine.

Gibson began writing for InfoWorld magazine in 1986 to bring complex issues to a level anyone could easily understand. Each of the five volumes represents a different year of research from 1986 to 1990 and contains of the original full length articles before they were edited for size and content by InfoWorld. This collection of Steve Gibson's work also includes hundreds of original detailed diagrams and illustrations, making abstract concepts clear and includes a comprehensive cumulative index al-

lowing readers to cross reference almost any subject imaginable.

This book set is for anyone who wants to learn more about computers and the computer industry. Each article takes what is often a complex and confusing subject and describes it in a non-technical way. These books were assembled and published to satisfy reader demand," said Mr. Gibson. "Readers were continually requesting reprints of past articles, or they would request an entire series of articles on a particular subject. Although we originally conceived the books as simply meeting these reader's requests, most people who have seen them have praised them as a invaluable reference work.

Gibson Research Corporation 22991 LaCadena, Laguna Hills, CA 92653.

**Learning DOS, By Sams, Macmillan Book Publishing, 459 pages, \$29.95.**

Beginning and intermediate personal computer users discover how to become proficient with 100 DOS topics after reading Learning DOS. The book offers a step-by-step introduction to the most popular computer operating system today, Learning DOS helps users become productive PC users.

Learning DOS covers MS-DOS 3.X, 4.X, and 5 and helps assess what users know and what they need to learn. This text comes complete with a disk featuring a friendly Learner's Guide that encourages users to try out commands by asking questions and telling them where to find more information in the book.

The book gives detailed descriptions and teaches users how to: properly install and start working with DOS, examine and manipulate DOS files, work within the DOS 5 Shell, customize the DOS system with the DOS 5 text editor, and speed up operations with batch files. Users also learn DOS commands and how they organize, examine and manipulate DOS files, as well as discover facts about file and directory management, data recovery, and backup.

Macmillan Book Publishing 1711 N. College Ave., Suite 140, Carmel IN 46032.

**Using PC Tools 7.1, By Walter R. Bruce III with Jodi Schroth, Prentice Hall Computer Publishing, 844 pages, \$24.95.**

Beginning and intermediate users find that this combination how-to/reference book adds peace of mind and power to their personal computing. Giving users the necessary information about files, directories, and disk management with PC Tools, this book makes it possible for users to become surehanded with the methods for gaining complete control of the PC.

Using PC Tools 7.1 provides clearly focused examples and in-depth advice that assists users with each PC Tool, including PC Shell, Central Point Backup, File Fix, Rebuild, PC Secure, Central Point Commute, and updated Windows capabilities. They learn how to back up the hard disk, organize files and directories, add security and power to hard disk performance, recover accidentally deleted files and inadvertently formatted

disks, run PC Tools within Windows 3, and speed up work with PC Tools macros.

Special tips, notes, and cautions inside Using PC Tools 7.1 help users improve performance. The book teaches readers how to use the latest PC Tool companions to organize thoughts, manage information, streamline schedules, communicate through the computer and a telephone, send fax, and perform numeric and financial computations. The book covers PC Tools versions 6 and 7.1. In addition, the book helps users fix damaged 1-2-3, Symphony, and dBASE files.

Prentice Hall Computer Publishing 11711 North College Avenue Carmel, IN 46032

**Easy DOS, By QUE Development Group, Prentice Hall Computer Publishing 198 pages, \$19.95.**

Once properly introduced to DOS, most computer users have little trouble getting the most from their com-

puter. With a solid understanding of DOS basics, it's easy to learn other programs and functions.

QUE's East DOS is filled with practical facts and useful tips on how to use a personal computer - and DOS - to complete common computer jobs. The streamlined format gives instructions one simple step at a time.

Users learn the secrets behind the "mysterious" DOS code; what is, what it does, and how it can make computing fun. There are step-by-step instructions on how to copy files, create directories, and work with floppy diskettes. DOS tasks are explained in plain English and illustrated with actual screen graphics. User-friendly "Oops" tips tell users what to do if they make a mistake. Users can follow along with chapters for a beginning course in DOS or skip around - they're bound to find new tips, tricks, and answers to questions. ■

Prentice Hall Computer Publishing, 11711 North College Avenue Carmel, IN 46032

**Come Out of the Dark.**

Highlight *your opportunity* to enrich your skills at the 1992 National Professional Electronics Convention, August 3-8, Fort Worth, TX. Programs include:

- \*Technical and Management Seminars
- \*Trade Show and Manufacturers Meetings
- \*Pre-registration includes **Microprocessor Course, and CD or Camcorder School (seating limited).**

For a registration form and more information, **rush** the following to NESDA:

Name \_\_\_\_\_

Business \_\_\_\_\_

Address \_\_\_\_\_

City \_\_\_\_\_ State \_\_\_\_\_

Zip \_\_\_\_\_

Phone \_\_\_\_\_

National Electronics Sales &  
**NESDA**  
Service Dealers Association

2708 W. Berry St.  
Ft. Worth, TX 76109  
(817) 921-9061

**ORGANIZE AND PROTECT YOUR COPIES OF ELECTRONIC**

*Servicing & Technology*

Custom-made titled cases and binders, designed to hold a year's issues, provide the storage system to help protect your valuable copies from damage. Reinforced board covered with durable leather-like material in (color), title hot-stamped in (gold/silver), cases V-notched for easy access, binders have special spring mechanism to hold individual rods which easily snap in.

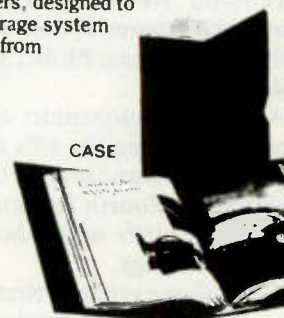

- Cases: 1—\$ 7.95  
3—\$21.95  
6—\$39.95
- Binders: 1—\$ 9.95  
3—\$27.95  
6—\$52.95

Electronic Servicing & Technology  
Jesse Jones Industries, Dept. EST  
499 East Erie Avenue, Philadelphia, PA 19134

Please send \_\_\_\_\_ cases; \_\_\_\_\_ binders

- Enclosed is \$ \_\_\_\_\_
- Charge my: (Minimum \$15)
- American Express  Visa
  - MasterCard  Diners Club

Add \$1 per case/binder postage and handling. Outside USA \$2.50 per case/binder. (U.S. funds only.)

Card # \_\_\_\_\_ Exp Date \_\_\_\_\_

Signature \_\_\_\_\_

Charge Orders: Call TOLL FREE 7 days, 24 hours 1-800-825-6690

Print Name \_\_\_\_\_

Address \_\_\_\_\_

No P.O. Box Numbers Please

City/State/Zip \_\_\_\_\_

PA Residents add 7% sales tax

**SATISFACTION GUARANTEED**

mode power supply, Philips digital compact cassette, Sony LN-1 TV chassis, Toshiba X-90C, Kenwood audio CD, Matsushita microwave ovens, and Mitsubishi cellular phones.

The week-long NPEC offers servicers additional benefits through management seminars, industry relations meetings, and an instructors conference. A two-day trade show houses a comprehensive collection of new product and service technology. Manufacturers of products and test equipment, service contract administrators, parts distributors, software suppliers, and trade publishers showcase their best products and processes.

#### Dealer convention in New Orleans adds satellite swapfest

SDA, the national Satellite Dealers Association, based in Greencastle Indiana, has announced a unique addition to its planned July 8 through 11 convention. One day prior to the SDA Satellite Trade Show, attendees can participate in a swap meet. The swap meet, called SATFEST, will occur on Thursday July 9, the same day as the one-day Business Management School seminars, and the Electronic Servicing School.

SDA Director Larry Hulsey, CSI, (Hulsey & Hulsey Electronics, Gainesville, GA) is the chairman for the SATFEST project. Larry stated "The dealer swap meet is an event dealers have been talking about for several years. Its going to happen this year in New Orleans. It is an opportunity for members to bring some of their excess used equipment and trade it for spares or other brands of products which they need more. Spare UST 1000's, Amplica downconverters, MATV modulators and rack equipment, trenching and test equipment are some of the type of gear expected to be offered."

Location for the SATFEST is the Clarion Hotel on Canal Street in New Orleans. Details are available from SDA. Write to SDA at 602 N. Jackson, Greencastle, IN or call: 317-653-8262.

#### Service management seminars announced

The National Association of Service Dealers (NASD) announced the 1992 Service Management Seminars schedule. June 17 in Boston, MA, June 18 in Saddlebrook, NJ, July 1 in Pittsburgh, PA, July 2 in Philadelphia, PA, July 22 Detroit, MI, August 12 Seat-

tle, WA, August 26, Chicago, IL, August 27 Minneapolis, MN and September 19-22 San Diego, CA. On October 7 Dallas, TX, October 8, Houston, TX, October 21-24 Atlanta, GA in conjunction with the Southeastern Electronic Conference (SEEC) and November 4 New Orleans, LA, and finally November 5 Los Angeles, CA.

The seminars will be presented by David M. Ashton, NASD's Managing Director. Subject matter will include Financial Management, Customer Relations, Service Advertising and Employee Relations.

NASD is a division of NARDA, Inc. with headquarters in Lombard, IL. Those wishing more information may call 1-800-621-0298 or fax 708-953-8957.

#### ETA/SDA National Convention

The joint ETA/SDA Convention Committee has packed the New Orleans July 8-11 National Convention agenda with activities. Cajun Dance, special interest sessions on today's most important topics; SAM Satellite/Antenna/MATV school; Electronic Servicing School; Golf Tournament; State Association meeting; SDA and ETA elections; Certification Examinations; Satellite Trade Show, and more.

One event that is of special interest to any small business operator is the July 9th Business Management School.

The BMS runs from 9 a.m. to 5 p.m. Four other events will be occurring that same day, but this one may be the key to solving daily business problems according to ETA/SDA.

The objective of the BMS is to provide sales and service dealers with management tools needed to:

- improve the bottom line of the financial statement.
- to reduce the suffocating pressures of running a business.
- gain the confidence to establish prices and policies that will lead to success.

The 7 hour-long sessions are titled as follows:

- critical P&L/balance sheet ratios - easy ways to understand your financial accounting.
- productivity - know your own, and your technicians productivity. Learn how to overcome low efficiency.
- pricing service at a profit - learn how to set profitable service rates, and to be able to defend them.
- profit from a professional business image.

The Clarion Hotel, New Orleans French Quarter, is the location of the 1992 SDA/ETA convention. Members and nonmembers alike are invited to attend. ■

## SUBSCRIBE NOW & SAVE

One Year - \$24 (12 issues)

Two Years - \$40 (24 issues)

Send check or money order to:

CQ Communications  
76 North Broadway  
Hicksville, NY 11801

Or pay by Credit card (VISA, Mastercard, AMEX). FAX your order to CQ Communications 516-681-2926

# Readers' Exchange

Reader's Exchange has been reinstated as a free service.

The following restrictions apply to Reader's Exchange:

- Only individual readers may use Reader's Exchange, and items must be restricted to those that are ordinarily associated with consumer electronics as a business or hobby. If you're in business to sell the item(s) you want to offer for sale, the appropriate place for your message is in a paid advertisement, not Reader's Exchange.

- Readers Exchange items must be restricted to no more than three items each for wanted and for sale, and may be no more than approximately four magazine column lines in length (about 20 words).

Send your Reader's Exchange submissions to:

**Reader's Exchange**  
**Electronic Servicing & Technology**  
 76 N. Broadway  
 Hicksville, NY 11801

## FOR SALE

Dual trace delayed sweep 40 MHz scope. Works perfect 9 mos old. Factory warranty for one year. \$400.00, COD OK. *Ray Dorsner 509 Main Street Windsor, CT 80550 303 686-7204.*

Heath EE3201 three volume digital techniques course with audio tapes, components and trainer \$250.00. Also complete NRI audio and video VCR course with VHS training tapes and trainer \$250.00. Complete audio and video servicing equipment including Sencore test equipment, reference material Profax and photofacts, \$5000.00. *Call William Stiles 412 676-5236.*

Photofacts over 1,000 folders; numbers 400-1600 \$300.00 or best offer plus shipping. *AI's Radio and TV 432 Trinity Ave. Trenton, NJ 08619 609 587-6454.*

TV shop owner retiring. Send large SASE for tube and test equipment list. Complete set Riders TV manuals best offer. Box of new transistors. B&K 470B \$160.00 - 1461 oscilloscope \$190.00. Some antique number tubes \$9.00 each. *Maurer TV 29 South Street 4th Street Lebanon, PA 17042 717 272-2481.*

Panasonic tuner assembly complete with harness, on-off volume control antenna terminals (TJB 721601J) tuners TNT 7654 and TNK 36121 w/knobs for model CTF 1900 \$40.00 plus COD. CM "Chuck" Kelly 708-623-2597.

Sencore ST65 stereo TV adder used twice. \$450.00 or B.O. LC75 cap meter with SCR250 like new \$595 or B.O. *Marc Derkrikorian 603-434-0041.*

Sencore VA62 with VC63, NT64 and accessory jack expander, \$2500.00; SC61 scope, \$2500; LC10ZZ, \$1000.00. All one year old. Exc. cond. *Call 814-342-1014 after 5pm.*

Old time radio-TV dealer retiring. Send large SASE tube and test equipment lists. B&K 520B transistor checker \$160.00. B&K 1461 oscilloscope \$180.00 RCA Senior Voltomyst - \$90.00 all with manuals plus shipping. Old Riders television service manual - best offer. *Maurer TV 29 South 4th Street Lebanon, PA 17042 717 272-2481.*

Datapulse model 110B generator \$300.00. Leader LHC-909 video head checker \$50.00 PROM multi programmer model M64 \$270.00. *Lien Nguyen 2373 Pruneridge Ave., Santa Clara, CA 95050 408 241-5420.*

Retiring. Complete Sencore video servicing bench including new Sencore VC93; refurbished VA62 & SC61 (10/91). *Dave Lafave 33539 Hansville Rd. Kingston, WA 98346.*

Sencore VA62 Universal Video Analyzer. Seldom used \$1500. 713 363-9278 after 6pm CST. *CM Corner 208 Cashwood Dr. Spring, TX 77386 713 363-9728.*

TVRO Sales-Service & 35+ brand service center available (Owner financing/lease possible). Send SASE for info to: *Better Reception 2471 Montpelier Rd. Columbia, KY 42728. No calls!*

## Manufacturers Parts and Literature Directory

This monthly section is sponsored by manufacturers to help you find the parts and technical literature needed to service their equipment. Call them for replacement parts or for the name of their nearest distributor.

<p><b>Hitachi Home Electronics</b>                      401 W. Artesia Blvd.                      Compton, CA 90220                      800-HITACHI</p>	<p><b>Mitsubishi Electronics America</b>                      5757 Plaza Drive                      Cypress, CA 90630                      800-553-7278 fax 800-825-6655</p>	<p><b>Panasonic</b>                      50 Meadowlands Parkway                      Secaucus, NJ 07094                      800-545-2672</p>
<p><b>Philips ECG</b>                      1025 Westminister Drive                      Williamsport, PA 17701                      800-526-9354 fax 800-346-6621</p>	<p><b>Quasar</b>                      50 Meadowlands Parkway                      Secaucus, NJ 07094                      800-545-2672</p>	<p><b>Technics</b>                      50 Meadowlands Parkway                      Secaucus, NJ 07094                      800-545-2672</p>
<p><b>Thomson Consumer Electronics</b>                      2000 Clements Bridge Road                      Deptford, NJ 08096                      800-257-7946 fax 800-524-1498</p>	<p><b>Zenith Electronics Corp.</b>                      1900 N. Austin Avenue                      Chicago, IL 60634                      312-745-2000</p>	<p><b>Call Jonathan Kummer at                      516-681-2922 to reserve                      space in this special section.</b></p>

Classified advertising is available by the word or per column inch.

**By-the-word:** \$1.65 per word, per insertion, pre-paid. Minimum charge is \$35 per insertion. Initials and abbreviations count as full words. Indicate free category heading (For Sale, Business Opportunities, Miscellaneous, Wanted). Blind ads (replies sent to ES&T for forwarding) are \$40 additional. No agency discounts are allowed for classified advertising by the word. Contact Emily Kreutz at 516-681-2922 to place your classified ad (by-the-word). Or send your order, materials and payment to Emily Kreutz, Electronic Servicing & Technology, 76 North Broadway, Hicksville, NY 11801. Per Column Inch (Classified Display): \$235 per column inch, per insertion, with frequency discounts available. 1" minimum, billed at 1/4" increments after that 10" maximum per ad. Blind ads are \$40 additional. Reader Service Number \$25 additional to cover processing and handling costs. (Free to 4-inch or larger ads.) For more information regarding classified display advertising please contact Jonathan C. Kummer at 516-681-2922. Optional color (determined by magazine) \$150 additional per insertion.

## FOR SALE

**THE ONLY ANSWER TO REPAIRING ELECTRONICS PROFITABLY** (This should have been done years ago) **GET SMART!** Someone somewhere has already repaired the next job you take in for repair. **YOUR BEST TECHNICIAN**, who you have paid for the experience of learning on your customers, and also the manufacturers required training you have paid him to attend to keep your authorized status, just left with all that invested knowledge and ability. **YOU'RE THE BOSS** and now you have put on your rusty technician's cap and appease customer estimates. **TODAY YOUR BANK** sent you three NSF checks that your customers so graciously gave you, can you collect? **IT'S TAKING YOU LONGER** to assess the repairs and your customers are now coming to collect their units. You promised to give them a free estimate, but you just realized you don't have a schematic or time to do it. **NOW YOU ARE DOING NIGHT REPAIRS** because during store hours the phone rings off the hook with nuisance questions about setting VCR clocks and you have parts to order, bills to pay and service literature to file. **CIRCUIT CITY JUST MOVED IN** and your wife tells you that there never was any money in electronics. **FRIEND!! YOU DEFINITELY HAVE AN EMERGENCY!!** Spend \$350.00 NOW & **SAVE THOUSANDS** Available in print or computer disk or by category with annual updates. Send for DEMO \$15.00. AMEX/MC/VISA & CHECKS, 2 weeks delivery 305-474-2677. Factory service 8614 SR-84, Ft. Lauderdale, FL 33324. 4-92-tfb

**REPAIR MANAGEMENT SOFTWARE:** for IBM PC's. Repair tracking, inventory, reports, billing, maillist, more. Demo disk \$15. CAHILL ELECTRONICS, PO Box 568, Kingston, NH 03848. 603-642-4292 3-92-3t

**PHOTOFACTS:** Folders under #1400, \$5.00. Above #1400, \$7.00, sent same day first class postpaid. A. G. Tannenbaum, P.O. Box 110, East Rockaway, NY 11518. 516-887-0057. 11-91-5t

**COMPUTER AIDED TV/VCR REPAIR SOLUTIONS:** 5 1/4" IBM Compatible disks, 1,000 VCR, Printout \$83, Disks \$72. 5,400 TV, Printout \$135, Disks \$113 (Hardrive). Add to or quick scan by chassis, model and stage. Two solutions pays for it. Electronic Solutions, 407 W. Ave. "N", San Angelo, TX 76903. 3-92-5t

**TV TOUGH DOGS** 300 symptoms and cures. Send \$10.95 to Davis TV, 11772 Old Fashion Way, Garden Grove, CA 92640. 3-92-1t

**VCR HEADACHES?** 500 Most common problems and cures. Printout \$49. 1300 Symptoms and cures. Printout and IBM disc. \$125.00. Guaranteed satisfaction. VCR Tuneup Center, 43 James Avenue, Redwood City, CA 94063 or call 1-800-777-7883. Mastercard and Visa accepted. 3-92-2t

**REDUCED 85%**, Diehl Mark 111 scanner \$79. Diehl Mark V scanner \$199. New. Restore remote control keypads with our conductive coating \$8.99 ppd. WEEC, 2805 University Ave., Madison, WI 53705. 608-238-4629, 608-233-9741. 12-91-tfb

**RETIRED:** Must sell test equipment, SAMS, etc. Please send SASE for listing. Jack B. Williams, 15820 Cornus Road, Clarksburg, MD 20871. 301-428-0674 5-92-2t

**YOUR CONDUCTIVE SOLUTION** Super thin liquid allows effective rejuvenation of rubber conductive pads on remote controls/keypads. Will layer for decreased resistance. Detailed instructions/hints included. \$14.95 MC/Visa. COD add \$4.00. 1-800-742-8165 Ext 10. 6-92-2t

**HEAVY DUTY REPAIR TIPS MANUALS.** Stereos-cassette \$5, TVs \$20, VCRs \$25. All 3 \$40. Berge Systems, Unit 342-ES, 253 College, Toronto, Ontario, Canada, M5T 1R5. 6-92-1t

**USED VCR'S.** All or parts. Copies of VCR service manuals. RCA Torque Gauge. Part #144396. New! \$200. VCR Doctor 6145 Watt Avenue, North Highlands, CA 95660. 1-916-348-6409. 6-92-1t

**VHS-VCR Repair Solution Sets I, II, III, IV, V, VI, VII.** Each contains 150 symptoms and cures, updated cross reference chart, free assistance, \$11.95 each, all seven \$69.95. Schematics available. Visa/MC. Eagle Electronics, 52053 Locks Lane, Granger, IN 46530. 6-92-7t

## BUSINESS OPPORTUNITIES

**MOVE TO SUNNY FLORIDA - GREAT DEAL!** In Hollywood Florida there is a 34 year old TV shop for sale. Great location with an excellent reputation. The selling price is \$25,000. It includes inventory and equipment. For an even better business deal, the property is also for sale. For information, call 305-927-3990. Ask for Mike or Debbie 5-92-2t

**TELEVISION SALES AND SERVICE** In sunny southwest Florida. 15 years same location. Computerized client list, full technical library, paper and microfilm. 3,200 square feet available on busy U.S. 41. Authorized Zenith, Sony and Philips lines. A steal at \$50,000. Retiring. E. Rabell, 103 SW Peckham Street, Port Charlotte, FL 33952. 813-629-2440, evenings 813-629-5246. 6-92-1t

**BUSY PROFITABLE WELL ESTABLISHED** Audio/Video repair shop located center booming north county coast of San Diego County. Well equipped shop, Sencore-Tek-Fluke-Pace-etc. Business is up forth year in row and second location would be good business. Contact Peter at 619-944-9048 or FAX 619-944-0345. 6-92-1t

**TV VCR SERVICE** near new pier and ocean. Oldest shop in Huntington Station California. Retiring. Can help you get started. 714-846-1591. 6-92-1t

## WANTED

**H.H. SCOTT:** 222C power transformer. Also pre 1950 radios and TVs. Jon Kummer, 23-35 Bell Blvd, Bayside, NY 11360. 718-428-9070. 3-92-1fb

**1950's TRANSISTOR RADIOS:** with civil defense markings brought! Paying \$25-\$500. Harry Poster, Box 1883, So. Hack., NJ 07606. 201-794-9606 Before 7 pm 5-92-3t

## MISCELLANEOUS

**CAMCORDER REPAIR:** Don't turn away good profits let our experienced technicians provide your shop with complete camcorder repair service. Also, VCR, "Tough Dogs." Call 1-800-846-4648. Edlington VCR/TV, 204 North Kimble Drive, Bloomington, IN 47404. 10-91-6t

# Readers' Exchange

## WANTED

Schematic for Curtis Mathes VCR model-KV729. Voltage tripler (ECXB 1028) for Panasonic color TV model CT-398A. Joe Wallace, 1485 Rock Island Ln. Las Vegas, NV 89110 702 459-9017.

Signal generator made in the 1960's by Don Bosco Electronics. Called the mosquito resembled large silver fountain pen. Used in tube radio work. Harry W. Hughes HCR31 Box 241 Sandy Valley, NV 89019 702 723-5472.

Schematic for Goldstar Radio/Cassette player, model TSR-911. Robert Miller Rt 1, Box 223, Anadarko, OK 73005.

Any info on Sony TC-580 reel tape deck and on a Sony SQ100 Amp. Diagrams or trouble shooting hints. Would be very helpful. Dan's TV 316 East E. Hutchinson, KS 67501 316 665-5901.

Used VCR remote controls, Panasonic flyback #TLF 14712F. Ed Herbert 410 N. Third Street., Minersville PA 17954.

Oscilloscope, Hitachi V-509, or Tek 321/A. Mary Lofiness, 115 West 20th Ave, Olympia, WA 98501 206 357-8336.

Output transformer for Harmon Kardon model A224 Tri-Plex stereo amplifier. Old P/N FT 2362704, new P/N 10512704. Fred Vanpala 11 Sperry Street Milford, CT 06460 203 877-3038.

Electronic tuner for JVC TV model #C1950. Part -An7572EP-AO3,4. Peter Stoessler 590 Englishtown Rd., Old Bridge, NJ 08857 908 723-0075.

H.H. Scott VCR model -SVR100; part #T948B072-8 and power push-button. Needed now! Please reply 916 836-1749 Simpler Electronics. (Leave message).

Zenith tuner #175-2214-50 - state price. M.E. Andrews P.O. Box 91, Exeter, RI 02022.

Schematic service info on Kenwood model DP-840 CD player. David Suodth 2418 Shady Lane #19, Gladstone, MO 64118 816 454-6783.

Service info for Sharp CD player DX650 (BK) and Marta MVR2000 VCR. John Pipp's 1412 Navaho Trail St. Charles, MO 63304.

Yoke assy for CK3000 Sylvania test jig. Ralph Bianco 1431 Robinson Ave Havertown, PA 19083 215 446-4519.

Schematic for cosmo cordless telephone model TR-3008. Also basket and handunit for Mitsubishi VCR Model HS-3283UR. Brackeen TV 3905 Stateline, Texarkana, TX 75503 903 792-0021.

Schematic for Sanyo model 91C50. Model 91C50N will not work. Ernst Jones 1204 Bond St. Kinston, NC 28501 919 523-4654.

Picture tube A-48 JKL60X. Donald Stevens, 1005 N. Brookfield, South Bend IN 46628. 219 233-3746.

A 45rpm adapter (automatic) for dual turntable #1225. Ted D. Miller 1201 S. Linden St. Normal, IL 61761.

## TUBES • TUBES • TUBES

World's Largest Range

Over 2,000 Types, Domestic & Foreign

**UP TO 85% OFF** Ask for price list

International Components Corporation

Toll Free 800-645-9154 • N.Y. State 516-293-1500  
105 Maxess Road, Melville, New York 11747

Circle (3) on Reply Card

## ANTIQUA RADIO CLASSIFIED

**Free Sample!**

Antique Radio's

Largest Circulation Monthly.

Articles, Ads & Classifieds.

Also: 40's & 50's Radios, Ham Equip., Early TV, Books & more. *Free 20-word ad each month.*

6-Month Trial: \$15. 1-Yr: \$27 (\$40-1st Class).  
A.R.C., P.O. Box 802-C12, Carlisle, MA 01741



## THE SOURCE . . . for quality Electronic Parts & Accessories.

"We'll get your parts to you as fast as you need them!"

Call today and ask about our **PREMIUM DELIVERY** and for your **FREE** copy of our catalog . . .

**1-800-558-9572**

or for 24 hour ordering call FAX 414-473-4727

"First in Quality, Service and Delivery"



P.O. Box 28 • Whitewater, Wisconsin 53190

Circle (10) on Reply Card

Tech's  
Guide  
To  
Pricing

**"Sperry Tech's Pricing Guide"**

Updated new 6th edition... a framework for setting rates that apply to Hi-Tech products... a formula that guarantees SUCCESS!

Call Toll Free for details  
1-800-228-4338

Circle (12) on Reply Card

# SAVE TIME

*For fast, accurate service, please remove the peel off label used to address your magazine, and attach it to the Reader Service Card, the Address Change Card or to any correspondence you send us regarding your subscription.*

## Advertisers' Index

Company	Page Number	Reader Service Number	Advertiser Hotline
Anatek Corporation . . . . .	51	1 . . . . .	800/999-0304
Antique Radio Classified . . . . .	60	. . . . .	506/371-0512
C & S Sales . . . . .	IBC	81 . . . . .	800/292-7711
Electronix, Inc. . . . .	16	15 . . . . .	800/223-3205
Fox International . . . . .	53	2 . . . . .	800/321-6993
Hitachi Home Electronics . . . . .	59	. . . . .	800/545-2672
Iscet . . . . .	12	. . . . .	817/921-9101
International Components Corporation . . . . .	60	3 . . . . .	800/645-9154
Leader Instruments . . . . .	3	32,33 . . . . .	800/645-5104
MCM Electronics . . . . .	38	4 . . . . .	800/543-4330
Matshushita Services . . . . .	19	5 . . . . .	. . . . .
Mitsubishi Electronics America . . . . .	59	. . . . .	800/553-7278
NESDA . . . . .	51,56	. . . . .	817/921-9061
PTS Corporation . . . . .	7	6 . . . . .	812/824-9331
Panasonic . . . . .	59	. . . . .	800/545-2672
Parts Express . . . . .	12	7 . . . . .	513/222-0173
Philips ECG . . . . .	11,59	8,9 . . . . .	800/526-9354
Premium Parts + . . . . .	60	10 . . . . .	800/558-9572
Quasar . . . . .	59	. . . . .	800/545-2672
Russell Industries, Inc. . . . .	38	11 . . . . .	800/645-2202
Sencore . . . . .	IFC,BC	20,34 . . . . .	800/SEN-CORE
Sperry Tech . . . . .	60	12 . . . . .	800/228-4338
Technics . . . . .	59	. . . . .	800/545-2672
Tentel . . . . .	47	13 . . . . .	800/538-6894
Thomson Consumer Electronics . . . . .	59	. . . . .	800/257-7946
Viejo Publications . . . . .	51	14 . . . . .	800/537-0589
Zenith Electronic Corporation . . . . .	59	. . . . .	312/745-2000

We'd like to see your company listed here too. Contact Jonathan C. Kummer to work out an advertising program tailored to suit your needs.

### SALES OFFICE

THE MAGAZINE FOR CONSUMER ELECTRONICS SERVICING PROFESSIONALS  
**ELECTRONIC**  
Servicing & Technology

76 North Broadway  
Hicksville, NY 11801  
(516) 681-2922  
FAX: (516)681-2926

**Jonathan Kummer**  
Advertising Manager

**Emily Kreutz**  
Sales Assistant

### To Order Back Issues

Send \$3.50 Per Issue (Check, Money Order, Mastercard, VISA, And AMEX).

Send All Correspondence To:  
**CQ Communications**  
76 North Broadway  
Hicksville, NY 11801  
**516-681-2922**

48 HOUR SHIPPING

# ELENCO & HITACHI PRODUCTS AT DISCOUNT PRICES

TO ORDER  
CALL TOLL FREE  
1-800-292-7711  
1-800-445-3201 (Can.)

## Hitachi RSO Series

(Portable Real-time Digital Storage Oscilloscopes)  
VC-6023 - 20MHz, 20MS/s \_\_\_\_\_ \$1,695  
VC-6024 - 50MHz, 20MS/s \_\_\_\_\_ \$1,995  
VC-6025 - 50MHz, 20MS/s \_\_\_\_\_ \$2,195  
VC-6045 - 100MHz, 40MS/s \_\_\_\_\_ Call  
VC-6145 - 100MHz, 100MS/s \_\_\_\_\_ Call

RSO's from Hitachi feature roll mode, averaging, save memory, smoothing, interpolation, pretriggering, cursor measurements. These scopes enable more accurate, simpler observation of complex waveforms, in addition to such functions as hardcopy via a plotter interface and waveform transfer via the RS-232C interface. Enjoy the comfort of analog and the power to digital.

## 25MHz Elenco Oscilloscope



**\$349**  
S-1325

- Dual Trace
- 1mV Sensitivity
- 6" CRT
- X-Y Operation
- TV Sync

• (2) 1x, 10x Probes included

All scopes include probes, schematics, operators manual and 3 year (2 yrs for Elenco scopes) world wide warranty on parts & labor. Many accessories available for all Hitachi scopes. Call or write for complete specifications on these and many other fine oscilloscopes. **1x, 10x Scope Probes: P-1 65MHz \$17.95, P-2 100MHz \$21.95**

## SPECIAL BUY

V-212 - 20MHz Scope **\$409**

## Hitachi Portable Scopes

DC to 50MHz, 2-Channel, DC offset function, Alternate magnifier function

V-525 - CRT Readout, Cursor Meas. \$995  
V-523 - Delayed Sweep \$975  
V-522 - Basic Model \$875  
V-422 - 40MHz \$775  
V-223 - 20MHz delayed sweep \$695  
V-222 - 20MHz deluxe \$625

## PRICE BREAKTHRU

20MHz Digital Storage Oscilloscope

• Analog/Digital Scope  
• 2K word per channel memory **DS203 \$775**  
• 10MS/s sampling rate  
• State-of-art technology  
• Includes probes  
S-1360 60MHz Delay Sweep **\$775**

## HITACHI COMPACT SERIES SCOPES

This series provides many new functions such as CRT Readout, Cursor measurements (V-1085/1065A/665A), Frequency Ctr. (V-1085), Sweeptime Autoranging, Delayed sweep and Trigger Lock using a 6-inch CRT. You don't feel the compactness in terms of performance and operation.

V-660 - 60MHz, Dual Trace \_\_\_\_\_ \$1,149  
V-665A - 60MHz, DT, w/cursor \_\_\_\_\_ \$1,345  
V-1060 - 100MHz, Dual Trace \_\_\_\_\_ \$1,395  
V-1065A - 100MHz, DT, w/cursor \_\_\_\_\_ \$1,649  
V-1085 - 100MHz, QT, w/cursor \_\_\_\_\_ \$1,995  
V-1100A - 100MHz, Quad Trace \_\_\_\_\_ \$2,195  
V-1150 - 150MHz, Quad Trace \_\_\_\_\_ \$2,695

## Elenco 40MHz Dual Trace



Good to 50MHz **\$495**  
S-1340

- High luminance 6" CRT
  - 1mV Sensitivity
  - 10KV Acceleration Voltage
  - 9ns Rise Time
  - X-Y Operation
- Includes (2) 1x, 10x Probes

## Digital Capacitance Meter



CM-1550B  
**\$58.95**  
9 Ranges  
1pf-20,000uF  
5% basic acy.  
Zero control w/ Case  
Big 1" Display



## Digital Multimeter

with Inductance & Capacitance  
**\$75.00**  
LCM-1850  
Ten Functions



## Multimeter with Capacitance & Transistor Tester

**\$55** CM-1500B  
Reads Volts, Ohms  
Current, Capacitors,  
Transistors and  
Diodes / with case

## FLUKE MULTIMETERS

Scopemeters	(All Models Available Call)
Model 93	\$1,095.00
Model 95	\$1,395.00
Model 97	\$1,695.00
10 Series	
Model 10	\$62.95
Model 12	\$79.95
70 Series	
Model 70II	\$65.00
Model 77II	\$145.00
Model 79II	\$169.00
80 Series	
Model 87	\$289.00

## B + K

TEST EQUIPMENT  
All Models Available

Call for special price

## Soldering Station Temperature Controlled



SL-30 \$99  
Digital Display  
Temp Range:  
300F-900F  
Grounded Tip  
Overheat Protect

## Video Head Tester



HT-200  
**\$44.95**  
Tells you if VHS head is defective or worn. A must for VCR work

## COMPUTER INTERFACE TRAINER



XK-450  
**\$139.95**  
Convert your IBM PC/XT or compatible computer into a trainer

## Color Convergence Generator



SG-250  
**\$89.95**  
Kit \$69.95  
Finest in the industry  
10 rock steady patterns  
RF & Video output

## Quad Power Supply XP-580



**\$69.95**  
2-20V @ 2A  
12V @ 1A  
5V @ 3A  
-5V @ .5A

Fully regulated and short circuit protected

## Digital Triple Power Supply XP-765



**\$289**  
0-20V @ 1A  
0-20V @ 1A  
5V @ 5A

Fully regulated, Short circuit protected with 2 limit control, 3 separate supplies  
XP-660 with Analog Meters **\$195**

## AM/FM Transistor Radio Kit with Training Course

Model AM/FM 108  
**\$26.95**

14 Transistors • 5 Diodes  
Makes a great school project

## True RMS 4 1/2 Digit Multimeter



M-700T  
**\$135**

.05% DC Accuracy  
.1% Resistance with Freq. Counter  
Data Hold

## GF-8016 Function Generator with Freq. Counter



**\$249**

Sine, Square, Triangle Pulse, Ramp, .2 to 2MHz  
Freq Counter, 1 - 10MHz Int/Ext operation

GF-8015 without Freq. Meter **\$179**

## Function Generator Blox



#9600  
**\$28.95**

Provides sine, triangle, square wave from 1Hz to 1MHz  
AM or FM capability

## Learn to Build and Program Computers with this Kit

Includes: All Parts, Assembly and Lesson Manual



Model MM-8000  
**\$129.00**

Starting from scratch you build a complete system. Our Micro-Master trainer teaches you to write into RAMs, ROMs and run a 8085 microprocessor, which uses similar machine language as IBM PC.

## Wide Band Signal Generators



SG-9000 **\$129**

RF Freq 100K-450MHz AM Modulation of 1KHz Variable RF output  
SG-9500 w/ Digital Display & 150 MHz built-in Counter **\$249**

## XK-500 Digital / Analog Trainer

A complete mini-lab for building, testing, prototyping analog and digital circuits. Elenco's Digital/Analog Trainer is specially designed for school projects, with 5 built-in power supplies. Includes a function generator with continuously variable, sine, triangular, square wave forms. All power supplies are regulated and protected against shorts.

Power Supplies **\$149.95 Assembled \$119.95 Kit**

- Variable Power Supply
- +1.25 to 20VDC @ 5 Amp (+1.25 to 15VDC @ 1 Amp)
- -1.25 to -20VDC @ 5 Amp (-1.25 to -15VDC @ 1 Amp)
- +12VDC @ 1 Amp
- -12VDC @ 1 Amp
- +5VDC @ 1 Amp
- 30VAC Center tapped @ 15VAC at 1 Amp

## Analog - Section

- Function Generator Sine, Triangular, Square wave forms
- Frequency adjustable in five ranges from 1 to 100KHz
- Fine frequency adjust
- Amplitude adjust
- OC offset
- Modulation FM-AM

## Digital - Section

- Eight data switches
- Two no bounce logic switches
- 8 LED readouts TTL buffered
- Clock frequency 1 to 100KHz
- Clock amplitude 5VPP square wave

## Breadboards

- 2 breadboards, each contain: 840 tie points (total 1,680)



**\$149.95 Assembled \$119.95 Kit**

WE WILL NOT BE UNDERSOLD

UPS SHIPPING: 48 STATES 5%  
IL RES 7.5% TAX (\$3 min \$10 max)  
OTHERS CALL

C&S SALES INC.

1245 ROSEWOOD, DEERFIELD, IL 60015  
FAX: 708-520-0085 • (708) 541-0710



15 DAY MONEY BACK GUARANTEE

2 YEAR WARRANTY

WRITE FOR FREE CATALOG

Circle (81) on Reply Card

# Introducing The Only Complete Solution For All Your Monitor Servicing Needs!

**Completely Test And Troubleshoot All High Resolution And Multi-Scan Computer Monitors From The Input Connector To The CRT . . . Guaranteed!**

Here's What The CM2000 Offers You:

- Complete High Resolution Monitor Analyzing
- Fully Programmable Scan Rate And Pixel Resolution
- Innovative Performance Testing Patterns
- Special Sync-Locked Substitution Signals
- Patented "Ringer" Test To Dynamically Analyze All:
  - Yokes
  - IHVTs/Flybacks
  - Switching X-formers
- Integrated 2,000 DCV And P-P Meter
- Exclusive "Hook-up" Adapters Available
- Portable For All Your Field Service Needs

*New!*



**CM2000 Computer Monitor Analyzer**  
Patented - A Sencore Exclusive!

**Call 1-800-SENCORE**  
ext. 537 (736-2673)

**SENCORE**

3200 Sencore Drive, Sioux Falls, South Dakota 57107

Circle (93) on Reply Card